

The
Significance
of
Evidence-based Reasoning
for
Mathematics
Mathematics Education
Philosophy
and the
Natural Sciences

*Distinguishing between what is believed to be true, what can be
evidenced as true, and what ought not to be believed as true*

Second Edition (Draft)

BHUPINDER SINGH ANAND

MUMBAI

Let not posterity view us as having spent the gift of life polishing the pebbles, and tarnishing the diamonds.
... *Anonymous*

If it is not worth doing, it is not worth doing well.
... *Daniel C. Demett*

The Significance of *Evidence-based* Reasoning in Mathematics, Mathematics Education, Philosophy, and the Natural Sciences

Distinguishing between what is believed to be true, what can be evidenced as true, and what ought not to be believed as true

In this multi-disciplinary investigation, we address the philosophical challenge that arises when an intelligence—whether human or mechanistic—accepts arithmetical propositions as true under an interpretation—either axiomatically or on the basis of *subjective* self-evidence—*without* any specified methodology for *objectively* evidencing such acceptance.

We then show how an *evidence-based* perspective of *quantification* in terms of:

- algorithmic *verifiability*, and
- algorithmic *computability*

admits *evidence-based* definitions of:

- *well-definedness*, and
- *effective computability*.

We further show how such a perspective yields two, unarguably *constructive*, interpretations of the first-order Peano Arithmetic PA—over the structure \mathbb{N} of the natural numbers—that are *complementary*, not *contradictory*:

- The first yields the *familiar*, standard, *weak* interpretation $\mathcal{I}_{PA(\mathbb{N}, SV)}$ of PA over \mathbb{N} :
 - which is *well-defined* with respect to assignments of algorithmically *verifiable* Tarskian truth values to the formulas of PA under $\mathcal{I}_{PA(\mathbb{N}, SV)}$;
 - and thus constitutes a constructively *weak* proof of consistency for PA.
- The second yields the *hitherto unsuspected*, finitary, *strong* interpretation $\mathcal{I}_{PA(\mathbb{N}, SC)}$ of PA over \mathbb{N} :
 - which is *well-defined* with respect to assignments of algorithmically *computable* Tarskian truth values to the formulas of PA under $\mathcal{I}_{PA(\mathbb{N}, SC)}$;
 - and so constitutes a constructively *strong* proof of consistency for PA.

We situate our investigation within a broad analysis of *quantification* vis à vis:

- | | |
|---|--|
| • Hilbert's ε -calculus | • Gödel's ω -consistency |
| • The Law of the Excluded Middle | • Hilbert's ω -Rule |
| • An Algorithmic ω -Rule | • Gentzen's Rule of Infinite Induction |
| • Rosser's Rule C | • Markov's Principle |
| • The Church-Turing Thesis | • Aristotle's particularisation |
| • Wittgenstein's constructive mathematics | • <i>Evidence-based</i> quantification |

By showing how these are formally inter-related, we highlight the fragility of both:

- the persisting, *theistic*, classical/Platonic interpretation of quantification grounded in Hilbert's ε -calculus;
- the persisting, *atheistic*, constructive/Intuitionistic interpretation of quantification rooted in Brouwer's *mistaken* belief that the Law of the Excluded Middle is non-finitary.

We then consider some consequences for mathematics, mathematics education, philosophy, and the natural sciences, of an *agnostic*, *evidence-based*, finitary interpretation of quantification which challenges classical paradigms in all these disciplines, and illuminates:

- | | |
|--|--|
| • <i>Why</i> Fermat's Last Theorem is <i>pre-formally</i> true | • <i>Why</i> the Four Colour Theorem is <i>pre-formally</i> true |
| • <i>Why</i> $P \neq NP$ is <i>pre-formally</i> true | • <i>Why</i> PA is categorical |
| • <i>Why</i> ZF admits Goodstein's Theorem | • <i>Why</i> PA may <i>not</i> admit Goodstein's Theorem |
| • <i>Why</i> Dirichlet's Theorem is true | • <i>Why</i> there are an infinity of twin primes |

BHUPINDER SINGH ANAND *The author is an independent researcher reviewing classical interpretations of Cantor's, Gödel's, Tarski's and Turing's reasoning, and addressing some grey areas in the foundations of mathematics, logic, philosophy and computability.*

2010 Mathematics Subject Classification. 03B10

[Also: 00A30; 00A35; 03A05; 03B42; 03B70; 03C35; 03C57; 03C62; 03D10; 03D20; 03F03; 03F25; 03F30; 03F40; 03F50; 03F55; 03F60; 03F65; 03H15; 11A41; 11A51; 68Q05; 68Q15; 68Q55; 68T15; 68T27; 81P05; 81P10; 97C30; 97C50; 97D20; 97E20; 97E30; 97E40]

Bhupinder Singh Anand

Author

#1003 Lady Ratan Tower

Dainik Shivner Marg

Gandhinagar, Upper Worli

Mumbai - 400 018

Maharashtra, INDIA

email: bhup.anand@gmail.com

©Bhupinder Singh Anand 2021

This publication is in copyright. Subject to statutory exception and to the provisions of relevant collective licensing agreements, no reproduction of any part may take place without the written permission of the publisher.

This book is sold subject to the condition that it shall not, by way of trade or otherwise, be lent, resold, hired out, or otherwise circulated without the publisher's prior written consent in any form of binding or cover other than that in which it is published and without a similar condition including this condition being imposed on the subsequent purchaser and, without limiting the rights under copyright reserved above, no part of this publication may be reproduced, stored in or introduced into a retrieval system, or transmitted in any form or by any means (electronic, mechanical, photocopying, scanning, recording or otherwise), without the prior written permission of both the copyright owner and the above-mentioned publisher of this book.

First published: 2021

(First edition commemorates UNESCO's 2nd World Logic Day, 14 January 2020.)

Second edition (Draft)

ISBN:

The publisher has no responsibility for the persistence or accuracy of URLs for external or third-party internet websites referred to in this publication, and does not guarantee that any content on such websites is or will remain, accurate or appropriate.

Printed at:

Published by:

Dedicated

To the shoulders of Giants, with gratitude from one who has been privileged a life-time prancing on the shoulders of some—occasionally indulgent, more often long-suffering—Giants.

Bernard of Chartres used to say that we are like dwarfs on the shoulders of giants, so that we can see more than they, and things at a greater distance, not by virtue of any sharpness of sight on our part, or any physical distinction, but because we are carried high and raised up by their giant size.

... John of Salisbury: Metalogica, 1159.

To my son Ari, and particularly my wife Dharini, whose courage, fortitude, selflessness and irrepressible good humour in the face of overwhelming adversity continue to inspire me.

The heaviest burden a scholar carries is that of being right for the wrong reason.

. . . Anonymous

You cannot reason a person out of a position he did not reason himself into in the first place.

. . . Jonathan Swift

"Whereof one cannot speak, thereof one must be silent."

... Ludwig Wittgenstein: [Wi22], p.90.

Author's Preface (Second Edition)

This investigation seeks to caution about the consequences, and dangers, of preferring *knowledge as intuitively justified true belief* over Piccinini's *knowledge as factually grounded (evidence-based) belief*, in an age of *alternative facts* (whose social and political ramifications were starkly highlighted by the unprecedented influence, and power, of an emergent, and unbridled, *social media* in the global responses to the 2020 COVID 19 pandemic) for which we—at least those of my ilk and generation (born circa 1940)—must shoulder the main responsibility.

Dangers we may have unknowingly *belittled*—even if not *denied* outright—and counter-intuitive consequences we may have not only uncritically *welcomed*, but passionately *nurtured* in our schools and universities, post Cantor, by assuming in classical mathematics, logic, philosophy, and the natural sciences, that the *unspecified* can be treated as *specifiable* without supporting *evidence*.

For the far-reaching significance of the qualification '*unspecified*' see, for instance, §7., Definition 20; §8.G., Lemma 8.20; §8.G., Corollary 8.21; §15.H.h.; §15.H.j.; also §2., Definition 8.

Moreover the—arguably, misleading if not false—consequences of such a 'faith-based' philosophy are highlighted in Section 5., 'Three fragile Hilbertian, Brouwerian, and Gödelian, dogmas'.

The challenge is thus that of accommodating intuitively justified true beliefs, in what philosopher Markus Pantsar calls *pre-formal mathematics*, in order to *arrive* at factually grounded (evidence-based) beliefs in our usual systems of *formal mathematics*; beliefs which can then be treated as *knowledge* within a well-defined community only if they can, first, be interpreted under Tarski's definitions of the satisfaction, and truth, of the formulas of a formal language under a well-defined interpretation as corresponding to our intuitively justified true beliefs, *and*, second, categorically communicated *within* the community.

The point is emphasised further in the second edition by the inclusion of *evidence-based (essentially pictorial) pre-formal* proofs of Fermat's Last Theorem (§1.F.), the Four Colour Theorem (§1.I.), and the P ν NP problem (§4.), which aim to illustrate why each proposition can be treated as a true arithmetical proposition that, when formalised appropriately, would be provable in a categorical first-order mathematical language.

Fittingly, *ALL* the argumentation and formal conclusions in this book (see §30.) follow from just *one*—seemingly trivial—distinction, between algorithmic *verifiability* and algorithmic *computability*, formalised in the paper: *The truth assignments that differentiate human reasoning from mechanistic reasoning: The evidence-based argument for Lucas' Gödelian Thesis*, which appeared in the December 2016 issue of *Cognitive Systems Research*.

Specifically, this investigation seeks to distinguish between what is believed to be true, what can be evidenced as true, and what ought not to be believed as true, in the foundations of mathematics, philosophy, and the natural sciences.

Accordingly, where authors have unequivocally stated what they believe to be true, I have (not invariably) preferred quoting short passages—from their works—which I see as either illuminating, or being illuminated by, the evidence-based perspective of this investigations.

Where, however, authors have not explicitly stated their beliefs concerning the subject matter, and/or where their works seem to me relevant to the evidence-based perspective of this investigation, I have preferred to quote—often at considerable length—passages with minimum comment and/or interpretation, in order to minimise inadvertently misrepresenting what the authors may believe to be true.

This investigation is intended (as I relate in the concluding paragraphs of the Acknowledgments section of the Appendices) to be a personally—not professionally—motivated intellectual *foray*, rather than a definitive scholarly *exposition*, seeking to identify what I believe can be evidenced, beyond mere justifiable belief, as factually grounded 'knowledge' of selected issues. I have not—at least not wittingly—attempted, nor am I equipped (since, as a non-institutional scholar, I have lacked access to academic libraries) or competent, to do justice to all I have quoted by attempting to interpret and present a balanced perspective of how academicians, and other equally respected scholars, perceive the subject matter.

Bhupinder Singh Anand

Mumbai
July 7, 2024

Contents

I	INTRODUCTION	18
1.	The Complementarity Thesis	23
1.A.	Pre-formal mathematics	26
1.B.	Logic as a methodological tool	36
1.C.	The foundational significance of the Complementarity Thesis and of <i>evidence-based</i> reasoning	40
1.D.	The significance of <i>pre-formal, evidence-based</i> (pictorial) proofs for $P \neq NP$, Fermat's Last Theorem, 4CT	44
1.E.	Prologue: A 'Disembodied' Proof of FLT (A <i>fictional, pre-formal, narrative</i>)	48
1.E.a.	When is $x^2 + y^2 = z^2$ solvable for $x, y, z \in \mathbb{N}$?	48
1.E.b.	Why $x^3 + y^3 = z^3$ is <i>not</i> solvable for $x, y, z \in \mathbb{N}$	49
1.E.c.	Why $x^p + y^p = z^p$ is <i>not</i> solvable for $x, y, z \in \mathbb{N}$ and any prime $p > 2$	50
1.F.	An <i>evidence-based</i> (pictorial), <i>pre-formal</i> , proof of Fermat's Last Theorem	51
1.F.a.	Could <i>this</i> have been Fermat's <i>Lost Insight</i> ?	54
1.F.b.	Could <i>this</i> have been Fermat's <i>Lost Argument</i> ?	56
1.F.c.	Could this be viewed <i>pre-formally</i> as a 'truly marvelous proof' of Fermat's Last Theorem?	58
1.F.d.	Why is $x^n + y^n = z^n$ solvable for $n = 2$, but not for $n = 3$	64
1.F.e.	Conclusions: Fermat's <i>Lost Argument</i>	65
1.F.f.	Epilogue	65
1.G.	Should Wiles' <i>pre-formal</i> proof of FLT be treated putatively as sufficiently <i>formal</i> ?	67
1.G.a.	Resolving the persisting ambiguity in current paradigms on the nature of, and relation between, mathematical <i>truth</i> and mathematical <i>proof</i>	71
1.H.	Could this paragraph be treated as Fermat's Unrecorded 'Proof' of FLT?	75
1.H.a.	Arithmetical interpretation of Fermat's Unrecorded 'Proof' of FLT	75
1.H.b.	Does Fermat's Last Theorem validate string theory?	76
1.H.c.	Fermat's Last Theorem	77
1.H.d.	Does the volume of water obey Fermat's Last Theorem?	77
1.H.e.	Could Fermat's Unrecorded 'Proof' FUP of FLT 'validate' string theories?	78
1.H.f.	The epistemological status of Fermat's Last Theorem	78
1.I.	<i>Evidence-based</i> (pictorial), <i>pre-formal</i> , proofs of the Four Colour Theorem	79
1.I.a.	A historical perspective	80
1.I.b.	Two <i>pre-formal</i> proofs of the 4-Colour Theorem	82
1.I.c.	A formal, <i>computer-independent</i> , proof of 4CT	86
1.I.d.	The perceived 'flaw' in Kempe's 1879 argument	89
1.I.e.	Could there be an <i>unperceived, inherited, 'flaw'</i> in Appel and Haken's argument?	90
1.I.f.	Why the <i>geometrical</i> proof of 4CT may not be expressible <i>graphically</i>	92
1.I.g.	Theorem 1.10 vis à vis Kempe's argument in his 1879 'proof'	94
1.I.h.	Why the Four Colour Theorem is <i>true</i> by Fermat's Infinite Descent	97
1.J.	Validating knowledge, truth, and proof in <i>pre-formal</i> mathematics	102
1.K.	Pre-formal mathematics as 'culturally appropriate, intuitive explanations'	111
1.L.	What mathematics <i>is</i> , and what it <i>is not</i>	115
1.M.	Conclusions	122
2.	Revisiting an <i>evidence-based</i> paradigm	127
2.A.	Reviewing Tarski's inductive assignment of truth-values under an interpretation	130
2.A.a.	Tarski's inductive definitions	130
2.A.b.	The ambiguity in the classical <i>standard</i> interpretation of PA over \mathbb{N}	131
2.B.	The <i>weak</i> , algorithmically <i>verifiable</i> , standard interpretation $\mathcal{I}_{PA(\mathbb{N}, SV)}$ of PA	132
2.B.a.	The PA axioms are algorithmically <i>verifiable</i> as true under $\mathcal{I}_{PA(\mathbb{N}, SV)}$	132
2.C.	The <i>strong</i> , algorithmically <i>computable</i> , interpretation $\mathcal{I}_{PA(\mathbb{N}, SC)}$ of PA	134
2.C.a.	The PA axioms are algorithmically <i>computable</i> as true under $\mathcal{I}_{PA(\mathbb{N}, SC)}$	134
2.D.	Dissolving the Poincaré-Hilbert debate	136
2.E.	Bridging PA Provability and Turing Computability	139
2.E.a.	Preamble	139

2.E.b. A Provability Theorem for PA	146
2.F. Gödel's ' <i>undecidable</i> ' formula $[\neg(\forall x)R(x)]$ is provable in PA	150
2.F.a. An evidence-based perspective of Lucas' Gödelian argument	152
3. The significance of the Provability Theorem for PA for number theory and computability	154
4. The significance of the Provability Theorem for PA for the P<i>v</i>NP problem	156
4.A. The P <i>v</i> NP problem	157
4.A.a. SAT is not deterministically 'polynomial time'	158
4.B. An implicit ambiguity in the 'official' definition of P	158
4.B.a. The P <i>v</i> NP Separation Problem	160
4.B.b. An arithmetical perspective on the P <i>v</i> NP Separation Problem	162
4.B.c. Why the class NP is not <i>well-defined</i>	163
4.B.d. An <i>evidence-based</i> separation of computational complexity	164
5. Three fragile Hilbertian, Brouwerian, and Gödelian, dogmas	166
5.A. What is knowledge?	167
5.B. A removable ambiguity in Brouwer-Heyting-Kolmogorov realizability	177
5.B.a. Paradigm challenging consequences	177
6. Overview	178

II SOME MATHEMATICAL CONSEQUENCES OF *EVIDENCE-BASED* REASONING 181

7. Both Hilbert's ε-calculus and Brouwer's Intuitionism are fragile	181
7.A. Gödel's ω -consistency too is fragile	184
7.B. <i>Faith-based</i> quantification	186
7.C. <i>Evidence-based</i> quantification	187
7.D. Quantification in constructive mathematics is ambiguous	189
7.E. Where realizability in constructive mathematics is ambiguous	194
7.E.a. Recursive realizability and the Law of the Excluded Middle	198
7.F. Well-definedness	199
7.G. Algorithmically <i>verifiable</i> but not algorithmically <i>computable</i>	200
7.H. The classical Church-Turing Thesis	202
7.H.a. <i>Evidence-based</i> reasoning does not admit the classical Church-Turing Thesis	205
7.H.b. Effective computability and the Church-Turing Thesis	206
7.I. Every (<i>evidence-based</i>) <i>eb</i> -real number is <i>specifiable</i> in PA	209
7.I.a. <i>Evidence-based</i> reasoning does not admit Cantor's theorem	214
7.J. Arithmetical truth from a Wittgensteinian perspective	218
7.K. Skolem's paradox: intended and unintended interpretations of PA	219
7.L. Algorithmic <i>verifiability</i> and algorithmic <i>computability</i> from a Brouwerian perspective	226
7.M. Algorithmic <i>verifiability</i> and algorithmic <i>computability</i> from Carnap's perspective	227
7.N. Algorithmic <i>verifiability</i> and algorithmic <i>computability</i> in Buss' Bounded Arithmetic	231
8. The significance of Hilbert's ω-Rule for Gödel's ω-consistency	235
8.A. Is Hilbert's ω -Rule equivalent to Gentzen's Infinite Induction?	237
8.B. Hilbert's <i>weak</i> proof of consistency for PA	239
8.C. Hilbert's ω -Rule is stronger than ω -consistency	241
8.D. Aristotle's particularisation entails ω -consistency	243
8.E. Markov's principle does not hold in PA	245
8.F. Aristotle's particularisation is 'stronger' than the Axiom of Choice	246
8.G. Rosser's Rule <i>C</i> is <i>stronger</i> than Gödel's ω -consistency	247
9. Hilbert's purported 'sellout' of finitism	251
9.A. <i>Evidence-based</i> reasoning meets Gödel's criteria for constructivity	251
9.A.a. Shift in Hilbert's focus	257

10. Hilbert’s and Brouwer’s interpretations of quantification	262
10.A. Hilbert’s interpretation of quantification	262
10.B. Brouwer’s objection	263
10.C. Is the PA-formula $[(\forall x)F(x)]$ to be interpreted <i>weakly</i> or <i>strongly</i> ?	264
10.C.a. The Church-Turing Thesis entails Aristotle’s particularisation	265
10.D. The standard interpretation $\mathcal{I}_{PA(\mathbb{N}, SV)}$ of PA interprets $[(\forall x)F(x)]$ <i>weakly</i>	270
10.E. A finitary interpretation $\mathcal{I}_{PA(\mathbb{N}, SC)}$ of PA which interprets $[(\forall x)F(x)]$ <i>strongly</i>	271
10.F. Are <i>both</i> interpretations $\mathcal{I}_{PA(\mathbb{N}, SV)}$ and $\mathcal{I}_{PA(\mathbb{N}, SC)}$ of PA over \mathbb{N} <i>well-defined</i> ?	272
11. Three perspectives of logic	273
11.A. Hilbert’s theism	273
11.B. Brouwer’s atheism	274
11.B.a. Denial of an unrestricted applicability of the Law of the Excluded Middle is a <i>belief</i>	276
11.B.b. Brouwerian interpretations of $\wedge, \vee, \rightarrow, \exists, \forall$	278
11.B.c. Conception of Truth in Intuitionism	281
11.C. Finitary agnosticism	283
11.C.a. The significance of finitary agnosticism	285
11.D. Theological metaphors in mathematics	287
11.D.a. Brouwer’s intuitionism seen as mysticism	288
11.D.b. The unsettling consequences of belief-driven mathematics	288
11.D.c. Does mathematics <i>really</i> ‘need’ to be omniscient?	290
11.D.d. Mathematicians ought to practice what they preach	290
11.D.e. Mathematicians must always <i>know</i> what they are talking about	292
11.E. Explicit omniscience in set theory	293
11.F. Do mathematicians practice a ‘faith-less’ platonism?	295

III THE PHILOSOPHICAL FOUNDATIONS OF *EVIDENCE-BASED* REASONING 297

12. What is logic?	297
12.A. What is an axiom	301
12.A.a. Do the axioms circumscribe the ontology of an interpretation?	301
12.B. Wittgenstein’s ‘notorious’ paragraph about ‘the Gödel Theorem’	302
12.B.a. Wittgenstein’s objection to Gödel’s reasoning	310
12.B.b. Interpreting Tarski’s Theorem constructively	311
12.B.c. Tarski’s definitions under the <i>weak</i> standard interpretation $\mathcal{I}_{PA(\mathbb{N}, SV)}$ of PA	314
12.B.d. A <i>weak</i> , Wittgensteinian, interpretation $\mathcal{I}_{PA(\mathbb{P}\mathbb{A}, W)}$ of PA <i>in</i> PA	315
12.B.e. <i>Weak</i> truth under $\mathcal{I}_{PA(\mathbb{N}, SV)}$ is equivalent to <i>weak</i> truth under $\mathcal{I}_{PA(\mathbb{P}\mathbb{A}, W)}$	316
12.B.f. <i>Why</i> a consistent PA is not ω -consistent	317
12.B.g. Conclusions	318
13. What <i>is</i> mathematics?	320
13.A. An empathetic perspective of Wittgenstein’s views on what mathematics is, and what it is not	325
13.B. The semiotics of an <i>evidence-based</i> perspective of logic and mathematics	333
13.C. Mathematics must <i>serve</i> Philosophy and the Natural Sciences	335
13.C.a. The ‘unreasonable’ effectiveness of mathematics	343
13.D. When can a formal assertion claim to ‘mean’ what it represents?	351
13.D.a. Formal expressibility and representability	352
13.D.b. When may we assert that $A(x_1, \dots, x_n)$ ‘means’ $R(x_1, \dots, x_n)$?	352
13.E. Recognising the strengths and limitations of ZF and PA	353
13.E.a. Reductionism in mathematics	360
13.E.b. Cohen on Skolem and pessimism about proof in mathematics	367
13.E.c. Cohen and The Axiom of Choice	370
13.E.d. No putative model of ZF can appeal to Aristotle’s particularisation	370
13.E.e. Cohen and the Gödelian Argument	371
13.F. Three categories of information	372

13.F.a. The value of contradiction	373
13.F.b. How does the human brain address contradictions?	375
13.F.c. The bias problem in science	378
13.F.d. The Case for Professors of Stupidity	379
13.G. An interpretation must be effectively decidable	381
13.G.a. Is the converse necessarily true?	381
13.G.b. Tarskian truth under the standard interpretation $\mathcal{I}_{PA(\mathbb{N}, SV)}$ of PA	382
14. Conflating ‘Proof’ with ‘Truth’ and ‘For any’ with ‘For all’	384
14.A. Conflating ‘Proof’ with ‘Truth’	385
14.B. Conflating ‘For any’ with ‘For all’	388
14.C. <i>Where</i> physicists may <i>need</i> to distinguish between ‘For any’ and ‘For all’	390
15. Gödel 1931 in hindsight	394
15.A. The illusory significance of Gödel 1931	394
15.B. The significance of a shared misperception of Gödel 1931	400
15.C. Can Gödel be held guilty of implicit obfuscation?	400
15.D. Is the ‘Gödel’ sentence unprovable but true?	403
15.E. Is Gödel’s proof self-referential?	415
15.F. Is Gödel’s reasoning unverifiable?	419
15.G. The <i>implicit</i> Query in Gödel’s reasoning	421
15.G.a. The essence, and genius, of Gödel’s reasoning	422
15.G.b. Theorem VI: Gödel’s conclusions	424
15.H. Theorem XI: Where Gödel <i>can</i> be held guilty of obfuscation	424
15.H.a. Why Gödel’s interpretation of his Theorem XI is classically objectionable	427
15.H.b. Defining meta-propositions of P number-theoretically	428
15.H.c. Expressing primitive recursive functions and relations in P	429
15.H.d. Ambiguity in the interpreted ‘meaning’ of formal mathematical expressions	430
15.H.e. Gödel’s <i>fragile</i> presumption: “ P is consistent” is always expressible in P	430
15.H.f. Gödel’s formula $[(\forall x)R(x, p)]$ does not assert its own unprovability	430
15.H.g. ‘Inherited’ limitations of the ‘implicit obfuscation’ in Gödel’s interpretation of his own reasoning	433
15.H.h. The unproven assumption in the statement of the fixed point theorem	439
15.H.i. The misleading entailment of the fixed point theorem	442
15.H.j. The Gödel number of an <i>unspecified</i> PA formula is not a PA formula	444
15.H.k. A curious consequence of Gödel’s informal claim in his Theorem XI	449
15.H.l. The significance of Wittgenstein’s insistence on interpreting Gödel’s claims algorithmically	450
15.H.m. Gödel’s reasoning, ironically, justifies Wittgenstein’s ‘notorious’ paragraph	452
15.H.n. A phenomenological critique of Gödel’s interpretation of his own formal argumentation	454

IV WHERE EVIDENCE-BASED REASONING CHALLENGES CURRENT PARADIGMS 458

16. The significance of <i>evidence-based</i> reasoning for Cantor’s Continuum Hypothesis	459
16.A. Gödel’s β -function	460
16.B. An <i>evidence-based</i> arithmetical perspective on Cantor’s Continuum Hypothesis	461
16.C. Wittgenstein’s perspective on real numbers and Cantor’s diagonal procedure	462
17. The significance of <i>evidence-based</i> reasoning for Rosser’s ‘extension’ of Gödel’s Theorem	478
17.A. Rosser and formally undecidable arithmetical propositions	478
17.B. Wang’s outline of Rosser’s argument	479
17.C. Beth’s outline of Rosser’s argument	480
17.D. Rosser’s original argument <i>implicitly</i> presumes ω -consistency	480
17.E. Mendelson’s proof highlights where Rosser’s argument presumes ω -consistency	481
17.E.a. Where Mendelson’s proof tacitly assumes ω -consistency	482

18.The significance of <i>evidence-based</i> reasoning for non-standard models of PA	485
18.A.The ambiguity in admitting an ‘infinite’ constant	485
18.A.a.We cannot force PA to admit a transfinite ordinal	486
18.A.b.Why we cannot force PA to admit a transfinite ordinal	487
18.B.Forcing PA to admit denumerable descending dense sequences	488
18.C.An argument for a non-standard model of PA	488
18.C.a.Why the argument in §18.C. is logically fragile	489
18.D.A formal argument for a non-standard model of PA	489
18.D.a.Why Kaye’s argument too is logically fragile	490
19.The significance of <i>evidence-based</i> reasoning for Goodstein’s Theorem	492
19.A.The subsystem ACA_0	494
19.B.Goodstein’s sequence	496
19.B.a. The recursive definition of Goodstein’s Sequence	497
19.B.b.The hereditary representation of $g_n(m)$	497
19.B.c. Goodstein’s argument in arithmetic	498
20.The significance of <i>evidence-based</i> reasoning for the philosophy of science	501
20.A.Is quantification currently interpreted constructively?	504
20.B.When is the concept of a completed infinity consistent?	506
20.C.Mythical ‘set-theoretical’ limits of fractal constructions	509
20.C.a. Case 1: Interpretation as a virus cluster	511
20.C.b. Case 2: Interpretation as an elastic string	512
20.C.c. Case 3: Interpretation as a quantum chimera	512
20.C.d. Case 4: Interpretation as a political revolution	514
20.D.Algorithmically <i>verifiable</i> but not algorithmically <i>computable</i> Cauchy sequences	514
20.D.a.Mathematical intuition vs mathematical monsters	515
20.D.b.The mythical completability of metric spaces	519
20.D.c. Case 5: Modelling the states of the total energy in a universe that recycles	523
20.D.d.Asking of a language more than it is designed to deliver	528
20.D.e. Have we reached the limits of what <i>can</i> be physically <i>evidenced</i> ?	532
20.D.f. The crisis in physics is not only about physics	533
21.The significance of <i>evidence-based</i> reasoning for the Gödelian Thesis and a Turing Test	540
21.A.Lucas’ perspective on the Gödelian Argument	545
21.A.a.The cognitive significance of Lucas’ Gödelian Argument	546
21.B.Penrose’s perspective on the Gödelian Argument	548
21.C.Distinguishing between quantification over <i>specified</i> and <i>unspecified</i> values of a variable	552
21.D. <i>Evidence-based</i> validation of Lucas’ and Penrose’s Gödelian Theses	553
21.E.Are you a man or a machine: A Definitive Turing Test	557
21.E.a. Does Query 22 yield a definitive Turing Test?	560
21.F.Turing’s Halting problem	561
21.F.a. The Halting-decidability problem for T	563
21.F.b. Forcing a Turing machine to decide effective computability	565
21.F.c. Why some algorithmically <i>verifiable</i> functions are <i>essentially</i> uncomputable	567
21.G.On the Collatz conjecture and similar, open, arithmetical problems	568
21.G.a.Representing fundamental physical constants by Fiske’s ex-machines \mathfrak{D}	578
21.G.b.An <i>evidence-based</i> perspective of the ‘decidability’ of the Collatz conjecture	579
21.H.An <i>evidence-based</i> perspective of Deutsch’s Church-Turing principle	581
21.I. Kalmár’s perspective on the Church-Turing Thesis	590
21.J. Is the brain a Turing machine?	592
21.J.a. Awareness is <i>not</i> an emergent <i>state</i>	597

22.	The significance of <i>evidence-based</i> reasoning for Number Theory and Integer Factorising	603
22.A.	Are the prime divisors of an integer mutually independent?	603
22.A.a.	Current paradigms	609
22.A.b.	Illusory barriers	609
22.A.c.	Why the prime divisors of an integer are mutually independent	611
22.A.d.	On the probability of <i>determining</i> that a <i>specified</i> integer n is a prime	613
22.A.e.	Why determining primality is deterministically ‘polynomial time’	614
22.A.f.	FACTORISATION is not deterministically ‘polynomial-time’	614
22.B.	Formal properties of the residues $r_i(n)$.	615
22.B.a.	The probability model $\mathbb{M}_i = \{(0, 1, 2, \dots, i - 1), r_i(n), \frac{1}{i}\}$	616
22.B.b.	The prime divisors of any integer n are mutually independent	616
22.B.c.	Density of integers not divisible by primes $Q = \{q_1, q_2, \dots, q_k\}$	618
22.B.d.	The function $\pi_H(n)$	618
22.B.e.	The function $\pi_L(n)$	618
22.B.f.	The interval (p_n^2, p_{n+1}^2)	619
22.B.g.	The functions $\pi_L(x)/\frac{x}{\log_e x}$ and $\pi_H(x)/\frac{x}{\log_e x}$	619
22.C.	Primes in an arithmetic progression	620
22.C.a.	The asymptotic density of Dirichlet integers	621
22.C.b.	An elementary proof of Dirichlet’s Theorem	622
22.D.	An elementary proof that there are infinite twin-primes	623
22.D.a.	The Generalised Prime Counting Function: $\sum_{j=1}^n \prod_{i=a}^{\pi(\sqrt{j})} (1 - \frac{b}{p_i})$	625
22.E.	The functions $\pi(x)$ and $\frac{x}{\log_e x}$: A historical perspective	626
22.E.a.	A better heuristic approximation to $\pi(x)$: The integral $Li(x)$	627
22.F.	A non-heuristic cumulative approximation of $\pi(n)$ for <i>all</i> values of n	628
22.G.	Expected number of primes in the interval $(p_{\pi(\sqrt{n})}^2, p_{\pi(\sqrt{n})+1}^2)$	628
22.H.	Appendix I: The residue function $r_i(n)$	631
22.H.a.	An elementary equivalence for Goldbach’s Conjecture	636
23.	The significance of <i>evidence-based</i> reasoning for the physical sciences	637
23.A.	Some determinate physical phenomena may not be expressible recursively	639
23.A.a.	Describable but not predictable	642
23.B.	<i>EPR</i> , Bohm’s <i>hidden variables</i> , and Bell’s equations	648
23.B.a.	An <i>evidence-based</i> perspective of <i>EPR</i> , Bohm’s <i>hidden variables</i> , and Bell’s equations	659
23.B.b.	Dissolving the Bohr-Einstein debate	662
23.B.c.	Aerts’ ‘overlooked solution’ to the Einstein-Podolsky-Rosen paradox	668
23.B.d.	An <i>evidence-based</i> ‘ontological’ perspective of Aerts’ ‘overlooked solution’ to <i>EPR</i>	678
23.C.	How <i>evidence-based</i> reasoning dissolves the <i>EPR</i> ‘paradox’	682
23.C.a.	<i>EPR</i> paradox: An implicit mathematical ambiguity in interpreting quantification non-constructively	683
23.C.b.	Truth-values must be a computational convention	684
23.C.c.	A finitary perspective of the structure \mathbb{N} of the natural numbers	684
23.C.d.	Functions that are algorithmically <i>verifiable</i> but not algorithmically <i>computable</i>	686
23.C.e.	Some well-known functions that are algorithmically <i>verifiable</i> but not algorithmically <i>computable</i>	686
23.D.	Are some physical constants algorithmically <i>uncomputable</i> ?	687
23.D.a.	Completed Infinities	688
23.D.b.	Zeno’s arguments	688
23.D.c.	Classical laws of nature	688
23.D.d.	Neo-classical laws of nature	689
23.D.e.	Incompleteness: Arithmetical analogy	690
23.D.f.	Conjugate properties	698
23.D.g.	Entangled particles	698
23.D.h.	Schrödinger’s cat ‘paradox’	723

24.The significance of <i>evidence-based</i> reasoning for quantum computing	725
24.A.An <i>evidence-based</i> perspective of Deutsch’s Church-Turing principle in his quantum computer	728
24.A.a.Deutsch’s <i>oracle</i> argument appeals to algorithmically <i>verifiable</i> , but not algorithmically <i>computable</i> , functions	731
24.A.b.Why Deutsch’s ‘oracle’ argument cannot appeal to ‘information loss’	737
24.A.c. Why is quantum computing faster than classical computing?	740
24.A.d.The significance of <i>information loss</i> in quantum computing	743
24.A.e. A philosophical perspective of quantum computing	752
24.A.f. What, precisely, is the role of proof assistants in quantum computing?	754
24.A.g. Can we treat PA as Deutsch’s and Wójtcowicz’s quantum oracle?	762
25.The significance of <i>evidence-based</i> reasoning for TSP	765
25.A.Overview: The problem of scheduling homing routes optimally	765
25.A.a.Overview: An Optimal Focal Node method for scheduling homing routes	766
25.B.The formal argument	771
25.B.a. Population	772
25.B.b.Resource requirements for linking two Nodes	773
25.B.c. The Data Set D_n	773
25.B.d. Identifying Minimal Resource Configurations $MRC_{C_a} \vec{R}_{n_{min}}$ and $MRC_P \vec{R}_{n_{min}}$	774
25.B.e. Identifying $MRC_{C_a} \vec{R}_{2_{min}}$ for two Nodes	775
25.B.f. Identifying a $MRC_{C_a} \vec{R}_{3_{min}}$ by identifying an Optimum Focal Node with respect to $\vec{R}_{2_{min}}$	776
25.B.g. Identifying a $MRC_{C_a} \vec{R}_{4_{min}}$ by identifying an Optimum Focal Node with respect to $\vec{R}_{3_{min}}$	779
25.B.h. Identifying a $MRC_{C_a} \vec{R}_{5_{min}}$ by identifying an Optimum Focal Node with respect to $\vec{R}_{4_{min}}$	780
25.B.i. Identifying a $MRC_{C_a} \vec{R}_{6_{min}}$ by identifying an Optimum Focal Node with respect to $\vec{R}_{5_{min}}$	782
25.B.j. Identifying a $MRC_{C_a} \vec{R}_{7_{min}}$ by identifying an Optimum Focal Node with respect to $\vec{R}_{6_{min}}$	783
26.The significance of <i>evidence-based</i> reasoning for SETI	786
26.A.Is there a rational danger to humankind in actively seeking an extra-terrestrial intelligence?	786
26.B.So what’s new? Unprecedented categorical communication	789
26.C.Is it rational to fear communicating with an extra-terrestrial intelligence?	790
26.D.Recursive Arithmetic: The language of algorithms	791
26.E.First-order Peano Arithmetic PA: A universal language of Arithmetic	791
26.F.Communicating PA and its Theorems categorically	792
26.G.How we currently interpret PA	792
26.H.A malevolent ETI must interpret some of our true arithmetical propositions as false	793
26.I. The rational argument for not seeking an ETI pro-actively	793
26.J. Does PA lend itself to essentially different interpretations?	793
27.The significance of <i>evidence-based</i> reasoning for Cognitive Science	797
27.A.Mathematical idea analysis	797
27.B.Extending Lakoff and Núñez’s intent on ‘understanding’	800
27.C.How can human beings understand the idea of actual infinity?	802
27.D.What does a mathematical representation reflect?	805
27.E.Lakoff and Núñez’s cognitive argument	806
27.F.The Veridicality of Mathematical Propositions	811
27.G.Where does the veridicality of mathematics come from?	813
27.G.a.Russel’s paradox?	815
27.G.b.An illustrative model: language and ontology	818
27.G.c. Is the Russell-Frege definition of number significant?	820
27.G.d.Conclusion	822
28.The significance of <i>evidence-based</i> reasoning for mathematics education	824
28.A.The science of numbers: does language help or hinder?	825
28.B.What is our ‘first philosophy’ in mathematics education?	831
28.C.Math Anxiety	835
28.C.a. Is mathematics a language?	845

V	APPENDICES	849
29.	Appendix A: Some comments on standard definitions, notations, and concepts	849
29.A.	Appendix A1: Turing Algorithm	855
29.B.	Appendix A2: Gödel-numbering	857
30.	Appendix B: Definitions, Queries, Theses, Lemmas, Theorems and Corollaries	857
30.A.	Definitions	857
30.B.	Theses	861
30.C.	Hypotheses	864
30.D.	Queries	865
30.E.	Propositions, Lemmas, Theorems, Corollaries	867
31.	Acknowledgements	875
VI	BIBLIOGRAPHY	878

Part I

INTRODUCTION

PREFACE

In this multi-disciplinary investigation of the perception, and role, of quantification *in* formal mathematical languages, *and* under their intended interpretations (in the sense of §7.K.), we presume familiarity with the following, classical, foundations of current scientific paradigms, as well as with where such, inherited, foundations are now sought to be challenged, and undermined, by an *evidence-based* paradigm.

- (1) Introductory-level texts on mathematical logic and computability¹;
- (2) David Hilbert’s, Luitzen Egbertus Jan Brouwer’s and Kurt Gödel’s deliberations² apropos a constructive definition of quantification, over the domain \mathbb{N} of the natural numbers, which might yield a finitary proof of consistency for arithmetic;

and, *most crucially*, with:

- (3) The following (amongst other; see §2.), paradigm challenging, consequences of the *evidence-based* definitions of algorithmic *verifiability*, and algorithmic *computability*, introduced in the relatively recent paper [An16], ‘*The Truth Assignments That Differentiate Human Reasoning From Mechanistic Reasoning: The Evidence-Based Argument for Lucas’ Gödelian Thesis*’, which appeared in the December 2016 issue of *Cognitive Systems Research*:
 - (a) The first-order Peano Arithmetic PA has *two*—hitherto unsuspected and unarguably *constructive*—Tarskian (see §2.A.) interpretations over the domain \mathbb{N} of the natural numbers (compare [Art07]):
 - (i) The *standard* interpretation $\mathcal{I}_{PA(\mathbb{N}, SV)}$ of PA, which interprets quantification *weakly* in terms of algorithmic *verifiability* ([An16], Theorem 5.6, p.40); whence PA is *constructively (weakly)* consistent ([An16], Theorem 5.7, p.40);
 - (ii) A *finitary* interpretation $\mathcal{I}_{PA(\mathbb{N}, SC)}$ of PA, which interprets quantification *strongly* in terms of algorithmic *computability* ([An16], Theorem 6.7, p.41); whence PA is *finitarily (strongly)* consistent ([An16], Theorem 6.8, p.41);
 - (b) PA is categorical ([An16], Corollary 7.2, p.41).

We shall situate our investigation within a broad analysis of quantification vis à vis:

- Hilbert’s ε -calculus
- Gödel’s ω -consistency
- The Law of the Excluded Middle LEM

¹We take Elliott Mendelson [Me64], George Boolos et al [BBJ03], and Hartley Rogers [Rg87], as representative—in the areas that they cover—of standard expositions of classical first-order theory and of computability (in particular, of the first-order Peano Arithmetic PA, and of classical Turing-computability).

²See, for instance, *van Heijenoort*: [Hei76]; *Davis*: [Da64]; *Benacerraf, Putnam*: [BPu64].

- Hilbert’s ω -Rule
- An Algorithmic ω -Rule
- Gentzen’s Rule of Infinite Induction
- Rosser’s Rule C
- Markov’s Principle
- The Church-Turing Thesis CT
- Aristotle’s particularisation (defined as the postulation that from the provability of a formula $[(\forall x)F(x)]$ in a formal theory \mathcal{L} , we may conclude the existence of some *unspecified* object a , in the domain of any *well-defined* interpretation \mathcal{I} of \mathcal{L} , for which the interpretation $F^*(a)$ of $[F(a)]$ is true)
- Wittgenstein’s perspective of constructive mathematics
- An *evidence-based* perspective of quantification.

By showing how these are formally inter-related, we shall highlight the fragility of both:

- the persisting, *theistic* (see §11.A.), classical/Platonic interpretation of quantification grounded in Hilbert’s non-finitary ε -calculus; and the
- persisting, *atheistic* (see §11.B.) constructive/Intuitionistic interpretation of quantification rooted in Brouwer’s *mistaken* belief that the Law of the Excluded Middle LEM is non-finitary.

We shall then consider some consequences³ for:

- Mathematics;
- Mathematics education;
- Philosophy; and the
- Natural sciences;

of an agnostic, *evidence-based*, finitary interpretation of quantification that challenges classical paradigms in all these disciplines.

The ‘flavour’, and ultimate goal, of this *evidenced-based*, multi-disciplinary, investigation of the perception, and role, of quantification *in* formal mathematical languages, *and* of its ‘truth’ under their intended, Tarskian, interpretations, is aptly reflected in Leo Corry’s assertion in [Cry22]⁴:

“I will consider mathematics to be a cognitive system definitely involving a quest for objective truth, an objective truth that in the long run is also cumulatively and steadily expanding.”

... Corry: [Cry22], pp.8-9.

³See the list of Propositions, Lemmas, Theorems and Corollaries in Appendix B, §30.E.

⁴Reproduced by permission of the author.

and in Markus Pantsar’s introductory remarks in [Pan09] (*if* we substitute ‘validating’ for ‘explaining’ in his concluding sentence):

“In general, I think philosophers should be careful about telling mathematicians how to do their jobs. This is not to say that the accepted results and methods of mathematics should be considered sacrosanct. Nor is it to say that philosophy cannot offer anything of interest to mathematicians. I disagree on both of these counts. There should always be room for healthy interaction between mathematicians and philosophers of mathematics. Nevertheless, the philosophical disposition of this work is definitely that of an anti-revisionist. After all, mathematical truth is the subject matter, and philosophical accounts of it should be careful not to neglect the way mathematics is actually practised. Here I am not interested in creating a new concept of mathematical truth as much as I am in explaining the one most of us already have, whether implicitly or explicitly.”

...Pantsar: [Pan09], §1.1 General background.

In Part I of this investigation (§1. to §5.B.a.), we highlight the significance of the formal thesis of this investigation (§1., Complementarity Thesis 1), which is, essentially, that:

- Whilst the focus of proof theory *may* be viewed as seeking to ensure that any mathematical language intended to *formally* represent our *pre-formal* conceptual metaphors and their inter-relatedness is unambiguous, and free from contradiction;
- The focus of constructive mathematics *must* be viewed as seeking to ensure that any such representation does, indeed, uniquely identify and adequately represent such metaphors and their inter-relatedness.

The need for recognising the primacy of *pre-formal* reasoning is argued cogently, and unequivocally, by Markus Pantsar in his introduction to ‘Truth, Proof and Gödelian Arguments: A Defence of Tarskian Truth in Mathematics’ (see [Pan09]; also §1.A.).

Moreover, the *evidence-based* perspective of the Complementarity Thesis reflects both:

- preference for Gualtiero Piccinini’s perspective of knowledge as ‘Factually Grounded Belief’ (see §5.A.; also the Author’s Preface) over perspectives of knowledge as intuitively ‘Justified True Belief’; and
- Pantsar’s critical perspective in [Pan09] that although ‘the formalist program uses the actual practice of mathematics as a ladder that they later discard’, and is, by itself, ‘perfectly acceptable’ since ‘it mirrors the way we strive for formal axiomatic systems in mathematics’, what is not acceptable is their disavowal of the use, and necessity, of such a ‘ladder’.

The significance of Pantsar’s ‘critical perspective’—from the *evidence-based* perspective of the Complementarity Thesis—is that even the *implicit* disavowal of the use, and necessity, of such a ‘ladder’ can—as we shall argue in §7.B.⁵—lead to interpretations of quantification (with seriously misleading consequences as detailed in §5.⁶) that have ‘subsequently been sanctified by prevailing custom in published classical, and constructivist/intuitionistic, literature and textbooks at such an early stage of any mathematical curriculum, and planted so deeply into students’ minds, that thereafter most cannot even detect its presence—let alone need for justifying quantification—in a definition or a proof sequence!’

⁵§7.B.: *Faith-based* quantification.

⁶§5.: Three fragile Hilbertian, Brouwerian, and Gödelian, dogmas.

We shall argue, further, that the epistemological perspective of the Complementarity Thesis is that (see §1.B.) logic, too, can be viewed as merely a methodological tool that seeks to formalise an intuitive human ability that pertains not to the language which seeks to express it formally, but to the cognitive sciences in which its study is rooted.

In other words—a view that seemingly resonates with Ludwig Wittgenstein’s perspective in the *Tractatus*—a mathematical or logical truth is merely an assertion of the reliability of a mathematical language to faithfully *express* that which is sought to be expressed formally within the language. It has no bearing on the *ontological status* of that which is sought to be expressed within the language.

The goals of proof theory and constructive mathematics ought to, thus (as argued in Part III, §13.E.), be viewed as necessarily interdependent and complementing, rather than being independent of, or in conflict with, each other as to which is more ‘foundational’.

The significance of, and need for greater appeal to:

- Piccinini’s concept (see [Pic19]) of ‘knowledge’ as *factually grounded belief* for justifying and/or treating the axioms of a formal system as ‘self-evident’, and
- Pantsar’s concept (see [Pan09]) of *pre-formal*, implicitly ‘intuitively understandable’ and *evidence-based*, mathematics (and proofs) as the *raison d’être* of formal mathematics (and proofs),

is evidenced by how these, together, illuminate myriad outstanding, unresolved, and/or problematic issues; such as, for instance:

- *Why* Fermat’s Last Theorem is *pre-formally* true only for $n < 3$ (§1.E. and §1.H.);
- *Why* accepted, computer-assisted, proofs of the Four Colour Theorem may be *vacuously* true (§1.I.c.);
- *Why* the Four Colour Theorem is *pre-formally* true (§1.I.h.);
- *Why* the prime divisors of n can be *pre-formally* seen to be mutually independent in the usual, linearly displayed, Sieve of Eratosthenes (§22.A.);
- *Why* PA is *finitarily* consistent (§2.C.a.) (whence the first-order logic FOL—in which the Law of the Excluded Middle LEM is a theorem—is ipso facto *finitarily* consistent);
- *Why* Poincaré’s and Hilbert’s interpretations of the finitariness of the PA axiom of Finite Induction are *complementary*, and not *contradictory* (§2.D.);
- *Why* PA is categorical (§2.E.b.), and cannot admit non-standard models (§18.);
- *Why* Gödel’s arithmetical formula $[R(x)]$ interprets as an algorithmically verifiable, but not algorithmically computable, tautology over \mathbb{N} (§2.F.);
- *Why* SAT is not deterministically ‘polynomial time’ (§4.A.a.);
- *Why* PA is *not* ω -consistent (§2.F.);

- *Why* Rosser’s implicit appeal to Rule C in his ‘extension’ of Gödel’s Incompleteness Theorem entails ω -consistency (§17.D.);
- *Why* there can be no mechanist model of human reasoning if the assignment $\mathcal{I}_{PA(\mathbb{N}, SV)}$ can be treated as circumscribing the ambit of human reasoning about ‘true’ arithmetical propositions, and the assignment $\mathcal{I}_{PA(\mathbb{N}, SC)}$ can be treated as circumscribing the ambit of mechanistic reasoning about ‘true’ arithmetical propositions (§2.F.);
- *Why* there can be *no* PA formula that interprets over \mathbb{N} as the meta-statement ‘PA is consistent’ *without* inviting the paradoxes of impredicativity (§3.);
- *Why* we *can* interpret the number-theoretic expression $Wid(PA) \equiv (\exists x)[Form(x) \ \& \ \overline{Bew}_{PA}(x)]$ (see [Go31], p.36) over \mathbb{N} as asserting: ‘There is a PA-formula that is not PA-provable’, which is equivalent to asserting that ‘PA is consistent’ (§3.);
- *Why* there can be *no* Turing machine U which, given the ‘standard description’ of any ‘arbitrary’ Turing machine T and any instantaneous tape description α , can determine whether or not there is a computation of T beginning with α (Halting-decidability problem for T), *without* inviting the paradoxes of impredicativity (§3.);
- *Why* there *is* a PA formula that will determine whether or not T halts on α (§3.);
- *Why* $P \neq NP$ is *pre-formally* true (§4.);
- *Why* we cannot *unrestrictedly* conclude from the provability of $[(\exists x)F(x)]$ ⁷ that $[F(n)]$ is PA-provable for some *unspecified* numeral $[n]$, since such a putative numeral may not always be *specifiable* by the rules that determine the formation of PA-terms (§5.);
- *Why evidence-based* reasoning does not admit the standard classical interpretation of quantification that Hilbert sought to formalise in his ε -calculus (§5.);
- *Why evidence-based* reasoning does not admit Brouwer’s belief that LEM—which he apparently conflated with Hilbert’s ‘principle of excluded middle’—is non-constructive (§5.);
- *Why* Goodstein’s sequence $G_o(m_o)$ over the finite ordinals in any putative model \mathbb{M} of ACA_0 *terminates* with respect to the ordinal inequality ‘ $>_o$ ’ even if some Goodstein’s sequence $G(m)$ over the natural numbers *does not terminate* with respect to the natural number inequality ‘ $>$ ’ in \mathbb{M} (§19.);
- *Why* the subsystem ACA_0 of second-order arithmetic is not a conservative extension of PA (19.A.).

⁷We note that $[(\exists x)F(x)]$ is merely an abbreviation for the formula $[\neg(\forall x)\neg F(x)]$, i.e., $[(\exists x)F(x) \equiv \neg(\forall x)\neg F(x)]$.

CHAPTER 1. INTRODUCTION

1. The Complementarity Thesis

The thesis of this investigation is that (as we shall argue in Part III, §12.) current mathematical paradigms of what is entailed by David Hilbert’s development of proof theory⁸, and by L. E. J. Brouwer’s development of constructive mathematics⁹, *appear* contradictory¹⁰ *only* because they fail to adequately accommodate that, as reportedly believed by Hilbert¹¹ prior to 1929 (see [Knd13], *Introduction*; also §9.A.a.):

Thesis 1. (Complementarity Thesis) *Mathematical ‘provability’ and mathematical ‘truth’ need to be interdependent and complementary, ‘evidence-based’, assignments-by-convention towards achieving:*

(1) *The goal of proof theory, post Peano, Dedekind and Hilbert, which is:*

- *to uniquely characterise each informally defined mathematical structure S (e.g., the Peano Postulates and their associated, classical, predicate logic),*
- *by a corresponding, formal, first-order language L , and a set P of finitary axioms/axiom schemas and rules of inference (e.g., the first-order Peano Arithmetic PA and its associated first-order logic FOL),*
- *which assign unique provability values (provable/unprovable) to each well-formed proposition of the language L without contradiction;*

(2) *The goal of constructive mathematics, post Brouwer and Tarski, which must be:*

- *to assign unique, evidence-based, truth values (true/false) to each well-formed proposition of the language L ,*
- *under an, unarguably constructive, well-defined interpretation \mathcal{I} over the domain D of the structure S ,*
- *such that the provable formulas of L are true under the interpretation.*

In other words (as addressed in greater detail in Part III, §13.C.):

- Whilst the focus of proof theory *may* be viewed as seeking to ensure that any mathematical language intended to *formally* represent our *pre-formal* conceptual metaphors and their inter-relatedness is unambiguous, and free from contradiction;

⁸As surveyed, for instance, in *Sieg*: [Si12].

⁹As covered, for instance, in *Kleene*: [Kl52] and *Bauer*: [Ba16].

¹⁰See, for instance, Curtis Franks [Fr09]; Henk Barendregt [Brd13]; Errett Bishop [Bi18]; Gila Sher [Shr18]; Penelope Maddy [Ma18], [Ma18a]; Ferenc Csátári [Csr24].

¹¹“Hilbert also worried about language and interpretation, demanding that all interpretations in the theory should be isomorphic, and all deductive techniques should be invariant under different interpretations. Hilbert’s program lies at the base of modern mathematics so let’s clarify the details of some of the ingredients in these theories.” ... *Granville*: [Grn22], §1. *Proof—why and how*.

- The focus of constructive mathematics *must* be viewed as seeking to ensure that any such representation does, indeed, uniquely identify and adequately represent such metaphors and their inter-relatedness (essentially ‘*validating*’ them in the sense of §1.J.).

Comment 1. From the following perspective of Curtis Franks’ [Fr09], it would not be unreasonable to conjecture that what Hilbert’s Program sought could be viewed as a ‘justification’ of sorts for the Complementarity Thesis:

“The traditional interpretation of Hilbert’s program that I have challenged has Hilbert’s philosophical vision somehow riding on the results of his new science. There is much wrong with this description, but also some kernel of truth in it. Of course I maintain that Hilbert was not, as he is commonly described as being, trying to demonstrate that modern mathematics is ultimately grounded in finitary reasoning about concrete signs. Like Wittgenstein, he did not think it worthwhile, or even coherent, to look for mathematics’ foundations in anything at all. And it is also a mistake to think that Hilbert’s conception of mathematical autonomy depends in any way on the verdicts issued from meta-mathematics or even on his ability to invent a stable meta-mathematical science. The relationship between Hilbert’s views about mathematics and his development of meta-mathematical techniques is exactly the reverse. Hilbert was only able to envision a mathematical investigation of questions about mathematics because he was already so firmly committed to his naturalistic views.”

... Franks: [Fr09], §6.4, *Evidence of Autonomy*, pp.195-196.

Moreover, that Hilbert may have viewed mathematical ‘proof’ and mathematical ‘truth’—in the sense of the the Complementarity Thesis—as tools (see §13.C.) for unambiguously expressing, and categorically communicating, our sensory perceptions—and their related conceptual metaphors—of the common universe we inhabit, is suggested by Leo Corry’s following remarks in [Cry17]:

“... In this regard, and even before one starts to look carefully at Hilbert’s mathematical ideas and practice throughout his career, it is illustrative to look at a quotation from around 1919—the time when Hilbert began to work out the finitist program for the foundations of arithmetic in collaboration with Paul Bernays—that expounds a view diametrically opposed to that attributed to him many years later by Dieudonné, and that is rather widespread even today. Thus Hilbert said:

We are not speaking here of arbitrariness in any sense. Mathematics is not like a game whose tasks are determined by arbitrarily stipulated rules. Rather, it is a conceptual system possessing internal necessity that can only be so and by no means otherwise. ([18], p. 14)

The misleading conflation of the formalist aspect of the “Hilbert program” with Hilbert’s overall views about mathematics and its relationship with physics is also closely related with a widespread, retrospective misreading of his early work on the foundations of geometry in purely formalist terms. However, the centrality attributed by Hilbert to the axiomatic method in mathematics and in science is strongly connected with thoroughgoing empiricist conceptions, that continually increased in strength as he went on to delve into ever new physical disciplines, and that reached a peak in 1915-17, the time of his most intense participation in research associated with GTR.

The axiomatic approach was for Hilbert, above all, a tool for retrospectively investigating the logical structure of *well-established and elaborated* scientific theories, and the possible difficulties encountered in their study, and never the starting point for the creation of new fields of enquiry. The role that Hilbert envisaged for the axiomatic analysis of theories is succinctly summarized in the following quotation taken from a course on the axiomatic method taught in 1905. Hilbert thus said:

The edifice of science is not raised like a dwelling, in which the foundations are first firmly laid and only then one proceeds to construct and to enlarge

the rooms. Science prefers to secure as soon as possible comfortable spaces to wander around and only subsequently, when signs appear here and there that the loose foundations are not able to sustain the expansion of the rooms, it sets about supporting and fortifying them. This is not a weakness, but rather the right and healthy path of development. ([5], p. 127)"

... Corry: [Cry17], §2, *Axiomatics and Formalism*.

Comment 2. The need for, and significance of, the *evidence-based* perspective of ‘pre-formal mathematical truth’ as validating ‘formal mathematical proof’¹² sought to be articulated as the Complementarity Thesis (Thesis 1) is also implicit in Danielle Macbeth’s [Mcb14]; where she explicitly states that one of her aims ‘... is to provide a cogent and compelling account of how the practice of mathematics works as a mode of intellectual inquiry into objective mathematical truth, and the role that various written systems of signs have played and continue to play in this practice’:

“By the end of the nineteenth century, developments in mathematics had seemed decisively to show that Kant’s account of mathematical practice in terms of constructions in pure intuition was fatally flawed. What those developments did not show was just how Kant had gone wrong. Two very different responses emerged. The first, which would come to dominate the philosophical culture throughout the twentieth century (at least in the English-speaking world), was to jettison the idea that constructions have any role at all to play in mathematical practice and so to hold, with Kant, that without pure intuition to provide it content, mathematics must be understood in terms of the notion of form alone, as strictly deductive and hence purely formal and merely explicative.⁴ The second, more radical response was to jettison not only Kant’s account of mathematics as founded on constructions but also Kant’s account of logic as merely formal and of deduction as merely explicative. Knowing nothing of each other’s work, both Charles Sanders Peirce, an American logician, and Gottlob Frege, a German mathematician, pursued this second path. Both held that even strictly deductive reasoning by logic from definitions can extend our mathematical knowledge.⁵ Only Frege managed to take the further step of showing how this can be by developing a mathematical language within which to reason deductively to conclusions that are ampliative in Kant’s sense. Indeed, it will be argued, Frege’s language, *Begriffsschrift*, together with the logical advances it embodies, holds the key not only to an adequate philosophical understanding of advances in mathematics in the nineteenth century but also to such an understanding of advances in physics in the twentieth, and much else besides.

This work has, then, three principal and interrelated aims. The first is to trace the essential moments in the historical unfolding, from the ancient Greeks to the present, that culminates in the full realization of pure reason as a power of knowing that is manifested first and foremost in ampliative, deductive mathematical proofs. The second is to provide a cogent and compelling account of how the practice of mathematics works as a mode of intellectual inquiry into objective mathematical truth, and the role that various written systems of signs have played and continue to play in this practice. The third is to develop and defend a new conception of our being in the world, one that at once builds on and transforms the now standard conception (sometimes called the sideways-on view) according to which our experience of reality is the result of the merely causal impacts on our sense organs and ultimately our brains of physical stuffs that surround us, according to which “inside” are meanings and meaningful experiences, while “outside” is merely brute, causally efficacious reality.⁶ The task here is to overcome that conception, to recover ancient insights into our being as the rational animals we are but in a way that incorporates also the insights of early modernity.

Fn4: It was just this sort of view that led Poincaré to deny that developments in mathematics had shown Kant to be wrong about the nature of mathematical practice. According to him, mathematical reasoning clearly is ampliative and

¹²See also §1.J.: *Validating knowledge, truth, and proof in pre-formal mathematics*.

hence it cannot be strictly deductive. To take a mathematician's proof and formalize it, make it strictly deductive, is to somehow destroy its character as a mathematical proof. See Detlefsen (1992) and (1993). We return to Poincaré's views in section 5.4.

Fn5: Enlightening though it would be, I cannot in this work take up the question of the similarities and differences between Peirce's philosophy of mathematics and Frege's. A very brief discussion of Peirce's philosophy of mathematics is provided below in section 5.4. For other recent work on Peirce's philosophy of mathematics see Moore (2010).

Fn6: Compare Matthews (1977, 25): "The 'inside' is a mind or subject of consciousness, whose acts and states are indubitable to itself. The 'outside' is a body known to the mind or 'inside' only indirectly through quite dubitable inferences from sense impressions. / The picture of human beings as having, in this way, both an 'inside' and an 'outside' is so commonplace, so (as it may seem to us) commonsensical that we find it hard to realize how strikingly modern it is." Price (1997, 174) argues that this inside/outside, or sideways-on, conception of our being in the world is something science has revealed, that "physiology . . . teaches us that Kant was right: what we get from our sensory apparatus depends on quite contingent features of our physical construction, as well as on the nature of the external world. . . . This product of a sideways-on scientific perspective is not a kind of comatose version of transcendentalism, but a plausible first-order theory about the way in which our brains are linked to their environment. Nor is it a kind of philosophical opening bid, which we can abandon on the grounds that it causes problems elsewhere in philosophy. To all intents and purposes it is a fact of modern life, within the constraints of which philosophy must operate." In fact, we will see, this conception is not a finding of science. It is a metaphysical thesis that we inherit from early modernity and will need ultimately to jettison."
 . . . *Macbeth*: [Mcb14], Introduction, pp.7-8.

1.A. Pre-formal mathematics

The need for recognising the primacy of *pre-formal* reasoning is argued cogently, and unequivocally, by Markus Pantsar in his introduction to 'Truth, Proof and Gödelian Arguments: A Defence of Tarskian Truth in Mathematics':

"In this work I will argue that without any outer reference, mathematics as we know it could simply not be possible: it could not have developed, and it could not be learnt or practised. Sophisticated formal theories are the pinnacle of mathematics but, philosophically, they cannot be studied separately from all the non-formal background behind them.

This way, what might seem like a completely formalist theory of mathematics turns out to be nothing of the sort. It could not have existed without a wide *pre-formal* background, which we will see when we examine mathematical practice in general.³ Formal systems are not of the self-standing type that extreme formalism seems to claim. My purpose in this work is to show that the formalist program uses the actual practice of mathematics as a ladder that they later discard. This by itself is of course perfectly acceptable, and it mirrors the way we strive for formal axiomatic systems in mathematics. What is not acceptable is how they refuse using the ladder.

When it comes to the question of truth and proof, this could not be any more relevant. The deflationist truth of extreme formalism equates mathematical truth with formal proof. However, as we will see, that strategy requires that we take mathematics to concern only formal systems. Once we look at the wider picture, we see that outer criteria are needed to avoid arbitrariness. Theory choice must be explained, and this requires reference outside formal systems of mathematics. Philosophers have tried to explain this by a wide array of concepts—usefulness, assertability, consistency and conservativeness, to name a few—but ultimately none of them have been satisfactory. The only plausible way to answer the problem of theory choice, I will argue, is by appealing to *truth*.

[3] What I refer to as pre-formal mathematics in this work is more often discussed as informal mathematics in literature. The choice of terminology here is based on two reasons. First, I want to stress the order in which our mathematical thinking develops. We initially grasp mathematics through informal concepts and only later acquire the corresponding formal tools. Second, the term "informal mathematics" seems to have an emerging non-philosophical meaning of mathematics in everyday life, as opposed to an academic pursuit—which is not at all the distinction that I am after here."

. . . *Pantsar*: [Pan09], §1.1 General background.

"(Extreme) Formalism: to say that a mathematical sentence is true involves no reference to any entity outside formal systems. Hence, a mathematical sentence is true in a formal system S if and only if it is provable in S, and mathematical truth cannot be discussed in any other context."

. . . *Pantsar*: [Pan09], §2.4 Formalism/nominalism.

The significance of, and need for, an *explicit, evidence-based*, perspective such as that of the Complementarity Thesis (§1., Thesis 1), and of Pantsar's *pre-formal* mathematical *truth* and *proof*, is occasionally articulated *tacitly* in pedagogy.

For instance, in the introduction to his 2002 *Lecture Notes on Logic for Computer Science*, Andrzej Szalas notes that, traditionally, ‘... *there are two methodologies¹ to introduce a logic*’, wherein he posits (in his footnote 1) that ‘... *it is often desirable and even necessary to follow both methodologies, assuming that they lead to compatible results*’, and—reflecting further the concept of treating a *well-defined* logic as a methodological tool (see §1.B., Definition 1; also §12.)—formally defines what he means by a ‘*logic*’:

“Logical formalisms are applied in many areas of computer science. The extensive use of those formalisms resulted in defining hundreds of logics that fit nicely to particular application areas. Let us then first clarify what do we mean by a logic.

Recall first the rôle of logic in the clarification of human reasoning. In order to make the reasoning fruitful, first of all we have to decide what is the subject of reasoning or, in other words, what are we going to talk about and what language are we going to use. The next step is to associate a precise meaning to basic notions of the language, in order to avoid ambiguities and misunderstandings. Finally we have to state clearly what kind of opinions (sentences) can be formulated in the language we deal with and, moreover, which of those opinions are true (valid), and which are false (invalid). Now we can investigate the subject of reasoning via the validity of expressed opinions. Such an abstraction defines a specific logic.

Traditionally, there are two methodologies¹ to introduce a logic:

- syntactically, via a notion of a proof and proof system
- semantically, via a notion of a model, satisfiability and truth.

Both methodologies first require to chose a language that suits best a particular application. Of course we use different vocabulary talking about politics and about computer science. Moreover, we even use different linguistic tools. Logical language is defined by means of basic concepts, formulas and logical connectives or operators. Thus a syntax of the language is to be defined, so that one obtains a precise definition what are well formed sentences or formulas.

Having a language syntax defined, one knows how to “speak” correctly and does not know what do the spoken sentences mean and whether these are true or false. Thus a meaning (also called an interpretation) is to be attached to any well formed formula of the logic. The meaning is given either by the notion of provability, or satisfiability. Namely, a sentence (formula) is considered valid provided that it can be proved (syntactical approach) or it is valid in models accepted as semantical structures (semantical approach).

I find the semantical approach more fundamental and consider the syntactic approach as (still extremely important) tool. Thus logic will always be presented here primarily via the underlying semantics, showing also how various types of proof systems for the logics can be constructed. We then accept the following definition of logic.

Definition 1.2.1 By a *logic* we shall mean triple $L = \langle F, C, \models \rangle$, where:

- F is a set of *well-formed formulas*
- C is a class of possible *interpretations (models)*
- $\models \subseteq C \times F$ is a *satisfiability relation*.

For $I \in C$ and $\alpha \in F$, if $I \models \alpha$ then we say that interpretation I *satisfies* formula α or I is a *model* [of] α . For $C' \subseteq C$ and $F' \subseteq F$, by $C' \models F'$ we shall mean that for any interpretation $I \in C'$ and any formula $\alpha \in F'$ we have that $I \models \alpha$.

A formula is a *tautology* of L iff for any interpretation $I \in C$, we have that $I \models \alpha$. A formula is *satisfiable* iff there is an interpretation $I \in C$, such that $I \models \alpha$.□

^[1] And it is often desirable and even necessary to follow both methodologies, assuming that they lead to compatible results. "

... Szalas: [Sza02], §1.2 Introduction to Logics

In [Pdn15], erstwhile¹³ philosopher and computer scientist Karlis Podnieks offers a lucid, and compellingly empathetic, defence of what Pantsar terms as (extreme) Formalism, and Podnieks terms as a ‘pure and extreme version of formalism’ which ‘is called by some authors “game formalism”, because it is alleged to represent mathematics as a meaningless game with strings of symbols’.

Podnieks seeks ‘to draw attention to some arguments in favour of game formalism as an appropriate philosophy of real mathematics’ that ‘have not yet been used or were neglected in past discussions’:

“7 Game Formalism As a Philosophy of Real Mathematics

As a philosophy of real mathematics, game formalism allows mathematicians to *postulate any axioms that make sense*, and explore the consequences that can be derived from these axioms (by the application of some accepted means of reasoning, i.e., of some logic). Making sense (there may be multiple ways to do so) is crucial here, of course. Mathematics has always contained elements of gaming, but this was never a meaningless game.

The consequences obtained from a definite set of axioms are applicable to any structures that satisfy these axioms. Thus, uninterpreted axioms are not meaningless, they are interpretable in multiple ways. As expressed by one of the founders of category theory, Saunders Mac Lane (1986):

“Mathematics aims to understand, to manipulate, to develop, and to apply those aspects of the universe which are formal.” (p. 456)

Argument 4. *Uninterpreted axioms are not meaningless, they are interpretable in multiple ways. The consequences of uninterpreted axioms are applicable to any structures that satisfy the axioms.*

One cannot imagine working in the modern branches of mathematics for a long time without knowing exactly which axioms one is using. The simplest example: when people are working in group theory, their results will apply to all groups (or to some precisely defined subtypes of groups) only if they deliberately keep themselves within the framework of the group axioms. Or, when publishing in advanced set theory, people must indicate explicitly which large cardinal and/or determinacy axioms they are using. This is mandatory even for the most devoted set theory platonists. And, as mentioned above, people working in the old classical branches of mathematics agree easily (when pressed) that they are working “within ZFC”. Those working in category theory and other modern mathematical theories are aware that their work can be formalized in ZFC extended by the axiom “there is a proper class of strongly inaccessible cardinals” (for details, see C. McLarty (2010)).

Argument 5. *In fact, real mathematics is developed within axiomatic frameworks. This is why uninterpreted formal systems (formal languages, axioms and logics) can serve as a clean representation of the real mathematics of modern times.*

Stephen W. Hawking (2002): “. . . we are not angels, who view the universe from the outside. Instead, we and our models are both part of the universe we are describing.”

Argument 6. *Any formal system, after its definition is put on paper, becomes part of the physical universe. Therefore, asking about the “unreasonable effectiveness of mathematics in the natural sciences” (E. P. Wigner (1960)) is, in fact, asking about the applicability of a particular fragment*

¹³Erstwhile’, since Professor Podnieks notes in a personal communication that: “I left the field of philosophy of mathematics by publishing the farewell paper: Fourteen Arguments in Favour of a Formalist Philosophy of Real Mathematics (2015)”. Accordingly, to respect Professor Podnieks’ intention, all citations and quotations reflecting his philosophical proclivities, pronouncements, and perspectives—as evidenced in the various works cited in this investigation—should be viewed more as faithfully illustrative of where he views the discipline he addresses is ‘coming from’, rather than of where it is ‘headed’.

of the physical universe to other fragments. This rebuts the “applicability argument” raised by Gottlob Frege against game formalism (for details, see A. Weir (2011)).”

... Podnieks: [Pdn15], §7 Game Formalism As a Philosophy of Real Mathematics.

To the extent that academics indeed follow, and implement in their teaching and research, Podnieks ‘game formalism’, his argumentation in [Pdn15] evidences—*implicitly* in practice even if not *explicitly* in belief—both:

- preference for treating knowledge as intuitively ‘Justified True Belief’ over Piccinini’s knowledge as ‘Factually Grounded Belief’ (see §5.A.; also the Author’s Preface); and
- Pantsar’s critical perspective that although ‘the formalist program uses the actual practice of mathematics as a ladder that they later discard’, and is, by itself, ‘perfectly acceptable’ since ‘it mirrors the way we strive for formal axiomatic systems in mathematics’, what is not acceptable is their disavowal of the use, and necessity, of such a ‘ladder’.

Moreover, from the *evidence-based* perspective of the Complementarity Thesis (§1., Thesis 1), disavowal of the use, and necessity, of such a ‘ladder’ can—as we have argued in §7.B.¹⁴—lead to interpretations of quantification (with seriously misleading consequences as detailed in §5.¹⁵) that have ‘subsequently been sanctified by prevailing custom in published classical, and constructivist/intuitionistic, literature and textbooks at such an early stage of any mathematical curriculum, and planted so deeply into students’ minds, that thereafter most cannot even detect its presence—let alone need for justifying quantification—in a definition or a proof sequence!’

Amongst such *misleading* consequences—for which Podnieks (for reasons detailed in §15.A.¹⁶, §17.¹⁷, and §18.¹⁸) ought not to be held accountable¹⁹ when wearing his ‘erstwhile’ philosopher’s hat (see §13.C.²⁰)—is, for instance, the following *inherited* perspective—of Rosser’s claimed ‘extension’ of Gödel’s Theorem (see [Ro36], and its putative entailments—that we could, from an *evidence-based* perspective, term as part of Podnieks’ system of ‘Justified Axiomatic Beliefs’²¹—i.e., part of Arguments 1-14 and supporting Theorems 1-5 in [Pdn15]—which Podnieks seemingly treats as both a justification of, and a justified pathway to, a ‘knowledge’ of possible ‘Justified True Beliefs’, rather than the converse (as, as argued in the concluding paragraph of §1.F.e.²², ought to be the case in order to avoid, *misleadingly*, elevating intuitively ‘Justified True Beliefs’ to ‘knowledge’ in the absence of Piccinini’s ‘Factually (*evidence-based*) Grounded Belief’):

“9 Gödel’s First Incompleteness Theorem

¹⁴§7.B.: *Faith-based* quantification.

¹⁵§5.: Three fragile Hilbertian, Brouwerian, and Gödelian, dogmas.

¹⁶§15.A.: The illusory significance of Gödel 1931.

¹⁷§17.: The significance of *evidence-based* reasoning for Rosser’s ‘extension’ of Gödel’s Theorem.

¹⁸§18.: The significance of *evidence-based* reasoning for non-standard models of PA.

¹⁹Like Wittgenstein, Lucas, Penrose and others of similar ilk (see [An07b], [An07c]), Podnieks too can, in this instance, be excused for depending upon, and being constrained by, fallible classical *and* intuitionistic, essentially *inherited*, wisdom (see also §5.) to the effect that a consistent Peano Arithmetic such as PA can admit undecidable propositions by Rosser’s reasoning, and attendant entailments.

²⁰§13.C.: Mathematics must *serve* Philosophy and the Natural Sciences.

²¹As the anecdotal incident concerning Professor Huzurbazar (see §31.; also §7.B., fn.76) illustrates, one can *choose*—for functional rather than epistemological reasons—to treat an ‘Axiomatic Belief’ as ‘Justified’, but not amounting to ‘knowledge’, even in the absence of a ‘Justified True Belief’ that Plato treats as ‘knowledge’.

²²§1.F.e.: Conclusions: Fermat’s *Lost* Argument.

The *pure mathematical contents* of Gödel's First Incompleteness Theorem, without any admixture of philosophical assessment, is represented in the following formulation (the modern version as improved by J. B. Rosser):

Theorem 1. *Assume T is a formal system of axioms (formal theory) in which the basic theorems about natural numbers $(0, 1, 2, \dots)$ can be proved. Then there are two algorithms. The first one builds, depending on the axioms of T , a formula G_T that expresses some definite statement about natural numbers. The second allows for the conversion:*

- a) *of any T -proof of G_T into a T -proof of $\neg G_T$ (the negation of G_T); and*
- b) *of any T -proof of $\neg G_T$ into a T -proof of G_T .*

From this point on, one may start drawing philosophical consequences.

The most popular first step is the (seemingly harmless) re-formulation of the theorem given below. If T is an inconsistent system, then T proves anything, G_T and $\neg G_T$ included. However, if T is a consistent system, then T can prove neither G_T , nor $\neg G_T$. Hence, the re-formulation:

Theorem 2. *If T is a consistent formal theory in which the basic theorems about natural numbers can be proved, then there is a definite statement about natural numbers that T can neither prove, nor disprove.*

In short, if T is a consistent formal theory proving the basic theorems about natural numbers, then T is *incomplete*, hence, the term "incompleteness theorem". This is still correct, but the next step leads to confusion.

Is our theory T consistent? An easy theorem follows.

Theorem 3. *If there is at least one consistent formal theory proving the basic theorems about natural numbers, then there is no algorithm that makes it possible to decide, from the axioms of T , whether or not T is consistent.*

Hence, one cannot, simply staring at the axioms, decide, are they consistent, or not.

10 Is Arithmetic Consistent?

And, if so, which theory T do we have in mind? First-order arithmetic (also called PA)? Almost all people believe, following their intuition of the natural number sequence $0, 1, 2, \dots$, that the axioms of PA are true for these numbers, and hence, "obviously", PA is a consistent formal theory. These people will not agree with the following argument.

Argument 7. *The argument about the "obvious" consistency of first-order arithmetic returns us to Argument 2 about the reliability of mathematical intuitions. Why should we regard our intuition about the natural number sequence as absolutely reliable? As we know, until 1895, Cantor's intuition of infinite sets was widely regarded as "obviously true", but then the "antinomies surrounding the Russell-Zermelo paradox" appeared. The arithmetical intuition is likely more reliable than Cantor's intuition of infinite sets, but should it be regarded as absolutely reliable?*

As a consequence of this argument, a philosophically neutral formulation of Gödel's First Incompleteness Theorem should be *symmetrical*:

Theorem 4. *If T is a formal theory in which the basic theorems about natural numbers can be proved, then T is either inconsistent, or incomplete.*

Working in T (for example, in PA, ZFC, or any more powerful theory), one will arrive inevitably either at contradictions, or at unsolvable problems belonging to the scope of the competence of T . The outcome of the process cannot be predicted in advance.

... Podnieks: [Pdn15], §10 Is Arithmetic Consistent?.

However, from the *evidence-based* perspective of this investigation, Game Formalism as exemplified by Podnieks’ ‘Justified Axiomatic Beliefs’ either contradicts, or is unable to admit, that the first-order Peano Arithmetic PA has *two*, and *only two*, *evidence-based* Tarskian (see §2.A.) interpretations over the domain \mathbb{N} of the natural numbers:

- (i) The *standard* interpretation $\mathcal{I}_{PA(\mathbb{N}, SV)}$ of PA, which interprets quantification *weakly* in terms of algorithmic *verifiability* ([An16], Theorem 5.6, p.40); whence PA is *constructively (weakly)* consistent ([An16], Theorem 5.7, p.40);
- (ii) A *finitary* interpretation $\mathcal{I}_{PA(\mathbb{N}, SC)}$ of PA, which interprets quantification *strongly* in terms of algorithmic *computability* ([An16], Theorem 6.7, p.41); whence PA is *finitarily (strongly)* consistent ([An16], Theorem 6.8, p.41).

Together, these entail:

- (i) [An16], Theorem 6.8, p.41 (see also §2.C.a., Theorem 2.16): *PA is consistent.*
- (ii) [An16], Corollary 7.2, p.41 (see also §2.E.b., Corollary 2.18): *PA is categorical with respect to algorithmic computability;*
- (iii) [An16], Corollary 8.2, p.42 (see also §2.F., Corollary 2.20) *The PA formula $[\neg(\forall x)R(x)]$ defined in Lemma 8.1 is PA-provable;*
- (iv) [An16], Corollary 8.3, p.42 (see also §2.F., Corollary 2.21) *In any model of PA, Gödel’s arithmetical formula $R(x)$ interprets as an algorithmically verifiable, but not algorithmically computable, tautology over \mathbb{N} ;*
- (v) §8.D., Theorem 8.12: *Aristotle’s particularisation does not hold in any finitary interpretation of PA under which the PA-axioms interpret as true, and the PA rules of inference preserve such truth;*
- (vi) §8.G., Lemma 8.20: *Rosser’s Rule C entails Aristotle’s particularisation;* and
- (viii) §8.G., Corollary 8.21: *Rosser’s Rule C is stronger than Gödel’s ω -consistency.*

From the *evidence-based* perspective of the Complementarity Thesis (§1., Thesis 1)—and in order to avoid the unintended *misleading* consequences highlighted above—both of Pantsar’s *pre-formal* mathematics, and Podnieks’ *formal* mathematics, ought to, thus, be viewed more appropriately as:

- merely a set of complementary, symbolic, languages (see §13.),
- intended to serve Philosophy and the Natural Sciences (see §13.C.),
- by seeking to provide the necessary tools for adequately expressing our sensory observations—and their associated perceptions (and abstractions)—of a ‘common’ external world;
- corresponding to what some cognitive scientists, such as Lakoff and Núñez in [LR00] (see also §27.), term as *primary* and *secondary* ‘conceptual metaphors’,
- in a symbolic language of unambiguous expression and, ideally, categorical communication.

Comment 3. Such a perspective is also reflected in Andrew Aberdein’s 2019 paper, *Evidence, Proofs, and Derivations*, from an educational perspective:

“One of the morals of this paper is that it is important to carefully distinguish proof from derivation. This observation certainly has profound implications for the teaching of mathematics. However, it is scarcely novel: I have already cited a paper from almost thirty years ago which addresses the educational implications of the distinction (Hanna, 1990). The role of evidence in relation to proof and derivation has received rather less attention. I have suggested that it can be successfully accommodated within the framework of argumentation schemes. Specifically, appeals to evidence can be understood as C-schemes: argumentation schemes drawn from natural language reasoning that generally fall short of rigorous proof, but can sometimes be used rigorously. In this manner, mathematical arguments that rely on evidence to provide less than rigorous support for their conclusions can be understood as belonging to the same genus as mathematical proofs, but not the same species. Thereby the importance of rigour in proof is maintained, but without misleading the student into imagining that proof is somehow entirely alien from ordinary reasoning.”

... Aberdein: [Abr19], §5. *Conclusions for Education*.

Further (see §13.E.), we may need to recognise explicitly in our basic mathematical education (see §28.) that *evidence-based* reasoning:

- (a) restricts the ability of highly expressive mathematical languages, such as the first-order Zermelo-Fraenkel Set Theory ZF, to *categorically* communicate abstract concepts (corresponding to Lakoff and Núñez’s conceptual metaphors in [LR00]; see also §27.) such as those involving Cantor’s first limit ordinal ω ²³;

and:

- (b) restricts the ability of effectively communicating mathematical languages, such as the first-order Peano Arithmetic PA, to *well-define* infinite concepts such as ω (see §18.A.a.).

In other words (as highlighted by §20.C., Cases 20.C.a. to 20.C.d., and §20.D., Case 20.D.c.), from the *evidence-based* perspective of this investigation and, ideally, that of all disciplines which appeal to currently accepted scientific methods:

- although ZF admits unique, set-theoretical, definitions of—and allows us to unambiguously talk about the *putative* existence of—‘*ideal*’ real numbers as the *putative* limits of Cauchy sequences of rational numbers, and their *putative* properties, in a mathematically defined, albeit Platonically conceived, universe,
- only PA, by virtue of the Provability Theorem for PA (see §2.E.b., Theorem 2.17), admits unique, algorithmically *verifiable*, number-theoretic definitions of—and allows us to unambiguously talk about the *categorical* existence of (see §7.I.)—*specifiable* real numbers (see §7.I., Theorem 7.5), and their properties, which can be communicated as *knowledge* (in the sense of §5.A.) when describing the actual universe we inhabit.

Mathematics, therefore, needs to be treated as a sub-discipline of linguistics (as suggested in §28.; §28.A.); and any ontological commitments associated with mathematical statements

²³See [LR00], Preface, p.xii-xiii: “How can human beings understand the idea of actual infinity?”

pertain not to the language per se, but to the conceptual metaphors that the language is intended to represent and communicate.

This is, essentially, a phenomenological perspective which resonates with what Francis Bailly and Giuseppe Longo seek to pursue, and persuade, in [BLo08]:

“Let’s conclude this paper by stressing the perspective that guided our work. In our views, the epistemological investigation of mathematics cannot be detached from a constitutive analysis of concepts and structures (and thus of the very object of knowledge) in other scientific disciplines, such as physics. This is the project that, in a very preliminary and modest fashion, but along the same phenomenological approach, we try to pursue in several papers and in [BaillyLongo06], an extension, within a scientific project, of some of the ideas we hinted here. The analogies and differences in the “phenomenology of in-completeness” is a fundamental part of it. We believe that further work should lead to an analysis of this phenomenon in other disciplines (see [LongoTe07] for some reflections on a form of causal incompleteness in biology).”

... Bailly and Longo: [BLo08], Conclusion.

If we treat his ‘particular idea’ as Lakoff and Núñez’s *primary* metaphor in [LR00], and his ‘general idea’ as their *secondary* metaphor, Babu Thaliath’s perspective in his 2019 essay [Th19] on *Language and Reference* essentially admits, and reflects, the distinction which both the Complementarity Thesis (§1., Thesis 1), and Pantsar’s perspective of *pre-formal* mathematical reasoning, seek to make as above—particularly regarding the ontological status of formally defined ‘infinite’ mathematical objects—between mathematical languages that seek adequate and unambiguous expression of human cognition, such as ZF, and those such as PA which, additionally, admit categorical communication of the intended *meaning* and *truth* of their well-formed formulas under a *well-defined* Tarskian interpretation:

“Like cognition, the language in which the cognition finds expression has, in principle, a function of synthesis, that is, a function of connecting the cognizing subject with the object of cognition. Language enables the human subject to have epistemic access to the object; in its form and function this epistemic access constitutes the necessary referentiality of the language itself. Cognition must inevitably refer to the object of knowledge in the mode of pre-linguistic-sensory and abstract-conceptual accesses, as clearly highlighted by Kant in his basic notion of the synthetic nature and structure of conceptual knowledge. This points to an aporetic ambiguity of the epistemic referentiality of language. In the process of cognition, the subject should have anepistemic access to the particular. However, the conceptual cognition departs from the particular and is directed to a general universal idea. The ambiguity between the referential access and the referential departure in cognition necessarily requires a supplementation of the abstract-logical through the pre-linguistic-sensory or aesthetic knowledge, as emphasized by Alexander G. Baumgarten in his doctrine of sensory cognition (*cognitio sensitiva*) and the aesthetic-logical truth. Such a supplementation within the framework of a theory of perception seems to establish a unique form of epistemological reference, in which the subjective-epistemic access to the particular object does not terminate in the ontological finality of a concept or conceptual cognition, but transcends the cognition into the infinity of an aesthetic perception.”

... Thaliath: [Th19], Abstract.

Further, from the *evidence-based* perspective of this investigation, both the Complementarity Thesis, and the thesis that *pre-formal mathematics* (in Pantsar’s sense in [Pan09]) precedes (and, implicitly, entails but is not entailed by) *formal mathematics*, are reflected in the case for a ‘formalism free’ mathematics as argued by Juliette Kennedy in [Knd13]; where she comments (see also §9.A.a.: *Shift in Hilbert’s focus*) that Hilbert—essentially echoing the Complementarity Thesis (§1., Thesis 1)—sought to ‘embed mathematics in a formal language with an exact proof concept and an exact semantics’ prior to Gödel’s 1931 paper [Go31]:

“§1. **Introduction.** That mathematics is practiced in what one might call a formalism free manner has always been the case—and remains the case. Of course no one would have thought to put it this way prior to the emergence of formal systems in the late nineteenth and early twentieth centuries;¹ what is interesting, to the foundationalist at least, is that mathematicians continue to practice their subject in a formalism free manner even now, in what one might call the post-foundational era.

What was the *foundational era*? This was the period inaugurated, roughly, by Frege and continuing through the first part of the twentieth century,² during which worries essentially about consistency—to simplify matters only a little—motivated the development of various foundational formal systems; a development which, if it did not exactly set those worries to rest, at least increased confidence in the unlikelihood of their ever being realized. The foundationalist objective which eventually emerged was stated in a preliminary but exact form³ by Hilbert and his school. In its full form what we are calling the formalism-oriented foundationalist program, was simply this: embed mathematics in a formal language with an exact proof concept and an exact semantics, such that the proof concept is sound and complete with respect to the associated semantics as well as syntactically complete in the sense that all propositions that can be written in the formalism are also decided. The preservation of meaning, as well as other epistemically valuable features, were important desiderata which were to be shown in various ways. Characteristic of the Hilbert Program was the demand that the formal environment, however it was conceived, be *finitary*; though what the Hilbert School meant by the term “finitary” was not clear at the time, and indeed would not be resolved, at least to a reasonable degree of satisfaction, until Tait’s 1988 [79]. The principal demand imposed by the Hilbert Program of course, was that the formalism be demonstrably, indeed internally consistent—a demand which, if met, would have assuaged qualms about the use of infinitary concepts, along with, or more precisely by means of, resolving the consistency issue. The demand for an internal consistency proof was replaced after Gödel’s 1931 Incompleteness Theorems with a multiplicity of coping mechanisms—or assertions to the effect that such were not needed, as the case may be.”

Kennedy: [Knd13], Introduction.

Thus, apropos Pantsar’s thesis that *pre-formal mathematics* not only necessarily precedes, but is the *raison d’être* for *formal mathematics*, Kennedy argues that ‘it is simply a fact that foundationalism in this form came and went with little lasting impact on mathematical practice’:

“Setting aside the interesting mathematical questions—indeed the entirely new subject areas altogether,⁴ which emerged from the various foundationalist programs of the time, it is simply a fact that foundationalism in this form came and went with little lasting impact on mathematical practice. The demonstrable failure of syntactic completeness for systems like Peano Arithmetic (via Gödel’s First Incompleteness Theorem) and the attendant collapse of the Hilbert Program (via the two Incompleteness Theorems together) affected the mathematician’s working life very minimally, if at all. The reasons for this are interesting, and though they are not strictly speaking the subject of this paper, we can take note of certain responses at critical moments. For Kreisel, a *sine qua non* of interest in the Hilbert Program was not the consistency question per se but rather the presumed equivalence of second order consequence with, “at least in suitable contexts,” formal derivability (as had been shown in the first order case).⁵ However the question is of secondary importance for mathematics, concerned as mathematics is with (in Kreisel’s terminology) *fundamental analysis*. “Logical hygiene,” as he called it, might be useful, e.g., psychologically; but independence proofs, formalization, and such like, are not what mathematics deals with at its most fundamental level. “*C’est magnifique, mais ce ne sont pas les fondements*”⁶ he would say, of formalization.”

Kennedy: [Knd13], Introduction.

Moreover, Kennedy proffer’s the perspective:

“From a completely different standpoint, Gödel echoed the thought that mathematicians and logicians are involved in two distinct enterprises. About his own Incompleteness Theorems, although they had a negative impact on e.g., the Hilbert program,⁷ in the most important conceivable

sense,⁸ they should have no impact on the working life of the average mathematician (or set theorist) otherwise: “As to problems with the answer Yes or No, the conviction that they are always decidable remains untouched by these results.”⁹ In other words, a way has to be found to set incompleteness to the side—with conviction.”

Kennedy: [Knd13], Introduction.

From the *evidence-based* perspective of this investigation, the significance of Kennedy’s interpretation of Gödel’s remarks—as implying that the Incompleteness Theorems ‘should have no impact on the working life of the average mathematician (or set theorist)’, and that ‘a way has to be found to set incompleteness to the side—with conviction’—lies in:

- (1) The argument that mathematics must serve Philosophy and the Natural Sciences (§13.C.);
- (2) The distinction sought to be made between languages that adequately represent our primary and secondary conceptual metaphors; and languages that can categorically communicate only *some* such metaphors (§13.E.)
- (3) The Provability Theorem for PA²⁴, which bridges PA provability and Turing computability, entails that PA is categorical with respect to algorithmic *computability*²⁵; whence it does not admit *undecidable* propositions²⁶ (hence PA has no non-standard model; see §18.).

Moreover, we note that the *pictorial* ‘pre-formal’ proofs of Fermat’s Last Theorem in §1.E. and §1.F., and those of the Four Colour Theorem in §1.I., can be viewed as essentially seeking an *understanding*—in Kennedy’s following sense—of *why* these Theorems can be treated as *mathematical truths* that can (only?) *then* be appropriately expressed and proven in some formal system:

“This paper is an attempt to arrange a differently interested encounter with the concept of formalization, in the light of the tendency in mathematical logic over the last century to bend away from foundational epistemology and towards the subject of mathematics itself, and the project, simply put, of understanding it more fully. Expressing an attitude toward formalization which is *opportunistic* rather than foundational, in that very simple sense the contemporary model theorist, for example, is, at best, a local foundationalist—wanting to shed light on a certain area of the practice, but eschewing any attempt to supply a global foundation for it.”⁹ In other words, a way has to be found to set incompleteness to the side—with conviction.”

Kennedy: [Knd13], Introduction.

From the *evidence-based* perspective of this investigation, Kennedy’s thesis, that ‘the notion of computability be replicated, not for the notion of computable function but for the concept of definability—witnessing *its* formalism independence, as it were’, seems to share the insight that a mathematical truth must be ‘evidenced’ *algorithmically* (in Chetan Murthy’s sense; see §2.), for it to be treated as knowledge in Piccinini’s sense of ‘Factually Grounded Belief’, and not merely as knowledge which is intuitively ‘Justified True Belief’ (see also §5.A.: *What is knowledge*):

²⁴[An16], Theorem 7.1: *A PA formula $[F(x)]$ is PA-provable if, and only if, $[F(x)]$ is algorithmically computable as always true in \mathbb{N} . See also §2.E., Theorem 2.17.*

²⁵[An16], Corollary 7.2. See also §2.E.b., Corollary 2.18.

²⁶[An16], Corollary 8.2. See also §2.F.

“Our point, simply put, is this: while the syntax/semantics distinction is still very much with us, so is formalism freeness. For Brouwer the radical decoupling of mathematics with language and its grounding in time intuition, was its fundamental feature. We read Gödel’s 1946 lecture as an important but perhaps overlooked step in this line of thought, not with respect to language necessarily, or to time intuition, but with respect to formalization altogether; in particular we will interpret Gödel there as making the suggestion, albeit in a preliminary form, that Turing’s analysis¹² of the notion of computability be replicated, not for the notion of computable function but for the concept of definability—witnessing *its* formalism independence, as it were. We will sketch at the end of this paper an implementation of this, based on our interpretation of that lecture.”

Kennedy: [Knd13], Introduction.

1.B. Logic as a methodological tool

Further, the epistemological perspective (compare Gila Sher [Shr18]) of the Complementarity Thesis (§1., Thesis 1) is that (see §12. and §13.F.) logic, too, can be viewed as merely a methodological tool that seeks to formalise an intuitive human ability that pertains not to the language which seeks to express it formally, but to the cognitive sciences in which its study is rooted:

Definition 1. (Well-defined logic) *A finite set λ of rules is a well-defined logic of a formal mathematical language L if, and only if, λ assigns unique, evidence-based, values:*

- (a) *Of provability/unprovability to the well-formed formulas of L ; and*
- (b) *Of truth/falsity to the sentences of the Theory $T(U)$ which is defined semantically by the λ -interpretation of L over a given mathematical structure U that may, or may not, be well-defined; such that*
- (c) *The provable formulas interpret as true in $T(U)$.*

Comment 4. We note that although the question of whether or not λ categorically defines a unique Theory $T(U)$ is mathematical, the question of whether, and to what extent, any Theory $T(U)$ succeeds (in the sense of Carnap’s *explicatum* and *explicandum* in [Ca62a]) in faithfully representing the structure U —which, from the *evidence-based* perspective of this investigation, can be viewed as corresponding to Piantar’s *pre-formal mathematics* in [Pan09] (§4. Formal and pre-formal mathematics)—is a philosophical question for the cognitive sciences (cf. [LR00]; see also §27.), where:

“By the procedure of *explication* we mean the transformation of an inexact, prescientific concept, the *explicandum*, into a new exact concept, the *explicatum*. Although the explicandum cannot be given in exact terms, it should be made as clear as possible by informal explanations and examples. . . . A concept must fulfill the following requirements in order to be an adequate explicatum for a given explicandum: (1) similarity to the explicandum, (2) exactness, (3) fruitfulness, (4) simplicity.”

... Carnap: [Ca62a], p.3 & p.5.

In other words—a view that resonates with Ludwig Wittgenstein’s perspective in the *Tractatus* (see Frascolla: [Fra94], § The “Knowledge” of Forms: Vision and Calculation, pp.24-27)—a mathematical or logical truth is merely an assertion of the reliability of a mathematical language to faithfully *express* that which is sought to be expressed formally within the language. It has no bearing on the *ontological status* of that which is sought to be expressed within the language.

Comment 5. We note that such an *evidence-based* definition of logic (see also §12.)—as an, essentially, human construct which is neither of an empirical nature nor a priori, but intended only for validating (in the sense of §1.J.) and, ideally, enabling categorical scientific, and philosophical, communication between intelligences with a lingua franca (in the sense of §13.C.)—seemingly resonates not only with the influence of Wittgenstein’s perspective on Heisenberg’s attempted interpretation of quantum mechanics as perceived by Patrizia Piredda in [Prd23], but also with her intent ‘to formulate a new logic, namely quantum logic’ that, prima facie, seeks to ground the perceived anomalies of quantum mechanics in the mathematical language we use to represent those of our conceptual metaphors that reflect our observations/experiences of physical phenomena (an intent reflected more in §23., §23.A., §23.C., and §23.D.g.):

“The new discoveries of QM led to reassessing, broadening the meanings of many physical concepts, and formulating a new logic that was no longer based on the classical principles of non-contradiction, identity, and causality. Heisenberg considered the classical logic and the conception of language expressed in the *Tractatus Logico-Philosophicus* inadequate for the understanding of the problems of language with which the physicists of the Copenhagen school had had to deal in order to define the foundations of Quantum Mechanics. On the contrary, he saw in Wittgenstein’s posthumous *Philosophical Investigations* the key to solving those problems. One may formulate a proposition and state that the use of language described in the *Tractatus* fits the use of language in Classical Mechanics, as the use of language described in *PI* fits the use of language in QM. In this article, I interpret the reflections of the physicists of the Copenhagen school on the limits of language relative to QM by highlighting how the epistemological revolution of quantum physics shares a conception of language similar to that expressed by late Wittgenstein in *PI*. By doing so, I also aim to explain why Heisenberg considered it inappropriate to subsume the propositions and concepts of QM under the rules of the propositional logic of *Tractatus*. Furthermore, I explain why the philosophy of language expounded in *PI*, which is based on language games and resemblance families, sheds a light on how and why QM has contributed to renewing existing concepts (such as space, trajectory, observer, etc.) and to formulate a new logic, namely quantum logic.”

... Piredda: [Prd23], Abstract.

The goals of proof theory and constructive mathematics²⁷ ought to, thus (as argued in Part III, §13.E.), be viewed as necessarily interdependent and complementing, rather than being independent of, or in conflict with, each other as to which is more ‘foundational’.

A similar perspective towards the need for re-appraisal of the role of semantics in the syntactical development of formal mathematical and, implicitly, pre-formal mathematical and physical, structures and theories is argued for by philosophers Décio Krause and Jonas R. B. Arenhart in [KA19]:

“... the central issue concerns whether scientific theories (specifically, empirical theories) are more properly characterized as syntactical entities, in terms of formal languages and sets of axioms and inference rules expressed in such formal language, or as semantic entities, in terms of classes of models and/or structures (there is disagreement over whether structures and models are the same kind of thing and about which is more appropriate for the semantic approach, as we shall see soon). It is generally agreed that the semanticists have won the battle, and the semantic approach is now considered as the new orthodoxy [Con.06]. Now, as we have remarked, it should come as no surprise that the semantic view established itself, given that the syntactic view was seen as unable to deal with its criticisms even before the semantic approach clearly emerged. Along with the rise of the new orthodoxy, a less rigorous and less formal-friendly mood has dominated the philosophical studies of scientific theories.

²⁷Corresponding to what Gila Sher terms in [Shr18] as ‘proof-theoretic’ and ‘truth-theoretic’ approaches to the classical perspective of ‘logic’.

However, apart from how the story is usually told, new studies on the Received View are emerging and along with them, a more faithful understanding of the characterization of scientific theories by the Logical Empiricists is being achieved. With the publication of such works, we start to understand that the debate is presented in such a way that is not favorable to the syntactical approach; in fact, the Received View is generally presented as a caricature of a highly naive and implausible view (see [Lut.12], [Hal.15] and the references in those works). The syntactic approach, mainly *identified* with the approach advanced by some members of the Vienna Circle such as Carnap and Hempel, was criticized in almost every aspect. As it was characterized by its opponents, it really did suffer from profound difficulties as an approach to scientific theories. Perhaps the heavier criticisms seem to be those accusing it of too radical deviance of actual scientific practice, mainly due to its heavy reliance on first-order logic and axiomatization. As an account of scientific theories, the Received View failed badly by distancing itself from real science and by relying so heavily on formal tools and techniques (or, at least, so the argument goes).

The semantic view, on the other hand, seemed to be completely different from the syntactical view in those aspects, keeping close to actual scientific practice and not requiring that scientific theories be formulated in any specific language. In particular, the last feature was erected as a great virtue of the view and defended by van Fraassen and his followers (see for instance [vanF.89, pp.221, pp.225-6]). The so-called model revolution initiated by Patrick Suppes in the '60s would be reduced to nothing if language were allowed to play a substantial role in the formulation of a theory (the claim is not from Suppes himself, but see [Sups.60, Sups.67] and [Mul.11, sec.6]). However, as we shall discuss in what follows, it is perhaps this sole requirement of being 'language free' that makes the semantic approach almost senseless, while at the same time it is this requirement that allegedly marks a radical divide between both approaches nowadays. Leave that requirement out and we have a position that can, perhaps, be made compatible with a syntactical approach too.

We shall not attempt to present here a revision of the literature about the whole dispute. However, given that the following chapters will deal with issues that are related to both the semantic and the syntactic approaches, and references shall be made to those approaches, we shall give here to the reader a brief summary of the debate and present reasons for its seemingly going out of the tracks. Our aim is not to promote one of the approaches as superior, but rather to argue that scientific theories may be profitably studied by the philosopher and by those interested in foundations from many distinct points of view. Instead of a competition between distinct approaches, we propose that they do complement each other. This kind of claim will involve another revision of the attitude towards the relation between theories in real scientific practice and our rational reconstruction of them for philosophical purposes. As we shall argue, our constructs may employ distinct technical resources, and it is not clear that they should reproduce in every detail their informal counterparts. Perhaps formalized theories (be it in a formal language or some set theory) gain a life of their own, helping us to understand their informal counterparts; that is their purpose."

... Krause/Arenhart: [KA19], Chapter 1, *The Quandary on the Characterization of Scientific Theories*, pp.2-3.

Comment 6. The significance of Krause and Arenhart's remark that it 'is generally agreed that the semanticists have won the battle' is seen in the following comment made by Professor Leo Harrington, during a brief 10 minute meeting in his office at UC, Berkeley, in the summer of 1996, when the author brought to his attention that the Deduction Theorem in first-order logic implicitly favoured a particular interpretation of quantification:

"Now you've got me worried. That's why I tell my students to avoid arguing in the formal theory, and to argue only in the model".

... Harrington: *Anecdotal comment, 1996*

Nearly 25 years on, in a remarkably candid, humble and humbling, admission of a learned lesson, (now emeritus) Professor Harrington not only confirms, and endorses, his 1996 remark as reflective of his preference towards interpreting quantification semantically, despite an inability to communicate the semantics categorically, but—implicitly echoing Krause and Arenhart's perspective—remarks that the price paid for such a 'valuable insight' (presumably of a putative barrier towards categorical

communication that might be unsurmountable, and not merely a personal limitation) may involve having ‘lost touch with something also valuable’:

“After almost 25 years, I do not recall the 10 minute meeting, but I can definitely validate my philosophic concerns about quantification. When teaching undergraduate mathematical logic, I have been acutely aware of the divide in the class between those who understood the semantic approach, and those who did not; and I have been acutely aware of being unable to actually explain it to those who did not, since any explanation was dependent on the presumption that the English language already entailed the mathematical meaning of quantification.

I am also acutely aware that during the course of the twentieth century mathematicians have lost something, we no longer know how to fully feel a verification from within—we only believe in external universally recognizable proofs. We have learned an extremely valuable insight, but thereby also lost touch with something also valuable.

I recently made contact with someone who I believe would be extremely interested in your book. I have the urge to forward him the link you sent; but am checking with you first to see if that is acceptable to you, or should I instead just inform him of your book’s upcoming appearance.”

... *Harrington: Personal communication, 1st November 2020.*

From the evidence-based perspective of this investigation, however, we would view such a putative inability to communicate the semantics of quantification categorically as merely reflecting (see also §13.E.):

(a) in the first-order Set Theory ZF an implicit commitment to an in-principle unverifiable, faith-based (as detailed in §7.B.), interpretation of formal quantification that is essentially as defined by Hilbert in his ε -calculus (which can be viewed as uncritically treating the mathematical meaning of formal quantification as entailed by any language of common discourse in which it is sought to be interpreted);

(b) in the first-order Peano Arithmetic PA an absence of the distinction between algorithmic computability (when interpreting, for instance, the universal quantifier as ‘For all x ’ as detailed in §7.C.), and algorithmic verifiability (when interpreting, for instance, the universal quantifier as ‘For any specified x ’ as detailed in §7.C.).

As expressed also in [BKPS] by Samuel R. Buss (albeit obliquely in his perspective on the significance of Proof Theory for the mathematical sciences in general, and computer science in particular) in the context of the development of a mechanical intelligence (AI) that can be respected on a par with human intelligence (compare the Turing Test detailed in §21.E., Query 22):

“I wish to avoid philosophical issues about consciousness, self-awareness and what it means to have a soul, etc., and instead seek a purely operational approach to artificial intelligence. Thus, I define artificial intelligence as being constructed systems which can reason and interact both syntactically and semantically. To stress the last word in the last sentence, I mean that a true artificial intelligence system should be able to take the meaning of statements into account, or at least act as if it takes the meaning into account. There is some debate about whether logic is really a possible foundation for artificial intelligence. The idea that logic should be the foundation for AI has fallen out of favor; indeed, much of the work of artificial intelligence today is done with non-discrete systems such as neural nets, which would not count as part of proof theory. To the best of my knowledge, there is only one large-scale present-day attempt to build an AI system based on logic, namely the Cyc system, and this so far has not reported significant success in spite of a massive effort. Nonetheless, it is my opinion that purely analog systems such as neural nets will not provide a complete solution of the AI problem; but rather, that discrete processing, including proof theoretic aspects, will be needed for constructing AI systems.”

... *Buss: [BKPS], §3, Proof Theory and Logic for Computer Science, p.8.*

1.C. The foundational significance of the Complementarity Thesis and of *evidence-based* reasoning

The foundational significance of the Complementarity Thesis (§1., Thesis 1) for the physical sciences (see Query 18) is highlighted in Part IV, §20.C., Cases 20.C.a. to 20.C.d.; and its paradigm-challenging consequences in §23.

Comment 7. For instance, one could interpret the first order Peano Arithmetic PA so that the numeral [1] interprets as a grain of sand, and the numeral [n] interprets as a heap of n grains of sand. By the Provability Theorem for PA (see §2.E.b., Theorem 2.17), the theorems of PA then interpret as:

- all the possible arithmetically definable—in classical mechanics—properties of, and relations between, heaps of sand located *anywhere* in the universe that, by Definition 10, we can *evidence* as algorithmically *computable* truths which are both *determinate* and *predictable*;

as well as:

- all the possible arithmetically definable—in quantum mechanics—properties of, and relations between, *accessible* heaps of sand in the universe that, by Definition 7, we can only *evidence* as algorithmically *verifiable* truths which are *determinate* but not necessarily *predictable*.

Finally, the foundational significance of *evidence-based* reasoning and the Complementarity Thesis (§1., Thesis 1) for mathematics education, and the philosophy of mathematics education, is addressed in §28.; albeit briefly, since doing justice to the subject of what mathematics is (see, for instance, §13.; also §1.L.), and how mathematics and the philosophy of mathematics, respectively, ought to be taught as suggested by Thesis 1, is outside the ambit and competence of this investigation.

We note that the above, *evidence-based-by-consensual* methodology, perspective of this investigation is nothing new. For instance, treating knowledge as Gualtiero Piccinini's *factually grounded belief* (see [Pic19]) rather than as intuitively *justified true belief*, seemed natural to ensure the certitude that—given the limitations of languages of common discourse for expressing conceptual metaphors unambiguously and communicating them categorically—early Indian mathematicians (like those elsewhere) sought in both their deliberations and practice. As P. P. Divakaran observes in [Dvk18]:

“As a general rule practising mathematicians in India, like those elsewhere, did not mix their science with its metaphysical and logical foundations, with one fortunate exception. When someone as articulate and as deeply reflective about his vocation as Nilakantha speaks about how we acquire new knowledge and how we are to know it to be true (the three wise books, Chapter 9.2), we have to listen. It is more than likely that his thoughts are not just personal but mirror the epistemic ethos of his time and place and perhaps that of Indian mathematics as a whole from the time of Aryabhata; after a thousand years, the insistence on the supremacy of the intellect (*mati*) continues to echo in these pronouncements. In slightly oversimplified terms, here is the model he proposes (a more analytic account in the canonical philosophical language will be found in Narasimha, cited above, and references therein).

The primary instrumentality of our apprehension of the world is our senses, not only of the astronomical world but even of the mathematical (visual geometry such as in cut-and-shift proofs, 3-dimensional geometric versions of algebraic identities, etc.). The sense data are to be subjected to analysis and tentative inferences drawn by means of our mental faculties, our ability to compute included. These are then exposed to scrutiny by the knowledgeable, debated and revisions made if necessary, and shared with pupils, thus sustaining a living chain of continuity. Nilakantha

would not go out of his way to run down revealed wisdom, *śruti*, (his remote predecessors from 9th century Mahodayapuram in Kerala had already done that with their derisive remarks about *paurāṇika śruti*, the supposed revelations of the Puranas) and he has reverence for the words of the great teachers from the past. But he is uncompromising about the need to subject prior knowledge, whether revealed or merely uttered by mortals and lodged in an abstract communal memory (*smṛti*), to the tests of observation and logical inference and rejected if found wanting. In an uncanny paraphrase of Aryabhata's "*svamatināvā*", but more modestly, he says: "Everything here (the proof of the theorem of the diagonal) is rooted in *yukti* (about which, see below) alone, not in the beliefs and practices of yore (*āgama*)". And, as for the primacy of observation, he practised what he preached, taking upon himself the mission of campaigning for his teacher Parameshvara's *Ḍṛggaṇita* revision, forced by fresh data, of the planetary model of Aryabhata, no less.

The principles on which the practice of mathematics in India was grounded were not, thus, very rigid or 'theoretical' (Nilakantha says that theories are unending and inconclusive) and they could not have been more different from the inflexible frame in which Euclid's austere axiomatic-deductive system was confined. There were no unquestionable first principles to help choose, once and for all, a set of postulates and rules of logic, or to decide what objects needed to be defined. Instead we have a more dynamic and fluid foundation that was built from intelligent, rigorously exercised common sense so to say, and responsive to accumulated experience. The idea of an infallible set of axioms leading, by equally infallible logic, to mathematical truths of unquestionable certitude would not have been given a hearing: if all knowledge is contingent, how can it be otherwise for metaknowledge, the knowledge that some part of that knowledge is (or is not) true? How then did Indian mathematicians know or decide that their mathematical insights were indeed true?

The answer, the only satisfactory one given their philosophical stance, is in the last two of Nilakantha's tests of validation: there is no absolute criterion but only a convergence towards a consensus; the search for the infallible proof is ultimately a futile search, "unending and inconclusive" like all theorising. In practice most mathematicians seem to have been happy to leave the judgement to their peers, as Bhaskara II suggests in his comparison of a putative proposition whose *upapatti* does not get the approval of the assembly of the learned to rice without butter, unpalatable. The miracle is that the mathematics that this philosophical openness produced is true (and interesting) mathematics by contemporary axiomatic-deductive standards. Or, perhaps, there is no miracle; perhaps the universal and immutable truths of mathematics are open to all gifted and prepared minds—even of those who never heard of Plato and Aristotle."

... Divakaran: [Dvk18], Chapter 15.1, pp.402-403

That the significance of defining mathematical 'knowledge'—and, ipso facto, mathematical 'truth'—in terms of a consensus amongst a 'community of mathematicians'²⁸ is nothing new, is also highlighted by M. D. Srinivas in [Sra05]:

"3.4 *Upapatti* and "Proof"

We now summarize our discussion on the classical Indian understanding of the nature and validation of mathematical knowledge:

1. The Indian mathematicians are clear that results in mathematics, even those enunciated in authoritative texts, cannot be accepted as valid unless they are supported by *yukti* or *upapatti*. It is not enough that one has merely observed the validity of a result in a large number of instances.
2. Several commentaries written on major texts of Indian mathematics and astronomy present *upapatti*-s for the results and procedures enunciated in the text.
3. The *upapatti*-s are presented in a sequence proceeding systematically from known or established results to finally arrive at the result to be established.

²⁸Reflecting the evidence-based-by-consensual methodology perspective of mathematical 'truth', implicit in the Complementarity Thesis (§1., Thesis 1) of this investigation.

4. In the Indian mathematical tradition the *upapatti*-s mainly serve to remove doubts and obtain consent for the result among the community of mathematicians.
5. The *upapatti*-s may involve observation or experimentation. They also depend on the prevailing understanding of the nature of the mathematical objects involved.
6. The method of *tarka* or “proof by contradiction” is used occasionally. But there are no *upapatti*-s which purport to establish existence of any mathematical object merely on the basis of *tarka* alone.
7. The Indian mathematical tradition did not subscribe to the ideal that *upapatti*-s should seek to provide irrefutable demonstrations establishing the absolute truth of mathematical results. There was apparently no attempt to present the *upapatti*-s as a part of a deductive axiomatic system. While Indian mathematics made great strides in the invention and manipulation of symbols in representing mathematical results and in facilitating mathematical processes, there was no attempt at formalization of mathematics.

The classical Indian understanding of the nature and validation of mathematical knowledge seems to be rooted in the larger epistemological perspective developed by the *Nyāya* school of Indian logic. Some of the distinguishing features of *Nyāya* logic, which are particularly relevant in this context, are: That it is a logic of cognitions (*jñāna*) and not “propositions”, that it has no concept of pure “formal validity” as distinguished from “material truth”, that it does not distinguish necessary and contingent truth or analytical and synthetic truth, that it does not admit, in logical discourse, premises which are known to be false or terms that are non-instantiated, that it does not accord *tarka* or “proof by contradiction” a status of independent *pramāṇa* or means of knowledge, and so on.³³

Fn33: For a discussion of some of these features, see J.N.Mohanty: Reason and Tradition in Indian Thought, Oxford, 1992.

... Srinivas: [Sra05], §3.4 Upapatti and “Proof”.

The *evidence-based-by-consensual* methodology perspective of mathematical ‘truth’, implicit in the Complementarity Thesis (§1., Thesis 1) of this investigation, is also reflected in Giovanni lorio Giannoli’s more contemporary 1997 analysis, in [Gia97], of how mathematical truth has been, still is, and ought to be, perceived. When viewed from an AI perspective²⁹ of Lucas’ and Penrose’s Gödelian arguments (see §21.), Giannoli cogently argues that:

“If one conceives “reductionism” in its current epistemological meaning, i.e. as a fact of *intertheoretic reduction*⁶ (or at most as a fact of *psychophysiological* and *psychophysical parallelism*⁷), rather than as the turning of some ontological level (some substance) into other “fundamental” levels (into primary substances), there is no need for a dodge like “Strong AI” to provide models of mental activity. In this framework, one can perfectly well admit that every model constructed is a mere conjecture, even if one is trying to reduce certain mental activities to physical laws, to quantitative relationships, in a suitable formal language.

Obviously, seeking to reduce some “mental powers” to *intentional stances* is not at all identical or equivalent to reduce these “powers” to *functional states*, or to *physical quantities*, or to *biological processes*, or to *configurations in a logical network*. In fact, all these different attempts refer to specific “ontological” commitments, if we accept Quine’s suggestion⁸ that the use of quantifiers in scientific theories compels the theoretician to believe that the “universe” he is defining is not empty. But this is not relevant to the present discussion. As a matter of fact, here it suffices to admit that reductionism is consistent with a hypothetico-deductive conception of scientific theorizing, whatever “universe” the theorist prefers. Therefore, it is not shocking to maintain that even *the attempt to show that machines are able to solve certain semantic problems is inevitably supported by preliminary conjectures and theoretical conventions.*”

... Giannoli: [Gia97], §1. Preliminary Remarks.

²⁹A perspective which, from the *evidence-based* perspective of this investigation, is however critically weakened by uncritical, and unnecessary, appeal to Gödel’s—albeit arguably—misleading (see §15.A.; also §15.C.) interpretations of his own formal argumentation in [Go31].

since:

- “any semantic interpretation can be represented as a functional relation between the input and the output of a suitable transducer; . . .
- semantics and syntax do not constitute separate and opposite logical fields, since every semantic relation, between different terms of the given object language, is established within an appropriate syntactical meta-language; . . .
- “truth” can be asserted only in terms of conventional assumptions, which apply equally to the “mind” as to any other machine.”

“Many critics of AI contend that the proof of the “stupidity” of machines was established in the thirties, on account of the famous “limitative theorems” of Gödel, Turing, Tarski, and others. Being endowed with strictly syntactical ability, machines would by nature be incapable of “understanding”. More specifically, they would be unable to evaluate the truthfulness of certain propositions. The following work shows that: — any semantic interpretation can be represented as a functional relation between the input and the output of a suitable transducer; therefore, the ability to “understand” banally depends on the interface with the environment; — semantics and syntax do not constitute separate and opposite logical fields, since every semantic relation, between different terms of the given object language, is established within an appropriate syntactical meta-language; — precisely in the light of the work done in the thirties, “truth” can be asserted only in terms of conventional assumptions, which apply equally to the “mind” as to any other machine.”

. . . *Giannoli: [Gia97], Abstract.*

Giannoli argues that ‘the presumption that the reference of an interpretation should appear clothed as a concept, or a “mental state”, ignores that ‘in fact the nervous system, from the peripheral sensors to the cerebral cortex, is nothing but a sophisticated network of transducers’:

“In an elementary sense, it can be said that syntax is concerned with the purely formal structure of language, entirely leaving apart interpretation. To semantics, on the other hand, is assigned the field of meaning (the signified); that is—schematically—the area of relationships between symbols, objects, and concepts. Roughly speaking, syntax has the role of dictating the rules of formation and derivation of the sentences within a given language, while semantics is concerned with reference between symbols and other symbols, entities, or values, defined within particular codomains. Traditionally, following the schema of Frege, one can restrict his consideration to a codomain made up of only two elements: the “truth-values”, true and false. Note that these logical values are in their turn simply symbols within a formal language, and it is entirely improper to evoke any ontological significance.

In fact, even though the truth-values are entirely neutral with respect to ontological questions, when one refers to semantics one alludes in some way to a close relationship between the plane of expression, the plane of material things, and the plane of concepts. Semantics is thus given a role that is clearly overdetermined with respect to the faculties of reason, which can only conjecture about such relationships. In a more rigorous conception, a “flatter” conception of the semantic relationship is needed, in which symbols, material things and thoughts have the same generic status as “entities”, that is, abstract nodes of multiple relationships, each capable of being at the same time both signified and signifier of another. If one then admits that for every “mental state” there is a corresponding physical, cerebral state, since it is quite feasible to express things and material symbols in a physicalistic language, all the entities that semantics treats could be described as signals, as simply differences of physical quantities in space-time.

In any case, whatever language is chosen to describe the objects proper to a semantic relationship, one must admit that such a relation, from a more abstract and elementary point of view, consists simply in a correspondence between entities, formally expressible as a function that maps a given domain onto a given codomain; nothing more seems to be required to achieve an interpretation.

Looked at this way, and granted that a semantic interpretation defines nothing more than a functional relation between entities, one might ask why a transducer shouldn't be considered to be a system endowed with semantics, however elementary: a dynamo is the site of a functional relation between a velocity and an intensity of electric current; a microphone transforms pressure into a variation of electrical resistance; a photo-cell causes a current to correspond to an intensity of light. Probably the reluctance to consider such objects as the sites of true semantic relationships comes from the presumption that the reference of an interpretation should appear clothed as a concept, or a "mental state". As a rule, one tends to reject the idea that the correspondent of any concept is only a given physical configuration, or activity, of the cerebral system; in fact the nervous system, from the peripheral sensors to the cerebral cortex, is nothing but a sophisticated network of transducers."

... Giannioli: [Gia97], §3. *Syntax and Semantics*.

Thus Giannioli's thesis is that '*mathematics is not self-expressive about truthfulness*, nor are mathematical truths apodictical: we have to reach some kind of agreement about them':

"Preliminary to discussing what amount of conventional agreement is unavoidable in treating mathematical "Truth", let us briefly consider the problem of semantic interpretation. In what follows, I will assume the familiar (long-standing) schema that "to give an interpretation" means "to refer something to some other thing", i.e. "to fix a relationship between domain and codomain" in a suitable universe. In keeping with the reductionistic attitude of the present paper, I will take the "domain" and "codomain" as "input" and "output" of a suitable *transducer*, which I conceive of as a "device" engaged in interpretation. No doubt some readers will be utterly skeptical about the possibility of such a "device". A further treatment is given in a previous paper of mine (and in Section 3 below); for the moment it is enough to say that this *flat* conception of semantics finds its main purpose in rejecting all Platonic approaches to the problem of "meaning". As concerns the interpretation of statements in arithmetic, for instance, I will admit that the semantic referent of a certain formula written on a piece of paper could be found in physical states of some brain, or perhaps in the vibrations produced by my voice stating that formula, or perhaps in some graphs drawn on another piece of paper, and so on; I only exclude that it is possible to look for this referent in some "Hyperuranium". That is all.

Connected with the foregoing is the problem of "mathematical truth", which is the main theme of the present paper.

It is well known that every term of a formalized language—before any interpretation—has its own preliminary "definition" (more precisely: it is "introduced") on account of the conditions (list of symbols and rules) of the language itself. According to D. Hilbert (and to the great Italian mathematicians who grappled with the foundations of mathematics and geometry at the beginning of this century, such as G. Veronese, F. Enriques, G. Peano and C. Burali-Forti), these "implicit definitions" constitute a sort of "implicit meaning", which provides a full, preliminary semantics to the language (to geometry, for instance), even if further interpretations (associating numbers to points, or dots, or tomatoes, or whatever) are still not given. But this full, implicit semantics is completely useless for the problem of "Truth". In fact, as will be better recalled in Section 5, below, no sufficiently rich formalized language is semantically complete, so in these languages it is not possible to provide adequate definitions of many semantic concepts (such as "Truth"). In short, *mathematics is not self-expressive about truthfulness*, nor are mathematical truths apodictical: we have to reach some kind of agreement about them."

... Giannioli: [Gia97], §1. *Preliminary Remarks*.

1.D. The significance of *pre-formal, evidence-based* (pictorial) proofs for $P \neq NP$, Fermat's Last Theorem, 4CT

The significance of, and need for greater appeal to:

- Piccinini's concept (see [Pic19]) of 'knowledge' as *factually grounded belief* for justifying and/or treating the axioms of a formal system as 'self-evident', and
- Pantsar's concept (see [Pan09]) of *pre-formal*, implicitly 'intuitively understandable' and *evidence-based*, mathematics (and proofs) as the *raison d'être* of formal mathematics (and proofs),

is reflected in M. D. Srinivasan's 'Proofs in Indian Mathematics' ([Sra05]), where he apprehensively remarks that:

"...there is also the growing awareness that the ideal of mathematics as a formal deductive system has had serious consequences in the teaching of mathematics. The formal deductive format adopted in mathematics books and articles greatly hampers understanding and leaves the student with no clear idea of what is being talked about ..."

and concludes by hoping, albeit somewhat pessimistically, for a shift 'Towards a new epistemology for Mathematics':

3.5 Towards a new epistemology for Mathematics

Mathematics today, rooted as it is in the modern Western tradition, suffers from serious limitations. Firstly, there is the problem of 'foundations' posed by the ideal view of mathematical knowledge as a set of infallible eternal truths. The efforts of mathematicians and philosophers of the West to secure for mathematics the status of indubitable knowledge has not succeeded; and there is a growing feeling that this goal may turn out to be a mirage.

After surveying the changing status of mathematical truth from the Platonic position of "truth in itself", through the early twentieth century position that "mathematical truth resides ... uniquely in the logical deductions starting from premises arbitrarily set by axioms", to the twentieth century developments which question the infallibility of these logical deductions themselves, Bourbaki are forced to conclude that:

To sum up, we believe that mathematics is destined to survive, and that the essential parts of this majestic edifice will never collapse as a result of the sudden appearance of a contradiction; but we cannot pretend that this opinion rests on anything more than experience. Some will say that this is small comfort; but already for two thousand five hundred years mathematicians have been correcting their errors to the consequent enrichment and not impoverishment of this science; and this gives them the right to face the future with serenity.³⁵

Fn35: N.Bourbaki, *Elements of Mathematics: Theory of Sets*, Springer 1968, p.13; see also N.Bourbaki, *Elements of History of Mathematics*, Springer 1994, p.1-45.

Apart from the problems inherent in the goals set for mathematics, there are also other serious inadequacies in the Western epistemology and philosophy of mathematics. The ideal view of mathematics as a formal deductive system gives rise to serious distortions. Some scholars have argued that this view of mathematics has rendered philosophy of mathematics barren and incapable of providing any understanding of the actual history of mathematics, the logic of mathematical discovery and, in fact, the whole of creative mathematical activity.³⁶

There is also the inevitable chasm between the ideal notion of infallible mathematical proof and the actual proofs that one encounters in standard mathematical practice, as portrayed in a recent book:

On the one side, we have real mathematics, with proofs, which are established by the ‘consensus of the qualified’. A real proof is not checkable by a machine, or even by any mathematician not privy to the *gestalt*, the mode of thought of the particular field of mathematics in which the proof is located. Even to the ‘qualified reader’ there are normally differences of opinion as to whether a real proof (i.e., one that is actually spoken or written down) is complete or correct. These doubts are resolved by communication and explanation, never by transcribing the proof into first order predicate calculus. Once a proof is ‘accepted’, the results of the proof are regarded as true (with very high probability). It may take generations to detect an error in a proof ... On the other side, to be distinguished from real mathematics, we have ‘meta-mathematics’ ... It portrays a structure of proofs, which are indeed infallible ‘in principle’ ... [The philosophers of mathematics seem to claim] that the problem of fallibility in real proofs ... has been conclusively settled by the presence of a notion of infallible proof in meta-mathematics ... One wonders how they would justify such a claim.³⁷

Fn36: I.Lakatos, Proofs and Refutations: The Logic of Mathematical Discovery, Cambridge 1976.

Apart from the fact that the modern Western epistemology of mathematics fails to give an adequate account of the history of mathematics and standard mathematical practice, there is also the growing awareness that the ideal of mathematics as a formal deductive system has had serious consequences in the teaching of mathematics. The formal deductive format adopted in mathematics books and articles greatly hampers understanding and leaves the student with no clear idea of what is being talked about.

Notwithstanding all these critiques, it is not likely that, within the Western philosophical tradition, any radically different epistemology of mathematics will emerge; and so the driving force for modern mathematics is likely to continue to be a search for infallible eternal truths and modes of establishing them, in one form or the other. This could lead to ‘progress’ in mathematics, but it would be progress of a rather limited kind.

If there is a major lesson to be learnt from the historical development of mathematics, it is perhaps that the development of mathematics in the Greco-European tradition was seriously impeded by its adherence to the cannon of ideal mathematics as laid down by the Greeks. In fact, it is now clearly recognized that the development of mathematical analysis in the Western tradition became possible only when this ideal was given up during the heydays of the development of “infinitesimal calculus” during 16th – 18th centuries. As one historian of mathematics notes:

It is somewhat paradoxical that this principal shortcoming of Greek mathematics stemmed directly from its principal virtue—the insistence on absolute logical rigour ... Although the Greek bequest of deductive rigour is the distinguishing feature of modern mathematics, it is arguable that, had all the succeeding generations also refused to use real numbers and limits until they fully understood them, the calculus might never have been developed and mathematics might now be a dead and forgotten science.³⁸

Fn38: C.H.Edwards, History of Calculus, New York 1979, p.79.

It is of course true that the Greek ideal has gotten reinstated at the heart of mathematics during the last two centuries, but it seems that most of the foundational problems of mathematics can also be perhaps traced to the same development. In this context, study of alternative epistemologies such as that developed in the Indian tradition of mathematics, could prove to be of great significance for the future of mathematics."

... Srinivas: [Sra05], §3.5 Towards a new epistemology for Mathematics.

Moreover, compelling arguments for:

— Pantasar’s perspective of *pre-formal* mathematics that:

- ‘without any outer reference, mathematics as we know it could simply not be possible’;
- Giannoli’s perspective that:
 - ‘semantics and syntax do not constitute separate and opposite logical fields’;
- and, as is implicit in the Complementarity Thesis (§1., Thesis 1), that:
 - whereas a formal proof is necessary to validate the ‘truth’ of *evidence-based* reasoning, the latter is the *raison d’être* for, and must illuminate the significance of, a formal proof;

are highlighted *pictorially* by:

- (i) §22.A., Proposition 22.2 (Prime independence), which entails Proposition 22.5 ($P \neq NP$ by Eratosthenes sieve)³⁰;
- (ii) §1.I.b., Proposition 1.3, which seeks an elementary *pre-formal* proof that *transparently* illustrates *why* four colours suffice to chromatically differentiate any set of contiguous, simply connected and bounded, planar spaces by showing that there is *no minimal* 4-coloured planar map \mathcal{M} (see also [An21b], [An22e]);
- (iii) §1.F.c., Proposition 1.1, which seeks to show that representing FLT as a putative, hyper-geometric, LEGO blocks puzzle for $n = 2, 3$ could be viewed as yielding ‘a truly marvelous’ pre-formal, *pictorial*, proof of FLT by evidencing that if, for some natural numbers x, y, z, n , we can *well-define unique* hypercubes $\overline{x^n}, \overline{y^n}, \overline{z^n}$ which entail, under a *well-defined* interpretation, that $x^n + y^n = z^n$, then $n < 3$.

Comment 8. Although purists (for instance, Leo Corry in [Cry10]) might frown upon what could be viewed as a ‘frivolous’ appeal to Fermat’s name, and personality, in the following fictional narrative (as seems implicit in the *Submission History* of [An21a]), the following excerpt from [WBF22] illustrates that using names of well-known personalities—whether living or dead—in fictional accounts may sometimes be deemed appropriate in academic literature:

“So is potentially exposing yourself, and then others, to the risk of contracting a potentially serious virus a case of unacceptable risk? Jason Brennan presents us with a fictional case that might lead us to believe that it does; the case of the “reckless astronauts”:

Elon Musk has just invented instantaneous interplanetary teleportation, and the technology is widely available. Suppose a group of privately-funded astronauts plans to visit a newly discovered planet, a planet that, for all they know, contains a wide range of deadly bacteria and viruses. When they arrive, they drink the water, without sanitizing it. They also give the possibly contaminated water to their children. When they arrive back home a day later, they refuse quarantine. Some of them visit Disneyland, while others immediately place their (for all they know, infected) children in daycare centers or schools. They could have taken steps to sanitize the water samples and to prevent themselves from contracting any alien diseases, but they decided not to do so, because they get their health advice from Jenny McCarthy. (2018, 41)

³⁰As also §22.C.b., Theorem 22.48 (Dirichlet’s Theorem); and §22.D., Theorem 22.56 (Twin Prime Theorem).

The astronauts' conduct, according to Brennan, involves active exposure of others to risk of harm, and this risk cannot be regarded as acceptable because others do not benefit from the astronauts' refusal to take precautions. Because of this, Brennan concludes—perhaps surprisingly given his position in his article with Winsberg and Surprenant (2020)—that the forcible quarantine of the reckless astronauts is justifiable."

... White, Basshuysen and Frisch: [WBF22], §2 March 2020: Lead-up to Lockdown, p.7.

1.E. Prologue: A 'Disembodied' Proof of FLT (A *fictional, pre-formal, narrative*)

1.E.a. When is $x^2 + y^2 = z^2$ solvable for $x, y, z \in \mathbb{N}$?

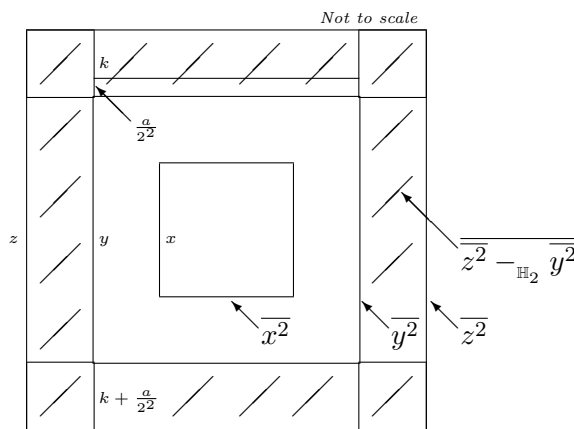

Fig.a

1. Sometime prior to 1637, Pierre de Fermat received for endorsement a jigsaw puzzle J_2 (illustrated by Fig.a), ostensibly consisting of one square tile of side y plus:
 - (a) 4 rectangular tiles with dimensions $y \times (k + \frac{a}{2^2})$; and
 - (b) 4 square tiles of side $(k + \frac{a}{2^2})$,
 where (a) plus (b) had been certified by the Manufacturer as having been cut and re-assembled from a square tile of side x , such that $x^2 + y^2 = z^2$ and $z = y + 2(k + \frac{a}{2^2})$, with $x, y, z, k, a \in \mathbb{N}$.
2. However, Fermat found that the 4 square tiles of side $(k + \frac{a}{2^2})$ were missing, and requested from the Manufacturer a matching set of square tiles as per the packing list.
3. Customer Service checked with Stores, and confirmed they had a matching square tile R_2 of side $2(k + \frac{a}{2^2})$ and area $4(k + \frac{a}{2^2})^2$, which they would happily have cut into a matching set of square tiles that would complete the puzzle J_2 to Fermat's satisfaction.
4. Customer Service then directed Stores to issue the square tile R_2 to the Factory, with instructions to cut R_2 into 'smaller' square tiles.
5. The Factory cut R_2 as instructed, and dispatched a set S_2 of 'smaller' square tiles to Fermat.
6. A bemused Fermat observed, however, that the Factory had, either carelessly or in ignorance, cut the square tile R_2 of side $2(k + \frac{a}{2^2})$ and volume $4(k + \frac{a}{2^2})^2$ into a set of 16 'smaller' square tiles, instead of the 4 square tiles of side $(k + \frac{a}{2^2})$ as specified in the packing list!

7. *Beyond bemusement, Fermat also realised that the challenge in endorsing the Manufacturer’s claim lay in formally defining what it would mean for the set of rectangular tiles (a) and (b) to have been cut and re-assembled from a square tile of side x .*
8. After considerable consideration, Fermat decided *any* such definition³¹ should entail that: *Every configuration of rectangular tiles resulting from cutting the set of tiles (a) and (b) into smaller rectangular tiles which, after a re-configuration, claims to well-define a square tile of side x must, when combined suitably with the square tile of side y , also well-define the square tile of side z .*
9. Following a thorough investigation at the Factory, Fermat concluded he could confirm, and endorse³², that if x, y, z were stipulated as a Pythagorean triple³³, then *any* such configuration (as in §1.E.a.(8)) of the 2-D tiles (a) plus (b) supplied by the Manufacturer would indeed, in the above sense, *well-define* a square tile of side x such that $x^2 + y^2 = z^2$, as certified.

1.E.b. Why $x^3 + y^3 = z^3$ is not solvable for $x, y, z \in \mathbb{N}$

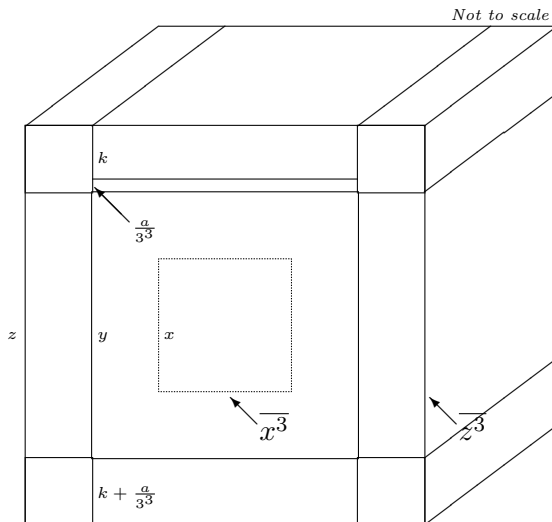

Fig.b

1. Shortly thereafter, Fermat received a further request for endorsement, this time for a LEGO blocks puzzle J_3 (illustrated by Fig.b), ostensibly consisting of one cube of side y plus:

- (a) 6 parallelepiped blocks with base y^2 and height $(k + \frac{a}{3^3})$,
- (b) 12 parallelepiped blocks with base $(k + \frac{a}{3^3})^2$ and height y , and
- (c) 8 cube blocks of side $(k + \frac{a}{3^3})$,

where (a) plus (b) plus (c) had been certified by the Manufacturer as having been cut and re-assembled from a LEGO cube block of side x , such that $x^3 + y^3 = z^3$ and $z = y + 2(k + \frac{a}{3^3})$, with $x, y, z, k, a \in \mathbb{N}$.

³¹Expressed formally in §1.F.b. as Definitions 2, 3, and 4. It is not obvious whether Andrew Wiles’ (essentially set-theoretic) 1995 proof of FLT, as outlined by Michael Harris in [Hrs19] (see also §1.G.), admits—or needs to admit—corresponding definitions.

³²Without, as was not unusual with Fermat (see [Sng97], p.42), bothering to provide a ‘proof’; but see §1.F.d.(a).

³³Such as (3, 4, 5), (5, 12, 13), (161, 240, 289), etc.; of which there are an infinity of *essentially* different sets.

2. To his exasperation, Fermat again found the 8 cube blocks of side $(k + \frac{a}{3^3})$ inexplicably missing, and irritably requested from the Manufacturer a matching set of cube blocks as per the packing list.
3. An embarrassed Customer Service checked with Stores, and confirmed they did have a matching cube block R_3 of side $2(k + \frac{a}{3^3})$ and volume $8(k + \frac{a}{3^3})^3$, which they were only too willing to have cut into a matching set of cube blocks that would complete the puzzle J_3 to Fermat's satisfaction.
4. Customer Service then directed Stores to issue the cube block R_3 to the Factory, with instructions to cut R_3 into 'smaller' cubes.
5. The Factory cut R_3 as instructed, and despatched a set S_3 of 'smaller' cubes to Fermat.
6. However Fermat observed, now more intrigued than irritated, that the Factory had, either carelessly or in ignorance, cut the cube block R_3 of side $2(k + \frac{a}{3^3})$ and volume $8(k + \frac{a}{3^3})^3$ into 9 cube blocks of side $(\frac{2}{3})(k + \frac{a}{3^3})$, instead of 8 cube blocks of side $(k + \frac{a}{3^3})$ as specified in the packing list.
7. Since the set S_3 could not complete the puzzle J_3 , Fermat could not endorse that: *Every* configuration of 3-D LEGO blocks resulting from cutting the set of 3-D LEGO blocks (a) plus (b) plus (c) into smaller 3-D LEGO blocks which, after a re-configuration, claims to *well-define* a LEGO cube block of side x (as certified³⁴ by the Manufacturer), when combined suitably with the 3-D LEGO cube block y^3 , also *well-defines* a 3-D LEGO cube block of side z .
8. Fermat concluded, moreover, that the above reasoning—which he treated as entailing that $x^3 + y^3 = z^3$ is not solvable for $x, y, z \in \mathbb{N}$ —ought to hold by symmetry in the general case; and laconically laid claim in the margin of his copy of Diophantus' *Arithmetica* to 'a truly marvellous demonstration' that there were no integer solutions to $x^n + y^n = z^n$ for $n > 2$.

1.E.c. **Why $x^p + y^p = z^p$ is *not* solvable for $x, y, z \in \mathbb{N}$ and any prime $p > 2$**

1. Almost 400 years later, disembodied and drifting desultorily in a n -dimensional universe beyond human conception, the shades of Fermat welcomed receipt, for endorsement, of a p -dimensional LEGO puzzle J_p (with prime $p > 3$, $n \geq p \in \mathbb{N}$) from a n -D Manufacturer, ostensibly consisting of one p -D hypercube of side y^p , denoted by $\overline{y^p}$ in a p -D Euclidean space \mathbb{H}_p , plus:

- (a) $2.^p C_1$ p -D hyper-objects, each denoted by $\overline{(k + \frac{a}{p^p}) \times_{\mathbb{H}_p} y^{(p-1)}}$ with hyper-dimensions:

$$(k + \frac{a}{p^p}) \times_{\mathbb{H}_p} \underbrace{y \times_{\mathbb{H}_p} y \times_{\mathbb{H}_p} \dots \times_{\mathbb{H}_p} y}_{(p-1)}$$

- (b) $2.^p C_2$ p -D hyper-objects, each denoted by $\overline{(k + \frac{a}{p^p})^2 \times_{\mathbb{H}_p} y^{(p-2)}}$ with hyper-dimensions:

$$(k + \frac{a}{p^p}) \times_{\mathbb{H}_p} (k + \frac{a}{p^p}) \times_{\mathbb{H}_p} \underbrace{y \times_{\mathbb{H}_p} y \times_{\mathbb{H}_p} \dots \times_{\mathbb{H}_p} y}_{(p-2)}$$

...

- (c) 2^p p -D hypercubes, each denoted by $\overline{(k + \frac{a}{p^p})^p}$ with sides $(k + \frac{a}{p^p})$;

where (a) plus (b) plus ... plus (c) had been certified by the n -D Manufacturer as having been cut and re-assembled from a p -D hypercube of side x , such that $x^p + y^p = z^p$ and $z = y + 2(k + \frac{a}{p^p})$, with $x, y, z, k, a \in \mathbb{N}$.

³⁴And, as the jurist (see [Sng97], p.37) in Fermat had begun to suspect, *misleadingly*.

2. The, by now fascinated, disembodied Fermat again found, as almost anticipated, that the 2^p p -D hypercubes of side $(k + \frac{a}{p^p})$ were inexplicably missing, and patiently requested from the n -D Manufacturer a matching set of p -D hypercubes as per the packing list.
3. The n -D Customer Service checked with their n -D Stores, and confirmed they did have a matching p -D hypercube R_p of side $2(k + \frac{a}{p^p})$ and hyper-volume $2^p \cdot (k + \frac{a}{p^p})^p$, which they would happily have cut into a matching set of p -D hypercubes that would complete the puzzle J_p , and satisfy the disembodied Fermat.
4. The n -D Customer Service then directed their n -D Stores to issue the p -D hypercube R_p to their n -D Factory, with instructions to cut R_p into ‘smaller’ p -D hypercubes.
5. The n -D Factory cut R_p as instructed, and despatched a set S_p of ‘smaller’ p -D hypercubes to the disembodied Fermat.
6. The disembodied Fermat now observed that the n -D Factory too had, not entirely *unexpectedly* but yet *inexplicably*, cut the p -D hypercube R_p , of side $2(k + \frac{a}{p^p})$ and hyper-volume $2^p \cdot (k + \frac{a}{p^p})^p$, into p^p p -D hypercubes of side $(\frac{2}{p})(k + \frac{a}{p^p})$, instead of the 2^p p -D hypercubes of side $(k + \frac{a}{p^p})$ specified in the packing list.
7. Since $2^p \nmid p^p$, the set S_p could not complete the puzzle J_p ; whence the disembodied Fermat could *not* endorse that: *Every* configuration of p -D hyper-objects resulting from ‘cutting’ the set of p -D hyper-objects (a) plus (b) plus . . . plus (c) into ‘smaller’ p -D hyper-objects which, after a re-configuration, claims to *well-define* a p -D hypercube of side x , when ‘combined’ suitably with the p -D hypercube y^p , also *well-defines* a p -D hypercube of side z (as certified by the n -D Manufacturer).
8. Relieved after centuries of uncertainty, a disembodied Fermat concluded contentedly that, since the p -D hypercube \bar{x}^p of side x could not be *well-defined* by the p -D hyper-objects (a) plus (b) plus . . . plus (c), there were no integer solutions to $x^p + y^p = z^p$ for $p > 3$; thus justifying the erstwhile mortal Fermat’s claim (FLT), which entailed that $x^p + y^p = z^p$ was unsolvable for $p > 2$.
9. Moreover, since the mortal Fermat had shown that $x^4 + y^4 = z^4$ is unsolvable for $x, y, z \in \mathbb{N}$ (see [Sng97], p.98), the preceding now entailed (see [Sng97], p.99) that $x^n + y^n = z^n$ is unsolvable for $x, y, z \in \mathbb{N}$ if $n > 2$!

Moral of the Fable (see also §1.H. ans §1.H.a.): Solving FLT requires defining ‘smaller’ unequivocally in para 4 of each of §1.E.a. - §1.E.c.

1.F. An *evidence-based* (pictorial), *pre-formal*, proof of Fermat’s Last Theorem

Fermat’s Last Theorem FLT states that no three positive integers x, y, z satisfy the equation $x^n + y^n = z^n$ for any integer value of n greater than 2. FLT has been made famous, literally and literarily³⁵ beyond it’s innate challenge for mathematicians, by Pierre de Fermat’s posthumously revealed remarks, written around 1637 in the margin of his copy of Diophantus’ major work, *Arithmetica*:

“It is impossible to separate a cube into two cubes, or a fourth power into two fourth powers, or in general, any power higher than the second, into two like powers. I have discovered a truly marvelous proof of this, which this margin is too narrow to contain”.

... Fermat: Wikipedia, Fermat’s Last Theorem.

³⁵See Wikipedia: *Fermat’s Last Theorem in fiction*; also [Sng97], p.73.

For 358 years, FLT remained unsolved; until the 108-page proof [Wls95]—appealing to *geometrical* properties of *real* and *complex* numbers in order to prove an essentially *arithmetical* problem over the *natural numbers*—was published in 1995 by Andrew Wiles in the *Annals of Mathematics*. It proved an equivalence between, seemingly disparate, *geometric* properties of elliptic curves and modular forms that can be cogently argued (see §1.G.) as entailing FLT from the *specified* premises³⁶.

What yet remains unanswered, though, is whether, and if so what, Fermat might have ‘realised’ he had ‘briefly deluded himself’ as having solved ‘with an irretrievable idea’:

“It is not known whether Fermat had actually found a valid proof for all exponents n , but it appears unlikely. Only one related proof by him has survived, namely for the case $n = 4$, as described in the section Proofs for specific exponents. While Fermat posed the cases of $n = 4$ and of $n = 3$ as challenges to his mathematical correspondents, such as Marin Mersenne, Blaise Pascal, and John Wallis, he never posed the general case. Moreover, in the last thirty years of his life, Fermat never again wrote of his “truly marvelous proof” of the general case, and never published it. Van der Poorten suggests that while the absence of a proof is insignificant, the lack of challenges means Fermat realised he did not have a proof; he quotes Weil as saying Fermat must have briefly deluded himself with an irretrievable idea.

The techniques Fermat might have used in such a “marvelous proof” are unknown.

... Wikipedia: https://en.wikipedia.org/wiki/Fermat%27s_Last_Theorem, accessed 10th October 2020.

Comment 9. The collateral significance of Fermat’s unrecorded deliberations is reflected in Richard P. Feynman’s wry observation:

“We have a habit in writing articles published in scientific journals to make the work as finished as possible, to cover up all the tracks, to not worry about the blind alleys or describe how you had the wrong idea first, and so on. So there isn’t any place to publish, in a dignified manner, what you actually did in order to get to do the work ...”

... Feynman: *In his Nobel Lecture, 1966*, <https://www.nobelprize.org/prizes/physics/1965/feynman/lecture/>.

That, then, is the issue we shall seek here to illuminate by a putative reconstruction—from a *pre-formal* perspective—of:

- (i) *What* argument or technique might Fermat have used that led him to, even if only briefly, believe he had ‘discovered a truly marvelous proof’ of FLT?

“Wiles’s proof of Fermat’s Last Theorem relies on verifying a certain conjecture born in the 1950s. The argument exploits a series of mathematical techniques developed in the last decade, some of which were invented by Wiles himself. The proof is a masterpiece of modern mathematics, which leads to the inevitable conclusion that Wiles’s proof of the Last Theorem is not the same as Fermat’s. Fermat wrote that his proof would not fit into the margin of his copy of Diophantus’s *Arithmetica*, and Wiles’s 100 pages of dense mathematics certainly fulfills this criterion, but surely the Frenchman did not invent modular forms, the Taniyama-Shimura conjecture, Galois groups, and the Kolyvagin-Flach method centuries before anyone else.

If Fermat did not have Wiles’s proof, then what did he have?”

... Singh: [Sng97], p.307.

³⁶Detailed consideration of Wiles’ ‘analytic’ proof (see [Wls95], [DDR95]) lies beyond the scope, and competence, of this perspective; which only seeks an ‘elementary’ understanding of why $x^n + y^n = z^n$ is provable *only* for $x, y, z, n \in \mathbb{N}$ and $n < 3$. However we include, in an Appendix (§1.G.), Michael Harris’ outline of the logical steps in Wiles’ ‘analytic’ reasoning, in order to highlight how these ‘mirror’ the logical steps in the ‘elementary’ reasoning of this putative reconstruction of the reasoning behind Fermat’s laconic marginal noting.

(ii) *Why is $x^n + y^n = z^n$ solvable only for $n = 2$?*³⁷

A curious feature (see [Dck20], Chapter XXVI, pp.731-776; [Bel61], pp.303-304; [Sng97], pp.115-117, 126-127, & 251-252; [LbP10], p.657, §3.1 *Germain's plan for proving Fermat's Last Theorem*; [CCZ15], *Abstract*) of recorded, post-Fermat, attempts to prove FLT has been the, seemingly universal, focus on seeking a formal proof, and understanding, of *only* why $x^n + y^n = z^n$ is unsolvable for both specific, and general, values of $n > 2$ when $x, y, z, n \in \mathbb{N}$.

Moreover, Michael Harris' recent claim in [Hrs19] (see §1.G.) that 'Wiles' proof, complicated as it is, has a simple underlying structure that is easy to convey to a lay audience', implicitly admits that such an understanding yet remains as elusive as was reflected in Keith Devlin's 1994 observation:

"Wiles made his claim at the end of a series of three lectures he gave at a small meeting of number-theorists at the Isaac Newton Institute at Cambridge, England. The powerful new techniques he outlined in his proof, together with his own track record as a research mathematician, were enough to convince the audience that the new proof was probably correct. And, since that audience included many of the world's most highly qualified experts in the area, that was good enough for everyone else. Such was the complexity of Wiles' argument that, even with a copy of his 200-page proof, most of us would in any case have to rely on the judgement of these experts."

... Devlin: [Dev94].

A possible reason could be that even definitive expositions of Wiles' reasoning—such as, for instance, [Hrs19]—may not (see §1.G.) view the 'proof' as enhanced by *formally* justifying the *necessity* of appeal to arcane *geometrical* properties, of *real* and *complex* numbers³⁸, for concluding the *logical truth* of putative Diophantine solutions of essentially *arithmetical* propositions when expressed *geometrically* as elliptic curves.

The fragility of uncritically accepting 'sociological validation of proofs' in lieu of *logical* validity is highlighted by Henk Barendregt and Freek Wiedijk in [BW05]³⁹:

"During the course of history of mathematics proofs increased in complexity. In particular in the 19-th century some proofs could no longer be followed easily by just any other capable mathematician: one had to be a specialist. This started what has been called the sociological validation of proofs. In disciplines other than mathematics the notion of peer review is quite common. Mathematics for the Greeks had the 'democratic virtue' that anyone (even a slave) could follow a proof. This somewhat changed after the complex proofs appeared in the 19-th century that could only be checked by specialists. Nevertheless mathematics kept developing and having enough stamina one could decide to become a specialist in some area. Moreover, one did believe in the review by peers, although occasionally a mistake remained undiscovered for many years. This was the case with the erroneous proof of the Four Colour Conjecture by Kempe [1879].

In the 20-th century this development went to an extreme. There is the complex proof of Fermat's Last Theorem by Wiles. At first the proof contained an error, discovered by Wiles himself, and later his new proof was checked by a team of twelve specialist referees[†]. Most mathematicians have not followed in detail the proof of Wiles, but feel confident because of the sociological verification.

³⁷The Diophantine equation is, of course, trivially solvable for $n = 1$; and Pythagoras' Theorem evidences that it is solvable for $n = 2$.

³⁸A justification the *pre-formal* proof of FLT in §1.F.c. seeks to achieve more transparently by identifying, and generalising, the *necessary* and *sufficient* geometrical properties which entail the specific case of FLT for $n = 3$, in the *pre-formal* argument in §1.F.d.(b), *without* appeal to properties of *real* and *complex* numbers.

³⁹As also by Melvyn B. Nathanson in [Na08], 'Desperately Seeking Mathematical Truth' (see §20.).

† One of these referees told us the following. “If an ordinary non-trivial mathematical paper contains an interesting idea and its consequences and obtains ‘measure 1’, then Wiles’ proof can be rated as having measure 156.”ⁿ

...Barendregt and Wiedijk: [BW05], 1. The Nature of Mathematical Proof.

For instance, if FLT⁴⁰ is not provable in PA, it would follow by [An16], Theorem 7.1 (p.41)⁴¹, that *no* deterministic algorithm TM could, for any *specified* $n > 2$, *evidence* that $x^n + y^n = z^n$ is unsolvable⁴².

In which case, even if⁴³—as entailed by Wiles’ proof [Wls95]—FLT can be *evidenced* as numeral-wise *true*⁴⁴ under a *well-defined* interpretation of PA over \mathbb{N} ⁴⁵, seeking to understand *why* $x^n + y^n = z^n$ is unsolvable for *all* $n > 2$ may be futile. Instead, one could reasonably expect a better insight (see §1.F.d.) by seeking *why* $x^n + y^n = z^n$ is solvable *only* for $n = 2$ (and trivially for $n = 1$), but not for $n = 3$.

1.F.a. Could *this* have been Fermat’s *Lost Insight*?

Some insight into *why* $x^n + y^n = z^n$ can be treated *informally* as true *only* for $n = 2$ (and trivially for $n = 1$) follows if—instead of expressing any putative integral solution $a, b, c \in \mathbb{N}$ of the, essentially *arithmetical*, equation $a^p + b^p = c^p$ with p an odd prime, *geometrically* as an elliptic curve, and seeking to identify the latter’s Galois representation with a unique modular form (see [Hrs19]; also §1.G.)—we note that, if $x^n + y^n = z^n$ for $x, y, z, n \in \mathbb{N}$, and $z = y + 2(k + \frac{a}{n^n})$ (see Figs.1-3), we can express:

$$(i) \quad x^n = 2.^nC_1(k + \frac{a}{n^n})y^{n-1} + 2^2.^nC_2(k + \frac{a}{n^n})^2y^{n-2} + \dots + 2^n(k + \frac{a}{n^n})^n$$

FLT is then equivalent to proving the necessary and sufficient conditions (see §1.F.d.(b)) that, for any *specified* $n \geq 1 \in \mathbb{N}$, admit some $y, z \geq 1 \in \mathbb{N}$ which yield a unique representation of x^n as (i) above.

Moreover, were FLT PA-unprovable, we could yet view Fermat’s Last Theorem as a formal proposition concerning the arithmetical and geometrical properties of recursively *well-defined* n -D hyper-geometric objects in the structure, say \mathbb{H}_n , of n -D hyper-objects⁴⁶ in a n -dimensional Euclidean space which includes the cases where $n = 2, 3$ —corresponding to the arithmetical and geometrical properties in physical space of the familiar LEGO blocks when $n = 2, 3$.

An insight that could be viewed as yielding a *pre-formal* proof of FLT by visually evidencing, *without* appeal to properties of *real* and *complex* numbers, that if, for some natural numbers x, y, z, n , we can *well-define unique* n -D hyper-cubes $\overline{x^n}, \overline{y^n}, \overline{z^n} \in \mathbb{H}_n$ which entail $x^n + y^n = z^n$, then $n = 2$.

‘Pre-formal’, as detailed by Markus Pantsar in [Pan09]:

⁴⁰Strictly speaking the PA-formula, say [FLT], expressing FLT in PA.

⁴¹A PA formula $[F(x)]$ is PA-provable if, and only if, $[F(x)]$ is algorithmically computable as always true in \mathbb{N} .

⁴²Since FLT is not then algorithmically *computable* as an always *true* arithmetical proposition by [An16], Definition 2, p.37: A number theoretical relation $F(x)$ is algorithmically computable if, and only if, there is an algorithm AL_F that can provide objective evidence for deciding the truth/falsity of each proposition in the denumerable sequence $F(1), F(2), \dots$.

⁴³As in the case of Kurt Gödel’s well-known ‘formally undecidable’ arithmetical proposition $[(\forall x)R(x)]$ (see [An16], Corollary 8.3, p.42): In any model of PA, Gödel’s arithmetical formula $[R(x)]$ interprets as an algorithmically verifiable, but not algorithmically computable, tautology over \mathbb{N} .

⁴⁴In the sense of being algorithmically *verifiable* as a *true* arithmetical proposition for any *specified* instantiation by [An16], Definition 1, p.37: A number-theoretical relation $F(x)$ is algorithmically verifiable if, and only if, for any given natural number n , there is an algorithm $AL_{F,n}$ which can provide objective evidence for deciding the truth/falsity of each proposition in the finite sequence $\{F(1), F(2), \dots, F(n)\}$.

⁴⁵In other words, for any *specified* $n > 2$, there would be some deterministic algorithm TM_n which could *evidence* $x^n + y^n = z^n$ as unsolvable for *only* that *specified* value of n ; or, equivalently, for all values $\leq n$.

⁴⁶See Wikipedia: Hypercube.

“What I refer to as pre-formal mathematics in this work is more often discussed as informal mathematics in literature. The choice of terminology here is based on two reasons. First, I want to stress the order in which our mathematical thinking develops. We initially grasp mathematics through informal concepts and only later acquire the corresponding formal tools. Second, the term “informal mathematics” seems to have an emerging non-philosophical meaning of mathematics in everyday life, as opposed to an academic pursuit—which is not at all the distinction that I am after here.”

...Pantsar: [Pan09], §1.1 General background.

Moreover, we interpret Pantsar’s ‘pre-formal mathematics’ here as evidencing the philosophy that mathematical truth is a necessarily transparent, *evidence-based*, prerequisite for determining—in a formal proof theory—which axiomatic assumptions of a formal theory underlie the truth of *pre-formal*, *evidence-based*, reasoning. ‘Evidence-based’, in the sense of Gualtiero Piccinini’s *knowledge as factually grounded belief* (see [Pic19]), rather than *knowledge as intuitively justified true belief*.

In a recent paper [Mur20] on *Proof vs Truth in Mathematics*, Roman Murawski too emphasises (as does Harris in [Hrs19]; see also [Th94]) the critical role that “informal proofs” (which could be viewed as corresponding to Pantsar’s *pre-formal* proofs) variously play in ‘mathematical research practice’ for not only the *understanding*, but also the *verification* and *justification*, of formal proofs:

“Mathematics was and still is developed in an informal way using intuition and heuristic reasonings— it is still developed in fact in the spirit of Euclid (or sometimes of Archimedes) in a *quasi*-axiomatic way. Moreover, informal reasonings appear not only in the context of discovery but also in the context of justification. Any correct methods are allowed to justify statements. Which methods are correct is decided in practice by the community of mathematicians. The ultimate aim of mathematics is “to provide correct proofs of true theorems” [2, p. 105]. In their research practice mathematicians usually do not distinguish concepts “true” and “provable” and often replace them by each other. Mathematicians used to say that a given theorem holds or that it is true and not that it is provable in such and such theory. It should be added that axioms of theories being developed are not always precisely formulated and admissible methods are not precisely described.²

Informal proofs used in mathematical research practice play various roles. One can distinguish among others the following roles (cf. [4], [7]):

- (1) verification,
- (2) explanation,
- (3) systematization,
- (4) discovery,
- (5) intellectual challenge,
- (6) communication,
- (7) justification of definitions.

The most important and familiar to mathematicians is the first role. In fact only verified statements can be accepted. On the other hand a proof should not only provide a verification of a theorem but it should also explain why does it hold. Therefore mathematicians are often not satisfied by a given proof but are looking for new proofs which would have more explanatory power. Note that a proof that verifies a theorem does not have to explain why it holds. It is also worth distinguishing between proofs that convince and proofs that explain. The former should show that a statement holds or is true and can be accepted, the latter—why it is so. Of course there are proofs that both convince and explain. The explanatory proof should give an insight in the matter whereas the convincing one should be concise or general. Another distinction that can be made is the distinction between explanation and understanding. In the research practice of mathematicians simplicity is often treated as a characteristic feature of understanding. Therefore, as G.-C. Rota writes: “[i]t is an article of faith among mathematicians that after a new theorem is discovered, other, simpler proof of it will be given until a definitive proof is found” [23, p. 192].

It is also worth quoting in this context Aschbacher who wrote:

The first proof of a theorem is usually relatively complicated and unpleasant. But if the result is sufficiently important, new approaches replace and refine the original proof, usually by embedding it in a more sophisticated conceptual context, until the theorem eventually comes to be viewed as an obvious corollary of a larger theoretical construct. Thus proofs are a means for establishing what is real and what is not, but also a vehicle for arriving at a deeper understanding of mathematical reality [1, p. 2403].

As indicated above a concept of a "normal" proof used by mathematicians in their research practice (we called it "informal" proofs) is in fact vague and not precise.

... Murawski: [Mur20], §2. *Proof in Mathematics: Formal vs Informal*, pp.11-12.

Thus the *evidence-based* perspective underlying this hypothetical reconstruction of Fermat's reasoning that led him to record his marginal noting postulating FLT laconically, is that *pre-formal, evidence-based, mathematical truth* is *stronger* than mathematical *proof* since, contrary to the inherited relationship between mathematical *truth* and mathematical *proof* in current mathematical paradigms:

1. The *proof* of a mathematical proposition in a first-order mathematical language does not entail its *truth* in any first-order mathematical language if the proposition has no *evidence-based* interpretation;
2. The *truth* of a mathematical proposition that has a *pre-formal, evidence-based*, interpretation entails its *proof* in some, suitably defined, first-order mathematical language.

1.F.b. Could *this* have been Fermat's *Lost Argument*?

Thus, it is conceivable Fermat argued with himself (without making his proof explicit) that, for any pair of natural numbers $z > y$:

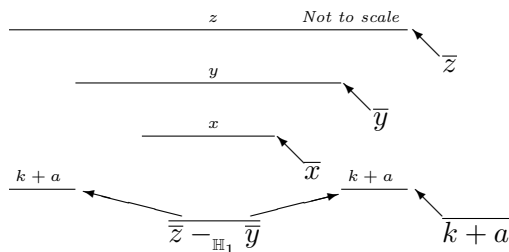

- (1) We can take a string (see Fig.1), say \bar{z} , of length z units, cut off a central section \bar{y} of length y units, and we will *always* (courtesy human self-evidence) have a 1-dimensional object consisting of two separated pieces of length $k+a$ units each, denoted by say $\overline{\bar{z} -_{\mathbb{H}_1} \bar{y}}$, which can be *uniquely* defined upto *isomorphism* under change of scale (see Definition 3):

- by cutting into smaller, whole number of units, a string \bar{x} of length x units, where x is also a natural number,
- and re-assembling the smaller lengths to form the symmetrically centered configuration: $\mathbb{C}_{Sym}(\overline{\bar{z} -_{\mathbb{H}_1} \bar{y}}) =_{\mathbb{H}_1} \overline{2k+a}$,
- so that any two such re-assemblies are *isomorphic* upto *uniqueness* (by Definition 3);

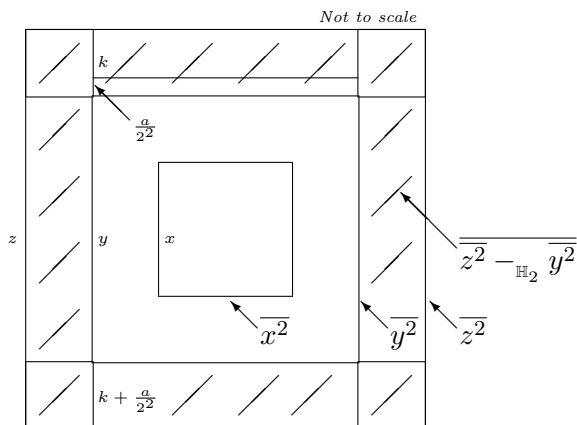

Fig.2

(2) We can take a square tile (see Fig.2), say $\overline{z^2}$, of side z and area z^2 , cut off a central square tile $\overline{y^2}$ of side y and area y^2 , and we will *sometimes* (courtesy Pythagoras' Theorem) have a 2-dimensional object, say $\overline{z^2 -_{\mathbb{H}_2} y^2}$ (shaded area in Fig.2), which can be *uniquely* defined upto *isomorphism* under change of scale (see Definition 3):

- by cutting into smaller square tiles a square tile $\overline{x^2}$ of side x and area x^2 , where x is also a natural number,
- and re-assembling the smaller square tiles to form the symmetrically centered configuration of $\overline{z^2 -_{\mathbb{H}_2} y^2}$:

$$\mathbb{C}_{Sym}(\overline{z^2 -_{\mathbb{H}_2} y^2}) =_{\mathbb{H}_2} 4\overline{(k + \frac{a}{2^2})y} +_{\mathbb{H}_2} 4\overline{(k + \frac{a}{2^2})^2},$$

- so that any two such re-assemblies are *isomorphic* upto *uniqueness* (by Definition 3);

Comment 10. In other words, by Pythagoras' Theorem we can *always* design a jigsaw puzzle for *some* $y, z \in \mathbb{N}$ such that the square tile $\overline{y^2}$, along with *any* configuration which is *isomorphic* to $\mathbb{C}_{Sym}(\overline{z^2 -_{\mathbb{H}_2} y^2}) =_{\mathbb{H}_2} 4\overline{(k + \frac{a}{2^2})y} +_{\mathbb{H}_2} 4\overline{(k + \frac{a}{2^2})^2}$, could be assembled into the square tile $\overline{z^2}$.

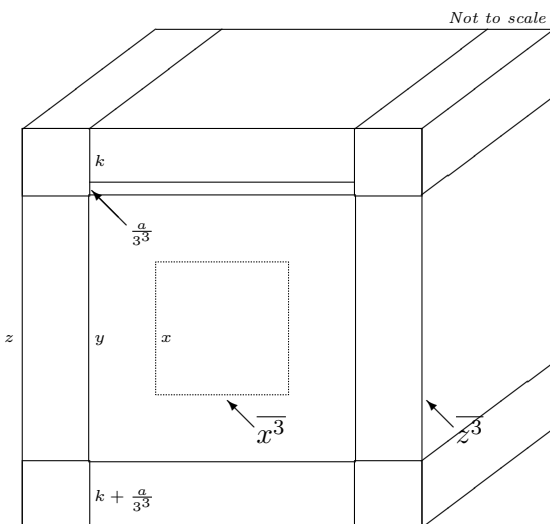

Fig.3

(3) We can take a cube (see Fig.3), say $\overline{z^3}$, of side z and volume z^3 , cut off a central cube $\overline{y^3}$ of side y and volume y^3 , but we will *never* (courtesy Fermat's insight) have a 3-dimensional object, say $\overline{z^3 -_{\mathbb{H}_3} y^3}$, which can be *uniquely* defined upto *isomorphism* under change of scale (see Definition 3):

- by cutting into smaller cubes a cube $\overline{x^3}$ of side x and volume x^3 , where x is also a natural number,
- and re-assembling the smaller cubes to form the symmetrically centered configuration of $\overline{z^3 -_{\mathbb{H}_3} y^3}$:

$$\mathbb{C}_{Sym}(\overline{z^3 -_{\mathbb{H}_3} y^3}) =_{\mathbb{H}_3} 6\overline{(k + \frac{a}{3^3})y^2} +_{\mathbb{H}_3} 12\overline{(k + \frac{a}{3^3})^2 y} +_{\mathbb{H}_3} 8\overline{(k + \frac{a}{3^3})^3},$$

- so that any two such re-assemblies are *isomorphic* upto *uniqueness* (by Definition 3);

Comment 11. In other words, Fermat's insight entails that we can *never* design a LEGO blocks puzzle for *any* $y, z \in \mathbb{N}$ such that the LEGO cube $\overline{y^3}$, along with *any* configuration of LEGO blocks which is *isomorphic* to $\mathbb{C}_{Sym}(\overline{z^3 -_{\mathbb{H}_3} y^3}) =_{\mathbb{H}_3} 6\overline{(k + \frac{a}{3^3})y^2} +_{\mathbb{H}_3} 12\overline{(k + \frac{a}{3^3})^2 y} +_{\mathbb{H}_3} 8\overline{(k + \frac{a}{3^3})^3}$, could be assembled into the LEGO cube $\overline{z^3}$.

We note that all three are particular instances of a n -dimensional mathematical object, say $\overline{z^n -_{\mathbb{H}_n} y^n}$, which is *uniquely* defined upto *isomorphism* by the following, symmetrically centered, configuration $\mathbb{C}_{Sym}(\overline{z^n -_{\mathbb{H}_n} y^n})$ of $\overline{z^n -_{\mathbb{H}_n} y^n}$ if, and only if, $z^n - y^n = x^n$ for some particular set of natural numbers z, y, x :

$$\mathbb{C}_{Sym}(\overline{z^n -_{\mathbb{H}_n} y^n}) =_{\mathbb{H}_n} 2.^n C_1 \overline{(k + \frac{a}{n^n})y^{(n-1)}} +_{\mathbb{H}_n} 2^{2.^n} C_2 \overline{(k + \frac{a}{n^n})^2 y^{(n-2)}} +_{\mathbb{H}_n} \dots +_{\mathbb{H}_n} 2^n \overline{(k + \frac{a}{n^n})^n},$$

where:

Definition 2. (Isomorphic configuration) Any two ‘configurations’ of a n -D hyper-object $\overline{x^n} \in \mathbb{H}_n$, denoted by $\sum_1^j a_i (\prod_{k=1}^n u_{ik})$ and $\sum_1^j b_i (\prod_{k=1}^n v_{ik})$ where $a_i, b_i \in \mathbb{N}$ and $(\prod_{k=1}^n u_{ik}), (\prod_{k=1}^n v_{ik}) \in \mathbb{H}_n$, are defined as *isomorphic* if, and only if, $b_i = r^n a_i$ and $(\prod_{k=1}^n u_{ik}) = r^n (\prod_{k=1}^n v_{ik})$ for any rational $r > 0 \in \mathbb{Q}$ ⁴⁷ and $1 \leq i \leq j \in \mathbb{N}$.

Definition 3. (Uniqueness) A n -D hyper-object $\overline{x^n}$ is *uniquely* defined upto *isomorphism* if, and only if, for all $1 \leq i \leq j \in \mathbb{N}$, either $a_i | b_i$ or $b_i | a_i$ in any two ‘configurations’ $\sum_1^j a_i (\prod_{k=1}^n u_{ik})$ and $\sum_1^j b_i (\prod_{k=1}^n v_{ik})$ of $\overline{x^n}$ that are *isomorphic*.

Definition 4. (Well-defined object) A n -D hyper-object $\overline{x^n}$ is *well-defined* by the configuration $\mathbb{C}(\overline{x^n})$ if, and only if, $\mathbb{C}(\overline{x^n})$ is *uniquely isomorphic*.

For $\overline{x^n}$ to, then, admit a configuration that will *uniquely* define $\overline{z^n -_{\mathbb{H}_n} y^n}$ (and vice versa), we must have that each of the terms in the above configuration (which are also configurations of n -D objects) must be *uniquely* defined upto *isomorphism* under any change of scale by Definition 3.

However, we argue *pre-formally* in §1.F.c. that, for any natural numbers x, y, z which claim to yield a solution of $z^n - y^n = x^n$, such *unique isomorphism* is only possible for $n < 3$.⁴⁸

1.F.c. Could this be viewed *pre-formally* as a ‘truly marvelous proof’ of Fermat’s Last Theorem?

Proposition 1.1. If $x^p + y^p = z^p$, where $1 < x < y < z \in \mathbb{N}$ and $p \in \mathbb{N}$ is a prime, then $p = 2$.

⁴⁷ \mathbb{Q} is the structure of the rational numbers.

⁴⁸We note that, in his commentary [Hrs19] on FLT, Michael Harris outlines Wiles’ proof as arguing that (see §1.G.): If $a^p + b^p = c^p$ for some odd prime p and $a, b, c \in \mathbb{N}$, then there would exist ‘another modular form, this one of weight 2 and level 2’; however there are no such modular forms.

Proof. 1.

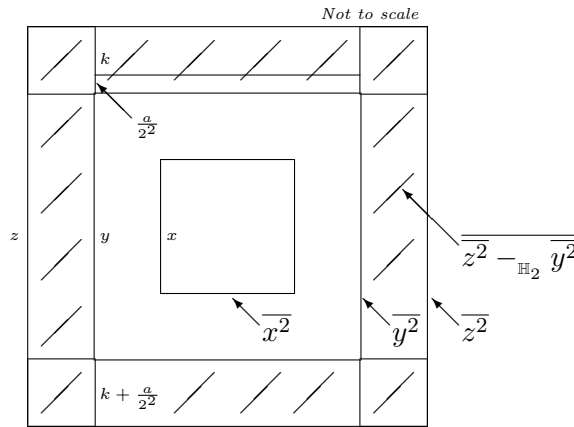

Fig.4

Consider the three, symmetrically centered, squares (2-D hypercubes) with sides x, y, z in Fig.4 for any specified natural numbers $1 < x < y < z$ which are co-prime.

Then Fig.4 is a *pictorial* proof (compare [Sng97], p.29, Fig. 4) that $x^2 + y^2 = z^2$ if, and only if, we can *physically construct* (assemble *uniquely*) a 2-D LEGO blocks (tiles) puzzle for $k > 0$ and $a \in \{0, 1, 2, 3\}$, where $k + \frac{a}{2^2} > 0$, such that:

- (a) one square block (tile) of side y ,
- (b) plus 4 rectangular blocks (tiles) with dimensions $y \times (k + \frac{a}{2^2})$,
- (c) and 4 square blocks (tiles) of side $(k + \frac{a}{2^2})$,

must combine to *well-define* a square block (tile) denoted by, say, $\overline{z^2}$, of side z , where the 2-D ‘hyper-object’ denoted by, say (shaded area), $\overline{z^2 - y^2}$, is *uniquely* defined upto *isomorphism* (by Definition 3) by the symmetrically centered ‘configuration’ of 2-D LEGO blocks (tiles):

$$(i) \mathbb{C}_{Sym}(\overline{z^2 - y^2}) =_{\mathbb{H}_2} 4\overline{(k + \frac{a}{2^2})y} +_{\mathbb{H}_2} 4\overline{(k + \frac{a}{2^2})^2}.$$

2.

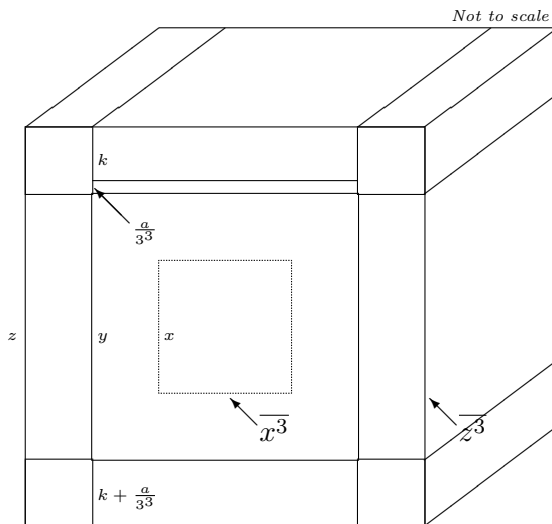

Fig.5

Similarly, Fig.5 is a *pictorial* proof (compare [Sng97], p.31, Fig.5; also p.255, Fig.23) that $x^3 + y^3 = z^3$ if, and only if, we can *physically construct* (assemble *uniquely*) a 3-D LEGO blocks puzzle for $k > 0$ and $a \in \{0, 1, 2, \dots, 26\}$, where $k + \frac{a}{3^3} > 0$, such that:

- (a) one cube block of side y ,

- (b) plus 6 parallelepiped blocks with base y^2 and height $(k + \frac{a}{3^3})$,
- (c) plus 12 parallelepiped blocks with base $(k + \frac{a}{3^3})^2$ and height y ,
- (d) plus 8 cube blocks of side $(k + \frac{a}{3^3})$,

must combine to *well-define* a cube block denoted by $\overline{z^3}$, of side z , where the 3-D ‘hyper-object’ denoted by $\overline{z^3 -_{\mathbb{H}_3} y^3}$ is *uniquely* defined upto *isomorphism* (by Definition 3) by the symmetrically centered ‘configuration’ of 3-D LEGO blocks:

$$(i) \quad \mathbb{C}_{Sym}(\overline{z^3 -_{\mathbb{H}_3} y^3}) =_{\mathbb{H}_3} 6\overline{(k + \frac{a}{3^3})y^2} +_{\mathbb{H}_3} 12\overline{(k + \frac{a}{3^3})^2 y} +_{\mathbb{H}_3} 8\overline{(k + \frac{a}{3^3})^3}.$$

3. In the general case, if $x^p + y^p = z^p$ for $p \geq 2$, and $z = y + 2(k + \frac{a}{p^p})$, a not unreasonable appeal to a principle of symmetry such as Curie’s (see [BC05], §2.2, Curie’s principle) *suggests* that the p -D hyper-object denoted by $\overline{z^p -_{\mathbb{H}_p} y^p}$ *must* then be *well-defined uniquely* upto *isomorphism* (by Definition 3) by the symmetrically centered ‘configuration’ of p -D hyper-objects denoted by:

$$(i) \quad \mathbb{C}_{Sym}(\overline{z^p -_{\mathbb{H}_p} y^p}) =_{\mathbb{H}_p} 2^p C_1 \overline{(k + \frac{a}{p^p})y^{(p-1)}} +_{\mathbb{H}_p} 2^2 {}^p C_2 \overline{(k + \frac{a}{p^p})^2 y^{(p-2)}} +_{\mathbb{H}_p} \dots +_{\mathbb{H}_p} 2^p \overline{(k + \frac{a}{p^p})^p}.$$

“2.2 Curie’s principle

Pierre Curie (1859-1906) was led to reflect on the question of the relationship between physical properties and symmetry properties of a physical system by his studies on the thermal, electric and magnetic properties of crystals, since these properties were directly related to the structure, and hence the symmetry, of the crystals studied. More precisely, the question he addressed was the following: in a given physical medium (for example, a crystalline medium) having specified symmetry properties, which physical phenomena (for example, which electric and magnetic phenomena) are allowed to happen? His conclusions, systematically presented in his 1894 work ‘Sur la symétrie dans les phénomènes physiques’, can be summarized as follows:³

- (a₁) When certain causes produce certain effects, the symmetry elements of the causes must be found in their effects.
- (a₂) When certain effects show a certain dissymmetry, this dissymmetry must be found in the causes which gave rise to them.⁴
- (a₃) In practice, the converses of these two propositions are not true, i.e., the effects can be more symmetric than their causes.
- (b) A phenomenon may exist in a medium having the same characteristic symmetry or the symmetry of a subgroup of its characteristic symmetry. In other words, certain elements of symmetry can coexist with certain phenomena, but they are not necessary. What is necessary, is that certain elements of symmetry do not exist. Dissymmetry is what creates the phenomenon.

Conclusion (a₁) is what is usually called Curie’s principle in the literature. Conclusion (a₂) is logically equivalent to (a₁); the claim is that symmetries are necessarily transferred from cause to effect, while dissymmetries are not. Conclusion (a₃) clarifies this claim, emphasizing that since dissymmetries need not be transferred from cause to effect, the effect may be more symmetric than the cause.⁵ Conclusion (b) invokes a distinction found in all of Curie’s examples, between the ‘medium’ and the ‘phenomena’. We have a medium with known symmetry properties, and Curie’s principle concerns the relationship between the phenomena that can occur in the medium and the symmetry properties—or rather, ‘dissymmetry’ properties—of the medium. Conclusion (b) shows that Curie recognized the important function played by the concept of dissymmetry—of *broken symmetries* in current terminology—in physics.

In order for Curie’s principle to be applicable, various conditions need to be satisfied: the cause and effect must be well-defined, the causal connection between them must hold good,

and the symmetries of both the cause and the effect must also be well-defined (this involves both the physical and the geometrical properties of the physical systems considered). Curie's principle then furnishes a necessary condition for given phenomena to happen: only those phenomena can happen that are compatible with the symmetry conditions stated by the principle. Curie's principle has thus an important methodological function: on the one hand, it furnishes a kind of selection rule (given an initial situation with a specified symmetry, only certain phenomena are allowed to happen); on the other hand, it offers a falsification criterion for physical theories (a violation of Curie's principle may indicate that something is wrong in the physical description)."

... *Brading/Castellani: [BC05], §2.2, Curie's principle*

4. If we, therefore, represent:

- the concept '*physically construct*' mathematically by the concept '*well-define*' (in the usual sense of deterministically assigning an unambiguous 'configuration', which need not, however, be *unique*); and
- the concept '*pictorial*' by '*formal*';

we can uniquely correspond:

- the relation $z^p - y^p = x^p$ in a *formal* Peano Arithmetic (such as PA); and
- the relation, $\mathbb{C}_{Sym}(\overline{z^p -_{\mathbb{H}_p} y^p}) =_{\mathbb{H}_p} \mathbb{C}_{Sym}(\overline{x^p})$ —in any putative, *formal*, geometry $\mathbb{T}_{\mathbb{H}_p}$ (of the structure \mathbb{H}_p of p -D hyper-objects in a p -dimensional Euclidean space which includes the cases where $p = 2, 3$)—between the p -D hyper-objects denoted by $\overline{z^p -_{\mathbb{H}_p} y^p}$ and $\overline{x^p}$, that is *well-defined uniquely upto isomorphism* (see Definition 3) by the symmetrically centered 'configuration' of p -D hyper-objects:

$$(i) \quad \mathbb{C}_{Sym}(\overline{z^p -_{\mathbb{H}_p} y^p}) =_{\mathbb{H}_p} 2.^p C_1 \overline{(k + \frac{a}{p^p}) y^{(p-1)}} +_{\mathbb{H}_p} 2.^2 .^p C_2 \overline{(k + \frac{a}{p^p})^2 y^{(p-2)}} +_{\mathbb{H}_p} \dots +_{\mathbb{H}_p} 2^p \overline{(k + \frac{a}{p^p})^p}.$$

Of course we assume here as intuitively evident that we could *formally* define '*configuration* $\mathbb{C}(\overline{x^p})$ of a p -D hyper-object $\overline{x^p}$ ', '*symmetrically centered configurations* of a p -D hyper-object $\overline{x^p}$ ', '*isomorphic configurations* of a p -D hyper-object $\overline{x^p}$ ', 'hyper-volume $\mathbb{V}(\overline{x^p})$ of a p -D hyper-object $\overline{x^p}$ ', ' $-_{\mathbb{H}_p}$ ', ' $=_{\mathbb{H}_p}$ ', ' $+_{\mathbb{H}_p}$ ' and ' $\equiv_{\mathbb{H}_p}$ ' in $\mathbb{T}_{\mathbb{H}_p}$ so as to admit the pictorial interpretations §1.F.c.1 and §1.F.c.2 when $p = 2, 3$ respectively, such that §1.F.c.4(i) interprets as:

- (ii) $\overline{z^p -_{\mathbb{H}_p} y^p}$ denotes a p -D hyper-object that is *well-defined uniquely upto isomorphism* (see Definition 3) in \mathbb{H}_p by the symmetrically centered 'configuration' of:

- (a) the $2.^p C_1$ p -D hyper-objects, each denoted by $\overline{(k + \frac{a}{p^p}) \times y^{(p-1)}}$ with hyper-dimensions:

$$(k + \frac{a}{p^p}) \times \underbrace{y \times y \times \dots \times y}_{(p-1)}$$

- (b) the $2.^2 .^p C_2$ p -D hyper-objects, each denoted by $\overline{(k + \frac{a}{p^p})^2 \times y^{(p-2)}}$ with hyper-dimensions:

$$(k + \frac{a}{p^p}) \times (k + \frac{a}{p^p}) \times \underbrace{y \times y \times \dots \times y}_{(p-2)}$$

...

- (c) the 2^p p -D hypercubes, each denoted by $\overline{(k + \frac{a}{p^p})^p}$ with sides $(k + \frac{a}{p^p})$;

and where, in the usual arithmetic of the natural numbers:

$$(iii) \quad x^p = 2.^p C_1 (k + \frac{a}{p^p}) y^{(p-1)} + 2.^2 .^p C_2 (k + \frac{a}{p^p})^2 y^{(p-2)} + \dots + 2^p (k + \frac{a}{p^p})^p.$$

5. Since $z - y = 2(k + \frac{a}{p^p}) \in \mathbb{N}$, each term of §1.F.c.4(iii) admits only those values of $a \in \mathbb{N}$ that yield a natural number. We thus have that if §1.F.c.4(iii) *well-defines* a p -D hypercube denoted by $\overline{x^p}$ in the theory $\mathbb{T}_{\mathbb{H}_p}$ of p -D hyper-objects, then this would correspond to the symmetrically centered ‘configuration’ of p -D hyper-objects defined *only* upto *isomorphism* (see Definition 2) by:

$$(i) \mathbb{C}_{Sym}(\overline{x^p}) =_{\mathbb{H}_p} 2.^p C_1(k + \frac{a}{p^p})y^{(p-1)}\overline{(u)^p} +_{\mathbb{H}_p} 2^2.^p C_2(k + \frac{a}{p^p})^2 y^{(p-2)}\overline{(u)^p} +_{\mathbb{H}_p} \dots +_{\mathbb{H}_p} 2^p(k + \frac{a}{p^p})^p \overline{(u)^p}$$

where $\overline{(u)^p}$ denotes the p -D *unit* hypercube.

6. However, for $1 \leq r \leq p$, the p -D hyper-objects defined in §1.F.c.4(ii)(a)-§1.F.c.4(ii)(c) *must* further be *well-defined uniquely* upto *isomorphism* (see Definition 3) at any rational scale $0 < s \leq 1$ of scaled down p -D hyper-objects denoted by:

$$(i) 2^r.^p C_r \overline{(k + \frac{a}{p^p})^r y^{(p-r)}} =_{\mathbb{H}_p} \frac{1}{s^p} \cdot 2^r.^p C_r \overline{((k + \frac{a}{p^p})s)^r (ys)^{(p-r)}}.$$

7. In particular, since $z - y = 2(k + \frac{a}{p^p}) \in \mathbb{N}$, the p -D hyper-object *well-defined uniquely* upto *isomorphism* (see Definition 3) by the symmetrically centered ‘configuration’ of p -D hyper-objects denoted by:

- (i) the 2^p p -D hypercubes $\overline{(k + \frac{a}{p^p})^p}$ with hyper-dimensions denoted by $(k + \frac{a}{p^p})^p$, and cumulative p -D hyper-volume $2^p(k + \frac{a}{p^p})^p$, in a p -dimensional Euclidean space;

must be capable of also being *well-defined uniquely* upto *isomorphism* (see Definition 3) by the symmetrically centered ‘configuration’ of p -D hyper-objects denoted by:

- (ii) the p^p scaled down p -D hypercubes $\overline{((k + \frac{a}{p^p})\frac{2}{p})^p}$ with hyper-dimensions denoted by $((k + \frac{a}{p^p})(\frac{2}{p}))^p$, and cumulative p -D hyper-volume $p^p((k + \frac{a}{p^p})(\frac{2}{p}))^p = 2^p(k + \frac{a}{p^p})^p$.

since both *well-define* the p -D hypercube:

$$(iv) \mathbb{C}_{Sym}(\overline{2^p(k + \frac{a}{p^p})^p}) =_{\mathbb{H}_p} 2^p \overline{(k + \frac{a}{p^p})^p} =_{\mathbb{H}_p} p^p \overline{((k + \frac{a}{p^p})(\frac{2}{p}))^p}$$

8. Moreover, since $\mathbb{T}_{\mathbb{H}_p}$ must admit the pictorial interpretations §1.F.c.1 and §1.F.c.2 when $p = 2, 3$ respectively—as detailed in §1.F.d.(a) and §1.F.d.(b)—then the p -D hyper-object denoted by $\overline{z^p -_{\mathbb{H}_p} y^p}$ is *well-defined uniquely* upto *isomorphism* (see Definition 3) under interpretation in \mathbb{H}_p by the symmetrically centered ‘configuration’ of p -D hyper-objects §1.F.c.4(i) if, and only if, each term in §1.F.c.4(i) is *isomorphic* (see Definition 2) under any change of scale.

9. Consequently, if $\overline{z^p -_{\mathbb{H}_p} y^p}$ denotes a p -D hyper-object that is *well-defined uniquely* upto *isomorphism* (see Definition 3) under interpretation in \mathbb{H}_p by the symmetrically centered ‘configuration’ of p -D hyper-objects §1.F.c.4(i), by Definition 3 we cannot have that both:

$$(i) \mathbb{C}_{Sym}(\overline{z^p -_{\mathbb{H}_p} y^p}) =_{\mathbb{H}_p} 2.^p C_1 \overline{(k + \frac{a}{p^p})y^{(p-1)}} +_{\mathbb{H}_p} 2^2.^p C_2 \overline{(k + \frac{a}{p^p})^2 y^{(p-2)}} +_{\mathbb{H}_p} \dots +_{\mathbb{H}_p} 2^p \overline{(k + \frac{a}{p^p})^p};$$

and:

$$(ii) \mathbb{C}_{Sym}(\overline{z^p -_{\mathbb{H}_p} y^p}) =_{\mathbb{H}_p} 2.^p C_1 \overline{(k + \frac{a}{p^p})y^{(p-1)}} +_{\mathbb{H}_p} 2^2.^p C_2 \overline{(k + \frac{a}{p^p})^2 y^{(p-2)}} +_{\mathbb{H}_p} \dots +_{\mathbb{H}_p} p^p \overline{((k + \frac{a}{p^p})(\frac{2}{p}))^p};$$

satisfy $\mathbb{C}_{Sym}(\overline{z^p -_{\mathbb{H}_p} y^p}) =_{\mathbb{H}_p} \mathbb{C}_{Sym}(\overline{x^p})$, and thereby entail $z^p - y^p = x^p$, if $2^p \nmid p^p$.

10. Hence, if the p -D hyper-object denoted by $\overline{z^p -_{\mathbb{H}_p} y^p}$ is *well-defined uniquely* upto *isomorphism* (see Definition 3) under interpretation in \mathbb{H}_p by the symmetrically centered ‘configuration’ of p -D hyper-objects §1.F.c.4(i), then $p^p = 2^p$, and $p = 2$.

11. We thus have the contradiction that, for prime $p > 2$, if $z^p - y^p = x^p$:

(i) then $z^p - y^p = 2.^pC_1(k + \frac{a}{p^p})y^{p-1} + 2^2.^pC_2(k + \frac{a}{p^p})^2y^{p-2} + \dots + 2^p(k + \frac{a}{p^p})^p$

(ii) but⁴⁹ $z^p - y^p \neq 2.^pC_1(k + \frac{a}{p^p})y^{p-1} + 2^2.^pC_2(k + \frac{a}{p^p})^2y^{p-2} + \dots + p^p((k + \frac{a}{p^p})\frac{2}{p})^p$

12. Further (see §1.F.d.(a) below), since $2^2 = 2.^2C_1 = 2^2.^2C_2$, the p -D hyper-object sought to be *well-defined uniquely* upto *isomorphism* (see Definition 3) in §1.F.c.(4(i)) by the symmetrically centered ‘configuration’ of p -D hyper-objects:

(i) $\mathbb{C}(\overline{z^p -_{\mathbb{H}_p} y^p}) =_{\mathbb{H}_p} 2.^pC_1(\overline{k + \frac{a}{p^p}})y^{(p-1)} +_{\mathbb{H}_p} 2^2.^pC_2(\overline{k + \frac{a}{p^p}})^2y^{(p-2)} +_{\mathbb{H}_p} \dots +_{\mathbb{H}_p} 2^p(\overline{k + \frac{a}{p^p}})^p$,

where $y, z \in \mathbb{N}$, does *uniquely well-define* a p -D hypercube denoted by $\overline{x^p}$ under change of scale, where $x \in \mathbb{N}$, for $p = 2$.

The proposition follows. □

Corollary 1.2. (Fermat’s Last Theorem) *If $x^n + y^n = z^n$, where $1 < x < y < z \in \mathbb{N}$, and $1 < n \in \mathbb{N}$, then $n = 2$.*

Corollary 1.2 follows since, as noted by Simon Singh in [Sng97] (p.98), by showing that $x^4 + y^4 = z^4$ is unsolvable for $x, y, z \in \mathbb{N}$, Fermat had ‘given mathematicians a head start’ in proving FLT since, additionally:

“To prove Fermat’s Last Theorem for all values of n , one merely has to prove it for the prime values of n . All other cases are merely multiples of the prime cases and would be proved implicitly.”

... Singh: [Sng97], p.99.

The significance of showing we cannot *well-define* the n -D hyper-object denoted by $\overline{z^n}$ *uniquely* upto *isomorphism* (see Definition 3), for $n > 2$, such that $\mathbb{C}_{Sym}(\overline{z^n -_{\mathbb{H}_n} y^n}) =_{\mathbb{H}_n} \mathbb{C}_{Sym}(\overline{x^n})$ interprets as $z^n - y^n = x^n$ in \mathbb{N} , is that it circumvents any implicit appeal (see [Sng97], p.126) to unique factorisation ‘in number systems that extend beyond the ordinary integers’:

“In the 1840’s, several mathematicians worked on a general proof which, like Miyaoka’s, foundered on an unwarranted assumption: they had assumed that the unique factorization of integers into primes (such as $60 = 2 \times 2 \times 3 \times 5$) would hold for number systems that extend beyond the ordinary integers. In actuality, unique factorization is rather rare. For instance, 2×3 and $1 + \sqrt{-5}$ and $1 - \sqrt{-5}$ are distinct factorizations of 6 in a number system that treats $\sqrt{-5}$ as an integer.”

... Cipra: [Cip88].

⁴⁹Reason: Even if the hyper-volume $\mathbb{V}_{Sym}(\overline{z^n -_{\mathbb{H}_n} y^n})$, sought to be *well-defined* in the particular configuration §1.F.c.(4(i)) by the n -D hyper-object denoted by $\overline{z^n -_{\mathbb{H}_n} y^n}$, could be *platonically* assumed as being capable of being ‘filled’ with *unit* n -D hypercubes of total hyper-volume $\mathbb{V}_{Sym}(\overline{x^n})$, it could not even *platonically* be assumed as capable of being ‘filled’ with n -D hypercubes of side $\frac{2}{n}$, of total hyper-volume $\mathbb{V}_{Sym}(\overline{x^n})$, if n is a prime greater than 2; see §1.F.f.

1.F.d. Why is $x^n + y^n = z^n$ solvable for $n = 2$, but not for $n = 3$

We consider the cases $n = 2$ and $n = 3$ to illustrate *why* $x^n + y^n = z^n$ can be argued *informally* as solvable for $n = 2$, but unsolvable for $n > 2$; where we note that for any specified natural numbers $x, y, z, k, a \in \mathbb{N}$ as defined in §1.F.c., Proposition 1.1:

(a) If $x^2 + y^2 = z^2$ and $z - y = 2(k + \frac{a}{2^2})$ then, for instance:

(i) the $2^2 C_1$ 2-D hyper-objects denoted by $\overline{(k + \frac{a}{2^2}) \times y}$, with hyper-dimensions $(k + \frac{a}{2^2}) \times y$, and cumulative 2-D hyper-volume $2^2 C_1 \cdot (k + \frac{a}{2^2}) y$,

defined in §1.F.c.(4(i)) are *well-defined uniquely* upto *isomorphism* (see Definition 3) by (assembled *uniquely* from):

(ii) the 2^4 scaled down 2-D hyper-objects denoted by $\overline{(k + \frac{a}{2^2})^{\frac{1}{2}} \times y(\frac{1}{2})}$, with hyper-dimensions $(k + \frac{a}{2^2})^{\frac{1}{2}} \times y(\frac{1}{2})$, and cumulative 2-D hyper-volume $2^4 \cdot (k + \frac{a}{2^2})^{\frac{1}{2}} y(\frac{1}{2}) = 2^2 C_1 \cdot (k + \frac{a}{2^2}) y$;

whilst:

(iii) the $2^2 \cdot 2 C_2$ 2-D hypercubes denoted by $\overline{(k + \frac{a}{2^2})^2}$, with hyper-dimensions $(k + \frac{a}{2^2}) \times (k + \frac{a}{2^2})$, and cumulative 2-D hyper-volume $2^2 \cdot 2 C_2 \cdot (k + \frac{a}{2^2})^2$,

are also *well-defined uniquely* upto *isomorphism* (see Definition 3) by (assembled *uniquely* from):

(iv) the 2^4 scaled down 2-D hypercubes denoted by $\overline{((k + \frac{a}{2^2})(\frac{1}{2}))^2}$ with hyper-dimensions $((k + \frac{a}{2^2})(\frac{1}{2})) \times ((k + \frac{a}{2^2})(\frac{1}{2}))$, and cumulative 2-D hyper-volume $2^4 \cdot ((k + \frac{a}{2^2})(\frac{1}{2}))^2 = 2^2 \cdot 2 C_2 \cdot (k + \frac{a}{2^2})^2$.

(b) However, if $x^3 + y^3 = z^3$ and $z - y = 2(k + \frac{a}{3^3})$, then:

(i) the 2^3 3-D hypercubes denoted by $\overline{(k + \frac{a}{3^3})^3}$, with hyper-dimensions $(k + \frac{a}{3^3}) \times (k + \frac{a}{3^3}) \times (k + \frac{a}{3^3})$, and cumulative 3-D hyper-volume $2^3 \cdot (k + \frac{a}{3^3})^3$,

are capable of being *well-defined* upto *isomorphism* (see Definition 2), but *not* capable of being *well-defined uniquely* upto *isomorphism* (see Definition 3) by (assembled *uniquely* from):

(ii) the 3^3 scaled down 3-D hypercubes denoted by $\overline{((k + \frac{a}{3^3})(\frac{2}{3}))^3}$, with hyper-dimensions $((k + \frac{a}{3^3})(\frac{2}{3})) \times ((k + \frac{a}{3^3})(\frac{2}{3})) \times ((k + \frac{a}{3^3})(\frac{2}{3}))$ and cumulative 3-D hyper-volume $3^3 \cdot ((k + \frac{a}{3^3})(\frac{2}{3}))^3 = 2^3 \cdot (k + \frac{a}{3^3})^3$;

in a 3-D LEGO blocks puzzle which evidences $\mathbb{C}_{Sym}(\overline{z^3 -_{\mathbb{H}_3} y^3}) =_{\mathbb{H}_3} \mathbb{C}_{Sym}(\overline{x^3})$ as *well-defined only* upto *isomorphism* (see Definition 2) in §1.F.c.4(i), since we cannot assemble the 3-D hypercube denoted by $\overline{z^3}$ in the puzzle by replacing 2^3 identical 3-D hypercubes (as defined in (i)), with 3^3 scaled down, identical, 3-D hypercubes (as defined in (ii)).

Comment 12. In other words, we can *never* design a LEGO blocks puzzle for *any* $y, z \in \mathbb{N}$ such that the LEGO cube $\overline{y^3}$, along with *any* configuration of LEGO blocks which is *isomorphic* (see Definition 2) to $\mathbb{C}_{Sym}(\overline{z^3 -_{\mathbb{H}_3} y^3}) =_{\mathbb{H}_3} 6(k + \frac{a}{3^3})y^2 +_{\mathbb{H}_3} 12(k + \frac{a}{3^3})^2 y +_{\mathbb{H}_3} 8(k + \frac{a}{3^3})^3$, could be assembled into the LEGO cube $\overline{z^3}$.

Reason: If, in the above LEGO blocks puzzle, $\sum_1^j a_i \overline{(\prod_{k=1}^n u_{ik})}$ and $\sum_1^j b_i \overline{(\prod_{k=1}^n v_{ik})}$ are *any* two *uniquely well-defined* configurations upto *isomorphism* (see Definition 3) of the hypercube $\overline{x^n}$, each of which, along with the n -D hypercube $\overline{y^n}$, could be assembled *uniquely* into a hypercube $\overline{z^n}$, then it is:

- *necessary*, but not *sufficient*, that $\sum_1^j a_i(\prod_{k=1}^n u_{ik})$ and $\sum_1^j b_i(\prod_{k=1}^n v_{ik})$ are *isomorphic* (by Definition 2);
- *necessary* and *sufficient* that $\sum_1^j a_i(\prod_{k=1}^n u_{ik})$ and $\sum_1^j b_i(\prod_{k=1}^n v_{ik})$ are *isomorphic* (by Definition 2); and, for all $1 \leq i \leq j$, either $a_i|b_i$ or $b_i|a_i$.

1.F.e. Conclusions: Fermat’s *Lost* Argument

In conclusion, we note §1.F.c. and §1.F.d. argue the *pre-formal* perspective that FLT is a *true* arithmetical proposition which circumscribes some geometrical properties of the n -dimensional hyper-cubes $\overline{x^n}, \overline{y^n}, \overline{z^n}$, in the structure \mathbb{H}_n of n -D hyper-objects in a n -dimensional Euclidean space, such that:

- (a) Fermat’s Last Theorem can be interpreted as an assertion concerning the geometrical properties of the hyper-geometric objects sought to be *well-defined* (by Definition 3) in §1.F.c.4(i); where
- (b) If $x, y, z, n, \in \mathbb{N}$, and $z^n = x^n + y^n$, the n -D hyper-object denoted by $\overline{z^n -_{\mathbb{H}_n} y^n}$, with symmetrically centered configuration $\mathbb{C}_{Sym}(\overline{z^n -_{\mathbb{H}_n} y^n})$, is *well-defined only* if $n \leq 2$; and
- (c) Since it would then follow that $\mathbb{C}_{Sym}(\overline{z^n -_{\mathbb{H}_n} y^n})$ and $\mathbb{C}_{Sym}(\overline{x^n})$ *well-define* the same n -D hyper-object, the n -D hypercube denoted by $\overline{x^n}$, and sought to be *well-defined* in §1.F.c.5(i), is *well-defined only* if $n \leq 2$; whence
- (d) For any *specified* $y, z, \in \mathbb{N}$, x^n cannot be *well-defined* in \mathbb{N} by $2.^nC_1(k + \frac{a}{n^n})y^{(n-1)} + 2^2.^nC_2(k + \frac{a}{n^n})^2y^{(n-2)} + \dots + 2^n(k + \frac{a}{n^n})^n$ such that there is a deterministic algorithm which will *evidence* $x^n + y^n = z^n$ for any *specified* $n > 2$.

It is conceivable that such a *pre-formal* insight could have been *intuited* by Fermat, and viewed initially as a ‘truly marvelous proof’; but perhaps⁵⁰ one whose ‘truth’ in the general case he was unable to *evidence* just enough (lacking a seemingly common argument for sufficient special cases) to let his initial claim lie obscured, but not disowned; thus bequeathing posterity the conundrum:

“If Fermat did not have Wiles’s proof, then what did he have?”

Mathematicians are divided into two camps. The hardheaded skeptics believe that Fermat’s Last Theorem was the result of a rare moment of weakness by the seventeenth century genius. They claim that, although Fermat wrote ‘I have discovered a truly marvellous proof,’ he had in fact found only a flawed proof. The exact nature of this flawed proof is open to debate, but it is quite possible that it may have been along the same lines as the work of Cauchy or Lamé.

Other mathematicians, the romantic optimists, believe that Fermat may have had a genuine proof. Whatever this proof might have been, it would have been based on seventeenth-century techniques, ...”

... Singh: [Sng97], pp.307-308.

1.F.f. Epilogue

We remark, finally, that the *pre-formal* argument for FLT in §1.F.c. raises some intriguing philosophical issues—suggesting a, possibly unsuspected, distinction between properties of *continuous* and *discrete* measures⁵¹—that could conceivably have significance for the physical sciences:

⁵⁰In the absence of an *evidence-based* distinction between the *weaker* requirements for *evidencing* the *logical truth* of algorithmically *verifiable* arithmetical propositions (see [An16], Definition 1; also §7.C., Definition 21), vis à vis the *stronger* requirements for *evidencing* the *logical truth* of algorithmically *computable* arithmetical propositions (see [An16], Definition 2; also §7.C., Definition 23).

⁵¹The significance of this distinction is addressed in detail in §1.H.b.: *Does Fermat’s Last Theorem validate string theory?*

- (i) In *any* physical interpretation of FLT, say as a water tank of volume $z^3\text{L}$ (in litres), with mutually independent hollow compartments in lieu of the 3-D LEGO blocks defined in §1.F.c., Fig.5, FLT entails that we cannot fill the volume $z^3\text{L}$ completely—and without overspill—with water volumes $x^3\text{L}$ and $y^3\text{L}$, if $x, y, z \in \mathbb{N}$.
- (ii) Moreover, we can also consider such an interpretation *theoretically* for any *platonic* model for $n > 3$.
- (iii) Even if the hyper-volume $\mathbb{V}_{Sym}(\overline{z^n -_{\mathbb{H}_n} y^n})$, sought to be *well-defined uniquely* upto *isomorphism* in the particular configuration §1.F.c.(4(i)) by the n -D hyper-object denoted by $\overline{z^n -_{\mathbb{H}_n} y^n}$, could be *platonically* assumed as being capable of being ‘filled’ with unit n -D hypercubes of total hyper-volume $\mathbb{V}_{Sym}(\overline{x^n})$, it could not even *platonically* be assumed as capable of being ‘filled’ with n -D hypercubes of side $\frac{2}{n}$, of total hyper-volume $\mathbb{V}_{Sym}(\overline{x^n})$, if n is a prime greater than 2 (an eventuality that would not arise with a *continuous* measure).

Comment 13. (see also §1.F.c.(11)): FLT follows since $x^p + y^p = z^p$ does not entail $(\frac{p}{2})^p (\frac{2x}{p})^p + y^p = z^p$ for prime $p > 2!$

- (iv) Moreover, even if the putative hyper-volume $\mathbb{V}_{Sym}(\overline{z^n -_{\mathbb{H}_n} y^n})$ ‘between’ the n -D hypercubes denoted by $\overline{y^n}$ and $\overline{z^n}$ in such a *platonic* configuration could always be assumed as capable of being *platonically* ‘filled’ with a *continuous* measure (such as that of, say, flowing water) so as to satisfy $x^n + y^n = z^n$, even *platonically* this cannot always be done with *discrete* measures (say water frozen as blocks of ice) if $n > 2$.
- (v) Any proof of FLT within a putative, formal, theory such as $\mathbb{T}_{\mathbb{H}_p}$ could, then, be interpreted as a formal expression of this, *pre-formal*, distinction between properties of *continuous* and *discrete* measures that must be reflected in the theory.

Comment 14. A distinction that could conceivably have significance for the physical sciences, which appeal to, *essentially unfalsifiable* (see §20.D.f.), interpretations of *well-defined*, formal, mathematical systems (such as *string theories* in particle physics) that admit n -dimensional objects in quantized mathematical structures.

- (vi) In the absence of such an *informal* interpretation, it is not obvious *why*, and in *what* sense, Andrew Wiles proof of FLT can be treated as entailing a true arithmetical proposition under a *well-defined* interpretation of the first-order Peano Arithmetic PA.
- (vii) *Reason:* As argued in §20.C. (§20.C.a., Case 1, to 20.D.c., Case 5) any well-defined, set-theoretical, interpretation of a formal number-theoretic argument—such as, for instance, that of Wiles which must, presumably, implicitly appeal to the limits of Cauchy sequences as well-defined, set-theoretical, real numbers—need not be true *pre-formally* in the arithmetic of the natural numbers (as highlighted in the—albeit distinctly different—case of Goodstein’s Theorem in §19., Theorem 19.1).

From the *evidence-based* perspective of this investigation, the significance of §1.F.c., Proposition 1.1, for the Complementarity Thesis (§1., Thesis 1), is that it illustrates the symbiotic inter-dependence of formal provability and *evidence-based, pre-formal*, truth, since it is the lack of *uniqueness* of the *well-defined, evidence-based*, arithmetical property §1.F.c.(4(i)), in the hyper-geometric representation §1.F.c.(4), of the formal arithmetical relation $x^n + y^n = z^n$, which yields the *pre-formal*, transparent, proof of Fermat’s Last Theorem in §1.F.c..

In other words, one could conjecture that the challenges in, and illusory barriers to, formulating a formal proof of Fermat’s Last Theorem (as also that of the P vs NP problem as evidenced *pictorially* by

§22.A., Proposition 22.5), and in reconstructing Fermat’s putative ‘Lost Proof’, has been rooted in a philosophy that views interpreted mathematical truth as an adjunct entailment of mathematical provability, rather than as a necessarily transparent, and equal, *evidence-based* prerequisite for determining in a formal proof theory which axiomatic assumptions underlie the truth of *pre-formal*, *evidence-based*, reasoning.

1.G. Should Wiles’ *pre-formal* proof of FLT be treated putatively as sufficiently *formal*?

The significance of, and need for, Pantsar’s explicit distinction between *formal* and *pre-formal* proofs of mathematical propositions (see §1.F.a.) is highlighted by Michael Harris’ recent questioning of the necessity for a foundational perspective that would justify *why* Wiles’ proof [Wls95] of FLT may be treated putatively as a *logically true* arithmetical proposition:

“After Wiles’ breakthrough, it became common to hear talk of a new “golden age” of mathematics, especially in number theory, the field in which the Fermat problem belongs. The methods introduced by Wiles and Taylor are now part of the toolkit of number theorists, who consider the FLT story closed. But number theorists were not the only ones electrified by this story.

I was reminded of this unexpectedly in 2017 when, in the space of a few days, two logicians, speaking on two continents, alluded to ways of enhancing the proof of FLT—and reported how surprised some of their colleagues were that number theorists showed no interest in their ideas.

The logicians spoke the languages of their respective specialties—set theory and theoretical computer science—in expressing these ideas. The suggestions they made were intrinsically valid and may someday give rise to new questions no less interesting than Fermat’s. Yet it was immediately clear to me that these questions are largely irrelevant to number theorists, and any suggestion that it might be otherwise reflects a deep misunderstanding of the nature of Wiles’ proof and of the goals of number theory as a whole.

The roots of this misunderstanding can be found in the simplicity of FLT’s statement, which is responsible for much of its appeal: If n is any positive integer greater than 2, then it is impossible to find three positive numbers a, b and c such that

$$a^n + b^n = c^n$$

This sharply contrasts with what happens when n equals 2: Everyone who has studied Euclidean geometry will remember that $3^2 + 4^2 = 5^2$, that $5^2 + 12^2 = 13^2$, and so on (the list is infinite). Over the last few centuries, mathematicians repeatedly tried to explain this contrast, failing each time but leaving entire branches of mathematics in their wake. These branches include large areas of the modern number theory that Wiles drew on for his successful solution, as well as many of the fundamental ideas in every part of science touched by mathematics. Yet no one before Wiles could substantiate Fermat’s original claim."

... Harris: [Hrs19], Other publications, #21.

Prima facie, Harris seems to hold that ‘the simplicity of FLT’s statement’ and, presumably, the seeming straightforwardness of his following outline of the argument underlying Wiles’ proof—covering ‘large areas of the modern number theory that Wiles drew on for his successful solution, as well as many of the fundamental ideas in every part of science touched by mathematics’—should suffice for establishing FLT informally (also *pre-formally* in Pantsar’s sense) as a *logically true* arithmetical proposition that substantiates Fermat’s original claim:

“... Wiles’ proof, complicated as it is, has a simple underlying structure that is easy to convey to a lay audience. Suppose that, contrary to Fermat’s claim, there is a triple of positive integers a, b, c such that

$$(A) \quad a^p + b^p = c^p$$

for some odd prime number p (it's enough to consider prime exponents). In 1985, Gerhard Frey pointed out that a, b and c could be rearranged into

$$(B) \quad \text{a new equation, called an elliptic curve,}$$

with properties that were universally expected to be impossible. More precisely, it had long been known how to leverage such an elliptic curve into

$$(C) \quad \text{a Galois representation,}$$

which is an infinite collection of equations that are related to the elliptic curve, and to each other, by precise rules.

The links between these three steps were all well-understood in 1985. By that year, most number theorists were convinced—though proof would have to wait—that every Galois representation could be assigned, again by a precise rule,

$$(D) \quad \text{a modular form,}$$

which is a kind of two-dimensional generalization of the familiar sine and cosine functions from trigonometry.

The final link was provided when Ken Ribet confirmed a suggestion by Jean-Pierre Serre that the properties of the modular form entailed by the form of Frey's elliptic curve implied the existence of

$$(E) \quad \text{another modular form, this one of weight 2 and level 2.}$$

But there are no such forms. Therefore there is no modular form (D), no Galois representation (C), no equation (B), and no solution (A).

The only thing left to do was to establish the missing link between (C) and (D), which mathematicians call the modularity conjecture.

This missing link was the object of Wiles' seven-year quest. It's hard from our present vantage point to appreciate the audacity of his venture. Twenty years after Yutaka Taniyama and Goro Shimura, in the 1950s, first intimated the link between (B) and (D), via (C), mathematicians had grown convinced that this must be right. This was the hope expressed in a widely read paper by André Weil, which fit perfectly within the wildly influential Langlands program, named after the Canadian mathematician Robert P. Langlands. The connection was simply too good not to be true. But the modularity conjecture itself looked completely out of reach. Objects of type (C) and (D) were just too different."

... Harris: [Hrs19], Other publications, #21.

Comment 15. We note that in the putative reconstruction of Fermat's unrecorded 'proof' of FLT in §1.F.c., instead of (B) above, we consider the arithmetical expression detailed in §1.F.a.:

$$(i) \quad x^n = 2.^nC_1(k + \frac{a}{n^n})y^{n-1} + 2^2.^nC_2(k + \frac{a}{n^n})^2y^{n-2} + \dots + 2^n(k + \frac{a}{n^n})^n$$

and, instead of (C) above, we consider the corresponding geometrical configuration of n -dimensional mathematical objects as defined and detailed in §1.F.b.:

$$(ii) \quad \mathbb{C}_{Sym}(\overline{z^n - \frac{a}{n^n} y^n}) =_{\mathbb{H}_n} 2.^nC_1(k + \frac{a}{n^n})y^{(n-1)} +_{\mathbb{H}_n} 2^2.^nC_2(k + \frac{a}{n^n})^2y^{(n-2)} +_{\mathbb{H}_n} \dots +_{\mathbb{H}_n} 2^n(k + \frac{a}{n^n})^n$$

We then argue *pre-formally* in §1.F.d. that (i) *uniquely* defines (ii) *upto isomorphism*—by extrapolating the pictorial argument for $n = 1, 2, 3$ in §1.F.b., and considering what is entailed by Definition 2 and Definition 3 in the general case—if, and only if, $n < 3$. We conclude that this entails FLT.

We further note that:

- Wiles' proof appeals to properties of *real* and *complex* numbers for establishing that: 'the missing link between (C) and (D)' entails that 'there is no modular form (D), no Galois representation (C), no equation (B), and no solution (A)' for some odd prime p ;
- the *pre-formal* proof in §1.F.d. does *not* appeal to properties of *real* and *complex* numbers for establishing that: for $n > 2$, (i) above does not *uniquely* define (ii) *upto isomorphism* by Definition 3, thereby entailing that there is no solution (A) for some odd prime p .

Harris acknowledges that establishing FLT as a theorem within a formal system such as the first-order Zermelo-Fraenkel set theory ZFC, or a first-order Peano Arithmetic such as PA, may be desirable in principle; since both admit automated theorem proving that would, then, establish FLT additionally as an algorithmically *computable* (logical) *truth* under any *well-defined* (i.e., *evidence-based*) Tarskian interpretation of the concerned formal theory:

"Mathematical logic was developed with the hope of placing mathematics on firm foundations—as an axiomatic system, free of contradiction, that could keep reasoning from slipping into incoherence."

... Harris: [Hrs19].

However he questions both the practical utility and theoretical necessity of such rigour in the absence of a consensus on what constitutes a mathematical language of categorical communication:

"Although Kurt Gödel's work revealed this hope to be chimerical, many philosophers of mathematics, as well as some logicians (a small but vocal minority, according to the set theorist), still regard ZFC and the requirements listed above as a kind of constitution for mathematics.

Mathematicians never write proofs this way, however. A logical analysis of Wiles' proof points to many steps that appear to disregard ZFC, and this is potentially scandalous: When mathematicians make up rules without checking their constitutionality, how can they know that everyone means the same thing?"

... Harris: [Hrs19], *Other publications*, #21.

Instead, he justifies his perspective of the validity of Wiles' proof of FLT by commenting, from a professional mathematician's perspective, that:

"More recently, in the fall of 2016, for example, 10 mathematicians gathered at the Institute for Advanced Study in Princeton, New Jersey, in a successful effort to prove a connection between elliptic curves and modular forms in a new setting. They had all followed different routes to understanding the structure of Wiles' proof, which appeared when some of them were still small children. If asked to reproduce the proof as a sequence of logical deductions, they would undoubtedly have come up with 10 different versions. Each one would resemble the (A) to (E) outline above, but would be much more finely grained.

Nevertheless—and this is what is missing from the standard philosophical account of proof—each of the 10 would readily refer to their own proof as Wiles' proof. They would refer in a similar way to the proofs they studied in the expository articles or in the graduate courses they taught or attended. And though each of the 10 would have left out some details, they would all be right.

What kind of thing is Wiles' proof, if it comes in so many different flavors? In philosophy of mathematics it's customary to treat a published proof as an approximation of an ideal formalized proof, capable in principle of being verified by a computer applying the rules of the formal system. Nothing outside the formal system is allowed to contaminate the ideal proof—as if every law had to carry a watermark confirming its constitutional justification.

But this attitude runs deeply counter to what mathematicians themselves say about their proofs. Mathematics imposes no ideological or philosophical litmus test, but I'm convinced that most of

my colleagues agree with the late Sir Michael Atiyah, who claimed that a proof is “an ultimate check—but it isn’t the primary thing at all.” Certainly the published proof isn’t the primary thing.

Wiles and the number theorists who refined and extended his ideas . . . were certainly aware that a proof like the one Wiles published is not meant to be treated as a self-contained artifact. On the contrary, Wiles’ proof is the point of departure for an open-ended dialogue that is too elusive and alive to be limited by foundational constraints that are alien to the subject matter.”

. . . Harris: [Hrs19], *Other publications*, #21.

From the *evidence-based* perspective of this reconstruction (see §1.H.) of what Fermat might have intuited when making his marginal notation on FLT, Harris could be viewed as drawing upon his earlier perceptions of mathematical ‘truth’, mathematical ‘knowledge’, and mathematical ‘intuition’ for his, seemingly questionable, defense that Wiles’ proof can be viewed putatively as *logically true*:

“It will therefore come as a surprise . . . to many philosophers, that truth is also a secondary issue in mathematics. Of course we want to prove true theorems, but this is hardly an adequate or even useful description of our objective. Mathematicians, and scientists for that matter, judge our peers not by the truth of their work but by how interesting it is⁵². . . .

This point is hardly novel; Lévy-Leblond says something similar in IS (p. 39), and Dieudonné distinguishes further between “mathématiques vides” and “mathématiques significatives.”⁵⁴ But it is surprising to see just how little we seem to be concerned with “truth” these days. Mathematicians rarely discuss foundational issues any more⁵⁵, so it was significant that an article by Arthur Jaffe and Frank Quinn, reaffirming the importance of rigorous proof in the current context of strong interaction between physics and mathematics, provoked no fewer than 16 responses by eminent mathematicians, physicists, and historians. No two of the positions expressed were identical, which already should suggest caution in laying down the law on rationality, as Sokal and Bricmont (and Lévy-Leblond, see note *) seem inclined to do. But for our purposes here, what is remarkable is that almost none of the responses had much to say about “truth.”⁵⁶ “Truth” was central, predictably, only to the responses of Chaitin and Glimm. Chaitin’s branch of mathematics treats “truth” as a technical term, without metaphysical connotations, and Chaitin’s claim to have “found mathematical truths that are true for no reason at all” suggests that it may be harder than Fredkin suspects to know just when to award his prize. Glimm’s brand of truth is quite the opposite: it “lies not in the eye of the beholder, but in objective reality . . . It is thus reproducible across barriers of distance, political boundaries and time.”⁵⁷ Turning to the introduction to the book *Quantum Physics*, by Glimm and Jaffe, one finds the unusual assertion that “mathematical analysis must be included in the list of appropriate methods in the search for truth in theoretical physics.” Generally speaking, the mathematics department may be the only spot on campus where belief in the reality of the external world is not only optional but frequently an annoying distraction. But this patently does not apply to mathematical physicists, and I can’t help thinking it’s not a coincidence that both Bricmont and Sokal are amply represented in the Glimm-Jaffe bibliography.

Philosophers and philosophically-minded sociologists concerned with mathematics seem to think their job is to explain mathematical truth. Edinburgh sociologist David Bloor and philosopher Philip Kitcher, cast for science wars purposes as an irresponsible relativist and a moderate realist, respectively,⁵⁸ have both attempted to develop empiricist accounts of mathematical knowledge⁵⁹. (Knowledge and truth are not synonyms but they are on the same wavelength.⁶⁰) They have their own (very different) reasons, but in so doing I’m convinced they have missed the point of mathematics. As is typical in such discussions, their examples are drawn either from mathematical logic or from mathematics no more recent than the 19th century. If the sociologist, at least, had done some field work, he couldn’t have helped observing that what mathematicians seem to value most are “ideas” (not necessarily of the Platonic variety); the most respected mathematicians are those with strong “intuition.” Now intuition, the philosopher assures us, is philosophically indefensible; Sokal and Bricmont add that “intuition cannot play an explicit role in the reasoning leading to the verification (or falsification) of these theories, since this process must remain independent of the subjectivity of individual scientists.”⁶¹ Fredkin’s theorem-proving machine may see things that way, but what are we [t]o make of Thurston’s emphasis on the “continuing desire

for human understanding of a proof, in addition to knowledge that the theorem is true"?⁶² We know what he means, as we know what Robert Coleman means, when, having discovered a gap in Manin's proof of Mordell's conjecture over function fields, he nevertheless writes "I believe that all this is testimony to the power and depth of Manin's intuition."⁶³ Is Coleman trying to slip a counterfeit coin between the context of discovery and the context of justification? Do these offhand comments touch on something genuine and profound about mathematics? Or is it just my indoctrination that makes me think so?"

... Harris: [Hrs01], Other publications, #2.

1.G.a. Resolving the persisting ambiguity in current paradigms on the nature of, and relation between, mathematical *truth* and mathematical *proof*

If so, although Harris' perspective faithfully reflects the persisting ambiguity in current paradigms on the nature of, and relation between, mathematical *truth* and mathematical *proof*, it may also need to accommodate a putative resolution of such ambiguity that appears sympathetic to his argumentation; such as the Complementarity Thesis (§1., Thesis 1).

Consequently, from the perspective of any discipline which claims (whether *explicitly* or *implicitly*) to appeal only to *evidence-based* reasoning, any claim that Wiles' proof can be treated as a *categorically* communicable *logical truth* may *necessarily* require its validation as a finite sequence of *formal* propositions each of which, at the very least, is algorithmically *verifiable* (in the sense of [An16], Definition 1), for any *specified* instantiation, as a *logically true* proposition under a *well-defined* Tarskian interpretation of some recursively *well-defined* set of axioms/axiom schemata and rules of deduction.

Such validation would also eliminate any uncertainty on the status of Wiles' proof as a valid *pre-formal* piece of *evidence-based* reasoning that is a legitimate contender, even if not a claimant, to being treated as a *logically true* arithmetical proposition:

"... How do we know Wiles' proof of Fermat's Last Theorem, completed by Taylor and Wiles, is correct? Although this particular theorem, better publicized than any in history, has been treated with unusual care by the mathematical community, whose "verdict" is developed at length in a graduate textbook of exceptionally high quality, I'd guess that no more than 5% of mathematicians have made a real effort to work through the proof⁶⁴. Some scientists (and some mathematicians as well) apparently view Wiles and his proof as an "anachronism."⁶⁵ The general public is not entirely convinced. Why are we? Can a sociologist study this question without knowing the proof? Can mathematicians pose the question in terms sociologists would find meaningful? Knowing the truth of the matter is obviously of no help, and relativism is not the issue: it's not clear what kind of "reality" would be relevant to settling the question, but the fact that no one has found a counterexample is certainly not a good candidate. ...

Few of us would choose to treat our belief that Wiles proved Fermat's last theorem as "a mythical and false ideology," but is it possible that our attempts to justify this belief always involve an element of self-delusion? And how are we to convince a skeptical outsider that this is not the case? The only reasonable answers that come to mind are empirical in nature, and specifically historical and sociological, rather than philosophical.¹¹¹ We would have to pay attention to the question of how knowledge is transmitted among mathematicians. Fermat's last theorem provides a particularly good test case. Wiles' proof generated an unprecedented¹¹² number of reports, survey articles, colloquium talks, working seminars, graduate courses, and mini-conferences, as well as books, newspaper and magazine articles, television reports, and other forms of communication with non-mathematicians. Not to mention the spate of announcements, designed to impress public policy-makers and the public at large, citing Wiles' work as proof that mathematics "has never been healthier.*" Has anyone been keeping track of all these incitements to belief formation, checking them for contamination by myth and false ideology?

Studying questions like these provides a second answer to the thought experiment proposed above, complementary to the answer we would naturally provide based on our experience as

mathematicians, and potentially just as interesting. Leaving aside romantic rhetoric, these two answers are not in competition, much less on opposite sides of a battlefield. Arriving at the second answer would be the work of sociologists. For this, full cooperation with mathematicians would be necessary. The examples just cited provide hope that such cooperation may be possible."

...Harris: [Hrs01], Other publications, #2.

Moreover, the need for such rigour in any *proof* of *number-theoretic* propositions that, explicitly or implicitly, appeals essentially to set-theoretical reasoning is that (see §1.A.) it would also address an earlier issue raised by Harris in [Hrs01], concerning the epistemological status of set-theoretically defined real numbers:

"More interestingly, one can ask what kind of object π was before the formal definition of real numbers. To assume the real numbers were there all along, waiting to be defined, is to adhere to a form of Platonism.³⁴ Dedekind wouldn't have agreed.³⁵ In a debate marked by the accusation that postmodern writers deny the reality of the external world, it is a peculiar move, to say the least, to make mathematical Platonism a litmus test for rationality.³⁶ Not that it makes any more sense simply to declare Platonism out of bounds, like Lévy-Leblond, who calls Stephen Weinberg's gloss on Sokal's comment "une absurdité, tant il est clair que la signification d'un concept quelconque est évidemment affectée par sa mise en œuvre dans un contexte nouveau!"³⁷ Now I find it hard to defend Platonism with a straight face, and I prefer to regard formula $\pi^2 = 6\zeta(2)$ as a creation rather than a discovery. But Platonism does correspond to the familiar experience that there is something about mathematics, and not just about other mathematicians, that precisely doesn't let us get away with saying "évidemment!"³⁸ This experience is clearly captured by Alain Connes, a self-avowed Platonist, in his dialogue with neurobiologist J.-P. Changeux, who (to oversimplify) expects to find mathematical structures in the brain.³⁹ I don't think Connes (or Roger Penrose, another prominent Platonist) is confused about reality, and I have a hard time imagining a neuronal representation that does justice to the concept of π . But the ontological issues are far from settled, and while there is no reason to assume they will ever be settled, the important point is that this situation is not an obstacle to mathematics, much less to rationality.⁴⁰ The real absurdity is to claim otherwise."

...Harris: [Hrs01], Other publications, #2.

Thus, from an *evidence-based* perspective, set-theoretically defined real numbers exist as axiomatically *postulated*, purely Platonic, mathematical objects⁵² in any first-order set theory such as ZF; whilst those of such numbers that can further be defined arithmetically exist as axiomatically *postulated* mathematical objects⁵³ (symbols) in any first-order arithmetic such as PA.

Moreover, only the latter have the *evidence-based* properties that can be communicated under a *finitary* interpretation of PA (as detailed in [An16], §6, p.40), as algorithmically *verifiable* (i.e., *logical truths*) which can be treated as *factually grounded knowledge* (in the sense of §5.A.) when describing properties of the *actual* universe we inhabit.

In other words:

- although ZF admits unique, set-theoretical, definitions of—and allows us to unambiguously talk about the *putative* existence of—'ideal' real numbers as the *putative* limits of Cauchy sequences of rational numbers in a mathematically defined, albeit Platonically conceived, *putative* set-theoretical universe, ZF has no *well-defined* Tarskian interpretation that would necessarily

⁵²More specifically, symbols corresponding to what George Lakoff and Rafael Núñez describe as *secondary* conceptual metaphors in [LR00] (see also §13.F., *Three categories of information*, and §27.F., *The Veridicality of Mathematical Propositions*).

⁵³ibid.

evidence a ZF theorem over the *finite ordinals* as an algorithmically *computable* truth over the *natural numbers* in the interpretation⁵⁴;

- only PA, by virtue of the Provability Theorem for PA (see [An16], Theorem 7.1, p.41), admits unique, algorithmically *verifiable*, number-theoretic definitions of—and allows us to unambiguously talk about the *categorical* existence of (see §7.1.)—*specifiable* real numbers (see §7.1., Theorem 7.5), and their properties which, under a *finitary* interpretation of PA (as detailed in [An16], §6, p.40), can be communicated as algorithmically *verifiable* (i.e., *logical*) *truths* which can be treated as *factually grounded knowledge* (in the sense of §5.A.) when describing properties of the *actual* universe we inhabit.

The significance of seeking an *evidence-based, pre-formal*, basis for not only a *deeper* understanding of formal reasoning as, say, in Wiles’ proof of FLT, but also for *identifying* as mathematically significant *only* those formal proofs that admit conceptualisation as *pre-formal* proofs, is highlighted by Jeremy Avigad’s observations in his recent ‘Varieties of Mathematical Understanding’ [Avg21].

For instance, Avigad acknowledges that if ‘the goal of mathematics is to obtain a *conceptual* understanding of mathematical phenomena, and a *deep* understanding at that’, then—particularly with the attraction and ‘use of computational proof assistants to develop libraries of formally checked mathematics’—Wiles’ proof of FLT is evidence that a ‘really deep proof often requires more background knowledge than any one person can master’:

“It is common to say that the goal of mathematics is to obtain a *conceptual* understanding of mathematical phenomena, and a *deep* understanding at that. The Laglands program, which seeks to develop far-reaching connections between number theory and geometry, is often held as a paradigm of conceptual depth. What makes it so? To develop some intuitions, I will draw on informal writings by Kevin Buzzard, a number theorist at Imperial College in London. In 2017, Buzzard launched his *Xena* blog,¹ in part to document his newfound interest in the use of computational proof assistants to develop libraries of formally checked mathematics.

...

One observation is that deep mathematics is usually pretty complicated. Generally speaking, the deeper the result, the harder it is for the general public or even mathematicians not directly involved with the research to appreciate it.

So what are the mathematicians I know interested in? Well, let’s take the research staff in my department at Imperial College. They are working on results about objects which in some cases take hundreds of axioms to define, or are even more complicated: sometimes even the definitions of the objects we study can only be formalised once one has proved hard theorems. For example the definition of a Shimura variety over a number field can only be made once one has proved most of the theorems in Deligne’s paper on canonical models, which in turn rely on the theory of CM abelian varieties, which in turn rely on the theorems of global class field theory. That’s the kind of definitions which mathematicians in my department get excited about [...]. I once went to an entire 24 lecture course by John Coates which assumed local class field theory and deduced the theorems of global class field theory. I have read enough of the book by Shimura and Taniyama on CM abelian varieties to know what’s going on there. I have been to study group on Deligne’s paper on canonical models. So after

⁵⁴A striking example is that of Goodstein’s Theorem, where it can be argued that, although the finite ordinals can be meta-mathematically put into a 1-1 correspondence with the natural numbers (see §19., Theorem 19.1):

Theorem 18.1. Goodstein’s sequence $G_o(m_o)$ over the finite ordinals in any putative model \mathbb{M} of ACA_0 *terminates* with respect to the ordinal inequality ‘ $>_o$ ’ even if Goodstein’s sequence $G(m)$ over the natural numbers *does not terminate* with respect to the natural number inequality ‘ $>$ ’ in \mathbb{M} .

perhaps 100 hours study absorbing the prerequisites, I was ready for the definition of a Shimura variety over a number field. And then there is still the small matter of the definition of étale cohomology. (*Xena*, July 6, 2018)

Perhaps more important than the complexity of statements and definitions is the complexity of the proofs. A really deep proof often requires more background knowledge than any one person can master.

To completely understand a proof of FLT (let's say, for now, the proof explained in the 1995 Darmon-Diamond-Taylor paper) you will need to be a master of the techniques used by Langlands in his proof of cyclic base change (and I know people who are), and a master of Mazur's work on the Eisenstein ideal (and I know people who are). But what about the far less sexy technical stuff? To move from the complex analytic theory of modular forms to the algebraic theory of moduli spaces of elliptic curves (and I know people who know this—but I went through some of this stuff once and it's far more delicate than I had imagined, and there are parts of it where the only useful reference seems to be Brian Conrad's brain). This last example is perhaps a good example of a tedious technical issue which it's very easy to forget about, because the results are intuitive and the proofs can be technical. There are many other subtleties which one would have to fully understand because they're on the syllabus. Is there really one human being who would feel confident answering questions on all of this material? I am really not sure at all. (*Xena*, September 27, 2019)

It would be a mistake, however, to equate depth with complexity, and other postings on *Xena* make it clear that complexity is only a means to an end. Complex definitions and proofs are worth the effort when they provide answers to questions that are judged by the community to be interesting and important."

... Avigad: [Avig21], §3, *Conceptual Understanding and Depth*.

Moreover, whilst acknowledging that the current emphasis on trying to grasp the totality of formal reasoning—such as all the ‘subtleties’ involved in Wiles’ proof of FLT—could tend to ‘equate depth with complexity’, Avigad makes ‘it clear that complexity is only a means to an end’: a conceptual understanding of what is termed as ‘deep’ mathematics.

The above argumentation suggests that a ‘pre-formal proof’ is essentially an argument, supported by evidence in Murthy’s sense⁵⁵, which is more than a conjecture.

The argument would lie somewhere between treating ‘knowledge’ as ‘intuitively justified true belief’, and Gualtiero Piccinini’s ‘knowledge as factually grounded belief’ in [Pic19]; until it can be unambiguously expressed and formally proven in some formal language that has a finitary (or at least constructive) interpretation in which the ‘pre-formal proof’ can be shown to be either an algorithmically *computable*, or at least an algorithmically *verifiable*, Tarskian ‘truth’—at which point it could validly claim to be ‘knowledge’ in Piccinini’s sense.

It would not be entirely unreasonable to thus suggest, on the basis of Michael Harris’ argument in [Hrs19], that, presently, both Wiles’s *arcane* proof and the argument for the truth of FLT in §1.F.c., Proposition 1.1, could be viewed as lying in the area of ‘pre-formal proofs’ (possibly with varying degrees of ‘pre-formal belief’).

⁵⁵“It is by now folklore ... that one can view the *values* of a simple functional language as specifying *evidence* for propositions in a constructive logic ... ”

... Murthy: [Mu91], §1 Introduction.

1.H. *Could this paragraph be treated as Fermat’s Unrecorded ‘Proof’ of FLT?*

What yet remains unanswered, though, is whether, and if so what, Fermat might have ‘realised’ he had ‘briefly deluded himself’ as having solved ‘with an irretrievable idea’. That is the issue we shall seek here to illuminate by the following hypothetical, one-paragraph, elementary ‘reconstruction’—in Fermat’s Unrecorded⁵⁶ ‘Proof’—of what Fermat could, conceivably, have intuited, but found both:

- too long initially to record in the margin of his copy of Diophantus’ *Arithmetica*; and,
- in the absence of an Arithmetical Interpretation of Fermat’s Unrecorded ‘Proof’ of FLT as below;
- not convincing enough as a *formal* proof of FLT on further reflection.

This ‘reconstruction’ seeks to suggest an alternative to post-Wiles wisdom, which dismisses Fermat’s claim of ‘a truly marvellous demonstration’ as unjustified, lacking even a plausible argument for FLT.

Fermat’s Last Theorem (FLT) $x^p + y^p \neq z^p$ for any prime $p > 2$, where $x, y, z, p \in \mathbb{N}$ and x, y, z are co-prime.

Fermat’s Unrecorded ‘Proof’ of FLT In any mathematical model of a universe U_p where a fundamental particle is not *treated* as a *point* particle⁵⁷, but as a p -D hypercube⁵⁸ of side $\frac{2}{p}$ and volume $(\frac{2}{p})^p$ —where $\frac{2}{p}$ is a fundamental constant like, say, Planck’s constant \hbar —we cannot have finite sets of particles X, Y, Z —with corresponding volumes x^p, y^p, z^p —and natural numbers $(\frac{px}{2})^p, (\frac{py}{2})^p, (\frac{pz}{2})^p$, where x, y, z are co-prime, such that $(\frac{2}{p})^p(\frac{px}{2})^p + (\frac{2}{p})^p(\frac{py}{2})^p = (\frac{2}{p})^p(\frac{pz}{2})^p$ if $p > 2$. The theorem follows.⁵⁹ \square

1.H.a. Arithmetical interpretation of Fermat’s Unrecorded ‘Proof’ of FLT

We note that the above has an arithmetical interpretation which, in hindsight, would justify Fermat’s intuition:

If p is a prime, $k, m, n, x, y, z \in \mathbb{N}$, and x, y, z are co-prime, then we can find $x, y, z \in \mathbb{N}$ such that:

- x^p can be the total volume of a set of $m = (\frac{px}{k})^p$ cubes of side $(\frac{k}{p})^{\frac{p}{3}}$;
- y^p can be the total volume of a set of $n = (\frac{py}{k})^p$ cubes of side $(\frac{k}{p})^{\frac{p}{3}}$; and

⁵⁶The collateral significance of Fermat’s unrecorded deliberations is reflected in Richard P. Feynman’s wry observation:

“We have a habit in writing articles published in scientific journals to make the work as finished as possible, to cover up all the tracks, to not worry about the blind alleys or describe how you had the wrong idea first, and so on. So there isn’t any place to publish, in a dignified manner, what you actually did in order to get to do the work . . . ”

. . . Feynman: *In his Nobel Lecture, 1966*, <https://www.nobelprize.org/prizes/physics/1965/feynman/lecture/>.

⁵⁷See https://en.wikipedia.org/wiki/Point_particle.

⁵⁸See <https://en.wikipedia.org/wiki/Hypercube>.

⁵⁹Curiously, the natural number 1 can, thus, be viewed as representing a fundamental, dimensionless, constant of nature which can be treated as an ‘absolute’ unit of discreteness. This suggests, further, that a fundamental particle cannot be treated, even in principle, as a ‘point’ particle; it must be treated as associated with an ‘absolute’ unit of discreteness (volume?) denoted by ‘1’.

- (c) z^p can be the total volume of the set of $m + n = (\frac{pz}{k})^p$ cubes of side $(\frac{k}{p})^{\frac{p}{3}}$;
- (d) whence (a) + (b) + (c) entails $x^p + y^p = z^p$;
- (e) and, conversely, $x^p + y^p = z^p$ entails (a) + (b) + (c);

if, and only if, $k = p$.

Reason: If p is a prime, and $x, y, z \in \mathbb{N}$ are co-prime, then $(\frac{px}{k})^p, (\frac{py}{k})^p, (\frac{pz}{k})^p \in \mathbb{N}$ if, and only if, $k = p$.

Hence $k = 2$, since $3^2 + 4^2 = 5^2$.

Reason: If $x, y, z, k \in \mathbb{N}$ such that $x^p + y^p = z^p$ is solvable only if $k = p$, then $k \neq 2$ entails the contradiction that $x^2 + y^2 = z^2$ is not solvable.

1.H.b. Does Fermat's Last Theorem validate string theory?

A curious—hitherto unsuspected—consequence of the preceding sections for physical theories is that admitting ‘point’ particles into mathematical models of molecular phenomena might harbour inconsistency⁶⁰!

For instance, we shall show that, and why, given any two cubic water tanks T_1 and T_2 , of sides x and y where $x, y \in \mathbb{N}$ ⁶¹:

- (a) we can *always* construct a cubic water tank T_3 of side $z \in \mathbb{R}$ whose volume equals that of $T_1 + T_2$;
- (b) in any mathematical model that admits molecular phenomena, we can consistently claim *only* that the volume of water in T_3 , when completely full, equals the sum of the water volumes in T_1 and T_2 when the latter too are completely full if, and only if, $x^2 + y^2 = z^2$ and $z \in \mathbb{N}$.

Moreover there are further curious consequences of this seeming anomaly not only for Fermat's Last Theorem, but also for ‘string’ theories of physics; consequences which seemingly *validate* not only the forbidding of ‘point’ (zero-dimensional) particles, and admittance of fundamental particles as either ‘open’ (one-dimensional) or ‘closed’ (two-dimensional) strings into a mathematical model but, curiously, also suggest that any underlying theory cannot admit higher dimensional fundamental particles!

Of interest too is the epistemological status of Fermat's Last Theorem (see §1.H.f.); in the sense that:

- the hypothetical, one-paragraph, elementary ‘reconstruction’ of Fermat's Unrecorded ‘Proof’ FUP (in §1.H.e.), now suggests an alternative to post-Wiles wisdom; which
- *despite* the absence of any well-defined (finitary) interpretation of Wiles' argument that would validate it as—at the very least—an algorithmically *verifiable* arithmetical *truth* (in the sense of [An16]);
- *dismisses* Fermat's claim of ‘a truly marvellous demonstration’ as *unjustified*;
- *lacking* even a plausible argument for treating FLT as a ‘pre-formal’ mathematical *truth*—in Markus Pantsar's sense in [Pan09] (see §1.A.)—which could then ‘justify’, in some sense, the human (intangible) or material (tangible) resources consumed by the search for not only a formal *proof* of FLT by Wiles (as eventually evidenced by the success of his relentless pursuit of the problem over decades), but for *any* ‘post-formal’ mathematical *truth* of the Theorem.

⁶⁰As hinted at in §1.F.f.: *Epilogue*.

⁶¹We denote the domain of the natural numbers by \mathbb{N} ; that of the rationals by \mathbb{Q} or \mathbb{Q} ; and that of the real numbers by \mathbb{R} .

1.H.c. Fermat's Last Theorem

We recall that Fermat's Last⁶² Theorem FLT states that no three positive integers x, y, z satisfy the equation $x^n + y^n = z^n$ for any integer value of n greater than 2.

However, we shall consider here only the equivalent form of FLT⁶³, which states that no three positive integers x, y, z satisfy the equation $x^p + y^p = z^p$ for any prime p greater than 2.

1.H.d. Does the volume of water obey Fermat's Last Theorem?

Indisputably, given any two cubic water tanks T_1 and T_2 of sides x and y where $x, y \in \mathbb{N}$, we can *always* construct a cubic water tank T_3 of side $z \in \mathbb{R}$ whose volume equals that of $T_1 + T_2$.

The question arises:

Query 1. *Can we further claim that the volume of water in tank T_3 , when completely full, equals the sum of the water volumes in tanks T_1 and T_2 when the latter too are completely full?*

To appreciate the significance of Query 1, we note that—under our current mathematical representation of water as uniquely identified by a discrete molecular structure⁶⁴—each of the cubic water tanks T_1, T_2 and T_3 can only hold a *finite* number of molecules of water when completely full.

Further, we can tentatively assume—*prima facie* without inviting contradiction—that the volume 'effectively occupied' in a 3-D Euclidean space by an individual molecule of water can—in principle for purposes of this argument only—be represented mathematically as $(\frac{k}{p})^p$, where $k \in \mathbb{N}$, p is a prime, and $\frac{k}{p} \in \mathbb{R}$ is treated as a fundamental constant of nature⁶⁵ which denotes an absolute unit of discreteness for any dimensions associated with a water molecule⁶⁶.

It would then immediately follow that *if* $k, m, n, x, y \in \mathbb{N}$, p is a prime and x, y are co-prime⁶⁷, *then* we can *always* find $x, y \in \mathbb{N}$ such that:

- (a) x^p is the total volume X of a set of $m = (\frac{px}{k})^p$ water molecules, each of volume $(\frac{k}{p})^p$;
- (b) y^p is the total volume Y of a set of $n = (\frac{py}{k})^p$ water molecules, each of volume $(\frac{k}{p})^p$;
and
- (c) z^p is the total volume Z of the set of $m + n = (\frac{pz}{k})^p$ water molecules, each of volume $(\frac{k}{p})^p$;

whence:

- (d) $(X + Y = Z) \leftrightarrow (x^p + y^p = z^p)$;

⁶²For the significance of the adjective 'Last', see §1.F.

⁶³"To prove Fermat's Last Theorem for all values of n , one merely has to prove it for the prime values of n . All other cases are merely multiples of the prime cases and would be proved implicitly." ... Singh: [Sng97], p.99. See also [Wls95], p.448, THEOREM 0.5. *Suppose that $u^p + v^p + w^p = 0$ with $u, v, w \in \mathbb{Q}$ and $p \geq 3$, then $uvw = 0$.*

⁶⁴For the purposes of this investigation, we do not distinguish between the two chemical forms of water, but treat them as discrete objects occupying identical 'effective volumes' in the mathematical model under consideration; where we further disregard differences due to pressure, temperature, or other extraneous factors that do not affect the property of 'discreteness' which constitutes the focus our argumentation.

⁶⁵Akin, for instance, to the reduced Planck constant \hbar ; or similar dimensionless, empirically postulated, constants such as α , the fine structure constant; μ or β , the proton-to-electron mass ratio; αG , the gravitational coupling constant.

⁶⁶Such as, for instance, its *molar volume*. See <https://en.wikipedia.org/wiki/Water>.

⁶⁷Two natural numbers are defined as co-prime if, and only if, they have no common factor other than 1.

if, and only if, $z \in \mathbb{N}$ and $k = 1$ or $k = p$.

Reason: If p is a prime, and $x, y \in \mathbb{N}$ are co-prime, then $(m = (\frac{px}{k})^p), (n = (\frac{py}{k})^p), ((m+n) = (\frac{pz}{k})^p) \in \mathbb{N}$ if, and only if, $z \in \mathbb{N}$ and either $k = 1$, or $k = p$ (since no prime factor of $k > 1$ can be a factor of both x and y).

Hence $k = 2$, since $3^2 + 4^2 = 5^2$; which immediately entails FLT.

Reason: If $x, y, k \in \mathbb{N}$ and x, y are co-prime, such that $x^p + y^p = z^p$ is solvable if, and only if, $z \in \mathbb{N}$ and either $k = 1$ or $k = p$, then $k \neq 2$ entails the contradiction that $x^2 + y^2 = z^2$ is not solvable.

1.H.e. Could Fermat's Unrecorded 'Proof' FUP of FLT 'validate' string theories?

The above now suggests Fermat might conceivably have soliloquized (see §1.F.) that:

In any mathematical model of a 'universe' U_p , where a fundamental particle is not *treated* as a *point* particle but as a p -D hypercube⁶⁸ of side $\frac{2}{p}$ and hypervolume $(\frac{2}{p})^p$ —where $\frac{2}{p}$ is a fundamental constant—we cannot have sets of particles X, Y, Z —with corresponding hypervolumes x^p, y^p, z^p —and natural numbers $(\frac{px}{2})^p, (\frac{py}{2})^p, (\frac{pz}{2})^p$, where x, y, z are co-prime, such that $(\frac{2}{p})^p(\frac{px}{2})^p + (\frac{2}{p})^p(\frac{py}{2})^p = (\frac{2}{p})^p(\frac{pz}{2})^p$ (i.e., $x^p + y^p = z^p$) if $p \neq 2$.

Comment 16. We note that forbidding 'point' particles—as in FUP—is a premise of any string theory⁶⁹ that admits fundamental particles as representable mathematically only by 'open' and 'closed' *strings* (which can be treated as 'existing' in some sense in a multi-dimensional physical space, of which we can only directly experience three physical dimensions plus the passage of time); where however, although represented mathematically as 'one-dimensional' (open) or two-dimensional (closed), the strings implicitly admit of an associated 'volume' unless a string is treated as having zero 'cross-section' (which would, however, entail a curious assumption akin to the forbidden assumption of 'point' particles).

Comment 17. Since $x^n + y^n = z^n$, where $x, y, z, n \in \mathbb{N}$, is solvable only for $n = 1$ (trivially) and $n = 2$, but not for $n = 0$ and $n > 2$, the hypothetical FUP suggests not only that fundamental particles *cannot* be represented mathematically as having 0 dimensions but, moreover, can *only* be represented mathematically as having dimensions 1 or 2, as is suggested by string theories that admit both 'open' (one-dimensional) or 'closed' (two-dimensional) strings.

Comment 18. Since $\frac{2}{p} = 1$ in FUP, the natural number 1 could thus be treated as representing a fundamental, dimensionless, constant⁷⁰ of nature which can be treated as an 'absolute' unit of discreteness; thereby suggesting further that treating natural phenomena as representable mathematically in a (*continuous*) continuum, which admits 'point' particles *unqualifiedly*, may introduce unsuspected inconsistencies into the mathematical model.

1.H.f. The epistemological status of Fermat's Last Theorem

We conclude by noting that:

- Whereas Wiles' proof [Wls95] considers only a *mathematical* interpretation (model) of FLT over continuous, 2-dimensional, objects (elliptic curves), and concludes that constraints on scalar properties (genus and level of associated modular forms) associated with these objects, in a *continuous* 2-D Euclidean space, entail FLT as mathematically *proven*;

⁶⁸cf., <https://en.wikipedia.org/wiki/Hypercube>.

⁶⁹cf., [https://en.wikipedia.org/wiki/String_\(physics\)](https://en.wikipedia.org/wiki/String_(physics)).

⁷⁰cf., https://en.wikipedia.org/wiki/Dimensionless_physical_constant.

- Query 1, and the hypothetical reconstruction of Fermat’s Unrecorded ‘Proof’ FUP of FLT, consider *physical* interpretations (gedanken) of FLT over discrete, 3-dimensional, objects (finite sets of molecules/putative volumes associated with fundamental particles), which *validate* Wiles’ *proof* as a mathematical *truth* by showing that, and why, constraints on scalar properties (volumes) associated with these mathematical objects in a *discrete* 3-D Euclidean space entail, and are entailed by, FLT.

1.I. *Evidence-based* (pictorial), *pre-formal*, proofs of the Four Colour Theorem

Although the Four Colour Theorem 4CT itself is considered passé (see §1.I.a.), and no longer treated as an open problem, it serves to highlight the significance of *pre-formal* reasoning that seeks to *transparently* illustrate—independent of Kenneth Appel and Wolfgang Haken’s computer-generated ‘pre-formal proof’⁷¹ of 4CT (in [AH77] and [AHK77])—*why* four colours suffice to chromatically differentiate any set of contiguous, simply connected and bounded, planar spaces; by showing that:

- (1) If, for some natural numbers m, n , every planar map of less than $m + n$ contiguous, simply connected and bounded, areas can be 4-coloured;
- (2) And, we assume (Hypothesis 1) that there is a *sub-minimal* 4-coloured planar map \mathcal{M} , of $m + n$ such areas, where *finitary* creation of a *specific*, additional, contiguous, simply connected and bounded, area C within \mathcal{M} yields a *minimal* map \mathcal{H} which entails that C require a 5th colour;
- (3) Then Hypothesis 1 is false (by Proposition 1.3), since there can be *no* such *sub-minimal* 4-coloured planar map \mathcal{M} .

We further show that Proposition 1.3 is also entailed independently by:

- (a) If A_m is a set of m contiguous, simply connected, and bounded areas of \mathcal{H} , *none* of which shares a non-zero boundary segment with C ; and B_n is a set of n contiguous, simply connected and bounded, areas of \mathcal{H} , *some* of which share *at least* one, non-zero, boundary segment with C , then $m = 0$; and each area of the region B_n abuts the area C at least once (Proposition 1.4);
- (b) *No* two areas $b_{n,i}, b_{n,j}$ of B_n can share *two*, distinctly separated, non-zero boundary segments (Corollary 1.5);
- (c) *No* two areas $b_{n,i}, b_{n,j}$ of B_n can share a non-zero boundary segment that has *no* point in common with C if each area of B_n abuts the area C *only* once (Corollary 1.14);
- (d) *Some* area $b_{n,i}$ of B_n *must* share *at least* two, distinctly separated, non-zero, boundary segments with C (Corollary 1.7);
- (e) *No* area $b_{n,i}$ of B_n can share *two*, distinctly separated, non-zero boundary segments with C (Corollary 1.15).

⁷¹‘Pre-formal proof’ since, although formally unproven and questionably vacuous (see §1.I.e.), we would consider it as a putative ‘proof’ that is expressed in the language of algorithmically *computable* functions and, if found sound, is *implicitly* validated by the Provability Theorem for PA in [An16] (§7, Theorem 7.1): *A PA formula $[F(x)]$ is PA-provable if, and only if, $[F(x)]$ is algorithmically computable as always true in \mathbb{N} .*

We note that this seemingly supports Patrick Allo’s perspective that (see also §1.B.): ‘*When we thus reconsider the nature of logic from a constructionist perspective, logic becomes associated with epistemic ideals that can in principle be used to evaluate various forms of automated reasoning-systems, ranging from theorem provers that are based on strict procedures to so-called algorithmic systems that rely on machine-learning methods*’ ... Allo:

[Allo17], *Conclusion*, p.562.

We then give a *formal* proof of 4CT in Theorem 1.10, which *validates* (see §1.J.) that the pre-formal proofs of 4CT can be treated as mathematical ‘truths’.

Moreover, we show in §1.I.f. *why the pictorial proof cannot* be expressed within classical graph theory.

1.I.a. A historical perspective

It would probably be a fair assessment that the mathematical significance of any new proof of the Four Colour Theorem 4CT *continues* to be perceived as lying not in any ensuing theoretical or practical utility of the Theorem per se, but in whether the proof can address the philosophically ‘unsatisfying’, and occasionally ‘despairing’ (see [Tym79]; [Sw80]; [Gnt08], [Cl01]) lack of, mathematical ‘insight’, ‘simplicity’ and ‘elegance’ in currently known proofs of the Theorem (eg. [AH77], [AHK77], [RSST], [Gnt08])—an insight and simplicity this investigation seeks in a *pre-formal* proof of 4CT.

For instance we note—amongst others⁷²—some candid comments from Robertson, Sanders, Seymour, and Thomas’s 1995-dated (apparently pre-publication) web-survey⁷³ of their proof [RSST]:

“The Four Color Problem dates back to 1852 when Francis Guthrie, while trying to color the map of counties of England noticed that four colors sufficed. He asked his brother Frederick if it was true that any map can be colored using four colors in such a way that adjacent regions (i.e. those sharing a common boundary segment, not just a point) receive different colors. Frederick Guthrie then communicated the conjecture to DeMorgan. The first printed reference is due to Cayley in 1878 ([Cay79]). . . .

The next major contribution came from Birkhoff whose work allowed Franklin in 1922 to prove that the four color conjecture is true for maps with at most 25 regions. It was also used by other mathematicians to make various forms of progress on the four color problem. We should specifically mention Heesch who developed the two main ingredients needed for the ultimate proof - reducibility and discharging. While the concept of reducibility was studied by other researchers as well, it appears that the idea of discharging, crucial for the unavoidability part of the proof, is due to Heesch, and that it was he who conjectured that a suitable development of this method would solve the Four Color Problem.

This was confirmed by Appel and Haken in 1976, when they published their proof of the Four Color Theorem [1.2] (*sic*).

Why a new proof?

There are two reasons why the Appel-Haken proof is not completely satisfactory.

- Part of the Appel-Haken proof uses a computer, and cannot be verified by hand, and
- even the part that is supposedly hand-checkable is extraordinarily complicated and tedious, and as far as we know, no one has verified it in its entirety."

... Thomas et al. [RSSp], Pre-publication web survey.

“It has been known since 1913 that every minimal counterexample to the Four Color Theorem is an internally six-connected triangulation. In the second part of the proof, published in [4, p. 432], Robertson et al. proved that at least one of the 633 configurations appears in every internally six-connected planar triangulation. This condition is called “unavoidability,” and uses the discharging method, first suggested by Heesch. Here, the proof differs from that of Appel and Haken in that it relies far less on computer calculation. Nevertheless, parts of the proof still cannot be verified by a human. The search continues for a computer-free proof of the Four Color Theorem.”

... Brun: [Bru02], §1. Introduction (Article for undergraduates)

⁷²Particularly Crilly [Cr105] and McKay [McK12], who seek to do more justice to the history of 4CT.

⁷³See [RSSp]; also [Thm98], [Cl01], and the survey [Rgrs] by Leo Rogers.

“The four-colour problem had a long life before it eventually became the four-colour theorem. In 1852 Francis Guthrie (later Professor of Mathematics at the University of Cape Town) noticed that a map of the counties of England could be coloured using only four colours. He wondered if four colours would always suffice for any map. He, or his brother Frederick, proposed the problem to Augustus De Morgan (see the box at the end of Section 3.5 in Chapter 3) who liked it and suggested it to other mathematicians. Interest in the problem increased after Arthur Cayley presented it to the London Mathematical Society in 1878 ([Cay79]). The next year Alfred Bray Kempe (a British lawyer) gave a proof of the conjecture. His proof models the problem in terms of graphs and breaks it up into a number of necessary cases to be checked. Another proof was given by Peter Tait in 1880. It seemed that the four-colour problem had been settled in the affirmative.

However, in 1890 Percy John Heawood found that Kempe’s proof missed one crucial case, but that the approach could still be used to prove that five colours are sufficient to colour any map. In the following year Tait’s proof was also shown to be flawed, this time by Julius Petersen, after whom the Petersen graph is named. The four-colour problem was therefore again open, and would remain so for the next 86 years. In that time it attracted a lot of attention from professional mathematicians and good (and not so good) amateurs alike. In the words of Underwood Dudley:

The four-color conjecture was easy to state and easy to understand, no large amount of technical mathematics is needed to attack it, and errors in proposed proofs are hard to see, even for professionals; what an ideal combination to attract cranks!

The four-colour theorem was finally proved in 1976 by Kenneth Appel and Wolfgang Haken at the University of Illinois. They reduced the problem to a large number of cases, which were then checked by computer. This was the first mathematical proof that needed computer assistance. In 1997 N. Robertson, D.P. Sanders, P.D. Seymour and R. Thomas published a refinement of Appel [and] Haken’s proof, which reduces the number of necessary cases, but which still relies on computer assistance. The search is still on for a short proof that does not require a computer."

... Conradie/Goranko: [CG15], §7.7.1, *Graph Colourings*, p.417.

“Being the first ever proof to be achieved with substantial help of a computer, it has raised questions to what a proof really is. Many mathematicians remain sceptical about the nature of this proof due to the involvement of a computer. With the possibility of a computing error, they do not feel comfortable relying on a machine to do their work as they would be if it were a simple pen-and-paper proof.

The controversy lies not so much on whether or not the proof is valid but rather whether the proof is a valid proof. To mathematicians, it is as important to understand why something is correct as it is finding the solution. They hate that there is no way of knowing how a computer reasons. Since a computer runs programs as they are fed into it, designed to tackle a problem in a particular way, it is likely they will return what the programmer wants to find leaving out any other possible outcomes outside the bracket.

Many mathematicians continue to search for a better proof to the problem. They prefer to think that the Four Colour problem has not been solved and that one day someone will come up with a simple completely hand checkable proof to the problem."

... Nanjwenge: [Nnj18], Chapter 8, *Discussion (Student Thesis)*.

“The heavy reliance on computers in Appel and Haken’s proof was immediately a topic of discussion and concern in the mathematical community. The issue was the fact that no individual could check the proof; of special concern was the reductibility [*sic*] part of the proof because the details were “hidden” inside the computer. Though it isn’t so much the *validity* of the result, but the *understanding* of the proof. Appel himself commented: “... there were people who said, ‘This is terrible mathematics, because mathematics should be clean and elegant,’ and I would agree. It would be nicer to have clean and elegant proofs.” See page 222 of Wilson."

... Gardner: [Grd21], §11.1, *Colourings of Planar Maps*, pp.6-7 (*Lecture notes*).

1.I.b. Two *pre-formal* proofs of the 4-Colour Theorem

We consider the surface of the hemisphere (*minimal* planar map \mathcal{H}) in Fig.1 where:

- (1) A_m denotes a region of m contiguous, simply connected and bounded, surface areas $a_{m,1}, a_{m,2}, \dots, a_{m,m}$, *none* of which share a non-zero boundary segment with the contiguous, simply connected, surface area C (as indicated by the red barrier which, however, is *not* to be treated as a boundary of the region A_m);

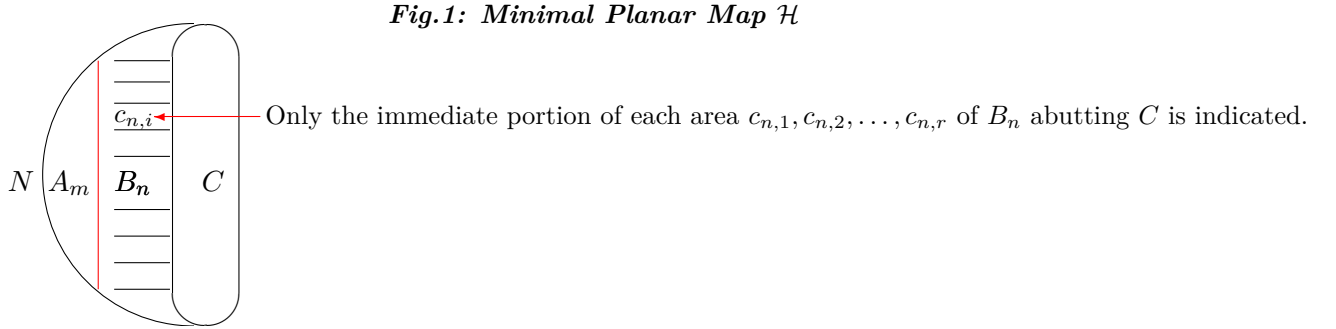

- (2) B_n denotes a region of n contiguous, simply connected and bounded, surface areas $b_{n,1}, b_{n,2}, \dots, b_{n,n}$, *some* of which, say $c_{n,1}, c_{n,2}, \dots, c_{n,r}$, share *at least one* non-zero boundary segment of c_i with C ; where, for each $1 \leq i \leq r$, $c_{n,i} = b_{n,j}$ for some $1 \leq j \leq n$;
- (3) C is a single contiguous, simply connected and bounded, area created *finitarily* by sub-dividing and annexing one or more contiguous, simply connected, portions of each area $c_{n,i}^-$ (defined in Hypothesis 1(b) below) in the region B_n^- (defined in Hypothesis 1(b) below);
- (4) N is the orientation pole N of the hemisphere in Fig.1

Hypothesis 1. (Minimality Hypothesis) *Since four colours suffice for maps with fewer than 5 regions, we assume the existence of some m, n , in a putatively minimal planar map \mathcal{H} , which defines a minimal configuration of the region $\{A_m + B_n + C\}$ where:*

- (a) *any configuration of p contiguous, simply connected and bounded, areas can be 4-coloured if $p \leq m + n$, where $p, m, n \in \mathbb{N}$, and $m + n \geq 5$;*
- (b) *any configuration of the $m + n$ contiguous, simply connected and bounded, areas of the region, say $\{A_m^- + B_n^-\}$, in a putative, sub-minimal, planar map \mathcal{M} before the creation of C —constructed finitarily by sub-dividing and annexing some portions from each area, say $c_{n,i}^-$, of B_n^- in \mathcal{M} —can be 4-coloured;*
- (c) *the region $\{A_m + B_n + C\}$ in the planar map \mathcal{H} is a specific configuration of $m + n + 1$ contiguous, simply connected and bounded, areas that cannot be 4-coloured (whence the area C necessarily requires a 5th colour by the Minimality Hypothesis).*

Proposition 1.3. (Four Colour Theorem) *No planar map needs more than four colours.*

Proof. (By Fermat's Infinite descent)⁷⁴ If the area C of the *minimal* planar map \mathcal{H} in Fig.1 is divided further (as indicated in Fig.2) into two non-empty areas D_1 and E_1 , yielding a planar map \mathcal{H}^* where:

⁷⁴See also the updated proof of this proposition in §1.I.h., Proposition 1.17

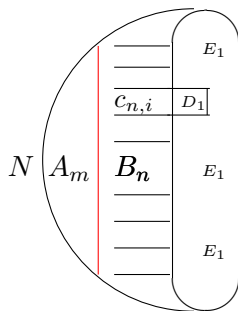

Fig.2: Planar Map \mathcal{H}^*

- D_1 shares a non-zero boundary segment with only *one* of the areas $c_{n,i}$; and
- D_1 can be *treated* as an original area of $c_{n,i}^-$ in \mathcal{M} (see Hypothesis 1(b)) that was annexed to form part of C in \mathcal{H} (in Fig.1);

then D_1 can be absorbed back into $c_{n,i}$ without violating the Minimality Hypothesis. Moreover, $c_{n,i} + D_1$ *must* share a non-zero boundary with E_1 in \mathcal{H}' if $c_{n,i} = b_{n,j}$ for some $1 < j < n$, and $b_{n,j}, C$ are required to be differently coloured, in \mathcal{H} .

However, such a division, as illustrated in Fig.2, followed by re-absorption of D_1 into $c_{n,i}^-$ (denoted, say, by $B_n + D_1$), would reduce the configuration \mathcal{H}^* in Fig.2 again to a *minimal* planar map, say \mathcal{H}_1 with a configuration $\{A_m + B'_n + E_1\}$, where $B'_n = (B_n + D_1)$; which would in turn necessitate a 5th colour for the area $E_1 \subset C$ by the Minimality Hypothesis.

Since we cannot, by reiteration, have a non-terminating sequence $C \supset E_1 \supset E_2 \supset E_3 \supset \dots$, the sequence must terminate in an area E_k of a *minimal* planar map, say \mathcal{H}_k , for some finite integer k ; where E_k contains no area that is annexed from any of the areas of B_n^- in \mathcal{M} prior to the formation of the *minimal* planar map \mathcal{H} (in Fig.1).

However, by Hypothesis 1(b), this contradicts the definition of the area C , in the *minimal* planar map \mathcal{H} (in Fig.1)—ergo of the area E_k in the *minimal* planar map \mathcal{H}_k —as formed *finitarily* by sub-division and annexation of existing areas of B_n^- in \mathcal{M} .

Comment 19. Note that we cannot admit as a putative limit of $C \supset E_1 \supset E_2 \supset E_3 \dots$ the configuration where all the $c_{n,i}^-$ —corresponding to the abutting areas $c_{n,i}$ of C in the Minimal Planar Map \mathcal{H} —meet at a point in the putative, sub-minimal, planar map \mathcal{M} , since any *finitarily* (i.e., not postulated) creation of C , begun by initially annexing a non-empty area of some $c_{n,i}^-$ at such an apex (corresponding to the putative ‘finally merged’ area of the above non-terminating sequence $C \supset E_1 \supset E_2 \supset E_3 \supset \dots$), would require, at most, a 4th but not a 5th colour.

We conclude by Fermat’s Infinite descent that there can be no *minimal* planar map \mathcal{H} which defines a *minimal* configuration such as the region $\{A_m + B_n + C\}$ in Fig.1. The theorem follows. \square

We note that, since classical graph theory represents non-empty areas as points (*vertices*), and a non-zero boundary between two areas as a line (*edge*) joining two points, it *cannot*⁷⁵ express the proof of Proposition 1.3 graphically.

Reason: The proof appeals to properties of a series of putatively minimal planar maps $\mathcal{H}, \mathcal{H}_1, \mathcal{H}_2, \dots$, created by the sequence of areas C, E_1, E_2, \dots , where each area is finitarily created as a proper subset of the preceding area in such a way that the graphs of $\mathcal{H}, \mathcal{H}_1, \mathcal{H}_2, \dots$ remain undistinguished.

We show, further, that Proposition 1.3 is also entailed by Proposition 1.4 and Corollaries 1.5 to 1.15:

⁷⁵Thereby illustrating Pantsar’s argument for the primacy of *pre-formal* proofs (see §1.J.).

Proposition 1.4. *If A_m is a set of m contiguous, simply connected, and bounded areas—of the minimal planar map \mathcal{H} —none of which shares a non-zero boundary segment with C ; and B_n is a set of n contiguous, simply connected and bounded, areas of \mathcal{H} , some of which share at least one, non-zero, boundary segment with C , then $m = 0$; and each area of the region B_n abuts the area C at least once.*

Proof. Consider the mirror image of Fig.1, with mirrored regions A'_m, B'_n , area C' , and pole S (Fig.3).

By our hypothesis that the region $\{A_m + B_n\}$ (ergo its mirror image $\{A'_m + B'_n\}$) can be 4-coloured, joining the two halves into a sphere, where each area of the region B_n is aligned with its mirror image,

Fig.3: Minimal Planar Map \mathcal{H}' (mirror image of \mathcal{H})

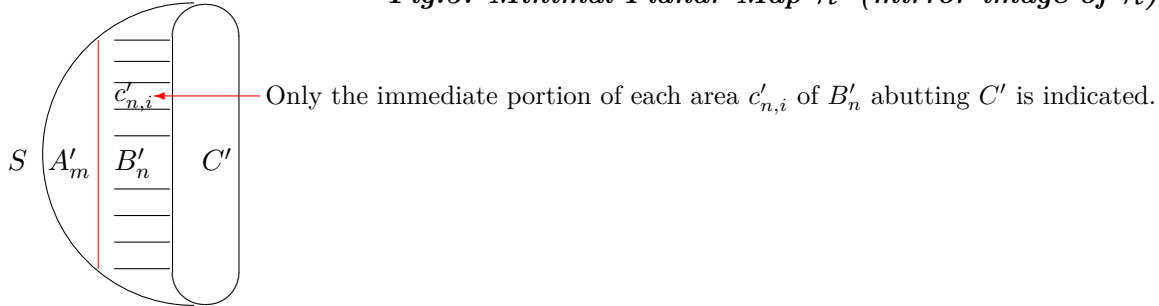

would extinguish both C and C' ; thereby yielding a 4-coloured configuration of *at least* $n + 2m$ contiguous, simply connected and bounded, areas forming the region $\{A_m + B_n + B'_n + A'_m\}$ (now on the surface of the sphere formed by melding the two hemispheres).

However, this entails that some intermediate steps in the creation of $\{A_m + B_n + B'_n + A'_m\}$ from $\{A_m + B_n + C\}$, initially by annexing areas of \mathcal{M} to form \mathcal{H} , and thereafter of \mathcal{H} to form successor maps, could then be reversed to eliminate C , thus contradicting Hypothesis 1 if A_m contained *at least* one area which does *not* share a non-zero boundary segment with C .

Hence the region A_m is empty under *minimality*, and $m = 0$. Moreover, by repeated reasoning, the region B_n cannot contain *any* area which does *not* share a non-zero boundary segment with C ; whence *each* area of the region B_n abuts the area C *at least* once. \square

Corollary 1.5. *No two areas $b_{n,i}, b_{n,j}$ of B_n in the minimal planar map \mathcal{H} can share two, distinctly separated, non-zero boundary segments.*

Proof. If region A_m is empty, and *each* area of region B_n abuts the area C *at least* once, then:

- no two areas $b_{n,i}$ and $b_{n,j}$ of B_n can share *two*, distinctly separated, non-zero boundary segments,
- since the l areas of the region, say A_l ($l > 0$), enclosed by such boundary segments of the areas $b_{n,i}$ and $b_{n,j}$ would *not* then share *any* non-zero boundary segment with the area C ; contradicting Proposition 1.4. \square

Corollary 1.6. *No two areas $b_{n,i}, b_{n,j}$ of B_n in the minimal planar map \mathcal{H} can share a non-zero boundary segment that has no point in common with C if each area of B_n abuts the area C *only* once.*

Proof. If the region A_m is empty, and two areas of B_n —say $b_{n,1}$ and $b_{n,2}$ (see Fig.4)—share a non-zero boundary (shown in red) that *does not* intersect C , that would divide $\{B_n - b_{n,1} - b_{n,2}\}$ into two *non-empty* regions $B_{n,upper}$ and $B_{n,lower}$, such that *no* area of the region $B_{n,upper}$ shares a non-zero boundary with *any* area of the region $B_{n,lower}$; whence:

- (i) some areas in each of the regions $B_{n,upper}$ and $B_{n,lower}$ would necessarily require 2 additional colours not shared with the areas C , $b_{n,1}$ and $b_{n,2}$; since:

Fig.4: Minimal Planar Map \mathcal{H}

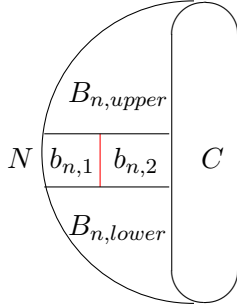

- both regions requiring only 1 additional colour—which can then be the same—would violate the *minimality* of \mathcal{H} by making it 4-colourable;
 - if one of the regions, say $B_{n,upper}$, requires only 1 of the 2 colours,
 - then annexing one of the areas of $B_{n,lower}$, say $b_{n,lower}$, which has this colour, say x , into the area C would again reduce the map \mathcal{H} to a *sub-minimal* map \mathcal{M}' ,
 - but still require 5 colours, since the merged area ($b_{n, lower} + C$) would now abut areas with all the four colours of the map \mathcal{M}' , thus violating the *minimality* of \mathcal{H} ;
- (ii) each of the regions $\{B_{n,upper} + b_{n,1} + b_{n,2} + C\}$ and $\{B_{n,lower} + b_{n,1} + b_{n,2} + C\}$ would necessarily require C to have the 5th colour—and violate the *minimality* of \mathcal{H} —in order to avoid violating *minimality* when combined (superimposed suitably) to form map \mathcal{H} . □

Corollary 1.7. *If each area of the region B_n abuts the area C only once, then some area $b_{n,i}$ of B_n in \mathcal{H} must share at least two, distinctly separated, non-zero, boundary segments with the area C .*

Fig.6: Minimal Planar Map \mathcal{H}

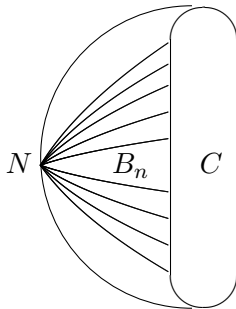

Proof. If the region A_m is empty, and each area of the region B_n abuts the area C only once, then all the areas of the region B_n can be treated as bounded by longitudinals that meet at the orientation pole N of the hemisphere (see Fig.5).

However, the region B_n would then require at most 2 colours if n is even, and 3 colours if n is odd; whence the area C would not require a 5th colour, contradicting the *minimality* of \mathcal{H} . □

Corollary 1.8. *No area $b_{n,i}$ of B_n in the minimal planar map \mathcal{H} can share two, distinctly separated, non-zero boundary segments with C .*

Proof. By Corollary 1.7, some area in the region B_n , say $b_{n,k}$, must abut the area C at *at least two*, distinctly separated, non-zero boundary sections (one of which is shown in red in Fig.6).

Fig.6: Minimal Planar Map \mathcal{H}_L

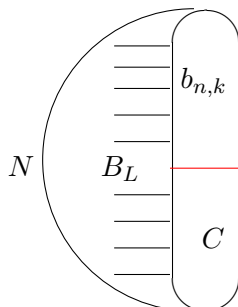

However, the region $\{C + b_{n,k}\}$ can then be treated as an equatorial band which divides the areas in the region $\{B_n - b_{n,k}\}$ into the *two* regions B_L (see Fig.6) and B_R (not shown); such that *no* area of the region B_L abuts *any* area of the region B_R .

Hence the regions $\{C + b_{n,k} + B_L\}$ and $\{C + b_{n,k} + B_R\}$ can be treated as two, distinctly separated, hemispherical planar maps \mathcal{H}_L and \mathcal{H}_R :

- each of which has less than the number of areas required for *minimality*; but
- each of which necessarily requires a 5^{th} colour;

thus contradicting the assumption that $\{A_m + B_n + C\}$ is a *minimal* configuration. \square

We thus conclude, independently of Proposition 1.3, that no planar map needs more than four colours.

1.I.c. A formal, *computer-independent*, proof of 4CT

We now give a formal⁷⁶, *computer-independent*, proof of 4CT which, further, shows that, and why, the perceived ‘flaw’ in Alfred Kempe’s 1879 proof [Kmp79] of 4CT is not *fatal* (see §1.I.g.).

The search for a *formal* proof was motivated by consideration of Robin Wilson’s noting in [Wln13] (p.156 and p.166 respectively) that the computer-dependent proofs appeal—*prima facie* mysteriously—to consideration of a specific number of 1,482 ‘reducible configurations’ in [AH77], and ‘only 633 reducible configurations’ in [RSST].

Why there should be any specific number—which would entail a minimum number that can, therefore, be treated as a mathematical constant such as e or π —of ‘reducible configurations’ is neither intuitively obvious, nor even remotely suggested by the argumentation of either proof.

The inescapable conclusion: The *minimum* number of ‘unavoidable’ and ‘reducible configurations’ can only be 1^{77} —the quadrilateral identified by Kempe in [Kmp79]!

To see this, we note that colouring any planar map M with only 1, 2, 3 or 4 countries requires, at most, 4 colours if no two countries with the same colour are neighbours (defined as having a common, *non-zero*, boundary). Moreover:

Theorem 1.9. *There is no minimum number $n > 4$ of countries in a minimal planar map M_{min} , such that a 5^{th} colour is necessary in every possible differentiated coloring of M_{min} ; whilst any sub-minimal map, say S_{sub} , with less than n countries, can always be differentiated with only 4 colours.*

⁷⁶See also [An22d]: *Why Four Colours Suffice: Why pre-formal ‘proofs’ entail formal proofs, and not vice versa..*

⁷⁷Whence the computer-assisted proofs of 4CT are vacuously true! See [An22e], [An23]; also §1.I.e..

Fig.1: The minimal planar map M_{min}

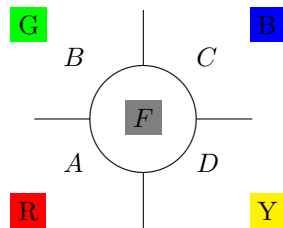

Proof. (1) If there is such a planar map M_{min} , then it must contain some country F surrounded by at least 4 countries A, B, C, D identified by, say, the colours *Red, Green, Blue, Yellow*, respectively; whence F must require a 5th colour, say *Gray*, as in Fig.1.

Fig.2: Areas meeting at apex P_F in S_{sub} with colours inherited from M_{min}

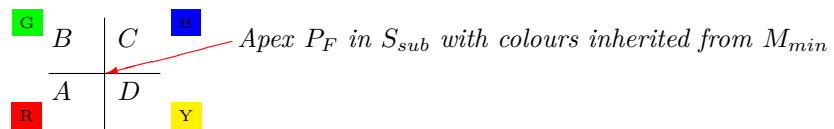

(2) **CASE 1:** If F is surrounded by *only* 4 neighbouring countries as in Fig.1, and we shrink F to a point, say, P_F (see Fig.2), then the number of countries will be less than n , reducing M_{min} to the *sub-minimal* map S_{sub} in Fig.2 which is 4-colourable by definition.

Fig.3: Merging areas A and C at apex P_F in S_{sub} and recolouring S'_{sub}

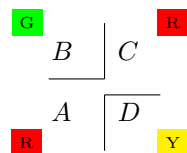

(a) Merging the countries A and C at the apex P_F into one country (see Fig.3) now yields another *sub-minimal*, hence 4-colourable, map S'_{sub} ; which can be recoloured so that the areas A, B, C, D now require only 3 colours (see Fig.3).

Fig.4: Restoring areas A and C at apex P_F in S_{sub} with colours inherited from S'_{sub}

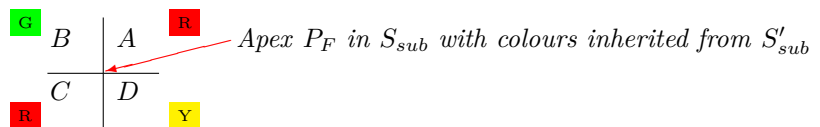

(b) Restoring the apex P_F , so that A and C are again non-neighbouring countries that have *only* the apex point P_F , but no *non-zero* boundary, in common (see Fig.4), thus yields a fresh 4-colouring of S_{sub} in which only 3 colours at most meet at the apex P_F (see Fig.4).

Fig.5: Areas in M_{min} with F recreated in S_{sub} and colours inherited from S'_{sub}

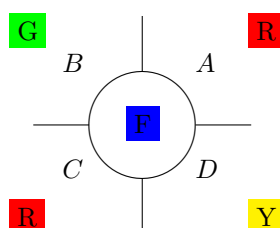

- (c) Recreating F in S_{sub} (see Fig.5) further yields a chromatic differentiation of M_{min} that requires only a 4th colour for F , thus contradicting the *putative minimality* of M_{min} .
- (d) **Conclusion:** Hence no *minimal* map M_{min} can contain an area F that is surrounded by *only* 4 countries *if* F necessarily requires a 5th colour.
- (3) **CASE 2:** Hence any *minimal* map M_{min} must contain a *Gray*-coloured country F which is surrounded by at least 5 countries, of which four, say A, B, C, D , are necessarily coloured *Red, Green, Blue, Yellow*; whereas a fifth country, say E , which abuts F must repeat *some* colour.

Fig.6: F shares a non-zero boundary segment with 5 areas in M_{min}

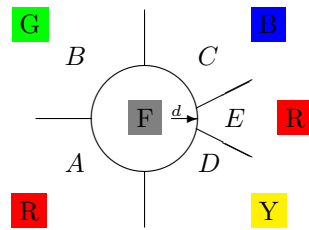

- (a) Without loss of generality, we need to only consider the case where F is surrounded by 5 countries (see Fig.6) to show *why* F cannot abut two countries which have the same colour.
- (b) If (see Fig.6) the country E —necessarily different from A to avoid reduction to Case 1—repeats the colour *Red*, and country F annexes country E by deleting their common boundary d (see Fig.7), then deletion of the boundary d reduces the *minimal* map M_{min} to a *sub-minimal* map S_{sub} which has one less country.

Fig.7: Annexing E into F yields a *sub-minimal* map S_{sub}

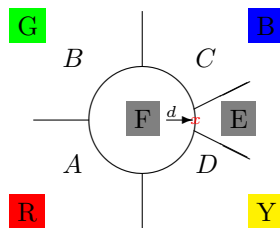

- (c) However, the *sub-minimal* map S_{sub} is now 4-colourable as shown in Fig.8, where the areas A and E are necessarily differently coloured.
- (d) Moreover, in *any* 4-colouring of S_{sub} , the countries A and E (now a part of F which abuts A), cannot have the same colour.

Fig.8: The *sub-minimal* map S_{sub} would be 4-colourable

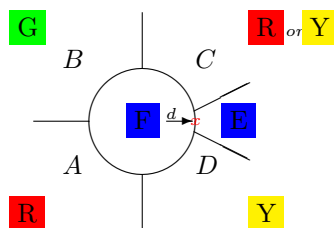

- (e) In other words, no matter *how* we 4-colour the *sub-minimal* map S_{sub} in Fig.8, restoring F and E to their original status as independent countries in M_{min} (see Fig.9) does not allow A and E to have the same colour in M_{min} .
- (f) This contradicts our assumption that A and E can be assumed to have the same colour in *some* differentiated colouring of M_{min} , where F necessarily requires a 5th colour.

Fig.9: After restoration A and E cannot share identical colours in M_{min} as postulated

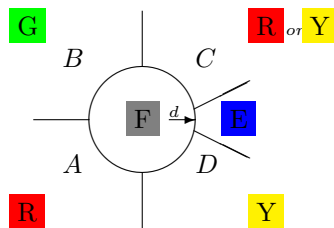

- (g) **Conclusion**⁷⁸: Any country in a *minimal* map M_{min} that necessarily requires a 5th colour can have at most 4 neighbours. Hence, by Case 1, there is no *minimal* map M_{min} such that a 5th colour is necessary in *every* possible differentiated coloring of M_{min} . \square

We shall further argue in §1.J. in what sense the above can be viewed as *evidencing* (and how the *pre-formal* ‘proofs’ of the Four Colour Theorem in §1.I.b. were *necessary* for *formally* proving):

Theorem 1.10. (Four Colour Theorem) *No chromatically differentiated planar map needs more than four colours.* \square

1.I.d. The perceived ‘flaw’ in Kempe’s 1879 argument

In their *computer-assisted* proof of the Four Colour Theorem [AH77], Appel and Haken review the ‘flaw’ in Kempe’s 1879 ‘proof’ [Kmp79]:

“The first published attempt to prove the Four Color Theorem was made by A. B. Kempe [19] in 1879. Kempe proved that the problem can be restricted to the consideration of “normal planar maps” in which all faces are simply connected polygons, precisely three of which meet at each node. For such maps, he derived from Euler’s formula, the equation

$$(1.1) \quad 4p_2 + 3p_3 + 2p_4 + p_5 = \sum_{k=7}^{k_{max}} (k - 6)p_k + 12$$

where p_i is the number of polygons with precisely i neighbors and k_{max} is the largest value of i which occurs in the map. This equation immediately implies that every normal planar map contains polygons with fewer than six neighbors.

In order to prove the Four Color Theorem by induction on the number p of polygons in the map ($p = \sum p_i$), Kempe assumed that every normal planar map with $p \leq r$ is four colorable and considered a normal planar map M_{r+1} with $r + 1$ polygons. He distinguished the four cases that M_{r+1} contained a polygon P_2 with two neighbors, or a triangle P_3 , or a quadrilateral P_4 , or a pentagon P_5 ; at least one of these cases must apply by (1.1). In each case he produced a map M_r , with r polygons by erasing from M_{r+1} one edge in the boundary of an appropriate P_k . By the induction hypothesis, M_r admits a four coloring, say c_{r+1} , and Kempe attempted to derive a four coloring c_{r+1} of M_{r+1} from c_r . This task was very easy in the cases of P_2 and P_3 . To treat the cases of P_4 and P_5 , Kempe invented the method of interchanging the colors in a maximal connected part which was colored by c_r with a certain pair of colors (two-colored chains were

⁷⁸Compare with the informal proof of Theorem 1.9 in §1.I.g.(a)-(d); and with §1.I.h., Lemma 1.18: *The area C in the minimal map \mathcal{H} can have only four, all differently coloured, neighbours.*

later called Kempe chains) to obtain a coloring c_r' of M_r from which one can then obtain a four coloring c_{r+1} of M_{r+1} .

While Kempe's argument was correctly applied to the case of P_4 , it was incorrectly applied to the case of P_5 as was shown by Heawood [18] in 1890." ... Appel and Haken: [AH77], §1. Introduction, p.429.

We note, however, that the 'flaw' is not fatal if Kempe's argument is expressed *geometrically*.

Reason: The case Appel and Haken refer to as P_5 corresponds to §1.I.c.(3) **CASE 2** where:

- We do not appeal—in a *graphical* representation of *minimal* 'normal planar maps'—to a 'method of interchanging the colors' in 'Kempe chains', so as to identify 'reducible' configurations in an 'unavoidable' set.
- Instead, we appeal—in a *geometrical* representation of *minimal* planar maps—to the Minimality Hypothesis 1, and argue that:
 - in any *Minimal Planar Map* such as \mathcal{H} in §1.I.b., Fig.1,
 - any area such as P_5 which necessarily requires a 5th colour,
 - cannot share non-zero boundaries with *two*, similarly coloured, neighbours.

This then yields P_4 as the sole configuration in an 'unavoidable' set. Moreover, as Appel and Haken note, P_4 is shown by Kempe to be 'reducible' (corresponding to the proof of the Four Colour Theorem in §1.I.c., Theorem 1.10).

1.I.e. Could there be an *unperceived, inherited, 'flaw' in Appel and Haken's argument?*

Unarguably meriting a philosophical discussion of consequences that lie beyond the immediate ambit of this investigation, we merely note here that:

If the 'flaw' in Kempe's 1879 'proof' [Kmp79] is perceived as falsely claiming to have proven the argument that:

- (α) Any *minimal* 'normal planar map' admits an *unavoidable* set containing a 'pentagon' that can be shown as *reducible*; where (cf. [Wln13], Ch.8):
- (i) An *unavoidable* set is a set of configurations such that every map that satisfies some necessary conditions for being a minimal non-4-colorable triangulation (such as having minimum degree 5) must have at least one configuration from this set.
 - (ii) A *reducible* configuration is one that cannot occur in a minimal counterexample. If a map contains a reducible configuration, the map can be reduced to a smaller map. This smaller map has the condition that if it can be colored with four colors, this also applies to the original map. This implies that if the original map cannot be colored with four colors the smaller map cannot either and so the original map is not minimal.

then the following remarks suggest that Appel and Haken's computer-dependent 'proof' [AH77] (as also Robertson et al's [RSST]), too could be viewed as 'flawed' (in the sense of being vacuously true, even if logically valid):

“While Kempe’s argument was correctly applied to the case of P_4 , it was incorrectly applied to the case of P_5 as was shown by Heawood [18] in 1890. Kempe’s argument proved, however, that five colors suffice for coloring planar maps and that a minimal counter-example to the Four Color Conjecture (minimal with respect to the number p of polygons in the map) could not contain any two-sided polygons, triangles, or quadrilaterals. This restricts the Four Color Problem to the consideration of normal planar maps in which each polygon has at least five neighbors. Each such map must contain at least twelve pentagons since in (1.1) we have $p_2 = p_3 = p_4 = 0$ and thus

$$(1.2) \quad p_5 = \sum_{k=7}^{k_{max}} (k-6)p_k + 12.$$

Since 1890 a great many attempts have been made to find a proof of the Four Color Theorem. We distinguish two types of such attempts: (i) attempts to repair the flaw in Kempe’s work; and (ii) attempts to find new and different approaches to the problem. Among attempts of type (i) we distinguish two subtypes: (i)(a) attempts to find an essentially stronger chain argument for “reducing the pentagon,” i.e., proving that a minimal counter-example to the Four Color Conjecture cannot contain any pentagon, and thus does not exist; and (i)(b) attempts to make more extended use of Kempe’s arguments in different directions and, instead of “reducing” the pentagon directly, to replace it by configurations of several polygons. Since the method used in this paper is of type (i)(b) we shall restrict our attention to further developments in this branch.” ... Appel and Haken: [AH77],

§1. Introduction, p.430.

Reason: By §1.I.c.(3) **CASE 2** (essentially Appel/Haken’s ‘type (i)(a)’) no *minimal* planar map can admit an ‘unavoidable’ set containing a pentagon.

In other words, both Kempe and Appel/Haken argue that:

- (I) 4CT is equivalent to proving that, in any *minimal* ‘normal planar map’, there is an ‘unavoidable’ set of *two* configurations, P_4 and P_5 , each of which is ‘reducible’;
- (II) Kempe [Kmp79] has validly shown that the configuration P_4 is ‘reducible’.

Moreover, Appel/Haken restricted their argument to ‘type (i)(b)’ to further argue that:

- (a) Kempe did not prove in [Kmp79] that the configuration P_5 is ‘reducible’.
- (b) If each of the 1,482 configurations, as *manually* defined in their ‘unavoidable’ set in [AH77], is ‘reducible’, then P_5 is ‘reducible’;
- (c) A *computer-dependent* proof validates that each of the 1,482 configurations is ‘reducible’;
- (d) Hence 4CT is proven.

However, §1.I.c.(3) **CASE 2** shows that (I) admits an invalid *implicit* assumption, since no *minimal* planar map can contain a configuration such as P_5 ; whence (d) would hold *vacuously* as having proven:

- (β) If every *minimal* planar map admits an ‘unavoidable’ set containing a five-sided figure such as P_5 , then P_5 is ‘reducible’.

and not that:

- (γ) No *minimal* planar map can admit an ‘unavoidable’ set containing a five-sided figure such as P_5 .

1.1.f. Why the *geometrical* proof of 4CT may not be expressible *graphically*

We note that, since classical graph theory (see, for instance, Brun [Bru02], Conradie/Goranko [CG15], Gardner [Grd21]) represents non-empty areas as points (*vertices*), and a non-zero boundary between two areas as a line (*edge*) joining two points (*vertices*) (see Fig.1), the theory does not immediately *evidence* a graphical proof of §1.1.c., Theorem 1.10.

Fig.1: Graphical representation of \mathcal{H}

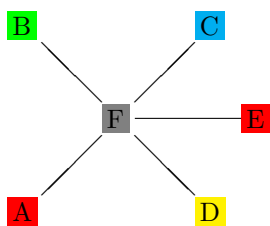
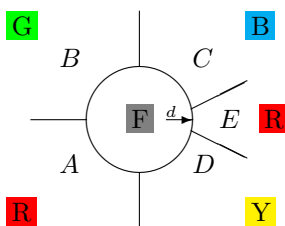

Fig.2: Geometrical representation of \mathcal{H}



In other words, the proof of §1.1.c., Theorem 1.10 appeals critically to re-configuring the *geometrical* representation of the, putatively *minimal*, planar map \mathcal{H} in Fig.2 by:

- (a) first *removing* the non-zero boundary d in Fig.2 to yield a 4-colourable sub-minimal map $\mathcal{M}_{\mathcal{F}}$ (see Fig.4);

Fig.3: Graphical representation of $\mathcal{M}_{\mathcal{F}}$

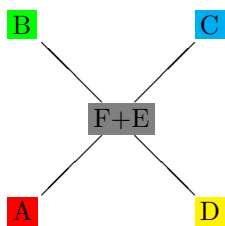
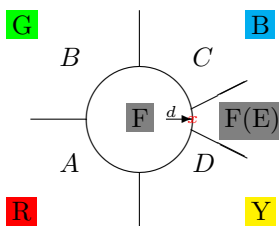

Fig.4: Geometrical representation of $\mathcal{M}_{\mathcal{F}}$



- (b) then recoloring $\mathcal{M}_{\mathcal{F}}$ with four colours as implicitly indicated in Fig.6; and
- (c) finally *restoring* the non-zero boundary d so that the area F of the restored minimal map \mathcal{H} again requires a fifth colour, as shown in Fig.6.

so as to merge/de-merge the areas F and E (in Fig.2), in a *geometrically* distinguishable way, that, *prima facie*, cannot be immediately *evidenced* in the corresponding argument, *when* represented *graphically* by Figs.1, 3 and 5.

Fig.5: Graphical representation of \mathcal{H}

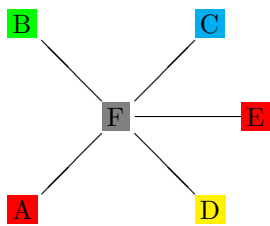
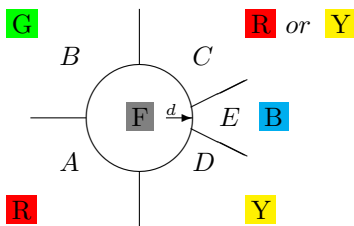

Fig.6: Geometrical representation of \mathcal{H}



We thus speculate that the barriers to proving 4CT *graphically* may possibly lie in Alfred Kempe's unsupported *postulation*, that the four-color map problem could be reformulated *equivalently* as a problem involving *linkages* between the 'lettering' of colours at *unspecified* points of a map in a *graph*:

“If we lay a sheet of tracing paper over a map and mark a point on it over each district and connect the points corresponding to districts which have a common boundary, we have on the tracing paper a diagram of a “linkage,” and we have as the exact analogue of the question we have been considering, that of lettering the points in the linkage with as few letters as possible, so that no two directly connected points shall be lettered with the same letter. Following this up, we may ask what are the linkages which can be similarly lettered with not less than n letters?”

The classification of linkages according to the value of n is one of considerable importance. I shall not, however, enter here upon this question, as it is one which I propose to consider as part of an investigation upon which I am engaged as to the general theory of linkages. It is for this reason also that I have preferred to treat the question discussed in this paper in the manner I have done, instead of dealing with the analogous linkage." ... Kempe: [Kmp79], p.200

In other words, it is conceivable—perhaps even likely—that Kempe was misled by a *pseudo-graphical* representation of $\mathcal{M}_{\mathcal{F}}$ (see Fig.7) into believing that a *graphical* argument *must* follow which entails that a five-sided configuration in \mathcal{H} (see Fig.2) must be ‘reducible’.

Reason: In a *pseudo-graphical* representation—as shown in Fig.7 just *before* their merger—countries A and E *obviously* could not have been identically coloured in any 4-colouring of $\mathcal{M}_{\mathcal{F}}$ inherited by, or

Fig.7: *Pseudo-graphical representation of $\mathcal{M}_{\mathcal{F}}$*

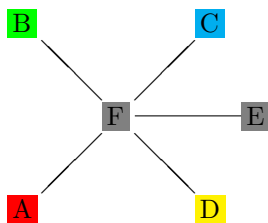
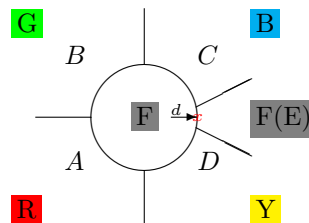

Fig.8: *Geometrical representation of $\mathcal{M}_{\mathcal{F}}$*



from, \mathcal{H} (as is evident in the *geometrical* representation in Fig.8).

Comment: It is trivial to paste (or even merely imagine pasting) a small, black, piece of paper anywhere on a children’s 4-coloured globe to confirm that:

- there is never a need to re-colour the, inherited, 4-coloured areas of the globe; *and*,
- if the black area partitions a country into two, no two of the countries abutting the black area *after* partitioning could have shared the same colour *before* partitioning,

This could account for Kempe’s intuitively ‘preferred’ alternative in informal explanations vis à vis his explicit assumption that a formal representation by ‘linkages’ may be viewed ‘as the exact analogue’ of the four-color map problem; a preference reflected in Robin Wilson’s *italicised* remark in [Wln13], wherein he too, seemingly *uncritically*, assumes such an equivalence:

“Any coloring of the countries of the map gives rise to a lettering of the points in the linkage in which no two directly connected points are lettered the same.

We now refer to such a linkage as a *graph* ... and to the preceding process as forming the graph (or dual graph) of the map. This reformulation of the four-color problem as a problem involving the lettering of points reappeared briefly in the 1880s (see Chapter 6) and was later reintroduced in the 1930s and used in all subsequent attempts to solve the problem.

So as not to complicate matters, we shall usually stick to coloring the countries of maps (rather than switching to lettering the points of a graph) throughout the rest of this book." ... Wilson: [Wln13], p.67.

It is thus also conceivable that subsequent articulations of 4CT failed to recognise the *geometrical* argument in §1.I.c.(3) **CASE 2** *only* because Kempe’s formal appeal to Euler’s formula $V + F = E + 2$ ‘seemingly’ simplified the problem substantially by entailing that every *minimal* planar map must contain a configuration of fewer than six sides.

‘Seemingly’, since it is not obvious—unlike the *geometrical* argument in §1.I.c.(3) **CASE 2** which is immediately evident in Fig.4—that:

- a *graphical* argument *must* follow from Fig.3,
- which admits the possibility that a five-sided figure may *not* be definable in a *minimal* planar map⁷⁹.

1.I.g. Theorem 1.10 vis à vis Kempe’s argument in his 1879 ‘proof’

We note that, notwithstanding the critical difference, as highlighted in §1.I.d.—and elucidated further below—between:

- Kempe’s ‘flawed’ appeal in [Kmp79] to ‘the method of interchanging the colors’ in ‘Kempe chains’; and
- The pictorially *transparent* appeal to the Minimality Hypothesis 1 in the proof of Theorem 1.10 in §1.I.c.,

the two arguments can be seen to share a similar structure.

For instance, Kempe’s concluding argument in his 1879 ‘proof’ of 4CT by finite induction:

“Returning to the question of colour, if the map at any stage of its development, can be coloured with four colours, we can arrange the colours so that, at the point of concurrence on the patch next to be taken off, where less than six boundaries meet, only three colours shall appear, and, therefore, when the patch is stripped off, only three colours surround the disclosed district, which can. therefore, be coloured with the fourth colour, *i. e.* the map can be coloured at the next stage. But, at the first stage, one colour suffices, therefore, four suffice at all stages, and therefore, at the last. This proves the theorem and shows how the map may be coloured.” ... Kempe: [Kmp79], p.199.

can be viewed as faithfully mirrored in the *language* of Definition 5, and the *intent* of Theorem 1.3, as follows:

Returning to the question of colour, if the map at any stage of its [finitary creation by annexation], can be coloured with four colours, we can arrange the colours so that, at [an apex where the next area is to be created by annexation], where less than six boundaries meet, only three colours shall appear, and, therefore, when the [new area is created therein by annexation], only three colours surround the [newly created area], which can. therefore, be coloured with the fourth colour, *i. e.* the map can be coloured at the next stage. But, at the first stage, one colour suffices, therefore, four suffice at all stages, and therefore, at the last. This proves the theorem and shows how the map may be coloured.

if we correspond [finitary creation by annexation at an apex] to Kempe’s ‘disclosed district’ at the ‘point of concurrence on the patch next to be taken off’ (as illustrated by Kempe’s Fig.14 in [Kmp79], Plate II).

The above correspondence, moreover, seeks to reflect a common assessment of Kempe’s argument as essentially sound:

⁷⁹In which case any proof of 4CT—such as [FF98], pp.168-230—that appeals, explicitly or implicitly ([FF98], p.68), to the argument that every five-sided figure in a *minimal* planar map is *reducible* would be *vacuous*.

“The importance of Kempe’s work cannot be overlooked. His basic ideas provided the starting point for what would be a century of effort culminating with Appel and Haken’s proof. In 1989, as a tribute to Kempe, Appel and Haken declared:

“Kempe’s argument was extremely clever, and although his “proof” turned out not to be complete, it contained most of the basic ideas that eventually led to the correct proof one century later.”

... Sipka: [Spk02], *Conclusion*.

However, the critical difference between the geometrical proof of §1.I.c., Theorem 1.10, and Kempe’s—essentially graphical—argument is evidenced by Timothy Sipka’s elementary—albeit detailed and more ‘contemporary’—exposition [Spk02] of Kempe’s 1879 ‘proof’; where we note that §1.I.c.(2) **CASE 1** and §1.I.c.(3) **CASE 2** correspond respectively to Sipka’s **Case 1** and **Case 2**:

“There are two observations that should be made when one reads Kempe’s paper, observations that may explain why the subtle error in his argument went undetected for eleven years. First all of his diagrams (there are 16) are relatively simple, and most of them are used to provide examples of the terms he defines. He never provides a nontrivial diagram (map) that demonstrates his argument. Second, the paper is virtually all prose which, though well written, makes it difficult to verify his work.

Though the phrase “mathematical induction” was never mentioned in Kempe’s paper, the “patching process” he used made his argument essentially a proof by mathematical induction.

Therefore, in presenting Kempe’s argument, we will use his vocabulary and basic ideas, but we’ll give a more contemporary version of his proof.

As with most induction proofs, the base step is quite obvious: any map containing four or fewer countries can easily be colored with at most four colors.

Now, assume that any map containing n countries can be colored with at most four colors, and then let M be a map consisting of $n + 1$ countries. It can then be shown—and Kempe did so—that M must contain at least one country that is adjacent to five or fewer other countries.

Let X denote such a country in M ; then temporarily disregard X . We are left with a map of n countries, which we’ll denote by $M - X$. Now, color the countries of $M - X$ with at most four colors. Let’s use red, blue, green, and yellow as Kempe did.

Kempe actually said “take a piece of paper and cut it out to the same shape” as the country X , and then “fasten this patch to the surface and produce all the boundaries which meet the patch to meet at a point within the patch.” In other words, Kempe described a process that physically removed the country X and extended the boundaries of the surrounding countries to meet at a point within the region once covered by X .

In the map $M - X$, we have colored n countries with at most four colors, and we’ve left X uncolored. Kempe’s goal was to find a way to reduce (if necessary) the number of colors used to color the countries surrounding X so that some color would be “free” for X . He quickly dispensed with the easy cases. First, if X is surrounded by three or fewer countries, then clearly there will be a color available for X . Second, if X is surrounded by four or five countries colored with at most three colors, then there will also be a color available for X . With these cases out of the way Kempe was left with two cases to consider:

Case 1: X is adjacent to exactly four countries colored with four different colors.

Case 2: X is adjacent to exactly five countries colored with four different colors.

In handling these two cases, Kempe used a technique that today we call “the method of Kempe chains.” He first asked that we consider all the countries (he called them districts) in the map which are colored red and green; then he observed that these countries form one or more red-green regions. Kempe’s notion of a red-green region was simply a continuous “chain” of countries colored

red or green. He then made the important observation that one could interchange the colors in any red-green region, and the map would still remain properly colored. We will now demonstrate, using nontrivial examples, the arguments Kempe gave for the two cases."

... Sipka: [Spk02], The "Proof".

Noting that Kempe's argument in **Case 1** is valid, Sipka then illustrates the flaw subsequently found in 1890, by Percy J. Heawood, in Kempe's reasoning for **Case 2**:

"For case 2, we label the five countries surrounding X with the letters A, B, C, D , and E . Kempe then considered two subcases. ...

Subcase 2.2: Suppose countries A and C belong to the same red-yellow region and countries A and D belong to the same red-green region.

In this, the fourth and final case, Kempe's process for reducing the number of colors surrounding X contained a subtle flaw. In Figure 7 we have an example of a map where countries A and C belong to the same red-yellow region and where countries A and D belong to the same red-green region. In a case such as this, Kempe correctly observed that "the two regions cut off B from E , so that the blue-green region to which B belongs is different from that to which D and E belong, and the blue-yellow region to which E belongs is different from that to which B and C belong." To reduce the number of colors surrounding X , Kempe then made the claim, "interchanging the colours in the blue-green region to which B belongs, and in the blue-yellow region to which D belongs, B becomes green and E yellow, A, C , and D remaining unchanged." In Figure 8, the interchanges of colors have been performed as Kempe described with the outcome he expected, making the color blue available for X .

Heawood's Counterexample

In the example used in subcase 2.2, Kempe's process worked exactly as he had hoped. By simultaneously interchanging the colors in the blue-green region containing B and the blue-yellow region containing E , the number of colors surrounding X was reduced to three. Unfortunately for Kempe, this process would not work for all maps satisfying the conditions of subcase 2.2.

In 1890, Percy J. Heawood produced a map for which Kempe's process would fail. Heawood's example revealed a subtlety that had escaped detection by the rest of the mathematics community. And that subtlety was the possibility that the blue-green region containing B and the blue-yellow region containing E might "touch." When this happens, Heawood observed, "Either transposition prevents the other from being of any avail."

In Figure 9 we see the map Heawood used to expose the flaw in Kempe's process for reducing the number of colors in subcase 2.2. Notice that the blue-green region containing B and the blue-yellow region containing E share a boundary. If we interchange the colors in both regions, the two countries sharing this boundary, Y and Z , would both receive the color blue. Thus, as Heawood remarked, "Mr. Kempe's proof does not hold unless some modifications can be introduced into it to meet this case of failure."

Kempe certainly tried to fix this "case of failure," but neither he nor any of his contemporaries could do so. The modifications that were needed would require many years of work by many individuals."

... Sipka: [Spk02], The "Proof".

We can now see that, and how, §1.I.c.(3) **CASE 2** avoids the flaw detailed by Sipka in Kempe's argument for **Case 2** by, essentially, arguing that *if* X is adjacent to exactly five countries A, B, C, D, E , coloured with four different colours *then*, since two of A, B, C, D, E , must share the same colour:

- (a) In any putative colouring α of **Case 2**, treating X as a rebel province of $A \cup X \cup C$ that broke away to form a new country, entails that A and C *can* share the same colour;

- (b) However, A and C cannot be the same country in **Case 2**, as this would reduce **Case 2** to **Case 1**;
- (c) On the other hand, treating X as a rebel province of $X \cup C$ that broke away to form a new country now entails that A and C *cannot* share the same colour; since:
 - a rebel province cannot dictate that the country it broke away from *must* change its standard;
 - and $X \cup C$ and A were neighbours in *every* four-coloured map *before* the breakaway, whence they could *not* have shared the same colour;
 - X cannot *both* lay claim to a fifth colour as *necessary*, and *insist* that C must share the same colour as A in the, essentially *inherited*, colouring α of **Case 2** *after* the breakaway;
 - as this would invalidly (see §1.I.h., Proposition 1.18) *postulate* that A and $X \cup C$ could have shared the same colour *before* the breakaway.
- (d) Since (a) contradicts (c), we conclude that no *Minimal* Planar Map \mathcal{H} (see §1.I.b., Fig.1) can admit a country with five neighbours.

1.I.h. Why the Four Colour Theorem is *true* by Fermat’s Infinite Descent

Fig.1: Minimal Planar Map \mathcal{H}

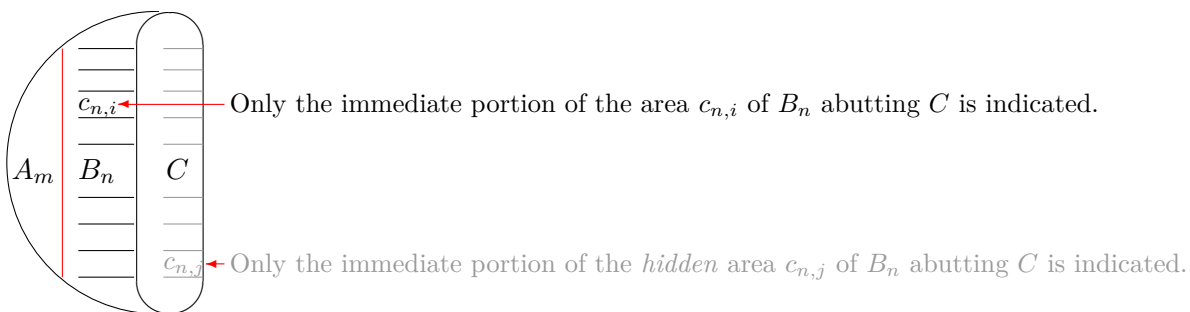

Without loss of generality, the surface of the solid hemisphere in Fig.1 is taken (as in §1.I.b., Fig.1) to define a *Minimal* Planar Map \mathcal{H} where:

1. A_m denotes a region of m contiguous, simply connected and bounded, surface areas $a_{m,1}, a_{m,2}, \dots, a_{m,m}$ (of the hemisphere in Fig.1), *none* of which share a non-zero boundary segment with the contiguous, simply connected, surface area C (as indicated by the red barrier which, however, is *not* to be treated as a boundary of the region A_m);
2. B_n denotes a region of n contiguous, simply connected and bounded, surface areas $b_{n,1}, b_{n,2}, \dots, b_{n,n}$, *some* of which, say $c_{n,1}, c_{n,2}, \dots, c_{n,r}$, share *at least one* non-zero boundary segment with C ; where, for each $1 \leq i \leq r$, we have that $c_{n,i} = b_{n,j}$ for some $1 \leq j \leq n$;

Fig.2: Sub-minimal Planar Map \mathcal{M}_C defined uniquely by shrinking C to a point P_C in \mathcal{H}

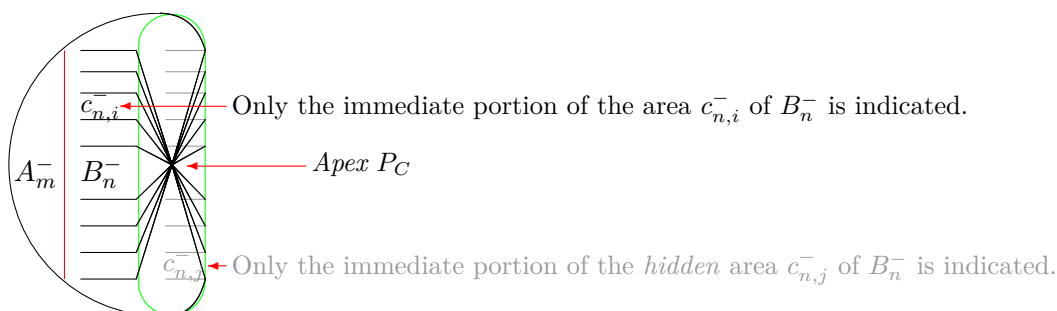

3. C is a single contiguous, simply connected and bounded, area (see Fig.1) constructed *finitarily* by sub-dividing and annexing (compare Kempe [Kmp79], Plate II, Fig.14) one or more contiguous, simply connected, portions surrounding a common apex P_C of each area $c_{n,i}^-$ (see Fig.2) in the region B_n^- of some *putative* sub-minimal map \mathcal{M}_C (see Fig.2), defined uniquely by *putatively* shrinking C to a point P_C in \mathcal{H} .

We define:

Definition 5. (Finitary Constructibility) *A single contiguous, simply connected and bounded, area D of a planar map \mathcal{G} is finitarily constructible if, and only if, it can be constructed in a finite number of steps by annexing non-zero areas of the planar map \mathcal{M}_D obtained by shrinking D to a point in \mathcal{G} .*

Lemma 1.11. *Any single contiguous, simply connected and bounded, area D of a planar map \mathcal{G} with n areas is finitarily constructible.*

Proof. If D shares m non-zero boundary segments with abutting areas, then:

- shrinking D to a point (as in Fig.2),
- yields a planar map \mathcal{M}_D ,
- with at most m areas of \mathcal{G} ,
- that now meet in \mathcal{M}_D ,
- at least once at a common apex P_D .

The area D can then be *finitarily* constructed in m steps by annexing m triangular areas of those immediate portions of each area of \mathcal{M}_D that contain P_D . The Lemma follows. \square

Definition 6. (Finitary Definability) *A single contiguous, simply connected and bounded, area D of a planar map \mathcal{G} is finitarily definable if, and only if, it can be shrunk in a finite number of steps to a point in \mathcal{G} .*

We note that:

Lemma 1.12. *The minimal map \mathcal{H} cannot admit two areas, say C and C' , both of which necessarily require a 5th colour.*

Proof. Shrinking C to a point would reduce \mathcal{H} to a 4-colourable map where C' does not require a 5th colour. Restoring C with a 5th colour establishes the Lemma. \square

Since any area D of \mathcal{H} can be shrunk to a point, the argument of Lemma 1.12 immediately entails:

Corollary 1.13. *The minimal map \mathcal{H} can always be chromatically distinguished so that any specified area D of \mathcal{H} requires a 5th colour.* \square

We note next that:

Lemma 1.14. *No two, non-adjacent, areas of B_n , each sharing a non-zero boundary segment with C in the minimal planar map \mathcal{H} in Hypothesis 1, can also share a non-zero boundary that has no point in common with C .*

Fig.3: No two, non-adjacent, areas $c_{n,i}$ and $c_{n,j}$ can share a non-zero boundary in \mathcal{H}

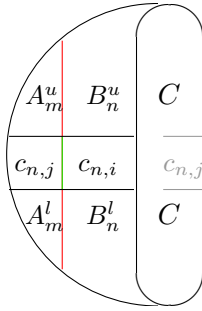

Proof. Let two, non-adjacent, areas of B_n , say $c_{n,i}$ and $c_{n,j}$ in Fig.1, each of which shares a non-zero boundary with C , also share a non-zero boundary with each other that *does not* intersect C (as shown in green in Fig.3). This would divide $\{A_m + B_n - c_{n,i} - c_{n,j}\}$ into two *non-empty* regions $A_m^u + B_n^u$ and $A_m^l + B_n^l$, such that *no* area of the region $A_m^u + B_n^u$ shares a non-zero boundary with *any* area of the region $A_m^l + B_n^l$.

However, it would entail that the areas $c_{n,k}$ ($k \neq i, j$) which abut C in each of the regions B_n^u and B_n^l would necessarily require 2 additional colours not shared with the areas C , $c_{n,i}$ and $c_{n,j}$; since:

- (a) if all such $c_{n,k}$ require only 1 additional colour, then \mathcal{H} would be 4-colourable, and violate *minimality*;
- (b) if all such $c_{n,k}$ in only one of the regions, say B_n^u , require only 1 additional colour,
 - then annexing one of the areas of B_n^l , say $c_{n,lower}$, which has this colour, say x , into the area C would again reduce the map \mathcal{H} to a *sub-minimal* map, say \mathcal{C}' ,
 - where \mathcal{C}' still requires 5 colours, since the merged area ($c_{n, lower} + C$) would now abut areas with all the four colours of the map \mathcal{C}' , thus violating the *minimality* of \mathcal{H} ;

Consequently, each of the regions $\{B_n^u + c_{n,i} + c_{n,j} + C\}$ and $\{B_n^l + c_{n,i} + c_{n,j} + C\}$ —when considered as separate planar maps, each with less than $m + n + 1$ areas—would necessarily then require C to have the 5th colour, thus violating Hypothesis 1. The Lemma follows. \square

Comment 20. Lemma 1.14 seeks to give a formal proof of Kempe’s informal ‘observation’ in [Kmp79], as cited below by Timothy Sipka:

“In Figure 7 we have an example of a map where countries A and C belong to the same red-yellow region and where countries A and D belong to the same red-green region. In a case such as this, Kempe correctly observed that “the two regions cut off B from E , so that the blue-green region to which B belongs is different from that to which D and E belong, and the blue-yellow region to which E belongs is different from that to which B and C belong.” ...”

... Sipka: [Spk02], The “Proof”.

Corollary 1.15. No area $c_{n,i}$ of B_n in the minimal planar map \mathcal{H} can share two, distinctly separated, non-zero boundary segments with C . \square

Lemma 1.16. Every area D of a minimal planar map \mathcal{H} shares non-zero boundaries with at least four neighbours.

Proof. Shrinking *any* area D of a *minimal* map \mathcal{H} to a point would yield a 4-colourable, *sub-minimal*, map. By Hypothesis 1, restoring D in any 4-colouring of such a *sub-minimal* map must require a 5th colour for D . The Lemma follows. \square

The significance of *Finitary Definability* (Definition 6) is seen in the following, *pre-formal*⁸⁰, proof—by Fermat’s *infinite descent*—which *pictorially* illustrates why 4CT can be treated as a *true* mathematical proposition⁸¹:

Proposition 1.17. (Four Colour Theorem) *No chromatically differentiated planar map needs more than four colours.*

Pre-formal proof. Assume Hypothesis 1. Then:

Fig.4: The Planar Map \mathcal{H}'

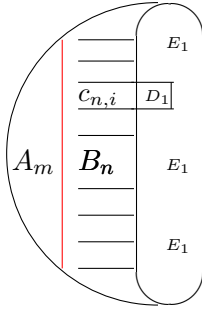

- (1) If the area C of the *minimal* planar map \mathcal{H} in Fig.1 is divided further (as indicated in Fig.4) into two *non-empty* areas D_1 and E_1 , where:
 - (a) D_1 shares a *non-zero* boundary segment with only *one* of the areas $c_{n,i}$; and
 - (b) D_1 is, or can be *treated* as, part or whole of the original area of $c_{n,i}^-$ in \mathcal{M}_C (see Hypothesis 1(d)) that was annexed to form part of C in the Minimal Map \mathcal{H} (in Fig.1);
then D_1 can be annexed back into $c_{n,i}$ without violating Hypothesis 1.
- (2) Moreover, $c_{n,i} + D_1$ *must* share a *non-zero* boundary with E_1 in \mathcal{H}' *if*, in \mathcal{H} :
 - (i) $c_{n,i} = b_{n,j}$ for some $1 < j < n$; and
 - (ii) $b_{n,j}$, C are required to be differently coloured.
- (3) Such a division, as illustrated in Fig.4, *followed* by re-annexation of D_1 into $c_{n,i}^-$ (denoted, say, by $B_n + D_1$), would transform the configuration \mathcal{H}' in Fig.4 to another *minimal* planar map, say \mathcal{H}_1 with a configuration $\{A_m + B'_n + E_1\}$, where $B'_n = (B_n + D_1)$.
- (4) This would, in turn, necessitate a 5th colour for the area $E_1 \subset C$ by Hypothesis 1.
- (5) Since, by Hypothesis 1, C is *finitely* constructible in \mathcal{M}_C , so too must be E_1 .
- (6) We cannot therefore, by reiteration, have a *non-terminating* sequence $C \supset E_1 \supset E_2 \supset E_3 \supset \dots$ if each E_i is *finitarily* constructible in \mathcal{M}_C .

⁸⁰The need for distinguishing between *belief-based* ‘informal’, *evidence-based* ‘pre-formal’, and *proof-based* ‘formal’ reasoning is addressed by philosopher Markus Pantsar in [Pan09]; where he cogently argues that it is *evidence-based* ‘pre-formal’ proof which *entails* ‘formal’ proof, and not vice-versa. See also §5.A. for the significance of Gualtiero Piccinini’s argument in his 2019 preprint [Pic19] that only *evidence-based*, ‘Factually Grounded Belief’ can be treated as ‘Knowledge’, and *not* intuitively ‘Justified True Belief’ as argued to the contrary by, for instance, Job de Grefte in his 2021 paper [Grf21].

⁸¹See also Proposition 1.3.

- (7) Hence the sequence must terminate in a *non-empty* area E_k of a *minimal* planar map, say \mathcal{H}_k , for some finite integer k .
- (8) This would further entail that E_k contains *no* area:
- that can be *treated* as an area of $c_{n,i}^-$ in the *putative*, 4-colourable, sub-minimal planar map \mathcal{M}_C (see Hypothesis 1(c)); and
 - which was annexed to form part of C in the Minimal Map \mathcal{H} (in Fig.1).
- (9) However, such an entailment would be false, since any *non-empty* area such as E_k can always be sub-divided further, and putatively re-annexed, as stipulated in (1).
- (10) Moreover, by Hypothesis 1(c), such an entailment would also contradict the definition:
- of the area C , in the *Minimal* Planar Map \mathcal{H} (in Fig.1) *before* chromatic differentiation;
 - ergo of the area E_k in the *minimal* planar map \mathcal{H}_k *before* chromatic differentiation

as constructed *finitarily* by sub-division and annexation of existing areas of B_n^- in some *putatively unique* sub-minimal planar map \mathcal{M}_C .

- (11) In other words, the sequence $C \supset E_1 \supset E_2 \supset E_3 \supset \dots$ is *non-terminating*, hence not *finitarily* defined, by the stipulation in (2) that $c_{n,i} + D_1$ *must* share a *non-zero* boundary segment with E_1 in \mathcal{H}' , as entailed by the requirement that $b_{n,j}$, C *must necessarily* be differently coloured.

We conclude that Hypothesis 1 is false, since there can be no *minimal*, chromatically differentiated, planar map \mathcal{H} in which the regions $\{A_m + B_n + C\}$ are *finitarily defined* if C necessarily requires a 5th colour. The proposition follows. \square

Moreover, it follows that:

Proposition 1.18. *The area C in the minimal map \mathcal{H} can have only four, all differently coloured, neighbours.*

Pre-formal proof. Assume Hypothesis 1. Then:

- (12) In continuation of the proof of Proposition 1.17:
- (i) if, for some *unspecified* k , we relax the stipulation (see (2)) that:
- the area corresponding to $c_{n,i} + D_1$,
 - as defined with respect to the sequence $C \supset E_1 \supset E_2 \supset E_3 \supset \dots$,
 - *must* share a *non-zero* boundary segment with E_{k-1} in \mathcal{H}_{k-1} ;
- (ii) and stipulate *instead* that the *non-terminating* sequence $C \supset E_1 \supset E_2 \supset E_3 \dots$ is constructed so that:
- for all $l \geq k$, the non-empty areas E_l and E_{l-1} can be treated as having been annexed from the same area of \mathcal{M}_C ;
- (iii) then we *can* admit as a well-defined (i.e., *unique*) limit of $C \supset E_1 \supset E_2 \supset E_3 \dots$ the *specific* configuration \mathcal{M}_C (see Fig.2) where:
- the area E_k in (7) can *now* be treated as *putatively empty*; and

- D_{k-1} could be treated as the terminal, non-zero, area E_{k-1} of $C \supset E_1 \supset E_2 \supset E_3 \dots \supset E_{k-1} \supset E_k$ which is annexed back into some $c_{n,i}^-$ in \mathcal{M}_C .

Fig.5: Sub-minimal, 4-coloured, Planar Map \mathcal{H}^- yielded by deleting the boundary x in \mathcal{H}

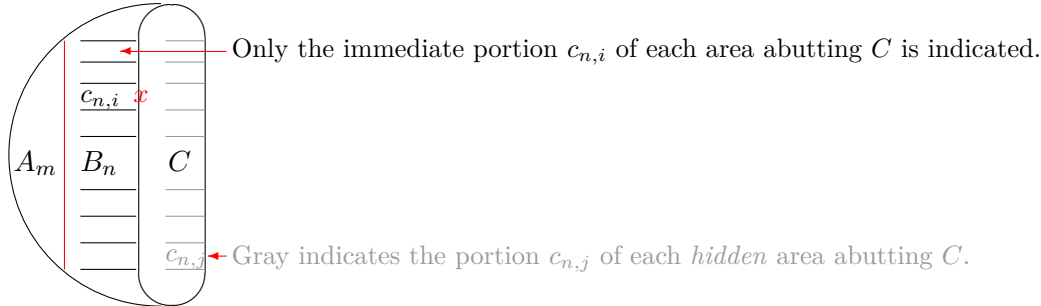

- (13) In other words, the area C in any *minimal* planar map \mathcal{H} is formed by bifurcating *any* area $c_{n,i} + C$ in the *sub-minimal*, 4-coloured, map \mathcal{H}^- yielded by—as shown in Fig.5—merging $c_{n,i}$ and C in the *Minimal* Map \mathcal{H} in Fig.1.

- (14) Moreover, this would entail that:

- if the areas $c_{n,i-1}$, $c_{n,i}$, and $c_{n,i+1}$ are coloured, say, yellow, red, and blue respectively in the *sub-minimal*, 4-coloured, map \mathcal{H}^- in Fig.5,
- then none of these colours can occur in $c_{n,j}$ if $j \neq i - 1, i, \text{ or } i + 1$.

Reason: If the area C in the *minimal* planar map \mathcal{H} is formed by bifurcating the area $c_{n,i} + C$ in the *sub-minimal*, 4-coloured, map \mathcal{H}^- then $c_{n,i}$ and $c_{n,j}$ cannot be identically coloured for $j \neq i$.

Comment 21. It is trivial to paste (or even merely imagine pasting) a small, grey, piece of paper *anywhere* on a children's 4-coloured globe to confirm that:

- there is never a need to re-colour the, inherited, 4-coloured areas of the globe in order to maintain chromatic differentiation; *and*,
- if the grey area partitions a country into two, none of the *other* countries abutting the grey area *after* partitioning could have shared the same colour as the partitioned country *before* partitioning,

- (15) Hence area C in the *minimal* map \mathcal{H} can have *only* four, all differently coloured, neighbours. \square

1.J. Validating knowledge, truth, and proof in *pre-formal* mathematics

“How does the mathematical community accept that a given proof is correct? Is objective verification from axioms feasible, or must the reviewer's experiences and prejudices necessarily come in to play? Can automated provers avoid mistakes (as well as experiences and prejudices) to provide objective verification? And can an automated prover's claims be provably verified?”

We will follow examples of proofs that were found to be flawed, but then corrected (as the proof plan was sufficiently robust). What does this imply about the desirability of the current community standard for proofs?” ... Granville: [Grn22], Abstract.

Although of debatable *mathematical* significance, the above *pre-formal* proofs of the Four Colour Theorem seek—albeit obliquely—to highlight the *philosophical* significance of the insight and understanding proffered by a concept of *evidence-based*, *pre-formal* truth which can differentiate between⁸²:

⁸²See §5.A., *What is knowledge?*

- Intuitive *knowledge* as *justified true belief* which, in the above context, we interpret as implicitly seeking a *formal* proof of a mathematical proposition, in a first-order mathematical language, in order to *justify* the proposition as *true*;
- Gualtiero Piccinini’s *knowledge* as *factually grounded belief* (see [Pic19]) which, in the above context, we interpret as implicitly seeking, within a well-defined community, a *pre-formal* proof (in Pantsar’s sense: see [Pan09]) of a mathematical proposition, *within* the community, in order to *justify* the axioms and rules of inference of a first-order mathematical language; which can, then, formally prove and *validate* (in Martin-Löf’s sense: see [Mlf87]) the proposition as *justifiably true*, within the well-defined community, under an *evidence-based* interpretation of the language.

Comment 22. The significance of differentiating between individually (subjectively) *justifying* a proposition as *true*, and consensually (objectively) *validating* the proposition as *justifiably true* (within a well-defined community/intelligence), is reflected in what—from an *evidence-based* perspective—Mario Bacelar Valente seemingly seeks to highlight in [Vln22] as *the faithfulness problem*:

“Logic provides a powerful formalism to address the correctness of reasonings. Within logic itself, the soundness of inferences is not subjected to doubt, in the sense that for every logical system we have a collection of sound rules of inference. Outside logic, if we try to address the correctness of reasonings expressed with natural language, we face enormous difficulties due to the lack of a formal approach to address it. One way to deal with this difficulty is to envisage logical models of the reasoning under study. If we can find logical models of the reasoning, then we might say that the reasoning is correct or sound in the sense of having a sound logical model. But for this to be the case, we really must have a logical model of the reasoning. That is, the model must be faithful to the reasoning that it models. In this work we consider two examples of reasonings, the Euclidean reasoning in the proofs on planar geometry in the Elements, and the reasoning in Byrne’s suppression task. In the case of the Euclidean reasoning, a logical model has been proposed by Avigad, Dean, and Mumma. In the case of the reasoning task, a logical model has been proposed by Stenning and van Lambalgen. In both cases, issues can be raised concerning the faithfulness of these models. The purpose of the present work is to call the attention to what we have called the faithfulness problem, which we suspect to be a generalized issue in logical modeling, by using these two logical models as examples. Like in the case of these two examples, the general case might be that we have no way to decide with (absolute) certainty that a logical model is faithful to the reasoning it is supposed to be modeling.⁶”

... Valente: [Vln22], §4. Conclusions.

‘*Evidence-based*’ in the sense of, for instance, Chetan Murthy and Martin Löb (as detailed in [An16]):

“It is by now folklore ... that one can view the *values* of a simple functional language as specifying *evidence* for propositions in a constructive logic ...”

... Murthy: [Mu91], §1 Introduction.

“Intuitively we require that for each event-describing sentence, $\phi_{o^i} n_i$ say (i.e. the concrete object denoted by n_i exhibits the property expressed by ϕ_{o^i}), there shall be an algorithm (depending on \mathbf{I} , i.e. M^*) to decide the truth or falsity of that sentence.”

... Löb: [Lob59], p.165.

The *need* for recognising the primacy of *pre-formal* reasoning—illustrated strikingly by the proof of Proposition 1.3, which *cannot* be expressed within classical graph theory—is articulated cogently, and unequivocally, by philosopher Markus Pantsar in his introduction to [Pan09].

The *significance* of recognising the primacy of Piantar's *pre-formal* reasoning as the 'contact' point for initially expressing symbolically the primary and secondary conceptual metaphors—and their intuitively perceived natures and associated relationships—of an individual intelligence's perspective—based on the intelligence's individual observations and experiences of what we view as the common universe that we inhabit—is that it can then be viewed as the source of the 'paradoxical content' that a deductive language subsequently seeks to first formalise in a symbolic language of unambiguous expression such that a subsequent interpretation of the language, which ensures categorical communication over some finitarily defined symbolic structure ('common' model), can be treated as *validating* the individual intelligence's *pre-formal* conceptual metaphors as a common 'reality' within a community of similar intelligence that share a lingua franca.

Comment 23. In other words, what may be experienced as the 'surprising' conclusion of a formal deduction—presumably under a well-defined interpretation—that is not obvious in the premises of the the formal language and/or its logical entailments preceding the conclusion, is just *that* which its 'parent' *preformal reasoning* seeks to unambiguously express and communicate categorically; through individual elements of a *preformal* perspective which, when formalised as premises in a manner that ensures the unambiguous expression and, ideally, categorical communication of the premises and their entailments, *validates* treating an individual perspective as a 'shared' one, where the significance of the conclusion of a formal deduction under interpretation is viewable within a community—which has a categorically communicable lingua franca—as a 'whole' having a significance more than that of its individual premises ('parts').

Such a perspective could then help place in an appropriate perspective—if not dissolve—the paradoxical element that Catarina Dutilh Novaes analyses in [Nvs09] as the 'paradox of inference'—that a logical conclusion entailed by a set of premises can yet yield a surprising perspective, under a well-defined interpretation, of that which was sought to be communicated by the premises; a perspective which is 'surprising' since—akin to the 'surprising' pictures that suddenly 'emerge' only on the appropriate focusing of the eyes on an autostereogram⁸³—it was not obvious in any well-defined interpretation of the individual premises or their immediate entailments:

"The so-called paradox of inference has received quite some attention from logicians and philosophers at different times, and rightly so: it is perhaps the most crucial philosophical issue concerning deductive reasoning in general. The point of deductive reasoning is precisely not to allow for external information to 'sneak in', to conduct reasoning solely on the basis of the information explicitly on the table in such a way that no additional information could possibly defeat the conclusion at a later stage. But if all the information that can be used and is relevant is already on the table, how can we learn anything new by reasoning deductively?

In a sense, the conclusion is already contained in the previously available information, the premises. "The existence of deductive inference is problematic because of the tension between what seems necessary to account for its legitimacy and what seems necessary to account for its usefulness." (Dummett, 1978) (p. 297) (Notice that this discussion intersects directly with the matter of analyticity, which is of course one of the concepts used to explain in more precise terms what it means for the conclusion to be 'contained' in the premises—see (Primiero, 2008).)

Awareness of this somewhat paradoxical nature of deductive reasoning can be traced back to Mill (Mill, 1843). Some of the authors who have taken an interest in the issue are Keynes (Keynes, 1884) (p. 414 et passim), Hintikka (Hintikka, 1973) (p. 222 et passim), and more recently D'Agostino and Floridi (D'Agostino & Floridi, 2009), Sequoiah-Grayson (Sequoiah-Grayson, 2008) (the last three refer to the issue as 'a scandal of deduction', a term introduced by Hintikka) and Primiero (Primiero, 2008) (section 2.3), among others. Different approaches and solutions to the dilemma have been proposed in order to explain why there seems to be gain of information when one

⁸³See <https://en.wikipedia.org/wiki/Autostereogram>.

performs a deduction, even though the whole point is precisely not to go beyond what is given by the premises. Hintikka proposed a syntactic approach to the issue, based on the notion of distributive normal form of a sentence F ; Sequoiah-Grayson criticized Hintikka's solution and suggested that instead a semantic approach would 'be required to deal with the puzzle. D'Agostino and Floridi address the issue from the point of view of the computational complexity of different logical systems. They notice that there is a certain tension between the idea that logic does not yield new information and the undecidability of first-order logic, and suggest that, on the basis of some computational properties, a hierarchy of logical systems can be formulated, which would determine the lower or higher degree of 'analyticity' of a given system. Primero addresses the issue from a constructive point of view, arguing that the tension between the validity and the usefulness of logic can be dissipated once one pays sufficient attention to the distinction between proposition and judgment.

I think these different solutions all outline important factors that may be involved in the apparent information gain resulting from reasoning logically (deductively), and outlining yet another one of such factors is the purpose of the present contribution. In other words, I believe that there are different phenomena involved, and thus that different accounts may complement each other rather than compete with each other when it comes to explaining why there seems to be information gain in logic after all. To my knowledge, the 'paradox of inference' has never been formulated specifically in terms of the presence or absence of surprises in logic, but some authors (Carnap, Hintikka) come very close to this idea when pointing out that information flow and information gain go hand in hand with unpredictability (e.g. that the measure of content of a proposition is inversely proportional to the probability weight assigned to it). There is information gain in particular when the outcome of some reasoning goes against what was initially anticipated—thus, when the conclusion is unexpected and surprising in one way or another. Indeed, the paradox (dilemma) can also be neatly formulated in terms of surprises: for deductive reasoning to be legitimate, it must not deliver any surprises; but for deductive reasoning to be useful, it must do just that—deliver surprises.³"

... Novaes: [Nus09], §2 *The paradox of inference and surprises in logic.*

Moreover, Pantsar's perspective implicitly reflects the *Complementarity Thesis* (§1., Thesis 1) which, essentially, admits that Pestalozzi's 'Principle of Anschauung' can be viewed as the basis of a 'common intuition' which could, then, be treated as the necessary, and sufficient, *evidence* for formalising the concept of 'intuitive truth' in *pre-formal* reasoning/mathematics/proof, within a well-defined community, as a mathematical *truth* that can be communicated *categorically*⁸⁴:

"Pestalozzi developed the concept of Anschauung, or object lesson, which was the principle that no word should be employed until it was thoroughly understood by concrete observation or perception, whether it referred to a material object, an action, or a means of distinguishing one thing from another. From this his proponents have developed principles which inform much of modern-day pedagogic practice at all levels, such as the necessity, in effective teaching, of starting with the concrete before moving to the abstract, and starting with the simple before moving to the complex."

... *Oxford Reference*: Johann Heinrich Pestalozzi, (1746–1827) *Swiss educational reformer.*

Comment 24. That the significance of Pestalozzi's *Principle of Anschauung*—which lays the foundation for what is sometimes referred to as a "pre-rigorous" stage of mathematical education—is not always accorded in current mathematical paradigms the appreciation that it merits, is evidenced by Terence Tao's pedagogical essay [Tao07], which implicitly treats 'proof'—of an 'intuitive' mathematical argument—in a 'formal' mathematical theory as the, seemingly, 'ultimate goal' of mathematical reasoning, to be achieved by differentiating between the seemingly Platonic concepts—eerily akin to revelations—of 'good' and 'bad' intuition; rather than seeking an appropriate

⁸⁴In a language such as, for instance, the first-order Peano Arithmetic PA; see [An16], Corollary 7.2: *PA is categorical with respect to algorithmic computability* (also §2.E.b., Corollary 2.18: *PA is categorical*).

formal first-order theory in which the ‘intuitively understood’ mathematical argument follows from first-order axioms/axiom schemas and finitary rules of inference that, under an appropriate Tarskian interpretation, can then be *categorically* communicated—thereby ‘validating’ the ‘intuitive understanding’ of the mathematical argument as a ‘mathematical truth’ within a community that share the common, mathematical, language (such as, say, the first-order Peano Arithmetic PA: see §13.E.) as a lingua franca:

“One can roughly divide mathematical education into three stages:

1. The “pre-rigorous” stage, in which mathematics is taught in an informal, intuitive manner, based on examples, fuzzy notions, and hand-waving. (For instance, calculus is usually first introduced in terms of slopes, areas, rates of change, and so forth.) The emphasis is more on computation than on theory. This stage generally lasts until the early undergraduate years.
2. The “rigorous” stage, in which one is now taught that in order to do maths “properly”, one needs to work and think in a much more precise and formal manner (e.g. re-doing calculus by using epsilons and deltas all over the place). The emphasis is now primarily on theory; and one is expected to be able to comfortably manipulate abstract mathematical objects without focusing too much on what such objects actually “mean”. This stage usually occupies the later undergraduate and early graduate years.
3. The “post-rigorous” stage, in which one has grown comfortable with all the rigorous foundations of one’s chosen field, and is now ready to revisit and refine one’s pre-rigorous intuition on the subject, but this time with the intuition solidly buttressed by rigorous theory. (For instance, in this stage one would be able to quickly and accurately perform computations in vector calculus by using analogies with scalar calculus, or informal and semi-rigorous use of infinitesimals, big-O notation, and so forth, and be able to convert all such calculations into a rigorous argument whenever required.) The emphasis is now on applications, intuition, and the “big picture”. This stage usually occupies the late graduate years and beyond.

The transition from the first stage to the second is well known to be rather traumatic, with the dreaded “proof-type questions” being the bane of many a maths undergraduate. (See also “There’s more to maths than grades and exams and methods”.) But the transition from the second to the third is equally important, and should not be forgotten.

It is of course vitally important that you know how to think rigorously, as this gives you the discipline to avoid many common errors and purge many misconceptions. Unfortunately, this has the unintended consequence that “fuzzier” or “intuitive” thinking (such as heuristic reasoning, judicious extrapolation from examples, or analogies with other contexts such as physics) gets deprecated as “non-rigorous”. All too often, one ends up discarding one’s initial intuition and is only able to process mathematics at a formal level, thus getting stalled at the second stage of one’s mathematical education. (Among other things, this can impact one’s ability to read mathematical papers; an overly literal mindset can lead to “compilation errors” when one encounters even a single typo or ambiguity in such a paper.)

The point of rigour is not to destroy all intuition; instead, it should be used to destroy bad intuition while clarifying and elevating good intuition. It is only with a combination of both rigorous formalism and good intuition that one can tackle complex mathematical problems; one needs the former to correctly deal with the fine details, and the latter to correctly deal with the big picture. Without one or the other, you will spend a lot of time blundering around in the dark (which can be instructive, but is highly inefficient). So once you are fully comfortable with rigorous mathematical thinking, you should revisit your intuitions on the subject and use your new thinking skills to test and refine these intuitions rather than discard them. One way to do this is to ask yourself dumb questions; another is to relearn your field.

The ideal state to reach is when every heuristic argument naturally suggests its rigorous counterpart, and vice versa. Then you will be able to tackle maths problems by using both halves of your brain at once—i.e., the same way you already tackle problems in “real life”.

... Tao: [Tao07].

Moreover, from the *evidence-based* perspective of this investigation, by ignoring the significance of Pestalozzi’s *Principle of Anschauung* as the *evidence* supporting *pre-formal* reasoning/mathematics/proof, the classically inherited ‘*theisms*’ of Brouwer and Hilbert (compare §11.A., *Hilbert’s theism*; §11.B., *Brouwer’s atheism*), both of which could be viewed as *implicitly* treating ‘knowledge’ as ‘intuitively justified true belief’, and which together circumscribe current mathematical and philosophical paradigms could—as articulated by Vojtěch Kolman in his cogently argued [Kma18]—be viewed as ‘ending up with the very opposite of what they promised to achieve’:

“The lesson from the failure of logicism that is relevant here seems to be twofold:

- (1) As for the first part, logicism concluded from intuition’s unreliability or from the unreliability of the “gaze” that the alleged reliability of mathematics and knowledge in general must come from the other part of the Kantian distinction, namely from concepts of language. The original tension between clear-sighted intuition and blind symbols is thus turned *upside-down*. Blind symbols and concepts are now the only ones seeing, and intuition is now the blind one because it is unreliable. But this turn did not work. The alleged reliability of logic betrayed Frege at the very beginning, with principles he took not only for being true, but even for being true on analytic grounds.
- (2) The second part starts with the supposition that one can do without intuition in the sense of leaving its manifestations to the pre-scientific or psychological level of pre-theoretical counting or drawing diagrams. In any mathematical science worthy of its name, one shall deal only with concepts. In the end, though, the concepts turned out to be not only unreliable but dependent in their goal on the recursive, i.e. intuitive definitions. Thus, ironically, all the remedies suggested by Frege or his followers, particularly type theory, consist in the employment of constructive principles, which is at blatant variance with the original anti-Kantian approach.

Now, based on this two-part lesson, it seems that one might feel compelled to adopt one of the following attitudes toward the logicist failure as far as intuition’s reliability is concerned:

- (1) First, there is the *attitude of Brouwer* according to which original intuition is reliable enough—one must only keep it sufficiently apart from the blind reasoning of logic.
- (2) The second *attitude is that of the early Hilbert* who accused Frege and his logic in general of not being formal or conceptual enough in that they still give, even in their anti-intuitionistic attitude, too much room to intuition by simply presupposing that there is something beyond their formulas which these try to express.

Interestingly, in their foundational endeavors neither Hilbert nor Brouwer fare much better than Frege, ending up with the very opposite of what they promised to achieve.

Brouwer’s appeal to a more intuitive mathematics that does not depend on the linguistic schemata but, instead, is anchored in the constructive decision of the *creating subject*, led famously to theorems which almost nobody—including Brouwer’s followers—took to be intuitive or even true. From the other side, the variety and artfulness of ways in which Brouwer tried to refute the classical theorems, including such absolute “certainties” as the *principle of the excluded middle*, not only gave rise to the one and only split in modern mathematics but inspired Wittgenstein—after attending one of Brouwer’s Vienna Lectures—to enter the second period of his thinking, one characterized by a belief in the plurality of language games as opposed to the intuitively given discourse.

As for Hilbert, his first version of formalism and his attitude to intuition started with the explicit idea that mathematics' certainty consists in concrete but blind symbols and their finite organizations in formulas and formal derivations. The question whether these symbols refer to something—e.g., to infinite entities as Cantor suggested—was bracketed not for being unjustified or unscientific, but rather for being *irrelevant* as far as the issue of foundations is concerned. Gradually, this cautious approach had become an intrinsic one adopting noticeable *transcendental* features: Since the roots of any knowledge are to be identified with a finite (or finitely describable) system of rules and axioms, and finite deductions from them, the certainty of them is also the certainty of given intuition, which, similar to the pure intuition of Kant, is thus not purely empirical but has apodictic features. This is the so-called “finite Einstellung”.³

In the light of this, one can say that Hilbert and Brouwer represent, in the philosophy of mathematics, certain kinds of *antithetical* positions reminding one of the early chapters of Hegel's *Phenomenology of Spirit*. Analogously to its starting position of *immediately* given and certain knowledge, which—compared to its own standards—turns out to be the most general and mediated, Brouwer starts with the self-certainty of the given intuition only to end up with the most uncertain and counter-intuitive results. In the next stage, one decides with Hilbert to eliminate the reference to intuition and its object in favor of a meaningless language so as to be forced to acknowledge a new kind of intuition dealing with linguistic artefacts. These examples, of course, make sense only as a part of a bigger story that I have tried to develop elsewhere.⁴

Its lesson, obviously, is not historical but rather *dialectical*. Namely, that there is another, third, secret part of the lesson to be taken from the original logicist failure. And this consists in the conclusion that intuition—even in its pure form—does not have to be *immediate* and *reliable* in the absolute sense of the word. In the same sense in which I do not doubt that this is my hand (to quote G. E. Moore while raising my hand), I will not doubt that the sum of all angles in a triangle equals two right angles. This is not to say that, e.g., by empirical measuring, different results cannot come about, but that they are not typically treated as *counter-instances* to the given claims but as failures to be ignored. And this is what we mean by the given sentences to be *a priori*: That we treat them as irrefutable by standard singular experience because this standard experience—or let us say, with Wittgenstein, the whole stage on which it is played—is defined by their *stability*. But this stability is only a relative one and might be shaken by some drastic change in the situation, e.g., if some secret surgery were performed on me or in the need to measure cosmic distances and times.”

... Kolman: [Kma18], §4. Three lessons, pp.398-400

In other words, the *evidence-based* perspective of §11.C. (*Finitary agnosticism*) could, reasonably, be viewed as essentially endorsing Kolman's argument that:

‘there is another, third, secret part of the lesson to be taken from the original logicist failure. And this consists in the conclusion that intuition—even in its pure form—does not have to be *immediate* and *reliable* in the absolute sense of the word’,

and that:

‘this is what we mean by the given sentences to be *a priori*: That we treat them as irrefutable by standard singular experience because this standard experience—or let us say, with Wittgenstein, the whole stage on which it is played—is defined by their *stability*.’

Kolman compellingly concludes that:

“... To make the philosophy of mathematics up-to-date, though, one does not have to leave intuition aside as something contradictory and obsolete. What one needs to do is to learn from the development of failed attempts at making the founding principle of mathematics explicit. This is the moment where the phenomenological method of Hegel enters the stage.

As for arithmetic, what has been seen is a repeated pattern of the rebirth of the *constructive* even in the most abstract disciplines of mathematics such as set theory and logic. In light of this, even the

"revolution" of Brouwer does not seem to be such a radical break with the whole development but instead represents an explicit acknowledgment of their tacit pre-conditions to which the systematic use of constructive principles such as *transfinite induction* or situation-dependent formations such as *diagonalization* belong. This does not need to be read as a defense of *constructivism* but simply as an alert that many of the theoretical questions have a *practical* dimension which cannot be eliminated from the foundational debates. As a result, we should enrich the concept of intuition by this practical aspect. Such an adjustment is, in fact, in accord with Kant's original conception of pure intuition which is always explicitly connected to *constructions*—i.e. to doing something—in space and time.

In the realm of geometry, e.g., by claiming that two different lines orthogonal to the third line cannot intersect in any *possible* prolongation, one can mean neither an empirical nor a purely theoretical possibility but a practical and normative one of prolongations that are "good enough" or "acceptable." The mathematicians' talk about the intersection in infinity is thus only a theoretical abbreviation for this practical certainty which, in the context of cosmic distances, loses its original sense. So the discovery of non-Euclidian geometries and their successful applications in physics does not count as an absolute refutation of Euclidian geometry but only as a kind of *proto-theoretical* impulse to revise it with respect to the given context.

Drawing on Lorenzen's work,⁵ Stekeler (2008) in *Formen der Anschauung* elaborates on this basic approach to Euclidian geometry starting with the postulates from which the quality of *rectangular solids* (or *blocks*) and *wedges* should be measured.⁶

...

These postulates are obviously neither axioms in the traditional sense of self-evidently true sentences nor in Hilbert's modern sense of implicit definitions. They are *material norms* defining the given concept by re-course to the pre-given practice of forming the solids and assessing the quality of their form to the extent that it is the very possibility of this practice that guarantees that these postulates are (in)dependent and consistent. By their *completeness*, Stekeler means that they are sufficient to found classical Euclidian geometry in an inferentially-holistic way, forming what is known as its standard model. The basic geometric concepts such as *flat surface*, *straight line* or *orthogonality*—or theorems about them—are taken to be the simple (material) consequences of the postulates: plane is the surface that fits on a block, straight is the line fitting on the edge of a block and orthogonal is the angle formed by two intersecting edges of a block. The parallel postulate which is not (formally) deducible from the rest of Euclid's or Hilbert's axioms is a material consequence of the postulates (6) and (8).

Similarly, in *arithmetic* one can understand *Peano axioms* as material norms expressing the truth about working within the underlying calculi and not as some a priori given truth about some independently given objects. I will come to this in the next, final section. What matters now is that, along these lines, the Kantian concept of pure intuition can be reconstructed in a way which does not have to follow all the details of the Kantian corpus and yet will still remain true to the original idea of his philosophy. This amounts, in the end, to the general insight that the differences one makes do not exist here simply *in itself*, but always *for us* as cognitive subjects. This reading includes also the later rectification of Hegel, by which the apriori structures of reason cannot be interpreted as belonging to the *privacy* of a subject's mind—as some of Kant's followers presumed—but in the joint practice of our orientation in space and time. The general message is simple: One cannot ground any knowledge by merely *looking at* things. This is not only because every act of looking is theoretically charged, but because it is substantially clothed in social agency. The following specification of intuition is given by Stekeler (Unpublished):

Anschauung stands for any possibly *conceptually articulated reference to some object or event in real perception*—such that the same object can or could be perceived by others as well. *Pure intuition* is a label for the mere form of such an objective reference to objects of perception—including the corresponding spatial and temporal transformations of perspectives if there are different observers at different places or if we refer to the same object or event from different times.

Such a practically and socially articulated intuition cannot be infallible simply because I, as the cognitive subject, can never be the absolute guarantee of the corresponding truth. But this feature, as Wittgenstein (and Hegel) have taught us, *makes such an intuition as a prospective basis of knowledge something that is quite impossible in its immediate and infallible form.*

... Kolman: [Kma18], §5. Pragmatic turn, pp.401-403.

The epistemological perspective⁸⁵ of the *Complementarity Thesis* is thus that logic, too, can be viewed as merely a methodological tool⁸⁶ that seeks to formalise an intuitive human ability that pertains not to the language which seeks to express it formally, but to the cognitive sciences in which its study is rooted (see §1.B., Definition 1, and §12., Definitions 32 to 35).

We would thus argue that, from such an evidence-based perspective, Appel and Haken's proof of 4CT can be viewed as seeking to *validate* a pre-formal mathematical 'truth' which is entailed by the pre-formal proofs of Propositions 1.3 and 1.4.

We note that such a perspective seems implicit in Patrick Allo's 2017 paper [All17], where he alludes to Appel and Haken's proof to argue from a *constructionist* perspective that, instead of admitting only classical perceptions of '*Logics as Levels of Abstraction*', we could additionally/alternatively treat '*Logic as Cognitive Technology*'; such that '*... logic becomes associated with epistemic ideals that can in principle be used to evaluate various forms of automated reasoning-systems*'.

"The first example concerns a notorious problem within the philosophy of mathematics, namely the acceptability of computer-generated proofs or proofs that can only be checked by a computer; for instance because it includes the verification of an excessively large set of cases. The text-book example of such a mathematical result is the proof of the 4-colour theorem, which continues to preoccupy philosophers of mathematics (Calude 2001). Here, we only need to note that the debate does not primarily concern the correctness of the result, but rather its failure to adhere to the standard of *surveyability* to which mathematical proofs should conform." ... Allo: [All17], Conclusion, p.562.

Moreover he offers the argument—significant for Pantsar's pre-formal mathematics—that '*... in a fully formalised context, explicit concepts and proof-procedures together with the conceptual and technological means to efficiently use and verify these concepts and procedures can be used to certify the epistemic reliability of mathematical results*':

"The third and last example may be the most surprising, and exemplifies how the use of automated proof-procedures can indeed be in agreement with the epistemic ideals we highlighted. It concerns the value that is accorded to computer-verified proofs within the *Univalent Foundations* and *Homotopy Type Theory* programme. In addition to providing a new way of thinking about the foundations of mathematics, this grand project also sets new epistemic standards for foundational work. Highly simplified, these standards combine the adherence to the very strict standards of formalised type-theory (which is made possible with the help of automated proof-assistants like Coq or Agda) with the adoption of the same high standards as the "implicit formal basis of informal reasoning" (Univalent Foundations Program 2013, 7). Again, we can remark how, this time in a fully formalised context, explicit concepts and proof-procedures together with the conceptual and technological means to efficiently use and verify these concepts and procedures can be used to certify the epistemic reliability of mathematical results.²¹

²¹ On the implications of the use of proof-assistants based on formal type-theory for the older debate on the four-colour theorem, see Arkoudas and Bringsjord (2007). ... Allo: [All17], Conclusion, p.562.

The *evidence-based* perspective of the *Complementarity Thesis*, and of Pantsar's *pre-formal* mathematics, both of which seek to view logic as a methodological tool, thus resonates with Patrick Allo's 2017 conclusion:

⁸⁵Compare Gila Sher [Shr18].

⁸⁶As argued, seemingly similarly, by Patrick Allo in [All17].

“The emphasis on how logic facilitates knowability and feasible knowability suggests, by contrast, that logic also provides an interface that is in principle—and ideally also in practice—open to scrutiny. Each of these features has clear origins in the history of (modern) logic, and can naturally be connected to the desire to reduce ambiguity and equivocation, and to the need for rigorous standards of proof (for instance in the foundations of mathematics). At the same time, they simultaneously point to two preconditions for reliable informational interaction, namely:

1. common concepts and
2. common standards for justification,

and to two preconditions for reliable epistemic scrutiny, namely:

3. common concepts (again) and
4. feasibly verifiable reasoning and justification-procedures.

These features provide a counter-point to the (intended) deflationary approach to logic that I adopted in this article, and which makes it hard to explain how logic could be used to provide any kind of absolutely secure ontological or epistemic foundations. They moreover sit well with a constructionist epistemology and meta-philosophy because they (1) emphasise the need to negotiate or to agree on a communication-channel, (2) imply that a reliable channel or interface should be free of noise and equivocation, (3) recognise the role of meta-level reasoning, and (4) adhere to a white-box philosophy with respect to the conceptual and cognitive technologies one has to rely on to obtain knowledge from the world." ... *Allo: [All17], Conclusion, p.562.*

1.K. Pre-formal mathematics as ‘culturally appropriate, intuitive explanations’

In a cogently argued opinion piece [Grn22] from the perspective of a general mathematician, Andrew Granville critically surveys, and muses upon, various issues that—reflecting the Complementarity Thesis (§1., Thesis 1), and the need to validate a formal proof as a ‘mathematical truth’—he seemingly perceives as obscuring the very *raison d’être* of ‘formal’ proofs.

Prima facie, such a perspective is not dissimilar to that of Markus Pantsar’s concept of ‘pre-formal mathematics’ in [Pan09]; and could be viewed as similarly seeking to express mathematically some of our ‘culturally appropriate, intuitive explanations’ robustly within a language of, ideally, categorical communication⁸⁷:

“3. FORMAL PROOF VS CULTURALLY APPROPRIATE, INTUITIVE EXPLANATION

Hales [16] explains what formal proofs are and why some people find them appealing:

A formal proof is a proof in which every logical inference has been checked all the way back to the fundamental axioms of mathematics. All the intermediate logical steps are supplied, without exception. No appeal is made to intuition, even if the translation from intuition to logic is routine.

One might ask how would such a proof be verified? Do we just believe it on the say-so of the formal prover (human or otherwise). If not, who would be the “independent authority” that does the verifying? And what skills does that independent authority bring to the job of verification? Would they check it line-by-line, and perhaps miss the wood for the trees? Or would the authority have a strong intuitive notion of what is going on (and if so where do they get that intuition from)? Hales goes on to write

⁸⁷Such as the first-order Peano Arithmetic PA (see §13.E.: *Recognising the strengths and limitations of ZF and PA*); or (equivalently by the Provability Theorem for PA; see §2.E.b., Theorem 2.17) the various computer languages that derive their validity from Church’s λ -calculus.

Thus, a formal proof is less intuitive, and yet less susceptible to logical errors.

How does one interpret this claim? What errors are not “logical errors”? Why does the formal approach necessarily reduce the possibility of overlooking issues that arise, especially if the reader is not expected to see the big picture?”

... Granville: [Grn22], §3. *Formal proof vs culturally appropriate, intuitive explanation.*

Granville acknowledges that although: ‘Formal proof tries to avoid “intuition” as being imprecise’, it also raises the query: ‘How do we know that a proof is correct?’:

More logical fallacies about formal proof. Formal proof tries to avoid “intuition” as being imprecise. There is a belief that a presentation with only formal steps can help an independent authority more easily verify the proof. In 1895, Peano wrote Imprecise ideas cannot be represented by symbols, which implies that ideas represented by symbols must be precise. Even if we agree with this extraordinary (and unproven) claim, it is easy to misinterpret it into believing that once you have translated your mathematical problem into symbols you are guaranteed to not be wrong (rather than not be imprecise); of course, one can be precise and wrong! Let’s suppose that we are careful about meaning. Then who is the “independent authority” that does the verifying? And if that authority has limited understanding and little intuition, could a subtle error slip by?¹⁶ So Peano suggested a formalization that necessitates identifying the fundamental mathematical ideas in an explanation and then finding a way to express these within a limited language ([38, section 2.3]). Moreover Peano wishes to reduce proofs in his formal language (via various “identities”) to as few symbols as possible to conclude that the mathematics has then been better understood. Even if we agree that the mathematics is better understood in this context, what happens when one translates Peano’s shortest proofs into the standard lexicon so more humans can understand? Will this be the most desirable proof? Will it help us to see the next results?

Nathanson [31] writes:

How do we know that a proof is correct? By checking it, line by line.

However, perhaps the most common fear is that in reading a formal proof, line by line, one can be convinced by each step yet not perceive the whole, not see global errors nor see how to reproduce the proof from one’s own intuition. So has one really verified it, if it is not easily reproducible? It is then part of the union of human knowledge but is it really known of its own accord?

Formal proofs typically chase the details of a proof back to the axioms. It is like a child tirelessly asking “Why?” (until one gets back to immutable truths), but at the end of that process, does the child remember what they asked at the start and how they got to the end? A proof like this is little better than the answer “Because I said so”, no matter who is the objective trusted authority. When we are functioning participants in a community we expect answers we can understand, interpret, appreciate, and even use if possible.

¹⁶ Many errors can occur, not only mathematical, but also, for example, interpretation of symbols and language. It is easy to invent an unambiguous protocol for any given identified issue, but can we know we have thought out all possible situations that need a protocol to avoid ambiguity or misunderstanding? ”

... Granville: [Grn22], §3. *Formal proof vs culturally appropriate, intuitive explanation.*

Granville notes the view that ‘mathematicians perceive formal proof as an over-focus on precision’, since their subjective ‘confidence in a proof stems from its robust nature under enquiry from technically competent, interested peers, not from some abstract verification’.

Moreover, even though errors ‘are regularly found in published proofs that have been accepted to be true ... yet we stick with our system; it must have its advantages’:

What other kinds of proof? Eugenia Cheng [6] writes that philosophers¹⁷ believe that

Thanks to the notion of ‘proof’, we have an utterly rigorous way of knowing what is and isn’t true in mathematics,

but that mathematicians perceive formal proof as an over-focus on precision. So if we are so skeptical about formal proof, what works instead? There is a wide gulf that separates traditional proof from formal proof. Hales [16] writes,

Traditional mathematical proofs are written in a way to make them easily understood by mathematicians. Routine logical steps are omitted. An enormous amount of context is assumed on the part of the reader . . . A trained mathematician [can translate] those intuitive arguments into a more rigorous argument.

Indeed, Eugenia Cheng [6] remarks,

Although proof is what supposedly establishes the undeniable truth of a piece of mathematics, proof doesn't actually convince mathematicians of that truth . . . Something else does.

Research mathematicians therefore write "proofs" that are a convincing argument which perhaps could be turned into a formal proof, written primarily to enhance knowledge and understanding, while maintaining some level of rigour that convinces the reader that more could be done in that direction. Mancosu [28] notes that this type of proof

does not bear directly upon some of the traditional foundational concerns, such as certainty, which have dominated much of philosophy of mathematics.

Nonetheless, we believe that such a proof, especially if it is widely understood, is "robust" and so less prone to error. This has long been the "community standard":

There is no . . . mathematician so expert in his science as to place entire confidence in his proof immediately on his discovery of it . . . Every time he runs over his proofs, his confidence increases; but still more by the approbation of his friends; and is rais'd to its utmost perfection by the universal assent and applauses of the learned world. — David Hume (1739)

Hume is claiming that confidence in a proof stems from its robust nature under enquiry from technically competent, interested peers, not from some abstract verification. This system is not perfect. Errors are regularly found in published proofs that have been accepted to be true, and yet we stick with our system; it must have its advantages.

¹⁷ I think she means to write "some philosophers" and indeed some mathematicians. *

. . . Granville: [Grn22], §3. *Formal proof vs culturally appropriate, intuitive explanation.*

Granville argues that to 'a mathematician a proof is read to add to one's own intuition and scope, not simply to agree that something is correct'; even though 'proofs are accepted by community standards', and 'the purpose of proofs' could be viewed as 'a plan . . . explaining what ideas are strung together to prove the proposed theorem, so the reader can learn, retain and re-use the ideas':

The usefulness of a good proof. To a mathematician a proof is read to add to one's own intuition and scope, not simply to agree that something is correct. The reader is not passive. She wants to understand, to synthesize and to use the ideas in her own research[.] Different people get different things out of a reading and therefore a new research article can inspire new ideas in hitherto unforeseen directions. Even the same person can, at different times, get different things from reading an article, our understandings do change over time, sometimes even how we approach the whole area.

Rather than chase proofs back to the axioms, most readers rely on the published literature (a library of reliable knowledge), on what is already known. This means the reader says "Why?" just once, at least if the reader has enough current knowledge that they have read and mostly understood all, or most of, the references on which the article is based.

To summarize, proofs are accepted by community standards. This means that they might be wrong since we don't expect the details to be incredibly carefully checked; so what is the purpose of proofs? Perhaps the plan of the proof is the primary thing, explaining what ideas are strung together to prove the proposed theorem, so the reader can learn, retain and re-use the ideas.¹⁸ The details are usually of less interest, especially as an experienced reader can reconstruct them with effort.

¹⁸ Cheng [6] compares this to legality (the proof) and morality (understanding that the proof is correct in principle). It would be nice if proof and understanding were synonymous but they are not, and we have to appreciate and often accept how they match and how they differ. "

... Granville: [Grn22], §3. *Formal proof vs culturally appropriate, intuitive explanation.*

Granville supports this perspective further by arguing that, a 'proof is an explanation to a particular audience' which 'is less likely to remain skeptical with a well reasoned argument in the form of a proof':

Writing a proof. A proof is an explanation to a particular audience.

Mathematical explanations are context-dependent since "in different contexts different features might be salient" — Mancosu [29] quoting Lange [26]

An explanation for an expert in the field (the first readers of a research paper) is different from that for a novice student in the area, which is different from someone not in the area. Here we are talking about the level of detail required, and explanation of how arguments fit together. The usual protocol is that papers are written so that the abstract and half the introduction is accessible to a broad audience, an overview in the introduction to specialists (including novices), and the details for experts[.]

Explanation can be given by examples and test cases, by analogy with already understood results, or by proving the result in some special cases that highlight the main ideas. A "good proof" to a mathematician is one that explains as well as proves, in fact the better the explanation the less danger in omitting cumbersome details. However there is a wider community that may wish to read and appreciate a proof of a result and then the details may become more useful.

Cheng [6] claims that the purpose of mathematical communication is to turn the author's beliefs, via a proof, into a *believed truth* of her reader. One cannot convincingly just state the belief; the colleague will only start to consider it to be true if there is plausible reasoning attached. But what is reasoning? Will our correspondent believe the reasons? Without the rigour and structure of proof, without fitting the reasons into an appropriate framework, the reader will probably remain skeptical, or at least is less likely to remain skeptical with a well reasoned argument in the form of a proof. This is because a carefully worded proof helps allay the fear of ambiguity or misdirection."

... Granville: [Grn22], §3. *Formal proof vs culturally appropriate, intuitive explanation.*

Granville seemingly argues against conflating 'mathematical truth' with 'beauty'; since proofs 'develop over time', and such conflation ignores our experience that 'partial results can encourage others and enhance the sense of community':

Mathematical truth is beauty, and beauty truth. What makes a piece of mathematics "feel right"? Cheng [6] claims it is about what "ought to be", and not to be confused with "useful, fun, intriguing, beautiful, proved in detail". This perspective helps understand what motivates the approach that many take to proving theorems.

The prolific and influential mathematician Paul Erdős claimed that an objective supreme being has a "Book" which contains the perfect proof for every true theorem, each of which is short and elegant. Short, so it is easy to verify, and elegant so one knows that the statement fits so well that it must be true. This is a wonderful conceit of professional pure mathematicians, when a concept is ripe to be understood then it should willingly yield its most succulent fruits.

The great Groethendieck did not believe in big steps or examples to elucidate progress: when a subject is ready the theory should be clear so there is no point in trying to push progress too fast.¹⁹ Case-by-case analyses may be complicated and clumsy but can help the researcher understand the patterns that may lead to a proof that makes a case-by-case analysis unnecessary. Proofs develop over time, and different authors choose to publish at different stages in the potential process.²⁰ Some research mathematicians are loathe to publish anything but a “final proof” in which one can see why a concept is true in one fell swoop. Others are less selective, publishing a less complete theory, but partial results can encourage others and enhance the sense of community. It takes all sorts.

¹⁹ To my taste, a sad reductionist theory of progress.

²⁰ This is one of many arguments against “citation indices”. Half-baked good ideas will get improved by lots of people and so will be often quoted. A brilliantly thought out breakthrough, with a beautiful proof, may be difficult to improve, even marginally, and so get less referenced. ”

... Granville: [Grn22], §3. *Formal proof vs culturally appropriate, intuitive explanation.*

Granville emphasises this point by noting that to ‘a large extent mathematicians follow the library model of building upon past papers’; and even though ‘no two people view language the same way, no matter how well defined ... we hope that our description gets the reader to be able to “figure out” or to re-construct what we meant from what we have written, perhaps in their own way which may be subtly different (and that perhaps leads to something new)’:

The language of research articles. To a large extent mathematicians follow the library model of building upon past papers. A theorem is a key new result of the research paper. Since research papers build on the library of knowledge, they typically quote what is known, and perhaps make simple modifications of what is already known to fit their needs—these are the “lemmas”. If such a simple deduction seems to be interesting in its own right, then it might be called a “proposition”. There are no hard and fast rules for the use of these words but one will find few variants.

One can argue that no two people view language the same way, no matter how well defined. Indeed we get used to words in common usage, like “epistemic” seemingly used for a rainbow of connected but subtly different meanings. But language is how we communicate proof, and it is rarely a perfect tool for that. Instead we hope that our description gets the reader to be able to “figure out” or to re-construct what we meant from what we have written, perhaps in their own way which may be subtly different (and that perhaps leads to something new). This argues for formal proof and language but we have seen that that has its pitfalls.”

... Granville: [Grn22], §3. *Formal proof vs culturally appropriate, intuitive explanation.*

1.L. What mathematics *is*, and what it *is not*

The question, then, arises of what mathematics *is*, and what it *is not*; a question that remains a serious concern of mathematics educators, since the *faith-based*⁸⁸ foundations of classical mathematical paradigms admit interpretations of *quantification* which entail Platonic ontologies that do not admit any coherent⁸⁹ philosophical perspective of the nature of mathematics, to both teachers and students of mathematics⁹⁰. As remarked by mathematics educationist Laxman Luitel:

“Talking about the nature of mathematics is not a new agenda. It had been discussed even before the fourth century. Plato and his student Aristotle are the first who provided the space to discuss nature of mathematics. From Plato’s point of view, objects of mathematics had an existence of their own, behind the mind, in the external world (Dossey, 1992). As a mathematics student from the school level, now I am realizing that my schooling was shaped by Plato’s point of view. In my schooling, I thought that mathematics was beyond of our thinking, abstract and discovered. In this context, a student of Plato, Aristotle, had different views. His views of mathematics were not

⁸⁸See §11.: *Three perspectives of logic.*

⁸⁹See, for instance, §20.: *The significance of evidence-based reasoning for the philosophy of science.*

⁹⁰See §28.: *The significance of evidence-based reasoning for mathematics education.*

based on a theory of an external, independent, unobservable body of knowledge but were based on experienced reality where knowledge is obtained from the experimentation, observation, and abstraction (Dossey, 1992). From this, I want to say that the observation of any object differs from person to person. This is based on their experience or related to how they perceive. Thus, there is no objective truth related to mathematics or there is no any objective answer to what mathematics is. What is mathematical knowledge? How is the mathematical knowledge constructed?"

... Luitel: [Lui19], pp.4-5.

Comment 25. That Luitel's concerns may reflect a more profound uneasiness (see Comment 26) about the current, albeit tacit and seemingly universal, commitment in scientific pedagogy—to treating the first-order Set Theory as an *adequate* 'foundation' for expressing all abstract mathematical ideas in practice, even if not in theory—is evidenced in Roy Wagner's [Wgn19], where he seeks 'to re-evaluate the desiderata of foundational programs in mathematics', since some cogently argued perspectives 'find foundations potentially harmful':

"This note opens with brief evaluations of classical foundationalist endeavors—those of Frege, Russell, Brouwer and Hilbert. From there we proceed to some pluralist approaches to foundations, focusing on Putnam and Wittgenstein, making a note of what enables their pluralism. Then I bring up approaches that find foundations potentially harmful, as expressed by Rav and Lakatos. I conclude with a brief discussion of a late medieval Indian case study (Śaṅkara's and Nārāyaṇa's Kriyākramakārī) in order to show what an "unfounded" mathematics could look like. The general purpose is to re-evaluate the desiderata of foundational programs in mathematics."

... Wagner: [Wgn19], Abstract.

Wagner not only raises the question of the appropriate methodology that 'modern research mathematics *should* adopt', but implicitly argues that current perspectives as to the soundness of what we currently accept as adequately sound foundations for mathematics in our research 'are perhaps not necessarily desirable'; and that once 'we accept that foundations are not strictly necessary for just any mathematical culture, then the debates over the reasons for adopting or rejecting foundational systems in *our* mathematical culture, and the role we assign to presumably foundational systems, become much more contingent and open ended':

"The point I am trying to make with this case study is that a rich mathematical proof culture does not necessarily require foundations in order to thrive. Mathematics can in principle endorse Wittgenstein's holistic view and reject the ground/consequence division in favor of a system of correlation of practices, possibly containing circularities and manageable contradictions. It can further endorse Lakatos's view and expose mathematics to the sway of interpretive drifts by purposely not tying it to (a) formal system(s). Whether modern research mathematics *should* adopt this approach is a different question, on which I remain here (with Friend) agnostic.

Shared standards and *risk assessment* can be achieved and have historically been achieved without committing to formal foundations. If they like, meta-mathematicians can keep their formalized *meta-mathematical corral*—this does not require them to impose it on the rest of us and restrict the *generous arena* of plural mathematics. True, the high level of consensus obtained from granting some formal foundation the power of final arbitration may suffer. Moreover, *bounding the scope of debate* and *keeping intruders out* would be more difficult to achieve without formal foundations. The latter, however, are perhaps not necessarily desirable. Once we accept that foundations are not strictly necessary for just any mathematical culture, then the debates over the reasons for adopting or rejecting foundational systems in *our* mathematical culture, and the role we assign to presumably foundational systems, become much more contingent and open ended."

... Wagner: [Wgn19], Conclusion.

Comment 26. The significance of Wagner’s perspective—despite his stated agnosticism—lies in the apparent paradigm shift it seemingly portends, and/or might even influence, in the way post-graduate research in mathematics is sought to be viewed administratively in academe (as evidenced by the August 2023 developments in West Virginia University⁹¹).

For instance we could—not entirely unreasonably—argue that the reason post-graduate (particularly state-funded) courses in mathematics (and in physics/other natural sciences) are (or may inevitably be) sought to be down-sized is that—almost universally—the current perspective, and focus, of such courses in (particularly fundamental) research seemingly admits only seeking, and publishing, (essentially ‘formal’) proofs of propositions/theorems in the language of some Set Theory that, tacitly even if not explicitly, admits an axiom of infinity as an article of *faith*⁹²; even when such propositions/theorems are not only algorithmically *unverifiable*, but would also be *essentially unfalsifiable*, under any evidence-based interpretation.

Historically, however, research has proven its value to society (as distinct from its unquantifiable—and eternally debatable—contribution to an individual’s intellectual evolution) only when it seeks *both* the *understanding* and *truth* of plausible, but falsifiable, propositions/theorems.

This is reflected in the increasing funding by commercial concerns into fundamental research that, even when not perceived as immediately cost-effective, shares the perspective (yet not evidenced significantly in academe globally) that Mathematics must serve Philosophy and the Natural Sciences in the sense of §13.C..

In other words fundamental research must first address (see §2.) the philosophical challenge that arises when an intelligence—whether human or mechanistic—*accepts* propositions as true under an interpretation—either axiomatically or on the basis of subjective self-evidence—*without* any specified methodology for evidencing such acceptance.

Moreover, evolving a ‘methodology for evidencing such acceptance’—and viewing seemingly conflicting perspectives as complementary—may require us to explicitly recognise the complementary roles each scholar plays—or, ideally, ought and be taught to play—as a natural scientist, as a philosopher, and as a mathematician, when wearing at different moments (see §13.C.):

- The natural scientist’s hat, whose wearer’s responsibility is recording—as precisely and as objectively as possible—our sensory observations (corresponding to what some cognitive scientists, such as Lakoff and Núñez term as ‘primary’, and ‘secondary’, conceptual metaphors);
- The philosopher’s hat, whose wearer’s responsibility is abstracting a coherent—albeit informal and not necessarily objective—holistic perspective of the external world from the natural scientist’s sensory observations and their associated perceptions (corresponding to, say, Carnap’s explicandum);

⁹¹See <https://sites.google.com/view/wvusmdsreview/home?authuser=0>; also Combinatorialist Igor Pak’s 2019 post ‘*What if math dies?*’ in his blog *Views on life and math*.

Significantly, in a seemingly prescient 1999 ‘spoof’ essay [W1b99], mathematician Norman Wildberger essentially seeks to caution both emerging mathematicians, and their teachers, against divorcing falsifiable mathematical research from the pursuit of essentially unfalsifiable, but formally provable, theorems in the fecundity of artificially defined axiomatic systems that have no plausible mathematical or real-life model (hence debatable scientific or social value); a pursuit seemingly aimed predominantly even then at publishing intellectually impressive, but arcane, ‘research’ purely for ‘embellishing’ job-oriented curriculum vitae.

A caution that can be viewed as implicit—albeit from a different perspective—in Melvyn B. Nathanson’s 2008 essay [Na08]: ‘*Desperately Seeking Mathematical Truth*’; and reflected obliquely in Elliott Mendelson’s earlier 1990 article [Me90]: ‘*Second Thoughts About Church’s Thesis and Mathematical Proofs*’.

⁹²The significance of this is sought to be highlighted in §7.B. *Faith-based quantification* vis à vis §7.C. *Evidence-based quantification*.

- The mathematician’s hat, whose wearer’s responsibility is providing the tools for adequately expressing such recordings and abstractions in a symbolic language of unambiguous expression and, ideally, categorical communication (corresponding to, say, Carnap’s explicatum).

We could view this distinction as seeking to address the corresponding questions of:

- What we do in scientific disciplines;
- Why we do what we do in scientific disciplines; and
- How we express and communicate whatever it is that we do in scientific disciplines.

From an *evidence-based* perspective of the *pre-formal* proofs of 4CT in §1.I.b., we shall thus argue that mathematics could—and should—be viewed as merely a set of symbolic languages; the *validity* of whose propositions under Tarski’s standard definitions (see [Me64]⁹³) of their ‘satisfiability’, and ‘truth’, under a *well-defined* interpretation, must be rooted in, and reflect, what Pantsar terms as the *truths* of ‘pre-formal—semantical—mathematical thinking’ that *formal* mathematical languages are *then* intended to *express faithfully* in unambiguous mathematical expression, and, ideally⁹⁴ *communicate categorically*:

“Mathematics is a human endeavour, and we must not ignore the way mathematics is practised, learnt and taught. We as human beings use pre-formal—semantical—mathematical thinking all the time, and this enables us to understand mathematics. Human beings do not process mathematics completely formally as computers do. We comprehend mathematical ideas in our pre-formal thinking, and the formal theories are a way of making these ideas maximally unambiguous. *Proof* is of course the method by which we acquire new theorems in the formal systems, but the rules of proof cannot be arbitrary. They have been designed to correspond to our pre-formal ideas of *truth*. It is in this domain of pre-formal thinking that we see the truth of Gödel sentences. As the semantical arguments show, Tarskian truth is all we need for that, and it corresponds well with the pre-formal thinking in mathematics. That is why the semantical arguments are valid, and mathematical truth is substantial. Of course this would be the case even without Gödel’s incompleteness theorems and the semantical arguments; their importance lies in giving us an explicit sentence to study the problems with.”

...Pantsar: [Pan09], §1.9 *The structure of this work*.

For Pantsar, in the end it all ‘comes down to the question of reference’:

“In the end, all of the above comes down to the question of reference. If we follow extreme formalism in that mathematical theories have absolutely no outer references, we will end up with the position that mathematics is arbitrary fiction. Deep down, under this interpretation, going through a mathematical proof is similar to solving a Sudoku puzzle. Although this goes against the image most of us have about the nature of mathematics—as well as all the practical applications—the formalist program has one clear strength: it avoids the daunting ontological problems we are faced with in the philosophy of mathematics. If we accept that mathematical theories have references, the understandable consensus is that we must specify what these are. On this matter, however, non-formalists have found very little to agree on. Platonism, structuralism, empiricism, naturalism and many other suggestions have been presented—and all of them have been shown to be problematic in one way or another. The conclusion for strict formalists has been that references in mathematics are not possible, and mathematics must be a fiction. In particular—against the main thesis of this work—mathematical truth is deflationary.”

...Pantsar: [Pan09], §1.2 *Another approach*.

⁹³For reasons detailed in §15.H.i. (*The misleading entailment of the fixed point theorem*) we prefer [Me64] to [Me15].

⁹⁴Gödelian incompleteness notwithstanding (see §15.: *Gödel 1931 in hindsight*).

In other words Pansar concedes that admitting, for instance, that proving theorems in a first-order set theory which admits an axiom of infinity (such as ZF) does not *require* a *well-defined* interpretation⁹⁵; and so might seek to avoid ‘the daunting ontological problems we are faced with in the philosophy of mathematics’. However, it then admits, as Pansar notes, the disquieting conclusion—no longer tenable by the *finitary* proof in [An16] (Theorem 6.8, p.41) that the first-order Peano Arithmetic PA is *consistent*⁹⁶—‘that references in mathematics are not possible, and mathematics must be a fiction’. Moreover:

“The approach for the extreme formalist, hence, is to minimize the ontological commitments in order to make mathematics as philosophically unproblematic as possible. In this work I want to suggest another approach, one that is necessitated by the failure of extreme formalism. While ontologically minimal, extreme formalism makes mathematics impossible as a human endeavour—which is much more alarming than any intricate philosophical problems. In a nutshell, I will argue that if extreme formalism were correct, mathematics could not have developed in the first place—nor could it be practised today. It must not be forgotten that mathematics is a *human endeavour* just like all other sciences. If something is essential to mathematics as a human endeavour, we would seem to have good reason to believe it is also a factor in the philosophy of mathematics—or at least something we should expect a theory in philosophy of mathematics not to *conflict* with. As well as providing an explanation for the formal theories that are the core of mathematical knowledge, philosophical accounts of mathematics must be able to explain why we prefer certain theories to others, why they are useful in practice, and how we are able to teach and learn mathematics. When it comes to mathematics as a science, this is of course something everybody is ready to agree on. In fact, it is so obvious that most philosophers of mathematics seem content not to grant any importance to it. For the majority of philosophers, mathematics seems to consist of formal systems—often using Peano arithmetic (PA) as the example—and the philosophy of mathematics concerns the ontological and epistemological status of these systems.

As central as those questions are, to me they only seem to cover half the picture. It is obvious that besides formal systems, mathematics as a human endeavour has a large informal element. Textbooks of mathematics are not written in completely formal languages and all kinds of informal examples are used in learning mathematics. The communication in mathematics is facilitated everywhere by informal elements. Indeed, it should be safe to say that in order to understand mathematics, we as human beings *must* use these informal elements. In addition, the history of mathematical thinking of course reveals that formal axiomatic systems of mathematics are a rather late development. The Peano axiomatization of arithmetic, for example, was only published in 1889, millennia after arithmetic was first used to great success. These informal—*pre-formal*—elements have made mathematics possible to use and learn whether we consider individual or the wider historical development.

Yet the pre-formal element has been largely neglected in the philosophy of mathematics. It has been widely assumed—and not just among formalists—that these are matters for psychology and sociology, and not of much interest to philosophers. In this work I must argue against that. These pre-formal elements are the very reason why mathematics makes sense to us. Not surprisingly, they also have a central position in the whole problem of mathematical reference. When we acknowledge that formal theories have been *designed* to correspond to our pre-formal mathematical ideas, we immediately recognize that the latter are in fact the reference of formal mathematics. Rather than think of, say, the natural numbers as defined by the axioms of PA as fiction, we can consider them referring to our pre-formal notion of number—and arbitrariness is avoided.

That is the first stage of mathematical reference, and when we speak about the truth of formal mathematical theories, at this first stage we are concerned with them *corresponding to our pre-formal ideas*. Of course, in order to avoid arbitrariness, the pre-formal ideas themselves must have references, and that second stage is the question of Platonism, structuralism and other ontological

⁹⁵As argued by Michael Harris in [Hrs19] (see also the counter argument in §1.G.: *Should Wiles’ pre-formal proof of FLT be treated putatively as sufficiently formal?*).

⁹⁶See also §2.C.a., Theorem 2.16: *PA is strongly consistent*.

theories. In a way, by introducing pre-formal thinking into philosophy we are admittedly only moving the problem of reference to another level. However, this is giving the strict formalist too strong a case. I will argue that the non-formalist does not need to specify her ontological and epistemological positions. All she needs to show is that *some* theory of reference—and truth—is needed in the second stage for a philosophical theory of mathematics to make sense. In this work I defend Alfred Tarski's (1936) T-scheme as a theory of truth fitting both of these two stages. Tarskian truth is *semantical* and the connection of formal and pre-formal mathematics seems to be a semantical one, as well: we understand formal sentences by what they mean pre-formally.

It will be seen that Tarskian truth in the first stage—over formal mathematics—is not deflationary. What Tarskian truth in the second stage refers to is a whole other question—but it is also one we do not need to answer in order to refute extreme formalism and deflationism. There exists a reference for formal mathematics, and when it comes to the question of truth and proof, it will be enough to complete the argument here to show that there must exist one for pre-formal mathematics, as well. If we examine mathematics as a wider phenomenon, we will see that there is only one philosophical theory of mathematics that conflicts with this—and that is extreme formalism with its irrevocable problems of arbitrariness. Other than repudiating that kind of strict formalism, I will argue, the deep ontological questions of the second stage can be left unanswered in a work about truth and proof."

... *Pantsar*: [Pan09], §1.2 *Another approach*.

From an *evidence-based* perspective, we could further view Pantsar's compelling insight—into the significance of what he terms as 'semantical', *pre-formal*, mathematics in *validating* 'syntactical' *mathematical truth*⁹⁷—as being strikingly highlighted by the two 'pictorial', *pre-formal*, proofs of the 4-Colour Theorem in §1.1.b.

Moreover, Pantsar's approach could be viewed as favouring a perspective which would admit that⁹⁸ mathematics must limit, and be seen as limiting, its relationship to Philosophy and the Natural Sciences by explicitly acknowledging its roots in Rudolf Carnap's *explicandum*, and its goal in Carnap's *explicatum* (see [Ca62a]); leaving to cognitive scientists, such as George Lakoff and Rafael Núñez (see [LR00]), an appropriate mathematical, and philosophical, determination of the ontological status of, first, the primary conceptual metaphors that have been *classically* sought to be represented symbolically in a mathematical language by *quantification* over putatively *infinite* domains and, second, the secondary conceptual metaphors that correspond to subsequent, possibly Platonic and essentially *unfalsifiable*⁹⁹, interpretations of the symbolic expressions of the language that admit *quantification*.

Although admitting Platonic interpretations of secondary conceptual metaphors would make a mathematical language, such as ZF, 'richer' in its ability to unambiguously express conceptual metaphors that are *not* rooted in a reality which can be *evidenced*, such a 'richness' of expression denies ZF the ability to assign *evidence-based* characteristics of 'satisfaction' and 'truth' to the well-formed propositions of the language under Tarski's definitions (as argued in [An16], §4¹⁰⁰), and thereby assure categorical communication of the 'meaning' and mathematical 'significance' of its provable propositions¹⁰¹.

It is a cost, however, that Pantsar might consider worth paying in order to avoid committing ideologically to any 'metaphysical and epistemological theories of mathematics', so long as we can 'know there is a difference between truth and proof without knowing what truth exactly is'; a difference without which, as Pantsar remarks vividly, 'mathematics as we know it could not be possible':

⁹⁷I.e., *mathematical truth* defined in terms of *mathematical provability*, but *validated* without appeal to *provability* (unlike as in §12.B.d.: *A weak, Wittgensteinian, interpretation $\mathcal{I}_{PA(\mathbb{P}A, W)}$ of PA*).

⁹⁸As argued in §13.C.: *Mathematics must serve Philosophy and the Natural Sciences*.

⁹⁹As detailed in §7.B.: *Faith-based quantification*.

¹⁰⁰See also §7.D.: *Quantification in constructive mathematics is ambiguous*, and §7.E.: *Where realizability in constructive mathematics is ambiguous*.

¹⁰¹As detailed in §13.E.: *Recognising the strengths and limitations of ZF and PA*.

"In the very final chapter of this work the concept of substantiality (robustness) of truth is discussed. In it I have tried to make explicit an underlying argument of this work: we do not need to know the exact nature of mathematical truth in order to be able to talk about it. In fact, from this work one will not find comprehensive arguments for Platonism, empiricism, naturalism, structuralism or any other metaphysical and epistemological theories of mathematics. Yet the study on truth and proof here should not be on any weaker basis than in more complete philosophical pictures of mathematics. Aside from the substantiality of truth, that is the main thesis (sort of metathesis) of this work: we can know there is a difference between truth and proof without knowing what truth exactly is. Simply put, if such a difference did not exist, mathematics as we know it could not be possible."

...Pantsar: [Pan09], §1.9 The structure of this work.

We note that the notion of *validating* 'pre-formal truth' and 'pre-formal proof' is implicit in Per Martin-Löf's 1987 analysis [Mlf87] of the *meaning* and *truth* of a proposition; which we view as:

Löf's Thesis: A proposition '**A**' is a '**truth**' if, and only if, it can be '**asserted/judged**' as '**A is true**' by appeal to some '**evidence/proof**' for the truth of **A** which can be '**validated**'.

In other words, from an *evidence-based* perspective Martin-Löf can be viewed as essentially arguing that the two notions are the same, *if* we were to interpret his 'schematic figure'—illustrative of giving 'meaning to the most primitive notions that' we deal with—as the above *Thesis*:

"How are you to proceed then to give meaning to the most primitive notions that you are dealing with? I think the answer is that you must enter on something completely different from modelling or translation, depending on whether you look at it model theoretically or proof theoretically: you must enter on a genuinely semantical or meaning theoretical investigation, which means that you must enter on something that you are not at all prepared for as a mathematical logician, whether model theorist or proof theorist: you must enter on an enterprise which is essentially philosophical or phenomenological, if you prefer, in nature. And, since it is this which is our concern at this workshop on theories of meaning, I think it would be appropriate to give, or at least outline, *one* example of a theory of meaning, namely, a theory of meaning for the standard language of predicate logic, because if we cannot deal even with that exceedingly simple language it is very unlikely that we should be able to give any substantial theories of meaning for more complicated languages, like fragments Of natural language. So I shall outline one particular theory of meaning, intuitionistic or verificationistic theory of meaning, for the language of predicate logic. Of course, pure predicate logic is not sufficient for all of mathematics: in addition to the logical operations you need ordinary inductive definitions, possibly also generalized or transfinite inductive definitions, but the pattern of this kind of meaning theory can certainly be seen already from the explanations for the pure predicate logic.

The fundamental concepts that have to be explained semantically can be read off either from the title of my talk or else from the schematic figure

[SCHEMATIC FIGURE which we interpret as the thesis: A proposition '**A**' is a '**truth**' if, and only if, it can be '**asserted/judged**' as '**A is true**' by appeal to some '**evidence/proof**' for the truth of **A** which can be '**validated**']

First of all, we have the notion of proposition. Second, we have the notion of truth of a proposition. Third, combining these two, we arrive at the notion of assertion or judgement. There are various forms that a judgement may exhibit, in general, but I am only going to consider judgements of the particular form which is used for holding a proposition to be true. Fourth, in addition to the notion of judgement, we have the notion of evidence or proof of a judgement, which I have indicated schematically in the figure by means of the vertical line. Fifth, in the very end, I shall also have to consider the notion of correctness or validity of a proof: that is the last notion that enters into the title of my talk. So the semantical or meaning theoretical explanations that have to be supplied in the case of the language of predicate logic are explanations of the notions of proposition, of truth, of judgement, of proof, and eventually something has to be said about validity of proofs also."

... Martin-Löf: [Mlf87], pp.408-409.

From an *evidence-based* perspective, we would then interpret Martin-Löf's analysis as reflecting the perspective of the *Complementarity Thesis*¹⁰²: that a mathematical language is merely a means for expressing those of our conceptual metaphors, whether primary or secondary, that can be expressed as valid grammatical constructions of the language.

The meaning of a proposition, then, lies not in the syntactical construction of a proposition, nor in its *well-defined* interpretation (if any), but in what an intelligence seeks to express in a well-formed expression of the language by means of an effective (i.e., *finitely* determinate) method that, first, admits an unambiguous 'encoding' of a primary conceptual metaphor in the language and, thereafter admits an unambiguous 'decoding' of the symbolic expression into a secondary conceptual metaphor.

Such an expression would be unambiguous if it succeeds in 'encoding' the primary metaphor such that the 'encoding' admits a 'decoding' which uniquely defines a secondary, 'interpreted', conceptual metaphor that the 'encoding' intelligence can *evidence* as corresponding to that which was intended to be expressed within the language by the initial 'encoding'.

The proposition would then be definable as *pre-formally* true within a *well-defined* community if, and only if, any two intelligences within the community—that share an identical method for 'encoding' their individual primary conceptual metaphors in a shared language—arrive at the same symbolic expression of the language; and can *evidence* that the expression does, indeed, 'decode' and uniquely define a 'secondary' conceptual metaphor that corresponds to that which the intelligences, by consensus, treat as what was sought to be expressed initially within the language.

A *well-defined* proposition could then be defined as *formally* true if, and only if, there is an *effective* method that can assign unique 'truth-values' of 'provability' and 'truth' to the symbolic expressions of a formal language (defined by a finite alphabet, finitary rules for the formation of well-formed formulas, axioms, rules of inference, definitions, finite proof sequences, lemmas, theorems, and corollaries) such that, first, every *provable* expression of the language is *formally* true under a Tarskian interpretation of the language, and second, that a proposition is *formally* true if, and only if, it is *evidenced* as *pre-formally* true by the concerned intelligences.

1.M. Conclusions

In §1.I.b., we have given two elementary, computer-free, *pre-formal* proofs of the classical Four Colour Theorem 4CT; and argued in §1.J. that the mathematical significance of the proofs lies not in any ensuing theoretical or practical utility of the Theorem per se, but in the *insight* and *understanding* proffered by a concept of *pre-formal* mathematical *truth* which can differentiate between:

- *knowledge as intuitively justified true belief*; and
- *knowledge as factually grounded belief*.

We further argued in §1.J. that the *pictorial* proof for Proposition 1.3 illustrates the need for recognising the primacy of *pre-formal* reasoning; and requires addressing the issues of what mathematics is, and what it is not, in relation to the inter-dependence of mathematical *truth*, and mathematical *proof*, in so far that:

- Whilst the focus of proof theory *may* be viewed as seeking to ensure that any mathematical language intended to represent our conceptual metaphors and their inter-relatedness is unambiguous, and free from contradiction;
- The focus of constructive mathematics *must* be viewed as seeking to ensure that any such representation does, indeed, uniquely identify and adequately represent such metaphors and their inter-relatedness.

¹⁰²§1., Thesis 1; see also §1.J..

Essentially, such a *Complementarity Thesis* (§1., Thesis 1) implicitly admits that Pestalozzi's 'Principle of Anschauung' can be viewed as the basis of a 'common intuition' which could, then, be treated as the necessary, and sufficient, *evidence* for formalising the concept of mathematical *truth* in *pre-formal* reasoning/mathematics/proof within a well-defined community.

Moreover, such a *pre-formal* approach could be viewed as favouring a perspective which would admit that:

- mathematics must limit, and be seen as limiting, its relationship to Philosophy and the Natural Sciences by explicitly acknowledging its roots in Carnap's *explicandum*, and its goal in Carnap's *explicatum*;
- leaving to cognitive science an appropriately sound determination of the ontological status of:
 - first, the primary conceptual metaphors that are sought to be represented symbolically in a mathematical language by *quantification* over putatively infinite domains; and,
 - second, the secondary conceptual metaphors that correspond to subsequent, possibly Platonic and essentially *unfalsifiable*, interpretations of the symbolic expressions of the language that admit such *quantification*.

A mathematical language is, thus, merely a means for expressing those of our conceptual metaphors, whether primary or secondary, that can be expressed as valid grammatical constructions of the language.

The 'truth' and 'meaning' of a *well-defined* proposition of the language, consequently, is not *entailed*, but only *validated*, by the syntactical construction of a *proof* sequence for the proposition.

Comment 27. From the *evidence-based* perspective of this investigation, the significance of pictorial, *pre-formal*, proofs for not only *validating* (in the sense of §1.J.; see also 1.I.h.) a formal proof as a mathematical, and meaningful, mathematical *truth*, but even as substituting *essentially* in some cases for formal proofs (as argued in §1.I.f. in the case of the questionable 'proofs' of the Four Colour Theorem) can be viewed as cogently argued by Carlo Cellucci in [Cll19].

A *proof* sequence is then *that* which an intelligence seeks to express only subsequently, in a well-formed expression of the language, by means of an *effective* method that:

- first, admits a *finitary* and unambiguous 'encoding' of a primary conceptual metaphor in the language; and,
- thereafter, admits a *finitary* and unambiguous 'decoding' of the symbolic expression into a secondary conceptual metaphor under a *well-defined* interpretation.

We thus conclude that:

- it is only *pre-formal* proofs (in Pansar's sense) of the Four Colour Theorem—such as, for instance, those posited for Proposition 1.3 in §1.I.b.—which can *justify* (intuitively as well as in Piccinini's sense) treating a *formal* proof of 4CT as a mathematical *truth*, and not vice versa; although
- any *well-defined* interpretation of some putative, even if yet unidentified, *formal* proof of 4CT *would* serve to *validate* (in Martin-Lof's sense) that the *pre-formal* proof does, indeed, entail a mathematical *truth* as intended.

Comment 28. The need for a *formal* proof of 4CT,

- such that any *well-defined*, computer-assisted, interpretation of the proof,
- along the lines of, for instance, [AH77], [AHK77], [RSST] and [Gnt08],
- could then be treated as validating its *truth*,

is highlighted by the argument in [An23] that the proofs of 4CT in [AH77], [AHK77], [RSST] and [Gnt08] are *vacuously* true.

Reason These proofs are currently accepted as, collectively, having proven 4CT ‘robustly’ (i.e., satisfactorily, even if not rigorously) such that—as Andrew Granville muses in [Grn22]—‘no serious mathematician doubted that 4CT is proved, at least by community standards. That is, this RSST proof is sufficiently robust that one expects to be able to easily patch up any misunderstanding that some future researcher might unearth’¹⁰³:

“**The Four Colour Theorem (4CT)**. There is a lot of (philosophy) literature expressing epistemic dismay at the original proof of 4CT, some of which misunderstood what happens in the purported proof(s), so let me try to clarify. The key notion is, again, “robustness”. In all proofs the idea is to show that if a counterexample exists to 4CT then one can “reduce” it to find a “minimal counterexample” belonging to some computable finite set, and then to prove that no such minimal counterexamples exist since they would have to have too special properties (or be further reducible).⁴³ This has, to date, been complicated.

In Appel and Haken’s 1976 original proof of 4CT, their discussion of how to reduce is not entirely well organized and in parts is difficult to verify. They needed to show that 1478 different subgraphs can be reduced further; they used a computer but without convincing documentation. Moreover the computer program, as described, is complicated (involving 487 steps) and difficult to verify as valid and non-self-contradictory. Nonetheless Appel and Haken did create a convincing plan for proving 4CT in which one could see the point of each major step and why it should work. Here the devil was in the details, and even if these were implemented correctly they were always going to be hard to verify, believe and build upon.⁴⁴ There is a robustness to the overall plan but the implementation was unconvincing.

In 1996, four leading graph theorists, Robertson, Sanders, Seymour and Thomas [37] (RSST) decide[d] to rework the existing proof to make it more believable. They followed the same overarching plan as Appel and Haken but looked for simplifications in the implementation. They had to computer reduce just 633 subgraphs (still a large number, but the authors went to great pains to make their construction transparent.) More important is that their computer program only involved 32 steps, so that a strong mathematician in the area could spend a day or two and believe that the authors have successfully covered all the options. This new proof was consciously written to be easily verifiable (though still long and complicated) and no serious mathematician doubted that 4CT is proved, at least by community standards. That is, this RSST proof is sufficiently robust that one expects to be able to easily patch up any misunderstanding that some future researcher might unearth.

¹⁰³An uncritically inherited perspective that, for instance, is also reflected—albeit implicitly—in [Tao24]:

- Early machine-assisted proofs, such as Appel and Haken’s proof of the **four color theorem** in 1976, did not use a fully developed formal proof assistant; instead, the proof was verified by a combination of computer and human checking, and was still prone to various (fixable) errors.
- A truly computer-verifiable proof of the four color theorem was first produced in 1996 by Robertson, Sanders, Seymour, and Thomas.
- A fully formalized proof of the theorem was given in 2005 by Werner and Gonthier, in the proof assistant **Coq**. ... Tao: [Tao24], Slide 9, Proof assistants.

A few years later Gonthier [11] verified the RSST proof using the Coq v7.3.1 proof assistant, by developing a “formal proof” that covers both the 32 steps and the 633 subgraphs that needed to be reduced; the proof then “depends [only] on the correct operation of several computer hardware and software components” and is not specific to this proof, which feels more robust. Most importantly many of the programs used here had been used in other calculations, which makes one feel that no bug that is specific to what is done here could have crept in. Moreover Coq can produce a proof “witness” (albeit human-unreadable).⁴⁵

⁴² In practice a typical PC might be able to do 1015 basic computer steps (like adding two digits) in a day, which means that checking < 108 positions should be easy in a day, but more than 1014 impractical in a year.

⁴³ This is not an uncommon strategy in graph theory.

⁴⁴ I have heard it said that quite a few mistakes were identified but each could be dealt with by relatively minor modifications of the details; however there were so many such fixes that few people in the area had faith in the details of the end-product.

⁴⁵ A witness is a relatively short verification that a problem has been correctly solved. For example, to prove to you that I have factored 147573952589676412927 , I can simply produce the factors $193707721 \times 761838257287$; you do not need to repeat the steps that led me to these factors.”

... Granville: [Grn22], §8, *Uses of computers in major theorems*.

Moreover if Georges Gonthier’s verification of ‘the RSST proof using the Coq v7.3.1 proof assistant—by developing a “formal proof” that covers both the 32 steps and the 633 subgraphs that needed to be reduced’—*deduced*, rather than *accepted* as instructed, that every Minimal Planar Map such as \mathcal{H} in §1.I.b. (Fig.1) necessarily admitted a ‘pentagon’, this would weaken uncritical reliance on the reliability of proof assistants such as Coq; as sought, for instance, by Rass et al in their intriguing, game-changing, argument in [RJHH] for assisting—if not entirely substituting—peer-review with a necessary requirement of proof-assistant assisted self-review in journal submissions:

“A. THE POSSIBILITY TO “OBJECTIVELY SELF-REVIEW” ONES PAPER

Based on the collection of proofs, we believe that the scientific community would simply be overwhelmed by the sheer flood of papers coming out, why not empower the ones interested in the problem with running their own objective and independent reviews?

Clearly, a human reader, if it were the author itself, is biased, but formal proof assistants like Isabelle/HOL [46] or Coq [47] may help out here.

While it is prestigious to present a mathematical proof to the community, the equally important task of independent verification, today almost in all cases done by a peer-review, is far less “attractive” and offers only little incentive to domain experts to invest lots of time here without any revenue for it. Somewhat ironically, the P-vs-NP question is again special in this regard, since the aforementioned intuition behind NP is it capturing all problems to which a given solution is efficiently verifiable. So, the question is whether a proof about P and NP can itself be verified in reasonable (e.g., polynomial) time by humans or a machine. A machine-verification has the appeal of being objective by construction.

Of course, objectivity only holds to the extent of the human accurately mapping human-made proof into a machine readable form that allows an automated verification. However, with the goal being a relief for domain experts from the burden to review P-vs-NP proofs, the author of such a proof has a natural interest in an accurate representation of the proof to a machine, who can then subsequently do an independent verification. This idea of assigning the verification back to the author, but obliging the person with the provisioning of a machine-verifiable proof has been investigated along a research project about which this paper in parts will report.”

... Rass, Jakobsch, Haan and Hiebler: [RJHH] §II(A).

From the *evidence-based* perspective of this investigation, of particular interest would be the entailment by §4.A.a., Theorem 4.3—asserting that SAT is neither in P nor in NP since Kurt

Gödel's familiar arithmetical formula $[R(x)]$ ¹⁰⁴ is algorithmically *verifiable* by a human intelligence as a tautology, but not recognisable as a tautology by any Turing-machine (whether deterministic or non-deterministic)¹⁰⁵—apropos the authors' above remarks in [RJHH]:

"Somewhat ironically, the P-vs-NP question is again special in this regard, since the aforementioned intuition behind NP is it capturing all problems to which a given solution is efficiently verifiable. So, the question is whether a proof about P and NP can itself be verified in reasonable (e.g., polynomial) time by humans or a machine. A machine-verification has the appeal of being objective by construction."

... *Rass, Jakobitsch, Haan and Hiebler: [RJHH] §II(A).*

¹⁰⁴Which he finitarily defines in [Go31], p.25, eqn.12, *only* in terms of its Gödel-number 'r'.

¹⁰⁵See also the definitive Turing Test in §21.E., Query 22.

CHAPTER 2. INTRODUCTION

2. Revisiting an *evidence-based* paradigm

To place this investigation in its appropriate, *evidence-based*, perspective we first revisit the *evidence-based* paradigm introduced in [An12] and the paper [An16]; a paradigm whose philosophical significance is that it pro-actively addresses the challenge¹⁰⁶ which arises when an intelligence:

- whether human or mechanistic,
- accepts arithmetical propositions as *true* under an interpretation,
- either axiomatically or on the basis of *subjective* self-evidence,
- *without* any specified methodology for *objectively evidencing* such acceptance,
- in the sense of, for instance, Chetan Murthy and Martin Löb:

"It is by now folklore ... that one can view the *values* of a simple functional language as specifying *evidence* for propositions in a constructive logic ..."

... Murthy: [Mu91], §1 Introduction.

"Intuitively we require that for each event-describing sentence, $\phi_{o^i} n_i$ say (i.e. the concrete object denoted by n_i exhibits the property expressed by ϕ_{o^i}), there shall be an algorithm (depending on \mathbf{I} , i.e. M^*) to decide the truth or falsity of that sentence."

... Löb: [Lob59], p.165.

The foundational significance of the *evidence-based* definitions of arithmetical truth, introduced in [An12], lies in the fact that the first-order Peano Arithmetic PA—which, by [An16], Theorem 6.7 (p.41), is *finitarily* consistent (see also §2.C.a., Theorem 2.16)—forms the bedrock on which all formal mathematical languages that admit rational and real numbers are founded (see, for instance, Edmund Landau's classically concise exposition [La29] on the foundations of analysis; see also §23.C.c.).

Axioms and rules of inference of the first-order Peano Arithmetic PA

PA₁ $[(x_1 = x_2) \rightarrow ((x_1 = x_3) \rightarrow (x_2 = x_3))];$

PA₂ $[(x_1 = x_2) \rightarrow (x'_1 = x'_2)];$

PA₃ $[0 \neq x'_1];$

PA₄ $[(x'_1 = x'_2) \rightarrow (x_1 = x_2)];$

PA₅ $[(x_1 + 0) = x_1];$

PA₆ $[(x_1 + x'_2) = (x_1 + x_2)'];$

PA₇ $[(x_1 \star 0) = 0];$

PA₈ $[(x_1 \star x'_2) = ((x_1 \star x_2) + x_1)];$

PA₉ For any well-formed formula $[F(x)]$ of PA:
 $[F(0) \rightarrow ((\forall x)(F(x) \rightarrow F(x'))) \rightarrow (\forall x)F(x)].$

Generalisation in PA If $[A]$ is PA-provable, then so is $[(\forall x)A]$.

Modus Ponens in PA If $[A]$ and $[A \rightarrow B]$ are PA-provable, then so is $[B]$.

¹⁰⁶For a brief review of such challenges, see *Feferman*: [Fe06] and [Fe08]; also [An04] and [Fre18].

Hence the reliability of any conceptual metaphors of our observations of physical phenomena which appeal—in their mathematical representations—to mathematical definitions of real numbers (in the sense of [LR00]; see also §27.) must be circumscribed by whether, or not, PA can be interpreted *categorically*, in some practicable sense (see [An16], Corollary 7.2 (p.41); also §2.E.b., Corollary 2.18) over the domain \mathbb{N} of the natural numbers.

Now conventional wisdom, whilst accepting Alfred Tarski’s classical definitions of the satisfiability and truth of the formulas of a formal language, under a *well-defined* interpretation, as adequate to the intended purpose, *postulates* that under the classical putative standard interpretation $\mathcal{I}_{PA(\mathbb{N}, S)}$ of the first-order Peano Arithmetic PA over the domain \mathbb{N} of the natural numbers:

- (i) The satisfiability/truth of the atomic formulas of PA can be assumed as *uniquely* decidable under $\mathcal{I}_{PA(\mathbb{N}, S)}$;
- (ii) The PA axioms can be assumed to *uniquely* interpret as satisfied/true under $\mathcal{I}_{PA(\mathbb{N}, S)}$;
- (iii) The PA rules of inference—Generalisation and Modus Ponens—can be assumed to *uniquely* preserve such satisfaction/truth under $\mathcal{I}_{PA(\mathbb{N}, S)}$;
- (iv) Aristotle’s particularisation can be assumed to hold under $\mathcal{I}_{PA(\mathbb{N}, S)}$.

Comment 29. In [An16], Aristotle’s particularisation (see also §7., Definition 20) is treated as the implicit, *non-finitary*, assumption that the classical first-order logic FOL¹⁰⁷ is ω -consistent; and so we may always interpret the formal expression ‘ $(\exists x)F(x)$ ’¹⁰⁸ of a formal language under any *well-defined* interpretation of FOL as ‘There exists an object s in the domain of the interpretation such that $F^*(s)$ ’, where the formula $[F(x)]$ of the formal language interprets as $F^*(x)$.

ω -consistent. A formal system S is ω -consistent if, and only if, there is no S-formula $[F(x)]$ for which, first, $[\neg(\forall x)F(x)]$ is S-provable and, second, $[F(a)]$ is S-provable for any *specified* S-term $[a]$.

However, we shall see that the seemingly innocent and self-evident assumptions of *uniqueness* in (i) to (iii) conceals an ambiguity with far-reaching consequences; as, equally if not more so, does the seemingly innocent assumption in (iv) which, despite being obviously *non-finitary*, is unquestioningly (see §7.B.) accepted in classical literature as equally self-evident under any logically unexceptionable interpretation of the classical first-order logic FOL.

The ambiguity is revealed if we note that Tarski’s classic definitions (see [An16], §3, p.37; also §2.A. and §2.A.a.) permit both human and mechanistic intelligences to admit finitary, i.e., *evidence-based*, definitions of the satisfaction and truth of the *atomic* formulas of PA over the domain \mathbb{N} of the natural numbers in *two*, hitherto unsuspected and essentially different, ways:

- (1a) In terms of *classical* algorithmic *verifiability* (see §2., Definition 7); and

¹⁰⁷For purposes of this investigation we take FOL to be a first-order predicate calculus such as the formal system K defined in [Me64], p.57.

¹⁰⁸We note that, in a formal language, the formula ‘ $(\exists x)F(x)$ ’ is merely an abbreviation of the formula ‘ $[\neg(\forall x)\neg F(x)]$ ’. Moreover, that we shall use square brackets to differentiate between a symbolic expression—such as $[F(x)]$ —which denotes a formula of a formal language L (treated syntactically as a string of symbols without any associated meaning), and the symbolic expression—such as $F^*(x)$ —which denotes its meaning under a *well-defined* (in the sense of §7.F., Definition 26) interpretation; we find such differentiation useful in order to avoid the possibility of conflation between the two, particularly when (as is not uncommon) the same symbolic expressions are used to denote—or are common to—the two.

Comment 30. ‘Classical’ since, as we shall argue in §2.A.b., the classical, *standard* (intuitively-defined) interpretation $\mathcal{I}_{PA(\mathbb{N}, S)}$ of PA (see [Me64], p.107) can be viewed as implicitly appealing to the algorithmic *verifiability* of PA-formulas under the (*well-defined*) interpretation $\mathcal{I}_{PA(\mathbb{N}, SV)}$ (as detailed in [An16], §5, p.38; see also §2.B.).

(1b) In terms of *finitary* algorithmic *computability* (see §2., Definition 10);

where we introduce the following *evidence-based* (finitary) definitions:

Definition 7. (Algorithmic verifiability) A number-theoretical relation $F(x)$ is algorithmically verifiable if, and only if, for any specifiable natural number n , there is a deterministic algorithm $AL_{(F, n)}$ which can provide objective evidence for deciding the truth/falsity of each proposition in the finite sequence $\{F(1), F(2), \dots, F(n)\}$.

Definition 8. (Integer specifiability) An unspecified natural number n in \mathbb{N} is specifiable if, and only if, it can be explicitly denoted as a PA-numeral by a PA-formula that interprets as an algorithmically computable constant (natural number) in \mathbb{N} .

Comment 31. The significance of Definition 8 is highlighted in §10.C.a., Theorem 10.3.

Definition 9. (Deterministic algorithm) A deterministic algorithm is a well-defined mechanical method, such as a Turing machine, that computes a mathematical function which has a unique value for any input in its domain, and the algorithm is a process that produces this particular value as output.

Comment 32. By ‘deterministic algorithm’ we mean a ‘realizer’ in the sense of the Brouwer-Heyting-Kolmogorov rules (see Stephen Cole Kleene’s [Kl52], p.503-505).

Definition 10. (Algorithmic computability) A number theoretical relation $F(x)$ is algorithmically computable if, and only if, there is a deterministic algorithm AL_F that can provide objective evidence for deciding the truth/falsity of each proposition in the denumerable sequence $\{F(1), F(2), \dots\}$.

Comment 33. In §7.G., Theorem 7.2 (corresponding to [An16], Theorem 2.1, p.37), we shall show that there are *well-defined* number theoretic Boolean functions that are algorithmically *verifiable* but not algorithmically *computable*; and consider some consequences for the classical Church-Turing Thesis in §7.H.b.

Comment 34. (*Analogous distinctions in analysis*) The distinction between *algorithmically computable*, and *algorithmically verifiable* but not *algorithmically computable*, number-theoretic functions seeks to reflect in arithmetic the essence of *uniform* methods, classically characterised by the distinctions in analysis between:

- (a) uniformly continuous, and point-wise continuous but not uniformly continuous, functions over an interval ([Ru53], Theorem 4.15, p.69; [Ah153], Theorem 10, p.64);
- (b) uniformly convergent, and point-wise convergent but not uniformly convergent, series ([Ru53], p.137, Ex.5; [Ah153], §1.3, *Uniform Convergence*, p.135).

Comment 35. (*A limitation of set theory and a possible barrier to computation*) We note, further, that the above distinction cannot be reflected within a language—such as the first-order set theory ZF—which identifies ‘equality’ with ‘equivalence’ under any *well-defined* interpretation. Since functions are defined extensionally as mappings, such a language cannot recognise that a set which represents a primitive recursive function may be equivalent to, but computationally different from, a set that represents an arithmetical function; *if* the former function is (by definition) *algorithmically computable* over \mathbb{N} , whilst the latter is *algorithmically verifiable* but not *algorithmically computable* over \mathbb{N} .

2.A. Reviewing Tarski’s inductive assignment of truth-values under an interpretation

The paper [An16] essentially follows standard expositions (such as [Me64]; see §29.) of Tarski’s inductive definitions on the ‘satisfiability’ and ‘truth’ of the formulas of a formal language under an interpretation where:

Definition 11. *If $[A]$ is an atomic formula $[A(x_1, x_2, \dots, x_n)]$ of a formal language S , then the denumerable sequence (a_1, a_2, \dots) in the domain \mathbb{D} of an interpretation $\mathcal{I}_{S(\mathbb{D})}$ of S satisfies $[A]$ if, and only if:*

- (i) $[A(x_1, x_2, \dots, x_n)]$ interprets under $\mathcal{I}_{S(\mathbb{D})}$ as a unique relation $A^*(x_1, x_2, \dots, x_n)$ in \mathbb{D} for any witness $\mathcal{W}_{\mathbb{D}}$ of \mathbb{D} ;
- (ii) there is a Satisfaction Method that provides objective evidence¹⁰⁹ by which any witness $\mathcal{W}_{\mathbb{D}}$ of \mathbb{D} can objectively **define** for any atomic formula $[A(x_1, x_2, \dots, x_n)]$ of S , and any given denumerable sequence (b_1, b_2, \dots) of \mathbb{D} , whether the proposition $A^*(b_1, b_2, \dots, b_n)$ holds or not in \mathbb{D} ;
- (iii) $A^*(a_1, a_2, \dots, a_n)$ holds in \mathbb{D} for any $\mathcal{W}_{\mathbb{D}}$.

Witness: From an *evidence-based* perspective, the existence of a ‘witness’ as in (i) above is implicit in the usual expositions of Tarski’s definitions.

Satisfaction Method: From an *evidence-based* perspective, the existence of a Satisfaction Method as in (ii) above is also implicit in the usual expositions of Tarski’s definitions.

An *evidence-based* perspective: We highlight the word ‘*define*’ in (ii) above to emphasise the *evidence-based* perspective underlying this paper; which is that the concepts of ‘satisfaction’ and ‘truth’ under an interpretation are to be explicitly viewed as objective assignments by a convention that is witness-independent. A Platonist perspective would substitute ‘decide’ for ‘define’, thus implicitly suggesting that these concepts can ‘exist’, in the sense of needing to be discovered by some witness-dependent means—eerily akin to a ‘revelation’—if the domain \mathbb{D} is \mathbb{N} .

2.A.a. Tarski’s inductive definitions

Moreover, the truth values of ‘satisfaction’, ‘truth’, and ‘falsity’ are assignable inductively—whether *finitarily* or *non-finitarily*—to the compound formulas of a first-order theory S under the interpretation $\mathcal{I}_{S(\mathbb{D})}$ in terms of *only* the satisfiability of the atomic formulas of S over \mathbb{D} as usual¹¹⁰:

Definition 12. *A denumerable sequence s of \mathbb{D} satisfies $[\neg A]$ under $\mathcal{I}_{S(\mathbb{D})}$ if, and only if, s does not satisfy $[A]$;*

Definition 13. *A denumerable sequence s of \mathbb{D} satisfies $[A \rightarrow B]$ under $\mathcal{I}_{S(\mathbb{D})}$ if, and only if, either it is not the case that s satisfies $[A]$, or s satisfies $[B]$;*

Definition 14. *A denumerable sequence s of \mathbb{D} satisfies $[(\forall x_i)A]$ under $\mathcal{I}_{S(\mathbb{D})}$ if, and only if, given any denumerable sequence t of \mathbb{D} which differs from s in at most the i ’th component, t satisfies $[A]$;*

Definition 15. *A well-formed formula $[A]$ of \mathbb{D} is true under $\mathcal{I}_{S(\mathbb{D})}$ if, and only if, given any denumerable sequence t of \mathbb{D} , t satisfies $[A]$;*

¹⁰⁹In the sense of [Mu91] and [Lob59] (see §2.).

¹¹⁰See [Me64], p.51; [Mu91].

Definition 16. A well-formed formula $[A]$ of \mathbb{D} is false under $\mathcal{I}_{S(\mathbb{D})}$ if, and only if, it is not the case that $[A]$ is true under $\mathcal{I}_{S(\mathbb{D})}$.

The implicit assumption of Aristotle’s particularisation in current mathematical paradigms is evidenced in (V)(ii) of Mendelson’s assertion—following his formulation of Tarski’s definitions (essentially as above)—that:

“Verification of the following consequences of the definitions above is left to the reader. (Most of the results are also obvious if one wishes to use only the ordinary intuitive understanding of the notions of truth and satisfaction). . . .

(V) (i) A sequence s satisfies $\mathcal{A} \wedge \mathcal{B}$ if and only if s satisfies \mathcal{A} and s satisfies \mathcal{B} . A sequence s satisfies $\mathcal{A} \vee \mathcal{B}$ if and only if s satisfies \mathcal{A} or s satisfies \mathcal{B} . A sequence s satisfies $\mathcal{A} \equiv \mathcal{B}$ if and only if s satisfies both \mathcal{A} and \mathcal{B} or s satisfies neither \mathcal{A} nor \mathcal{B} .

(ii) A sequence s satisfies $(Ex_i)\mathcal{A}$ if and only if there is a sequence s' which differs from s in at most the i^{th} place such that s' satisfies \mathcal{A} ."

... Mendelson: [Me64], pp.51-52.

2.A.b. The ambiguity in the classical *standard* interpretation of PA over \mathbb{N}

Now, the classical *standard* interpretation $\mathcal{I}_{PA(\mathbb{N}, S)}$ of PA over the domain \mathbb{N} of the natural numbers (as detailed in [Me64], p.107) is obtained if, in $\mathcal{I}_{S(\mathbb{D})}$:

- (a) we define S as PA with the standard first-order predicate calculus FOL as the underlying logic¹¹¹;
- (b) we define \mathbb{D} as the set \mathbb{N} of natural numbers;
- (c) we assume for any *atomic* formula $[A(x_1, x_2, \dots, x_n)]$ of PA, and any given sequence $(b_1^*, b_2^*, \dots, b_n^*)$ of \mathbb{N} , that the proposition $A^*(b_1^*, b_2^*, \dots, b_n^*)$ is decidable in \mathbb{N} ;
- (d) we define the witness $\mathcal{W}_{(\mathbb{N}, S)}$ *informally* as the ‘mathematical intuition’ of a human intelligence for whom, classically, (c) has been *implicitly* accepted as ‘*objectively decidable*’ in \mathbb{N} .
- (e) we postulate that Aristotle’s particularisation¹¹² holds over \mathbb{N} .

Comment 36. Clearly, (e) (which, in [Me64], is implicitly entailed by [Me64], para (V)(ii), p.52) does not form any part of Tarski’s inductive definitions of the satisfaction, and truth, of the formulas of PA under the above interpretation. Moreover, its inclusion makes $\mathcal{I}_{PA(\mathbb{N}, S)}$ extraneously non-finitary¹¹³ (see also §7.B.).

We shall show that the implicit acceptance in (d) conceals an ambiguity that needs to be made explicit since:

Lemma 2.1. Under the interpretation $\mathcal{I}_{PA(\mathbb{N}, S)}$, an atomic formula $A^*(x_1, x_2, \dots, x_n)$ is both algorithmically verifiable and algorithmically computable in \mathbb{N} by $\mathcal{W}_{(\mathbb{N}, S)}$.

Proof. (i) It follows from the argument in §2.B., Theorem 2.3, that $A^*(x_1, x_2, \dots, x_n)$ is algorithmically verifiable in \mathbb{N} by $\mathcal{W}_{(\mathbb{N}, S)}$.

(ii) It follows from the argument in §2.C., Theorem 2.9, that $A^*(x_1, x_2, \dots, x_n)$ is algorithmically computable in \mathbb{N} by $\mathcal{W}_{(\mathbb{N}, S)}$. The lemma follows. \square

¹¹¹Where the string $[(\exists \dots)]$ is defined as—and is to be treated as an abbreviation for—the PA formula $[\neg(\forall \dots)\neg]$. We do not consider the case where the underlying logic is Hilbert’s formalisation of Aristotle’s logic of predicates in terms of his ε -operator ([Hi27], pp.465-466).

¹¹²See §7., Definition 20; which postulates that a PA formula such as $[(\exists x)F(x)]$ can always be taken to interpret under $\mathcal{I}_{PA(\mathbb{N}, S)}$ as ‘There is some natural number n such that $F(n)$ holds in \mathbb{N} ’.

¹¹³As argued by Brouwer in [Br08].

2.B. The *weak*, algorithmically *verifiable*, standard interpretation $\mathcal{I}_{PA(\mathbb{N}, SV)}$ of PA

We note that conventional wisdom considers the *weak*, algorithmically *verifiable*, interpretation $\mathcal{I}_{PA(\mathbb{N}, SV)}$ of PA, detailed in [An16], §5, p.38, as *the* classical *standard* interpretation $\mathcal{I}_{PA(\mathbb{N}, S)}$ of PA (see [Me64], p.107), since it implicitly defines:

Definition 17. *An atomic formula $[A]$ of PA is satisfiable under the interpretation $\mathcal{I}_{PA(\mathbb{N}, SV)}$ if, and only if, $[A]$ is algorithmically verifiable under $\mathcal{I}_{PA(\mathbb{N}, SV)}$.*

We note that:

Theorem 2.2. *The atomic formulas of PA are algorithmically verifiable as true or false under the algorithmically verifiable interpretation $\mathcal{I}_{PA(\mathbb{N}, SV)}$.*

Proof. It follows by Gödel's definition of the primitive recursive relation xBy ¹¹⁴—where x is the Gödel number of a proof sequence in PA whose last term is the PA formula with Gödel-number y —that, if $[A]$ is an atomic formula of PA, we can algorithmically verify which one of the PA formulas $[A]$ and $[\neg A]$ is necessarily PA-provable and, ipso facto, true under $\mathcal{I}_{PA(\mathbb{N}, SV)}$. \square

Comment 37. We note that the interpretation $\mathcal{I}_{PA(\mathbb{N}, SV)}$ cannot claim to be finitary¹¹⁵, since it follows from §7.G., Theorem 7.2, that we cannot conclude finitarily from Tarski's Definition 11 (in §2.A.), and Definitions 12 to 16 (in §2.A.a.), whether or not a quantified PA formula $[(\forall x_i)R]$ is algorithmically verifiable as true under $\mathcal{I}_{PA(\mathbb{N}, SV)}$, if $[R]$ is algorithmically verifiable but not algorithmically computable under $\mathcal{I}_{PA(\mathbb{N}, SV)}$ ¹¹⁶.

2.B.a. The PA axioms are algorithmically *verifiable* as true under $\mathcal{I}_{PA(\mathbb{N}, SV)}$

The significance of defining satisfaction in terms of algorithmic *verifiability* under $\mathcal{I}_{PA(\mathbb{N}, SV)}$ is that:

Lemma 2.3. *The PA axioms PA_1 to PA_8 are algorithmically verifiable as true over \mathbb{N} under the interpretation $\mathcal{I}_{PA(\mathbb{N}, SV)}$.*

Proof. Since $[x + y]$, $[x \star y]$, $[x = y]$, $[x']$ are defined recursively¹¹⁷, the PA axioms PA_1 to PA_8 (see §2.) interpret as recursive relations that do not involve any quantification. The lemma follows from §2.B., Theorem 2.2, Tarski's Definition 11 (in §2.A.), and Tarski's Definitions 12 to 16 (in §2.A.a.). \square

Lemma 2.4. *For any given PA formula $[F(x)]$, the Induction axiom schema $[F(0) \rightarrow ((\forall x)(F(x) \rightarrow F(x')))) \rightarrow (\forall x)F(x)]$ interprets as an algorithmically verifiable true formula under $\mathcal{I}_{PA(\mathbb{N}, SV)}$.*

Proof. We note that, by Tarski's Definition 11 (in §2.A.), and Definitions 12 to 16 (in §2.A.a.):

- (a) If $[F(0)]$ interprets as an algorithmically *verifiable* false formula under $\mathcal{I}_{PA(\mathbb{N}, SV)}$, the lemma is proved.

¹¹⁴[Go31], p. 22(45).

¹¹⁵Since it defines a model of PA if, and only if, PA is ω -consistent and so we may always non-finitarily conclude from $[(\exists x)R(x)]$ the existence of some numeral $[n]$ such that $[R(n)]$.

¹¹⁶Although a proof that such a PA formula exists is not obvious, by [An16], Corollary 8.3, p.42 (see also §2.F., Corollary 2.21), Gödel's 'undecidable' arithmetical formula $[R(x)]$ is algorithmically *verifiable*, but not algorithmically *computable*, under the interpretation $\mathcal{I}_{PA(\mathbb{N}, SV)}$.

¹¹⁷cf. [Go31], p.17.

Reason: Since $[F(0) \rightarrow ((\forall x)(F(x) \rightarrow F(x')))) \rightarrow (\forall x)F(x)]$ interprets as an algorithmically *verifiable* true formula under $\mathcal{I}_{PA(\mathbb{N}, SV)}$ if, and only if, either $[F(0)]$ interprets as an algorithmically *verifiable* false formula, or $[((\forall x)(F(x) \rightarrow F(x')))) \rightarrow (\forall x)F(x)]$ interprets as an algorithmically *verifiable* true formula, under $\mathcal{I}_{PA(\mathbb{N}, SV)}$.

- (b) If $[F(0)]$ interprets as an algorithmically *verifiable* true formula, and $[((\forall x)(F(x) \rightarrow F(x')))]$ interprets as an algorithmically *verifiable* false formula, under $\mathcal{I}_{PA(\mathbb{N}, SV)}$, the lemma is proved.
- (c) If $[F(0)]$ and $[((\forall x)(F(x) \rightarrow F(x')))]$ both interpret as algorithmically *verifiable* true formulas under $\mathcal{I}_{PA(\mathbb{N}, SV)}$ then, for any *specified* natural number n , there is an algorithm which (by Definition 7) will evidence that $[F(n) \rightarrow F(n')]$ is an algorithmically *verifiable* true formula under $\mathcal{I}_{PA(\mathbb{N}, SV)}$.
- (d) Since $[F(0)]$ interprets as an algorithmically *verifiable* true formula under $\mathcal{I}_{PA(\mathbb{N}, SV)}$, it follows, for any *specified* natural number n , that there is an algorithm which will evidence that each of the formulas in the finite sequence $\{[F(0), F(1), \dots, F(n)]\}$ is an algorithmically *verifiable* true formula under the interpretation.
- (e) Hence $[(\forall x)F(x)]$ is an algorithmically *verifiable* true formula under $\mathcal{I}_{PA(\mathbb{N}, SV)}$.

Since the above cases are exhaustive, the lemma follows. □

Comment 38. We note that if $[F(0)]$ and $[(\forall x)(F(x) \rightarrow F(x'))]$ both interpret as algorithmically *verifiable* true formulas under $\mathcal{I}_{PA(\mathbb{N}, SV)}$, then we can only conclude that, for any *specified* natural number n , there is an algorithm, say $\text{TM}_{(F,n)}$, which will give evidence for any $m \leq n$ that the formula $[F(m)]$ is true under $\mathcal{I}_{PA(\mathbb{N}, S)}$.

We cannot conclude that there is an algorithm TM_F which, for any *specified* natural number n , will give evidence that the formula $[F(n)]$ is true under $\mathcal{I}_{PA(\mathbb{N}, S)}$.

Lemma 2.5. *Generalisation preserves algorithmically verifiable truth under $\mathcal{I}_{PA(\mathbb{N}, SV)}$.*

Proof. The two meta-assertions:

‘ $[F(x)]$ interprets as an algorithmically *verifiable* true formula under $\mathcal{I}_{PA(\mathbb{N}, SV)}$ ’¹¹⁸,

and

‘ $[(\forall x)F(x)]$ interprets as an algorithmically *verifiable* true formula under $\mathcal{I}_{PA(\mathbb{N}, SV)}$ ’

both mean:

$[F(x)]$ is algorithmically *verifiable* as always true under $\mathcal{I}_{PA(\mathbb{N}, SV)}$. □

It is also straightforward to see that:

Lemma 2.6. *Modus Ponens preserves algorithmically verifiable truth under $\mathcal{I}_{PA(\mathbb{N}, SV)}$.* □

We thus have that:

Theorem 2.7. *The axioms of PA are always algorithmically verifiable as true under the interpretation $\mathcal{I}_{PA(\mathbb{N}, SV)}$, and the rules of inference of PA preserve the properties of algorithmically verifiable satisfaction/truth under $\mathcal{I}_{PA(\mathbb{N}, SV)}$.* □

By §2.B., Theorem 2.2 we further conclude that PA is *weakly* consistent:

¹¹⁸See Definition 15 (in §2.A.a.)

Theorem 2.8. *If the PA formulas are algorithmically verifiable as true or false under $\mathcal{I}_{PA(\mathbb{N}, SV)}$, then PA is consistent.* \square

Comment 39. We note that, unlike Gentzen’s argument¹¹⁹, which appeals to debatably ‘constructive’ properties of set-theoretically defined transfinite ordinals, such a—strictly arithmetical—*weak* proof of consistency is unarguably ‘constructive’; however it is not ‘finitary’ since we cannot conclude from §2.B., Theorem 2.2 that the quantified formulas of PA are ‘finitarily’ decidable as true or false under the interpretation $\mathcal{I}_{PA(\mathbb{N}, SV)}$.

2.C. The *strong, algorithmically computable, interpretation* $\mathcal{I}_{PA(\mathbb{N}, SC)}$ of PA

The paper [An16] considers next a *strong, algorithmically computable, interpretation* $\mathcal{I}_{PA(\mathbb{N}, SC)}$ of PA, under which we define:

Definition 18. *An atomic formula $[A]$ of PA is satisfiable under the interpretation $\mathcal{I}_{PA(\mathbb{N}, SC)}$ if, and only if, $[A]$ is algorithmically computable under $\mathcal{I}_{PA(\mathbb{N}, SC)}$.*

We note that:

Theorem 2.9. *The atomic formulas of PA are algorithmically computable as true or as false under the algorithmically computable interpretation $\mathcal{I}_{PA(\mathbb{N}, SC)}$.*

Proof. If $[A(x_1, x_2, \dots, x_n)]$ is an *atomic* formula of PA then, for any given sequence of numerals $[b_1, b_2, \dots, b_n]$, the PA formula $[A(b_1, b_2, \dots, b_n)]$ is an *atomic* formula of the form $[c = d]$, where $[c]$ and $[d]$ are *atomic* PA formulas that denote PA numerals. Since $[c]$ and $[d]$ are recursively defined formulas in the language of PA, it follows from a standard result¹²⁰ that, by §2., Definition 10, $[c = d]$ is algorithmically *computable* as either true or false in \mathbb{N} since there is an algorithm that, for any given sequence of numerals $[b_1, b_2, \dots, b_n]$, will give *evidence* (in the sense of [Mu91] and [Lob59]) whether $[A(b_1, b_2, \dots, b_n)]$ interprets as true or false in \mathbb{N} . The lemma follows. \square

We note that the interpretation $\mathcal{I}_{PA(\mathbb{N}, SC)}$ is finitary since:

Lemma 2.10. *The formulas of PA are algorithmically computable finitarily as true or as false under $\mathcal{I}_{PA(\mathbb{N}, SC)}$.*

Proof. The Lemma follows by finite induction from by §2., Definition 10, Tarski’s Definition 11 (in §2.A.), and Definitions 12 to 16 (in §2.A.a.), and Theorem 2.9. \square

2.C.a. The PA axioms are algorithmically *computable* as true under $\mathcal{I}_{PA(\mathbb{N}, SC)}$

The significance of defining satisfaction in terms of algorithmic *computability* under $\mathcal{I}_{PA(\mathbb{N}, SC)}$ as above is that:

Lemma 2.11. *The PA axioms PA_1 to PA_8 are algorithmically computable as true under the interpretation $\mathcal{I}_{PA(\mathbb{N}, SC)}$.*

¹¹⁹See [Me64], pp.258-271.

¹²⁰For any natural numbers m, n , if $m \neq n$, then PA proves $[\neg(m = n)]$ ([Me64], p.110, Proposition 3.6). The converse is obviously true.

Proof. Since $[x + y]$, $[x \star y]$, $[x = y]$, $[x']$ are defined recursively¹²¹, the PA axioms PA_1 to PA_8 (see §2.) interpret as recursive relations that do not involve any quantification. The lemma follows from §2.B., Theorem 2.2 and Tarski's Definition 11 (in §2.A.), and Definitions 12 to 16 (in §2.A.a). \square

Lemma 2.12. *For any given PA formula $[F(x)]$, the Induction axiom schema $[F(0) \rightarrow ((\forall x)(F(x) \rightarrow F(x')) \rightarrow (\forall x)F(x))]$ interprets as an algorithmically computable true formula under $\mathcal{I}_{PA(\mathbb{N}, SC)}$.*

Proof. By Tarski's Definition 11 (in §2.A.), and Definitions 12 to 16 (in §2.A.a.):

- (a) If $[F(0)]$ interprets as an algorithmically *computable* false formula under $\mathcal{I}_{PA(\mathbb{N}, SC)}$ the lemma is proved.

Reason: Since $[F(0) \rightarrow ((\forall x)(F(x) \rightarrow F(x')) \rightarrow (\forall x)F(x))]$ interprets as an algorithmically *computable* true formula if, and only if, either $[F(0)]$ interprets as an algorithmically *computable* false formula, or $[((\forall x)(F(x) \rightarrow F(x')) \rightarrow (\forall x)F(x))]$ interprets as an algorithmically *computable* true formula, under $\mathcal{I}_{PA(\mathbb{N}, SC)}$.

- (b) If $[F(0)]$ interprets as an algorithmically *computable* true formula, and $[((\forall x)(F(x) \rightarrow F(x')))]$ interprets as an algorithmically *computable* false formula, under $\mathcal{I}_{PA(\mathbb{N}, SC)}$, the lemma is proved.
- (c) If $[F(0)]$ and $[((\forall x)(F(x) \rightarrow F(x')))]$ both interpret as algorithmically *computable* true formulas under $\mathcal{I}_{PA(\mathbb{N}, SC)}$, then by Definition 10 there is an algorithm which, for any natural number n , will give *evidence* (in the sense of [Mu91] and [Lob59]) that the formula $[F(n) \rightarrow F(n')]$ is an algorithmically *computable* true formula under $\mathcal{I}_{PA(\mathbb{N}, SC)}$.
- (d) Since $[F(0)]$ interprets as an algorithmically *computable* true formula under $\mathcal{I}_{PA(\mathbb{N}, SC)}$, it follows that there is an algorithm which, for any natural number n , will give *evidence* that $[F(n)]$ is an algorithmically *computable* true formula under the interpretation.
- (e) Hence $[((\forall x)F(x))]$ is an algorithmically *computable* true formula under $\mathcal{I}_{PA(\mathbb{N}, SC)}$.

Since the above cases are exhaustive, the lemma follows. \square

Lemma 2.13. *Generalisation preserves algorithmically computable truth under $\mathcal{I}_{PA(\mathbb{N}, SC)}$.*

Proof. The two meta-assertions:

' $[F(x)]$ interprets as an algorithmically computable true formula under $\mathcal{I}_{PA(\mathbb{N}, SC)}$ '¹²²,

and

' $[((\forall x)F(x))]$ interprets as an algorithmically computable true formula under $\mathcal{I}_{PA(\mathbb{N}, SC)}$ '

both mean:

$[F(x)]$ is algorithmically computable as always true under $\mathcal{I}_{PA(\mathbb{N}, S)}$. \square

It is also straightforward to see that:

Lemma 2.14. *Modus Ponens preserves algorithmically computable truth under $\mathcal{I}_{PA(\mathbb{N}, SC)}$.* \square

We thus have that¹²³:

¹²¹cf. [Go31], p.17.

¹²²See §2.A.a, Definition 15

¹²³Without appeal, moreover, to Aristotle's particularisation.

Theorem 2.15. *The axioms of PA are always algorithmically computable as true under the interpretation $\mathcal{I}_{PA(\mathbb{N}, SC)}$, and the rules of inference of PA preserve the properties of algorithmically computable satisfaction/truth under $\mathcal{I}_{PA(\mathbb{N}, SC)}$.* \square

We thus have a *finitary* proof that:

Theorem 2.16. *PA is strongly consistent.* \square

2.D. Dissolving the Poincaré-Hilbert debate

The significance of *evidence-based* reasoning is also highlighted in the case of the Poincaré-Hilbert debate¹²⁴ on whether the PA Axiom Schema of Induction can be labelled ‘finitary’ or not.

It turns out that the debate dissolves since the Axiom Schema is:

- (a) Algorithmically *verifiable* as true under the *weak* standard interpretation of PA by §2.B.a., Lemma 2.4;
- (b) Algorithmically *computable* as true under a *strong* finitary interpretation of PA by §2.C., Lemma 2.12.

In other words:

- (i) The algorithmically *verifiable*, non-finitary, interpretation $\mathcal{I}_{PA(\mathbb{N}, SV)}$ of PA validates Poincaré’s argument that the PA Axiom Schema of Finite Induction could not be justified finitarily with respect to algorithmic *verifiability* under the classical *standard* interpretation of arithmetic¹²⁵, as any such argument would necessarily need to appeal to some form of infinite induction¹²⁶; whilst
- (ii) The algorithmically *computable* finitary interpretation $\mathcal{I}_{PA(\mathbb{N}, SC)}$ of PA validates Hilbert’s belief that a finitary justification of the Axiom Schema was possible under some finitary interpretation of an arithmetic such as PA.

Comment 40. The further significance of showing that:

- (a) PA is *constructively* consistent with respect to algorithmically *verifiable* ‘truth’ (§2.B.a., Theorem 2.7); and
- (b) PA is *finitarily* consistent with respect to algorithmically *computable* ‘truth’ (§2.C.a., Theorem 2.15);

is reflected in, for instance, the 2008 paper [Kma08] by philosopher Vojtěch Kolman *if*:

- (i) Theorem 2.7 is taken to correspond to what Kolman refers to as a proof of consistency of ‘arithmetical semi-formalism’; and
- (ii) Theorem 2.15 is taken to correspond to what Kolman refers to as a proof of consistency of ‘arithmetical formalism’.

¹²⁴See [Hi27], p.472; also [Br13], p.59; [We27], p.482; [Pa71], p.502-503.

¹²⁵See [Me64], p.107.

¹²⁶Such as, for instance, in Gerhard Gentzen’s *non-finitary* proof of consistency for PA, which involves a *non-finitary* Rule of Infinite Induction (see [Me64], p.259(II)(e).) that appeals to the well-ordering property of transfinite ordinals.

Reason: The distinction can then be viewed as illuminating Kolman's argument that if 'one leaves ... the concept of effective procedure or proof to a large extent open and does not tie it ... to the concept of the Turing machine', then a 'constructivist reading does not necessarily wipe out the differences between the proof and truth'; and that 'full-formal systems such as Peano and Robinson arithmetic are consistent simply because their axioms are provable in the arithmetical semi-formalism', which does 'not evaluate arithmetical sentences incorrectly':

"Now, if one leaves, like, e.g., Lorenzen and Bishop, the concept of effective procedure or proof to a large extent open and does not tie it, like, e.g., Goodstein and Markov, to the concept of the Turing machine,²⁰ there is still room for an effective, yet liberal enough *semantics* (semi-formal system) and a strongly effective or 'mechanical' syntax or *axiomatics* (full-formal system). Hence, the constructivist reading does not necessarily wipe out the differences between the proof and truth, as, e.g., Brouwer's mentalism or Wittgenstein's verificationism seem to. As a result, one can officially differentiate not only between full-formal \vdash and semi-formal \models consequence, but also between semi-formal consequence in a stricter (constructive) sense and in the more liberal (classical) sense. All these differences stem from (Gödel, 1931) for the following reason:

Gödel's theorem affects only the full-formal systems, because their schematic nature makes it possible to devise a general meta-strategy for constructing true arithmetical sentences not provable in them. The unprovable sentence of Gödel is of the so-called Goldbach type, i.e., it is of the form $(\forall x)A(x)$ where $A(x)$ is a decidable property of numbers. Now, Gödel's argument shows that this decision is done already by Peano axioms in the sense that all the instances $A(N)$ are deducible and, hence, set as true. So, with Gödel's proof we have a general strategy for proving all the premises $A(N)$ at once, which makes the critical unprovable sentence $(\forall x)A(x)$ constructively true, i.e. provable by means of the ω -rule interpreted constructively. Lorenzen (1974, p.222) put it like this:²¹

ω -incompleteness [...] demonstrates that not all constructively true propositions are logically deducible from the axioms. This should come as no surprise. A universal proposition $(\forall x)A(x)$ is constructively true when $A(N)$ for all N is true. But in order *logically* to deduce the universal proposition $(\forall x)A(x)$, we must first deduce $A(x)$ with a free variable x . So we should have expected ω -incompleteness. But Peano arithmetic is ω -complete if we restrict ourselves to addition. The point of Gödel's proof was to demonstrate that Peano arithmetic with only addition and multiplication (without the higher forms of inductive definition) already shows the ω -incompleteness that was to be expected in general.

It is of real significance here that it was none other than (Hilbert, 1931) who—probably still unaware of Gödel's result²²—employed the (ω) -rule as a means of improving his old project of founding arithmetic on axiomatic grounds. So, our claim that Gödel's theorems did not destroy but refine Hilbert's optimism in the suggested semi-formal way is sound also from a historical perspective. And using the concept of semi-formalism again, we can extend this optimism yet further by claiming that full-formal systems such as Peano and Robinson arithmetic are consistent simply because their axioms are provable in the arithmetical semi-formalism and, moreover, even in its constructive variant. This, in fact, is the usual model-theoretic argument:

if a theory is inconsistent, then it does not have a model,

in a relative setting:

if Peano arithmetic is inconsistent, then so is the arithmetical semi-formalism.

In the first case the consequent is precluded "by fiat". In the second case one does not need to use such tricks, because it was actually proved that the rules of semi-formalism do not evaluate arithmetical sentences incorrectly."

... Kolman: [Kma08], §3, pp.96-98.

From the *evidence-based* perspective of this investigation, Kolman can be viewed as arguing here against perspectives that ignore Ockham's dictum, and thereby *unnecessarily*¹²⁷ appeal to Church's Thesis for bridging the gap between 'full-formal \vdash and semi-formal \models consequence'.

'*Unnecessarily*' since, implicitly reflecting §2.F., Corollary 2.21, Kolman interprets Hilbert's ω -rule constructively to *implicitly* argue that in 'Gödel's proof we have a general strategy for proving all the premises $A(N)$ at once, which makes the critical unprovable sentence $(\forall x)A(x)$ constructively true'¹²⁸.

It may be pertinent to note further that Kolman's argument is part of his broader thesis in [Kma08], where he:

- seeks 'a closer analysis of the distinction between proof and truth which does not endorse one of them at the expense of the other'¹²⁹;
- by arguing that in 'this paper I would like to present Gödel's theorems not as a direct refutation of Hilbert's axiom but only as an impulse to phrase it with more caution, in such a way that the Continuum Hypothesis is no longer regarded as a *real* problem'¹³⁰:

"In his *Parisian address*,² Hilbert not only phrased the conjecture that all questions which human mind asks must be answerable (the so-called axiom of solvability)³ but supplemented it, as a kind of challenge, with a list of ten and later of twenty-three problems of prime interest, including the *Second Problem* of the consistency (and completeness) of arithmetical axioms.

In Hilbert's later writings, particularly in his *Königsberg address*,⁴ the solvability argument takes a more subtle form. Introducing the finite mode of thought (*finite Einstellung*)⁵ as a new kind of Kantian intuition, Hilbert argues that the harmony between *nature* (experience) and *thought* (theory) must lie exactly in the transcendental fact they are both finite.⁶ As a consequence, the seeming infinity of human knowledge (particularly in the realm of mathematics) must have finite roots which are to be identified with a finite (or finitely describable) system of rules and axioms, and finite deductions from them.⁷ Hence, "we must know, we shall know."⁸ Obviously, this is a *transcendental deduction* of its own kind, namely of inferentialism or broader axiomatism from finitism, starting with the words: in the beginning was a sign.⁹

Gödel (1931), so we are usually told, put an end to Hilbert's optimism by proving that the Second Problem is essentially unsolvable. This verdict is sometimes supported by the seemingly analogous case of Hilbert's *First Problem*, the Continuum Hypothesis, which, partially also due to Gödel, was proved to be undecidable on the basis of

¹²⁷As is also entailed by §7.H.a., Definition 28 (Effective computability); and §7.H.b., Theorem 7.3.

¹²⁸We note that:

- whereas this argument avoids the—not uncommon (see §15.D.)—conflation between Gödel's purportedly 'semantical' proof and his 'syntactical' proof in Theorem VI of [Go31];
- Kolman's earlier assertion ([Kma08], p.93) that the gist of Gödel's 'argument lies in the fact that this unprovable sentence of arithmetic (informally saying "I am unprovable") is unprovable because it is true (it is unprovable), its truth being proven as a part of the argument', does not;

since, as argued in §15.E., such an assertion uncritically accepts—albeit not unreasonably, and in good faith—unjustifiable, and misleading, inherited paradigms as definitive.

¹²⁹A perspective that implicitly reflects the Complementarity Thesis (§1., Thesis 1); see also §14., Conflating Truth and Proof.

¹³⁰A perspective that can be viewed as reflecting in intent §16.B., Theorem 16.3; which entails, seemingly paradoxically, that—although the Continuum Hypothesis is independent of the axioms of ZF *if* ZF is consistent—when interpreted constructively (see §16.) over the domain \mathbb{R} of the real numbers, CH follows from the axioms of PA (which, as 'sought' by Hilbert's *Second Problem*, is finitarily provable as consistent by §2.C.a., Theorem 2.16).

currently accepted axioms. In this paper I would like to present Gödel's theorems not as a direct refutation of Hilbert's axiom but only as an impulse to phrase it with more caution, in such a way that the Continuum Hypothesis is no longer regarded as a *real* problem. I will draw on two rather different sources, both, however, connected to Hilbert's philosophy, namely

- the late metamathematical views of Zermelo and
- Lorenzen's post-Hilbertian program of operative mathematics.

This will lead me to a closer analysis of the distinction between proof and truth which does not endorse one of them at the expense of the other, as Lorenzen, the constructivist, and Zermelo, the Platonist, still tend to do."

... Kolman: [Kma08], pp.91-92 (Introduction).

2.E. Bridging PA Provability and Turing Computability

Moreover, we now show how *evidence-based* reasoning allows us to bridge arithmetic provability and arithmetic computability in the sense expressed by Christian S. Calude, Elena Calude and Solomon Marcus in [CCS01]:

"Classically, there are two equivalent ways to look at the mathematical notion of proof: logical, as a finite sequence of sentences strictly obeying some axioms and inference rules, and computational, as a specific type of computation. Indeed, from a proof given as a sequence of sentences one can easily construct a Turing machine producing that sequence as the result of some finite computation and, conversely, given a machine computing a proof we can just print all sentences produced during the computation and arrange them into a sequence."

... Calude, Calude and Marcus: [CCS01].

where the authors seem to hold that Turing-computability of a 'proof', in the case of a mathematical proposition, ought to be treated as equivalent to the provability of its representation in the corresponding formal language.

2.E.a. Preamble

In a 2003 paper [WG03], Peter Wegner and Dina Goldin argue the thesis that:

"A paradigm shift is necessary in our notion of computational problem solving, so it can provide a complete model for the services of today's computing systems and software agents."

... Wegner and Goldin: [WG03].

We note that Wegner and Goldin's arguments, in support of their above thesis, seem to reflect an extraordinarily eclectic view of mathematics, combining both an implicit acceptance of, and implicit frustration at, the standard interpretations and dogmas of classical mathematical theory:

"... Turing machines are inappropriate as a universal foundation for computational problem solving, and ... computer science is a fundamentally non-mathematical discipline. ...

(Turing's) 1936 paper ... proved that mathematics could not be completely modeled by computers.

...

... the Church-Turing Thesis ... equated logic, lambda calculus, Turing machines, and algorithmic computing as equivalent mechanisms of problem solving.

Turing implied in his 1936 paper that Turing machines ... could not provide a model for all forms of mathematics. ...

... Gödel had shown in 1931 that logic cannot model mathematics ... and Turing showed that neither logic nor algorithms can completely model computing and human thought."

... Wegner and Goldin: [WG03].

These remarks vividly illustrate the dilemma with which not only theoretical computer sciences, but all applied sciences that depend on mathematics for providing a verifiable, *evidence-based*, language to express their observations precisely, are faced:

Query 2. *Are formal classical theories essentially unable to adequately express the extent and range of human cognition, or does the problem lie in the way formal theories are classically interpreted at the moment?*

Comment 41. Of oblique interest here is the issue addressed by Corey J. Maley in [Mly22]; of whether, when formal classical theories seek to adequately express the extent and range of human cognition, ‘representation’ (in some sense) is *essential* to computation:

“Current orthodoxy takes representation to be essential to computation. However, a philosophical account of computation that does not appeal to representation would be useful, given the difficulties involved in successfully theorizing representation. Piccinini’s recent mechanistic account of computation proposes to do just that: it couches computation in terms of what certain mechanisms do without requiring the manipulation or processing of representations whatsoever (Piccinini, 2015). Most crucially, mechanisms must process medium-independent vehicles. There are two ways to understand what “medium-independence” means on this account; however, on either understanding, the account fails. Either too many things end up being counted as computational, or purportedly natural computations (e.g., neural computations) cannot be counted at all. In the end, illustrating this failure sheds some light on the way to revise the orthodoxy in the hope of a better account of computation.”

... Maley: [Mly22], Abstract.

Prima facie, Maley’s observation that ‘Either too many things end up being counted as computational, or purportedly natural computations (e.g., neural computations) cannot be counted at all’ can be viewed as illustrative of:

- (a) the *evidence-based* thesis that¹³¹ ‘mathematics creates far more tools than those that are actually sought and/or employed by the natural sciences at any one time’, and:
- (b) a seeming lack of recognition that¹³² *evidence-based* reasoning:
 - (i) restricts the ability of *highly expressive* mathematical languages, such as the first-order Zermelo-Fraenkel Set Theory ZF, to *categorically* communicate *well-defined* set-theoretical concepts such as ω (see §18.A.a.);

and:

- (ii) restricts the ability of *effectively communicating* mathematical languages, such as the first-order Peano Arithmetic PA, to *well-define* infinite concepts such as ω (see §18.A.a.).

In other words, the Provability Theorem for PA¹³³ could, not unreasonably, be viewed as proffering the ‘semantic account’ sought by Maley in [Mly22] for developing ‘a new account of physical computation that prioritizes physical representations’:

“The mechanistic account of computation fails as a unified philosophical account of computation because of a dilemma having to do with medium-independence at the heart of the account. Either too many things (by Piccinini’s own lights) are characterized as computational, or it cannot count natural systems as computational without some separate, independent attribution of (and justification for) medium-independence already in place. Nevertheless, the mechanistic account of computation

¹³¹See §13.C.a.: *The ‘unreasonable’ effectiveness of mathematics.*

¹³²See §13.E.: *Recognising the strengths and limitations of ZF and PA.*

¹³³§2.E.b. **Theorem 2.17. (Provability Theorem for PA)** *A PA formula $[F(x)]$ is PA-provable if, and only if, $[F(x)]$ is algorithmically computable as always true in \mathbb{N} .*

makes significant progress toward articulating an important and necessary feature of physical computational systems; namely, the presence of the right kind of mechanism. By coupling this part of the mechanistic account with a version of a semantic account, we can develop a new account of physical computation that prioritizes physical representations."

... Maley: [Mly22], Conclusion.

The former addresses the question of whether there are absolute limits on our capacity to express human cognition unambiguously; the latter, whether there are only temporal limits—not necessarily absolute—to the capacity of classical interpretations to communicate unambiguously that which we *initially intended* to capture within our formal expression.

Prima facie, applied science continues, perforce, to interpret mathematical concepts Platonically¹³⁴, whilst waiting for mathematics to provide suitable, and hopefully reliable, answers as to how best it may faithfully express its observations *verifiably*.

This dilemma is also reflected in Lance Fortnow’s on-line rebuttal [Frt03] of Wegner and Goldin’s thesis, and of their reasoning

Thus Fortnow divides his faith between the standard interpretations of classical mathematics (and, possibly, the standard set-theoretical models of formal systems such as standard Peano Arithmetic), and the classical computational theory of Turing machines.

He relies on the former to provide all the proofs that matter:

“Not every mathematical statement has a logical proof, but logic does capture everything we can prove in mathematics, which is really what matters”;

... Fortnow: [Frt03].

and, on the latter to take care of all essential, non-provable, truth:

“... what we can compute is what computer science is all about”.

... Fortnow: [Frt03].

However, as we shall argue in §7.H.a., Fortnow’s faith in a classical Church-Turing Thesis that ensures:

“... Turing machines capture everything we can compute”,

... Fortnow: [Frt03].

may be as misplaced as his faith in the infallibility of standard interpretations of classical mathematics.

In other words, the *evidence-based* perspective introduced in [An12] and [An16] argues cogently for a Kuhnian paradigm shift; not, as Wegner and Goldin believe, in the notion of computational problem solving, but in the standard interpretations of classical mathematical concepts.

Wegner and Goldin could, though, be right in arguing that the direction of such a shift must be towards the incorporation of non-algorithmically computable effective methods into classical mathematical theory; presuming, from the following remarks, that this is, indeed, what ‘external interactions’ are assumed to provide beyond classical Turing-computability:

¹³⁴e.g., Lakoff and Núñez’s debatable (as argued by James J. Madden in [Md01]; see also §27.) argument in [LR00] that—even though not verifiable in the sense of having an *evidence-based* interpretation—set theory is *the* appropriate language for expressing the ‘conceptual metaphors’ by which an individual’s ‘embodied mind brings mathematics into being’.

“... that Turing machine models could completely describe all forms of computation ... contradicted Turing’s assertion that Turing machines could only formalize algorithmic problem solving ... and became a dogmatic principle of the theory of computation. ...

... interaction between the program and the world (environment) that takes place during the computation plays a key role that cannot be replaced by any set of inputs determined prior to the computation. ...

... a theory of concurrency and interaction requires a new conceptual framework, not just a refinement of what we find natural for sequential [algorithmic] computing. ...

... the assumption that all of computation can be algorithmically specified is still widely accepted.”

... *Wegner and Goldin: [WG03].*

A widespread notion of particular interest, which seems to be recurrently implicit in Wegner and Goldin’s assertions too, is that mathematics is a dispensable tool of science, rather than its indispensable mother tongue (as argued in §13. and §13.C.).

However, the roots of such beliefs may also lie in ambiguities, in the classical definitions of foundational elements, that allow the introduction of non-constructive—hence non-verifiable, non-computational, ambiguous, and essentially Platonic—elements into the standard interpretations of classical mathematics.

For instance, in a 1990 philosophical reflection, Elliott Mendelson’s following remarks implicitly imply that classical definitions of various foundational elements can be argued as being either ambiguous, or non-constructive, or both:

“Here is the main conclusion I wish to draw: it is completely unwarranted to say that CT is unprovable just because it states an equivalence between a vague, imprecise notion (effectively computable function) and a precise mathematical notion (partial-recursive function). ... The concepts and assumptions that support the notion of partial-recursive function are, in an essential way, no less vague and imprecise than the notion of effectively computable function; the former are just more familiar and are part of a respectable theory with connections to other parts of logic and mathematics. (The notion of effectively computable function could have been incorporated into an axiomatic presentation of classical mathematics, but the acceptance of CT made this unnecessary.) ... Functions are defined in terms of sets, but the concept of set is no clearer than that of function and a foundation of mathematics can be based on a theory using function as primitive notion instead of set. Tarski’s definition of truth is formulated in set-theoretic terms, but the notion of set is no clearer than that of truth. The model-theoretic definition of logical validity is based ultimately on set theory, the foundations of which are no clearer than our intuitive understanding of logical validity. ... The notion of Turing-computable function is no clearer than, nor more mathematically useful (foundationally speaking) than, the notion of an effectively computable function.”

... *Mendelson: [Me90].*

Consequently, standard interpretations of classical theory may, inadvertently, be weakening a desirable perception of mathematics as the lingua franca of scientific expression by ignoring the possibility that, since mathematics is indisputably accepted as the language that most effectively expresses and communicates semantic truth, the chasm between—at the least—semantic arithmetical truth and syntactic arithmetical provability must, of necessity, be bridgeable explicitly.

Of interest in this context is Martin Davis’ argument that an unprovable truth may, indeed, be arrived at ‘algorithmically’:

“Is Mathematical Insight Algorithmic?”

Roger Penrose replies “no,” and bases much of his case on Gödel’s incompleteness theorem: it is *insight* that enables to *see* that the Gödel sentence, undecidable in a given formal system is actually

true; how could this *insight* possibly be the result of an algorithm? This seemingly persuasive argument is deeply flawed. To see why will require looking at Gödel's theorem at a somewhat more microscopic level than Penrose permits himself. . . .

. . . Gödel's incompleteness theorem (in a strengthened form based on work of J. B. Rosser as well as the solution of Hilbert's tenth problem) may be stated as follows:

There is an algorithm which, given any *consistent* set of axioms, will output a polynomial equation $P = 0$ which in fact has no integer solutions, but such that this fact can not be deduced from the given axioms.

Here then is the true but unprovable Gödel sentence on which Penrose relies and in a simple form at that. Note that the sentence is provided by an *algorithm*. If *insight* is involved, it must be in convincing oneself that the given axioms are indeed consistent, since otherwise we will have no reason to believe that that the Gödel sentence is true."

. . . Davis: [Da95].

Now, what Davis is essentially critiquing here—albeit unknowingly—is Penrose's failure to recognise that Gödel's true but unprovable sentence interprets as a quantified arithmetical proposition over \mathbb{N} whose truth is, *weakly*, algorithmically *verifiable* (Definition 7), but not, *strongly*, algorithmically *computable* (Definition 10), in \mathbb{N} .

However, it can be argued ([An07b], [An07c]) that Penrose—as well as other philosophers and scientists such as, for instance, Lucas ([Lu61]), Wittgenstein ([Wi78]) and [Bu10]—should not be held to serious account for such lapse, since, as illustrated by Jeff Buechner's fallacious (in view of §2.C.a., Theorem 2.16, and §21.D., Theorem 21.1) argument, it merely reflects their unquestioning faith in standard expositions of classical theory which, too, can be critiqued similarly for failing to make this distinction explicit:

“In 1984, Putnam proposed an ingenious argument, which he claimed avoided Penrose's error and which restored the Gödel incompleteness theorems as limitative results in psychology. That his argument is invalid is argued in detail in my book *Gödel, Putnam and Functionalism* [20]. As we shall see below, even if human beings could prove the consistency of any formal system strong enough to express the truths of arithmetic, the Gödel incompleteness theorems could not be used as limitative results in psychology. The reason is straightforward, but it has eluded most thinkers who have weighed in on the role of the Gödel theorems as limitative results in psychology.

What eluded Hilary Putnam, philosophers, mathematicians, cognitive scientists, and neuroscientists is that the Gödel theorems show that no one—whether the Gödel theorems apply to them or not—can finitistically prove the consistency of Peano arithmetic *with mathematical certainty*. They do *not* show that one cannot prove the consistency of Peano Arithmetic with less than mathematical certainty. The proof relation of a formal system confers mathematical certainty upon everything that is proved in it. This importantly qualifies any claim about what can and cannot prove in a formal system. The *only* way finitary beings can achieve mathematical certainty in what they prove is to prove it in a finitary formal system. There are few results in mathematics that are proved with mathematical certainty since few mathematicians prove their results in a finitary formal system (such as first-order logic). No being—not even God—could prove a Gödel sentence with mathematical certainty in a finitary formal system. The only way to prove a Gödel sentence with mathematical certainty is to either use a stronger finitary formal system—in which case there will be a new Gödel sentence that cannot be proved in it—or to employ an infinitary system in which one constructs infinitary proofs. The latter is within the powers of God, but it is not within the powers of finitary human beings. We cannot construct infinitary proof trees.

The upshot is that no finitary human being can use the Gödel incompleteness theorems to show there are proof-theoretic powers human cognition has that no computational device intended to simulate it can capture."

. . . Buechner: [Bu10], p.12.

We also note that, in a survey of the foundations of mathematics in the 20th century, V. Victor Marek and Jan Mycielski emphasise the significance of bridging the gap between computability and provability:

“Finally let us formulate three open problems in logic and foundations which seem to us of special importance.

1. *To develop an effective automatic method for constructing proofs of mathematical conjectures, when these conjectures have simple proofs!* Interesting methods of this kind already exist but, thus far, “automated theorem proving procedures” are not dynamic in the sense that they do not use large lists of axioms, definitions, theorems and lemmas which mathematicians could provide to the computer. Also, the existing methods are not yet powerful enough to construct most proofs regarded as simple by mathematicians, and conversely, the proofs constructed by these methods do not appear simple to mathematicians.
2. *Are there natural large cardinal existence axioms LC such that $ZFC + LC$ implies that all OD sets X of infinite sequences of 0s and 1s satisfy the axiom of determinacy $AD(X)$?* This question is similar to the continuum hypothesis in the sense that it is independent of ZFC plus all large cardinal axioms proposed thus far.
3. *Is it true that $PTIME \neq NPTIME$, or at least, that $PTIME \neq PSPACE$?* An affirmative answer to the first of these questions would tell us that the problem of constructing proofs of mathematical conjectures in given axiomatic theories (and many other combinatorial problems) cannot be fully mechanized in a certain sense.”

... Marek and Mycielski: [MM01], p.467.

In his critical review [Krp13] of the Church-Turing Thesis, Saul A. Kripke too argues that any mathematical computation can, quite reasonably under an unarguable ‘Hilbert’s thesis’, be corresponded to a deduction in a first-order theory:

“My main point is this: a computation is a special form of mathematical argument. One is given a set of instructions, and the steps in the computation are supposed to follow—follow deductively—from the instructions as given. *So a computation is just another mathematical deduction, albeit one of a very specialized form.* In particular, the conclusion of the argument follows from the instructions as given and perhaps some well-known and not explicitly stated mathematical premises. I will assume that the computation is a deductive argument from a finite number of instructions, in analogy to Turing’s emphasis on our finite capacity. It is in this sense, namely that I am regarding computation as a special form of deduction, that I am saying I am advocating a logical orientation to the problem

Now I shall state another thesis, which I shall call “Hilbert’s thesis”,²¹ namely, that the steps of any mathematical argument can be given in a language based on first-order logic (with identity). The present argument can be regarded as either reducing Church’s thesis to Hilbert’s thesis, or alternatively as simply pointing out a theorem on all computations whose steps can be formalized in a first-order language.

Suppose one has any valid argument whose steps can be stated in a first-order language. It is an immediate consequence of the Gödel completeness theorem for first-order logic with identity that the premises of the argument can be formalized in any conventional formal system of first-order logic. Granted that the proof relation of such a system is recursive (computable), it immediately follows in the special case where one is computing a function (say, in the language of arithmetic) that the function must be recursive (Turing computable).

²¹ Martin Davis originated the term “Hilbert’s thesis”; see Barwise (1974, 41). Davis’s formulation of Hilbert’s thesis, as stated by Barwise, is that “the informal notion of *provable* used in mathematics is made precise by the formal notion *provable in first-order logic* (Barwise, 41). The version stated here, however, is weaker. Rather than referring to provability, it is simply that any mathematical *statement* can be formulated in a first-order language. Thus it is about *statability*, rather than provability. For the purpose of the present paper, it could be restricted to steps of a computation.

Very possibly the weaker thesis about *statability* might have originally been intended. Certainly Hilbert and Ackermann’s famous textbook (Hilbert and Ackermann, 1928) still regards the completeness of conventional predicate logic as an open problem, unaware of the significance of the work already done in that direction. Had Gödel not solved the problem in the

affirmative a stronger formalism would have been necessary, or conceivably no complete system would have been possible. It is true, however, that Hilbert's program for interpreting proofs with ε -symbols presupposed a predicate calculus of the usual form. There was of course "heuristic" evidence that such a system was adequate, given the experience of Frege, Whitehead and Russell, and others.

Note also that Hilbert and Ackermann do present the "restricted calculus", as they call it, as a fragment of the second-order calculus, and ultimately of the logic of order ω . However, they seem to identify even the second-order calculus with set theory, and mention the paradoxes. Little depends on these exact historical points."

... Kripke: [Krp13], pp.80-81 & 94.

We shall therefore attempt to build such a bridge explicitly, since a significant consequence of §2.C.a., Theorem 2.15, for constructive mathematics is that it justifies the belief expressed in [CCS01], where the authors seem to argue (see §2.E.) that Turing-computability of a 'proof', in the case of a mathematical proposition, ought to be treated as equivalent to the provability of its representation in the corresponding formal language.

We contrast this with the perspective in a 2017 on-line article¹³⁵ by Wilfried Sieg and Patrick Walsh on the *verifiability* of formalizations of the Cantor-Bernstein Theorem in ZF—via the *proof assistant* AProS which 'allows the direct construction of formal proofs that are humanly intelligible'.

Sieg and Walsh briefly reaffirm conventional wisdom by emphasising the need to distinguish between proof sequences of formal mathematical languages that are computable as 'formal derivations in particular calculi', and their interpretations which are 'the informal arguments given in mathematics'; hinting obliquely that the crucial problem is finding a faithful mathematical representation of the logical inferences in informal arguments that involve 'not surprisingly, the introduction and elimination rules for logical connectives, including quantifiers':

"The objects of proof theory are proofs, of course. This assertion is however deeply ambiguous. Are proofs to be viewed as formal derivations in particular calculi? Or are they to be viewed as the informal arguments given in mathematics?—The contemporary practice of proof theory suggests the first perspective, whereas the programmatic ambitions of the subject's pioneers suggest the second. We will later mention remarks by Hilbert (in sections 5 and 7) that clearly point in that direction. Now we refer to Gentzen who inspired modern proof theoretic work; his investigations and insights concern *prima facie* only formal proofs. However, the detailed discussion of the proof of the infinity of primes in his [Gentzen, 1936, pp. 506-511] makes clear that he is very deeply concerned with *formalizing* mathematical practice. The crucial problem is finding the atomic inference steps involved in informal arguments. The inference steps Gentzen brings to light are, perhaps not surprisingly, the introduction and elimination rules for logical connectives, including quantifiers."

... Sieg and Walsh: [SW17].

The authors note further that:

"When extending the effort from logical to mathematical reasoning one is led to the task of devising additional tools for the *natural formalization of proofs*. Such tools should serve to directly reflect standard mathematical practice and preserve two central aspects of that practice, namely, (1) the axiomatic and conceptual organization in support of proofs and (2) the inferential mechanisms for logically structuring them. Thus, the natural formalization in a deductive framework *verifies* theorems relative to that very framework, but it also deepens our understanding and isolates core ideas; the latter lend themselves often, certainly in our case, to a diagrammatic depiction of a proof's conceptual structure. ..."

... Sieg and Walsh: [SW17].

Without addressing here the larger dimensions of the authors' argument which implicitly—and debatably (see §8.C., Thesis 3)—sanctifies Gentzen's use of transfinite, set-theoretical, reasoning in formal proofs, and is critically based on the arguable (see §13.E.) thesis that:

¹³⁵Subsequently published in 2019 as [SW19].

"The language of set theory is, however, the *lingua franca* of contemporary mathematics and ZF its foundation."

... *Sieg and Walsh: [SW17]*.

we conclude from the following (§2.E.b., Theorem 2.17) that although set theory may be *the* appropriate language for the symbolic expression of Lakoff and Núñez's 'conceptual metaphors', by which an individual's 'embodied mind brings mathematics into being' (see [LR00]; see also §27.), it is the *strong* finitary interpretation of the first-order Peano Arithmetic PA (see §2.C.a., Theorem 2.15) that makes PA a stronger contender for the role of the *lingua franca* of adequate expression and categorical communication for contemporary mathematics and its foundations.

2.E.b. A Provability Theorem for PA

Moreover, the Provability Theorem for PA in [An16] (Theorem 7.1, p.42) shows that PA can have no non-standard model¹³⁶, since it is 'computably' complete semantically, in the sense that¹³⁷:

Theorem 2.17. (Provability Theorem for PA) *A PA formula $[F(x)]$ is PA-provable if, and only if, $[F(x)]$ is algorithmically computable as always true in \mathbb{N} .*

Proof. We have by definition that $[(\forall x)F(x)]$ interprets as true under the interpretation $\mathcal{I}_{PA(\mathbb{N}, SC)}$ if, and only if, $[F(x)]$ is algorithmically *computable* as always true in \mathbb{N} .

By §2.C.a., Theorem 2.15, $\mathcal{I}_{PA(\mathbb{N}, SC)}$ defines a finitary model of PA over \mathbb{N} such that:

- (a) If $[(\forall x)F(x)]$ is PA-provable, then $[F(x)]$ interprets as an arithmetic relation $F^*(x)$ which is algorithmically *computable* as always true in \mathbb{N} ;
- (b) If $[\neg(\forall x)F(x)]$ is PA-provable, then it is not the case that $[F(x)]$ interprets as an arithmetic relation $F^*(x)$ which is algorithmically *computable* as always true in \mathbb{N} .

Now, we cannot have that both $[(\forall x)F(x)]$ and $[\neg(\forall x)F(x)]$ are PA-unprovable for some PA formula $[F(x)]$, as this would yield the contradiction:

- (i) There is a finitary model—say $\mathcal{I}'_{PA(\mathbb{N}, SC)}$ —of $PA + [(\forall x)F(x)]$ in which $[F(x)]$ interprets as an arithmetic relation $F^*(x)$ that is algorithmically *computable* as always true in \mathbb{N} .
- (ii) There is a finitary model—say $\mathcal{I}''_{PA(\mathbb{N}, SC)}$ —of $PA + [\neg(\forall x)F(x)]$ in which it is not the case that $[F(x)]$ interprets as an arithmetic relation $F^*(x)$ that is algorithmically *computable* as always true in \mathbb{N} .

The theorem follows. □

We note the immediate consequence that, contradicting current paradigms¹³⁸:

Corollary 2.18. *PA is categorical.* □

¹³⁶Contradicting current paradigms as detailed in §18.

¹³⁷We note that Theorem 2.17 (Provability Theorem for PA) offers a solution to Barendregt and Wiedijk's: 'The challenge of computer mathematics' [BW05].

¹³⁸Paradigms that, as Melvyn B. Nathanson despairingly notes in [Na08] (see also §20.) are, generally, uncritically inherited in good faith; such as, for instance: "It is a well-known fact that first-order Peano Arithmetic (PA1) is not categorical, i.e. it does not uniquely describe the sequence of the natural numbers that is typically viewed as the 'intended model' of arithmetic. Indeed, PA1 equally describes structures that strictly contain the sequence of the natural numbers but are not isomorphic to it, and these are known as the non-standard models of arithmetic." ... *Novaes: [Nov19], §1 Introduction.*

Comment 42. From the *evidence-based* perspective of this investigation, the possibility of treating arithmetic provability in a formal system such as PA, and arithmetic computability by a Turing machine, as both ‘equivalent¹³⁹’ and ‘absolute¹⁴⁰’ can be viewed as presciently implicit in Wilfried Sieg and John Byrnes’ 1999 highlighting of an insightful 1936 quote by Gödel:

“In order to give the most general formulation of the incompleteness theorems and thus to allow for their broadest philosophical interpretation, a general concept of “formality” is required. For Gödel that meant to provide a precise characterization of effective calculability for number-theoretic functions. That was a primary, motivating concern for Gödel; cf. [Gödel 1951] and [Davis 1982]. To approach such a characterization, Gödel introduced in his Princeton Lectures of 1934 the class of *general recursive functions*, i.e., those functions whose values can be calculated in an equational calculus from basic equations by means of very elementary rules. Clearly, any system that is adequate for the formation of (weak parts of elementary) number theory will allow such calculations. Gödel noticed in 1936, to his own surprise, that no extension by higher types (even transfinite ones) would allow the calculation of more functions; this is the basis for his assertion that the concept of computability has a certain *absoluteness*:

Thus the notion ‘computable’ is in a certain sense ‘absolute’, while almost all metamathematical notions otherwise known (for example, provable, definable, and so on) quite essentially depend upon the system adopted. (p. 399)

In his lecture for the Princeton bicentennial conference, Gödel re-emphasized the significance of absoluteness. And yet, Gödel found only Turing’s analysis convincing and claimed that the latter’s work provides “a precise and unquestionably adequate definition of the general concept of a formal system” [1964, p. 369]. As a formal system is simply defined to be a mechanical procedure for producing theorems, the adequacy of the definition rests clearly on Turing’s analysis of the concept “mechanical procedure”. The analyzed concept must obviously be a sharp, mathematical notion to enter a rigorous proof showing its equivalence to the concept of a Turing machine.”

... *Sieg and Byrnes: [SB99], §1 Mechanical procedures.*

Comment 43. We briefly mention in §3. the far-reaching consequences, of the Provability Theorem for PA, that highlight the significance of *evidence-based* reasoning for interpreting mathematical propositions as ‘true’ in number-theory, computability, philosophy and the natural sciences.

For instance, as Wilfried Sieg and Farzaneh Derakhshan outline in the Abstract of their 2021 paper [SD21]:

“Human-centered automated proof search aims to capture structures of ordinary mathematical proofs and discover human strategies that are used (implicitly) in their construction. We analyze the ways of two theorem provers for approaching that goal. One, the G&G-prover, is presented in Ganesalingam and Gowers (J Autom Reason 58(2):253–291, 2017); the other, Sieg’s AProS system, is described in Sieg and Walsh (Rev Symb Logic 1-35, 2019). Both systems make explicit, via their underlying logical calculi, the goal-directedness and bi-directionality of proof construction. However, the calculus for the G&G-prover is a weak fragment of minimal first-order logic, whereas AProS uses complete calculi for intuitionist and classical first-order logic. The strategies for the construction of proofs are dramatically different as well. The G&G-prover uses a waterfall strategy and is thus restricted to problems that can be solved without backtracking. The AProS strategies, by contrast, support a complete search procedure with backtracking. These divergences are rooted in the fact that the concrete goals of the systems are different: The G&G-prover is to yield write-ups indistinguishable from good mathematical writing; AProS is to yield humanly intelligible formal proofs by

¹³⁹In the sense of the Provability Theorem for PA.

¹⁴⁰In the sense that PA is categorical by Corollary 2.18.

logically and mathematically motivated strategies. In our final Programmatic remarks, we sketch a plausible, but difficult project for achieving more fully G&G's broad goals by radically separating proof search from proof translation: one could use AProS for the proof search and then exploit the strategic structure of the completed proof as the deterministic underpinning for its translation into a natural language."

... *Sieg and Derakhshan: [SD21], Abstract.*

Although the broader issues involved in the subject of automated theorem proving lie largely outside the immediate focus of this investigation, we note *prima facie* that—from the evidence-based perspective of the Provability Theorem for PA—it would not be unreasonable to conjecture (conclude?) that, given an arithmetical formula $[F]$:

- (a) the goal of G&G is to:
 - (i) verify whether (if $[F]$ is PA-provable), or not (if $[F]$ is PA-unprovable), we can identify a Turing machine TM_F , defined by $[F]$, which evidences $[F]$ as a 'true' arithmetical proposition in the sense of, say, Chetan Murthy [Mu91]¹⁴¹; and
 - (ii) express the computational steps of any such 'verification' in a suitably selected 'high-level' mathematical language (such as, say, Alonzo Church's λ -calculus);
- (b) the goal of AProS is to convert the computational steps of any such 'verification' of $[F]$ —by TM_F using, say, either G&G, AProS, or any other automated theorem prover—into a PA-proof of $[F]$.

Comment 44. The significance of being able 'to convert the computational steps of any such 'verification' of $[F]$ —by TM_F using, say, either G&G, AProS, or any other automated theorem prover—into a PA-proof of $[F]$ ', is reflected in Andrew Granville's musings [Gm22].

In an unusually candid and insightful—albeit informal—survey, Granville seeks to address the query, '*Do Proofs Yield Objective Truth, Or Are They Culturally Robust At Best*', from a general mathematician's perspective when faced with the problem of identifying an evidence-based methodology that, in each case, can be 'trusted' to interpret 'axioms' and 'consequences' as *computer-verifiable* mathematical 'truths':

"However formal proofs are making a comeback! No longer are they "roped-off museum pieces to be silently appreciated, but not handled directly" ([16]). Now we have computers that have the memory space to handle the length of more-or-less any proof, and (we hope) the logical resources to ensure that no steps are omitted (though this raises questions about trust in computer calculations, as discussed below).

In the future proof-verification might employ "computer-assisted proofs", since the author could interactively explain her proof to an appropriately designed proof-checker. Indeed in 2008 Harrison [20] at Intel, wrote that one of his goals for formalization is

Supplementing, or even partly replacing, the process of peer review for mainstream mathematical papers with an objective and mechanizable criterion for the correctness of proofs.

Even now this would involve an inordinate drain on the author's time, but it might nonetheless be useful in situations where there are many new definitions that must be correct, for example in the works of Biss and Voevodskii that we discussed above.

We must surely be wary of believing in computer verified proofs for the old reason that we are translating mathematics into a specialized language.³⁹ To justify this one can resuscitate Peano's belief that in an appropriately designed language one can eliminate mistranslations and obtain "precision" so as to eliminate mistakes. However, even if

¹⁴¹"It is by now folklore ... that one can view the *values* of a simple functional language as specifying *evidence* for propositions in a constructive logic ... " ... Murthy: [Mu91], §1 Introduction.

this is possible and you have achieved this dream, how would you prove that you have succeeded?

In Voevodskii’s work on his univalence foundation program he felt he no longer trusted himself on the details and designed a proof assistant. In [35] he claims that a proof-assistant can keep you honest: you lay down the plan, it builds the boring details. When it can’t you have to refine your plan further; like working with a mythical pedantic enthusiastic colleague.

³⁹ In fact proof verification software is a spin-off of hardware verification software, and software now can formally verify that high level computer languages or microprocessors (or anything in-between) operate as claimed. For example Leroy [27] created a formally verified compiler for the C programming language. *
... Granville: [Grn22], §7. *Computers and proofs. Establishing, assisting with, and generating, proofs.*

Comment 45. We can, moreover, view the Provability theorem for PA as a possible starting point for Granville’s urging that, even though the ‘proof verifications that we have discussed above (4CT and Kepler’s conjecture) worked interactively with a person to construct a proof from the ground up ... are not human readable ... one must find a wide variety of ways to explain and to verify any given proof, even a computer proof, and to look at it from as many different persp[ectives] as possible’:

“What features would be desirable in a proof checker? The proof verifications that we have discussed above (4CT and Kepler’s conjecture) worked interactively with a person to construct a proof from the ground up. Those proofs are not human readable, but they can attempt to confirm further claims made by humans, for example minor variants to improve our trust in them. Indeed the more they show that they provide understanding, by helping us go further, the more faith we might have in a computer proof.

However, is a “proof” that cannot be understood in detail, really a proof? We have discussed how the purpose of a proof is not just to establish truth, but also to enhance understanding. If it cannot do that then what use is it to the community?

Why should we trust the output from a proof verifier or a prover if we can’t read them? Can proof-assistants be self-correcting if they can only checked by their own internal logic—it may well be that they continue to propagate a subtle error.

Surely these programs need a community to verify their proofs—perhaps their output may be independently verified by using different programs; in effect, we propose refereeing computer proof verifiers output within their own community! This assumes that they work in a common language which adds extra burden to the different designs. In this way humans might believe a computer-verified proof, via an independent computer verification, and so the proof verifier becomes a trusted, objective, expert authority (that is, a referee). The computer programs will use their community to obtain a worthwhile seal of approval. In this way we can design the future based on what already works.⁵¹

Proof presentation. To believe in a proof that goes back to axioms, we need to have a common language so that the proof can be independently verified. We have seen that it is not feasible for a human to do the verification, and that humans gain little from this process, so how can we make it more useful? It seems evident that a proof verifier could also output a human readable proof. It could learn the types of high-level arguments that humans understand and appreciate, and then present its proof not only for human verification but also to help enhance human understanding.

The automated prover might select results from the existing library of verified results to build a short, person-readable argument to deduce the latest advance and so fit into the well-established protocols of how the community agrees on the correctness of a proof. Anyone may use any result that has been previously established. Although each step in each proof is computer verified, back to axioms, one hopes that as more researchers contribute to the system, interaction will move towards something resembling the

high-level practice of mathematicians. A system like this is user-friendly and should become an integral part of the mathematician’s arsenal.

Typically theorem-provers are interactive, the user being able to give it hints. The user enters statements into the proof-verifier, based on simpler objects that the machine already knows about. The proof assistant will determine whether the statement is ‘obviously’ true or false based on its current knowledge. If not, the user enters more details. The proof assistant therefore forces the user to explain their arguments in a rigorous way, and to fill in simpler steps than human mathematicians might feel they need.⁵² For example suppose a proof needs ten lemmas. Some the theorem-prover will see and resolve quickly. Others it might be stuck on and the user gives it more details until the computer can see its way to a proof. In so-doing the program learns more, and maintains a library and is perhaps more efficient when it next encounters similar issues.

For now proof assistants can’t read a textbook, they need it all broken down for them by humans. Proof assistants can’t judge whether a mathematical statement is interesting or important, only whether it is correct. It should eventually require less help, perhaps much less help. We have no idea when (and whether) it will be able to generate its own proofs.

The uncertainty principle of objective proof verification. The history of mathematical practice suggests that

The less one questions a proof, the more susceptible it is to error.

This important principle strongly suggests one must find a wide variety of ways to explain and to verify any given proof, even a computer proof, and to look at it from as many different perspectives as possible.

⁵¹ Rather like how e-journals used the refereeing process to establish integrity and the standards of traditional print journals.

⁵² Users report that they often learn a lot during the input process! *
... Granville: [Gm22], §10. Protocols for automated theorem checkers/provers. What can we hope for?

2.F. Gödel’s ‘*undecidable*’ formula $[\neg(\forall x)R(x)]$ is provable in PA

We note that the above argumentation reflects the conclusion in [An16], Lemma 8.1, p.42, that:

Lemma 2.19. *If $\mathcal{I}_{PA(\mathbb{N}, M)}$ defines a model of PA over \mathbb{N} , then there is a PA formula $[F]$ which is algorithmically verifiable as always true over \mathbb{N} under $\mathcal{I}_{PA(\mathbb{N}, M)}$ even though $[F]$ is not PA-provable.*

Proof. Gödel has shown how to construct an arithmetical formula with a single variable—say $[R(x)]$ ¹⁴²—such that, if PA is consistent, then $[R(x)]$ is not PA-provable¹⁴³, but $[R(n)]$ is instantiationally PA-provable for any given PA numeral $[n]$. Since PA is consistent by §2.C.a., Theorem 2.16, for any given numeral $[n]$, Gödel’s primitive recursive relation $xB\ulcorner[R(n)]\urcorner$ ¹⁴⁴ must hold for some x . The lemma follows. □

By the argument in Theorem 2.17 it further follows that, contradicting current paradigms¹⁴⁵:

Corollary 2.20. *The PA formula $[\neg(\forall x)R(x)]$ defined in Lemma 2.19 is PA-provable.* □

¹⁴²Gödel refers to the formula $[R(x)]$ only by its Gödel number r ([Go31], p.25(12)).

¹⁴³Gödel’s aim in [Go31] was to show that $[(\forall x)R(x)]$ is not P-provable; by Generalisation it follows, however, that $[R(x)]$ is also not P-provable.

¹⁴⁴Where $\ulcorner[R(n)]\urcorner$ denotes the Gödel-number of the PA formula $[R(n)]$.

¹⁴⁵For S any recursively axiomatized Σ_0 -complete theory sound with respect to truth in the structure of the natural numbers, there is a sentence G such that $S \not\vdash G$ and $S \not\vdash \neg G$ Isaacson: [Is11], §1 Introduction.

Corollary 2.21. *In any well-defined model of PA, Gödel’s arithmetical formula $[R(x)]$ interprets as an algorithmically verifiable, but not algorithmically computable, tautology over \mathbb{N} .*

Proof. Gödel has shown that $[R(x)]$ ¹⁴⁶ always interprets as an algorithmically *verifiable* tautology over \mathbb{N} ¹⁴⁷. By Corollary 2.20 $[R(x)]$ is not algorithmically *computable* as always true in \mathbb{N} . \square

Comment 46. In an, admittedly ‘informal’, contribution [Bld16] to a *Festschrift* honouring philosopher Wolfgang Spohn—where he takes the opportunity to candidly express his perspective *On Fixed Points, Diagonalization, and Self-Reference*—philosopher Bernd Buldt also observes in a curious ‘Disclaimer’ that:

“There is a robust consensus among logicians that Gödel’s first theorem, properly conceived, is not a result in proof theory (in whose context it was first formulated) but a result in computability or recursion theory. There, its informal version reads:

For every effective method that generates only true sentences of arithmetic we can effectively determine a true sentence that this method cannot generate.

This statement, translated into the language of recursion theory, becomes,

The set of (Gödel numbers of) all true arithmetical sentences is productive.

Let a Gödel numbering be given and TA be True Arithmetic, here understood to be the set of Gödel numbers of all true arithmetical sentences. Productivity means that there is a total computable function f such that whenever i is the index of a computable subset W_i of TAs : $W_i \subseteq TA$, then $f(i)$ lies in W_i ’s complement relative to TA : $f(i) \in TA \setminus W_i$. In other words, $f(i)$ is the Gödel number of a true arithmetical sentence (since it is in TA) but not generated by the i th method (since it is not in W_i)."

... Buldt: [Bld16], §2 Disclaimer.

The significance of the Provability Theorem for PA (Theorem 2.17)—and the distinction between algorithmic *verifiability* and algorithmic *computability* in Corollary 2.21—is reflected in the following, *evidence-based*, modification of Buldt’s ‘Disclaimer’, if we add qualifications that are seemingly consistent with Buldt’s intent:

There is a robust consensus among logicians that Gödel’s first theorem, properly conceived, is not a result only in proof theory (in whose context it was first formulated) but a result in computability or recursion theory. There, its informal version reads:

For every effective method¹⁴⁸ that generates only algorithmically *computable* true sentences of arithmetic we can effectively determine an algorithmically *verifiable* true sentence that this method cannot generate.

This statement, translated into the language of recursion theory, becomes,

The set of (Gödel numbers of) all true arithmetical sentences is productive.

Let a Gödel numbering be given and TA be True Arithmetic, here understood to be the set of Gödel numbers of all algorithmically *verifiable* true arithmetical sentences. Productivity means that there is a total algorithmically *verifiable* function f such that whenever i is the index of an algorithmically *computable* subset W_i of TA : $W_i \subseteq TA$ then, if $f(i)$ lies in W_i ’s complement relative to TA : $f(i) \in TA \setminus W_i$, then $f(i)$ is the Gödel number of a true, algorithmically *verifiable* but not algorithmically *computable*, arithmetical sentence (since it is in TA) but not generated by the i th method (since it is not in W_i).

¹⁴⁶Gödel refers to the formula $[R(x)]$ only by its Gödel number r ; [Go31], p.25, eqn.12.

¹⁴⁷[Go31], p.26(2): “ $(n) \rightarrow (nB_\kappa(17Gen r))$ holds”

¹⁴⁸We contrast the classically intuitive ‘definition’ of Buldt’s ‘effective method’—rooted in Church’s Thesis (see 7.H.)—with the *evidence-based* concept of ‘effective computability’ in §7.H.a., Definition 28 (under which Church’s Thesis does not hold; by Theorem 7.3 in §7.H.b.: *Effective computability and the Church-Turing Thesis*).

Corollary 2.22. *PA is not ω -consistent.*

Proof. Gödel has shown that if PA is consistent, then $[R(n)]$ is PA-provable for any given PA numeral $[n]$ ¹⁴⁹. By Corollary 2.20 and the definition of ω -consistency, if PA is consistent then it is *not* ω -consistent. \square

Comment 47. We prove Corollary 2.22 independently in §12.B.f., Theorem 12.6. We note that this conclusion is contrary to accepted dogma. See, for instance, Davis' remarks in [Da82], p.129(iii) that "... there is no equivocation. Either an adequate arithmetical logic is ω -inconsistent (in which case it is possible to prove false statements within it) or it has an unsolvable decision problem and is subject to the limitations of Gödel's incompleteness theorem".

Corollary 2.23. *The classical standard interpretation $\mathcal{I}_{PA(\mathbb{N}, S)}$ of PA does not well-define a model of PA.*

Comment 48. *Well-define* in the sense of §7.F., Definition 26. We note that 'finitists' of all hues—ranging from Brouwer [Br08], to Wittgenstein [Wi78], to Alexander Yessenin-Volpin [He04]—have persistently questioned the assumption that the classical standard interpretation $\mathcal{I}_{PA(\mathbb{N}, S)}$ (see [Me64], p.107) can be treated as *well-defining* a model of PA; see also [Brm07].

Proof. If PA is consistent but not ω -consistent, then Aristotle's particularisation does not hold over \mathbb{N} . Since the classical *standard* interpretation of PA appeals to Aristotle's particularisation, the lemma follows. \square

2.F.a. An evidence-based perspective of Lucas' Gödelian argument

The paper [An16] concludes from this that Lucas' Gödelian argument ([An16], Thesis 1, p.42; see also §21.) can validly claim (as validated in §21.D., Theorem 21.1) that:

Thesis 2. (Gödelian Thesis) *There can be no mechanist model of human reasoning if the assignment $\mathcal{I}_{PA(\mathbb{N}, SV)}$ can be treated as circumscribing the ambit of human reasoning about 'true' arithmetical propositions, and the assignment $\mathcal{I}_{PA(\mathbb{N}, SC)}$ can be treated as circumscribing the ambit of mechanistic reasoning about 'true' arithmetical propositions.*

Argument: Gödel has shown how to construct an arithmetical formula with a single variable—say $[R(x)]$ ¹⁵⁰—such that $[R(x)]$ is not PA-provable, but $[R(n)]$ is instantiationally PA-provable for any given PA numeral $[n]$. Hence, for any given numeral $[n]$, Gödel's primitive recursive relation $xB\ulcorner[R(n)]\urcorner$ ¹⁵¹ must hold for some natural number m .

If we assume that any mechanical witness can only reason *finitarily* then although, for any given numeral $[n]$, a mechanical witness can give evidence under the assignment $\mathcal{I}_{PA(\mathbb{N}, SC)}$ that the PA formula $[R(n)]$ holds in \mathbb{N} , no mechanical witness can conclude *finitarily* under the assignment $\mathcal{I}_{PA(\mathbb{N}, SC)}$ that, for any given numeral $[n]$, the PA formula $[R(n)]$ holds in \mathbb{N} .

However, if we assume that a human witness can also reason *non-finitarily*, then a human witness can conclude under the assignment $\mathcal{I}_{PA(\mathbb{N}, SV)}$ that, for any given numeral $[n]$, the PA formula $[R(n)]$ holds in \mathbb{N} . \square

The above distinction illuminates the argument in [An13] and [An15], where we suggest how such a perspective offers a resolution to the *EPR* paradox, by recognising that (see also §23.):

¹⁴⁹[Go31], p.26(2).

¹⁵⁰Gödel refers to this formula only by its Gödel number r ([Go31], p.25(12)).

¹⁵¹Where xBy denotes Gödel's primitive recursive relation ' x is the Gödel-number of a proof sequence in PA whose last term is the PA formula with Gödel-number y ' ([Go31], p. 22(45)); and $\ulcorner[R(n)]\urcorner$ denotes the Gödel-number of the PA formula $[R(n)]$.

-
- (i) the assignment $\mathcal{I}_{PA(\mathbb{N}, SV)}$ can be viewed as corresponding to the way human intelligence conceptualises, symbolically represents, and logically reasons about, those sensory perceptions that are triggered by physical processes which are representable—not necessarily finitarily—by algorithmically *verifiable* formulas;
 - (ii) the assignment $\mathcal{I}_{PA(\mathbb{N}, SC)}$ can be viewed as corresponding to the way human intelligence conceptualises, symbolically represents, and logically reasons about, only those sensory perceptions that are triggered by physical processes which are representable—finitarily—by algorithmically *computable* formulas;
 - (iii) there are physical processes of a quantum nature that are representable only by determinate, algorithmically *verifiable*, mathematical functions, but not by any predictable, algorithmically *computable*, mathematical function.

CHAPTER 3. INTRODUCTION

3. The significance of the Provability Theorem for PA for number theory and computability

From the *evidence-based* perspective of this investigation (see §1., Thesis 1), the significance of the Provability Theorem for PA (§2.E.b., Theorem 2.17) for number theory is that:

- (a) although (see §15.H.), there can be *no* PA formula that interprets over \mathbb{N} as the meta-statement ‘PA is consistent’ *without* inviting the paradoxes (see §20.) of impredicativity;
- (b) we *can* interpret the number-theoretic expression $Wid(PA) \equiv (\exists x)[Form(x) \ \& \ \overline{Bew}_{PA}(x)]$ (see [Go31], p.36) over \mathbb{N} as asserting: ‘There is a PA-formula that is not PA-provable’, which is equivalent to asserting that ‘PA is consistent’.

Its corresponding significance for computability theory is that:

- (c) whilst (see [Tu36], p.134 and [Me64], p.256) there can be *no* Turing machine U which, given the ‘standard description’ of any ‘arbitrary’ Turing machine T and any instantaneous tape description α , can determine whether or not there is a computation of T beginning with α (see §21.F.a., Query 26, Halting-decidability problem for T), *without* inviting the paradoxes (see §20.) of impredicativity;
- (d) there *is* a PA formula that will determine whether or not T halts on α (see §21.F.b., Theorem 21.3 and Corollary 21.4).

In other words:

- we can express properties about the natural numbers in the language of recursive functions that cannot be expressed in the language of arithmetic; and
- we can express properties about the natural numbers in the language of arithmetic that cannot be expressed in the language of recursive functions.

Comment 49. From the perspective of this *evidence-based* investigation, the Provability Theorem for PA (§2.E.b., Theorem 2.17) can also be viewed as implicitly anticipated in Fred Richman’s 1983 ‘Church’s Thesis Without Tears’ [Rch83]:

“The modern theory of computability is based on the works of Church, Markov and Turing who, starting from quite different models of computation, arrived at the same class of computable functions. The purpose of this paper is the show how the main results of the Church-Markov-Turing theory of computable functions may quickly be derived and understood without recourse to the largely irrelevant theories of recursive functions, Markov algorithms, or Turing machines. We do this by ignoring the problem of what constitutes a computable function and concentrating on the central feature of the Church-Markov-Turing theory: that the set of computable partial functions can be effectively enumerated. In this manner we are led directly to the heart of the theory of computability without having to fuss about what a computable function is.

The spirit of this approach is similar to that of [RGRS]. A major difference is that we operate in the context of constructive mathematics in the sense of Bishop [BSH1], so all functions are computable by definition, and the phrase “you can find” implies “by a finite calculation.” In particular if P is some property, then the statement “for each m there is n such that $P(m, n)$ ” means that we can construct a (computable)

function Θ such that $P(m, \Theta(m))$ for all m . Church's thesis has a different flavor in an environment like this where the notion of a computable function is primitive.

One point of such a treatment of Church's thesis is to make available to Bishop-style constructivists the Markovian counterexamples of Russian constructivism and recursive function theory. The lack of serious candidates for computable functions other than recursive functions makes it quite implausible that a Bishop-style constructivist could refute Church's thesis, or any consequence of Church's thesis. Hence counterexamples such as Specker's bounded increasing sequence of rational numbers that is eventually bounded away from any given real number [SPEC] may be used, as Brouwerian counterexamples are, as evidence of the unprovability of certain assertions.

Another point of our treatment is to gain the benefits of economy and generality that accompany an axiomatic development. Economy is achieved by bypassing the technically involved theory of recursive functions. Generality flows from the fact that the set of partial recursive functions is not the only model for the axiom CPF of §2. In this respect our approach can be viewed as axiomatic recursion theory in the spirit of Wagner and Strong [FRDM]; indeed CPF implies that the partial functions form an ω -BRFT as defined in [FRDM].

We are particularly interested in applications to constructive analysis. A real number is a Cauchy sequence of rational numbers, which is essentially a function from the positive integers to the positive integers. Thus CPF has implications in the theory of real numbers. Except for the last section on the recursion and isomorphism theorems, it is these implications that we are most concerned with."

... Richman: [Rch89], §1. Introduction.

Seemingly equating algorithmic computability with PA-decidability, Richman seeks to show here:

- (a) that 'the main results of the Church-Markov-Turing theory of computable functions may quickly be derived and understood without recourse to the largely irrelevant theories of recursive functions, Markov algorithms, or Turing machines';
- (b) by offering a 'treatment' that yields 'the benefits of economy and generality that accompany an axiomatic development' (implicitly viewable as Theorem 2.17);
- (c) where 'all functions are computable by definition' (implicitly viewable as decidable under the *strong*, algorithmically *computable*, interpretation $\mathcal{I}_{PA(\mathbb{N}, SC)}$ of PA in §2.C.);
- (d) and 'the statement "for each m there is n such that $P(m, n)$ " means that we can construct a (computable) function Ω such that $P(m, \Omega(m))$ for all m ' (cf., §7.C., Definitions 21 to 24);
- (e) so that 'Church's thesis has a different flavor in an environment like this where the notion of a computable function is primitive' (cf., §7.F., Definition 25: *A Boolean number-theoretical sequence $\{F^*(1), F^*(2), \dots\}$ is well-defined if, and only if, the number-theoretical relation $F^*(x)$ is algorithmically verifiable; and §7.H.a., Definition 28: *A number-theoretic function $F^*(x_1, \dots, x_n)$ is effectively computable if, and only if, $F^*(x_1, \dots, x_n)$ is well-defined*);*
- (f) and 'to make available to Bishop-style constructivists the Markovian counterexamples of Russian constructivism and recursive function theory';
- (g) where the 'lack of serious candidates for computable functions other than recursive functions makes it quite implausible that a Bishop-style constructivist could refute Church's thesis, or any consequence of Church's thesis' (cf., §7.H.b., Theorem 7.3: *The classical Church-Turing Thesis is false in any interpretation of the first-order Peano Arithmetic PA that admits evidence-based quantification*);
- (h) thus mistakenly admitting Specker's sequence 'as evidence of the unprovability of certain assertions' (cf., §7.G., Comment 74: *We note that Specker sequences ... are algorithmically computable, monotonically increasing, bounded sequences of rational numbers*);
- (i) and where a 'real number is a Cauchy sequence of rational numbers, which is essentially a function from the positive integers to the positive integers' (cf., §7.I., *Every (evidence-based) eb-real number is specifiable in PA*).

CHAPTER 4. INTRODUCTION

4. The significance of the Provability Theorem for PA for the PvNP problem

From the *evidence-based* perspective of this investigation (see §1., Thesis 1), the significance of the Provability Theorem for PA (§2.E.b., Theorem 2.17) for the PvNP problem is that (compare §2.F., Corollary 2.21):

Theorem 4.1. (First Tautology Theorem) *There is no deterministic Turing-machine that evidences Gödel's tautology $R^*(n)$ —when treated as a Boolean function—as an algorithmically computable truth.*

Proof. In his seminal 1931 paper [Go31], Gödel has constructed a PA-formula $[R(n)]$ that is PA-provable for any *specified* PA-numeral $[n]$. Hence, under any *well-defined* interpretation of PA over \mathbb{N} , $[R(n)]$ interprets as a tautological arithmetical relation $R^*(n)$ since it is true for any *specified* natural number n , but — since the corresponding PA-formula $[R(x)]$ ¹⁵² is not PA-provable (cf. [Go31], p25(1))—it follows from the Provability Theorem for PA that there is no deterministic Turing-machine that evidences $R^*(n)$ as a tautology (*i.e.*, as true for any *specified* natural number n). \square

Comment 50. By Generalisation¹⁵³, stating that the PA-formula $[R(x)]$ is not PA-provable is equivalent to stating that the PA-formula $[(\forall x)R(x)]$ ¹⁵⁴ is not PA-provable; the latter is what Gödel actually proved in [Go31].

We also have, further, that:

Theorem 4.2. (Second Tautology Theorem) *Gödel's tautology $R^*(n)$ is algorithmically verifiable as true.*

Proof. Gödel has defined a primitive recursive relation, $xB_{PA}y$ that holds if, and only if, y is the Gödel-number of a PA-formula, say $[R]$, and x the Gödel-number of a PA-proof of $[R]$ ([Go31], p22, dfn. 45).

Since every primitive recursive relation is Turing-computable (*when treated as a Boolean function*), $xB_{PA}y$ defines a Turing-machine TM_B that halts on any *specified* natural number values of x and y .

Now, if $g_{[R(1)]}$, $g_{[R(2)]}$, \dots are the Gödel-numbers of the PA-formulas $[R(1)]$, $[R(2)]$, \dots , it follows that, for any *specified* natural number n , when the natural number value $g_{[R(n)]}$ is input for y , the Turing-machine TM_B must halt for some value of x —which is the Gödel-number of some PA-proof of $[R(n)]$ —since Gödel has shown ([Go31], p25(1)) that $[R(n)]$ is PA-provable for any *specified* numeral $[n]$.

Hence $R^*(n)$ is algorithmically *verifiable* as true for any *specified* natural number n . \square

¹⁵²Gödel defines, and refers to, this formula by its Gödel-number r (cf. [Go31], p25, eqn.12).

¹⁵³Generalisation in PA: $[(\forall x)A]$ follows from $[A]$.

¹⁵⁴Gödel defines, and refers to, this formula by its Gödel-number $17Gen\ r$ (cf. [Go31], p25, eqn.13).

4.A. The P ν NP problem

We note that the standard definition of the classes P and NP is the one provided by Stephen Cook to the Clay Mathematical Institute in a 2000 paper, [Cook], which has come to be widely accepted as the official description of the P ν NP problem; where Cook admits a number-theoretic function F —viewed set-theoretically as extensionally defining (and being defined by) a unique subset L of the set Σ^* of finite strings over some non-empty finite alphabet set Σ —in P if, and only if, some deterministic Turing machine TM accepts L and runs in polynomial time:

“The computability precursors of the classes P and NP are the classes of decidable and c.e. (computably enumerable) languages, respectively. We say that a language L is c.e. i.e. (or semi-decidable) iff $L = L(M)$ for some Turing machine M . We say that L is decidable iff $L = L(M)$ for some Turing machine M which satisfies the condition that M halts on all input strings w . . .

Thus the problem Satisfiability is: Given a propositional formula F , determine whether F is satisfiable. To show that this is in NP we define the polynomial-time checking relation $R(x, y)$, which holds iff x codes a propositional formula F and y codes a truth assignment to the variables of F which makes F true."

... Cook: [Cook].

In this *evidence-based* investigation, however, we shall—for reasons detailed in §4.B.—prefer to interpret number-theoretic functions and relations over an infinite domain \mathbb{D} as pre-Cantorian computational instructions that, for any *specified* sequence of permissible values to the variables in the function/relation, determine how the function/relation is to be evaluated—and whether, or not, the result of such evaluation yields a value (or values)—in the domain \mathbb{D} .

We shall not assume—as is the case in Cantorian set theories such as the first-order set Theory ZF, or the second-order Peano Arithmetic ACA_0 (see §19.A.)—that the evaluations always determine a completed infinity (set) which can be referred to as a unique mathematical constant that identifies the function/relation in a mathematical language (or its interpretation) *outside* of the set theory in which the function/relation is defined.

We shall, instead, address the P ν NP problem here from the *logical* perspective of the paper [Ra02] presented to ICM 2002 by Ran Raz, where he notes that:

“A Boolean formula $f(x_1, \dots, x_n)$ is a tautology if $f(x_1, \dots, x_n) = 1$ for every x_1, \dots, x_n . A Boolean formula $f(x_1, \dots, x_n)$ is unsatisfiable if $f(x_1, \dots, x_n) = 0$ for every x_1, \dots, x_n . Obviously, f is a tautology if and only if $\neg f$ is unsatisfiable.

Given a formula $f(x_1, \dots, x_n)$, one can decide whether or not f is a tautology by checking all the possibilities for assignments to x_1, \dots, x_n . However, the time needed for this procedure is exponential in the number of variables, and hence may be exponential in the length of the formula f .

... P \neq NP is the central open problem in complexity theory and one of the most important open problems in mathematics today. The problem has thousands of equivalent formulations. One of these formulations is the following:

Is there a polynomial time algorithm \mathcal{A} that gets as input a Boolean formula f and outputs 1 if and only if f is a tautology?

P \neq NP states that there is no such algorithm."

... Raz: [Ra02].

We note that a propositional logic formula, also called Boolean expression, is built from variables, operators AND (conjunction, also denoted by \wedge), OR (disjunction, \vee), NOT (negation, \neg), and parentheses. A formula is said to be satisfiable if it can be made TRUE by assigning appropriate logical values (i.e. TRUE, FALSE) to its variables. The SAT problem is then:

Definition 19. (SAT) *The Boolean satisfiability problem (SAT) is, given a formula, to check whether it is satisfiable.*

4.A.a. SAT is not deterministically ‘polynomial time’

Clearly, the issue of whether, or not, there is a *polynomial time* ‘algorithm \mathcal{A} that gets as input a Boolean formula f and outputs 1 if, and only if, f is a tautology’ is meaningful only if we can *evidence* that there *is*, in fact, an ‘algorithm \mathcal{A} that gets as input a Boolean formula f and outputs 1 if and only if f is a tautology’.

So, if the Gödelian relation $R(n)$ defined in §4. is algorithmically *verifiable* as a tautology, but not recognisable as a tautology by any Turing-machine (see also §21.E., Corollary 21.2, and §21.E., Query 22 (Turing Test)), then it is trivially true *logically* that $P \neq NP$ since:

Theorem 4.3. (SAT is not in P or NP) *SAT is not in P or NP since there is an arithmetical formula that is algorithmically verifiable as a tautology, but not recognisable as a tautology by any Turing-machine.*

Proof. The Theorem follows immediately from §4., Theorem 4.1 and Theorem 4.2. □

Comment 51. See also:

- §4.B.b., Corollary 4.5 ($P \neq NP$ by separation), for an independent, *evidence-based*, proof that if P is the class of problems that admit algorithmically *computable* solutions, and NP is the class of problems that admit algorithmically *verifiable* solutions, then $P \neq NP$.
- §22.A., Proposition 22.5 ($P \neq NP$ by Eratosthenes sieve), for an independent, *pictorial* proof that the prime divisors of an integer are mutually independent by §22.A., Proposition 22.2; whence the Prime Number Theorem and Mertens’ Theorem further entail that $P \neq NP$.
- §22.A.f., Theorem 22.16 (FACTORISATION is not in P), for an independent, *evidence-based*, *arithmetical* proof that $P \neq NP$, since factorisation is not deterministically ‘polynomial time’.

4.B. An implicit ambiguity in the ‘official’ definition of P

We note that, in a 2009 survey [Frt09] of the status of the P vs NP problem, Lance Fortnow despairs that ‘we have little reason to believe we will see a proof separating P from NP in the near future’ since ‘[n]one of us truly understand the P versus NP problem’:

“... in the mid-1980’s, many believed that the quickly developing area of circuit complexity would soon settle the P versus NP problem, whether every algorithmic problem with efficiently verifiable solutions have efficiently computable solutions. But circuit complexity and other approaches to the problem have stalled and we have little reason to believe we will see a proof separating P from NP in the near future.

... As we solve larger and more complex problems with greater computational power and cleverer algorithms, the problems we cannot tackle begin to stand out. The theory of NP-completeness helps us understand these limitations and the P versus NP problems begins to loom large not just as an interesting theoretical question in computer science, but as a basic principle that permeates all the sciences.

... None of us truly understand the P versus NP problem, we have only begun to peel the layers around this increasingly complex question.”

... Fortnow: [Frt09].

In this investigation we shall argue that Fortnow’s pessimism reflects the circumstance that standard, set-theoretical, interpretations—such as the following¹⁵⁵—of the formal definitions of the classes P and NP in [Cook] can be seen to admit an implicit ambiguity:

¹⁵⁵See also [Mor12].

"The computability precursors of the classes P and NP are the classes of decidable and c.e. (computably enumerable) languages, respectively. We say that a language L is c.e. i.e. (or semi-decidable) iff $L = L(M)$ for some Turing machine M . We say that L is decidable iff $L = L(M)$ for some Turing machine M which satisfies the condition that M halts on all input strings w ."

... Cook: [Cook].

Comment 52. For instance, it is not clear from the above whether (a) $S \in P$ iff S is decidable and $S \in NP$ iff S is c.e, in which case the separation between the two classes would be qualitative; or whether (b) both P and NP are decidable classes, in which case (following contemporary wisdom) the separation between the two classes can be assumed to be only quantitative.

Specifically, from the *evidenced* based perspective of this investigation as reflected in the Complementarity Thesis (see §1., Thesis 1), and argued in §13.E.—concerning the relative strengths and limitations of first order set theories and first order arithmetics—set-theoretical interpretations of the P vs NP problem are *essentially* unable to recognise that the assignment of satisfaction and truth values to number-theoretic formulas, under a *well-defined* (in the sense of §7.F.) interpretation, can be defined in two, distinctly different, *evidence-based* ways¹⁵⁶:

(a) in terms of algorithmic *verifiability* (see §2., Definition 7);

It immediately follows from this definition that a number-theoretical formula F is algorithmically *verifiable* under an interpretation (and should therefore be defined in NP) if, and only if, we can define a checking relation $R(x, y)$ ¹⁵⁷—where x codes a propositional formula F and y codes a truth assignment to the variables of F —such that, for any given natural number values (m, n) , there is a deterministic algorithm which will finitarily decide whether or not $R(m, n)$ holds over the domain \mathbb{N} of the natural numbers.

(b) in terms of algorithmic *computability* (see §2., Definition 10).

It immediately follows from this definition that a number-theoretical formula F is algorithmically *computable* under an interpretation (and should therefore be defined in P) if, and only if, we can define a checking relation $R(x, y)$ ¹⁵⁸—where x codes a propositional formula F and y codes a truth assignment to the variables of F —such that there is a deterministic algorithm which, for any given natural number values (m, n) , will finitarily decide whether or not $R(m, n)$ holds over the domain \mathbb{N} of the natural numbers.

Consequently, standard, set-theoretical, interpretations of the formal definitions of the classes P and NP which do not admit the relative strengths and limitations of first order set theories and first order arithmetics (as argued in §13.E.), are liable to implicitly assume that every propositional formula which is algorithmically *verifiable* is necessarily algorithmically *computable*.

It would then follow that the differentiation between the classes P and NP is only quantitative, and can therefore be adequately expressed in terms of computational complexity; i.e., whether or

¹⁵⁶The distinction is explicitly introduced, and its significance in establishing a finitary proof of consistency for the first order Peano Arithmetic PA highlighted, by Theorem 6.8, p.41, in [An16] (see also §2.C., Theorem 2.16).

¹⁵⁷If F is a formula of the first order Peano Arithmetic PA, the existence of such a checking relation is assured by Theorem 5.1, p.38, in [An16] (see also §2.B., Theorem 2.2).

¹⁵⁸If F is a PA formula, the existence of such a checking relation is assured by Theorem 6.1, p.40, in [An16] (see also §2.C., Theorem 2.9).

not the class P can be defined as consisting of all, and only, those problems that can be solved in polynomial time by a deterministic Turing machine, and the class NP as consisting of all, and only, those problems that can be solved in polynomial time by a non-deterministic Turing machine.

However, we shall argue that—since the two concepts §4.B.(a) and §4.B.(b) are *well-defined*¹⁵⁹, and there are classically defined arithmetic formulas—such as Gödel’s ‘undecidable’ formula $[R(x)]$ ¹⁶⁰—which are algorithmically *verifiable* but not algorithmically *computable* (see [An16], Corollary 8.3, p.42; also §2.F., Corollary 2.21), the differentiation between the classes P and NP is also qualitative, and cannot be adequately expressed in terms of only computational complexity.

4.B.a. The P ν NP Separation Problem

In his 2009 survey [Frt09], Fortnow describes the P ν NP problem informally as follows:

“In 1965, Jack Edmonds . . . suggested a formal definition of “efficient computation” (runs in time a fixed polynomial of the input size). The class of problems with efficient solutions would later become known as P for “Polynomial Time”.

. . . But many related problems do not seem to have such an efficient algorithm.

. . . The collection of problems that have efficiently verifiable solutions is known as NP (for “Nondeterministic Polynomial-Time” . . .).

So P=NP means that for every problem that has an efficiently verifiable solution, we can find that solution efficiently as well.

. . . If a formula ϕ is not a tautology, we can give an easy proof of that fact by exhibiting an assignment of the variables that makes ϕ false. But if . . . there are no short proofs of tautology that would imply P \neq NP.”

. . . Fortnow: [Frt09].

From the *evidence-based* perspective of this investigation we shall, however, address the following, implicitly set-theoretical, formulation of the P ν NP Separation Problem:

Query 3. (Efficient P ν NP Separation) *Is there an arithmetical formula F that is efficiently verifiable and not efficiently computable?*

by considering a more precise formulation in arithmetic.

In other words, we shall avoid the ambiguity—in the meaning of Edmonds’ concept of ‘efficient’—which is admitted by asymmetrically defining ‘efficient computation’ as computation by a deterministic Turing machine in polynomial time, and ‘efficient verification’ as computation by a non-deterministic Turing machine in polynomial time.

We shall, instead, define Edmonds’ ‘efficient *computation*’ as ‘algorithmic *computation*’, and ‘efficiently *verifiable*’ as ‘algorithmically *verifiable*’; whence an affirmative answer to Query 3 would entail, and be entailed by, an affirmative answer to:

Query 4. (Algorithmic P ν NP Separation) *Is there an arithmetical formula F that is algorithmically verifiable but not algorithmically computable?*

We shall now show that Query 4 not only removes the ambiguity in the standard, set-theoretical, asymmetrical definitions of the classes P and NP, but it also admits of an affirmative answer.

¹⁵⁹In the sense of §7.F.. We note informally in [An13a] how the distinction between the two concepts may have far-reaching and significant consequences not only for the foundations of mathematics, logic and computability, but also for our perspective on the underlying structure of the laws of nature.

¹⁶⁰Which Gödel defines and refers to only by its Gödel number r in [Go31], p.25, eqn.12.

We shall first show how Gödel's β -function (see §16.A.) uniquely corresponds each classically defined real number to an algorithmically *verifiable* arithmetical formula.

Since classical theory admits the existence of real numbers that are not algorithmically *computable*¹⁶¹, we shall conclude that classical theory must also admit the existence of arithmetical formulas that are algorithmically *verifiable* but not algorithmically *computable*.

We note, first, that every *atomic* number-theoretical formula is algorithmically *verifiable*¹⁶²; further, by Tarski's definitions¹⁶³, the algorithmic *verifiability* of the *compound* formulas of a formal language (which contain additional logical constants) can be inductively defined—under a *well-defined* (see §7.F.) interpretation—in terms of the algorithmic *verifiability* of the interpretations of the atomic formulas of the language (see, for instance, [An16], §3, p.37; also §2.A.).

In particular, by [An16], §5, Theorems 5.6 and 5.7 (p.40; see also §2.B., Corollary 2.7 and Theorem 2.8), the formulas of the first order Peano Arithmetic PA are decidable under the *weak*, standard (see §2.B.), algorithmically *verifiable* interpretation $\mathcal{I}_{PA(\mathbb{N}, SV)}$ of PA over the domain \mathbb{N} of the natural numbers if, and only if, they are algorithmically *verifiable* under the interpretation.

Similarly, every *atomic* number-theoretical formula is algorithmically *computable*¹⁶⁴; further, by Tarski's definitions¹⁶⁵, the algorithmic *computability* of the *compound* formulas of a formal language (which contain additional logical constants) can be inductively defined—under a *well-defined* (see §7.F.) interpretation—in terms of the algorithmic *computability* of the interpretations of the atomic formulas of the language (see, for instance, [An16], §3, p.37; also §2.A.).

In this case, however, by [An16], Corollary 7.2 (p.41; see also §2.E., Corollary 2.18) the PA-formulas are *always* decidable under the *strong*, finitary, algorithmically *computable* interpretation $\mathcal{I}_{PA(\mathbb{N}, SC)}$ of PA over \mathbb{N} , since PA is categorical with respect to algorithmic *computability*.

We also note that, by [An16], Theorem 2.1 (p.37; see also §7.G., Theorem 7.2), there are algorithmically *verifiable* number theoretical formulas which are not algorithmically *computable*.

We note that algorithmic *computability* implies the existence of a deterministic algorithm that can *finitarily* decide the truth/falsity of each proposition in a well-defined denumerable sequence of propositions¹⁶⁶, whereas algorithmic *verifiability* does not imply the existence of a deterministic algorithm that can *finitarily* decide the truth/falsity of each proposition in a well-defined denumerable sequence of propositions¹⁶⁷.

From the point of view of a *finitary* mathematical philosophy, the significant difference between the two concepts could be expressed by saying that we may treat the decimal representation of a real number as corresponding to a physically measurable limit—and not only to a mathematically definable limit—if and only if such representation is definable by an algorithmically *computable* function.¹⁶⁸

¹⁶¹As detailed in [Tu36].

¹⁶²An immediate consequence of [Tu36].

¹⁶³On the inductive assignment of satisfaction and truth values to the formulas of a formal language under an interpretation; [Ta35].

¹⁶⁴An immediate consequence of [Tu36].

¹⁶⁵On the inductive assignment of satisfaction and truth values to the formulas of a formal language under an interpretation; [Ta35].

¹⁶⁶Which is why (see §2.D.) the PA Axiom Schema of Finite Induction *can* be *finitarily* verified as true (see §2.C.a., Lemma 2.12) under the *strong*, finitary, algorithmically *computable* interpretation $\mathcal{I}_{PA(\mathbb{N}, SC)}$ of PA, over \mathbb{N} , with respect to 'truth' as defined by the algorithmically *computable* formulas of PA.

¹⁶⁷Which is why, in this case (see §2.D.), the PA Axiom Schema of Finite Induction *cannot* be *finitarily* verified as true—but only algorithmically *verified* as true (see §2.B.a., Lemma 2.4)—under the *weak*, standard (see §2.B.), algorithmically *verifiable* interpretation $\mathcal{I}_{PA(\mathbb{N}, SV)}$ of PA, over \mathbb{N} , with respect to 'truth' as defined by the algorithmically *verifiable* formulas of PA.

¹⁶⁸The significance of this for the natural sciences is highlighted in §20.C.: Mythical 'set-theoretical' limits of

4.B.b. An arithmetical perspective on the PvNP Separation Problem

We finally argue that Gödel's β -function (see §16.A.) entails:

Theorem 4.4. *There is an arithmetical formula that is algorithmically verifiable, but not algorithmically computable, under any evidence-based interpretation of PA.*

Proof. Let $\{r(n)\}$ be the denumerable sequence defined by the denumerable sequence of digits in the decimal expansion $\sum_{i=1}^{\infty} r(i) \cdot 10^{-i}$ of a putatively *well-defined* real number \mathbb{R} in the interval $0 < \mathbb{R} \leq 1$.

By §16.A., Lemma 16.1, for any *specified* natural number k , there are natural numbers b_k, c_k such that, for any $1 \leq n \leq k$:

$$\beta(b_k, c_k, n) = r(n).$$

By §16.A., Lemma 16.2, $\beta(x_1, x_2, x_3)$ is strongly represented in PA by $[Bt(x_1, x_2, x_3, x_4)]$ such that, for any $1 \leq n \leq k$:

$$\text{If } \beta(b_k, c_k, n) = r(n) \text{ then PA proves } [Bt(b_k, c_k, n, r(n))].$$

We now define the arithmetical formula $[R(b_k, c_k, n)]$ for any $1 \leq n \leq k$ by:

$$[R(b_k, c_k, n) = r(n)] \text{ if, and only if, PA proves } [Bt(b_k, c_k, n, r(n))].$$

Hence every putatively *well-defined* real number \mathbb{R} in the interval $0 < \mathbb{R} \leq 1$ uniquely corresponds to an algorithmically *verifiable* arithmetical formula $[R(x)]$ since:

For any k , the primitive recursivity of $\beta(b_k, c_k, n)$ yields a deterministic algorithm $AL_{(\beta, \mathbb{R}, k)}$ that can provide evidence (in the sense of [Mu91] and [Lob59]; see §2.) for deciding the unique value of each formula in the finite sequence $\{[R(1), R(2), \dots, R(k)]\}$ by evidencing the truth under an *evidence-based* interpretation of PA for:

$$\begin{aligned} & [R(1) = R(b_k, c_k, 1)] \\ & [R(b_k, c_k, 1) = r(1)] \\ & \\ & [R(2) = R(b_k, c_k, 2)] \\ & [R(b_k, c_k, 2) = r(2)] \\ & \dots \\ & \\ & [R(k) = R(b_k, c_k, k)] \\ & [R(b_k, c_k, k) = r(k)]. \end{aligned}$$

The correspondence is unique because, if \mathbb{R} and \mathbb{S} are two different putatively *well-defined* reals in the interval $0 < \mathbb{R}, \mathbb{S} \leq 1$, then there is always some m for which:

$$r(m) \neq s(m).$$

Hence the corresponding arithmetical formulas $[R(n)]$ and $[S(n)]$ are such that:

$$\begin{aligned} & [R(n) = r(n)] \text{ for all } 1 \leq n \leq m. \\ & [S(n) = s(n)] \text{ for all } 1 \leq n \leq m. \\ & [R(m) \neq S(m)]. \end{aligned}$$

By [An16], §2, Theorem 2.1 (p.37; see also §7.G., Theorem 7.2), there is an algorithmically *uncomputable* real number \mathbb{R} such that the corresponding PA formula $[(\exists y)(R(x) = y)]$ is also algorithmically *uncomputable*, but algorithmically *verifiable*, under any *evidence-based* interpretation of PA over \mathbb{N} .

fractal constructions.

The theorem follows. □

We conclude that if we were to unambiguously separate the classes P and NP as in §4.B.a., then it would follow that:

Corollary 4.5. (P≠NP by separation) *If P is the class of problems that admit algorithmically computable solutions, and NP is the class of problems that admit algorithmically verifiable solutions, then $P \neq NP$.* □

Comment 53. See also:

- §4.A.a., Theorem 4.3 (SAT is not in P or NP), for an independent, *evidence-based, arithmetical* proof that SAT is not in P or NP since there is an arithmetical formula that is algorithmically *verifiable* as a tautology, but not recognisable as a tautology by any Turing-machine.
- §22.A., Proposition 22.5 (P≠NP by Eratosthenes sieve), for an independent, *pictorial* proof that the prime divisors of an integer are mutually independent by §22.A., Proposition 22.2; whence the Prime Number Theorem and Mertens' Theorem further entail that $P \neq NP$.
- §22.A.f., Theorem 22.16 (FACTORISATION is not in P), for an independent, *evidence-based, arithmetical* proof that $P \neq NP$, since factorisation is not deterministically 'polynomial time'.

4.B.c. Why the class NP is not *well-defined*

We can now see why the classical definition of NP cannot claim to be *well-defined*:

Theorem 4.6. (NP is algorithmically verifiable) *If a number-theoretical formula $[F(n)]$ is in NP, then it is algorithmically verifiable.*

Proof. By the classical definition of NP (in [Cook]), if $[F(n)]$ is in NP, then it is classically computable by a non-deterministic Turing machine, say NDTM, in polynomial time. Hence, for any *specified* natural number k , NDTM computes the sequence $\{[F(1), F(2), \dots, F(k)]\}$ in polynomial time. By Gödel's β -function (see §16.A.), we can define a primitive recursive function $[G_k(n)]$ such that $[G_k(i) = F(i)]$ for all $1 \leq i \leq k$. By §2., Definition 10, $[G_k(n)]$ is algorithmically *computable*. The theorem follows. □

Thus, for NP to be a *well-defined* class we would—in view of §4.A.a., Theorem 4.3 (SAT is not in P or NP), and §22.A.f., Theorem 22.16 (FACTORISATION is not in P)—need to prove, conversely, that if $[F(n)]$ is algorithmically *verifiable*, then it must be classically computable by a non-deterministic Turing machine *in polynomial time*.

Prima facie, such a proof is neither obvious, nor intuitively plausible from the *evidence-based* perspective of this investigation, as there seems to be no conceivable reason why—even in principle since *evidence-based* reasoning treats a formula that is not algorithmically *verifiable* as *ill-defined* (see §7.F.)—*every well-defined* number-theoretic formula *must*, necessarily, be classically computable by a non-deterministic Turing machine *in polynomial time*.

However, such a putative proof seems precisely what is implicitly appealed to in the 2019 claim [AAB19]¹⁶⁹ by a 78-member team of researchers, to have successfully reached the threshold of quantum supremacy by **building**¹⁷⁰ at Google AI Quantum, Mountain View, California, USA, a:

‘...high-fidelity processor capable of running quantum algorithms in an exponentially large computational space ...’

... Arute, Arya, Babbush, et al: [AAB19], §The future.

¹⁶⁹Already cogently challenged on the basis of competing experimental data by competing industry researchers, and on the basis of theoretical considerations in §24..

¹⁷⁰Structured, prima facie, essentially as in Deutsch, [Deu85] (see also Fiske, [Fi19]; §21.G.).

Comment 54. Prima facie, the purported implicit assumption in [AAB19] that ‘if $[F(n)]$ is algorithmically *verifiable*, then it must be classically computable by a non-deterministic Turing machine in *polynomial time*’, seemingly corresponds to the explicit thesis sought to be proven by Vasil Penchev—in his 2020 preprint [Pnc20]—that ‘...if the class of “non-P, but NP” problems is defined by means of “quantum superposition”, there exist calculations of quantum computer which cannot be simulate[d] by any Turing machine in any polynomial time, but the solution of quantum computer can be checked by a Turing machine for a polynomial time’¹⁷¹, where he argues that:

“The CMI Millennium “P vs NP Problem” can be resolved e.g. if one shows at least one counterexample to the conjecture “P is equal to NP”. A certain class of problems being such counterexamples is formulated. This implies the rejection of the hypothesis “P is equal to NP” for any conditions satisfying the formulation of the problem. Thus, the solution “P is different from NP” of the problem is proved. The class of counterexamples can be interpreted as any quantum superposition of any finite set of quantum states. The Kochen-Specker theorem is involved. Any fundamentally random choice among a finite set of alternatives belong[s] to NP, but not to P. The conjecture that the set complement of P to NP can be described by that kind of choice is formulated exhaustively.”

... Penchev: [Pnc20], Abstract.

4.B.d. An *evidence-based* separation of computational complexity

The preceding argumentation of §4.B.a. suggests that a more natural separation of computational complexity—that takes into account aspects of human mathematical cognition which, even if admitted as capable of being *evidenced* in what Markus Pantsar terms as ‘preformal mathematics’ in [Pan09], may not be formalisable mathematically in terms of provable formulas—could be to distinguish between:

- (i) all that is algorithmically *computable* by a deterministic Turing machine in *polynomial time*; which does not include FACTORISATION (see §22.A.f., Theorem 22.16) and SAT (see §4.A.a., Theorem 4.3);
- (ii) all that is algorithmically *computable* by a deterministic Turing machine in *exponential time*; which includes FACTORISATION but does not include SAT;
- (iii) all that encompasses evidencing algorithmically *verifiable* truths by meta-reasoning in *finite time*; which includes SAT, since a human intelligence can evidence the algorithmically *verifiable* truth of the Gödel sentence $R(x)$ (see [An16], Corollary 8.3, p.42; see also §2.F., Corollary 2.21) by meta-reasoning in *finite time*; reasoning which, however, by §21.E., Query 22, is not admitted by any mechanistic intelligence whose architecture admits the classical Church-Turing thesis.

We conclude by noting that, prima facie, referencing a Turing Test such as §21.E., Query 22 (Are you a man or a machine?), in para (iii) above, could admit aspects of human mathematical cognition such as those addressed by Pantsar in [Pan19]; doing justice to these considerations, however, lies outside the scope and competence of this *evidence-based* investigation:

“...In a purely computational-level approach it is natural to assume that human competence can be modeled by optimal algorithms for solving mathematical problems, rather than studying empirically what kind of problem solving algorithms actual human reasoners use.

While this computational-level approach has clear advantages, I submit that there should be limits to how strong and wide the application of the a priori computational methodology should be. As

¹⁷¹Compare with §4.B.b. (*An arithmetical perspective on the P vs NP Separation Problem*), Corollary 4.5 (P ≠ NP by separation) *If P is the class of problems that admit algorithmically computable solutions, and NP is the class of problems that admit algorithmically verifiable solutions, then P ≠ NP.*

fruitful as the computational complexity paradigm may be, we should not dismiss the possibility that human competence in mathematical problem solving may indeed differ in important and systematic ways from the optimal algorithms studied in the computational complexity approach. In the rest of this paper, I will argue that by including considerations on the algorithmic level, we can get a more informative framework for studying the actual human problem solving capacity. Furthermore, I will show that the algorithmic-level approach does not move the discussion from competence to performance. Instead, we get a theoretical framework that is better-equipped for explaining human competence by including considerations of the algorithms that are cognitively optimal for human reasoners."

...Pantsar: [Pan19], §5, *Complexity Within P and the Computational Paradigm*.

CHAPTER 5. INTRODUCTION

5. Three fragile Hilbertian, Brouwerian, and Gödelian, dogmas

We note that [An16] highlights the fragility of three Hilbertian, Brouwerian, and Gödelian mathematical and philosophical dogmas by showing that, from an—unarguably constructive—*evidence-based* perspective:

- (1) Since PA is not ω -consistent ([An16], Corollary 8.4, p.42; see also §2.F., Corollary 2.22; §12.B.f., Theorem 12.6), we cannot *unrestrictedly* conclude from the provability of $[(\exists x)F(x)]$ ¹⁷² that $[F(n)]$ is PA-provable for some *unspecified* numeral $[n]$, since such a putative numeral may not always be *specifiable* by the rules that determine the formation of PA-terms.

Hence *evidence-based* reasoning does not admit the standard—albeit *faith-based* (see §7.B.)—classical interpretation of quantification that Hilbert sought to formalise in his ε -calculus (see §7.);

- (2) The classical first-order logic FOL—in which the Law of the Excluded Middle (LEM) is the theorem $[A \vee \neg A]$ —is *finitarily* consistent (an immediate consequence of [An16], Theorem 6.7, p.41; see also §2.C.a., Theorem 2.15; §8.D., Theorem 8.13).

Thus *evidence-based* reasoning does not admit Brouwer’s belief that LEM—which he apparently conflated with Hilbert’s ‘principle of excluded middle’ (see §7.)—is non-constructive. We note that whereas Hilbert’s ‘principle of excluded middle’ entails LEM, the converse does not hold;

- (3) PA is categorical ([An16], Corollary 7.2, p.42; see also §2.E.b., Corollary 2.18); whence there are no formally undecidable arithmetical propositions definable over the numerals in PA.

Comment 55. However, in his sketch of his proof of undecidability in the system PM on pp.7-8 of [Go31], Gödel *does* implicitly—perhaps unconsciously—prove that if ZF is consistent, then there are formally undecidable arithmetical propositions definable over the finite ordinals in ZF (see §15.C.).

We note, though, that by §15.C., Lemma 15.1 (as well as by §19.A., Corollary 19.3, and independently by §19.A., Theorem 19.4), the structure of the finite ordinals under any putative *well-defined* interpretation of ZF is not isomorphic to the structure \mathbb{N} of the natural numbers; whence the subsystem ACA_0 of second-order arithmetic (see §19.A.) is not a conservative extension of PA. Hence arithmetical undecidability over the finite ordinals in ZF does not entail arithmetic undecidability over the numerals in PA.

Conservative extension: A theory T_2 is a (proof theoretic) conservative extension of a theory T_1 if the language of T_2 extends the language of T_1 ; that is, every theorem of T_1 is a theorem of T_2 , and any theorem of T_2 in the language of T_1 is already a theorem of T_1 .

Thus *evidence-based* reasoning does not admit Gödel’s belief that his formal reasoning in [Go31] entails non-standard models of PA (see also §18.).

The above three examples highlight the significance of *evidence-based* reasoning for asserting any piece of information as *knowledge* (see also §13.F.).

¹⁷²We note that $[(\exists x)F(x)]$ is merely an abbreviation for the formula $[\neg(\forall x)\neg F(x)]$, i.e., $[(\exists x)F(x) \equiv \neg(\forall x)\neg F(x)]$.

5.A. What is knowledge?

“When do we have a scientific fact? Scientists, policymakers, and laypersons could all use an answer to this question. But despite its obvious importance, humanity lacks a good answer.”

... Vickers: [Vck22].

The point is currently sought to be codified as FGB by philosopher and neuroscientist Gualtiero Piccinini in his thesis [Pic19], where he argues that any piece of information should be treated as *knowledge*:

- *only* if it is ‘*factually grounded belief*’ (FGB),
- and not if it is *only* a ‘*justified true belief*’ (JTB);

and where we treat his phrase ‘*a truthmaker*’ to correspond to a ‘*methodological evidence-based assignment of a truth-value by a witness*’ in the Tarskian sense (see §2.A.):

“According to the traditional analysis, to know that *p* is to have a justified true belief (JTB) that *p* (Plato, *Meno* 98). This traditional analysis seems to be missing something: beliefs can be both true and justified, yet fail to be knowledge. This is the Gettier problem (Gettier 1963). For example, consider someone who looks at a broken clock that displays 4:39 when, coincidentally, it is 4:39 (Russell 1948). Their belief that the time is 4:39 is true and justified; yet it does not amount to knowledge.

Gettier problem notwithstanding, some maintain that knowledge is justified true belief—or something close (e.g., Sellars 1975, p. 99; Hetherington 1999, 2011, 2016; Weatherson 2003; Turri 2012a, Kern 2017; see also Shope 1983, Turri 2012b, Olsson 2015, and Ichikawa and Steup 2017). Even virtue epistemology may be summarized as the claim that, in spite of Gettier, knowledge is virtuously produced true belief (Greco 1993, p. 413). This is not far from the traditional analysis.

I will argue that this allegiance is correct to this extent: the traditional analysis has the right ingredients but misses the right *connection* between them. The traditional analysis and cognate views endure despite the Gettier problem because they are tantalizingly close to the correct account.

In order for belief, justification, and truth to constitute knowledge, they must be mutually connected as follows: justification must tie a belief to the facts. Accordingly, I will argue that knowledge is *factually grounded belief*—belief grounded in the facts. This account explains why Gettierized beliefs do not count as knowledge, illuminates the sensitivity of knowledge attributions to epistemic standards, and suggests an improved reply to the skeptic.

A few caveats before we begin. First, I take “fact” as primitive. Second, I take a truthmaker to be whatever fact makes something true. Third, I assume truthmaker maximalism: every truth has a truthmaker. My proposal does not depend on truthmaker maximalism; I assume it because it makes the exposition easier. Fourth, for present purposes, grounding is an epistemically normative relation between a belief and the facts—grounding in this epistemic sense should not be confused with grounding as ontological dependence.”

... Piccinini: [Pic19] (preamble).

Piccinini apparently seeks to distinguish between:

- providing justification for a piece of information that is already accepted as an *infallible* truth¹⁷³ (a contentious—albeit inherited, and seemingly ‘*Platonic*’—attitude in the sense of §13.F.(1), which is only too familiar in day to day human conflict);

¹⁷³See, for instance, Oswaldo Chateaubriand: [Cha05], Chapter 24, *Knowledge and Justification*, pp.398-414.

Comment 56. Or a related thesis such as that of Job de Grefte who, whilst avoiding a claim of *infallibility* insofar ‘that knowledge is justified true belief’, yet argues that:

“What is knowledge? In this paper I defend the claim that knowledge is justified true belief. This account is well-known as the ‘classical’ or ‘tripartite’ analysis of knowledge. Many epistemologists, however, regard the claim to be plainly false.¹ In this paper I aim to show that the tripartite analysis of knowledge should be given more credit than the current state of the debate affords it.

My defence will be indirect: I will argue that, on a plausible interpretation of the justification condition, Gettier cases do *not* present counter-examples to the tripartite analysis of knowledge. If successful, my argument shows that the tripartite analysis is more plausible than commonly supposed, not that it is beyond question.”

Grefte: [Grf21], Introduction.

and

- providing justification for a piece of information that admits labeling it consequently as a *fallible* truth (the ideal attitude sought in any scientific enquiry in the sense of §13.F.(3)):

“1. *Knowledge is Factually Grounded Belief*

Gettier “successfully refuted the traditional analysis of knowledge as justified true belief” (Sosa et al. 2009, p. 189). Given that Gettier’s refutation is widely acknowledged, why have epistemologists continued to tiptoe around the traditional analysis? It’s because the traditional analysis has all the right ingredients. It just doesn’t connect them in the right way.

The flaw in the traditional analysis derives from what I call Plato’s procedure. Plato starts with true belief and tries to improve it; his proposal is to improve true belief by adding justification (Plato, *Meno* 98 and *Theaetetus* 201). Taking true belief as the starting point results both in the traditional analysis and an immediate dilemma: either justification entails truth, or it doesn’t.

If justification entails truth, then justified beliefs are infallible. As Julien Dutant (2015) argues, some version of infallibilism about justification was widely held until the 1950s. The problem is that, on the face of it, few if any of our beliefs have any kind of justification that entails their truth. Therefore, infallibilism about justification begets skepticism.

To avoid skepticism, many philosophers argued that at least some beliefs about our mental states are justified in the right way. In an effort to preserve knowledge, they attempted to reduce the external world to (bundles of) mental states. Prominent examples of this program are idealism and phenomenalism. When those efforts collapsed, infallibilism about justification collapsed with them. The historical outcome was precisely the fallibilist view that knowledge is JTB even though justification does not entail truth (Malcolm 1952; Chisholm 1956, 1957; Ayer 1956).

This is the view that Gettier refuted: if justification does not entail truth, then JTB falls short of knowledge. Any attempt to patch up the traditional analysis by adding conditions that do not entail truth is bound to encounter the same problem (Zagzebski 1994). To summarize the dialectic, infallibilism about justification is a dead end that ultimately leads either to skepticism or to fallibilism, and fallibilist versions of JTB face the Gettier problem (though see Dodd 2011, Littlejohn 2012, Schroeder 2015, Booth 2017, and Kern 2017 for recent efforts to revive versions of infallibilism).

The Gettier problem is so intractable that some have despaired of analyzing knowledge at all, or at least of analyzing knowledge as a kind of true belief (Williamson 2000). One radical departure from the JTB tradition is due to John Hyman (1999, 2006, 2015). He argues that knowledge is the ability to be guided by the facts in our actions, thoughts, and feelings. Although Hyman’s proposal is unviable, it contains a crucial insight that I will incorporate in my proposal.

Having the ability to be guided by the facts is neither necessary nor sufficient for knowledge. It is unnecessary because sometimes we know things without having the ability to be guided by what

we know. For instance, someone might know that fire is hot but lack the ability to be guided by that fact in thinking or acting, perhaps because they are in a minimally conscious state. It is insufficient because there are situations in which we are guided by a fact without knowing that fact. For instance, someone's typing might be guided by the relative positions of the keys on the keyboard absent any knowledge *that* the keys are in certain positions. In other words, someone may be guided by the fact that p simply because they know *how* to respond to p ; they may not know that p (cf. Hughes 2014). Another limit of Hyman's account is that it calls for an explanation of how we are guided by the facts. In many cases, the explanation involves our ability to represent knowledge in our minds, which pushes us back towards JTB accounts.

Even though knowledge is not the ability to be guided by the facts, there is something right about Hyman's proposal: knowledge is partially constituted by an agent's relation to the facts. I will graft Hyman's insight onto the traditional analysis of knowledge.

The solution is to abandon Plato's starting point. Instead of starting with true belief and trying to improve on true belief, as Plato and his many followers do, let's start with belief alone. A first improvement to belief is justification: a justified belief is better than a belief without justification. To avoid some of the internalist connotations of the term "justification," I use the term "grounding" instead. Thus, a first improvement over belief alone is that a belief be grounded. A second improvement connects the belief to the facts. As I use the term, a belief is factually grounded if and only if that belief's grounding connects it with its truthmaker and other relevant facts. Please note that although for simplicity I will write that having knowledge that p amounts to having a belief grounded in the fact that p , grounding a belief in its truthmaker may require connecting it to other facts besides its truthmaker. When a belief is thus grounded in the facts, it amounts to knowledge. The result is an account of knowledge as belief grounded in the facts—*factually grounded belief*.

More explicitly:

Factually Grounded Belief (FGB)

An agent A knows that p if and only if:

- (1) A believes that p
- (2) A's belief that p is grounded
- (3) A's belief that p is grounded in the fact that p .

Compare this to the traditional analysis:

JTB

An agent A knows that p if and only if:

- (4) p is true
- (5) A believes that p
- (6) A's belief that p is justified.

(1) is the same as (5) and, setting aside the terminological difference, (2) plays the same role as (6). The main difference between the two accounts is that (3) entails (4) but not vice versa.

Requiring that knowledge be grounded in the facts meets Stephen Hetherington's (2016) challenge of explaining why Gettierized beliefs do not count as knowledge even though they are justified, true, and yet possibly false—that is, explaining why Gettierized beliefs are not knowledge without presupposing any implicit infallibilism. The explanation is that Gettierized beliefs are grounded to a degree—a degree that varies from Gettier case to Gettier case—but they are not fully grounded in the facts. That's also why Gettierized beliefs could easily have been false: since they are not fully grounded in the facts, minor departures from the alignment of factors that conspires to make them both justified and true would result in their being false."

... Piccinini: [Pic19], §1.

Piccinini's further analysis of '*Factually Grounded Belief*' suggests we can cogently argue that:

- Hilbert's (§5., 1),
- Brouwer's (§5., 2), and
- Gödel's (§5., 3),

mathematical and philosophical dogmas are *fragile* because although, *prima facie*, they appear acceptable as '*Justified True Beliefs*', they cannot claim further to ensure their categorical communication—as they ought to—in order to be treated as '*Factually Grounded Beliefs*':

“2. *Factually Grounded Belief*

Knowledge is factually grounded *belief*. A belief is an agent's cognitive state that represents things as being one way or another and guides the agent, whether consciously or unconsciously. Cognitive states are part of an agent's cognitive economy—they interact with other cognitive states and sensory inputs to form new cognitive states and guide actions. A belief in this sense may guide the agent's action in some circumstances but not others.

...

Knowledge is *factually* grounded belief. “Factually” refers first and foremost to the specific fact a true belief is about—a true belief's truthmaker. It also refers to other facts that must be taken into account to fully ground a belief. Knowledge is *factive* because the beliefs that partially constitute it represent facts. By the same token, false beliefs cannot be knowledge because they do not represent facts.”

... Piccinini: [Pic19], §2.

Moreover, the *fragility* of Hilbert's and Brouwer's dogmatic beliefs (identified in §11.) illustrates Piccinini's argument that:

- although ‘a true belief is a belief with the property of being true’ in current paradigms, such as those admitting *Justified True Belief* as the norm (e.g., in Chateaubriand [Cha05]);

Comment 57. Amongst the latest to defend this thesis is Job de Grefte, who argues that:

“... by focussing [sic] on the relation between epistemic justification and luck, we can defend the traditional analysis of knowledge as justified, true, belief. Gettier cases are usually seen to refute any such attempt, but we have seen that all Gettier cases involve veritic luck, and that a plausible version of reliabilism about epistemic justification eliminates veritic luck. If this is so, then no belief in Gettier cases is epistemically justified, properly understood. That means that Gettier cases lose their teeth, and we can consistently maintain the claim that knowledge is justified true belief even in the light of any failure to know in Gettier cases.”

Grefte: [Grf21], Conclusion.

- such a ‘belief’ may not necessarily be ‘true’ to the ‘facts’—in which it implicitly claims to be ‘grounded’—according to Piccinini's suggested paradigm, where *Factually Grounded Belief* is the norm:

“A true belief is a belief with the property of being true. Being true is being in accordance with the facts—at least on a correspondence theory of truth. So on a JTB account, the facts are relevant to being true, but the facts themselves may not be constitutive of truth, and therefore of being a true belief. In other words, while requiring that a belief be true does relate a belief to the facts, it need not include the facts as a constituent of a true belief. Being grounded in the facts does include the facts as a constituent.

The fact that makes a belief true is that belief's truthmaker. According to the present proposal, a belief amounts to knowledge just in case it's grounded in its truthmaker. Thus, the FGB account

is similar to the truthmaker account of knowledge proposed by Adrian Heathcote in a series of recent papers (2006, 2012, 2014a, 2014b, 2016). Heathcote argues that Gettier's counterexamples can be addressed by distinguishing the truthmaker for the belief from the proposition that justifies the belief, showing that these two come apart in Gettier cases, and then requiring that they not come apart in cases of knowledge. In other words, Heathcote argues that in order to constitute knowledge, it's not enough that a belief be true and justified—in addition, the truthmaker for the belief and the "state of affairs from which the evidence for the belief is drawn" (2006, 151) must be identical.

In his official formulation, Heathcote requires that the justification agents have for their belief must be evidence of the fact that makes the belief true. He adds this as a fourth condition to JTB: "the evidence that [the agent] has which constitutes the justification is evidence of the very state of affairs that makes [the belief] true" (2006, p. 165). In Heathcote's usage, evidence *of* a fact should not be confused with evidence *for* a fact. Unlike evidence *for*, evidence *of* is factive (2014a, p. 3); so, having evidence of p entails that p . This makes the requirement that the belief be true redundant. If we eliminate this redundancy, Heathcote's truthmaker account overlaps the JTB account in a way that parallels the FGB account:

Truthmaker Account An agent A knows that p if and only if:

- (5) A believes that p
- (6) A's belief that p is justified
- (7) A's belief that p is justified by evidence of p .

By requiring that the evidence justifying a belief be *of* the belief's truthmaker, Heathcote can elegantly address those Gettier cases in which the truthmaker for the belief is different from the proposition that justifies the belief. His truthmaker account does not accommodate Gettier cases in which a belief is justified by evidence of its truthmaker."

... Piccinini: [Pic19], §2.

The significance of Piccinini's argument that any piece of information should be treated as *knowledge*:

- *only* if it is '*factually grounded belief*' (FGB),
- and not if it is *only* a '*justified true belief*' (JTB);

is itself grounded in the findings of contemporary research 'on the capacity to understand others' minds', where Jonathan Phillips et al contend that:

"Research on the capacity to understand others' minds has tended to focus on representations of *beliefs*, which are widely taken to be among the most central and basic theory of mind representations. Representations of *knowledge*, by contrast, have received comparatively little attention and have often been understood as depending on prior representations of belief. After all, how could one represent someone as knowing something if one doesn't even represent them as believing it? Drawing on a wide range of methods across cognitive science, we ask whether belief or knowledge is the more basic kind of representation. The evidence indicates that nonhuman primates attribute knowledge but not belief, that knowledge representations arise earlier in human development than belief representations, that the capacity to represent knowledge may remain intact in patient populations even when belief representation is disrupted, that knowledge (but not belief) attributions are likely automatic, and that explicit knowledge attributions are made more quickly than equivalent belief attributions. Critically, the theory of mind representations uncovered by these various methods exhibit a set of signature features clearly indicative of knowledge: they are not modality-specific, they are factive, they are not just true belief, and they allow for representations of egocentric ignorance. We argue that these signature features elucidate the primary function of knowledge representation: facilitating learning from others about the external world. This suggests a new way of understanding theory of mind—one that is focused on understanding others' minds in relation to the actual world, rather than independent from it."

... Phillips et al: [PBC20], Long Abstract.

From the *evidence-based* perspective of the Complementarity Thesis (§1., Thesis 1), ‘*knowledge*’ in the sense of Phillips et al can be corresponded to our sensory observations and their associated perceptions of a ‘common’ external world’—that are termed as a natural scientist’s ‘primary’ and ‘secondary’ *conceptual metaphors* (see §13.C.)—which we:

- first seek to represent *unambiguously* as intuitively ‘*Justified True Beliefs*’ (that—as argued in §7.B.—may be *faith-based* rather than *evidence-based*) in a language of *adequate* expression (such as, say, the first-order Zermelo-Fraenkel Set Theory ZF when expressing our ‘mathematical’ conceptual metaphors; see §13.E.);
- and then seek to communicate as Piccinini’s ‘*Factually Grounded Beliefs*’ to another in a language of *categorical* communication (such as, say, the first-order Peano Arithmetic PA when expressing our ‘mathematical’ conceptual metaphors; see §13.E.); categorical in the sense that what is eventually communicated can be corresponded unequivocally back to our original sensory observations—and their associated perceptions of a ‘common’ external world’—and, thereby, be termed as ‘*knowledge*’ which can then be treated as ‘*factually grounded belief*’.

The significance of such a distinction is that, by treating seemingly conflicting philosophical perspectives as *complementary*—such as a metaphysicist’s appeal to JTB vis à vis a scientific realist’s appeal to FGB¹⁷⁴—it protects their mutually benefiting features from being eclipsed by distracting differences as reflected, for instance, in Simon Allzén’s argumentation in [Alz22]:

“The main purpose of this paper is to refute the ‘methodological continuity’ argument supporting epistemic realism in metaphysics. This argument aims to show that scientific realists have to accept that metaphysics is as rationally justified as science given that they both employ inference to the best explanation, i.e. that metaphysics and science are methodologically continuous. I argue that the reasons given by scientific realists as to why inference to the best explanation (IBE) is reliable in science do not constitute a reason to believe that it is reliable in metaphysics. The justification of IBE in science and the justification of IBE in metaphysics are two distinct issues with only superficial similarities, and one cannot rely on one for the other. This becomes especially clear when one analyses the debate about the legitimacy of IBE that has taken place between realists and empiricists. The metaphysician seeking to piggyback on the realist defense of IBE in science by the methodological continuity argument presupposes that the defense is straightforwardly applicable to metaphysics. I will argue that it is, in fact, not. The favored defenses of IBE by scientific realists make extensive use of empirical considerations, predictive power and inductive evidence, all of which are paradigmatically absent in the metaphysical context. Furthermore, even if the realist would concede the methodological continuity argument, I argue that the metaphysician fails to offer any agreed upon conclusions resulting from its application in metaphysics.”

... Allzén: [Alz22], Abstract.

Comment 58. The dangers—as cautioned in the Author’s preface—of not distinguishing between what we believe to be true, what we can evidence as true, and what we ought not to believe as true, are reflected in uncritically inherited dogmas that, seemingly implicitly, treat—and perhaps yet continue to treat—‘Knowledge’ as synonymous with intuitively ‘Justified True Belief’.

For instance, from the *evidence-based* perspective of this investigation, what philosopher David Owens terms in his [Own06] as the ‘*Belief Expression* mode of testimony’ could be viewed as—albeit inadvertently—having planted the seeds for the recently emerging political doctrine of ‘alternative facts’¹⁷⁵; by seemingly endorsing—perhaps unintentionally in literature open to ‘loose’ interpretation by emerging, and yet to be committed, scholars—that even when an untenable—i.e.,

¹⁷⁴Critical for recognising the relative strengths and limitations of the first-order languages ZFC and PA, as argued in §13.E.

¹⁷⁵As alluded to, for instance, in the Author’s preface.

‘factually dubious’ or even, in some cases, falsifiable—but individually justified as ‘knowledge’, ‘expression of belief has an audience, and that audience believes what the speaker says, that audience may acquire a belief with the same justificational status. And when the belief expressed constitutes knowledge, they may thereby learn what the speaker knows’:

“A number of writers have recently questioned the idea that an assertion can transmit knowledge only by serving as evidence for the truth of the proposition asserted. Instead they maintain that successful testimony does its work by getting the audience to believe what the speaker asserts whilst putting the responsibility of justifying that belief onto the speaker.¹ Like many fruitful ideas, this line of thought has been developed in rather different ways by different authors. In this paper, I shan’t attempt to defend non-evidentialist views of testimony against their opponents. Rather I shall compare two different forms of non-evidentialism with a view to discovering the best version of this approach to testimony.

I am concerned with a distinctive way in which language users transmit information: they assert things. To accept testimony is to take someone else’s word for it. Thus any epistemology of testimony presupposes some account of assertion and of the role that it plays in testimony. According to the *Assurance* model, we can learn that p when someone *tells us* that p; telling someone that p involves asserting that p with a view to providing them with an assurance that p is true. Assurance theorists maintain that the audience is usually entitled to accept these assurances, thereby acquiring a belief which it is up to the speaker to justify. When all goes well, the audience thereby learns that p.

According to the *Belief Expression* model of testimony, we can learn that p when we hear someone assert that p. On this view, to sincerely assert that p is to express (in a distinctive way) your belief in p, where *expressing* a belief differs both from indicating to others tha[t] you have it and from giving them an assurance that it is true. When such an expression of belief has an audience, and that audience believes what the speaker says, that audience may acquire a belief with the same justificational status. And when the belief expressed constitutes knowledge, they may thereby learn what the speaker knows.”

... Owens: [Owm06], §1. Introduction.

That Owens is seemingly seized of the underlying issue—even if only implicitly—is reflected in his ‘debatable’ distinction that ‘the act of assertion expresses belief and thereby enables its audience to acquire not knowledge of the speaker’s belief but a belief with the same content and epistemic credentials and thus knowledge of the fact testified to’:

“For the evidentialist about testimony, the act of assertion is a fallible indicator of the speaker’s belief. Would we could know of this belief directly without the mediation of this act. The assurance theorist responds that the act of assertion provides the hearer with something which he could never get simply from knowledge of the speaker’s beliefs. But the assurance theorist mischaracterizes this something as a guarantee or promise, tracing the special epistemic significance of assertion to the addressive relation it establishes with the hearer. I have proposed that the act of assertion expresses belief and thereby enables its audience to acquire not knowledge of the speaker’s belief but a belief with the same content and epistemic credentials and thus knowledge of the fact testified to.²³”

... Owens: [Owm06], §6. Conclusion.

‘Debatable’, since the intellectual level of the hypothetical ‘audience’ that is even capable of distinguishing between the two, within a dialogue in languages of common discourse, is left unaddressed; as is a categorically communicable explication of the terms ‘know’ and ‘knowledge’.

Comment 59. Similarly—from the *evidence-based* perspective of this investigation—what can be viewed as the pernicious influence of uncritically inherited dogmas which yet treat ‘Knowledge’

as, essentially, synonymous with intuitively ‘Justified True Belief’, is also reflected in Philipp Berghofer’s [Bgh23].

Berghofer seemingly seeks to avoid the implicit, and essentially ‘subjective’, commitment of an unexplicated ‘truth’ value, to claims of à priori intuitive beliefs, by redefining the concept more in keeping with, but seemingly short of, Piccinini’s concept in [Pic19] of ‘Knowledge’ as ‘Factually Grounded Belief’; albeit *without* explicitly challenging the definition of ‘Knowledge’ as intuitively ‘Justified True Belief’, since he claims that ‘perhaps the distinctive feature of my definition of a priori knowledge is that I neither need to make the justification condition so strong that only infallible justification is allowed, nor do I need to explicitly introduce a truth condition’:

“... Intuitions do not simply present their contents as true. They seem to make you aware of why the intuited proposition must be true.⁹ Above I have briefly motivated my view that if an intuition is non-veridical, then the intuiting subject made an error, has overlooked something. This means that the method of intuiting is method-infallible in the sense specified above. In this paper, I presuppose this view on intuition and intellectual hallucination and spell out what I consider its main consequence. This consequence is that we can put forward the following analysis of knowledge that avoids the Gettier cases specified in Section 1.

Definition of a priori knowledge:

S a priori knows that p iff

- (i) S has an intuitional experience as of p or deduces p from premises S is or has been intuiting,
- (ii) S believes that p based on these intuitions and deductions,
- (iii) S performed the method(s) of intuiting and (if also involved) deduction correctly (there is no agent-failure),
- (iv) S has no (a priori) counter-evidence that defeats their belief in p ; S is *ultima facie* justified in believing p .

(i) ensures that S is justified in believing p . However, note that this is propositional justification. (ii) ensures that S believes that p and that S is doxastically justified in believing that p . (iii) ensures that p is true. What is more, (iii) ensures that S’s belief in p is non-accidentally true. It is impossible to construct cases of epistemic luck in which the conditions (i) and (iii) are fulfilled but S has been lucky in an epistemically defective way. What is important and perhaps the distinctive feature of my definition of a priori knowledge is that I neither need to make the justification condition so strong that only infallible justification is allowed, nor do I need to explicitly introduce a truth condition. As Linda Zagzebski has famously observed: ‘I conclude that Gettier problems are inescapable for virtually every analysis of knowledge which at least maintains that knowledge is true belief plus something else’ (Zagzebski, 1994, p. 65). My conception escapes the Gettier problem because I do not need to explicitly postulate truth. Truth necessarily follows from only allowing method-infallible forms of justification and postulating that there has not been an agent-failure. Contrast this with (BonJour, 2010) where Laurence BonJour opts for only allowing infallible justification in order to avoid the Gettier problem. Indeed, BonJour also succeeds in avoiding Gettier cases since he does not need to explicitly postulate truth, but his account radically limits the scope even of a priori knowledge. I take it that my account is clearly superior since it allows for knowledge in all the cases we typically assume to have a priori knowledge.”

... Berghofer: [Bgh23], §3 An Analysis of a priori knowledge.

Comment 60. A yet more unsettling¹⁷⁶ view of the very ‘concept of knowledge’ as inherently dangerous and, implicitly, dispensable, is that of David Papineau in [Ppn19]; where he argues:

¹⁷⁶Albeit, arguably, more ‘practical’ from the perspective of Charles Dickens’ Mr. Bumble (‘The law is an ass’; see §20..

“... that the concept of knowledge is a relic of a bygone age, erroneously supposed to do no harm. I illustrate this claim by showing how a concern with knowledge distorts the use of statistical evidence in criminal courts, and then generalize the point to show that this concern hampers our enterprises across the board and not only in legal contexts.”

... Papineau: [Ppn19], Abstract.

What is particularly ‘unsettling’ in view of the rapid emergence of AI-based Large Language Models as communication tools with incrementally increasing reliability, is Papineau’s seemingly implicit acceptance of uncritically inherited paradigms that categorical communication—in the sense of [An16], Corollary 7.2, *PA is categorical with respect to algorithmic computability*)—is unfeasible; and need not be pursued as an attainable goal for finitarily defining what could then be treated—amongst intelligences with a lingua franca—as ‘knowledge’ in Gualtiero Piccinini’s sense in [Pic03] of ‘Knowledge’ as ‘Factually Grounded Belief’ that is *evidence-based* (in the sense of [An16]):

“Once we do have the concept of belief to hand, it is not clear why we should continue to be interested in knowledge. Of course, we will still want to distinguish, among believers, those whose thinking is in line with the facts, and those whose isn’t, for the actions of the former but not the latter will generally meet with success. But the notion of *true belief* would seem to serve this function just as well as *knowledge*. A true belief that some cake is in the pantry will ensure the satisfaction of hunger just as well as knowledge to the same effect.

(Moreover, once we have the concept of belief to hand, we can also think about *degrees of belief*, and about their conformity to relevant objective probabilities. This offers further levels of conceptual sophistication with which to manage our doxastic affairs. But let us leave such refinements until later. For now I will stick to belief *simpliciter*. I will return to degrees of belief in Sect. 10.)

If knowledge calls for more than true belief, as on an intuitive level it clearly does, then why should it matter to anything whether or not the extra requirements are satisfied? What extra pay-off is delivered by knowledge but not true belief? As we shall shortly see, plenty of philosophers have sought to identify some such knowledge-dividend, some way in which the possession of knowledge makes a positive difference. Still, such attempts to find ‘the value of knowledge’ have met with very limited success. It has proved remarkably difficult, to say the least, to show how knowledge delivers better consequences than true belief or might otherwise be of benefit to its possessors.²

My own view is that there is no such pay-off and so no need to be interested in knowledge. The concern with knowledge is a stone-age hangover. Knowledge differs from true belief in ways that derive from the primitive idea of perceptual openness to a fact. But there is no advantage in focusing on this archaic category. We would do just as well if we forgot about knowledge and concerned ourselves only with true belief. Now that the more sophisticated notions of belief and truth are available, we get no benefit from pursuing knowledge.

In fact, I shall be arguing that things are worse than this. Not only does a concern with knowledge do no good, it does an appreciable amount of harm. Somewhat paradoxically, I shall defend this claim by focusing on what I regard as the most plausible account of a distinctive pay-off delivered by knowledge. Clayton Littlejohn has recently argued that we cannot make sense of certain legal practices unless we recognise that they are aimed at ensuring we do not convict and punish when guilt cannot be *known* (Littlejohn 2017). I think he is entirely right about this. As we normally think, we regard punishment when guilt cannot be not known as unacceptable, even when guilt is overwhelmingly probable.

My reaction is that, even if this how we ordinarily think, we ought not to. We might find it natural to shape our practices in this way, but the world would be a better

place if we did not. We are being seduced by archaic ways of thinking into procedures that positively hinder our attempts to punish the guilty and save the innocent. We need to stop thinking in terms of knowledge.

I shall focus on the legal example because it brings out the issues in a particularly clear way. But I take the point to be of far more general significance. The premium placed on knowledge does not only distort the workings of courts of law. It hampers our thinking across the board as well as in legal contexts. I shall discuss these more general implications in the last two sections of this paper.

² What about the value of true belief? In previous papers I have argued that this is derivative rather than fundamental (Papineau 1999, 2013). For present purposes, however, we can put this issue to one side, and take it as given that true belief is valuable.
 ... Papineau: [Ppn19], 2 Knowledge and true belief, pp.5312-5313.

We note, however, that from the *evidence-based* perspective of this investigation, the issue ought not to be whether or not ‘true belief’ is, or is not, ‘valuable’. That issue ought to be satisfactorily settled if we interpret Markus Pantsar’s implicit perspective in [Pan19] (see also §1.A.) as further implying that ‘true belief’ is the essential ‘ladder’ that leads to ‘factually grounded belief’; and that recognising use of such a ‘ladder’ is essential for grounding the significance of the latter in the former.

To place this in perspective, we note the similar case for the first-order Peano Arithmetic PA vis à vis the first-order Set Theory ZF (see §13.E.); where the theorems of ZF interpret as Platonic mathematical truths which can be treated as algorithmically computable, finitary, categorically communicable mathematical truths¹⁷⁷ if, and only if, they can be *well-defined*, and proven, in PA.

That Papineau is seemingly as much aware of the need for such an *evidence-based* perspective of ‘truth’, ‘belief’, and ‘knowledge’, as he is sceptical of finding appropriate ‘norms’ for *well-defining* the concepts, is reflected in his concluding section of [Ppn19]:

“What communicative practice might we engage in, if not one governed by a norm of knowledge? This is not the place to resolve this issue, but it is worth observing that many languages require speakers to mark all indicative utterances with an *evidential* that indicates the provenance of their claim (such as first-hand observation, testimony, inference, and so on, depending on the range of evidentials available) (Aikhenvald 2004). This seems an improvement on a system that simply assumes that all indicative utterances are geared to a single standard. This is not to argue that all languages need a formal system of evidentials. Speakers can always use other means to convey what kind of backing their claims enjoy. Indeed it is hard to believe that this isn’t already demanded of speakers of non-evidential languages, in any context where hearers are likely to rely on their claims. The idea that communication hinges on a uniform category of ‘assertion’ answering to some undifferentiated standard strikes me as something of a philosophical myth.

Finally, let me mention the idea that the notion of knowledge is needed to understand *evidence*. Timothy Williamson has argued that our evidence always coincides with we know and defends this equation as the best explanation of various intuitive facets of evidence.

This topic deserves fuller discussion, but let me make some quick remarks. A first question is whether we need a uniform notion of evidence, rather than a more flexible understanding of legitimate starting points for different kinds of investigative reasoning (Joyce 2004). Second, even if we do need such a uniform notion, why should it require flat-out belief, as opposed to credences on which we can Jeffrey-conditionalize (Jeffrey

¹⁷⁷By the Provability theorem for PA; see:

- (a) §2.E.b., Theorem 2.17: *A PA formula $[F(x)]$ is PA-provable if, and only if, $[F(x)]$ is algorithmically computable as always true in \mathbb{N} ; and*
- (b) §2.E.b., Corollary 2.18: *PA is categorical.*

1965, ch. 11)? Third, even if these two points are granted, it is debatable whether the intuitive structure of evidence is best explained by equating it with knowledge rather than with justified non-inferential belief, or true non-inferential belief, or perhaps true justified non-inferential belief; Alvin Goldman has argued in detail that the points Williamson appeals to are equally well accommodated by the first of the latter options (Goldman 2009). And finally, and most importantly, even if the intuitive notion of evidence were tied to the concept of knowledge, it is hard to see how that could be a good thing, given the way that the concept of knowledge arbitrarily privileges causal sources of belief over others."

... Papineau: [Ppn19], 12 *Knowledge norms*, pp.5329-5330.

5.B. A removable ambiguity in Brouwer-Heyting-Kolmogorov realizability

We note [An16] also highlights that the roles of classical and constructive mathematics are interdependent and complementary; as evidenced, for instance (see also §2.D., Poincaré-Hilbert debate), by the Provability Theorem for PA (see §2.E.b., Theorem 2.17), which bridges formal arithmetical provability and its interpreted, *evidence-based*, arithmetical truth under the *finitary* interpretation $\mathcal{I}_{PA(\mathbb{N}, SC)}$ of PA.

The far-reaching consequences of such complementarity for mathematics, mathematics education, philosophy and the natural sciences, are appreciated once we identify, and remove, the root of a critical ambiguity in interpreting quantification constructively (see §7.C.)—essentially an ambiguity in Brouwer-Heyting-Kolmogorov realizability—which seems to have, for instance, inhibited the recognition of (see §13.E.):

- (a) The role of a first-order set theory such as ZFC in identifying those of our mathematical metaphors (as detailed, for instance, in [LR00]; see also §27.) which can be *defined* unambiguously;

vis à vis:

- (b) The role of a first-order Peano Arithmetic such as PA in identifying those of our mathematical metaphors which can, further, be *well-defined* and communicated *categorically*.

We identify the root of the ambiguity as lying in the postulation of an *unspecified* value in classical, *faith-based* (see §7.B.), existential quantification—e.g., by appeal to Hilbert’s ε -function (see §10.A.), or to Rosser’s Rule C (see §8.G.)—without *evidencing* that such an *unspecified* value is *specifiable*—i.e., *well-defined* (see §7.F.; also Theorem 7.5)—by the rules that circumscribe the domain of the quantifier.

5.B.a. Paradigm challenging consequences

It is an ambiguity which, further, by failing to differentiate that:

- (a) algorithmic *verifiability* (§2., Definition 7); and
- (b) algorithmic *computability* (§2., Definition 10);

are distinct, but *constructive*, concepts (as is the concept algorithmic ‘*undecidability*’; see [Fe94], p.6), has far-reaching consequences for varied logical, mathematical, philosophical and scientific paradigms (as detailed in Part IV, §16. to §28.).

Paradigms which, we shall argue, have hitherto tolerated unsustainable, *faith-based*, beliefs whose illusory ‘self-evidentiary’ appeal (for instance, the ‘obviousness’ of an isomorphism between the structure of the natural numbers and that of the finite ordinals in Goodstein’s *curious* argumentation highlighted in Part IV, §19.) could, reasonably, be viewed as owing more to psychological factors than to mathematical ones—as Andrej Bauer ([Ba16]) suggests from a classically constructive perspective (or to theological ones, as Stanislaw Krajewski argues in [Kr16]).

CHAPTER 6. INTRODUCTION

6. Overview

To situate our foregoing thesis in an appropriate perspective vis à vis current mathematical beliefs and practices, we shall begin the rest of our investigation (in Part II) by a broad analysis of quantification vis à vis:

1. Hilbert's ε -function (§7.);
2. Hilbert's principle of excluded middle (§7.);
3. Aristotle's particularisation (§7., Definition 20);
4. An *evidence-based* perspective of quantification (§2., Definitions 7, 10, and §7.C., Definitions 21 to 24);
5. Wittgenstein's perspective of constructive mathematics (§7.J.);
6. An *evidence-based* definition of effective computability (§7.H.b., Definition 28);
7. The Church-Turing Thesis (§7.H.b., Theorem 7.3, and §10.C., Theorem 10.3);
8. Cantor's diagonal argument (§7.I.a.);
9. An Algorithmic ω -Rule (§8.);
10. Hilbert's ω -Rule (§8.C., Lemma 8.5);
11. Gentzen's Rule of Infinite Induction (§8.B., Thesis 3);
12. Gödel's ω -consistency (§8.D., Corollary 8.10);
13. The Law of the Excluded Middle (§8.D., Corollary 8.15);
14. Markov's Principle (§8.E., Corollary 8.16);
15. The Axiom of Choice (§8.F., Lemma 8.18);
16. Rosser's Rule C (§8.G., Corollary 8.21);
17. Hilbert's purported 'sellout' of finitism (§9.).

By showing how these are formally inter-related, we shall highlight (in §11.A.) the fragility of both the persisting, *theistic*, classical/Platonic interpretation of quantification grounded in Hilbert's ε -calculus; and the persisting, *atheistic* (see §11.B.), constructive/Intuitionistic interpretation of quantification rooted in Brouwer's unjustifiable belief that the Law of the Excluded Middle (LEM) is not finitary.

We shall then consider (in §11.C.) an *agnostic, evidence-based* interpretation of quantification that:

- (a) admits *evidencing* the satisfaction and truth of the *quantified* formulas of the first-order Peano Arithmetic PA, over the domain \mathbb{N} of the natural numbers, in two, hitherto unsuspected and essentially different, ways: namely, in terms of *weak* algorithmic *verifiability* (§2., Definition 7) and *strong* algorithmic *computability* (§2., Definition 10);

- (b) yields (see §2.C.a., Theorem 2.16) a finitary proof of consistency for PA, as sought by Hilbert in the second of his twenty three Millenium 1900 Problems (see [Hi00]); an immediate consequence of which is that the classical first-order logic FOL—in which LEM is a theorem—too is finitarily consistent (see §8.D., Theorem 8.13).

In Part III, §12. we shall consider some consequences—for mathematics, mathematics education, philosophy, and the natural sciences—of formalising a Wittgensteinian perspective of constructive mathematics; and in §15.C. consider the questions of whether, to what extent, and how, Gödel could be held guilty of implicit obfuscation in the conclusions he draws from his formal reasoning in his seminal paper [Go31] on formally undecidable arithmetical propositions.

In Part IV, §16. to §28., we shall conclude this investigation by analysing the arguments where *evidence-based* reasoning challenges current paradigms in mathematics, mathematics education, philosophy, and the natural sciences, apropos:

- Cantor’s Continuum Hypothesis (§16.);
- Gödel’s and Rosser’s proofs of ‘undecidability’ (§17.);
- Non-standard models of PA (§18.);
- Goodstein’s argument (§19.);
- The logical and semantic paradoxes (§20.);
 - The mythical ‘set-theoretical’ limits of fractal constructions (§20.C.);
 - The mythical completability of metric spaces (§20.D.b.);
- Lucas’ and Penrose’s Gödelian Arguments (§21.);
 - A Definitive Turing Test (§21.E.);
 - Turing’s Halting problem (§21.F.);
 - The Mind-Body problem (§21.J.a.);
- Prime divisibility and integer factorisation (§22.);
 - The mutual independence of prime divisors (§22.A.);
 - The P vs NP problem (§22.A.f.);
 - Estimating primes in an arithmetical progression (§22.C.);
 - Estimating twin primes (§22.D.);
- The *EPR* paradox (§23.A.);
 - The Bohr-Einstein debate (§23.B.);
 - Dimensionless constants (§23.D.);
 - Conjugate properties (§23.D.f.);
 - Entangled particles (§23.D.g.);
 - Schrödinger’s cat ‘paradox’ (§23.D.h.).
- The Church-Turing Thesis and quantum computing (§24.);

- The search for extra-terrestrial intelligence, SETI/METI (§26.);
- The Cognitive Sciences (§27.);
- The philosophy of mathematics education (§28.).

In the concluding Part [V](#) we append standard definitions and *evidence-based* perspectives of some concepts to which this investigation critically appeals.

Part II

SOME MATHEMATICAL CONSEQUENCES OF *EVIDENCE-BASED* REASONING

CHAPTER 7. *MATHEMATICAL CONSEQUENCES*

7. Both Hilbert's ε -calculus and Brouwer's Intuitionism are fragile

We begin our investigation by noting that Hilbert formalised quantification in his ε -calculus as follows:

“Hilbert’s formalisation of quantification in his ε -calculus:

IV. The logical ε -axiom

$$13. A(a) \rightarrow A(\varepsilon(A))$$

Here $\varepsilon(A)$ stands for an object of which the proposition $A(a)$ certainly holds if it holds of any object at all; let us call ε the logical ε -function.

1. By means of ε , “all” and “there exists” can be defined, namely, as follows:

$$(i) (\forall a)A(a) \leftrightarrow A(\varepsilon(\neg A))$$

$$(ii) (\exists a)A(a) \leftrightarrow A(\varepsilon(A)) \dots$$

On the basis of this definition the ε -axiom IV(13) yields the logical relations that hold for the universal and the existential quantifier, such as:

$$(\forall a)A(a) \rightarrow A(b) \dots (\text{Aristotle’s dictum}),$$

and:

$$\neg((\forall a)A(a)) \rightarrow (\exists a)(\neg A(a)) \dots (\text{principle of excluded middle})."$$

... Hilbert: [Hi27].

We further note that (see §10.A.), in any formal first order language whose logic subsumes Hilbert’s ε -calculus, Hilbert’s ‘principle of excluded middle’ is an intended formalisation of (and interprets as)¹⁷⁸:

Definition 20. (Aristotle’s particularisation) *If the formula $[\neg(\forall x)\neg F(x)]$ of a formal first order language L is defined as ‘true’ under an interpretation, then we may always conclude unrestrictedly that there must be some well-definable, albeit unspecified, object s in the domain D of the interpretation such that, if the formula $[F(x)]$ interprets as the relation $F^*(x)$ in D , then the proposition $F^*(s)$ is ‘true’ under the interpretation.*

¹⁷⁸**Notation:** We shall use square brackets to differentiate between a symbolic expression—such as $[F(x)]$ —which denotes a formula of a formal language L (treated syntactically as a string of symbols without any associated meaning), and the symbolic expression—denoted by $F^*(x)$ —that denotes its meaning under a well-defined interpretation; we find such differentiation useful in order to avoid the possibility of conflation between the two, particularly when (as is not uncommon) the same symbolic expressions are used to denote—or are common to—the two.

Comment 61. The significance of the qualification ‘unrestrictedly’ is that it admits the possibility where an *unspecified* instantiation may sometimes be *unspecifiable*—in the sense of §10.C., Definition 8—within the parameters of a formal system S that subsumes the *classical* first-order logic FOL (thereby implicitly admitting non-standard models of S) which, under its *classical* interpretation, is uncritically (see §7.B.) *assumed* to admit Aristotle’s particularisation unrestrictedly.

Non-standard model: A non-standard model of a formal system S is a model of S that admits objects in the domain D of the interpretation defining the model if, and only if, there is some object in D which is not definable in S .

We note that (compare with §8.G., Lemma 8.20 and Corollary 8.21)

Theorem 7.1. *Hilbert’s ‘principle of excluded middle’ is ‘stronger’ than Aristotle’s particularisation.*

Comment 62. ‘Stronger’ in the sense that a formal mathematical theory S is ‘stronger’ than a theory T if every provable formula of T is provable in S . The two are ‘equivalent in strength’ if T is also ‘stronger’ than S .

Proof. If the formula $[\neg(\forall x)\neg F(x)]$ is provable in a formal first order language L that admits Hilbert’s ε -calculus then:

- in any *well-defined* interpretation of L over a domain D that admits Aristotle’s particularisation,
- there is the possibility that, if $[F(x)]$ interprets as $F^*(x)$,
- there *may* be an *unspecified* instantiation $F^*(s)$ in D
 - where s is an element of D
 - that is *unspecifiable* as an L -term (in a ‘broader’ sense of §10.C., Definition 8).

However, Hilbert’s ‘principle of excluded middle’ entails that the *unspecified* instantiation in Aristotle’s particularisation *must* correspond to an *unspecified*—but *specifiable*—term of L ¹⁷⁹. The theorem follows. □

Comment 63. The significance of Theorem 7.1 is highlighted from a phenomenological perspective by Stathis Livadas in [Lvd16], where he notes—in the context of Paul Cohen’s *forcing* argument in [Co63] (see also §13.E.b. to §13.E.e.)—an implicit circularity in ignoring that ‘in particularizing a formal individual from a universal sentence of a general form in order to fulfill another predicative sentence or formula we may be subject to the requirement of confirmation by a continuous connection of actual and possible intuitions’:

“In regarding self-constituting temporality as the ultimate common ground of all phenomenologically motivated analysis of logical-mathematical concepts and meanings (which is my position), the issue of the inverse procession, namely that of passing from a general pure concept to its pure possibilities as its particularizations is also conditioned on the phenomenological notion of time. More specifically the logical requirement of individuality in the sense, for instance, of positing an object-individual as the identical substrate of predicates and logical truths is not just a particularization of the universal concept individual in general but may be bound to the conditions of temporal constitution. This means that in particularizing a formal individual from a universal

¹⁷⁹As is also postulated by Rosser’s Rule C ; see §8.G., Corollary 8.21.

sentence of a general form in order to fulfill another predicative sentence or formula we may be subject to the requirement of confirmation by a continuous connection of actual and possible intuitions. In turn, the possibility of a continuous connection of actual and possible intuitions is conditioned on the existence of a subjectively generated continuous unity and is associated with a sense of inner temporality, one that is not rooted in the 'external' objective temporality. For instance to check that a subset A of a partially ordered space (X, \leq) is dense in X we must take a random element $x \in X$ and prove the existence of another element y , possibly fulfilling some other property, to satisfy the formula $(\forall x \in X)(\exists y \leq x)[y \in A]$ **(1)**. In case such an element y is a free or bounded variable of a second formula its identification as the particular element that fulfills the definition formula **(1)** of density presupposes the confirmation of all actual and possible intuitions relative to its place in the second formula which is conditioned in turn on the continuous (immanent) unity of all possible connections establishing its prior ontological status (see for some technical details "Appendix 2")."

... Livadas: [Lvd16], §4 The Question of Universal-Existential Quantification ..., para (d), pp.20-21.

The implicit circularity is evident when interpreting 'a second-order universal quantification over all subsets of the power-set of the set of natural numbers $\mathcal{P}(N)$ ' since, as Livadas notes further, 'any universal quantification over such sets, regardless of any temporal or constitutional concerns for this quantification, already establishes their de facto acceptance as completed totalities':

"I complete this section with a review of the role of universal-existential quantification over an indefinite horizon in formulas with ontological claims, in particular, in the proof-theoretic process of generation of Gödel's incompleteness results. In fact, universal quantification over an indefinite horizon plays a major part in the proof of almost all significant infinity results in foundational mathematics, e.g., in certain well-known independence results as it is the *Continuum Hypothesis* (**CH**) and its generalized form **GCH**. In this case one has to go a step further and apply a second-order universal quantification over all subsets of the power-set of the set of natural numbers $\mathcal{P}(N)$, a process considered as as presupposing a concept of completed totality for the uncountably infinite set $\mathcal{P}(N)$ and therefore as losing contact with 'real-world' intuition.⁶ Any statement (or relation) expressed by applying universal quantification over sets such as $\mathcal{P}(N)$ or even $\mathcal{P}(\mathcal{P}(N))$ is normally taken as a definite one with legitimate ontological claims which is evidently a circular interplay since any universal quantification over such sets, regardless of any temporal or constitutional concerns for this quantification, already establishes their de facto acceptance as completed totalities.⁷

Consequently any universal-existential quantification over an indefinite horizon, and *a fortiori* a second-order one clearly presupposes a notion of complete totality for the intended scope of its quantifiers which, in view of the previous discussion at the level of constitutional-temporal processes, reduces to the constitution of infinite sets of any order in the form of the continuous unity of completed wholes in presentational immediacy. In turn, this kind of actual infinity far from being a spatio-temporal and causality-generated one, insofar as it is immanent to the self-constituting temporal consciousness, conditions in one way or another not only the already established key foundational results of K. Gödel and P. Cohen but also more recent attempts to achieve enlargements of inner models so as to be consistent with all known large cardinal axioms."

... Livadas: [Lvd16], §4 The Question of Universal-Existential Quantification ..., pp.21-22.

From the *evidence-based* perspective of this investigation we note that we can interpret Livadas' stipulation that:

"in particularizing a formal individual from a universal sentence of a general form in order to fulfill another predicative sentence or formula we may be subject to the requirement of confirmation by a continuous connection of actual and possible intuitions"

as requiring that even any intuitive ontological commitment, consequent to the 'particularizing of a formal individual from a universal sentence', must, even if only in principle, necessitate:

- algorithmic *verifiability* of 'actual intuitions' in some sense of §2., Definition 7, and §7.C., Definition 21;

and:

- algorithmic *computability* of 'possible intuitions' in some sense of §2., Definition 10 and §7.C., Definition 23;

in order to claim—'in a next 'second-order' level', as clarified by Livadas¹⁸⁰—'a continuous connection of actual and possible intuitions'.

We shall further see that, from an *evidence-based* perspective of the Complementarity Thesis 1 (see §1.), both Hilbert's ε -calculus and Brouwer's Intuitionism are fragile since:

- (a) On the one hand—as L. E. J. Brouwer had protested (see §10.B.)—Hilbert's intended interpretation of his ε -calculus does not admit (see §8.D., Theorem 8.12), or even seek to admit, a finitary interpretation;
- (b) On the other hand, whereas Aristotle's particularisation entails the classical Law of the Excluded Middle LEM (see §10.A., Lemmas 10.1 and 10.2), intuitionistic perspectives—following Brouwer—unjustifiably (see §8.D., Theorem 8.12 and §8.D., Corollary 8.15) believe that the converse must also be true, thereby failing to recognise LEM as finitary.

Classical Law of the Excluded Middle LEM (cf., [Me64], p.4): For any well-formed formula $[P]$ of a formal system S that subsumes the first-order logic FOL, $[P \vee \neg P]$ is a theorem of S .

7.A. Gödel's ω -consistency too is fragile

We note further that, in order to avoid intuitionistic objections to his reasoning in his seminal 1931 paper on formally undecidable arithmetical propositions, Kurt Gödel did not assume that, for instance, the classical 'standard' interpretation $\mathcal{I}_{PA(\mathbb{N}, SV)}$ of PA ¹⁸¹ must be semantically well-definable—essentially since unbounded quantification in arithmetic may not be definable recursively¹⁸², as noted by Gödel when defining his number-theoretical relation ' $Bew(x)$ ', which asserts that x is the Gödel-number of a provable formula of Gödel's formal system P in [Go31]:

"46. $Bew(x) \equiv (\exists y) y B x$

x is a PROVABLE FORMULA. [$Bew(x)$ is the only one of the concepts 1-46 which cannot be asserted to be recursive.]"

... Gödel: [Go31], p.22.

Instead, Gödel introduced the syntactic property of ω -consistency as an explicit assumption in his formal reasoning ([Go31], p.23 and p.28).

¹⁸⁰In a private correspondence on 14th April 2020.

¹⁸¹As defined in [Me64], p.107; see also §29.(16)/(17).

¹⁸²A consequence of a, subsequent, seminal theorem by Alfred Tarski in [Ta35]:

Tarski's Theorem: The set Tr of Gödel numbers of wfs of S which are true in the standard model is not arithmetical, i.e., there is no wf $A(x)$ of S such that Tr is the set of numbers k for which $A(\bar{k})$ is true in the standard model. ... Mendelson: [Me64], p.151, Corollary 3.38.

ω -consistency: A formal system S is ω -consistent if, and only if, there is no S -formula $[F(x)]$ for which, first, $[\neg(\forall x)F(x)]$ is S -provable and, second, $[F(a)]$ is S -provable for any specified S -term $[a]$.

Gödel explained that his reason for introducing ω -consistency as an explicit assumption in his intended, strictly syntactical, reasoning was to avoid appealing to the semantic concept of classical arithmetical truth¹⁸³—a concept based on an intuitionistically objectionable logic which implicitly¹⁸⁴ assumes that Aristotle’s particularisation (see §7., Definition 20) holds over the domain \mathbb{N} ¹⁸⁵ of the natural numbers.

“The method of proof which has just been explained can obviously be applied to every formal system which, first, possesses sufficient means of expression when interpreted according to its meaning to define the concepts (especially the concept “provable formula”) occurring in the above argument; and, secondly, in which every provable formula is true. In the precise execution of the above proof, which now follows, we shall have the task (among others) of replacing the second of the assumptions just mentioned by a purely formal and much weaker assumption.”

... Gödel: [Go31], p.9.

We shall see (§8.D., Corollary 8.10) that Gödel’s assumption is ‘weaker’ in the sense that:

- If Tarski’s inductive definitions (see §2.A.) of the satisfaction and truth of existentially quantified PA formulas under the standard interpretation $\mathcal{I}_{PA(\mathbb{N}, SV)}$ assume that Aristotle’s particularisation is valid over \mathbb{N} ,

Comment 64. ‘Assume’, since the following is not *unrestrictedly* entailed by Tarski’s inductive definitions:

“A sequence s satisfies $(Ex_i)A$ if and only if there is a sequence s' which differs from s in at most the i^{th} place such that s' satisfies A .”

... Mendelson: [Me64], p.52, V(ii).

- Then PA is consistent if, and only if, it is ω -consistent.

Comment 65. It is also ‘weaker’ in the more formal sense that a formal mathematical theory S is ‘weaker’ than a theory T if every provable formula of S is provable in T . The two are ‘equivalent in strength’ if T is also ‘weaker’ than S .

Now, if there were a finitary proof that PA is ω -consistent, it would follow that Gödel’s formula $[(\forall x)R(x)]$ (see §2.F., Lemma 2.19) would be formally undecidable in PA by [Go31], Theorem VI, p.24.

However, since $[\neg(\forall x)R(x)]$ is PA-provable (§2.F., Corollary 2.20), we conclude that Gödel’s assumption of ω -consistency for arithmetic is fragile (§2.F., Corollary 2.22; see also §12.B.f., Theorem 12.6).

¹⁸³To which Gödel implicitly appeals in his semantic—set-theoretical and debatably (see §15.C.) constructive—proof of the existence of a formally undecidable proposition in Russel and Whitehead’s Principia Mathematica (PM); which he defines therein as $[R(q); q]$ ([Go31], pp.7-8).

¹⁸⁴And invalidly, by §8.D., Theorem 8.12.

¹⁸⁵We take \mathbb{N} to be the classical mathematical structure of the natural numbers that is uniquely defined by Dedekind’s second order formalisation of the Peano Postulates.

7.B. Faith-based quantification

We note that, unusually for a mathematical assertion, *Aristotle's particularisation* (§7., Definition 20) is not offered in classical mathematics—which subsumes the first-order logic FOL—as an axiom or a thesis, but as a belief that is not unequivocally self-evident, and must be appealed to as an article of unquestioning faith.

A faith which explicitly avoids, yet implicitly follows in essence (see §10.), Hilbert's formalisation of quantification in terms of his ε -operator in [Hi25].

A faith that has subsequently been sanctified by prevailing custom in published classical, and constructivist/intuitionistic pedagogy (see, for instance: [Sza02]¹⁸⁶, p.24), literature and textbooks¹⁸⁷, at such an early stage of any mathematical curriculum, and planted so deeply into students' minds¹⁸⁸, that thereafter most cannot even detect its presence—let alone need for justifying quantification¹⁸⁹—in a definition or a proof sequence¹⁹⁰!

A faith, moreover, whose absurdity is illustrated starkly (see [BP14]; [Kr19]) not only in

¹⁸⁶[Sza02] Andrzej Szalas. 2002. *Logic for Computer Science. Lecture Notes*.

https://www.academia.edu/25072711/Logic_for_Computer_Science_Lecture_Notes?email_work_card=title

¹⁸⁷ See, for instance: *Whitehead/Russell*: [WR10], p.20; *Hilbert*: [Hi25], p.382; *Hilbert/Ackermann* [HA28], p.48; *Skolem*: [Sk28], p.515; *Gödel*: [Go31], p.32; *Carnap*: [Ca37], p.20; *Kleene*: [Kl52], p.169; *Mostowski*: [Mo52], p.18; *Rosser*: [Ro53], p.90; *Bernays/Fraenkel*: [BF58], p.46; *Beth*: [Be59], pp.178 & 218; *Suppes*: [Su60], p.3; *Luschei*: [Lus62], p.114; *Wang*: [Wa63], p.314-315; *Quine*: [Qu63], pp.12-13; *Kneebone*: [Kn63], p.60; *Mendelson*: [Me64], pp.4-5, V(ii) (op. cit.); *Novikov*: [Nv64], p.92; *Lightstone*: [Li64], p.33; *Cohen*: [Co66], p.4; *Shoenfield*: [Sh67], p.13; *Smoryński*: [Smy77]; *Davis*: [Da82], p.xxv; *Rogers*: [Rg87], p.xvii; *Epstein/Carnielli*: [EC89], p.174; *Murthy*: [Mu91]; *Smullyan*: [Sm92], p.18, Ex.3; *Karlis Podnieks*: [Pdn92], p.102; *Cook/Urquhart*: [CU93], p.105; *Awodey/Reck*: [AR02b], p.94, Appendix, Rule 5(i); *Boolos/Burgess/Jeffrey*: [BBJ03], p.102; *Crossley*: [Cr05], p.6; *Hedman*: [Hd06], p.54; *Srivastava*: [Sri08], p.3 & p.18; *Voevodsky*: [Vo10]; *Aschieri/Zorzi*: [AsZ12], p.8, Dfn.7; *Smith*: [Smi13], p.39(4); *Da Silva*: [DaS14], p.35; *Detlovs/Podnieks*: [DP17], p.17; *Cho*: [Cho18]; *Lelyk/Wcisto*: [LW23], §2.3.1 Sequential Theories, Convention 9; *Drăghici*: [Drg23], p.72, Definition 4.(a); *Csatári*: [Csr24], p.3(vii).

¹⁸⁸Friend and Molinini anecdotally highlight the pernicious influence of such faith-based reasoning on the perspective—and understanding—of even seasoned scholars (see [FM15], pp.201-202). The remarkable anecdote about Professor Manohar S. Huzurbazar offers, however, a contrasting example in §31.

¹⁸⁹For instance, Andrzej Szalas' Definitions of quantification in his 2002 Lecture Notes on *Logic for Computer Science* ([Sza02], p.24):

$$v(\forall x.\alpha(x)) = \min(\{v_a^x(\alpha(x)) : a \in \text{Dom}\})$$

$$v(\exists x.\alpha(x)) = \max(\{v_a^x(\alpha(x)) : a \in \text{Dom}\})$$

implicitly assume—without qualification—that the *evaluations* of the *minima* and *maxima* of a (presumably finite) set of ordered truth values, such as **False** \leq **True**, can be treated as algorithmically *computable* (i.e., deterministic *strongly* in the sense of §2., Definition 10) even when the domain *Dom* is *infinite*.

Similarly, in his musings [Grn22] from a general mathematician's perspective—where he seeks to address the query '*Do Proofs Yield Objective Truth, Or Are They Culturally Robust At Best*'—Andrew Granville implicitly accepts such a—classically inherited—*faith-based* interpretation of quantification as, seemingly, intuitively justified:

"*First order logic* keeps the special symbols down to a sensible minimum, allowing the quantifiers \forall , \exists , the associations \vee and \wedge , *A* implies *B* by $A \implies B$, and the negation \neg . This is enough of a language to quantify and work with most intuitive mathematics, and the hope was that it, or it supplemented by one or two necessary refinements, could cover all mathematical truths."

... Granville: [Grn22], §1. *Proof—why and how*.

¹⁹⁰See, for instance, Mendelson: [Me64], p.52, V(ii) (op. cit.); [Cho18]; [Dvd19]!

the admittance of a mathematical definition of the most unarguable concept of ‘God’—as an ‘existence’ of which nothing can be greater—but in purported mathematical proofs of the existence of such a Deity!

Comment 66. That *faith-based* quantification is inherently problematic philosophically is highlighted by Philosopher Danielle Macbeth in [Mcb14]; where, whilst accepting the uncritically inherited¹⁹¹ Tarskian interpretations of the symbols ‘ \forall ’ and ‘ \exists ’ representing universal and existential quantification respectively, she notes that *Philosophical debates about the precise nature of the quantifiers also sprang up; and although they no longer command any interest, this is not because they have been resolved but instead because they have come to seem unresolvable*:

“The basic idea of quantification is very simple. Much as ‘ Fa ’ is true just in case the object denoted by the letter ‘ a ’ has the property F , so ‘ $(\forall x)Fx$ ’ is true just in case all objects—more exactly, as we have to say to avoid falling into a contradiction, all objects in the domain of quantification—have the property F and ‘ $(\exists x)Fx$ ’ is true just in case at least one object (in the domain of quantification) has that property. But, although the basic idea is very simple, and appears already in Kant’s late lectures on logic, working it up into a theory powerful enough to deal with all cases would be achieved by Tarski only in 1933, fifty years after its first official introduction by Peirce. Nor were there only technical difficulties. Philosophical debates about the precise nature of the quantifiers also sprang up; and although they no longer command any interest, this is not because they have been resolved but instead because they have come to seem unresolvable. . . .

We formulate the truth definition for our language as follows.¹¹

1. Names: ‘ a ’ designates a ; ‘ b ’ designates b ; and so on.
2. Predicates: object α satisfies ‘ F ’ iff α is F ; α satisfies ‘ G ’ iff α is G ; and so on.
3. A sequence S satisfies a (closed) sentence ‘ Φn ’ iff the object n satisfies Φ .
4. A sequence S satisfies an open sentence ‘ Φx_k ’ iff the k^{th} member of S satisfies Φ .
5. A sequence S satisfies ‘ $(\exists x)\Phi x_k$ ’ iff ‘ Φx_k ’ is satisfied by some sequence S' that is like S except perhaps in the k^{th} term.
6. A sequence S satisfies ‘ $(\forall x)\Phi x_k$ ’ iff ‘ Φx_k ’ is satisfied by all sequences S' that are like S except perhaps in the k^{th} term.
7. A sentence is true iff it is satisfied by all sequences.

Fn11: I here follow the account developed in Platts (1997, 21).*

... Macbeth: [Mcb14], §6.1: *Quantifiers in Mathematical Logic*, p.252 and p.259.

7.C. *Evidence-based* quantification

The significance of Aristotle’s particularisation for Gödel’s assumption of ω -consistency—and, as we shall see, for Hilbert’s Program (see [Zac07]) in particular and constructive mathematics (see [KI52], [Ba16]) in general—is highlighted when contrasted (see §2.) with a constructive perspective of quantification that admits *evidencing* the satisfaction and truth of the *quantified* formulas of the first-order Peano Arithmetic PA, over the domain \mathbb{N} of the natural numbers, in two, hitherto unsuspected and essentially different, ways:

- (1) in terms of *weak* algorithmic *verifiability* (see §2., Definition 7); and
- (2) in terms of *strong* algorithmic *computability* (see §2., Definition 10).

¹⁹¹‘Uncritically inherited’ since, as highlighted in §2.A.b., Comment 36, interpreting the existential quantifier as Aristotle’s particularisation in # 5 does *not* qualify as part of Tarski’s recursive definitins.

The distinction between (1) and (2) illuminates the Brouwerian perspective of quantification that, we argue in §11.B., could be appropriately labeled as ‘atheistic’ vis à vis the classical, Hilbertian, ‘theistic’ (see §11.A.) perspective of quantification.

In *evidence-based* reasoning, for instance, if the PA formula $[(\forall x)F(x)]$ ¹⁹² is intended (see also §10.C.) to be read *weakly* as ‘For any specified x , $F^*(x)$ is decidable as true’ under an interpretation, where the formula $[F(x)]$ interprets as the arithmetical relation $F^*(x)$, then it must be consistently interpreted *weakly* in terms of algorithmic *verifiability* as follows:

Definition 21. (Weak quantification) A PA formula $[(\forall x)F(x)]$ is algorithmically verifiable as true under an interpretation if, and only if, $F^*(x)$ is algorithmically verifiable as always true.

Moreover, the PA formula $[\neg(\forall x)F(x)]$, if intended to be read *weakly* as ‘It is not the case that, for any specified x , $F^*(x)$ is true’ must be consistently interpreted *weakly* in terms of algorithmic *verifiability* as:

Definition 22. (Weak negation) The PA formula $[\neg(\forall x)F(x)]$ is algorithmically verifiable as true under an interpretation if, and only if, there is no algorithm which will evidence that $[(\forall x)F(x)]$ is algorithmically verifiable as always true under the interpretation.

Comment 67. We note that *weak negation* implies that $[(\forall x)F(x)]$ is not provable in PA; it *does not*, however, entail that $F^*(x)$ is not algorithmically *verifiable* as always true.

Similarly, if $[(\forall x)F(x)]$ is intended to be read *strongly* as ‘For all x , $F^*(x)$ is decidable as true’, then it must be consistently interpreted *strongly* in terms of algorithmic *computability* as follows:

Definition 23. (Strong quantification) A PA formula $[(\forall x)F(x)]$ is algorithmically computable as true under an interpretation if, and only if, $F^*(x)$ is algorithmically computable as always true.

Whilst the PA formula $[\neg(\forall x)F(x)]$, if intended to be read *strongly* as ‘It is not the case that, for all x , $F^*(x)$ is true’ must be consistently interpreted *strongly* in terms of algorithmic *computability* as:

Definition 24. (Strong negation) The PA formula $[\neg(\forall x)F(x)]$ is algorithmically computable as true under an interpretation if, and only if, there is no algorithm which will evidence that $[(\forall x)F(x)]$ is algorithmically computable as always true under the interpretation.

Comment 68. We note that *strong negation*, too, implies that $[(\forall x)F(x)]$ is not provable in PA. By §2.E.b., Theorem 2.17 (*Provability Theorem for PA*), it *does*, however, entail that $F^*(x)$ is not algorithmically *computable* as always true.

We note that *strong* algorithmic *computability* implies the existence of an algorithm that can *finitarily* decide the truth/falsity of each proposition in a *well-defined* denumerable sequence of number-theoretical propositions, whereas *weak* algorithmic *verifiability* does not imply the existence of an algorithm that can *finitarily* decide the truth/falsity of each proposition in a *well-defined* denumerable sequence of number-theoretical propositions.

Comment 69. Classically, the concepts ‘well-defined’ and ‘effectively computable’ are treated as intuitive, and not expressible formally in a manner subject to verification by a Turing machine. However we show, in §7.F. and §7.H.b., that both concepts can be defined in terms of *weak* algorithmic *verifiability*, even when they are not subject to verification by a Turing machine in terms of *strong* algorithmic *computability*.

¹⁹²For ease of exposition we consider, without loss of generality, only the case of a PA-formula with a single variable.

7.D. Quantification in constructive mathematics is ambiguous

The distinction between the concepts of *weak* ‘algorithmic verifiability’ and *strong* ‘algorithmic computability’ seeks to eliminate an implicit ambiguity in the classical concept of ‘realizability’ (see §7.E.; also [Ba16], p.5; [K152], p.503-505).

Comment 70. Although the conventional *set-theoretical* terminology of constructive mathematics—as detailed in [Ba16]—may prefer that §2., Definitions 7, 10, and §7.C., Definitions 21 to 24, be expressed in terms, for instance, of ‘*verifiable* realizability’ and ‘*computable* realizability’ instead of ‘algorithmic *verifiability*’ and ‘algorithmic *computability*’, we have preferred the latter terminology as more illuminating from the perspective of this introductory investigation into the philosophical and mathematical significance of post-computational, *evidence-based* and purely *arithmetical*, reasoning (see §11.C.).

That such an ambiguity needs elimination in other areas of constructive mathematics too is evidenced by Jakob Grue Simonsen’s implicit definitions in his 2005 revisitation of Specker sequences:

“We expect the reader to have a working knowledge of BISH, cf. [BB85, BR87], and of either Russian constructive mathematics or computable analysis [Abe80, Ko91, Wei98]; the well-known Blum-Shub-Smale framework for computable analysis [BCSS97] is quite different from the aforementioned notions and will not be treated here. Terminology will be that of constructive mathematics; the reader with background in computer science will thus be well-advised to interpret every statement (“there is X”) in this paper as “there is a program computing X” and “countable” as “recursively enumerable”. Definitions of standard concepts from classical mathematics, e.g. convergence of sequences and (sequential) continuity carry over to the constructive setting *mutatis mutandis*, unless otherwise noted.”

... Simonsen: [Smm05], §2, Preliminaries.

In [ArRm09], Mohammad Ardeshir and Rasoul Ramezani seemingly seek to address a similar ambiguity in intuitionistic mathematics explicitly, by introducing formal definitions that distinguish between ‘intuitionistic enumerability’ and ‘intuitionistic decidability’ which, *prima facie*, can be viewed as *informally* corresponding to the distinction between *weak* ‘algorithmic verifiability’ and *strong* ‘algorithmic computability’, respectively:

“A bounded monotone sequence of reals without a limit is called a Specker sequence. In Russian constructive analysis, Church’s Thesis permits the existence of a Specker sequence. In intuitionistic mathematics, Brouwer’s Continuity Principle implies it is false that every bounded monotone sequence of real numbers has a limit. We claim that the existence of Specker sequences crucially depends on the properties of intuitionistic decidable sets. We propose a schema (which we call ED) about intuitionistic decidability that asserts “there exists an intuitionistic enumerable set that is not intuitionistic decidable” and show that the existence of a Specker sequence is equivalent to ED. We show that ED is consistent with some certain well known axioms of intuitionistic analysis as Weak Continuity Principle, bar induction, and Kripke Schema. Thus, the assumption of the existence of a Specker sequence is conceivable in intuitionistic analysis. We will also introduce the notion of double Specker sequence and study the existence of them.”

... Ardeshir and Ramezani: [ArRm09], Abstract.

Comment 71. *The correspondence can only be treated as ‘informal’, since it is not obvious that the intuitionistic perspective of [ArRm09]¹⁹³ also admits LEM¹⁹⁴ (since FOL is constructive¹⁹⁵),*

¹⁹³Unlike Brouwer’s (see §11.B.: *Brouwer’s atheism*).

¹⁹⁴See §8.D. **Corollary 8.14.** *The Law of the Excluded Middle $[P \vee \neg P]$ is a theorem of the first-order logic FOL.*

¹⁹⁵See §8.D. **Theorem 8.13.** *The first-order logic FOL is finitarily consistent.*

and a formal definition of 'effective computability' (see §7.H.a., Definition 28) which entails that Church's Thesis is false in evidence-based reasoning (see §7.H.b., Theorem 7.3); where, further, not every Cauchy sequence admits of (entails) a Cauchy limit (see §20.D., Query 18 and §20.D.b.).

We shall see that the distinction between the concepts of *weak* 'algorithmic verifiability' and *strong* 'algorithmic computability' was also anticipated by both Brouwer (see §7.L.) and Hilbert (see §8.B.).

Moreover, the significance of the Complementarity Thesis (§1., Thesis 1) is highlighted if we note that the distinction between 'any' and 'all'¹⁹⁶ sought to be made in §7.C., Definitions 21 to 24, pertains to the assignment of truth-values to the formulas of a formal theory under an interpretation of the universal quantifier over a *well-defined* domain of interpretation.

From the *evidence-based* perspective of this investigation, a distinction such as that between the algorithmically *verifiable* quantification 'For any', and the algorithmically *computable* quantification 'For all' can, not unreasonably, also be viewed as what Matthias Eberl's novel formalisation of Dummett's notion of *indefinite extensibility* seeks to achieve, in [Ebr20], for resolving what he, however, perceives as an ambiguity in *both* the formal expression, and interpretation, of quantification in classical mathematics:

"The basic property of a (potential) infinite set \mathcal{M} is its *indefinite extensibility*. But quantification requires reference to some state and the naive interpretation of "for all ..." cannot be used—it is meaningful only if there is a completed set of objects. Hence one needs a fixed finite set that is a replacement of the idealized totality of all possible elements. This is an indefinitely large stage \mathcal{M}_i within \mathcal{M} , relative to a context of other states. ...

The notion of indefinite extensibility that we use includes Dummett's understanding⁵. In (Dummett, 1994) he defines: "An indefinitely extensible concept is one such that, if we can form a definite conception of a totality all of whose members fall under that concept, we can, by reference to that totality, characterize a larger totality of all whose members fall under it." The ordinal numbers and sets are a typical example: If we refer to "all sets", this creates or reveals a new set and thus the totality of all sets has changed.

But already the natural numbers form such an indefinitely extensible concept. If we refer to the number of all numbers, then this reference creates a new number. First there is no number, hence the number of numbers is 0. So we created a first number, namely 0, and the number of numbers is 1. Henceforth there are the two numbers 0 and 1, creating number 2 and so on.

The notion of an indefinitely large finite could be seen as a *relative infinite*. If \mathcal{I} denotes the set of states or indices, then a relative infinite is a relation $C \ll i$ (or $i \gg C$) between an index $i \in \mathcal{I}$ and a context $C := (i_0, \dots, i_{n-1})$, with $i_0, \dots, i_{n-1} \in \mathcal{I}$, stating that i is *indefinitely large* or, using a more technical notion, *sufficiently large* relative to C .

We can only investigate finitely many objects in a way that we explicitly refer to them. Say these are currently a_0, \dots, a_{n-1} . Most often these objects are not fixed but variable ones, taken from some infinite sets. Assume that a_0, \dots, a_{n-1} are (variable) natural numbers, then saying that a_k is a natural number means $a_k \in \mathbb{N}_{i_k}$ for some state $i_k \in \mathcal{N}$. So the currently investigated objects, here a_0, \dots, a_{n-1} , are always within a context $C = (i_0, \dots, i_{n-1})$.

By seeing infinity as an indefinitely large finite, the infinite is not outside of an indefinitely extensible set, it is a part of it. It is only outside the region that we can reach from the current stage with our current means. The indefinitely large finite sets \mathcal{M}_i with $i \gg C$ behaves exactly as actual infinite sets in the current context of investigation. But they are not completed in an absolute way, i.e., if we change the context, an extension could be necessary.

¹⁹⁶See also §14.: *Conflating 'Proof' with 'Truth' and 'For any' with 'For all'*.

The notion of an indefinitely large finite is relative in three ways. First, it is not a single state $i \in \mathcal{I}$, but a region, e.g. $\{i \in \mathcal{I} \mid i \geq h\}$, the *indefinitely large region*. If there is a least element in this region, we call it *horizon*. Secondly, the region depends on a context $C = (i_0, \dots, i_{n-1})$, it is thus a relation $C \ll i$. Figure 1. illustrates this situation. And thirdly, it is not a single relation but several ones. Their basic properties are that $C \ll i \leq i'$ implies $C \ll i'$ and additionally that $(i_0, \dots, i_{k-1}) \ll i_k$ holds for all $k < n$. The latter expresses a dependency of the size of set \mathcal{M}_{i_k} on the sizes of the sets $\mathcal{M}_{i_0}, \dots, \mathcal{M}_{i_{k-1}}$.

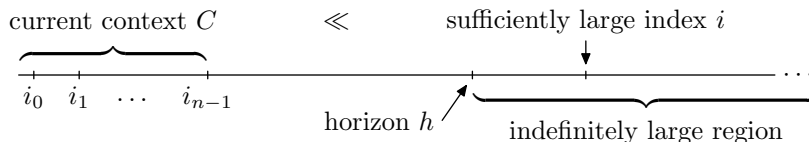

Figure 1: The structure of indefinitely extensible sets.

If it is necessary to include the indefinitely large set \mathcal{M}_i into the current context C as a further set \mathcal{M}_{i_n} , then the current context becomes $C' = (i_0, \dots, i_{n-1}, i_n)$. We may then again choose an indefinitely large index $i' \gg C'$."

... Eberl: [Ebr20], §2.5, *Indefinitely Extensible and Indefinitely Large*.

Seemingly, Eberl views such ambiguity as rooted in the lack of a formal distinction between an ‘actual’ and a ‘potential’ infinity; since he notes that, in classical mathematics, a ‘new interpretation makes it impossible to formulate the concept of a potential infinite in the object language’, since an ‘actual or potential infinite cannot be stated in a formal system’.

Eberl’s claim is that *indefinite extensibility* avoids what are termed as the ‘semantic’ and ‘logical’ paradoxes¹⁹⁷ including, for instance, the highly counter-intuitive Banach-Tarski paradox¹⁹⁸:

“The existence of actual infinite sets are based on the “domain principle” (Hallett, 1984), that every potential infinity presupposes an actual infinity. Indefinite extensibility, as we understand it, is contrary to this principle. Nevertheless, statements still have determined truth values.

Actual infinities have several counter-intuitive properties. This starts with simple examples, e.g. there are as many natural numbers as even numbers. More complex examples are the Banach-Tarski paradox, as a consequence of the idea that a continuum is an actual infinite set of points. The deficiency of this view is not the fact that actual infinite sets have unfamiliar properties, but the fact that these “properties” stem from relations and dependencies between infinite sets which have been removed—we show this in an exemplary way in Section 2.4. Simply taking these dependencies into account prevents these paradoxes, which arise as self-made problems that have nothing to do with the mathematical content.

And even more, to introduce actual infinities does not eliminate the phenomenon of indefinite extensibility. After establishing infinite sizes in [the] form of ordinal and cardinal numbers, the question arises naturally, what is the size of the totality of these infinite numbers. It is well known that this again leads to contradictions or paradoxes and a satisfying solution is not available⁴."

... Eberl: [Ebr20], §2.3, *Paradoxes of the Actual Infinite*.

by admitting the conclusion that ‘in a formalization of the background theory it is possible to distinguish potential and actual infinity as different interpretations of the universal quantifier’¹⁹⁹, and not as a measure of ‘size’:

¹⁹⁷See §20., *The significance of evidence-based reasoning for the philosophy of science*.

¹⁹⁸See §20.C.c., **Case 3: Interpretation as a quantum chimera**.

¹⁹⁹Seemingly similar in intent, Eberl’s ‘different interpretations of the universal quantifier’ should not, however, be conflated with the *evidence-based* distinction between the algorithmically *verifiable* quantification ‘For any’, and the algorithmically *computable* quantification ‘For all’, sought to be made in §7.C., Definitions 21 to 24.

"The reinterpretation of the universal quantifier, or better, its finitistic reading, is crucial here. Van Bendegem (1999) argues that a reinterpretation of the universal quantifier is indispensable and unassailable for a finitistic point of view:

"In the first place, a classical mathematician or logician will surely remark that, however clever this procedure might be, it still implies a reinterpretation of the universal quantifier. 'For all x, \dots ' does not have its classical meaning, for, in all cases, we are supposed to read 'For all $x \leq K, \dots$ '. [...] if one asks for a standard interpretation of the universal quantifier, then one presupposes the possibility of an infinite domain, hence one can never have such an interpretation in a finite domain."

A new interpretation makes it impossible to formulate the concept of a potential infinite in the object language. So whether an unbounded set is seen as actual or potential infinite cannot be stated in a formal system, e.g. as some axiom—for this reason Niebergall (2014) found no convincing formulation that a theory assumes merely the potential infinite, and not an actual infinite. Only in a formalization of the background theory it is possible to distinguish potential and actual infinity as different interpretations of the universal quantifier."

... Eberl: [Ebr20], §3.2.1, *A Reinterpretation of the Universal Quantifier?*

We note that the distinction between 'any' and 'all' sought to be made in §7.C., Definitions 21 to 24, is to be distinguished from the distinction Bertrand Russell sought to make in [Rus08] (pp.156-163; see also [Fe02], pp.3-4) between 'all' and 'any' with respect to the assignment of provability-values to the formulas of a formal theory that admits 'apparent' and 'real' variables in a proof sequence.

The distinction between the concepts of *weak* 'algorithmic verifiability' and *strong* 'algorithmic computability' also illuminates the illusory barriers faced by formal theories of constructive mathematics which seek to interpret formal existential quantification constructively in terms of only algorithmic *computability* or Kleene's *recursive realizability* (see §7.E.a.).

For instance, as observed by E. B. Davies in his defense of pluralism in mathematics, "and in particular Errett Bishop's constructive approach to mathematics":

"1. Introduction

Errett Bishop's book 'Foundations of Constructive Analysis' appeared in 1967 and started a new era in the development of constructive mathematics. His account of the subject was entirely different from, and far more systematic than, Brouwer's programm of intuitionistic mathematics.

...

Briefly, I defend what I call pluralism in mathematics—the view that classical mathematics, constructive mathematics, computer assisted mathematics and various forms of finitistic mathematics can coexist. I revive Carnap's dictum that one must decide the framework of discourse *before* questions about existence and truth make sense; see Carnap (1950). In different frameworks the answer to a question may be different, but this in no way implies that one or the other is 'right'. This position is anti-Platonistic."

... Davies: [Dav05].

From the *evidence-based* perspective of quantification in §7.C., the Complementarity Thesis 1 (in §1.) can be viewed as *the* 'pluralism' and 'constructivism' that Davies seeks, but apparently views as in need of defense since it seemingly limits the classical theorems that can be accepted as constructive.

In other words, Davies seems to be of the view that although every theorem in Bishop's constructive mathematics—in which the existential quantifier ' \exists ' is interpreted in terms of

algorithmic *computability* only—is a theorem in classical mathematics, not every theorem of classical mathematics can be interpreted constructively under Aristotle’s particularisation (see §7., Definition 20):

“2. What is constructive mathematics?”

It has often been said that Bishop rejected the law of the excluded middle, but a more useful description of the situation is that he gave the symbol \exists a different meaning from the usual one. In classical mathematics \exists refers to Platonic existence, but Bishop used it to refer to the production of an algorithm for constructing the relevant quantity. In classical mathematics \exists may be defined in terms of \forall : the expression $\exists xA$ is logically equivalent to $\neg(\forall a\neg A)$ [sic]. In constructive mathematics, \exists is a new quantifier with stricter conditions for its application. All of the differences between classical and constructive mathematics follow from the new meaning assigned to the new symbol. We wish to emphasize that every theorem in Bishop’s constructive mathematics is also a theorem in classical mathematics. Constructive mathematicians have to work harder to prove theorems, because their criteria for existence are stricter; the pay-off is that the statements of the theorems contain more information."

... Davies: [Dav05].

Moreover, Davies ascribes more to Bishop’s *interpretation* of the existential quantifier ‘ \exists ’ in terms of algorithmic *computability* (or of Kleene’s *recursive realizability*) as the characteristic feature of Bishop’s constructivism, rather than to the latter’s rejection of the classical Law of the Excluded Middle (LEM) à la Brouwer (see §11.B.a.).

He thus implicitly accepts Bishop’s constructive analysis as a formal mathematical system that has a classical interpretation under which ‘ \exists ’ entails Aristotle’s particularisation—a concept that is *not* ‘intelligible’ to a machine—and a constructive interpretation under which ‘ \exists ’ entails algorithmic *computability*—a concept that *is* ‘intelligible’ to a machine:

“The use of a formal mathematical system as a programming language presupposes that the system has a constructive interpretation. Since most formal systems have a classical, or nonconstructive, basis (in particular, they contain the law of the excluded middle), they cannot be used as programming languages.

The role of formalisation in constructive mathematics is completely distinct from its role in classical mathematics. Unwilling—indeed unable, because of his education—to let mathematics generate its own meaning, the classical mathematician looks to formalism, with its emphasis on consistency (either relative, empirical, or absolute), rather than meaning, for philosophical relief. For the constructivist, formalism is not a philosophical out; rather it has a deeper significance, peculiar to the constructivist point of view. Informal constructive mathematics is concerned with the communication of algorithms, with enough precision to be intelligible to the mathematical community at large. Formal constructive mathematics is concerned with the communication of algorithms with enough precision to be intelligible to machines."

... Bishop: [Bi18], pp.1-2.

From the *evidence-based* perspective of quantification in §7.C., however, Bishop’s above notion of ‘formal constructive mathematics’ implicitly admits an ambiguity that could be viewed as *the* barrier which constrains recognising:

- that PA is a categorical language (see §2.E.b., Corollary 2.18)
- which can communicate ‘algorithms with enough precision to be intelligible to machines’.

Such a perspective would reflect that:

- a formal system can admit a constructive, *evidence-based*, algorithmically *verifiable* interpretation of PA (see §2.B.a., Theorem 2.7),
 - that admits a ‘truth’ assignment which is *not* ‘intelligible’ to a machine (see §21.E., Query 22),
 - where ‘ $\exists xA$ ’ (treated as an abbreviation for ‘ $\neg(\forall x\neg A)$ ’) entails only a *weak* algorithmic *verifiability* (by §7.C., Definition 22),
 - which, in turn, entails *strong* algorithmic *computability* (by §7.C., Definition 24);
- and, moreover, by:
 - the *finitary* proof of consistency for PA (§2.C.a., Theorem 2.16),
 - the Provability Theorem for PA (§2.E.b., Theorem 2.17),
 - and its immediate corollary (§2.E.b., Corollary 2.18),
- the system:
 - *can* admit the classical Law of the Excluded Middle (see §8.D., Corollary 8.14),
 - without entailing Aristotle’s particularisation (see §8.D., Corollary 8.15),
 - which entails ω -consistency if the system is consistent (see §8.D., Corollary 8.10);
 - and
 - which is entailed by Rosser’s Rule C (see §8.G., Lemma 8.20).

7.E. Where realizability in constructive mathematics is ambiguous

We briefly outline the—albeit explicitly unrecognised—ambiguity as highlighted further, for instance, by Bauer’s argumentation in [Ba16], where he characterises classical mathematics, vis à vis current paradigms of constructive mathematics, as a compromise on the intuitive notion of ‘truth’:

“Classical mathematical training plants excluded middle so deeply into young students’ minds that most mathematicians cannot even detect its presence in a proof. In order to gain some sort of understanding of the constructivist position, we should therefore provide a method for suspending belief in excluded middle.

If a geometer tried to disbelieve Euclid’s fifth postulate, they would find helpful a model of non-Euclidean geometry—an artificial world of geometry whose altered meanings of the words ‘line’ and ‘point’ caused the parallel postulate to fail.

Our situation is comparable, only more fundamental because we need to twist the meaning of ‘truth’ itself. We cannot afford a full mathematical account of constructive worlds, but we still can distill their essence, as long as we remember that important technicalities have been omitted.”

... Bauer: [Ba16], p. 6.

He then claims that:

“It is well worth pointing out that constructive mathematics is a generalization of classical mathematics, as was emphasized by Fred Richman, for a proof which avoids excluded middle and choice is still a classical proof. However, trying to learn constructive thinking in the classical world is like trying to learn noncommutative algebra by studying abelian groups.”

... Bauer: [Ba16], p. 6.

Bauer expands on the need of constructive mathematics to ‘twist’ the meaning of ‘truth’ as necessitated by the differing modes of truth-assignments required by the gamut of differing constructive worlds which—Bauer ruefully notes—a constructive mathematics that claims to generalise classical mathematics is compelled to accommodate.

He then addresses two such assignments, the first of which appeals to the *computable* properties of realisability.

“In our first honestly constructive world only that is true which can be computed. Let us imagine, as programmers do, that mathematical objects are represented on a computer as data, and that functions are programs operating on data. Furthermore, a logical statement is only considered valid when there is a program witnessing its truth. We call such programs realizers, and we say that statements are realized by them. The *Brouwer-Heyting-Kolmogorov* rules explain when a program realizes a statement:

- (1) falsehood \perp is not realized by anything;
- (2) truth \top is realized by a chosen constant, say \star ;
- (3) $P \vee Q$ is realized by a pair (p, q) such that p is a realizer of P and q of Q ;
- (4) $P \wedge Q$ is realized either by $(0, p)$, where p realizes P , or by $(1, q)$, where q realizes Q ;
- (5) $P \Rightarrow Q$ is realized by a program which maps realizers of P to realizers of Q ;
- (6) $\forall x \in A. P(x)$ is realized by a program which maps (a representation of) any $a \in A$ to a realizer of $P(a)$;
- (7) $\exists x \in A. P(x)$ is realized by a pair (p, q) such that p represents some $a \in A$ and q realizes $P(a)$;
- (8) $a = b$ is realized by a p which represents both a and b .

The rules work for any reasonable notion of ‘program’. Turing machines would do, but so would quantum computers and programs actually written by programmers in practice.”

... Bauer: [Ba16], pp.6-7.

As examples of the use of realizers, Bauer first offers an example of a universally quantified ‘for all’ (cf. §10.C.(b)) proposition that, by §2., Definition 10, is algorithmically *computable* under interpretation:

“For every natural number there is a prime larger than it.

This is a ‘for all’ statement, so its realizer is a program p which takes as input a natural number n and outputs a realizer for ‘there is a prime larger than n ’, which is a pair (m, q) where m is again a number and q realizes ‘ m is prime and $m > n$ ’. If we forget about q , we see that p is essentially a program that computes arbitrarily large primes. Because such a program exists, there are arbitrarily large primes in the computable world.”

... Bauer: [Ba16], p.7.

He then proffers, as a more interesting example, a universally quantified ‘for any’ (cf. §10.C.(a)) proposition that, by Definitions 7 and 10, is algorithmically *verifiable* but not algorithmically *computable* (see §7.G., Theorem 7.2) under interpretation:

“(1) $\forall x \in R. x = 0 \vee x \neq 0$.

If we define real numbers as the Cauchy completion of rational numbers, then a real number $x \in R$ is represented by a program p which takes as input $k \in \mathbb{N}$ and outputs a rational number r_k such that $|x - r_k| \leq 2^{-k}$. Thus a realizer for (1) is a program q which accepts a representation p for any

$x \in \mathbb{R}$ and outputs either $(0, s)$ where s realizes $x = 0$, or $(1, t)$ where t realizes $x \neq 0$. Intuitively speaking, such a q should not exist, for however good an approximation r_k of x the program q calculates, it may never be sure whether $x = 0$. To make a water-tight argument, we shall use q to construct the Halting oracle, which does not exist. (The usual proof of nonexistence of the Halting oracle is yet another example of a constructive proof of negation.) Given a Turing machine T and an input n , define the sequence r_0, r_1, r_2, \dots of rational numbers by

- $r_k = 2^{-j}$ if $T(n)$ halts at step j and $j \leq k$,
- $r_k = 2^{-k}$ otherwise.

This is a Cauchy sequence because $|r_k - r_m| \leq 2^{-\min(k,m)}$ for all $k, m \in \mathbb{N}$, and it is computable because the value of r_k may be calculated by a simulation of at most k steps of execution of $T(n)$. The limit $x = \lim_k r_k$ satisfies

- $x = 2^{-j} > 0$, if $T(n)$ halts at step j ,
- $x = 0$, if $T(n)$ never halts.

The program p which outputs r_k on input k represents x because $|x - r_k| \leq 2^{-k}$ for all $k \in \mathbb{N}$. We may now decide whether $T(n)$ halts by running $q(p)$: if it outputs $(0, s)$, then $T(n)$ does not halt, and if it outputs $(1, t)$, then $T(n)$ halts."

... Bauer: [Ba16], pp.7-8.

Bauer notes that although the above argument needs:

"... the following (valid) instance of excluded middle: for every $k \in \mathbb{N}$, either $r_k = 2^{-k}$ or $r_k = 2^{-j}$ for some $j < k$ "

... Bauer: [Ba16], p.8.

the statement (1) is an instance of excluded middle which is not realized.

He concludes with an anti-mechanist thesis that echoes—albeit for debatable reasons—the concluding thesis of [An16] (Lucas' Gödelian Thesis, see §2.F., Thesis 2):

"The strategy to place constructivism inside a box is working! If one takes the limited view that everything must be computed by machines, then excluded middle fails because machines cannot compute everything. Our excluded middle is not affected because we are not machines."

... Bauer: [Ba16], p.8.

Bauer uses the computable world to further explain why the following instance of 'subsets of finite sets are finite' is not realized:

"(2) All countable subsets of $0, 1$ are finite.

In computable mathematics a finite set is represented by a finite list of its elements, and a countable set by a program which enumerates its elements, possibly with repetitions. The subsets $\{\}, \{0\}, \{1\}$ and $\{0, 1\}$ are all countable and finite, so (2) looks pretty true. Remember though that in the computable world 'for all' means not 'it holds for every instance' but rather 'there is a program computing witnesses from instances'. A realizer for (2) is a program q which takes as input a program p enumerating the elements of a subset of $\{0, 1\}$ and outputs a finite list of all the elements so enumerated."

... Bauer: [Ba16], p.8.

Bauer argues that:

“To see intuitively where the trouble lies, suppose p starts enumerating zeroes:

0, 0, 0, 0, 0, 0, ...

The output list should contain 0, but should it contain 1? However long a prefix of the enumeration we investigate, if it is all zeroes, then we cannot be sure whether 1 will appear later. For an actual proof we use the same trick as before: with q in hand we could construct the Halting oracle. Given any Turing machine T and input n , consider the program p which works as follows:

- $p(k) = 1$ if $T(n)$ halts in fewer than k steps,
- $p(k) = 0$ otherwise.

The subset $S \subseteq \{0, 1\}$ enumerated by p is constructed so that

- $1 \in S$ if $T(n)$ halts,
- $1 \notin S$ if $T(n)$ does not halt.

Now scan the finite list computed by $q(p)$: if it contains 1, then $T(n)$ holds, otherwise it does not.”

... Bauer: [Ba16], p.8.

From the *evidence-based* perspective of §7.C., however, we can ‘see intuitively where the trouble lies’ in the above examples if we recognise that:

- the Law of the Excluded Middle (LEM) is *finitarily* valid (an immediate consequence of §2.C.a., Theorem 2.16); and,
- by unnecessarily disallowing appeal to LEM, the *Brouwer-Heyting-Kolmogorov* rules
 - are unable to accommodate
 - * algorithmic *verifiability* (i.e., evidencing each *specified* instance by *some* algorithm), and
 - * algorithmic *computability* (i.e., evidencing all *intended* instances by a *single* algorithm),
 - as distinct, but constructive, concepts.

The *Brouwer-Heyting-Kolmogorov* rules are, thus, unable to offer a resolution of the query raised in Bauer’s second, *more interesting*, example, which is essentially whether:

Halting problem for T (§21.F.a., Query 26): Given a Turing machine T , can one effectively decide, given any instantaneous description α , whether or not there is a computation of T beginning with α ?

That the underlying issue is not restricted to Bauer’s specific example is seen if we note that, from an *evidence-based* perspective:

- the Halting problem for T (§21.F.a., Query 26)
- is not only answerable in the affirmative (see §21.F.b., Corollary 21.4),
- but is conflated (see §21.F.a.), in current paradigms of both constructive and classical mathematics,

- with Turing's Halting problem (§21.F., Query 25),
- which admits a negative answer (see §21.F.b., Corollary 21.5).

Turing's Halting problem (§21.F., Query 25) Is it always decidable by a Turing machine whether or not a partial recursive function is total?

7.E.a. Recursive realizability and the Law of the Excluded Middle

The inability of *Brouwer-Heyting-Kolmogorov* rules to accommodate:

- algorithmic *verifiability* (i.e., evidencing each *specified* instance by *some* algorithm), and
- algorithmic *computability* (i.e., evidencing all *intended* instances by a *single* algorithm),

as distinct, but constructive, concepts reflects, *prima facie*, the perception that treating 'realizability' as only 'recursive realizability' should suffice in intuitionistic argumentation.

For instance, as detailed by Stephen Cole Kleene:

"Realizability is intended as an intuitionistic interpretation of a formula; and to say intuitionistically that $\mathbf{A}(x_1, \dots, x_n, y)$ is realizable should imply its being intuitionistically true, i.e. that the proposition $A(x_1, \dots, x_n, y)$ constituting its intuitionistic meaning holds. The formula $\exists y A(x_1, \dots, x_n, y)$ asserts the existence, for every x_1, \dots, x_n , of a y depending on x_1, \dots, x_n , such that $A(x_1, \dots, x_n, y)$; or in other words, the existence of a function $y = \phi(x_1, \dots, x_n)$ such that, for every x_1, \dots, x_n , $A(x_1, \dots, x_n, \phi(x_1, \dots, x_n))$.

...

The formula $\exists y A(x_1, \dots, x_n, y)$ does not assert the uniqueness of the function $y = \phi(x_1, \dots, x_n)$ such that $A(x_1, \dots, x_n, \phi(x_1, \dots, x_n))$; for this we need $\exists! y A(x_1, \dots, x_n, y)$ (§41).

Classically, given the existence of some function ϕ such that, for all x_1, \dots, x_n , $A(x_1, \dots, x_n, \phi(x_1, \dots, x_n))$, the least number principle provides formally a method of describing a particular one (*149 § 40, *174b § 41). While we do not have the least number principle intuitionistically, we do know by Corollary 2 that, whenever a particular intuitionistic proof of a formula of the form $\exists y A(x_1, \dots, x_n, y)$ is given, we can on the basis of that proof describe informally a particular general recursive function $\phi(x_1, \dots, x_n)$ such that, or all x_1, \dots, x_n , $A(x_1, \dots, x_n, \phi(x_1, \dots, x_n))$."

... Kleene: [K152], pp.509-510.

However, a consequence for constructive mathematics of limiting the concept of 'realizability' to only 'recursive realizability' (what we have termed as 'algorithmic *computability*') is that—misleadingly in view of §8.D., Theorem 8.13—it does not admit the Law of the Excluded Middle:

"The formula $\forall x(A(x) \vee \neg A(x))$ is classically provable, and hence under classical interpretations true. But it is unrealizable. So if realizability is accepted as a necessary condition for intuitionistic truth, it is untrue intuitionistically, and therefore unprovable not only in the present intuitionistic formal system, but by any intuitionistic methods whatsoever.

This incidentally implies that our classical formal system reinforced by an intuitionistic proof of simple consistency cannot serve as an instrument of intuitionistic proof, as suggested in §14, except of formulas belonging to a very restricted class (including those of the form $B(x)$ and $\forall B(x)$ end § 42, but not the present formula $\forall x(A(x) \vee \neg A(x))$).

The negation $\neg\forall x(A(x) \vee \neg A(x))$ of that formula is classically untrue, but (by the corollary) realizable, and hence intuitionistically true, if we accept realizability (intuitionistically established) as sufficient for intuitionistic truth.

So the possibility appears of asserting the formula $\neg\forall x(A(x) \vee \neg A(x))$ intuitionistically. Thus we should obtain an extension of the intuitionistic number theory, which has previously been treated as a subsystem of the classical, so that the intuitionistic and classical number theories diverge, with $\neg\forall x(A(x) \vee \neg A(x))$ holding in the intuitionistic and $\forall x(A(x) \vee \neg A(x))$ in the classical."

... Kleene: [K152], pp.513-514.

'Misleadingly', since the *finitary* interpretation of PA in [An16], Theorem 6.7 (p.41; see also §8.D., Theorem 8.13), entails that the first-order logic FOL, in which the classical Law of the Excluded Middle $[(\forall x)(A(x) \vee \neg A(x))]$ is a theorem, is also *finitarily* consistent.

We can no longer, thus, admit the 'possibility' entertained by Kleene that the formula ' $\neg\forall x(A(x) \vee \neg A(x))$ ' could be asserted intuitionistically; nor the further argument that a 'strengthened' intuitionistic system denying ' $\forall x(A(x) \vee \neg A(x))$ ' could be 'shown by interpretation to be simply consistent':

"Not only is the formula $\neg\forall x(A(x) \vee \neg A(x))$ itself realizable, but by Theorem 62 (a) (taking it as the Γ), when we add it to the present intuitionistic formal system, only realizable formulas become provable in the enlarged system. So then every provable formula will be true under the realizability interpretation. In particular, the strengthened intuitionistic system is thus shown by interpretation to be simply consistent."

... Kleene: [K152], p.514.

Moreover, by failing to recognise that algorithmic *verifiability* is not only constructive, but *the* 'truth' assignment that yields the *weak*, standard interpretation of PA in classical mathematics, intuitionistic perspectives uncritically accept that, if $\mathbf{A}_p(\mathbf{p})$ corresponds to Gödel's formula 17 *Gen r* ([Go31], p.25, eqn. 13), then:

"... we can interpret the formula $\mathbf{A}_p(\mathbf{p})$ from our perspective of the Gödel numbering as expressing the proposition that $\mathbf{A}_p(\mathbf{p})$ is unprovable, i.e. it is a formula A which asserts its own provability."

... Kleene: [K152], p.207.

The fallacy in the—not uncommon—conclusion that $\mathbf{A}_p(\mathbf{p})$ 'is a formula A which asserts its own provability' is highlighted in §15.H..

7.F. Well-definedness

We note that the distinction between §2., Definition 7, and §2., Definition 10, now allows us to define:

Definition 25. (Well-defined sequence) *A Boolean number-theoretical sequence $\{F^*(1), F^*(2), \dots\}$ is well-defined if, and only if, the number-theoretical relation $F^*(x)$ is algorithmically verifiable.*

Moreover, by insisting that, for any specified natural number i , there be a deterministic algorithm that computes $F^*(j)$ as either 0 or 1 for all $j \leq i$ in a Boolean sequence, Definition 25 essentially restricts the introduction of putative, set-theoretically postulated, *unspecified* real numbers into any *evidence-based* reasoning (see §7.I., Theorem 7.5) unless their binary representations are presumed *well-defined*.

Comment 72. The significance of Definition 25 for the natural sciences is seen in the putative resolution that it admits of the *EPR* paradox in [An15] (see also §23.).

In this investigation we shall, accordingly, assume the following definition that, no matter how imprecise, seeks to capture at least the essence of what we intuitively mean by ‘well-defined’:

Definition 26. (Well-definedness) *A mathematical concept is well-defined if, and only if, it can be defined in terms of algorithmic verifiability.*

7.G. Algorithmically *verifiable* but not algorithmically *computable*

The following argument (see also [An16], Theorem 2.1, p.37) illustrates that although every algorithmically *computable* relation is algorithmically *verifiable* (hence well-defined), the converse is not true:

Theorem 7.2. *There are well-defined number theoretic functions that are algorithmically verifiable but not algorithmically computable.*

Proof. We note that:

- (a) Since any putative, set-theoretically postulated, real number $R = Lt_{n \rightarrow \infty} \sum_{i=0}^n r(i) \cdot 2^{-i}$ in binary notation is mathematically definable by a correspondingly unique Cauchy sequence²⁰⁰:

$$\{\sum_{i=0}^n r(i) \cdot 2^{-i} : n = 0, 1, \dots; r(i) \in \{0, 1\}\}$$

of rational numbers in binary notation, it follows that:

- (i) If $r(n)$ denotes the n^{th} digit in the decimal expression of the real number R in binary notation;
- (ii) Then, for any *specified* natural number n , Gödel's primitive recursive β -function defines an algorithm $AL_{(R, n)}$ that can verify the truth/falsity of each proposition in the finite sequence:

$$\{r(0) = 0, r(1) = 0, \dots, r(n) = 0\}.$$

Hence, for any real number R , the relation $r(x) = 0$ is algorithmically *verifiable* (hence *well-defined*) trivially by §2., Definition 7.

- (b) Since it follows from Alan Turing's Halting argument ([Tu36], p.132, §8) that there are algorithmically *uncomputable* real numbers:
- (i) Let $r(n)$ denote the n^{th} digit in the decimal expression of an algorithmically *uncomputable* real number R in binary notation.
- (ii) By (a), the relation $r(x) = 0$ is algorithmically *verifiable* trivially.

²⁰⁰**Cauchy sequence:** A sequence x_1, x_2, x_3, \dots of real numbers is a Cauchy sequence if, and only if, for every real number $\epsilon > 0$, there is an integer $N > 0$ such that, for all natural numbers $m, n > N$, $|x_m - x_n| \leq \epsilon$.

- (iii) However, by definition there is no algorithm AL_R that can decide the truth/falsity of each proposition in the denumerable sequence:

$$\{r(0) = 0, r(1) = 0, \dots\}.$$

Hence, although the relation $r(x) = 0$ is algorithmically *verifiable* (hence *well-defined*), it is not algorithmically *computable* by §2., Definition 10. □

Gödel’s β -function Lemma: If f is an arbitrary sequence of natural numbers and k is an arbitrary natural number, then there exists a pair of natural numbers n, d such that $f^{(n,d)}$ and f coincide in their first k terms. ([Go31], Theorem VII, Lemma 1, p.31).

Comment 73. The significance of Gödel’s β -function Lemma is that if f is a function defined by primitive recursion on a parameter n , say by $f(0) = c$ and $f(n + 1) = g(n, f(n))$, then to express $f(n) = y$ one would like to say: there exists a sequence a_0, a_1, \dots, a_n such that $a_0 = c, a_n = y$ and for all $i < n$ one has $g(i, a_i) = a_{i+1}$. While that is not possible directly, one can say instead: there exist natural numbers a, b , and a primitive recursive function $\beta(b, c, i)$, such that $\beta(a, b, 0) = c, \beta(a, b, n) = y$ and for all $i < n$ one has $g(i, \beta(a, b, i)) = \beta(a, b, i + 1)$ (see also [Me64], p.131).

Although a proof that some number-theoretic relation instancing §7.G., Theorem 7.2 can be *well-defined* (in the sense of §7.F., Definition 25) is not obvious, §2.F., Corollary 2.21 shows that Gödel’s *meta-mathematically* defined formula $[R(x)]$ is algorithmically *verifiable* as always true under the *weak*, standard, interpretation $I_{PA(N,SV)}$ of PA (see §2.B.), hence *well-defined* (in the sense of Definition §7.F., 25), but not algorithmically *computable* as always true under the *strong*, finitary, interpretation $I_{PA(N,SC)}$ of PA (see §2.C.).

We note that a definition of a set of computationally significant, *well-defined*, number-theoretic functions which are algorithmically *verifiable*, but not algorithmically *computable*, was also given by Gregory Chaitin in [Ct75].

He defined a class of Ω constants such that, if $C(n)$ is the n^{th} digit in the decimal expression of an Ω constant, then the function $C(x)$ is algorithmically *verifiable* but not algorithmically *computable*; where Ω is Chaitin’s Halting Probability given by $0 < \Omega = \sum 2^{-|p|} < 1$, the summation is over all self-delimiting programs p that halt, and $|p|$ is the size in bits of the halting program p (see [Ct82]).

Comment 74. We note that Specker sequences (see [Smn05]; also §7.I.; §20.D.) do not instance §7.G., Theorem 7.2, since they are algorithmically *computable*, monotonically increasing, bounded sequences of rational numbers.

Theorem 7.2 now admits a formal definition of *relative* randomness:

Definition 27. (Relative randomness) *A number-theoretic sequence is relatively random if, and only if, it is algorithmically verifiable, but not algorithmically computable.*

Comment 75. The significance of Definition 27 for the mathematical representation of quantum phenomena is highlighted in §23.D. by Thesis 16, and in §23.D.d. by Thesis 20.

A *relatively* random number-theoretic sequence cannot thus be represented—nor defined—as a partial recursive function; since the latter always defines, and is defined by, some deterministic Turing machine (see [Me64], p.237; [Kl52], p.373).

However, complementing the Provability Theorem for PA which models algorithmically *computable* number-theoretic functions arithmetically (see §3.), any *relatively* random sequence *can* be defined within PA in terms of Gödel’s β -functions (as detailed in §16.A. and §16.B.).

7.H. The classical Church-Turing Thesis

We note that classical theory holds (see also §21.F.):

- (a) Every Turing-computable function $F(x_1, \dots, x_n)$ is partial recursive, and, if $F(x_1, \dots, x_n)$ is total, then $F(x_1, \dots, x_n)$ is recursive (see [Me64], p.233, Corollary 5.13).
- (b) Every partial recursive function $F(x_1, \dots, x_n)$ is Turing-computable (see [Me64], p.237, Corollary 5.15).

From this, classical theory concludes that the following, essentially unverifiable (since it treats the notion of ‘effective computability’ as intuitive, and not definable formally) but refutable, theses (informally referred to as the Church-Turing Thesis CT) are equivalent (see [Me64], p.237):

Church’s Thesis: A number-theoretic function $F(x_1, \dots, x_n)$ is effectively computable if, and only if, $F(x_1, \dots, x_n)$ is recursive (see [Me64], p.227).

Turing’s Thesis: A number-theoretic function $F(x_1, \dots, x_n)$ is effectively computable if, and only if, $F(x_1, \dots, x_n)$ is Turing-computable (see [BBJ03], p.33).

Comment 76. Although Church’s and Turing’s theses—as expressed above—are usually treated as functionally equivalent, their original intentions—when viewed from the *evidence-based* perspective of this investigation in §7.H.a., Definition 28—seemingly justify Paula Quinon’s insightful argument that the two are sufficiently distinguishable so as to cast doubt on their having—between them—captured the notion of ‘effective computability’:

“Mathematicians’ project of formalizing the concept of effective computability in the 1930s had various motivations. Turing wanted to solve the *Entscheidungsproblem*—the decision problem regarding provability of first-order sentences—formulated by Hilbert and Ackermann (1928). Gödel and Church were interested in specifying the concept of formal system and therefore needed a sharp concept of effective method to account for finite reasoning in such systems. In particular, Church and his group searched for effective methods of defining functions on natural numbers, and thereby, a way of singling out the class of functions that can be effectively computed.¹

Various models of computation were formulated in response to these objectives. Church’s thesis, formulated in 1936, identifies the pre-systematic concept of “effectively computable” or “calculable” with the property of “being generally recursive” defined for functions on natural numbers.² Turing’s thesis, formulated in the same year, translates this pre-systematic concept into “being computable by a Turing machine”. The two definitions were soon shown to be extensionally equivalent. Hence, the “Church–Turing thesis”.³

However, the fact that general recursiveness and Turing computability are extensionally equivalent does not mean that they capture the same properties. This raises the question of which of the two accounts, Church’s or Turing’s, if any, provides an adequate conceptual analysis of the concept of effective computability, where by “conceptual analysis” I mean an attempt to clarify a given concept by identifying its conceptual parts. On this understanding the two theses differ significantly in many aspects. For instance, Church’s thesis states that effective computability can be analyzed in terms of properties of functions defined on natural numbers understood as abstract objects. Turing’s thesis, by contrast, expresses that effective computability can be analyzed in terms of properties of functions defined on strings of symbols. Thus, the two theses provide very different analyses of the concept in question. If one

assumes, as is often tacitly done, that only one analysis of a given concept can be correct, once the latter has been properly disambiguated, then Church's analysis and Turing's analysis cannot both be adequate."

... Quinon: [Quin19], §Introduction.

It is significant that both Gödel (initially) and Alonzo Church (subsequently—possibly under the influence of Gödel's disquietude) enunciated Church's formulation of 'effective computability' as a Thesis because Gödel was instinctively uncomfortable with accepting it as a definition that *minimally* captures the essence of *intuitive* effective computability (see [Si97]).

Gödel's reservations seem vindicated if we accept that a number-theoretic function can be effectively computable instantiationally (in the sense of being algorithmically *verifiable*), but not by a uniform method (in the sense of being algorithmically *uncomputable*).

That arithmetical 'truth' too can be effectively decidable instantiationally, but *not* by a uniform method, under an appropriate interpretation of PA is speculated upon by Gödel in his famous 1951 Gibbs lecture, where he remarks²⁰¹:

"I wish to point out that one may conjecture the truth of a universal proposition (for example, that I shall be able to verify a certain property for any integer given to me) and at the same time conjecture that no general proof for this fact exists. It is easy to imagine situations in which both these conjectures would be very well founded. For the first half of it, this would, for example, be the case if the proposition in question were some equation $F(n) = G(n)$ of two number-theoretical functions which could be verified up to very great numbers N ."

... Gödel: ([Go51]).

Comment 77. In her 2017 CiE2017 talk [Knd17], 'Gödel's reception of Turing's model of computability', Juliette Kennedy remarks that:

"The project of developing an autonomous logical perspective permeated Gödel's outlook from then on. Gödel alludes to it a number of times in his Princeton Bicentennial Lecture, in connection with finding absolute notions of decidability and provability. One can also read the perspective into Gödel's over-arching goal of attaining decidability in set theory—for how else to achieve decidability in set theory, except by remaining, as we have called it, formalism free?"

Kennedy: [Knd17], pp.47-48.

From the *evidence-based* perspective of this investigation²⁰² we would argue that, if so, a contributory cause could have been that Gödel failed to formally express, and explicate, the distinction between algorithmic 'verifiability' (§2., Definition 7) and algorithmic 'computability' (§2., Definition 10); a distinction that is implicit in his 1951 Gibbs's lecture. Gödel may have, thus, failed to realise the far-reaching consequences of the distinction for number theory, computability, and logic (see, for instance, §3., §4., and §5.).

Such a possibility is also implicit in Turing's remarks ([Tu36], §9(II), p.139):

"The computable numbers do not include all (in the ordinary sense) definable numbers. Let P be a sequence whose n -th figure is 1 or 0 according as n is or is not satisfactory. It is an immediate consequence of the theorem of §8 that P is not computable. It is (so far as we know at present) possible that any assigned number of figures of P can be calculated, but not by a uniform process.

²⁰¹Rohit Parikh's paper [Pa71] on existence and feasibility can also be viewed as an attempt to investigate the consequences of expressing the essence of Gödel's remarks formally.

²⁰²In this instance as reflected by the Provability Theorem for PA (§2.E.b., Theorem 2.17), which seeks to bridge the gap between PA provability and Turing computability (see §2.E.).

When sufficiently many figures of P have been calculated, an essentially new method is necessary in order to obtain more figures."

... Turing: ([Tu36], §9(II), p.139).

The need for placing such a distinction²⁰³ on a formal basis has also been expressed explicitly on occasion. Thus, Boolos, Burgess and Jeffrey ([BBJ03], p. 37) define a diagonal function, d , any value of which can be decided effectively, although there is no single algorithm that can effectively compute d .

Now, the straightforward way of expressing this phenomenon informally should be to say that there are constructively well-defined number-theoretic functions that are 'effectively' computable 'instantiationally', but not 'algorithmically'. However, as the authors quizzically observe, such functions are labeled as *uncomputable*!

"According to Turing's Thesis, since d is not Turing-computable, d cannot be effectively computable. Why not? After all, although no Turing machine computes the function d , we were able to compute at least its first few values. For since, as we have noted, $f_1 = f_2 = f_3 =$ the empty function we have $d(1) = d(2) = d(3) = 1$. And it may seem that we can actually compute $d(n)$ for any positive integer n —if we don't run out of time."

... Boolos/Burgess/Jeffrey: ([BBJ03], p.37).

The reluctance to treat a function such as $d(n)$ —or the function $\Omega(n)$ that computes the n^{th} digit in the decimal expression of a Chaitin constant Ω ²⁰⁴—as computable, on the grounds that the 'time' needed to compute it increases monotonically with n , is curious²⁰⁵; the same applies to any total Turing-computable function $f(n)$.

The only difference is that, in the latter case, we 'know'—or are willing to accept as reasonable—that there exists²⁰⁶ a common 'program' of constant length that will compute $f(n)$ for any given natural number n ; in the former, we know we may need distinctly different programs for computing $f(n)$ for different values of n , where the length of the program may, sometime, reference n .

In a panel discussion on "The Prospects for Mathematical Logic in the Twenty-First Century" at the annual meeting of the Association for Symbolic Logic held in Urbana-Champaign, June 2000, Richard A. Shore concluded his perspective with three 'pie-in-the-sky, problems', where he argues for 'a formal definition of algorithm and the appropriate analog of the Church-Turing thesis':

"In a different direction, we return to the original language of computation. Here the beginnings of recursion theory have already played an important role, e.g. the Turing machine model as a basic one for computation and the λ -calculus as one for programming languages both abstract and actual. And so we come back to the beginnings of the study of the formal languages of computation. Along these lines, I would like to close with three, certainly not original and probably pie-in-the-sky, problems.

²⁰³Rohit Parikh's distinction between 'decidability' and 'feasibility' in [Pa71] also appears to echo the need for such a distinction.

²⁰⁴Chaitin's Halting Probability Ω is given by $0 < \Omega = \sum 2^{-|p|} < 1$, where the summation is over all self-delimiting programs p that halt, and $|p|$ is the size in bits of the halting program p ; see [Ct75].

²⁰⁵The incongruity of this is addressed by Parikh in [Pa71].

²⁰⁶The issue here seems to be that, when using language to express the abstract objects of our individual, and common, mental 'concept spaces', we use the word 'exists' loosely in three senses, without making explicit distinctions between them (see [An07c]).

1. "Prove" the Church-Turing thesis by finding intuitively obvious or at least clearly acceptable properties of computation that suffice to guarantee that any function so computed is recursive. Turing [64] argues for the thesis that any function that can be calculated by an abstract human being using various mechanical aids can be computed by a Turing machine (and so is recursive). Gandy [24] argues that any function that can be calculated by a machine is also Turing computable. Deutsch [14] approaches this issue from a more quantum mechanical perspective. Martin Davis has pointed out (personal communication) that one can easily prove that computations as given by deductions in first order logic relations from a finite set of sentences about numerals and the function being defined are necessarily recursive. An analysis based on the view that what is to be captured is human mechanical computability is given in Sieg [55].

Perhaps the question is whether we can be sufficiently precise about what we mean by computation without reference to the method of carrying out the computation so as to give a more general or more convincing argument independent of the physical or logical implementation. For example, do we reject the nonrecursive solutions to certain differential equations as counterexamples on the basis of our understanding of physics or of computability. Along these lines, we also suggest two related questions.

2. What does physics have to say about computability (and provability or logic)? Do physical restrictions on the one hand, or quantum computing on the other, mean that we should modify our understanding of computability or at least study other notions? Consider Deutsch's [14] Church-Turing principle and arguments that all physically possible computations can be done by a quantum computer analog of the universal Turing machine. He argues, in addition, that the functions computable (in a probabilistic sense) by a quantum Turing machine are the same as the ones computable by an ordinary Turing machine, but that there is, in principle, an exponential speed-up in the computations. How do these considerations affect our notions of both computability and provability? For some of the issues here see Deutsch et al. [15].

3. Find, and argue conclusively for, a formal definition of algorithm and the appropriate analog of the Church-Turing thesis. Here we want to capture the intuitive notion that, for example, two particular programs in perhaps different languages express the same algorithm, while other ones that compute the same function represent different algorithms for the function. Thus we want a definition that will up to some precise equivalence relation capture the notion that two algorithms are the same as opposed to just computing the same function. Moschovakis [46] is an interesting approach to this problem from the viewpoint that recursion, and an appropriate formal language for it, should be taken as basic to this endeavor."

... Shore: [BKPS], §2, *Recursion Theory*, pp.6-8

7.H.a. *Evidence-based* reasoning does not admit the classical Church-Turing Thesis

If, however, we accept that algorithmically *verifiable* functions may be instantiationally computable but not algorithmically computable then—since algorithmic *verifiability* is defined constructively (see §2., Definition 7)—§7.F., Definition 25 now admits an *evidence-based* definition of 'effective computability' that violates the Church-Turing Thesis (see §29.(2); also §21.F.):

Definition 28. (Effective computability) *A number-theoretic function $F^*(x_1, \dots, x_n)$ is effectively computable if, and only if, $F^*(x_1, \dots, x_n)$ is well-defined.*

Moreover, from the *evidence-based* perspective of [An16], the Provability Theorem for PA (Theorem 7.1, p.41) could be viewed as:

— meeting Shore's need for 'a formal definition of algorithm' in (3) above;

whilst §7.H.a., Definition 28 could be viewed as:

- ‘the appropriate analog of the Church-Turing thesis’ in *evidence-based* reasoning that:
 - disproves the Church-Turing thesis as argued for in (1) above; and
 - illuminates Deutsch's, putatively physical, Church-Turing principle in (2) (as detailed further in §21.H.).

That a paradigm shift may be involved in:

- (1) defining algorithmic *verifiability* (§2., Definition 7) and algorithmic *computability* (§2., Definition 10) constructively; and
- (2) accepting §7.H.a., Definition 28,

is suggested by Lázsló Kalmár's reluctance to treat his—essentially similar—argument (see §21.I.) against the plausibility of Church's Thesis as a proof:

“...I shall not disprove Church's Thesis. Church's Thesis is not a mathematical theorem which can be proved or disproved in the exact mathematical sense, for it states the identity of two notions only one of which is mathematically defined while the other is used by mathematicians without exact definition. Of course Church's Thesis can be masked under a definition: we call an arithmetical function effectively calculable if and only if it is general recursive, venturing however that once in the future, somebody will define a function which is on one hand, not effectively calculable in the sense defined thus, on the other hand, its value obviously can be effectively calculated for any given arguments.”

... Kalmár: [Km59], p.72.

Making the same point somewhat obliquely, the need for introducing a formally undefined concept of effective computability into the classical Church-Turing thesis is also questioned from an unusual perspective by Saul A. Kripke, who argues that, since any mathematical computation can, quite reasonably under an unarguable ‘Hilbert's thesis’, be corresponded to a deduction in a first-order theory (see §2.E.a.), the Church-Turing ‘thesis’ ought to be viewed more appropriately as an immediate corollary of Gödel's completeness theorem:

“So, to restate my central thesis: computation is a special form of deduction. If we restrict ourselves to algorithms whose instructions and steps can be stated in a first-order language (first-order algorithms), and these include all algorithms currently known, the Church-Turing characterization of the class of computable functions can be represented as a special corollary of the Gödel completeness theorem.”

... Kripke: [Krp13], pp.80-81 & 94.

7.H.b. Effective computability and the Church-Turing Thesis

We conclude that (see also §10.C., Theorem 10.3), contrary to current paradigms²⁰⁷ (see [OWJ06]; also [Pic11], [Ty107]):

Theorem 7.3. *The classical Church-Turing Thesis is false in any interpretation of the first-order Peano Arithmetic PA that admits evidence-based quantification.*

²⁰⁷Challenged—albeit on different grounds—also by Selmer Bringsjord and Naveen Sundar Govindarajalu in [BG11], [BG11a]: “One of us has previously argued that the Church-Turing Thesis (CTT), contra Elliot Mendelson, is not provable, and is—in light of the mind's ability to effortlessly hypercompute—moreover false”.

Proof. By §7.H.b., Definition 28 and [An16], Corollary 8.3 (p.42; see also §2.F., Corollary 2.21), Gödel’s meta-mathematically *well-defined* formula $[R(x)]$ is algorithmically *verifiable* as always true under $I_{PA(N,SV)}$, but not algorithmically *computable* as always true under $I_{PA(N,SC)}$. Hence it is not partial recursive. \square

Comment 78. The significance of Theorem 7.3 is seen in the attempt by Mihai Ganea—in his preprint [Gna14]—to provide a *categorically communicable* interpretation of the Church-Turing Thesis ($CTT_{\mathcal{L}}$) by appeal to, intriguingly *finitary*, computations ‘by idealized human agents’; an appeal which, from the *evidence-based* perspective of this investigation, seemingly²⁰⁸ entails that $CTT_{\mathcal{L}}$ can be claimed as provable in a first-order arithmetic such as PA:

“The Church-Turing thesis is given a provable interpretation based on the idea that a computation by an idealized human agent must be a logically definable finite mathematical object. The argument is preserved under a large variation in the expressive power of the underlying logical language, thus providing a possible explanation of why the notion of effective computability is so robust.”

... Ganea: [Gna14], Abstract.

That Ganea’s thesis entails PA-provability follows from Corollary 7.2²⁰⁹ of [An16], since he ‘takes ‘effective computation’ to mean computation by idealized human agents’, and insists that computation ‘(as performed by rational agents) is an inter-subjective mathematical activity and its products must be [categorically?] communicable. It can be argued that a computation which cannot be fully described, reproduced and checked (by another agent) does not fall under the intuitive notion of effective computation’:

“The Church-Turing Thesis (CTT) asserts that effectively computable functions on natural numbers are precisely the functions computable by Turing machines (or another mathematical model of computation equivalent to Turing machines). As such it allows distinct versions depending on what is understood by ‘effectively computable function’¹. The version examined here takes ‘effective computation’ to mean computation by idealized human agents.

Arguments offered for this version of CTT seek to derive it from an analysis of the capabilities of such agents. [Turing 1936-7], [Kolmogorov and Uspenskii 1963] and [Smith 2007, Chapter 35] focus on their symbol-manipulating capabilities. I propose instead to derive CTT from an analysis of the communication ability of the rational agents engaged in computation, i.e. from what seem natural constraints on the possible descriptions they can give for an effective computation procedure. From this perspective, the often commented on phenomenon of the extensional equivalence of various definitions of computability is to be explained by the fact that they share certain simple invariant characteristics.

Computation (as performed by rational agents) is an inter-subjective mathematical activity and its products must be communicable. It can be argued that a computation which cannot be fully described, reproduced and checked (by another agent) does not fall under the intuitive notion of effective computation. Furthermore, it seems natural to assume that the end-products of this activity and the behaviors that lead to them are *finite*. While there are no specific finite limits to the resources of the idealized computing agents, a completed computation on an input n is always (describable as) a

²⁰⁸‘Seemingly’, since Ganea’s proof in [Gna14], §2 (*Proving the thesis*)—that $CTT_{\mathcal{L}}$ can be claimed as provable (ostensibly also in a first-order arithmetic such as PA)—appeals to interpretations of the quantifiers; where it is not immediately obvious (see §14.) whether these are intended to be interpreted ‘weakly’ as ‘For any’ and its negation in the sense of §7.C., Definitions 21 and 22, or ‘strongly’ as ‘For all’ and its negation in the sense of 7.C., Definitions 23 and 24.

²⁰⁹**Corollary 7.2.** *PA is categorical with respect to algorithmic computability.*

finite object. Agents capable of performing supertasks are thus excluded as belonging to a different level of idealization. We adopt the following finite representability requirement:

(R) It must be possible to represent a computation (with input m and output n) as a fully described finite object (state of affairs), which could be reproduced precisely by any computing agent satisfying certain minimal requirements.

Computations are also *abstract* mathematical objects, in the sense that they allow different concrete instantiations. They are not specific states of affairs but rather their *structures* or isomorphism types. We also adopt the following *structuralist thesis*:

(S) A necessary and sufficient condition for states of affairs \mathcal{S}_1 and \mathcal{S}_2 to represent the same computation for a computing agent a is that a is aware that \mathcal{S}_1 and \mathcal{S}_2 are isomorphic, i.e. they satisfy the same relevant structural description.

A finite state of affairs \mathcal{S} of the most basic kind is a finite set of objects that stand in (a finite number of) certain relations, i.e. is a finite first-order structure. It is well known that the language of first-order logic (FOL) is necessary and sufficient to characterize any finite first-order structure up to isomorphism (see Proposition 2.1.1 of [Ebbinghaus and Flum 1999, p. 13]). Therefore (from (S)) it is reasonable to demand that the language of computing agents is as least as expressible as FOL and that they are able to determine whether a finite state of affairs satisfies a first-order description. We thus impose a minimal logical competence requirement:

(L_{min}) Any (idealized) computing agent a understands FOL and is able to determine if $\mathcal{U} \models \phi$ or $\mathcal{U} \not\models \phi$ for any FOL sentence ϕ and any finite L_ϕ -structure \mathcal{U} .

The representation of a computation with input m and output n is therefore a logically definable finite structure which must represent m and n as argument and value respectively. Number representation is thus a key component in computation representation. Following [Frege 1884, §§62-69], it can be argued that the foundation of all arithmetical knowledge is the ability to determine whether any two given (finite) sets are equinumerous and that for identifying a specific natural number it is sufficient to exhibit a set (concept) of that cardinality. Therefore for the purposes of this analysis numbers will be identified with classes of equinumerous finite sets, each such set acting as a representation of its cardinal number.

(N) The input (argument) and output (calculated value) of a particular computation will be represented by identifiable subsets (of those respective cardinalities) of the state of affairs representing the computation."

... Ganea: [Gna14], §1. A logical characterization of computation.

Ganea then postulates that 'an effective procedure f is specified by a finite general description of all its particular cases', and defines a *logically definable computation*, and *logical computability* as follows:

"In communication between computing agents an effective procedure f is specified by a finite general description of all its particular cases and by the principle of minimal logical competence (L_{min}) this description is an FOL-sentence. We are thus led to the following pair of definitions:

Definition 1. A *logically definable computation* (\mathcal{L} -computation) with input (argument) m and output (value) n is a finite L -structure \mathcal{C} , with L a finite first-order signature including the unary predicates 'A' (for 'argument') and 'V' (for 'value'), such that $|A^{\mathcal{C}}| = m$ and $|V^{\mathcal{C}}| = n$ (P^S is the interpretation of the predicate 'P' in the structure S and $|X|$ is the number of elements in the finite set X). \mathcal{C} is said to functionally represent m and n .

Definition 2. A (partial) function $f : \mathbb{N} \rightarrow \mathbb{N}$ is *logically computable* (\mathcal{L} -computable) if and only if there exists a first-order formula ϕ whose language includes the monadic predicates ‘ A ’ and ‘ V ’ such that:

(*) $f(m) = n$ if and only if there exists a finite L_ϕ -model \mathcal{M} for ϕ such that \mathcal{M} functionally represents m and n ."

... Ganea: [Gna14], §1. A logical characterization of computation.

He concludes from this that:

“The characterization of computation from §1 yields the following provable version of the Church-Turing thesis:

($CTT_{\mathcal{L}}$) A function $f : \mathbb{N} \rightarrow \mathbb{N}$ is \mathcal{L} -computable if and only if f is computable by a Turing machine (f is \mathcal{T} -computable)."

... Ganea: [Gna14], §1. A logical characterization of computation, and §2. Proving the thesis.

Prima facie, Ganea’s postulate that ‘an effective procedure f is specified by a finite general description of all its particular cases’, can be viewed as corresponding to §7.H.a. Definition 28:

Definition 28. (Effective computability) A number-theoretic function $F^*(x_1, \dots, x_n)$ is *effectively computable* if, and only if, $F^*(x_1, \dots, x_n)$ is well-defined.

where:

Definition 25. A Boolean number-theoretical sequence $\{F^*(1), F^*(2), \dots\}$ is well-defined if, and only if, the number-theoretical relation $F^*(x)$ is algorithmically verifiable.

and:

Definition 7. A number-theoretical relation $F(x)$ is algorithmically verifiable if, and only if, for any specifiable natural number n , there is a deterministic algorithm $AL_{(F, n)}$ which can provide objective evidence for deciding the truth/falsity of each proposition in the finite sequence $\{F(1), F(2), \dots, F(n)\}$.

If so, it would follow from the Provability Theorem for PA that Ganea’s proof of $CTT_{\mathcal{L}}$ entails a function f is \mathcal{L} -computable if, and only if, it is PA-provable.

However, Ganea’s proof is then invalid since, by his definition, a formula is \mathcal{L} -computable if, and only if, it is algorithmically verifiable whereas, by [An16], Corollary 8.3²¹⁰, Gödel’s formula $[R(x)]$ is algorithmically verifiable, but not PA-provable.

7.I. Every (*evidence-based*) *eb*-real number is *specifiable* in PA

The distinction between algorithmic *verifiability* ([An16], Definition 1, p.37; see also §2., Definition 7), and algorithmic *computability* ([An16], Definition 2, p.37; see also §2., Definition 10), also allows us to place Cantor’s Theorem²¹¹—namely that the domain \mathbb{R} of set-theoretically postulated *stp*-real numbers is algorithmically *uncountable*—into a coherent, *evidence-based*, *arithmetical* perspective if we identify geometrical points on a line not with Platonically postulated limits of *set-theoretical* Cauchy sequences of rationals under an interpretation, but with the interpreted *evidence-based* sequences of rational numbers themselves:

²¹⁰**Corollary 8.3.** In any model of PA, Gödel’s arithmetical formula $[R(x)]$ interprets as an algorithmically verifiable, but not algorithmically computable, tautology over \mathbb{N} .

²¹¹Classically expressed as $\aleph_0 \not\leftrightarrow 2^{\aleph_0}$. See, for instance, Walter Rudin [Ru53], §2.16, Theorem, p.23; [Ru53], §2.40, Corollary, p.34; also [BBJ03], p.16.

Cauchy sequence (rationals): A sequence r_1, r_2, r_3, \dots of rational numbers is a Cauchy sequence if, and only if, for every rational number $\epsilon > 0$, there is an integer $N > 0$ such that, for all natural numbers $m, n > N$, $|r_m - r_n| \leq \epsilon$.

Comment 79. We note that our consideration here is limited only to distinguishing the *necessary, evidence-based, arithmetical* vis à vis the *set-theoretical*, properties of 'real numbers' that are classically defined Platonically under interpretation as corresponding to the set-theoretical limits of Cauchy sequences; not to the *sufficiency* of such properties for the classical theory of real analysis.

Definition 29. (eb-real numbers) *A sequence of rational numbers is an eb-real number if, and only if, it is either a Cauchy sequence or a monotonically increasing, bounded, sequence.*

Comment 80. We note that:

- whereas the 'value' under interpretation of a classical, set-theoretically defined, *stp*-real number is a postulated Platonic limit of *an* associated Cauchy sequence;
- an *evidence-based eb*-real number is a sequence that is an 'eternal work-in-progress' in Brouwer's sense (see §7.L.), and cannot be assumed to always have a *specifiable* 'value' under interpretation.

The significance of Definition 29 for the physical sciences and philosophy is reflected in physicists Flavio Del Santo and Nicolas Gisin's recent preprint [SG24]; where they, too, argue that—and *why*—a real number must be treated as an 'eternal work-in-progress' for a faithful representation of 'time'—explicitly either as 'geometric' or 'creative'—in mathematical representations of a natural scientist's recordings of our sensory observations, and their associated perceptions, if these are to form the basis of any coherent perspective²¹² of a common 'external' world that admits of 'uncertainty'²¹³ in our descriptions of quantum phenomena:

“Although it is not common to discuss time in mathematics at all, the problem of the two different kinds of time introduced above has almost a perfect counterpart in mathematics. Let us now consider a standard mathematical object, e.g. a real number. Typical real numbers—in fact, almost all of them in a mathematical sense—are uncomputable, i.e. for each of these numbers there exists no algorithm—which is by definition a finite list of instructions—that outputs all their digits (they have infinite Kolmogorov complexity) [10]. On the contrary, all the (irrational) numbers that we usually consider as prototypical examples of reals, such as $\sqrt{2}$ or π , are all computable (the ratio between the diagonal of a square to its edge is a simple algorithm that outputs all the digits of $\sqrt{2}$ and similarly the ratio of the circumference to the diameter of a circle for π). Obviously, all the rational numbers are also computable: they can be directly written down or compressed (in the case of repeating decimals) in a finite string.

The standard way of regarding mathematics, the so-called classical-mathematics, is a form of Platonism which posits that, among the other mathematical entities, real numbers exist with their infinite series of digits, although there is in general no way to even label and thus grasp them (since there is no algorithm that generates them [20, 21]. Hence, classical Platonistic mathematics is a timeless language, which per se is not a bug, but it becomes problematic when mathematics is elevated to the language of science, i.e., it is used to describe the physical world.

²¹²See §13.C.: *Mathematics must serve Philosophy and the Natural Sciences.*

²¹³Such as, for instance, the consequences of introducing a *discontinuity* into a mathematical model that admits only of *geometrical* time, as addressed in §23.D.g. by Query 30: *What would introducing experimental observations—which implicitly subsume 'free will'—into a mathematical model entail?* See also §23.A.a.: *Describable but not predictable.*

However, there are alternative approaches known as constructive mathematics, of which the most prominent is intuitionism. Therein, mathematical entities are not given at once, but rather are processes in development (digits get *created* continuously, one after the other). This provides mathematics with a concept of passage of time (and it would be only at infinite time—at the end of time, so to say—that the mathematical entities, such as real numbers, are completed into the ones defined by classical mathematics). The initiator of intuitionism, L.E.J. Brouwer, envisioned a “creative subject”, i.e., an idealized mind or mathematician, who is responsible for this progressive process of creation in time of, for instance, the digits of an uncomputable real numbers. Several authors, however, have distanced themselves from this controversial concept of a creative subject. In particular, one of us (N.G.) has put forward the idea that the digits of a typical real number are generated by a *true random number generator*,⁴ i.e., a natural process that is able to create a piece of new information by changing a fundamentally indeterminate bit into a determined one [10].⁵ This version of intuitionism could thus be labeled “objective” or “naturalistic” intuitionism. In this way, typical real numbers become a graspable concept directly linked to creative time, that is, to the change from the indeterminate to the determinate. Hence, naturalistic intuitionism, is a tensed mathematical language.

To think about computable real numbers, one just needs geometric time. In fact, it is possible to think that the full information about those numbers is contained in the (finite) algorithm that defines them, i.e., in their initial conditions. For instance, one can ask what is the 43800th digit of π and the answer is given by running an algorithm that outputs the digits of π and picking its 43800th digit. Note that it is not necessary to go through all the previous digits of π to compute [the] 43800th one. There are so-called *digit-extraction algorithms* that allow one to directly compute the n th digit of π [23].⁶ This can be seen as a further evidence that computable (irrational) numbers are already fully determined and do not require creative time. The point is that since this is found through a deterministic outcome, the answer to this kind of questions is fully contained in the algorithm, which can be run more or less fast, giving the ability to manipulate this “mathematical geometric time”. This exactly resembles the weather example in Sect. II for the deterministic evolution of the physical system that forms the weather.

In contrast, if one considers instead a typical, i.e., uncomputable, real number, things are different. There are no algorithms compressing the information of that number. The only existing “algorithm” is the number itself. Each next digit is generated by a genuinely natural random process, therefore, asking which is the 43800th digit of such a number requires to wait for all 43800 instances of creating of the “next digit” (see footnote 4), i.e., it requires “mathematical creative time”.

Finally, one can also ask a question of the kind “are there 700 consecutive sevens in the digits of a number.”⁷ If that number is uncomputable, then one has no choice but to wait and see. However, even for computable numbers, like e.g. π , the question is interesting. The situation is similar to the example of the weather—i.e., 700 consecutive days of rain if one assumes determinism—but the axiomatic character of mathematics makes the solution to this question clearer. One can, in fact, think of programming two softwares: The first, S_1 is exactly the one we used in the physical example of the weather, i.e., the systematic search of a 700 consecutive sevens in π ; on the other hand, the second software, S_2 outputs all the theorems that can be derived within Peano arithmetic and it halts should it find the negation of the conjecture. If the statement is true, S_1 will find this sequence of 700 sevens and therefore halt after a finite (geometric) time. If the statement is provable (within Peano’s arithmetic), S_2 will halt after a finite (though presumably enormous) geometric time. Interestingly, if one assumes that neither halts, then the statement is false (if not S_1 would halt), but not provable within Peano’s arithmetic (if not S_2 would halt).⁸ This would be an example of Gödel’s celebrated theorem. Note that mathematicians don’t use softwares like S_1 and S_2 , but use their creativity to find shortcuts to analyse such statements,

i.e., de facto they use creative time. In the case of the weather in Geneva, if one assumes that the system is indeterministic, like uncomputable numbers, then there is no choice but wait and see. However, if one trusts the equations describing the weather evolution and the fully determined initial conditions, then one could run analogues of S_1 and S_2 , as for computable numbers. Note however, that this assumes one can compress the initial conditions into a finite algorithm (hence into a computer which is necessarily finite).

Let us acknowledge that this distinction between geometric and creative time in mathematics distances our view from the most accepted position in intuitionism, such as that of C. Posy [25] or M. van Atten [26, 27], who consider all numbers, whether computable or not, as generated by new information that comes about, so that they all require creative time in our parlance.

⁴ More precisely, it is not necessarily new digits that come into existence, but the new information reduces the indeterminacy of intuitionistic real numbers [21].

⁵ For more works that relate constructive mathematics to physics, see [20] and [22].

⁶ The most well-known of such algorithms is perhaps the Bailey-Borwein-Plouffe formula [24], that allows to directly compute the hexadecimal digits of π . Digit-extraction algorithms, also in base 10, are known for several other irrational computable real numbers, such as for e .

⁷ The example of 700 consecutive sevens is borrowed from C. Posy [25].*
... Del Santo and Gisin: [SG24], §III. Two Times in Mathematics.

We note that Specker sequences (see [Smm05]; also §7.G.; §20.D.)—which do not instance §7.G., Theorem 7.2, since they are algorithmically *computable*—are monotonically increasing, bounded sequences of rational numbers that, by §7.I., Definition 29, are *eb*-real numbers; whilst their supremum is taken to Platonically define putative, *uncomputable*, *stp*-real numbers—even though the sequences themselves are not Cauchy sequences in the constructive (algorithmic) sense (compare §7.I.a., Theorem 7.6).

Specker sequence: Let A be any recursively enumerable set of natural numbers that is not decidable, and let (a_i) be an algorithmically *computable* enumeration of A without repetition. Define a sequence (q_n) of rational numbers with the rule:

$$q_n = \sum_{i=0}^n 2^{-a_i-1}.$$

Since Specker sequences are algorithmically *computable*, but not Cauchy sequences, we conclude from §7.I., Definition 29, that *evidence-based* reasoning entails:

Corollary 7.4. *Every eb-real number is not well-definable by a Cauchy sequence.* □

Definition 30. (*eb*-real number specifiability) *An eb-real number \mathcal{R} in \mathbb{R} is specifiable if, and only if, it can be explicitly expressed as a PA-formula that is algorithmically verifiable.*

In other words—as entailed by Cantor's diagonal argument—there is no, algorithmically *computable*, number-theoretic function $C(n)$ whose values can be put in a 1-1 correspondence with *all* *eb*-real numbers that are definable as non-terminating Cauchy sequences.

From an *evidence-based* perspective we *cannot*, however, conclude from this that that there are *unspecifiable* *eb*-real numbers, since:

Theorem 7.5. (Specifiability Theorem for *Eb*-reals) *Every eb-real number is specifiable in PA.*

Proof. Let $\{r(n)\}$ be the denumerable sequence defined by the denumerable sequence of digits in the binary decimal expansion $\sum_{n=1}^{\infty} r(n).10^{-n}$ of a putatively *well-defined* (hence *evidence-based*) *eb*-real number \mathcal{R} in the interval $0 < \mathcal{R} \leq 1$ where, for any specified i , $r(i)$ is either 0 or 1.

By a standard result ([Me64], p.131, Proposition 3.22), for any *specified* natural number k , we can define natural numbers b_k, c_k such that, for any $1 \leq n \leq k$, we can define the primitive recursive Gödel β -function:

$$\beta(b_k, c_k, n) = r(n).$$

Also by a standard result ([Me64], p.131, proposition 3.21), $\beta(b_k, c_k, n)$ is uniquely represented in the first order Peano Arithmetic PA by $[Bt(b_k, c_k, n, x)]$ such that, for any $1 \leq n \leq k$:

$$\text{If } \beta(b_k, c_k, n) = r(n) \text{ then PA proves } [Bt(b_k, c_k, n, r(n))].$$

We now define the arithmetical formula $[R(b_k, c_k, n)]$ for any $1 \leq n \leq k$ by:

$$[R(b_k, c_k, n) = r(n)] \text{ if, and only if, PA proves } [Bt(b_k, c_k, n, r(n))].$$

Hence every putatively *well-defined eb*-real number \mathcal{R} in the interval $0 < \mathcal{R} \leq 1$ can be uniquely corresponded to an algorithmically *verifiable* arithmetical formula $[R(x)]$ since:

For any k , the primitive recursivity of $\beta(b_k, c_k, n)$ yields an algorithm $AL_{(\beta, \mathbb{R}, k)}$ that provides objective evidence for deciding the unique value of each formula in the finite sequence $\{[R(1), R(2), \dots, R(k)]\}$ by evidencing the truth under a sound interpretation of PA for:

$$\begin{aligned} & [R(1) = R(b_k, c_k, 1)] \\ & [R(b_k, c_k, 1) = r(1)] \\ & [R(2) = R(b_k, c_k, 2)] \\ & [R(b_k, c_k, 2) = r(2)] \\ & \dots \\ & [R(k) = R(b_k, c_k, k)] \\ & [R(b_k, c_k, k) = r(k)]. \end{aligned}$$

The correspondence is unique because, if \mathcal{R} and \mathcal{S} are two unequal, putatively *well-defined, eb*-reals in the interval $0 < \mathcal{R}, \mathcal{S} \leq 1$, then there is always some m for which:

$$r(m) \neq s(m).$$

Hence we can always find corresponding arithmetical functions $[R(n)]$ and $[S(n)]$ such that:

$$\begin{aligned} & [R(n) = r(n)] \text{ for all } 1 \leq n \leq m. \\ & [S(n) = s(n)] \text{ for all } 1 \leq n \leq m. \\ & [R(m) \neq S(m)]. \end{aligned}$$

The theorem follows. □

Comment 81. To place §7.I., Theorem 7.5 in an appropriate perspective, we note that, as Bauer remarks:

“A cursory literature search reveals other bizarre statements considered in constructive mathematics: ‘ \mathbb{R} has measure zero’, ‘there is a bounded increasing sequence without an accumulation point’, ‘ordinals form a set’, ‘there is an injection of $\mathbb{N}^{\mathbb{N}}$ into \mathbb{N} ’, and so on.”

... Bauer: [Ba16], p.6.

He defends such constructivist conclusions by arguing that:

"A constructivist might point out that what counts as bizarre is subjective and remind us that once upon a time the discovery of non-Euclidean geometries was shelved in fear of rejection, that Weierstraß's continuous but nowhere differentiable function was and remains a curiosity, and that the Banach-Tarski theorem about conjuring two balls from one is even today called a 'paradox'."

... Bauer: [Ba16], p.6.

The significance of 'specifiable' mathematical terms—vis à vis 'unspecified' terms implicitly entailed by classical, *faith-based* interpretations of quantification (see §7.B.)—is reflected in Émile Borel's philosophical perspective which—according to philosopher Kati Kish Bar-On in [Bro22]—can be perceived as striving to caution—albeit in a broader context—against the unintended admittance into a mathematical language of 'unrealizable' consequences of conflating the two:

"Mathematics, according to Borel (1907), is a human mental activity expressed by language, and mathematical proofs cannot rely solely on logical rules since logic can provide the working framework but not the elements themselves. The role of logic is "limited to supplying the material for it, and one does not confuse the mason with the architect" (Borel 1907, p. 279).

Borel (1914) argued that consistency is a necessary demand for mathematical existence but not sufficient. According to Borel, it is not enough for an object to be part of a consistent system in order for it to exist mathematically; the object also has to be effectively definable, namely, that it is possible to define it with a finite number of words. If a number cannot be defined in a finite number of words within a consistent system, it is considered unrealized or non-existent. As an example of a non-existent number, Borel (1928, p. 154) describes the scenario of a denumerable number of people choosing a digit, one after the other. Since there is a denumerable number of choices, the number created cannot be defined in a finite number of words; therefore, it cannot be considered realized and hence, does not exist.

It should be noted that Borel does not exclude the use of words like 'infinite' when describing mathematical objects, but only that such a definition should be clearly described by a law, in a finite number of words, and should have clear instructions in which order they should be executed. Borel's definition of mathematical existence resembles, at least to some extent, Brouwer's construction of choice sequences, one of the essential elements of his intuitionistic theory. Similar to Brouwer, Borel accepted as legitimate sets only the denumerable ones since they are the only ones that can be defined. Consequentially, Borel differentiates between the geometrical continuum that is given to us in nature and is accessible through our intuition and the numerical continuum, which is an artificial creation that is uncountable, hence undefinable.

The concept of intuition is omnipresent in Borel's work, even though he does not account for the term's exact nature. According to Borel (1898, p. 176–222), mathematical reality cannot be built solely upon logical arguments; it must be linked to intuition. As for the concept of the natural number and the set of natural numbers, Borel (1914, p. 179) accepted both as "clear notions" for mathematicians since there exists a "practical agreement among mathematicians in the use of these notions". Here Brouwer and Borel differ, as Borel felt that it is the work of philosophers and psychologists to understand why some mathematical notions are clearer than others to mathematicians, while Brouwer placed such philosophical distinctions at the core of his theory."

... Bar-On: [Bro22], 3.1 Kant and the French semi-intuitionists.

7.I.a. *Evidence-based* reasoning does not admit Cantor's theorem

We note that §7.I., Theorem 7.5, challenges current paradigms as to how *stp*-real numbers are currently viewed ontologically and epistemologically.

For instance, the classical conclusion, expressed symbolically as $\aleph_0 \not\leftrightarrow 2^{\aleph_0}$, reflects the Platonic *postulation/assumption* that there *exist* ‘set-theoretically completed’ Cauchy sequences which cannot be expressed in PA.²¹⁴

However, §7.I., Theorem 7.5 shows that the *postulation/assumption* is fragile both ontologically and epistemologically, since Cauchy sequences which are defined as algorithmically *verifiable*, but not algorithmically *computable*, correspond to *well-defined*, ‘essentially incompletable’, *eb*-real numbers whose Cauchy sequences cannot, in a sense, be known ‘completely’ even to Laplace’s *vast intelligence*:

“We ought then to regard the present state of the universe as the effect of its anterior state and as the cause of the one which is to follow. Given for one instant an intelligence which could comprehend all the forces by which nature is animated and the respective situation of the beings who compose it—an intelligence sufficiently vast to submit these data to analysis—it would embrace in the same formula the movements of the greatest bodies of the universe and those of the lightest atom; for it, nothing would be uncertain and the future, as the past, would be present to its eyes. The human mind offers, in the perfection which it has been able to give to astronomy, a feeble idea of this intelligence. Its discoveries in mechanics and geometry, added to that of universal gravity, have enabled it to comprehend in the same analytic expressions the past and future stars of the system of the world. Applying the same method to some other objects of its knowledge, it has succeeded in referring to general laws observed phenomena and in foreseeing those which given circumstances ought to produce. All these efforts in the search for truth tend to lead it back continually to the vast intelligence which we have just mentioned, from which it will always remain infinitely removed.”

... Laplace: [Lap02], p.4.

Comment 82. We note that Laplace’s conception of a ‘vast intelligence’ to which the ‘human mind offers ... a feeble idea of this intelligence’ essentially articulates the Mechanist’s argument which Lucas’s Gödelian Thesis seeks to refute (see [An16], §8, Thesis 1; also §21.A.a.). An argument seemingly echoed in 2016 by Stephen Hawking:

“I believe there is no deep difference between what can be achieved by a biological brain and what can be achieved by a computer. It therefore follows that computers can, in theory, emulate human intelligence—and exceed it.”

... Hawking: *Stephen Hawking—Will AI kill or save humankind?*

In other words we can, not unreasonably, argue as Brouwer does (see §7.L.) that the numerical values of algorithmically *verifiable*, but not algorithmically *computable*, sequences must be treated as *well-defined*, formally specifiable, first-order, non-terminating processes which are ‘eternal work-in-progress’ in the sense of §7.I., Theorem 7.5.²¹⁵

Thus, from an *evidence-based* perspective, §7.I., Theorem 7.5 implies that *stp*-real numbers do not exist in some Platonic, set-theoretic, universe of *points* that constitute a line, but are arithmetical constructs identifiable as number-theoretic definitions of specific *points* that are algorithmically *verifiable* (hence *well-defined*), but not necessarily algorithmically *computable*.

The following theorem shows that such arithmetical constructs assume significance as *eb*-real numbers which can, debatably, be termed as ‘existing’ mathematically as geometric *points*, only when such a definition is made explicit formally in an argumentation.

²¹⁴Such a conclusion can also be viewed as illustrating Skolem’s cautionary remarks in [Sk22] (see also §7.K.) about unrestrictedly corresponding putative mathematical entities across domains of different axiom systems.

²¹⁵A perspective suggested by the way dimensionless constants are viewed in the physical sciences, as highlighted in [An15], §4. p.9, by **Thesis 1**: *Some of the dimensionless physical constants are only representable in a mathematical language as real numbers that are defined by functions which are algorithmically verifiable, but not algorithmically computable.*

Theorem 7.6. (Invalid Cauchy Limit Theorem) *The values of n for which Gödel's arithmetic formula $[R(x)]$, with Gödel number r as defined in [Go31], p.25, eqn.12, interprets as a true arithmetic proposition $R^*(n)$ in \mathbb{N} do not well-define the *eb*-real number $c = \sum_{n=1}^{\infty} (1/10^n) = 0.c_1c_2 \dots c_n \dots$; which is classically treated as defining/denoting the *eb*-real number $1/9$.*

Proof. We note that:

- (i) If $c = \sum_{n=1}^{\infty} (1/10^n) = 0.c_1c_2 \dots c_n \dots$ defines the *eb*-real number $1/9$ then $c_n = 1$ is a recursive relation that is algorithmically *computable* as always true in \mathbb{N} ²¹⁶ by a Turing machine that computes the decimal representation of $1/9$.
- (ii) Hence it is expressible in PA by some PA-formula $[C(x) = 1]$ such that, for any specified $n \in \mathbb{N}$:
 - If $c_n = 1$ holds in \mathbb{N} , then $[C(n) = 1]$ is PA-provable;
 - If $c_n \neq 1$ holds in \mathbb{N} , then $[\neg(C(n) = 1)]$ is PA-provable.
- (iii) The PA-formula $[C(x) = 1]$ now interprets as an arithmetical relation $C^*(x) = 1$ such that $C^*(n) = 1$ is an arithmetical relation which is also algorithmically *computable* as always true in \mathbb{N} since $(C^*(n) = 1) \equiv (c_n = 1)$.
- (iv) Hence, by the Provability Theorem for PA ([An16], Theorem 7.1, p.41), the arithmetical formula $[C(x) = 1]$ is PA-provable.
- (v) Now, Gödel has shown (see [Go31], p.26(2)) that, for any specified PA-numeral $[n]$, the PA-formula $[R(n)]$ is PA-provable.
- (vi) Moreover, since $[R(x)]$ is a *well-defined* PA-formula, we can define a PA-formula $[D(x)]$ such that $[(D(x) = 1) \equiv R(x)]$.
- (vii) Thus $[D(x) = 1]$ interprets as an arithmetical relation $D^*(x) = 1$ such that $D^*(n) = 1$ holds in \mathbb{N} if, and only if, $[R(n)]$ interprets as true in \mathbb{N} .
- (viii) Hence $D^*(n) = C^*(n) = c_n = 1$ for any specified n in \mathbb{N} .
- (ix) If, now, $d = 0.D^*(1)D^*(2) \dots D^*(n) \dots$ were to define the real number $c = \sum_{n=1}^{\infty} (1/10^n) = 0.c_1c_2 \dots c_n \dots = 0.D^*(1)D^*(2) \dots D^*(n) \dots$, then $D^*(x) = 1$ would be algorithmically *computable* as always true in \mathbb{N} .
- (x) In which case, by the Provability Theorem for PA ([An16], Theorem 7.1, p.41), $[D(x) = 1]$ would be PA-provable;
- (xi) Whence $[R(x)]$ —and therefore $[(\forall x)R(x)]$ by Generalisation—would both be provable in PA.
- (xii) Since Gödel has shown that $[(\forall x)R(x)]$ is not PA-provable (see [Go31], p.25(1)), neither $[R(x)]$ nor $[D(x) = 1]$ can be PA-provable.
- (xiii) Hence d does not define an *eb*-real number, even though $0.D^*(1)D^*(2) \dots D^*(n) \dots$ defines/denotes the Cauchy sequence $\sum_{n=1}^{\infty} (1/10^n)$.

²¹⁶See §2.; also [Mu91], §1, Introduction.

The theorem follows. □

We conclude that:

- whether or not a *well-defined*—hence algorithmically *verifiable* by §7.F., Definition 25—Cauchy sequence in a formal mathematical language,
- can be treated as having a classical, algorithmically *computable*, Cauchy limit that defines an *eb*-real number under a *well-defined* interpretation,
- depends not only on the terms of the sequence,
- but also on *how* the terms of the sequence are defined within the formal language,
- and whether the language has a *well-defined* interpretation.

Since the above distinction cannot be made in any set theory which admits an axiom of infinity, and therefore defines sets extensionally in a Platonically conceived domain which cannot claim to be *well-defined* (in the sense of §7.F., Definition 26), Theorem 7.6 shows that (compare §7.I., Corollary 7.4):

Corollary 7.7. *Every Cauchy sequence of rational numbers does not well-define an eb-real number.* □

The significance of Theorem 7.6 for the natural sciences is highlighted in §23.D. (see also §21.G.a.).

Comment 83. The argument that ‘every Cauchy sequence of rational numbers cannot be postulated as defining a real number by the usual set-theoretical arguments’ is implicit in physicist Nicolas Gisin’s unusual, intuitionistic, interpretation of ‘real numbers’ as ‘the hidden variables of classical physics’ in [Gi19]; where he argues (see also [Gi20]) that ‘real numbers should not be considered as “physical real” and classical mechanics, like quantum physics, is indeterministic’:

“... At first sight, no doubts, quantum theory imposes limits to what can be known. There are Heisenberg’s uncertainty relation and—Copenhagen obliged—Bohr’s complementary principle. But is it scientific to believe that scientific theories limit human knowledge? In particular, does quantum theory limit our knowledge or does it faithfully describe an indeterministic world, a world in which objects do not have determined positions, momenta and further properties? In short, should one speak of the uncertainty relation or of the indeterminacy relation?”

For a realist, like myself, scientific theories describe what there is, not the limits of our knowledge. One cannot simultaneously know with arbitrary precision the position and momentum of particles not because of some fancy limitations to our knowledge, but merely because particles do not have simultaneous precise positions and momenta. Nevertheless, looking for additional variables is highly interesting, because it may allow one to discover new physics. This implies that the hypothetical new variables should not be hidden, at least not be hidden by essence for ever: they may be hidden today, but the interest is to find and reveal them.¹ At least, this is the rough story. In quantum theory, things are more complex, because of the locality issue, on one side, and for historical reasons on the other side.”

... Gisin: [Gi19], Introduction.

We note that such an *evidence-based* perspective reflects Leopold Kronecker’s views on what may be treated as a *well-defined* mathematical concept. As detailed by Sieg:

"Kronecker made restrictive demands on the formation of mathematical concepts, e.g., he insisted on their decidability.⁶ Being well aware of these demands, Dedekind attached the following footnote to his remark that a system S , as an object of our thinking, is completely determined as soon as "of each thing it is determined, whether or not it is an element of S " (Dedekind 1888, p. 2):

How this determination is brought about, and whether we know of a way of deciding upon it, is a matter of utter indifference for all that follows; the general laws to be developed in no way depend upon it; they hold under all circumstances. I mention this expressly because Kronecker not long ago (in *Kronecker* 1886) has endeavored to impose certain limitations upon the free formation of concepts in mathematics, which I do not believe to be justified . . .

This footnote is directed against one in (Kronecker 1886), where Kronecker argues not only against Dedekind's concepts like module or ideal, but also against a *general concept of irrational number*. Explaining his rejection, Kronecker writes:

Even the *general* concept of an infinite series . . . is in my opinion . . . only admissible on condition that in every special case, on the basis of the arithmetical law for the formation of the terms (or of the coefficients), certain presuppositions are shown to be satisfied, which permit the series to be applied like finite expressions, and which consequently make it really unnecessary to go beyond the concept of a *finite series*. (Kronecker 1886, p. 947)

The effect of such a finiteness condition on the concept of real number is stated in a letter Kummer wrote to Schwartz on 15 March 1872. Kummer remarks that he and Kronecker share the conviction that "the effort to create enough individual points to fill out a continuum, i.e., enough real numbers to fill out a line, is as vain as the ancient efforts to prove Euclid's parallel postulate".⁷

If *individual points* can be created only in accord with Kronecker's finiteness demand, then Kummer's observation is provable. One first notices that the system of real numbers thus created is countable. Next one has to address the question, what is the geometric line that cannot be filled by the individually created points? In 1872, the very year of Kummer's letter, Dedekind had characterized an *arithmetical continuum* as the system of all cuts of rational numbers.⁸ As that system is isomorphic to the continuous geometric line and is uncountable, Kummer's observation has been established. The argument I just sketched is, of course, anachronistic, but brings out the strikingly different approaches to the arithmetization of the geometric continuum. In this way, it makes evident the impact of broader foundational views on mathematical practice. At the heart of the difference between these foundational positions is the freedom of introducing abstract concepts—given by *structural definitions*."

... *Sieg: [S112], pp. 10-11.*

In other words, whereas expressing intuitive concepts in the language of a formal mathematical theory on the basis of *structural definitions*²¹⁷ have—following Dedekind—been considered justified so long as the introduction of such definitions is consistent with the theory, the interpretations of such concepts—according to Kronecker—are meaningful (in the sense of accommodating §1., Thesis 1(1) and §1., Thesis 1(2); and justifiably so as demonstrated in §20.D.d.) only if the definitions are *well-defined* over the domain of the interpretation in the sense of §7.F., Definition 25.

7.J. Arithmetical truth from a Wittgensteinian perspective

We shall see that the significance of differentiating between:

²¹⁷In the sense of [S112], §4, Structural Definitions, p.11-14.

- (i) the *strong*, algorithmically *computable*, ‘truth’—of the provable formulas of a formal mathematical language L —that follows by *finitary mathematical* reasoning from the axioms and rules of inference of L under a *well-defined* interpretation; and
- (ii) the *weak*, algorithmically *verifiable*, ‘truth’—of the provable formulas of L —that follows by *non-finitary meta-mathematical* reasoning from the axioms and rules of inference of L under a *well-defined* interpretation;

is implicit in and, from the *evidence-based* perspective of this investigation, could be viewed as illuminating (see §12.), Timm Lampert’s interpretation of Ludwig Wittgenstein’s objection—in the latter’s ‘notorious’ paragraph in [Wi78] (see §12.B.)—to the, philosophically disquieting, conclusions (see §15.C.) that Gödel drew from his undifferentiated *mathematical* and *meta-mathematical* reasoning in [Go31]:

“The most crucial aspect of any comparison of two different types of unprovability proofs is the question of what serves as the “criterion of unprovability” (I, §15). According to Wittgenstein, such a criterion should be a purely syntactic criteria independent of any meta-mathematical interpretation of formulas. It is algorithmic proofs relying on nothing but syntactic criteria that serve as a measure for assessing meta-mathematical interpretations, not vice-versa.”

... Timm Lampert: [Lam17].

We note that the Wittgenstein scholar and philosopher, Michael Starks, too seeks, in his various articles and reviews, to present the concept of mathematical ‘truth’, from a Wittgensteinian perspective; which he represents as valid under an interpretation only if supporting evidence—in the form of a ‘warrant’—can be unambiguously defined ‘algorithmically’:

“We commented many times that ‘truth’ in math means axioms or the theorems derived from axioms, and ‘false’ means that one made a mistake in using the *definitions* (from which results follow necessarily and algorithmically), and this is utterly different from empirical matters where one applies a *test* (the results of which are unpredictable and debateable). We often noted that to be acceptable as mathematics in the usual sense, it must be useable in other proofs and it must have real world applications, but neither is the case with Godel’s Incompleteness. Since it *cannot* be proved in a consistent system (here Peano Arithmetic but a much wider arena for Chaitin), it cannot be used in proofs and, unlike all the ‘rest’ of Peano Arithmetic, it cannot be used in the real world either. As Rodych notes “... Wittgenstein holds that a formal calculus is only a *mathematical* calculus (i.e., amathematical language-game) if it has an extra-systemic application in a system of contingent propositions (e.g., in ordinary counting and measuring or in physics) ...” Another way to say this is that one needs a *warrant* to apply our normal use of words like ‘proof’, ‘proposition’, ‘true’, ‘incomplete’, ‘number’, and ‘mathematics’ to a result in the tangle of games created with ‘numbers’ and ‘plus’ and ‘minus’ signs etc., and with ‘Incompleteness’ this warrant is lacking. Rodych sums it up admirably. “On Wittgenstein’s account, there is no such thing as an incomplete *mathematical* calculus because ‘in mathematics, *everything* is algorithm [and syntax] and *nothing* is meaning [semantics] ...”

... Starks: [Stk12], Abstract.

7.K. Skolem’s paradox: intended and unintended interpretations of PA

Moreover, Wittgenstein’s perspective is reflected in, and illuminates (see §15.C., Lemma 15.1; also §15.H.k.), Thoralf Skolem’s cautionary remarks against inviting paradox²¹⁸ by conflating

²¹⁸See, for instance, Goodstein’s argument in §19., Theorem 19.1.

entailments of formal systems under different interpretations (see §2.D.), or over different domains.

Thus, we note that, in a 1922 address delivered in Helsinki before the Fifth Congress of Scandinavian Mathematicians, Skolem improved upon both the argument and statement of Löwenheim's 1915 theorem ([Lo15], p.235, Theorem 2)—subsequently labelled as the (downwards) Löwenheim-Skolem Theorem ([Sk22], p.293):

(Downwards) Löwenheim-Skolem Theorem ([Lo15], p.245, Theorem 6; [Sk22], p.293): If a first-order proposition is satisfied in any domain at all, then it is already satisfied in a denumerably infinite domain.

Skolem then drew attention to a:

Skolem's (apparent) paradox: "... peculiar and apparently paradoxical state of affairs. By virtue of the axioms we can prove the existence of higher cardinalities, of higher number classes, and so forth. How can it be, then, that the entire domain B can already be enumerated by means of the finite positive integers? The explanation is not difficult to find. In the axiomatization, "set" does not mean an arbitrarily defined collection; the sets are nothing but objects that are connected with one another through certain relations expressed by the axioms. Hence there is no contradiction at all if a set M of the domain B is non-denumerable in the sense of the axiomatization; for this means merely that *within* B there occurs no one-to-one mapping Φ of M onto Z_o (Zermelo's number sequence). Nevertheless there exists the possibility of numbering all objects in B , and therefore also the elements of M , by means of the positive integers; of course such an enumeration too is a collection of certain pairs, but this collection is not a "set" (that is, it does not occur in the domain B)."

... Skolem: [Sk22], p.295.

In a 2004 paper from the perspective of contemporary mathematics, [Gaf04], Haim Gaifman consider's Skolem's remarks from a 'broader perspective' of non-standard models (see also §18.), arguing that:

"Non-standard models were introduced by Skolem, first for set theory, then for Peano arithmetic. In the former, Skolem found support for an anti-realist view of absolutely uncountable sets. But in the latter he saw evidence for the impossibility of capturing the intended interpretation by purely deductive means."

... Gaifman: [Gaf04], Abstract.

Gaifman argues that Skolem's 'paradox does not imply that absolutely uncountable sets do not exist', but 'that there is no possibility of introducing something absolutely uncountable except by means of pure dogma'; a dogma that can, however, claim to be a useful aid to comprehension if it 'can give comfort to someone who is skeptical, because it shows how one who rejects absolutely uncountable sets can nonetheless apply the concept coherently when relativized to some countable model':

"A non-standard model is one that constitutes an interpretation of a formal system that is admittedly different from the intended one. The import of 'admittedly different' will become clear in sections 2 and 3. To prevent misunderstandings, let me emphasize that by 'interpretation' I mean a structural interpretation, where isomorphic models count as the same interpretation. (Any attempt to find what the mathematical objects really are amounts to a wild goose chase.)

Non-standard models have been introduced by Skolem, in a series of papers from 1922 to 1934, in two cases: set theory and arithmetic. The earlier papers concern set theory. In [1922] he observes that if there is a structure satisfying the axioms of set theory, then, because of the Löwenheim-Skolem theorem, there is also such a countable structure. This came to be known as

Skolem's paradox: a theory that asserts the existence of uncountable sets is itself satisfiable in a countable model (if it has models at all). There is of course no paradox. As Skolem notes, the model satisfies the claim that some member, X , is uncountable just when there is no member in the model that, inside the model, constitutes a one-to-one mapping of X into the model's natural numbers. This is compatible with the fact that the set of all members of the model is countable. The mappings that establish countability "from the outside" need not belong to the model. Skolem himself was somewhat leery of uncountable totalities and he found that Skolem's paradox sits well with the view that everything is countable; uncountability is a property that an entity might have inside some countable structure, but that is all there is to "uncountability". As reported by Wang, in [Skolem 1970], Skolem makes in [Skolem 1929] the following observation:

One recognizes here again, as with the earlier review of the Löwenheim Theorem, that there is no possibility of introducing something absolutely uncountable except by means of pure dogma.

By 'absolutely' Skolem means the non-relative concept. A set is absolutely uncountable, when it has this property not inside a model, but in the "real universe", which is studied by non-formalized mathematics (i.e., it is an infinite set that is not equinumerous with the set of natural numbers). The non-absolute concept is, by contrast, something that is model-dependent. It is a property a set can satisfy within a model, assuming that there are models that satisfy the sentence 'there are uncountable sets'.

Of course, the paradox does not imply that absolutely uncountable sets do not exist; it is compatible with what Skolem calls "dogma". But it can give comfort to someone who is skeptical, because it shows how one who rejects absolutely uncountable sets can nonetheless apply the concept coherently when relativized to some countable model. One can thus work in set theory and speak of uncountable sets, but view all such talk as a description of what goes on in countable models. It is likely that Skolem, who spoke of the "relativity of set theoretic notions", was inclined to such a view. He was willing, for example, to accept the axiom of choice as a formal consistent supposition, but rejected it as a principle that goes beyond this. In a lecture from 1932 (reported by Fenstad in [Skolem 1970] p. 14) we find:

If one works within a completely formalized mathematics, based on a finite number of precisely stated axioms, there is nothing to discuss but questions of consistency and the ease of manipulation. But in ordinary mathematical practice, e.g., in the usual studies on continua, which are never given by a set of specified rules, the axiom of choice is, in my opinion, definitely undesirable—a kind of scientific fraud."

... Gaifman: [Gaf04], pp.1-2.

From the *evidence-based* perspective of this investigation as reflected in the Complementarity Thesis (§1., Thesis 1)—and in Wittgenstein's perspective (see §12.B.) of a formal mathematical theory as a symbolic language with an, implicitly intended and 'rule-based', interpretation (as detailed in §13.A.)—the significance of Gaifman's analysis of Skolem's remarks, as above, lies in his further observation 'that 'consistency' was for Skolem not a syntactic notion but a semantic one':

"It should be noted that 'consistency' was for Skolem not a syntactic notion but a semantic one: the existence of structures satisfying the axioms. Skolem thus distinguishes between "completely formalized mathematics" and "ordinary mathematical practice". The first amounts to a study of structures satisfying the axioms; the second is presumably a study of what we might call today 'the intended interpretation'. The shift to a completely formalized mathematics can serve to defuse foundational disagreement about what the intended interpretation should be. **A** can doubt the truth, plausibility, or factual meaningfulness of an axiom adopted by **B**, but, as long as it is consistent, **A** can make sense of what **B** is doing by regarding it as an investigation into the common properties of the structures that satisfy the axioms. This is possible as long as the

completely formalized theory is consistent; if it is not, then those who presuppose it are not investigating anything. The consistency problem becomes crucial.¹ Formalized mathematics may thus serve as a mediator of sorts between different foundational views. But for this very reason it does not fully capture the view that underlies ordinary mathematical practice—in as much as the practice implies a particular structure that constitutes the subject matter of the inquiry, “what it is all about”. If set theory is about some domain that includes uncountable sets, then any countable structure that satisfies the formalized theory must count as an unintended model. From the point of view of those who subscribe to the intended interpretation, the existence of such nonstandard models counts as a failure of the formal system to capture the semantics fully.”

... Gaifman: [Gaf04], p.3.

Consequently, for Gaifman, whether in set theory or arithmetic, from ‘the point of view of those who subscribe to the intended interpretation, the existence of such nonstandard models counts as a failure of the formal system to capture the semantics fully’.

However, Gaifman notes that Skolem distinguished (compare with the distinction sought to be made in §13.E.) between ‘unintended models in the case of set theory and in the case of arithmetic’, in so far that (as is implicitly argued in §18.D.a.) ‘the existence of a non-standard model of arithmetic is not a consequence of the Löwenheim-Skolem theorem’:

“This indeed is the way Skolem views non-standard models of arithmetic. The very title of his 1934 paper, in which he constructs an elementary extension of the standard model of arithmetic, says as much: “About the impossibility of characterizing the number sequence by means of a finite or an infinite countable number of statements involving only numeric variables”. A 1933 forerunner of this paper bears a similar title. (Note that the existence of a non-standard model of arithmetic is not a consequence of the Löwenheim-Skolem theorem. Skolem’s original construction of it anticipates the formation of an ultrapower.)

Skolem thus drew different lessons from the existence of unintended models in the case of set theory and in the case of arithmetic. In the first case, the existence of countable (hence, “non-standard”) models helps him to maintain his doubts about absolutely uncountable sets. In the second, non-standard models show an essential shortcoming of a formalized approach: the failure to fully determine the intended model. The reason for the difference is obvious: In as much as the intended model is problematic, the existence of non-standard models support one’s doubts. But when the intended model is accepted as a basic precondition of our mathematical investigations, the existence of non-standard models points to the inability of the formalization to characterize the intended model. The difference thus stems from the gulf that separates the standard model of natural numbers from higher order arithmetic. In [Skolem 1934], the very statement of Theorem V, which asserts the existence of a non-standard model, takes for granted the standard model:

There exists a system N' of things, for which two operations $+$ and \cdot and two relations $=$ and $<$ are defined, such that N' is not isomorphic to the system N of natural numbers, but nevertheless all sentences of P which are true of N are true of N' .

This is not to say that foundational misgivings may not apply to the standard model of arithmetic. But such misgivings, which may lead to the adoption of a weaker deductive system, do not derive from the existence of non-standard models.”

... Gaifman: [Gaf04], pp.3-4.

The significance of *evidence-based* reasoning in admitting a distinction between the *weak*, algorithmically *verifiable*, interpretation $\mathcal{I}_{PA(\mathbb{N}, SV)}$ of PA (see §2.B.), and the *strong*, algorithmically *computable*, interpretation $\mathcal{I}_{PA(\mathbb{N}, SC)}$ of PA (see §2.C.) is highlighted by the dichotomy in Gaifman’s:

- (a) acceptance, on the one hand, that ‘when the intended model is accepted as a basic precondition of our mathematical investigations, the existence of non-standard models points to the inability of the formalization to characterize the intended model’; and his
- (b) acceptance, on the other, that despite such inability, the intended ‘standard’ model of PA in classical theory is:
- defined by the *weak*, algorithmically *verifiable*, interpretation $\mathcal{I}_{PA(\mathbb{N}, SV)}$ of PA,
 - rather than by the *strong*, algorithmically *computable*, interpretation $\mathcal{I}_{PA(\mathbb{N}, SC)}$ of PA, as was posited by Hilbert in his Program, and sought by him as the solution to the second of his 23 Millenium 1900 Problems ([Hi00]; see also §29.(7));

whereas it is the latter that ought to be the ‘intended’, and the former the ‘unintended’, interpretation:

“Unintended interpretations have loomed large in the philosophy of language in the second half of the twentieth century. Quine used them famously (or infamously) in his behavioristic approach to language. Goodman’s celebrated example of ‘Grue’ belongs here as well. In the nineties they attracted considerable attention, following Kripke’s use of them in his highly controversial interpretation of Wittgenstein. Underlying the employment of these unintended interpretations is, roughly, the idea that language acquires its meaning through its use in overt interactions between people or with the world. Therefore, in principle, one should be able to manifest, through public usage, differences between different interpretations. What cannot be thus manifested should be dismissed as something occult. This theme in the philosophy of language is beyond the scope of this paper. I shall only address a particular offshoot of it, which relates directly to the philosophy of mathematics. On this view, if we cannot point to public usage that distinguishes between the standard and the non-standard interpretation of ‘the sequence of natural numbers’, then the reference of this term is undetermined. Let \mathcal{N} be the standard model, and let \mathcal{N}' be a non-standard elementary extension of it. What is there, it is asked, that determines that one refers to \mathcal{N} rather than \mathcal{N}' ? Nothing in our deductive practices and in our use of mathematics in science and everyday life seems to decide this.¹³ It is important to be clear on the logic of this move. The questioner, call him Q., bases the question on the construction of a non-standard model. Having shown that such a model, which is different from the standard one, exists, Q. claims that the reference is undetermined, since nothing in our public behavior determines it. The trouble with this question is that Q. presupposes the distinction between standard and non-standard models to start with. For Q. appeals to a construction of a nonstandard model, which yields, as we can convince ourselves, a different model. If it were impossible to refer differentially to the two types of models, Q.’s question could not be asked.¹⁴ The point can be also put as follows: Q. seems to assume the superior stance of someone who can switch the interpretation from standard to nonstandard, while we, who use routinely arithmetical concepts, do not notice. But in fact, Q. plays in the same court, appealing to the same conceptual apparatus. To the question “What is it that determines that the intended interpretation is the standard model?”, the simple answer is: “The intended interpretation is, by definition, what you yourself called ‘the standard model’.”¹⁵ This is not an appeal to some mysterious common understanding (“We both know what we mean by ‘natural numbers’ ”), but an exploitation of the fact that the questioner uses the very term, and presupposes the very meaning, which he tries to undermine. Also the question cannot be construed as a *reduction* argument, where one assumes the opponent’s point of view in order to derive a difficulty within it. For, by presupposing the conceptual apparatus that is needed to construct a non-standard model (the basis of the question), Q. provides us with a way of answering it. The question may have, though, a hidden motive: a request for some sort of explanation of how we come to know mathematical entities. If the explanation is supposed to provide some sort of causal link between the brain and the mathematical structures, then the request should be rejected as a muddled question stemming from a muddled philosophical picture. But if it is a request for an account of mathematical knowledge, then it amounts to a fundamental question

that the philosophy of mathematics should tackle. I do not propose to embark on it here."

... Gaifman: [Gaf04], pp.13-15

Gaifman argues further that—essentially reflecting the Complementarity Thesis (§1., Thesis 1) of this investigation, as evidenced by the Provability Theorem for PA (§2.E.b., Theorem 2.17), if we replace the word ‘standard’ by ‘intended’—by ‘subscribing to the standard model of natural numbers, we are committing ourselves to the objective truth or falsity of number-theoretic statements, where these are usually taken as statements of first-order arithmetic’:

“Intended interpretations are closely related to realistic conceptions of mathematical theories. By subscribing to the standard model of natural numbers, we are committing ourselves to the objective truth or falsity of number-theoretic statements, where these are usually taken as statements of first-order arithmetic. The standard model is supposed to provide truth-values for these statements. Since deductive systems can only yield r.e. (recursively enumerable) sets of theorems, they can only partially capture truth in the standard model.¹⁶ Thus we get a substantial notion of truth: truth that goes beyond what we can prove (from any given r.e. set of axioms, using any r.e. collection of inference rules). Even the truth of Π_1 sentences cannot be fully captured. Realism and intended interpretations are thus intimately related; often they are treated as the same problem. Yet the intended models of a given mathematical language may contain non-isomorphic structures (e.g., the theory of all well-ordered sets, with ordinal addition and multiplication). Truth in the theory then means truth in all the intended models, and, depending on the case, it may or may not outrun deductive capacity.”

... Gaifman: [Gaf04], p.15

However, Gaifman argues further, although:

“One can be skeptic with regard to the standard model of arithmetic, because, say one has doubts about actual infinities; but, as argued above, one cannot support this skepticism by appeal to non-standard models. This applies also in the case of set theory. For one who subscribes to some standard model of ZFC (Cantor’s universe, or whatever), the existence of different models of the same theory, does not *per se* pose a problem. One can however pose a different question: *Which, if any, of some given models, is the standard one?* This question does not presuppose the notion of a standard model; it only asks us to locate the intended model within a given family. This question brings out the difference between arithmetic and set theory. In the case of the natural numbers, the standard model is characterized by a *minimality* condition: it is the smallest model, included as an initial segment in any other model. If a given model is non-standard, then this will be revealed by a proper initial segment that is closed under the successor function. Formally, the characterization is expressed by the inductive scheme:

$$(I) \quad P(0) \wedge \forall x[N(x) \rightarrow (P(x) \rightarrow P(x+1))] \rightarrow \forall x[N(x) \rightarrow P(x)]$$

where ‘ $N(x)$ ’ stands for ‘ x is a natural number’, and where ‘ $P()$ ’ stands for any predicate. Any wff of the language we are using can be substituted for ‘ $P()$ ’. The concept of the sequence of natural numbers is, however, *not* language dependent. The absoluteness of the concept can be secured, if we help ourselves to the full (standard) power set of some given infinite set; for then we can treat ‘ P ’ as a variable ranging over that power set. But this is highly unsatisfactory, for it bases the concept of natural numbers on the much more problematic shaky concept of the full power set. It is, to use a metaphor of Edward Nelson [1986], like establishing the credibility of a person through the evidence of a much less credible character witness.

The inductive scheme should be therefore interpreted as an open ended metacommitment:

$$(II) \quad \text{Any non-vague predicate, in whatever language, can be substituted for ‘}P\text{’ in (I).}^{17}$$

(We assume here either that the substitution involves no category mistakes, or that category mistakes are treated as false by definition, so that the antecedent in (I) becomes false, and the whole conditional–true.) As Van McGee expresses it, if God himself creates a new predicate, then this predicate can be substituted for ‘*P*’.

... Gaifman: [Gaf04], pp.15-16

In other words, skepticism about the non-finitary nature of the classical ‘standard’ model of arithmetic should not prevent us from admitting it as an unintended, *weak*, algorithmically *verifiable*, interpretation $\mathcal{I}_{PA(\mathbb{N}, SV)}$ of PA (see §2.B.).

Moreover—from the *evidence-based* perspective of this investigation—it is the *lack* hitherto of a distinction between the ‘unintended’, *weak*, algorithmically *verifiable*, interpretation $\mathcal{I}_{PA(\mathbb{N}, SV)}$ of PA (see §2.B.), and the ‘intended’, *strong*, algorithmically *computable*, interpretation $\mathcal{I}_{PA(\mathbb{N}, SC)}$ of PA (see §2.C.), that has allowed the meta-mathematical conclusions which Gödel draws informally—albeit persuasively and misleadingly, as argued in §15.A.—from his own formal reasoning in [Go31]—where, for instance, he implicitly footnotes in [Go31], Theorem VIII (p.31) that an arithmetic such as PA can be treated as ω -consistent, and must, therefore, admit formally undecidable propositions—to prevail and, *prima facie*, compel admittance of, uncomfortably non-finitary, non-standard models of PA as above.

The consequences of compelling admittance of, uncomfortably non-finitary, non-standard models of PA can be both far-reaching and constraining for attempts to align our ‘sound’ intuitions (corresponding to what Pansart terms *pre-formal mathematics* in [Pan09]; see also §1.A.) with accepted dogmas—where it ‘is a well-known fact that first order Peano arithmetic has infinitely many different models’.

For instance, such constraint is evidenced in Paula Quinon and Konrad Zdanowski’s appeal—with implicit disquietude and tentativeness—to cognitive assumptions in order to identify an ‘intended’ model of PA that, they believe, reflects our intuition more faithfully than what current paradigms treat as *the* ‘standard’ model of PA:

“In this paper we justify the following thesis: our notion of natural number is determined by any recursive ω -model of PA up to recursive isomorphism.

It is a well-known fact that first order Peano arithmetic has infinitely many different models. Most of them are called *non-standard* and only one class of isomorphic models is considered as *standard*.⁴ We call a model of arithmetic standard if its ordering is of the type ω . We used to consider that standard model of arithmetic as the one that reflects our intuitions about natural numbers adequately. A model that reflects our intuitions adequately is called *intended*.

In this paper we want to answer the following questions: why is one of the interpretations of the Peano axioms distinguished among so many others? Are standard models really intended models?

It is important to notice, that we make a distinction between an *intended* model and a *standard* model of arithmetic. The second notion is well known in metamathematics of arithmetic. The intended model is a model that satisfies intuitions concerning natural numbers. These two concepts were often identified even though the the standard model of PA is a well defined metamathematical notion while the intended model refers rather to our intuitions. In what follows, we postulate a restriction of the class of intended models to a proper subclass of standard models.

Using cognitive assumptions we argue that the intended model should be recursive (computable). This fact, together with the first order induction principle, determines a subclass of standard models. Similar arguments were developed in [HH05] in the context of Benacerraf analysis of the standard model. We differ from them in putting the main stress on the cognitive nature of our assumptions.”

... Quinon/Zdanowski: [QZ07], §1 Introduction.

Thus, from the *evidence-based* perspective of this investigation, and the Complementarity Thesis (§1.; Thesis 1), Quinon and Zdanowski's postulating 'a restriction of the class of intended models to a proper subclass of standard models' appears somewhat contrived—if not misleading.

Reason: We could, prima facie, correspond Quinon and Zdanowski's 'standard' model of PA to the one determined by the 'unintended', *weak*, algorithmically *verifiable*, interpretation $\mathcal{I}_{PA(\mathbb{N}, SV)}$ of PA (see §2.B.); and their 'intended' model of PA to the one determined by the 'intended', *strong*, algorithmically *computable*, interpretation $\mathcal{I}_{PA(\mathbb{N}, SC)}$ of PA (see §2.C.).

It is a postulation, however, for which neither Paula Quinon nor Konrad Zdanowski—when wearing their philosopher's hats—should be held accountable (for reasons detailed in §15.A. and §18.).

Like Wittgenstein, Lucas, Penrose and others of similar ilk (see [An07b], [An07c]) they can, in this instance, be excused for depending upon fallible classical *and* intuitionistic wisdom (see also §5.) to the effect that a Peano Arithmetic such as PA can admit non-standard models.

7.L. Algorithmic *verifiability* and algorithmic *computability* from a Brouwerian perspective

We also note that the distinction in §7.G., Theorem 7.2, between algorithmically *verifiable* number-theoretic functions (and the real numbers defined by them) and algorithmically *computable* number-theoretic functions (and the real numbers defined by them) is, prima facie, similar to the one that, according to Mark van Atten, L. E. J. Brouwer sought to make explicit in his 1907 PhD thesis:

"The distinction between a construction proper and a construction project was well known to Brouwer. It is essential to his notion of denumerably unfinished sets:

[H]ere we call a set denumerably unfinished if it has the following properties: we can never construct in a well-defined way more than a denumerable subset of it, but when we have constructed such a subset, we can immediately deduce from it, following some previously defined mathematical process, new elements which are counted to the original set. But from a strictly mathematical point of view this set does not exist as a whole, nor does its power exist; however we can introduce these words here as an expression for a known intention. [10, p.148; trl. 45, p.82]

But in the quotations from 1947 and 1954 above we do not see Brouwer say, analogously, that sequences that are not completely defined do from a strictly mathematical point of view not exist as objects, but that terms for them are introduced as expressions for a known intention (namely, to begin and continue a construction project of a certain kind). This explains the fact noted in the latter half of Gielen, De Swart, and Veldman's reflection.

Still, the distinction at the basis of De Iongh's view between construction processes that are governed by a full definition of the object under construction and those that, as a matter of principle, cannot be thus governed, is a principled one of mathematical relevance, and it is important to realise that, if a proposed axiom turns out not to hold in general, it may still hold for one of these two subclasses.

[...]

[10] L. E. J. Brouwer. Over de grondslagen der wiskunde. PhD thesis, Universiteit van Amsterdam, 1907."

... van Atten: [At18], pp.67-68.

7.M. Algorithmic *verifiability* and algorithmic *computability* from Carnap's perspective

The distinction in §7.G., Theorem 7.2, between algorithmically *verifiable* number-theoretic functions (and the real numbers defined by them) and algorithmically *computable* number-theoretic functions (and the real numbers defined by them) is also, prima facie, similar to the one which, according to Vera Flocke (see [Flo19]), Rudolf Carnap sought to make when distinguishing between 'proofs of "numeric", and of "specific", generality' in his defense of impredicative definitions:

"Carnap (1931, p. 102) criticizes Ramsey's views as follows: "It seems to me that this view is not far away from a belief in Platonic realm of ideas, which exist in themselves, independently from whether and in which way finite people are able to conceive of them". In other words, Carnap finds Ramsey's defense of impredicative definitions unacceptable since it rests on a problematic form of Platonism. Against this backdrop, Carnap characterizes the "*most difficult* problem confronting contemporary studies in the foundations of mathematics" as follows:

"How can we develop logic if, on the one hand, we are to avoid the danger of the meaninglessness of impredicative definitions and, on the other hand, are to reconstruct satisfactorily the theory of real numbers as classes (or properties) of fractions?" (Carnap, 1931, p. 101, my translation)

Carnap here describes a dilemma: either one accepts impredicative definitions that, according to some mathematicians, really are meaningless, or one runs into problems concerning the theory of real numbers. Simple type theorists take the first horn of the dilemma, and ramified type theorists the second. Given Carnap's preference for simple over ramified type theory (see p. 7), this dilemma turns into the following problem: "Is it possible to retain Ramsey's results without accepting his absolutist conception?" This, according to Carnap, is "*the decisive question*" concerning the foundations of mathematics (1931, p. 103, my translation, Carnap's emphasis). I will in what follows first explain what Carnap means by "Platonism" or "absolutism", then go on to explain why he finds it problematic, and finally present his alternative defense of impredicative definitions.

Carnap does not offer a definition of absolutism in the 1931 paper. He, however, does offer one in the *Untersuchungen zur Allgemeinen Axiomatik* (2000, §1.10).³⁷ According to this definition, absolutism contrasts with constructivism, and the key difference between these views concerns the use of quantifiers. Absolutists regard an existentially quantified sentence of the form ' $\exists xFx$ ' as meaningful, whether or not an object b that is F can in fact be found. Constructivists, in contrast, regard an existentially quantified sentence of the form ' $\exists xFx$ ' as meaningful only if it has either been inferred from a sentence of the form ' Fb ', or else an object b which is F can be found in finitely many steps. This condition is very strong, since it entails that all meaningful existence claims are true. A more plausible version of constructivism would hold that an existentially quantified sentence of the form ' Fb , or an object b which is F can be found in finitely many steps, or it can be ruled out in finitely many steps that any object b is F .

Carnap explicitly marks his constructivist views on quantification as being in agreement with intuitionism. Unlike intuitionists, Carnap nevertheless upholds the principle of excluded middle. He observes that there is a tripartite division between objects that have been shown to be F , objects that have been shown to be not- F , and objects that have neither been shown to be F nor shown to be not- F . However, everything is such that we know that it can be shown to be F , or we don't know that it can be shown to be F , which is why Carnap accepts the principle of excluded middle.

The basic difference between "absolutists" and "constructivists" can be illustrated as follows.³⁸ "Absolutists" define the property of being the least upper bound x of a bounded class C of reals thus:

(Abs) x is the least upper bound of a bounded class C of reals if and only if, for every $q \in x$ there is a P such that $P \in C$ and $q \in P$.

Knowability plays no part in this definition. However, "constructivists" define the least upper bound x of a bounded class C of reals thus:

(Con) x is the least upper bound of a bounded class C of reals if and only if it can be shown for every q that, if $q \in x$, then some P can be found in finitely many steps such that $P \in C$ and $q \in P$.

It is clear why Ramsey counts as an "absolutist" according to this conception. Ramsey regards an existentially quantified sentence ' $\exists x(Fx)$ ' as meaningful whether or not an x which is F can be found, and hence "goes beyond the limits of the truly knowable and definable" (Carnap, 1931, p. 102, my translation).

Given Carnap's constructivism, one should expect him to restrict quantification over infinite domains. If the domain of an existential quantifier is infinite, then, for at least some predicates F , it is not guaranteed that the truth of ' $\exists xFx$ ' can be decided in finitely many steps, as Carnap requires for this sentence to be meaningful. However, Carnap grants that the domains of interest in mathematics generally are infinite (p. 103). He resolves the apparent conflict with constructivism by distinguishing between two different ways of proving general statements, which he calls proofs of "numeric" and of "specific" generality, respectively.³⁹ Here is an example to illustrate the difference:

(2) Every whale is a mammal.

A proof of the numeric generality of (2) would proceed by considering every individual whale and showing that it is a mammal. A proof of the specific generality of (2), however, first assumes that some arbitrary x is a whale, and shows that, since x is a whale, x is a mammal. Such a proof of specific generality does not require to consider each element of the domain of quantification and is compatible with quantification over infinite domains.⁴⁰

... Flocke: [Flo19], §4 Carnap's 1931 Defense of Impredicative Definitions.

In particular Carnap, according to Flocke, distinguishes between the *specific* generality of an arithmetic proposition—such as (1') below—which can be 'proved' (presumably in an appropriate formal system of arithmetic), and its *numeric* generality, which cannot:

"This distinction allows Carnap (1931, p. 103-105) to defend impredicative definitions, as follows. Consider the definition of *being the least upper bound of a bounded class C of reals*:

(1') $\lambda x_{(i)}. [\forall_{(i)} q_{(i)} (q_{(i)} \in x_{(i)} \leftrightarrow \exists_{(i)} P_{(i)} (P_{(i)} \in C \wedge q_{(i)} \in P_{(i)}))]$

Carnap's constructivism imposes certain constraints on when the use of the quantifiers $\forall_{(i)}$ and $\exists_{(i)}$ in this definition is to be regarded as meaningful. According to these constraints, (1') is meaningful if it can be shown for each $q_{(i)} \in x_{(i)}$ (in finitely many steps) that some $P_{(i)} \in C$ can be found (in finitely many steps) of which $q_{(i)}$ is a member. Showing that (1') is meaningful hence requires establishing the following proposition: it can be shown for each $q_{(i)} \in x_{(i)}$ (in finitely many steps) that some $P_{(i)} \in C$ can be found (in finitely many steps) of which $q_{(i)}$ is a member. Since there are infinitely many $q_{(i)} \in x_{(i)}$, the *numeric* generality of this proposition cannot be proved. Its *specific* generality, however, can be proved: the least upper bound of x of a bounded class C of reals $P_{(i)}$ just is the set of all $q_{(i)}$ that are elements of some $P_{(i)}$. Being an element of the least upper bound x of a bounded class C of reals $P_{(i)}$ hence entails being an element of some $P_{(i)} \in C$.

Carnap then imposes the further condition that the definition of a property P is meaningful if it is possible to decide, for at least some x , whether x has P .⁴¹ That means with respect to (1') that this definition is meaningful if it is possible to decide, for at least some real number x , whether x is the least upper bound of C . This condition is met, too. We just need to find a real number that is represented by a set of rationals which includes elements that are not shared with (the representation of) any of the real numbers that are elements of C .⁴²

This view provides a specific example of a non-Platonistic defense of impredicative definitions, even though impredicative mathematics is often thought to be acceptable only on Platonistic grounds. However, Carnap's views on the foundations of mathematics soon shifted away that required him to search for an alternative defense of impredicativity, as I will go on to discuss in the next section."

... Flocke: [Flo19], §4 Carnap's 1931 Defense of Impredicative Definitions.

Prima facie, from the *evidence-based* perspective of this investigation, Carnap's *numeric* generality could be interpreted as algorithmic *verifiability*, and his *specific* generality as algorithmic *computability*.

Consequently, by the Provability Theorem for PA ([An16], Theorem 7.1, p.41; see also §2.E.b., Theorem 2.17), whilst the *specific* generality of arithmetical propositions—such as (1')—when represented in PA would be provable in PA, their *numeric* generality would not (the possible significance of which can be seen in [An16], Theorem 2.1, p.37; see also §7.G., Theorem 7.2).

One reason that may have inhibited recognition of the significance of such a distinction for *evidence-based* reasoning and its far-reaching consequences—as is highlighted in this investigation—could be that the influence (critically misleading according to §15.) of Gödel's interpretation of his own formal reasoning in [Go31] might have been responsible for Carnap's reported—according to Flocke—shift away from his earlier views on the foundation of mathematics to an exclusively syntactical perspective—devoid of semantical considerations²¹⁹—that 'required him to search for an alternative defense of impredicativity':

"Carnap's views on the foundations of mathematics changed dramatically after he learned of Gödel's incompleteness theorems. According to his intellectual biography, a completely new approach

"came to me like a vision during a sleepless night in January 1931, when I was ill. On the following day, still in bed with fever, I wrote down my ideas on forty-four pages under the title 'Attempt at a metalogic'. These shorthand notes were the first version of my book *Logical Syntax of Language*" (Carnap, 1963a, p. 53).

...

The key difference between Carnap's pre-*Syntax* philosophy of mathematics and the new syntactic approach is that he replaces his earlier definitional reductionism by a new metalinguistic approach.⁴⁵ As discussed earlier, one of Carnap's goals during the 1920's was to show that mathematics is analytic via a definitional reduction of all mathematical concepts to a small class of logical concepts (see §3). There is no trace of this reductionism after 1931. Instead, Carnap (1937[1934]) clearly distinguishes between object- and meta- languages, and provides meta-linguistic definitions of 'analytic' as a term that applies to object-language sentences. On this new approach, there is not a single notion of analyticity anymore. The meaning of 'analytic' rather has to be formally defined, and can be defined variously in different formal systems. Carnap thus tries to achieve his old goal of showing that mathematics is analytic by radically new means. However, this is not his only goal. Carnap, more generally, wants to provide a new "syntactic method" for the analysis of statements and clarification of disputes. As he puts it in the forward (p. xiii):

²¹⁹A dubious distinction, in hindsight, from the *evidence-based* perspective of the Complementarity Thesis of this investigation—i.e., §1., Thesis 1, and §1., Definition 1—which seeks to define the semantics of a formal system such as PA categorically (see [An16], Corollary 7.2, p.41) in terms of *evidence-based*, syntactical, definitions in recursive arithmetic, as detailed in [An16], §5, p.38, [An16], §6, p.40, [An16], Theorem 7.1, p.41; as also §7.C. above.

"The aim of logical syntax is to provide a system of concepts, a language, by the help of which the results of logical analysis will be exactly formulable. *Philosophy is to be replaced by the logic of science*—that is to say, by the logical analysis of the concepts of the sciences [...]. The book itself makes an attempt to provide, in the form of an exact syntactical method, the necessary tools for working out the problems of science."

As is evident from this quotation, Carnap develops the new syntactic method in pursuit of much of the same goals as the ones that guided the development of the axiomatic method.

An application of the syntactical method consists in the definition of the logical syntax of a language. By a "language", Carnap means what we would today call a "formal system", i.e. a formal language together with a deductive proof system. Carnap's "languages" resemble formal systems since they are specified by means of two sets of rules: *formation* and *transformation* rules. The formation rules specify which strings of symbols are sentences in the system. The transformation rules may include inference rules such as *modus ponens* or a list of axiom schemata, and they settle, for every sentence s and every set R of sentences of the system, whether s is a consequence of R .⁴⁶

The logical syntax of such a system specifies what would today be called its *syntax*, i.e. the signs that occur in the system and their possible combinations. Carnap was concerned, moreover, with providing definitions of concepts of formal deductive *logic*—including concepts of analyticity, provability, logical independence, and so on. Carnap constructed syntactic definitions of these logical concepts, so that their application conditions depend merely on the forms and not on the meanings of sentences. The logical syntax of a language hence is a *formal* theory that makes "no reference [...] either to the meanings of the symbols (for example, words), or to the sense of the expressions (e.g. the sentences), but simply and solely to the kinds and order of the symbols from which the expressions are constructed" (1937[1934], p. 1).⁴⁷ Carnap's further discussion makes clear that it is possible to define the logical syntax of a language whose component expressions *are* meaningful. and whose sentences *do* possess "senses". The logical syntax of such a language is a theory that ignores these "meanings" and "senses", and refers to only syntactical properties of the language in question.⁴⁸

A syntactic treatment of language was important to Carnap because, he thinks, it is impossible to "lay down sharply defined rules" (p. 1) for linguistic meanings. That is, Carnap regards it as possible to lay down syntactic composition rules that define how complex sentences may be built up from simpler expressions, and syntactic derivation rules that define how a sentence may be derived from a set of sentences. He, however, regards it as impossible to similarly lay down semantic composition rules that define the meaning of a complex expression as a function of the meanings of its component parts, or semantic entailment relations. He learned of Tarski's semantic truth-definitions only in 1935, after the German edition of *The Logical Syntax of Language* had already been published (in 1934).⁴⁹"

... Flocke: [Flo19], §5 Carnap's Syntax Program.

Another reason could be that (compare with the shift in Hilbert's focus as noted in §9.A.a.) the deterministic infinite procedures (corresponding to Hilbert's 'reduction procedure' quoted in §8.B.) needed to *formalise* the distinction between 'constructive' and 'finitary' reasoning (as illustrated for quantification in §10.A.; and generally by §2., Definitions 7 and 10) become explicit only *after* the belated realisation that Turing's 1936 paper [Tu36]) admits *evidence-based* reasoning in the sense of [Mu91] and [Lob59] (see §2.), such that one can view the *values* of a simple functional language as specifying *evidence* for quantified propositions in a constructive logic in two, essentially different, ways (see §7.C.).

7.N. Algorithmic *verifiability* and algorithmic *computability* in Buss’ Bounded Arithmetic

We also briefly outline the significance of the distinction between algorithmically *verifiable* number-theoretic functions and algorithmically *computable* number-theoretic functions—introduced in [An16]—for the seminal 1997 paper [Bs97] by Samuel R. Buss, where he considers Bounded Arithmetics obtained by:

- (a) limiting the applicability of the PA Axiom Schema of Finite Induction only to functions with quantifiers bounded by an unspecified natural number bound b ;
- (b) ‘weakening’ the statement of the axiom with the aim of differentiating between effective computability over the sequence of natural numbers, and feasible²²⁰ ‘polynomial-time’ computability over a bounded sequence of the natural numbers.

Presumably Buss’ intent is to build a bridge between provability in a Bounded Arithmetic and algorithmic *computability* (compare with the Provability Theorem for PA: [An16], Theorem 7.1, p.41; see also §2.E.b., Theorem 2.17) so that a Π_k formula, say $[(\forall x)f(x)]$, is provable in the Bounded Arithmetic if, and only if, there is a deterministic polynomial-time algorithm that, for any *specifiable* numeral $[n]$, decides the $\Delta_{(k/(k-1))}$ formula $[f(n)]$ as ‘true’:

“2 Bounded Arithmetic

A *constructive* proof system is one in which proofs of existence contain, or imply the existence of, algorithms for finding the object which is proved to exist. For a feasibly constructive system, the algorithm will be feasible, not merely effective. For instance, if $\forall x\exists yA(x, y)$ is provable then there should be a feasible algorithm to find y as a function of x . In the next section, we introduce feasible proof systems for number theory: more precisely, S_2^1 will be a feasible proof system, and other systems, S_2^i and T_2^i are systems that have proof-theoretic strength corresponding to higher levels of the polynomial time hierarchy.

2.1 The Language of Bounded Arithmetic

The theories of bounded arithmetic will be first-order theories for the natural numbers $\mathbb{N} = \{0, 1, 2, \dots\}$. The first-order language for bounded arithmetic contains the predicates $=$ and \leq and contains function symbols 0 , S (successor), $+$, \cdot , $\lfloor \frac{1}{2}x \rfloor$, $|x|$, $\#$ and relation symbol \leq , where

$$x\#y = 2^{|x|\cdot|y|}$$

It is easy to check that the $\#$ (pronounced “smash”) function allows us to express $2^{q(|\vec{a}|)}$ for q any polynomial with positive integer coefficients.

Definition A *bounded quantifier* is a quantifier of the form $(Qx \leq t)$ with t a term not involving x . A *sharply bounded quantifier* is one of the form $(Qx \leq |t|)$. $(\forall x)$ and $(\exists x)$ are unbounded quantifiers. A *bounded formula* is one with no unbounded quantifiers.

A hierarchy of classes Σ_k^b, Π_k^b of bounded formulas is defined by counting alternations of bounded quantifiers, ignoring sharply bounded quantifiers. (Analogously to defining the arithmetic hierarchy by counting unbounded quantifiers, ignoring bounded quantifiers.)

Definition $\Sigma_0^b = \Pi_0^b$ is the set of formulas with only sharply bounded quantifiers.

If $A \in \Sigma_k^b$ then $(\forall x \leq |t|)A$ and $(\exists x \leq t)A$ are in Σ_k^b and $(\forall x \leq t)A$ is in Π_{k+1}^b . Dually, if $A \in \Pi_k^b$ then $(\exists x \leq |t|)A$ and $(\forall x \leq t)A$ are in Π_k^b and $(\exists x \leq t)A$ is in Σ_{k+1}^b . For formulas not in prenex

²²⁰See Parikh [Pa71].

form, we say that a formula is in Σ_i^b (resp., Π_i^b) iff prenex operations can be used to put the formula in to the prenex Σ_1^b (resp., Π_1^b) form defined above.

One of the primary justifications for the definition of Σ_1^b —and Π_1^b —formulas is the following theorem.

Theorem 2 *Fix $k \geq 1$. A predicate Q is in Σ_k^p iff there is a Σ_k^b formula which defines it.*

...

2.2 Induction Axioms for Bounded Arithmetic

The *IND* axioms are the usual induction axioms. The *PIND* and *LIND* axioms are "polynomial" and "length" induction axioms that are intended to be feasibly effective forms of induction.

Definition Let $i \geq 0$. The following are axiom schemes often used for theories of bounded arithmetic.

$$\Sigma_k^b\text{-IND} : A(0) \wedge (\forall x)(A(x) \supset A(x+1)) \supset (\forall x)A(x) \text{ for } A \in \Sigma_k^b.$$

$$\Sigma_k^b\text{-PIND} : A(0) \wedge (\forall x)(A(\lfloor \frac{1}{2}x \rfloor) \supset A(x)) \supset (\forall x)A(x) \text{ for } A \in \Sigma_k^b.$$

$$\Sigma_k^b\text{-LIND} : A(0) \wedge (\forall x)(A(x) \supset A(x+1)) \supset (\forall x)A(|x|) \text{ for } A \in \Sigma_k^b.$$

The axiom schemes $\Sigma_k^b\text{-LIND}$ and $\Sigma_k^b\text{-PIND}$ typically are equivalent and are (strictly?) weaker than $\Sigma_k^b\text{-IND}$. Since exponentiation is not provably total in Bounded Arithmetic, the $|x|$ function is not provably surjective; therefore, the *LIND* axioms do not appear to [be] equal to the *IND* axioms in strength.

2.3 Theories of Bounded Arithmetic

Definition Let $i \geq 0$. T_2^i is the first-order theory with language $0, S, +, \cdot, \lfloor \frac{1}{2}X \rfloor, |x|, \#$ and \leq and axioms:

- (1) A finite set, BASIC, of (universal closures of) open axioms defining simple properties of the function and relation symbols. BASIC properly contains Robinson's Q since it has to be used with weaker induction axioms.
- (2) The $\Sigma_k^b\text{-IND}$ axioms.

T_2^{-1} has no induction axioms. T_2 is the union of the T_2^i 's.

T_2 is equivalent to $I\Delta_0 + \Sigma_1$ (see Parikh [40] and Wilkie and Paris [50]) modulo differences in the nonlogical language.

Definition Let $i \geq 0$. S_2^i is the first-order theory with language $0, S, +, \cdot, \lfloor \frac{1}{2}x \rfloor, |x|, \#$ and \leq and axioms:

- (1) The BASIC axioms, and
- (2) The $\Sigma_k^b\text{-IND}$ axioms.

$S_2^{-1} = T_2^{-1}$ has no induction axioms. S_2 is the union of the S_2^i 's.

Remark: The theory S_2^1 , which we will relate closely to polynomial computability, is defined by *PIND* on NP properties (in light of Theorem 2).

The following, somewhat surprising, relationship holds between the hierarchy of theories S_2^i and the hierarchy of theories T_2^i .

Theorem 3 (Buss [3, 4]). *Let $i \geq 1$. $T_2^i \vdash S_2^i$ and $S_2^i \vdash T_2^i$. So $S_2 \equiv T_2$.*

... Buss: [Bs97].

Since Buss treats the notion of ‘feasibility’ as intuitive (see [Bs97], p. 2), it is not obvious whether or not his intended interpretation of the existential quantifier of a Bounded Arithmetic admits as provable a formula $[(\forall x)(\exists y)f(x, y)]$ which may be algorithmically *verifiable*, but not algorithmically *computable*, under a *well-defined* interpretation of the Arithmetic over \mathbb{N} .

Moreover, since the Provability Theorem for PA ([An16], Theorem 7.1, p.41; see also §2.E.b., Theorem 2.17) establishes precisely such an iff bridge between PA provability and algorithmic *computability*, where, however, the provability of a PA formula does not ensure the ‘feasibility’ of its polynomial-time computability under interpretation over \mathbb{N} , the question arises:

Query 5. *Does the introduction of implicit bounded quantifiers yield any computational advantage in Buss’ Bounded Arithmetics?*

Now, the only difference between a Bounded Arithmetic and PA is that, limiting the applicability of the PA Axiom Schema of Finite Induction only to functions with quantifiers bounded by an *unspecified* natural number bound b in Bounded Arithmetics, also presumes Aristotle’s particularisation *implicitly*²²¹, so that, from a PA proof of $[(\exists y)f(n, y)]$, we may always conclude that there is some PA numeral $[m]$ such that $[f(n, m)]$ is provable in the arithmetic. However, §2.E.b., Theorem 2.17 shows that this is not a valid inference in PA.

To see why²²² this may not always be the case, interpret $[(\forall x)f(x)]$ as:

There is an algorithm that decides $[f(n)]$ as ‘true’ for any *specified* numeral $[n]$.

In such case, if $[(\forall x)(\exists y)f(x, y)]$ is provable in PA, then we can only conclude that:

There is an algorithm that, for any *specified* numeral $[n]$, decides that it is not the case that there is an algorithm that, for any *specified* numeral $[m]$, decides $[\neg f(n, m)]$ as ‘true’.

We cannot, however, conclude—as we can in a Bounded Arithmetic—that:

There is an algorithm that, for any *specified* numeral $[n]$, decides that there is an algorithm that, for some *specifiable* numeral $[m]$, decides $[f(n, m)]$ as ‘true’.

This could be the case if $[(\forall x)(\exists y)f(x, y)]$ were PA-*unprovable*, but $[(\exists y)f(n, y)]$ PA-*provable* for any *specifiable* numeral $[n]$ ²²³.

Thus, the Provability Theorem for PA ([An16], Theorem 7.1, p.41; see also §2.E.b., Theorem 2.17) suggests that the postulation of an *unspecified* bound in a Bounded Arithmetic in order to arrive at a ‘provability iff computability’ bridge not only invites a questionable, *non-finitary*, presumption of Aristotle’s particularisation²²⁴, but may also be formally dispensable.

Since PA is finitarily consistent (by [An16], Theorem 6.7, p.41; see also §2.C.a., Theorem 2.16), we conclude that all arguments and conclusions of Buss’ Bounded Arithmetic can be reflected in PA without any loss of generality. Query 5 thus admits the formal negative answer:

²²¹Prima facie, any interpretation of such a Bounded Arithmetic over \mathbb{N} could, therefore, be isomorphic to the *standard*, algorithmically *verifiable* interpretation $\mathcal{I}_{PA(\mathbb{N}, SV)}$ of PA over \mathbb{N} .

²²²As Brouwer had steadfastly held (see for instance Brouwer [Br08]; Brouwer [Br27]).

²²³cf. Kurt Gödel’s argumentation in Gödel [Go31].

²²⁴Which (see §7., Definition 20), prima facie, appears contrary to both Buss’ intent and spirit.

Theorem 7.8. (Bounded Arithmetic Theorem) *Weakening the PA Axiom Schema of Finite Induction formally in Buss' Bounded Arithmetic does not yield any computational advantage.*

Proof. Buss considers a Bounded Arithmetic S_2 which is, essentially, the first-order Peano Arithmetic PA (as defined in §2.) with the following 'weakened' Axiom Schema of Finite Induction, PIND²²⁵:

$$[\{f(0) \ \& \ (\forall x)(f(\lfloor \frac{x}{2} \rfloor) \rightarrow f(x))\} \rightarrow (\forall x)f(x)]$$

Now, PIND can be expressed in PA as follows:

$$[\{f(0) \ \& \ (\forall x)(f(x) \rightarrow (f(2x) \ \& \ f(2x + 1)))\} \rightarrow (\forall x)f(x)].$$

Moreover, the above is a particular case of, say, PIND(k):

$$[\{f(0) \ \& \ (\forall x)(f(x) \rightarrow (f(kx) \ \& \ f(kx + 1) \ \& \ \dots \ \& \ f(kx + k - 1)))\} \rightarrow (\forall x)f(x)].$$

- (a) By [An16], Lemma 5.3, p.39 (see also §2.B.a., Lemma 2.4), for any *specifiable* PA formula $[f(x)]$, the PA Axiom Schema of Finite Induction:

$$[f(0) \rightarrow (((\forall x)(f(x) \rightarrow f(x + 1))) \rightarrow (\forall x)f(x))]$$

interprets as an algorithmically *verifiable* true formula under $\mathcal{I}_{PA(\mathbb{N}, SV)}$. Moreover, it immediately follows that PIND(k) too is algorithmically *verifiable* as true under the classical, standard, algorithmically *verifiable* interpretation $\mathcal{I}_{PA(\mathbb{N}, SV)}$ of PA.

- (b) Now we have the PA theorem:

$$[(\forall x)f(x) \rightarrow \{f(0) \ \& \ (\forall x)(f(x) \rightarrow f(x + 1))\}]$$

It follows that the following is also a PA theorem:

$$[\{f(0) \ \& \ (\forall x)(f(x) \rightarrow f(x + 1))\} \rightarrow \{f(0) \ \& \ (\forall x)(f(x) \rightarrow (f(kx) \ \& \ f(kx + 1) \ \& \ \dots \ \& \ f(kx + k - 1)))\}]$$

In other words, for any *specifiable* numeral $[k]$, PIND(k) is entailed by the standard PA Axiom Schema of Finite Induction. Hence, by [An16], Lemma 6.4, p.40 (see also §2.C.a., Lemma 2.12) PIND(k) interprets as an algorithmically *computable* true formula under $\mathcal{I}_{PA(\mathbb{N}, SC)}$; and, ipso facto, as an algorithmically *verifiable* true formula under $\mathcal{I}_{PA(\mathbb{N}, SV)}$.
□

²²⁵Where $\lfloor \frac{x}{2} \rfloor$ denotes the largest, natural number, lower bound of the rational $\frac{x}{2}$.

CHAPTER 8. MATHEMATICAL CONSEQUENCES

8. The significance of Hilbert's ω -Rule for Gödel's ω -consistency

The distinction between §2., Definition 7, and §2., Definition 10, also allows us to address, and place, Hilbert's ω -Rule of infinite induction ([Hi30], pp.485-494) within a broader *evidence-based* perspective; where we first define an:

Proposition 8.1. (Algorithmic (weak) ω -Rule of infinite induction) *If it is proved that the PA formula $[F(x)]$ interprets as an arithmetical relation $F^*(x)$ that is algorithmically computable as true for any specified natural number n , then the PA formula $[(\forall x)F(x)]$ can be admitted as an initial formula (axiom) in PA.*

The significance of the (*weak*) Algorithmic ω -Rule of infinite induction is that it is defined in terms of algorithmic *computability*; and is an immediate consequence of the Provability Theorem for PA (§2.E.b., Theorem 2.17) which, essentially, was what Hilbert had sought in his Program (see [Hi00]).

Thus, as part of his program for giving mathematical reasoning a finitary foundation, Hilbert proposed a *stronger* (since it implies the Provability Theorem for PA) ω -Rule of infinite induction as an ad hoc means of extending a Peano Arithmetic to a possible completion²²⁶, which we can rephrase, without loss of generality, in terms of algorithmic *verifiability* as:

Proposition 8.2. (Hilbert's (*strong*) ω -Rule of infinite induction) *If it is proved that the PA formula $[F(x)]$ interprets as an arithmetical relation $F^*(x)$ that is algorithmically verifiable as true for any specified natural number n , then the PA formula $[(\forall x)F(x)]$ can be admitted as an initial formula (axiom) in PA.*

The question of whether or not *weakened* versions of Hilbert's original ω -Rule of infinite induction could be regarded as finitary is addressed in detail by Matthias Schirn and Karl-Georg Niebergall in [SN01]:

"Restricted versions of the ω -rule have been suggested both as a means of explicating certain forms of finitary arguments or proofs and as a way of correctly extending a theory already accepted. In this section, we want to deal with the question as to whether weak versions of the ω -rule can be regarded as finitary. For if they can, they may prove useful for the construction of metamathematical theories that clash neither with Hilbert's programme nor with Gödel's Incompleteness Theorems. In pursuing our aim, we align ourselves with Hilbert's programme. By contrast, in his 1931 essay Hilbert himself introduces a restricted ω -rule as a means of extending PA, though he does so in a way which admits different interpretations.

Rule ω^ :* When it is shown that the formula $A(\mathbf{Z})$ is a correct numerical formula for each particular numeral \mathbf{Z} , then the formula $\forall xA(x)$ can be taken as a premise.

Hilbert qualifies this rule expressly as finitary and goes on to remind us that $\forall xA(x)$ has a much wider scope than $A(\tilde{n})$, where \tilde{n} is an arbitrary given numeral."

... Schirn and Niebergall: [SN01], p.137.

²²⁶In other words, to logically showing that, for any specified arithmetical proposition, either the proposition, or its negation, is formally provable from the axioms and rules of inference of the extended Arithmetic.

Schirn and Niebergall conclude that Hilbert's assumption of Aristotle's particularisation as a valid, and essential, form of reasoning—as evidenced in his definitions of the universal and existential quantifiers in terms of his ε -operator (see §10.A.)—committed him to an essentially non-finitary perspective; reflected also in his ω -rule of infinite induction; both of which we shall show—§8.C., Lemma 8.5 and §8.D., Corollary 8.10—are stronger than Gödel's assumption of ω -consistency in the latter's 1931 paper [Go31] on 'formally undecidable' arithmetical propositions:

"We venture to surmise that Hilbert qua metalogician relies on existence assumptions of precisely this kind without being haunted by any finitist qualms. And we do think that those assumptions of infinity that are made by accepting one application of rule ω^* are not more far-reaching than those made by accepting transfinite induction upto ε_0 .

It should be evident that the ω -rule or even one application of it cannot be accepted from Hilbert's original finitist point of view. Yet both modern metalogic and Hilbert's metamathematics of the 1920s rest on certain assumptions of infinity that clash anyway with his classical finitism (cf. Niebergall and Schirn 1998, section 4). Intuitively speaking, one may tend to believe that the metalogical assumptions of infinity just appealed to, or Hilbert's assumption in his work on proof theory in the 1920's that there are infinitely many stroke-symbols, are slightly weaker than those that we make when we apply an ω -rule. However this may be, we do not rule out that Hilbert wants to commit himself only to the possible existence of infinitely many stroke-figures or, alternatively, to the existence of infinitely many possible stroke-figures. Unless a satisfactory theory of the potential infinite is to hand, it is probably wise to postpone closer scrutiny of the question whether, from the point of view of strength, applications of a given ω -rule and the assumptions of infinity, both made by Hilbert in the 1920s and common in contemporary metalogic, differ essentially from each other."

... Schirn and Niebergall: [SN01], p.141.

Now, Gödel's 1931 paper can, not unreasonably, be viewed as the outcome of a presumed attempt to formally validate Hilbert's ω -rule of infinite induction finitarily, since:

Lemma 8.3. *If we meta-assume Hilbert's ω -rule of infinite induction for PA, then a consistent PA is ω -consistent.*

Proof. If the PA formula $[F(x)]$ interprets as an arithmetical relation $F^*(x)$ that is algorithmically *verifiable* as true for any specified natural number n , and the PA formula $[(\forall x)F(x)]$ can be admitted as an initial formula (*axiom*) in PA, then $[\neg(\forall x)F(x)]$ cannot be PA-provable if PA is consistent. The lemma follows. \square

Comment 84. We note, however, that we cannot similarly conclude from the the Algorithmic ω -Rule of infinite induction that a consistent PA is ω -consistent.

However, by Gödel's Theorem VI in [Go31], it follows from §8., Lemma 8.3 that one consequence of assuming Hilbert's ω -Rule of infinite induction is that there must, then, be a formally undecidable arithmetical proposition; a further consequence of which would be that any first-order arithmetic such as PA must be essentially incomplete (i.e., not completable by the addition of an ω -Rule of infinite induction as envisaged by Hilbert).

Gödel's Theorem VI: "For every ω -consistent recursive class κ of FORMULAS, there exists a recursive CLASS EXPRESSION r such that neither v Gen r nor $\text{Neg}(v$ Gen $r)$ belongs to $\text{Flg}(\kappa)$ (where v is the FREE VARIABLE of r)."

... [Go31], Theorem VI, p.24

8.A. Is Hilbert’s ω -Rule equivalent to Gentzen’s Infinite Induction?

Schirn and Niebergall also address the question of whether Hilbert’s ω -rule of infinite induction is weaker than Gentzen’s cut-elimination, and consider the argument that:

“Since we can construe the infinitely many premises of one application and, hence, of finitely many applications of the ω -rule as ordered with order type ω , the proof theorist who intends to employ the ω -rule has to presuppose only (the existence of) ω . By contrast, Gentzen’s consistency proof for pure number theory in his 1936 article presupposes (the existence of) ε_0 . Moreover, if a proof theorist endorsing the basic tenets of Hilbert’s finitism were asked how he brings it about to prove infinitely many premises, he might respond as follows:

To accept one application of rule ω^* is not more problematic than to make the assumption that one can conclude from the PA-provability of ‘ $\forall x(0 \leq x)$ ’ to the PA-provability of ‘ $0 \leq n$ ’ for every n . Both cases require that *modus ponens* be applied infinitely many times, where the sequence of the prooflines has order-type ω .”

... Schirn and Niebergall: [SN01], p.140.

Schirn and Niebergall remark, and stress, that the issue confronting Hilbert then—as also ‘finitists’ of all hues since²²⁷—was that of unambiguously defining a deterministic procedure for interpreting quantification finitarily; both over the numerals and the numbers that they seek to formally represent:

“It is important to bear in mind that finitist mathematics may be extended by adding well-formed formulae or by adjoining further ‘principles’. It is the first that is at issue in Hilbert’s proposed finitist interpretation of quantified statements about numerals (Hilbert and Bernays 1934, 32ff.). So, let us begin by taking a closer look at this.

- (1) A general statement about numerals ‘ $\forall \tilde{n} \tilde{\mathcal{U}}(\tilde{n})$ ’ can be interpreted finitistically only as a *hypothetical* statement, i.e. as a statement about every *given* numeral. A general statement about numerals expresses a law that has to be verified for each individual case.²⁵
- (2) An existential statement about numerals ‘ $\exists \tilde{n} \tilde{\mathcal{U}}(\tilde{n})$ ’ must be construed, from the finitist point of view, as a ‘partial proposition’, i.e. ‘as an incomplete communication of a more exactly determinate statement, which consists either in the direct specification of a numeral with the property $\tilde{\mathcal{U}}$ or in the specification of a procedure for gaining such a numeral’ (Hilbert and Bernays 1934, 32). The specification of the procedure requires that for the sequence of acts to be carried out a determinate limit be presented.
- (3) In like manner we have to interpret finitistically statements in which a general statement is combined with an existential statement such as ‘For every numeral $\tilde{\tau}$ with the property $\tilde{\mathcal{U}}(\tilde{\tau})$ there exists a numeral \tilde{l} for which $\tilde{\mathfrak{B}}(\tilde{\tau}, \tilde{l})$ holds’, for example. In the spirit of the finitist attitude, this statement must be regarded as the incomplete communication of a procedure with the help of which we can find for each given numeral $\tilde{\tau}$ with the property $\tilde{\mathcal{U}}(\tilde{\tau})$ a numeral \tilde{l} which stands to $\tilde{\tau}$ in the relation $\tilde{\mathfrak{B}}(\tilde{\tau}, \tilde{l})$.
- (4) Hilbert points out that negation is unproblematic when applied to what he calls ‘elementary propositions’, i.e. to statements which can be decided by direct intuitive observation. In the case of universally and existentially quantified statements about numerals, however, it is not immediately clear what ought to be regarded as their negation in a finitist sense. The assertion that a numeral \tilde{n} with the property $\tilde{\mathcal{U}}(\tilde{n})$ does not exist has to be conceived of as

²²⁷We note that ‘finitists’—ranging from Brouwer [Br08], to Wittgenstein [Wi78], to Alexander Yessenin-Volpin [He04]—have persistently (and not unreasonably in view of §2.F., Corollary 2.23) questioned the assumption that the classical ‘standard’ interpretation $\mathcal{I}_{PA(\mathbb{N}, SV)}$ of PA—which implicitly admits non-constructive entailments such as Aristotle’s particularisation—can be treated as constructively *well-defining* a model of PA (in the sense of §12., Definition 34; see also [Brm07], [Pos13]).

the assertion that it is *impossible* that a numeral \tilde{n} has the property $\tilde{\mathcal{U}}(\tilde{n})$. Strengthened negation of an existential statement, thus constructed, is not (as in the case of negation of an elementary statement) the contradictory of ' $\exists \tilde{n} \tilde{\mathcal{U}}(\tilde{n})$ '. From the finitist standpoint, we therefore cannot make use of the alternative according to which there either exists a numeral \tilde{n} to which $\tilde{\mathcal{U}}(\tilde{n})$ applies or the application of $\tilde{\mathcal{U}}(\tilde{n})$ to a numeral \tilde{n} is excluded. Hilbert admits that, from the finitist perspective, the law of the excluded middle is invalid in so far as for quantified sentences we do not succeed in finding a negation of finitist content which satisfies the law.

Fn25 The proposed interpretation of universal quantification is reminiscent of Gentzen's and W. W. Tait's account (See Tait 1981) in that it likewise embodies a version of the ω -rule which rests on the identification of numerals with numbers. Tait's additional idea is that the law in question is to be construed as something given by a finitist function. ... Schirn and Niebergall: [SN01], p.143.

Comment 85. We note that Schirn and Niebergall too seem to implicitly subscribe to the—*misleading* by §8.D., Corollary 8.14—admission they ascribe to Hilbert: namely that 'from the finitist perspective, the law of the excluded middle is invalid in so far as for quantified sentences we do not succeed in finding a negation of finitist content which satisfies the law'.

Schirn and Niebergall note that, although Hilbert endeavoured to distinguish between quantified propositions over numerals and quantified propositions over the numbers that they seek to represent (corresponding to what we have termed as *weak* and *strong* interpretations of quantification in §7.C., Definition 21 to §7.C., Definition 24), he could not express the distinction formally:

Now, when we compare (1)-(4) with Hilbert's remarks on what can be formulated finitistically in say, 'Über das Unendliche' (1926), we notice two things. Explication (4) is very much akin to the points made in that paper about the negation of quantified statements. The matter stands differently with (1)-(3). On plausible grounds, one should assume that a finitistically interpreted sentence is capable of being formulated finitistically in the first place. If that is correct, then (1) to (3) ought to be understood in such a way that universally quantified sentences, even sentences whose formalizations are genuine Π_2^0 -sentences (cf. (3)), can be formulated in the language of finitist mathematics. Plainly, if around 1934 Hilbert really wished to maintain that quantified sentences of types (1)-(3) have a proper place in the language of finitist metamathematics, he would have departed significantly from his conception of metamathematics in the 1920s. It is quite true that both in 'Über das Unendliche' and in *Grundlagen der Mathematik* (1934) Hilbert spares himself the trouble of developing the language of finitist metamathematics in a systematic way. There is one crucial difference, though. In his celebrated essay, the distinction between real and ideal statements, although chiefly designed to streamline the formalism, provides at least a clue for assessing the scope and the limits of the language of finitist mathematics. By contrast, the reader of Hilbert and Bernays 1934 who is expecting to encounter this helpful distinction again here will be disappointed. In this book, there is not even a trace of it framed in familiar terms.

Admittedly, all this does not exclude that an alternative way of construing the phrase 'finitistically interpretable' can be contrived. Consider sentences of type (1). In 'Über das Endliche' ' $\forall x(x + 1 = 1 + x)$ ' is not a sentence of L_M , and the same applies to an expression like (*) 'For every given \tilde{a} ' $\tilde{a} + 1 = 1 + \tilde{a}$ ' is true'. By contrast, if a numeral \tilde{a} is given, the expression ' $\tilde{a} + 1 = 1 + \tilde{a}$ ' is a sentence of the language of finitist metamathematics. In *Grundlagen der Mathematik* (1934), the question of which language (*) may belong to is passed over in silence. We are only told that a finitist interpretation of (*) requires that it be construed as a hypothetical judgement about every given numeral (cf. (1)) (we assume that (*) should be considered a general statement about numerals). A similar formulation is employed in 'Über das Endliche' (91 [378]), with the minor difference that here Hilbert talks about interpretation *simpliciter*.²⁸ And it is almost precisely at this point that he introduces his conception of real and ideal statements, stressing that the latter are, from the finitist point of view, devoid of meaning. This shows: the fact that in 'Über das Endliche' certain sentences of type (1), like (*), are amenable to (a finitist) interpretation is compatible with the fact that the language of finitist metamathematics does not comprise

sentences of this type. The finitist interpretation of (*) proceeds in such a way that for every given numeral \tilde{a} (*) is replaced with ' $\tilde{a} + 1 = 1 + \tilde{a}$ ', and then each of the sentences ' $\tilde{a} + 1 = 1 + \tilde{a}$ ' is interpreted finitistically. Seen from this angle, we should not take it for granted that in *Grundlagen der Mathematik* (1934) finitist interpretability implies finitist formulability. What we do take for granted is that if this implication holds for sentences of one of these types, then it must also hold for the sentences of the remaining types.

F_n28 It is reasonable to assume that here he likewise has a finitist interpretation in mind. Notice that non-finitary sentences, i.e. ideal sentences, are not interpreted at all."
... Schirn and Niebergall: [SN01], p.143.

Perhaps—as illustrated by §2., Definitions 7 and 10—a transparent and unambiguous description of the deterministic infinite procedures²²⁸ needed to *evidence* the distinction formally becomes available only *after* the realisation that Turing's 1936 paper [Tu36]) admits *evidence-based* reasoning in the sense of [Mu91] and [Lob59]; namely, that one can view the *values* of a simple functional language as specifying *evidence* for propositions in a constructive logic²²⁹.

8.B. Hilbert's *weak* proof of consistency for PA

Schirn and Niebergall note further that, in order to argue that every numerical formula derivable from the axioms of a weakened arithmetic H was 'true', Hilbert and Bernays introduced the concept of 'verifiability', whose well-definedness, however, appealed to the existence of appropriate 'reduction procedures' in cases where quantification and/or its negation was intended to be interpreted over only all 'numeral' instantiations of the formulas of H:

"In order to find out whether in *Grundlagen der Mathematik* (1934) quantified sentences of types (1)-(4) are indeed regarded to belong to the well-formed sentences of the language of finitist metamathematics, it is useful to take a closer look both at the number-theoretic formalisms presented there and at the corresponding consistency proofs. In §6 (Hilbert and Bernays 1934, 220ff.), Hilbert carries out a consistency proof for a certain weak arithmetical axiom system (cf. 1934, 219) which we call H. The 'proof' is entirely informal, and it is not clear whether Hilbert shows metamathematically 'There is no proof in H for *falsum*' or only for every concretely given proof figure *a* that *a* is no proof for *falsum* in H. The very beginning of the proof speaks in favour of the second option, that is, we conjecture that Hilbert conducts what is in effect an informal version of what in our paper 'Hilbert's finitism and the notion of infinity' (1998) we call an *approximative* consistency proof:²⁹ 'We now imagine that we are given such a proof figure with the end formula $0 \neq 0$. On this (proof figure) two processes can be effected one after another which we call *dissolution* of the proof figure in "*proof-threads*" and *elimination of the free variables*' (Hilbert and Bernays 1934, 220; cf. 298).

Hilbert and Bernays show, in the first place, that every numerical formula that can be derived from the axioms of H without the use of bound variables is true.³⁰ In a second step, they demonstrate that every numerical formula provable in H is true even if we drop the restriction concerning the bound variables. They generalize the notion of a true formula in such a way that all formulae of a given proof figure are taken into account, not only the numerical ones (cf. Hilbert and Bernays 1934, 232ff.). This is accomplished by introducing the term 'verifiable'. Confining themselves provisionally to formulae without universal quantifiers, Hilbert and Bernays explain the term as follows: (i) a numerical formula is verifiable, if it is true; (ii) a formula containing one or more free individual variables, but no other variables, is verifiable, if it can be shown that it is true for every replacement of the variables with numerals; and (iii) a formula with bound variables, but without formula variables and without universal quantifiers is verifiable, if the application of a certain reduction procedure leads to a verifiable formula in the sense of (i) or (ii).³¹ In a further

²²⁸Corresponding to Hilbert's 'reduction procedure' quoted in §8.B..

²²⁹Moreover, as it turns out, in two, essentially different, ways (see §7.C.).

step, Hilbert and Bernays show that the end formula of the given proof (in H) is verifiable (cf. Hilbert and Bernays 1934, 244ff.). H is therefore consistent.

As to (ii), it is plain that verifiability is defined through an unbounded quantification over numerals, i.e. for all substitution instances. The phrase 'can be shown' remains unexplained and is possibly meant to impart a 'constructive' or finitist air to unbounded universal quantification over numerals. These belong, in the terminology of Hilbert (1926), to the class of ideal statements and are as such unacceptable for the finitist of the 1920s. We further note that carrying out consistency proofs along the lines of (i)-(iii) requires that the verifiability predicate can be formulated in the language of finitist metamathematics. Hence, this language must contain sentences of type (1)."

Fn29 In Niebergall and Schirn 1998, §6 we define this notion as follows (for axiomatizable theories S and T with representation τ): S proves the approximative consistency of T: $\Leftrightarrow \forall n S \vdash \neg \text{Proof}_\tau(n, \perp)$. We assume here that the formalized proof predicate is the standard one. In our opinion, the notion of an approximative consistency proof captures the core of the conception of finitary metamathematical consistency proofs which Hilbert developed in his papers on proof theory in the 1920s.

Fn30 Numerical formulae are characterized as quantifier-free sentences; see Hilbert and Bernays 1934, 228. Hilbert emphasizes that this is only a stricter version of the assertion that it is impossible to derive $0 \neq 0$ from the axioms of H without admitting bound variables (Hilbert and Bernays 1934, 230)."

... Schirn and Niebergall: [SN01], pp.144-145.

Now, if we treat Hilbert and Bernays' intent whilst introducing their concept of 'verifiability' as corresponding to the concept of 'algorithmic verifiability' introduced in §2., Definition 7 then—despite Schirn and Niebergall's reservations in [SN01]—it can be argued that Hilbert's reasoning does yield a *weak*, constructive, proof of consistency for PA which is essentially that of §2.B.a., Theorem 2.8; even though it fails to yield the *strong*, finitary, proof of consistency for PA (see §2.C.a., Theorem 2.16) which Hilbert sought in the second of his 23 Millennium 1900 Problems ([Hi00]; see also §29.(7)).

Moreover, from such a perspective Hilbert and Bernays' reasoning would be at least as constructive as Gentzen's, essentially set-theoretical, trans-finitary proof ([Me64], p.258) of consistency for a first-order number theory if we admit Gentzen's Rule of Infinite Induction ([Me64], p.259) in a formal system S_∞ in which all theorems of S are provable ([Me64], p.263, Lemma A-3):

Infinite Induction:
$$\frac{\mathcal{A}(\bar{n}) \vee \mathcal{D} \text{ for all natural numbers } n}{((x)\mathcal{A}(x)) \vee \mathcal{D}}$$

Comment 86. From the *evidence-based* perspective of this investigation, Gentzen's, essentially set-theoretical, trans-finitary proof ([Me64], p.258) of consistency for a first-order Arithmetic can claim to be a proof of consistency for the formal first-order system S of Peano Arithmetic defined by Mendelson (in [Me64], pp.102-103) *only* if the Arithmetic of the set-theoretically-defined finite ordinals is treated as a conservative extension of PA.

However, we note that, by §19.A., Corollary 19.3—and equivalently by §19.A., Theorem 19.4—this is not the case.

Further, if we were to interpret Infinite Induction as essentially stating that:

Proposition 8.4. (Gentzen's ω -Rule of infinite induction) *If the S_∞ -formula $[\mathcal{A}(\bar{n})]$ interprets as true for any specified natural number n , then we may conclude that $[(\forall x)\mathcal{A}(x)]$ is provable in S_∞ .*

then it would immediately follow that:

Thesis 3. *Hilbert's ω -Rule of infinite induction is equivalent to Gentzen's ω -Rule of infinite induction.*

8.C. Hilbert’s ω -Rule is stronger than ω -consistency

Now we note that, in his 1931 paper [Go31], Gödel constructed an arithmetical formula $[R(x)]$ ²³⁰ in his formal Peano Arithmetic P and showed that, if P is assumed ω -consistent, then both $[(\forall x)R(x)]$ and $[\neg(\forall x)R(x)]$ ²³¹ are unprovable in P ([Go31], p.25(1), p.26(2)), even though $[R(n)]$ is provable in P for any specified numeral $[n]$ (whence $[R(n)]$ would be ‘true’ under any well-defined interpretation of P).

It immediately follows that:

Lemma 8.5. *Assuming that PA admits Hilbert’s ω -Rule of infinite induction is stronger than assuming that PA is ω -consistent.* \square

Proof. If PA admits Hilbert’s ω -rule of infinite induction, then Gödel’s arithmetical formula $[(\forall x)R(x)]$ would be PA-provable. The lemma follows. \square

Comment 87. We note that the ‘constructiveness’ of mathematical rigour in *evidence-based* arithmetical reasoning—implicitly reflected in §8.C., Lemma 8.5 and §8.B., Thesis 3—is in striking contrast to the—debatable to the point of inconsistency, as argued by Vladimir Voevodsky in [Vo10]—‘constructiveness’ of classically accepted mathematical rigour in set-theoretically-based arithmetical reasoning such as Gentzen’s proof of consistency of PA.

For instance, the seeming core of Voevodsky’s objection is considered, and dismissed as ‘at best misleadingly phrased’, in [Cho18]:

“Gentzen’s proof certainly meets ordinary standards of mathematical rigor, but remember that we are trying to adhere to higher than usual standards. So what assumptions are really needed to carry out the proof? Answering this question requires not just understanding the argument, but also some experience with formalizing mathematical arguments. Fortunately for us, logicians have carefully analyzed the argument, and the verdict is that other than Theorem 2, everything in Gentzen’s proof can be formalized in PRA, which as we said earlier is a system of axioms that is widely regarded as being finitary and very conservative. In particular, PRA makes no reference to infinite sets. Thus, Gentzen has reduced the analysis of arbitrarily complicated first-order sentences of PA, and their classical logical consequences, to a single finitary statement, namely Theorem 2. What objection might one have to Theorem 2?

Voevodsky’s objection was that Gentzen’s only justification for Theorem 2 was that it was self-evident—a suspicious claim, according to Voevodsky, since Gödel’s theorem tells us that Theorem 2 cannot be proved using “usual induction techniques.” If we take this objection at face value, then it is at best misleadingly phrased. Gentzen does not say that Theorem 2 (or rather, the variant of it that he uses in his proof) is self-evident; he gives an inductive argument along the lines we have given. As we have seen, by normal mathematical standards, there is nothing particularly “unusual” about the inductive argument⁸.

⁸ A far stronger induction argument was used by Robertson and Seymour in their proof of the Graph Minor Theorem [9], and nobody seems to have rejected the Graph Minor Theorem on those grounds.”
... Chow: [Cho18], §7, *Implications of Gentzen’s Proof*.

²³⁰Which, in his terminology, Gödel defined, and referred to only indirectly, in [Go31] by its Gödel-number r (see eqn.(12), p.25).

²³¹Which Gödel defined, and referred to, in [Go31] only by their Gödel-numbers $17\ Gen\ r$ and $Neg(17\ Gen\ r)$, respectively (see eqn.(13), p.25).

Comment 88. We note that the ‘constructiveness’ of Gentzen’s proof of consistency for PA yet remains the core issue of an ‘ongoing debate within the mathematical community concerning the philosophical implications of Gentzen’s contributions to proof theory’ ([Aky24]).

Thus, as Ryota Akiyoshi observes in [Aky24], the question of whether ‘transfinite induction up to ε_0 ’ can be viewed constructively as a principle which ‘aligns with or departs from the essence of Hilbert’s standpoint remains an unavoidable and contentious issue’:

“In light of the arguments presented in the preceding section, it becomes apparent that Tarski’s perspective, as articulated in a discussion on the assessment of research in proof theory (1954), finds a natural context [40, p.19]:

Gentzen’s proof of the consistency of arithmetic is undoubtedly a very interesting metamathematical result, which may prove very stimulating and fruitful. I cannot say, however, that the consistency of arithmetic is now much more evident to me (at any rate, perhaps, to use the terminology of the differential calculus more evident than by an epsilon) than it was before the proof was given.

Indeed, a central reason behind this line of thinking should be that Gentzen’s proof relies on a stronger principle, surpassing the boundary of Hilbert’s finitistic standpoint. This principle, specifically the transfinite induction up to ε_0 , appears to encompass the very principle of mathematical induction that Gentzen’s proof aims to justify. It is important to address Tarski’s objection by claiming that Gentzen’s proof uses solely transfinite induction up to ε_0 *restricted to quantifier-free formulas*, thereby circumventing issues of circularity. However, a persistent debate ensues concerning whether this principle harmonizes with the fundamental tenets of Hilbert’s standpoint. This debate remains a subject of ongoing discussion and scrutiny, particularly when one takes into account Hilbert’s concept of reliability. Consequently, the question of whether such a principle aligns with or departs from the essence of Hilbert’s standpoint remains an unavoidable and contentious issue.

It is indeed intriguing to note that Takeuti appears to share a similar presupposition to Tarski but holds an opposing opinion. Here is Takeuti’s passage [37, p.368]:

Anyway since I am a logician and am very familiar with the magic of quantifiers Gentzen’s consistency proof, which consists of the elimination of quantifiers and an accessibility proof for the ordinals less than ε_0 , is greatly reassuring. It does add to my confidence in the consistency and truth of Peano arithmetic.

In this passage, Takeuti seems to assert that Gentzen’s proof enhances the reliability of consistency. This interpretation appears to imply that Gentzen’s standpoint, inclusive of the quantifier-free transfinite induction up to ε_0 , aligns with or falls within the framework of Hilbert’s theory.

This juxtaposition of Tarski’s and Takeuti’s perspectives provide the complex and nuanced discussions surrounding the relationship between Gentzen’s standpoint and Hilbert’s one, specifically regarding whether Gentzen’s work can be considered an extension or departure from Hilbert’s standpoint. These differing viewpoints reflect the ongoing debate within the mathematical community concerning the philosophical implications of Gentzen’s contributions to proof theory."

... Akiyoshi: [Aky24], §4 Takeuti’s View about Finitism.

Lemma 8.5 can be viewed as justifying Gödel’s claim that his argument in [Go31]—from which he concludes the existence of an undecidable arithmetical proposition—is based on the weaker²³² premise that a consistent PA can be ω -consistent.

²³²i.e., weaker than assuming Hilbert’s ω -rule, which entails §8., Lemma 8.3: *If we meta-assume Hilbert’s ω -rule of infinite induction for PA, then a consistent PA is ω -consistent.*

The question arises whether an even weaker Algorithmic ω -Rule—as defined above²³³—can yield a finitary completion for PA as sought by Hilbert, albeit for an ω -inconsistent PA.

It is a question that can now be answered in the affirmative, since PA is not only ‘algorithmically’ complete in the sense of the *weak* Algorithmic ω -Rule (see §2.E.b., Theorem 2.17), but categorical (see also §8.G.) with respect to algorithmic *computability* (see §2.E.b., Corollary 2.18)!

8.D. Aristotle’s particularisation entails ω -consistency

In this investigation we argue that these issues are related, and placing them in an appropriate perspective requires any constructive perspective of mathematics to question (see §11.) not only the persisting, *theistic*, belief in classical mathematics that Aristotle’s particularisation remains valid even when applied over an infinite domain such as \mathbb{N} , but also the basis of Brouwer’s unjustifiable, *atheistic*, belief that the Law of the Excluded Middle is non-constructive, following his challenge of the classical belief in [Br08] (see §10.).

Comment 89. Unjustifiable, since §2.C.a., Theorem 2.16, finitarily establishes that PA is consistent. Hence the underlying first-order logic FOL—in which the Law of the Excluded Middle is a theorem—too is finitarily consistent. Consequently, whereas the sole target of Brouwer’s objection to Hilbert’s formalisation of quantification—Aristotle’s particularisation—implies the Law of the Excluded Middle, the converse is not true.

For instance, we note that:

Lemma 8.6. *If PA is consistent but not ω -consistent, then there is some PA formula $[F(x)]$ such that, under any interpretation—say $\mathcal{I}_{PA(N)}$ —of PA over \mathbb{N} :*

- (i) *the PA formula $[\neg(\forall x)F(x)]$ interprets as an algorithmically verifiable true arithmetical proposition under $\mathcal{I}_{PA(N)}$;*
- (ii) *for any specified numeral $[n]$, the PA formula $[F(n)]$ interprets as an algorithmically verifiable true arithmetical proposition under $\mathcal{I}_{PA(N)}$.*

Proof. If PA is consistent then, by definition, a provable PA-formula is true in any *well-defined* interpretation of PA under which the PA-axioms interpret as true, and the PA rules of inference preserve such truth. The lemma follows immediately from the definition of ω -consistency, and from Tarski’s standard definitions of the satisfaction, and truth, of the formulas of a formal system such as PA under an algorithmically *verifiable* interpretation (see §2.B.). \square

Further:

Lemma 8.7. *If PA is consistent and the interpretation $\mathcal{I}_{PA(N)}$ admits Aristotle’s particularisation over \mathbb{N} ²³⁴, then:*

- (i) *if the PA formula $[\neg(\forall x)F(x)]$ interprets as an algorithmically verifiable true arithmetical proposition under $\mathcal{I}_{PA(N)}$,*

²³³Which, *prima facie*, does not imply that a consistent PA is necessarily ω -consistent.

²³⁴Such as, for instance, any interpretation that defines the existential quantifier as in [Me64], pp.51-52 V(ii).

(ii) then there is some unspecified natural number m such that the interpreted arithmetical proposition $F^*(m)$ is algorithmically verifiable as false in \mathbb{N} .

Proof. The lemma too follows immediately from the definition of Aristotle's particularisation and Tarski's standard definitions of the satisfaction, and truth, of the formulas of a formal system such as PA under an algorithmically *verifiable* interpretation (see §2.B.). \square

It follows immediately from §8.D., Lemma 8.7 that:

Corollary 8.8. *If PA is consistent and Aristotle's particularisation holds over \mathbb{N} , then there can be no PA formula $[F(x)]$ such that, under any interpretation $\mathcal{I}_{PA(\mathbb{N})}$ of PA over \mathbb{N} :*

- (i) the PA formula $[\neg(\forall x)F(x)]$ interprets as an algorithmically verifiable true arithmetical proposition under $\mathcal{I}_{PA(\mathbb{N})}$;
- (ii) for any specified numeral $[n]$, the PA formula $[F(n)]$ interprets as an algorithmically verifiable true arithmetical proposition under $\mathcal{I}_{PA(\mathbb{N})}$. \square

In other words²³⁵:

Corollary 8.9. *If PA is consistent and Aristotle's particularisation holds over \mathbb{N} , then PA is ω -consistent.* \square

It follows that:

Corollary 8.10. *If Aristotle's particularisation holds over \mathbb{N} , then PA is consistent if, and only if, it is ω -consistent.*

Proof. We note first that, by §8.D., Corollary 8.9, if PA is consistent and Aristotle's particularisation holds over \mathbb{N} , then PA is ω -consistent.

We note next that if PA is ω -consistent then, since $[n = n]$ is PA-provable for any specified PA numeral $[n]$, we cannot have that $[\neg(\forall x)(x = x)]$ is PA-provable. Since an inconsistent PA proves $[\neg(\forall x)(x = x)]$, an ω -consistent PA cannot be inconsistent. \square

It also follows that:

Corollary 8.11. *If PA is consistent but not ω -consistent, then Aristotle's particularisation does not hold in any interpretation of PA over \mathbb{N} .* \square

Finally since, by §2.F., Corollary 2.22, PA is finitarily consistent but not ω -consistent, it further follows that (compare [An13a], §2, Theorem 1, p.6):

Theorem 8.12. *Aristotle's particularisation does not hold in any finitary interpretation of PA under which the PA-axioms interpret as true, and the PA rules of inference preserve such truth.* \square

Moreover:

²³⁵We note that §8.D., Corollary 8.9 negates Martin Davis' speculation in [Da82], p.129, that such a proof of ω -consistency may be "... open to the objection of *circularity*".

Theorem 8.13. *The first-order logic FOL is finitarily consistent.*

Proof. The theorem follows from the finitary proof that the first-order Peano Arithmetic is *strongly* consistent (§2.C.a., Theorem 2.16)—whence FOL too is *finitarily* consistent. \square

Further since, by definition, $[P \rightarrow P \equiv \neg P \vee P]$, it immediately follows that:

Corollary 8.14. *The Law of the Excluded Middle $[P \vee \neg P]$ is a theorem of the first-order logic FOL.* \square

Comment 90. We note that Corollary 8.14 continues to contradict, essentially uncritical, inherited wisdom; as evidenced by, for instance, philosopher Ferenc Csátári’s [Csr24]:

“We know that first order intuitionist logic is undecidable (as a matter of fact so is classical predicate logic), meaning that there is no algorithmic way to decide for each and every sentence whether it follows from the system or not.”

... Csátári: [Csr24], §4 *Incompleteness and Circularity*.

We conclude that:

Corollary 8.15. *The Law of the Excluded Middle does not entail Aristotle’s particularisation.* \square

8.E. Markov’s principle does not hold in PA

We note that an immediate consequence of §8.D., Theorem 8.12 is that Markov’s principle does not—contrary to what has been argued by some advocates of intuitionistic logic—hold in PA:

“Mathematicians of the Russian school accept the following principle: if $[n]$ is a recursive binary sequence (i.e., for each i , $n_i = 0$ or $n_i = 1$), and if we know that not for all i does $n_i = 0$, then we may say that there is an i such that $n_i = 1$. Formally, in terms of a binary number-theoretic function, f :

$$\neg \forall x(f(x) = 0) \rightarrow \exists n(f(n) = 1).$$

Advocates of intuitionistic logic often find this unpalatable. Existential statements should be harder to prove. But in fact this is the principle that allows one to prove in constructive recursive analysis that every real valued function is continuous at each point in which it is defined. This was first proved by Tseïtin. Markov himself had proved weaker versions, which are classically but not constructively equivalent.”

... Posy: [Pos13], p.112.

Corollary 8.16. *Markov’s principle: $\neg(\forall x)(f(x) = 0) \rightarrow (\exists n)(f(n) = 1)$, where $f(n)$ is a Boolean number-theoretic function such that $f(n) = 0$ or $f(n) = 1$, does not hold in PA.*

Proof. Gödel has shown in [Go31] how to construct an arithmetical formula with a single variable—say $[R(x)]$ ²³⁶—such that $[(\forall x)R(x)]$ is not PA-provable²³⁷, but $[R(n)]$ is instantiationally PA-provable for any specified PA numeral $[n]$ ²³⁸.

²³⁶Gödel refers to the formula $[R(x)]$ only by its Gödel number r ([Go31], p.25, eqn.12). Although Gödel’s aim in [Go31] was to show that $[(\forall x)R(x)]$ is not P-provable, it follows that $[R(x)]$ is also, then, not P-provable.

²³⁷Which corresponds to Gödel’s proof in [Go31] that (p.26(2)): $(n)nB_\kappa(17Gen\ r)$ holds.

²³⁸Which corresponds to Gödel’s proof in [Go31] that (p.26(2)): $(n)Bew_\kappa \left[Sb \left(r \begin{matrix} 17 \\ Z(n) \end{matrix} \right) \right]$ holds.

Hence, for any specified numeral $[n]$, treating Gödel's primitive recursive relation $xB^\ulcorner[R(n)]^\urcorner$ as a Boolean number-theoretical function that takes the value 0 if 'true', and the value 1 if 'false', $xB^\ulcorner[R(n)]^\urcorner$ must hold for some x (where $^\ulcorner[R(n)]^\urcorner$ denotes the Gödel-number of the formula $[R(n)]$).

The corollary follows since, by §2.F., Corollary 2.20, the PA formula $[\neg(\forall x)R(x)]$ is also PA-provable. \square

8.F. Aristotle's particularisation is 'stronger' than the Axiom of Choice

To appreciate the extent of non-constructivity implicit in the concept, we note that the postulation of an 'unspecified' object in Aristotle's particularisation is 'stronger' than the usual set-theoretical Axiom of Choice.

This follows from Rudolf Carnap's analysis in a 1962 paper on the use of Hilbert's ε -operator in scientific theories ([Ca62], pp.157-158; see also Wang's remarks [Wa63], pp.320-321):

"What now is the connection between the ε -operator and the axiom of choice? Is the acceptance of the former tantamount to that of the latter? In more formal terms, is the axiom of choice derivable from the other axioms of set theory if the underlying logic contains the ε -operator with its axioms? In some sense, this is the case, but the assertion needs some qualifications. . . . The decisive point for this question of derivability is the specific form of the axiom schema of subsets (*Aussonderungsaxiom*). In the customary language L it may be formulated as follows, where " Su " stands for " u is set":

- (4) ' $Su \supset (\exists y) [Sy \cdot (v)(v \in y \equiv v \in u \cdot \phi)]$ ' where ϕ is any sentential formula of language L containing ' v ' as the only free variable.

If L_ε is taken as the axiomatic language, there is the choice of two versions of the axiom schema, differing in the kinds of formulas admitted as ϕ . The first version is the same as (4): only the formulas of L_ε without ' ε ' are admitted; in other words, formulas of L (as a sub-language of L_ε). The second version, which we shall call (4_ε) , is formed from (4) by replacing ' L ' with ' L_ε '. (4_ε) is stronger than (4). But to accept this version seems natural, once the ε -operator has been accepted as a primitive logical constant.

Consider now the principle of choice:

- (5) If x is a set such that:
- (a) any element of x is non-empty,
 - (b) any two distinct elements of x are disjoint,
- then there is a set y (called a selection set of x) such that
- (c) $y \subset \bigcup x$,
 - (d) for any element z of x , $y \cap z$ has exactly one element.

It can now be seen easily that, if the axiom schema of subsets is taken in the stronger form (4_ε) , then (5) is derivable. The derivation is as follows. Let x be any set satisfying the conditions (a) and (b) in (5). According to the axiom of the union set, $\bigcup x$ is a set. Therefore, by (4_ε) , there is a set y containing exactly those elements v of $\bigcup x$ for which

$$(\exists z) [z \in x \cdot v = \varepsilon_u(u \in z)],$$

(This last formula is taken as ϕ in (4_ε) .) Thus y is a subset of $\bigcup x$ containing just the representative of the elements of x . Hence y satisfies the conditions (c) and (d) in (5). Thus (5) is derived."

... Carnap: ([Ca62], pp.157-158)

Now, it follows from Carnap's analysis that, if we define a formal language ZF_ε by replacing:

$[(\forall x)F(x)]$ with $[F(\varepsilon_x(\neg F(x)))]$

$[(\exists x)F(x)]$ with $[F(\varepsilon_x(F(x)))]$

in the Zermelo-Fraenkel set theory ZF, then it can be seen that:

Lemma 8.17. *The Axiom of Choice is true in any well-defined interpretation of the Zermelo-Fraenkel set theory ZF_ε that admits Aristotle's particularisation.* \square

Lemma 8.18. *The postulation of an 'unspecified' object in Aristotelean particularisation is a stronger postulation than the Axiom of Choice.* \square

8.G. Rosser's Rule C is *stronger* than Gödel's ω -consistency

Clearly the proof that PA is categorical with respect to algorithmic *computability* (§2.E.b., Corollary 2.18) conflicts immediately with the conventional wisdom that J. Barkley Rosser's proof of undecidability ([Ro36]) successfully avoids the assumption of ω -consistency.

Comment 91. It also conflicts with conventional set-theoretical wisdom:

- (a) that ZF provides a relative proof of consistency for PA (see, for instance, [Cho18]); and
- (b) that ZF entails the existence of non-standard models of PA which admit elements other than the natural numbers (see §18.).

However, we note that:

Lemma 8.19. *If:*

- (i) *from the P -provability of $[(\exists x)F(x)]$ we can always conclude the existence within a proof sequence of an unspecified P -term $[a]$ such that $[F(a)]$ is provable;*

then:

- (ii) *we cannot have that a P -formula $[(\exists x)F(x)]$ is P -provable and also that $[\neg F(a)]$ is P -provable for any specified, constructively well-defined, term $[a]$ of P .*

Proof. The lemma follows immediately from its statement. \square

We note that (ii) is Gödel's definition of ω -consistency, which he explicitly assumed when deriving his 'formally undecidable' arithmetical formula (which involves a universal quantifier) in [Go31].

We also note that (i) is essentially Hilbert's definition of existential quantification in his ε -calculus (see §6.), which Rosser enunciated as Rule C ([Ro53], pp.127-130), and tacitly assumed (see §17.) as a valid deduction rule of FOL—albeit restricted as an eliminable 'catalyst' to *strictly* within a proof sequence, in the sense that whatever is assumed under Rule C does not appear in the final formula of the sequence—when deriving his 'formally undecidable' arithmetical formula (which involves an existential quantifier) in [Ro36], where he explicitly assumed only that P is simply consistent:

Rosser's Rule C (*Excerpted from Mendelson [Me64], p.73-74, §7, Rule C.*)

"It is very common in mathematics to reason in the following way. Assume that we have proved a wf of the form $(\exists x)\mathcal{A}(x)$. Then, we say, let b be an object such that $\mathcal{A}(b)$. We continue the proof, finally arriving at a formula which does not involve the arbitrarily chosen element b

In general, any wf which can be proved using arbitrary acts of choice, can also be proved without such acts of choice. We shall call the rule which permits us to go from $(\exists x)\mathcal{A}(x)$ to $\mathcal{A}(b)$, Rule C ("C" for "choice"). More precisely, the definition of a Rule C deduction in a first-order theory K is as follows:

$\Gamma \vdash_c \mathcal{A}$ if and only if there is a sequence of wfs $\mathcal{B}_1, \dots, \mathcal{B}_n = \mathcal{A}$

such that the following four statements hold.

- (I) For each i , either
 - (i) \mathcal{B}_i is an axiom of K, or
 - (ii) \mathcal{B}_i is in Γ , or
 - (iii) \mathcal{B}_i follows by MP or Gen from preceding wfs in the sequence, or
 - (iv) There is a preceding wf $(\exists x)\mathcal{C}(x)$ and \mathcal{B}_i is $\mathcal{C}(d)$, where d is a new individual constant. (Rule C)
- (II) As axioms in (I)(i), we can also use all logical axioms involving the new individual constants already introduced by applications of (I)(iv), Rule C.
- (III) No application of Gen is made using a variable which is free in some $(\exists x)\mathcal{C}(x)$ to which Rule C has been previously applied.
- (IV) \mathcal{A} contains none of the new individual constants introduced in any application of Rule C.

En† The first formulation of a version of Rule C similar to that given here seems to be due to Rosser ([Ro53], pp.127-130).[¶]

Comment 92. We note that, by admitting introduction of an *unspecified* new individual constant d into the formal reasoning, Rule C(I)(iv) implicitly assumes—without a valid proof (see below; also §17.E.a.), and without formally admitting an axiom of choice into K which is equivalent to Hilbert's ε -based choice axiom (see §10.A.)—that such a d can, indeed, be recursively constructed—at least in principle—as a K-term by the first-order construction of terms permitted within K, since any putative K-formula which could define a K-term such as d can denote only algorithmically *computable* constants if K is first-order.

For instance, we note that the, ostensibly '*formal*', argument offered as validation of Rule C in standard texts, such as [Me15] (see Proposition 2.10, pp.80-81) and [Ro53] (see ^{**}Theorem VI.7.2, pp.131-133), appeals invalidly—and misleadingly—to the deduction that, if $[\mathcal{C}(x)]$ is a unary formula of K, and $[y]$ is not free in $[\mathcal{A}]$:

(i)	$[(\exists x)\mathcal{C}(x)]$	\vdash_c	$[\mathcal{A}]$	<i>(application of Rule C)</i>
(ii)	$[(\exists x)\mathcal{C}(x), [\mathcal{C}(d)]]$	\vdash	$[\mathcal{A}]$	
(iii)	$[(\exists x)\mathcal{C}(x)]$	\vdash	$[\mathcal{C}(d) \rightarrow \mathcal{A}]$	
(iv)	$[(\exists x)\mathcal{C}(x)]$	\vdash	$[\mathcal{C}(y) \rightarrow \mathcal{A}]$	
(v)	$[(\exists x)\mathcal{C}(x)]$	\vdash	$[(\forall y)(\mathcal{C}(y) \rightarrow \mathcal{A})]$	
(vi)	$[(\exists x)\mathcal{C}(x)]$	\vdash	$[(\exists y)\mathcal{C}(y) \rightarrow \mathcal{A}]$	
(vii)	$[(\exists x)\mathcal{C}(x)]$	\vdash	$[\mathcal{A}]$	

The 'invalid' element is that the deduction assumes, in step (ii), that we can introduce a well-formed term $[d]$ into K such that $[\mathcal{C}(d)]$ can be treated as a well-formed formula of K.

The argument thus assumes that which is to be proven since, if the assumption is invalid, then the above deduction reduces to:

(i)	$[(\exists x)\mathcal{C}(x)]$	\vdash_c	$[\mathcal{A}]$
(ii)	$[(\exists x)\mathcal{C}(x)]$	\vdash	$[\mathcal{A}]$

The ‘misleading’ element is that the deduction of (iv) from (iii) implicitly appeals to a semantic interpretation of the formula $[(\exists x)C(x)]$.

However, Rosser’s belief that simple consistency suffices for establishing his ‘formally undecidable’ arithmetical formula²³⁹ (which involves an existential quantifier) in P is illusory since (compare with §7., Theorem 7.1):

Lemma 8.20. *Rosser’s Rule C entails Aristotle’s particularisation.*

Proof. If P is simply consistent, the introduction of an *unspecified* P -term into the formal reasoning under Rule C entails, by §7., Definition 20, Aristotle’s particularisation in any interpretation of P . \square

Corollary 8.21. *Rosser’s Rule C is stronger than Gödel’s ω -consistency.*

Proof. If P is simply consistent, the introduction of an *unspecified* P -term into the formal reasoning under Rule C entails Aristotle’s particularisation in any interpretation of P , which in turn entails that P is ω -consistent (see §8.D., Corollary 8.9). The corollary follows by §8.G., Lemma 8.19. \square

Although the *implicit* assumption of ω -consistency—entailed by Rosser’s Rule C—is not immediately obvious in Rosser’s original proof (see §17.)—nor in Kleene’s proof of ‘Rosser’s form of Gödel’s theorem’ ([K152], Theorem 29, pp.208-209)—it is seen to be implicit in §17.E.a. (i) - (ix), which is an essential step in Mendelson’s argument for Proposition 3.32 (Gödel-Rosser Theorem) in [Me64].

We note that, in a relatively recent paper [SS17], Saeed Salehi and Payam Seraji claim that Rosser’s Incompleteness Theorem ‘does not generally hold for definable non-recursively enumerable theories’, whilst Gödel’s First Incompleteness Theorem could hold for some such theory; thus implicitly reflecting (compare Corollary 8.21) that the former is ‘stronger’ than the latter:

“Gödel’s First Incompleteness Theorem is generalized to definable theories, which are not necessarily recursively enumerable, by using a syntactic-semantic notion (that is the consistency of a theory with the set of all true Π_n sentences or equivalently the Σ_n soundness of the theory) that corresponds to Gödel’s notion of ω -consistency in an appropriate way. It is also shown that Rosser’s Incompleteness Theorem does not generally hold for definable non-recursively enumerable theories; whence Gödel-Rosser’s Incompleteness Theorem is optimal in a sense.”

... Saeed and Seraji: [SS17], Abstract.

²³⁹A ‘belief’ that is yet uncritically accepted as definitive in inherited paradigms—as evidenced, for instance, by Virgil Drăghici’s 2023 text [Drg23]—which, either explicitly or implicitly, appeal to Rosser’s Rule C as a valid Rule of Inference (even though it entails ω -consistency by Corollary 8.21):

“As we saw, the undecidability of G needs the assumption of ω -consistency.⁷⁹ But Rosser⁸⁰ has shown, for a more complex sentence R , that the undecidability of R can be proved under the assumption of simple consistency of PA^{ax} .

⁷⁹ The undecidability of a sentence G -type cannot be proved under the weaker assumption of *simple* consistency; comp. Ch. 4, Sect. 4.2.2 (final Remark).

⁸⁰ B. Rosser [1936].”

... Drăghici: [Drg23], §4.2.2.3 Gödel-Rosser Theorem for PA^{ax} (via DL), p.211.

Moreover, in his 2011 article [Is11], philosopher Daniel Isaacson, too, can be viewed as suggesting that Rosser's Incompleteness Theorem must appeal implicitly to assumptions that are not weaker than those underpinning Gödel's First Incompleteness Theorem:

"From Theorem 12 we saw that consistency is not sufficient to show that the Gödel sentence for a system S is not refutable in S . This shows that Rosser's Theorem, that for a particular sentence R constructed for a given system S , if S is consistent then $S \not\vdash R$ and $S \not\vdash \neg R$, is incomparable in strength with and not strictly a stronger theorem than Gödel's incompleteness theorem, contrary to the way [it] is often presented, for example, (Mendelson, 1997, p. 208); (Adamowicz and Zbierski, 1997, p. 178), and more to the point, Kleene when he says, "Rosser in [1936] achieved a noteworthy improvement of the first Gödel incompleteness theorem" (Kleene, 1986, p. 140). Of course what people who talk this way have in mind is that Rosser's theorem shows that any consistent Σ_0 -complete system will be Π_1 -incomplete, while Gödel's Theorem shows this on an assumption stronger than consistency. However Rosser's result does not show that the Gödel sentence is irrefutable just on the assumption of consistency (which, as we have seen, cannot be done). We also know that Rosser's theorem is no strengthening of Gödel incompleteness in that it cannot give rise to the Second Incompleteness Theorem, and it is the Second Incompleteness Theorem that is the heart of the matter."

... Isaacson: [Is11], §7 Comparing Gödel's Incompleteness Theorems with Rosser's Theorem.

CHAPTER 9. MATHEMATICAL CONSEQUENCES

9. Hilbert’s purported ‘sellout’ of finitism

We digress here slightly to assess the ‘*weak*’ proof of consistency for PA in §2.B.a., Theorem 2.8, and the ‘*strong*’ proof of consistency for PA in §2.C.a., Theorem 2.16, from the perspective of what Schirn and Niebergall—in their analysis of Hilbert’s finitism ([SN01])—term as ‘The sellout of finitism’ by Hilbert and Bernays, where they note that:

“In §5.2 of Hilbert and Bernays (1939), entitled ‘The formalized metamathematics of the number-theoretic formalism’ (cf. 302ff.), the authors introduce a notational variant of PA which they call Z_μ . Its purported drawback for metamathematical purposes rests on the fact ‘that in the formalization of finitist reasoning in the system (Z_μ) the characteristic of the finitist argumentation is, for the most part, lost’ (1939, 361). Nonetheless, Z_μ is regarded as setting a provisional upper limit for a finitistically acceptable metatheory (Hilbert and Bernays 1939, 353ff., 361ff.).

At the beginning of the section ‘Eliminability of the “tertium non datur” for the investigation of the consistency of the system (Z_μ)’, Hilbert and Bernays observe that the ‘proof-theoretic methods hitherto applied (by them), even though they partially go beyond the domain of recursive number theory, apparently do not transcend the domain of those concept formations and modes of inference that can still be presented within the formalism Z_μ ’ (Hilbert and Bernays 1939, 361).⁵⁰ On the face of it, this passage suggests that Hilbert and Bernays are here operating with a twofold notion of extending proof-theory or metamathematics: the extension involves both the language of metamathematics and the metamathematical theory itself. Unfortunately, they do not distinguish clearly between these two methods of extending metamathematics; their respective remarks give rise to ambiguity.

Hilbert and Bernays sketch, in the first place, an extension L_{PRA}^+ of L_{PRA} which is supposed to contain only ‘finitary’ statements. Taking L_{PRA} as the starting point, L_{PRA}^+ is arrived at in two stages: first, symbols for certain computable number-theoretic functions are adjoined to L_{PRA} (call the set of formulae thereby defined L'_{PRA}). Second, L'_{PRA} is converted into L_{PRA}^+ by way of adding to L'_{PRA} only those statements that can be ‘interpreted in a strict sense’ by a statement of L'_{PRA} (cf. Hilbert and Bernays 1939, 362). Hilbert and Bernays do not explain the phrase ‘interpreted in a strict sense’, but their ensuing exposition suggests that it is at least formulae of the type ‘ $\forall x \exists y \psi(x, y)$ ’ with quantifier-free formula ψ that are capable of being ‘interpreted in a strict sense’ in L'_{PRA} . The interpretation can be given by choosing for such a ‘ $\forall x \exists y \psi(x, y)$ ’ the quantifier-free formula ‘ $\psi(x, f(x))$ ’ in L'_{PRA} , where f is a function-sign for a recursive function which has already been introduced in L'_{PRA} . That these two formulae are equivalent to one another in some sense of ‘equivalent’ is suggested by the phrase ‘strict interpretation’, but the authors do not argue for this ‘equivalence’.⁵¹

Fn50 The authors also argue that the proof-theoretical methods have been extended from PRA to PA without infringing the ‘methodic fundamental idea of finitist proof theory’ (1939, 362).

Fn51 Obviously, the conception of the finitistically admissible presented in this example is akin to the position Hilbert and Bernays advocate in 1934, but deviates from Hilbert’s finitism in the 1920s. The truly original, austere notion of a finitary statement embodies less than what can be expressed in L_{PRA}^+ .⁵¹

... Schirn and Niebergall: [SN01], p.154.

9.A. *Evidence-based* reasoning meets Gödel’s criteria for constructivity

What is noteworthy—from the *evidence-based* perspective of [An16] (see §2.)—about the above account is that the search for finitary means of reasoning in the first volume of *Grundlagen*

der Mathematik (1934)—which even then conflicted with Hilbert's enthusiastic espousal of Cantor's set theory, thereby leading to what came to be known as 'Hilbert's Program'—was apparently abandoned around the period of the second volume of *Grundlagen der Mathematik* (1939); influenced in part, perhaps, by developments following Gödel's 1931 incompleteness theorems which seemed to suggest—as Gödel reportedly remarked in his 1938 Zilsel lecture—that “intuitionistic methods went beyond finitist ones” (as Gödel had analysed formally in [Go33]).

In a detailed account of these developments, and their impact on Hilbert's Program, Wilfried Sieg refers to a lecture Gödel delivered in Vienna on 29 January 1938:

“...to a seminar organized by Edgar Zilsel. The lecture presents an overview of possibilities for continuing Hilbert's program in a revised form. It is an altogether remarkable document: biographically, it provides, together with (1933b) and (1941), significant information on the development of Gödel's foundational views; substantively, it presents a hierarchy of constructive theories that are suitable for giving (relative) consistency proofs of parts of classical mathematics (see §§2-4 of the present note); and, mathematically, it analyzes Gentzen's (1936) proof of the consistency of classical arithmetic in a most striking way (see §7). A surprising general conclusion from the three documents just mentioned is that Gödel in those years was intellectually much closer to the ideas and goals pursued in the Hilbert school than has been generally assumed (or than can be inferred from his own published accounts). ...

The Zilsel lecture gives, as we remarked, an overview of possibilities for a revised Hilbert program. The central element of that program was to prove the consistency of formalized mathematical theories by finitist means. Gödel's 1931 incompleteness theorems have been taken to imply that for theories as strong as first-order arithmetic this is impossible, and indeed, so far as Gödel ventures to interpret Hilbert's finitism, that is Gödel's view in the present text as well as earlier in (1933b) (though not in (1931d)) and later in (1941), (1958) and (1972). The crucial questions then are what extensions of finitist methods will yield consistency proofs, and what epistemological value such proofs will have.

Two developments after (Gödel 1931d) are especially relevant to these questions. The first was the consistency proof for classical first-order arithmetic relative to intuitionistic arithmetic obtained by Gödel (1933d). The proof made clear that intuitionistic methods went beyond finitist ones (cf. footnote 10 below). Some of the issues involved had been discussed in Gödel's lecture (1933b), but also in print, for example in (Bernays 1935b) and (Gentzen 1936). Most important is Bernays's emphasis on the “abstract element” in intuitionistic considerations. The second development was Gentzen's consistency proof for first-order arithmetic using as the additional principle—justified from an intuitionistic standpoint—transfinite induction up to ε_0 . Already in (1933b, p. 31) Gödel had speculated about a revised version of Hilbert's program using constructive means that extend the limited finitist ones without being as wide and problematic as the intuitionistic ones:

But there remains the hope that in future one may find other and more satisfactory methods of construction beyond the limits of the system A [[capturing finitist methods]], which may enable us to found classical arithmetic and analysis upon them. This question promises to be a fruitful field for further investigations.

The Cambridge lecture does not suggest any intermediate methods of construction; by contrast, Gödel presents in the Zilsel lecture two “more satisfactory methods” that provide bases to which not only classical arithmetic but also parts of analysis might be reducible: quantifier-free theories for higher-type functionals and transfinite induction along constructive ordinals. Before looking at these possibilities, we sketch the pertinent features of the Cambridge talk, because they give a very clear view not only of the philosophical and mathematical issues Gödel addresses, but also of the continuity of his development.”

... Sieg: [S12], Chapter II.4, pp.193-195.

Comment 93. Of interest in this context is Vladimir Voevodsky's remark (see also [Cho18]; Comment 87) on what Gentzen's proof of consistency for first-order arithmetic entails from a univalent foundational perspective:

“There is another argument which is often cited as a proof of consistency of first-order arithmetic which has been invented by Gerhard Gentzen (1909-1945).

While Gentzen’s reduction argument leads to many very interesting developments it can not be used as a proof of consistency. In relation to the consistency issue the only thing which it shows is that any inconsistency will define a non-terminating decreasing sequence of ‘ordinals less than ε_0 ’.”

... Voevodsky [Vo10].

The above account also raises the following point of interest from the *evidence-based* perspective of [An16]:

For any integer $n \geq 0$, and integers $x_i \geq 0$, we denote the ordinal $W < \omega^\omega$ by $(x_0, x_1, x_2, x_3, x_4, \dots, x_n)$, where:

$$W = \omega^n . x_n + \dots + \omega^4 . x_4 + \omega^3 . x_3 + \omega^2 . x_2 + \omega . x_1 + x_0$$

Define:

$$S_k = \{(x_0, x_1, x_2, x_3, x_4, \dots, x_n)\} \ni (x_0 + x_1 + x_2 + x_3 + x_4 + \dots + x_n) = k$$

Then S_k is a finite set of n -tuples for any $k \geq 0$. Hence $\{S_k\}$ is denumerable.

Now we note that $\omega^i \in S_1$ for all $n \geq i \geq 1$, and it is reasonable to assume that some finite initial segment of any denumerable ordering of the ordinals below ω^ω , which does not appeal (non-constructively) to an axiom of choice, must include an ordinal $\omega^i . x_j$ for some $x_j > 0$ corresponding to each $n \geq i \geq 1$.

Query 6. *Can the above argument in §93 be extended to ordinals below ϵ_0 by defining higher order ordinals similarly in terms of the ordered n -tuples $(W, W_1, W_2, \dots, W_n)$, where $W_i = \omega_i^n . x_{i,n} + \dots + \omega_i^4 . x_{i,4} + \omega_i^3 . x_{i,3} + \omega_i^2 . x_{i,2} + \omega_i . x_{i,1}$, and so on recursively?*

Since transfinite induction can reasonably be considered constructive only if the induction is definable in terms of an *evidence-based* procedure over an *algorithmically verifiable* (even if not *algorithmically computable*) ordering of the ordinals which does not appeal to an axiom of choice, it is not obvious in what sense Gentzen’s proof—unlike the *weak* proof of consistency in §2.B.a., Theorem 2.8—can be considered constructive.

Sieg notes that the issue of constructivity was addressed by Gödel earlier in his 1933 ‘Cambridge’ lecture as follows:

Understanding by mathematics “the totality of the methods of proof actually used by mathematicians”, Gödel sees the problem of providing a foundation for these methods as falling into two distinct parts (p. 1):

At first these methods of proof have to be reduced to a minimum number of axioms and primitive rules of inference, which have to be stated as precisely as possible, and then secondly a justification in some sense or other has to be sought for these axioms, i.e., a theoretical foundation of the fact that they lead to results agreeing with each other and with empirical facts.

The first part of the problem is solved satisfactorily through type theory and axiomatic set theory, but with respect to the second part Gödel considers the situation to be extremely unsatisfactory. “Our formalism”, he contends, “works perfectly well and is perfectly unobjectionable as long as we consider it as a mere game with symbols, but as soon as we come to attach a meaning to our symbols serious difficulties arise” (p. 15). Two aspects of classical mathematical theories (the non-constructive notion of existence and impredicative definitions) are seen as problematic because of a necessary Platonist presupposition “which cannot satisfy any critical mind and which does not even produce the conviction that they are consistent” (p. 19). This analysis conforms with that given in the Hilbert school, for example in (Hilbert and Bernays 1934), (Bernays 1935b) and

(Gentzen 1936). Gödel expresses the belief, again as the members of the Hilbert school did, that the inconsistency of the axioms is most unlikely and that it might be possible "to prove their freedom from contradiction by unobjectionable methods".

...Sieg: [Si12], Chapter II.4, pp.195-196.

We note that the *strong* (intuitionistically unobjectionable) finitary proof of consistency for PA in §2.C.a., Theorem 2.16, justifies the optimism Gödel shared in 1933 with Hilbert and Bernays over a positive outcome for Hilbert's Program.

Moreover, §2.C.a., Theorem 2.16, underscores another implicit thesis of this investigation that:

The deterministic infinite procedures (corresponding to Hilbert's 'reduction procedure' quoted in §8.B.) needed to *formalise* the distinction between 'constructive' and 'finitary' reasoning (as illustrated for quantification in §10.A., and generally by §2., Definitions 7 and 10), involve a paradigm shift in recognising that:

- Turing's 1936 paper [Tu36]) admits *evidence-based* reasoning for assigning the values of 'satisfaction' and 'truth' to the formulas of a first-order language such as PA,
- in the sense that one can view the *values* of a simple functional language as specifying *evidence* for propositions in a constructive logic ([Mu91], §1 Introduction; [Lob59], p.165),
- which yields two constructively well-defined, hitherto unsuspected, *complementary* interpretations of PA (as defined in §2.B. and §2.C.)
- under Tarski's inductive definitions of the satisfiability and truth of the PA-formulas under an interpretation.

We note further that, according to Sieg, Gödel's focus in 1933 was already on identifying the minimum requirements that *any* method claiming to prove consistency of a system must satisfy in order to be considered constructive:

"Clearly, the methods whose justification is being sought cannot be used in consistency proofs, and one is led to the consideration of parts of mathematics that are free of such methods. Intuitionistic mathematics is a candidate, but Gödel emphasizes (p. 22) that

the domain of this intuitionistic mathematics is by no means so uniquely determined as it may seem at first sight. For it is certainly true that there are different notions of constructivity and, accordingly, different layers of intuitionistic or constructive mathematics. As we ascend in the series of these layers, we are drawing nearer to ordinary non-constructive mathematics, and at the same time the methods of proof and construction which we admit are becoming less satisfactory and less convincing.

The strictest constructivity requirements are expressed by Gödel (pp. 23–25) in a system A that is based "exclusively on the method of complete induction in its definitions as well as in its proofs". That implies that the system A satisfies three general characteristics: (A1) Universal quantification is restricted to "infinite totalities for which we can give a finite procedure for generating all their elements"; (A2) Existential statements (and negations of universal ones) are used only as abbreviations, indicating that a particular (counter-)example has been found without—for brevity's sake—explicitly indicating it; (A3) Only decidable notions and calculable functions can be introduced. As the method of complete induction possesses for Gödel "a particularly high degree of evidence, "it would be the most desirable thing if the freedom from contradiction of ordinary non-constructive mathematics could be proved by methods allowable in this system A" (p. 25)."

...Sieg: [Si12], Chapter II.4, p.196.

If we apply Gödel's stipulations (A1), (A2) and (A3) to the *weak* standard interpretation $\mathcal{I}_{PA(\mathbb{N}, SV)}$ of PA defined in §2.B., and the *strong* finitary interpretation $\mathcal{I}_{PA(\mathbb{N}, SC)}$ of PA defined in §2.C., we note that they can be viewed as broadly meeting Gödel's criteria of constructivity:

- (A1) *Universal quantification is restricted to infinite totalities for which we can give a finite procedure for verifying all assertions about their elements.*

The *weak* interpretation of universal quantification under the *weak* standard interpretation $\mathcal{I}_{PA(\mathbb{N}, SV)}$ of PA (see §10.D.), as well as the *strong* interpretation of universal quantification under the *strong* finitary interpretation $\mathcal{I}_{PA(\mathbb{N}, SC)}$ of PA (see §10.E.), are both defined constructively in terms of finitely determinate algorithms over the respective domains of quantification;

- (A2) *Existential statements (and negations of universal ones) are used only as abbreviations, indicating that a particular (counter-)example has been found without—for brevity's sake—explicitly indicating it.*

Existential quantification in each case is used only as an abbreviation for the negation of universal quantification such that:

- (a) The formula $[(\exists x)F(x)]$ is an abbreviation of $[\neg(\forall x)\neg F(x)]$, and is *defined as verifiably true* in $\mathcal{I}_{PA(\mathbb{N}, SV)}$ relative to its truth assignment T_V if, and only if, it is not the case that, for any *specified* natural number n , we may conclude on the basis of *evidence-based* reasoning that the proposition $\neg F^*(n)$ holds in $\mathcal{I}_{PA(\mathbb{N}, SV)}$; where the proposition $F^*(n)$ is *postulated* as holding in $\mathcal{I}_{PA(\mathbb{N}, SV)}$ for some *unspecified* natural number n if, and only if, it is not the case that, for any *specified* natural number n , we may conclude on the basis of *evidence-based* reasoning that the proposition $\neg F^*(n)$ holds in $\mathcal{I}_{PA(\mathbb{N}, SV)}$;
- (i) However, we note that we cannot assume that the satisfaction and truth of quantified formulas of PA are always finitarily decidable—in the sense of being algorithmically *computable*—under the *weak* standard interpretation $\mathcal{I}_{PA(\mathbb{N}, SV)}$ of PA over \mathbb{N} (as defined in §29.), since we cannot prove finitarily from *only* Tarski's definitions and the assignment T_V of algorithmically *verifiable* truth values to the atomic formulas of PA under $\mathcal{I}_{PA(\mathbb{N}, SV)}$ whether, or not, a specified quantified PA formula $[(\forall x_i)R]$ is algorithmically *verifiable* as true under $\mathcal{I}_{PA(\mathbb{N}, SV)}$;
- (ii) Moreover, it is not unreasonable to conclude—in the light of Gödel's stipulation (A2) in the previous quote—that the failure to successfully carry out Hilbert's Program may be attributed to an unawareness of the *evidence-based* distinction between algorithmically *computable* truth and algorithmically *verifiable* truth (see §7.C.(1) and §7.C.(2)).
- (b) The formula $[(\exists x)F(x)]$ is an abbreviation of $[\neg(\forall x)\neg F(x)]$, and is *defined as true* in $\mathcal{I}_{PA(\mathbb{N}, SC)}$ relative to its truth assignment T_C if, and only if, we may conclude on the basis of *evidence-based* reasoning that it is not the case, for any *specified* natural number n , that the proposition $\neg F^*(n)$ holds in $\mathcal{I}_{PA(\mathbb{N}, SC)}$.

We note that $\mathcal{I}_{PA(\mathbb{N}, SC)}$ is a *strong* finitary interpretation of PA since—when interpreted suitably—all theorems of first-order PA interpret as *finitarily* true in $\mathcal{I}_{PA(\mathbb{N}, SC)}$ relative to T_C (see §2.C.a., Theorem 2.15).

(A3) *Only decidable notions and calculable functions can be introduced.*

Only decidable notions are used to establish that the PA axiom schema of induction interprets as *verifiably* true under the *weak* standard interpretation $\mathcal{I}_{PA(\mathbb{N}, SV)}$ of PA (§2.B.a., Lemma 2.4); and as *computably* true under the *strong* finitary interpretation $\mathcal{I}_{PA(\mathbb{N}, SC)}$ of PA (2.C.a., Lemma 2.12).

To an extent, the above explains in hindsight why, according to Sieg, Gödel's focus shifted from seeking the consistency sought originally by Hilbert's Program to assessing the relative consistency of various systems and proofs:

“Gödel infers that Hilbert's original program is unattainable from two claims: first, all attempts for finitist consistency proofs actually undertaken in the Hilbert school operate within system A; second, all possible finitist arguments can be carried out in analysis and even classical arithmetic. The latter claim implies jointly with the second incompleteness theorem that finitist consistency proofs cannot be given for arithmetic, let alone analysis. Gödel puts this conclusion here quite strongly: “. . . unfortunately the hope of succeeding along these lines [[using only the methods of system A]] has vanished entirely in view of some recently discovered facts" (p. 25). But he points to interesting partial results and states the most far-reaching one, due to (Herbrand 1931) in a beautiful and informative way (p. 26):

If we take a theory which is constructive in the sense that each existence assertion made in the axioms is covered by a construction, and if we add to this theory the non-constructive notion of existence and all the logical rules concerning it, e.g., the law of excluded middle, we shall never get into any contradiction.

Gödel conjectures that Herbrand's method might be generalized to treat Russell's “ramified type theory”, i.e., we assume, the theory obtained from system A by adding ramified type theory instead of classical first-order logic.⁹

There are, however, more extended constructive methods than those formalized in system A; this follows from the observation that system A is too weak to prove the consistency of classical arithmetic together with the fact that the consistency of classical arithmetic can be established relative to intuitionistic arithmetic.¹⁰ The relative consistency proof is made possible by the intuitionistic notion of absurdity, for which “exactly the same propositions hold as do for negation in ordinary mathematics—at least, this is true within the domain of arithmetic” (p. 29). This foundation for classical arithmetic is, however, “of doubtful value”: the principles for absurdity and similar notions (as formulated by Heyting) employ operations over all possible proofs, and the totality of all intuitionistic proofs cannot be generated by a finite procedure; thus, these principles violate the constructivity requirement (A1).

Despite his critical attitude towards Hilbert and Brouwer, Gödel dismisses neither in (1933b) when trying to make sense out of Hilbert's program in a more general setting, namely, as a challenge to find consistency proofs for systems of “transfinite mathematics” relative to “constructive” theories. And he expresses his belief that epistemologically significant reductions may be obtained.

Fn9 In Konzept, p. 0.1, Godel mentions Herbrand's results again and also the conjecture concerning ramified type theory. The obstacle for an extension of Herbrand's proof is the principle of induction for “transfinite” statements, i.e., formulae containing quantifiers. Interestingly, as discovered in (Parsons 1970), and independently by Mints (1971) and Takeuti (1975, p. 175), the induction axiom schema for purely existential statements leads to a conservative extension of A, or rather its arithmetic version, primitive recursive arithmetic. How Herbrand's central considerations can be extended (by techniques developed in the tradition of Gentzen) to obtain this result is shown in (Sieg 1991).

Fn10 In his introductory note to (1933d), Troelstra (1986, p. 284) mentions relevant work also of Kolmogorov, Gentzen and Bernays. Indeed, as reported in (Gentzen 1936, p. 532), Gentzen and Bernays discovered essentially the same relative consistency proof independently of Godel. According to Bernays (1967, p. 502), the above considerations made the Hilbert school distinguish intuitionistic from finitist methods. Hilbert and Bernays (1934, p. 43) make the distinction without referring to the result discussed here.
 . . . Sieg: [Sii2], Chapter II.4, pp.196-197.

9.A.a. Shift in Hilbert's focus

We also note that—according to Carl J. Posy's implicitly empathetic account of Hilbert's Program—prior to publication of the second volume of the *Grundlagen der Mathematik* in 1929, Hilbert was yet 'confident in our ability to produce provably adequate formal systems':

Hilbert's Program: Constructivism of the Right

"It might seem strange to call Hilbert a constructivist. After all, he himself introduced non-constructive methods into algebra, he was unfriendly towards the Kroneckerian restrictions, and—in opposition to Brouwer—he was a staunch supporter of classical logic. Indeed, Hilbert did not practice or condone "constructive mathematics" in the sense that I have been using the term. Nevertheless, he was a constructivist: he saw infinity as a problem for mathematics (or, more precisely, as the source of mathematics' problems), and as a solution he aimed to found mathematics on a base of intuition, just as do all the constructivists we have considered.

Hilbert in fact was driven by an opposing pair of pulls, and his program for the foundation of mathematics was the result of those pulls.

On the one hand, Hilbert held that there is no infinity in physical reality, and none in mathematical reality either. Only intuitible objects truly exist, and only an intuitively grounded process (he spoke of "finitary thought") can keep us within the realm of the intuitible. This is his constructivism. Mathematical paradox arises, he said, when we exceed those bounds. And indeed, he held that infinite mathematical objects do go beyond the bounds of mathematical intuition. For him finite arithmetic gave the basic objects, and he held that arithmetic reasoning together was the paradigm of finitary thought. Together this comprised the "real" part of mathematics. All the rest—set theory, analysis, and the like—he called the "ideal" part, which had no independent "real content".

On the other hand, Hilbert also believed that this ideal mathematics was sacrosanct. No part of it was to be jettisoned or even truncated. This is why I dub it "constructivism of the right". "No one will expel us," he famously declared, "from the paradise into which Cantor has led us (Hilbert 1926).

Hilbert's program, which was first announced in 1904 and was further developed in the 1920s, was designed to reconcile these dual pulls.³⁵ outline of the program for a branch of mathematics whose consistency is in question is generally familiar: axiomatize that branch of mathematics; formalize the axiomatization in an appropriate formal language; show that the resulting formal system is adequate to the given branch of mathematics (i.e., sound and complete); and then prove the formal system to be consistent.

The important assumptions here are that formal systems are finitely graspable things and that the study of formal systems is a securely finitary study. Thus, he is proposing to use the finitary, trustworthy part of mathematics to establish the consistency of the ideal part.

Today, of course, we know that the program as thus formulated cannot succeed. Gödel's theorems tell us that. But in the late 1920s, Hilbert still had ample encouraging evidence. Russell and Whitehead's *Principia Mathematica* stood as a monument to formalization. He and his students successfully had axiomatized and formalized several branches of mathematics. Moreover, he firmly believed that within each branch of mathematics we can prove or refute any relevant statement. He believed that is, optimistically, in the solvability of all mathematical problems. And so he was confident in our ability to produce provably adequate formal systems. And—assuming in advance the success of his program—he was comfortable in developing the abstract, unanchored realms of ideal mathematics.

Fn35 It was announced in Hilbert's lecture "Über die Grundlagen der Logik und der Arithmetik" (published as Hilbert 1905). He developed the Program more fully in the 1920s. Hilbert and Bernays' book *Grundlagen der Mathematik* (1934) contains the most mature statement of the program.

Comment 94. We note that Posy's conclusion, 'we know the program as thus formulated cannot succeed. Gödel's theorems tell us that', can no longer be treated as definitive, particularly in view of the finitary, *evidence-based*, proofs of PA-consistency in §2.C.a., Theorem 2.16, and of PA-categoricity in §2.E.b., Corollary 2.18.

Moreover, such a conclusion is not uncommon; but could be misleading²⁴⁰ when it is—not unreasonably—inherited by non-logicians as definitive.

For instance, in his musings [Grn22] from a general mathematician's perspective—where he seeks to address the query '*Do Proofs Yield Objective Truth, Or Are They Culturally Robust At Best*'—Andrew Granville relies upon unjustifiable inherited paradigms to mistakenly (in view of §2.C.a., Theorem 2.16 and §2.E.b., Corollary 2.18) conclude, albeit in good faith, that Gödel showed Hilbert's 'dream is inescapably impossible':

"As we wrote above, we wish to create a (finitely described) language/theory to quantify and work with all intuitive mathematics, perhaps enhanced by further axioms as we determine new issues that are independent of the axioms we are already using, so that any true theorem is accessible and provable. Hilbert's dream was that one could create axioms and a theory that would allow one to prove or disprove any given mathematical claim.

In 1931 Gödel showed that this dream is inescapably impossible."

... Granville: [Grn22], §1. Proof—why and how.

Posy's perspective that Hilbert—essentially echoing the Complementarity Thesis (§1., Thesis 1)—was 'confident in our ability to produce provably adequate formal systems' prior to Gödel's 1931 paper [Go31], is also reflected in Juliette Kennedy's reference to this period as 'the *foundational era*':

"What was the *foundational era*? This was the period inaugurated, roughly, by Frege and continuing through the first part of the twentieth century,² during which worries essentially about consistency—to simplify matters only a little—motivated the development of various foundational formal systems; a development which, if it did not exactly set those worries to rest, at least increased confidence in the unlikelyhood of their ever being realized. The foundationalist objective which eventually emerged was stated in a preliminary but exact form³ by Hilbert and his school. In its full form what we are calling the formalism-oriented foundationalist program, was simply this: embed mathematics in a formal language with an exact proof concept and an exact semantics, such that the proof concept is sound and complete with respect to the associated semantics as well as syntactically complete in the sense that all propositions that can be written in the formalism are also decided. The preservation of meaning, as well as other epistemically valuable features, were important desiderata which were to be shown in various ways. Characteristic of the Hilbert Program was the demand that the formal environment, however it was conceived, be *finitary*; though what the Hilbert School meant by the term "finitary" was not clear at the time, and indeed would not be resolved, at least to a reasonable degree of satisfaction, until Tait's 1988 [79]. The principal demand imposed by the Hilbert Program of course, was that the formalism be demonstrably, indeed internally consistent—a demand which, if met, would have assuaged qualms about the use of infinitary concepts, along with, or more precisely by means of, resolving the consistency issue. The demand for an internal consistency proof was replaced after Gödel's 1931 Incompleteness Theorems with a multiplicity of coping mechanisms—or assertions to the effect that such were not needed, as the case may be."

Kennedy: [Knd13], Introduction.

The Complementarity Thesis (§1., Thesis 1) is also reflected—albeit *implicitly*—in Curtis Franks' following assessment of Hilbert's 'thought'—essentially prior to 1931—if we treat 'logic'

²⁴⁰See §15.A. *The illusory significance of Gödel 1931.*

as ‘a methodological search for truth’, and ‘mathematics/arithmetic’ as ‘a methodological search for proof’, in the context of a search for firm ‘foundations’ for scientific reasoning of the times:

“A unique characteristic of Hilbert’s thought is that the question of the priority of logic over mathematics does not arise. The logicians, and to some extent other foundationalist thinkers, wanted to rebuild mathematics on logic, thereby infusing mathematical techniques with the security of logical conviction. Against this suggestion, Peirce took mathematics to be prior. Hilbert saw through both sides of this debate:

Arithmetic is often considered to be a part of logic, and the traditional fundamental logical notions are usually presupposed when it is a question of establishing a foundation for arithmetic. If we observe attentively, however, we realize that in the traditional exposition of the laws of logic, certain fundamental arithmetic notions are already used ... ([1904], p.13)

The feeling of paradox is therefore inevitable as soon as one seeks justificatory grounds in this arena. Hilbert proposed to shake this feeling by giving up on justification altogether. He continued: “Thus we find ourselves turning in a circle, and that is why a partly simultaneous development of the laws of logic and of arithmetic is required if paradoxes are to be avoided” (ibid.). In the 1920’s “the simultaneous development of logic and mathematics” became one of Hilbert’s favorite slogans.¹³ By accepting the fact that logic and mathematics are intertwined, Hilbert deliberately stripped from each the illusion that they are rooted in the other. He did this, not to show that they are unfounded, but to show that they do not call for foundation. “If mathematical thinking is defective,” he wrote, “where are we to find truth and certitude?” ([1926], p. 191)."

... Franks: [Fr09], §1.3, *Freedom from philosophy*.

In other words, around 1929 Hilbert’s focus, and that of mainstream classical meta-mathematics thereafter, apparently shifted from seeking finitary means of reasoning (compare with the Complementarity Thesis—§1., Thesis 1) to where it has resided ever since: determining the relative proof-theoretic strengths of formal systems, irrespective of whether or not they have any *evidence-based* interpretation that would assure the soundness—and hence the consistency—of the concerned systems.

Comment 95. We can, not unreasonably, view such a shift as abandoning Hilbert’s initial intent to justify that:

- a formal system (which we can informally view as corresponding to Carnap’s *explicatum* in [Ca62a]; or to Gamez’s ‘P-description’ and ‘C-description’ in [Gam18], Fig.5.2, p.79);
- does indeed represent that which (viewed as corresponding informally to Pantsar’s *pre-formal mathematics* in [Pan09] (§4. Formal and pre-formal mathematics); or to Carnap’s *explicandum* in [Ca62a]; or to Gamez’s ‘C-theory’ in [Gam18], F, p.79; or to what some cognitive scientists, such as Lakoff and Núñez in [LR00] (see also §27.), term as ‘conceptual metaphors’);
- it seeks to express formally.

Schirn and Niebergall deplore at length this weakening of Hilbert’s finitary resolve²⁴¹, which they implicitly seem to also ascribe to efforts by Hilbert and Bernays to contain the

²⁴¹Not entirely unreasonably, since an unintended consequence of such a shift for the natural sciences—which use formal mathematical structures to express, and communicate, their observations of a commonly accepted reality—might, for instance, be viewed as the arguably unreasonable (according to Sabine Hossenfelder in [Hos18a]; see also §20.D.e.) focus of particle physicists on only the proof-theoretic properties of their theories, irrespective of whether or not such theories have any *evidence-based* interpretation that would assure their soundness in mirroring the external reality they seek to express.

perceived negative implications of Gödel's 1931 paper [Go31] on finitism, whilst at the same time unquestioningly accepting the validity of Gödel's conclusions therein; even though such acceptance entailed accepting non-standard integers, such as Cantor's transfinite ordinals ' ω ' and ' ε_0 ' as legitimate objects in 'constructive' reasoning.

"We observe that in Hilbert and Bernays 1939 the authors pass easily from the determination of what is finitistically formulable to a characterization of what is finitistically provable. We are told that for the formalization of certain general results of proof theory it is *desirable* to obtain as mathematical theorems conditionals containing a universally quantified sentence as antecedent (Hilbert and Bernays 1939, 358, 362). Such sentences are for example (formalizations of) assertions concerning the unprovability or verifiability of formulae or the computability of functions. To illustrate the idea, Hilbert and Bernays sketch a formalization of the informal consistency proof for H in *Grundlagen der Mathematik* (1934), to which we have already referred in §2. The formalization is carried out in PA, and it is shown by means of a complexity analysis that a fragment of PA, though extending PRA, would actually suffice for the consistency proof.. Proof-theoretic means extending PRA, including a form of complete induction which cannot be formalized by the induction schema of recursive number theory (Hilbert and Bernays 1939, 358), are said to be useful or desirable for conducting certain formal consistency proofs.

However this may be, the crucial question for Hilbert and Bernays is whether the so-called finitary methods may go beyond the scope of the modes of inference formalizable in Z_μ . The question is said to lack a precise formulation, on the grounds that 'finitary' has not been introduced as a sharply defined term, but only as a label for a 'methodic guideline'. It serves merely to recognize certain forms of concept formation and of inference definitely as finitary and certain others definitely as non-finitary. It is not appropriate, though, for drawing an exact dividing line between modes of inference which meet the requirements of the finitist method and modes of inference which do not.⁵²

It is in this connection that Hilbert and Bernays mention a typical borderline-case; it concerns the question whether conditionals with a universally quantified sentence as antecedent can be formulated finitistically. They claim to have removed this indeterminacy by distinguishing between sentences and inference rules (Hilbert and Bernays 1939, 358f., 361). Hilbert and Bernays admit, though, that in some cases this distinction may strike us as *forced*, and all this is said to require that the bounds of the finitist framework hitherto established be somewhat loosened, that is, that we go beyond what can be formulated in L_{PRA}^+ and proved in recursive number theory.

Two comments on these and similar remarks and ideas in Hilbert and Bernays (1939) are in order here. First, what the authors may make clear with them is at best that, compared with Hilbert's finitism of the 1920s, the *language* of finitist metamathematics must be extended; for instance, unbounded quantifications should now be finitistically formulable. Yet Hilbert and Bernays do not even address the issue why in that case all theorems of PA should be sound from a finitist point of view. Moreover, remarks to the extent that it is useful or desirable that the language of metamathematics has a certain expressive power and that the metamathematical theory itself includes a certain repertoire of proof-theoretic means convey nothing about the assumed finitary character of both the metamathematical language and the metamathematical theory under consideration.

Second, Hilbert's and Bernays's remarks presented above suggest that the old *foundational* view dominating the pre-Gödelian period of Hilbertian proof theory has been replaced with a view like this: we are accustomed to certain informal metamathematical considerations, and experience teaches us that they can be formalized in PA. Hence, we are entitled to use them in metamathematical reasoning. Whether Hilbert and Bernays do not care any longer much about questions of finitist justifiability, or whether they leave their readers with a principle of the following kind: *what is not definitely infinitistic may be regarded as finitist*, remains unclear. Deplorably, this is not the only place where Hilbert and Bernays hedge instead of putting their cards on the table. Surely Hilbert, as the founder of the finitist point of view, should feel called upon to give a clear-cut explication of 'finitist' allowing a fair assessment of his programme. So, it could seem that the

appeal to the alleged indefinability of ‘finitist’ is meant to serve as a safeguard against possible objections. This may come out a little clearer in Hilbert’s and Bernays’s treatment of transfinite induction to which we now turn.

Possibly guided by some principle of the kind just mentioned and the desire to be able to formalize metatheoretical considerations to as high a degree as possible, Hilbert and Bernays arrive at PA (or Z_μ , respectively) as a provisional boundary within which a finitist metatheory may be developed (1939, 354, 361). The crucial question for Hilbert and Bernays is now whether the so-called finitary methods may go beyond the scope of the modes of inference formalizable in Z_μ . (Remember that, owing to the vagueness of the word ‘finitary’, they do not consider this question to be formulated in precise terms.) For, as they point out (1939, 353f.), a (formal) metamathematical consistency proof for PA cannot be carried out in PA itself. Nevertheless, Hilbert and Bernays do not rest content with the idea that there can be no finitary proof for PA. Accordingly, they insist that ‘in any case, it is possible [...] to surpass the modes of inference formalizable in (Z_μ) without using the typically non-finitary inferences. And in this way we succeed in giving a very simple consistency proof for the system (Z)’ (1939, 362). Hilbert and Bernays refer in this connection to an arithmetical version of transfinite induction.⁵³ The line of thought which leads them eventually to considering transfinite induction, in particular up to ε_0 , as a possibly ‘legitimate’ method of proof theory deserves close attention."

[...]

“At the very end of the last chapter of *Grundlagen der Mathematik* (1939), Hilbert and Bernays make a concluding (but convoluted) remark on Gentzen’s (1936) consistency proof, which suggests that it was no longer their serious concern to argue for the finitist nature of the proof-theoretic means applied in consistency proofs for mathematical theories they consider important. We are told that it is a consequence of Gödel’s Theorem that

the more comprehensive the formalism to be considered is, the higher are the order types, i.e. forms of the generalized induction principle, that must be used. [...] The methodic requirements for the contentual proof of that higher induction principle supply the standard for [determining] which kind of methodic assumptions must be taken as a basis for the contentual attitude, if the consistency proof for the formalism in question is to be successful, (Hilbert and Bernays 1939, 387)

Fn52 We think that in Hilbert’s classical papers the expression ‘finitary’ is much less vague than in *Grundlagen der Mathematik* (1939). In spite of its vagueness both during the pre-Gödelian and post-Gödelian period of Hilbertian proof theory, it is reasonable to say that it had undergone a thorough shift of meaning by 1939.

Fn53 Therefore the remark just quoted seems to suggest that $PA + TI[\varepsilon_0]$ could be treated as a finitistically admissible theory."

... Schirn and Niebergall: [SN01], pp.154-157.

However, since:

- (i) Schirn and Niebergall observe that, regarding the consistency of PA, ‘Hilbert and Bernays do not rest content with the idea that there can be no finitary proof for PA’; and
- (ii) Hilbert’s and Bernays’ ‘informal’ proof of the consistency of arithmetic in the *Grundlagen der Mathematik*—as analysed in [SN01] (see §8.B.)—can be viewed as essentially outlining a proof of §2.B.a., Theorem 2.8;

a more appropriate perspective may be that Hilbert’s weakened finitism in 1939 reflected, as we noted earlier, the circumstance that the deterministic infinite procedures (corresponding to Hilbert’s ‘reduction procedure’ quoted in §8.B.) needed to *formalise* the distinction between ‘constructive’ and ‘finitary’ reasoning (as illustrated for quantification in §10.A.; and generally by §2., Definitions 7 and 10) were already intuited by Hilbert, even though they become explicit only *after* the realisation that Turing’s 1936 paper [Tu36]) admits *evidence-based* reasoning—in the sense that one can view the *values* of a simple functional language as specifying *evidence* for quantified propositions in a constructive logic in two, essentially different, ways (see §7.C.).

CHAPTER 10. MATHEMATICAL CONSEQUENCES

10. Hilbert's and Brouwer's interpretations of quantification

It is not entirely unreasonable (as argued in [An15a], [An15b]) to view Hilbert's evolving finitism as a search for a definitive response to Brouwer's objection to his classical interpretation of quantification; which Hilbert formalised in [Hi27] by defining a formal ε -calculus L_ε where he sought to capture the essence:

- of Aristotle's *unspecified* x in Definition 20,
- as an *unspecified* term $[\varepsilon_x(F(x))]$.

Hilbert then defined:

1. $[(\forall x)F(x) \leftrightarrow F(\varepsilon_x(\neg F(x)))]$
2. $[(\exists x)F(x) \leftrightarrow F(\varepsilon_x(F(x)))]$

and showed that Aristotle's logic is a well-defined interpretation of L_ε :

- if $[\varepsilon_x(F(x))]$ can be interpreted as some, *unspecified*, x satisfying $F(x)$.

10.A. Hilbert's interpretation of quantification

Formally, Hilbert interpreted quantification in terms of his ε -function as follows:

“IV. The logical ε -axiom

13. $A(a) \rightarrow A(\varepsilon(A))$

Here $\varepsilon(A)$ stands for an object of which the proposition $A(a)$ certainly holds if it holds of any object at all; let us call ε the logical ε -function.

1. By means of ε , “all” and “there exists” can be defined, namely, as follows:

- (i) $(\forall a)A(a) \leftrightarrow A(\varepsilon(\neg A))$
- (ii) $(\exists a)A(a) \leftrightarrow A(\varepsilon(A)) \dots$

On the basis of this definition the ε -axiom IV(13) yields the logical relations that hold for the universal and the existential quantifier, such as:

$$(\forall a)A(a) \rightarrow A(b) \dots (\text{Aristotle's dictum}),$$

and:

$$\neg((\forall a)A(a)) \rightarrow (\exists a)(\neg A(a)) \dots (\text{principle of excluded middle})."$$

... Hilbert: [Hi27].

Thus, Hilbert's interpretation (i) of universal quantification—under any objective (i.e., *evidence-based*) method T_H of assigning truth values to the sentences of a formal logic L —is that the sentence $(\forall x)F(x)$ can be defined as holding (presumably under a well-defined interpretation \mathbf{H} of L with respect to T_H) if, and only if, $F(a)$ holds whenever $\neg F(a)$ holds for some *unspecified* a (under \mathbf{H}); which would imply that $\neg F(a)$ does not hold for any specified a (since \mathbf{H} is well-defined), and so $F(a)$ holds for any specified a (under \mathbf{H}).

Further, Hilbert's interpretation (ii) of existential quantification, with respect to T_H , postulates that $(\exists x)F(x)$ holds (under \mathbf{H}) if, and only if, $F(a)$ holds for some *unspecified* a (under \mathbf{H}).

Comment 96. The consequent—and continuing—influence of Hilbert's interpretation of quantification on mathematics and philosophy is illustrated by Hilary Putnam's 1971 remark that:

“Quantification over mathematical entities is indispensable for science—but this commits us to—the [independent] existence of the mathematical entities [that satisfy our theories]. This type of argument stems, of course, from Quine, who has for years stressed both the indispensability of quantification over mathematical entities and the intellectual dishonesty of denying the existence of what one daily presupposes.”

... Putnam: [Pu71], p.347.

We can express this formally as (compare with §8.D., Theorem 8.12):

Lemma 10.1. *Aristotle's particularisation holds under every well-defined interpretation of Hilbert's ε -calculus L_ε .* □

We also have further that (compare with §8.D., Corollary 8.14):

Lemma 10.2. *The Law of the Excluded Middle (LEM) holds under every well-defined interpretation of Hilbert's ε -calculus L_ε .*

Proof The lemma follows since the principle of excluded middle is a theorem of L_ε and entails LEM. □

10.B. Brouwer's objection

Brouwer's objection to such an *unspecified* and 'postulated' interpretation of quantification was that, for an interpretation to be considered *constructively well-defined* relative to T_H when the domain of the quantifiers under an interpretation is infinite, the decidability of the quantification under the interpretation must be constructively verifiable in some intuitively, and mathematically acceptable, sense of the term 'constructive' ([Br08]).

In other words (as highlighted by the semantic and logical paradoxes analysed in §20.), any assumption of an *unspecified* object under an interpretation of a formal language L is valid if, and only if, such an element is shown to be *specifiable* as a term in L by the rules for the formation of L -terms.

Two questions arise:

- (a) Is Brouwer's objection relevant today?
- (b) If so, can we interpret quantification finitarily?

10.C. Is the PA-formula $[(\forall x)F(x)]$ to be interpreted *weakly* or *strongly*?

The perspective we choose for addressing these issues is that of the structure \mathbb{N} , defined by:

1. \mathbb{N} (the set of natural numbers);
2. $=$ (equality);
3. S (the successor function);
4. $+$ (the addition function);
5. $*$ (the product function);
6. 0 (the null element)

which serves for a definition (see §29.(16)) of the, classical, standard interpretation $\mathcal{I}_{PA(\mathbb{N}, SV)}$ of the first-order Peano Arithmetic PA.

However, if we are to avoid intuitionistic objections to the admitting of *unspecified* natural numbers in the definition of quantification under $\mathcal{I}_{PA(\mathbb{N}, SV)}$, we are faced with the ambiguity where *if*:

- $[(\forall x)F(x)]$ and $[(\exists x)F(x)]$ denote PA-formulas; and
- The relation $F^*(x)$ denotes the interpretation in the standard interpretation $\mathcal{I}_{PA(\mathbb{N}, SV)}$ of the PA-formula $[F(x)]$ under an inductive assignment of Tarskian truth values T_{SV} ; where
- The underlying first-order logic FOL of PA admits *evidence-based* interpretation (in the sense of §7.C.);

then the question arises²⁴²:

(a) Is the PA-formula $[(\forall x)F(x)]$ to be interpreted *weakly* as:

- ‘For any specified n , $F^*(n)$ ’,
 - which holds if, and only if,
 - for any specified n in \mathbb{N} ,
 - there is *algorithmic evidence* that $F^*(n)$ holds in \mathbb{N} ,

and the PA-formula $[\neg(\forall x)F(x)]$ interpreted *weakly* as:

- *There is no algorithm which will evidence that the PA-formula $[(\forall x)F(x)]$ can be interpreted weakly*²⁴³;

²⁴²We reiterate that the distinction between ‘any’ and ‘all’ made below pertains to the assignment of truth-values to the formulas of a formal theory under an interpretation of the universal quantifier over a *well-defined* domain of interpretation. It is to be distinguished from the distinction Russell makes in [Rus08] (pp.156-163) between ‘all’ and ‘any’ with respect to the assignment of provability-values to the formulas of a formal theory that admits ‘apparent’ and ‘real’ variables in a proof sequence. See also [Fe02], pp.3-4.

²⁴³Which implies *only* that $[(\forall x)F(x)]$ is not provable in PA; it *does not* entail that $F^*(x)$ is not algorithmically verifiable.

or:

(b) is the formula $[(\forall x)F(x)]$ to be interpreted *strongly* as:

- ‘For all n , $F^*(n)$ ’,
 - which holds if, and only if,
 - there is *algorithmic evidence* that,
 - for *any specified* n in \mathbb{N} ,
 - $F^*(n)$ holds in \mathbb{N} ?

and the PA-formula $[\neg(\forall x)F(x)]$ interpreted *strongly* as:

- *There is no algorithm which will evidence that the PA-formula $[(\forall x)F(x)]$ can be interpreted strongly²⁴⁴.*

Comment 97. The significance of making an *evidence-based* distinction between ‘For any’, and ‘For all’²⁴⁵, for the unambiguous expression, and categorical communication, of our conceptual metaphors of what we perceive, and term, as ‘quantum’ phenomena is highlighted by Décio Krause in [Krs22] (see §14.C.).

10.C.a. The Church-Turing Thesis entails Aristotle’s particularisation

The significance of §10.C., Definition 8 for *evidence-based* reasoning (which admits *only* §7.C.) is that (compare with the conclusions in §8. and §8.D.):

Theorem 10.3. *The Church-Turing Thesis entails Aristotle’s particularisation.* □

Proof. If we accept the Church-Turing Thesis (§29.(2)), then admitting a natural number as *unspecified* in \mathbb{N} (as in §7., Definition 20), implies that, by §10.C., Definition 8, it is *specifiable* in PA and, ipso facto, *specified* under any well-defined interpretation of PA. □

Since Aristotle’s particularisation entails ω -consistency (see §8.D.), we note that, as related by philosopher Stanislaw Krajewski in [Kr14], Stephen C. Kleene had articulated Theorem 10.3 equivalently when:

“In his article [1987], written for the special issue on Church’s Thesis of the *Notre Dame Journal of Formal Logic*, [Stephen C. Kleene] presented an argument to the effect that CT implies incompleteness. Even though only a weak form of the incompleteness theorem is derived, not the strong one giving an example of an undecidable sentence, the argument seems to be quite remarkable. It gives reason to say, as Kleene did, that “if in 1936 mathematicians had been ignorant of Gödel’s incompleteness theorem, one could have proposed Church’s thesis and let it lead one to Gödel’s theorem” ([1987], p. 491).”

... Krajewski: [Kr14], §1. When is CT needed?

²⁴⁴Which, too, implies that $[(\forall x)F(x)]$ is not provable in PA. By §2.E.b., Theorem 2.17 (*Provability Theorem for PA*), this *does*, however, entail that $F^*(x)$ is not algorithmically *computable*.

²⁴⁵See also §14.

The significance of Theorem 10.3 is, further, that it emphasises the extent to which *faith-based* reasoning—which appeals *unrestrictedly* to Aristotle's particularisation (see §7., Definition 20; also §7.B.)—is implicit even in argumentation that—contradicting §7.H.b., Theorem 7.3 (CT falsifiable)—seeks to ‘prove’ the Church-Turing Thesis, or equivalent theses, from finitary, or constructive, premises.

For instance, in her article [Du14], Marie Duží attempts ‘to define the notion of *algorithm/effective procedure*’; in this case by applying ‘a *procedural theory of concepts*’ which was ‘formulated by Materna using Transparent Intensional Logic (TIL) as a background theory’, to support her hypothesis that, consequently, ‘the *Church-Turing thesis* becomes *provable*’ in such a context:

“We considered four ways of construing the notion of computability:

- 1) *EP*—analytical concept of effective procedure, algorithm
- 2) *TM*—Turing machine, *GR*—general recursivity, λD —lambda definability
- 3) *MN*—machine-computable in the narrow sense (for instance with laws of physics imposing limitations on the machine)
MW—machine-computable in the wide sense (for instance involving infinitely small times ...)
- 4) *O*-machines with an oracle.

The Church-Turing thesis claims the equivalence of (1) and (2). Thus the Church-Turing thesis proposes three kinds of a refinement of the concept of effective procedure/algorithm.

At this point we can formulate a *hypothesis*: if the concept of an effective procedure (algorithm) is sufficiently refined and delimited, for instance, as proposed above by our *refined definition*, then the *Church-Turing thesis* becomes *provable*."

... Duží: [Du14], §6. *Summary and concluding remarks*.

In an earlier paper [DG08] (subsequently qualified, and clarified, by Gurevich in [Gu19]), Nachum Dershowitz and Yuri Gurevich too argue that Church's Thesis provably follows from—in their case—four, seemingly ‘undeniably’ computable, postulates:

“The first issue that needs to be addressed when axiomatizing effective computation is: What kind of object is a “computation”? Once we agree that it is some sort of state transition system (Postulate I in what follows), we need to formalize the appropriate notions of “state” and of “transition”. To model states, we take the most generic of mathematical objects, namely, logical structures (Postulate II). To ensure that each transition step is effective, we require only that it not entail an unbounded amount of exploration of the current state (Postulate III). Finally, we need to make sure that a computation does not start out with any magical abilities (Postulate IV). We will demonstrate that under these very natural and general hypotheses regarding algorithmic activity, which certainly suffice for the computation of all recursive functions, the recursiveness of the computed function is in fact guaranteed.

More precisely, but still informally, the postulates say the following about algorithms:

- I. *An algorithm determines a sequence of “computational” states for each valid input.*
- II. *The states of a computational sequence are structures. And everything is invariant under isomorphism.*
- III. *The transitions from state to state in computational sequences are governable by some fixed, finite description.*

IV. *Only undeniably computable operations are available in initial states.*

Postulates I–III are called the “Sequential Postulates” [42]. They axiomatize (deterministic, sequential) algorithms in general, not only those for computable functions; they apply equally to algorithms dealing with complex numbers, say, as to those for integers only. Postulate IV, which will be fleshed out later, ensures that an algorithm is not endowed from the outset with uncomputable oracles, such as infinite precision operations on real numbers, or a solvability decider for Diophantine equations. We will show in this paper that Church’s Thesis provably follows from these four postulates.”

... Dershowitz/Gurevich: [DG08], §1.3. Sketch of axioms, p.306.

The implicit non-constructivity imputed to the above argumentations in [Du14] and [DG08]—as being entailed by Theorem 10.3—was sought, in the case of [DG08], to be identified by Doukas Kapantais in [Kap16]; where, in his refutation of the Church-Turing Thesis (compare §7.H.b., Theorem 7.3), he argues against Dershowitz and Gurevich’s ‘Postulates’ (in [DG08]) by proposing ‘an effective computation that cannot be translated *salva* isomorphism into a computation of a machine with this abstract structure’:

“I now present three different interpretations of the Church-Turing thesis and single out the one I believe that my paper refutes.

In Church’s (1936) initial formulation, the Thesis consists in the claim that the class of effectively calculable numeric functions is identical to the class of recursive numeric functions, which is also identical to the class of λ -definable numeric functions. Turing (1936) proved that the latter two are identical to the class of Turing Machine computable numeric functions, and, like Church, he assumed that they all coincide with the effectively calculable numeric functions (although, unlike Church, he did not confine the domains of functions to numeric ones). Among the notions appearing in all these identity statements the only one that is not formal is the notion of “effectively calculable numeric function”.

Several alternative ways of interpreting the Thesis have been suggested. I will now classify them under three major categories/interpretations.

INT1. The Church-Turing thesis is in reality a definition. It has been proved that there is an idealized calculator with huge computational powers (i.e. the Turing Machine) and a family of equipotent machines⁸ and formalisms. We should all agree to name the functions these machines and formalisms can compute “effectively calculable functions”.

INT2. The Church-Turing thesis is in fact a conjecture. After the discovery of this idealized calculator with these huge computational powers, and the discovery of a family of other equipotent machines and formalisms, the conviction grew that these machines/formalisms really exhaust the computational powers in general. Now, if they really do so, anything that can be effectively calculated can be computed by a Turing Machine.

INT3. The Church-Turing thesis is the conjecture according to which not only anything that can be calculated can be computed by a Turing Machine, but also any formalism or machine that is equipotent to a Turing Machine is equivalent to it up to isomorphism. It comes down to the conjecture that all these maximal computational systems and machines share the same abstract structure, and so they do not only have the same computational power but, which is more, they compute in the same abstract way.

Were one to put INT1 to INT3 into slogans, INT1 would be: “Turing Machine computable functions are called ‘effectively calculable’”, INT2: “No numeric function that can be calculated cannot be computed by a Turing Machine”, and INT3: “All maximal models of computation share the same abstract structure with Turing Machines.

In what follows, I will be referring to the Church-Turing thesis as the thesis behind INT3, an interpretation well attested in the literature ...

INT3 goes beyond INT2 in the following two respects. First, it tries to provide an explanation of the otherwise mysterious co-extensiveness of this family of formalisms and machines. For to say that they are all equipotent, because they exhaust the limits of computation, is not an explanation of why they exhaust the limits of computation; it's just some further evidence that they do so. On the other hand, bringing forward what they themselves share in common (i.e. a common structure) is much more ambitious. For, after having brought forward what these formalisms/machines share in common, one could further suppose that any formalism/machine that exhausts the limits of computation shares this element in common too. Notice here that, if this last supposition turns out to be correct, one would also have a formal proof of the Thesis. For consider it this way. *Prima facie*, the Church-Turing thesis cannot be formally proved, since it claims that a non-formal item (i.e. "effectively calculable") is identical with a formal one (i.e. "Turing Machine computable"). Now, there can be no formal proof of any identity statement relating a formal and a non-formal item. The only identity statements that can be formally proved are statements relating items within a formal language of a theory. So, suppose that some explanation has been provided as for why these formalisms/machines are equipotent. If this explanation consists in the finding of yet another formal item, i.e. their common structure, and you further assume that any formalism/machine that exhausts the limits of computation must be characterized by this item too, then, what you are actually doing is proposing a formal interpretation for the "effectively calculable". I.e. you do not only prove that all these formalisms/machines share a formal element in common, you further propose that this element is shared by all formalisms and machines that exhaust the limits of computation. So, you can now formally define "effectively calculable" through this.

An enterprise of this sort has been undertaken in Dershowitz & Gurevich (2008).¹¹ What these authors did is the following. On the one hand, they have proposed a specific axiomatization as the formal counterpart of "effectively calculable".¹² On the other, they have proved that all the formalisms/machines of the second part of the equivalence are interpretations of this axiomatization. So, in case this axiomatization really captures the informal notion of "effectively calculable", then, their proof must also be a formal proof of the Thesis. Additionally, they have informally argued that this axiomatization must indeed be capturing the informal notion of "effectively calculable", for, in order not to be capturing it, one would need to be able to imagine a computational method that is both effective and, at the same time, falsifies at least one among the four Postulates of their system.¹³ So, now, the burden of (dis)proof is on the opponent, who must either argue against these Postulates directly, or come forward with an effective computation that cannot be translated *salva* isomorphism into a computation of a machine with this abstract structure.

In what follows, I will do the latter by indicating a certain way of mechanically calculating the original Ackermann function that we, humans, can perform and that cannot be mimicked by any Turing Machine. If this is exact, the isomorphism between us, as calculators, and these formalisms/machines fails. More precisely, I will claim that there are some updates in this particular way of computing the original Ackermann function that have no isomorphic counterparts in any computation of the same function as performed by these machines. This implies not only that the set of Postulates of Dershowitz and Gurevich need to be loosened in order to be able to capture "effectively calculable", but also that INT3 is false, since the same Postulates provably capture the abstract structure behind Turing Machines and equipotent machines and formalisms.¹⁴

... Kapantaïs: [Kap16], §3 What the Church-Turing thesis says. Quotation accessed Apr 18 2020 from ResearchGate.

Intriguingly—from the *evidence-based* perspective of this investigation—Kapantaïs argues in [Kap16] from an unusual anthropomorphic image²⁴⁶ of a *function* 'as a person to whom you give some items and who, then, returns some items back':

What is a "function"? In essence, what a function is comes down to this: Something, an item, the so-called "argument" of the function, is substituted by another (not necessarily different) thing,

²⁴⁶Functional and, seemingly, intentionally non set-theoretical to avoid any implicit appeal to non-constructive concepts as, we have imputed above, is the case in Dershowitz and Gurevich's argumentation in [DG08].

item. What performs this substitution is the function itself. The “not necessarily different” clause above is suggestive and not contradictory with respect to the verb “is substituted” it depends upon. For the important thing, as far as functions are concerned, is only this: they take some arguments as their input and they return some values as their output. So, the function is an operation that operates on items (trivially, on what else could an operation operate upon?) and produces items. The set of items, from which the function takes the items it operates upon, is called the “domain of arguments”, and the set of items, from which the function takes the items that result from the operation, is called “the domain of values”. It is not compulsory that the operation is fruitful for all arguments. Some functions produce no result, when given some argument values. These functions are called “partial”. The rest are called “total”.

You can easily—and safely, from the formal point of view—make an anthropomorphic model of what a function is. You can imagine it as a person to whom you give some items and who, then, returns some items back.

So far we’ve only said that functions operate on items and return items. A natural question is what kind of items these items might be. The straightforward answer is: “any kind”. Provided they satisfy suitable identity criteria, people, atoms, streets, sets, numbers, functions, intensions, feelings—you name it!—might serve as the arguments or values of functions.

The way we have presented things thus far suggests that we consider functions to be items in their own right, and so, since no item can be an argument/value of a function, unless it satisfies appropriate identity criteria, we now ask: What kind of criteria are these with respect to functions? The criteria we will employ are these: two functions will be identical, if and only if they return the same values for same arguments. This is called an “extensional” criterion, since it ignores the way the function arrives at its values. The only thing that matters is that, on being given these specific arguments, it provides these specific values.

Seen thus, functions exist “out there”, along with trees, human beings, sets, numbers and any other item that belongs to our world. Upon the same extensional criterion, functions can ultimately be reduced to sets of ordered pairs.

Functions from natural numbers to natural numbers are called “numeric functions”.

... Kapantaïs: [Kap16], §1 What a function is. Quotation accessed Apr 18 2020 from [ResearchGate](#).

What is intriguing about Kapantaïs’ unusual anthropomorphic image of a function ‘as a person to whom you give some items and who, then, returns some items back’, is that if we, instead, treated the latter as the image of an algorithmically *verifiable* function ([An16], Definition 1, p.37; see also §2., Definition 7), then the definition of ‘effective computability’ (as defined by §7.F., Definition 25, and §7.H.b., Definition 28) corresponds faithfully to Kapantaïs’ meaning of the term, ‘the idea being that a function that cannot be effectively calculated/computed is not calculable/computable at all’.

Comment 98. Kapantaïs cautions, however, that the above perspective could be interpreted ambiguously:

“I am just having the slightest of worries about the term “anthropomorphic” with respect [to] my image of a function. The reason is that I do [not] want to commit myself to the idea that in principle there is something intrinsic to human calculators as opposed to non human ones that gratifies them with superior insights/capabilities. I wish to remain agnostic as for that. I would rather prefer to say that my idea of a function is “agentcentric”, were such a word available. This agent might be anything whatsoever, from a human being to a black box, provided that it satisfies the condition of operating mechanically. In the case of the black box, one would need to open it and see how it functions, of course.

Even more than that, at the end of the day, I tend to think that I would not be identifying this agent with the function itself; I would rather prefer to say that the agent can be made into a model of the function."

... Kapantaïs: *Personal communication. Email dated May 7 2020.*

Moreover, Kapantaïs' 'conclusion that the human brain/mind is not equivalent up to isomorphism to Turing Machines' essentially echoes the conclusion of Lucas' Gödelian argument as detailed in the concluding thesis of [An16] (Thesis 1, p.42; see also §2.F.a.; §21.D., Theorem 21.1, and §21.E., Query 22):

"What the above proof establishes is that the Machine cannot mimic the way the human calculator finds A_n in the following essential respect. The human calculator launches a program, implementing an algorithm such that it builds recursively the function A_n by n consecutive updates A_0 that involve no 'do until' commands. Had the operation of the Machine and of the human calculator been isomorphic, there should be a translation function such that it takes each element of the stages the human calculator goes through, while computing A_n , to the stages the Machine goes through, while computing $f(n)$, and this translation would have left the abstract algorithm they both implement, by their distinct programs, intact. Suppose that there is such a translation function τ . Obviously, $\tau(A_0)=[A_0]$, $\tau(A_1)=[A_1]$, ... Say that "u" denotes the update function upon states during a calculation. What is missing for the isomorphism to be preserved is $\tau(u(Ax))$. For example, $u(Ax)$ is $Ax+1$, but $u([Ax])$ is not $[Ax+1]$. There is simply no way for the Machine to update $[Ax]$ in a way that preserves isomorphism.³⁰ That is to say that, there can be no translation of *theway* the human calculator updates states along her way to A_n to a similar way that the Machine updates states along its way to $[A_n]$. The particular details as for how exactly the Machine arrives at $[A_n]$ are of no importance. The "dumbest" but still effective way would be to check all numbers from 0 onwards to see whether they are $[A_n]$ or not. If $f(x)=y$ is decidable, the Machine will eventually stop at $[A_n]$. One can imagine several interesting shortcuts, but, still, there would be no program available to the Machine in order to calculate an upper bound for (or to calculate the exact number of) the updates it needs for reaching $[A_n]$, and, so, the way it updates its states must be structurally different.³¹

Notice that this is stronger than saying that the Turing Machine as a calculator and the human being as a calculator differ. After all, a one dimensional Turing Machine also differs from a two dimensional Turing Machine, and both differ from a Post Machine. However, these machines are interpretations of the same abstract structure, and, so, their calculations can be translated into one another. Strings are strings, graphs are graphs, sets are sets, but this variety reflects no structural difference.

On the other hand, the difference between the idealized human calculator and the Turing Machine is structural, and, so:

- (i) Not all maximal models of mechanical computation are equivalent up to isomorphism to Turing Machines (This is a refutation of the Church-Turing thesis in the form of INT3).

And:

- (ii) The human brain/mind is not equivalent up to isomorphism to Turing Machines. (Notice that the counterexample to the Turing Machine was an algorithm implemented by the idealized human calculator.)"

... Kapantaïs: [Kap16], §5 Conclusions. Quotation accessed Apr 18 2020 from ResearchGate.

10.D. The standard interpretation $\mathcal{I}_{PA(\mathbb{N}, SV)}$ of PA interprets $[(\forall x)F(x)]$ weakly

Keeping the distinction between §10.C.(a) and §10.C.(b) in mind, it would seem that classically, under the standard interpretation $\mathcal{I}_{PA(\mathbb{N}, SV)}$ of PA:

- (1a) The formula $[(\forall x)F(x)]$ is *defined* as true in $\mathcal{I}_{PA(\mathbb{N}, SV)}$ relative to an assignment T_{SV} of truth values under interpretation over \mathbb{N} if, and only if, for any *specified* natural number n , we may conclude on the basis of *evidence-based* reasoning that the proposition $F^*(n)$ holds in $\mathcal{I}_{PA(\mathbb{N}, SV)}$;
- (1b) The formula $[(\exists x)F(x)]$ is an abbreviation of $[\neg(\forall x)\neg F(x)]$, and is *defined* as true in $\mathcal{I}_{PA(\mathbb{N}, SV)}$ relative to T_{SV} if, and only if, we may conclude on the basis of *evidence-based* reasoning that it is not the case there is an algorithm which will evidence the formula $[(\forall x)F(x)]$ as true in $\mathcal{I}_{PA(\mathbb{N}, SV)}$ relative to T_M ;
- (1c) The proposition $F^*(n)$ is *postulated* as holding in $\mathcal{I}_{PA(\mathbb{N}, SV)}$ for some *unspecified* natural number n if, and only if, it is not the case that, for any *specified* natural number n , we may conclude on the basis of *evidence-based* reasoning that the proposition $\neg F^*(n)$ holds in $\mathcal{I}_{PA(\mathbb{N}, SV)}$.

If we *assume* that Aristotle's particularisation holds under the standard interpretation $\mathcal{I}_{PA(\mathbb{N}, SV)}$ of PA (as defined in §29.(16)), then (1a), (1b) and (1c) together interpret $[(\forall x)F(x)]$ and $[(\exists x)F(x)]$ under $\mathcal{I}_{PA(\mathbb{N}, SV)}$ *weakly*, as seems implicitly intended by Hilbert's ε -function; whence they attract Brouwer's objection.

This would, then, answer question §10.B.(a).

10.E. A finitary interpretation $\mathcal{I}_{PA(\mathbb{N}, SC)}$ of PA which interprets $[(\forall x)F(x)]$ *strongly*

Now, our thesis is that the implicit target of Brouwer's objection²⁴⁷ is the unqualified semantic *postulation* of Aristotle's particularisation entailed by §10.D.(1c), which appeals to Platonically non-constructive, rather than intuitively constructive, plausibility.

We note that this conclusion about Brouwer's essential objection apparently differs from conventional intuitionistic wisdom (i.e., perspectives based essentially on Brouwer's explicitly stated objection to the Law of the Excluded Middle (LEM) as expressed in [Br23], p.335-336):

- which would presumably deny appeal to §10.D.(1c) in an interpretation of FOL by denying that the FOL theorem $[P \vee \neg P]$ (*Law of the Excluded Middle*) is *finitary*;
- even though denying appeal to §10.D.(1c) in an interpretation of FOL does *not* entail denying the FOL theorem $[P \vee \neg P]$ (a consequence of §8.D., Corollary 8.15).

We can thus re-phrase question §10.B.(b) more specifically:

- Can we define an interpretation of PA over \mathbb{N} without appealing to §10.D.(1c)?

We note that we *can*, indeed, define another—hitherto unsuspected—*evidence-based* interpretation $\mathcal{I}_{PA(\mathbb{N}, SC)}$ of PA under an inductive assignment of Tarskian truth values T_{SC} over the structure \mathbb{N} , where:

²⁴⁷And perhaps of parallel objections perceived generically as "*Limitations of first-order logic*"; see [AR02b], p.78, §2.1.

- (2a) The formula $[(\forall x)F(x)]$ is *defined* as true in $\mathcal{I}_{PA(\mathbb{N}, SC)}$ relative to T_{SC} if, and only if, we may conclude on the basis of *evidence-based* reasoning that there is an algorithm which, for any *specified* natural number n , will evidence that the proposition $F^*(n)$ holds in $\mathcal{I}_{PA(\mathbb{N}, SC)}$;
- (2b) The formula $[(\exists x)F(x)]$ is an abbreviation of $[\neg(\forall x)\neg F(x)]$, and is *defined* as true in $\mathcal{I}_{PA(\mathbb{N}, SC)}$ relative to T_{SC} if, and only if, we may conclude on the basis of *evidence-based* reasoning that it is not the case there is an algorithm which will evidence the formula $[(\forall x)F(x)]$ as true in $\mathcal{I}_{PA(\mathbb{N}, SC)}$ relative to T_{SC} .

We note that $\mathcal{I}_{PA(\mathbb{N}, SC)}$ is a *strong* finitary interpretation of PA since—when interpreted suitably—all theorems of first-order PA interpret as *finitarily* true in $\mathcal{I}_{PA(\mathbb{N}, SC)}$ relative to T_C (an immediate consequence of §2.C.a., Theorem 2.16).

This answers question §10.B.(b).

10.F. Are both interpretations $\mathcal{I}_{PA(\mathbb{N}, SV)}$ and $\mathcal{I}_{PA(\mathbb{N}, SC)}$ of PA over \mathbb{N} well-defined?

The question arises:

Query 7. *Are both the interpretations $\mathcal{I}_{PA(\mathbb{N}, SV)}$ and $\mathcal{I}_{PA(\mathbb{N}, SC)}$ of PA over the structure \mathbb{N} well-defined, in the sense that the PA axioms interpret as true, and the rules of inference preserve truth, relative to each of the assignments of truth values T_V and T_C respectively?*

We note that [An16] answers the question affirmatively by showing that the two interpretations $\mathcal{I}_{PA(\mathbb{N}, SV)}$ and $\mathcal{I}_{PA(\mathbb{N}, SC)}$ of PA over the structure \mathbb{N} can be viewed as complementary, since (see §2.A.) Tarski's classic definitions permit an intelligence—whether human or mechanistic—to admit finitary, *evidence-based*, inductive definitions of the satisfaction and truth of the *atomic* formulas of the first-order Peano Arithmetic PA, over the domain \mathbb{N} of the natural numbers, in two, hitherto unsuspected and essentially different, ways:

- (1) in terms of *weak* algorithmic *verifiability*; and
- (2) in terms of *strong* algorithmic *computability*.

However, we note that, from the PA-provability of $[\neg(\forall x)F(x)]$, we may *only* conclude under the finitary interpretation $\mathcal{I}_{PA(\mathbb{N}, SC)}$, on the basis of *evidence-based* reasoning, that it is not the case $[F(n)]$ interprets as always true in \mathbb{N} .

We may *not* conclude further, in the absence of *evidence-based* reasoning, that $[F(n)]$ interprets as false in \mathbb{N} for some numeral $[n]$.

More precisely, we may not conclude from the PA-provability of $[\neg(\forall x)F(x)]$, in the absence of *evidence-based* reasoning, that the proposition $F^*(n)$ does not hold in \mathbb{N} for some *unspecified* natural number n since, by §2.F., Corollary 2.22, PA is *not* ω -consistent.

CHAPTER 11. MATHEMATICAL CONSEQUENCES

11. Three perspectives of logic

We conclude from the foregoing considerations that the common perceptions of a mutual inconsistency between classical and constructive mathematical philosophies—vis à vis ‘omniscient’ mathematical truth, and ‘omniscient’ mathematical ontologies, decried by Krajewski in [Kr16]—are illusory; they merely reflect the circumstance that (see §1., Thesis 1), to date, all such philosophies do not explicitly—and unambiguously (as proposed in §12.)—define the relations between a language and the logic that is necessary to assign unequivocal, *evidence-based*, truth-values of both ‘provability’ and ‘truth’ to the propositions of the language.

11.A. Hilbert’s theism

For instance, classical perspectives which admit Hilbert’s formal definitions of quantification can be labelled ‘theistic’, since they implicitly assume—without providing *evidence-based* criteria for interpreting quantification constructively—both that:

- (a) the first-order logic FOL is consistent;

and that:

- (b) Aristotle’s particularisation (see §7., Definition 20)—which postulates that ‘ $[\neg\forall\neg x]$ ’ can unrestrictedly be interpreted as ‘there exists an *unspecified* instantiation of x ’—holds under any interpretation of FOL.

The significance of the label ‘theistic’ is that conventional wisdom ‘omnisciently’ believes that Aristotle’s particularisation remains valid—sometimes without qualification—even over infinite domains; a belief that—as highlighted in §7.A.—is not unequivocally self-evident, but must be appealed to as an article of unquestioning faith (see §7.B.).

Comment 99. We note that our deliberate use of the term ‘Hilbert’s theism’ in this context cannot be extended to Hilbert’s philosophy without explicit qualification²⁴⁸.

Reason In support of his paradigm-challenging thesis in [Fr09] that ‘History has not been kind to Hilbert in its depiction of his turning from mathematics to philosophy to find reassurance that mathematical techniques are justified’, Curtis Franks proffers a particularly insightful perspective:

“...Hilbert did not have a “philosophy of mathematics” in the sense that Plato, Kant, and Frege had theirs. He had no views about what mathematical activity “consists in,” for he thought that all such views endanger mathematics. But this does not mean that he had no philosophical views at all.

Hilbert believed that science in general, and mathematical activity in particular, can advance human understanding both of the world we live in and of the process of understanding itself. His disinterest in traditionally philosophical projects was based not on a dismissal of those projects’ goals, but on a rejection of the ideas that

²⁴⁸Although intended to highlight an entirely different distinction, that the choice of the label ‘theistic’ may not be *totally* inappropriate is suggested by Tarski’s reported point of view to the effect (Franks: [Fr09], p.3): “... that Hilbert’s alleged hope that meta-mathematics would usher in a ‘feeling of absolute security’ was a ‘kind of theology’ that ‘lay far beyond the reach of any normal human science’ ...”.

attaining them calls for extraordinary philosophical means. Hilbert believed that ordinary, “first-order” inquiry—scientific and artistic activity—should suffice. Thus he described Cantor’s mathematical work as providing “the deepest insight into the nature of the infinite,” and he called set theory “a discipline which comes closer to a general philosophical way of thinking [than analysis] and which was designed to cast new light on the whole complex of questions about the infinite” ([1926], p. 188). But he did not agree with Cantor that “even for finite multiplicities a ‘proof’ of their ‘consistency’ cannot be given,” that “the fact of the ‘consistency’ of finite multiplicities is a simple, unprovable truth” (Cantor [1899], p. 937). Before Cantor, the infinite was philosophical terrain; before Hilbert, knowledge of the consistency of mathematical principles was. Design to annex philosophical territory through artistic or scientific revolutions are not signs of philosophical naiveté or naturalistic fallacy, but of genius.

Tarski called Hilbert’s thought “theology.” When Hilbert described his investigation, he characterized them in exactly the opposite way:

Already at this time I should like to assert what the final outcome will be: mathematics is presuppositionless science. To found it I do not need God, as does Kronecker, or the assumption of a special faculty of our understanding attuned to the principle of mathematical induction as does Poincaré, or the primal intuition of Brouwer, or, finally, as do Russell and Whitehead, axioms of infinity, reducibility, or completeness ... ([1928], p. 479)"

... Franks: [Fr09], §1.4, *The wrong conclusion*.

‘Particularly insightful’ because Franks’ interpretation of Hilbert’s thought (see also §9.A.a.), and intent, prior to 1931 can be viewed as implicitly reflecting the *evidence-based* perspective of this investigation, as articulated in the Complementarity Thesis (§1., Thesis 1), if we treat Hilbert’s purported belief ‘that ordinary, “first-order” inquiry—scientific and artistic activity—should suffice’ to mean that *evidence-based* reasoning should suffice (see the concluding paragraphs of §5.A., *What is knowledge*):

- (a) for establishing the truth of mathematical propositions as knowledge in the sense of Piccinini’s ‘Factually Grounded Beliefs’;
- (b) for establishing the provability of mathematical propositions as knowledge in the sense of intuitively ‘Justified True Beliefs’.

11.B. Brouwer’s atheism

In sharp contrast, constructive approaches based on Brouwer’s philosophy of Intuitionism can be labelled ‘atheistic’²⁴⁹ because they—also without providing adequate *evidence-based* criteria for interpreting quantification constructively—deny both that²⁵⁰:

- (a) FOL is consistent (since they *omnisciently* deny that the Law of the Excluded Middle LEM—which is a theorem of FOL—holds under any *well-defined* interpretation of FOL);

Comment 100. The *omniscience* of the belief is reflected in [K152]:

“The formula $\forall x(A(x) \vee \neg A(x))$ is classically provable, and hence under classical interpretation true. But it is unrealizable. So if realizability is accepted as a necessary condition for intuitionistic truth, it is untrue intuitionistically, and therefore unprovable not only in the present intuitionistic formal system, but by any intuitionistic methods whatsoever.”

... Kleene: [K152], p.513.

²⁴⁹As can other ‘constructive’ approaches such as those analysed by Posy in [Pos13] (p.106, §5.1).

²⁵⁰But see also Maietti: [Mt09] and Maietti/Sambin: [MS05].

and that:

- (b) Aristotle’s particularisation holds under any interpretation of FOL that has an infinite domain.

Although Brouwer’s explicitly stated objection appeared to be to the Law of the Excluded Middle (LEM) as expressed and interpreted at the time (Brouwer: [Br23], p.335-336; Kleene: [Kl52], p.47; Hilbert: [Hi27], p.475), some of Kleene’s remarks ([Kl52], p.49), some of Hilbert’s remarks (e.g., in [Hi27], p.474) and, more particularly, Kolmogorov’s remarks (in [Ko25], fn. p.419; p.432) suggest that the intent of Brouwer’s fundamental objection can also be viewed today as being limited only to the (yet prevailing) classical belief—as an article of Hilbertian faith—that the validity of Aristotle’s particularisation can be extended without qualification to infinite domains.

Comment 101. Of interest here is [At23], where Mark van Atten seemingly suggests that Brouwer’s intent was limited to *only* rejection of LEM; in the sense that ‘ $A \rightarrow (B \rightarrow A)$ would not hold’ unrestrictedly.

Reason: Prima facie, van Atten treats Aristotle’s particularisation²⁵¹ as ‘uncontentious’ in Brouwer’s logic; in the sense that ‘from a proof of an existential proposition one should be able to obtain an instance’:

“Pre-theoretically, the following two familiar conditions on constructive non-formal proof are uncontentious: from a proof of an existential proposition one should be able to obtain an instance, and from a proof of a disjunction a proof of one of the disjuncts. Further conditions have led to debate. For example, in the development of intuitionistic logic, Johansson denied that Ex Falso holds for it, Freudenthal held that a proof of any proposition $A \rightarrow B$ must begin by proving A , and Griss argued that negation is not a constructive operation.⁹ There is a large overlap with the concerns that led to the development of relevance logic, and it may be argued that Brouwer’s ideas about logic (Brouwer 1907, 1908) lead to a relevance logic (Atten 2009, p. 124). In the latter case, $A \rightarrow (B \rightarrow A)$ would not hold; certain instances may still be demonstrable, but not on the ground on which the schema is considered acceptable by others.”

... van Atten: [At23], §1.2.3 Constructivity.

Moreover, the ‘uncontentious’ acceptance of Aristotle’s particularisation in constructive logic in general—as the intended interpretation of the formal existential quantifier $[\exists]$ —is also implicit in van Atten’s definition of his ‘Existence Property’ (EP):

“The statements of the informal conditions on existential and disjunctive propositions have formal analogues in what have become known as the Disjunction Property

$$\text{If } S \vdash A \vee B \text{ then } S \vdash A \text{ or } S \vdash B. \quad (\text{DP})$$

and the Existence Property

$$\text{If } S \vdash \exists x P(x) \text{ then } S \vdash P(t) \text{ for some term } t. \quad (\text{EP})$$

The natural and common system HA has both (Kleene 1945). But whereas the mentioned pre-theoretical conditions are constitutive of non-formal constructivism, it is not the case that, analogously, a formal system must have the properties (DP) and (EP) to count as formalisation of meaningful constructive thought.”

... van Atten: [At23], §1.2.3 Constructivity.

²⁵¹§7., Definition 20: *If the formula $[\neg(\forall x)\neg F(x)]$ of a formal first order language L is defined as ‘true’ under an interpretation, then we may always conclude unrestrictedly that there must be some well-definable, albeit unspecified, object s in the domain D of the interpretation such that, if the formula $[F(x)]$ interprets as the relation $F^*(x)$ in D , then the proposition $F^*(s)$ is ‘true’ under the interpretation.*

That such ‘uncontentious’ acceptance of Aristotle’s particularisation is also more *faith*-based (see §7.B.), than *evidence*-based (see §7.C.), is highlighted by the evidence-based proof in [An16]²⁵²: that Gödel’s formula $[\neg(\forall x)R(x)]$, which he proved in [Go31] as formally undecidable in ω -consistent systems such as the first-order Set Theory ZF, is provable in the ω -inconsistent²⁵³ first order Peano Arithmetic PA (see §2.F.: Gödel’s ‘undecidable’ formula $[\neg(\forall x)R(x)]$ is provable in PA).

The significance of the label ‘atheistic’ is that whereas intuitionistic approaches to mathematics deny the faith-based belief in the unqualified validity of Aristotle’s particularisation over infinite domains, their denial of the Law of the Excluded Middle is itself an ‘omniscient’ belief that is also not unequivocally self-evident, and must be appealed to as an article of unquestioning faith²⁵⁴.

11.B.a. Denial of an unrestricted applicability of the Law of the Excluded Middle is a *belief*

The perspective is implicit in Bauer’s unusually candid acknowledgment in [Ba16] that constructive mathematics holds denial or acceptance of the Law of the Excluded Middle (LEM) as an optional belief that is open to persuasion:

“Unless we already believe in $\neg\neg P \Leftrightarrow P$, we cannot get one from the other by exchanging P and $\neg P$.”

... Bauer: [Ba16], p.2.

“Classical mathematical training plants excluded middle so deeply into young students’ minds that most mathematicians cannot even detect its presence in a proof. In order to gain some sort of understanding of the constructivist position, we should therefore provide a method for suspending belief in excluded middle.”

... Bauer: [Ba16], p.6.

We note, however, that Bauer’s admission masks an atheistic disbelief that is embedded equally deeply in constructive mathematics.

Reason: It is *non evidence-based* constructive mathematics that mistakenly equates denial of the ‘principle of excluded middle’, i.e., ‘ $\neg((\forall a)A(a)) \rightarrow (\exists a)(\neg A(a))$ ’ (see §7.B.), in Hilbert’s ε -calculus (in [Hi27]) with denial of LEM in *well-defined* interpretations (in the sense of §1., Definition 1, and §12., Definitions 34 and 35) of formal theories; where the logical axioms and rules of inference are those of the standard first-order logic FOL, in which the classical Law of the Excluded Middle LEM²⁵⁵, i.e., $[(\forall x)(A(x) \vee \neg A(x))]$ ²⁵⁶—is a theorem, and which—as defined in *standard*, introductory, texts on mathematical logic (e.g., [Me64])—forms an essential part of classical mathematical training.

The root of this conflation lies in the fact that Brouwer’s original objection (in [Br08]) was to the definition of existential quantification in terms such as those of Hilbert’s ε -operator in the latter’s ε -calculus, in which LEM is a theorem.

²⁵²Corollary 8.2. The PA formula $[\neg(\forall x)R(x)]$ defined in Lemma 8.1 is PA-provable.

²⁵³[An16], Corollary 8.4. PA is not ω -consistent (see also §2.F., Corollary 2.22).

²⁵⁴Thus lending justification to Krajewski’s comment in [Kr16]: “Brouwer created mathematical intuitionism and was a mystic”.

²⁵⁵Law of the Excluded Middle LEM (cf., [Me64], p.4): For any well-formed formula P of a formal system S, $P \vee \neg P$ is a theorem of S.

²⁵⁶Tertium non datur with an exclusive ‘ \vee ’.

Denying LEM is thus *sufficient* for Brouwer's purpose of denying validity to any interpretation of Hilbert's definition of existential quantification over any putative structure in which the calculus is satisfied.

However it is not *necessary* since—as entailed by §8.D., Corollary 8.15—the converse does not hold.

In other words, denying validity to any interpretation of Hilbert's definition of existential quantification over a structure in which the calculus FOL is satisfied does not entail that LEM is not satisfied over the structure.

Moreover, as observed by Gödel in [Go33], such a denial of tertium non datur *misleadingly* compelled Arend Heyting to admit an intuitionistic notion of “absurdity” into his formalisation of intuitionistic arithmetic, which entailed that “all of the classical axioms become provable propositions for intuitionism as well”:

“If one lets correspond to the basic notions of Heyting's propositional calculus the classical notions given by the same symbols and to “absurdity” (\neg), ordinary negation (\sim), then the intuitionistic propositional calculus **A** appears as a proper subsystem of the usual propositional calculus **H**. But, using a different correspondence (translation) of the concepts, the reverse occurs: *the classical propositional calculus is a sub-system of the intuitionistic one*. For, one has: Every formula constructed in terms of conjunction (\wedge) and negation (\neg) alone which is valid in **A** is also provable in **H**. For each such formula must be of the form: $\neg A_1 \wedge \neg A_2 \wedge \dots \wedge \neg A_n$, and if it is valid in **A**, so must be each individual $\neg A_i$; but then by Gilvenko $\neg A_i$ is also provable in **H** and hence also the conjunction of the $\neg A_i$. From this, it follows that: if one translates the classical notions $\sim p$, $p \rightarrow q$, $p \vee q$, $p \cdot q$ by the following intuitionistic notions: $\neg p$, $\neg(p \wedge \neg q)$, $\neg(\neg p \wedge \neg q)$, $p \wedge q$ then each classically valid formula is also valid in **H**.

The aim of the present investigation is to prove that something analogous holds *for all of arithmetic and number theory*, as given e.g. by the axioms of Herbrand. Here also one can give an interpretation of the classical notions in terms of intuitionistic notions, *so that all of the classical axioms become provable propositions for intuitionism as well*.

[...]

Theorem I, whose proof has now been completed, shows that *intuitionistic arithmetic and number theory are only apparently narrower than the classical versions, and in fact contain them (using a somewhat deviant interpretation)*. The reason for this lies in the fact that the intuitionistic prohibition against negating universal propositions to form purely existential propositions is made ineffective by permitting the predicate of absurdity to be applied to universal propositions, which leads formally to exactly the same propositions as are asserted in classical mathematics. Intuitionism would seem to result in genuine restrictions only for analysis and set theory, and these restrictions are the result, not of the denial of tertium non datur, but rather of the prohibition of impredicative concepts. The above considerations, of course, yield a consistency proof for classical arithmetic and number theory. However, this proof is certainly not “finitary” in the sense given by Herbrand, following Hilbert.”

... Gödel: [Go33], pp.75 & 80.

Thus, from an *evidence-based* perspective, Gödel's demonstration of an equivalence between classical arithmetic and Heyting's Arithmetic emphasises the thesis of this investigation that denial of LEM (tertium non datur) was unnecessary for ensuring finitism; especially since such denial denied formal, finitary, argumentation to Intuitionism for much of that which it apparently sought to protect.

Comment 102. Although, from the perspective of *finitary agnosticism* (see §11.C.) underpinning this investigation, the ‘lack of reception of Brouwer's intuitionism’ in mainstream mathematics can

be seen to lie in his ‘theistic’, and mathematically unjustified²⁵⁷, rejection of classical first-order logic, philosopher Kati Kish Bar-On offers an insightful analysis—as viewed through the prism of Friedman’s [Frd01]—into the philosophical foundations that Brouwer, seemingly, considered critical to his Intuitionism; where she concludes that rejecting an, intuitively plausible, LEM had the consequence that in ‘the community’s eyes, the overall damage Brouwer’s intuitionism caused to mathematics was greater than its achievements’:

“The environmental cost of transitioning to a new framework is another aspect of Friedman’s theory that might shed new light on the lack of reception of Brouwer’s intuitionism. Friedman argues that successive scientific revolutions resemble a series of nested developments and that “earlier constitutive frameworks are exhibited as limiting cases” of the new ones (Friedman 2001, p. 63). Hence, during framework transitions, the price practitioners committed to the old framework have to pay is relatively low. Following this line of thought, the disapproval of Brouwer’s intuitionism did not occur merely because it lacked a solid philosophical tradition but also due to the enormous price intuitionistic mathematics coerced mathematicians to pay. Even the mathematicians who were willing to seriously reconsider their commitments to the old framework found themselves caught between a rock and a hard place; they were aware of the foundational problems that intuitionism seemed to solve, but they could not continue their scientific work without the mathematical theories that Brouwer’s intuitionism forced them to renounce. Eventually, despite not having any concrete solution to the foundational problem, most practicing mathematicians chose to continue their everyday mathematical work and lived with the contradiction. To the community’s eyes, the overall damage Brouwer’s intuitionism caused to mathematics was greater than its achievements. This aspect of Friedman’s theory provides yet another possible explanation of the reluctant response of the mathematical community to Brouwer’s intuitionism.”

... Bar-On: [Bro22], 4.2 Hermann Weyl.

11.B.b. Brouwerian interpretations of $\wedge, \vee, \rightarrow, \exists, \forall$

The significance of the label ‘atheistic’ is also seen in the following, presumably standard, intuitionistic interpretations of $\wedge, \vee, \rightarrow, \exists, \forall$, as detailed by Bishop in [Bi18]:

“Each formula of Σ represents a constructively meaningful assertion, in that it denotes a constructively meaningful assertion for given values of the free variables, if we interpret $\wedge, \vee, \rightarrow, \exists, \forall$ in the constructive (Brouwerian) sense. Here is a brief summary of Brouwer’s interpretations. (The interpretations hold for all fixed values of the free variables.)

- (a) $A \wedge B$ asserts A and also asserts B .
- (b) $A \vee B$ either asserts A or asserts B , and we have a finite method for deciding which of the two it does assert.
- (c) $A \rightarrow B$ asserts that if A is true, then so is B . (To prove $A \rightarrow B$ we must give some method that converts each proof of A into a proof of B .)
- (d) $\forall x A(x)$ asserts that $A(f)$ holds for each (constructively) defined functional f of the same type as the variable x , where $A(f)$ is obtained from $A(x)$ by substituting f for all free occurrences of x .
- (e) $\exists x A(x)$ asserts that we know an algorithm for constructing a functional f for which $A(f)$ holds.”

... Bishop: [Bi18], pp.6-7.

²⁵⁷Unjustified’, since Brouwer seemingly *misconstrued* the Law of the Excluded Middle as entailing Hilbert’s ‘principle of excluded middle’ in the latter’s ε -calculus (see §7).

We note that although Bishop asserts the above interpretations as constructive²⁵⁸, they are ambiguous as to the intended meaning of the words ‘all’ and ‘each/any’²⁵⁹, since the interpretations do not distinguish between:

- (i) *algorithmic computability*, i.e., whether there is an algorithm which, for ‘all’ specifiable values of the free variables, evidences that the formula Σ denotes a constructively meaningful assertion; and
- (ii) *algorithmic verifiability*, i.e., whether, for ‘any/each’ specified value of the free variables, there is an algorithm which evidences that the formula Σ denotes a constructively meaningful assertion.

Accordingly, they cannot accommodate a coherent computational interpretation of Gödel’s first-order arithmetical formula $[R(x)]$, which:

- (1) is such that the PA-formula $[R(n)]$ is PA-provable for any substitution of the numeral $[n]$ for the variable $[x]$ in the PA-formula $[R(x)]$, even though the formula $[(\forall x)R(x)]$ is not PA-provable;

and which:

- (2) interprets as an arithmetical relation, say $R^*(x)$, such that, for any specified natural number n , there is *always* some algorithm that will evidence the proposition $R^*(n)$ as true, but there is *no* algorithm that, for any specified natural number n , will evidence $R^*(n)$ as a true arithmetical proposition (an immediate consequence of §2.F., Corollary 2.21).

Curiously, although (1) is essentially the first half of Gödel’s ‘undecidability’ argument in [Go31]²⁶⁰, the significance of interpretation (2) apparently escaped Gödel’s attention; even though what we have termed as an ambiguity—reflecting a failure to constructively define, and distinguish between, the concepts ‘for each/any’ and ‘for all’—in the intuitionistic interpretation of quantification can, reasonably, be seen as something that Gödel too viewed with disquietude as a ‘vagueness’ in Heyting’s formalisation of intuitionistic logic—a vagueness which he, however, seemed at the time to view as an *unsurmountable* barrier²⁶¹ towards the furnishing of a constructive intuitionistic proof of consistency for classical arithmetic. As remarked by Mark van Atten in [At17]:

²⁵⁸As does Arend Heyting in [Hyt59]:

“A formula of the form $\exists xA(x)$ can have no other meaning than: “A mathematical object x satisfying the condition has been constructed.”

... Heyting: [Hyt59], p.69.

²⁵⁹For the broader, *evidence-based*, significance of the distinction, see §10.C., *Is the PA-formula $[(\forall x)F(x)]$ to be interpreted weakly or strongly?*; also §7.C., *Evidence-based quantification*.

²⁶⁰p.25: “1. 17 Gen r is not κ -provable”.

²⁶¹Albeit surmountable today, once the source of the ambiguity is identified and removed, since PA is finitarily consistent (see §2.C., Theorem 2.16).

“Gödel’s 1933 lecture is concerned with the question of a constructive consistency proof for classical arithmetic. In considering what should count as constructive mathematics, Gödel there argues against accepting impredicative definitions, and insists on inductive definitions. Gödel discusses the prospects for a consistency proof for classical arithmetic using intuitionistic logic, then best known from Heyting’s formalisation ‘Die formalen Regeln der intuitionistischen Logik’ (Heyting, 19301,b,c), as well as Heyting’s Königsberg lecture of 1931, ‘Die intuitionistische Grundlegung der Mathematik’, published as Heyting 1931.

[...]

The principles in Heyting’s formalisation that have Gödel’s special interest are those for ‘absurdity’, that is, intuitionistic negation. But Gödel goes on to argue that this notion is not constructive in his sense, and hence of no use for a constructive consistency proof of classical arithmetic. The problem he sees is that their intuitionistic explanation involve a reference to the totality of all constructive proofs. The example he gives is

$$p \supset \neg\neg p$$

which, he says, means ‘If p has been proved, then the assumption $\neg p$ leads to a contradiction. Gödel says that these axioms are not about constructions on a substrate of numbers but rather on a substrate of proofs, and therefore the example may be explicated as ‘Given *any* proof for a proposition p , you can construct a reductio ad absurdum for the proposition $\neg p$ ’. He then comments that

Heyting’s axioms concerning absurdity and similar notions [...] violate the principle, which I stated before, that the word ‘any’ can be applied only to those totalities for which we have a finite procedure for generating all their elements [...]. The totality of all possible proofs certainly does not possess this character, and nevertheless the word ‘any’ is applied to this totality in Heyting’s axioms [...]. Totalities whose elements cannot be generated by a well-defined procedure are in some sense vague and indefinite as to their borders. And this objection applies particularly to the totality of intuitionistic proofs because of the vagueness of the notion of constructivity. Therefore this foundation of classical arithmetic by means of the notion of absurdity is of doubtful value. (Gödel, 1933b, p.53)

A draft of this passage in Gödel’s archive does not quite end with rejection of Heyting’s logic. Instead, it reflects:

Therefore you may be doubtful [sic] as to the correctness of the notion of absurdity and as to the value of a proof for freedom from contradiction by means of this notion. But nevertheless it may be granted that this foundation is at least more satisfactory than the ordinary platonistic interpretation [...]

Either way, the doubt about, or objection to, the notion of absurdity immediately generalises to implication as such.

It is remarkable, given the construction of Gödel’s talk, in which the discussion of the intuitionistic logical connectives is preceded by an argument against the use of impredicative definitions for foundational purposes, that the objection Gödel puts forward is not that Heyting’s principles for absurdity are impredicative, but that they are vague. Impredicativity of course entails constructive undefinability and in that sense vagueness, and it is possible that Gödel had seen the problem of impredicativity but thought that, in the context of a consistency proof that is looked for because of its epistemic interest, vagueness is the more important thing to note, even if impredicativity is the cause of it."

... van Atten: [At17], pp.6-7.

11.B.c. Conception of Truth in Intuitionism

The following review of the concept of truth in Intuitionism by Panu Raatikainen, in [Raa04], highlights that the consequence, of what we have termed as the ‘atheistic’ denial of the Law of the Excluded Middle in Intuitionistic calculi, has been to treat the concept of ‘truth’ in Intuitionism as a constructive alternative—rather than as the complement suggested by the Complementarity Thesis (§1., Thesis 1)—to the concept of ‘proof’ in formal argumentation, entailed by what we have termed as the ‘theistic’ assumption of the validity of Aristotle’s particularisation in any well-defined interpretation of Hilbert’s ε -calculus:

“I will end by recalling what Heyting once said is the aim of intuitionism: ‘We look for a basis of mathematics which is directly given and which we can immediately understand without philosophical subtleties’ (*Heyting 1974*, p. 79). It is arguable that after almost a hundred years of intensive attempts, intuitionism has not yet succeeded in this. Above, we have examined the three basic choices there are for the intuitionistic theory of truth, the strict actualism, the liberalized actualism and possibilism, and found all them wanting.

In this Appendix, I shall deal solely with the later intuitionism which has a more positive view of logic than the orthodox intuitionism of Brouwer, according to which mathematics is absolutely independent of logic. Indeed, much of contemporary intuitionism, or constructivism, views mathematics simply as deriving theorems with the help of intuitionistic logic from intuitionistically acceptable axioms (and whatever principles used in proofs not covered by intuitionistic logic). Thus e.g. Bridges says that in practice what the contemporary constructive mathematicians are doing amounts to ‘doing mathematics with intuitionistic logic’ (*Bridges 1997*).

Another popular trend in the present-day intuitionism is to emphasize that one should recognize a proof when one sees one.²⁸ This idea derives from Kreisel, and has been pressed repeatedly especially by Dummett. More formally, it is expressed by the requirement that the proof relation must be decidable. It is indeed arguable that such a requirement is necessary for the intuitionistic epistemology. It also harmonizes well with Heyting’s view that ‘[a] mathematical construction ought to be so immediate to the mind and its result so clear that it needs no foundation whatsoever’ (*Heyting1956b*, p. 6).

The whole picture I want to consider here is beautifully expressed by Sundholm: ‘Proofs begin with immediate truths (axioms), which themselves are not justified further by proof, and continue with steps of immediate inference, each of which cannot (be) further justified by proof’ (*Sundholm 1983*, p. 162). I shall next argue that the two above ideas are incompatible. (Interestingly, also Beeson (*1985*) denies the decidability of proof relation. He ends up with this conclusion somewhat differently than the way I do.)

For simplicity, let us focus on the provability in the language of arithmetic $L(HA)$. Now given a finite sequence of formulas, it is certainly possible to check effectively whether every step in it is an application of intuitionistically acceptable rule of inference. But how about the premises? Only if one can in addition see that all the premises of a derivation are intuitionistically true one can say that one has a proof of the conclusion at hand. This is at least in principle possible if axiomhood is a decidable property. However, in the intuitionistic setting, it cannot be! For if it was, the intuitionistic provability could be captured by a formalized system. And then, by Gödel’s theorem, there would be truths that are unprovable, contrary to the basic principle of intuitionism, which equates truth with provability.

The situation is actually even much worse—I doubt that it is generally realized how bad it really is. Not only must the set of admissible axioms be undecidable. It cannot be semi-decidable, i.e. recursively enumerable (Σ_1^0), it cannot be Trial-and-Error decidable (Δ_2^0); it cannot be anywhere in the arithmetical hierarchy (not Σ_n^0 for any n). (Here I assume that the notions of arithmetical hierarchy, or at least the idea of being definable in the language of arithmetic, make sense; in practice quite many contemporary intuitionists seem to accept them.) For assume that the property of being an admissible axiom were definable by an arithmetical formula (however complex). This

implies that also provability is definable in the language of arithmetic. Then one can apply Gödel's technique and construct a statement of the language which is unprovable but true.

Thus the totality of intuitionistically provable sentences (already, restricted to $L(HA)$ i.e. the arithmetical sentences) necessarily is non-arithmetical, i.e. at least hyperarithmetical (Δ_1^1). But this means that they are just as abstract and inaccessible as truth in classical arithmetic. The same holds already for the alleged axioms, that is, 'the immediate truths'. But certainly non-arithmeticality makes the sphere of 'the immediate truths' implausibly complex and inaccessible. If one cannot tell whether the premises used in a derivation are acceptable, that is, true, or not, one cannot tell whether one has a genuine proof before one's eyes or not, contrary to the standard assumption of contemporary intuitionism."

... Raatikainen: [Raa04]

Although, in an illuminating attempt [Bro22a] to view as *complementary* the differences between the works of Brouwer, Heyting, and Weyl—vis à vis the concepts of 'truth' and 'proof' in Intuitionism—philosopher Kati Kish Bar-On *does* argue that:

"Brouwer, Weyl, and Heyting each held a different view regarding the proper way of doing mathematics, and those differences translated into three different versions of intuitionism. Unlike Brouwer's intuitionism and Weyl's intuitionism, Heyting's mathematical intuitionism affected the classical body of knowledge by absorbing into it an intuitionistic image of knowledge, thereby creating a mathematical theory that is part of both layers. Among the three, Heyting was the only one who used formal methods from the classical body of knowledge to express his intuitionistic mathematics, thereby creating a way for classical mathematicians to discuss intuitionistic ideas. This perspective, therefore, enriches current historical and philosophical accounts, and when all are considered together, they combine to offer a more comprehensive account of the intuitionistic story and its reception than any can offer alone."

... Bar-On: [Bro22a], §7, Concluding Remarks.

'Illuminating' from the evidence-based perspective of this investigation, since Brouwer, Heyting and Weyl can be viewed as pursuing essentially *complementary* goals; where, with hindsight:

- (a) Brouwer's philosophy can be putatively viewed as focusing upon (restricting his considerations to?) what Markus Pantsar terms (see §1.A.) as 'pre-formal mathematical truth'; where he (Brouwer) 'sought' to differentiate between 'finitary pre-formal mathematical truth', and 'non-finitary pre-formal mathematical truth'.
- (b) Heyting's philosophy can be putatively viewed as focusing upon (restricting his considerations to?) what the Complementarity Thesis (see §1.) terms as 'proof theory'; where he 'sought' to identify a first-order mathematical language/theory in which all, and only all, of Brouwer's 'finitary pre-formal mathematical truths' were capable of being expressed formally as 'provable propositions' that were logically entailed, by a finite set of axioms/axiom schemas, as the terminal formulas of 'finite proof sequences' using a finitary first-order logic.
- (c) Weyl's philosophy can be putatively viewed as focusing upon (restricting his considerations to?) what the Complementarity Thesis (see §1.) terms as 'constructive mathematics'; where he 'sought' to identify a finitary interpretation of, say, 'Heyting's' mathematical language/theory, under which the axioms/axiom schemas and provable propositions could be assigned values of 'formal truth' that corresponded to—and thereby validated²⁶²—Brouwer's 'finitary pre-formal mathematical truths'.

²⁶²Validated' in the sense of §1.G.d, *Validating knowledge, truth, and proof in pre-formal mathematics*.

However, they all suffered under the handicap of Brouwer’s powerfully advocated—albeit unjustified—insistence on disallowing the Law of the Excluded Middle LEM as a finitary rule of inference (and, thereby, their perspectives could not admit appeal to the first-order logic FOL, in which LEM is a theorem²⁶³).

‘Unjustified’ since Brouwer conflated LEM with Hilbert’s ‘principle of excluded middle’ in the latter’s—essentially ‘non-finitary’— ε -calculus²⁶⁴; and thus remained unaware that whereas Hilbert’s ‘principle of excluded middle’ entails LEM, the converse is not true²⁶⁵.

Moreover, as entailed by the finitary proof of Theorem 2.16 (PA is *strongly* consistent) in §2.C.a., FOL too is finitarily consistent (see §8.D., Theorem 8.13).

11.C. Finitary agnosticism

Finally, the *evidence-based* reasoning in [An16] shows that we can avoid both Hilbertian and Brouwerian ‘omniscience’, in our foundational assumptions, by adopting what may be labelled as a finitarily ‘agnostic’—essentially Wittgensteinian (see also §12.B.; §13.)—perspective; and noting that although, if Aristotle’s particularisation holds in an interpretation of a FOL then LEM must also hold in the interpretation, the converse is not true (see §8.D., Corollary 8.15).

“What really matters to Wittgenstein is not the denial that an arithmetical term has a meaning, but rather that this meaning is an ideal object, named or described by the term. In his view, even the distinction between a numeral and a number is quite legitimate, in perfect analogy with the distinction, explicitly made by him, between a propositional sign (*Satzzeichen*) and a proposition (*Satz*). That between numerals and numbers is not an ontological distinction between two kinds of entities (material entities versus ideal entities), but a distinction between two ways of considering the one linguistic reality: the way in which one considers a sign as a mere physical entity and the way in which one takes into account its role of notational device to represent a certain formal property.⁵⁹ Nonetheless, a point has to be stressed, which to a large extent shortens Wittgenstein’s distance from formalism and justifies, in my opinion, the description of his earlier conception of mathematics as quasi-formalistic (a label that, as we shall see, is fitting for every stage of the whole development of his philosophy of mathematics). The recognition of the mutual reducibility of two models of linguistic construction—when calculation is required—is the outcome of a rule-governed process of transformation of a certain grouping of the elements of a string of “ Ω ”, *exhibiting* the first model, into a different one, *exhibiting* the second model. Thus, although arithmetical signs within calculations are not considered as mere physical structures, doing mathematics is appropriately described as a sign manipulation activity.

The last remark leads us to the comparison with intuitionism. We have said that the reference to vision, intuition or immediate recognition plays a decisive role in Wittgenstein’s conception of our “knowledge” of the formal domain. And there is also a certain similarity between Wittgenstein’s theses on the purely instrumental role assigned to mathematical notation and even to the formulation of theorems (equations), on the one hand, and certain typical ideas of Brouwer concerning logical and mathematical language, on the other. However, a decisive element of disagreement between the two conceptions can be easily identified. When Wittgenstein, dealing with mathematics and logic, speaks of vision, he does not intend to supply a psychological foundation to mathematical activity. Rather, he resorts to the notion of intuition or to the metaphor of vision to describe the relationship between speakers and what is shown by language (the domain of necessity) and to contrast it with the meaningful expression of a thought (the picture of a contingent state of affairs). It goes without saying that all this has nothing to do with the psychologization of mathematics of

²⁶³See §8.D., Corollary 8.14: *The Law of the Excluded Middle* [$P \vee \neg P$] is a theorem of the first-order logic FOL.

²⁶⁴See §7.: *Both Hilbert’s ε -calculus and Brouwer’s Intuitionism are fragile.*

²⁶⁵See also §5.: *Three fragile Hilbertian, Brouwerian, and Gödelian, dogmas.*

intuitionists.⁶⁰

... Frascolla: [Fra94], § Foundations of Mathematics (I), p.40.

The significance of the label ‘agnostic’ is that an *evidence-based* perspective:

- (a) Neither shares an ascetic Brouwerian faith which unnecessarily denies appeal to LEM, and, ipso facto, to the consistency of FOL—in which LEM is a theorem—since such consistency follows immediately (see §8.D., Theorem 8.13) from the *finitary* proof of consistency for the first order Peano Arithmetic PA in [An16], Theorem 6.8 (p.41; see also §2.C.a., Theorem 2.16);
- (b) Nor shares a libertarian Hilbertian faith that unrestrictedly admits Aristotle’s particularisation over infinite domains (see §8.D., Corollary 8.12).

Moreover, recognising such distinction has significant consequences for the the natural sciences in general, and cognitive sciences in particular, since they yet subscribe unquestioningly to the, not uncommon, perception²⁶⁶ that Gödel’s Incompleteness Theorems set absolute limits on the ability of the brain to express and communicate mental concepts verifiably.

On the contrary, both the classical and intuitionistic interpretations of quantification yield interpretations of the first-order Peano Arithmetic PA—over the structure \mathbb{N} of the natural numbers—that are complementary, not contradictory.

The former yields the *weak* standard interpretation $\mathcal{I}_{PA(\mathbb{N}, SV)}$ of PA over \mathbb{N} , which is *well-defined* with respect to *weak* non-finitary assignments of algorithmically verifiable Tarskian truth values T_V to the formulas of PA under $\mathcal{I}_{PA(\mathbb{N}, SV)}$ and which, from a perspective such as that of John Lucas’ Gödelian Thesis ([Lu61]; [Lu96]), can be viewed as circumscribing the ambit of *non-finitary* human reasoning about ‘true’ arithmetical propositions (see §2.F.).

The latter yields a *strong* finitary interpretation $\mathcal{I}_{PA(\mathbb{N}, SC)}$ of PA over \mathbb{N} , which is *constructively well-defined* (in the sense of §12., Definitions 32 to 34) with respect to *strong* finitary assignments of algorithmically computable Tarskian truth values T_C to the formulas of PA under $\mathcal{I}_{PA(\mathbb{N}, SC)}$ and which, from the perspective of Lucas’ Gödelian Thesis, can be viewed as circumscribing the ambit of *finitary* mechanistic reasoning about ‘true’ arithmetical propositions; where we tentatively define:

Definition 31. (Well-defined interpretation) *An interpretation \mathcal{I} of a formal language L , over a domain D of a structure \mathcal{S} , is constructively well-defined relative to an assignment of truth values $T_{\mathcal{I}}$ to the formulas of L if, and only if, the provable formulas of L interpret as true over D under \mathcal{I} relative to the assignment of truth values $T_{\mathcal{I}}$.*

Of interest is Frank Waaldijk’s perspective, which particularly emphasises the need for such a unified, constructive, foundation for the mathematical representation of elements of reality such as those considered in [LR00] (see also §27.):

“Our investigations lead us to consider the possibilities for ‘reuniting the antipodes’. The antipodes being classical mathematics (CLASS) and intuitionism (INT). . . It therefore seems worthwhile to explore the ‘formal’ common ground of classical and intuitionistic mathematics. If systematically developed, many intuitionistic results would be seen to hold classically as well, and thus offer

²⁶⁶Addressed informally from a naive perspective in [An04].

a way to develop a strong constructive theory which is still consistent with the rest of classical mathematics. Such a constructive theory can form a conceptual framework for applied mathematics and information technology. These sciences now use an ad-hoc approach to reality since the classical framework is inadequate. . . . [and can] easily use the richness of ideas already present in classical mathematics, if classical mathematics were to be systematically developed along the common grounds before the unconstructive elements are brought in."

... Waaldijk: [W103], §1.6, p.5).

11.C.a. The significance of finitary agnosticism

The significance of finitary agnosticism, and of the entailed *evidence-based, strong* proof (see [An16], Theorems 6.7 and 6.8, p.41; also §2.C., Theorem 2.16) of the consistency of the first-order Peano Arithmetic PA, for Hilbert's Program, and its consequences for a coherent philosophy of the nature of mathematics and of mathematical truth, is highlighted in Pantsar's following, remarkably incisive, analysis of the inter-relationship between what he calls *pre-formal mathematics*, formal mathematics, and Tarski's definitions of the satisfaction and truth of the formulas of a formal system under a *well-defined* interpretation:

"The concept of pre-formal mathematical thinking is essential to this work, and it needs elaboration. The details that we attribute to preformal thinking, however, should not be considered to be crucial for the arguments here. More important is the fact that the phenomenon of pre-formal thinking *exists*, and that it is bound to bear enough resemblance to the account here in its central facets. As it is presented in this work, pre-formal mathematics consists of two sides. First, there is the individual learning of mathematical concepts, to which we will return later. Second, even those who are familiar with mathematical formalism still use the pre-formal element in their thought process all the time, even when the results get a purely formal presentation. Constructing a mathematical proof is not only about mechanically grinding out the formalism; it also includes the crucial stage of discovering the connections and ideas that will be the basis for the formal presentation. One crucial part of this is the discovery of *new* mathematical theorems. Of course this only concerns a minuscule part of all the practising mathematicians, but that part is all the more interesting.

Because of the elusive and heterogenic subject matter, comprehensive psychological studies of mathematical discovery/invention are obviously too much to ask. The best we have are the regrettably few accounts of the subjective experiences of mathematicians. Although obsolete in its psychological terminology, the mathematician Jacques Hadamard's *The Psychology of Invention in the Mathematical Field* (1954) is probably still the most important work in this area. The bulk of that book is based on Henri Poincaré's account of mathematical invention, where such matters as the unconscious element, mental images and the aesthetic aspects of mathematical discovery are given an important role. In Hadamard's research he found out that most mathematicians shared similar experiences. The details of them are fascinating, but as such not central to this work. What is important is that Hadamard's book gives us clear evidence that the psychology of mathematical invention is not reducible to the neat formal accounts that are the end product of mathematical studies. Mathematical thinking as a human phenomenon is a vastly more complex and broad field.

However, it must be remembered that Hadamard is concerned with the discovery of mathematical truths, which is only half of the picture. At least as important is the way that we *justify* believing in such supposed truths. That of course happens ultimately by proving them. Mathematical discovery/invention by itself could be thoroughly un-mathematical—which it of course is not—but as long as the discovered/invented theorems can be proven, the nonformal elements included in the discovery could be philosophically irrelevant. But from Hadamard's book we get a different picture. The psychology of mathematical invention is closely connected to the formal mathematics, and all our non-formal ways of processing mathematics make for an indispensable part of mathematics as a human phenomenon. I want to extend that conclusion to mathematical thinking in general, and not just the context of discovery.

Of course this approach as such is nothing drastic: even extreme formalists would not claim that mathematics does not include a non-formal element. What they do claim is that in the philosophical accounts of mathematics this element is essentially superfluous. However, in this chapter I will argue that this is not the case. The recognition of pre-formal mathematical thinking is essential to the philosophy of mathematics. In the model proposed in Chapter 4.3, mathematics consisted of three parts. Starting from the end product, the part (1) is formal mathematics. The part (2) is pre-formal mathematics, which is our actual mathematical *thinking*, how we process mathematics “in our heads”. This part is essentially semantical, dealing with the *meanings* of the theorems of formal mathematics. That is why in the pre-formal part we use examples, diagrams and informal presentations—they give us a better *understanding* of the meanings of the formal concepts. The part (3) is the reference of pre-formal mathematics, that is, the subject matter of mathematics: what the theorems of mathematics *ultimately* refer to.

How are these parts of mathematical thinking connected to each other? *Proof* is obviously in the realm of formal mathematics, and it is designed to correspond to our pre-formal ideas of *truth*, which in turn corresponds to the part (3), the final subject matter of mathematics. In this way, there is a connection through all the stages. Had Hilbert’s program been established successfully, formal theories of mathematics could describe a direct correspondence between the parts (1) and (3). However, that would not have done anything to make the pre-formal thinking obsolete. In the practice of mathematics it would most likely have caused no changes. Certainly the completeness and consistency of formal systems would have been important results in the philosophy of mathematics: ultimately, they would have shown pre-formal thinking to be superfluous in the connection between formal mathematics and their references. But even so, it would not have changed the fact that human beings process mathematics semantically. Although the philosophical importance of pre-formal thinking may have been diminished, all three levels of mathematics would still have been needed to make a theory of philosophy of mathematics complete. Knowing what happened to Hilbert’s formalist program, it is all the more important to recognize all three levels."

...Pantsar: [Pan09], §4.5 Pre-formal mathematics.

What is striking about Pantsar’s illuminating perspective of the inter-relation between his pre-formal mathematics, formal mathematics, and classical Tarskian truth definitions, is that:

- since the *strong* proof (see [An16], Theorems 6.7 and 6.8, p.41; also §2.C.a., Theorem 2.16) of the consistency of the first-order Peano Arithmetic PA validates Hilbert’s Program (see [Zac07]),
- by essentially providing the *finitary* proof of consistency for arithmetic that Hilbert had sought when articulating the second of his twenty three Millenium problems (see [Hi00]) at the 1900 International Congress of Mathematicians in Paris,

Tarski’s definitions:

- when *evidence-based* (in the sense of §7.C.), and applied *strongly* (see [An16], §6, p.40; see also §2.C.), show ‘pre-formal thinking to be superfluous in the connection between formal mathematics and their references’; whilst
- when *faith-based* (in the sense of §7.B.), and applied *weakly* (see [An16], §5, p.38; see also §2.B.), could establish a possible reference between pre-formal mathematics and ‘our actual mathematical *thinking*, how we process mathematics “in our heads”’,
- which, essentially, is that which can be viewed as corresponding to what Pantsar’s pre-formal mathematics seeks to express formally—in the sense of Carnap’s *explicandum* in [Ca62a]; or of Gamez’s ‘C-theory’ in [Gam18], F, p.79; or of what some cognitive scientists, such as Lakoff and Núñez in [LR00] (see also §27.), term as ‘conceptual metaphors’.

From the *evidence-based* interpretation of this investigation, the above perspective can also be viewed as asserting that:

- what can be *conceived as justifiably true* in pre-formal mathematics,
- exceeds that which can be *proven* in formal mathematics,
- which exceeds that which can be *evidenced* as algorithmically *verifiable truths* in formal mathematics,
- which exceeds that which can be *evidenced* as algorithmically *computable truths* and, ipso facto, which can be *categorically* communicated as mathematical *knowledge* in formal mathematics.

The mathematical significance of this can be variously seen, for instance, in:

- (a) the *pictorial proof* of §22.A., Proposition 22.2 (The prime factors of an integer are mutually independent), and its entailment
 - (a') §22.A., Proposition 22.5 ($P \neq NP$ by Eratosthenes sieve); vis à vis
- (b) the algorithmically *verifiable* proof of §22.A.c., Theorem 22.12 (The prime factors of an integer are mutually independent); and its entailment
 - (b') §22.A.f., Theorem 22.16 (FACTORISATION is not in P); as well as
- (c) the algorithmically *verifiable* proof of §21.D., Corollary 21.2 (Lucas' Gödelian Thesis); and its entailment
 - (c') §21.E., Query 22 (Turing Test).
- (d) the algorithmically *computable* proof of §2.C.a., Theorem 2.16 (PA is *strongly* consistent); and its entailment
 - (d') §2.E.b., Corollary 2.18 (PA is categorical).

11.D. Theological metaphors in mathematics

The significance of, and justification for, the theological distinction sought to be made in this investigation is highlighted by philosopher Stanislaw Krajewski in a relatively recent review of the unsettling 'omniscient theological' claims that mathematics has sought—and yet seeks—to impose upon those whom it should seek to serve (in the sense sought to be elaborated in §13.C.).

11.D.a. Brouwer's intuitionism seen as mysticism

For instance we note that, from Krajewski's perspective:

“Brouwer created mathematical intuitionism and was a mystic. The relationship between the two must not be excluded even though Brouwer seemed to deny any connection. In 1915, he wrote that neither “practical nor theoretical geometry can have anything to do with mysticism.” (after van Dalen, 1999, 287) On the other hand, in a 1948 lecture *Consciousness, Philosophy, and Mathematics*, he summed up his famous picture of the mental – or, indeed, is it mystical? – origins of arithmetic, and eventually of the whole of mathematics:

‘Mathematics comes into being, when the two-ity created by a move of time is divested of all quality by the subject, and when the remaining empty form of the common substratum of all two-ities, as a basic intuition of mathematics is left to an unlimited unfolding, creating new mathematical entities ...’ (Brouwer, 1949, 1237; or 1975, 482)".

... Krajewski: [Kr16].

In [AT03], Mark van Atten and Robert Tragesser note how the ephemeral nature of Brouwer's ‘mysticism’—and the relevance of his, by conviction ‘mathematically inarticulable’, intuitionistic beliefs for the foundations of mathematics—may escape rational articulation; and the dramatically contrasting ways in which not only Brouwer, but also Gödel—although arguably at opposite philosophical poles—perceived their own mystical beliefs and vainly strained— in the absence of a common evidential yardstick for defining arithmetical truth—to seek subjectively sustainable bases for their respective dogmas.

Comment 103. Namely, Brouwer's rejection of LEM as non-constructive, and Gödel's ‘omnisciently’ believing all formal arithmetics to be ω -consistent, both of which we show as mistaken (the first as an immediate consequence of §8.D., Theorem 8.13; and the second by §2.F., Corollary 2.22 and, independently, by §12.B.f., Theorem 12.6).

11.D.b. The unsettling consequences of belief-driven mathematics

In his review Krajewski stresses the disquieting consequences of such belief-driven mathematics:

“Examples of possible theological influences upon the development of mathematics are indicated. The best known connection can be found in the realm of infinite sets treated by us as known or graspable, which constitutes a divine-like approach. Also the move to treat infinite processes as if they were one finished object that can be identified with its limits is routine in mathematicians, but refers to seemingly super-human power. For centuries this was seen as wrong and even today some philosophers, for example Brian Rotman, talk critically about “theological mathematics”. Theological metaphors, like “God's view”, are used even by contemporary mathematicians. While rarely appearing in official texts they are rather easily invoked in “the kitchen of mathematics”. There exist theories developing without the assumption of actual infinity the tools of classical mathematics needed for applications (For instance, Mycielski's approach). Conclusion: mathematics could have developed in another way. Finally, several specific examples of historical situations are mentioned where, according to some authors, direct theological input into mathematics appeared: the possibility of the ritual genesis of arithmetic and geometry, the importance of the Indian religious background for the emergence of zero, the genesis of the theories of Cantor and Brouwer, the role of Name-worshipping for the research of the Moscow school of topology. Neither these examples nor the previous illustrations of theological metaphors provide a certain proof that religion or theology was directly influencing the development of mathematical ideas. They do suggest, however, common points and connections that merit further exploration.”

... Krajewski: [Kr16].

The disquieting, ‘reality-denying’, consequences of Krajewski's point that:

“... the move to treat infinite processes as if they were one finished object that can be identified with its limits is routine in mathematicians, but refers to seemingly super-human power.”

is seen in §20.C., where we are confronted with 2-dimensional geometrical models, of infinite processes expressing plausible real-world examples, that have well-defined geometrical limits which do not, however, correspond to their ‘limiting’ configurations in a putative ‘completion’ of Euclidean Space.

As we argue in §7.I., Theorem 7.5, since every real number is specifiable in PA, instead of defining real numbers as the putative limits of putatively definable Cauchy sequences²⁶⁷ which ‘exist’ in some omniscient Platonic sense in the interpretation of an arithmetic, we can alternatively define—from the perspective of constructive mathematics, and seemingly without any loss of generality—such numbers instead by their *evidence-based*, algorithmically *verifiable*, number-theoretic functions (as defined in §7.C.) that formally express—in the sense of Carnap’s ‘explication’—the corresponding Cauchy sequences, viewed now as non-terminating *processes* in the standard interpretation of the arithmetic that may, sometimes, tend to a discontinuity (see §20.C., Cases 1-4).

Moreover, as Krajewski further notes—and implicitly questions—the dichotomy in accepting omniscient ‘limits’ on the basis of, seemingly subjective, ‘self-evidence’ comes at an unacceptable price: it compels the prevalent double-standards in addressing mathematical and logical concepts that are defined in terms of ‘infinite’ processes:

“Up to the 18th century only potential infinity was considered meaningful. For example, Leibniz believed that “even God cannot finish an infinite calculation.” (Breger, 2005, 490) Since the 19th century we have been using actually infinite sets, and for more than a hundred years we have been handling them without reservations. Nowadays students are convinced that this is normal and self-evident as soon as they begin their study of modern mathematics. This constitutes the unbelievable triumph of Georg Cantor. There may have been precursors of Cantor, and as early as five centuries before him there had been ideas about completing infinite additions—as documented in the paper by Zbigniew Król in the present volume—but clearly it was Cantor who opened to us the realm of actually infinite structures.

As is well known, we handle, or at least we pretend we can handle, with complete ease the following infinite sets (and many other ones): the set of (all) natural numbers, real numbers etc.; the transfinite numbers—even though the totality of all of them seems harder to master; the set of (all) points in a given space, the sets of (all) functions, etc.

It is apparent that we behave in the way described by Boethius or Burley as being proper to God. Infinite structures are everyday stuff for mathematicians. What is more, we are used to handling infinite families of infinite structures. Thus the set (class) of all models of a set of axioms is routinely taken into account as is the category of topological spaces and many other categories approached as completed entities. In addition, in mathematical logic one unhesitatingly considers such involved sets as the set of all sentences true in a specific set theoretical structure or in each member of an arbitrary family of structures.

Such behavior is so familiar that no mathematician sees it as remarkable. But the fact is that this is like being omniscient. We do play the role of God or, rather, the role not so long ago deemed appropriate only for God!

From where could the idea of actual infinity in mathematics have arisen? The only other examples of talk that remind of actual infinity are religious or theological, as the just mentioned verses from

²⁶⁷‘putatively definable’ since not all Cauchy sequences are algorithmically computable (see §7.G., Theorem 7.2). The significance of this distinction for the physical sciences is highlighted in §23.D. and §23.D.a..

the psalms indicate. This fact is suggestive but it does not constitute a proof that post-Cantorian mathematics was derived from theology. Actually, we know that Cantor was stimulated by internal mathematical problems of iterating the operation of the forming of a set of limit points and performing the “transfinite” step in order to continue the iteration. This fact leads to a more general issue of infinite processes.”

... Krajewski: [Kr16].

11.D.c. Does mathematics *really* ‘need’ to be omniscient?

The ‘need’ for an omniscience that permits ‘reification’ of a putative infinite process—as in the postulation of an Axiom of Choice—is frowned upon by Krajewski (also shown as dispensable from a cognitive perspective by Lakoff and Núñez in [LR00]; see also §27.), since it merely obscures the lack of *well-definedness*—in the sense of *evidence-based* justification as detailed in §7.F. (Definition 26)—of the infinite process and, ergo, of any consequences that appeal to the Axiom:

“Another historically important example of a reification of an infinite action is provided by the Axiom of Choice. Choosing one element from each set of an arbitrary family of (disjoint) sets must constitute a series of movements; if the family is infinite it must be an infinite series of operations.

If there is a single rule according to which the choice is done then the resulting set of representatives can be defined and can be relatively safely assumed to exist. In the case of an arbitrary family of sets there is no such definition, and it is necessary to postulate the existence of the selection set. Its existence is not self-evident. The first uses of the Axiom of Choice were unconscious, but seemed natural to the advocates of unrestricted infinite mathematics. However, when the use of this axiom became understood, opposition against it arose. Among the opponents were important mathematicians, like the French “semi-intuitionists”, who did handle infinite operations, but felt that some limitations were necessary. For example, in 1904 Emile Borel claimed that arbitrary long transfinite series of operations would be seen as invalid by every mathematician. According to him the objection against the Axiom of Choice is justified since “every reasoning where one assumes an arbitrary choice made an uncountable number of times ... is outside the domain of mathematics”. Interestingly, against Borel, Hadamard saw no difference between uncountable and countable infinite series of choices. He rejected, however, an infinity of dependent choices when the choice made depends on the previous ones. (Borel 1972, 1253) All the just mentioned choice principles are considered obviously acceptable and innocent by contemporary mathematicians. The former opposition was clearly derived from the realization that an infinite number of operations is impossible. Or, it is impossible if our power is not divine.

Another familiar example of handling the result of an infinite process as if it was unproblematic is found in mathematical logic. Namely, we often consider the set of all logical consequences of a set of propositions. Of course, it is impossible to “know” all of them. It is also impossible to write down all of them—their number is infinite and most of these consequences are too long to be practically expressible—although when the initial set is recursive a program can produce the list (in a given language) if it runs infinitely long or infinitely fast. Thus, by assuming suitable idealizations we can assume that the set of all logical consequences can be seen as “given”. Many similar moves are routinely done in contemporary mathematical logic. An infinite process of deriving subsequent consequences is seen as one step. We behave as if we knew all the logical consequences. This is like being omniscient.”

... Krajewski: [Kr16].

11.D.d. Mathematicians ought to practice what they preach

Echoing Melvyn B. Nathanson’s disquiet expressed in another context (see §20.), Krajewski notes with concern the fact that there is an unhealthy divide between what mathematicians do and what they preach:

“Occasionally traces of this way of talking can be retained in an “official” text. Thus, as mentioned before, we can talk about performing infinitely many acts (or even a huge finite number of steps that is practically inaccessible) as if we had an unlimited, “divine” mind; we can refer to a complete knowledge (for instance, taking the set of all sentences true in a given interpretation) as if we were actually omniscient. We can also refer to paradise in Hilbert’s sense. This paradise was challenged by Wittgenstein who built upon the metaphor saying that rather than fear expulsion we should leave the place. “I would do something quite different: I would try to show you that it is not a paradise—so that you’ll leave of your own accord.” (Wittgenstein, 1976, 103)

One could say that all such figurative utterances using, directly or indirectly, theological terms are irrelevant and should be ignored in reflections about the nature of mathematics; they are mere chatting, present around mathematics, but not part of it.

Yet this loose conversation does constitute a part of real mathematics, says Reuben Hersh in (1991). His argument is ingenious: let us consider seriously the fact that mathematics, like any other area of human activity, has a front and a back, a chamber and a kitchen. The back is of no less importance since the product is made there. The guests or customers enter the front door but the professionals use the back door. Cooks do not show the patrons of their restaurant how the meals are prepared. The same can be said about mathematics, and for this reason its mythology reigns supreme.

It includes, says Hersh, such “myths” as the unity of mathematics, its objectivity, universality, certainty (due to mathematical proofs). Hersh is not claiming that those features are false. He reminds, however, that each one has been questioned by someone who knows mathematics from the perspective of its kitchen. Real mathematics is fragmented; it relies on esthetic criteria, which are subjective; proofs can be highly incomplete, and some of them have been understood in their entirety by nobody. And it is here where the ancient or primitive references can be retained. It is deep at “the back” that we could say that only God knows the entire decimal representation of the number π . If we were to say that “at the front”, we would stress it was just a joke.

In the kitchen, mathematicians borrow liberally from religious language. One telling example is the saying of Paul Erdős, the famous author of some 1500 mathematical papers (more than anyone else), according to which there exists the Book in which God has written the most elegant proofs of mathematical theorems. Erdős was very far from standard religiosity, but he reportedly said in 1985, “You don’t have to believe in God, but you should believe in The Book.” (Aigner & Ziegler, 2009) Probably the most famous example of direct use of theology in mathematics can be found in the reaction, in 1888, of Paul Gordan to Hilbert’s non-constructive proof of the theorem on the existence of finite bases in some spaces. Gordan said, “Das ist nicht Mathematik. Das ist Theologie.” It is worth adding that later, having witnessed further accomplishments of Hilbert, he would admit that even “theology” could be useful (Reid, 1996, 34, 37).

One can easily dismiss such examples. Almost everyone would say that while the criticism of a non-constructive approach to mathematics is a serious matter, the use of theological language is just a rhetorical device and has no deeper significance. The same would be said about Hilbert’s mention of “the paradise” in his lecture presenting “Hilbert’s Program”. However, in another classic exposition of a foundational program, Rudolf Carnap, in 1930, while talking about logicism, used the phrase “theological mathematics.” According to him, Ramsey’s assumption of the existence of the totality of all properties should be called “theological mathematics” in contradistinction to the “anthropological mathematics” of intuitionists; in the latter, all operations, definitions, and demonstrations must be finite. When Ramsey “speaks of the totality of properties he elevates himself above the actually knowable and definable and in certain respects reasons from the standpoint of an infinite mind which is not bound by the wretched necessity of building every structure step by step.” (Benacerraf & Putnam, 1983, 50)

Carnap’s statement brings us back to the issue of being omniscient, considered above in Section II. There are other examples of religious references which do not deal directly with infinity. In the 19th century, the trend arose to provide foundations for mathematics, and it turned out to be very fruitful. The very idea of the foundations of mathematics assumes the presence of

an absolute solid rock on which the building of mathematics is securely built. This image has been challenged, and the vision of mathematics without foundations is now favored by many philosophers of mathematics. The question that can be asked in our context is, Whence did the idea of foundations come from? It could have come from everyday experience. However, the idea of absolute certainty has a theological flavor. In our world, in our lives, foundations are hardly absolute, unchanging, unquestionable. As soon as we hope for absolutely secure foundations we invoke a religious dimension. The metaphor of the rock on which we can firmly stand is as much common human experience as it is a Biblical image: God is called the Rock, truth means absolute reliability, etc."

... Krajewski: [Kr16].

11.D.e. Mathematicians must always *know* what they are talking about

Krajewski notes with concern how such perspectives could be leading mathematicians into a false sense of security concerning structures whose putative existence they are able to conceive, but whose logic may not be constructively well-defined (in the sense of the proposed Definitions 32 to 34):

"The mathematicians who established the Moscow school of mathematics, Dimitri Egorov, Nikolai Luzin, and Pavel Florensky (who was also a priest), unlike their French colleagues, were not afraid of infinities and contributed in a decisive way to the creation of descriptive set theory. ...

The connection of this practice to mathematics is supposedly to be seen in the fact that objects like transfinite numbers exist "just from being named." Naming a certain infinite set using appropriate logical formula makes sure that the set exists. Although to a modern skeptic there is hardly a special connection between those theological views and mathematics, the fact is that Luzin, Egorov, and some others saw the connection. In addition, a somewhat similar view was later expressed by another mathematical genius, Alexander Grothendieck; he stressed the importance of naming things in order to isolate the right entities from the complex scene of mathematical objects and "keep them in mind". "Grothendieck, like Luzin, placed a heavy emphasis on 'naming,' seeing it as a way to grasp objects even before they have been understood." (Graham & Kantor, 2009, 200)"

... Krajewski: [Kr16].

He deplores the implicit Creationism underlying the 'creation' of Cantor's paradise²⁶⁸ of transfinite sets in terms of, ultimately, a null set (nothingness), rather than treating sets from an Evolutionary perspective as successors of a postulated fundamental unit set (an undefined something):

"A well-known foundational approach to mathematics uncovers the role of theological categories: the void and infinite power. In standard set theory zero is identified with the empty set, and then 1 is defined as 0, 2 as 0, 0, and, in general, $n + 1$ as 0, 1, 2, . . . , n.

This construction, introduced by John von Neumann, is the most convenient one, but not the only way to define natural numbers as sets. Other numbers—integers, rationals, reals, complex numbers—can be easily defined.

Actually, in a similar way all mathematical entities investigated in traditional mathematics—functions, structures, spaces, operators, etc.—can be defined as "pure" sets, that is, sets constructed from the empty set.

²⁶⁸A 'paradise' that, curiously, is seemingly yet of value even to those seeking a 'constructive truth concept' such as Ferenc Csátári in [Csr24]:

"Of course, no one wants to exile anyone from the set theoretical paradise.²⁷"

... Csátári: [Csr24], §6 Conclusions.

The construction must be performed in a transfinite way. Note that the universe of pure sets arises via a transfinite induction, indexed by ordinal numbers.

In other words, from zero we can create “everything,” or rather the universe of sets sufficient for the foundations of mathematics. The construction assumes the reality of the infinity of ordinal numbers, which means that in order to create from zero we need infinite power. Nothing, emptiness, is combined with infinite power and a kind of unrestricted will to continue the construction ad infinitum. Together they give rise to the realm of sets where mathematics can be developed. This is a rather normal way of describing the situation. Mathematicians would reject suggestions that this has something to do with theology. Yet terms like “infinite power,” “all-powerful will” are unmistakably theological. If Leibniz had known modern set theory, he would have rejoiced, both as a theologian and as a mathematician. He claimed that “all creatures derive from God and nothing.” (Breger, 2005, 491) When he introduced the binary notation, he gave theological significance to zero and one: “It is true that as the empty voids and the dismal wilderness belong to zero, so the spirit of God and His light belong to the all-powerful One.”

... Krajewski: [Kr16].

11.E. Explicit omniscience in set theory

Such visions of omniscience are also reflected in the following remarks, where it is not obvious whether set-theorist Saharon Shelah makes a precise distinction between:

- the authority that derives from vision-based, intuitive ‘truth’; and
- the authority that derives from Tarski’s formal, classical, definitions of the ‘truth’ of the formulas of a formal system under a constructively well-defined, i.e., *evidence-based*, interpretation,

since he remarks that:

“I am in my heart a card-carrying Platonist seeing before my eyes the universe of sets ... (regarding) the role of foundations, and philosophy ... I do not have any objection to those issues per se, but I am suspicious ... My feeling, in an overstated form, is that beauty is for eternity, while philosophical value follows fashion.”

... Shelah: [She91].

As we seek to establish in this investigation, Shelah’s faith—in the ability of intuitive truth to faithfully reflect relationships between elements of a seemingly Platonic universe of sets—may be as misplaced as his assumption that such truth cannot be expressed in a constructive, and effectively verifiable, manner (see §12.B.b.).

In other words, the question of intuitive truth may be linked to that of the consistent introduction of mathematical concepts into first-order languages such as ZF, through axiomatic postulation, in ways that—as explicated by cognitive scientists Lakoff and Núñez in [LR00] (see also §27.)—may not be immediately obvious to a self-confessed Platonist such as Shelah; even if we grant him the vision that is implicit in his following remarks:

“From the large cardinal point of view: the statements of their existence are semi-axioms, (for extremists - axioms). Adherents will probably say: looking at how the cumulative hierarchy is formed it is silly to stop at stage ω after having all the hereditarily finite sets, nor have we stopped with Zermelo set theory, having all ordinals up to \aleph_ω , so why should we stop at the first inaccessible, the first Mahlo, the first weakly compact, or the first of many measurables? We are continuing the search for the true axioms, which have a strong influence on sets below (even on reals) and they are plausible, semi-axioms at least.

A very interesting phenomenon, attesting to the naturality of these axioms, is their being linearly ordered (i.e., those which arise naturally), though we get them from various combinatorial principles many of which imitate \aleph_0 , and from consistency of various “small” statements. It seems that all “natural” statements are equiconsistent with some large cardinal in this scale; all of this prove their naturality.

This raises the question:

ISSUE: Is there some theorem explaining this, or is our vision just more uniform than we realize?

Intuition tells me that the power set and replacement axioms hold, as well as choice (except in artificial universes), whereas it does not tell me much on the existence of inaccessibles. According to my experience, people sophisticated about mathematics with no knowledge of set theory will accept ZFC when it is presented informally (and well), including choice but not large cardinals. You can use collections of families of sets of functions from the complex field to itself, taking non-emptiness of cartesian products for granted and nobody will notice, nor would an ω -fold iteration of the operation of forming the power set disturb anybody. So the existence of a large cardinal is a very natural statement (and an interesting one) and theorems on large cardinals are very interesting as implications, not as theorems (whereas proving you can use less than ZFC does not seem to me very interesting)."

... Shelah: [She91].

We note that if—as Shelah appears to imply—we may²⁶⁹ treat the subsystem ACA_0 of second-order arithmetic as a conservative extension of PA that is *equiconsistent* with PA, then we are led to the curious conclusion—since PA is *finitarily* consistent by §2.C.a., Theorem 2.16—that (see §19., Theorem 19.1) Goodstein’s sequence $G_o(m_o)$ over the finite ordinals in ACA_0 *terminates* with respect to the ordinal inequality ‘ $>_o$ ’ *even if* Goodstein’s sequence $G(m)$ over the natural numbers in ACA_0 *does not terminate* with respect to the natural number inequality ‘ $>$ ’ in any putative model of ACA_0 !

That Shelah’s Platonism is reflective of a continuing widespread practice, if not belief—decried by Krajewski²⁷⁰—is seen in this 1997 observation by mathematician Reuben Hersh:

“The working mathematician is a Platonist on weekdays, a formalist on weekends. On weekdays, when doing mathematics, he’s a Platonist, convinced he’s dealing with an objective reality whose properties he’s trying to determine. On weekends, if challenged to give a philosophical account of this reality, it’s easiest to pretend he doesn’t believe in it. He plays formalist, and pretends mathematics is a meaningless game.”

... Hersh [Hr97].

which echoed an unusually frank—seemingly unrepentant—confession of double standards made 27 years earlier by Jean Dieudonné:

“On foundations we believe in the reality of mathematics, but of course, when philosophers attack us with their paradoxes, we rush to hide behind formalism and say ‘mathematics is just a combination of meaningless symbols,’... Finally we are left in peace to go back to our mathematics and do it as we have always done, with the feeling each mathematician has that he is working with something real. The sensation is probably an illusion, but it is very convenient.”

... Dieudonné [Di70].

²⁶⁹Contradicting §19.A., Corollary 19.3, and §19.A., Theorem 19.4.

²⁷⁰And uneasily accepted by Bauer in [Ba16] (see §4. DEPRESSION, p.491).

11.F. Do mathematicians practice a ‘faith-less’ platonism?

An intriguing perspective on the implicit ‘platonism’ of a practicing mathematician is offered by philosopher John Corcoran in his thought-provoking 1973 paper [Cor73]: ‘Gaps between logical theory and mathematical practice’.

"The view of mathematics adopted here can be called neutral platonism. It understands mathematics to be a class of sciences each having its own subject-matter or universe of discourse. Set theory is a science of objects called sets. Number theory is about the natural numbers. Geometry presupposes three universes of objects: points, lines and planes. String theory or *Semiotik* is about strings of ciphers (digits or characters). Group theory presupposes the existence of complex objects called groups.

Following Bourbaki, Church, Hardy, Gödel and many other mathematicians, it holds that these objects exist and that they are independent of the human mind in the sense that

- (1) their properties are fixed and not subject to alteration and
- (2) they are not created by any act of will.

In a word: mathematical truth is discovered, not invented; mathematical objects are apprehended, not created.

According to this view the unsettled propositions of mathematics (Goldbach’s problem, the twin prime problem, the continuum problem and the like) are each definitely true or definitely false and when their truth-values are derived it will be by discovery and not by *convention* and not by *invention*.

Foundations of mathematics is usually discussed in a metalanguage of mathematical languages, as has been the case here. Platonism, purely and simply, makes in the metalanguage the presuppositions that mathematicians make in their object languages. What the mathematician lets his object language variables range over the platonist lets *his* metalanguage variables range over. The neutral platonist differs from the platonist by distinguishing the foundations of the *foundations* of mathematics from the foundations of mathematics. With regard to foundations, simply, the neutral platonist is a platonist, simply. With regard to the foundations of the foundations the neutral platonist is neutral. Using the metalanguage the neutral platonist agrees that numbers exist but adds, using the meta-metalanguage, that he does not know how such assertions should be *ultimately* understood. The question of the existence of mathematical objects is answered affirmatively but the question of the ultimate nature of that existence is not answered at all. To the neutral platonist the various philosophies of mathematics which have been offered are all considered as interesting hypotheses concerning foundations of foundations each of which may be true, false or meaningless—indeed the neutral platonist admits that foundations of foundations may be meaningless. Contrast neutral platonism with extreme formalism. The extreme formalist claims that foundations of mathematics is contentful but that mathematics itself is meaningless. The neutral platonist claims that both foundations and mathematics are meaningful but offers no view on foundations of foundations."

... Corcoran: [Cor73], §1, pp.23-25.

Viewed from the *evidence-based* perspective implicit in the Complementarity Thesis (§1., Thesis 1) of this investigation—that the objects of mathematics are merely the *formal* terms (Carnap’s explicatum in [Ca62a]), of a first-order mathematical language which seeks to faithfully express what Pantsar terms as *pre-formal mathematics* in [Pan09] (§4. Formal and pre-formal mathematics), and Lakoff and Nunez ([LR00]; see also §27.) term as the conceptual metaphors (Carnap’s explicandum in [Ca62a]) of an individual intelligence—the question arises (see also §13.E.):

- Could one today generically substitute a term such as, for instance, ‘subjective platonism’ for ‘neutral platonism’, whose domain/s may then be taken as those conceptual metaphors of an individual intelligence which can be faithfully expressed in a first-order mathematical language such as the set theory ZFC; and
- Reserve the term ‘neutral platonism’ or, say, ‘objective platonism’ for only those conceptual metaphors of an individual intelligence that can be both faithfully expressed and unambiguously communicated to an other intelligence in a categorical first-order mathematical language such as the Peano Arithmetic PA?

If so, could one then justifiably claim that the philosophy underlying the practice of mathematics is a ‘faith-less’ platonism (in Corcoran’s foundational sense) since it admits of mathematical objects that:

- (a) their properties are fixed by the immutable symbols (semiotic strings) in which an individual intelligence’s conceptual metaphors are grounded, and are therefore not subject to alteration; and
- (b) they are not created by any act of will of an individual intelligence, but by an agreed upon convention (for the generation of the semiotic strings);
- (c) mathematical truth is discovered (as a property assigned by convention to the semiotic strings), not re-invented;
- (d) mathematical objects (semiotic strings) are apprehended, not created?

Or would this stretch an analogy too far from the intent of the original?

Part III

THE PHILOSOPHICAL FOUNDATIONS OF *EVIDENCE-BASED* REASONING

CHAPTER 12. *PHILOSOPHICAL FOUNDATIONS*

12. What is logic?

In Part III of this investigation we consider, and speculate upon, some philosophical consequences of finitary *agnosticism* that, by removing the ambiguity in the rules for Brouwer-Heyting-Kolmogorov realizability as indicated in §7.C., now allows us to formalise a Wittgensteinian perspective of constructive mathematics, and of its goal, by distinguishing between:

- a *first-order theory*—such as the Set Theory ZFC or the Peano Arithmetic PA—that admits a *proof-theoretic logic* which, on the basis of *evidence-based* reasoning, assigns the values ‘provable/unprovable’ to the well-formed formulas of the theory;
- a *first-order theory*—such as the Peano Arithmetic PA, that further admits a *model-theoretic logic* which, on the basis of *evidence-based* reasoning, assigns the values ‘true/false’ to the well-formed formulas of the theory;

where we address §1., Thesis 1 formally by qualifying §1.B., Definition 1:

Definition 32. (Proof-theoretic logic) *The proof-theoretic logic of a first-order theory S is a set of rules consisting of:*

- a selected set of well-formed formulas of S labelled as ‘axioms/axiom schemas’ that are assigned the value ‘provable’; and
- a finitary set of rules of inference in S ;

that assign evidence-based values of ‘provable’ or ‘unprovable’ to the well-formed formulas of S by means of the axioms and rules of inference of S .

Definition 33. (Model-theoretic logic) *The model-theoretic logic of a first-order theory S with a proof-theoretic logic is a set of rules that assign evidence-based truth values of ‘satisfaction’, ‘truth’, and ‘falsity’ to the well-formed formulas of S under an interpretation \mathcal{I} such that the axioms of S interpret as ‘true’ under \mathcal{I} , and the rules of inference of S preserve such ‘truth’ under \mathcal{I} .*

We contrast §1.B., Definition 1, with the epistemically grounded perspective of conventional wisdom (such as, for instance, [Mur06]; see also [Brd13], §2. *Foundational Formalisms, Logic*; [BW05]) when it fails to distinguish between the multi-dimensional nature of the logic of

a formal mathematical language (as defined above; compare also with [Han06]²⁷¹), and the one-dimensional, implicitly Platonic, nature of the veridicality of its assertions; articulated either informally as in, for example, Lakoff and Núñez [LR00] (see also §27.), or implicitly as, for instance, in Gila Sher [Shr13], Colin R. Caret [Crt23] and, most recently, Anandi Hattiangadi [Htt23]²⁷² (also Corine Besson and Anandi Hattiangadi [BH24]²⁷³):

“Logic, the investigation suggests, is grounded in the formal aspect of reality, and the outline proposes an account of this aspect, the way it both constrains and enables logic (gives rise to logical truths and consequences), logic’s role in our overall system of knowledge, the relation between logic and mathematics, the normativity of logic, the characteristic traits of logic, and error and revision in logic. . . .

It is an interesting fact that, with a small number of exceptions, a systematic philosophical foundation for logic, a foundation for logic rather than for mathematics or language, has rarely been attempted.

([fn1]: One recent exception is Maddy [2007, Part III], which differs from the present attempt in being thoroughly naturalistic. Another psychologically oriented attempt is Hanna [2006]. Due to limitations of space and in accordance with my constructive goal, I will limit comparisons and polemics to a minimum).

. . . By a philosophical foundation for logic I mean in this paper a substantive philosophical theory that critically examines and explains the basic features of logic, the tasks logic performs in our theoretical and practical life, the veridicality of logic - including the source of the truth and falsehood of both logical and meta-logical claims, . . . the grounds on which logical theories should be accepted (rejected, or revised), the ways logical theories are constrained and enabled by the mind and the world, the relations between logic and related theories (e.g., mathematics), the source of the normativity of logic, and so on. The list is in principle open-ended since new interests and concerns may be raised by different persons and communities at present and in the future.

²⁷¹“In *Rationality and Logic*, Robert Hanna argues that logic is intrinsically psychological and that human psychology is intrinsically logical. He claims that logic is cognitively constructed by rational animals (including humans) and that rational animals are essentially logical animals. In order to do so, he defends the broadly Kantian thesis that all (and only) rational animals possess an innate cognitive “logic faculty.” Hanna’s claims challenge the conventional philosophical wisdom that sees logic as a fully formal or “topic-neutral” science irreconcilably separate from the species- or individual-specific focus of empirical psychology. Logic and psychology went their separate ways after attacks by Frege and Husserl on logical psychologism—the explanatory reduction of logic to empirical psychology. Hanna argues, however, that—despite the fact that logical psychologism is false—there is an essential link between logic and psychology. Rational human animals constitute the basic class of cognizers or thinkers studied by cognitive psychology; given the connection between rationality and logic that Hanna claims, it follows that the nature of logic is significantly revealed to us by cognitive psychology. Hanna’s proposed “logical cognitivism” has two important consequences: the recognition by logically oriented philosophers that psychologists are their colleagues in the metadiscipline of cognitive science; and radical changes in cognitive science itself. Cognitive science, Hanna argues, is not at bottom a natural science; it is both an objective or truth-oriented science and a normative human science, as is logic itself.” . . . Publisher’s overview of [Han06].

²⁷²We note, in particular, that the need both for recognising the primacy of pre-formal reasoning—as argued cogently, and unequivocally, by Markus Pantsar in [Pan09] (see §1.A.)—and for recognising ‘*Logic as a methodological tool*’ (see §1.B.), as essential for *evidence-based* reasoning that enables categorical communication even in non-mathematical discourse, can be viewed as implicitly reflected in Hattiangadi’s conclusion in [Htt23] that since ‘the ability to handle generality in particular cases must be prior to the ability to explicitly adopt any general rule’, it would follow ‘that the meanings of our logical terms, and the validity of our inferences, cannot depend on our adoption of logico-linguistic conventions’.

²⁷³“This paper provides a novel account of the psychology and epistemology of deductive reasoning, according to which the capacity to perform inferences in particular cases is prior to the capacity to follow any general rule. Inspired by the central argument of Kripke’s paper, ‘The Question of Logic’, to the effect that logical rules cannot be adopted, we show that the widespread view that deductive reasoning requires rule following must be abandoned”.

. . . Besson & Hattiangadi: [BH24], Abstract.

In addition, the investigation itself is likely to raise new questions (whether logic is similar to other disciplines in requiring a grounding in reality, what the distinctive characteristics of logical operators are, etc.). ...

The motivation for engaging in a foundational project of this kind is both general and particular, both intellectual and practical, both theoretical and applicational. Partly, the project is motivated by an interest in providing a foundation for knowledge in general - i.e., a foundation both for human knowledge as a whole and for each branch of knowledge individually (logic being one such branch). Partly, the motivation is specific to logic, and is due to logic's unique features: its extreme "basicness", generality, modal force, normativity, ability to prevent an especially destructive type of error (logical contradiction, inconsistency), ability to expand all types of knowledge (through logical inference), etc. In both cases the interest is both intellectual and practical. Finally, our interest is both theoretical and applicational: we are interested in a systematic theoretical account of the nature, credentials, and scope of logical reasoning, as well as in its applications to specific fields and areas. ...

If the bulk of our criticisms is correct, the traditional foundationalist strategy for constructing a foundation for logic (and for our system of knowledge in general) should be rejected. It is true that for a long time the foundationalist strategy has been our only foundational strategy, and as a result many of its features have become entangled in our conception of a foundation, but this entanglement can and ought to be unraveled. ... My goal is an epistemic strategy that is both free of the unnecessary encumbrances of the foundationalist strategy and strongly committed to the grounding project. Following Shapiro [1991], I will call such a strategy a *foundation without foundationalism*."

... Sher: [Shr13], pp.145-146, 151.

"Logic is similar to other fields of knowledge, including the empirical sciences, in being grounded in the world, committed to truth, engaged in discovery, open to revision, and not being analytic, purely apriori, or foundational in the traditional foundationalist sense. But it differs from most fields, including the empirical sciences, in being formal, highly necessary, general, quasi-apriori, and foundational, though in a holistic, non-foundationalist, sense."

... Sher: [Shr23], Abstract.

"The term "logic" can refer to at least three different things (Caret,2021b). While these uses are closely related, it is important not to casually conflate them when grappling with a philosophical discussion of issues in this vicinity.

- (i) Logic as a tool: In this sense of the term, "logic" is a count noun used to refer to formal systems (symbolic languages coupled with a semantics or proof theory). We can speak of a *logic* and give them proper names like "FDE."
- (ii) Logic as a phenomenon: In this sense of the term, "logic" collectively refers to a family of relations between propositions, viz. the *logical relations*. The most familiar examples are relations such as logical consequence and provability.
- (iii) Logic as a discipline: In this sense of the term, "logic" is the name for a traditional area of academic inquiry. These days, it is most often found as part of other departments: philosophy, mathematics, linguistics, and computer science.

Logic the discipline uses logical tools to theorize about logical phenomena, but the phenomena are of primary interest. Formal systems are not an end in themselves, they just serve as the "common language" of logicians."

... Caret: [Crt23], 2 *The role(s) of logic*.

"As I have argued, the adoption problem fundamentally has to do with the generality of logical principles. It shows that the ability to handle generality in particular cases must be prior to the ability to explicitly adopt any general rule. It therefore threatens the explicit adoption of any general logical principle, not just UI, or even those that possess the special feature of encoding in general terms the capacities that are required for reasoning with general principles. If I am right,

the adoption problem ultimately shows that *no* general logical principle or rule can be explicitly adopted, because the ability to see what follows from a universal statement in particular cases is prior to the ability to adopt any general rule. I have argued further that general logical principles cannot be implicitly adopted either, at least if the conventionalist's commitment to naturalism is to be respected, since the naturalistic implicit use facts do not suffice to provide an adequate grounding explanation of rule-adoption. So, it is not possible to adopt any general logical principle, either explicitly or implicitly.

This, I suggest, gives rise to a *reductio* of conventionalism. According to conventionalists, the adoption of a system of general linguistic rules governing our use of logical terms is necessary and sufficient to determine the meanings of our logical terms, and to settle the facts of logical validity, necessity and truth. However, the adoption problem shows that it is not possible to adopt general logical rules, either explicitly or implicitly. It follows that it is impossible for any logical term to have a meaning or for any inference to be valid. But obviously our logical terms do have a meaning, and some of our inferences are valid. So we have a contradiction. What is the guilty premiss? I have considered a variety of ways to resist the adoption problem, and found them to be wanting. The guilty premiss must therefore be the conventionalist's core claim: that we impose a logic on ourselves by adopting linguistic conventions governing our use of logical terms, thereby determining the logical facts, such as which of our inferences are valid. This, I submit, is the claim we ought to abandon.³⁸ "

... Hattiangadi: [Htt23], §V, pp.74-75.

For a formal mathematical language \mathcal{L} to, then, precisely express and objectively (i.e., on the basis of *evidence-based* reasoning) communicate categorically characteristics of some structure \mathcal{U} that may, or may not, be constructively *well-defined* (in the sense of §7.F., Definition 26), it must be able to categorically represent some Theory $T(\mathcal{U})$ whose characteristic is that:

Definition 34. (Well-defined model) *The Theory $T(\mathcal{U})$ defined semantically by the λ -interpretation of a formal mathematical language \mathcal{L} over the structure \mathcal{U} is a constructively well-defined model of \mathcal{L} if, and only if, λ is a constructively well-defined Logic of \mathcal{L} . \square*

This, now, yields the perspective that:

Definition 35. (Constructive mathematics) *Constructive mathematics is the study of formal mathematical languages that have a constructively well-defined logic. \square*

The significance of §12., Definitions 32 to 35 is illustrated by the following account by Carl J. Posy of the purported ways in which:

"... adopting intuitionistic logic limits the ways in which a constructivist can carry out a mathematical proof. A standard example is the classical proof that there are irrational r and s such that r^s is a rational number: either $\sqrt{2}^{\sqrt{2}}$ is rational or it is irrational. If it is rational, then take $r = s = \sqrt{2}$. If it is irrational, then take $r = \sqrt{2}^{\sqrt{2}}$ and $s = \sqrt{2}$. In this case $r^s = (\sqrt{2}^{\sqrt{2}})^{\sqrt{2}} = (\sqrt{2})^2 = 2$. The constructivist cannot make that initial assumption that $\sqrt{2}^{\sqrt{2}}$ is either rational or irrational."

... Posy: [Pos13], p.109.

Though—as the author notes—this theorem is in fact constructively recoverable, the question—left unaddressed here by both classical and constructive theories—is not whether a particular formula is rational or irrational, but whether the logic that assigns truth assignments to the formulas of the concerned language is sufficiently *well-defined* so as to *evidence* the decidability of whether a formula is either rational or irrational.

12.A. What is an axiom

From the perspective of §12., it would thus follow that the axioms and rules of inference of a language:

- are not intended to correlate the ‘provable’ propositions of a language with the (platonically?) ‘true’ propositions under a constructively well-defined interpretation of the language (though that might be an incidental consequence),
- but are essential logical rules of the language that are intended to constructively assign ‘truth’ values to the propositions of the language under the interpretation,
- with the sole intention of enabling unambiguous and effective communication about various characteristics of the structure—which may, or may not, be constructively well-defined—over which the interpretation is defined.

12.A.a. Do the axioms circumscribe the ontology of an interpretation?

If so, it would further follow that the ontology of any interpretation of a language is circumscribed not by the ‘logic’ of the language—which is intended solely to assign unique ‘truth’ values to the declarative sentences of the language—but by the rules that determine the ‘terms’ that can be admitted into the language without inviting contradiction in the broader sense of how, or even whether, the brain—viewed as the language defining and logic processing part of any intelligence—can address contradictions (see §13.F.b.).

We contrast the above perspective with a more classical perspective such as that, for instance, of Hermann Weyl which, from an early-intuitionistic point of view, posits axioms as ‘implicit definitions’ (as does Solomon Feferman later in [Fe99]; see also [Fe97], p.2):

“You all know that Descartes’ introduction of coordinates seems to reduce geometry to arithmetic (understood in the widest sense, i.e., as a theory of the real numbers). Given Pieri’s formulation of geometry, which remains entirely within the geometric realm, we can perform the reduction to arithmetic by means of the following three propositions (in which, as before, I limit myself to plane geometry):

1. A pair of real numbers (x, y) is called a point.
2. If $(x_1, y_1), (x_2, y_2), (x_3, y_3)$ are three points, then they satisfy relation E if and only if

$$(x_2 - x_1)^2 + (y_2 - y_1)^2 = (x_3 - x_1)^2 + (y_3 - y_1)^2.$$
3. We count as geometric point-relations only those numerical relations between the coordinates of the points that are invariant under translation and orthogonal transformation.

Would it be right to treat these propositions as definitions of “point,” “geometry,” and the fundamental relation E ? Surely they are definitions only in a severely extended sense. We earlier altered the significant content (*Vorstellungsinhalt*) of such expressions as “three points lie on a straight line”—but only in a way that preserved the scope of these concepts. We have now replaced the original concepts with others that, at first glance, are entirely different.

Nonetheless, if a proposition of Euclidean geometry is true when taken in its proper sense, it will remain true when we take its constituent expressions in the new arithmetical sense. This situation has a kind of complement in our ability to express the same significant content in various languages in entirely different ways. Here, however, the same verbal expression receives thoroughly different contents because we assign a new meaning to each concept. The procedure applied here might best be described as follows. There are two systems of objects. Certain relations $\varepsilon_1, \varepsilon'_1, \dots$ obtain

between objects of the first system while relations $\varepsilon_2, \varepsilon'_2, \dots$ obtain between those of the second. If there is a one-to-one correlation between the objects and relations of the one system and the objects and relations of the other such that correlated relations always hold between correlated objects—if the systems are, in this sense, completely isomorphic with one another—then there is also a one-to-one correlation between the true propositions of the two systems and we could, without falling into any errors, *identify* the two systems with one another. The discovery of such an isomorphism is obviously important and has benefits quite analogous to those mathematics derives from abstract group theory: unification, great economy of thought, but also an expansion of the methods available to researchers. Thanks to Descartes' discovery, I can not only use numerical analysis to prove geometric theorems; I can use geometric intuition to discover truths about numbers. It is in the spirit of this identification of isomorphic systems (an identification justified from the mathematical point of view) that we treat the axioms of, say, geometry not as fundamental statements about spatial relations obtaining in the actual space surrounding us, but merely as implicit definitions of certain relations devoid in themselves of any intuitive content. These axioms, construed as implicit definitions, certainly do not make those concepts entirely definite. But that does not matter because, even in geometry, we only care about the properties asserted in the axioms. The significant content of Euclidean geometry, what we call space and spatial relations, is not exhausted by that geometry's assertions. This strikes me as a situation of philosophical interest.

The method of implicit definition—a method that does not clarify concepts on the basis of other concepts whose sense is taken to be understood, but only offers a system of propositions or axioms in which the concepts occur—this method has been employed frequently in mathematics. It has the advantage of highlighting, at the very start, the most important properties of the concepts to be defined, properties that might be only remote consequences of a proper definition. However, an implicit definition through axioms is always provisional in that you can rely on it only if the axioms are consistent, i.e., only if you can identify a system of explicitly defined concepts that satisfies the axioms. A good example of what we are discussing is Lebesgue's treatment of the concept of the integral in Ch. VII of his "Leçons sur l'intégration" (Paris 1904). There he distinguishes between explicit and implicit definitions drawing a contrast between the "constructive" and the "descriptive."

... Weyl: [We10], pp.5-6.

12.B. Wittgenstein's 'notorious' paragraph about 'the Gödel Theorem'

We note that such an *evidence-based* perspective reflects in essence the views Ludwig Wittgenstein emphasised in his 'notorious paragraph' in [Wi78] (paragraph #8 below²⁷⁴), where he essentially argues—albeit obscurely—that mathematical truth must necessarily be an 'assignment-by-convention' (in the sense, for instance, of §1., Thesis 1) which, in the absence of an associated *evidence-based* methodology for finitarily *verifying* any assignment of truth values to the propositions of a language (such as those defined for PA in 12.B.d.; see also §2.B., §2.C., and §7.C.), might legitimately entail contradictions which appeal to putative truth-values, and from which we can conclude *no more* than the *absence* of an associated *evidence-based* methodology for *verifying* an assignment; and certainly not the *presence* of an inherent *to-be-avoided-at-all-costs* inconsistency:

"1. It is easy to think of a language in which there is not a form for questions, or commands, but question and command are expressed in the form of statements, e.g. in forms corresponding to our "I should like to know if ..." and "My wish is that ...".

²⁷⁴In footnote 9 of [FP00], Floyd and Putnam note that: "The 'notorious' paragraph RFM I Appendix III 8 was penned on 23 September 1937, when Wittgenstein was in Norway (see the Wittgenstein papers, CD Rom, Oxford University Press and the University of Bergen, 1998, Item 118 (Band XIV), pp. 106ff)".

No one would say of a question (e.g. whether it is raining outside that it was true or false. Of course it is English to say so of such a sentence as "I want to know whether ...". But suppose this form were always used instead of the question?

2. The great majority of sentences we speak, write and read, are statement sentences.

And—you say—these sentences are true or false. OR, as I might also say, the game of truth-functions is played with them. For assertion is not something that gets added to the proposition, but an essential feature of the game we play with it. Comparable, say, to the that characteristic of chess by which there is winning and losing in it, the winner being the one who takes the other's king. Of course, there could be a game in a certain sense very near akin to chess, consisting in making the chess moves, but without there being any winning and losing in it; or with different conditions for winning.

3. Imagine it were said: A command consists of a proposal ('assumption') and the commanding of the thing proposed.

4. Might we not do arithmetic without having the idea of uttering arithmetical propositions, and without ever having been struck by the similarity between a multiplication and a proposition?

Should we not shake our heads, though, when someone shewed us a multiplication done wrong, as we do when someone tells us it is raining, if it is not raining?—Yes; and there is a point of connexion. But we also make gestures to stop our dog, e.g. when he behaves as we do not wish.

We are used to saying "2 times 2 is 4" and the verb "is" makes this into a proposition, and apparently establishes a close kinship with everything we call a 'proposition'. Whereas it is only a matter of a very superficial relationship.

5. Are there true propositions in Russell's system, which cannot be proved in his system?—What is called a true proposition in Russell's system, then?

6. For what does a proposition's '*being true*' mean? '*p* is true = *p*. (That is the answer.)

So we want to ask something like: under what circumstances do we assert a proposition? Or: How is the assertion of the proposition used in the language game? And the 'assertion of the proposition' is here contrasted with the utterance of the sentence, e.g. as practice in elocution,—or as *part* of another proposition, and so on.

If, then, we ask in this sense: "Under what circumstances is a proposition asserted in Russell's game?" the answer is: at the end of one of his proofs, or as a 'fundamental law' (Pp.) There is no other way in this system of employing asserted propositions in Russell's symbolism.

7. "But may there not be true propositions which are written in this symbolism, but are not provable in Russell's system?"—"True propositions", hence propositions which are true in another system, i.e. can rightly be asserted in *another* game. Certainly; why should there not be such propositions; or rather: why should not propositions—of physics, e.g.—be written in Russell's symbolism? The question is quite analogous to: Can there be true propositions in the language of Euclid, which are not provable in his system, but are true?—Why, there are even propositions which are provable in Euclid's system, but are *false* in another system. May not triangles be—in another system—similar (*very* similar) which do not have equal angles?—"But that's just a joke! For in that case they are not 'similar' to one another in the same sense!"—Of course not; and a proposition which cannot be proved in Russell's system is "true" or "false" in a different sense from a proposition of *Principia Mathematica*.

8. I imagine someone asking my advice; he says: "I have constructed a proposition (I will use '*P*' to designate it) in Russell's symbolism, and by means of certain definitions and transformations it can be so interpreted that it says: '*P* is not provable in Russell's system'. Must I not say that this proposition on the one hand is true, and on the other hand is unprovable? For suppose it were false; then it is true that it is provable. And that surely cannot be! And if it is proved, then it is proved that it is not provable. Thus it can only be true, but unprovable."

Just as we ask, “‘Provable’ in what system?”, so we must also ask: “‘True’ in what system?” ‘True in Russell’s system’ means, as was said: proved in Russell’s system; and ‘false in Russell’s system’ means: the opposite has been proved in Russell’s system.—Now what does your “suppose it is false” mean? *In the Russell sense* it means, ‘suppose the opposite is proved in Russell’s system’; *if that is your assumption* you will now presumably give up the interpretation that it is unprovable. And by ‘this interpretation’ I understand the translation into this English sentence.—If you assume that the proposition is provable in Russell’s system, that means it is true *in the Russell sense*, and the interpretation “ P is not provable” again has to be given up. If you assume that the proposition is true in the Russell sense, *the same* thing follows. Further: if the proposition is supposed to be false in some other than the Russell sense, then it does not contradict this for it to be proved in Russell’s system (What is called “losing” in chess may constitute winning in another game.)

9. For what does it mean to say that P and “ P is unprovable” are the same proposition? It means that these *two* English sentences have a single expression in such-and-such a notation.

10. “But surely P cannot be provable, for, supposing it were proved, then the proposition that it is not provable would be proved.” But if this were now proved, or if I believed—perhaps through an error—that I had proved it, why should I not let the proof stand and say I must withdraw my interpretation “*unprovable*”?

11. Let us suppose I prove the unprovability (in Russell’s system) of P ; then by this proof I have proved P . Now if this proof were one in Russell’s system—I should in that case have proved at once that it belonged and did not belong to Russell’s system.—That is what comes of making up such sentences.—But there is a contradiction here!—Well, then there is a contradiction here. Does it do any harm here?

12. Is there harm in the contradiction that arises when someone says: “I am lying.—So I am not lying.—So I am lying.—etc.”? I mean: does it make our language less usable if in this case, according to the ordinary rules, a proposition yields its contradictory, and vice versa?—the proposition itself is unusable, and these inferences equally; but why should they not be made?—It is a profitless performance!—It is a language-game with some similarity to the game of thumb-catching.

13. Such a contradiction is of interest only because it has tormented people, and because this shews both how tormenting problems can grow out of language, and what kind of things can torment us.

14. A proof of unprovability is as it were a geometrical proof; a proof concerning the geometry of proofs. Quite analogous e.g. to a proof that such-and-such a construction is impossible with ruler and compass. Now such a proof contains an element of prediction, a physical element. For in consequence of such a proof we say to a man: “Don’t exert yourself to find a construction (of the trisection of an angle, say)—it can be proved that it can’t be done”. That is to say: it is essential that the proof of unprovability should be capable of being applied in this way. It must—we might say—be a forcible reason for giving up the search for a proof (i.e. for a construction of such-and-such a kind).

A contradiction is unusable as such a prediction.

15. Whether something is rightly called the proposition “ X is unprovable” depends on how we prove this proposition. The proof alone shews what counts as the criterion of unprovability. The proof is part of the system of operations, of the game, in which the proposition is used, and shews us its ‘sense’. Thus the question is whether the ‘proof of the unprovability of P ’ is here a forcible reason for the assumption that a proof of P will not be found.

16. The proposition “ P is unprovable” has a different sense afterwards—from before it was proved. If it is proved, then it is the terminal pattern in the proof of unprovability.—If it is unproved, then what is to count as a criterion of its truth is not yet clear, and—we can say—its sense is still veiled.

17. Now how am I to take P as having been proved? By a proof of unprovability? Or in some other way? Suppose it is by a proof of unprovability. Now, in order to see *what* has been proved, look at the proof. Perhaps it has here been proved that such-and-such forms of proof do not lead to P .—Or, suppose P has been proved in a direct way—as I should like to put it—and so in that case there follows the proposition “ P is unprovable”, and it must now come out how this interpretation of the symbols of P collides with the fact of the proof, and why it has to be given up here.

Suppose however that not- P is proved.—Proved how? Say by P 's being proved directly—for from that follows that it is provable, and hence not- P . What am I to say now, “ P ” or “not- P ”? Why not both? If someone asks me “Which is the case, P , or not- P ?” then I reply: P stands at the end of a Russellian proof, so you write P in the Russellian system; on the other hand, however, it is then provable and this is expressed by not- P , but this proposition does not stand at the end of a Russellian proof, and so does not belong to the Russellian system.

—When the interpretation “ P is unprovable” was given to P , this proof of P was not known, and so one cannot say that P says: *this* proof did not exist.—Once the proof has been constructed, this has created a *new situation*: and now we have to decide whether we will call *this* a proof (a *further* proof), or whether we will still call this the statement of unprovability.

Suppose not- P is directly proved; it is therefore proved that P can be directly proved! So this is once more a question of interpretation—unless we now also have a direct proof of P . If it were like that, well, that is how it would be.

(The superstitious dread and veneration by mathematicians in face of contradiction.)

18. “But suppose, now, that the proposition were *false*—and hence provable?”—Why do you call it ‘false’? Because you can see a proof?—Or for other reasons? For in that case it doesn’t matter. For one can quite well call the Law of Contradiction false, on the grounds that we very often make good sense by answering a question “Yes and no”. And the same for the proposition sim ‘ $\sim\sim p = p$ ’ because we employ double negation as a *strengthening* of the negation and not merely as its cancellation.

19. You say: “. . . , so P is true and unprovable”. That presumably means: “Therefore P ”. That is all right with me—but for what purpose do you write down this ‘assertion’? (It is as if someone had extracted from certain principles about natural forms and architectural style the idea that on Mount Everest, where no one can live, there belonged a ch  let in the Baroque style. And how could you make the truth of the assertion plausible to me, since you can make no use of it except to do these bits of legerdemain?)

20. Here one needs to remember that the propositions of logic are so constructed as to have *no* application as *information* in practice. So it could very well be said that they were not *propositions* at all; and one’s writing them down at all stands in need of justification. Now if we append to these ‘propositions’ a further sentence-like structure of another kind, then we are all the more in the dark about what kind of application this system of sign-combinations is supposed to have; for the mere *ring of a sentence* is not enough to give these connexions of signs any meaning.”

... Wittgenstein: [W78], Appendix III.

In their paper ‘A note on Wittgenstein’s ‘notorious paragraph’ about the G  del Theorem’, Juliet Floyd and Hilary Putnam draw attention to Wittgenstein’s remarks, and argue that this paragraph contains a “philosophical claim of great interest” which:

“... is simply this: if one assumes (and, a fortiori if one actually finds out) that $\neg P$ is provable in Russell’s system one should ... give up the “translation” of P by the English sentence “ P is not provable”.”

... Floyd and Putnam: [FP00].

In §15.A. we shall show that Wittgenstein’s reservations on Gödel’s interpretation of his own formal reasoning are not only of historical importance but, from the *evidence-based* perspective of this investigation, could be viewed as presciently reflecting the justifiable uneasiness that academicians and philosophers such as Floyd and Putnam—and, more recently, Timm Lampert in [Lam17]—have continued to sense, express, and debate (as reviewed, for instance, in [Mat13]), over standard (text-book) interpretations of Gödel’s formal reasoning even eighty five years after the publication of the latter’s seminal 1931 paper ([Go31]) on formally undecidable arithmetical propositions:

“Contrary to Wittgenstein’s early critics, Shanker [1988], Floyd & Putnam[2000] and Floyd [2001] argue that Wittgenstein does not question Gödel’s undecidability proof itself. Instead, they say, Wittgenstein’s remarks are concerned with the semantic and philosophical consequences of Gödel’s proof; those remarks represent, according to Floyd and Putnam, a “remarkable insight” regarding Gödel’s proof. I share the view that Wittgenstein believed that it is not the task of philosophy to question mathematical proofs. However, I argue that from Wittgenstein’s perspective, Gödel’s proof is not a mathematical proof. Instead, it is a proof that relies on “prose” in the sense of meta-mathematical interpretations, and thus, it is a valid object of philosophical critique. Thus, I deny that Wittgenstein views Gödel’s undecidability proof as being just as conclusive as mathematical impossibility proofs. Wittgenstein’s simplified, rather general way of referring to an ordinary language interpretation of G without specifying exactly where questionable meta-mathematical interpretations are relevant to Gödel’s proof might have led to the judgment that Wittgenstein’s critique is not relevant to Gödel’s proof.

Contrary to Floyd and Putnam, Rodych [1999] and Steiner [2001] assume that Wittgenstein argues against Gödel’s undecidability proof. According to their interpretation, Wittgenstein’s objection against Gödel’s proof is that from proving G or $\neg G$, it does not follow that PM is inconsistent or ω -inconsistent. Instead, one could abandon the meta-mathematical interpretation of G . However, according to both authors, this critique is inadequate because Gödel’s proof does not rely on a meta-mathematical interpretation of G . By specifying where Wittgenstein’s critique is mistaken, they wish to decouple Wittgenstein’s philosophical insights from his mistaken analysis of Gödel’s mathematical proof. I agree with Rodych and Steiner that Wittgenstein’s critique does not offer a sufficient analysis of the specific manner in which a meta-mathematical interpretation is involved in Gödel’s reasoning. However, in contrast to these authors, I will explain why both Gödel’s semantic proof and his so-called syntactic proof do rely on a meta-mathematical interpretation.

Priest [2004], Berto [2009a] and Berto [2009b] view Wittgenstein as a pioneer of paraconsistent logic. They are especially interested in Wittgenstein’s analysis of Gödel’s proof as a proof by contradiction. Like Rodych and Steiner, they maintain that Wittgenstein’s remarks are not, in fact, pertinent to Gödel’s undecidability proof because Wittgenstein refers not to a syntactic contradiction within PM but rather to a contradiction between the provability of G and its meta-mathematical interpretation. However, according to them, Wittgenstein’s critique is not mistaken. Rather, it is concerned with the interpretation and consequences of Gödel’s undecidability proof. Presuming Wittgenstein’s rejection of any distinction between (i) metalanguage and object language and (ii) provability and truth, they show that engaging with Gödel’s proof depends on philosophical presumptions. I do not question this. However, I will argue that Wittgenstein’s critique can be interpreted in a way that is indeed relevant to Gödel’s undecidability proof.

The intention of this paper is not to enter into an exegetical debate on whether Wittgenstein understands Gödel’s proof and whether he indeed objects to it. For the sake of argument, I assume that to be given. Furthermore, similarly to, e.g., Rodych and Steiner, I take “Wittgenstein’s objection” to Gödel’s proof to be as follows: “Instead of inferring the incorrectness or (ω -)inconsistency of PM (or PA) from a proof of G (or $\neg G$), one might just as validly abandon the meta-mathematical interpretation of G . Therefore, Gödel’s proof is not compelling because it rests on a doubtful meta-mathematical interpretation.” I recognize that this is highly controversial, to say the least. However, the literature seems to agree that such an objection, be it Wittgenstein’s or not, has no relation to Gödel’s undecidability proof and thus is not reasonable. The intention

of this paper is to show that this is not true. This objection can, indeed, be related to Gödel's method of defining provability within the language of PM, and it questions this essential element of Gödel's meta-mathematical proof method by measuring its reliability on the basis of an algorithmic conception of proof."

... Lampert: [Lam17].

We shall argue further that Wittgenstein's reservations in [Wi78], as also what we view as the uneasiness expressed by, amongst others, Floyd and Putnam in [FP00] and Lampert in [Lam17], can—and arguably must, as we advocate in this investigation—be seen as indicating specific points of ambiguity that need to be addressed on both technical *and* philosophical grounds, rather than be dismissed on mere technicalities, since both Wittgenstein and Gödel can be held guilty of conflating 'ω-consistency' with 'correctness'.

In his master's thesis [Mat13], Ásgeir Berg Matthíasson seeks to give a fairly balanced account of where Wittgenstein could justifiably have been held to account:

"As we saw in the introduction and the first chapter of this thesis, the early debate on Wittgenstein's remarks on Gödel was mostly negative and characterized by the claim that Wittgenstein misunderstood Gödel's theorem in essentially two ways: that (a) he did not see how consistency was a necessary premise of Gödel's proof, or simply did not understand what consequences inconsistency would have on a formal system, and (b) the claim that he mistakenly thought Gödel's proof used some kind of natural language interpretation of the sentence P in order to show that it was true, but unprovable, thus by abandoning this interpretation, Gödel's result could be avoided. It is almost certain that the widespread acceptance of these claims severely damaged Wittgenstein's reputation as a philosopher of mathematics.

The later debate, however, offered a much more nuanced and broader view, more sensitive to both Wittgenstein's other philosophical writings and the overall spirit in which he wrote. Despite this, they are not all without their shortcomings. Many of them almost seem made especially for the purpose of vindicating Wittgenstein and absolving the great philosopher from all charges of technical incompetence and misunderstanding. Others have been much more elaborate in their exegesis of Wittgenstein's remarks than the text could possibly support and are thus very unlikely to persuade anyone not already convinced of the truth of their conclusions.

In this thesis a fairly comprehensive critical overview of this debate has been given. Unfortunately, the conclusion of this discussion however is undeniably a certain *aporia*—it is still difficult to give a precise account of what Wittgenstein actually did say in his infamous remarks on Gödel, and given their cryptic and unpolished nature, this will most likely always be the case. However, a few things can be gleaned from the preceding discussion.

First of all, we can see from the discussion on Berto and the dialetheists that Wittgenstein's remarks on consistency are far from being as outrageous as they were originally seen, and that the charge of technical incompetence on Wittgenstein's part was overstated by the early commentators. Of course the philosophical position of dialetheism is far from being the accepted position in mainstream analytic philosophy, but at least it [is] taken seriously nowadays and more logicians are interested in paraconsistent logic than ever before. This should vindicate Wittgenstein's remarks somewhat in the mind of modern readers, even though they are perhaps not ready to accept his claims from a philosophical standpoint.

On the other hand, the interpretations which have tried to interpret Wittgenstein's remarks in such a way as to deny claim (b), namely the interpretations of Shankar, Floyd and Floyd and Putnam, must—when all is considered—be taken to have failed in this task. This reading is simply the most natural one, and they only manage to avoid this conclusion by building very elaborate interpretations with many implausible assumptions and textual problems. In this respect the unequivocal conclusion must be that the early commentators (and Victor Rodych, of course) were simply right: When Wittgenstein wrote the remarks contained in (RFM I, App. III) he did not have a good understanding of Gödel's proof and this led him to say wrong things about it.

This mistake, on Wittgenstein's part, is however not necessarily so severe, as to justify the damage it has done to his reputation as a philosopher of mathematics. It is undoubtedly true that Gödel's proof causes, as it is often seen, serious problems for the positions of logicism and formalism in the philosophy of mathematics, if it is not simply a refutation of those views. The matter is however far from being clear whether or not Wittgenstein's philosophy of mathematics entails such a position, as is often assumed, and many reasons to suppose that this is not the case—at least it is not what one would expect from the author of the *Philosophical Investigations*."

... Matthiasson: [Mat13], §Concluding remarks.

From the *evidence-based* perspective of this investigation however, that the onus of guilt must fall heavier on Gödel (see §15.C.) follows not only from his misleading remark that the semantic concept of 'truth' might be replaceable by the 'purely formal and much weaker assumption' of ω -consistency:

"The method of proof which has just been explained can obviously be applied to every formal system which, first, possesses sufficient means of expression when interpreted according to its meaning to define the concepts (especially the concept "provable formula") occurring in the above argument; and, secondly, in which every provable formula is true. In the precise execution of the above proof, which now follows, we shall have the task (among others) of replacing the second of the assumptions just mentioned by a purely formal and much weaker assumption."

... Gödel: [Go31], p.9.

but also from his implicit—and equally misleading—footnote 48a on page 28 of [Go31], which suggests that assuming any formal system of arithmetic—such as, for instance, the first-order Peano Arithmetic PA—to be ω -consistent is intuitionistically unobjectionable, and may be treated *as a matter of fact*:

"In the proof of Theorem VI no properties of the system P were used other than the following:

1. The class of axioms and the rules of inference (i.e. the relation "immediate consequence") are recursively definable (when the primitive symbols are replaced in some manner by natural numbers).
2. Every recursive relation is definable within the system P (in the sense of Theorem V).

Hence, in every formal system which satisfies assumptions 1, 2 and is ω -consistent, there exist undecidable propositions of the form $(x)F(x)$, where F is a recursively defined property of natural numbers, and likewise in every extension of such a system by a recursively definable ω -consistent class of axioms. To the systems which satisfy assumptions 1, 2 belong, as one can easily confirm, the Zermelo-Fraenkel and the v. Neumann axiom systems for set theory, and, in addition, the axiom system for number theory which consists of Peano's axioms, recursive definitions (according to schema (2)) and the logical rules. Assumption 1 is fulfilled in general by every system whose rules of inference are the usual ones and whose axioms (as in F) result from substitution in finitely many schemata.^{48a}

[Footnote 48a] The true reason for the incompleteness which attaches to all formal systems of mathematics lies, as will be shown in Part II of this paper, in the fact that the formation of higher and higher types can be continued into the transfinite."

... Gödel: [Go31], p.28.

That both of Gödel's assertions are misleading follows since PA is *both* strongly (finitarily) consistent by §2.C.a., Theorem 2.16—hence 'correct'—and ω -inconsistent by §2.F., Corollary 2.22 and, as we shall show, independently, by §12.B.f., Theorem 12.6.

Moreover, from the *evidence-based* perspective of this investigation, the defining of, both:

- arithmetical *truth*, under a *weak*, Wittgensteinian, interpretation $\mathcal{I}_{PA(\mathbb{N}, W)}$ of PA over the structure of the PA numerals (see §12.B.d.), by appeal to arithmetical *provability*, as evidenced in the proof of §12.B.f., Theorem 12.6; and
- arithmetical *truth* in terms of algorithmic *verifiability* (in §2.B.), and algorithmic *provability* (in §2.C.), over the domain \mathbb{N} of the natural numbers, as implicitly appealed to in the proof of §2.F., Corollary 2.22;

can be viewed as reflecting Lampert’s interpretation of Wittgenstein’s argument in [Wi78], to the effect that it ‘is algorithmic proofs relying on nothing but syntactic criteria that serve as a measure for assessing meta-mathematical interpretations, not vice-versa’:

“In I, §17, Wittgenstein suggests to look at proofs of unprovability “in order to see *what* has been proved”. To this end, he distinguishes two types of proofs of unprovability. He mentions the first type only briefly: “Perhaps it has here been proved that such-and-such forms of proof do not lead to *P*.” (*P* is Wittgenstein’s abbreviation for Gödel’s formula *G*). In this section, I argue that Wittgenstein refers in this quote to an algorithmic proof proving that *G* is not provable within PM. Such a proof of unprovability would, to Wittgenstein, be a compelling reason to give up search for a proof of *G* within PM. Wittgenstein challenges Gödel’s proof because it is not an unprovability proof of this type. This is also why Wittgenstein does not consider algorithmic proofs of unprovability in greater detail in his discussion of Gödel’s proof. Such proofs represent the background against which he contrasts Gödel’s proof to a type of proof that is beyond question.

Unfortunately, Wittgenstein does not follow his own suggestion to more carefully evaluate unprovability proofs with respect to Gödel’s proof. Instead, he distinguishes different types of proofs of unprovability in his own words and in a rather general way; cf. I, §8-19. His critique focuses on a proof of unprovability that relies on the representation of provability within the language of the axiom system in question. Thus, following his initial acknowledgement of algorithmic unprovability proofs in I, §17, Wittgenstein repeats, at rather great length, his critique of a meta-mathematical unprovability proof. It is this type of unprovability proof that he judges unable to provide a compelling reason to give up the search for a proof of *G*. The most crucial aspect of any comparison of two different types of unprovability proofs is the question of what serves as the “criterion of unprovability” (I, §15). According to Wittgenstein, such a criterion should be a purely syntactic criteria independent of any meta-mathematical interpretation of formulas. It is algorithmic proofs relying on nothing but syntactic criteria that serve as a measure for assessing meta-mathematical interpretations, not vice-versa.

[...]

Gödel’s proof is not an algorithmic unprovability proof. Instead, Gödel’s proof is based on the representation of provability within the language of PM. Based on this assumption, Gödel concludes that PM would be inconsistent (or ω -inconsistent) if *G* (or $\neg G$) were provable. Thus, given PM’s (ω)-consistency, *G* is undecidable. This reasoning is based on the purely hypothetical assumption of the provability of *G*; it does not consider any specific proof strategies for proving formulas of a certain form within PM.

Given an algorithmic unprovability proof for *G*, the meta-mathematical statement that *G* is provable would be reduced to absurdity. This would be a compelling reason to abandon any search for a proof. Such a proof by contradiction would contain a “physical element” (I, §14) because a *meta*-mathematical statement concerning the provability of *G* is reduced to absurdity on the basis of an algorithmic, and thus purely mathematical, proof. Wittgenstein does not reject such a proof by contradiction in §14.”

... Lampert: [Lam17].

We note further that from the *evidence-based* interpretation of this investigation, we would conclude—from the passage quoted below—that Wittgenstein’s remarks in [Wi78] can be

interpreted as claiming that, any interpretation of a formula containing a quantifier, as used by Wittgenstein when he refers to meta-mathematical “proofs of contradiction”, ‘refers to an *instance* of a formula or of its abbreviation, such as G or $\neg\exists yB(y, [G])$ ’, in Gödel’s reasoning, which would introduce an element of ‘prose’ that—in the context of the *evidence-based* perspective of this investigation—may reasonably be taken to be an assumption such as that of Aristotle’s particularisation²⁷⁵—which is stronger than (see §8.D.) both Gödel’s ω -consistency²⁷⁶ and Rosser’s Rule C ²⁷⁷—into an ‘intended’ interpretation (see also §7.K.):

“The proofs by contradiction of the type to which Wittgenstein objects are proofs that involve *interpretation* of logical formulas: the inconsistency concerns the relation between the provability of a formula (proven or merely assumed) and its interpretation. Here, “interpretation” is not to be understood in terms of purely formal semantics underlying proofs of correctness or completeness. Formal semantics assign extensions to formal expressions without considering specific instances of formal expressions that are meant to refer to extensions. Instead, in proofs of contradiction Wittgenstein is concerned with an “interpretation of a formula” refers to an *instance* of a formula or of its abbreviation, such as G or $\neg\exists yB(y, [G])$, stated as a sentence in ordinary language or a standardized fragment of an ordinary language. Interpretations of this kind are so-called “intended interpretations” or “standard interpretations”, which are intended to identify extensions such as truth values, truth functions, sets or numbers by means of ordinary expressions. As soon as interpretations of this kind become involved, one departs from the realm of mathematical calculus and “prose” comes into play, in Wittgenstein’s view. Therefore, Wittgenstein’s “non-revisionist” attitude does not apply to proofs by contradiction that rest on intended interpretations. A rigorous mathematical proof should not be affected by the problem that some intended interpretation may not refer to that to which it is intended to refer, which is a genuinely philosophical problem.”

... Lampert: [Lam17].

12.B.a. Wittgenstein’s objection to Gödel’s reasoning

The substance of Wittgenstein’s objection on philosophical considerations to Gödel’s reasoning—essentially to the latter’s argument that a Peano Arithmetic such as PA can be assumed ω -consistent without inviting contradiction—emerges if we note that, apart from:

- (a) the *weak* standard interpretation $\mathcal{I}_{PA(\mathbb{N}, SV)}$ of PA (see §10.D.) where decidability is defined *weakly* in terms of algorithmic *verifiability* by §2., Definition 7; and
- (b) the *strong* finitary interpretation $\mathcal{I}_{PA(\mathbb{N}, SC)}$ of PA (see §10.E.) where decidability is defined *strongly* in terms of algorithmic *computability* by §2., Definition 10;

there is a *weak* ‘Wittgensteinian’ interpretation $\mathcal{I}_{PA(PA, W)}$ of PA (see §12.B.d.) where ‘satisfaction/truth’ is defined, also *weakly*, in terms of algorithmic *verifiability* over the structure of the PA-numerals in PA (see §12.B.d., Definition 36).

²⁷⁵**Aristotle’s particularisation** (see §7., Definition 20): If the formula $[\neg(\forall x)\neg F(x)]$ of a formal first order language L is defined as ‘true’ under an interpretation, then we may always conclude *unrestrictedly* that there must be some *well-definable*, albeit *unspecified*, object s in the domain D of the interpretation such that, if the formula $[F(x)]$ interprets as the relation $F^*(x)$ in D , then the proposition $F^*(s)$ is ‘true’ under the interpretation..

²⁷⁶ **ω -consistency**: A formal system S is ω -consistent if, and only if, there is no S -formula $[F(x)]$ for which, first, $[\neg(\forall x)F(x)]$ is S -provable and, second, $[F(a)]$ is S -provable for any specified S -term $[a]$.

²⁷⁷**Rosser’s Rule C** (see §8.G.): “It is very common in mathematics to reason in the following way. Assume that we have proved a wf of the form $(Ex)\mathcal{A}(x)$. Then, we say, let b be an object such that $\mathcal{A}(b)$. We continue the proof, finally arriving at a formula which does not involve the arbitrarily chosen element b In general, any wf which can be proved using arbitrary acts of choice, can also be proved without such acts of choice. We shall call the rule which permits us to go from $(Ex)\mathcal{A}(x)$ to $\mathcal{A}(b)$, Rule C”.

The interpretation $\mathcal{I}_{PA(PA, W)}$ of PA reflects in essence the views Wittgenstein emphasised in his ‘notorious paragraph’ ([Wi78], Appendix III 8; see also §12.B.), where he seems to suggest that the ‘truth’ of a proposition of a mathematical system must be definable in terms of its ‘provability’ within the system.

12.B.b. Interpreting Tarski’s Theorem constructively

The significance of the interpretation $\mathcal{I}_{PA(PA, W)}$ is that standard expositions of Tarski’s Theorem (see [Ta35]) appear to *implicitly* suggest²⁷⁸ that—contrary to §12.B.d., Definition 36—an *evidence-based*, algorithmically *verifiable*, truth of the formulas of a first-order Arithmetic such as PA, under a well-defined interpretation, cannot be *well-defined* formally.

Tarski’s Theorem: “The set *Tr* of Gödel numbers of wfs of *S* which are true in the standard model is not arithmetical, i.e., there is no wf $A(x)$ of *S* such that *Tr* is the set of numbers k for which $A(\bar{k})$ is true in the standard model.”

... Mendelson: [Me64], p.151, Corollary 3.38.

For instance, in his 2006 paper [Mur06], Roman Murawski interprets ‘ $\mathcal{N}_0 \models \phi$ ’, where ϕ denotes any *well-defined* arithmetical proposition over \mathbb{N} , as a self-evident, and ostensibly unambiguous, definition of arithmetical truth; and—in view of the Provability Theorem for PA ([An16], Theorem 7.1, p.41; see also §2.E.b., Theorem 2.17)—invalidly concludes ‘that the notion of truth for arithmetic is hyperarithmetical’ since, unlike arithmetic provability in PA, arithmetic truth cannot be defined algorithmically over \mathbb{N} :

“... let us restrict ourselves to Peano Arithmetic. This is a first-order theory formalized in the language $L(PA)$ with the following nonlogical symbols: $0, S, +, \cdot$ and based on the following nonlogical axioms:

- (A1) $S(x) = S(y) \rightarrow x = y$,
- (A2) $\neg(0 = S(x))$,
- (A3) $x + 0 = x$,
- (A4) $x + S(y) = S(x + y)$,
- (A5) $x \cdot 0 = 0$,
- (A6) $x \cdot S(y) = x \cdot y + x$,
- (A7) $\phi(0) \wedge \forall x[\phi(x) \rightarrow \phi(S(x))] \rightarrow \forall x\phi(x)$,
where ϕ is any formula of the language $L(PA)$.

Fix an arithmetization of the language $L(PA)$ and denote by $\ulcorner \phi \urcorner$ the Gödel number of a formula ϕ by the given arithmetization.² Let \bar{n} be the term $\underbrace{S \dots S(0)}_n$ denoting the natural number n .

The strong version of Tarski’s theorem (i.e., the version without parameters) can now be formulated in the following way.

THEOREM 1 (Tarski, 1933). *If Peano arithmetic PA is consistent then there exists no formula $\mathbf{St}(x)$ of the language $L(PA)$ being the definition of truth for formulas of $L(PA)$, i.e., such a formula $\mathbf{St}(x)$ that for any sentence ψ of the language $L(PA)$*

²⁷⁸We note that the weak point of, both, John Lucas’ ([Lu61], [Lu96]) and Roger Penrose’s ([Pe90], [Pe94]) Gödelian arguments is that they—as non-logicians—accept this seeming implication unquestioningly in good faith (see [An07a], [An07b], [An07c]), and use it explicitly as an arguable cornerstone of their respective defence of their respective Gödelian Theses (see also §21.).

$$\text{PA} \vdash \psi \equiv \mathbf{St}(\overline{\ulcorner \psi \urcorner}).$$

Let \mathcal{N}_0 be the standard interpretation of the language of Peano arithmetic, i.e., $\mathcal{N}_0 = \langle \mathbb{N}, 0, S, +, \cdot \rangle$ where \mathbb{N} is the set of natural numbers, 0 is the number zero, S is the successor function and $+$ and \cdot are addition and multiplication of natural numbers, resp. The structure \mathcal{N}_0 is called the standard model of PA. Tarski's theorem states that there exists no formula \mathbf{St} of the language $L(\text{PA})$ such that for any sentence ψ of $L(\text{PA})$, $\text{PA} \vdash \psi \equiv \mathbf{St}(\overline{\ulcorner \psi \urcorner})$, hence in particular there exists no formula \mathbf{St} such that for any sentence ψ of $L(\text{PA})$, $\mathcal{N}_0 \models \psi$ if and only if $\mathcal{N}_0 \models \mathbf{St}(\overline{\ulcorner \psi \urcorner})$, i.e., there is no definition (in the language of $L(\text{PA})$) of the set of (Gödel numbers of) those sentences of $L(\text{PA})$ which are true in the domain of natural numbers (= in the standard model \mathcal{N}_0). Consequently the notion of truth for arithmetic of natural numbers, i.e., the set

$$\{\ulcorner \phi \urcorner : \phi \text{ is a sentence of } L(\text{PA}) \ \& \ \mathcal{N}_0 \models \phi\}$$

is not an arithmetical set. This contrasts with the fact that the notion of provability for arithmetic, i.e., the set

$$\{\ulcorner \phi \urcorner : \phi \text{ is a sentence of } L(\text{PA}) \ \& \ \text{PA} \vdash \phi\}$$

is an arithmetical set, in fact it is recursively enumerable. This indicates the gap between provability and truth. On the other hand one can show that the notion of truth for arithmetic is hyperarithmetical, i.e., it belongs to the class Δ_1^1 .^{3"}

... Murawski: [Mur06], pp.287-288.

We note that Murawski is implicitly postulating by definition that a sentence ψ of PA can be *intuitively* treated either as a 'Platonic truth', or as a 'Platonic falsehood', under a similarly postulated 'standard' interpretation \mathcal{N}_0 of PA; which can therefore be postulated as a 'standard' model of PA.

The fragility of such postulation is seen since, classically (see [Me64], p.107), the '*intended*' standard interpretation of PA (see §7.K.) is, albeit arguably, the *weak*, algorithmically *verifiable*, interpretation $\mathcal{I}_{\text{PA}(\mathbb{N}, \text{SV})}$ of PA defined *finitarily* by [An16], Theorem 5.6 (see also §2.B.a., Theorem 2.7).

However, in view of the *strong*, algorithmically *computable*, interpretation $\mathcal{I}_{\text{PA}(\mathbb{N}, \text{SC})}$ of PA defined *finitarily* by [An16], Theorem 6.7, p.41 (see also §2.C.a., Theorem 2.15)—which, by virtue of the Provability Theorem for PA ([An16], Theorem 7.1, p.41; see also §2.E.b., Theorem 2.17), meets the *finitary* criteria for the *intended* interpretation of PA envisaged in Hilbert's Program—the classical, standard, interpretation of PA ought now to be viewed (as argued in §7.K.) as the '*unintended*' interpretation of PA, since (by [An16], Corollary 8.5; see also §2.B.a., Theorem 2.8) it does not define a *constructive* model of PA such that any sentence ψ of PA interprets as either an 'algorithmically *verifiable* truth' or an 'algorithmically *verifiable* falsehood'.

The lack of an unambiguous distinction between an '*intended*' interpretation/model and an '*unintended*' interpretation/model of arithmetic is evidenced in Murawski's conclusions:

"Let us turn to conclusions. As Gaifman (2004, p. 15) wrote:

Intended interpretations are closely related to realistic conceptions of mathematical theories. By subscribing to the standard model of natural numbers, we are committing ourselves to the objective truth or falsity of number-theoretic statements, where these are usually taken as statements of first-order arithmetic. The standard model is supposed to provide truth-values for these statements.

Deductive systems can only yield recursively enumerable sets of theorems and therefore they can only partially capture truth in the standard model. Even more, the truth in the standard model is not arithmetically definable.

On the other hand, there are nonstandard (hence unintended) models (not only for Peano arithmetic but even for the theory of the standard model \mathcal{N}_0). This shows an essential shortcoming of a formalized approach: the failure to fully determine the intended model.

An attempt to define arithmetical truth (truth for arithmetic) in a higher order theory, for example in the second-order arithmetic or its appropriate fragment where its existence can be proved, does not give a satisfactory solution. Indeed second-order arithmetic as a deductive system is incomplete and, additionally, there appears the problem of nonstandard models and interpretations."

... Murawski: [Mur06], p.300.

Thus—from the *evidence-based* perspective of this investigation—we shall argue (see also §7.K.) that it is the *lack* hitherto of a distinction between the ‘unintended’, *weak*, algorithmically *verifiable*, interpretation $\mathcal{I}_{PA(\mathbb{N}, SV)}$ of PA (see §2.B.), and the ‘intended’, *strong*, algorithmically *computable*, interpretation $\mathcal{I}_{PA(\mathbb{N}, SC)}$ of PA (see §2.C.), that, *prima facie*, compels Murawski to prematurely concede that a ‘general moral of our considerations is that semantics needs infinitistic means and methods’, whence ‘finitistic tools and means proposed by Hilbert in his programme are essentially in sufficient’:

“Moreover, even for a fixed model \mathcal{M} of Peano arithmetic for which there exists a satisfaction class, the concept of satisfaction and truth cannot be uniquely determined and, even worse, not always can be defined in such a way that the required (and expected because useful) nice metamathematical properties would be satisfied. There is no uniqueness and no bivalency (for nonstandard models). But nonstandard models and nonstandard languages (generated by such models and by axiomatic approach to the concept of truth) turn out to be useful and to have an impressive spectrum of applications. In particular they can be used to establish properties of deductive systems, provide insight into fragments of Peano arithmetic as well as into (second-order) expansions of it. They can also serve as a heuristic guide for behavior of the infinity (one can code by nonstandard objects appropriate infinite sets, in particular infinite sets of standard formulas).

Note also that considering satisfaction classes and truth for the language of Peano arithmetic and attempting to characterize them axiomatically we use the whole time at the metatheoretical level Tarski’s definition with respect to structures of the type $\langle \mathcal{M}, \mathcal{S} \rangle$ and the latter is understood as being defined in a non-formalized metasystem.

A general moral of our considerations is that semantics needs infinitistic means and methods. Hence finitistic tools and means proposed by Hilbert in his programme are essentially insufficient."

... Murawski: [Mur06], pp.301-302.

We note that the barriers in admitting the *evidence-based*, finitary, proof of consistency for PA in [An16], Theorem 6.8 (see also §2.C.a., Theorem 2.16) in inherited mathematical paradigms—as reflected in the following extract from the 2008 Beth lecture [Mlf08] by Per Martin-Löf: ‘*The Hilbert-Brouwer controversy resolved?*’—seem insurmountable *only* since such paradigms do not admit a distinction (see §13.E.) between a language of unambiguous expression, such as the first-order set theory ZF, and a language of categorical communication, such as the first-order Peano Arithmetic PA:

“So now I will tell two different stories that have eventually provided the information that makes the Hilbert-Brouwer controversy look different now from what it looked like in 1928, and the first of these is the double-negation interpretation. Naturally, the mathematical community was at the time very much bothered by this controversy, and especially those who were young enough to have their formative years in the twenties, they eagerly wanted to learn: what was it all about,

and could something be done about it? One of them was Kolmogorov, and one can see in his paper *On the law of the excluded middle* from 1925 (Kolmogorov 1925) a very strong wish to reach some kind of objective verdict in this controversy, but not only in that paper: there is also a much less known paper that was published in a popular scientific journal in 1929, *Contemporary debates on the nature of mathematics* (Kolmogorov 1929), which testifies to the same strong wish. And, if you read the Résumé which you find at the end of his 1925 paper, it is clear that he thought actually at the time that he had been able to settle this controversy. And how did he settle it? Well, he settled it by forgetting about Brouwer's distaste for language and logic: he sat down with the Hilbert axioms for propositional and predicate logic, removing those that did not look all right on a constructive interpretation and retaining the other ones, except for the crucial law *ex falso quodlibet*, which it remained for Heyting to add to the system in 1930, and then he simply interpreted all of classical propositional and predicate logic by means of constructive propositional and predicate logic, utilizing what we now call the double-negation interpretation. And, indeed, that does give a constructive interpretation of classical logic, and he thought that, having achieved that, the problem of giving a constructive interpretation of classical mathematics in its entirety was essentially solved. This was the mistake, because mathematics cannot be built on propositional and predicate logic alone: there has to be some amount of set theory also, and two questions then arise, first: what should be the laws of this set theory? and, second: does this set theory with classical logic, which is to say classical mathematics, allow the double-negation interpretation to go through? These questions were not addressed in Kolmogorov's 1925 paper, so he was overoptimistic at the time.

Then the double-negation interpretation was independently rediscovered, as we all know, by Gödel and Gentzen in 1933 (Gödel 1933a), but, more importantly, they extended it from pure logic to first-order arithmetic, and that immediately gave a constructive interpretation, and therefore a constructive consistency proof, of first-order arithmetic, but the question remained: could it be extended beyond first-order to second- or higher-order arithmetic?"

... Martin-Löf: [Mlf08]²⁷⁹, pp.247-248.

Moreover, by admitting a *faith-based* belief such as Aristotle's particularisation (see §7., Definition 20), such paradigms cannot admit the classical Law of the Excluded Middle as a theorem of the finitarily consistent classical first-order logic FOL (see §8.D., Theorem 8.13); with the curious consequence that even a proof of consistency for first order arithmetic, such as Gentzen's, which admits Cantor's admittedly non-constructive ordinal ω , can be deemed 'constructive' (thus admitting even curiously 'deemed constructive' argumentation):

"The Howard ordinal is also the ordinal of Kripke-Platek set theory, and it is the ordinal of Aczel's constructive version of Zermelo-Fraenkel set theory, which, although it has this comparatively limited proof-theoretic strength, is nevertheless such that, when you add the law of excluded middle to it, you get full classical Zermelo-Fraenkel set theory."

... Martin-Löf: [Mlf08], p.251.

12.B.c. Tarski's definitions under the *weak* standard interpretation $\mathcal{I}_{PA(\mathbb{N}, SV)}$ of PA

We note first that, from the *evidence-based* perspective of [An16], Tarski's definitions (see [An16], §3, p.37; also §29.(15)) of the *satisfiability* and *truth* of the formulas of the Peano Arithmetic PA, under an interpretation over \mathbb{N} , are of significance for a putative language of categorical communication only if, for any *specified* PA-formula $[A(x)]$ and any *specified* n in \mathbb{N} ,

²⁷⁹[Mlf08]: Per Martin-Löf. 2008. *The Hilbert-Brouwer controversy resolved?* In: van Atten M., Boldini P., Bourdeau M., Heinzmann G. (eds) *One Hundred Years of Intuitionism (1907–2007)*, Publications of the Henri Poincaré Archives. Birkhäuser Basel, Switzerland. https://doi.org/10.1007/978-3-7643-8653-5_15

<http://archive-pml.github.io/martin-lof/pdfs/Hilbert-Brouwer-Controversy-Resolved-2008.pdf>

there is a deterministic algorithm which will *evidence* whether or not the interpretation $A^*(n)$ of $[A(n)]$ holds under the *weak*, standard, interpretation $\mathcal{I}_{PA(\mathbb{N}, SV)}$ of PA.

Classically, such determination is implicitly assumed to be algorithmically *computable* by appeal to the Church-Turing Thesis. However, in this investigation we argue that, by the principle of Ockham's Razor:

- (i) there is no justification for such a presumption of *strong* algorithmic *computability* when we can define 'effective computability' (see §7.H.b.) in terms of *weak* algorithmic *verifiability* (see §2., Definition 7);
- (ii) the minimum requirement of Tarski's definitions under the *weak* standard interpretation $\mathcal{I}_{PA(\mathbb{N}, SV)}$ of PA (as defined in §2.B.) is only *weak* algorithmic *verifiability* (see also §10.D.).

A formula $[A(x)]$ of PA is thus defined as *satisfied* under $\mathcal{I}_{PA(\mathbb{N}, SV)}$ (see [An16], §5, p.38) if, and only if, its interpretation $A^*(x)$ is algorithmically *verifiable*; in other words, for any *specified* value n that lies within the range of the variable x in the domain \mathbb{N} of $\mathcal{I}_{PA(\mathbb{N}, SV)}$, there is a deterministic algorithm which will *evidence* that the interpretation $A^*(n)$ of $[A(n)]$ is *true* under $\mathcal{I}_{PA(\mathbb{N}, SV)}$.

The formula $[(\forall x)A(x)]$ of PA is then defined as *true* under $\mathcal{I}_{PA(\mathbb{N}, SV)}$ if, and only if, $[A(x)]$ is *satisfied* under $\mathcal{I}_{PA(\mathbb{N}, SV)}$. Other definitions also follow as usual (see [An16], §5, p.38; also §29.(15)).

12.B.d. A *weak*, Wittgensteinian, interpretation $\mathcal{I}_{PA(\mathbb{P}\mathbb{A}, W)}$ of PA in PA

We note next that, just as we can interpret PA without relativisation in ZF (in the sense indicated by Feferman in [Fe92]), we can—contrary to inherited paradigms²⁸⁰—interpret PA *in* PA, where PA formulas interpret as themselves, and where—also under Tarski's standard definitions (see [An16], §3, p.37; also §29.(15))—we now define the *satisfiability* and *truth* of the formulas of PA under a *weak*, Wittgensteinian, interpretation $\mathcal{I}_{PA(\mathbb{P}\mathbb{A}, W)}$ of PA, over the structure of the PA numerals *syntactically*, by appeal to the *numeralwise provability* of PA formulas.

Definition 36. (Wittgensteinian interpretation) *An atomic formula $[A(x)]$ of PA is satisfied under $\mathcal{I}_{PA(\mathbb{P}\mathbb{A}, W)}$ if, and only if, for any substitution of a specified PA-numeral $[n]$ for the variable $[x]$, there is a deterministic algorithm²⁸¹ which will evidence that the formula $[A(n)]$ is provable in PA.*

We note that:

Theorem 12.1. *The atomic formulas of PA are algorithmically verifiable as true or false under the algorithmically verifiable, weak, Wittgensteinian, interpretation $\mathcal{I}_{PA(\mathbb{P}\mathbb{A}, W)}$.*

²⁸⁰And this is just the Grelling Paradox, and shows the following fact: the language of PA, L_{PA} , does not admit of the semantic predicate of satisfiability (and therefore neither the semantic predicate of truth).⁹³

⁹³ This fact is just the content of *Tarski's Theorem* (see below). . . . Drăghici: [Drg23], §4.2.3.1 Paradoxes (examples), (3) Remark 1, p.217.

²⁸¹e.g., Gödel's primitive recursive relation xBy in [Go31], Definition 45, p.22.

Proof. It follows from Gödel’s definition of the primitive recursive relation xBy^{282} —where x is the Gödel number of a proof sequence in PA whose last term is the PA formula with Gödel-number y —that, if $[A]$ is an atomic formula of PA, we can algorithmically verify which one of the PA formulas $[A]$ and $[\neg A]$ is necessarily PA-provable and, ipso facto, true under $\mathcal{I}_{PA(\mathbb{P}\mathbb{A}, W)}$. \square

We further note that—as in the case of the *weak*, standard, interpretation $\mathcal{I}_{PA(\mathbb{N}, SV)}$ of PA (see [An16], §5, p.38)—the requirement of Tarski’s definitions (see §29.(15)) under the *weak*, Wittgensteinian, interpretation $\mathcal{I}_{PA(\mathbb{P}\mathbb{A}, W)}$ of PA is also only *weak* algorithmic *verifiability*. Further:

Definition 37. *The formula $[(\forall x)A(x)]$ of PA is true under $\mathcal{I}_{PA(\mathbb{P}\mathbb{A}, W)}$ if, and only if, $[A(x)]$ is satisfied under $\mathcal{I}_{PA(\mathbb{P}\mathbb{A}, W)}$.*

Other definitions, too, follow as usual.

Comment 104. We note that the truth of $[(\forall x)A(x)]$ under $\mathcal{I}_{PA(\mathbb{P}\mathbb{A}, W)}$ does not entail that $[(\forall x)A(x)]$ is provable in PA, since it only entails that the interpretation $A^*(x)$ of $[A(x)]$ is algorithmically *verifiable* as always *true* under $\mathcal{I}_{PA(\mathbb{N}, SV)}$.

For the truth of $[(\forall x)A(x)]$ under $\mathcal{I}_{PA(\mathbb{P}\mathbb{A}, W)}$ to entail that the interpretation of $[(\forall x)A(x)]$ is provable in PA (by appeal to the Provability Theorem for PA—see [An16], Theorem 7.1, p.41), it would have to entail further that the interpretation $A^*(x)$ of $[A(x)]$ is algorithmically *computable* as always *true* under $\mathcal{I}_{PA(\mathbb{N}, SV)}$.

12.B.e. *Weak* truth under $\mathcal{I}_{PA(\mathbb{N}, SV)}$ is equivalent to *weak* truth under $\mathcal{I}_{PA(\mathbb{P}\mathbb{A}, W)}$

It follows that:

Theorem 12.2. *The interpretations $\mathcal{I}_{PA(\mathbb{N}, SV)}$ and $\mathcal{I}_{PA(\mathbb{P}\mathbb{A}, W)}$ of PA are isomorphic.*

Proof. By definition, the PA numerals under $\mathcal{I}_{PA(\mathbb{P}\mathbb{A}, W)}$ interpret further uniquely as the natural numbers of \mathbb{N} under $\mathcal{I}_{PA(\mathbb{N}, SV)}$.

Further, both $\mathcal{I}_{PA(\mathbb{N}, SV)}$ and $\mathcal{I}_{PA(\mathbb{P}\mathbb{A}, W)}$ are interpretations of PA such that:

- (i) each predicate letter A_j^n of PA under $\mathcal{I}_{PA(\mathbb{P}\mathbb{A}, W)}$ interprets further uniquely as an n -place relation under $\mathcal{I}_{PA(\mathbb{N}, SV)}$ in \mathbb{N} ;
- (ii) each function letter f_j^n of PA under $\mathcal{I}_{PA(\mathbb{P}\mathbb{A}, W)}$ interprets further uniquely as an n -place operation under $\mathcal{I}_{PA(\mathbb{N}, SV)}$ in \mathbb{N} (i.e., a function from \mathbb{N} into \mathbb{N});
- (iii) each individual constant a_i of PA under $\mathcal{I}_{PA(\mathbb{P}\mathbb{A}, W)}$ interprets further uniquely as some fixed element under $\mathcal{I}_{PA(\mathbb{N}, SV)}$ in \mathbb{N} ;
- (iv) the provable formulas of PA are locally ‘true’ respectively by definition under each of the interpretations $\mathcal{I}_{PA(\mathbb{N}, SV)}$ and $\mathcal{I}_{PA(\mathbb{P}\mathbb{A}, W)}$.

The theorem follows. \square

²⁸²[Go31], p. 22(45).

Corollary 12.3. *A formula of PA is true (by §12.B.d., Definition 36 and §29.(15)) under the weak, Wittgensteinian, interpretation $\mathcal{I}_{PA(\mathbb{P}\mathbb{A}, W)}$ if, and only if, it is true (by [An16], §5, p.38) under the weak standard interpretation $\mathcal{I}_{PA(\mathbb{N}, SV)}$.*

Proof. Corollary 12.3 follows immediately from Theorem 12.2. □

Moreover, it also follows that, by the classical definition of a ‘model’ (see §29.(4)):

Corollary 12.4. *The weak, standard, interpretation $\mathcal{I}_{PA(\mathbb{N}, SV)}$, and the weak, Wittgensteinian, interpretation $\mathcal{I}_{PA(\mathbb{P}\mathbb{A}, W)}$, are both weak models of PA.*

Proof. By [An16], Theorem 5.6, p.40, the axioms of PA interpret as true, and the PA rules of inference preserve such truth, under $\mathcal{I}_{PA(\mathbb{N}, SV)}$, which thus defines the *weak*, standard, model of PA. By §12.B.e., Corollary 12.3, the axioms of PA interpret as true, and the PA rules of inference preserve such truth, under $\mathcal{I}_{PA(\mathbb{P}\mathbb{A}, W)}$, which too is thus a *weak* model of PA. □

Comment 105. In other words both Wittgenstein and his critics could be viewed as talking at cross-purposes by conflating ‘For any’ with ‘For all’ (see §14.B.); since it can be argued that:

- (a) For Wittgenstein, a formula $[R(x)]$ of the first-order Peano Arithmetic was ‘true’ under a weak Wittgensteinian, interpretation $\mathcal{I}_{PA(\mathbb{P}\mathbb{A}, W)}$ of PA over the domain of the PA-numerals (hence over the domain \mathbb{N} of the natural numbers, since PA is finitarily consistent by §2.C.a., Theorem 2.16) if, and only if, for any numeral $[n]$ of PA, $[R(n)]$ was PA-provable;
- (b) For Wittgenstein’s critics, a formula $[R(x)]$ of the first-order Peano Arithmetic was ‘true’ under the weak ‘standard’ interpretation $\mathcal{I}_{PA(\mathbb{N}, SV)}$ of PA over the domain \mathbb{N} of the natural numbers if, *but not* only if, $[R(x)]$ was PA-provable.

12.B.f. *Why* a consistent PA is not ω -consistent

We now show that (compare [An16], Corollary 8.5, p.42²⁸³):

Theorem 12.5. *The standard interpretation $\mathcal{I}_{PA(\mathbb{N}, SV)}$ of PA is a weak model of PA which admits theorems that are not algorithmically verifiable as true or false.*

Proof. Assume PA is consistent.

- (i) By Gödel’s Theorem VI, a consistent PA admits a PA-formula $[R(x)]$ ²⁸⁴ such that $[(\forall x)R(x)]$ is not provable in PA²⁸⁵, even though, for any *specified* numeral $[n]$, there is an algorithm which will evidence that the formula $[R(n)]$ is PA-provable. Hence, there is an algorithm to evidence that $[(\forall x)R(x)]$ interprets as numeralwise provable under $\mathcal{I}_{PA(\mathbb{P}\mathbb{A}, W)}$.
- (ii) Assuming that $[\neg(\forall x)R(x)]$ too is not provable in PA, and can therefore be treated as an axiom, would entail the contradiction that there is no algorithm to evidence that $[(\forall x)R(x)]$ is numeralwise provable under any algorithmically verifiable interpretation of $PA + [\neg(\forall x)R(x)]$.

²⁸³[An16], Theorem 6.8: The standard interpretation $\mathcal{I}_{PA(\mathbb{N}, S)}$ of PA does not define a model of PA.

²⁸⁴In his Theorem VI ([Go31], p.24) Gödel defines, and refers to: (i) $[R(x)]$ only by its Gödel number r ([Go31], p.25, eqn.12); (ii) $[(\forall x)R(x)]$ only by its Gödel number $17 \text{ Gen } r$ ([Go31], p.25, eqn.13); and (iii) $[\neg(\forall x)R(x)]$ only by its Gödel number $\text{Neg}(17 \text{ Gen } r)$.

²⁸⁵See [Go31], p.25(1): $17 \text{ Gen } r$ is not κ -provable.

- (iii) Hence $[\neg(\forall x)R(x)]$ is provable in PA, but not algorithmically verifiable as true or false under $\mathcal{I}_{PA(\mathbb{P}\mathbb{A}, W)}$. The theorem follows by Corollary 12.4. \square

Corollary 12.6. *PA is not ω -consistent.*

Proof. If PA is ω -consistent, then $[\neg(\forall x)R(x)]$ is not provable in PA²⁸⁶. The corollary follows. \square

12.B.g. Conclusions

- (1) Gödel has shown in Theorem VI of [Go31], pp.25-26, that if an arithmetic such as the first-order Peano Arithmetic PA is ω -consistent, then there is a PA formula $[R(x)]$ ²⁸⁷ such that:
 - (i) the formula $[(\forall x)R(x)]$ is not provable in PA;
 - (ii) for any *specified* numeral $[n]$ of PA, the formula $[R(n)]$ is provable in PA;
 - (iii) the formula $[(\forall x)R(x)]$ interprets as an arithmetical proposition that is algorithmically *verifiable* as true under the standard, Tarskian, interpretation $\mathcal{I}_{PA(\mathbb{N}, SV)}$ of PA;
 - (iv) the formula $[\neg(\forall x)R(x)]$ is also not provable in PA;
 - (v) adding $[\neg(\forall x)R(x)]$ as an axiom to PA does not invite inconsistency.
- (2) Theorem 12.2 establishes that if PA is consistent, and a PA formula $[F]$ is decidable as true or false under a *well-defined* Tarskian interpretation $\mathcal{I}_{PA(\mathbb{D})}$ of PA *only* if there is an algorithm to *evidence* that the interpretation F^* of $[F]$, under $\mathcal{I}_{PA(\mathbb{D})}$, is algorithmically *verifiable* over the domain \mathbb{D} , then the *semantic*, standard, interpretation $\mathcal{I}_{PA(\mathbb{N}, SV)}$ of PA over \mathbb{N} , and the *syntactic*, Wittgensteinian, interpretation $\mathcal{I}_{PA(\mathbb{P}\mathbb{A}, W)}$ of PA over PA, are *well-defined*, isomorphic, Tarskian interpretations of PA.
- (3) Theorem 12.5 establishes that :
 - (i) if $[\neg(\forall x)R(x)]$ were unprovable in PA, then it could be added as an axiom to PA;
 - (ii) adding $[\neg(\forall x)R(x)]$ as an axiom to PA would invite inconsistency since an axiom, by definition, would be decidable under any *well-defined* Tarskian interpretation of PA, whereas $[\neg(\forall x)R(x)]$ cannot interpret as an arithmetical proposition that is algorithmically *verifiable* as true under any *well-defined* Tarskian interpretation under which the formula $[(\forall x)R(x)]$ is *numeralwise provable*;
 - (iii) the formula $[\neg(\forall x)R(x)]$ is provable in PA;
 - (iv) the formula $[\neg(\forall x)R(x)]$ is not decidable as true or false under the *weak*, Tarskian, interpretations $\mathcal{I}_{PA(\mathbb{N}, SV)}$ and $\mathcal{I}_{PA(\mathbb{P}\mathbb{A}, W)}$ of PA.
- (4) Corollary 12.6 concludes that since the formula $[\neg(\forall x)R(x)]$ is provable in PA and $[(\forall x)R(x)]$ is *numeralwise provable*, PA is not ω -consistent.

²⁸⁶See [Go31], p.26(2): Neg(17 Gen r) is not κ -provable.

²⁸⁷In his Theorem VI ([Go31], p.24) Gödel defines, and refers to: (i) $[R(x)]$ only by its Gödel number r ([Go31], p.25, eqn.12); (ii) $[(\forall x)R(x)]$ only by its Gödel number 17 Gen r ([Go31], p.25, eqn.13); (iii) $[\neg(\forall x)R(x)]$ only by its Gödel number Neg(17 Gen r).

In other words, Gödel has shown earlier that:

- If PA is ω -consistent, then it admits a formally undecidable formula $[(\forall x)R(x)]$ which interprets as an arithmetical proposition $R^*(x)$ that is algorithmically *verifiable* as *true* under the standard interpretation $\mathcal{I}_{PA(\mathbb{N}, SV)}$ of PA;

whilst *evidence-based* reasoning now shows that:

- If PA is consistent, then it admits the provable formula $[\neg(\forall x)R(x)]$ of PA which is undecidable under $\mathcal{I}_{PA(\mathbb{N}, SV)}$.

The issue, here, seems to be as to what we ought to admit as an axiom.

From the *evidence-based* perspective of this investigation (a perspective seemingly reflected in Markus Pantsar's conception of pre-formal mathematics in [Pan09]), an axiom *must* be evidenced as finitarily 'true'—under some *well-defined* Tarskian interpretation—in Gualtiero Piccinini's sense of 'knowledge' as factually grounded belief in [Pic19]; or, at the very least, justifiably true as intuitively justified true belief.

Admitting a putative, formally 'undecidable', proposition as an axiom in Gödel's sense (or 'forcing' one in Paul J. Cohen's sense in [Co63] and [Co64]) cannot be treated as 'knowledge' by either of the above yardsticks (both of which are grounded to varying degrees in our intuition).

As the argument of Theorem 12.5 suggests, although we may consider whether a well-formed formula of an axiomatic theory is consistent or not with some set of putatively true axioms (in either Piccinini's or sense or as intuitive), we ought not to treat it as a putative axiom in the absence of an intuitive justification.

CHAPTER 13. PHILOSOPHICAL FOUNDATIONS

13. What *is* mathematics?

The question of what mathematics is, and what it is not, remains a serious concern of mathematics educators, since the faith-based foundations (see §7.B.) of classical mathematical paradigms do not offer any coherent (see, for instance, §20.) philosophical perspective of the nature of mathematics to both teachers and students of mathematics (see §28.). As remarked by mathematics educationist Laxman Luitel:

“Talking about the nature of mathematics is not a new agenda. It had been discussed even before the fourth century. Plato and his student Aristotle are the first who provided the space to discuss nature of mathematics. From Plato’s point of view, objects of mathematics had an existence of their own, behind the mind, in the external world (Dossey, 1992). As a mathematics student from the school level, now I am realizing that my schooling was shaped by Plato’s point of view. In my schooling, I thought that mathematics was beyond of our thinking, abstract and discovered. In this context, a student of Plato, Aristotle, had different views. His views of mathematics were not based on a theory of an external, independent, unobservable body of knowledge but were based on experienced reality where knowledge is obtained from the experimentation, observation, and abstraction (Dossey, 1992). From this, I want to say that the observation of any object differs from person to person. This is based on their experience or related to how they perceive. Thus, there is no objective truth related to mathematics or there is no any objective answer to what mathematics is. What is mathematical knowledge? How is the mathematical knowledge constructed?”

... Luitel: [Lui19], pp.4-5.

From the *evidence-based* perspective of this investigation, we shall argue that mathematics ought to be viewed as merely a set of symbolic languages, the validity of whose propositions under Tarski’s definitions of their ‘satisfiability’, and ‘truth’, under a *well-defined* interpretation, must be rooted in, and reflect, what philosopher Markus Pantsar terms as the ‘pre-formal mathematics’ that the formal language is intended to capture faithfully in unambiguous expressions and, ideally—‘illusory’ Gödelian incompleteness notwithstanding (see §15.A.)—communicate categorically:

“Mathematics is a human endeavour, and we must not ignore the way mathematics is practised, learnt and taught. We as human beings use pre-formal—semantical—mathematical thinking all the time, and this enables us to understand mathematics. Human beings do not process mathematics completely formally as computers do. We comprehend mathematical ideas in our pre-formal thinking, and the formal theories are a way of making these ideas maximally unambiguous. *Proof* is of course the method by which we acquire new theorems in the formal systems, but the rules of proof cannot be arbitrary. They have been designed to correspond to our pre-formal ideas of *truth*. It is in this domain of pre-formal thinking that we see the truth of Gödel sentences. As the semantical arguments show, Tarskian truth is all we need for that, and it corresponds well with the pre-formal thinking in mathematics. That is why the semantical arguments are valid, and mathematical truth is substantial. Of course this would be the case even without Gödel’s incompleteness theorems and the semantical arguments; their importance lies in giving us an explicit sentence to study the problems with.”

... Pantsar: [Pan09], §1.9 The structure of this work.

For Pantsar, in the end it all ‘comes down to the question of reference’:

“In the end, all of the above comes down to the question of reference. If we follow extreme formalism in that mathematical theories have absolutely no outer references, we will end up with the position that mathematics is arbitrary fiction. Deep down, under this interpretation,

going through a mathematical proof is similar to solving a Sudoku puzzle. Although this goes against the image most of us have about the nature of mathematics—as well as all the practical applications—the formalist program has one clear strength: it avoids the daunting ontological problems we are faced with in the philosophy of mathematics. If we accept that mathematical theories have references, the understandable consensus is that we must specify what these are. On this matter, however, non-formalists have found very little to agree on. Platonism, structuralism, empiricism, naturalism and many other suggestions have been presented—and all of them have been shown to be problematic in one way or another. The conclusion for strict formalists has been that references in mathematics are not possible, and mathematics must be a fiction. In particular—against the main thesis of this work—mathematical truth is deflationary."

... *Pantsar*: [Pan09], §1.2 Another approach.

In other words admitting, for instance, that proving theorems in a first-order set theory, such as ZF, which admits an axiom of infinity, does not *require* a *well-defined* interpretation—thus avoiding ‘the daunting ontological problems we are faced with in the philosophy of mathematics’—also admits the disquieting conclusion—no longer tenable by the *finitary* proof in [An16] (Theorem 6.8, p.41; see also §2.C., Theorem 2.16) that the first-order Peano Arithmetic PA is consistent—‘that references in mathematics are not possible, and mathematics must be a fiction’.

“The approach for the extreme formalist, hence, is to minimize the ontological commitments in order to make mathematics as philosophically unproblematic as possible. In this work I want to suggest another approach, one that is necessitated by the failure of extreme formalism. While ontologically minimal, extreme formalism makes mathematics impossible as a human endeavour—which is much more alarming than any intricate philosophical problems. In a nutshell, I will argue that if extreme formalism were correct, mathematics could not have developed in the first place—nor could it be practised today. It must not be forgotten that mathematics is a *human endeavour* just like all other sciences. If something is essential to mathematics as a human endeavour, we would seem to have good reason to believe it is also a factor in the philosophy of mathematics—or at least something we should expect a theory in philosophy of mathematics not to *conflict* with. As well as providing an explanation for the formal theories that are the core of mathematical knowledge, philosophical accounts of mathematics must be able to explain why we prefer certain theories to others, why they are useful in practice, and how we are able to teach and learn mathematics. When it comes to mathematics as a science, this is of course something everybody is ready to agree on. In fact, it is so obvious that most philosophers of mathematics seem content not to grant any importance to it. For the majority of philosophers, mathematics seems to consist of formal systems—often using Peano arithmetic (PA) as the example—and the philosophy of mathematics concerns the ontological and epistemological status of these systems.

As central as those questions are, to me they only seem to cover half the picture. It is obvious that besides formal systems, mathematics as a human endeavour has a large informal element. Textbooks of mathematics are not written in completely formal languages and all kinds of informal examples are used in learning mathematics. The communication in mathematics is facilitated everywhere by informal elements. Indeed, it should be safe to say that in order to understand mathematics, we as human beings *must* use these informal elements. In addition, the history of mathematical thinking of course reveals that formal axiomatic systems of mathematics are a rather late development. The Peano axiomatization of arithmetic, for example, was only published in 1889, millennia after arithmetic was first used to great success. These informal—*pre-formal*—elements have made mathematics possible to use and learn whether we consider individual or the wider historical development.

Yet the pre-formal element has been largely neglected in the philosophy of mathematics. It has been widely assumed—and not just among formalists—that these are matters for psychology and sociology, and not of much interest to philosophers. In this work I must argue against that. These pre-formal elements are the very reason why mathematics makes sense to us. Not surprisingly, they also have a central position in the whole problem of mathematical reference. When we acknowledge

that formal theories have been *designed* to correspond to our pre-formal mathematical ideas, we immediately recognize that the latter are in fact the reference of formal mathematics. Rather than think of, say, the natural numbers as defined by the axioms of PA as fiction, we can consider them referring to our pre-formal notion of number—and arbitrariness is avoided.

That is the first stage of mathematical reference, and when we speak about the truth of formal mathematical theories, at this first stage we are concerned with them *corresponding to our pre-formal ideas*. Of course, in order to avoid arbitrariness, the pre-formal ideas themselves must have references, and that second stage is the question of Platonism, structuralism and other ontological theories. In a way, by introducing pre-formal thinking into philosophy we are admittedly only moving the problem of reference to another level. However, this is giving the strict formalist too strong a case. I will argue that the non-formalist does not need to specify her ontological and epistemological positions. All she needs to show is that *some* theory of reference—and truth—is needed in the second stage for a philosophical theory of mathematics to make sense. In this work I defend Alfred Tarski's (1936) T-scheme as a theory of truth fitting both of these two stages. Tarskian truth is *semantical* and the connection of formal and pre-formal mathematics seems to be a semantical one, as well: we understand formal sentences by what they mean pre-formally.

It will be seen that Tarskian truth in the first stage—over formal mathematics—is not deflationary. What Tarskian truth in the second stage refers to is a whole other question—but it is also one we do not need to answer in order to refute extreme formalism and deflationism. There exists a reference for formal mathematics, and when it comes to the question of truth and proof, it will be enough to complete the argument here to show that there must exist one for pre-formal mathematics, as well. If we examine mathematics as a wider phenomenon, we will see that there is only one philosophical theory of mathematics that conflicts with this—and that is extreme formalism with its irrevocable problems of arbitrariness. Other than repudiating that kind of strict formalism, I will argue, the deep ontological questions of the second stage can be left unanswered in a work about truth and proof."

... *Pantsar*: [Pan09], §1.2 Another approach.

From the *evidence-based* perspective of this investigation, we could view Pantsar's remarkable insight—into the significance of what he terms as 'semantical', pre-formal, mathematics in validating 'syntactical' mathematical truth (i.e., mathematical truth defined in terms of mathematical provability, as in §12.B.d.)—as being strikingly highlighted by the '*pictorial proof*' of §22.A., Proposition 22.2²⁸⁸; and its claimed entailment, in §22.A., Proposition 22.5, of what is considered as one of the more important open problems in computational complexity, if not in all of mathematics, philosophy, and the natural sciences—the P vs NP problem.

Comment 106. Referring to the P vs NP problem, Lance Fortnow remarks that:

"Aside from being an important problem in computational theory, a proof either way would have profound implications for mathematics, cryptography, algorithm research, artificial intelligence, game theory, multimedia processing, philosophy, economics and many other fields."

... *Fortnow*: [Frt13].

Moreover, Pantsar's approach could be viewed as favouring a perspective which would admit that—as argued in §13.C.—mathematics must limit, and be seen as limiting, its relationship to Philosophy and the Natural Sciences by explicitly acknowledging its roots in Carnap's *explicandum*, and its goal in Carnap's *explicatum*; leaving to cognitive scientists, such as Lakoff and Núñez in [LR00], the ontological status of, first, the primary conceptual metaphors that were

²⁸⁸ §22.A., Proposition 22.2: Whether or not a prime p divides an integer n is independent of whether or not a prime $q \neq p$ divides the integer n .

sought to be represented symbolically in a mathematical language and, second, the secondary conceptual metaphors that correspond to subsequent, possibly Platonic, interpretations of the symbolic expressions of the language.

Although admitting such Platonic interpretations would make a mathematical language, such as ZF, ‘richer’ in its ability to unambiguously express conceptual metaphors that are not rooted in a reality which can be evidenced, such a ‘richness’ of expression must come at the cost of an inability to assign *evidence-based* characteristics of ‘satisfaction’ and ‘truth’ to the well-formed propositions of the language under Tarski’s definitions.

It is a cost, however, that Pantsar seemingly considers worth paying in order to avoid committing ideologically to ‘Platonism, empiricism, naturalism, structuralism or any other metaphysical and epistemological theories of mathematics’, so long as we can ‘know there is a difference between truth and proof without knowing what truth exactly is’; a difference without which ‘mathematics as we know it could not be possible’:

“In the very final chapter of this work the concept of substantiality (robustness) of truth is discussed. In it I have tried to make explicit an underlying argument of this work: we do not need to know the exact nature of mathematical truth in order to be able to talk about it. In fact, from this work one will not find comprehensive arguments for Platonism, empiricism, naturalism, structuralism or any other metaphysical and epistemological theories of mathematics. Yet the study on truth and proof here should not be on any weaker basis than in more complete philosophical pictures of mathematics. Aside from the substantiality of truth, that is the main thesis (sort of metathesis) of this work: we can know there is a difference between truth and proof without knowing what truth exactly is. Simply put, if such a difference did not exist, mathematics as we know it could not be possible.”

... Pantsar: [Pan09], §1.9 *The structure of this work*.

We note that the notion of ‘*pre-formal* proof’ and ‘*pre-formal* evidence’ are implicit in Per Martin Löf’s 1987 analysis [Mlf87] of the meaning and truth of a proposition.

Löf’s Thesis: A proposition ‘**A**’ is a ‘**truth**’ if, and only if, it can be ‘**asserted/judged**’ as ‘**A is true**’ by appeal to some ‘**evidence/proof**’ for the truth of **A** which can be ‘**validated**’.

Moreover, from the *evidence-based* perspective of this investigation, Martin-Löf can be viewed as essentially arguing that the two notions are the same, *if* we were to interpret his ‘schematic figure’—illustrative of giving ‘meaning to the most primitive notions that’ we deal with—as the above *Thesis*:

"How are you to proceed then to give meaning to the most primitive notions that you are dealing with? I think the answer is that you must enter on something completely different from modelling or translation, depending on whether you look at it model theoretically or proof theoretically: you must enter on a genuinely semantical or meaning theoretical investigation, which means that you must enter on something that you are not at all prepared for as a mathematical logician, whether model theorist or proof theorist: you must enter on an enterprise which is essentially philosophical or phenomenological, if you prefer, in nature. And, since it is this which is our concern at this workshop on theories of meaning, I think it would be appropriate to give, or at least outline, *one* example of a theory of meaning, namely, a theory of meaning for the standard language of predicate logic, because if we cannot deal even with that exceedingly simple language it is very unlikely that we should be able to give any substantial theories of meaning for more complicated languages, like fragments Of natural language. So I shall outline one particular theory of meaning, intuitionistic or verificationistic theory of meaning, for the language of predicate logic. Of course, pure predicate logic is not sufficient for all of mathematics: in addition to the logical operations you need ordinary inductive definitions, possibly also generalized or transfinite

inductive definitions, but the pattern of this kind of meaning theory can certainly be seen already from the explanations for the pure predicate logic.

The fundamental concepts that have to be explained semantically can be read off either from the title of my talk or else from the schematic figure

[SCHEMATIC FIGURE which we interpret as: A proposition 'A' is a 'truth' if, and only if, it can be 'asserted/judged' as 'A is true' by appeal to some 'evidence/proof' for the truth of A which can be 'validated'.]

First of all, we have the notion of proposition. Second, we have the notion of truth of a proposition. Third, combining these two, we arrive at the notion of assertion or judgement. There are various forms that a judgement may exhibit, in general, but I am only going to consider judgements of the particular form which is used for holding a proposition to be true. Fourth, in addition to the notion of judgement, we have the notion of evidence or proof of a judgement, which I have indicated schematically in the figure by means of the vertical line. Fifth, in the very end, I shall also have to consider the notion of correctness or validity of a proof: that is the last notion that enters into the title of my talk. So the semantical or meaning theoretical explanations that have to be supplied in the case of the language of predicate logic are explanations of the notions of proposition, of truth, of judgement, of proof, and eventually something has to be said about validity of proofs also."

... Martin-Löf: [Mlf87]²⁸⁹, pp.408-409.

From the *evidence-based* perspective of this investigation, we would then interpret Martin-Löf's analysis as reflecting the perspective of the Complementarity Thesis (§1., Thesis 1): that a mathematical language is merely a means for expressing those of our conceptual metaphors, whether primary or secondary, that can be expressed as valid grammatical constructions of the language.

The meaning of a proposition, then, lies not in the syntactical construction of a proposition, but in what an intelligence seeks to express in a well-formed expression of the language by means of an effective method that, first, admits an unambiguous 'encoding' of a primary conceptual metaphor in the language and, thereafter admits an unambiguous 'decoding' of the symbolic expression into a secondary conceptual metaphor.

An expression is unambiguous if it succeeds in 'encoding' the primary metaphor such that the 'encoding' admits a 'decoding' which uniquely defines a secondary, 'interpreted', conceptual metaphor that the 'encoding' intelligence can 'evidence' as corresponding to that which was intended to be expressed within the language by the initial 'encoding'.

A proposition is then defined as 'pre-formally' true within a *well-defined* community if, and only if, any two intelligences within the community that share an identical method for 'encoding' their individual primary conceptual metaphors in a shared language, arrive at the same symbolic expression of the language; and can 'evidence' that the expression does, indeed, 'decode' and uniquely define a 'secondary' conceptual metaphor that corresponds to that which the intelligences, by consensus, treat as what was sought to be expressed initially within the language.

A proposition is further defined as 'formally true' if, and only if, there is an effective method that can assign unique 'truth-values' of 'provability' and 'truth' to the symbolic expressions of a formal language (defined by a finite alphabet, finitary rules for the formation of well-formed formulas, axioms, rules of inference, definitions, finite proof sequences, lemmas, theorems, and corollaries) such that, first, every provable expression of the language is formally true under a

²⁸⁹[Mlf87]: Per Martin-Löf. 1987. *Truth of a proposition, evidence of a judgement, validity of a proof*. In *Synthese*, Volume 73, pp.407-420 (1987). <https://doi.org/10.1007/BF00484985>

<https://github.com/michael/martin-lof>.

Tarskian interpretation of the language, and second, that a proposition is formally true if, and only if, it is ‘evidenced’ as ‘pre-formally’ true by the concerned intelligences.

13.A. An empathetic perspective of Wittgenstein’s views on what mathematics is, and what it is not

Without attempting to address the issue in its broader dimensions, we take Wittgenstein’s remarks in [Wi78] (see §12.B.) as implicitly suggesting that (see also §11.C.; §28.A.):

Thesis 4. (Mathematics Thesis) *Mathematics is a set of precise, symbolic, languages such that:*

- (i) *Any language of such a set, say the first order Peano Arithmetic PA (or Russell and Whitehead’s PM in Principia Mathematica, or the Set Theory ZF) is, ideally, intended to adequately express and effectively communicate—in a finite and unambiguous manner—relations between elements that are external to the language PA (or to PM, or to ZF).*
- (ii) *Moreover, each such language is two-valued if we assume that, again ideally, there is some evidence-based methodology that defines/determines whether a specific relation either holds (is true) or does not hold (is false) externally under any well-defined interpretation of the language.*
- (iii) *Further:*
 - (a) *A selected, finite, number of primitive formal assertions about a finite set of selected primitive relations of, say, a language \mathcal{L} are defined as axiomatically \mathcal{L} -provable;*
 - (b) *All assertions about relations that can be effectively defined in terms of the primitive relations are termed as \mathcal{L} -provable if, and only if, there is a finite sequence of assertions of \mathcal{L} , each of which is either a primitive assertion or which can effectively be determined in a finite number of steps as an immediate consequence of any two assertions preceding it in the sequence by a finite set of finitary rules of consequence;*
 - (c) *All \mathcal{L} -provable relations interpret as true under any well-defined interpretation of \mathcal{L} .*

As expressed by Pasquale Frascolla, when analysing Ludwig Wittgenstein’s perspective on the ‘truth’ values assignable to the formal expressions of a mathematical language that are intended to represent ‘real facts’:

“To speak of a contingent state of affairs pictured by “ $\Omega^{(2x^2)},x = \Omega^4,x$ ” is like admitting the conceivability of a situation in which this equation is incorrect; but this would imply that the whole logical space in which real facts are placed would no longer be the same. The possibility that two different facts are pictured, respectively, by a proposition in which an expression generated by a double application of the second iteration of a given operation (when applied to an initial symbol) occurs, and by the proposition obtained from the former by replacing that same expression with the expression generated by three applications of the same operation to its own result—starting from the result of its application to the same initial symbol—would be conceded. But, in virtue of the general properties of the concept of operation, this is an impossible world, exactly in the same way in which, according to the view of propositions held in the *Tractatus*, no possible world can contain two different facts corresponding to a proposition and to its double negation. In conclusion, the attempt to attribute a contingent status to numerical identities is bound to fail because we cannot conceive formal properties of the world alternative to those which constitute our logical

space and, at the same time, remain comfortably immersed in the latter. To attribute to our world formal properties different from those which we actually acknowledge would mean simply to abandon our logical space for a new one; and, according to Wittgenstein, this cannot be done.

The fundamental assumption of picture theory entail that one cannot speak meaningfully, in language, of the forms of language; this restriction of the sayable is tantamount to ruling out the possibility that forms be conceived as a peculiar sort of objects (as simple constituents of contingent ideal states of affairs), and thus to ruling out the possibility that they provide "the substance" of a second world. This circumstance explains the radical, extreme nature of the consequences deriving from the anti-Platonic conception of forms maintained by Wittgenstein in the *Tractatus*. Given the three following premises:

- 1 logic and mathematics deal (in a manner we are shortly going to examine in detail) with formal properties and relations of linguistic expressions;
- 2 the role of Wittgensteinian objects of an ideal world cannot be assigned to forms;
- 3 a thought, a meaningful proposition, is the logical picture of a contingent configuration of objects and is true if this configuration exists, false otherwise;

only one conclusion can be drawn, if the coherence of the whole has to be saved: the results achieved in logic and mathematics cannot be formulated in meaningful propositions expressing a thought (and, *a fortiori*, the predicates "true" and "false" cannot be appropriately applied). This is exactly the drastic and somewhat disconcerting inference that Wittgenstein makes, as regards mathematics, in 6.2 and 6.21: "The propositions of mathematics are equations (*Gleichungen*), and therefore pseudo-propositions (*Scheinsätze*). A proposition of mathematics does not express a thought."

Now the reason becomes clear why it is quite correct to speak of the existence of a logicist point of view in the philosophy of mathematics of the *Tractatus*. Both in logic and mathematics, suitable notations are constructed in order to perspicuous those formal properties of linguistic expressions which, for the reasons mentioned above, cannot be described meaningfully. In logic, the notation of propositional variables, of symbols of propositional functions, of sentential connectives, of quantifiers, etc., is needed, according to Wittgenstein, to construct formulae which clearly exhibit forms of propositions. These formulae can be used to check whether a given proposition has a certain metalogical property, or whether certain metalogical relations hold between two or more given propositions. The method of checking for a metalogical property or relation is either a mechanical procedure of decision, as occurs with the truth-table method and with any other equivalent method; or a semi-mechanical procedure of generation, as occurs with the derivation of tautological formulae in an axiomatized logical calculus. In exactly the same way, arithmetical notation (numerals and complex arithmetical terms) is introduced as part of a symbolism devoted to exhibiting perspicuously the forms of the results of the successive application of all sorts of iterations and compositions of logical operations. Arithmetical calculation has a perfectly analogous role to that of logical calculation: to ascertain that the relation of identity of meaning—which, according to Wittgenstein, cannot be meaningfully be spoken of—holds between any two given expressions having certain specified forms. Thus the first part of 6.2 states: "Mathematics is a logical method". However, for a thorough understanding of the content of the group of propositions 6.23-6.241, a further development of the comparison between logic and mathematics is required. To this purpose it is expedient to verify whether, and to what extent, Wittgenstein's view on logical *sinnlos* proposition applies also to the equations into which numerical identities are translated. As it concerns logic, the pivotal thesis is what Wittgenstein himself calls the "fact" which "contains in itself the whole philosophy of logic" (*T* 6.113). The "fact" in question concerns the process of recognition of the truth of a tautology (and of the falsity of a contradiction) and, more generally, the process of recognition of the formal properties of a proposition and of the formal relations between propositions. Suppose that a certain proposition is given. After its form has been perspicuously exhibited by means of logical notation, we are able to decide, using the method of truth-tables or some other equivalent procedure, whether the proposition under consideration is true for all the truth-possibilities of its component propositions, or whether it is false for all the

truth-possibilities, or whether it is true for some and false for some others. At this point, if only values **T** or only values **F** have been obtained, and if this procedure has been carried out in order to settle the truth-value of the given proposition, then our work can be considered concluded. In these two limiting cases (tautology and contradiction) the truth-values can be settled by applying suitable procedures of sign manipulation without “going out of language”. In contrast, if the tested proposition is true for some of the truth-possibilities of its component propositions (true in some possible worlds) and false for others of them (false in some other possible worlds), then the only method to decide its truth-value is “to go out and see” which of the possible has actually come true, or, in other words, what is the effective configuration of the world. Although Wittgenstein speaks only of the possibility of recognizing that logical propositions are true “from the symbol alone” (*am Symbol allein*), it is obvious that he considers the peculiar mark of all formal properties and relations precisely the possibility of being recognized in this way.⁴² This is a well-known aspect of Wittgenstein’s philosophy of logic and corresponds to the traditional opposition between *a priori* and *a posteriori* knowledge.”

... Frascolla: [Fra94], § The “Knowledge” of Forms: Vision and Calculation, pp.24-27.

In his doctoral thesis [Daw15], Ryan Dawson too seeks to give an empathetic perspective of how Wittgenstein’s views on what mathematics is, and what it is not, may be viewed as enlightening, rather than as specifying:

“Wittgenstein’s later philosophy of mathematics has been widely interpreted to involve Wittgenstein’s making dogmatic requirements of what can and cannot be mathematics, as well as involving Wittgenstein dismissing whole areas (e.g. set theory) as not legitimate mathematics. Given that Wittgenstein promised to ‘leave mathematics as it is’, Wittgenstein is left looking either hypocritical or confused.

This thesis will argue that Wittgenstein can be read as true to his promise to ‘leave mathematics as it is’ and that Wittgenstein can be seen to present coherent, careful and non-dogmatic treatments of philosophical problems in relation to mathematics. If Wittgenstein’s conception of philosophy is understood in sufficient detail, then it is possible to lift the appearance of confusion and contradiction in his work on mathematics. Whilst apparently dogmatic and sweeping claims figure in Wittgenstein’s writing, they figure only as pictures to be compared against language-use and not as definitive accounts (which would claim exclusive right to correctness).

Wittgenstein emphasises the importance of the applications of mathematics and he feels that our inclination to overlook the connections of mathematics with its applications is a key source of a number of philosophical problems in relation to mathematics. Wittgenstein does not emphasise applications to the exclusion of all else or insist that nothing is mathematics unless it has direct applications. Wittgenstein does question the alleged importance of certain non-applied mathematical systems such as set theory and the logicist systems of Frege and Russell. But his criticism is confined to the aspirations towards philosophical insight that has been attributed to those systems. This is consonant with Wittgenstein’s promises in (*PI*, §124) to ‘leave mathematics as it is’ and to see ‘leading problems of mathematical logic’ as ‘mathematical problems like any other.’ It is the aim of this thesis to see precisely what Wittgenstein means by these promises and how he goes about keeping them.”

... Dawson: [Daw15], Abstract.

Thus, Dawson not only implicitly endorses Frascolla’s view that, for Wittgenstein, a mathematical language is intended to represent ‘real facts’ but, as this extended extract from [Daw15] shows, reflects the *evidence-based* perspective posited in §13.(i) to §13.(iv) above (see also §13.C. and §13.C.a.), insofar ‘that mathematics is made up of a large number of systems, each of which has the meaning of its symbols set by the rules of the system’:

“Wittgenstein’s notion of ‘prose’ seems to be intended in part to contrast exact mathematical language with ambiguous ordinary (non-mathematical) language. Writing concerning certain work of Skolem’s, he comments:

An explanation in word-language of the proof (of what it proves) only translates the proof into another form of expression: because of this we can drop the explanation altogether. And if we do so, the mathematical relationships become much clearer, no longer obscured by the equivocal expressions of word-language. (*PG*, p.422)

One might be tempted to therefore take Wittgenstein's notion of 'prose' to be based upon a prior theory or conception of what mathematics is, this theory being such as to bring out the superior precision of mathematical language. This is how Shanker (1987, p.209) takes the notion and it is worth considering Shanker's view in some detail since Shanker's view risks making it impossible to take Wittgenstein seriously in his promise not to disagree with mathematicians about mathematics (*PG*, p.369). If Wittgenstein were to be read, as Shanker reads him, as having a theory of what mathematics is, then it would have to be answered how that theory could be understood in terms of Wittgenstein's conception of philosophy and how it could avoid being dogmatic. We shall explore how Shanker goes about reading Wittgenstein as having a theory of mathematics and this will provide a useful way to approach the question of what role the notion of 'prose' has for Wittgenstein. The discussion will naturally lead us on to the question of how the role of 'prose' can be understood as non-dogmatic.

As Shanker describes him, Wittgenstein holds that mathematics is made up of a large number of systems, each of which has the meaning of its symbols set by the rules of the system. The most important rules of a system are the axioms and any further rules are derived from there. Whilst this view needs to be explained at more length⁴⁰, the part which is most important for the purpose of how Shanker distinguishes 'prose' from 'proof' is that the meanings of mathematical terms are taken to be fixed by the axioms of the system in question. In order to put across this picture, Shanker lays a particular stress upon remarks like:

Mathematics consists entirely of calculations. In mathematics everything is algorithm and nothing is meaning: even when it doesn't look like that because we seem to be using words to talk about mathematical things. Even these words are used to construct an algorithm. (*PG*, p.208)

In remarks like this Wittgenstein can be read as articulating a conception of mathematical propositions as rules that fix the ways that terms are to be used within a mathematical system. Under this view mathematical systems can be seen to be 'autonomous', in that each system is not reliant upon anything other than the propositions of the system itself for its validity (*PR*, §111; Shanker 1987, p.305-306)."

... Dawson: [*Daw15*], §2.4. *Reading and Misreading Wittgenstein on 'prose'*, pp.32-33.

We note that such a reading of Wittgenstein's view of:

- mathematics as 'made up of a large number of systems, each of which has the meaning of its symbols set by the rules of the system';
- 'mathematical propositions as rules that fix the ways that terms are to be used within a mathematical system';
- mathematical systems as autonomous, in the sense that 'each system is not reliant upon anything other than the propositions of the system itself for its validity';

can be seen as implicit in the Complementarity Thesis §1., Thesis 1, and §1., Definition 1 (see also §12.); since the *evidence-based* perspective of this investigation—all of whose arguments and formal conclusions seek to follow from, or be entailed by, distinguishing between algorithmic *verifiability* (§2., Definition 7) and algorithmic *computability* (§2., Definition 10)—can be viewed as 'rule-based' from a Wittgensteinian perspective.

On the other hand, the significance of making a distinction between languages of adequate expression and languages of categorical communication—as in §13.E.—is reflected in Dawson’s argument that:

“The pictures of mathematical propositions as rules and of mathematical systems as autonomous are important parts of Wittgenstein’s thinking. Before directly considering how these ideas relate to the role of the notion of ‘prose’, it is worth considering the relationship to some other key themes, especially Wittgenstein’s thoughts on the significance of metamathematics and the possibility of scepticism in relation to mathematics. This will help us to better understand what motivates Shanker’s view and allow us to do justice to these motivations without following Shanker in ascribing a thesis concerning the nature of mathematics to Wittgenstein.

If mathematics is not seen as a set of autonomous systems and is instead seen as a single global system (perhaps unified by a single set of axioms) then the edifice of mathematics might seem to be open to the possibility of global doubts—problems that could bring down the entire edifice. This kind of picture might seem tempting when talking about ‘mathematics’ in very general terms, perhaps looking upon ‘the body of mathematics’ as akin to ‘the body of history.’ If it were to turn out that some crucial detail of history had been gotten wrong, say that Julius Caesar was not a real person, then this would force us to revise vast amounts of history. But if mathematical systems are autonomous then no analogous relationship holds with problems in mathematical systems (especially contradictions) since then at worst only the system in question could be affected.

This kind of system-specific thinking can be found in Hilbert’s writing as well and Friederich (2011, p.5, p.8) suggests that Hilbert may have been an influence on Wittgenstein’s development of the idea. But the picture of autonomy that Wittgenstein articulates goes further, since Wittgenstein also stresses that mathematical systems are only related to one another by relationships of analogy or by transformation of one system into another. Hilbert, by contrast, wanted to develop mathematics which would be ‘about’ mathematical systems. His idea was that mathematical techniques could be used to show whether certain important mathematical systems were consistent. These metamathematical techniques were intended to be part of a foundational programme of putting mathematics on a solid footing by showing mathematical systems to be consistent."

... Dawson: [Daw15], §2.4. *Reading and Misreading Wittgenstein on ‘prose’*, p.33.

Further, the significance of Dawson’s argument that:

- ‘pictures of mathematical propositions as rules and of mathematical systems as autonomous are important parts of Wittgenstein’s thinking’

since, otherwise:

- ‘the edifice of mathematics might seem to be open to the possibility of global doubts—problems that could bring down the entire edifice’,

too is implicit in the *evidence-based* perspective of this investigation, which argues that it is non-falsifiable (in the sense of §7.B.), philosophical, assumptions such as:

- Aristotle’s particularisation (§7., Definition 20) is valid in any *well-defined* interpretation of the first-order Peano Arithmetic PA; and
- an axiom of infinity interprets as a *well-defined* mathematical object in any *well-defined* interpretation of set theories such as ZF and ACA₀;

that have admitted false conclusions such as:

- (i) Gödel's formula $[(\forall x)R(x)]$, and its negation $[\neg(\forall x)R(x)]$, are both not provable in PA. (which contradicts [An16], Corollary 8.2, p.42; see also §2.F., Corollary 2.20);
- (ii) The structure of the finite ordinals under any putative interpretation of ZF is isomorphic to the structure \mathbb{N} of the natural numbers (which contradicts §15.C., Lemma 15.1);
- (iii) The subsystem ACA_0 of second-order arithmetic is a conservative extension of PA (which contradicts §19.A., Theorem 19.4).

The obscured significance of Dawson's argument emerges if we view such, *faith-based*, assumptions as metamathematical propositions which would meet his criteria of 'descriptive propositions and not rules':

"If metamathematical expressions were mathematics 'about' mathematical systems, at least in the referential sense, then metamathematical propositions would be descriptive propositions and not rules. The metamathematical expressions would not be parts of an autonomous system and would instead be dependent upon other systems for their meaning (namely the systems which they are 'about'). This would run contrary to the picture expressed in (*PG*, p.208) and hence one might wonder whether Wittgenstein would therefore have to reject metamathematics or whether he might instead philosophically interpret metamathematics in a different way from Hilbert.

Whilst Wittgenstein acknowledges the validity of metamathematics, he can be seen as disputing its alleged significance. Rather than interpreting metamathematics to be mathematics 'about' mathematics, he presses a picture in which metamathematical techniques just appear as more techniques. The picture is that when one employs a metamathematical technique, one is introducing a new technique and thereby adding something that enables one to do things in the system that one could not do before. In this sense one is creating a new system in which the old system might be seen to figure as a part—one now has a larger system in which a simulation of the old system can be seen. So the metamathematical technique allows one to prove results in the expanded system but it is a matter of prose to say that they are results 'about' the original system, at least if 'about' is meant referentially. One may well say this but saying it would not be to give an interpretation of the mathematical result rather than to simply state the result. One could put the point by saying that metamathematics for Wittgenstein would be mathematics 'about' mathematics in a very different way from how a description is a statement about its subject-matter.⁴¹ So it seems that Wittgenstein could have maintained a view of mathematical systems as autonomous (Shanker 1987, p.305-306) and still acknowledged the validity of metamathematics."

... Dawson: [Daw15], §2.4. *Reading and Misreading Wittgenstein on 'prose'*, p.34.

For instance, §12.B.f., Theorem 12.6—PA is not ω -consistent—appeals to a rule-based, *weak* 'Wittgensteinian' interpretation $\mathcal{I}_{PA(\mathbb{N}, W)}$ of PA (see §12.B.d.), which illustrates the argument that 'when one employs a metamathematical technique, one is introducing a new technique and thereby adding something that enables one to do things in the system that one could not do before'.

We contrast this with the metamathematical assertions that Gödel made with respect to his own formal reasoning in [Go31] which, from the perspective Dawson attributes to Wittgenstein, can be seen as 'descriptive propositions and not rules'.

For instance, as argued in §15.A. to §15.H.n., these would include:

- (i) "Theorem VIII: There exist undecidable arithmetical propositions in each of the formal systems⁵³ mentioned in Theorem VI."

Gödel: [Go31], p.31.

- (ii) "Let ω be the SENTENCE by which $Wid(\kappa)$ is expressed in P ."

Gödel: [Go31], p.37.

- (iii) "That the truth of ω *Imp* (17 *Gen r*) can be deduced from (23) rests simply on the fact that the undecidable proposition 17 *Gen r*, as was remarked at the very beginning, asserts its own unprovability."

Gödel: [Go31], p.37, fn.67.

The technical nuances implicit in the above examples could explain why, according to Dawson:

"Wittgenstein's thoughts related to metamathematics and its use can be hard to follow, especially for contemporary mathematicians, because of the way in which techniques related to metamathematics have become widespread. Wittgenstein's thinking might even appear confused to a contemporary mathematician but it is worth noting that Wittgenstein's thinking does not have to be seen as confused. The development that produces the most confusion in relation to understanding Wittgenstein is that it has become common to distinguish between the syntax and the semantics of a mathematical system. In loose terms the idea is that a system is syntactically a set of expressions the system is associated with the possible structures (described set-theoretically) which would satisfy the expressions—these are the models of the system. A sentence of the system is then described as true if it is satisfied in all consistent models of the system. This mathematical approach post-dates Wittgenstein's work but it is plausible that if Wittgenstein had encountered the approach then he would have acknowledged the validity of these techniques and denied that they offer a definitive analysis of 'truth.'⁴² He would perhaps say that the move to considering models for the system effectively moves us to an expanded system, allowing us to show things in the expanded system that relate by means of analogy to the original system. This sort of question will become particularly important in chapter 10, where we will see that some of the objections to Wittgenstein's remarks on Gödel's incompleteness theorems have originated from a failure to see how Wittgenstein understands such metamathematical techniques.⁴³"

... Dawson: [Daw15], §2.4. *Reading and Misreading Wittgenstein on 'prose'*, p.34.

Moreover, from the *evidence-based* perspective of this investigation, Dawson's view that what 'produces the most confusion in relation to understanding Wittgenstein is that it has become common to distinguish between the syntax and the semantics of a mathematical system', is reflected in the argument, in §1., that such distinction fails to recognise that mathematical 'provability' and mathematical 'truth' need to be interdependent and complementary, rule-based, assignments-by-convention.

As expressed by Dawson:

"If one looks at the picture of mathematical propositions as rules, of mathematical systems as autonomous and the criticism of interpretations of metamathematics as mathematics 'about' mathematics then a picture might seem to emerge of Wittgenstein as advocating a conception of mathematical systems as self-defining. According to such a picture, the axioms of a system might be said to be rules which fix certain aspects of the way that the terms should be used and then the propositions are further rules which are derived from the initial rules. Wittgenstein might then be seen, as he is portrayed by Shanker (1987, p.305-306) as advocating an account of mathematics as the totality of all such systems. Any expressions that are not part of these systems would be non-mathematical, even if they appeared to have some connection to the systems. Such expressions which appeared to be connected to the systems but were not themselves expressions of the systems could be distinguished by being referred to as 'prose.'"

... Dawson: [Daw15], §2.4. *Reading and Misreading Wittgenstein on 'prose'*, p.35.

From such a perspective, 'if mathematical propositions were simply rules that set up a system then the contrary of a mathematical proposition would not be a part of a system at

all and would thus be meaningless', it would follow that, as argued in §20., the well-known semantic and putatively logical paradoxes cannot be considered as posing serious linguistic or philosophical concerns from an *evidence-based* perspective of constructive mathematics:

"Whilst the notion of mathematical systems as autonomous systems of rules has various advantages (such as, as we shall see in chapter 7, undermining the notion that contradictions might pose a threat to all of mathematics) and it undoubtedly figures in Wittgenstein's thought, the key question is whether this conception is the basis of Wittgenstein's notion of 'prose' in the way that Shanker suggests (1987, p.209). Revealing of the difficulty with this claim is when Shanker says that Wittgenstein's idea of mathematical statements as rules is not an "alternative picture" (p.64) but "a precise philosophical clarification of mathematical syntax" (p.65). The trouble with Shanker's claim is that if the idea of mathematical propositions as rules is part of a clarification then it surely is just one possible picture and cannot be said to be simply part of "mathematical syntax." Otherwise comments like the following would ring hollow:

... the whole point is that I must not have an opinion ... I have no right to want you to say that mathematical propositions are rules of grammar. I only have the right to say to you, "Investigate whether mathematical propositions are not rules of expression ... " (*LFM*, p.55)

If Wittgenstein has to assume that mathematical systems are bodies of rules in order to say what is prose and what is not, then any of his claims concerning what is prose and what is not are just matters of opinion that he would have 'no right' to present as clarifications. The danger here is the danger of supposing that mathematical statements are rules rather than proposing the picture as an object of comparison with which to model mathematical statements as rules. Taking mathematical propositions to be rules would be problematic both because of Wittgenstein's promises not to be dogmatic, and also because Wittgenstein at points seems to point out the limitations of this picture. As Floyd (2000, p.251) notes (in criticism of Shanker), if mathematical propositions were simply rules that set up a system then the contrary of a mathematical proposition would not be a part of a system at all and would thus be meaningless. She cites the following remark by Wittgenstein:

My explanation mustn't wipe out the existence of mathematical problems.

That is to say, it isn't as if it were only certain that a mathematical proposition made sense when it (or its opposite) had been proved. (This would mean that its opposite would never have a sense (Weyl).) On the other hand, it could be that certain apparent problems lose their character as problems—the question as to Yes or No. (*PR*, p. 170)

This kind of self-cautioning remark makes much more sense if Wittgenstein is saying that mathematical propositions are 'like' rules or that it can help us see past certain problems if we see mathematical propositions as akin to rules. This strongly suggests that Shanker's reading is attributing a thesis to Wittgenstein which Wittgenstein is keen to avoid. But if mathematical propositions are only akin to rules (rather than actually being rules) then we are left with the problem of how Wittgenstein does go about using the term 'prose.' Contrary to Shanker, I want to suggest that Wittgenstein's use of this notion can be understood without any need to invoke a prior conception of mathematics. "

... Dawson: [[Daw15](#)], §2.4. *Reading and Misreading Wittgenstein on 'prose'*, pp.35-36.

As Dawson remarks in [[Daw15](#)] with reference to Wittgenstein's remarks (*PR*, p. 170) cited by Juliet Floyd, this 'kind of self-cautioning remark makes much more sense if Wittgenstein is saying that mathematical propositions are 'like' rules or that it can help us see past certain problems if we see mathematical propositions as akin to rules'.

That Wittgenstein might, indeed, have intended what Dawson's remark in the previous paragraph attributes to him, seems implicit also in Timm Lampert's 2019 paper [[Lam19](#)], where he notes that:

"In two letters to Russell from 1913, Wittgenstein conjectured that first-order logic is decidable. His conjecture was based on his conviction that a decision procedure amounts to an equivalence transformation that converts initial formulas into ideal symbols of a proper notation that provides criteria for deciding the logical properties of the initial formulas. According to Wittgenstein, logical properties are formal properties that are decidable on the basis of pure manipulations of symbols. This understanding of logical properties (such as provability or logical truth/falsehood) is independent of and prior to any interpretation or application of logic."

... Lampert: [Lam19], Abstract.

If so, Wittgenstein can be seen as essentially, informally and presciently, articulating (in 1913) the Complementarity Thesis (§1., Thesis 1) in anticipation of the *evidence-based* 2016 proof of consistency for PA detailed in [An16] (Theorem 6.8, p.41; see also §2.C.a., Theorem 2.16).

13.B. The semiotics of an *evidence-based* perspective of logic and mathematics

We note that the semiotics of the *evidence-based* perspective of §12. to §13.A. is reflected in Brian Rotman's broader analysis:

"Insofar, the, as the subject matter of mathematics is the whole numbers, we can say that its objects—the things which it countenances as existing and which it is said to be 'about'—are unactualized possibles, the potential sign production of a counting subject who operates in the presence of a notational system of signifiers. Such a thesis, though, is by no means restricted to the integers. Once it is accepted that the integers can be characterized in this way, essentially the same sort of analysis is available for numbers in general. The real numbers, for example, exist and are created as signs in the presence of the familiar extension of Hindu numerals—the infinite decimals—which act as their signifiers. Of course, there are complications involved in the idea of signifiers being infinitely long, but from a semiotic point of view the problem they present is no different from that presented by *arbitrarily* long finite signifiers. And moreover, what is true of numbers is in fact true of the entire totality of mathematical objects: they are all signs—thought/scribbles—which arise as the potential activity of a mathematical subject.

Thus mathematics, characterized here as a discourse whose assertions are predictions about the future activities of its participants, is 'about'—insofar as this locution makes sense—itself. The entire discourse refers to, is 'true' about, nothing other than its own signs. And since mathematics is entirely a human artefact, the truths it establishes—if such is what they are—are attributes of the mathematical subject: the tripartite agency of Agent/Mathematician/Person who reads and writes mathematical signs and suffers its persuasions.

But in the end, 'truth' seems to be no more than the unhelpful relic of the platonist obsession with a changeless eternal heaven. The question of whether a mathematical assertion, a prediction, can be said to *be* 'true' (or accurate or correct) collapses into a problem about the tense of the verb. A prediction—about some determinate world for which true and false make sense—might in the future be seen to be true, but only *after* what it foretold has come to pass; for only then, and not before, can what was pre-dicted be dictated. Short of fulfillment, as is the condition of all but trivial mathematical cases, predictions can only be believed to be true. Mathematicians believe because they are persuaded to believe; so that what is salient about mathematical assertions is not their supposed truth about some world that precedes them, but the inconceivability of persuasively creating a world in which they are denied. Thus, instead of a picture of logic as a form of truth-preserving inference, a semiotics of mathematics would see it as an inconceivability-preserving mode of persuasion—with no mention of "truth' anywhere."

... Rotman: [Rot88], pp.33-34.

The concepts sought to be formalised in §12., Definitions 32 to 34, and illuminated in §13.(i)

Comparison between Hilbert's and von Neumann's foundational standpoints

	Hilbert <i>Methodology of the Finitist Program</i>	von Neumann <i>Oppurtunistic Methodology of Science</i>
<i>Foundations Of Mathematics</i>	a) - Axiomatic presentation of informal mathematical theories b) - Justification through finitist consistency proof	a) - Axiomatic presentation of informal mathematical theories b) - Justification through the criterion of success in science
<i>Foundations of sciences</i>	a) - Axiomatic presentation of informal scientific theories b) - Justification through relative consistency proof in mathematics	a) - Axiomatic presentation of informal scientific theories b) - Justification through the criterion of success in applications
<i>Outcomes</i>	<i>Internalization</i> of the epistemological problem: finitist mathematics is a part of mathematics	<i>Externalization</i> of the epistemological problem: mathematics in science and science in applications

... Formica: [For10]

to §13.(iv), are also reflected in an informal survey of John von Neumann's 'Methodology of Science', where Giambattista Formica makes an intriguing perspective comparing Hilbert's and von Neumann's foundational 'standpoints' on the 'nature of mathematics', and remarks:

"...I would like to stress the fact that von Neumann, just like Hilbert, believes that there is this *quite peculiar duplicity in the nature of mathematics*, namely that its origin is to be found both in human experience and in pure thought. In other words, besides its abstract nature, mathematics has also an empirical nature. Otherwise, he would have talked about the success that mathematics - and through mathematics, science - achieves in applications in terms of a miracle or an unreasonable effectiveness. In *The Mathematician* (1947) he writes:

I think that it is a relatively good approximation to truth [...] that mathematical ideas originate in empirics, although the genealogy is sometimes long and obscure. But, once they are so conceived, the subject begins to live a peculiar life of its own and is better compared to a creative one, governed by almost entirely aesthetical motivations, than to anything else and, in particular, to an empirical science. [...]. It becomes more and more purely aestheticizing, more and more purely *l'art pour l'art*. [...]. [A]t a great distance from its empirical source, or after much "abstract" inbreeding, a mathematical subject in danger of degeneration. [...]. In any event, whether this stage is reached, the only remedy seems to me to be the rejuvenating return to the source: the reinjection of more or less directly empirical ideas. (von Neumann 1947, p. 9)"

... Formica: [For10]

Formica concludes that:

"What I have tried to do is to describe John von Neumann's opportunistic methodology of science. His closeness to Hilbert's spirit is evident. Von Neumann always shared with Hilbert a conservative attitude towards science, combined with a strong faith in the axiomatic method. Yet he never became dogmatic. After Gödel's remarkable results he began a profound reevaluation of the concept of mathematical rigour in order to find a solution to the epistemological problem left open in Hilbert's program, i.e. the justification of mathematical and scientific theories formulated in an axiomatic fashion. He found the solution in the criterion of success - not alien to Hilbert's school - to which he ascribed a key foundational task. With regards to Hilbert's program, he made exactly the opposite move: he thought that through the externalization of the epistemological problem, mathematics finds its justification in science, while science finds its own in the realm of applications. In spite of his radical opportunism, von Neumann also believed that mathematical models satisfy certain standards of objectivity. However, in his view these two apparently contrasting ideas - opportunism and objectivity - do not contradict each other, but can be reconciled on the basis of certain ontological assumptions on the nature of mathematics which he, once again, shared with Hilbert. Mathematics has a double origin, which is to be found pure thought and in human experience. Once this has been accepted, success in the realm of applications is not a miracle, but is probably due to the original empirical source, sometimes remote and obscure, latent in all mathematical thought."

... Formica: [For10]

13.C. Mathematics must *serve* Philosophy and the Natural Sciences

Formica's comparison between Hilbert's and von Neumann's foundational standpoints²⁹⁰ reflects another tacit thesis of this investigation, which is the making of an—admittedly arbitrary—distinction between (compare [Ma08]; see also [Fe99]):

- The *natural scientist's hat*, whose wearer's responsibility is recording—as precisely and as objectively as possible—our sensory observations (corresponding to computer scientist David Gamez's 'Measurement' in [Gam18], Fig.5.2, p.79) and their associated perceptions of a 'common' external world (corresponding to Gamez's 'C-report' in [Gam18], Fig.5.2, p.79; and to what some cognitive scientists, such as Lakoff and Núñez in [LR00]²⁹¹, term as 'primary', and 'secondary', *conceptual metaphors*);

Comment 107. By 'primary conceptual metaphors', we refer here to metaphors that a human mind conceives, corresponding to physical states of an individual brain which are rooted in the mind's awareness (compare §21.J.a., Hypothesis 3) of phenomena that are accepted as existing *in* a commonly accepted, external, physical reality.

By 'secondary conceptual metaphors', we refer here to metaphors that a human mind conceives, corresponding to physical states of an individual brain which are rooted in the mind's awareness (compare §21.J.a., Hypothesis 4) of phenomena that are accepted as existing *only in the individual mind's perceptions of the symbolic representations* of a commonly accepted, external, physical reality.

- The *philosopher's hat*, whose wearer's responsibility is abstracting a coherent—albeit informal and not necessarily objective—holistic perspective of the external world from the natural scientist's sensory observations and their associated perceptions (corresponding to what Pantsar terms as *pre-formal mathematics* in [Pan09] (§4. Formal and pre-formal mathematics); or to Carnap's *explicandum* in [Ca62a]; or Gamez's 'C-theory' in [Gam18], F, p.79); where

²⁹⁰Which merit further comparison with [Brd13] that lies, however, beyond the immediate scope of this investigation.

²⁹¹See also §27.

“By the procedure of *explication* we mean the transformation of an inexact, prescientific concept, the *explicandum*, into a new exact concept, the *explicatum*. Although the explicandum cannot be given in exact terms, it should be made as clear as possible by informal explanations and examples. . . . A concept must fulfill the following requirements in order to be an adequate explicatum for a given explicandum: (1) similarity to the explicandum, (2) exactness, (3) fruitfulness, (4) simplicity.”

... Carnap: [Ca62a], p.3 & p.5.

Comment 108. The significance of the *complementarity*²⁹² that competing scientific philosophies *ought* to seek and *teach*²⁹³—when they are rooted, as suggested above, in Piccinini’s *evidence-based* perspective of ‘knowledge’ as ‘Factually Grounded Belief’ (see §5.A.)—is highlighted when viewed against the *polemical* nature of inherited philosophical paradigms—seemingly yet rooted in the perspective of ‘knowledge’ as intuitively ‘Justified True Belief’ (see §5.A.)—that can, not without justification, be pessimistically viewed as, largely, unproductively competitive; a polemicism whose negative perceptions philosopher Arnon Keren seemingly seeks to dilute in his essay [Krn22]:

“Modest pessimism about philosophical progress is the view that while philosophy may sometimes make some progress, philosophy has made, and can be expected to make, only very little progress (where the extent of philosophical progress is typically judged against progress in the hard sciences). The paper argues against recent attempts to defend this view on the basis of the pervasiveness of disagreement within philosophy. The argument from disagreement for modest pessimism assumes a teleological conception of progress, according to which the attainment of true answers to the big philosophical questions, or knowledge of them, is the primary goal of philosophy. The paper argues that this assumption involves a misconception of the goal of philosophy: if philosophy has a primary goal, its goal is the understanding of philosophical problems rather than knowledge of answers to philosophical questions. Moreover, it is argued that if the primary goal of philosophy is such understanding, then widespread disagreement within philosophy does not indicate that philosophy makes little progress.”

... Keren: [Krn22], Abstract.

The ‘unproductively competitive’ element in the above, explicitly subjective²⁹⁴, ‘pessimistically viewed’ perspective of essentially ‘polemical’ argumentation²⁹⁵ is reflected—albeit as what may be termed as a putatively ‘co-operatively competitive’ element—in Andrew Aberdein and Dan Cohen’s [AC24]; where they cogently argue that, if ‘we take the goal of informal logic to be intelligent, critical assessment of arguments’, then ‘the prime question is, “What kind of arguer do (and should) I want to be?”; and ‘because virtue theories focus on arguers as the agents of argumentation, they have important implications for pedagogy, and thus integrate the theory and practice of argumentation’, since ‘insights of virtues-based theorizing should greatly affect how we go about teaching critical thinking and informal logic’ which, then, ‘becomes one of helping our students to become better arguers in the long-term, not simply helping them produce better arguments on specific occasions’:

²⁹²In the sense of the Complementarity Thesis in §1.

²⁹³Particularly ‘in an age of *alternative facts* (whose social and political ramifications were starkly highlighted by the unprecedented influence, and power, of an emergent, and unbridled, *social media* in the global responses to the 2020 COVID 19 pandemic) for which we—at least those of my ilk and generation (born circa 1940)—must shoulder the main responsibility’ (see *Author’s Preface*, p.7).

²⁹⁴In other words, reflecting a personal opinion to be treated as the author’s non-judgmental ‘*Justified True Belief*’, rather than as a ‘*Factually Grounded Belief*’ seeking ‘knowledge’ in the sense of §5.A., *What is knowledge?*.

²⁹⁵‘Polemical’ modes of argumentation when viewed as ‘inherited philosophical paradigms—seemingly yet rooted in the perspective of ‘knowledge’ as intuitively ‘Justified True Belief’ . . . that can, not without justification, be pessimistically viewed as, largely, unproductively competitive’ *debates*; rather than as *dialogues* wherein arguers and arguments seek *categorical communication*, and not *persuasive ability*, as their primary goal.

“Suppose we take the goal of informal logic to be intelligent, critical assessment of arguments. There are many different aspects that could be offered in support of a positive (or negative) critical assessment of an argument, most notably that the inferences are strong, that the reasoning succeeds in persuading the opponents, or that the parties reach a satisfactory resolution. Notice that these three answers implicate different conceptions of what an argument is. The first treats arguments as propositions arrayed in an inferential structure; the second addresses the performative aspects; while the third focuses on the communicative exchange. In some ways, these approaches are comparable to plot summaries of novels that ignore the characters: descriptive reports of what happened rather than explanations of why. This changes in virtue theories, where the prime question is, “What kind of arguer do (and should) I want to be?” The answer, of course, is a good arguer, but that deflects the question with a vacuous truism. It deserves a more substantial answer, so the first thing to like about virtue theories is that they emphasize that arguing is an integral part of who we are as rational beings and epistemological agents. This recaptures an insight well known to some of the pioneers of the study of argument in communication theory (Ehninger 1968; Brockriede 1972; Hamble 2007), but too often neglected since.

If we want to reap the benefits of arguing, it cannot be at the expense of the others with whom we argue because we want them to continue to want to argue with us so that we will continue to have opportunities to argue. A good argument, traditionally conceived, is a discrete event (*pace* those theorists who think of arguments as timeless, abstract arrays of propositions): the narrow judgment that it was good tells us nothing about any effects it had on its participants nor does it have any predictive value on their future arguments. Its goodness might be merely fortuitous. In contrast, the judgment that an arguer is a good arguer requires a broader perspective. The virtues approach to argumentation embeds arguing in the larger context of what it is to be rational.

Another thing to like about approaching argumentation this way is that it forces us to confront another question, viz., *why* do we argue? That is a teleological *why* with normative force (i.e., what should we want to get out of arguing?) not a *why* in search of a causal explanation. Epistemological and other cognitive considerations have to be prominent parts of an account of argumentation. Again, virtue approaches to argumentation embed arguing in a larger context: our cognitive lives.

A third attractive thing about thinking of arguments in terms of the virtues of arguers is that it also implicates our lives as rational, cognitive *agents* who are members of *communities* of similar agents. Indeed, group-deliberative virtues are a specific focus of research (Aikin and Clanton 2010; Amaya 2022)."

... Aberdein and Cohen: [AC24], §1. *Why Virtue?*

“Communication is an interaction between agents, so ethical considerations apply—and the interactive and agential aspects are especially prominent in arguments. There is, accordingly, an ethics of argumentation (Garver 1998; Blair 2011; Correia 2012; Stevens 2019; Aikin and Alsip Vollbrecht 2020; Breakey 2023). It includes principles about how to argue but also principles about when and when not to argue. Argumentation theories cannot ignore the normative dimension, and we think virtue argumentation theories do better on this score than traditional theories: on the one hand, virtues connect good arguers and arguing well; on the other, they serve as the conceptual conduit from the ethics of argumentation to communications ethics more generally (Baker 2008; Borden 2010, 2016; Fritz 2017), and beyond that to ethics in the broadest sense.

In addition, because virtue theories focus on arguers as the agents of argumentation, they have important implications for pedagogy, and thus integrate the theory and practice of argumentation. We like to think that thinking about arguments this way has actually made us better arguers, if only because we now think about what

it means to be a good arguer in these broader perspectives. It seems to have had the effect, at least in the short-term, of making us better at “losing” arguments, but it also means that we are generally more satisfied at the end of an argument regardless of the win/lose outcome. We hope, and believe, that the long-term result will be that we will also become better learners in all contexts.

What virtues should argumentation teachers try to inculcate in their students? It is relatively easy to identify some argumentative virtues—objectivity, civility, curiosity, open-mindedness, sincerity, fairness, and being knowledgeable all qualify—it is quite difficult to identify *specifically* argumentative virtues. Curiosity also counts as an epistemic virtue, fairness is also an ethical virtue, and open-mindedness is arguably argumentative, epistemic, and ethical. There are different kinds of arguments, different ways to argue, and different motivations, means and ends to argumentation. If the goal is rational persuasion, virtues pertinent to interpersonal relations move to the fore; others are more important in resolution-of-difference negotiations; the more epistemic ones are more relevant to problem-solving deliberations. This does not even take into account the different roles arguers might occupy in the course of an argument: proponent, critic, judge, spectator, or even kibitzer."

... Aberdein and Cohen: [AC24], §2. *Virtues, Argumentation, and Ethics*.

“The intimate connection to pedagogy is one of virtue theories’ great strengths, but the pedagogical implementation of virtue argumentation thinking comes with serious and high-priority challenges of its own. The insights of virtues-based theorizing should greatly affect how we go about teaching critical thinking and informal logic. The educational project becomes one of helping our students to become better arguers in the long-term, not simply helping them produce better arguments on specific occasions. This is more a matter of nurturing good argumentative habits rather than cultivating specific skills: habits endure while skills fade and may or may not be used once students leave the confines of the classroom. Virtue argumentation has a close relationship to critical thinking, which has long recognized the centrality of dispositions; since virtues are a type of disposition, this is at least a parallel development to virtue argumentation, as the similarities between lists of argumentational virtues and critical thinking virtues attest (Ennis 1996; Siegel 1999; Andrew Aberdein and Daniel H. Cohen Facione 2000; Nieto and Valenzuela 2012). More explicit treatments of the connection between critical thinking and virtue epistemology also antedate the virtue argumentation programme (Conley 1991; Burbules 1992; Curren 1998; Paul 2000; Bailin 2003; Hyslop-Margison 2003), as do closely related projects, such as that of supplementing critical thinking with an ethics of care (Thayer-Bacon 1993 2000). Critical thinking also addresses an important question for any virtue theory: the nature of the difference between a virtue and a skill—indeed, whether there is a difference, or whether skills are not themselves virtues (Missimer 1990; Siegel 1993; Hample 2003). As Francis Schrag observed, “A person may be clever without being thoughtful and vice versa. In the first sense, we commend something skill-like. In the second we commend something more like a virtue or trait of character” (Schrag 1988: 8). In recent years, this debate has resurfaced in terms of the aims of education: ought the primary epistemic goal of education be the acquisition of intellectual virtues (Baehr 2013, 2019) or the inculcation of critical thinking skills and dispositions (Siegel 2016, 2017; Kotzee et al. 2021)?

Critical thinking has found a place in the core curriculum of a great diversity of programmes. For example, it is a key component in many nursing degrees. This in turn has given rise to a growing body of research, including work relevant to virtue argumentation (Sellman 2003; Adam and Juergensen 2019). There have also been many attempts to link critical thinking to older intellectual traditions. For instance, many scholars have investigated the relationship between Confucianism and critical thinking pedagogy (Tominaga 1993; Kim 2003; Lam 2014; Chen et al. 2017; Tan 2017, 2020; Niu and Zheng 2020). Much of this work makes explicit

appeal to argumentative virtues.

Theory and practice in argumentation studies can seem remote from each other, particularly from the theory side, where virtue argumentation originates. Nonetheless, some people do successfully straddle the divide (Bailin and Battersby 2016; Byerly 2019; Hanscomb 2019). It is also a welcome development that there are now textbooks in introductory logic and critical thinking that showcase intellectual virtues (Byerly 2017; Symons 2017), even if there is not yet a true virtue argumentation textbook. If we want theorizing to be of more than merely theoretical interest, this has to be a priority. And if the programme is to be more than just a theory, it has to face this challenge."

... Aberdein and Cohen: [AC24], §3. Challenges.

- The *mathematician's hat*, whose wearer's responsibility is providing the tools for adequately expressing such recordings and abstractions in a symbolic language of unambiguous communication (corresponding to Carnap's *explicatum* in [Ca62a]; and to Gamez's 'P-description' and 'C-description' in [Gam18], Fig.5.2, p.79).

Comment 109. We could view this distinction as seeking to address the questions of:

- *What* we do in scientific disciplines;
- *Why* we do what we do in scientific disciplines; and
- *How* we express and communicate whatever it is that we do in scientific disciplines.

Philosophically, we could go even further and view the above activities holistically: as providing merely the means by which a 'self-aware'²⁹⁶ intelligence, such as that of homo sapiens, instinctively strives to realise its own creative—largely latent—potential within the evolutionary arrow of a, perpetually-changing, environment that not only gives birth to, but nurtures and encourages, a species to continually adapt to survive unforeseen and unforeseeable life-threatening challenges (including those that may be created by the species shooting itself in the foot).

'Largely latent' since it is scientific folklore that an 'average' human brain, during its lifetime, is estimated to have perceptively—as measured by posthumous brain scans—used only about 4-10% of its capacity to address the—not unreasonably, corresponding 4-10% of—challenges that, over the estimated millions/billions of years of its evolution, the brain has met and adapted to in order to survive.

Comment 110. We note that, essentially, such a distinction can be further viewed as resonating with—and seeking to crystallise—the perceived view of what Kant sought to articulate in his philosophy—which Kati Kish Bar-On ascribes to Michael Friedman in his [Frd01]—if we ignore Friedman's qualification 'the only genuine objects of knowledge there now are':

"The status of philosophy, as Friedman describes Kant's viewpoint, is entirely different from all empirical sciences. Empirical sciences, such as psychology or mathematics, as well as the elements of pure a priori knowledge, such as geometry, are first-level sciences. Philosophy is a second-level discipline that enables us to know and have representations of these first-level objects. To use Friedman's words, Kant viewed philosophy as a "transcendental inquiry into the conditions of possibility of our first-level knowledge of objects in space and time (the only genuine objects of knowledge there now are) supplied by mathematical natural science." (Friedman 2001, 9)"

... Bar-On: [Bro22], §2.1 From Kant to Kuhn and beyond.

²⁹⁶'Self-aware' in the sense, for instance, of §21.J.a., Hypothesis 4.

Comment 111. The significance of the *evidence-based* distinction between the complementary roles of natural science, philosophy, and mathematics in unambiguously representing and, where feasible, categorically communicating what Lakoff and Núñez term in [LR00] as our ‘primary’, and ‘secondary’, conceptual metaphors is reflected, for instance, in Philosopher Danielle Macbeth’s [Mcb14]; where she remarks vis à vis how we acquire ‘knowledge’²⁹⁷ of the universe we commonly inhabit that ‘*Even to the ancient Greeks, our knowledge of the familiar everyday world of change and becoming seemed somehow second best, somehow partial, limited, and unsatisfyingly perspectival, when compared to knowledge of things such as mathematical objects that are grasped instead by the mind’s eye and do not change*’:

“The world as it is revealed in and through natural language is inherently sensory. It is a world of objects, paradigmatically, living beings with their natures and characteristic powers. And we, as the rational animals we are, have the power to take in, in perception, as well as to say, how things are with such objects, and more generally what is happening. Perception, on this account is not, as action is, something we do but instead is an actualization with respect to which one is passive. One simply finds things to be thus and so in perception. Judgment, on our account, although not passive, is also not an action of the ordinary sort. It is not a move in a language game, or an act of assent to a contentful proposition; it is not a commitment that one forms. Instead it is, or aims to be, again, an acknowledgement of truth, an actualization of one’s power to know that, when successful (because what is acknowledged is true and recognized as such), fully manifests that power in a cognitive relation of knowing to the thing known.

But not everything there is to be known about the world is available from the perspective afforded by natural language. Indeed, it can seem that nothing that is afforded by natural language properly counts as knowledge. Even to the ancient Greeks, our knowledge of the familiar everyday world of change and becoming seemed somehow second best, somehow partial, limited, and unsatisfyingly perspectival, when compared to knowledge of things such as mathematical objects that are grasped instead by the mind’s eye and do not change. Although the paradigm of cognition for the ancient Greeks is our perceptual grasp of an object as what it is in its nature, and hence is essentially bodily and sensory, already they had a vision of a purely cognitive, purely rational and non-sensory grasp of what is. It is the subsequent unfolding of this marvelously seductive idea, beginning with the ancient practice of diagrammatic reasoning, that will occupy us for the remainder of this work.”

... Macbeth: [Mcb14], §1.6 Conclusion, pp.56-57.

That this distinction may not reflect conventional wisdom is highlighted in the following argument that:

- (a) if mathematics is to *serve* as a lingua franca for the physical sciences,
- (b) then it can only represent physical phenomena *unambiguously* by insistence upon *evidence-based* reasoning
- (c) which, in some cases (see §20.C. to §20.D.), may prohibit us from building a mathematical theory of a physical process
 - based on the assumption that the limiting behaviour of *every* physical process which can be described by a Cauchy sequence
 - *must* be taken to correspond to the behaviour of the classically defined Cauchy limit of the sequence.

²⁹⁷See also §5.A.: *What is knowledge?*; also §13.F.: *Three categories of information*.

Reason: If the discrete states of some physical phenomena are describable only in terms of arithmetical functions that are algorithmically *verifiable*, but not algorithmically *computable*—which, as suggested in [An15], §4 (see §23.D.), may be the case for quantum phenomena, or for the values of some fundamental physical constants—then although, as seen in §7.G., Theorem 7.2, such functions may define Cauchy sequences that, by definition, have algorithmically *uncomputable* mathematical limits, such abstract postulations may not correspond to any limiting state of the phenomena which might, for instance, involve a phase change (see §20.C. to §20.D.)!

The above attempts to crystallise Hermann Weyl’s perspective that:

“...I believe the human mind can ascend toward mathematical concepts only by processing reality as it is given to us. So the applicability of our science is only a symptom of its rootedness, not a genuine measure of its value. It would be equally fatal for mathematics—this noble tree that spreads its wide crown freely in the ether, but draws its strength from the earth of real intuitions and perceptions (*Anschauungen und Vorstellungen*)—if it were cropped with the shears of a narrow-minded utilitarianism or were torn out of the soil from which it grew.”

... Weyl: [We10], p.10.

From such an *evidence-based* perspective, eliminating ambiguity in critical cases—such as communication between mechanical artefacts, or a putative communication between terrestrial and/or extra-terrestrial intelligences (whether mechanical or organic)—may be viewed as the very *raison d’être* of mathematical activity.

An activity which aspires:

- (1) First, to the construction of mathematical languages that can symbolically express those of our abstract concepts—corresponding to what Pantsar terms as *pre-formal mathematics* in [Pan09] (§4. Formal and pre-formal mathematics); or to what Lakoff and Núñez term in [LR00] (see also §27.) as ‘primary’, and ‘secondary’, *conceptual metaphors*; or to Carnap’s *explicandum* in [Ca62a]—which can be subjectively addressed unambiguously.

Languages such as, for instance, the first-order Set Theory ZF, which can be well-defined formally but which have no constructively well-defined model that would admit *evidence-based* assignments of ‘truth’ values to set-theoretical propositions by a mechanical intelligence.

Author’s comment: By ‘subjectively address unambiguously’ I intend in this context that there is essentially a subjective acceptance of identity by me between:

- an abstract concept in my mind (corresponding to Lakoff and Núñez’s ‘conceptual metaphor’ in [LR00], p.5; see also §27.) that I intended to express symbolically in a language; and
- the abstract concept created in my mind each time I subsequently attempt to understand the import of that symbolic expression (a process which can be viewed in engineering terms as analogous to my attempting to formalise the specifications, i.e., *explicatum*, of a proposed structure from a prototype; and which, by the ‘Sapir-Whorf Hypothesis’, then determines that my perception of the prototype is, to an extent, essentially rooted in the symbolic expression that I am attempting to interpret).

Sapir-Whorf Hypothesis

“The hypothesis of linguistic relativity, part of relativism, also known as the Sapir-Whorf hypothesis ... is a principle claiming that the structure of a language affects its speakers’ world view or cognition, and thus people’s perceptions are relative to their spoken language.

The principle is often defined in one of two versions: the strong hypothesis, which was held by some of the early linguists before World War II^[1], and the weak hypothesis, mostly held by some of the modern linguists.^[1]

- The strong version says that language determines thought and that linguistic categories limit and determine cognitive categories.
- The weak version says that linguistic categories and usage only influence thought and decisions."

... Wikipedia: *Linguistic Relativity*, downloaded 24/10/2019.

Comment 112. From the *evidence-based* perspective of this investigation we would, however, qualify the (Sapir-Whorf) hypothesis of linguistic relativity as the assertion that language:

- * first, *limits* the expression of a thought (as distinct from the thought itself) to what can be expressed within the language by the vocabulary and grammar of the language; and,
- * second, *influences* how such an expression is understood under a subsequent interpretation of the expression,

so that—even to the originator of the thought—that which is communicated in a subsequent interpretation of the expression need not necessarily reflect faithfully that which was sought to be expressed in the first place.

The distinction between a ‘thought’ (that which was sought to be expressed in the first place), and ‘the expression of a thought’, can be viewed as complementing—and being contrastingly illuminated by, when placed within a broader perspective of (see also §21.J.a.)—the distinction by philosopher Hans Radder in [Rdd22] between ‘a structuring and an abstracting component’, where these ‘two meaning components are abstract entities, which can be justifiably interpreted as real objects’²⁹⁸, where he seeks to present:

“... a detailed, novel account of the emergence of (the meaning of) empirical concepts. Acquiring experience and empirical concepts is shown to be the result of multifaceted, cognitive processes, which require both material realization and conceptual interpretation. Generally speaking, the meaning of empirical concepts consists of several distinct components, but it includes at least a structuring and an abstracting component. These two meaning components are abstract entities, which can be justifiably interpreted as real objects.

On this basis, I address the subject of emergence. The primary claim is that the abstracting meaning component (but not the structuring one) emerges from its underlying empirical processes: it both depends on and transcends these processes. This claim is expounded by discussing relevant similarities and dissimilarities between the emergence of abstract meanings and a range of central features of emergence prominent in recent debates on this topic. The conception of empirical concepts with emergent abstracting meaning components involves an interpretation that avoids the problematic extremes of both empiricism and Platonism."

... Radder: [Rdd22], *Abstract*.

- (2) Second, to study the ability of a mathematical language to objectively communicate the formal expression—corresponding to Carnap’s *explicatum* in [Ca62a]—of *some* such concepts categorically.

²⁹⁸Not to be confused with the ‘abstract entities’ which, from the *evidence-based* perspective of this investigation, can be viewed as corresponding to physically observable brain patterns (real objects) that can be evidenced in brain scans; and can, moreover, be further viewed as corresponding to what some cognitive scientists, such as Lakoff and Núñez in [LR00] (see also §27.), term as ‘primary’, and ‘secondary’, *conceptual metaphors*.

A language such as, for instance, the first order Peano Arithmetic PA, which can not only be well-defined formally, but which has a finitary model that admits *evidence-based* assignments of ‘truth’ values to arithmetical propositions by a mechanical intelligence, and which is categorical—albeit, with respect to algorithmic computability (see §2.E.b., Corollary 2.18).

Author’s comment: By ‘objectively communicate categorically’ I intend in this context that there is essentially:

- (a) first, an objective (i.e., on the basis of *evidence-based* reasoning in the sense of §7.C.) acceptance of identity by another mind between:
- the abstract concept created in the other mind when first attempting to understand the import of what I have expressed symbolically in a language; and
 - the abstract concept created in the other mind each time it subsequently attempts to understand the import of that symbolic expression (a process which can also be viewed in engineering terms as analogous to confirming that the formal specifications, i.e., *explicatum*, of a proposed structure do succeed in uniquely identifying the prototype, i.e., *explicandum*);

and:

- (b) second, an objective acceptance of functional identity between abstract concepts that can be ‘objectively communicated categorically’ based on the *evidence* provided by a commonly accepted doctrine such as, for instance, the view that a simple functional language can be used for specifying *evidence* for propositions in a constructive logic (in the sense of §7.C.).

Comment 113. The significance of clearly distinguishing the complementary roles of the natural sciences, philosophy, and mathematics—as posited in this section—is highlighted by the lack of such distinction, with consequent loss of any comfortable consensus, in classical efforts to adequately address—and attempt resolution of (see §20.)—the well-known semantic and logical paradoxes. As perceived from a conventional perspective by philosopher Kati Kish Bar-On in [Bro22]:

“The story of Brouwer’s intuitionism serves as a good example of the relation Friedman describes between science and philosophy, as Brouwer’s intuitionistic program was primarily developed out of philosophical considerations. It is also an intriguing example of how a new mathematical theory was perceived as alien to practicing mathematicians. Even those who were willing to consider Brouwer’s intuitionism as a possible alternative to classical mathematics, such as Hermann Weyl and Abraham Fraenkel, eventually found his new theory too restricting or too philosophical for practical everyday work (Iemhoff 2019; van Dalen 1995).

Brouwer’s intuitionistic theory provided a way to avoid the paradoxes of set-theory by utterly changing the way mathematical entities were perceived. According to Brouwer, mathematical objects are not merely symbols and formulas written on a piece of paper, but creations of the human mind constructed through mental activity (Brouwer 1907; 1912; Dummett 1977; Troelstra and van Dalen 1988). Following this new conceptual framework, Brouwer’s solution to the foundational problem required a massive reformation to the discipline of mathematics which obliged practitioners to renounce widely acceptable concepts and theories.”

... Bar-On: [Bro22], §2.3 Einstein, Helmholtz, and Poincaré: How a new conceptual framework becomes a viable alternative.

13.C.a. The ‘unreasonable’ effectiveness of mathematics

We conclude, from the *evidence-based* perspective of this investigation, that any ‘meaningful’ dialogue as to ‘What is mathematics’ ought to admit—i.e., be consistent with—the interpretation where:

1. Mathematics is a language which, by implicit definition of a language, cannot entail an ontology. It can only denote/refer to ‘objects’ outside the language whose properties and inter-relationships the language seeks/is intended to first, unambiguously express and, second categorically communicate, symbolically in *well-defined* mathematical models *only*²⁹⁹.

Comment 114. The significance of this restriction is that differing perspectives on the mathematical representation—of differing (or even seemingly contradictory) individual conceptual metaphors of that which we experience, and seek to record, when attempting to describe physical phenomena ‘perceived’ in an accepted, common, universe—can be misleadingly viewed as *determining* different ontologies, rather than as reflecting complementary perspectives of a common ontology:

“The *Standard Model of particle physics* comprises a set of theories that together predict several different types of elementary particles,²¹ neatly arranged according to a few properties such as mass, spin, electric charge and other “generalised charges.” Each elementary particle is characterised by the values of these properties: the electron, for example, is a spin $-\frac{1}{2}$ particle with an electric charge of -1 , weak isospin of $-\frac{1}{2}$, weak hypercharge of -1 , a mass of about 9.11×10^{-31} kg and a colour charge of **1**. Mathematically, these quantum numbers correspond to labels of so-called irreducible representations of symmetry groups, so the colour charge of the electron **1** is not the natural number 1, but the label of the one-dimensional representation of the global colour gauge group, and similarly for the other charges.²² It is in this sense that one can say that the ontology of the Standard Model is determined by these symmetry groups and their representations.”

... Niederklapfer: [Ndr24], §5.1 The Standard Model.

2. We could also view such ‘objects’ as the fleeting—but, in principle, measurable/recordable and, hopefully, ‘identifiable’—physical brain patterns of individual brains that correspond to the *primary* and *secondary* concepts/conceptual metaphors created in the associated mind which, then, seeks to symbolically ‘capture’ these fleeting sensory perceptions.

Comment 115. We note that, in his paper [Lvd16], Stathis Livadas essentially seeks to address, from a more fundamental phenomenological perspective, the nature—and conceivable significance (for what is commonly referred to as ‘mathematics/mathematical activity’)—of precisely such, primarily set-theoretically originating, ‘fleeting brain patterns’ which could, conceivably, be postulated as corresponding to putative ‘mathematical-logical objects’:

“A major question that can be raised concerning the essential nature of mathematical-logical objects is their relation to objective reality, to the capacities of the mind and ultimately to temporality conceived in the dual sense of both a ‘real world’ factor underlying spatio-temporal phenomena and as an intrinsic property of a self-constituting temporal consciousness. On the one hand, they can be regarded in terms of the ‘external’ objective temporality as immutable objects occupying each time an absolute temporal position with regard to the reality of [the] objective world and on the other hand as temporally constituted re-identifications of appearing profiles with regard to the inner temporality of consciousness. In the following, I will consider the term ‘mathematical-logical objects’ as identical in meaning to ‘mathematical objects’ insofar as these are taken in the sense of objects of a formal axiomatical theory, their sense bearing a certain affinity with the one attributed to them, for instance, in Gödel’s *Is mathematics syntax of language?* (Feferman et al. 1995, pp.334-363), and, more closely, in Tieszen’s *After Gödel* (Tieszen

²⁹⁹The issue of whether, or to what extent, a model can be *validated* as faithfully representing that which was initially sought to be expressed *within* the language is addressed briefly in §1.J., *Validating knowledge, truth, and proof in pre-formal mathematics*.

2011). In this respect, I will talk about mathematical-logical objects primarily as objects of formal theories, consequently not in the sense of objects of sensuous observation within objective reality, e.g., as geometrical figures in plane or space or space-filling graphs in a digital screen, etc. On account of this general position one is confronted with a host of philosophical attitudes that range between pure platonism in which mathematical objects are perfect, immutable objects of an ideal world transcending human experience and naive empiricist approaches in which mathematical-logical objects are merely elaborated representations in our mind of what physical experience brings to us through our sense organs."

... Livadas: [Lvd16], §Introduction, p.4.

Livadas clarifies that:

"In general, constituted platonism to a significant extent meets my own view of mathematical-logical objects, for instance, in categorizing mathematical and logical objects as mind-dependent₁ and mind-independent₂ with the meaning given to these terms (Sect. 5, §8). I would like to add, though, that Tieszen's denying of Hilbert's approach to objects or constructions of mathematical theories as reducible to immediate sensory perceptions of sign tokens and the proposition of categorial intuition and certain intensional forms of consciousness to accede, for instance, to 'second order' mathematical concepts such as the transfinite sets enters us more generally into some tricky questions with to the fundamentals of Husserlian approach. For example, it is not very clear how it is possible to talk, e.g., about formal individuals as objects of a 'lowest-level' intentionality which are not necessarily causally related to the subject, namely about those individuals generated non-arbitrarily in imagination and yet not possessing an absolute 'real-world' temporal position. What I want to say is that one may propose the a priori directedness of intentionality to account for the possibility of grasping and reflecting on mathematical objects-individuals (and generally on collections of such objects and their categorial properties) and yet we have no means to describe this a priori directedness but in terms of the contents of its enactments considered as already objectified. However, in being objectified the intentional contents in question are already constituted as real objectivities and 'spatio-temporal like'."

... Livadas: [Lvd16], §5 Conclusion, p.29.

Livadas notes further that 'an interesting question to raise is the extent to which a further quest on the character of inner temporality of consciousness might further clarify the inner horizon especially of transfinite objects':

"In view of all that was argued in this paper, mathematical and in a wider sense mathematical-logical objects established as such within formal theories are largely shaped by the constitutional-intentional capacities of each one's consciousness in intersubjective coincidence in a way that their formation is constrained by each one's specific presence in the world (as the soil of primitive experience) and also by the mathematical intuitions associated with this kind of presence. These intuitions corresponding to such features of reason as abstraction, idealization, invariability in transformation, the sense of symmetry, permutation, uniformity, etc., are not intentional capacities of consciousness, at least in a pure reality-independent sense, as they are not conceivable without reference to a reality transcendent to a self-constituting subjectivity, even non-conceivable without reference to a reality impregnated with a sort of historicity with respect to the existence of all conscious beings as its co-constituting and reduction performing factors. Given that mathematical-logical objects, as long as we go up the level of abstraction and complexity, acquire a widening inner horizon of content and properties, an interesting question to raise is the extent to which a further quest on the character of inner temporality of consciousness might further clarify the inner horizon especially of transfinite objects. For what is an undeniable fact reducible to the evidence of cogito is the non-eliminable 'superfluity' of an objective whole in actual reflection, be it in extreme cases a transfinite set or a huge cardinal on

the level of constituted, with regard to the generating predicative activities of the mind in discrete steps within objective time. This kind of ‘deficiency’ in subjective constitution that ultimately seems as temporal in nature can be partly accountable for a characterization of mathematical-logical within the context of formal theories as intersubjectively identical, transtemporal ones and yet provided with an ‘inner’ and ‘outer’ horizon open to potentially new insights and clarifications corresponding to possible further refinements in the future to come of the intentional-predicative capacities of the mind. In this view the non-eliminability of the mathematical transfinite and the associated meanings of non-finitistic objects might seem as a question pointing to the need for a further clarification, if feasible at all on the constitutional level, of the notion of a self-constituting temporality and the way it underlies the meaning-giving acts of the mathematical mind."

... Livadas: [Lvd16], §5 Conclusion, p.33.

3. The *primary* concepts/conceptual metaphors are those that can be expressed unambiguously, and communicated categorically, to other minds and, ipso facto, treated by convention as referring to ‘objects’—and their inter-relationships—that we accept by consensus as ‘existing’ in a common external reality that living organisms experience through their individual sensory organs; and which we attempt to quantify, and record, by means of standardised methods/apparatus of measurement (using a language intended for that precise purpose).
4. The *secondary* concepts/conceptual metaphors are those that can be well-defined unambiguously within a language, by virtue of the fact that a rich enough language can well-define expressions (‘square circle’, ‘present king of France’) within the language that do not denote/refer—under any possible well-defined interpretation of the language—to anything in our commonly accepted reality. However, some such expressions may in turn create concepts/conceptual metaphors of ‘objects’ conceivable in an individual mind (‘present king of France’, ‘unicorn’) that are associated with fleeting brain patterns in the individual mind which, even if assumed capable of being ‘identified’ by that mind with a specific symbolic expression, cannot claim to be capable of any well-defined interpretation under which the symbolic expression denotes/refers to anything (mathematical/physical) other than the expression itself.
5. We distinguish here between the concept/conceptual metaphor created in a mind when attempting to interpret the word ‘unicorn’ from the concept/conceptual metaphor created in a mind when viewing, say, a sculpture depicting an artist’s conception of a ‘unicorn’; in the latter the concept/conceptual metaphor relates to a physical object that is the ‘artist’s unicorn’. The latter is, of course capable of being communicated categorically (for instance, photographically).
6. Another way of expressing this is to say that the representation of *primary* concepts/conceptual metaphors in a language always has an *evidence-based* Tarskian interpretation; whereas any representation of a *secondary* concept/conceptual metaphor has no evidence-based Tarskian interpretation.
7. In other words, *primary* concepts/conceptual metaphors are grounded in our consciousness (putatively corresponding to a fleeting brain pattern) of an ‘objective’ reality; *secondary* concepts/conceptual metaphors in our consciousness (putatively corresponding to a fleeting brain pattern) of only a ‘subjective’ reality.

8. The above distinction assumes significance, of course, only in view of the *finitary* proof of consistency for the first-order Peano Arithmetic PA (see §2.C., Theorem 2.16)—which entails that PA is *categorical* (see §2.E.b., Corollary 2.18)—since it enables a distinction to be made between what is only assignable as *provable* within an axiomatic mathematical theory, and what is additionally assignable as *true* under any *well-defined* (i.e., *evidence-based* in the sense of §7.F., Definition 26) interpretation of the theory.

Assuming that all the laws of nature are expressible in terms of (see §23.A., *Some determinate physical phenomena may not be expressible recursively*):

- (a) algorithmically *verifiable* functions/relations, whose values are deterministic but *not* necessarily predictable; and/or
- (b) algorithmically *computable* functions/relations, whose values are deterministic *and* predictable;

and that there can theoretically be an infinity of such functions/relations, the question seemingly considered by physicist Eugene Wigner in [Wgr60] arises as to how science can ‘reasonably’ expect to do what it in fact does: successfully seek to represent, and categorically communicate, all that it can observe and record, of a possible infinity of these functions/relations, unambiguously in a language with a finitary alphabet.

“... The first point is that the enormous usefulness of mathematics in the natural sciences is something bordering on the mysterious and that there is no rational explanation for it. Second, it is just this uncanny usefulness of mathematical concepts that raises the question of the uniqueness of our physical theories. In order to establish the first point, that mathematics plays an unreasonably important role in physics, it will be useful to say a few words on the question, “What is mathematics?”, then, “What is physics?”, then, how mathematics enters physical theories, and last, why the success of mathematics in its role in physics appears so baffling.”

... Wigner: [Wgr60], *What is mathematics?*

Comment 116. That the issue continues to be of relevance is reflected in Dustin Lazarovici’s [Lzr23], where he, too, seeks a perspective on ‘why the language we have been successful with is precisely that of mathematics rather than, say, biblical Hebrew or instructions for a Turing machine’:

“Why is mathematics so successful in describing the natural world? More profoundly, why are the fundamental laws of nature – as far as we know them today – expressed in mathematical language?”

The puzzle can present itself in different ways, depending on what one takes mathematics to be. If one believes that abstract mathematical objects or structures exist in some Platonic heaven, one may wonder why they should have anything to do with the physical world and how we, as material beings in space and time, are able to acquire knowledge of them. With such questions in mind, some authors have gone as far as to suggest that the universe we live in is itself mathematical (Tegmark (2014); see also Tumulka (2017)).

If one believes that mathematics is a human invention, one must marvel at the confluence of human genius and nature’s kindness that makes it so successful. One may try to deflate the “unreasonable effectiveness of mathematics” (Wigner, 1960) by attributing some of it to selection bias (Wenmackers, 2016), pointing to pieces of mathematics that, so far, have no use in natural science. One may also argue that our cognitive apparatus, which allowed us to invent mathematics, is the product of natural

evolution and therefore well-adapted to the world (as if the traits that prevented our ancestors from being eaten by a tiger would naturally lead to the invention of complex analysis). But none of these arguments explain why the language we have been successful with is precisely that of mathematics rather than, say, biblical Hebrew or instructions for a Turing machine. And at the end of the day, they do little to address Wigner’s sentiment that “[t]he miracle of the appropriateness of the language of mathematics for the formulation of the laws of physics is a wonderful gift which we neither understand nor deserve” (1960, p.14)."

... Lazarovici: [Lzr23], §1 The “Unreasonable” Effectiveness of Mathematics.

Lazarovici’s reference to the ‘instructions’ of a Turing machine is intriguing. By implicitly implying that—contrary to the Provability Theorem of PA³⁰⁰ that a mathematical proposition can be evidenced as true by a Turing machine if, and only if, it can be proven in the first-order Peano Arithmetic PA—it obscures the very answer Lazarovici seeks here:

That the ‘language we have been successful with is precisely that of mathematics’ only because PA (ergo also the language of a Turing machine) provide the categorically communicable means by which (see §13.C.):

- (a) the Natural Sciences can record—as precisely and as objectively as possible—our sensory observations and their associated perceptions of a ‘common’ external world; and,
- (b) Philosophy can abstract a coherent perspectives of the external world from the natural scientist’s sensory observations and their associated perceptions!

From the *evidence-based* perspective of this investigation, the ‘reasonable’ effectiveness of mathematics/mathematical reasoning is provided by Gödel’s Theorem VII in [Go31], which entails that every algorithmically *verifiable* function/relation can be expressed by some primitive recursive, hence algorithmically *computable* and deterministic, Gödel β -function which can, further, be expressed arithmetically.

The seemingly ‘unreasonable’ effectiveness of mathematics then stems from the theorem that the first-order Peano Arithmetic PA admits of categorical communication (see [An16], Corollary 7.2, p.41). We can thus rest assured that all our *primary* conceptual metaphors can, when appropriately expressed as algorithmically *verifiable* functions and relations, be expressed in PA; and those of these that are further algorithmically *computable* can be categorically communicated within a *well-defined* community.

From the *evidence-based* perspective of this investigation, Wigner’s sense of wonder and bafflement at the ‘unreasonable effectiveness of mathematics in the natural sciences’ can thus be viewed as reflecting the distinction between (see §5.A., *What is knowledge?*; also §13.F., *Three categories of information*):

- (i) the inherited, faith-based, mathematical paradigm that mathematical knowledge is intuitively ‘justified true belief’; whence an individual ‘justified true belief’ can be more valid than a majoritarian ‘justified true belief’ within a well-defined community;
- (ii) and the hitherto unsuspected categoricity of the first-order Peano arithmetic PA, which admits mathematical knowledge as ‘factually grounded belief’ in Piccinini’s sense; whence, by definition, the ‘factually grounded belief’ of an individual is subsumed within the common ‘factually grounded belief’ of a well-defined community.

³⁰⁰§2.E.b., Theorem 2.17 (Provability Theorem for PA) *A PA formula $[F(x)]$ is PA-provable if, and only if, $[F(x)]$ is algorithmically computable as always true in \mathbb{N} .*

The ‘unreasonable effectiveness of mathematics in the natural sciences’ thus merely reflects a scientific method which favours the falsible, common, ‘factually grounded beliefs’ over the ‘justified true beliefs’ of a well-defined community; a perspective that also illuminates Richard Hamming’s 1979 poser in [Hmg79] as to ‘why the logical side of science—meaning mathematics, mainly—is the proper tool for exploring the universe as we perceive it at present’:

“From all of this I am forced to conclude both that mathematics is unreasonably effective and that all of the explanations I have given when added together simply are not enough to explain what I set out to account for. I think that we—meaning you, mainly—must continue to try to explain why the logical side of science—meaning mathematics, mainly—is the proper tool for exploring the universe as we perceive it at present.”

... Hamming: [Hmg79], Conclusion, p.90.

Moreover, any ‘wonder’ at the ‘unreasonable’ power of mathematics to anticipate expression of the algorithmically *verifiable* functions/relations needed to represent our observations, and recordings, of natural phenomena unambiguously in a symbolic language merely reflects that we can conceptualise, and unambiguously express, far more *secondary* conceptual metaphors in a language of unambiguous expression, such as the first order Set Theory ZFC, than the *primary* conceptual metaphors which we can unambiguously express and *categorically* communicate in a first-order Peano Arithmetic such as PA.

Comment 117. The above³⁰¹ can, not unreasonably, be viewed as illustrating, even if not corresponding to, Jeremy Avigad’s contention in [Avg23] that ‘there is a sense in which formal systems specify too little, and there is a sense in which they specify too much’:

“As idealized descriptions of mathematical language, there is a sense in which formal systems specify too little, and there is a sense in which they specify too much. On the one hand, formal languages fail to account for a number of features of informal mathematical language that are essential to the communicative and inferential goals of the subject. On the other hand, many of these features are independent of the choice of a formal foundation, so grounding their analysis on a particular choice of a formal system introduces unnecessary specificity. This chapter begins to map out the design features of mathematical language without descending to the level of formal implementation, drawing on examples from the mathematical literature and insights from the design of computational proof assistants and their libraries.”

... Avigad: [Avg23], Abstract.

Moreover, the significance of Pantsar’s *pre-formal* mathematics (see §1.A.) is reflected in Jeremy Avigad’s observation in [Avg23] that³⁰², in mathematics, ‘it turns out to be surprisingly hard to say what it is we are talking *about*; mathematics seems to be, as the title of a book by John Burgess and Gideon Rosen proclaims, a subject with no object’.

³⁰¹That we can conceptualise, and unambiguously express, far more *secondary* conceptual metaphors in a language of unambiguous expression, such as the first order Set Theory ZFC, than the *primary* conceptual metaphors which we can unambiguously express and *categorically* communicate in a first-order Peano Arithmetic such as PA.

³⁰²Echoing Bertrand Russell’s aphorism—often misinterpreted as a quip—that:

“... mathematics may be defined as the subject in which we never know what we are talking about, nor whether what we are saying is true.” ... Russell: [Rus17], p.74, paragraph 3.

In other words, from the *evidence-based* perspective of this investigation, it would not be unreasonable to, further, view Markus Pantsar’s *pre-formal* mathematics³⁰³ as proffering an ‘empathetic’ alternative—even if not a solution—to Avigad’s search for ‘a model that is more informative than formal logic, one that tells a story of how mathematical language serves to support the processes that are needed to track mathematical objects and the relationships between them’:

“Mathematics is governed by a network of norms that determines what we can say and how we are supposed to say it. Learning how to speak about mathematics properly is an important part of learning to do mathematics. But, when pressed, it turns out to be surprisingly hard to say what it is we are talking *about*; mathematics seems to be, as the title of a book by John Burgess and Gideon Rosen proclaims, a subject with no object. And without making sense of what we are talking about, it is hard to see how we can make sense of what we are thinking about. The outward manifestations of mathematical thought are found in the way we communicate mathematics to others.

Here we adopt the view that an important way to make sense of what we are talking about is to develop a better understanding of mathematical language itself. From a grammatical point of view, the language of mathematics is rather simple. There are no subtle variations of tense, modality, or aspect, and the subject is generally devoid of subjunctives and counterfactuals. Mathematical statements make claims as to what is true, always has been true, and always will be true, and mathematical proofs back these claims up with more statements of the same sort. The subtleties of mathematical language stem rather from the features that render it suitable for reasoning about abstract objects and properties.

Formal languages provide informative models of mathematical discourse. It is by now well understood that ordinary mathematics can be formalized in various ways in first-order logic and the language of set theory, in variants of simple type theory or dependent type theory, or in category-theoretic foundations. These variations provide complementary perspectives and serve as bases for formalization in proof assistants like Mizar [Grabowski et al., 2010], Isabelle [Nipkow et al., 2002], Coq [Bertot and Castéran, 2004], HOL Light [Harrison, 2009], Metamath [Megill, 2006], and Lean [de Moura et al., 2015].

As valuable as they are, there is a sense in which formal languages specify too much, and there is a sense in which they specify too little. The fact that an ordinary mathematical text can be represented equally well in any of the foundations above shows that these foundations should be viewed as alternative *implementations* of mathematics. It is therefore reasonable to look for descriptions of mathematical language and patterns of inference that abstract away the superficial differences and clarify the specifications that the implementations are designed to meet.

Formal languages specify too little in the sense that many essential features of ordinary mathematical language are not addressed by a formal specification. Instantiating the formal foundation is only the first step in implementing a mathematical proof assistant, and the bulk of the work then goes into supporting the interactions that make them usable in practice. Such systems have to parse user input, disambiguate notation, manage libraries of theorems and definitions, and keep track of algebraic structures and relationships between them. They need to provide convenient manners of expression and support efficient inference. The design of a proof assistant requires countless engineering decisions that bear on the system’s usability, and these decisions can, in turn, be viewed as attempts to capture the functionality of informal mathematical language and inference. We might optimistically seek a better philosophical understanding of this functionality, one that can help us make sense of the implementation goals.

³⁰³Which essentially argues—from an *evidence-based* perspective—that *pre-formal* mathematics entails, but is not entailed by, formal mathematics; which we further argue must, in turn, have a finitary interpretation for validating any claim that the latter is the intended formalisation of the former (see §1.J.: *Validating knowledge, truth, and proof in pre-formal mathematics*).

Another approach to thinking about mathematical language is to view it as a part of natural language, albeit a part of natural language with its own characteristic features. Ganesalingam [2013] leans in this direction, which allows him to bring the methods of generative linguistics to bear on the analysis of ordinary mathematical texts. Various systems of *controlled natural language* offer a complementary approach, presenting structured languages with enough flexibility to incorporate a range of natural language constructs, so that users can write texts that read like natural language but can be translated to the language of an underlying formal system [Paskevich, 2007, Cramer et al., 2009].

Here we will not try to account for the range of grammatical and stylistic variation that one finds in natural language. We will rather seek idealizations that illuminate the features of mathematical language that are specifically adapted to supporting mathematical activity. One way of describing what we are after is to say that we are looking for a description of mathematics as a *semiformal language*. We want a description that renders it regimented and precise, like a formal language, designed to support certain types of abstraction and inference. At the same time, we want a model that is more informative than formal logic, one that tells a story of how mathematical language serves to support the processes that are needed to track mathematical objects and the relationships between them. Our overarching goal will be to develop such a design specification for mathematical language without descending to the level of a fully formal implementation."

... Avigad: [Aug23], Introduction.

In other words mathematics creates far more tools than those that are actually sought and/or employed by the natural sciences at any one time. That this is not unique to mathematics is evidenced by cases of curiosity-driven inventors and experimental scientists, who often create products or substances with properties that have no immediate applications—such as, for instance, the invention of Silly Putty—but which eventually offer the solutions sought by future challenges:

"Because of its adhesive characteristics, it was used by Apollo astronauts to secure their tools in zero gravity.^[23] Scale model building hobbyists use the putty as a masking medium when spray painting model assemblies.^{[24][25]} The Steward Observatory uses a Silly-Putty backed lap to grind astronomical telescope mirrors.^{[26][27]}

Researchers from Trinity College Dublin School of Physics (Centre for Research on Adaptive Nanostructures and Nanodevices (CRANN) and Advanced Materials and Bioengineering Research (AMBER) Research Centers) have discovered nano composite mixtures of graphene and Silly Putty behave as sensitive pressure sensors, claiming the ability to measure the footsteps of a spider crawling on it.^[28]"

... Wikipedia: *Silly Putty*.

13.D. When can a formal assertion claim to ‘mean’ what it represents?

The above perspective raises another important philosophical issue which is implicit in the key thesis of Floyd and Putnam’s paper [FP00], and reflected in Wittgenstein’s remark (see §12.B.):

"If you assume that the proposition is provable in Russell’s system, that means it is true in the Russell sense, and the interpretation ‘*P* is not provable’ ... has to be given up."

We may state this issue explicitly as:

Query 8. *When can a formal assertion claim, under a well-defined interpretation, to ‘mean’ what it represents?*

Now if, as argued earlier, we accept that PA formalises our intuitive arithmetic of the natural numbers, and that there is a *well-defined* interpretation \mathcal{I} of PA, it follows that every well-formed formula of PA interprets under \mathcal{I} as a *well-defined* arithmetical expression in \mathbb{N} , and every *well-defined* arithmetical expression in \mathbb{N} can be represented as a PA-formula.

The question then arises:

Query 9. *When is a specified number-theoretic function or relation representable in PA?*

13.D.a. Formal expressibility and representability

Now, the classical PA-expressibility and representability of number-theoretic functions and relations is addressed by the following three conventional definitions³⁰⁴:

- (a) A number-theoretic relation $R(x_1, \dots, x_n)$ is said to be expressible in PA if, and only if, there is a well-formed formula $[A(x_1, \dots, x_n)]$ of PA with n free variables such that, for any natural numbers k_1, \dots, k_n :
 - (i) if $R(k_1, \dots, k_n)$ is true³⁰⁵, then PA proves: $[A(k_1, \dots, k_n)]$;
 - (ii) if $R(k_1, \dots, k_n)$ is false, then PA proves: $[\neg A(k_1, \dots, k_n)]$.
- (b) A number-theoretic function $f(x_1, \dots, x_n)$ is said to be representable in PA if, and only if, there is a well-formed formula $[A(x_1, \dots, x_n, y)]$ of PA, with the free variables $[x_1, \dots, x_n, y]$, such that, for any natural numbers k_1, \dots, k_n, l :
 - (i) if $f(k_1, \dots, k_n) = l$, then PA proves: $[A(k_1, \dots, k_n, l)]$,
 - (ii) PA proves: $[(\exists! l)A(k_1, \dots, k_n, l)]$.
- (c) A number-theoretic function $f(x_1, \dots, x_n)$ is said to be strongly representable in PA if, and only if, there is a well-formed formula $[A(x_1, \dots, x_n, y)]$ of PA, with the free variables $[x_1, \dots, x_n, y]$, such that, for any natural numbers k_1, \dots, k_n, l :
 - (i) if $f(k_1, \dots, k_n) = l$, then PA proves: $[A(k_1, \dots, k_n, l)]$,
 - (ii) PA proves: $[(\exists! l)A(x_1, \dots, x_n, y)]$,

13.D.b. When may we assert that $A(x_1, \dots, x_n)$ ‘means’ $R(x_1, \dots, x_n)$?

We can, thus, re-phrase Query 9 as:

Query 10. *If a number-theoretic relation $R(x_1, \dots, x_n)$ is expressible by a PA-formula $[A(x_1, \dots, x_n)]$, when may we assert that, under a well-defined interpretation \mathcal{I} of PA, $A(x_1, \dots, x_n)$ ‘means’ $R(x_1, \dots, x_n)$?*

³⁰⁴cf. [Me64], p117-118.

³⁰⁵We can assume without any loss of generality that such ‘truth’ is implicitly *evidence-based*.

Now we note that, if $R(x_1, \dots, x_n)$ is arithmetical³⁰⁶, then one of its PA-representation is $[R(x_1, \dots, x_n)]$, whose interpretation is $R(x_1, \dots, x_n)$ under \mathcal{I} . Hence every arithmetical relation $R(x_1, \dots, x_n)$ is the interpretation of some PA-formula that expresses it in PA, and we can adapt this to give a formal definition of the term ‘means’:

Definition 38. (Meaning of a formula under interpretation) *If a number-theoretic relation $R(x_1, \dots, x_n)$ is expressible by a PA-formula $[A(x_1, \dots, x_n)]$ then, under any well-defined interpretation of PA, $A(x_1, \dots, x_n)$ means $R(x_1, \dots, x_n)$ if, and only if, $R(x_1, \dots, x_n)$ is the well-defined interpretation, under \mathcal{I} in \mathbb{N} , of some PA-formula that expresses $R(x_1, \dots, x_n)$ in PA.*

Query 9 can now be expressed precisely as:

Query 11. *When is a number-theoretic relation a well-defined interpretation of some PA-formula that expresses it in PA?*

Now, by definition, the number-theoretic relation $R(x_1, \dots, x_n)$, and the arithmetic relation $A(x_1, \dots, x_n)$, can be effectively shown as equivalent for any specified set of natural number values for the free variables contained in them.

However, for $A(x_1, \dots, x_n)$ to *mean* $R(x_1, \dots, x_n)$, we must have, in addition, that $R(x_1, \dots, x_n)$ can be effectively transformed into an arithmetical expression, such that it can be a *well-defined* interpretation of some PA-formula that expresses it in PA.

The significance of this is seen in §15.H., where we show how Gödel’s sketch of his proof of Theorem XI in [Go31] violates this restriction.

13.E. Recognising the strengths and limitations of ZF and PA

Another significant consequence of the preceding section is that we may need to recognise explicitly in our basic mathematical education (see §28.) that *evidence-based* reasoning:

- (a) restricts the ability of *highly expressive* mathematical languages, such as the first-order Zermelo-Fraenkel Set Theory ZF, to *categorically* communicate abstract concepts (corresponding to Lakoff and Núñez’s conceptual metaphors in [LR00]; see also §27.) such as those involving Cantor’s first limit ordinal ω ³⁰⁷;

Comment 118. From the *evidence-based* perspective of this investigation, the restricted ability of languages such as ZF to categorically communicate even a putative semantic interpretation of set-theoretical proofs, reflects Piccinini’s distinction (see §5.A.) between *Justified True Belief* and *Factually Grounded Belief*, and his thesis in [Pic19] that we can only term—and, implicitly, categorically communicate—the latter as ‘*knowledge*’.

In other words, the provable propositions of any set theory which admits an axiom of infinity can be seen to be axiomatically *Justified True Beliefs* that cannot, however, be treated as

³⁰⁶A number-theoretic relation is arithmetical if, and only if, it can be defined by means of only the concepts $+$, \cdot (addition and multiplication of natural numbers) and the logical constants \vee , \neg , $\forall x$, $=$, where $\forall x$ and $=$ are to refer to natural numbers. The definiens of such a concept must therefore be constructed only by means of the indicated symbols, variables for natural numbers x, y, \dots and the symbols 0 and 1 (function variables and set variables must not occur). (cf. [Go31], p.29.)

³⁰⁷See [LR00], Preface, p.xii-xiii: “How can human beings understand the idea of actual infinity?”

knowledge, and categorically communicated as *Factually Grounded Beliefs*, since such a theory does not admit a *well-defined* model (see Definition 34).

The point is sought to be emphatically expressed by Peter Simons in his brief, but cogent, critique [Sms04] of the uncritical, and unsuspectedly crippling, acceptance of Set Theory as the lingua franca of scientific discourse not only in mathematics, but also in philosophy and the natural sciences:

“Even within mathematics some uses of set theory are questionable. It is usual to interpret numbers of various kinds as sets, but as Benacerraf (1965) showed, this leads to the pseudo-question which sets the numbers should be. Numbers are old and very useful, whereas sets are new and problematic. To explicate numbers as sets is to explain the clear by the obscure. The obscurity turns on the fact that set theory has no natural interpretation.”

... Simons: [Sms04], §Set theory in mathematics, p.3.

and:

- (b) restricts the ability of *effectively communicating* mathematical languages, such as the first-order Peano Arithmetic PA, to *well-define* infinite concepts such as ω (see §18.A.a.).

Comment 119. From the *evidence-based* perspective of this investigation, the restricted ability of languages such as PA to *well-define* infinite concepts—such as Cantor’s first transfinite ordinal ω —reflects the fact that PA is categorical (see Corollary 2.18), and cannot therefore admit properties of terms that, by Piccinini’s distinction (see §5.A.), interpret as *Justified True Beliefs* but not *Factually Grounded Beliefs*.

In other words, the provable propositions of any arithmetic such as PA are axiomatically *Justified True Beliefs* that *can*, further, be treated under any *well-defined* interpretation of PA as *knowledge* which can be categorically communicated as *Factually Grounded Beliefs*.

Comment 120. The need for making the above distinction—between languages of adequate expression and languages of categorical communication vis à vis our conceptual metaphors—explicit in scientific discourse, is highlighted by linguist David Adger’s attempt to address—in an interview on the on-line blog Nautilus—the challenges faced in, first, faithfully representing in a language of ordinary discourse our sensory perceptions of the external world; and, second, in communicating such representations categorically:

“You write that language, like fiction, creates meaning where none existed before. Have you ever thought that when we talk to each other, we’re just throwing fictional worlds at one another?”

I totally think that’s what we’re doing! This goes back to what the limits of humans are. Our own internal worlds are what we represent and think about the external world. They’re probably all wrong to start with, and then we try and link those fictions with other people’s fictions. I think most of our interaction is an attempt to align the fictions that we build to be able to survive in the world. And this goes back to culture wars. People have different fictions of the world and sometimes they are pretty brutally out of alignment. Like now. And that’s quite terrifying, right?

So how do people understand each other?

Our languages allow us to both create these new ways of thinking and to maintain the ways of thinking we’ve already built. So there’s another paradox there, which is that language maintains as well as creates. But then our individual worlds can be distinct. And trying to pull them into cohesion with other people is a huge amount of work.”

... Adger: [Adg19], Interview.

We could express the above as the theses:

Thesis 5. (ZF Limiting Thesis) *Evidence-based reasoning restricts the ability of highly expressive mathematical languages, such as the first-order Zermelo-Fraenkel Set Theory ZF, to categorically communicate abstract concepts such as those involving Cantor's first limit ordinal ω .*

Thesis 6. (PA Limiting Thesis) *Evidence-based reasoning restricts the ability of effectively communicating mathematical languages, such as the first-order Peano Arithmetic PA, to well-define infinite concepts such as those involving Cantor's first limit ordinal ω .*

We would argue, further, that from an *evidence-based* perspective, the notorious semantic and logical paradoxes arise out of a blurring of this distinction, and an attempt to ask of a language more than it is designed to deliver (see §20.).

Comment 121. To situate this in the wider perspective of a common challenge faced by societies in holistically resolving—without conflict—paradoxes arising out of humankind's subjective spiritual, and objective material, yearnings, one could also argue analogously that we may need to recognise explicitly in our basic education the healthy humility induced in a society that seeks to appreciate—and emphasise the importance of—an *evidence-based* reasoning which:

- restricts the claim of religious education to *categorically* communicate abstract, essentially-subjective, concepts (corresponding to Lakoff and Núñez's *secondary* conceptual metaphors), such as, for instance, those involving spiritual concepts concerning the qualities and nature of a putative Deity (e.g., see [BP14]);

and:

- restricts the claim of scientific education to *well-define* such concepts (see §7.B.).

Such paradoxes dissolve once we accept that the ontology which we seek to represent in any interpretation of a symbolic language is determined not by the 'logic' of the language—which, contrary to conventional wisdom, we may take as intended solely to assign unique *evidence-based* 'truth' values to the declarative sentences of the language (in the sense of §12., Definitions 32 to 34)—but by the rules that determine the 'terms' which can be admitted into the language (see, for instance, §10.C., Definition 8) without inviting contradiction, in the broader sense of how, or even whether, the brain—viewed as the language defining and logic processing part of any intelligence—can address contradictions.

Comment 122. This point is emphasised succinctly by Wittgenstein in the concluding one-line paragraph #7 of his seminal 1922 'Tractatus Logico-Philosophicus' *if*—in the context of scientific discourse—we read 'categorically communicate' for 'speak':

"Whereof one cannot speak, thereof one must be silent."

... Wittgenstein: [Wi22], p.90.

Our concerns in these areas have been those commonly shared by scholars of all disciplines—including challenged graduate-level students—with a more than passing interest in the reliability, for their intended individual purposes, of the mathematical languages which any scientific inquiry—by implicit definition—finds essential for attempting unambiguous expression of abstract thought and, subsequently, its unequivocal communication to another.

Comment 123. For instance, the inter-disciplinary significance (a) of recognising the strengths and limitations of ZF and PA, and (b) of viewing a pre-formal mathematical proposition as a pre-formal truth that entails, and is not entailed by, a formally provable mathematical formula (as argued by Pantsar in [Pan09]; see §1.A.)—whose validity, moreover, as a categorically communicable mathematical truth lies, in turn, upon whether or not the formalisation admits of a well-defined Tarskian interpretation that is faithful to the intent of the pre-formal mathematical proposition (in the sense of §1.J.)—is reflected in Bio-scientist Paul Ola’s preprint [Ola23].

Ola argues the thesis that ‘... mathematics is not a “microscope” that has the capacity to uncover knowledge of reality by illuminating experimental results but rather a language into which the universal language of thought that begins in experimental results (pure thought) must be translated or in which such thought must be conducted if the doubtlessness of each step taken towards knowledge of reality will be ascertained before arrival at concepts and the principles that interrelate them’:

“The history of physics teaches us that the resolution of inconsistencies that stymie scientific fields is the reliable path to breakthroughs. What it does not teach us is the method by which Albert Einstein resolved inconsistencies in the process of developing General Relativity and how this method can be employed to resolve other inconsistencies that stymie scientific fields. Upon acquiring the capacity to use the method to resolve the inconsistencies that stymie public health after 13 years of the necessary philosophical and empirical immersion, it was found to be one in which the scientist forges a path to knowledge of reality by means of pure thought rather than assumptions about reality with the goal of giving greater explanatory and predictive power to theories. It was discovered that mathematics is not a “microscope” that has the capacity to uncover knowledge of reality by illuminating experimental results but rather a language into which the universal language of thought that begins in experimental results (pure thought) must be translated or in which such thought must be conducted if the doubtlessness of each step taken towards knowledge of reality will be ascertained before arrival at concepts and the principles that interrelate them. Thus, the mathematical equivalent of the universal language of pure thought, such as the non-Euclidean geometry of General Relativity, which increases the likelihood that the scientist will forge a path to empirical knowledge is analogous to the pictorial language in maps by which ancient voyagers ascertained the doubtlessness of their steps and increased the likelihood of success long before arrival at their destinations where such doubtlessness is confirmed. Together, these results reveal that the focus of scientists that aim to resolve the inconsistencies that stymie their fields must be fluency in the non-mathematical language of pure thought which must be achieved when the realities to be understood are those to which paths cannot be forged in any known mathematics, such as quantum reality which Einstein sought in the bid to unify knowledge in physics.”

... Ola: [Ola23], *Abstract*.

From the evidence-based perspective of this investigation, Ola seemingly argues for recognition of a ‘universal non-mathematical language of pure thought’ that can, however, be viewed as corresponding to Pantsar’s pre-formal mathematics (see §1.A.):

“... mathematical language is empty with regards to knowledge of reality unless it is spoken while forging a path to knowledge of reality with pure thought [2] or as a language into which the universal non-mathematical language of pure thought has been translated after a path has been forged to such knowledge. Without the creative principle that emerges from the pure thought of the empirical philosopher-scientist, theories that are developed in the language of mathematics are completely empty as regards reality [2], however simple or “mathematically beautiful” such mathematical language may be to scientists who, without the necessary philosophical immersion, see mathematics as a “microscope” that has the capacity to uncover knowledge of the observed phenomena and the mechanisms that underlie them by illuminating

experimental results. And indeed, the result which was obtained upon examining the mathematical structure of General Relativity is a soberer definition of mathematical "simplicity" which accords with the results presented here, that this "simplicity does not automatically bring truth" [12].

Without a mathematical language in which the empirical philosopher-scientist can conduct pure thought or into which the non-mathematical language of pure thought can be translated, the doubtlessness of the steps that lead to knowledge of reality cannot be ascertained until the data of experience and their mutual relations have corresponded perfectly with the concepts and those laws or principles that connect them. But unlike Einstein, who was fortunate that geometry, the mathematical equivalent of the universal non-mathematical language of pure thought through which a path can be forged to the empirical theory of gravity, had already been developed before he began developing this theory, empirical philosopher-scientists who do not have such mathematical equivalents at their disposal must first become fluent in this universal language and may need to forge a path to the knowledge of reality in this language before mathematicians can develop such mathematical equivalents."

... Ola: [Ola23], Abstract.

Ola concludes on a prophetic note by implicitly emphasising the need to distinguish between a mathematical language of unambiguous expression, and one of categorical communication, by observing that:

"... forging a path to knowledge of reality in the universal non-mathematical language of pure thought before translation gives empirical philosopher-scientists the opportunity to become so fluent in this language that they become able to communicate such knowledge effectively with colleagues and philosophers of science who may not be fluent in the language of mathematics as well as with the mathematicians who will translate the non-mathematical language of pure thought into its mathematical equivalents or develop new mathematics for the purpose of such translation if they do not already exist. Indeed, General Relativity was misunderstood in its early days when only a few scientists were familiar with the mathematical language of non-Euclidean geometry and the confusion which has been attributed to defects which were not inherent in the theory but rather in its exposition [22] would not have occurred if Einstein had first conducted pure thought in the universal non-mathematical language and had become fluent in this language before translating it into its geometrical equivalent because he would have been able to communicate the theory effectively even with the majority who were not familiar with this language.

Such models which will be digital twins of real-life processes that are sought by mathematical scientists in biology [23] and other sciences will not be obtained by interpreting data with new mathematics but rather by translating the universal non-mathematical language of pure thought into the necessary mathematical equivalents. And when paths have been forged to the empirical alternatives of all logically-deduced theories in each field of science, the result will be the disappearance of the deep-seated incompatibilities in our system of concepts [15] and the unification of knowledge which was not only Einstein's dream but also that of Herbert Spencer, the scientist who was commemorated with "On the method of theoretical physics" at Oxford in 1933 [2].

For instance, by conducting pure thought in the universal language, empirical philosopher-physicists will be able to forge a path to the quantum theory of Einstein's dreams [2] which, upon the translation of that non-mathematical language into its mathematical equivalent, will unite freely with General Relativity. And when science has empirical theories that unify knowledge and not only logically deduced theories that are useful, we will witness an acceleration of scientific progress that we cannot imagine at this time."

... Ola: [Ola23], pp.14-16.

We thus argue the thesis that the obstacles to such expression and communication are rooted in the disconcerting perceptions of mutual inconsistency between various ‘classical’ and ‘constructive’ philosophies of mathematics vis à vis the disquieting, and seemingly ‘omniscient’, status accorded classically to both mathematical truth and mathematical ontologies (highlighted by Krajewski in [Kr16] and Lakoff and Núñez in [LR00]; see also §27.); and that such perceptions are, at heart, illusions.

They merely reflect the circumstance that, to date, all such philosophies—whether due to explicitly or implicitly held beliefs—do not unambiguously *define* the relations between a language and the ‘logic’ (in the sense of §1., Definition 1, and §12., Definitions 34, 35) that is *necessary* to assign unequivocal truth-values of ‘satisfaction’ and ‘truth’ to the propositions of the language under a *well-defined* interpretation.

Moreover, an epistemically grounded perspective of conventional wisdom—as articulated, for instance, in [LR00] or [Shr13]—might inadvertently be ignoring the possibility of a distinction between the multi-dimensional nature of the logic of a formal mathematical language (in the sense of §1., Definition 1), and the one-dimensional nature of the veridicality of its assertions.

Similarly, current mathematical paradigms of what is entailed by Hilbert’s development of proof theory, and by Brouwer’s development of constructive mathematics, may appear contradictory only because they inadvertently fail (see, for example, [RS17]; also [Mycl]) to adequately recognise that ‘provability’ and ‘truth’ need to be complementary, ‘*evidence-based*’, assignments-by-convention towards achieving (cf., §1., Complementarity Thesis 1):

- (1) The goal of proof theory, post Peano, Dedekind and Hilbert, which has so far been:
 - to uniquely characterise each informally defined mathematical structure S (e.g., the Peano Postulates and their associated classical predicate logic),
 - by a corresponding formal first-order language L , and a set P of finitary axioms/axiom schemas and rules of inference (e.g., the first-order Peano Arithmetic PA and its associated first-order logic FOL),
 - which assign unique provability values (provable/unprovable) to each well-formed proposition of the language L without contradiction;

- (2) The goal of constructive mathematics, post Brouwer and Tarski, which has so far been:
 - to assign unique, *intuitionistic*, truth values (true/false) to each well-formed proposition of the language L ,
 - under an *intuitionistically* constructive interpretation I over the domain D of the structure S (when viewed as a ‘conceptual metaphor’ in the terminology of [LR00]; see also §27.),
 - such that the *intuitionistically* true formulas of L are true under the interpretation.

In other words, whilst the focus of proof theory can be viewed as seeking to ensure that any mathematical language intended to represent our conceptual metaphors is unambiguous, and free from contradiction, the focus of constructive mathematics must be viewed as seeking to ensure that any such representation does, indeed, uniquely identify such metaphors.

Comment 124. The, seemingly unqualified, acceptance of *essentially* Platonic elements such as inaccessible cardinals in set theory can be viewed not only as a failure, but as a refusal to admit, the necessity of the above distinction. For instance Colin J. Rittberg notes that:

“Non-platonist conceptions of the metaphysics of set theory are dismissed by Woodin as basically untenable and are not discussed in this paper. See Woodin (2009a) for Woodin’s argument against non-platonism.”

... Rittberg: [Rit15], p.126.

The goals of the two activities ought to, thus, be viewed as necessarily complementing each other, rather than being independent of, or in conflict with, each other as to which is more ‘foundational’—as is implicitly argued, for instance, in the following remarks of constructivist Errett Bishop in [Bi66]³⁰⁸:

“The constructive point of view is that all mathematics should have numerical meaning. In other words, every mathematical theorem should admit an ultimate interpretation to the effect that certain finite computations within the set of positive integers will give certain results. In contrast, classical (that is, contemporary) mathematics is idealistic: there is no requirement that theorems and their proofs have a numerical meaning, or any predicative content whatever. For instance, the theorem that the real numbers can be well-ordered is evocative (or idealistic), rather than descriptive (or constructive). So is the theorem that a bounded monotone sequence of real numbers converges.

Brouwer has shown that the idealizations involved in classical mathematics, can, in most instances, be traced to the use of a certain logical principle—the principle of the excluded middle. It is perhaps more natural to trace them to a closely related principle—the principle of omniscience—which states that an arbitrary set A either has an element with a given property P or it does not. In case A is an infinite set this principle is not constructively valid, because the examination of each element of A to see whether one of them has property P is not something that can necessarily be done by a finite, routine process.

The constructivist replaces such transcendent logical principles as the principle of omniscience by common sense. The common sense, or operational, meanings of the standard mathematical quantifiers and connectives have been established by Brouwer. Brouwer undertook to develop mathematics along constructive lines. His development, which was not systematic, was impeded by a revolutionary, semi-mystical theory of the continuum. This theory, which in retrospect seems so unnecessary, was repellant to most mathematicians.

In addition to Brouwer, others have espoused more or less constructive points of view, usually less. There are the formalizers of constructivity, whose formal systems have little relevance to the constructivization of existing mathematics; the recursive-function theorists, who base constructivitan ad hoc assumption which is more of an impediment than a tool; Hilbert, who believed the price of a constructive mathematics was too great; and various other groups, none of which is content to let constructive mathematics follow its natural course of development. This paper describes an attempt to redevelop abstract analysis along straightforward constructive lines, rather than forcing it to support a burden of philosophical preconceptions.”

... Bishop: [Bi66], pp.308-309.

and of Gila Sher in [Shr18](as also by Penelope Maddy’s perspective in [Ma18], [Ma18a]):

“Philosophers are divided on whether the proof-theoretic or truth-theoretic approach to logic is more fruitful. The proof-theoretic approach has its roots in Gentzen (1934-35) and Prawitz

³⁰⁸We note that Bishop erroneously treats the Law of the Excluded Middle LEM—ergo the classical first-order logic FOL in which LEM is a theorem—as ‘nonconstructive’. Erroneously, since the finitary consistency of PA (see §2.C.a., Theorem 2.16) entails the finitary consistency of FOL.

(1965). The truth-theoretic or semantic approach has its roots in Tarski (1936). More recently, the proof-theoretic approach has begun to encroach on semantics itself, with Dummett (1991), Brandom (2000), and others advocating proof-theoretic or inferentialist semantics, which they contrast with truth-theoretic, and in particular truth-conditional, semantics. Thematically, proof-theoretic semantics is associated with verificationism, the meaning-as-use approach to language, assertibilism, anti-realism, anti-representationalism, pragmatist approach to truth, and/or epistemic approach to logic. Truth-theoretic semantics is often associated with a truth-conditional theory of meaning, representational approach to mind and language, realism, correspondence truth, and/or metaphysics. Although the debate on the preferable approach to semantics goes beyond logic, it is often focused on logic, logical constants, logical inference, etc.

...

The high explanatory power of the truth-theoretic approach does not rule out an equal or even higher explanatory power of the proof-theoretic approach. But to the extent that the truth-theoretic approach is shown to be highly explanatory, it sets a standard for other approaches to logic, including the proof-theoretic approach."

... Sher: [Shr18].

13.E.a. Reductionism in mathematics

In a broad-ranging analysis of the issue, Solomon Feferman questions the rationale for even seeking 'to reduce all of mathematics to one supposedly "universal" system or foundational scheme', vis à vis reductive proof theory that merely 'pursues local reductions of one formal system to another which', Feferman remarks, 'is more justified in some sense':

"In this direction, two specific rationales have been proposed as aims for reductive proof theory, the constructive consistency-proof rationale and the foundational reduction rationale. However, recent advances in proof theory force one to consider the viability of these rationales. Despite the genuine problems of foundational significance raised by that work, the paper concludes with a defense of reductive proof theory at a minimum as one of the principal means to lay out *what rests on what* in mathematics. In an extensive appendix to the paper, various reduction relations between systems are explained and compared, and arguments against proof-theoretic reduction as a "good" reducibility relation are taken up and rebutted."

... Feferman: [Fe00], Abstract.

To illustrate his, seemingly anti-foundational—i.e., anti one-solution-for-all—thesis, Feferman distinguishes between the aims of reductionism in the natural sciences and in mathematics:

"The purposes of reduction in the natural sciences and in mathematics are quite different. In the natural sciences, one main purpose is to *explain* certain phenomena in terms of more basic phenomena, such as the nature of the chemical bond in terms of quantum mechanics, and of macroscopic genetics in terms of molecular biology. In mathematics, the main purpose is *foundational*. This is not to be understood univocally; as I have argued in (Feferman 1984), there are a number of foundational ways that are pursued in practice. One such way is organizational; in that enterprise, reduction in the number of basic concepts and principles is valued, as is ease and naturalness of development. The purpose of other foundational ways is to deal with problematic concepts or principles by special kinds of reduction, such as (historically) the reduction of the complex numbers to the real numbers, or the reduction of the use of infinitesimals to the systematic use of limits. More recent examples from logic are the reduction of set theory with the axiom of choice to that without, or the reduction of classical arithmetic to intuitionistic arithmetic (insofar as the law of excluded middle is problematic for the constructivist). Foundational concerns are of course also important in the natural sciences, such as that of providing a philosophically satisfactory and physically adequate foundation for quantum mechanics; but one does not necessarily think of this as a reductive project. And, explanation is ubiquitous in mathematics, such as in the use of Galois theory to explain the unsolvability of the quintic, or of combinatorial topology to explain the Descartes-Euler formula for polyhedra; again, these are not usually thought of reductively.

Another contrast to be made is that between piecemeal or *local* projects of reduction in both the natural sciences and mathematics, and *global reductionist* programs in both. In the natural sciences, the philosophy of reductionism calls for a level-by-level theoretical of the hierarchy of sciences to a basic material monism. This is envisioned, for example, by Openheim and Putnam (1958) as proceeding from social groups on down through multi-cellular organisms, living cells, molecules and atoms, all the way to elementary particles. (Nowadays, that is to be capped by the physicists' holy grail of the GUT, the "Grand Unified Theory", which is then to be the TOE, the "Theory of Everything".) I am personally very skeptical of this kind of reductionist program in science, for reasons that I have not tried to articulate, at least not in writing (and won't try to here).¹

Global reductionist programs in the foundations of mathematics share the monistic view with the scientific reductionism, but there is no real analogy with the hierarchical account. The most prominent examples to consider are the logicist program, set-theoretical foundations, functional foundations², categorical foundations and—in a sense—Hilbert's program (in its original conception). There are well-known problems with each of these that I shall not repeat here, though advocates of one or another of these programs persist in pushing them. My own view is again skeptical, and leads me to pursue local projects of reduction instead. But I would hope that even those who don't share my general skepticism as to global reductionist programs see the interest of such local projects as an illumination of what rests on what in mathematics. To the extent that various parts of mathematics are represented by formal systems, that comes down to considering relations of reduction between such systems."

... Feferman: [Fe00], §1, *Reduction and reductionism in the natural sciences and in mathematics.*

From the *evidence-based* perspective of the Complementarity Thesis (see §1., Thesis 1) of this investigation, what Feferman refers to as 'natural science' could be viewed essentially as interpretations—of formal mathematical theories of natural phenomena—where the theorems interpret as *evidence-based* truths that we, by convention, refer to as 'scientific knowledge' that corresponds to 'factually grounded beliefs' in the sense of Piccinini [Pic19] (see §5.A.).

Reduction in the interpreted theories of natural sciences would, then, consist of identifying, within a putative global reductionist program in the formal theories of mathematics, those formal propositions that would interpret as *evidence-based* truths in the above sense.

Feferman raises serious doubts concerning the possibility of identifying such a global reductionism; essentially since any such formal mathematical theory that admits interpretations which have an 'explanatory' element that, in human cognition, transcends our direct perceptions of natural phenomena, would necessarily need to accommodate the transfinite elements of set theory that can have no *evidence-based* interpretations in our perceptions of natural phenomena; and would not therefore constitute scientific 'knowledge' in Piccinini's sense (see [Pic19]):

"Hilbert's program was motivated by the view that the "actual infinite" in mathematics is problematic, leading in some cases to contradictions. The program aimed to justify various parts of mathematics that make implicit or explicit use of principles based on the actual infinite, by representing them in formal systems which would be shown to be consistent by purely finitistic arguments. Patently, the use of set theory and even of impredicative principles (such as that of the least upper bound) in analysis would require such justification on this view. But, according to Hilbert, already arithmetic (as represented in the system PA) makes use of the actual infinite in its application of classical logic to statements involving quantification over the natural numbers. That is already seen in the assumption of the law of excluded middle for statements of the form $\forall xR(x)$ with R quantifier-free; such cannot in general be decided in a finite number of steps—one must "run through" the totality of natural numbers to determine their truth or falsity. The Hilbert school did not delimit finitist proofs by defining finitist methods in terms of a formal system. In practice, at least in the early stages, it did not go beyond PRA, and that has been argued by (Tait 1981) to be the upper limit of finitism, a thesis which is largely accepted these days. In

any case, whatever formal system S_0 would be determined to represent finitism, Gödel's second incompleteness theorem showed that one would not be able establish the consistency of systems stronger than S_0 by the means available in S_0 . In other words, to continue the consistency program, the idea of a privileged basis for that kind of justification for all of mathematics would have to be abandoned, and would have to be replaced by a shifting basis on some other sort of constructive principles."

... Feferman: [Fe00], §4, *The constructive consistency-proof rationale for reductive proof theory*.

Now we note, first, that Feferman's implicit reservations concerning a finitary justification:

- for the 'application of classical logic to statements involving quantification over the natural numbers'; and
- for the classical Law of the Excluded Middle

are belied (see §2.D., Poincaré-Hilbert debate, and §8.D., Theorem 8.13/Corollary 8.14, respectively) by the *evidence-based* perspective of this investigation, which admits a *finitary* proof of *strong* consistency for PA (see §2.C.a., Theorem 2.16) based on distinguishing in arithmetic between:

- *classical* algorithmic *verifiability* (see §2., Definition 7); and
- *finitary* algorithmic *computability* (see §2., Definition 10).

However, we also note further that, from such a perspective, Feferman's reservations about the possibility of identifying a global reductionism for mathematics are justified since:

- whilst a case could conceivably be made for the applicability of Gödel's incompleteness theorems to set theory (see §15.C., Query 14 and Lemma 15.1),
- the Provability Theorem for PA (see §2.E.b., Theorem 2.17) entails that PA is categorical (see §2.E.b., Corollary 2.18),
- whence there are no formally undecidable arithmetical propositions (see also §2.F., Lemma 2.19 and Corollary 2.20);

and, moreover, since we can show that:

- *transfinite* reasoning entails that a Goodstein sequence over the finite ZF ordinals must terminate finitely *within* ZF,
 - *even if* the corresponding Goodstein sequence over the PA numerals did not terminate finitely *within* PA (see §19., Theorem 19.1 and Corollary 19.2).

In other words, Feferman's reservations can be seen to intuit the *evidence-based* conclusions of this investigation that:

- PA admits only *finitary* reasoning, and thus has a *finitary* model in which the *evidence-based* truths of the natural sciences can be interpreted categorically;
- ZF admits *transfinite* reasoning, and thus has no *finitary* model in which the *evidence-based* truths of the natural sciences can be interpreted categorically.

That, in the absence of reasoning which admits *evidence-based* quantification (see §7.C.), the distinction between finite and transfinite reasoning remains blurred can be seen in Feferman's analysis of Gentzen's reasoning:

"In Gerhard Gentzen's groundbreaking 1936 article "Die Widerspruchsfreiheit der reine Zahlentheorie" (referred to here through its English translation in Gentzen 1969, pp. 132-201), it was shown how, in the case of arithmetic, the consistency program might be extended while hewing to finitist principles as closely as possible. Gentzen's paper contains several sections discussing the aims and significance of his consistency proof—besides its extensive technical work whose general character was indicated in sec. 3 above. Under the heading, "How are consistency proofs possible?", Gentzen says: "There can be no 'absolute consistency proof'. A consistency proof can merely *reduce* the correctness of certain forms of inference to the correctness of other forms of inference. . . . in a consistency proof we can use only forms of inference that count as considerably *more secure* than the forms of inference of the theory whose consistency is to be proved." (op. cit., p. 138) Gentzen then goes on to say that because of Gödel's incompleteness theorem, it is not possible to establish the consistency of arithmetic using a part or all of the methods used in that system, but: "[it] remains quite conceivable that the consistency of elementary number theory can in fact be verified by means of techniques which, in part, no longer belong to elementary number theory, but which can nevertheless be considered to be *more reliable* than the doubtful components of elementary number theory itself." (op. cit., p. 139) He later argues (op. cit., pp. 193ff) that his entire proof is finitistic except possibly for the application of transfinite induction up to ε_0 , and that inspection of the argument for that principle shows it to be "*indisputable*", in contrast to the "transfinite" principles of the formal system of number theory."

... Feferman: [Fe00], §4, The constructive consistency-proof rationale for reductive proof theory.

However if, from the *evidence-based* perspective of this investigation, we identify 'constructive' with 'well-defined' (see §7.F., Definition 26), then we can distinctly distinguish between:

1. Gentzen's *transfinite* proof of the consistency of the arithmetic of the finite ordinals *relative* to reasoning, *within* ZF, that appeals to set-theoretical properties of transfinite ordinals which, by definition, are *non-constructive* since they can have no *well-defined* interpretations under which they can, even in some extended sense of 'number', be identified as algorithmically *verifiable* (see §2., Definition 7);
2. the *weak* proof of consistency of PA (see §2.B.a., Theorem 2.8) *relative* to the *evidence-based*, algorithmically *verifiable* and unarguably *constructive*, *number-theoretic* interpretation of PA (see §2.B., Theorem 2.7);
3. the *strong* proof of consistency of PA (see §2.C.a., Theorem 2.16) *relative* to the *evidence-based*, algorithmically *computable* and unarguably *finitary*, *number-theoretic* interpretation of PA (see §2.C., Theorem 2.15).

Although (3) establishes the *finitary* consistency of the first-order Peano Arithmetic PA as implicitly sought by Hilbert in [Hi00], whilst (2) establishes the *constructive* nature of the classical, standard interpretation of PA, (1) leaves open the question of the *finitary* consistency of a second-order Peano Arithmetic, such as ACA_0 (see §19.A.), that would yield a *constructive* model for the properties of the real numbers in any putative model of ACA_0 .

Prima facie, the utility of any such model would still be questionable since, as shown in §20.C., Cases 20.C.a. to 20.C.d. and §20.D., Case 20.D.c., the limit of a Cauchy sequence of real numbers in any set-theoretical representation of the states of a physical phenomena does not entail that the limiting state of the phenomena must correspond to the Cauchy limit of the sequence.

Moreover, from the *evidence-based* perspective of this investigation, every real is specifiable in PA (see §7.1, Theorem 7.5), since it can be uniquely corresponded to a Gödel- β -function.

This suggests that it may be the failure to adequately recognise that ‘provability’ and ‘truth’ need to be complementary, ‘*evidence-based*’, assignments-by-convention towards achieving the correspondingly complementary roles, and goals (see §13.E.(1) and §13.E.(2)), of a first-order set theory such as ZF vis à vis a first-order Peano arithmetic such as PA that, according to Feferman, obscures the role of ‘consistency’ in ‘finitism’ and vice versa:

“In the further pursuit of the consistency program for analysis and various of its subsystems, Schütte and Takeuti provided similar rationales for their work. Schütte’s explanation of the rationale for his proof-theoretic work is that “Gödel’s investigations (1931) have shown that the strictest finitist methods are basically inadequate for carrying out the consistency proof required by Hilbert’s programme. So proof theory needs not only the very strict finitist methods of a combinatorial nature but also higher level proof procedures. Thus we arrive at methods, first used by Gentzen (1936), using induction which in fact goes beyond the usual complete (mathematical) induction but still has a constructive character . . . We use inductive methods for the consistency proofs but do not admit *Tertium non datur* as a proof procedure.” (Schütte 1977, p. 3) The consistency-proof rationale was explained as follows by Takeuti (1987), p. 101: “We believe that our standpoint is a natural extension of Hilbert’s finitist standpoint, similar to that introduced by Gentzen, and so we call it the Hilbert-Gentzen finitist standpoint. Now a Gentzen-style consistency proof is carried out as follows: (1) Construct a suitable standard ordering, in the strictly finitist standpoint. (2) Convince oneself, in the Hilbert-Gentzen standpoint, that it is indeed a well-ordering. (3) Otherwise use only strict finitist means in the consistency proof.” Takeuti then goes on (*loc. cit.*) to explain what is supposed to be admitted under (2): these are “concrete” constructive methods, in contrast to those admitted to intuitionism, which calls on abstract notions of proof and construction.

In summary, the Gentzen-Schütte-Takeuti modified form of the consistency program, that I shall call the *extended Gentzen program*, comes down to carrying out the following three things:

1. Describe *finitistically* the ordering relation of a notation system for ordinals up to an ordinal α_s .
2. Give a *finitist* proof that the principle of transfinite induction up to α_s , $\text{TI}(\alpha_s)$, implies the consistency, Cons_S , of S.
3. Give a *constructive proof* of (the instances used in (2) of) $\text{TI}(\alpha_s)$.

The first obvious criticism to be made of the extended Gentzen program is that the notions of finitist and constructive proof required for it are vague. In particular, there are many varieties of constructivism, which on the one hand do not always square with each other, and on the other hand are not simply characterized by saying that one uses only inductive methods without the law of excluded middle. However, I think we can be charitable to an extent here, for two reasons. First of all, one can inspect specific executions of the program and, for the most part, see that the arguments employed in (1) and (2) are *prima-facie* finitist, while those employed in (3) are *prima-facie* constructive. Secondly, we now have a great deal of knowledge of formal systems which explicate finitism and constructivism in their various forms, with respect to which we can locate more precisely what a given execution of the program succeeds in doing. Still, one can anticipate that questions will have to be raised in borderline cases, as we shall see in sec. 6.

A second obvious criticism is that there is no reason given for the asymmetry of methods in (1), (2) as against those in (3). If one is to admit constructive proofs in (3), why not allow constructive definitions and proofs in (1) and (2), not just those that are finitist? And, if one takes that step, why not consider quite different constructive foundations, such as the simple reduction of classical to intuitionistic arithmetic (i.e., PA to HA) by the Gödel translation? (Interestingly, Gentzen describes the translation (1969, pp. 169-170), but doesn’t make an argument why that is insufficient for his aims.)”

... Feferman: [Fe00], §4, *The constructive consistency-proof rationale for reductive proof theory.*

Feferman notes further—apropos his criticism of the extended Gentzen program, that it perceives ‘the criterion of consistency itself as its be-all and end-all’—that (echoing essentially the *raison d’être* of the Complementarity Thesis 1 in §1. if we replace ‘consistency’ in Feferman’s analysis by ‘ ω -consistency’³⁰⁹) it was ‘Brouwer who first objected that consistency is insufficient to guarantee “correctness” in some intuitive interpretation’; a criticism, according to Feferman, that was most endorsed later by Kreisel who—also echoing the *raison d’être* of the Complementarity Thesis 1 in §1. if we, additionally, take Kreisel’s ‘functional interpretation’ to mean ‘*evidence-based* interpretation (see §2.)—sought to provide ‘general formal criteria such as functional interpretations to replace the incomparable condition of consistency’:

“But the main point of criticism of the extended Gentzen program, as of the Hilbert program which it modifies, is the criterion of consistency itself as its be-all and end-all. This had its origin in Hilbert’s early identification⁶ of the “existence” of mathematical concepts with the consistency and completeness of axiom systems for them. Later, in the mature formulation of his program, Hilbert only emphasized the consistency criterion in service of an instrumentalist justification of formal systems, though he still presumed that completeness would also be established in the cases of interest. The idea was to eliminate the “ideal” statements of a system in favour of the “real” statements, which we can identify with Π_1^0 formulas (treated as open statements). Indeed, for systems S containing a modicum of arithmetic, if S is consistent, then every Π_1^0 statement provable in S is valid. It was Brouwer who first objected that consistency is insufficient to guarantee “correctness” in some intuitive interpretation. Then Gödel’s incompleteness theorems bore out this criticism with the construction of a consistent system extending PA which is not valid in the natural numbers (namely $PA + \neg Con_{PA}$).

The most vocal critic of the consistency criterion (in numerous essays) has been Georg Kreisel, saying for example in a late survey of his own work that “I was repelled by Hilbert’s exaggerated claim for consistency as a sufficient condition for mathematical validity or some kind of existence” (Kreisel 1987, p. 395). Kreisel aimed instead to use proof theory to make “explicit the additional knowledge provided by those proofs.” (loc. cit.) More explicitly, he sought to “unwind” mathematical proofs on the one hand and to provide “general formal criteria such as functional interpretations to replace the incomparable condition of consistency; ‘incomparable’ because the aim of functional interpretations is meaningful without restriction on metamathematical methods.” (loc. cit.)⁷

... Feferman: [Fe00], §4, *The constructive consistency-proof rationale for reductive proof theory*.

We note that Feferman’s observation that:

“... Gödel’s incompleteness theorems bore out this criticism with the construction of a consistent system extending PA which is not valid in the natural numbers (namely $PA + \neg Con_{PA}$)”

is falsified by the Provability Theorem for PA (see §2.E.b., Theorem 2.17), which entails that PA is categorical (see §2.E.b., Corollary 2.18).

More significantly, it is a telling instance of the failure to adequately recognise the distinctly different (see §15.C., Lemma 15.1), albeit complementary, roles and goals (see §13.E.(1) and §13.E.(2)) of a first-order set theory such as ZF, vis à vis a first-order Peano arithmetic such as PA since, paraphrasing Feferman, what we *can* conclude instead in the above quote is that (see §15.C.(a) and §15.C.(b)):

- ‘Gödel’s incompleteness theorems bore out this criticism with the construction of a consistent system extending ZF which is not valid over the ordinals (namely $ZF + \neg Con_{ZF}$)’.

³⁰⁹Since, by definition, a consistent system has a *well-defined* (see §7.F., Definition 26)—which we treat as corresponding to Kreisel’s ‘functional’—interpretation within an *evidence-based* paradigm.

It is a similar failure to adequately recognise the distinctly different, albeit complementary, roles and goals of a second-order arithmetic such as PA_2 (or ACA_0), vis à vis a first-order Peano arithmetic such as PA, that misleads Feferman to treat, for instance, the consistency of ‘ $PA + \neg TP$, where TP is the Twin Prime conjecture’ as open to ‘genuine question’³¹⁰ as that of ‘ $PA_2 + \neg TP$ ’:

“Of course, consistency itself is meaningful without restriction on metamathematical methods, and one can point to systems of possible mathematical interest for which there may be genuine question as to their consistency, e.g. Quine’s system NF, or $PA + \neg TP$, where TP is the Twin Prime conjecture, or—more ambitiously— $PA_2 + \neg TP$, where PA_2 is full 2nd order arithmetic, or—still more ambitiously— $ZF + \neg TP$. (One may substitute for TP here any currently open problem in number theory, such as Goldbach’s Conjecture (GC) or the Riemann Hypothesis (RH), that is strongly suspected of being true but difficult to prove.⁸)”

... Feferman: [Fe00], §4, *The constructive consistency-proof rationale for reductive proof theory.*

A failure that, moreover, further misleads Feferman into overlooking Skolem’s caution (see §7.K.)—against drawing finitary conclusions from transfinite reasoning—and implicitly asserting (contrary to §15.C., Lemma 15.1; to §19., Corollary 19.2; and to §19.A., Corollary 19.3/Theorem 19.4) that PA can be ‘expanded through the notion of arbitrary subset of the natural numbers’ (see also [Fe97], p.18:):

“But what about the consistency of PA and PA_2 and ZF? The most advanced current work in proof theory that may contribute to the extended Gentzen program hardly reaches beyond the subsystem Π_2^1 -CA of $(\Pi_\infty^1$ -CA). I, for one, have absolutely no doubt that PA and even PA_2 are consistent, and no genuine doubt that ZF is consistent, and there seems to be hardly anyone who seriously entertains such doubts. Some may defend a belief in the consistency of these systems by simply pointing too the fact that no obvious inconsistencies are forthcoming in them, or that these systems have been used heavily for a long time without leading to an inconsistency. To an extent, those kinds of arguments apply to NF, which has been studied and worked on by a number of people. My own reason for believing in the consistency of these systems is quite different. Namely, in the case of PA, we have an absolutely clear intuitive model in the natural numbers, which in the case of PA_2 is expanded through the notion of arbitrary subset of the natural numbers. Finally, ZF has an intuitive model in the transfinite iteration of the power set operation taken cumulatively. This has nothing to do with a belief in a platonic reality whose members include the natural numbers and arbitrary sets of natural numbers, and so on. On the contrary, I disbelieve in such entities. But I have as good a conception of what arbitrary subsets of natural numbers are *supposed* to be like as I do of the basic notions of Euclidean geometry, where I am invited to conceive of points, lines and planes as being utterly fine, utterly straight, and utterly flat, resp. What is *not* evident on the latter conception without special work is the consistency of the system of Euclidean geometry with the parallel axiom replaced by its negation. Similarly, while the notion of arbitrary set and the cumulative hierarchy argues for believing straight off not only in the consistency of ZF but also of ZFC (= ZF + AC), much additional work had to be done to establish the consistency of $ZFC + \neg CH$ (namely Paul Cohen’s method of forcing). To return, for example, to NF, that has no intuitive model to support our direct belief in its consistency, and the problem of establishing such a result, it is to be established at all, will no doubt require special metamathematical work, for which restriction in advance to constructive methods would be irrelevant. But if, say, we find out that $ZFC \vdash Con_{NF}$ and we accept the consistency of ZF then we must accept the consistency of NF, since Con_{NF} is a Π_1^0 statement.”

... Feferman: [Fe00], §4, *The constructive consistency-proof rationale for reductive proof theory.*

We note that, from the *evidence-based* perspective of this investigation, Feferman’s implicit belief in:

³¹⁰Misleads’, since PA is *finitarily* consistent by §2.C.a., Theorem 2.16; and, by §22.D., Theorem 22.56, TP is provable.

- an ‘external’³¹¹ consistency of PA is justified by the *finitary* proof of consistency for PA (see §2.C.a., Theorem 2.16);
- the ‘internal’ consistency of systems such as ZF (or PA_2 , ACA_0) follows from Gödel’s set-theoretical proof of arithmetic undecidability in PM ([Go31], pp.7-9). This is, in effect³¹², a set-theoretical proof of arithmetic undecidability over the finite ordinals that is formally entailed by the axioms of a set-theory such as ZF (or PA_2 , ACA_0), since all the number-theoretic propositions that Gödel assumes as true in PM correspond to propositions over finite ordinals that are formally provable in ZF (or PA_2 , ACA_0); whence we can treat the system as ω -consistent and, therefore, as ‘internally’ consistent.

13.E.b. Cohen on Skolem and pessimism about proof in mathematics

In his penetrating analysis [Co05] of the limiting consequences of divorcing proof-theoretic considerations from model-theoretic considerations of formal mathematical languages, Paul J. Cohen raises several issues with a pessimism that the Complementarity Thesis 1 in §1. seeks to highlight, and show as unwarranted, in this *evidence-based* investigation into the role, goal, and *raison d’être*, of mathematical languages in philosophy and the natural sciences:

“Attitudes towards formalization and proof have gone through large swings during the last 150 years. We sketch the development from Frege’s first formalization, to the debates over intuitionism and other schools, through Hilbert’s program and the decisive blow of the Gödel Incompleteness Theorem. A critical role is played by the Skolem-Lowenheim Theorem, which showed that no first-order axiom system can characterize a unique infinite model. Skolem himself regarded this as a body blow to the belief that mathematics can be reliably founded only on formal axiomatic systems. In a remarkably prescient paper, he even sketches the possibility of interesting new models for set theory itself, something later realized by the method of forcing. This is in contrast to Hilbert’s belief that mathematics could resolve all its questions. We discuss the role of new axioms for set theory, questions in set theory itself, and their relevance for number theory. We then look in detail at what the methods of the predicate calculus, i.e. mathematical reasoning, really entail. The conclusion is that there is no reasonable basis for Hilbert’s assumption. The vast majority of questions even in elementary theory, of reasonable complexity, are beyond the reach of any such reasoning. Of course this cannot be proved and we present only plausibility arguments. The great success of mathematics comes from considering ‘natural problems’, those which are related to previous work and offer a good chance of being solved. The great glories of human reasoning, beginning with the Greek discovery of geometry, are in no way diminished by this pessimistic view.”

... Cohen: [Co05], Abstract.

From the *evidence-based* perspective of this investigation, Cohen presciently focuses upon what he considers ‘undoubtedly the most basic result about general axiomatic systems’, when he:

“... alludes to both the work of Thoralf Skolem, and, perhaps even more, to the conclusions he came to at a rather early stage of the development of mathematical logic. The work is, of course, the famous Lowenheim-Skolem Theorem, for which Skolem gave a simplified proof, and which is undoubtedly the most basic result about general axiomatic systems. It can be given various formulations, but the form which Skolem himself attributes to Lowenheim is that ‘every first order expression is either contradictory or satisfiable in a denumerably infinite domain’ (Skolem 1970). As Skolem showed, there is a natural extension to the case of countably many such expressions. ‘Contradictory’ here is defined by reference to the rules of the predicate calculus, i.e. normal

³¹¹‘External’ in the sense of appeal to a *well-defined* semantic interpretation.

³¹²However, see also the perspective in §15.C. *Can Gödel be held guilty of implicit obfuscation?*

mathematical reasoning. The startling conclusion that Skolem drew is the famous Skolem Paradox, that any of the usual axiom systems for set theory will have countable models, unless they are contradictory."

... Cohen: [Co05], Introduction.

Cohen's pessimism about the role of proof in mathematics—in resolving 'all but the tiniest fraction of possible mathematical questions'—is seemingly rooted in his interpretation of Skolem's 'startling' conclusion (see also §7.K.):

"Since I will not assume that my audience are all trained logicians, I point out that though the set of reals from the countable model is countable seen from outside, there is no function 'living in the model' which puts it one-to-one correspondence with the set of integers of the model. This fact and other considerations led Skolem to this viewpoint:

"I believed that it was so clear that axiomatization in terms of sets was not a satisfactory ultimate foundation of mathematics, that mathematics would, for the most part, not be very much concerned by it."

The view that I shall present differs somewhat from this, and is in a sense more radical, namely that it is unreasonable to expect that any reasoning of the type we call rigorous mathematics can hope to resolve all but the tiniest fraction of possible mathematical questions."

... Cohen: [Co05], Introduction.

However, Cohen's pessimism in this instance is misplaced since, from the *evidence-based* perspective of this investigation, the reals *can* be suitably defined in terms of algorithmically *verifiable* Gödel β -functions *within* the first-order Peano Arithmetic PA (see §7.I., Theorem 7.5) and, ipso facto, placed in 1-1 correspondence with the natural numbers (see §16.B., Theorem 16.3 and Corollary 16.4).

Cohen further refers to 'the Incompleteness Theorem of Gödel' as 'the first, and perhaps the only, proved statement supporting the basic pessimism of Skolem's viewpoint':

"Now, no discussion of proof can fail to refer to the Incompleteness Theorem of Gödel. The result states that no reasonable system of mathematics can prove its own consistency, where the latter is stated as a theorem about proofs in its own formal system, and hence can be construed as a result in combinatorics or number theory. The Incompleteness Theorem is a theorem of mathematics, and not a philosophical statement. Thus, in this sense, it is unassailable, but, in another sense, since it refers to such a specific question, it is not really relevant to the question which I am addressing in this talk, namely the extent to which problems in mathematics can reasonably be expected to be settled by mathematical reasoning. It is, of course, the first, and perhaps the only, proved statement supporting the basic pessimism of Skolem's viewpoint."

... Cohen: [Co05], Introduction.

Cohen's pessimism in this instance too is misplaced since, from the *evidence-based* perspective of this investigation, it is based on the common mis-perception (see §15.H.d.) that, reflecting Gödel's presumption in [Go31], " P is consistent" is always expressible in the formal Peano Arithmetic P defined by him in [Go31]. This, however, does not follow from Gödel's formal reasoning in [Go31] (see §15.H.f.).

Cohen observes that the earlier (beginning with the Greek mathematicians and philosophers), optimistically inspiring, stages of the development of formal proofs and the axiomatic method were motivated primarily (compare with the Complementarity Thesis 1 in §1.) by the need to precisely formulate intuitive concepts of mathematical truth and logical deduction; culminating in the 'Gödel Completeness Theorem, which many people regard as implicit in Skolem's work':

“With the publication of Frege’s epic work ‘Begriffsschrift’ in 1879, the notion of a formal system was given a definite form. Imported related work was done by Boole, and Pierce, and later Peano presented a similar approach, but with Frege’s work, for the first time in the history of human thought, the notion of logical deduction was given a completely precise formulation. Frege’s work not only included a description of the language (which we might nowadays call the ‘machine language’), but also a description of the rules for manipulating this language, which is nowadays known as the predicate calculus. . . .this was a major landmark. For the first time one could speak precisely about proofs and axiomatic systems. The work was largely duplicated by others, e.g. Russell and Whitehead, who gave their own formulations and notations, and even Hilbert made several attempts to reformulate the basic notions of a formal system. The variety of such attempts relates to the problem of clearly distinguishing between the axioms which are assumed as the starting point of the theory and the methods of deduction which are to be used. The Gödel Completeness Theorem, which many people regard as implicit in Skolem’s work, explicitly shows that there is no ambiguity in the rules of deduction. This is in marked contrast to the Incompleteness Theorem, which shows that no reasonable axiom system can be complete.”

... Cohen: [Co05], Introduction.

In other words, what are today referred to as ‘proof-theoretic’ considerations, and ‘model-theoretic’ considerations, were apparently treated as two sides of the same coin until the unsettling nature—and, largely, the commonly accepted, albeit misleading (see §15.A.), interpretations—of the entailments of Gödel’s Incompleteness Theorems for axiomatic systems.

These focused attention, almost entirely, on Hilbert’s (Program influenced) attempts to justify the axioms of formal systems without any reference to their intended interpretations (except, perhaps, as dispensable intuitive models to be used for conceptual guidance only).

Thus, Cohen remarks that:

“Alongside these developments, there raged a lively debate, continuing almost to the onset of World War 2, about the ultimate validity of mathematics. This debate saw the emergence of formalism, logicism and intuitionism as competitors for the correct foundation of mathematics. I will briefly discuss these competing philosophies, noting at the outset that each seems to focus on proofs rather than models. In this respect Skolem’s ideas were in sharp contrast to those of most of his contemporaries. I believe that today the situation is rather the reverse, due in part to my own work, showing how many models of set theory can be constructed using the notion of forcing (Cohen 1966). Indeed, Skolem even foresaw, in his 1922 paper, the construction of new models of set theory, for there he states:

“It would in any case be of much greater interest if one could prove that a new subset of Z could be adjoined without giving rise to contradictions; but this would probably be very difficult.”

As I said, his interest in models was perhaps ahead of his time, so let me discuss now some of the common viewpoints on foundations.”

... Cohen: [Co05], Introduction.

However, it is debatable whether Skolem’s, seemingly finitary, perspective would have admitted a ‘model’ in the same—intuitively non-constructive and Hilbertian—sense as Cohen; since the model ‘forced’ by the latter in [Co66] admits Aristotle’s particularisation (see §7., Definition 20 and [Co66], p.4).

Moreover, by §8.D., Theorem 8.12, not only would Aristotle’s particularisation not hold in any *well-defined* interpretation of a formal system that claims to also model the PA numerals, but ‘forcibly’ admitting Aristotle’s particularisation in any putative model of the system would, in turn, ‘force’ the syntactic property of ω -consistency upon the system (see §8.D.); thereby making the interpretation proof-theoretic, rather than model-theoretic (in the sense of [Shr18]) as claimed by Cohen.

13.E.c. Cohen and The Axiom of Choice

The significance of this is seen in the accepted interpretation of Cohen's argument in his 1963-64 papers³¹³; the argument is accepted as definitively establishing that the Axiom of Choice is essentially independent of a set theory such as ZF.

Now, Cohen's argument—in common with the arguments of many important theorems in standard texts on the foundations of mathematics and logic—appeals to the *unspecified* object in Aristotle's particularisation under any putative interpretation of the existential axioms of ZF (or statements about ZF ordinals).

This is seen in his proof (see [Co66], p.19) and application of the—seemingly paradoxical (see Skolem's remarks [Sk22], p.295; also [Co66], p.19)—(downwards) Löwenheim-Skolem Theorem (see [Lo15], p.245, Theorem 6; [Sk22], p.293):

(Downwards) Löwenheim-Skolem Theorem: If a first-order proposition is satisfied in any domain at all, then it is already satisfied in a denumerably infinite domain.

Cohen appeals to this theorem for legitimising putative models of a language—such as the standard model 'M' of ZF (see [Co66], p.19 and p.82), and its forced derivative 'N' (see [Co66], p.121)—in his argument (see [Co66], p.83 and p.112-118).

Now, the significance of Hilbert's formalisation of Aristotle's particularisation by means of the ε -function (see §7.) is seen in Cohen's following remarks, where he explicitly appeals in the above argument to a semantic—rather than formal—definition of the *unspecified* object in Aristotle's particularisation:

"When we try to construct a model for a collection of sentences, each time we encounter a statement of the form $(\exists x)B(x)$ we must invent a symbol \bar{x} and adjoin the statement $B(\bar{x})$ when faced with $(\exists x)B(x)$, we should choose to have it false, unless we have already invented a symbol \bar{x} for which we have strong reason to insist that $B(\bar{x})$ be true."

[Co66], p.112; see also p.4.

From the *evidence-based* perspective of this investigation, it follows from the appeal to Aristotle's particularisation in Cohen's argument that:

Lemma 13.1. *The Axiom of Choice is false in N.*

13.E.d. No putative model of ZF can appeal to Aristotle's particularisation

We note, however, that (see §7., Definition 20) such an *unspecified* instantiation may sometimes be *unspecifiable*—in the sense of §10.C., Definition 8—within the parameters of the formal system ZF, thereby implicitly admitting non-standard elements—in any putative interpretation of ZF—that cannot be recursively defined as 'terms' within a first-order theory such as ZF.

In other words, since the ZF-formula $[(\exists x)B(x)]$ is only an abbreviation for the ZF-formula $[\neg(\forall x)\neg B(x)]$, we can only conclude from the ZF-provability of $[(\exists x)B(x)]$ that $[(\forall x)\neg B(x)]$ is not ZF-provable if ZF is consistent; and so $[\neg B(a)]$ is not provable for *any* well-defined term $[a]$ of ZF.

³¹³[Co63] and [Co64].

We cannot conclude that—if the formula $[B(x)]$ interprets as the relation $B^*(x)$ under a putative interpretation, say M , of ZF—the ZF-provability of $[(\exists x)B(x)]$ entails there is some element \bar{x} in the model M for which $B^*(\bar{x})$ holds in M ; and which is such that we can introduce a term $[a]$ into ZF by adding $[B(a)]$ as an additional axiom to ZF without inviting inconsistency, since such a term may not be recursively definable by the rules for formation of first-order terms within ZF.

Moreover, since Hilbert's ε -function (see §7.) formalises precisely Cohen's concept of ' \bar{x} '—more properly, ' \bar{x}_B '—as $[\varepsilon_x B(x)]$, it follows that:

Theorem 13.2. *Any model of ZF, in which the quantifiers are interpreted according to Aristotle's particularisation, is a model of ZF_ε if the expression $[\varepsilon_x B(x)]$ is interpreted to yield Cohen's symbol ' \bar{x}_B ' whenever $[B(\varepsilon_x(B(x)))]$ interprets as true in the model.*

Hence Cohen's argument is also applicable to ZF_ε . However since, by [Ca62] (see §8.F., Lemma 8.17), the Axiom of Choice is true in any putative interpretation of ZF_ε which appeals to Aristotle's particularisation, Cohen's argument (see [Co63] and [Co64]; [Co66])—when applied to ZF_ε —actually shows that:

Corollary 13.3. *ZF_ε has no model that admits Aristotle's particularisation.*

Corollary 13.4. *ZF has no model that admits Aristotle's particularisation.*

We cannot, therefore, conclude that the Axiom of Choice is essentially independent of the axioms of ZF, since none of the 'models forced' by Cohen (in his argument for such independence) can be treated as putative interpretation of ZF without inviting inconsistency.

13.E.e. Cohen and the Gödelian Argument

At the conclusion of his lectures on "Set Theory and the Continuum Hypothesis", delivered at Harvard University in the spring term of 1965, Cohen remarked:

"We close with the observation that the problem of CH is not one which can be avoided by not going up in type to sets of real numbers. A similar undecidable problem can be stated using only the real numbers. Namely, consider the statement that every real number is constructible by a countable ordinal. Instead of speaking of countable ordinals we can speak of suitable subsets of ω . The construction $\alpha \rightarrow F_\alpha$ for $\alpha \leq \alpha_0$, where α_0 is countable, can be completely described if one merely gives all pairs (α, β) such that $F_\alpha \in F_\beta$. This in turn can be coded as a real number if one enumerates the ordinals. In this way one only speaks about real numbers and yet has an undecidable statement in ZF. One cannot push this farther and express any of the set-theoretic questions that we have treated as statements about integers alone. Indeed one can postulate as a rather vague article of faith that any statement in arithmetic is decidable in "normal" set theory, i.e., by some recognizable axiom of infinity. This is of course the case with the undecidable statements of Gödel's theorem which are immediately decidable in higher systems."

... Cohen: [Co66], p.151.

Cohen appears to assert here that if ZF is consistent, then we can 'see' that the Continuum Hypothesis is subjectively true for the integers under some model of ZF, but—along with the Generalised Continuum Hypothesis—we cannot objectively 'assert' it to be true for the integers since it is not provable in ZF, and hence not true in all models of ZF.

However, by this argument, Gödel's undecidable arithmetical propositions, too, can be 'seen' to be subjectively true for the integers in the standard model of PA, but cannot be 'asserted'

to be true for the integers since the statements are not provable in an ω -consistent PA, and hence they are not true in all models of an ω -consistent PA!

The latter is, essentially, John Lucas' well-known Gödelian argument (see [Lu61]; also §21.A.), forcefully argued by Roger Penrose in his popular expositions, 'Shadows of the Mind' ([Pe94]) and 'The Emperor's New Mind' ([Pe90]).

The argument seems plausible, but is unsound (see [An07a]; [An07b]; [An07c]), since PA is ω -inconsistent (see §2.F., Corollary 2.22). It is based on a misinterpretation—of what Gödel actually proved formally in his 1931 paper—for which, moreover, neither Lucas nor Penrose ought to be taken to account (see [An07b]; [An07c]; also §15.D.).

The distinction sought to be drawn by Cohen is curious, since we have shown that his argument—which assumes that putative interpretations of ZF can appeal to Aristotle's particularisation—actually establishes that putative interpretations of ZF cannot appeal to Aristotle's particularisation (compare with §8.D., Theorem 8.12, that any *well-defined* interpretation of PA, too, cannot appeal to Aristotle's particularisation).

Loosely speaking, the cause of the putative undecidability of the Continuum Hypothesis—and of the Axiom of Choice—in ZF as shown by Cohen, and that of Gödel's (also Rosser's; see §17.) putative 'undecidable proposition' in Peano Arithmetic, is common; it is interpretation of the existential quantifier under an interpretation as Aristotelean particularisation.

In Cohen's case, such interpretation is made explicitly and unrestrictedly in the underlying predicate logic (see [Co66], p.4) of ZF, and in its interpretation in Aristotle's logic of predicates (see [Co66] p.112).

In Gödel's case it is made explicitly—but formally to avoid attracting intuitionistic objections—through his specification of what he believed to be a 'much weaker assumption' of ω -consistency for his formal system P of Peano Arithmetic (see [Go31], p.9 and pp.23-24).

The significance of Gödel's 'much weaker assumption' is seen in §8.D., Corollary 8.9; namely that, if the Peano Arithmetic PA admits a *well-defined* interpretation that appeals to Aristotle's particularisation, then the Arithmetic is ω -consistent.

13.F. Three categories of information

From a psychological perspective (see, for instance, [Ba16]), we would thus argue that, both qualitatively and quantitatively, any piece of information (i.e., the perceived content of a *well-defined* declarative sentence) that we treat as a 'fact'³¹⁴ is necessarily associated with a suitably *well-defined* truth assignment which must fall into one or more of the following three categories:

Comment 125. The implicit thesis here is that the universe is what it is; any piece of 'information' relating to it should, by definition, be our perception of some part of it. If so, such perceptions might be based on *primary* conceptual metaphors arising from an external reality, or on *secondary* conceptual metaphors arising from symbolic expressions in a symbolic language of our original, *primary*, conceptual metaphors. In either case, by definition, such a perception would reflect a physical state of an individual intelligence in the universe at some instant of time. Again by

³¹⁴In the sense of Piccinini [Pic19]; see §5.A.. For the purposes of this investigation, we ignore the nuances involved in such a concept as detailed, for instance, in [SP10].

definition, such a state would be a state of energy³¹⁵, irrespective of whether or not the perception itself is claimed to ‘exist’ only fleetingly in an unverifiable, Platonic, realm of abstract ideas of the individual intelligence. However, see also [Lon14] for a contrary perspective.

- (1) Information that we³¹⁶ zealotly *believe* to be ‘true’ in an, absolute, Platonic sense, and have in common with others holding similar *beliefs* zealotly;
- (2) Information that we prophetically *hold* to be ‘true’—short of Platonic *belief*—since it *can* be treated as *self-evident*, and have in common with others who also *hold* it as similarly *self-evident*³¹⁷;
- (3) Information that we scientifically *agree* to *define* as ‘true’ on the basis of an *evidence-based convention* (such as, for instance, suggested in §1., Thesis 1), and have in common with others who accept the same *convention* for assigning *truth* values to such assertions.

Clearly the three categories of information have associated truth assignments with increasing degrees of objective (*evidence-based*) accountability that must, in turn, influence the perspective—and understanding (in the cognitive sense of [LR00]; see also §27.)—of whoever is exposed to a particular category at a particular moment of time.

In mathematics, for instance, Platonists who hold even axioms which are not immediately self-evident as ‘true’ in some absolute sense—such as Gödel ([Go51]) and Saharon Shelah ([She91])—might be categorised as accepting all three of (1), (2) and (3) as definitive; those who hold axioms as reasonable hypotheses only if self-evident—such as Hilbert ([Hi27])³¹⁸—as holding only (2) and (3) as definitive; and those who hold axioms as necessarily *evidence-based* propositions—such as Brouwer ([Br13])—as accepting only (3) as definitive.

13.F.a. The value of contradiction

In the first case, it is obvious that contradictions between two intelligences which arise solely on the basis of conflicting beliefs—such as, for instance, the classical debate between ‘creationists’ and ‘evolutionists’³¹⁹ or, currently, that between proponents of the theory of ‘alternative facts’ and those of ‘scientific facts’³²⁰—cannot yield any productive insight on the nature of the contradiction.

Although not obvious, it is the second case §13.F.(2)—of contradictions between two intelligences that arise on the basis of conflicting ‘reasonability’—which yields the most productive insight on the nature of the contradiction; essentially *perceived* contradictions such as, for instance:

³¹⁵Contrary to Norbert Weiner’s reported perspective in [Lon14], p.3: “Information is information, not matter or energy . . .”.

³¹⁶Admittedly, though, it would be more realistic to read ‘we’ as ‘influential opinion leaders’, thereby implicitly subscribing to the point sought to be made by Melvyn B. Nathanson [Na08] in ‘Desperately Seeking Mathematical Truth’.

³¹⁷Compare with Chateaubriand: [Cha05], Chapter 25, *The Tyranny of Belief*, pp.351-359.

³¹⁸See also §31. for a remarkably candid confession by the author’s mentor, Professor M. S. Huzurbazar, as to why one might, on occasion, *choose* to believe an axiom to be self-evident even in the absence of a corresponding, self-evident, belief!

³¹⁹Typical of a phenomena whose topical dimensions are insightfully—and sensitively—addressed by Harvey Whitehouse for a lay audience—from the perspective of Cognition and Evolutionary Anthropology—in an interview in [Gal18].

³²⁰As addressed, for instance, by physicists Steven Vigdor and Tim Londergan in [VL17].

- (a) The *perceived* conflict detailed in §10. between Hilbert’s and Brouwer’s interpretation of quantification; or
- (b) The *perceived* conflict detailed in §2.D. between Hilbert and Poincaré on the finitary interpretability of the axiom schema of induction of the first-order Peano Arithmetic PA; or
- (c) The *perceived* conflict (see §23.) between Bohr and Einstein on whether the mathematical representation of some fundamental laws of nature can only be expressed in terms of functions that are essentially unpredictable, or whether all the laws of nature can be expressed in terms of functions that are essentially deterministic;

Comment 126. We note that, in their paper [FV22] addressing some—prima facie unfalsifiable and seemingly irreconcilable—interpretations of quantum mechanics that physical realists seek to treat as yielding explanatory ‘knowledge’ of the nature of quantum phenomena, James Duncan Fraser and Peter Vickers seem to *implicitly* concede in conclusion that—more than the ‘overlap strategy’ proffered by them as a resolution of conflicting perspectives—it may be the perceived contradictions between the interpretations (seemingly on the basis of conflicting ‘reasonability’; or complementarity as highlighted in §23.) which could be viewed as yielding the more productive insight to ‘an aspiring scientific realist about quantum theory of the kind of explanatory resources they need to make their epistemic position compelling’:

“... The overlap strategy can thus be understood as guiding the appropriate level of abstraction for our commitments to be epistemically secure. As we argued in section 3, the amount of abstraction required to reach interpretation-neutrality is not so dramatic that one is left making completely trivial claims. However, a question remains about the strength of the explanation of predictive success that might be salvaged in this way. Advocates of particular ontic interpretations will claim, with some plausibility, that their theories offer robust physical explanations of the efficacy of the Born rule while the explanation available to an overlap theorist is, at best, extremely thin.

A final question that remains for the programme sketched in this article then is whether it wins the battle but loses the war by depriving an aspiring scientific realist about quantum theory of the kind of explanatory resources they need to make their epistemic position compelling in the first place.”

... Fraser and Vickers: [FV22], §4.2, *Explanatory deficit?*

Reason: Such conflicts compel us to address the element of implicit subjectivity in the individual conceptual metaphors (see [LR00]; also §27.) underlying the contradictory perspectives that, then, motivates us to seek (3) for an appropriate resolution of the corresponding contradiction, as in the case of:

- (i) The argument in §11. that Hilbert’s and Brouwer’s interpretations of quantification are complementary and not contradictory; and
- (ii) The dissolving of the Hilbert-Poincaré debate by virtue of §2.B.a., Lemma 2.4 and §2.C.a., Lemma 2.12;
- (iii) The dissolving of the Bohr-Einstein debate by the argument in [An15] (see §23.B.b.) that any mathematical representation of a law of nature is necessarily expressed in terms of functions that are algorithmically *verifiable*—hence *deterministic*—but that such functions need not be algorithmically *computable*—and therefore *predictable*.

The third case §13.F.(3) is thus the holy grail of communication³²¹—one that admits unambiguous and effective communication without contradiction; and which is the focus of this investigation.

13.F.b. How does the human brain address contradictions?

We further note that whilst human intelligence (and, presumably, other organic intelligences) can accommodate algorithmically *computable* truths which do not admit contradiction, it can also accommodate algorithmically *verifiable*, but not algorithmically *computable*, truths that admit contradictory statements without inviting inconsistency *until* it can be factually determined (by events that lie outside the database of the reasoning at the moment) which of the two statements is to be treated as consistent with, and added to, the existing set of algorithmically *verifiable* truths, and which is not.

In other words, it follows from §7.G., Theorem 7.2, that we cannot conclude finitarily from Tarski's inductive definitions (as detailed in §2.A.a.) whether or not a quantified PA formula $[(\forall x_i)R]$ is algorithmically *verifiable* as true under the *weak*, classical, 'standard' interpretation $\mathcal{I}_{PA(\mathbb{N}, SV)}$ (as detailed in §2.B.) of the first-order Peano Arithmetic PA if $[R]$ is algorithmically *verifiable* but not algorithmically *computable* under interpretation.

The significance of this is reflected in the case of quantum phenomena whose values can be consistently viewed as representable mathematically only by functions that are algorithmically *verifiable*, but not algorithmically *computable*.

For instance (see §23.D.h.), concerning Erwin Schrödinger's famous poser in [Sc35] regarding the state of a putative cat in a closed system containing a potentially lethal radio-active element, the two contradictory statements: 'The cat is alive' and 'The cat is dead', are both consistent with any first-order formulation of the laws of quantum mechanics that admits a representation of the state of the cat at any moment before the system it seeks to represent is opened to examination. Thereafter, only one of the two statements can be assigned the truth value 'true'.

More than anything, this illustrates that all genuine contradictions—i.e., those which do not reflect contradictions in existing truth assignments—imply only a lack of sufficient knowledge (as argued by Einstein, Podolsky and Rosen in [EPR35]) within a system for assigning a truth assignment consistently.

Comment 127. For instance, the significance of the Complementarity Thesis (§1., Thesis 1) in helping the natural sciences distinguish between:

- (a) 'Proof' and *categorically communicable* 'Truth' (see §14.); and
- (b) *faith-based* 'Knowledge as Justified True Belief', and *categorically communicable* 'Knowledge as Factually Grounded Belief' (see §5.A.);

is that it admits a holistic, *evidence-based*, perspective for 'the proper epistemic status of our current best physical theories' which, in the absence of such an, *evidence-based*, perspective Jeffrey Alan Barrett finds as 'particularly puzzling' in his 2008 paper [Brr08].

'Particularly puzzling' perhaps since—seemingly following *misleading* inherited paradigms (as argued in §5.; see also §23.)—Barrett, implicitly and in good faith, articulates as self-evident his belief that insofar 'as the standard collapse formulation of quantum mechanics and special relativity are logically incompatible on a strict reading, the two theories taken together are false; and since we do not know how to account for determinate measurement records subject to relativistic constraints, we do not know how they miss descriptive truth':

³²¹Critically so in any search for an extra-terrestrial intelligence.

“It is customary to imagine that our best physical theories are true, probably true, or probably approximately true. This view of the proper cognitive status of our best physical theories is perhaps well-expressed by Isaac Newton in Rule IV of his *Rules for the Study of Natural Philosophy*:

In experimental philosophy, propositions gathered from phenomena by induction should be considered exactly or very nearly true not withstanding any contrary hypothesis, until yet other phenomena make such propositions either more exact or liable to exceptions. (Newton 1999, 796)

Newton allowed for the possibility that his mechanics might be made more accurate or liable to exceptions, but he did not believe that it was simply false. From our current epistemic perspective, whether Newtonian mechanics should be taken to be approximately true or radically false as a description of the physical world depends on what one cares about. In some ways, Newtonian mechanics might be understood to be a limiting case of our current best physical theories. On the other hand, Newton did not have the conceptual tools, involving such notions as *superposition* and *spacetime*, needed to express even the descriptive differences between his mechanics and our current best physical theories. While Newtonian mechanics approximates our best current physical theories in some ways, it is only from the perspective of subsequent theories that one can say concretely how Newtonian mechanics may err in hitting the mark of descriptive truth.

We find ourselves in an epistemic situation similar to Newton’s with respect to our current best physical theories in that that we do not yet have a perspective from which to explicate fully the senses in which they may hit and miss the mark of descriptive truth. Moreover, insofar as quantum mechanics and special relativity are foundational to our current best physical theories, the relativistic quantum measurement problem provides good reason, by virtue of the structure of the physical theories themselves, to suppose that our best physical theories are false. In this sense, the proper epistemic status of our current best physical theories is particularly puzzling.[1]

The relativistic version of the quantum measurement problem is that the standard von Neumann-Dirac collapse formulation of quantum mechanics seeks to explain why one should expect to get determinate physical measurement records in a way that is logically inconsistent on a strict, uncharitable reading and both incomplete and incompatible with the constraints of relativity on even the most charitable reading and that it is not at all clear how one might modify quantum mechanics, relativity, or both in order (i) to account for our having determinate physical measurement records and (ii) to satisfy the constraints of relativity. Insofar as the standard collapse formulation of quantum mechanics and special relativity are logically incompatible on a strict reading, the two theories taken together are false; and since we do not know how to account for determinate measurement records subject to relativistic constraints, we do not know how they miss descriptive truth.[2]"

... Barrett: [Brr08], §I. Description, Error, and Approximate Truth.

Moreover, we show in §23.D.c., Thesis 19 and §23.D.d., Thesis 20 how differentiating between:

- (a) algorithmically *verifiable* truth (as entailed by §2., Definition 7); and
- (b) algorithmically *computable* truth (as entailed by §2., Definition 10);

admits an, *evidence-based*, resolution of the apparent paradox between the mathematical representation of classical and quantum phenomena; perceived as seemingly *irreconcilable* by Barrett:

“While there are many proposals for resolving the relativistic quantum measurement problem, they differ in where they locate the descriptive failures of our current best physical theories, and hence differ in the senses in which they may allow for our current physical theories to be judged approximately true. As relatively simple but

representative examples, the GRW formulation of quantum mechanics suggests that the standard linear dynamics is only approximately true since it lacks a stochastic term that explains spontaneous collapses of the quantum-mechanical state, while Bohmian mechanics suggests that the standard collapse theory misses descriptive truth in allowing for collapses of the quantum-mechanical state at all; and each of these proposals would arguably require a significant change in our understanding of the descriptive content of special relativity in order for one to even suggest that they might somehow be understood as compatible with relativistic constraints.[3]

If quantum mechanics and relativity are almost certainly false taken together and if, since we do not know how to fix them, we do not know the sense in which they can be taken to be approximately true, then in what sense do our current best physical theories provide physical knowledge?"

... Barrett: [Brr08], §I. *Description, Error, and Approximate Truth.*

The question to be addressed therefore may be whether a brain (human or mechanical) does by design, and if so how and to what extent, naturally seek to test any new ‘truth’ assignment to an emerging belief (or observation) for consistency with its existing set of ‘truth’ assignments; and how any such activity is (or can be) weakened or strengthened by time and circumstance.

In other words, the challenge for the physical sciences may be to recognise—and accept from an algorithmically *verifiable* perspective—that, in some ‘emergent’ sense, “at each level of complexity entirely new properties appear”, as articulated by physicist Philip W. Anderson:

The reductionist hypothesis may still be a topic for controversy among philosophers, but among the great majority of active scientists I think it is accepted without question. The workings of our minds and bodies, and of all the animate and inanimate matter of which we have any detailed knowledge, are assumed to be controlled by the same set of fundamental laws, which except under certain extreme conditions we feel we know pretty well.

It seems inevitable to go on uncritically to what appears at first sight to be an obvious corollary of reductionism: that if everything obeys the same fundamental laws, then the only scientists who are studying anything really fundamental are those who are working on those laws. In practice, that amounts to some astrophysicists, some elementary particle physicists, some logicians and other mathematicians, and few others. This point of view, which it [is] the main purpose of this article to oppose, is expressed in a rather well-known passage by Weisskopf (1):

‘Looking at the development of science in the Twentieth Century one can distinguish two trends, which I will call “intensive” and “extensive” research, lacking a better terminology. In short: intensive research goes for the fundamental laws, extensive research goes for the explanation of phenomena in terms of known fundamental laws. As always, distinctions of this kind are not unambiguous, but they are clear in most cases. Solid state physics, plasma physics, and perhaps biology are extensive. High energy physics and a good part of nuclear physics are intensive. There is always much less intensive research going on than extensive. Once new fundamental laws are discovered, a large and ever increasing activity begins in order to apply the discoveries to hitherto unexplained phenomena. Thus, there are two dimensions to basic research. The frontier of science extends all along the a long line from the newest and most modern intensive research, over the extensive research recently spawned by by the intensive research of yesterday, to the broad and well developed web of extensive research activities based on intensive research of past decades.’

The effectiveness of this message may be indicated by the fact that I heard it quoted recently by a leader in the field of materials science, who urged the participants at a meeting dedicated to “fundamental problems in condensed physics” to accept that there were few or no such problems and that nothing was left but extensive science, which he seemed to equate with engineering.

The main fallacy in this kind of thinking is that the reductionist hypothesis does not by any means imply a "constructivist" one: The ability to reduce everything to simple fundamental laws does not imply the ability to start from those laws and reconstruct the universe. In fact, the more the elementary particle physicists tell us about the nature of the fundamental laws, the less relevance they seem to have to the very real problems of the rest of science, much less to those of society.

The constructionist hypothesis breaks down when confronted with the twin difficulties of scale and complexity. The behaviour of large and complex aggregates of elementary particles, it turns out, is not to be understood in terms of a simple extrapolation of the properties of a few particles. Instead, at each level of complexity entirely new properties appear, and the understanding of the new behaviours requires research which I think is as fundamental in its nature as any other. ... "

... Anderson: [And72].

13.F.c. The bias problem in science

Confronting such a challenge meaningfully, according to theoretical physicist Sabine Hossenfelder, requires first recognising the existence of, and then addressing and redressing, the problem of ingrained biases in scientific discourse:

"Probably the most prevalent brain bug in science is confirmation bias. If you search the literature for support for your argument, there it is. If you look for a mistake because your result didn't match your expectations, there it is. If you avoid the person asking nagging questions, there it is. Confirmation bias is also the reason we almost end up preaching to the choir when we lay out the benefits of basic research. You knew that without discovering fundamentally new laws of nature, innovation would eventually run dry, didn't you?

[...]

There's also the false consensus effect: we tend to overestimate how many other people agree with us and how much they do so. And one of the most problematic distortions in science is that we consider a fact to be more likely the more often we have heard of it; this is called attentional bias or the mere exposure effect. We pay more attention to information especially when it is repeated by others in our community. This communal reinforcement can turn scientific communities into echo chambers in which researchers repeat their arguments back to each other over and over again, constantly reassuring themselves they are doing the right thing.

Then there is the mother of biases, the blind spot—the insistence that we certainly are not biased. It's the reason my colleagues only laugh when I tell them biases are a problem, and why they dismiss my "social arguments," believing they are not relevant to scientific discourse. But the existence of these biases has been confirmed in countless studies. And there is no indication whatsoever that intelligence protects against them; research studies have found no links between cognitive ability and thinking biases.¹⁷

Of course, it's not only theoretical physicists who have cognitive biases. You can see these problems in all areas of science. We're not able to abandon research directions that turn out to be fruitless; we're bad at integrating new information; we don't criticize our colleagues' ideas because we are afraid of becoming "socially undesirable." We disregard ideas that are out of the mainstream because these come from people "not like us." We play along in a system that infringes on our intellectual independence because everybody does it. And we insist that our behavior is good scientific conduct, based purely on unbiased judgement, because we cannot possibly be influenced by social and psychological effects, no matter how well established.

We've always had cognitive and social biases, of course. They are the reason scientists today use institutionalized methods to enhance objectivity, including peer review, measures for statistical significance, and guidelines for good scientific conduct. And science has progressed just fine, so why should we start paying attention now? (By the way, that's called the status quo bias.)

Larger groups are less effective at sharing relevant information. Moreover, the more specialized a group is, the more likely its members are to hear only what supports their point of view. This is

why understanding knowledge transfer in scientific networks is so much more important today than it was a century ago, or even two decades ago. And objective argumentation becomes more relevant the more we rely on logical reasoning detached from experimental guidance."

... Hossenfelder: [Hos18a], pp.230-232.

As our analysis of the dogmas that, from the *evidence-based* perspective of this investigation, we have labelled as Hilbert's theism and Brouwer's atheism in §11. illustrates, such biases can, sometimes, act as invisible barriers to the broadening of a perspective as may be needed to accommodate embarrassing data or seemingly incontrovertible arguments.

For instance, the roots of *all* the ambiguities sought to be addressed in this investigation can be seen to lie in the unquestioned, and *untenable* (see §8.D., Corollary 8.12) assumption that Aristotle's particularisation is valid over infinite domains

Aristotle's particularisation is defined (§7., Definition 20) as the postulation that, in any formal language L which subsumes the first-order logic FOL, the L -formula $[\neg(\forall x)\neg F(x)]$ —also denoted by $[(\exists x)F(x)]$ —is provable in L can *unrestrictedly* be interpreted as the assertion 'There exists an *unspecified* object a such that $F'(a)$ is true under any well-defined interpretation I of L ', where $F'(x)$ is the interpretation of $[F(x)]$ under I .

Following Hilbert's formalisation of it in terms of his ε -operator in [Hi25], the assumption—as noted in §7.B.—has been subsequently sanctified by prevailing wisdom in published literature and textbooks at such an early stage of any classical mathematical curriculum, and planted as a bias so deeply into students' minds, that thereafter most cannot even detect its presence—let alone need for its justification—in a proof sequence!

Similarly Brouwer's rejection of the Law of the Excluded Middle LEM—and ipso facto of the first order logic FOL, of which it is a theorem—as non-constructive, in the mistaken belief that LEM entails Aristotle's particularisation, resulted in as enduring—and as untenable—a bias that has constrained the development of a more encompassing, *evidence-based*, development of finitary mathematics.

It would not be unreasonable to conclude that such sub-conscious assumptions, especially where provably invalid (see, for instance, §8.D., Corollary 8.12, and §8.D., Theorem 8.13), has continued for over ninety years to unconsciously dictate, mislead, and so limit the perspective of not only active, but also emerging, scientists of any ilk who have depended upon classical mathematics for providing a language of adequate representation and effective communication for their abstract concepts.

13.F.d. The Case for Professors of Stupidity

The pernicious influence of differing dogmas, which arise solely on the basis of conflicting faith-based beliefs³²², on the perspective—and understanding—of even seasoned scholars is anecdotally highlighted by Michèle Friend and Daniele Molinini:

"While the text we refer to for a traditional explanation is meant as a textbook for students, not for professional scientists in the field; their explanations end with physical observations and 'physical' constants (such as 'observation', 'particle', 'travel', and 'light'), not mathematical constants. And there is not much further explanation of these in the standard professional literature.

Our claim here is that when there is no further explanation we are left with the following reactions:

³²²The most striking, from the foundational perspective of this investigation, being the conflicting entailments of §7.B. *Faith-based quantification*, and those of §7.C. *Evidence-based quantification*; see also §11. *Three perspectives of logic*.

- (i) we give up further search since we cannot ‘understand’ (any better);
- (ii) we develop an ‘intuition’ which corresponds to the constants; or
- (iii) we seek further explanation in the form of concepts we already understand.

Many students and less formally educated people fall in to (i). Most professional physicists fall into (ii). The Andréka-Németi group fall into (iii). In the absence of *already* having the required intuitions, when we are confronted with these possibilities we experience what we shall call a ‘*malaise*’. It is this malaise which motivates the Andréka-Németi project.

Let us illustrate the *malaise* with a story told by Németi. In a class on relativity theory attended by Németi, the professor explained the twin paradox to the students. The students were puzzled, wondered at this ‘paradox’, and generally experienced a sense of *malaise*. This is all we mean by ‘*malaise*’ here. Németi then asked the professor for a better explanation. Instead of an explanation, he was told the following: continue with your courses on relativity theory. Write a Ph.D. thesis in relativity theory. Become a professor teaching relativity theory. Then if you are very fortunate, after a few years, you will understand the twin paradox.

We do not think that the story is unrepresentative of relativity theory (as it is usually presented and taught). We saw an example of a standard explanation for particles not travelling faster than light earlier. We interpret the story in the following way. The professor himself was unable to give a better explanation. But he had ‘gotten used to it’. He had followed (ii) in the above methodology which is standard in the practice of physics. Or, he observed in his colleagues that they had ‘gotten used to it’ and was waiting for the day when he would ‘get used to it’. ‘Getting used to’ something is a matter of time and exposure, and either is a type of explanation or *substitutes* for explanation!

Take the first disjunct. If intuition, or a sense of familiarity is a type of explanation, then with the intuition, the *explanation* has come to an end, maybe a temporary end. The twin paradox is after all called a ‘paradox’. It is supposed to be puzzling. It invites why questions. That is, it invites further explanation; so at best it is an incomplete explanation. It is interesting to observe that labelling it a ‘paradox’ seems to license an authority not to have a further explanation! This little story is about a *lack* of explanation in a perfectly robust scientific theory. So at least the Andréka-Németi explanation is more complete than the standard one, since it does not rely on physical intuitions, but rather, on logic and mathematics. Maybe these are intuitions too, but they are *arguably* more fundamental or more basic.

After all, where could we look for a better explanation than the one given in the story? Not to the laws of relativity theory, since they promptly lead us to the paradox, and leave some physical constants without further explanation, except implicitly through the other laws. Instead, we have to question the physical laws themselves, and ask for explanations of those. How can we do this? The answer turns on what we think is ‘more primitive’ or ‘more basic’ than a scientific law. The answer we (and many scientists) give is: mathematics and logic are more primitive. But ultimately, of course, this can be disputed. In this case we have a draw."

... Friend and Molinini: [FM15], pp.201-202.

The relevance, and increasing gravity, of this point—equally for the *evidence-based* challenge to the unverifiable assumption of Aristotle’s particularisation in conventional wisdom (see §7.A. and footnote 187), as for the current challenges faced globally by democratic institutions which are constitutionally rooted in consensus of the lowest common denominator—is dramatically illuminated³²³ by science editor Brian Gallagher in a commentary where, referring to Bertrand Russell’s *The Triumph of Stupidity*, and to one of Russell’s “most famous” quips that the “fundamental cause of the trouble is that in the modern world the stupid are cocksure while the intelligent are full of doubt”, he writes:

³²³If we read ‘stupidity’ as ‘stupid behaviour’, and ‘intelligence’ as ‘intelligent behaviour’!

“Russell’s quip prefigured the scientific discovery of a cognitive bias—the Dunning-Kruger effect—that has been so resonant that it has penetrated popular culture, inspiring, for example, an opera song (from Harvard’s annual Ig Nobel Award Ceremony): “Some people’s own incompetence somehow gives them a stupid sense that anything they do is first rate. They think it’s great.” No surprise, then, that psychologist Joyce Ehrlinger prefaced a 2008 paper she wrote with Dunning and Justin Kruger, among others, with Russell’s comment—the one he later made in his 1951 book, *New Hopes for a Changing World*: “One of the painful things about our time is that those who feel certainty are stupid, and those with any imagination and understanding are filled with doubt and indecision.” “By now,” Erlinger noted in that paper, “this phenomenon has been demonstrated even for everyday tasks, about which individuals have likely received substantial feedback regarding their level of knowledge and skill.” Humans have shown a tendency, in other words, to be a bit thick about even the most mundane things, like how well they drive.

Russell, who died in 1970 at 97 years of age, probably would not be surprised to hear news of this new study, published in *Nature Human Behaviour*: “Extreme opponents of genetically modified foods know the least but think they know the most.” The researchers, led by Philip Fernbach, cognitive scientist and co-author of *The Knowledge Illusion: Why We Never Think Alone*, analyzed survey responses from a nationally representative sample of U.S. adults. They obtained similar results, they write, “in a parallel study with representative samples from the United States, France and Germany, and in a study testing attitudes about a medical application of genetic engineering technology (gene therapy).”

Fernbach called their result “perverse.” It was nevertheless consistent with prior work exploring the Dunning-Kruger effect and the psychology of extremism, he said. “Extreme views often stem from people feeling they understand complex topics better than they do.” Now as ever, societies need to know how to combat this.

But what exactly is stupidity? David Krakauer, the President of the Santa Fe Institute, told interviewer Steve Paulson, for *Nautilus*, stupidity is not simply the opposite of intelligence. “Stupidity is using a rule where adding more data doesn’t improve your chances of getting [a problem] right,” Krakauer said. “In fact, it makes it more likely you’ll get it wrong.” Intelligence, on the other hand, is using a rule that allows you to solve complex problems with simple, elegant solutions. “Stupidity is a very interesting class of phenomena in human history, and it has to do with rule systems that have made it harder for us to arrive at the truth,” he said. “It’s an interesting fact that, whilst there are numerous individuals who study intelligence—there are whole departments that are interested in it—if you were to ask yourself what’s the greatest problem facing the world today, I would say it would be stupidity. So we should have professors of stupidity—it would just be embarrassing to be called the stupid professor.”

... Gallagher: *Nautilus*, 30 Jan 2019, <http://nautil.us//blog/the-case-for-professors-of-stupidity>.

13.G. An interpretation must be effectively decidable

We take Rotman’s semiotic perspective [Rot88] (see §13.) as echoing the essence of Wittgenstein’s remarks in [Wi78] (see §12.B.), if we view the latter as indicating that an effective interpretation $\mathcal{I}_{L(D)}$ of a language L into the domain D of another language L' with a *well-defined* logic is essentially the specification of an effective method by which any assertion of L is translated unambiguously into a unique assertion in L' .

Clearly, if an assertion is provable in L , then it should be effectively decidable as true under any *well-defined* interpretation of L in the domain D of L' —since a finite deduction sequence of L would, *prima facie*, translate as a finite logical consequence in D under the interpretation.

13.G.a. Is the converse necessarily true?

The question arises:

Query 12. *If an assertion of L is decidable as true/false under an interpretation $\mathcal{I}_{L(D)}$ in the domain D of L' , then does such decidability also ensure an effective method of deciding its corresponding provability/unprovability in L ?*

Obviously, such a question can only be addressed unambiguously if there is an effective method for determining whether an assertion of L is decidable as true/false in D under the interpretation $\mathcal{I}_{L(D)}$. If there is no such effective method, then we are faced with the following thesis that is implicit in, and central to, Wittgenstein's 'notorious' paragraph in [Wi78] (see §12.B.):

Thesis 7. *If there is no effective method for the unambiguous decidability of the assertions of a mathematical language L under any interpretation $\mathcal{I}_{L(D)}$ of L in the domain D of a language L' , then L can only be considered a mathematical language of subjective expression, but not a mathematical language of effective, and unambiguous, communication under interpretation in L' .*

What this means is that, in the absence of an effective method of decidability of the truth/falsity of the formulas of a mathematical language such as PA in the domain \mathbb{N} of the natural numbers under the standard interpretation $\mathcal{I}_{PA(\mathbb{N}, SV)}$ of PA, it is meaningless to ask whether, in general, a specific assertion of PA is decidable as true or not in \mathbb{N} under the interpretation $\mathcal{I}_{PA(\mathbb{N}, SV)}$ (the question of whether the assertion is decidable in PA as provable or not is, then, an issue of secondary consequence).

13.G.b. Tarskian truth under the standard interpretation $\mathcal{I}_{PA(\mathbb{N}, SV)}$ of PA

The philosophical dimensions of this thesis emerge if we consider the classical, *weak*, standard interpretation $\mathcal{I}_{PA(\mathbb{N}, SV)}$ of PA over the structure of the natural numbers where (cf. [Me64]):

- (a) The set of non-negative integers is the domain \mathbb{N} ;
- (b) The integer 0 is the interpretation of the symbol '0' of PA;
- (c) The successor operation (addition of 1) is the interpretation of the "'' function (i.e. of f_1^1 in [Me64]);
- (d) Ordinary addition and multiplication are the interpretations of '+' and '×';
- (e) The interpretation of the predicate letter '=' is the equality relation.

Now, post-Gödel, classical theory seems to hold that:

- (f) $\mathcal{I}_{PA(\mathbb{N}, SV)}$ is a *well-defined* interpretation of PA in \mathbb{N} ;
- (g) PA formulas are decidable under $\mathcal{I}_{PA(\mathbb{N}, SV)}$ in \mathbb{N} by Tarski's definitions of satisfiability and truth (cf. [Me64], p49-53);
- (h) The truth and satisfiability of a PA formula under $\mathcal{I}_{PA(\mathbb{N}, SV)}$ is not always effectively verifiable in \mathbb{N} ³²⁴.

³²⁴Expressed formally by Tarski's 1936 Theorem (cf. [Me64], Corollary 3.38, p151):

"The set Tr of Gödel-numbers of wfs of PA which are true in the standard model is not arithmetical, i.e. there is no wf $A(x)$ of PA such that Tr is the set of numbers k for which $A(x)$ is true in the standard model."

However, the question, implicit in Wittgenstein's argument regarding the possibility of a semantic ambiguity in Gödel's reasoning in [Go31], then arises³²⁵:

Query 13. *How can we assert that a PA formula (whether PA-provable or not) is true under the standard interpretation $\mathcal{I}_{PA(\mathbb{N}, SV)}$ of PA, so long as such truth remains effectively unverifiable under $\mathcal{I}_{PA(\mathbb{N}, SV)}$?*

Since the issue is not resolved unambiguously by Gödel in his 1931 paper (nor, *prima facie*, by subsequent standard interpretations of his formal reasoning and conclusions), Wittgenstein's 'notorious' remark in [Wi78] (see §12.B.) can be taken to argue that, although we may validly draw various conclusions from Gödel's formal reasoning and conclusions, the Platonic existence of a true or false assertion under the classical, *weak*, standard interpretation $\mathcal{I}_{PA(\mathbb{N}, SV)}$ of PA cannot (as we shall argue in §15.D.) be amongst them.

As analysed and clarified by Paul M. Livingston in [Liv10]:

"More generally, at the heart of Wittgenstein's critical remarks about Gödel's proof is his skepticism that there is such a well-defined notion of "mathematical truth" that can be held in common between a system such as *Principia Mathematica* and the English "translations" of various of its notions, and so can license the usual interpretation of Gödel's result as showing that there are "truths" that cannot be proven in *Principia* (or any given system). In particular, if, as Wittgenstein suggests, there is indeed no *neutral* sense of "truth" that can be used to characterize both sentences in *PM* and their English translations, then there is no reason to suspect that Gödel's proof indeed shows what it has most often been taken to, that there is a "truth" that cannot be proven or disproven by *PM*. What we have, instead, is simply a particular sentence in *PM*, one that formulates a "perfectly ordinary" and undistinguished arithmetical claim, one that bears literally no implications for the powers or structure of the system as a whole.

When Gödel's theorem and its broader philosophical implications are discussed, the usual framework of discussion is a *model-theoretic* conception of truth. That is, the truth of the Gödel sentence P is conceived as a matter of its holding for a (natural) model, where it is assumed furthermore that there is at least one model where all of the objects of which it holds are natural numbers. As we have just seen, even remaining within a model-theoretic conception of truth, this last assumption is disputable, and might indeed well be disputed if a proof of $\sim P$ were to be given. However, just as importantly, the model-theoretic conception of truth itself might be disputed. Wittgenstein himself never held such a conception, tending to suggest instead a disquotational or redundancy theory.¹⁵ On such a theory, as he suggests in the passage on Gödel's proof itself, there is no language- or system-independent notion of truth, and so there is no absolute sense to the claim that the Gödel sentence P expresses a "mathematical truth." Instead, as Wittgenstein suggests, the only available sense of "true" that is evidently applicable to the Gödel sentence, conceived as a sentence of *PM*, is the sense "proven in *PM*." Under the assumption that this is indeed the only relevant sense of "true," though, the Gödel sentence simply collapses to a version of the "Knower Paradox" (the sentence P that says: "P is known to be false") or the liar paradox: P iff it is not true that P .¹⁶ (Here, we are still maintaining that $Prov(x)$ can be interpreted as a "Proof predicate" (and accordingly, under these assumptions, as a truth or knowledge predicate).)¹⁷ This may again tend to suggest the inconsistency of *PM*, but crucially, it does not at all suggest that Gödel's proof bears witness to a substantial "truth" that is beyond the capacity of *PM* to prove."

... Livingston: [Liv10], p.41-42

Moreover, the persisting—and pervasive—influence of Gödel's various philosophical and meta-mathematical claims—widely debated on philosophical grounds and objected to, particularly, by Wittgenstein as incisively analysed and reviewed in [Liv10]—is reflected in Livingston's subsequent 'Realism and the Infinite' [Liv12].

³²⁵We note that [An16] essentially addresses, and answers Query 13

Illustrating Melvyn B. Nathanson’s thesis in [Na08] (as highlighted in §20.), Livingston seems—even 80 years after Gödel’s [Go31]—to implicitly rely upon, in good faith, the essential soundness of the meta-mathematical conclusions (primarily as detailed in §15.H.n.(i) and §15.H.n.(ii)) that Gödel draws from his own formal argumentation in [Go31]:

“The significance of the investigation of formal systems for research into the structure of mathematical cognition and reality lies in the possibility it presents of rigorously posing various general questions about the capacities of such systems to solve mathematical problems or prove mathematical truths; for instance, one can pose as rigorous questions i) the question whether such a system is capable of proving all arithmetic truths about whole numbers; and ii) whether such a system is capable of proving a statement of its own consistency. Notoriously, Gödel’s first and second incompleteness theorems, respectively, answer these two questions, for any consistent formal system capable of formulating the truths of arithmetic, in the negative: given any such system, it is possible to formulate an arithmetic sentence which can (intuitively) be seen to be true but cannot be proven by the system, and it is impossible for the system to prove a statement of its own consistency (unless it is in fact inconsistent).”

... Livingston: [Liv12], p.3.

We shall, however, seek to largely vindicate further Wittgenstein’s philosophical perspective—particularly as articulated in his ‘notorious’ paragraph (see §12.B.)—by arguing in Chapter 15.A. that, and why, the significance given in current paradigms to the various philosophical and meta-mathematical conclusions Gödel draws from his own formal reasoning in [Go31] ought not to be treated as definitive.

14. Conflating ‘Proof’ with ‘Truth’ and ‘For any’ with ‘For all’

In their article ‘Is English consequence compact?’, Alexander Paseau and Owen Griffiths consider the following set of English propositions as their argument \mathcal{A} ([PG21], p.190):

There is at least one planet.

There are at least two planets.

...

There are at least n planets.

...

There are infinitely many planets.

They subsequently argue that whilst \mathcal{A} —whose premises are tacitly assumed to be a *non-terminating* sequence (as indicated by ...)—is a valid argument, the conclusion (below the line) cannot follow from any *finite* set of the premises.

“Here ‘ n ’ ranges over English numerals: ‘one’, ‘two’, ‘three’, ..., ‘one million’, ‘one million and one’, and so on.⁶ Argument \mathcal{A} seems valid, and evidently no finite subset of its premise set entails its conclusion.”

... Paseau and Griffiths: [PG21], p.190.

They conclude that the concept of logical ‘consequence’ in the English language is not ‘compact’³²⁶; and further elucidate that:

Logic as we understand it aims to capture implicational facts. It is not a theory of what we understand when we grasp an argument’s validity (or invalidity), or how we come to appreciate such facts. Hence our preference for the term ‘implicational’ over ‘inferential’: we are interested in what follows from what rather than what can be deduced from what. Whether \mathcal{A} ’s premises entail its conclusion is not, in other words, an anthropocentric question; it is a question about statements and the relations between them. The finite description objection thus confuses an epistemological fact (about how we convince ourselves of \mathcal{A} ’s validity) with a logical one (about whether the relation of logical implication obtains between premises and conclusion).

... Paseau and Griffiths: [PG21], p.195

However we shall show *why*, from the *evidence-based* perspective of this investigation, the above arguments can be treated as invalidly conflating ‘Proof’ with ‘Truth’; and ‘For any’ with ‘For all’.

14.A. Conflating ‘Proof’ with ‘Truth’

From the *evidence-based* perspective argued of this investigation, it is precisely the conflation of ‘what follows from what’ and ‘what can be deduced from what’—which we consider as conflating ‘Proof’ and ‘Truth’—that can be prevented—at least in formal mathematical languages³²⁷—by adequately accommodating the Complementarity Thesis (Thesis 1) in current mathematical paradigms.

Further, as argued in §12., the epistemological perspective of the Complementarity Thesis is that logic, too, can be viewed as merely a methodological tool that seeks to formalise—by, for instance, Definition 1 and Definitions 32-33—an intuitive human ability that pertains not to the language which seeks to express such ability formally, but to the cognitive sciences in which its study is rooted.

The need for such definitions arises from the circumstance that current paradigms fail to offer any *evidence-based* methodology for unequivocally establishing the ‘validity’ of what is claimed as ‘logically proven’ in a language (in the sense of [PG21]).

Consequently, such paradigms fail to distinguish between³²⁸:

- (i) Languages of common discourse—such as English—whose propositions are not *well-defined* (in the sense of Definition 26). Such languages cannot, therefore, admit any *evidence-based* methodology for determining the ‘validity’ of what is claimed as ‘logically proven’ in the language (whence they must resort to community-appointed ‘courts’ of arbitration for determining ‘validity’);
- (ii) Formal languages with recursively *well-defined* formulas—such as the first-order Set Theory ZF or the second-order Arithmetic ACA_0 —that admit an axiom of infinity. Such

³²⁶“If Γ is any set of sentences of a logic, δ any sentence in its language, and \models is the logic’s consequence relation, we may characterise the logic’s compactness as follows:

If $\Gamma \models \delta$ then $\Gamma^{fin} \models \delta$ for some finite subset Γ^{fin} of Γ .” ...Paseau and Griffiths: [PG21], p.188

³²⁷Although, prima facie, the *evidence-based* perspective argued for in this investigation would, in principle, apply also to languages of common discourse—such as English—considered in [PG21].

³²⁸See also §13.E.: *Recognising the strengths and limitations of ZF and PA*.

languages cannot, therefore, even in principle admit any *evidence-based* methodology for determining the ‘validity’³²⁹ of what is claimed as ‘logically proven’ in the language;

- (iii) Formal languages with recursively *well-defined* formulas—such as the first-order Peano Arithmetic PA³³⁰—which are categorical (see §2.E., Corollary 2.18³³¹). Such languages *do* admit an *evidence-based* methodology for determining the ‘validity’ of what is claimed as ‘logically proven’ in the language.

Ergo, the issue seems to be not so much one of identifying a pre-existing common, non-compact, logic of consequence as argued in [PG21]. Rather, each language is free to determine any *well-defined logic* (in the sense of Definition 1) that categorically assigns the values of ‘axiom’ and ‘consequence’ to a *well-definable* subset of its propositions.

The problem seems to be that of identifying an *evidence-based* methodology that, in each case, interprets such ‘axioms’ and ‘consequences’ as ‘valid’—by consensus—within the community that seeks to use the language for the faithful expression, and categorical communication, of its *primary* and *secondary* conceptual metaphors³³².

Comment 128. In his musings [Grn22]—where he seeks to address the query ‘*Do Proofs Yield Objective Truth, Or Are They Culturally Robust At Best*’—Andrew Granville implicitly reflects—and highlights—the conflation, between ‘proof’ and ‘truth’, that yet remains unresolved—in a general mathematician’s perspective, when faced with the problem of identifying an evidence-based methodology that, in each case, interprets ‘axioms’ and ‘consequences’ as *valid* mathematical ‘truths’:

“To begin we discuss why proofs are desirable, what is the generally accepted approach to proof, and what aspects are theoretically problematic.

The purpose of proof. Aristotle wrote

If ... understanding is as we posited, it is necessary for demonstrative understanding ... to depend on things which are true and primitive and immediate and more familiar than and prior to and explanatory of the conclusion.

The modern perspective on this was beautifully expressed by Nathanson [31]:

We mathematicians have a naive belief in truth. We prove theorems. Theorems are deductions from axioms. Each line in a proof is a simple consequence of the previous lines of the proof, or of previously proved theorems.

Our conclusions are true, unconditionally and eternally.

That is, modern mathematicians dream that all theorems should be provable from appropriate axioms, and we just have to find the proofs. However, even back in the late 19th and early 20th century, it was found to be difficult to decide what precisely is meant by these statements."

... Granville: [Grn22], §1. Proof—why and how.

Comment 129. In his cogently argued, and insightful, 2008 paper [Kma08], philosopher Vojtěch Kolman, too, seemingly views as unresolved ‘the nature of the difference ... between the *proof* and *truth*’; as implicitly reflected by his rhetorical query ‘what is arithmetical truth outside of a specific axiomatic system?’, where he concludes that ‘It is exactly the lack of any explicit answer to this question that leads to the Platonist account of arithmetical truth’:

³²⁹In the sense of §1.J.: *Validating knowledge, truth, and proof in pre-formal mathematics*. See also §1.L.: *What mathematics is, and what it is not*.

³³⁰Or the various computer languages based on Church’s λ -calculus.

³³¹See also [An16], Corollary 7.2: *PA is categorical with respect to algorithmic computability*.

³³²In the sense of George Lakoff and Rafael Núñez’s [LR00].

“Zermelo, in his unjustly infamous correspondence with Gödel, was probably the first person to make this observation. Setting himself the natural question, “What does one understand by a proof?”, his answer went like this:

In general, a proof is understood as a system of propositions that, when accepting the premises, yields the validity of the assertion as being *reasonable*. And there remains only the question of what may be “reasonable”. In any case—as you are showing yourself—not only the propositions of some finitary scheme that, also in your case, may always be extended. So, in this respect, we are of the same opinion, however, I *a priori* accept a more general scheme that does not need to be extended. And in this system, really all propositions are decidable.¹¹

What needs to be explained now is the nature of the difference between proof in the narrower and broader sense, or between the *proof* and *truth*, and the sense in which the second one is “decidable”, or better: complete and unextendable, as Zermelo claims.

The analogous differences between the general and narrower *construability* or *decidability* is less problematic since the *ad hoc* constructive or decision methods (like quadratrix or spiral) are still bound to some humanly feasible means, and so quite naturally counted as constructions and algorithms. The traditional problem of arithmetic is its very relationship to the empirical world, as (already before Kant) expressed in the claim it is a science of analytical nature. Hence, the whole issue of the difference between the truth and proof can be boiled down to a single question:

what is arithmetical truth outside of a specific axiomatic system?

It is exactly the lack of any explicit answer to this question that leads to the Platonist account of arithmetical truth.”

... Kolman: [Kma08], §1, p.93 - §2, p.94.

Further, Kolman seeks to address the distinction between ‘Proof’ and ‘Truth’—and ‘For any’ and ‘For all’—by treating them as reflecting a ‘distinction between two different kinds of consequence: strongly effective or *full-formal* \vdash and the more liberal or *semi-formal* \models ’; and considers under what conditions ‘the infinite vehicles of truth and judgment such as (\forall) or (ω) should be referred to as rules’:

“As for Gödel’s results, Lorenzen¹⁴ claims that instead of being about arithmetic, as completely given by its operative definition, they merely tell us something about Peano’s formalism in its particular shape of a first-order scheme within the language containing 0, s , $+$ and \times . So, coming from the other side, Lorenzen arrived at the same basic difference as Zermelo. It is also in accord both with Lorenzen’s later views, as developed in his *Metamathematik* (1962), and with Zermelo’s late project of infinitist logic,¹⁵ to rephrase this difference in *inferentialist* terms as the distinction between two different kinds of consequence: strongly effective or *full-formal* \vdash and the more liberal or *semi-formal* \models .¹⁶ Now, simplifying heavily:

Full-formal arithmetic, like the arithmetic of Peano, is arithmetic *in the narrower sense*, and deals with schematically or mechanically given and controllable axioms and rules. Semi-formal arithmetic or *the arithmetic proper* employs—in accord with the infinite nature of the number sequence 1, 2, 3, ...—rules with infinitely many premises, particularly the (ω) -rule

$$A(1), A(2), A(3), \text{ etc.} \Rightarrow (\forall x)(Ax). \quad (\omega)$$

As an arithmetical rule it is transparent and sound enough (or “reasonable”, as Zermelo would say), as long as one interprets the “etc.” correctly. In fact, Tarski’s idea of semantics¹⁷ employs this kind of rules systematically, with the (ω) -rule as a special case of the more general

$$A(N) \text{ for all substituents } N \Rightarrow (\forall x)A(x). \quad (\forall)$$

This rule is then nothing else than the well-known part of the so-called *semantic definition of truth*. Hence, the significance of semi-formalism is to make us think of semantic definitions as special (more generously conceived) systems of rules (proof systems) which—starting with some elementary sentences—evaluate the complex ones by *exactly one* of *two* truth values. The most important point to notice is that the semi-formal rules are called semantic not because they are infinite but because they, unlike Peano’s formalism, work with a uniquely determined range of quantification.

As a consequence, arithmetical truth need not be guaranteed by God or by intuition, but, as (Zermelo, 1932, p. 87) put it, simply by the fact that the broader concept of “mathematical proof is nothing other than a system of propositions which is well-founded by quantification.” Zermelo’s claim that all the sentences are decided by his “more general scheme”, i.e., completely and correctly evaluated by arithmetical semi-formalism, can be “proved” by an easy meta-induction like this:

1. Elementary arithmetical sentences ($M = P, M < N$) are evaluated unambiguously as true or false only on the basis of calculations with numerals.
2. Tarski’s definition provides for the evaluation of more complex sentences, particularly because: either for every term N from $1, 2, 3, \dots$, the sentence $A(N)$ is true and hence $(\forall x)A(x)$ is true, or there is N from $1, 2, 3, \dots$ such that $A(N)$ is false, and $(\forall x)A(x)$ is false, *tertium non datur*.

It is a known fact that the intuitionists and some constructivists (including Lorenzen,¹⁸ but not, e.g., Weyl¹⁹) question the completeness of this evaluation, arguing that the existence of concrete strategies for proving or refuting every $A(N)$ doesn’t entail the existence of a general strategy for $A(x)$. To give a familiar example: there is no problem in demonstrating whether, for any given even number M , it is the sum of two primes. However, the truth value of the general judgment that every even number is the sum of two primes (Goldbach Conjecture) is still unknown, 250 years after the problem was first posed. Hence, it is possible that we have proofs for all the sentences $A(N)$ without knowing it, i.e., without having the general strategy of how to prove a proposition concerning them all.

Consequently, a decision must be made whether the infinite vehicles of truth and judgment such as (\forall) or (ω) should be referred to as rules

1. only in the case when we positively know that all their premises are true, i.e., when we have at our disposal some general strategy for proving all of them at once, or
2. more liberally, if we know somehow that all their premises are positively true or false. The general distinction between the constructive and classical methods in arithmetic is based on this."

... Kolman: [Kma08], §2, pp.95-96.

14.B. Conflating ‘For any’ with ‘For all’

Moreover, the distinction between algorithmic *verifiability* (Definition 7) and algorithmic *computability* (Definition 10) illustrates *why* the argument \mathcal{A} in [PG21] is not valid from an *evidence-based* perspective.

Hence, even if the proposition, ‘There are at least n planets’, could be treated as putatively *evidenced* as true for any specified n , this would only entail that the proposition ‘There is a planet $P(n)$ ’ is algorithmically *verifiable* as true over the domain \mathbb{N} of the natural numbers.

It would not entail the conclusion ‘There are infinitely many planets’³³³, since the latter entails the assertion that ‘ $(\forall n)$ There is a planet $P(n)$ ’ which—like Kurt Gödel’s arithmetical

³³³Reason: As philosophers Michał Tomasz Godziszewski and Rafał Urbaniak observe, in their consideration

formula $[(\forall x)R(x)]$ in [Go31]³³⁴—may not be capable of being *evidenced* as an algorithmically *computable* true proposition over \mathbb{N} .

In other words, from an *evidence-based* perspective, the argument \mathcal{A} in [PG21]—unwittingly, and not unreasonably under current mathematical paradigms that do not insist upon *evidence-based* reasoning for ensuring categorical communication (see §1.)—conflates the two assertions:

- (a) For *any* specified n , there is an algorithm TM_n which can *evidence*³³⁵ that there are at least n planets.
- (b) There is an algorithm TM which, for *all* n , can *evidence* that there are at least n planets.

‘Not unreasonably’, since the conflation *merely* reflects the circumstance that, in any language S in which ‘there are at least x planets’ is expressible as a formula ‘ $[F(x)]$ ’, both the premises (non-terminating sequence, in which the notation ‘ \dots ’ is only a pictorial abbreviation indicating ‘non-termination’) in Paseau and Griffiths’ Argument \mathcal{A} in [PG21], and the conclusion ‘There are infinitely many planets’ in \mathcal{A} , would be expressed as the quantified formula ‘ $[(\forall x)F(x)]$ ’ (and not, as seemingly claimed by Paseau and Griffiths, by a physically ‘infinite’ conjunction requiring an ‘infinite’ logic of consequence).

The distinction between (a) and (b) would only emerge under an *evidence-based* interpretation of S that seeks to *validate* the axioms and rules of inference of S as faithful to that which the logic L_S of S was initially designed—in the sense of Definitions 2 and 3—to express unambiguously, and communicate categorically.

Thus, in *evidence-based* reasoning if, for instance, the formula $[(\forall x)F(x)]$ of PA—whose logic is the first-order logic FOL—is intended to be read *weakly* as ‘For any specified x , $F^*(x)$ is decidable as true’ under an *evidence-based* interpretation³³⁶, where the formula $[F(x)]$ interprets as the arithmetical relation $F^*(x)$, then it must be consistently interpreted *weakly* in terms of algorithmic *verifiability* according to Definitions 21 and 22 (see §7.C.: *Evidence-based quantification*³³⁷).

Similarly, if $[(\forall x)F(x)]$ is intended to be read *strongly* as ‘For all x , $F^*(x)$ is decidable as true’ under an *evidence-based* interpretation³³⁸, then it must be consistently interpreted

of Yablo’s paradox (see §20.) in [GoU19], we can replace a uniform disquotation with an infinity of local disquotation instances only if we use some infinitary inference rule (requiring an infinite number of premises) such as Hilbert’s (*strong*) ω -Rule of Infinite Induction (see §8., *The significance of Hilbert’s ω -Rule for Gödel’s ω -consistency*).

³³⁴Where Kurt Gödel finitarily constructed an arithmetical formula $[R(x)]$, which he referred to in his Theorem VI in [Go31] (p.25, Eqn. 12) by its Gödel-number r . Essentially, he then meta-mathematically showed that whereas, for any specified numeral $[n]$, we can *evidence* that $[R(n)]$ interprets as a true arithmetical proposition, we cannot *evidence* that the quantified formula $[(\forall x)R(x)]$ interprets as a true arithmetic proposition. In other words (see Corollary 2.21; also [An16], Corollary 8.3), in any *well-defined* model of PA, Gödel’s arithmetical formula $[R(x)]$ interprets as an algorithmically *verifiable*, but not algorithmically *computable*, tautology over \mathbb{N} .

³³⁵Broadly in the sense of [Mu91] and [Lob59] (see §2.).

³³⁶Such as (see §2.B.) the *weak*, algorithmically *verifiable*, standard interpretation $\mathcal{I}_{PA(\mathbb{N}, SV)}$ of PA originally defined in [An16], §5; under which the axioms of PA are always algorithmically *verifiable* as true, and the rules of inference of PA preserve the properties of algorithmically *verifiable* satisfaction/truth under $\mathcal{I}_{PA(\mathbb{N}, SV)}$ (see [An16], Theorem 5.6).

³³⁷Compare also with §7.B.: *Faith-based quantification*.

³³⁸Such as (see §2.C.) the *strong*, algorithmically *computable*, interpretation $\mathcal{I}_{PA(\mathbb{N}, SC)}$ of PA originally defined in [An16], §6; under which the axioms of PA are always algorithmically *computable* as true, and the rules of inference of PA preserve the properties of algorithmically *computable* satisfaction/truth under $\mathcal{I}_{PA(\mathbb{N}, SC)}$ (see [An16], Theorem 6.7).

strongly in terms of algorithmic *computability* according to Definitions 23 and 24 (see §7.C.: *Evidence-based quantification*).

We conclude by noting that, from an *evidence-based* perspective, it is an implicit conflation of a *weak* assertion such as ‘*For any specified x , $F^*(x)$ is decidable as true*’, and the *strong* assertion ‘*For all x , $F^*(x)$ is decidable as true*’, which misleads Paseau and Griffiths in [PG21] into contradictorily treating ‘what follows from what’ and ‘what can be deduced from what’ as mutually independent, rather than inter-dependent and complementary³³⁹, questions of logical ‘consequence’ and logical ‘deduction’ respectively.

‘Misleads’ because—as Markus Pantsar has cogently argued in [Pan09] in the context of mathematical ‘proof’ and ‘truth’ (see §1.A.)—from an *evidence-based* perspective, the aim of adducing any *well-defined* logic to a language is, by definition (see Definition 1 and Definitions 32-33), to ensure that any ‘meaningful’ assertion of logical ‘consequence’ *must* be preceded by a corresponding assertion of ‘*evidence-based truth*’; and followed by an assertion of ‘deduced logical truth’ that validates (in the sense of §1.J.) the assertion of logical ‘consequence’ as ‘faithful’ to its intended ‘meaning’.

‘Contradictorily’, because the ‘pictorial’ premise in Paseau and Griffiths’ argument \mathcal{A} can only be interpreted as a non-terminating sequence *semantically*, if \mathcal{A} is claimed to be an assertion of logical consequence.

14.C. *Where physicists may need to distinguish between ‘For any’ and ‘For all’*

The significance of the distinction between ‘For any’ and ‘For all’ (in the sense of §7.C., Definitions 21 to 24), for physicists, is highlighted by Décio Krause’s paper [Krs22] where he observes that, when attempting to express the common properties of ‘indiscernibles’ unambiguously in a language of (intended) categorical communication, ‘quantification over indiscernibles, in particular in the quantum domain, does not conform with quantification in the standard sense of classical logic’, according to which ‘once we quantify over one of them, we are quantifying over all of them’³⁴⁰.

Comment 130. From the *evidence-based* perspective of this investigation, we view the thesis of Krause’s paper [Krs22] as:

- (a) There is a problem in classical logics, reflexive or non-reflexive, when quantifying over indiscernibles; in particular, when talking about a single indiscernible of a collection without being able to precisely identify it (except when measured actually in a physical process, or putatively by an algorithmic definition);
- (b) There is no problem quantifying over indiscernibles in a non-reflexive logic over ‘quasi-sets’; which allow you to talk about a single indiscernible of a collection without having to precisely identify it.

Thus, our intent in the quoted sections of [Krs22] is to highlight only (a); and to avoid addressing (b) since, *prima facie*, that would go beyond the scope, and competence, of *evidence-based* reasoning.

³³⁹In the sense of the Complementarity Thesis in §1.

³⁴⁰In a private correspondence with the author dated 14 September 2022, Professor Krause clarifies: ‘Well, this is precisely what I intend to say: it does not occur in QM: we can quantify over one quantum without the supposed implication that we are quantifying over all of them’.

Moreover, our goal is limited to *only* raising the question of whether—from the evidence-based Definitions 21 to 24 of Quantification in §7.C.—the various approaches towards addressing (a) can be viewed as seeking to distinguish between assertions of ‘For any’ and ‘For all’ (and their negations) over the ‘indiscernibles’ considered in [Krs22].

Krause calls this ‘the collapse of quantifiers’³⁴¹, since in such a case ‘There exists one x such as P ’ would entail ‘All x are P ’:

“One of the main criticisms of the theory of collections of indiscernible objects is that once we quantify over one of them, we are quantifying over all of them since they cannot be discerned from one another. In this way, we would call the collapse of quantifiers: ‘There exists one x such as P ’ would entail ‘All x are P ’. In this paper we argue that there are situations (quantum theory is the sample case) where we do refer to a certain quantum entity, saying that it has a certain property, even without committing all other indistinguishable entities with the considered property. Mathematically, within the realm of the theory of quasi-sets \mathcal{Q} , we can give sense to this claim. We show that the above-mentioned ‘collapse of quantifiers’ depends on the interpretation of the quantifiers and on the mathematical background where they are ranging. In this way, we hope to strengthen the idea that quantification over indiscernibles, in particular in the quantum domain, does not conform with quantification in the standard sense of classical logic.”

... Krause: [Krs22], Abstract.

Comment 131. (*Collapse of quantifiers*): Prima facie, from any *evidence-based* perspective (whether that of a reflexive or non-reflexive logic), we could—not unreasonably—view the ‘collapse of quantifiers’ as asserting that:

- (i) ‘ $(\exists x)P(x)$ ’ cannot be asserted *strongly* (in the sense entailed by §7.C., Definition 24) as: ‘There is an algorithm (describing/corresponding to a physical process) that can identify x , and algorithmically *compute* that it has the property $P(x)$ ’ over a collection C of indiscernibles (even if C is treated as a putatively finite collection); and that:
- (ii) If, despite (i), we hold ‘ $(\exists x)P(x)$ ’ to be true over C , then—since x is not identifiable by any algorithm (describing/corresponding to a physical process)—the assertion must be held to be true for any x in C (in the sense of §7.C., Definition 21); and that:
- (iii) Holding ‘ $(\exists x)P(x)$ ’ to be true over C in (ii) above is the *weak* (in the sense of §7.C., Definition 21) assertion ‘ $(\forall x)P(x)$ ’ that: ‘For any x of C identified by an algorithm (describing/corresponding to a physical process), there is an algorithm (describing/corresponding to a physical process) that can algorithmically *verify* x has the property $P(x)$ ’.

Krause notes that at present, when attempting to unambiguously express, and categorically communicate, our conceptual metaphors of sensory perceptions linguistically, quantification ‘is one of the topics that has not received the deserved attention’. He notes, without endorsing³⁴², Newton C. A. da Costa and Otávio Bueno’s analysis that, given the identification of ‘each’ and ‘all’ in reflexive logics, ‘if we are unable to speak of the identity of certain objects, we cannot speak of these objects being different from one another either’:

³⁴¹However, in a private correspondence with the author dated 14 September 2022, Professor Krause clarifies that: ‘The ‘collapse of quantifiers’ is what some people say will occur when we apply quantification to a domain of indiscernible things. I don’t agree’.

³⁴²In a private correspondence with the author dated 14 September 2022, Professor Krause clarifies: ‘I disagree with da Costa and Bueno. In the theory of quasi-sets, we really can apply quantification to one entity without being obligated to accept that the quantification applies to all of the “others”. I agree with them in that a logic should keep compatible its syntactical and semantical aspects. This is why I sustain that a semantics for a quantum language cannot (or should not) be done in a standard set theory’.

“The consideration of indiscernible entities poses a problem to any attempt to discuss logical matters. The literature is abundant in pointing to the differences among ‘classical connectives’ and their quantum correspondents, so as [*sic*] about the validity of some ‘classical’ rules (such as the Lindenbaum property, the full Theorem of Deduction, etc.; see [1, 7] and the references therein). A particular case concerns quantification and this is one of the topics that has not received the deserved attention until now (some few exceptions being mentioned below, such as [4, 5, §5]). In general, quantum logicians speak less about quantification than about the propositional level, but it is to quantification that we restrict our analysis here. The basic question can be put this way: consider a collection A (we shall not refer to ‘sets’ for the reason to be mentioned soon) of indiscernible objects and let F be a property that applies to them. Then it is supposed that if F applies to one of these objects, due to their indiscernibility, it should apply to any other of them as well, at least this is what it seems. So, if $\exists xF(x)$, we ought to conclude that $\forall xF(x)$. This of course would cause a collapse of quantifiers and brings a problem for the quantification in non-reflexive logics. As da Costa and Bueno say [5],

In order to quantify over each object in the domain, such objects need to be distinguishable from one another. But this presupposes that identity can be applied to these objects so that quantification ranges over distinct objects rather than the same object again and again. Given the identification of ‘each’ and ‘all’ in reflexive logics [logics where identity applies to all objects], the latter presupposes that the objects that are quantified over have well-defined identity conditions. However, this assumption need not hold in the cases of logics, such as non-reflexive ones, in which the principle of identity is restricted. In fact, if we are unable to speak of the identity of certain objects, we cannot speak of these objects being different from one another either, given that difference involves the negation of identity.

The problem is with the assumption that indiscernibles are ‘the same’, as the above quotation seems to suggest. Quantum objects are absolutely indiscernible in certain situations, as in a bosonic condensate, and even so, they are not the same entity.”

... Krause: [Krs22], §1, Introduction.

Krause concludes that:

“Thirdly, the above discussion, conduced in an adequate mathematical framework, shows that the claim that ‘for all’ is equivalent to ‘for each’ (this meaning ‘for this, for that, for that other, etc.’ implying that we are able to provide an identification of the elements) is a false claim. A further example; in a BEC (Bose-Einstein Condensate), it is said that all elements (atoms, molecules, whatever form the BEC) behave as if they were just one thing (the ‘big wave’) [12]. Of course, we can speak this way and we really understand what it means, but we have no way to grasp the elements of the BEC one by one to fulfill the hypothesis of identification.”

... Krause: [Krs22], §5, Summing up.

In other words, from the *evidence-based* perspective of this investigation (cf. §7.C., Definition 21 and Definition 23), we would treat Krause as asserting below that: ‘For all x something’ means exactly that for every *unspecified* $x \in D$ ‘something happens’, where D can be treated as a ‘completed’³⁴³ totality, and we do not need to define its members *individually* (as we would if we were to assert ‘For any (specified) $x \dots$ ’):

“So, we can respond (and agree) with Bueno’s claim that the relationships between quantification and identity should be not only formal [4] but we depart from him in that we should look to the meaning of quantification by precisely claiming that the understanding of quantification over a domain D means precisely this: ‘For all x something’ means exactly that for every $x \in D$

³⁴³Completed’ in the sense of §2. as algorithmically *computable* by Definition 10, and not as *only* algorithmically *verifiable* by Definition 7, but not algorithmically *computable* (see §7.G., Theorem 7.2).

something happens, and we do not need to identify them; by the way, why should we? If I say that the COVID vaccine is available for anyone in a certain city, I don't need to name the inhabitants one by one."

... Krause: [Krs22], §5, *Summing up*.

CHAPTER 14. PHILOSOPHICAL FOUNDATIONS

15. Gödel 1931 in hindsight

The *raison d'être* for reviewing with hindsight Kurt Gödel's seminal paper [Go31], 'On formally undecidable propositions of Principia Mathematica and related systems I', in order to differentiate between:

- what Gödel has proven in [Go31];
- what Gödel believed he had proven in [Go31]; and
- what has been authoritatively accepted in current paradigms as proven by him in [Go31];

is that the distinction (see §7.G.) between algorithmically *verifiable* arithmetical formulas, and algorithmically *computable* arithmetical formulas, necessitates a paradigm shift; in so far that—in the absence of *evidence* to the contrary—we can no longer treat an *unspecified* PA-formula as a *well-defined* formula of PA that can be associated with a specific, even if unspecified, Gödel number (see §15.H.j.).

From the *evidence-based* perspective of this investigation, the need for such a paradigm shift can also be seen as reflected in Roy Wagner's concluding remarks in his 2009 outline [Wgn09] of a 'maverick' semiotic project intended to:

"... demonstrate that mathematical practices of iteration and substitution prevent syntactic order from tying symbols to fixed meanings and uses, and that the construction of mathematical meaning, rather than being restricted to specialised mathematical and logical contexts, depends on more generic linguistic semiotic processes."

... Wagner: [Wgn09], §2. *This project in contemporary academic context.*

where, amongst his conclusions, he remarks that:

"These explorations and those to follow are not about generalising my observations concerning Gödel's text to other mathematical corpuses. That would be to slow thinking down. These explorations generalise a way of thinking that insists on finding in mathematical texts irreducibly unstable cores. These experiments try to respect the peculiarities and contingencies of the analysed texts by confronting them with analyses that turn out productive and challenging on these texts' terms, not on the terms of my former negotiations with Gödel's proof. As long as my experiments serve the purpose of attracting attention to the problems of authority over meaning and of responsibility for its production in mathematical (and other) texts, I believe there's a point to pursuing them. When the horizons of critical judgement are no longer challenged by these experiments, then, perhaps, the time would come to summarise, universalise, and move on."

... Wagner: [Wgn09], *Conclusion.*

15.A. The illusory significance of Gödel 1931

It is today's folklore that the 'incompleteness' theorems Kurt Gödel proved, in his seminal 1931 paper [Go31] on formally undecidable arithmetical propositions, have set absolute limits on the ability of the brain to express and communicate mental concepts verifiably; a perception falsified by [An16] (see §2.)³⁴⁴ that has, however, meanwhile admitted a variety of misleading

³⁴⁴See also [An04].

conclusions, misunderstandings and misrepresentations (for some of which we shall, to an extent, hold Gödel accountable in §15.C.) in disciplines ranging from mathematics, mathematics education, philosophy, and the natural sciences to social anthropology and theology. As Solomon Feferman notes:

“...of the three major results that he obtained in mathematical logic in the 1930s, only the incompleteness theorem has registered on the general consciousness, and inevitably popularization has led to misunderstanding and misrepresentation. Actually there are two incompleteness theorems, and what people have in mind when they speak of Gödel’s theorem is mainly the first of these. Like Heisenberg’s Uncertainty Principle, it has captured the public imagination with the idea that there are absolute limits to what can be known. More specifically, it’s said that Gödel’s theorem tells us there are mathematical truths that can never be proved. Among postmodernists it’s used to support skepticism about objective truth; nothing can be known for sure. And in the *Bibliography of Christianity and Mathematics* (yes, there is such a publication!) it’s asserted that “theologians can be comforted in their failure to systematize revealed truth because mathematicians cannot grasp all mathematical truths in their systems either.” Not only that, the incompleteness theorem is held to imply the existence of God, since only He can decide all truths.

Among those who know what the incompleteness theorems actually tell us, there are some interesting views about their wider significance for both mind and matter. In his 1960 Gibbs Lecture, Gödel himself drew the conclusion that “either mind infinitely surpasses any finite machine or there are absolutely unsolvable number theoretic problems.” He evidently believed that mind can’t be explained mechanically, but since he couldn’t give an unassailable argument for that—in his typical style he formulated this in a more cautious way as a dichotomy. A lot has been written pro and con about the possible significance of Gödel’s theorem for mechanical models of the mind by a number of logicians and philosophers; my own critique of Gödel’s dichotomy is published in the July 2006 issue of the journal *Philosophia Mathematica* ... One of the most prominent proponents of the claim that Gödel’s theorem proves that mind is not mechanical is Roger Penrose (e.g. in *Shadows of the Mind*): “there must be more to human thinking than can ever be achieved by a computer”. However, he thinks that there must be a scientific explanation of how the mind works, albeit in its non-mechanical way, and that ultimately must be given in physical terms, but that current physics is inadequate to do the job. As far as I know, Penrose does not say that Gödel’s theorem puts any limits on what one may hope to arrive at in the search for those needed new laws of physics. But Stephen Hawking and Freeman Dyson, among others, have come to the conclusion that Gödel’s theorem implies that there can’t be a Theory of Everything. Both the supposed consequences of the incompleteness theorem for the nature of mind and the laws of the universe are quite interesting and should be examined on their own merits.”

... Feferman: [Fe06a], pp.2-4.

Now, since [An16] has shown that PA is both *finitarily* consistent (see §2.C.a., Theorem 2.16) and *categorical* (see §2.E.b., Corollary 2.18), most deliberations based upon, and conclusions drawn from, the perceived existence of formally undecidable arithmetical propositions become infructuous, and cannot lay claim to significance unless validated independently of their falsifiable premise.

For instance, from the *evidence-based* perspective of this investigation, which admits a finitary proof of consistency for the first-order Peano Arithmetic PA ([An16], Theorem 6.8, p.41), by admitting rule-based, algorithmic assignments of satisfaction and truth to the formulas of PA (see [An16], §3, p.37; also §2.A.), the pervasive influence:

- of what we shall argue in this chapter as Gödel’s conflation of his *unfalsifiable* set-theoretical, and falsifiable arithmetical, argumentation in [Go31];
 - and the consequent misleading, and occasionally false, interpretations of, and conclusions drawn by Gödel from, his own formal reasoning in [Go31],

- with respect to the common concepts *undecidability*, *incompleteness*, *truth/falsity*, *diagonalization*, *self-reference*, *syntax*, *semantics*;
 - and the question (see §15.H.m.) of when a putative formal arithmetical representation of a number-theoretic proposition,
 - necessarily *asserts/means*, under interpretation,
 - what the original number-theoretic relation proposition *asserts/means*;
- upon the usage and interpretation of parallel concepts in a generalised linguistic context from a deconstructive perspective;

is evidenced in Paul Livingston’s perspective [Liv09], ‘Derrida and Formal Logic: Formalising the Undecidable’:

“As early as 1970, Derrida suggested an analogy between what he calls the ‘undecidable’ and the incompleteness result discovered by Gödel and first announced in the article ‘On Formally Undecidable Propositions of *Principia Mathematica* and Related Systems’ published in 1931.¹ Derrida draws this connection in the course of a discussion in ‘The Double Session’ in which he juxtaposes an excerpt from Mallarmé’s text *Mimique* with a passage from Plato’s *Philebus*. The issue raised by both texts (but also, as Derrida argues, by the whole of the metaphysical tradition) is that of *mimesis*, and of the relationship between a representational text, image, or inscription and the ‘original’ that it represents. Mallarmé’s text, Derrida argues, makes possible a thinking of *mimesis* whereby it is no longer understandable as the hierarchical relationship between a representation and a (present or deferred) original. Rather, Mallarmé’s text gives us to think a ‘play’ of *mimesis* with no original, an order of mirroring defined by *allusion* rather than the hierarchical logic of truth and illusion:

In this perpetual allusion being performed in the background of the *entre* that has no ground, one can never know what the allusion alludes to, unless it is to itself in the process of alluding, weaving its hymen and manufacturing its text. Wherein allusion becomes a game conforming only to its own formal rules. As its name indicates, allusion *plays*. But that this play should in the last instance be independent of truth does not mean that it is false, an error, appearance, or illusion. Mallarmé writes ‘allusion,’ not ‘illusion.’ Allusion, or ‘suggestion’ as Mallarmé says elsewhere, is indeed that operation we are here *by analogy* calling undecidable. An undecidable proposition, as Gödel demonstrated in 1931, is a proposition which, given a system of axioms governing a multiplicity, is neither an analytical nor deductive consequence of those axioms, nor in contradiction with them, neither true nor false with respect to those axioms. *Tertium datur*, without synthesis.²

Since ‘undecidable’ and ‘undecidability’ are terms that Derrida retains throughout his career, indeed putting them to a central use in his later analyses of such phenomena as hospitality and the gift, it is worth pausing over this analogy and asking what it shows us about the status of deconstruction *vis à vis* formalism and formalization, of which Gödel’s result is a modern masterpiece.

As is familiar, the essence of Gödel’s proof is to construct a sentence in the language of Russell and Whitehead’s *Principia Mathematica* that is undecidable in the sense that, by way of the construction of a predicate that formalizes the rules of proof in that system, it ‘asserts’ of ‘itself’ that it cannot be proven or disproven within the system.³ That is, the Gödel sentence GS for a particular system is defined in terms of a predicate that is intended to hold of all and only sentences in that system that are provable within it; in terms of this ‘proof’ predicate, the sentence GS ‘says’ of itself that it cannot be proven. Because of this, neither GS nor its negation can be assumed to be provable, on pain of contradiction. Such a sentence is thus ‘undecidable’ in the sense that the axioms and constitutive rules of the system do not *decide* it: that is, they themselves

do not and cannot establish whether it is true or false. Gödel goes on to take this sentence as demonstrating the *incompleteness* of *Principia Mathematica* in the sense that (assuming *PM* is consistent) there is a truth that it cannot prove. For it is apparently possible to ‘see’ (by means, however, of an essentially informal argument) that the proposition asserted by the Gödel sentence is true (i.e. that it itself is indeed not provable within *PM*) although this cannot be proven within the system.⁴ Moreover, although Gödel himself demonstrated the result only in the special case of *Principia Mathematica*, it can certainly be generalized. Though the specific ‘Gödel sentence’ for each system will be different, it can be proven that any formal system of a sufficient (relatively low) degree of complexity will have a Gödel sentence, and thus can be shown to be, necessarily, either inconsistent or incomplete. Thus the more general significance of Gödel’s result is that it demonstrates undecidability as a *general* phenomenon of any moderately complex formal system, an inherent consequence of any attempt to formalize the total logic of a system of proof or the rule-governed establishment of truth.

In introducing the analogy to Gödel’s result, Derrida is quick to emphasize that the undecidability that concerns him is not a matter of semantic ambiguity or polysemy:

‘Undecidability’ is not caused here by some enigmatic equivocality, some inexhaustible ambivalence of a world in a ‘natural’ language, and still less by some ‘*Gegensinn der Urworte*’ (Abel). In dealing here with hymen, it is not a matter of what Hegel undertook to do with German words like *Aufhebung*, *Urteil*, *Meinen*, *Beispiel*, etc., marveling over that lucky accident that installs a natural language within the element of speculative dialectics. What counts here is not the lexical richness, the semantic infiniteness of a world or concept, its depth or breadth, the sedimentation that has produced inside it two contradictory layers of signification (continuity and discontinuity, inside and outside, identity and difference, etc.). What counts here is the formal or syntactical praxis that composes and decomposes it.⁵

That is, the undecidable, in the sense in which it concerns him, is not a matter of single terms having a multiplicity of non-equivalent or even mutually contradictory ‘meanings.’ Quite to the contrary, the undecidability that Derrida finds in Mallarmé’s text is a consequence of a total structural relationship that is, in *this* case, figured in the undecidability (for instance between ‘inside and outside,’ ‘continuity and discontinuity,’) of the single term ‘hymen.

One such term, employed in relation particularly to Saussure’s understanding of language as a ‘system of differences without positive terms,’ but bearing more general application as well, is the neologism ‘*différance*.’ The term, as Derrida explains in the article of the same title, problematically expresses a kind of general condition for the possibility of presentation itself, given that linguistic presentation is possible only within a system of signs defined both by synchronic difference and diachronic deferring.⁹ But the consequence of this is that *différance* itself cannot be presented or named, cannot be inscribed or marked by any positively meaningful representative sign. It is thus that ‘*différance* has no name in our language’ or in any other language¹⁰, and that accordingly ‘*différance* is neither a word or a concept.’¹¹ Rather, in its very incapacity to be named, it ‘exceeds the order of truth at a certain precise point,’ reserving itself or removing itself ‘in regular fashion’ from the systematic structural distinctions of truth or falsity or of presence and absence which it itself structures.¹²

This structure can, indeed, probably be extended to all of the key terms of deconstructive reading. *Différance*, *pharmakon*, *trace*, *supplement*, and (later) *chora* all indicate (without naming) the problematic point *within* a specific text at which the conditions of possibility of a total structural logic of presence and absence are figured and thereby undermined. All of these key terms, and the deconstructive operations they organize, figure the undecidable as the point at which the structural conditions for the possibility of the text fail in the movement of their own attempted figuration. It is in this sense that the regular, structural condition of possibility of the distinctions upon which these specific texts live and function is revealed as, simultaneously, the condition for their *impossibility*, the impossibility of completing the system of presence in a total description of its constitutive structural law.

Given this, it is possible to specify the analogy between Gödel's result and deconstructive undecidability on at least two significant points. First, both trade decisively on the capacity of a *total* system of signs, directed to the establishment of truth or the maintenance of presence, to represent its *own* constitutive conditions of possibility, to figure the basis of the central distinctions that organize the system itself. It is, in both cases, through the figuring of these conditions of possibility at a particular point—the Gödel sentence or Derrida's 'undecidable' terms—that these conditions are shown to undermine themselves, to be at the same time conditions of the *impossibility* of figuring the underlying logic of the system completely. In this way, in each case, the system achieves a kind of total *self-reference*, an 'encoding' at a single point of the total logic that governs the entirety of the system, as well as that point itself. This amounts to a demonstration of the essential *incompleteness* of the system in question, of the necessary existence of points or sentences (in particular, those that express the system's own conditions of possibility) that cannot be decided (as true or false, or as present or absent) in terms of it. In the case of the Gödel sentence itself, these conditions of possibility are represented in the 'provability predicate' for a particular system which encodes the systematic, rule-governed possibilities of proof within a particular system. In a similar fashion, Mallarmé's 'hymen' inscribes, within his text, the condition for the possibility of a structural distinction between original and representation in *mimesis*, and its inscription marks the point of the self-undermining of this distinction.

Second, in both cases the result can be *generalized*. Just as the existence of a Gödel sentence for *Principia Mathematica* points to the more general phenomenon of the incompleteness of any formal system of sufficient complexity, Derrida's *différance* encodes the *general* possibility of undecidability for any system of signs regularly governed by the opposition presence/absence. Thus, the phenomenon of undecidability demonstrated in the particular case of Mallarmé's text by the term 'hymen' is in no way limited to that particular text or term, but in fact can be extended to any mimetic system of signs whatsoever, wherever the general regular conditions of the possibility of representation are themselves represented. The more general terms *différance*, *trace*, and *supplement*, capture this, and are explicitly meant to intervene to destabilize the *totality* of the metaphysics of representation, or what Derrida elsewhere calls the 'metaphysics of presence' itself. They function wherever there is a field or structure of signs which presuppose, for their significative or truth-producing work, a distinction between presence and representation, or between truth and falsity—which is to say wherever there is a system of signs at all.

Thus, much as Gödel's result does not simply evince a contingent limitation of a particular system such as *Principia Mathematica*, but rather marks a fundamental problem for the possibility of formalization as *such* (one which may cause us to reconsider basic and otherwise plausible ideas about the nature of mathematical truth), Derrida's invocation of undecidability suggests a fundamental reconsideration of what is involved in *any* possible system of representation, and hence in any inscription or writing of any sign as such.¹³ The possibility of both operations—the generation of the undecidable Gödel sentence, or the internal/external tracing of the undecidable in Derrida—is based on the way the general structural laws responsible for a system's capacity for presentation—the system's constitutive and determinative logic—can themselves be brought to problematic presentation within that system itself, and so can be seen to undermine themselves at the very point of their positive statement.

As we have seen, then, the undecidability long asserted by Derrida as an essential component of deconstruction, and that shown by Gödel's own meta-mathematical argument, are structurally similar in at least two ways. First, both depend on a kind of 'self-referential' encoding whereby a system's total logic (the conditions for the possibility of its organizing distinctions) is formalized at a single point—the Gödel sentence or the 'undecidable term'—which in turn makes it possible to inscribe an 'undecidable.' Second, both suggest a *generalization* of this result to show that any system of sufficient complexity will allow the inscription of undecidables, and hence be 'incomplete' in a specific sense.

There is, moreover, a third, highly important point of analogy that, although it has been missed by most commentators, verifies this close connection and provides an essential clarification of the basis for any deconstructive strategy of reading. It is this: what Derrida calls the 'undecidable' always results from a semantical effect of *syntax* that cannot itself be excluded from any regular

system of writing. Although this effect involves, as I shall argue, a kind of essential crossing or confusion between the internal, rule-governed structure of a system and its external ‘meaning’ or semantics, it essentially *cannot* be captured by any analysis that works on the level of semantic meaning alone.

This essential crossing of syntax and semantics suggests an important analogy with the general metalogical procedure of ‘diagonalization,’ which underlies Gödel’s result, as well as several other key results of twentieth-century formal and metalogical reflection.¹⁴ The best way to understand diagonalization, in general, is to think of an infinite number of elements of a system, the totality of which exhausts the system as a whole, or comprises the totality of elements with a certain property within it. For instance, we might take the (infinite) totality of sentences that are provable within a given formal system, or the (infinite) totality of sentences that are assertable as true within the logic of a particular text. Diagonalization, then, operates on this totality as a whole to produce another element which is both: i) *formally* a member of the totality in question (that is, it bears the right formal properties to be a member of the totality) and, at the same time ii) *demonstrably* not the same as *any* of the (infinite number of) elements that already comprise the totality.¹⁵

Thus, diagonalization allows the construction, given an infinite set, of an element which is formally part of that set but, as can be shown, differs from each of its (infinite number of) members, and so is not after all part of it. For instance, the Gödel sentence GS for a particular system *diagonalizes* the set of all decidable sentences of the system, in the following sense: given the arithmetical specification of the rules that decide provability (or provability of the negation) of any sentence, it can be shown that GS is not a member of this set; the sentence is itself generated by means of reasoning about what must escape these rules. Most, if not all, instances of diagonalization depend on just such an intervention on syntax.

Thus, the existence of the undecidable within a system depends, in each case, on a productive intervention on syntax, whereby the formal/syntactical rules governing the logic of the system as a whole are encoded at one specific point."

... Livingston: [Liv09], pp.2-6.

Whether the above interpretations, by both Livingston and Derrida, of Gödel’s formal reasoning in [Go31] are appealed to for validating deconstructive argumentation—as, *prima facie*, the deliberately lengthy quote at times suggests—or for merely analogically illustrating such argumentation, is a question that lies beyond the scope and competence of this investigation:

“So far, I have argued, by way of the close analogy to Gödel’s result and to diagonalization more generally, for three claims about Derrida’s undecidables. First, I have argued that they are always the result of a reflective intervention on **syntax**, by means of which the constitutive rules governing a system are problematically ‘represented’ within that system itself. Second, I have argued that this possibility of inscribing the undecidable is always also the result of the possibility of encoding in ultimately syntactic rules some feature of the **totality** of the system itself, including in particular the totality of its ‘decision procedures.’ In this sense, the undecidable is an instance of **self-reference** or reflexivity: that is, an undecidable term functions by ‘encoding’ the logic of the totality of which it itself is a part. When this totality is the totality of language, or of the ‘metaphysics of presence,’ this reflexive moment means that the inscription of the undecidable operates as a kind of writing of the very possibility of writing, or a formalization of formalism as such. Third and finally, I have suggested that the inscription of the undecidable, thus understood, gives critical thought access to a complex topology of the limit: neither the *closure* of the system by means of the drawing of a fixed and steady limit, nor its *openness* to the ‘infinity’ of a transcendent beyond, but what we can term, following Priest (but hyphenating to emphasize the derivation of the term), precisely *in-closure*. The system is closed only at the price of the inherent paradox of tracing its limits, and open just insofar as this paradoxical closure also operates as the diagonalization that generates a contradictory point that is both inside and outside. The work of criticism, or deconstruction, in relationship to the problematic totality of metaphysics, or language itself, is henceforth the inscription and tracing (which also takes the form of erasure) of this problematic limit."

... Livingston: [Liv09], p.10.

15.B. The significance of a shared misperception of Gödel 1931

However, from an *evidence-based* perspective, the one significant—and possibly least remarked upon—consequence of Gödel’s reasoning in [Go31] has been that even conflicting—e.g., realist and constructivist—philosophic argumentations³⁴⁵ in current mathematical and scientific paradigms *share* the common misperception that [Go31] entails Platonic, non-standard, models of the first-order Peano Arithmetic PA (see, e.g., [Ka91], [Ka11]).

The significance of admitting such, seemingly unavoidable, entailment is that PA forms the bedrock upon which all formal mathematical languages that admit rational and real numbers are founded (as detailed succinctly in Edmund Landau’s classic exposition [La29] on the foundations of analysis).

Any mathematical representations of our observations of physical phenomena that appeal to real numbers must thus admit, and be circumscribed by, the mathematical and philosophical consequences of whether or not, and to what extent, we accept that a PA which admits Platonic, non-standard, models is consistent; an issue that characterises the perceived, seemingly irreconcilable, philosophical conflicts on the status, and nature, of not only the definitions that admit real numbers into scientific discourse, but also of what such definitions might unwittingly commit us to ontologically and epistemologically.

We therefore revisit Gödel’s argumentation in [Go31] to ascertain, in hindsight, what it entails, and what it does not, from the evidence-based perspective of [An16] (see §2).

15.C. Can Gödel be held guilty of implicit obfuscation?

Given, then, the significance of [Go31] for current mathematical, philosophical, and scientific paradigms, and since [An16] challenges the broader conclusions—both philosophical and mathematical—that Kurt Gödel draws from his own formal reasoning in his seminal 1931 paper on formally undecidable arithmetical propositions, we consider the, not entirely unreasonable, question:

Query 14. *Can Gödel be held responsible for not distinguishing—in his seminal 1931 paper on formally undecidable propositions—between the implicit circularity in (masked by the non-constructive nature of) his set-theoretical proof of arithmetic undecidability in PM; and the lack of any circularity in his finitary proof of arithmetic undecidability in his Peano Arithmetic P?*

Comment 132. The significance of Query 14 is highlighted, for instance, by philosopher Yu Li’s [Liy22] where, although she ostensibly seeks to show that:

‘...there are improper presuppositions in Gödel’s proof that enable Gödel to construct the paradoxical proposition Q as evidence for the existence of undecidability problems of PM ...’,

in order to conclude that:

‘...taken as a whole, the actual formulation of Gödel’s incompleteness theorem is:

—PM is incomplete, because there are undecidable problems similar to the liar’s paradox in PM’,

her explicitly articulated—and seemingly primary—intent is to initiate a more topical, AI-oriented, debate upon whether, and if so how, Gödel’s reasoning in [Go31] might help illuminate the P vs NP problem³⁴⁶:

³⁴⁵As evidenced in, for instance, [Ba16]; [Kr16].

³⁴⁶Compare §4.A.

1. Is the paradoxical proposition Q similar to the liar’s paradox an undecidable proposition in PM?
2. Is Gödel’s proof valid? If not, what is a valid proof for the incompleteness of PM?
3. By revisiting Gödel’s incompleteness theorem today, what would be the insights for us from the perspective of epistemology? What would be the insights for solving the “P vs NP” problem, as well as some underlying theoretical problems of artificial intelligence, from the perspective of algorithm theory?

... Li: [Liy22].

With the benefit of hindsight, it would not be entirely unreasonable to hold Gödel guilty for the continuing conflation³⁴⁷—as evidenced, for instance, in [Liy22]—between unfalsifiable proofs of purely arithmetically articulated problems over the finite ordinals when expressed in systems such as PM or ZF/ZFC—which have no finitary interpretation—and proofs of the same problems when sought to be expressed/reproduced over the numerals in PA, which *does* have a finitary (*evidence-based*) interpretation (see Theorem 2.15 in §2.C.a.).

The question of implicit obfuscation arises since Gödel’s set-theoretical proof of arithmetic undecidability in PM is, in effect, a set-theoretical proof of arithmetic undecidability that is formally entailed by the axioms of a set-theory such as ZF, since all the propositions that Gödel assumes as true in PM correspond to propositions that are formally provable in ZF (as formally shown in Andrzej Mostowski’s ‘First proof’ of incompleteness in [Mo52], p.91):

“A formula of PM with exactly one free variable, which is of the type of the natural numbers (class of classes), will be called a class-expression. We think of the class-expressions ordered in a sequence in some manner¹¹, we denote the n -th by $R(n)$, and we note that the concept “class-expression” as well as the ordering relation can be defined in the system PM. Let α be an arbitrary class-expression; by $[\alpha; n]$ we denote the formula which arises from the class-expression α by substitution of the symbol for the natural number n for the free variable. The ternary relation $x = [y; z]$ also turns out to be definable within PM. We now define a class K of natural numbers in the following way:

$$n \in K \equiv \overline{Bew} [R(n); n] \quad 11a \tag{1}$$

(where $Bew x$ means: x is a provable formula). Since the concepts occurring in the definiens are all definable in PM, so also is the concept K which is built up from them, i.e. there is a class-expression S ¹² such that the formula $[S; n]$, intuitively interpreted, says that the natural number n belongs to K . As a class-expression, S is identical with some definite $R(q)$, i.e.

$$S = R(q)$$

holds for some definite natural number q . We now show that the proposition $[R(q); q]$ ¹³ is undecidable in PM. For, if the proposition $[R(q); q]$ were assumed to be provable, then it would be true, i.e. according to what was said above, q would belong to K , i.e. according to (1), $\overline{Bew} [R(q); q]$ would hold, contradicting our assumption. On the other hand, if the negation of $[R(q); q]$ were provable, then $\overline{n \in K}$ would hold, i.e. $Bew [R(q); q]$ would be true. Hence, $[R(q); q]$ together with its negation would be provable, which is again impossible.

The analogy of this result with Richard’s antinomy is immediately evident; there is also a close relationship¹⁴ with the Liar Paradox, for the undecidable proposition $[R(q); q]$ says that q belongs to K , i.e. according to (1), that $[R(q); q]$ is not provable. Thus we have a proposition before us which asserts its own unprovability¹⁵.

³⁴⁷A conflation whose roots—mistakenly (see Corollary 19.3 in §19.A.) treating the second-order Peano Arithmetic ACA_0 as a conservative extension of the first-order Peano Arithmetic PA—may even have preceded, and contributed to, the perceived ‘fragility’ in Gödel’s reasoning—as highlighted by Corollary 19.2 in §19., *The significance of evidence-based reasoning for Goodstein’s Theorem*.

Fn11 Say, according to increasing sum of the terms, and lexicographically for equal sums.

Fn11a The bar above denotes negation.

Fn12 Again there is not the slightest difficulty in actually writing down the formula S .

Fn13 One should observe that “[$R(q); q$]” (or the synonymous “[$S; q$]”) is merely a metamathematical description of the undecidable proposition. Nevertheless, as soon as one has obtained the formula S , one can, of course, also determine the number q , and therefore effectively write down the undecidable proposition itself.

Fn14 Every epistemological antinomy can be used for a similar proof of undecidability.

Fn15 Contrary to appearances, such a proposition is not circular, for, to begin with, it asserts the unprovability of a quite definite formula (namely, the q -th in the lexicographic ordering, after a certain substitution) and only subsequently (accidentally, as it were) does it turn out that this formula itself is precisely the one whose unprovability is expressed.”

... Gödel: [Go31], §{1}, pp.7-8.

The putative obfuscation arises due to Gödel’s subsequent remarks in [Go31]³⁴⁸ that:

“In the proof of Theorem VI no properties of the system P were used other than the following:

1. The class of axioms and the rules of inference (i.e. the relation “immediate consequence”) are recursively definable (when the primitive symbols are replaced in some manner by natural numbers).
2. Every recursive relation is definable within the system P (in the sense of Theorem V).

Hence, in every formal system which satisfies assumptions 1, 2 and is ω -consistent, there exist undecidable propositions of the form $(x)F(x)$, where F is a recursively definable property of natural numbers, and likewise in every extension of such a system by a recursively definable ω -consistent class of axioms. To the systems which satisfy assumptions 1, 2 belong, as one can easily confirm, the Zermelo-Fraenkel and the v. Neumann axiom systems for set theory,⁴⁷ and, in addition, the axiom system for number theory which consists of Peano’s axioms, recursive definitions (according to schema (2)) and the logical rules.⁴⁸ Assumption 1 is fulfilled in general by every system whose rules of inference are the usual ones and whose axioms (as in P) result from substitution in finitely many schemata.^{48a}

Fn47 The proof of assumption 1 turns out to be even simpler here than in the case of the system P , since there is only one kind of primitive variable (resp. two in J. v. Neumann’s system).

Fn48 Cf. Problem III in D. Hilbert’s address: “Probleme der Grundlegung der Mathematik”, Math. Ann. 102.

Fn48a The true reason for the incompleteness which attaches to all formal systems of mathematics lies, as will be shown in Part II of this paper, in the fact that the formation of higher and higher types can be continued into the transfinite (cf. D. Hilbert, “Über der Unendliche”, Math. Ann. 95, p. 184), while, in every formal system, only countably many are available. Namely, one can show that the undecidable sentences which have been constructed here always become decidable through adjunction of sufficiently high types (e.g. of the type ω to the system P). A similar result holds for the axiom system of set theory.”

... Gödel: [Go31], p.28.

Consequently, since PA ‘satisfies the assumptions 1, 2’, Gödel has, in fact—albeit unknowingly—illuminated Thoralf Skolem’s cautionary remarks in [Sk22] (see §7.K.), about conflating interpretations across domains of different formal systems, by demonstrating in [Go31] that:

- (a) There is a formally undecidable arithmetical proposition over the domain of the finite ordinals in ZF;
- (b) There is a formally undecidable arithmetical proposition over the domain of the numerals in PA if, and only if³⁴⁹, PA is assumed ω -consistent.

In other words, since PA is not ω -consistent by §2.F., Corollary 2.22 (see also §12.B.f., Theorem 12.6), Gödel’s reasoning in [Go31] can be viewed as having proven that (see also §19., Corollary 19.2):

³⁴⁸Debatably misleading, since PA is not ω -consistent (see [An16], Corollary 8.4, p.42).

³⁴⁹A consequence of §2.E.b., Corollary 2.18, that PA is categorical.

Lemma 15.1. *The structure of the finite ordinals under any putative well-defined interpretation of ZF is not isomorphic to the structure \mathbb{N} of the natural numbers.* \square

Moreover, since PA is consistent (§2.C.a., Theorem 2.16), §15.C., Lemma 15.1 (see also §19., Corollary 19.2), raises the question of whether a set theory such as ZF—or ACA_0 (see §19.A.)—can reasonably be assumed, or even merely treated³⁵⁰, as consistent³⁵¹; where conventional wisdom seems reflected in Colin J. Rittberg’s comment:

“Remark: it is unknown, in fact unprovable from the *ZFC* axioms, if *ZFC* is consistent. The same holds true for number theory, for example. However, experience with these axiom systems makes it reasonable to expect that these systems are in fact consistent. It is common practice in set theory to assume the consistency of *ZFC*, and Woodin does so as well: “There will be no discovery ever of an inconsistency in $ZF + AD$ ” (Woodin 2009b, p. 10) . . . ”

. . . Rittberg: [Rit15], Footnote #3, p.127.

We note that Rittberg’s remark seeks to qualify a not uncommon perspective which can be traced back to that of Gödel in [Go31]—a perspective that is not only inconsistent with *evidence-based* reasoning (see §7.I.a.) and §15.C., Lemma 15.1, but one whose appeal to Gödel’s Theorem XI in [Go31] is questionable (see §15.H.a.):

“A large cardinal axiom is a statement that a very big set with certain properties exists. There are many different large cardinal axioms (also referred to as *axioms of strong infinity*, all proclaiming the existence of sets with certain properties. All such sets would be cardinals (hence the name), but the existence of such cardinals cannot be proved by our theory of sets, *ZFC*. One of the most illuminating examples of this is the large cardinal axiom, which states that there is an inaccessible cardinal (for the definitions of any large cardinal mentioned in this paper, see Sect. 5). If there is an inaccessible cardinal, then we have a model for *ZFC*. But having a model for *ZFC* is equivalent to knowing that there are no contradictions following from *ZFC*, i.e. knowing that *ZFC* is consistent. By Gödel’s Second Incompleteness Theorem, we know that a theory can prove its own consistency if and only if it is inconsistent. Hence, if *ZFC* could prove that there is an inaccessible cardinal, then it could prove its own consistency and would hence be inconsistent.”

. . . Rittberg: [Rit15], p.127.

15.D. Is the ‘Gödel’ sentence unprovable but true?

One serious consequence of conflating Gödel’s purportedly ‘semantical’ proof and his ‘syntactical’ proof in Theorem VI of [Go31], is the common misconception that, if we take the concept of truth in the integers for granted, i.e., as intuitively self-evident—so that quantified PA-formulas such as $[(\forall x)F(x)]$ and $[(\exists x)F(x)]$ are always intuitively decidable as either true or false under a *well-defined* interpretation that, however, is assumed to admit Aristotle’s particularisation (see §7., Definition 12) over \mathbb{N} —then we must accept the false conclusion:

Gödel has constructed an arithmetical proposition $[(\forall x)R(x)]$ that is unprovable in any formal system of Peano Arithmetic, such as his formal system P , but true under any well-defined interpretation of the Arithmetic.

Comment 133. The conclusion is false since, by §2.F., Corollary 2.20, $[\neg(\forall x)R(x)]$ is provable in PA, and therefore true under any well-defined interpretation of PA.

³⁵⁰The distinction seeks to reflect the perspective of §13.F. *Three categories of information.*

³⁵¹However, see also the perspective in §13.E. *Recognising the strengths and limitations of ZF and PA.*

Comment 134. We note that, in their paper [FP00], Juliet Floyd and Hilary Putnam conclude by remarking that, as argued by Wittgenstein, such an assertion cannot claim to be mathematical; it is, at best, a metaphysical one:

“That the Gödel theorem *shows* that (1) there is a well-defined notion of “mathematical truth” applicable to every formula of PM; and (2) that, if PM is consistent, then some “mathematical truths” in *that* sense are undecidable in PM, is *not* a mathematical result but a metaphysical claim. But that if P is provable in PM then PM is inconsistent and if $\neg P$ is provable in PM, then PM is ω -consistent is precisely the mathematical claim that Gödel proved. What Wittgenstein is criticizing is the philosophical naiveté involved in confusing the two, or thinking that the former follows from the latter. But not because Wittgenstein wants simply to *deny* the metaphysical claim; rather, he wants us to see how little sense we have succeeded in giving it.”

... Floyd/Putnam: [FP00], p.632.

The seriousness of the misconception lies in the uncritical perspective it fosters not only amongst emerging logicians—especially when seeking to draw significant formal conclusions from Gödel’s argumentation in [Go31]—but also amongst both non-logicians and logicians.

For instance, reportedly in his doctoral thesis where he seeks to argue that:

“The proofs of Kleene, Chaitin and Boolos for Gödel’s First Incompleteness Theorem are studied from the perspectives of constructivity and the Rosser property. A proof of the incompleteness theorem has the Rosser property when the independence of the true but unprovable sentence can be shown by assuming only the (simple) consistency of the theory. It is known that Gödel’s own proof for his incompleteness theorem does not have the Rosser property, and we show that neither do Kleene’s or Boolos’ proofs. However, we show that a variant of Chaitin’s proof can have the Rosser property. The proofs of Gödel, Rosser and Kleene are constructive in the sense that they explicitly construct, by algorithmic ways, the independent sentence(s) from the theory. We show that the proofs of Chaitin and Boolos are not constructive, and they prove only the mere existence of the independent sentences.”

... Salehi/Seraji: [SS18], Abstract.

Payam Seraji uncritically states that:

“Gödel’s original proof [6] for his incompleteness theorem is constructive, i.e., given a (finite) description of a consistent re theory (e.g. an input-free program which outputs the set of all the axioms of the theory) the proof exhibits, in an algorithmic way, a sentence which is true (in the standard model of natural numbers \mathbb{N}) but unprovable in the theory.”

... Salehi/Seraji: [SS18], §1, Introduction.

Similarly, in his pedagogical essay [Arn10], where:

“A variety of projects in proof theory of relevance to the philosophy of mathematics are surveyed, including Gödel’s incompleteness theorems, conservation results, independence results, ordinal analysis, predicativity, reverse mathematics, speed-up results, and provability logics.”

... Arana: [Arn10], p.336.

logician and philosopher Andrew Peter Arana’s perspective seems critically based upon the *fragile* assertion that:

“Hilbert’s nascent program received a jolt when Kurt Gödel (1931) revealed his two incompleteness theorems, asserting that for formal theories containing a basic arithmetic core, there are sentences that are true in those theories but unprovable (the “first incompleteness theorem”), ...”

... Arana: [Arn10], p.336.

Philosopher Ricardo J. Da Silva too argues that ‘the philosophical implications that the Incompleteness Theorem had on Hilbert’s metamathematical program Incompleteness Theorems’ was that the latter ‘required three steps for its complete execution’, of which ‘two demands found it impossible to be carried out’; seemingly because Gödel had demonstrated in [Go31] that ‘arithmetic cannot be trapped in a system’ since ‘there are propositions that, being true, are not demonstrable from the system, which means that the set of arithmetic truths is greater than the set of demonstrable arithmetic formulas’:

“There are many philosophical consequences that can come to light about Gödel’s Incompleteness Theorems, these consequences range from the use of the theorem as a resource to debate mechanism in philosophy of mind, to the use of the theorem to defend a realist position in philosophy. of mathematics. Within the latter there is an even larger range of consequences and philosophical interpretations of the theorem, but in this article we will take care of reflecting the philosophical implications that the Incompleteness Theorem had on Hilbert’s metamathematical program. Following interpretations such as those of J. von Neumann,⁶³ Hilbert’s metamathematical method required three steps for its complete execution, the first involved the complete formalization of classical mathematics, the second was to use finitary reasoning to prove the completeness of the system and the last step also involved the use of finite methods to test the consistency of the theory. The first demand had been successfully made by Frege and Russell, but the other two demands found it impossible to be carried out.

By saying that completeness fails for arithmetic calculation, what we mean is that there are an endless number of propositions that, being true, cannot be derived by inference rules from the set of axioms. With respect to the above, the first thing we must say is that for Gödel the incompleteness of formal systems is something already expected, since for our author no axiomatic system, no matter how powerful, can encompass all of mathematics. In the “Gibbs Lecture” Gödel treats “objective mathematics” as equivalent to a Platonic style reality where mathematical objects are found independently of the subject, however, none of our axiomatic systems can encompass this objective mathematics within itself, which means that finitist and constructivist methods fail to account for the mathematical object. Like Cantor, Gödel believed that the problem was inherent in formal systems and not in arithmetic, that is, arithmetic cannot be trapped in a system. In this way Gödel demonstrated that the axiomatic method has strong limitations, since “an axiomatic treatment of the theory of numbers (...) cannot exhaust the field of arithmetical truth.”⁶⁴

Now, the last quote introduces us to a quite interesting problem that in fact defines Gödel’s Platonist mood. For Gödel, the formalists confused the notion of truth with that of demonstrability and in fact interpreted the former in terms of the latter. In 1930, Gödel himself demonstrated that, in principle, in the calculus of first-order logic, a formula is logically true if and only if it is provable,⁶⁵ but this result is not extrapolated to formal recursive systems for arithmetic, because in fact, as we already know, there are propositions that, being true, are not demonstrable from the system, which means that the set of arithmetic truths is greater than the set of demonstrable arithmetic formulas.”

... Da Silva: [DaS14], §10. *Philosophical consequences of Gödel’s Incompleteness Theorems on David Hilbert’s meta-mathematical program.*
Spanish ⇒ English auto-translation by Google (minimally edited).

From the *evidence-based* perspective of this investigation, the conflationary influence of Gödel’s misleading interpretation of his own formal reasoning in [Go31] is significantly seen in the 1997 paper [Gia97], where it weakens Giovanni Iorio Giannoli’s, otherwise cogently argued, thesis (cited in §1.) that ‘the distinction between syntax and semantics becomes rather less drastic than as described by the critics of AI’:

“Church credits the possibility of “reducing semantics to syntax” to the conclusions reached by Tarski. Naturally, since Tarski, starting from semantic considerations, discovers the same “true” and unprovable propositions constructed by Gödel, this “reduction” of semantics cannot be considered as a pure correspondence. In fact, the syntactical meta-language, capable of expressing the

semantical properties, must be more powerful than the object language that has to be interpreted; there will therefore be theorems of the meta-syntactical language (e.g. concerning some semantical property) that are not theorems of the object language; so it will be possible to predicate (in the syntactical meta-language) the "truth" of some sentence that has no proof in the object language. At this point the distinction between syntax and semantics becomes rather less drastic than as described by the critics of *AI*: a syntax of high enough order appears completely adequate to express semantic evaluations with respect to sentences that belong to languages of a lower order."

... Giannioli: [Gia97], §3. *Syntax and Semantics*.

by admitting appeal to conventional interpretations—of Gödel's argumentation and conclusions in [Go31]—which argue that 'a syntax of high enough order appears completely adequate to express semantic evaluations with respect to sentences that belong to languages of a lower order':

"Only by introducing meta-languages, or variables of a higher order within the language, can these concepts be defined. In this framework, for the purposes of our analysis, special importance attaches to the observation that to establish the truth of Gödel's (unprovable) propositions one must either appeal to a meta-language (the evaluation of truth not being possible in an object language), or else enrich the language and the logical foundations of the theory by introducing variables of a superior order. We thus reach a conclusion already suggested in Church's remarks cited above in Section 3: semantics is not something that appears "alongside" and separately from syntax; the formation of semantics requires rules, expressed in a syntactical meta-language more powerful than the language to be interpreted; this syntactical meta-language is capable of expressing, in particular, the semantic properties that underlie any possible interpretation."

... Giannioli: [Gia97], §5. *Tarski's Semantic Truth*.

where we note that Giannioli, too, uncritically accepts that:

"...thanks to Gödel we know that it is possible to construct "true" sentences which (when interpreted) assert the non-existence of their own proof; therefore, there exist propositions that are "true" and not provable, that are thus accessible to the "mind's" judgment but cannot be produced as the result of a calculus. Hence, supposedly, the intellectual poverty of machines."

... Giannioli: [Gia97], §2. *The Semantic Critique of Artificial Intelligence*.

Similarly, philosopher Joseph Vidal-Rosset bases his perspective—of whether or not Gödel's Incompleteness Theorem proves that truth transcends proof³⁵²—on the premise that:

"Gödel's incompleteness theorem shows the existence of a statement (called 'Gödel sentence', or 'G sentence') true but undecidable in Peano arithmetic. Thus, at least in formal systems, 'somehow truth transcends proof'."

... Joseph Vidal-Rosset: [Vid06], Introduction, p.51.

Whilst critically reviewing Roger Penrose's Gödelian argument ([Pe90], [Pe94]), Martin Davis too argues that:

³⁵²A perspective obliquely echoed also by philosopher Yu Li in [Liy22] (see also **Comment 132**):

"Gödel claimed that the PM system is incomplete, as it is possible to show at least one such undecidable proposition. As a proof, Gödel gave a paradox similar in nature to the Liar's paradox : a proposition Q asserting about itself that it is unprovable. It is nowadays a commonly accepted view that Gödel proved the incompleteness of the PA system, thus revealing that truth is simply bigger than proof [4]."

... Li: [Liy22], 1. Introduction

"... Gödel's incompleteness theorem (in a strengthened form based on work of J.B. Rosser as well as the solution of Hilbert's tenth problem) may be stated as follows: There is an algorithm which, given any consistent set of axioms, will output a polynomial equation $P = 0$ which in fact has no integer solutions, but such that this fact can not be deduced from the given axioms. Here then is the true but unprovable Gödel sentence on which Penrose relies and in a particularly simple form at that. Note that the sentence is provided by an algorithm. If insight is involved, it must be in convincing oneself that the given axioms are indeed consistent, since otherwise we will have no reason to believe that the Gödel sentence is true."

... Davis: [Da95].

Another instance where, from the *evidence-based* perspective of [An16] and this investigation, the conflationary influence of Gödel's 'misleading' interpretation of his own formal reasoning, in [Go31], can be viewed as weakening an otherwise cogently argued thesis (in [Pan09]; see also the quotes in §I and §1.), is philosopher Markus Pantsar's 'Truth, Proof and Gödelian Arguments: A Defence of Tarskian Truth in Mathematics'; where Pantsar uncritically accepts Gödel's 'misleading' interpretation that, in *any* Peano Arithmetic—such as the system P of [Go31]—which can adequately express the structure of the natural numbers, there is a formally unprovable sentence—denoted in the system P by its Gödel number $17Gen\ r$ ([Go31], p.25, eqn.13)—that can be 'seen' to be true because the sentence asserts, under any *well-defined* interpretation of P over the domain \mathbb{N} of the natural numbers, that "this sentence is unprovable":

"While Goldbach's conjecture could be proved in the future, there are sentences that cannot be proved or disproved even in principle. Famously, Kurt Gödel (1931) proved that in *every* consistent formal system containing arithmetic there are such sentences. That already by itself is mathematically and philosophically highly interesting. Consistent formal systems are always incomplete. But the real philosophical catch is that such *Gödel sentences* can also be seen to be *true*. In short, given some very reasonable basic truth-theoretic assumptions, the Gödel sentences are true but unprovable. This way even the extension, as well as the intension, of truth will always differ for the formalist and non-formalist. That is why Gödel's incompleteness theorems are absolutely essential to the question of truth and proof in mathematics: they give us the only known *explicit* case of a difference between truth and proof. If that indeed were the case, it would already show that truth is a substantial, not a deflationary property.

However, when we say that the Gödel sentences are true, we are obviously talking about truth in a context different from proof in formal systems. From the first glance it is obvious that we mean semantic truth: looking at the construction of Gödel sentences we see that they have the semantic content: "this sentence is unprovable", which indeed is the case by Gödel's proof. That is what we mean by the truth of Gödel sentences: they are true through their meanings. But this is something seemingly very different from the rigid rules of proof we are accustomed to in mathematics, and it immediately raises two questions. First, if not in the original formal systems, in what kind of expanded systems do we establish the truth of Gödel sentences? Second, are we entitled to call such semantic properties *truth* in mathematics?

The apparent truth of Gödel sentences was already noted by Gödel himself, but he left open the question of the underlying conditions concerning truth."

... Pantsar: [Pan09], §1.3 Truth and Proof.

Such weakening of an otherwise insightful argument (see the excerpt in §21.) is evidenced also in Paula Quinon's constructive critique of Stanislaw Krajewski's argument against anti-mechanism in [Kr20], where she—albeit implicitly—uncritically accepts that:

"The first of Gödel's incompleteness theorem says that in every sufficiently rich¹ consistent first-order theory² there exist statements that are true³, but that cannot be proven within this theory. The second of Gödel's incompleteness theorem says that every sufficiently rich consistent first-order theory cannot prove its own consistency."

... Quinon: [Qun20], §2. The Lucas-Penrose Argument and Its Criticism.

A weakening of an equally insightful argument is also evidenced in Roy Wagner's semiotic critique (see also §15.):

"But while in narrative texts mystery can function as an end in itself, for the mathematical text as it operates in contemporary academic mathematical circles an unshakable mystery often functions as a hindrance or threat. This is the very threat that makes Gödel produce reasons to argue that, while the statement labelled $S(z_p, z_p)$ is unprovable and irrefutable, it must be marked as true. Other logicians resolve the same difficulty by stating that the predicates 'true' and 'false' simply do not apply to the statement marked $S(z_p, z_p)$. This again pushes mystery aside. On the other hand, 'It has a definite truth value, which we could never know' is a mystery-endorsing position, which contemporary mathematical texts appear to refuse."

... Wagner: [Wgn09], §3.2. *This is not even a plot.*

Similarly, Panu Raatikainen begins his reflections on the philosophical relevance of Gödel's incompleteness theorems by asserting that:

"Gödel's first incompleteness theorem (as improved by Rosser (1936)) says that for any consistent formalized system F , which contains elementary arithmetic, there exists a sentence G_F of the language of the system which is true but unprovable in that system."

... Raatikainen: [Raa05], *The fate of Hilbert's program.*

as does Fabrice Pataut in the Abstract of his 1998 'Incompleteness, constructivism and truth':

"Although Gödel proved the first incompleteness theorem by intuitionistically respectable means, Gödel's formula, true although undecidable, seems to offer a counter-example to the general constructivist or anti-realist claim that truth may not transcend recognizability in principle. It is argued here that our understanding of the formula consists in a knowledge of its truth-conditions, that it is true in a minimal sense (in virtue of a *reductio ad absurdum*) and, finally, that it is recognized as such given the consistency and ω -consistency of P . The philosophical lesson to be drawn from Gödel's proof is that our capacities for justification in favour of minimal truth exceed what is strictly speaking formally provable in P by means of an algorithm."

... Pataut: [Ptt98], *Abstract.*

In a talk on the nature and significance of Gödel's incompleteness theorems, Feferman too remarks:

"Taking the concept of truth in the integers for granted, we ... can now formulate one current precise version of Gödel's first incompleteness theorem as follows:

The first incompleteness theorem. If S is a formal system such that

- (i) the language of S contains the language of arithmetic,
- (ii) S includes PA, and
- (iii) S is consistent

then there is an arithmetic sentence A which is true but not provable in S ."

textit... Feferman: [Fe06a], pp.7-8.

In his highly accessible *Introduction to Gödel's Theorems* for a multi-disciplinary scholarship, philosopher Peter Smith too implicitly—albeit ambivalently—concludes variously that a language such as PA can have an interpretation³⁵³ \mathcal{I}_{PA} in which quantified PA-formulas—such as $[(\forall x)F(x)]$ and $[(\exists x)F(x)]$ —are acceptable as always decidable as either true or false by appeal to some form of an intuitive—albeit mathematically grounded—reasoning:

³⁵³Which, however, is assumed (see [Smi13], p.39(4)) to admit Aristotle's particularisation (§7., Definition 20) over \mathbb{N} .

"Later, when we come to present Gödel's Theorems, we will describe how to take an arbitrary theory T built in the language L_A , and construct a sentence G_T which turns out to be true but unprovable-in- T . And while the sentence in question is a bit exotic, there is nothing in the least exotic about the notion of truth being applied to it here either: it is the same workaday notion we've just so simply explained. \mathcal{I}_A explicitly defines what it takes for any L_A -sentence, however complex, to be true in this humdrum sense."

... Smith: [Smi13], p.40.

"23.2 Some ways to argue that G_T is true

The Gödelian arguments show that if a rich enough mathematical theory T is sound, or indeed if it is just consistent, then there will be a canonical Gödel sentence G_T which is unprovable in T , and—because it indirectly 'says' it is unprovable— G_T will then be true.⁵

Believing on the basis of the Gödelian arguments that G_T really *is* true will therefore depend on believing that T is indeed sound, or at least is consistent. But note that our reasons for accepting G_T as true can be equally varied. Let's take some examples.

...

Why note our different examples (1) to (4)? Two reasons. First, we want to drive home the message that, given a particular canonical Gödel sentence G_T , we might have *various* kinds of ground for believing it true, because we have varying grounds for believing T is sound or consistent. But second, our examples also reveal that while our grounds for accepting Gödel sentences may be various, the reasons we adduce in cases like (1) to (4) are—so to speak—perfectly ordinary mathematical reasons. When we initially met the idea of incompleteness at the very outset, we wondered whether we must have some special, rule-transcending, cognitive grasp of the numbers underlying our ability to recognize Gödel sentences as correct arithmetical propositions (see Section 1.4). That speculation should now perhaps begin to seem unnecessarily fanciful."

... Smith: [Smi13], p.173.

"... The truths of basic arithmetic run beyond what is provable in any given formal system : even arithmetic is—so to speak—*inexhaustible*. Given any nice theory of arithmetic T which we accept as sound, we have to recognize that there are truths that T cannot prove (there's G_T for a start). So at least mathematicians are not going to run out of work, even at the level of arithmetic, as they develop ever richer formal frameworks in which to prove more truths."

... Smith: [Smi13], p.175.

The significance of an uncritical acceptance of Gödel's conclusions apropos his Theorems VI and XI in [Go31];

- and the perception that *any* assignment of 'truth' values to arithmetical propositions under a *well-defined* interpretation \mathcal{I}_{PA} of PA,
- must yield arithmetical formulas that are PA-unprovable but true under \mathcal{I}_{PA} in Gödel's dichotomous query: 'Are there absolutely undecidable statements?' (see [Fe06]);

is also highlighted by Hannes Leitgeb's concluding remarks in [Lei09]:

"5 Are there true but informally unprovable statements?"

In this final section, we are not so much interested in how informal provability compares to formal provability extensionally, but rather how informal provability relates to truth extensionally. However, in order to say something non-trivial about the latter, it might be useful—and perhaps necessary—to invoke non-trivial insights into the former. For example, it follows from Gödel's First Incompleteness Theorem that if the set of informally provable statements is recursively enumerable, then truth exceeds informal provability extensionally. Or, by the Second Incompleteness Theorem, even if the set of informally provable statements is recursively enumerable, then it is not informally

provable of a particular Turing machine that it enumerates all and only informally provable statements. (See Gödel (1951); Shapiro (1998) gives a modern reconstruction of these two corollaries to the Incompleteness Theorems.) Note that the latter result still does not rule out that it is informally provable that there exists a Turing machine which enumerates all and only informally provable statements. Benacerraf (1967) is aware of this, and Carlson (1984), (2000) proves the consistency of the informal provability of this existence claim with a formal system of epistemic arithmetic.³⁴ It is arguments and conclusions like these that we have in mind here.

So what we are after is

- In which ways does informal provability approximate truth extensionally?

Or, equivalently, are there absolutely undecidable statements (cf. Gödel, 1951)?

According to Hilbert's famous *non ignorabimus* claim, the answer to the latter question is an emphatic "no!"; according to Cohen (2005, p. 2414) it is (a somewhat less emphatic) "yes!". Let us go with Cohen for the moment: how could we then argue in favour of the existence claim

$$\text{HG } \exists p(p \wedge \neg \Box p)$$

which we express in this case in operator terms, with a sentential operator \Box for informal provability?

...

Informal provability and truth coincide extensionally. Thus, instead of proving "merely" that HG is unprovable, we can even derive it is false (as (14) is logically equivalent to $\neg \text{HG}$). In light of the derivation, this is no longer so surprising, but maybe it is surprising at least at first glance since the underlying assumptions might have seemed to be pretty weak. Once again: Does this show that the status of HG has been settled now? The answer is still the same: No, as it is much more plausible to believe that the propositional epsilon calculus with a modal operator \Box has been shown logically deficient, than thinking that the truth value of HG has been determined; instantiations of the epsilon axiom by expressions in which the propositional epsilon symbol is applied to a modal formula are simply not to be counted as logical truths and sometimes maybe not even as truths at all. So the Holy Grail in philosophy of mathematics—for this is what "HG" stands for—is still waiting to be found, as is further insight into the elusive but fundamental concept of informal provability."

... Leitgeb: [Lei09], pp.287-288.

Now, if we read 'informally provable' as 'algorithmically *verifiable* as true', then HG is false!

Moreover, we note that any *unprovable-but-intuitively-true* conclusion (where we take the concept of truth in the integers for granted as in [Fe06a]) makes a *stronger* assumption than that in Gödel's claim (in [Go31], p.26(2)) for the formal 'undecidability' of his arithmetical formula $[(\forall x)R(x)]$ —whose Gödel-number is $17Gen\ r$ —in his Peano Arithmetic P .

Comment 135. From an *evidence-based* perspective, such conflation can also lead to misleading, if not patently false, conclusions; since, by [An16], Theorem 7.1 (Provability Theorem for PA), a PA formula $[F(x)]$ is PA-provable if, and only if, $[F(x)]$ is algorithmically *computable* as always true in \mathbb{N} (see also §2.E.b., Theorem 2.17³⁵⁴):

"The relation of Gödel's theorems to intuitionism is less straightforward. On the one hand, they seemed to confirm the intuitionists' misgivings about formalism. On the other hand, they underline the rather abstract nature of the intuitionistic notion of provability, with which intuitionists equate truth. For as a consequence of Gödel's theorems, truth cannot be equated with provability in any effectively axiomatizable theory."

... Raatikainen: [Raa05], *Intuitionism, truth and provability*.

³⁵⁴**Provability Theorem for PA:** "A PA formula $[F(x)]$ is PA-provable if, and only if, $[F(x)]$ is algorithmically computable as always true in \mathbb{N} ."

Stronger, since Gödel does not assume his proposition $[(\forall x)R(x)]$ to be *intuitively true*, but only demonstrates that though this formula is not provable in his Peano Arithmetic P if P is consistent, yet, for any specified P -numeral $[n]$, the P -formula $[R(n)]$ whose Gödel-number is $Sb\left(r \begin{matrix} 17 \\ Z(n) \end{matrix}\right)$ is P -provable and, implicitly, *therefore meta-mathematically true* in any well-defined model of P .

He further demonstrates that if P is assumed ω -consistent, then the formula $[\neg(\forall x)R(x)]$ too is not provable in P .

Neither of these arguments entails that if P is ω -consistent, then $[(\forall x)R(x)]$ is a true arithmetical proposition in any well-defined model of P .

Reason: Since the negation $[\neg(\forall x)R(x)]$ of Gödel's proposition $[(\forall x)R(x)]$ is provable in P (see §2.F., Corollary 2.20), it follows that $[(\forall x)R(x)]$ cannot be true in any well-defined model of P .

Comment 136. We note that, by §2.F., Corollary 2.23, the classical standard interpretation $\mathcal{I}_{PA(\mathbb{N}, S)}$ of PA (though *well-defined* in the sense of §7.F., Definition 26) does not yield a *well-defined* model in the sense of §12., Definition 34.

The significance of this apparently paradoxical circumstance is seen—and resolved—when viewed from the broader *evidence-based* perspective of §7.C.; since what Gödel's argumentation in [Go31] actually establishes is that arithmetical 'truth' and 'arithmetical 'provability' are complementary. A complementarity (see §2.E.b., Theorem 2.17) which is best expressed in computational terms (see §2.F., Corollary 2.21) as:

Under any *well-defined* interpretation of an arithmetic such as, say, the first-order Peano Arithmetic PA , Gödel's formula $[R(x)]$ translates as an arithmetical relation, say $R^*(x)$, such that, for any specified natural number n , the proposition $R^*(n)$ is algorithmically *verifiable* as true (see §2., Definition 7), but $R^*(n)$ is not algorithmically *computable* as true for any specified natural number n (see §2., Definition 10).

In other words, what neither Vidal-Rosset nor Raatikainen (both of whom can be argued as faithfully reflecting—even when disagreeing with—conventional wisdom) seem to consider in their argumentation and conclusions is the possible *fallibility* of Gödel's explicit assumption of ω -consistency for his Peano Arithmetic P ; nor do they seem to feel a need to question Gödel's explicit claim in [Go31] (p.28) that we can 'easily confirm' such an assumption to be a characteristic of any first-order Peano Arithmetic such as PA.

This is a serious omission since not only is PA ω -inconsistent (by §2.F., Corollary 2.22 and, independently, by §12.B.f., Theorem 12.6), but there are no formally undecidable propositions in PA (an immediate consequence of §2.F., Corollary 2.20; see also §18.).

It is an omission, however, for which neither Vidal-Rosset nor Raatikainen, when wearing their philosopher's hats, should be held accountable (see [An07b], [An07c]) since they—like Wittgenstein, Lucas, Penrose and others of similar ilk (such as [Srn11])—can, in this instance, be excused for depending upon fallible classical *and* intuitionistic wisdom to the effect that a Peano Arithmetic such as PA cannot be ω -inconsistent:

"... there is no equivocation. Either an adequate arithmetical logic is ω -inconsistent (in which case it is possible to prove false statements within it) or it has an unsolvable decision problem and is subject to the limitations of Gödel's incompleteness theorem."

... Martin Davis: ([Da82], p.129(iii)).

"We don't want our system to be ω -inconsistent, even if it is consistent. In particular, if the simple consistency were provable metamathematically, then the formula $\neg\mathbf{A}_p(\mathbf{p})$ would under the interpretation express a proposition contradicting one that is true on finitary grounds; and in case $\neg\mathbf{A}_p(\mathbf{p})$ were provable, following Hilbert and Bernays (1939, p. 282) we should call the system *externally inconsistent*, i.e. inconsistent with respect to the finitary interpretation. Thus a proof of simple consistency alone would not secure the formalized mathematics against the possibility of establishing something intuitively false."

... Kleene: [K152], p.212.

"Some earlier remarks Michael Dummett made on Gödel's theorem have recently inspired attempts to formulate an alternative to the standard demonstration of the truth of the Gödel sentence. The idea underlying the non-standard approach is to treat the Gödel sentence as an ordinary arithmetical one. But the Gödel sentence is of a very specific nature. Consequently, the non-standard arguments are conceptually mistaken. In this paper, both the faulty arguments themselves and the general reasons underlying their failure are analysed. The analysis reveals the true nature of the epistemological relation between the Gödel sentence and its numerical instances.

Ever since Gödel's great discovery of the incompleteness of arithmetic, many attempts have been made to exploit the fundamental new insights it provides in order to find answers to some old questions of the philosophy of mathematics, such as those concerning the nature of mathematical truth or the way our mind works. Generally, it is taken for granted that (provided the theory considered is consistent) the truth of the Gödel sentence follows simply from the fact that it was shown by Gödel to be unprovable and, by its very definition, it is true just in case it is unprovable. But not everyone takes this approach. In a paper on Gödel's incompleteness result, Michael Dummett comments on the demonstration of the truth of the Gödel sentence (which is of the form $(\forall x)A(x)$) as follows:

In fact, the transition from saying that all of the statements $A(0), A(1), A(2), \dots$ are true to saying that $(\forall x)A(x)$ is true is trivial. The principle of reasoning, not embodied in the system, which we employ in arriving at the truth of $(\forall x)A(x)$, is not this transition, but rather that which leads us to assert that all of the statements $A(0), A(1), A(2), \dots$ are true. [Dummett, 1963, p. 192]

These observations suggest that Dummett abandons the widely accepted usual approach and exploits the fact that the Gödel sentence is, after all, a universal sentence of the language of arithmetic. Indeed, he partly forgets its metamathematical interpretation and, as in the case of ordinary universal sentences, derives its truth from that of its numerical instances. Picking up on this idea, Crispin Wright [1995, p. 94] presented an intuitionistic demonstration of the Gödel sentence in the spirit of Dummett, and more recently, this same approach has been used by Neil Tennant [2002, p. 551] to 'show that the deflationist has at his disposal' methods to prove the Gödel sentence (in some extended theory) without making use of a truth-predicate.

An argument deriving the truth of a universal arithmetical sentence from that of its numerical instances suggests that the truth of the numerical instances has some kind of epistemological priority over the truth of the sentence itself: our knowledge of the truth of the sentence stems from the fact that we know all its numerical instances to be true. In this paper, I shall show that it is just the other way around. Indeed, the specific character of the Gödel sentence is mirrored in an exceptional property that it shares perhaps only with the other arithmetized metamathematical statements of its kind: the source of our knowledge of the truth of the totality of its numerical instances is the truth of the sentence itself. The better understanding of this peculiar epistemological relation between the Gödel sentence and its numerical instances may contribute to our better understanding of the whole phenomenon of arithmetical incompleteness. My aim in this paper, then, is to show that *the Gödel sentence is very special in that it is (equivalent to) a universal sentence which is epistemologically prior to its numerical instances*. What I shall do first is to analyse the arguments assuming (implicitly) the opposite. The result of this analysis will be that these arguments are faulty in one way or another. In fact, they are necessarily so. The reason is, or so I shall argue explicitly in the second part of the paper, that the only

proper argument for the truth of the Gödel sentence is the standard textbook demonstration of its *unprovability*.¹ And, needless to say, the demonstration of the unprovability of the Gödel sentence does not rely in any way on the truth of its numerical instances.

As a matter of fact, as we shall see, Dummett's argument (i.e., the argument formulated in the spirit of Dummett's remarks) is not a genuine alternative to the standard textbook demonstration, but simply its disguised version. Dummett's original idea on which both Wright and Tennant have built their arguments is fundamentally misleading. Actually, the result of Wright's effort to present an intuitionistic demonstration of the Gödel sentence is muddled by redundancies that reflect the circuitousness of the underlying idea. Thus a considerable part of Michael Detlefsen's criticism of Wright's demonstration had to be a systematic reconstruction of the latter [Detlefsen,1995, pp. 104–111]. This reconstruction could have been more concise and therefore much more transparent without the redundancies of the original demonstration. The misconception inherent in considering the Gödel sentence as an ordinary arithmetical sentence and the deceptiveness of an argument based on this approach is even more manifest in the case of Tennant's attempt to give a 'faithful and fully detailed [formal] regimentation' of Dummett's argument. For, as we shall see, due to its built-in redundancy, Dummett's argument cannot faithfully be formalized. Therefore, in his efforts to find a straightforward formal counterpart of Dummett's argument, Tennant almost inevitably commits the incorrigible mistake of not recognizing the ω -incompleteness of the theories he considers. Consequently, his central technical result on which he built his argument in the debate with Jeffrey Ketland (on the significance of the Gödel incompleteness phenomenon from the point of view of deflationism) is flawed."

... Serény: [Srn11], pp.1-3.

Comment 137. We note that the influence of what we have termed as Gödelian 'obfuscation' is conspicuously evidenced in György Serény's critique of attempts to assign an appropriate meaning, and truth value, to the 'Gödel Sentence' under a *well-defined*, presumably Tarskian, interpretation.

However, Serény's argumentation and conclusions are both *fragile* since, for instance:

- (a) Serény uncritically, and mistakenly (see [An16], Corollary 8.4, p.42; also §2.F., Corollary 2.22), accepts inherited, *misleading*, current paradigms that any arithmetic in which the 'Gödel Sentence' has a *well-defined* interpretation must necessarily be ω -consistent;
- (b) Serény's analysis, which seeks to address the issue, '*How do We Know that the Gödel Sentence of a Consistent Theory Is True?*', implicitly appeals to the classical doctrine of knowledge as intuitively 'justified true belief', rather than explicitly to Piccinini's *evidence-based* 'factually grounded belief' (see §5.A.), when he asserts that 'the source of our knowledge of the truth of the totality of its numerical instances is the truth of the sentence itself'.

The flaw in such an assumption is that, in the absence of an *evidence-based* distinction between algorithmically *verifiable* truth (see §2., Definition 7) and algorithmically *computable* truth (see §2., Definition 10), not every universally quantified formula of a formal theory interprets as a '*well-defined* sentence' under a Tarskian interpretation of the theory over a well-defined domain.

Moreover, since the negation of the Gödel Sentence—which is a PA-formula of the form $[\neg(\forall x)R(x)]$ —is provable in the first-order Peano Arithmetic PA (see [An16], Corollary 8.2, p.42; also §2.F., Corollary 2.20)—the Gödel sentence is—contrary to what is argued, and accepted, in current paradigms—false under any *well-defined* interpretation of PA (such as the *strong*, algorithmically *computable*, finitary interpretation $\mathcal{I}_{PA(\mathbb{N}, SC)}$ of PA defined in §2.C.).

Specifically, $[\neg(\forall x)R(x)]$ then asserts that the interpreted arithmetical relation $R^*(x)$ is not algorithmically *computable* as always true over \mathbb{N} , even though any specified instance $R^*(n)$ is algorithmically *computable* as true in \mathbb{N}^{355} (see [An16],

³⁵⁵Since the PA formula $[R(n)]$ is provable in PA for any specified numeral $[n]$.

Corollary 8.3, p.42; also §2.F., Corollary 2.21).

In other words, contrary to Serény's central argument, the Gödel Sentence is *not* 'true' because it *evidences* 'the truth of the totality of its numerical instances'; it is 'true' because it *evidences* only *the truth of any specified numerical instance*.

The significance of the distinction between:

- (i) interpreting a universally quantified formula $[(\forall x)R(x)]$ as 'For *all* x , $R^*(x)$ ';
and
- (ii) interpreting it as 'For *any specified* x , $R^*(x)$ ';

is addressed in §7.C., Definitions 23 and 21 (see also §14.B.).

It would not be unreasonable to conclude, therefore, that it could be a misplaced, *faith-based* (see, for instance, §7.B.), dependence and/or respect for inherited paradigms—which reflect the *uncritical* acceptance of highly technical formal argumentation as definitive—that may render some of the philosophical misgivings—in argumentations such as those cited above—as 'dismissible' on the grounds of appeal to ambiguous interpretations of formal, sociologically accepted³⁵⁶, reasoning.

For instance, as Paul M. Livingston argues in [Liv10], 'there are at least four ways, implicit in Wittgenstein's remarks, that we might resist the strong claim usually associated with Gödel's first incompleteness theorem (i.e. that it shows there is a "truth" that is beyond the capacity of PM to prove or disprove)' (see also §13.G.b.):

"First, we might simply abstain from interpreting the Gödel sentence P in terms of truth, falsity, provability, or "self-reference" at all. On this option, the derivability of the Gödel sentence in PM simply shows that a "perfectly ordinary" and unremarkable arithmetical sentence of PM is derivable. There are then, quite simply, no further consequences for the nature or structure of PM at all. Second, while agreeing to interpret the Gödel sentence in terms of issues of truth and provability, we might refuse the model-theoretic conception of truth and opt for a disquotational notion. Then the Gödel sentence is just equivalent to the Liar paradox, and raises the same issues as does that paradox. These may (but do not obviously) include the implication that PM is inconsistent.¹⁸ Third, we might *agree* to both the interpretation in terms of truth and falsity and the model-theoretic conception of truth, and still resist the interpretation of "Prov(x)" as a "provability predicate"; this is the interpretation suggested by Floyd and Putnam, according to which there is no admissible interpretation of PM whose models do not contain objects that are not natural numbers, and PM is accordingly ω -inconsistent (although not necessarily inconsistent outright); and fourth (and finally), we may, on any of the first three options or for other reasons, take the Gödel sentence to show PM to be (outright) inconsistent.

On *any* of these four options, the Gödel sentence does not have the consequences of showing that "there is" a mathematical truth that can be neither proven nor disproven in PM . This is enough to underwrite Wittgenstein's marked suspicion about the result as it is usually presented, and to show that it would be over-hasty simply to concur with the metalogical interpretation that Gödel himself gives.

Specifically, recall that Gödel's first theorem constructs a sentence P such that, as is provable in PM or a related system, $P \leftrightarrow \sim \text{Prov}([P])$, where Prov is a one-place "provability predicate" and enclosure in square brackets gives the Gödel number of the formula enclosed. Additionally, the "provability predicate" itself is defined by means of the predicates $\text{NaturalNo}(x)$, and $\text{Proof}(x, t)$, where $\text{NaturalNo}(x)$ is interpreted as " x is a natural number" and $\text{Proof}(x, t)$ is interpreted as a relation supposed to hold between two numbers when x is the Gödel number of a proof whose last line has the Gödel number t .¹² (Here, t abbreviates an expression which calculates out to the Gödel number of P itself). All of these are, of course, interpretations, and might be resisted

³⁵⁶For the significance of such 'sociological acceptance', see the analysis of Fermat's Last Theorem in §1.F..

under the right circumstances. *In particular*, suppose we actually assume that $\sim P$ is proven in *PM* (or, one day, actually come across a proof of it). Then we are in a position, of course, also to prove $\text{Prov}([P])$. In this case, however, as Wittgenstein points out, we might well be justified in dropping the *interpretation* that holds that $\text{Prov}([P])$ is *in fact* a provability predicate. And if we drop this interpretation, there is no need to conclude that the Gödel sentence is indeed something that is "true", but unprovable in *PM*."

... Livingston: [Liv10], p.42-43

15.E. Is Gödel's proof self-referential?

A less serious consequence³⁵⁷ of conflating Gödel's purportedly 'semantical' proof and his 'syntactical' proof in Theorem VI of [Go31] is the, not entirely unreasonable, argument which contends that:

Argument A: Gödel's set-theoretical definitions of ' $[R(n); n]$ ' and ' $\overline{\text{Bew}} [R(n); n]$ ' are:

- (a) self-referential under interpretation—in the sense of the above quote from Gödel's Introduction in [Go31]—despite his denial of any circularity; and

"Then appears the transformation internal to the second articulation: the homology between creatures and names. There I suppressed the fact that in Gödel's proof every name (arithmetic number), which is represented formally (a numeral in the formal system), has, again, its own arithmetic representation, which can, again, be formally transformed into a different numeral representing it in the formal system. My myth may have a fair degree of incestuous and cannibalistic features, but it doesn't even begin to measure up to the criss-crossing and self-reflective features included in Gödel's tour-de-force."

... Wagner: [Wgn09], §3.3. And it spirals away from Gödel's proof.

- (b) neither of the definitions can be verified by a deterministic Turing machine as yielding a valid formula of PM (or even of a first-order theory such as ZF).

Argument A is not entirely unjustified in its contentions. Such self-reference and non-constructiveness is a well-known, albeit philosophically debatable, characteristic of any set-theoretical system in which PM is interpretable.

Reason: Prima facie, the axioms of set-theoretical systems such as PM, ZF, etc. would, unlike PA (see §18.A.a., Theorem 18.1) all admit—under a well-defined interpretation, *if any*—infinite elements, in the putative domain of any such interpretation, which are not *well-definable* (by §7.F., Definition 26).

Moreover, by Gödel's self-confessed Platonism (apparent in his footnote #15 in the quote in §15.C.), we do not need to establish that his definitions of ' $[R(n); n]$ ' and ' $\overline{\text{Bew}} [R(n); n]$ ' need to be classically verifiable by a deterministic Turing machine to be valid formulas of PM (or of ZF).

However, *Argument A* needs to be distinguished from the unjustified *Argument B* with which it is often conflated:

Argument B: Gödel's formally undecidable *P*-formula, say $[(\forall x)R(x)]$ —whose Gödel-number is defined as $17Gen r$ in Gödel's proof of his Theorem VI (in eqn (13) on p.25 of [Go31])—also cannot be verified by a deterministic Turing machine to be a valid formula of Gödel's Peano Arithmetic *P* (defined on pp.9-13 of [Go31]).

³⁵⁷Though a serious momentum-breaker for aspiring scholars!

Though, to be fair to two generations of scholars who—apart from those who are able to comfortably wear the logician’s hat—have laboured in attempts to distinguish between the two *Arguments*, and to place the philosophical underpinnings of Gödel’s reasoning (in [Go31]) in a coherent perspective (see §15.F.), Gödel must, to some extent, be held responsible—even if not culpable—for the lack of a clear-cut distinction between the non-constructivity implicit in his semantic proof of arithmetical undecidability in PM, and the finitariness that he explicitly ensures for his syntactic proof of arithmetical undecidability in his Peano Arithmetic *P*.

Reason: Neither in his title, nor elsewhere in his paper, does Gödel categorically state that his goal was:

- (i) not only to incidentally demonstrate the existence of formally undecidable arithmetical propositions in PM, a system which admits non-finitary reasoning under any putative interpretation;
- (ii) but, primarily, to prevent the admittance of non-finitary reasoning—precisely that which would admit conclusions such as *Argument B*—when demonstrating the existence of formally undecidable arithmetical propositions in ‘related’ systems such as his Peano Arithmetic *P*.

He merely hints at this by stating (see quote below from pp.6-9 of [Go31]) that his demonstration of (i) is a ‘sketch’³⁵⁸ that lacked the ‘precision’ (read ‘finitism’) which he intended to achieve in (ii) by:

- (iii) weakening the implicit assumption, of the decidability of the semantic truth of PM-propositions under any well-defined interpretation of PM; the assumption which underlies his set-theoretical proof of the existence of formally undecidable arithmetical propositions in PM; and
- (iv) insisting—in his proof of the existence of formally undecidable arithmetical propositions in his Peano Arithmetic *P*—upon the introduction of a methodology for constructively assigning unique truth values to only those (primitive recursive) quantified number-theoretic assertions (#1 to #45 on pp.17-22 of [Go31]) that are bounded when interpreted over the domain \mathbb{N} of the natural numbers.

“Before we go into details, let us first sketch the main ideas of the proof, naturally without any claim to rigor. The formulas of a formal system (we restrict ourselves here to the system PM) are, considered from the outside, finite sequences of primitive signs (variables, logical constants, and parentheses or dots) and one can make completely precise which sequences of primitive symbols are meaningful formulas and which are not”

... Gödel: [Go31], p.6.

“The method of proof which has just been explained can obviously be applied to every formal system which, first, possesses sufficient means of expression when interpreted according to its meaning to define the concepts (especially the concept “provable formula”) occurring in the above argument; and, secondly, in which every provable formula is true. In the precise expression of the above proof, which now follows, we shall have the task (among others) of replacing the second of the assumptions just mentioned by a purely formal and much weaker assumption.”

... Gödel: [Go31], p.9

³⁵⁸Albeit one that is easily seen to be formalisable in a first-order set-theory such as ZF without any semantic assumptions.

From the current perspective of [An16] (see §2.) one could, not entirely unreasonably, argue—as in the putative *Argument A* above—that Gödel is misleadingly suggesting in the above quote that his definitions of ‘ $[R(n); n]$ ’ and ‘ $\overline{Bew} [R(n); n]$ ’ may be treated as yielding ‘meaningful’ formulas of PM which are well-definable constructively (in the sense of being inductively definable by a deterministic Turing machine).

However, §15.F. details precisely why such an argument would be fragile, by showing how the introduction of the boundedness Gödel insisted upon in (iv) distinguishes:

- (v) Gödel’s semantic proof of the existence of formally undecidable set-theoretical propositions in PM, which admits *Argument A*;

from:

- (vi) Gödel’s syntactic proof of the existence of formally undecidable arithmetical propositions in the language of his Peano Arithmetic P , which does not admit *Argument B*.

Moreover, we note that:

- (1) Whereas Gödel can legitimately claim³⁵⁹ that his definition of ‘ $Bew [R(n); n]$ ’ yields a formally undecidable formula in PM³⁶⁰, we cannot legitimately claim that his number-theoretic relation $Bew(x)$ is a formula in his Peano Arithmetic P .
- (2) The latter is defined by Gödel in terms of his primitive recursive relation #45, ‘ xBy ’, as:

$$\#46. Bew(x) \equiv (\exists y)yBx.$$

- (3) In Gödel’s terminology, ‘ $Bew(x)$ ’ translates under interpretation over the domain \mathbb{N} of the natural numbers as:

‘ x is the Gödel-number of some provable formula $[F]$ of the Peano Arithmetic P ’.

- (4) However, unlike Gödel’s primitive recursive functions and relations #1 to #45, both ‘ $(\exists y)yBx$ ’ and ‘ $\neg(\exists y)yBx$ ’ are number-theoretic relations which are not primitive recursive—whence they are not effectively decidable by a Turing machine under interpretation in \mathbb{N} .
- (5) *Reason*: There is no bound on the quantifier ‘ $(\exists y)$ ’ in the definition of $Bew(x)$, whereas Gödel ensured such bounds in his definitions #1 to #45:

“Everywhere in the following definitions where one of the expressions (x) , (Ex) , εx occurs it is followed by a bound for x . This bound serves merely to assure the recursive nature of the defined concept (cf. Theorem IV). On the other hand the extension of the defined concept would, in most cases, not be changed by omission of this bound.”

... Gödel: [Go31], p.17, fn.34.

³⁵⁹Albeit non-constructively, and despite an implicit element of circularity arising from the platonic assumption of a pre-existing ontology under any well-defined interpretation, as implied in *Argument A*.

³⁶⁰Or in a set theory such as ZF by some axiom of separation corresponding to: “... for any set x and class Y , there is a set consisting of the common elements of x and Y .” ([Me64], p.168).

Hence, by Turing's Halting Theorem (see §21.F.b., Corollary 21.5), we cannot claim—in the absence of specific proof to the contrary—that there must be some deterministic Turing machine which will determine whether or not, for any specified natural number m , the assertion $Bew(m)$ is true under interpretation in \mathbb{N} .

This is the crucial difference between Gödel's semantic proof of the existence of formally undecidable set-theoretical propositions in PM (which admits *Argument A*), and Gödel's syntactic proof of the existence of formally undecidable arithmetical propositions in the language of his Peano Arithmetic P (which does not admit *Argument B*).

(6) We cannot, therefore—in the absence of specific proof to the contrary—claim by Gödel's Theorems V or VII that there must be some P -formula, say $[Bew_P(x)]$ (corresponding to the PM-formula $Bew[R(n) : n]$), such that, for any specified natural number m :

- (a) If $Bew(m)$ is true under interpretation in \mathbb{N} , then $[Bew_P(m)]$ is provable in P ;
- (b) If $\neg Bew(m)$ is true under interpretation in \mathbb{N} , then $[\neg Bew_P(m)]$ is provable in P ;

where $[Bew_P(x)]$ is a formula of P which is recursively definable strictly in terms of *only* the primitive symbols of P by Gödel's definition:

"We define the class of formulas as the smallest class to which all elementary formulas belong and to which $\sim (a)$, $(a) \vee (b)$, $x \prod (a)$ (where x is an arbitrary variable) also belong whenever a and b belong."

... Gödel: [Go31], p.11.

Comment 138. We note that, by Gödel's stringent definition (which corresponds to the stipulation that the Peano Arithmetic PA is first-order), except Gödel's definitions #1-#3 ([Go31], pp.17-18), none of his primitive recursive functions and relations #4-#45 ([Go31], pp.18-22) can be treated as formulas of P ³⁶¹, since they all contain the factorial symbol '!' which is not a primitive symbol of P :

"The primitive symbols of the system P are the following:

- I. Constants: " \sim " (not), " \vee " (or), " \prod " (for all), " 0 " (zero), " f " (the successor of), " $($ ", " $)$ " (parentheses).
- II. Variables of the first type (for individuals, i.e. natural numbers including 0): " x_1 ", " y_1 ", " z_1 ", ...
 Variables of the second type (for classes of individuals): " x_2 ", " y_2 ", " z_2 ", ...
 Variables of the third type (for classes of classes of individuals): " x_3 ", " y_3 ", " z_3 ", ...
 ...
 — Etc., for every natural number as type."

... Gödel: [Go31], p.10.

Comment 139. We note the assumption, 'that there must be some P -formula, say $[Bew_P(x)]$ (corresponding to the PM-formula $Bew[R(n) : n]$)', is seemingly implicit in the following excerpt—from Virgil Drăghici's 2023 text [Drg23]—if we treat Gödel's formal system P in [Go31] as the first-order Peano Arithmetic PA; thus allowing him to conclude that his Gödelian sentence ' $R_q(\bar{q})$ is self-referential, asserting about itself that it is not provable in PA^{ax}'.

³⁶¹In other words, they can only be represented/expressed in P by *instantiationally* equivalent formulas of P as defined by Gödel's Theorem V ([Go31], p.22) and Theorem VII ([Go31], p.29).

“3. *Definition.* $x \in K =_{df} \sim \text{Bew}R_x(\bar{x})$,⁴⁴

whose meaning is the following: “ x is a number in K iff the formula obtained from the x th class sign in the above enumeration, i.e., $R_x(x)$, is not provable for the argument x ”.

Now, since all the notions in the expression “ $\sim \text{Bew}R_x(\bar{x})$ ” are definable in L_{PA} , it follows that the relation $x \in K$ is definable in L_{PA} by a class sign. Let it be [the] q th class sign in the above enumeration, i.e., $R_q(x)$ defines $x \in K$ in L_{PA} . And then we have the following equivalence:

(**Eq**) For any x : $x \in K$ iff $\sim \text{Bew}R_x(\bar{x})$ (by 3)
iff $R_q(\bar{x})$ is true in M (by 2).

Let $x = q$ (diagonalization!). By (**Eq**) we deduce:

(**Eq***) $q \in K$ iff $\sim \text{Bew}R_q(\bar{q})$ iff $R_q(\bar{q})$ is true in M .

As can be seen, since $R_q(x)$ defines K in L_{PA} , the sentence $R_q(\bar{q})$ says that $q \in K$ (by 2), and therefore that it is not provable (by 3). Hence $R_q(\bar{q})$ is self-referential, asserting about itself that it is not provable in PA^{ax} .

... Drăghici: [Drq23], §The Gödelian sentence G , p.202.

15.F. Is Gödel’s reasoning unverifiable?

Giving credence to §15.E., *Argument A*—which suggests that some scholars may yet harbour a lingering suspicion that Gödel’s arithmetical definition of his formally undecidable arithmetical proposition $[(\forall x)R(x, p)]$ ³⁶² may also involve a latent contradiction, arising from a putative, implicit, circular self-reference that is masked by unverifiable, even if not patently invalid, mathematical reasoning—the following proof of Gödel’s Theorem VI of his 1931 paper [Go31] is intended to:

- (a) strip away the usual mathematical jargon that shrouds proofs of Gödel’s argument which make his—admittedly arcane—reasoning difficult for a non-logician to unravel;

and:

- (b) show that, and why—unlike in the case of the paradoxical ‘Liar’ sentence: ‘This sentence is a lie’—Gödel’s proposition $[(\forall x)R(x, p)]$ does not involve any circular self-reference that could yield a Liar-like contradiction, either in a formal mathematical language, or when interpreted in any language of common discourse.

Comment 140. If we give credence³⁶³ to a thesis of this investigation, namely that mathematics *seeks* a language which must *serve* natural science and philosophy (see §13.C.), then:

- it is incumbent upon mathematicians and logicians to pay adequate heed to, and help mitigate, by appropriate articulation,
- the difficulties faced in understanding the strictures imposed by mathematical languages on the intellectual pursuits and perspectives of scholars³⁶⁴ in philosophy and the natural sciences who, ultimately,
- undertake the responsibility of providing to lay societies a coherent perspective of their observations and conceptions, of a common external reality,

³⁶²Defined by its Gödel number 17 *Gen r* in [Go31], p.25, eqn.13.

³⁶³With apologies to the shades of G. H. Hardy ([Har40])!

³⁶⁴Such as, for instance, [Cat07]; [Hej18]; [Pel18]; [Pel19].

- in mathematical languages that can be relied upon for ensuring unambiguous and effective communication in practical endeavours, and situations,
- that are subject to, and adjudicated within, systems of common law.

For instance, we note that the consequences of what we have termed as Gödel’s ‘implicit obfuscation’ can misleadingly influence not just casual, and essentially inconsequential, philosophical interpretations of Gödel’s reasoning and the conclusions he draws from it³⁶⁵, but also admit serious misinterpretations in scholarly dissertations in other disciplines that find it necessary to situate both the syntactic, and semantic, reasoning of Gödel’s [Go31]—and their purported entailments—in a coherent perspective that appeals, essentially in good faith, to formal logic (such as, for instance, the first-order logic FOL) for providing the firm foundation such disciplines seek which could enable them to ground their own formal argumentation in, ideally, a categorically communicable language.

A striking instance is Roy Wagner’s assertion, reflecting cogent semiotic argumentation in his ‘Post-Structural Readings of a Logico-Mathematical Text’ [Wgn08], that:

“§9 Gödel’s undecidable formula doesn’t exist

But we make one more observation. Even if we could decide whether the undecidable formula was a formal text, a number, the numeral representing it, or any former or further encoding, there is still no undecidable proposition. One might have been led to believe that there was, had Gödel not devoted no less than five different footnotes stressing the claim that, despite the fact that the undecidable proposition is only denoted, represented, abbreviated in the text—despite all this the undecidable proposition can actually be written down. But it can’t. It’s too long. It contains too many signs. The undecidable proposition has too many signs in it to be written down. And so does $S(z_p, z_p)$. And so does z_p alone. All we can do is denote them, represent them, and abbreviate them."

... Wagner: [Wgn08], p.223, §9 Gödel’s undecidable formula doesn’t exist.

It would not be unreasonable to conjecture that Wagner’s argumentation, and conclusion³⁶⁶, reflects an implicit faith (see the extract from [Wgn09] below) in the authoritative—and, as we argue, ultimately misleading—*faith-based*³⁶⁷ validation of Gödel’s interpretation of his own formal reasoning in current paradigms that can only serve to obscure further the distinction between the finitarily deterministic, *evidence-based*, ‘truth’ of an arithmetical proposition P^* *within* a *well-defined* community where (see [An16]):

³⁶⁵In [Go31] and other translations of his original 1931 paper on formally undecidable arithmetical propositions such as [Hei76].

³⁶⁶Which Professor Wagner clarifies in private correspondence with the author as follows:

“My observation that you quote (which is not an objection to Gödel’s argument or any of its widespread interpretations!) is not about computability, decidability, self-reference or finiteness.

My observation is about the finite but huge length of the formula.

It cannot be written down because it has finitely many, but too many characters to be actually written down.

I understand that this is not semiotically interesting from your perspective, but I believe it says something important about how mathematics works." ... Wagner: *Private correspondence*, 11th July 2021.

The misleading influence of what we have termed as Gödel’s ‘implicit obfuscation’ is reflected here in Wagner’s conclusion that Gödel’s ‘undecidable’ formula $[(\forall x)R(x, y)]$ ‘cannot be written down because it has finitely many, but too many characters to be actually written down’ since, as detailed in §15.H.j., $[(\forall x)R(x, y)]$ cannot be written down *only* because the putative Gödel number of an unspecified PA formula is not a PA term (numeral).

³⁶⁷See §7.B.

"...one can view the *values* of a simple functional language as specifying *evidence* for propositions in a constructive logic ..."

... Murthy: [Mu91], §1 Introduction.

and the formal provability of the formula $[P]$ expressing P^* in a first-order Peano Arithmetic such as PA:

"The textual components that I will attempt to bring into communication are post-structural semiotic theory and a couple of logico-mathematical texts. By 'logico-mathematical' I refer to Gödel's proof of his first incompleteness theorem. I read the proof in two versions: van Heijenoort's 1967 translation of the original paper from 1931, and the 1965 published notes of the 1934 Princeton lectures. Both versions were approved and revised by Gödel himself. References to these texts will be denoted by (1931) and (1934) respectively, and page numbers will refer to the first volume of Gödel (1986–2003). I focus almost exclusively on the proofs of the first incompleteness theorem in these texts, because they provide me with more than enough to work with. I do, however, occasionally refer to parts of the texts concerned with the second incompleteness theorem and with the construction of an arithmetic undecidable proposition.

I do not assume a familiarity with Gödel's argument, and a deep mathematical understanding of the entire argument is not necessary in order to follow this essay. Acquaintance with the elements of formal logic (propositional and predicate calculus) is, however, assumed. At some points (such as the section *The object: notion* in chapter 1) the discussion may get technical; I made an effort to contain such occurrences, and keep the text as accessible as possible to non-logicians without giving up a hands-on concrete analysis.

I use the term 'post-structural semiotics' to refer to French semiotics and discourse analysis developed between 1967 and 1974 by five prominent so-called '68 thinkers' (Foucault, Barthes, Derrida, Kristeva and Deleuze). From some of these thinkers I will borrow only guiding questions and methodologies, from others I will quote entire theoretic complexes."

... Wagner: [Wgn09], §1. *The components of this project.*

15.G. The *implicit* Query in Gödel's reasoning

We begin by noting that:

- (1) In his 1931 paper on formally 'undecidable' arithmetical propositions, Gödel shows that, given a well-defined system of Gödel-numbering, every formula of a first-order Peano Arithmetic such as PA can be Gödel-numbered by Gödel's primitive recursive relation #23, $Form(x)$, which is true if, and only if, x is the Gödel-number (GN) of a formula of PA.

Comment 141. It is important to note that ' x ' here is a variable over the natural numbers $0, 1, 2, \dots$, and not to be confused with the variable $[x]$ over the numerals $[0], [0'], [0''], \dots$ of PA.³⁶⁸

Note that whereas the numeral corresponding to any specified natural number n is represented by the PA-formula $[\bar{n}]$, expressions such as $[\bar{x}], [\bar{u}], [\bar{v}], \dots$, where $[x], [u], [v], \dots$ are PA-variables, are undefined in PA.

³⁶⁸It may be pertinent to reiterate that we use square brackets to indicate the expression inside them is to be treated purely syntactically as a 'meaningless' string of symbols, which is not to be interpreted at any stage, but manipulated purely as per the rules of substitution allowed in its construction by the first-order requirements of the formal system.

Moreover, if we study its definition in terms of Gödel's 22 earlier primitive recursive functions and relations, we will find that $Form(x)$ is a number-theoretic relation which is true if, and only if, x is a natural number that can be decomposed by Gödel's method of Gödel-numbering to yield some unique string of symbols, say $[F]$, which a Turing machine can evidence as being a well-formed formula of PA (since the well-formed formulas of a first-order system such as PA are defined recursively).

- (2) So, for any specified natural number n , (1) allows us to mechanically decompose n and effectively determine whether, or not, n is the GN of some PA formula.

Comment 142. We note that such decomposition into PA formulas cannot be defined by the PA numerals within PA, but is only definable recursively in terms of the prime properties of natural numbers as per Gödel's primitive recursive relation #5, and the correspondence between the primitive symbols of PA and the natural numbers by Gödel's system of Gödel-numbering.

- (3) Gödel also defines a primitive recursive relation #44, $Bw(x)$, which is true if, and only if, x is the GN of a finite sequence of formulas in PA, each of which is either an axiom, or an immediate consequence of two preceding formulas in the sequence.
- (4) So, for any specified natural number n , (3) allows us to effectively determine whether, or not, the natural number n is the GN of a proof sequence in PA.
- (5) Further, Gödel defines a primitive recursive relation #45, xBy , which is true if, and only if, x is the GN of a proof sequence in PA whose last formula has the GN y .
- (6) Gödel then defines a primitive recursive relation, say $xBSUBy$ ³⁶⁹, such that, for any m, n :

$mBSUBn$ is true if, and only if, m happens to be a GN that can be decomposed into a proof sequence whose last member is some PA formula $[F(\bar{n})]$, and n happens to be a GN that decomposes into the PA-formula $[F(u)]$ with only the one variable $[u]$.

- (7) The essence, and genius, of Gödel's reasoning in his Theorem VI lies in answering:

Query 15. *Is there any natural number n for which $mBSUBn$ is true?*

15.G.a. The essence, and genius, of Gödel's reasoning

Gödel's remarkable answer to Query 15 involved recognising that although—except for #1, #2 and #3—none of his 45 primitive recursive number-theoretic relations and functions (as also $xBSUBy$) are formulas of a first-order Peano Arithmetic such as PA³⁷⁰, for any specified primitive recursive number-theoretic relation, say $f(x, y)$ (which is *not* definable recursively in

³⁶⁹Which corresponds to Gödel's $xB_\kappa \left[Sb \left(y \frac{19}{Z(y)} \right) \right]$ in [Go31], eqn. (8.1), p.24.

³⁷⁰Since they are all defined in terms of the number-theoretic function 'n!', which is not definable in the restricted language of PA; see §29.(4), 'First-order language'.

the language of PA), it is possible (see Gödel's Theorems V and VII³⁷¹ in [Go31]) to define a PA-formula, say $[F(x, y)]$ ³⁷² such that, for any natural numbers m, n :

If $f(m, n)$ is true, then $[F(\bar{m}, \bar{n})]$ is provable in PA;

If $f(m, n)$ is false, then $[\neg F(\bar{m}, \bar{n})]$ is provable in PA.

(8) Thus, $xBSUBy$ can be expressed in PA by some (formally well-defined) PA-formula, say $[\neg R(x, y)]$ ³⁷³, such that, for any natural numbers m, n :

(a) If $mBSUBn$ is true, then $[\neg R(\bar{m}, \bar{n})]$ is PA-provable;

(b) If $\neg mBSUBn$ is true, then $[R(\bar{m}, \bar{n})]$ is PA-provable.

(9) Further, by (6) and (8), for any m, n , if n is the *GN* of some PA-formula $[F(u)]$ with only one variable, say $[u]$, then:

(a) If $mBSUBn$ is true, then $[\neg R(\bar{m}, \bar{n})]$ is PA-provable; and m is the *GN* of a PA-proof of the PA-formula $[F(\bar{n})]$;

(b) If $\neg mBSUBn$ is true, then $[R(\bar{m}, \bar{n})]$ is PA-provable; and m is not the *GN* of a PA-proof of the PA-formula $[F(\bar{n})]$.

(10) In his Theorem VI, Gödel then argues as follows:

(a) Let q be the *GN* of the PA-formula $[R(x, y)]$ defined in (8).

(b) Let p be the *GN* of $[(\forall x)R(x, y)]$.

(c) Let r be the *GN* of $[R(x, \bar{p})]$.

(d) Let $17Gen\ r$ be the *GN* of $[(\forall x)R(x, \bar{p})]$.

(11) We note that all the above primitive recursive functions and relations are formally well-defined recursively by Gödel's Theorems I-IV ([Go31], pp.14-17); and all the PA-formulas—as well as their corresponding Gödel-numbers—are well-defined in the first-order Peano Arithmetic PA.

In other words, as Gödel emphasised in his paper, the 46—i.e., $45 + xBSUBy$ —PRA functions and relations that he defines are all bounded, and therefore effectively decidable as true or false over the domain \mathbb{N} of the natural numbers.

Moreover, the PA-formulas that he defines do not involve any reference—or self-reference—to either the meaning or the truth/falsity of any PA-formulas under an interpretation in \mathbb{N} , but only to their PA-provability which, he shows, is effectively decidable by his system of Gödel-numbering and his definition of the primitive recursive relation xBy (see (5) above).

³⁷¹A standard representation theorem of arithmetic ([Me64], Proposition 3.23, p.131 and Corollary 3.24, p.134).

³⁷²Which *is* definable recursively in the language of PA by Gödel's Theorems VII. However, to see *why* the converse may not hold—i.e., *why* $f(x, y)$ and $[F(x, y)]$ cannot be *assumed* as 'equivalent' meta-mathematically by such definition (as a private correspondence with ultra-finitist James Geiser highlighted)—see §13.D. *When can a formal assertion claim to 'mean' what it represents?*

³⁷³We have preferred to express this formula as $[\neg R(x, y)]$, rather than as $[R(x, y)]$, in order to mirror Gödel's reasoning (without any loss of generality).

- (12) Since p is the *GN* of a formula, namely $[(\forall x)R(x, y)]$, with only the one variable $[y]$, we can substitute p for n , and therefore $[(\forall x)R(x, \bar{p})]$ for $[F(\bar{n})]$, in (9). We then have that:
- (i) If $mBSUBp$ is true, then $[\neg R(m, \bar{p})]$ is PA-provable; whence m is the *GN* of a PA-proof of $[(\forall x)R(x, \bar{p})]$, whose *GN* is p ;
 - (ii) If $\neg mBSUBp$ is true, then $[R(m, \bar{p})]$ is PA-provable; whence m is not the *GN* of any PA-proof of $[(\forall x)R(x, \bar{p})]$.

Hence $n = p$ answers **Query 15** affirmatively.

Once we accept that the above argument is constructive from even an *evidence-based* perspective, the rest of Gödel's reasoning follows straightforwardly.

15.G.b. Theorem VI: Gödel's conclusions

- (13) Gödel concludes that, if PA is consistent then:
- (a) By (12)(i), if $mSUBp$ is true for some natural number m , then both $[\neg R(m, \bar{p})]$ and $[(\forall x)R(x, \bar{p})]$ are PA-provable—a contradiction since³⁷⁴, by a logical axiom of first-order theories with quantifiers (see §29., 6(I)(4)), PA-provability of the latter entails that $[R(m, \bar{p})]$ is PA-provable by Modus Ponens.
 - (b) Hence $[(\forall x)R(x, \bar{p})]$, whose *GN* is $17Gen\ r$, is not provable in PA if PA is consistent.
- (14) Moreover, if PA is assumed to be also ω -consistent (which means that we cannot have a PA-provable formula $[\neg(\forall x)F(x)]$ such that $[F(\bar{m})]$ is also provable in PA for any specified numeral $[\bar{m}]$) then:
- (a) By (13), m is not the *GN* of any PA-proof of $[(\forall x)R(x, \bar{p})]$ for any specified m ; whence $[R(m, \bar{p})]$ is PA-provable for any specified m by (12)(ii);
 - (b) Hence $[\neg(\forall x)R(x, \bar{p})]$, whose *GN* is $Neg(17Genr)$, is not provable in PA.

Taken together with the [An16] proofs that PA is categorical (see §2.E.b., Corollary 2.18) and that PA is not ω -consistent (see §2.F., Corollary 2.22; proved independently in §12.B.f., Theorem 12.6), the above suggests that:

Thesis 8. *There can be no interpretation of Gödel's definition of his formally undecidable arithmetical proposition $[(\forall x)R(x, \bar{p})]$ over the domain \mathbb{N} of the natural numbers—whether expressed mathematically or in any language of common discourse—that could lead to a contradiction.*

15.H. Theorem XI: Where Gödel *can* be held guilty of obfuscation

Where Gödel *can*, however, be held guilty of explicit obfuscation is in both his statement and interpretation of his Theorem XI ([Go31], pp35-38):

“Theorem XI: Let κ be an arbitrary consistent class⁶³ of FORMULAS. Then the SENTENCE which asserts that κ is consistent is not κ -provable; in particular, the consistency of P is unprovable in P ,⁶⁴ assuming that P is consistent (in the contrary case, of course, every statement is provable).

³⁷⁴As highlighted during the course of a private correspondence between Catherine Christer-Hennix and the author on 2nd May 2020.

Fn63 κ is consistent (abbreviated $Wid(\kappa)$) is defined as follows: $Wid(\kappa) \equiv (Ex)[Form(x) \ \& \ \overline{Bew}_\kappa(x)]$.

Fn64 This follows when one substitutes for κ the empty class of FORMULAS."

... Gödel: [Go31], p.36.

"We have limited ourselves in this paper essentially to the system P and have only indicated the applications to other systems. The results will be expressed and proved in full generality in a sequel to appear shortly. Also in that paper, the proof of Theorem XI, which has only be sketched here, will be presented in detail."

... Gödel: [Go31], p.38.

Gödel's culpability lies in the fact that, by not providing the promised sequel in which he intended to prove his Theorem XI with the same rigour as his proof of Theorem VI, he not only overlooked a fatal flaw in his reasoning, but also emphasised in a footnote his earlier misleading conclusion (see §15.E.) that his proposition $[(\forall x)R(x, p)]$ "*asserts its own unprovability*":

"The proof is (in outline) the following: Let κ be an arbitrary recursive class of FORMULAS (in the simplest case, the empty class) which, for the following considerations, is chosen once and for all. In the proof of the fact that $17 \text{ Gen } r$ is not κ -PROVABLE,⁶⁵ only the consistency of κ is used, as can be seen from 1. on page 25; that is, we have:

$$Wid(\kappa) \rightarrow \overline{Bew}_\kappa(17 \text{ Gen } r)$$

i.e., by virtue of (6.1):

$$Wid(\kappa) \rightarrow (x)x\overline{B}_\kappa(17 \text{ Gen } r)$$

By (13), $17 \text{ Gen } r = Sb(p \ \overset{19}{Z(p)})$ and therefore:

$$Wid(\kappa) \rightarrow (x)x\overline{B}_\kappa Sb(p \ \overset{19}{Z(p)})$$

i.e., by (8.1):

$$Wid(\kappa) \rightarrow (x)Q(x, p) \tag{24}$$

Now we establish the following: All the defined concepts (proved assertions) of Section 2⁶⁶ and Section 4 are expressible (provable) in P . For, we have used throughout only the ordinary methods of definition and proof of classical mathematics, as they are formalized in the system P . In particular, κ (like every recursive class) is definable in P . Let ω be the SENTENCE by which $Wid(\kappa)$ is expressed in P . The relation $Q(x, y)$ is, according to (8.1), (9), (10), expressed by the PREDICATE q , and, consequently, $Q(x, p)$ by r (since, by (12), $r = Sb(q \ \overset{19}{Z(p)})$), and the sentence $(x)Q(x, p)$ by $17 \text{ Gen } r$.

Hence $\omega \text{ Imp } (17 \text{ Gen } r)$ is, by virtue of (24), PROVABLE in P ⁶⁷ (a fortiori, κ -PROVABLE). Now, were ω to be κ -PROVABLE, then $17 \text{ Gen } r$ would also be κ -PROVABLE, whence, by (23), it would follow that κ is not consistent.

Fn65 Of course, r (as well as p) depends upon κ .

Fn66 From the definition of "recursive" on p. 14 until the proof of Theorem VI, inclusive.

Fn67 That the truth of $\omega \text{ Imp } (17 \text{ Gen } r)$ can be deduced from (23) rests simply on the fact that the undecidable proposition $17 \text{ Gen } r$, as was remarked at the very beginning, asserts its own unprovability."

... Gödel: [Go31], pp.36-37.

The fatal flaw in Gödel's reasoning lies in his implicit assumption that there must be a *well-defined* P -formula $[\omega]$ which would admit the presumption:

“Let ω be the SENTENCE by which $Wid(\kappa)$ is expressed in P ”.

Since $Wid(\kappa)$ is the number theoretic assertion $[(Ex)(Ey)[Form(x) \& y \overline{B}_\kappa x]$, it is—like the number-theoretic assertion $Bew_\kappa(x)$ —not primitive recursive. Hence we cannot (see §15.E.(6)) conclude that:

- (a) If $Wid(\kappa)$ is true under interpretation in \mathbb{N} , then $[\omega]$ is provable in P ;
- (b) If $\neg Wid(\kappa)$ is true under interpretation in \mathbb{N} , then $[\neg\omega]$ is provable in P .

In other words, for Gödel's claim in, and interpretation of, his Theorem XI to be justified, his reasoning must not only show that:

- (i) The number-theoretic assertion ‘ $[Wid(\kappa)]$ ’ can be expressed by some formula of P as above;

but also that:

- (ii) Under any *well-defined* interpretation of P , $[\omega]$ must be shown to interpret as an assertion which formally implies that κ is consistent.

Neither of these follows unambiguously from Gödel's outline of his proof of Theorem XI. As remarked by Mendelson:

“One of the consequences of Feferman's work (1960) is the following precise version of Gödel's Second Theorem: Let K be a consistent extension of S . Let K_1 be any theory such that is an extension of K_1 and K_1 is an extension of Robinson's system Q . (In particular, k_1 may be S or K itself.) Let T_K be the set of Gödel numbers of theorems of K , and assume that $\mathcal{A}(x)$ is an RE-formula which expresses T_K in K_1 . Then $\text{not-}\vdash_K \text{Con}_{\mathcal{A}}$ (The assumption that $\mathcal{A}(x)$ is an RE-formula is shown to be necessary by Feferman's proof ([1960], Corollary 5.10) that there is a wf $\mathcal{B}(x)$ which expresses T_S in S such that $\text{Con}_{\mathcal{A}}$.)”

... Mendelson: [Me64], p.149.

In other words, the necessity of establishing that $[\omega]$ is a *well-defined*, recursively enumerable, P -formula was highlighted in 1960 by Feferman³⁷⁵:

“5.10. COROLLARY. *There is a π^* which bi-numerates P in \mathcal{P} for which*

$$\vdash_{\mathcal{P}} \text{Con}_{\pi^*}^*.$$

Rather than contradicting Gödel's second underivability theorem, 5.9 and 5.10 show the importance of a precise method of dealing with consistency statements, at any rate for theories with infinitely many axioms. We have maintained that insofar as a formula a expresses membership in A , the formula Pr_a^* expresses provability of \mathcal{A} in $\mathcal{M}(\mathcal{P})$ and the sentence Con_a expresses the consistency of \mathcal{A} in \mathcal{M} and \mathcal{P} . Thus, one particular conclusion we can draw is that the formula a^* , although it extensionally corresponds to A , does not properly express membership in \mathcal{A} . Indeed, inspection of the proof of 5.9 reveals that it expresses membership in a certain subsystem of A which, independent of the consistency of \mathcal{A} , is always consistent.

³⁷⁵In the extract below we have replaced Feferman's symbolism of ‘Con’ with an asterisk * below by Con^* ; his ‘Pr’ with an asterisk * below by Pr^* ; and his ‘ \sim ’ with an asterisk * below with \sim^* .

A first reaction following such realizations might be to restrict attention to a certain class of “natural” formulas a in problems of arithmetization; 5.6 suggests that the class of *RE*-formulas or some subclass of it might be appropriate for this purpose. However, we shall obtain in §6 results through the use of arbitrary formulas a which should be of interest even to those who would otherwise thus restrict attention. There is nothing “wrong” with the use of arbitrary formulas a ; rather, the guiding consideration should be to investigate how different restrictions on the choice of a affect the results of the arithmetization.

Let us return to the proof of 5.9. Although the arguments on the grounds of expressibility give us one way of seeing why the theorem is possible, we should also ask why it is not possible to carry through the proof of

$$\text{Con}_{a^*}^* \rightarrow v_{a^*},$$

as in 5.6

$$\sim v_{a^*} \rightarrow \text{Pr}_{a^*}^*(\sim^* \overline{v_{a^*}}),$$

which corresponds to the essential step in the proof of 5.6. Nevertheless, by the remark following 5.5, we shall be able to prove

$$\sim v_a \rightarrow \text{Pr}_a^*(\sim^* \overline{v_a}),$$

when a is an *RE*-formula."

... Feferman: [Fe60], Corollary 5.10, pp.59-60.

From the restrictions of *evidence-based* reasoning that underpin this investigation, Feferman’s remark that:

“There is nothing “wrong” with the use of arbitrary formulas a ; rather, the guiding consideration should be to investigate how different restrictions on the choice of a affect the results of the arithmetization.”

cautions about the possibility of unintended, non-constructive, consequences being entailed by admitting an arbitrary formula a into formal reasoning; as has been argued for the postulation of an *unspecified* value in classical, *faith-based* (see §7.B.), existential quantification—e.g., by appeal to Hilbert’s ε -function (see §10.A.), or to Rosser’s Rule C (see §8.G.)—without *evidencing* that such an *unspecified* value is *specifiable*—i.e., *well-defined* (see §7.F.; also Theorem 7.5)—by the rules that circumscribe the domain of the quantifier.

15.H.a. Why Gödel’s interpretation of his Theorem XI is classically objectionable

Specifically, in his Theorem XI, Gödel constructs a formula $[\omega]$ in P and *assumes without proof* that $[\omega]$ translates—under some *well-defined* interpretation of P —as an arithmetical proposition that is true if, and only if, some *unspecified* formula of P is unprovable in P .

Now, even if there *were* such a P -formula, then its significance would be questionable since:

- (a) If P were inconsistent then every well-formed formula of the system—including $[\omega]$ and $[\neg\omega]$ —would be provable; whence a proof sequence for $[\omega]$ within P would have no significance.
- (b) If P were consistent then whether or not $[\omega]$ is P -provable would be a trivial consequence, since the significance of such decidability under any well-defined interpretation of P would be conditional on P being consistent!

However, without establishing that there is, or can be, such a P -formula, Gödel lays unqualified claim to—and treats as significant—the conclusion that the consistency of any consistent formal system of Peano Arithmetic is not provable within the Arithmetic; a claim which immediately invites classical objection on the grounds of latent, and possibly lethal, impredicativity in Gödel’s underlying assumption.

Curiously, Gödel’s assumption and argumentation thus invites the very same objection—that they ‘do not establish what he wanted them to show’—which, according to Vera Flocke ([Flo19]), he reportedly raised against a prospective program for the foundations of mathematics proposed, and summarised, by Rudolf Carnap at a meeting on September 5, 1930, at the famous congress in Königsberg where:

“... a little later in the same roundtable discussion, Gödel used the very first public statement of the first incompleteness theorem specifically to raise a problem for Carnap’s view.³⁵ He says:

“One can even (assuming the consistency of classical mathematics) give examples of sentences (of the same kind as Goldbach’s and Fermat’s) that are actually true [inhaltlich richtig], but not derivable within the formal system of classical mathematics. Adding the negation of such a sentence to the axioms of classical mathematics, one obtains a consistent system in which a sentence is derivable that is actually false [inhaltlich falsch].” (Hahn et al, 1931, p. 148)

Gödel here effectively points out that the axiom system of Peano Arithmetic is forkable, whereas Carnap (2000) argues that this system is decidable on the grounds that it is categorical. However, care is required to identify the mistake in Carnap’s view, since his notion of completeness is different from the one that is standard today. Specifically, Carnap (2000) does not distinguish between the axiom system that is under investigation and the system that is used to carry out the investigation (see Awodey and Carus, 2001, §4). Given this shortcoming, Carnap’s results do not establish what he wanted them to show. For instance, Carnap formalizes ‘axiom system f is consistent’ as follows: $\neg\exists g(f \rightarrow g \wedge f \rightarrow \neg g)$. The provability of this formula in the system that is used to carry out the investigation is not equivalent with the consistency of the axiom system under consideration. The main mistake in Carnap’s results hence is not that they are invalid (they aren’t) but rather that they are unsound and do not establish what’s intended (see Awodey and Carus, 2001, p. 159).³⁶

... Flocke: [Flo19], §3 Carnap’s pre-Syntax Philosophy of Mathematics.

15.H.b. Defining meta-propositions of P number-theoretically

To recap a little, Gödel first shows how 46 meta-propositions of P can be defined by means of primitive recursive functions and relations ([Go31], pp.17-22). These include:

(#23) A primitive recursive relation, $Form(x)$, which is true if, and only if, x is the Gödel-number of a formula of P ;

(#45) A primitive recursive relation, xBy , which is true if, and only if, x is the Gödel-number of a proof sequence of P whose last formula has the Gödel-number y .

Gödel assures the constructive nature of the first 45 definitions by specifying:

“Everywhere in the following definitions where one of the expressions ‘ $\forall x$ ’, ‘ $\exists x$ ’, ‘ ϵx (There is a unique x)’ occurs it is followed by a bound for x . This bound serves only to assure the recursive nature of the defined concept.”

... Gödel: [Go31], p.17, footnote 34.

Gödel then defines a meta-mathematical proposition that is not primitive recursive:

(#46) A proposition, $Bew(x)$, which is true if, and only if, $(\exists y)yBx$ is true.

Thus $Bew(x)$ is true if, and only if, x is the Gödel-number of a provable formula of P .

15.H.c. Expressing primitive recursive functions and relations in P

Now, by Gödel's Theorem VII ([Go31], p.29), any primitive recursive number-theoretic relation, say $Q(x)$, can be represented in P by some arithmetical formula, say $[R(x)]$, such that, for any natural number n :

If $Q(n)$ is true, then $[R(n)]$ is P -provable;

If $Q(n)$ is false, then $[\neg R(n)]$ is P -provable.

However, Gödel's reasoning in the first half of his Theorem VI ([Go31], p.25(1)) establishes that the above representation does not extend to the closure of a recursive relation, in the sense that we cannot assume:

If $(\forall x)Q(x)$ is true (i.e, $Q(n)$ is true for any specified natural number), then $[(\forall x)R(x)]$ is P -provable.

In other words, we cannot assume that, even though the recursive relation $Q(x)$ is instantiationally equivalent to a well-defined interpretation of the P -formula $[R(x)]$, the number-theoretic proposition $(\forall x)Q(x)$ must, necessarily, be logically equivalent to the well-defined interpretation of the P -formula $[(\forall x)R(x)]$.

Reason: In recursive arithmetic, the expression ' $(\exists x)F(x)$ ' is an abbreviation for the assertion:

(*) There is some (at least one) natural number n such that $F(n)$ holds.

In a formal Peano Arithmetic such as P , however, the formula ' $[(\exists x)F(x)]$ ' is simply an abbreviation for ' $[\neg(\forall x)\neg F(x)]$ ' which, under a well-defined finitary interpretation of the Arithmetic, translates as:

(**) The relation $\neg F(x)$ is not algorithmically *computable* as always true.

Moreover, Gödel's Theorem VI establishes that we cannot conclude (*) from (**) without risking inconsistency.

Consequently, although a primitive recursive relation may be instantiationally equivalent to a well-defined interpretation of a P -formula, we cannot assume that the existential closure of the relation must have the same meaning as the interpretation of the existential closure of the corresponding P -formula³⁷⁶.

However this, precisely, is the presumption made by Gödel in the proof of his Theorem XI, from which he concludes that the consistency of P can be expressed in P , but is not P -provable.

³⁷⁶See also §13.D., *When can a formal assertion claim to 'mean' what it represents?*

15.H.d. Ambiguity in the interpreted ‘meaning’ of formal mathematical expressions

The ambiguity in the ‘meaning’ of formal mathematical expressions containing unrestricted universal and existential closure under an interpretation (see also §13.D.b.) was emphasised by Wittgenstein:

“Do I understand the proposition “There is ...” when I have no possibility of finding where it exists? And here there are two points of view: as an English sentence for example I understand it, so far, that is, as I can explain it (and note how far my explanation goes). But what can I do with it? Well, not what I can do with a constructive proof. And in so far as what I can do with the proposition is the criterion of understanding it, thus far it is not clear in advance whether and to what extent I understand it.”

... Wittgenstein: [W74], p.299.

To see the significance of Wittgenstein’s rhetorical protestation, we note that Gödel defines the notion of “ P is consistent” classically as follows:

P is consistent if, and only if, Wid_P is true

where Wid_P is expressed symbolically as the number-theoretic assertion:

$$(\exists x)(Form(x) \wedge \neg Bew_P(x))$$

This translates as:

There is a natural number n which is the Gödel-number of some *unspecified* formula of P , and this formula is not P -provable.

Thus, Wid_P is true if, and only if, P is consistent.

15.H.e. Gödel’s *fragile* presumption: “ P is consistent” is always expressible in P

However, Gödel, then, presumes without proof that:

- (i) Wid_P can be represented by some formula $[\omega]$ of P such that the assertion “[ω] is true over \mathbb{N} (under a well-defined interpretation of P)” is logically equivalent to the assertion that “ Wid_P is true over \mathbb{N} ”;
- (ii) if the recursive relation, $Q(x, p)$ ([Go31], p24(8.1)), is represented by the P -formula $[R(x, p)]$, then the proposition “[$(\forall x)R(x, p)$] is true over \mathbb{N} (under a well-defined interpretation of P)” is logically equivalent to (i.e., has the same meaning as) the number-theoretic assertion “[$(\forall x)Q(x, p)$] is true over \mathbb{N} ”.

15.H.f. Gödel’s formula $[(\forall x)R(x, p)]$ does not assert its own unprovability

Now, although, §15.H.e.(ii):

- (a) does follow if “[$(\forall x)R(x, p)$] is true over \mathbb{N} ” interprets, under some *well-defined* interpretation of P where the formula $[R(x, p)]$ interprets as the arithmetical relation $R^*(x, p)$, as:

“ $R^*(x, p)$ is algorithmically *computable* as always true over \mathbb{N} ”,

(b) it does not if “ $[(\forall x)R(x, p)]$ is true over \mathbb{N} ” interprets as:

“ $R^*(x, p)$ is algorithmically *verifiable* as true for any specified natural number n , but it is not algorithmically *computable* as true for any specified natural number n ”.

So IF , and only IF , $[\omega]$, too, interprets as an arithmetical proposition that is algorithmically *verifiable* as true, but not algorithmically *computable* as true, then the consistency of P *MIGHT* be provable instantiationally in P .

Hence, at best, Gödel’s reasoning can only be taken to establish that the consistency of P is *not* expressible as a P -formula that is algorithmically *computable* as true under some well-defined interpretation of P .

Gödel’s broader conclusion only follows if P purports to prove its own consistency by means of a P formula that *is* algorithmically *computable* as true under some *well-defined* interpretation of P .

However, Gödel’s particular argument, based on his definition of Wid_p , does not support this claim. In other words:

Theorem 15.2. *Gödel’s P -formula $[(\forall x)R(x, p)]$ does not assert its own unprovability in P .*

Proof. We have for Gödel’s primitive recursive relation $Q(x, y)$ that:

(a) $Q(x, p)$ is true if, and only if, the P -formula $[R(x, p)]$ is not provable in P .

Comment 143. In Gödel’s terminology, ‘ $Q(x, p) \equiv xB_{\kappa}[Sb(p \frac{19}{Z(p)})]$ ’ ([Go31], p.24, eqn.(8.1)).

Further, Gödel’s Theorem VI establishes that, if P is consistent, then (see §2., Definition 7):

(b) The arithmetical interpretation $R^*(x, p)$ of the P -formula $[R(x, p)]$ is algorithmically *verifiable* as always true over the structure \mathbb{N} of the natural numbers.

Comment 144. An immediate consequence, in Gödel’s terminology, of ‘ $(n)Bew_{\kappa}[Sb(r \frac{17}{Z(n)})]$ ’ ([Go31], p.26, #2).

Now, in order to conclude that the P -formula $[(\forall x)R(x, p)]$ asserts its own unprovability in P , Gödel’s argument must further imply the stronger meta-statement (see §2., Definition 10):

(c) The arithmetical interpretation $R^*(x, p)$ of the P -formula $[R(x, p)]$ is algorithmically *computable* as always true over the structure \mathbb{N} of the natural numbers,

from which we may then conclude that:

(d) The primitive recursive relation $Q(x, p)$ is algorithmically *computable* as always true if, and only if, the arithmetical interpretation $R^*(x, p)$ of the P -formula $[R(x, p)]$ is algorithmically *computable* as always true over the structure \mathbb{N} of the natural numbers.

However, this is not possible since (c) and (d) would then yield the contradiction:

- (e) By the Provability Theorem for PA (§2.E.b., Theorem 2.17), $(\forall x)Q(x, p)$ is true (i.e., $Q(x, p)$ is algorithmically *computable* as always true) if, and only if, the P-formula $[(\forall x)R(x, p)]$ is provable in P;

whereas:

- (f) By definition ([Go31], p.24, eqn.8.1), if $(\forall x)Q(x, p)$ is true, then the P-formula whose Gödel-number is p , i.e., the formula $[(\forall x)R(x, y)]$, is not provable in P when the numeral $[p]$ is substituted for the variable $[y]$ (in other words, the formula $[(\forall x)R(x, p)]$ is not provable in P).

The theorem follows. □

The significance of §15.H.f., Theorem 15.2, is that current paradigms uncritically accept Gödel's presumption in Theorem XI (see §15.H.e.(i)) as sufficient *validation* of his original intent, as suggested by his concluding remarks in [Go31]:

“We have limited ourselves in this paper essentially to the system P and have only indicated the applications to other systems. The results will be expressed and proved in full generality in a sequel to appear shortly. Also in that paper, the proof of Theorem XI, which has only been sketched here, will be presented in detail.”

... Gödel: [Go31], p.38.

However, assuming that the argumentation of §15.H.f., Theorem 15.2, would apply to 15.H.e.(i) had Gödel defined $[\omega]$ explicitly—as he had defined $R(x, p)$ —we conclude that, at best, Gödel's reasoning can only be taken to establish that the consistency of P is not provable in P by a P-formula that interprets as an algorithmically *computable* truth in \mathbb{N} .

In other words—contrary to conventional wisdom (e.g., [Smi13]³⁷⁷, p.234; [Hd06]³⁷⁸, p.382; [Bs98]³⁷⁹, p.118; [Liy22]³⁸⁰; [Sm92], p.109; [Vo10]; [EC89], Theorem 5, p.211; [Da82], p.129;

³⁷⁷“In Section 21.5 we proved the following (it's the easier half of the First Theorem):

If PA is consistent, then G is not provable in PA.

We now know that one way of representing the antecedent of this conditional in L_A is by the formal wff we are abbreviating as Con , while the consequent can of course be represented by $\neg Prov(\ulcorner G \urcorner)$. So, in sum, the wff:

$$Con \rightarrow \neg Prov(\ulcorner G \urcorner)$$

expresses one half of the incompleteness theorem for PA, and does so *inside* L_A , the language of PA itself.”

... Smith: [Smi13], §31.2 The Formalized First Theorem in PA, p.234.

What is particularly noteworthy here, from the *evidence-based* perspective of §5.A. and §7.B., is Smith's claim (in [Smi13], p.234) to a *knowledge* that, at best, can only claim to be a ‘Justified True Belief’, and not the ‘Factually Grounded Belief’ that Smith, presumably, intended.

³⁷⁸“The previous proposition provides an alternative proof for Gödel's First Incompleteness theorem. For any recursive subset T of T_N , the sentence λ that assert[s] “I am not provable from T ” must be both true and not provable from T . This is the proof Gödel originally gave for the First Incompleteness theorem. The Second Incompleteness theorem is deduced by showing that λ and $\neg Pr_T(t_c)$ are T -equivalent.”

... Hedman: [Hd06], §8.5 Gödel's Second Incompleteness theorem, p.382.

³⁷⁹“**2.2.1. The Gödel diagonal lemma.** The Gödel diagonal, or fixpoint, lemma is a crucial ingredient in the proof of the incompleteness theorems. This lemma states that, for any first-order property A , there is a formula B that states that the property A holds of the Gödel number of B . Thus, since we know that provability is a first-order property, it will be possible to construct a formula which asserts “I am not provable”.”

... Buss: [Bs98], §2.2. The Gödel Incompleteness theorems.

³⁸⁰“As a proof, Gödel gave a paradox similar in nature to the Liar's paradox : a proposition Q asserting about itself that it is unprovable.”

... Li: [Liy22], 1. Introduction

[Sh67], pp.212-213; [Me64], p.148; [Drg23]³⁸¹, p.202)—Gödel’s particular argument, based on his definition of $Wid(P)$, does not support the broader claim of his Theorem XI that, under any *well-defined* interpretation of his system P , his P -formula ω asserts that P is simply consistent; or that ω is *unprovable* in P .

15.H.g. ‘Inherited’ limitations of the ‘implicit obfuscation’ in Gödel’s interpretation of his own reasoning

The unsuspected, essentially ‘inherited’, limitations of what we have argued above as—albeit unintended—‘implicit obfuscation’ in Gödel’s interpretation of his own reasoning in [Go31], are critically evidenced when they can be explicitly seen to limit attempts by emerging scholars—in disciplines that uncritically appeal to classical paradigms—to uncover the foundational boundaries in the application of the first-order logic FOL, and the first-order Peano Arithmetic PA, to their disciplines.

For instance, in the dissertation for her Master’s thesis, philosopher Stella Moon uncritically accepts in good faith—the significance of which is highlighted in §7.B.—current paradigms concerning the entailments of Gödel’s ‘undecidable arithmetical propositions’ for achieving a coherent perspective of what can be believed as ‘true’, and what can be treated as ‘proven’, within the axiomatic or pre-formal (see §1.A.) assumptions of her discipline:

“Assuming that the readers are familiar with the formal statement and proofs of Gödel’s incompleteness theorems, I will informally remind the readers how Gödel sentences are obtained from the system PA before discussing Isaacson’s ‘hidden higher-order concepts’. For more technical details on Gödel’s incompleteness theorems, one should see (Kaye[1991]). Gödel (and later with Rosser’s modification) famously proved that any consistent formal system containing some basic arithmetic, that can be recursively axiomatised, cannot prove its own consistency. The result is obtained by defining a predicate that represents ‘provability’ in the language of arithmetic for the given system, and using the method of coding to represent a sentence composed in finitely many symbols as a single natural number. This method allows the system to refer to its own theorems, and thus formulate a sentence that represents ‘This sentence is not provable’ via diagonalisation. We call the sentences of this form, or those that are equivalent in PA to these sentences, *Gödel sentences*.”

... Moon: [Mon17], §3.1.1 Higher-order concepts.

From an *evidence-based* perspective, such uncritical acceptance³⁸² of what Gödel and Rosser had actually proven formally (as distinct from their claims; see §17.; also §8.G., Corollary 8.21³⁸³) *misleads* Moon into arguing—invalidly³⁸⁴ by virtue of [An16], Corollary 7.2 (see also §2.E.b.,

³⁸¹“**Remark 2.** The same result as to the construction of the sentence G and proving its undecidability in PA^{ax} can be obtained using the relation $R_1(n, y)$:⁵⁶ “ n is the Gödel number of a formula $\alpha(x_1)$, with x_1 free, and y is the Gödel number of a proof of its diagonalization: $\alpha(\bar{n})$ ”. Since it is primitive recursive, there is a formula $\beta(x_1, x_2)$ which formally expresses it in PA^{ax} . Let us consider the formula $\forall x_2 \neg \beta(x_1, x_2)$ whose Gödel number is k . Let $G = \forall x_2 \neg \beta(\bar{k}, x_2)$. As can be seen, the meaning of G is “the *diagonalization* of the formula with Gödel number k , i.e., G itself, is not provable”. Hence G is asserting its own unprovability in PA^{ax} .”

This was also the way Gödel constructs its undecidable sentence $G = \forall x Q(x, \bar{p})$. It is the diagonalization of the formula with Gödel number p : $\forall x Q(x, y)$ and according to the meaning of the relation $Q(x, y)$, G asserts its own unprovability.”

... Drăghici: [Drg23], §The Gödelian sentence G , p.202.

³⁸²Evidenced also in her explicit appeal to Kaye [1991], which is shown in §18. to misleadingly argue for the existence of non-standard models of the first-order Peano Arithmetic PA.

³⁸³§8.G., Corollary 8.21: Rosser’s Rule C is *stronger* than Gödel’s ω -consistency.

³⁸⁴An *invalid* argument, however, for which Moon—when wearing her philosopher’s hat (see §13.C.)—should not be held accountable (for reasons detailed in §15.A. and §18.). Like Wittgenstein, Lucas, Penrose and others

Corollary 2.18: PA is categorical)—that she can provide a proof ‘that there is no maximal theory of arithmetic that can be captured from second-order categorical axiomatisations’:

“§1.1 Outline of the thesis

In chapter 6, I will give a proof that there is no maximal theory of arithmetic that can be captured from second-order categorical axiomatisations. This result challenges the completeness statement of Isaacson’s thesis, since even if we can provide a formal result satisfying the soundness thesis, we cannot do so for the completeness thesis. But the proof I will give in this chapter relies on capturing the statements that are already independent from Peano arithmetic. This feature of the proof suggests that the formal result does not establish that Isaacson’s completeness thesis is incorrect. The main focus of this chapter will be to answer the following question:

Question 1. *Are there restricted categorical axiomatisations whose first-order counterparts are mutually independent? Wilkie’s Theorem in effect says that the first-order counterpart of second-order Peano arithmetic is minimal amongst such axiomatisations. Can it be shown that there is no maximal such one?*

We will conclude the thesis, in chapter 7, with a summary of what we obtained, and also with some open questions related to Isaacson’s thesis and the results. One potential direction is to extend the results in the thesis to ZFC¹. If this were achieved, it might give us a new way to understand what is part of mathematical knowledge and understanding.

I have assumed some reasonable background knowledge in first-order Peano arithmetic throughout the thesis. This includes the materials covered in (Kaye [1991, ch.1—9])."

... Moon: [Mon17], §1.1 Outline of the thesis.

“§3.1 Isaacson’s thesis

In this section, we outline two different formulations of Isaacson’s thesis. The idea behind Isaacson’s thesis has been developed through (Isaacson [1987]), (Isaacson [1992]) and (Isaacson [1994]). The formulations of Isaacson’s thesis I will discuss here can be found in (Smith [2008]) and (Incurvati [2008]). Incurvati states Isaacson’s thesis as:

PA is sound and complete with respect to ‘arithmetical truths’ (Incurvati [2008, p. 3]);

while Smith formulates Isaacson’s thesis as:

If we are to give a proof for any true sentence of \mathcal{L}_a which is independent of PA, then we will need to appeal to ideas that go beyond those that are required in understanding PA (Smith [2008, p. 1]),

where \mathcal{L}_a denotes the language of first-order arithmetic. In some sense, we can consider these statements to be equivalent to each other—we can take ‘understanding PA’ to mean ‘arithmetical’, and obviously if PA is ‘sound and complete’ then anything that is ‘independent of PA will require appealing to ideas going ‘beyond those that are required in understanding PA’. But with these formulations we still need to know what ‘arithmetical truths’ (Incurvati [2008]) and ‘ideas [going beyond] understanding PA’ (Smith [2008]) really mean."

... Moon: [Mon17], §3.1 Isaacson’s thesis.

“§5.1 Wilkie’s Theorem

of similar ilk (see [An07b], [An07c]) she can, in this instance, be excused for depending upon fallible classical and intuitionistic wisdom (see §5.) to the effect that a Peano Arithmetic such as PA can admit non-standard models.

Theorem 31 (Wilkie’s theorem (1987)). *Let $\Phi(X)$ be a restricted L_2 -formula and $\forall X\Phi(X)$ is categorical for \mathbb{N} for some finite T . Then there is a finite set T_1 of L_1 -sentences with $\mathbb{N} = T_1 + \text{Scheme}(\Phi) \vdash PA^1$.*

The above theorem tells us that Isaacson’s argument for PA^1 ’s significance as a genuinely complete theory might be based on an unstable ground. If PA is genuinely complete, there should not be another restricted categorisation that is stronger than PA . But Wilkie’s theorem only gives us that PA is the weakest such theory and leaves open whether it is also the maximal such theory. In the current chapter, I will present the proof of Wilkie’s theorem. And in the following chapter, I will present a proof that suggests that PA is not the maximal *genuinely complete* theory for arithmetic."

... Moon: [Mon17], §5.1 Wilkie’s Theorem.

A more serious consequence—from the *evidence-based* perspective of the Complementarity Thesis (§1., Thesis 1—is that a *faith-based* reliance on current paradigms concerning the validity of Gödel’s ‘undecidable arithmetical propositions’ obscures that although ZF admits such propositions (see §15.C.), PA does not (see [An16], Corollary 8.2; see also §2.F., Corollary 2.20).

The distinction is absent in Moon’s Thesis, but is one which is critical to it for recognising—and appreciating—the relative strengths and limitations of ZF and PA (see §13.E.), since Moon accepts in good faith the validity of Peter Smith’s, implicitly *faith-based* (see §7.B.), interpretation of quantification in his analyses of Goodstein’s Theorem and ‘Isaacson’s Thesis’:

“Goodstein’s Theorem, we have already noted, depends on the fundamental fact that there can’t be an infinite decreasing chain of ordinals which are sums of powers of ω , i.e. there can’t be an infinite decreasing chain of ordinals less than ε_0 , the first ordinal that comes after all the sums of powers of ω . Proving that fundamental result is equivalent to showing that *transfinite induction* up to ε_0 is sound.⁴

However, there are natural Gödel-numberings for the ordinals which are sums of powers of ω ; so we can transmute claims about these ordinals into arithmetical claims about their numerical codes. So, being able to prove Goodstein’s theorem inside PA would be tantamount to PA’s being able to handle (via our codings) transfinite induction up to ε_0 .

And now we appeal to two future results. First, this kind of transfinite induction is in fact strong enough to prove the consistency of PA by Gentzen’s argument (see Section 32.4). Hence, if PA could prove Goodstein’s theorem, it could also prove its own consistency. But second, PA can’t prove its own consistency by Gödel’s Second Theorem (see Section 31.3). So PA can’t prove Goodstein’s theorem.

30.4 Isaacson’s Thesis

The next key point to note is that the other known cases of mathematically interesting L_A truths which are provably independent of PA share an important feature with Goodstein’s Theorem. *The demonstration that they are L_A truths likewise use conceptual resources which go beyond those which are required for understanding the basic arithmetic of finite natural numbers.*

For example, proving the so-called Paris-Harrington theorem—which gives another arithmetical truth that is unprovable-in-PA—requires König’s Lemma, which says that an infinite tree that only branches finitely at any point must have an infinite path through it.⁵

And—in a rather different way—appreciating the truth of undecidable Gödel sentences for PA also seems to involve conceptual abilities that go beyond a grasp of elementary operations on the finite numbers. Maybe in this case we don’t need to invoke infinitary ideas like transfinite induction; but we surely have to be able to reflect on our own arithmetical theorizing in order to recognize e.g. that canonical Gödel sentences are true (see Section 36.5). We have to be able to make the move from (i) implicitly assuming in our unreflective mathematical practice that (say) every

natural number has a unique successor to (ii) explicitly accepting that a certain theory which has that proposition as an axiom is sound/consistent. And this *is* a move, because knowing your way around the numbers doesn't in itself entail the capacity to be able to reflect on that ability.

Putting these points about the Gödelian and non-Gödelian cases together suggests an interesting speculation:

Isaacson's Thesis. If we are to give a proof of *any* true sentence of L_A which is independent of PA, then we will need to appeal to ideas that go beyond those which are constitutive of our understanding of basic arithmetic.⁶

If that's right, then PA in fact reaches as far into the truths of basic arithmetic as any properly axiomatized theory can reach, at least if it aims to encapsulate no more than what follows from our purely arithmetical knowledge.

But *is* the thesis right? It isn't exactly clear what is involved in 'purely arithmetical knowledge'. But even so—at least before our discussions in the last chapter—we might well have thought that there is a way of going beyond first-order PA while keeping within the confines of what is given to our understanding of elementary arithmetic, namely by exploiting our informal understanding of induction which arguably seems to involve grasp of a *second-order* principle.

However, what we have discovered about second-order arithmetics is in fact entirely in conformity with Isaacson's Thesis. To repeat, there are indeed L_A sentences which we can derive in PA_2 but which aren't derivable in PA. But if we are to accept these these formal derivations as genuine *Proofs*, i.e. chains of reasoning which do give us grounds to accept their conclusions, then we must endorse PA_2 's generous treatment of the Comprehension Schema. And that involves something like making sense of the non-arithmetic infinitary idea of quantifying over arbitrary subsets of \mathbb{N} . By contrast, accepting the weaker formal theory ACA_0 , for example, doesn't seem to involve more than a grasp of arithmetic together with some very general logical ideas; but this theory doesn't give us any more basic arithmetic than PA does.⁷

... Smith: [Smi13], p24-226.

Smith's implicit acceptance of ACA_0 as a valid 'weaker formal theory' that 'doesn't seem to involve more than a grasp of arithmetic together with some very general logical ideas; but this theory doesn't give us any more basic arithmetic than PA does', is significant.

From an *evidence-based* perspective, ACA_0 not only admits a proof of Goodstein's Theorem, but *invalidly* concludes (see §19., Theorem 19.1³⁸⁵) that the Theorem can be expressed as a valid Π_2 PA-formula, $[\forall x \exists y S(x, y, 0)]$ —containing an existential quantifier—that *must* interpret so that the formula is true under any *well-defined* interpretation of PA (*invalidly*, since no such interpretation can admit Aristotle's particularisation by §8.D., Theorem 8.12³⁸⁶):

“Sketch of a proof sketch Take the Goodstein sequence for n . Render its k -th term into its pure base $k + 1$ representation as in our examples above (with each sum presented in descending order of exponents). Now consider the parallel sequence that you get by going through and replacing each base number by ω (the first infinite ordinal). For example, the parallel sequence to the Goodstein sequence for 19 starts

$$\begin{array}{l} \omega^{\omega^{\omega^1}} + \omega^1 + 1 \\ \omega^{\omega^{\omega^1}} + \omega^1 \end{array}$$

³⁸⁵§19., Theorem 19.1: Goodstein's sequence $G_o(m_o)$ over the finite ordinals in any putative model \mathbb{M} of ACA_0 *terminates* with respect to the ordinal inequality ' $>_o$ ' even if Goodstein's sequence $G(m)$ over the natural numbers *does not terminate* with respect to the natural number inequality ' $>$ ' in \mathbb{M} .

³⁸⁶§8.D., Theorem 8.12: Aristotle's particularisation does not hold in any finitary interpretation of PA under which the PA-axioms interpret as true, and the PA rules of inference preserve such truth.

$$\begin{array}{l} \omega^{\omega^{\omega^1}} + 1 + 1 + 1 \\ \omega^{\omega^{\omega^1}} + 1 + 1 \\ \omega^{\omega^{\omega^1}} + 1 \\ \vdots \end{array}$$

It isn't hard to show that this parallel sequence of ordinals will in every case be strictly decreasing.

But there just cannot be an infinite descending chain of such ordinals—that is quite a fundamental theorem about ordinals. Hence the ordinal sequence must terminate. And therefore the parallel Goodstein sequence for n must terminate too!¹

Don't worry at all, however, if you find that proof-sketch baffling. All you really need to take away is the idea that Goodstein's Theorem *can* easily be proved, *if* we invoke ideas from the theory of infinite ordinal numbers, i.e. if we invoke ideas that go beyond the basic arithmetic of finite numbers."

... Smith: [Smi13], p.223.

What is striking from the *evidence-based* perspective of the Complementarity Thesis (§1., Thesis 1), is Smith's uncritical acceptance of *faith-based* quantification (see §7.B.) to conclude that the putative truth of Goodstein's Π_2 PA-formula, $[\forall x \exists y S(x, y, 0)]$, under any *well-defined* interpretation over the domain \mathbb{N} of the natural numbers *must* follow even 'if we invoke ideas from the theory of infinite ordinal numbers, i.e. if we invoke ideas that go beyond the basic arithmetic of finite numbers'; since such a conclusion entails that ACA_0 is a conservative extension of PA, contradicting §19.A., Corollary 19.3³⁸⁷.

From a foundational perspective, Smith's analysis of Goodstein's Theorem and Isaacson's Thesis highlight the unintended consequences, and dangers of embracing *knowledge as intuitively justified true belief* over Piccinini's *knowledge as factually grounded (evidence-based) belief*³⁸⁸.

Dangers we may have unknowingly *belittled*—even if not *denied* outright—and counter-intuitive consequences we may have not only uncritically *welcomed*, but passionately *nurtured* in our schools and universities, post Cantor, by assuming in classical mathematics, logic, philosophy, and the natural sciences, that the *unspecified* can be treated as *specifiable* without supporting *evidence*.

For the far-reaching significance of the qualification '*unspecified*' see, for instance, §7., Definition 20³⁸⁹; §8.G., Lemma 8.20³⁹⁰; §8.G., Corollary 8.21³⁹¹; §15.H.h.; §15.H.j.; also §2., Definition 8.

Moreover the—arguably, misleading if not false—consequences of such a 'faith-based' philosophy are highlighted in Section 5., *Three fragile Hilbertian, Brouwerian, and Gödelian, dogmas*.

³⁸⁷Also, independently, both 19.A., Theorem 19.4: *The subsystem ACA_0 of second-order arithmetic is not a conservative extension of PA*; and §15.C., Lemma 15.1: *The structure of the finite ordinals under any putative well-defined interpretation of ZF is not isomorphic to the structure \mathbb{N} of the natural numbers*.

³⁸⁸See §5.A., *What is knowledge?*

³⁸⁹**Aristotle's particularisation:** If the formula $[\neg(\forall x)\neg F(x)]$ of a formal first order language L is defined as 'true' under an interpretation, then we may always conclude *unrestrictedly* that there must be some *well-definable*, albeit *unspecified*, object s in the domain D of the interpretation such that, if the formula $[F(x)]$ interprets as the relation $F^*(x)$ in D , then the proposition $F^*(s)$ is 'true' under the interpretation.

³⁹⁰§8.G., Lemma 8.20: *Rosser's Rule C entails Aristotle's particularisation*.

³⁹¹§8.G., Corollary 8.21: *Rosser's Rule C is stronger than Gödel's ω -consistency*.

The challenge is thus that of *using* intuitively justified true beliefs, in what philosopher Markus Pantsar calls *pre-formal mathematics* (see §1.A.), *in order to arrive* at factually grounded (evidence-based) beliefs in our usual systems of *formal mathematics*; beliefs which can then be treated as *knowledge* (see §5.A.) only if they can, first, be interpreted under Tarski's recursive definitions of the satisfaction, and truth, of the formulas of a formal language under a well-defined interpretation as corresponding to our intuitively justified true beliefs *and*, second, categorically communicated.

We emphasise the point by noting yet another, significant, instance where the question of 'implicit obfuscation' in Gödel's compelling interpretation of his own reasoning assumes critical significance when it can be explicitly seen to potentially limit attempts to uncover the foundational constraints in the application of the first-order logic FOL, and the first-order Peano Arithmetic PA, to disciplines that—in good faith—rely on current paradigms concerning the formal mathematical, and interpreted philosophical, entailments of Gödel's purported 'undecidable arithmetical propositions' for a coherent perspective of what can be believed as 'true', and what can be treated as 'proven', within the axiomatic or pre-formal (see §1.A.) assumptions of the discipline.

Thus, in their 2008 paper: 'Learning with belief levels' [BFS08], computer scientists Jānis Bārzdīņš, Rūsiņš Freivalds, and Carl H. Smith, address the main problem in algorithmic theory as that of finding 'out nontrivial assertions from particular observations'. They:

- argue for a new type of inductive inference 'learning with confidence' (or 'learning with belief levels');
- where they restrict themselves to considering only 'the first-order predicate logics [18] as the language for the assertions. This language is rich enough for nontrivial assertions, and, on the other hand, it is also universal enough, it does not use specific properties of particular languages';
- since they 'are more interested in understanding how such a learning process is performed by brain' and, consequently, 'are ready to allow infinite learning process';
- by concentrating on a notion which 'is closer to the human inference process. When we produce any hypothesis based on a finite number of observations we are tended to estimate some belief level of our hypothesis. Thus, we come to a natural inductive inference type "learning with belief levels from elementary facts." This inductive inference type is central in our paper';
- where 'The aim of axiomatization is to find the basic elements of which our practical everyday reasoning is constructed.'

From an *evidence-based* perspective, however, uncritical acceptance of 'inherited' interpretations—in current mathematical paradigms—of Gödel's formal reasoning, and its entailments, in [Go31] not only obscures their 'intent', but also limits their conclusions, by constraining them to 'discover' and settle for the—seemingly *uncomfortable* and *defensive*—argument that:

"...our axiom system is not complete. This may be considered as a serious defect. Yet, there are many famous incomplete axiom systems in mathematics. Remember the axioms of Euclidean geometry, axioms of first-order predicate logics (in these cases a complete axiomatization was achieved), axioms of Peano arithmetics, Zermelo–Fraenkel axiom system for the set theory. These

systems are incomplete, and they cannot be made complete (by Gödel incompleteness theorem [13]). But this does not challenge the importance of this axiomatization. For instance, when we speak of Peano axiom system [20], then all *natural* assertions in arithmetics can be proved in Peano arithmetics (not always in a trivial way). On the other hand, all the counterexamples provided by the proof of the Gödel incompleteness theorem are *highly artificial*. The same can be said about David Hilbert’s system of axioms of the elementary geometry [16] and about Zermelo–Fraenkel axiom system for the set theory [23].

We believe that our axiom system (being not complete) still is *kind of complete* in the following pragmatic sense. We hope that every true formula which can be deduced in a natural way from the infinite sequence of all elementary facts in the given model by a human being, can be deduced by our axiom system as well. Of course, such an assertion cannot be proved formally."

... Bārzdīņš, Freivalds and Smith: [BFS08], Introduction.

Bārzdīņš, Freivalds, and Smith’s argumentation in [BFS08] can, from the *evidence-based* perspective of the Complementarity Thesis (§1., Thesis 1), be viewed as a significant—albeit ‘obscured’—attempt to assign *evidence-based* truth values to propositions that are not only algorithmically *computable* as always true under a *well-defined* interpretation, but also those that are algorithmically *verifiable*, but not algorithmically *computable*, as always true; a distinction that entails all the argumentation and formal conclusions in this book (see the Author’s Preface).

15.H.h. The unproven assumption in the statement of the fixed point theorem

From the *evidence-based* perspective of [An16]—which admits defining the satisfaction and truth of the formulas of a formal arithmetic under a *well-defined* Tarskian interpretation in two, distinctly different, ways in terms of algorithmic *verifiability* (see [An16], §5, p.38), and algorithmic *computability* (see [An16], §6, p.40), respectively—§15.H.f., Theorem 15.2 highlights the unproven assumption in, and the misleading interpretation of, for instance, what Haim Gaifman refers to, in [Gaf06], as ‘the fixed point theorem (also known as the reflection theorem)’, which asserts the existence of sentences that “speak about themselves”:

“Gödel’s incompleteness results apply to formal theories for which syntactic constructs can be given names in the same language, so that some basic syntactic operations are representable in the theory. It is now customary to derive these results from the fixed point theorem (also known as the reflection theorem), which asserts the existence of sentences that “speak about themselves”. Let \mathbf{T} be the theory and, for each wff ϕ , let $\ulcorner\phi\urcorner$ be the term that serves as its name. Then the theorem says that, for any wff $\alpha(v)$ (with one free variable), there exists a sentence β for which:

$$\mathbf{T} \vdash [\beta \leftrightarrow \alpha(\ulcorner\beta\urcorner)]$$

... Gaifman: [Gaf06], p.709.

Now, not only is Gaifman’s assertion that ‘Gödel’s incompleteness results apply to formal theories for which syntactic constructs can be given names in the same language’ misleading—if not *false* (see §15.H.j.)—but, more significantly, there is an unproven assumption in the very statement itself of the fixed point theorem, which is that definitions of *unspecified* terms, such as those of ‘ $\ulcorner\beta\urcorner$ ’ and ‘ $\ulcorner\phi\urcorner$ ’, can be formally treated as *specifiable* in \mathbf{T} without proof, or supporting *evidence*.

Comment 145. For the far-reaching significance of the qualification ‘*unspecified*’, see §7., Definition 20, §8.G., Lemma 8.20, and §8.G., Corollary 8.21; see also §2., Definition 8, and the Author’s Preface.

We note that, for any *unspecified*, unary, \mathbf{T} -formula $[\alpha(v)]$, we have in Gaifman’s notation that ‘ $\ulcorner\beta\urcorner$ ’—defined as $\ulcorner\alpha(\ulcorner\alpha(v)\urcorner)\urcorner$ —is an *unspecified* algorithmically *computable* natural

number that satisfies the number-theoretic proposition $(\exists!x)(x = \ulcorner \beta \urcorner)$ ³⁹², where the primitive recursive relation $x = \ulcorner \beta \urcorner$ is representable in \mathbf{T} by a formula, say $[\gamma(x)]$, such that, for any *specified* natural number n , and its corresponding \mathbf{T} -numeral $[n]$:

- (i) If $n = \ulcorner \beta \urcorner$ is true then $[\gamma(n)]$ is \mathbf{T} -provable;
- (ii) If $n = \ulcorner \beta \urcorner$ is false then $[\neg\gamma(n)]$ is \mathbf{T} -provable.

However, by Gödel’s reasoning in the first part of his Theorem VI in [Go31] (p.25, ‘1.17Gen r is not κ -PROVABLE’), we cannot conclude from (i) and (ii) that:

- (iii) If $(\exists!x)(x = \ulcorner \beta \urcorner)$ is true then $[(\exists!x)(\gamma(x))]$ is \mathbf{T} -provable;
- (iv) If $(\exists!x)(x = \ulcorner \beta \urcorner)$ is false then $[\neg(\exists!x)(\gamma(x))]$ is \mathbf{T} -provable.

The ‘misleading’ interpretation that follows from the above, unproven, assumption is, then, that \mathbf{T} -formulas such as $[\beta]$ —defined as $[\alpha(\ulcorner \alpha(v) \urcorner)]$ —can be treated, under a *well-defined* interpretation of \mathbf{T} , as sentences which “speak about themselves”.

However, this would assume that, if the \mathbf{T} -formula $[\lambda(x)]$ interprets as the arithmetical relation $\lambda^*(x)$ under any *well-defined* interpretation of \mathbf{T} over the domain \mathbb{N} of the natural numbers, then the number-theoretic relations ‘ $x = \ulcorner \beta \urcorner$ ’ and ‘ $\lambda^*(x)$ ’ have the same meaning, and can be treated as identical³⁹³.

Such an assumption would be invalid if $[\lambda(x)]$, as in the case of Gödel’s formula $[R(x)]$ ³⁹⁴ (see [An16], Corollary 8.3; also §2.F., Corollary 2.21), were to interpret as an arithmetical relation $\lambda^*(x)$ whose instantiations are algorithmically *verifiable* (see [An16], Definition 1, p.37; also §2., Definition 7), but not algorithmically *computable* (see [An16], Definition 2, p.37; also §2., Definition 10), as true/false over \mathbb{N} , whereas those of $x = \ulcorner \beta \urcorner$ are, by definition, algorithmically *computable* as true/false over \mathbb{N} ³⁹⁵.

That the lacuna extends to expositions of the fixed point theorem in standard texts and literature is evidenced by the following extracts from³⁹⁶:

- Elliott Mendelson’s 2015 edition [Me15] of his ‘Introduction to Mathematical Logic’;
- Samuel R. Buss’ *First-Order Proof Theory of Arithmetic* ([Bs98]) in the ‘*Handbook of Proof Theory*, 1998;
- John L. Bell’s *Incompleteness in a General Setting* ([Bll07]);
- the entry on the Diagonalization Lemma in the on-line academic resource, ‘The Stanford Encyclopedia of Philosophy’; and

³⁹²i.e., $(\exists!x)(x = \ulcorner \phi(\ulcorner \phi(y) \urcorner) \urcorner)$; where ‘ $\exists!x$ ’ denotes uniqueness corresponding to Mendelson’s definition of ‘ $(\exists!x)$ ’ in [Me64], p.79: $(\exists!x)A(x) \equiv \{(\exists x)A(x) \wedge (\forall x)(\forall y)(A(x) \wedge A(y) \supset x = y)\}$

³⁹³See also §13.D., *When can a formal assertion claim to ‘mean’ what it represents?*

³⁹⁴Which he defines—and refers to—only by its Gödel number ‘ r ’ in [Go31], p.25, eqn.(12).

³⁹⁵We note the distinction reflects that, whilst ‘true/false’ in one case is *defined* to mean ‘algorithmically verifiable truth/falsity’ under an algorithmically *verifiable* interpretation of \mathbf{T} over \mathbb{N} , such as that defined in [An16], §5, p.38 (see also §2.B.); in the other it is *defined* to mean ‘algorithmically *computable* truth/falsity’ under an algorithmically *computable* interpretation, such as that defined in [An16], §6, p.40 (see also §2.C.).

³⁹⁶See also explicit and implicit appeals to the fixed point theorem, also referred to as Gödel’s diagonal lemma or the self-reference lemma, in [Smy81], p.358; [Pan09], p.53.

— the entry on the Diagonal Lemma in the on-line resource, Wikipedia;

where we note the common—unproven—assumption that if a natural number n can be well-defined by a number-theoretic proposition such as $(\exists!x)f(x)$, where $f(x)$ is a recursive relation which can be represented in a formal arithmetic by some formula $[G(x)]$, we may assume without proof that the corresponding numeral $[n]$ can be treated as well-defined in the arithmetic by the formula $[(\exists!x)G(x)]$.

“Proposition 3.35 (Fixed-Point Theorem)*

Assume that all recursive functions are representable in a theory with equality K in the language \mathcal{L}_A . Then, for any wf $\mathcal{E}(x_1)$ in which x_1 is the only free variable, there is a closed wf \mathcal{C} such that

$$\vdash_K \mathcal{C} \leftrightarrow \mathcal{E}(\ulcorner \mathcal{C} \urcorner)$$

... Mendelson: [Me15], p.206.

“2.2.1. The Gödel diagonal lemma. The Gödel diagonal, or fixpoint, lemma is a crucial ingredient in the proof of the incompleteness theorems. This lemma states that, for any first-order property A , there is a formula B that states that the property A holds of the Gödel number of B . Thus, since we know that provability is a first-order property, it will be possible to construct a formula which asserts “I am not provable”.

Gödel’s Diagonal Lemma. *Let $A(a_0)$ be a formula. Then there is a formula B such that S_2^1 proves*

$$B \leftrightarrow A(\ulcorner B \urcorner)$$

Furthermore, if A is a $\Sigma_i^b, \Pi_i^b, \Sigma_i$ or Π_i formula (respectively), then so is B ; and if A involves free variables other than a_0 , then so does B .”

... Buss: [Bs98], §2.2. *The Gödel Incompleteness theorems.*

“Full proofs of the Gödel incompleteness theorems are highly intricate affairs. Much of the intricacy lies in the details of setting up and checking the properties of a coding system representing the syntax of an object language (typically, that of arithmetic) within that same language. These details are seldom illuminating and tend to obscure the core of the argument. For this reason a number of efforts have been made to present the essentials of the proofs of Gödel’s theorems without getting mired in syntactic or computational details. One of the most important of these efforts was made by Löb [8] in connection with his analysis of sentences asserting their own provability. Löb formulated three conditions (now known as the Hilbert-Bernays-Löb derivability conditions), on the provability predicate in a formal system which are jointly sufficient to yield the Gödel’s second incompleteness theorem for it. A key role in Löb’s analysis is played by (a special case of) what later became known as the diagonalization or fixed point property of formal systems, a property which had already, in essence, been exploited by Gödel in his original proofs of the incompleteness theorems. The fixed point property plays a central role in Lawvere’s [7] category-theoretic account of incompleteness phenomena (see also [10]).”

... Bell: [Bl107], *Abstract.*

“Given any formula $A(x)$, we can now construct another formula $\exists y[A(y) \wedge S(x, x, y)]$ with one free variable x . Let us abbreviate it as $B(x)$.

This formula has a Gödel number, say $k = \ulcorner B(x) \urcorner$. By substituting the numeral \underline{k} denoting it for x in $B(x)$, we get $B(\underline{k})$; let us call this sentence D

$$F \vdash D \leftrightarrow A(\ulcorner D \urcorner)$$

This completes the proof.”

... Stanford Encyclopedia of Philosophy: [Supplement: The Diagonalization Lemma, referenced 10/08/2020](#)

“Let T be a first-order theory in the language of arithmetic and capable of representing all computable functions. Let F be a formula in the language with one free variable, then:

Lemma—There is a sentence ψ such that $\psi \leftrightarrow F(\ulcorner\psi\urcorner)$ is provable in T .”

... Wikipedia: *Diagonal Lemma*, referenced 10/08/2020.

In other words, although we may have, for any natural number n and numeral $[n]$ that:

If $f(n)$ is true, then $[G(n)]$ is provable in a formal arithmetic,

we cannot conclude without proof that:

If $f(n) \wedge (\exists!x)f(x)$ is true, then $[G(n) \wedge (\exists!x)G(x)]$ is provable in the arithmetic;

since, like Gödel’s formula $[R(x)]$ ³⁹⁷ (see [An16], Corollary 8.3; also §2.F., Corollary 2.21), the formula $[G(x)]$ may also interpret as an arithmetical relation $G^*(x)$ which is algorithmically *verifiable*, but not algorithmically *computable*, over the domain \mathbb{N} of the natural numbers.

15.H.i. The misleading entailment of the fixed point theorem

We note the further, more serious, false entailment (in addition to another misleading interpretation) of the fixed point theorem in standard texts such as [Me15];

“The Gödel-Rosser incompleteness theorem

The proof of undecidability of a Gödel sentence \mathcal{G} required the assumption of ω -consistency. We will now prove a result of Rosser (1936) showing that, at the cost of a slight increase in the complexity of the undecidable sentence, the assumption of ω -consistency can be replaced by consistency.

As before, let K be a theory with equality in the language \mathcal{L}_A satisfying conditions 1-3 on page 208. In addition assume:

4. $\vdash_K x \leq n \Rightarrow x = 0 \vee x = \bar{1} \vee \dots \vee x = \bar{n}$ for every natural number n .
5. $\vdash x \leq \bar{n} \vee \bar{n} \leq x$ for every natural number n .

Thus, K can be any extension of RR with a recursive axiom set. In particular, K can be RR or S .

Recall that, by Proposition 3.26 (14), Neg is a primitive recursive function such that, if x is the Gödel number of a wf \mathcal{B} , then $Neg(x)$ is the Gödel number of $(\neg\mathcal{B})$. Since all recursive functions are representable in K , let $\mathcal{N}\}\}(x_1, x_2)$ be a wf that represents Neg in K . Now construct the following wf $\mathcal{E}(x_1)$:

$$(\forall x_2)(\mathcal{P}f(x_2, x_1) \Rightarrow (\forall x_3(\mathcal{N}eg(x_1, x_3) \Rightarrow (\exists x_4)(x_4 \leq x_2 \wedge \mathcal{P}f(x_4, x_3))))))$$

By the fixed point theorem, there is a closed wf \mathcal{R} such that

$$(*) \quad \vdash_K \mathcal{R} \Leftrightarrow \mathcal{E}(\ulcorner\mathcal{R}\urcorner)$$

\mathcal{R} is called a *Rosser sentence* for K . Notice what the intuitive meaning of \mathcal{R} is under the standard interpretation. \mathcal{R} asserts that, if \mathcal{R} has a proof in K , say with Gödel number x_2 , then $\neg\mathcal{R}$ has a proof in K with Gödel number smaller than x_2 . This is a roundabout way for \mathcal{R} to claim its own unprovability under the assumption of the consistency of K .”

... Mendelson: [Me15], *The Gödel-Rosser incompleteness theorem*, pp.210-211.

³⁹⁷Which he defines—and refers to—only by its Gödel number ‘ r ’ in [Go31], p.25, eqn.(12).

The false entailment is that (see also §8.G.), ‘at the cost of a slight increase in the complexity of the undecidable sentence, the assumption of ω -consistency can be replaced by consistency’, since (*) assumes that $(\exists!x)(x = \ulcorner \mathcal{R} \urcorner)$ is provable in K; whose consequence—insofar that it entails the existence of a formally undecidable arithmetical proposition—is falsified if K is the categorical theory PA (see [An16], Corollary 7.2, p.41; also §2.E.b., Corollary 2.18).

The misleading interpretation is that \mathcal{R} can ‘claim its own unprovability under the assumption of the consistency of K’, since such a claim would necessarily appeal to Aristotle’s particularisation when interpreting the existential quantifier in \mathcal{R} and, by §8.D., Theorem 8.12, no *well-defined* interpretation of a theory such as PA can admit Aristotle’s particularisation.

The seriousness of the above is that even an intuitionistically unobjectionable standard text—such as *the* authoritative textbook of its times—the first 1964 edition [Me64] of Elliott Mendelson’s ‘Introduction to Mathematical Logic’, has, in its 2015 edition [Me15] admitted formal conclusions that are not only intuitionistically objectionable, but *false*:

“Definitions

Let K be any theory whose language contains the individual constant 0 and the function letter f_1^1 . Then K is said to be ω -consistent if, for every wf $\mathcal{B}(x)$ of K containing x as its only free variable, if $\vdash_K \neg \mathcal{B}(\bar{n})$ for every natural number n , then it is not the case that $\vdash_K (\exists x)\mathcal{B}(x)$.

Let K be any theory in the language \mathcal{L}_A . K is said to be a *true theory* if all proper axioms of K are true in the standard model. (Since all logical axioms are true in all models and MP and Gen lead from wfs true in a model to wfs true in that model, all theorems of a true theory will be true in the standard model.)

Any true theory K must be ω -consistent. (In fact, if $\vdash_K \neg \mathcal{B}(\bar{n})$ for all natural numbers n , then $\mathcal{B}(x)$ is false for all natural numbers and, therefore, $(\exists x)\mathcal{B}(x)$ cannot be true for the standard model. Hence, $(\exists x)\mathcal{B}(x)$ cannot be a theorem of K.) In particular, RR and S are ω -consistent."

... Mendelson: [Me15], Definitions, p.207.

‘False’ since, by [An16], Corollary 8.4. p.42 (see also §2.F., Corollary 2.22) and, independently by §12.B.f., Theorem 12.6, PA—which corresponds to Mendelson’s theory S—is *not* ω -consistent!

The significant difference between [Me64], and [Me15], seems to be that in [Me64] Mendelson is reluctant to appeal to Rosser’s Rule C ([Ro53], pp.127-130; see also [Me64], p.73-74, §7, Rule C; §8.G.), as evidenced by his assertion:

“3. Open problem: is every recursive function strongly representable in S?”

... Mendelson: [Me64], §3, Primitive Recursive and Recursive Functions, p.135, Exercises.

whereas, in [Me15], there is apparently no such reluctance:

“Let K be any theory with equality in the language \mathcal{L}_A of arithmetic. A number-theoretic function f of n arguments is said to be *representable* in K if and only if there is a wf $\mathcal{B}(x_1, \dots, x_n, y)$ of K with the free variables x_1, \dots, x_n, y such that, for any natural numbers k_1, \dots, k_n, m , the following hold:

1. If $f(k_1, \dots, k_n) = m$ then $\vdash_K \mathcal{B}(\bar{k}_1, \dots, \bar{k}_n, \bar{m})$.
- 2' $\vdash_K (\exists_1 y)\mathcal{B}(\bar{k}_1, \dots, \bar{k}_n, y)$.

If, in this definition, we replace condition 2 by

- 2'. $\vdash_K (\exists_1 y)\mathcal{B}(x_1, \dots, x_n, y)$

then the function f is said to be *strongly representable* in K . Notice that $2'$ implies 2 , by Gen and rule A4. Hence, strong representability implies representability. The converse is also true, as we now prove.

Proposition 3.12 (V.H. Dyson)

If $f(x_1, \dots, x_n)$ is representable in K , then it is strongly representable in K .

Proof

Assume f representable in K by a wf $\mathcal{B}(x_1, \dots, x_n, y)$. Let us show that f is strongly representable in K by the following wf $\mathcal{C}(x_1, \dots, x_n, y)$:

$$[(\exists_1 y)\mathcal{B}(x_1, \dots, x_n, y)] \wedge \mathcal{B}(x_1, \dots, x_n, y) \vee (\neg[(\exists_1 y)\mathcal{B}(x_1, \dots, x_n, y)] \wedge y = 0)$$

1. Assume $f(k_1, \dots, k_n) = m$. Then $\vdash_K \mathcal{B}(\overline{k_1}, \dots, \overline{k_n}, \overline{m})$ and $\vdash_K (\exists_1 y)\mathcal{B}(\overline{k_1}, \dots, \overline{k_n}, y)$. So, by conjunction introduction and disjunction introduction, we get $\vdash_K \mathcal{C}(\overline{k_1}, \dots, \overline{k_n}, \overline{m})$.

2'. We must show $\vdash_K (\exists_1 y)\mathcal{C}(x_1, \dots, x_n, y)$.

Case 1. Take $(\exists_1 y)\mathcal{B}(x_1, \dots, x_n, y)$ as hypothesis. It is easy, using rule C, to obtain $\mathcal{B}(x_1, \dots, x_n, b)$ from our hypothesis, where b is a new individual constant. . . ."

... Mendelson: [Me15], §3.2, *Number-Theoretic Functions and Relations*, pp.170-171.

From the *evidence-based* perspective of this investigation, Mendelson's reluctance in [Me64] can be seen to be intuitionistically justified since, taking K as PA, by §8.G., Theorem 8.20³⁹⁸, appeal to Rosser's Rule C admits—the intuitionistically objectionable—Aristotle's particularisation (see §7., Definition 20) in any *well-defined* interpretation of PA; which—as noted above—would falsely entail that PA is ω -consistent!

15.H.j. The Gödel number of an *unspecified* PA formula is not a PA formula

Although drawing a *false* conclusion from an explicit appeal to Rosser's Rule C within a proof sequence of a formal theory can, at best (as, for instance in [Me15], Proposition 3.12, pp.170-171, highlighted in §15.H.i.), be treated as merely a *false* consequence of an *implicit* appeal to Rule C , treating such a conclusion as a formal entailment of the theory itself is another matter where the significance of any appeal to Rule C —whether explicitly or implicitly—is not in evidence; particularly within introductory texts such as [Smi13], where such appeal makes further entailments seem misleadingly 'straightforward':

"24.2 An easy theorem about provability predicates

Here's a straightforward result about provability predicates:

Theorem 24.1 *Let T be a nice theory. Then for any sentence ϕ :*

C1. *If $T \vdash \phi$, then $T \vdash \text{Prov}_T(\ulcorner \phi \urcorner)$.*

$C\omega$. *Suppose T is ω -consistent: then if $T \vdash \text{Prov}_T(\ulcorner \phi \urcorner)$, $T \vdash \phi$.*

Proof for (C1) First assume $T \vdash \phi$. Then there is a T proof of the sentence with g.n. $\ulcorner \phi \urcorner$. Let this proof have the super g.n. m . Then, by definition, $\text{Prf}_T(m, \ulcorner \phi \urcorner)$. Hence since Prf_T is *captured* by Prf_T , it follows that $T \vdash \text{Prf}_T(\overline{m}, \ulcorner \phi \urcorner)$. Hence $T \vdash \exists v \text{Prf}_T(v, \ulcorner \phi \urcorner)$, i.e. $T \vdash \text{Prf}_T(\ulcorner \phi \urcorner)$.

An even quicker proof for (C1) If $T \vdash \phi$, then $\text{Prov}_T(\ulcorner \phi \urcorner)$ will be true. But $\text{Prov}_T(\ulcorner \phi \urcorner)$ is Σ_1 ; hence, since Q proves all true Σ_1 sentences (by Theorem 11.5) $Q \vdash \text{Prov}_T(\ulcorner \phi \urcorner)$. Hence $T \vdash \text{Prov}_T(\ulcorner \phi \urcorner)$."

... Smith: [Smi13], §24.2 *An easy theorem about provability predicates*, p.24

³⁹⁸§8.G., Theorem 8.20: *Rosser's Rule C entails Aristotle's particularisation.*

‘Misleadingly’—as evidenced, for instance, by Mateusz Łełyk and Bartosz Wcisło’s [LW23]—since, for an *unspecified* sentence $[\phi]$ of a theory T , the Gödel number $\ulcorner \phi \urcorner$ of the T -formula $[\phi]$ is defined by Gödel’s primitive recursive function $\text{Form}(\ulcorner \phi \urcorner)$ ³⁹⁹, which is generally not arithmetical (as it generally would contain the factorisation symbol ‘!’ that is not, and cannot be treated as, a T -symbol):

“Throughout the paper, when working in a sequential theory U with a fixed interpretation N of S_2^1 , E shall always denote the definable equivalence relation which is used by N to translate the identity relation from the arithmetical signature. For any $n \in \omega$, we write $n(x)$ for the N -translation of the formula $x = \underline{n}$. We stress that, in the context of a general sequential theory, $\phi(n)$ should be understood contextually as $\exists x (n(x) \wedge \phi(x))$, where $n(x)$ is a predicate expressing the property of “being the n -th ordinal”. We stress that $n(x)$ need not define any particular object, although it uniquely determines an E -equivalence class. Putting together this and the previous conventions, $[\phi]$ will denote a predicate corresponding to the Gödel code of a formula ϕ .”

... Łełyk and Wcisło: [LW23], §2.3.1 Sequential Theories, Convention 9.

Hence, contrary to what is implicitly claimed in [Smi13], $\ulcorner \phi \urcorner$ is simply a name for an, algorithmically *computable*, *unspecified* natural number; it cannot be treated as a ‘name’ for an *unspecified* T -term (numeral) $[\ulcorner \phi \urcorner]$ within T :

“Gödel’s construction involves taking an open wff that we’ll abbreviate as U , or as $U(y)$ when we want to emphasize that it contains just ‘ y ’ free. This wff has a g.n. $\ulcorner U \urcorner$. And then—the crucial move—Gödel substitutes *the numeral for* U ’s *g.n.* for the free variable in U . So the key step involves forming the wff $U(\ulcorner U \urcorner)$.”

... Smith: [Smi13], §19.6 The idea of diagonalization, p.i42.

Nor, in the absence of a proof that $T \vdash [(\exists!y)(y = \ulcorner \phi \urcorner)]$, can we treat as an ‘official definition’:

“The *diagonalization* of ϕ is $\exists y(y = \ulcorner \phi \urcorner) \wedge \phi$.”

... Smith: [Smi13], §19.6 The idea of diagonalization, p.i43.

We note that a similar ambiguity—if not conflation—can be seen in [Me15]:

“Notation

When \mathcal{C} is an expression of a theory and the Gödel number of \mathcal{C} is q , then we shall denote the numeral \bar{q} by $\ulcorner \mathcal{C} \urcorner$. We can think of $\ulcorner \mathcal{C} \urcorner$ as being a “name” for \mathcal{C} within the language \mathcal{L}_A .”

... Mendelson: [Me15], Notation, p.205.

The ‘ambiguity’ lies in that the notation does not specify whether \mathcal{C} is ‘specified’ or ‘unspecified’:

- If \mathcal{C} is ‘specified’, then $[\bar{q}]$ is a ‘specified’ numeral of the theory, and interprets as a ‘specific’ natural number, say q , that, in turn, is represented in the theory by the numeral $[\bar{q}]$.

Comment 146. For the far-reaching significance of the qualification ‘*unspecified*’, see §7., Definition 20, §8.G., Lemma 8.20, and §8.G., Corollary 8.21; see also §2., Definition 8, and the Author’s Preface.

- If \mathcal{C} is ‘unspecified’, then $[\bar{q}]$ is an ‘unspecified’ numeral of the theory that would, *when specified*, interpret as a ‘specified’ natural number, say q , that, *until then*, can only be treated as an ‘unspecified’ natural number n (another ‘name’ for which would be $\ulcorner \phi \urcorner$) which is representable in the theory only by an ‘unspecified’ numeral $[\bar{n}]$.

³⁹⁹Which interprets as ‘ $\ulcorner \phi \urcorner$ is the Gödel number of the T -formula $[\phi]$ (see [Go31], Definition 23, p.19).

The ‘conflation’ lies in treating the ‘name’ $\ulcorner \phi \urcorner$ —when interpreted over the domain \mathbb{N} of the natural numbers—of an *unspecified*, but putatively algorithmically *computable*, natural number n , as the ‘name’, expressible within T , of the ‘unspecified’ numeral $[\bar{n}]$ that represents n in T , *without* a formal proof in T that $[\bar{n} = \bar{q}]$!

Comment 147. For instance, such ‘conflation’ is seemingly implicit in Virgil Drăghici’s assertion, in his 2023 text [Drg23], that the putative Gödel number g of a putative, *unspecified*, PA-formula (‘sentence’) G —where g is merely the ‘name’ for a putative primitive recursive, hence algorithmically *computable*, arithmetical function f that well-defines a natural number n only when G is specified, but can be such that f contains the non-arithmetical factorisation symbol ‘!’—can be treated as the PA-numeral defined as \bar{g} even if any *well-defined* Tarskian interpretation of the PA-formula defining \bar{g} is algorithmically *verifiable* (by definition since \bar{g} represents g in PA), but not algorithmically *computable* (whence we cannot assume without proof that $[\bar{g} = \bar{n}]$ ⁴⁰⁰):

“§4.2.2.1 The Diagonal Lemma (DL)⁷⁶

Diagonal Lemma. For any formula $\beta(x_2) \in L_{PA}$ there is a sentence G such that: $PA^{ax} \vdash G \equiv \beta(\bar{g})$, where g is the Gödel number of G .⁷⁷

⁷⁶ Also called “fixed point lemma” or “self-referential lemma”. It is mentioned in K. Gödel [1934], §7 (as a result due to R. Carnap [1934], §35). Later, it also appear[s] in B. Rosser [1939] Lemma 1, S. Feferman [1960], Lemma 5.1, C. Smoryński [1977], 827, G. Boolos [1993], 53-54. For a short history of DL, comp. C. Smoryński [1981].

⁷⁷ This result holds for any formal system S extending the Robinson system Q .*

... Drăghici: [Drg23], §4.2.2.1 The Diagonal Lemma (DL), p.209.

Comment 148. That such misleading ‘conflation’⁴⁰¹ may be endemic in current scientific and philosophical paradigms is evidenced in the following excerpt from [GoU19], where it misleads philosophers Michał Tomasz Godziszewski and Rafał Urbaniak into appealing *explicitly* to the Gödel-numbering of *unspecified* formulas of PA—such as $\ulcorner \bar{Y}(\bar{w}) \urcorner$ —to conclude by further, albeit invalid (as argued above in §15.H.h. to §15.H.j.), appeal to ‘a general version of the diagonal lemma’, that the Yablo paradox⁴⁰² cannot be resolved finitarily, since it ‘turns out that the price of making potential infinity digestible to classical mathematicians is that the Yablo paradox strikes back, even with more power than in the standard arithmetical setting’⁴⁰³:

“1 Introduction

[10] provided a by now famous example of a semantic paradox which, according to the author, does not involve self-reference. Recall the paradox arises when one considers the following sequence of sentences:

Y_0 For any $k > 0$, Y_k is false.
 Y_1 For any $k > 1$, Y_k is false.
 Y_2 For any $k > 2$, Y_k is false.
 \vdots
 Y_n For any $k > n$, Y_k is false.
 \vdots

⁴⁰⁰The necessity for such a proof is addressed in §13.D.: *When can a formal assertion claim to ‘mean’ what it represents?*

⁴⁰¹Especially for non-logicians who depend upon classical—*uncritically* inherited in good faith—paradigms for the logical grounding of their argumentation.

⁴⁰²Which, in its non-finitary avatars, uses ‘some infinitary inference rule (requiring an infinite number of premises) such as the ω -rule’ (see also §8., *The significance of Hilbert’s ω -Rule for Gödel’s ω -consistency*).

⁴⁰³See also the brief consideration of—and *evidence-based* resolution proffered for—Yablo’s paradox in §20., *The significance of evidence-based reasoning for the philosophy of science*.

Take any Y_n and suppose it is true. Then, for any $j > n$ Y_j is false. In particular Y_{n+1} is false and also for any $j > n + 1$ Y_j is false. But the second conjunct is exactly what Y_{n+1} states, so Y_{n+1} is true after all. So Y_n is false. So for some $k > n$, Y_k is true. But then, we obtain a contradiction by repeating for Y_k the same reasoning.

A fruitful study of the paradox formalized over arithmetic performed e.g. in [1,3] has revealed that in order to derive the contradiction one needs a strong assumption: “for all n , Y_n if and only if $\ulcorner Y_n \urcorner$ is true.” $\forall n(Y_n \equiv Tr(Y_n))$. If we wanted to replace this *uniform disquotations* with an infinity of *local disquotations* instances, contradiction could be obtained only if we used some infinitary inference rule (requiring an infinite number of premises) such as the ω -rule.

So far, the story is rather well-known. What is somewhat less known, is that there is a way of handling the paradox which relies on finitistic assumptions. . . .

There is, however, a glitch. . . .

It turns out that the price of making potential infinity digestible to classical mathematicians is that the Yablo paradox strikes back, even with more power than in the standard arithmetical setting.

2 Arithmetization of Yablo Sentences

Let’s start with going over the results pertaining to Yablo sentences obtained in the standard arithmetical setting.

One might ask how we actually know that Yablo sequences exist in formal theories. This is a legitimate question since we’re moving from the paradox as formulated hand-wavily in natural language to its properly defined formalized counterpart. It is possible to construct a Yablo sequence within a given theory (but in order to do so, we need to use a general version of the diagonal lemma for formulae with two free variables in the language containing the truth predicate).

Definition 1 (Yablo Formula). $Y(x)$ is a Yablo formula in a theory T iff it satisfies the Yablo condition, i.e.:

$$T \vdash \forall x(Y(x) \equiv \forall w > x \neg Tr(\ulcorner Y(w) \urcorner)).$$

This also gives rise to a natural way of defining sentences belonging to a Yablo sequence.

Definition 2 (Yablo Sentence). ϕ is a Yablo sentence in a theory T iff it is obtained by substituting a numeral for x in Yablo formula $Y(x)$.

. . . Godziszewski and Urbaniak: [GoU19], §1, Introduction, pp.18-19.

Comment 149. A similar conflation by logician Bernd Buldt is seen in his—self-confessedly ‘informal’—contribution [Bld16] to a *Festschrift* honouring philosopher Wolfgang Spohn, where he takes the opportunity to candidly express his perspective *On Fixed Points, Diagonalization, and Self-Reference* by outlining his aims as:

“Despite the fact that generations of researchers have vetted Gödel’s result, there are some still who harbor a lurking suspicion that his incompleteness proof flirts with paradox or claim it to be one. Graham Priest, for example, built the entire cottage industry of paraconsistent logic and dialetheism on his initial analysis that a formally undecidable Gödel sentence is both true and false. But whether we look to Priest or others, the prime suspect to have facilitated the crime of paradox is always the allegedly self-referential Gödel sentence stating “I’m not provable.” Some logicians tried to remove the aura of paradox by eliminating self-reference or by making its mechanisms more transparent. Many, however, continued to use “self-reference” in highly visible places like book titles despite the fact that we do not seem to have a good grasp of how to make the intuitive idea of self-reference sufficiently precise in formal contexts. Others take offense at diagonalization, intimating that it amounts to

“black magic” (Soare) or at least is “intuitively unclear” (Kotlarski). Oftentimes the issue is further compounded by a somewhat loose language, which leaves unclear what “Gödel’s incompleteness proof” really refers to.

What I hope to achieve in this paper, then, is to alleviate the situation just sketched by clarifying the respective roles fixed points, diagonalization, and self-reference play in Gödel’s proof. This, I hope, will also refute the allegation that Gödel skates on the thin ice of paradox or that diagonalization is unintuitive. The exposition is organized around four claims: (i) the importance of fixed points; (ii) diagonalization as the technique of choice for fixed point construction; (iii) self-reference as a means for fixed point construction; (iv) distinctness of all three (e. g., diagonalization must not result in fixed points or fixed points not be self-referential)."

... Buldt: [Bld16], §1 Introduction.

The conflation⁴⁰⁴ seemingly lies in Buldt’s subsequent, false (see below), assumption that by ‘... adding the existential quantifier to the mix, we can extend these results and arrive at Σ_1 -completeness and Σ_1 -soundness of the formal system \mathcal{F} (i. e., completeness and soundness in respect to all expressions, recursive or formal, with at most one existential quantifier in front)’:

“Assume the formal system \mathcal{F} to contain (directly or via interpretation) the axioms of what is called Robinson’s Arithmetic \mathcal{Q} —viz., the six Peano Dedekind axioms that define successor, addition, and multiplication plus a seventh axiom stating that any number is zero or a successor. For all such systems we can establish that any recursive fact that is true (or false) can also be derived in \mathcal{F} (or its negation can).

Fact 1. Assume \mathcal{F} to contain \mathcal{Q} and to be consistent. For every recursive relation $R(x_1, \dots, x_k)$ there is a corresponding formal expression $\phi_{\mathcal{R}}(\mathbf{x}_1, \dots, \mathbf{x}_k)$ in the language of \mathcal{F} such that, for all $n \in \mathbb{N}$,

$$\begin{aligned} R(n_1, \dots, n_k) &\Leftrightarrow \vdash_{\mathcal{F}} \phi_{\mathcal{R}}(\bar{n}_1, \dots, \bar{n}_k), \\ \text{not-}R(n_1, \dots, n_k) &\Leftrightarrow \vdash_{\mathcal{F}} \neg \phi_{\mathcal{R}}(\bar{n}_1, \dots, \bar{n}_k). \end{aligned}$$

Remark. The presence of \mathcal{Q} guarantees the left-to-right direction ‘ \Rightarrow ’ in the two equivalences, consistency their reverse. Note how we use sans-serif font to communicate formal expressions in the language of \mathcal{F} .

From Fact 1 follows immediately,

Corollary 1. Assume \mathcal{F} to be as in Fact 1. For the primitive recursive proof relation $Proof_{\mathcal{F}}(x, y)$ there is a corresponding formal expression $\text{Proof}_{\mathcal{F}}(\mathbf{x}, \mathbf{y})$ in the language of \mathcal{F} such that, for all $n \in \mathbb{N}$,

$$\begin{aligned} Proof_{\mathcal{F}}(n, m) &\Leftrightarrow \vdash_{\mathcal{F}} \text{Proof}_{\mathcal{F}}(\bar{n}, \bar{m}). \\ \text{not-}Proof_{\mathcal{F}}(n, m) &\Leftrightarrow \vdash_{\mathcal{F}} \neg \text{Proof}_{\mathcal{F}}(\bar{n}, \bar{m}). \end{aligned}$$

By adding the existential quantifier to the mix, we can extend these results and arrive at Σ_1 -completeness and Σ_1 -soundness of the formal system \mathcal{F} (i. e., completeness and soundness in respect to all expressions, recursive or formal, with at most one existential quantifier in front).¹

¹ The situation is more complex than it was before since simple consistency does no longer suffice as it did for Fact 1 to secure the direction from right-to-left, i. e., soundness; or, in the current case, Σ_1 -soundness. This is the reason why Gödel introduced the concept of ω -consistency, which Rosser circumvented again by building it right into the provability predicate. We ignore these issues here; the curious reader may turn to (Buldt 2014, § 2.1)."

... Buldt: [Bld16], §3.3 Representation.

⁴⁰⁴Whose roots may conceivably lie in Buldt’s four claims *i*–*iv* in his Introduction (see §15.H.h.: *The unproven assumption in the statement of the fixed point theorem*).

‘False’ since, by the argumentation of §15.H.d. and §15.H.e., we *cannot* add ‘the existential quantifier to the mix’, and extend the above results to conclude that—as seemingly⁴⁰⁵ suggested by Buldt—for any specified natural number n :

$$\begin{aligned} (\exists m)Proof_{\mathcal{F}}(n, m) &\leftrightarrow \vdash_{\mathcal{F}} (\exists \bar{m})Proof_{\mathcal{F}}(\bar{n}, \bar{m}). \\ \text{not-}(\exists m)Proof_{\mathcal{F}}(n, m) &\leftrightarrow \vdash_{\mathcal{F}} \neg(\exists \bar{m})Proof_{\mathcal{F}}(\bar{n}, \bar{m}). \end{aligned}$$

Moreover since, by §8.G., Corollary 8.21, Rosser’s Rule C is *stronger* than Gödel’s ω -consistency—whence Rosser’s ‘extension’ of Gödel’s Theorem implicitly appeals to ω -consistency (see §17.)—it is not obvious how Buldt’s argument can be justified—or even illuminated—by his misleading allusion to ‘Gödel’s introduction of the concept of ω -consistency, which Rosser circumvented again by building it right into the provability predicate’.

15.H.k. A curious consequence of Gödel’s informal claim in his Theorem XI

The misleading influence—on current scientific paradigms—of the meta-mathematical and philosophical consequences that Gödel draws from his own informal claim in Theorem XI of [Go31], is strikingly highlighted by the following curious consequence of Gödel’s claim.

For instance, of particular significance for critics of the search for extra-terrestrial intelligence, SETI (see §26.) and, more especially, of METI (see §26.H.), is the following, curiously convoluted appeal to Skolem’s dictum (see §7.K.), in the interpretation of Gödel’s claim as highlighted by Penelope Maddy’s argument in [Ma18]:

“A simple example would be a proof of $1 = 0$ from the axioms of (first-order) Peano Arithmetic: $PA + \text{not-Con}(PA)$ is consistent (assuming PA is), so it has a model that thinks there’s a proof of $1 = 0$ from PA ; but viewed set-theoretically, that model is benighted, the thing it takes for a proof of $1 = 0$ has nonstandard length, isn’t really a proof.”

... Maddy: [Ma18], p.12.

⁴⁰⁵To avoid digression from the ‘conflation’ sought to be highlighted in the paragraph that is being commented upon—viz. treating the ‘name’ $\ulcorner \phi \urcorner$ of an ‘unspecified, but putatively algorithmically *computable*, natural number n as the ‘name’, expressible within T , of the ‘unspecified’ numeral $\lceil \bar{n} \rceil$ that represents n in T which may, or may not be formally specifiable in T —we shall merely note here that, in a personal communication to the author, Professor Buldt seeks to clarify his intent:

“I looked at your criticism, and it seems you criticize the language of “adding the existential quantifier to the mix.” In hindsight I’m happy to admit that it was not the most clear way of expressing myself, but Corollary 2, which follows immediately, should make things sufficiently clear.

What I meant was that we can extend the result on representability

$$R(n) \leftrightarrow \vdash \phi(n)$$

to the case of Σ_1 formulas

$$(*) \exists x R(x) \leftrightarrow \vdash \exists x \phi(x)$$

provided we can prove Σ_1 -completeness and assume Σ_1 -soundness. We cannot, however, extend the result

$$\neg R(n) \leftrightarrow \vdash \neg \phi(n).$$

This is why the following Corollary 2 only states (*), but NOT something like

$$(**) \neg \exists x R(x) \leftrightarrow \vdash \neg \exists x \phi(x),$$

which would be blatantly false. So your interpretation on p. 427 that “adding the existential quantifier to the mix” applies to both the unnegated and negated case ignores that the result is (*), ie, Corollary 2, but not (**).”

In other words, if we assume the P-formula $[\omega]$ can, indeed, be interpreted as ‘*Wid*(P) is true’ under some, putatively *well-defined*, non-standard, interpretation $\mathcal{I}_{PA(\mathbb{D}, NS)}$ of P over a putatively *well-defined* domain \mathbb{D} , then it would follow from:

- (i) the unprovability of the formula $[\omega]$ in P, and
- (ii) the unprovability of the formula $[\neg\omega]$ in P (since P is assumed ω -consistent),

that the theory $P + [\neg\omega]$ would not only be consistent, but have a putatively *well-defined* interpretation of P under which the P-formula $[\neg\omega]$ would ‘truthfully’ assert that:

‘*Wid*(P) is false; whence P is inconsistent and $1 = 0$ ’!

15.H.1. The significance of Wittgenstein’s insistence on interpreting Gödel’s claims algorithmically

The significance of interpreting Gödel’s claims:

- (a) of having finitarily constructed an *unprovable* PA formula $[(\forall x)R(x)]$ that interprets under any well-defined interpretation of PA as a *true* arithmetical proposition which *asserts* that ‘The PA-formula $[(\forall x)R(x)]$ is PA-unprovable’ (see §15.D.); and
- (b) of having finitarily constructed an *unprovable* PA formula $[w]$ that interprets under any well-defined interpretation of PA as a *true* arithmetical proposition which *asserts* that ‘PA is consistent’ (see §15.H.);

in terms of algorithmic *verifiability*, and algorithmic *computability*, is that, from the *evidence-based* perspective of this investigation, it can be viewed as vindicating what Timm Lampert attributes in [Lam19] as:

- (i) ‘Wittgenstein’s algorithmic conception of proof in terms of a finite transformation of the problem into a representation in some notation that allows one to decide the initial question based on properties of the resulting expressions’; and
- (ii) Wittgenstein’s contention that ‘representation of a formal property by a propositional function within the formal language itself’, as in undecidability proofs, reduce ‘the possibility to represent provability as a propositional function to absurdity, not the assumption of a decision procedure that is independent of such a representation’.

“Gödel’s undecidability proof proves that there exists at least one formula G in the language of PA (henceforth denoted by L_A) such that neither G nor $\neg G$ is provable from the axioms of PA. If Gödel had proven this result by providing a decision method for provability in PA, this would be in line with Wittgenstein’s own proof conception. His paradigm for acceptable, algorithmic proofs of unprovability is manifested in the algebraic proofs of the unsolvability of certain problems within Euclidean geometry, such as the problem of angle trisection with a straightedge and compass (cf. RFM I, appendix I, §14). Such proofs of unprovability are part of a decision procedure that distinguishes between possible and impossible constructions on the basis of their algebraic representations: the angles that can be constructed with a straightedge and compass are those and only those that are representable by algebraic equations that can be solved with nested square roots.⁸ This fits with Wittgenstein’s algorithmic conception of proof in terms of a finite transformation of the problem into a representation in some notation that allows one to decide the initial question based on properties of the resulting expressions.

However, Gödel's proof is not of this sort. Instead, it rests on the representation of a formal property, namely, PA-provability, in L_A , i.e., a language that is based on FOL supplemented with constants for numbers and arithmetic functions. This means that provability is expressed by a certain open formula (abbreviated by $\exists yByx$, according to Gödel's definition 46) in L_A iff, for all Gödel numbers n of L_A -propositions, [the L_A -proposition with Gödel number] n is provable iff $\exists yBy\bar{n}$ is true according to the intended interpretation of L_A .⁹ According to Wittgenstein's proof conception, any intent to represent a formal property, such as provability, by an open formula (propositional function) must be founded on confusion between material and formal properties, which is the fundamental mistake of mathematical logic. In contrast to Gödel, Wittgenstein claimed that formal properties can only be "shown", i.e., identified through a decision procedure; they cannot be "said", i.e., expressed within the formal language to which they apply.

Wittgenstein rejected the application of the axiomatic method in Gödel's undecidability proof of his formula G . He did not do so by referring to the relevant proof of the representability of recursive functions within LA (cf. theorems V and VII in [Gödel (1931)], p. 186; theorem 13.4 in [Smith (2007)], p. 109; and [Lampert (2018b)] for detailed discussions). Instead, he was aware that he was instead "bypass[ing]" (RFM V, §17, last sentence) Gödel's proof since he was discussing not the details of the proof but rather what could be taken as a "forcible reason for giving up the search for a proof" (RFM I, appendix I, §14). For Wittgenstein, this was a question of what counts as a "criterion of (un)provability" (cf. RFM I, appendix I, §14-16, and V, §18f.). According to his algorithmic proof conception, a criterion for a formal property must be a decision criterion in terms of some property of ideal symbols. This is why the proof of the impossibility of trisecting an angle with a straightedge and compass counts as a criterion for giving up the search for such a construction (RFM I, appendix I, §14). By contrast, the criterion for a "forcible reason" to give up the search for a decision procedure is not satisfied by meta-mathematical undecidability proofs since they are based on the representation of a formal property by a propositional function within the formal language itself. According to Wittgenstein, undecidability proofs reduce the possibility to represent provability as a propositional function to absurdity, not the assumption of a decision procedure that is independent of such a representation. Indeed, the verdict regarding the representation of formal properties by propositional functions had lain at the heart of Wittgenstein's critique of mathematical logic since the beginning (cf. TLP 4.126)."

... Lampert: [Lam19], §4.1 Wittgenstein's reaction to Gödel's undecidability proof.

Lampert analyses further how Wittgenstein's belief 'that formal properties are not representable by propositional functions' could justify 'why Wittgenstein could not accept Gödel's undecidability proof as a proof of incompleteness':

"One reason why Wittgenstein thought that formal properties are not representable by propositional functions is that he rejected the possibility of self-referential representations within a formalism based on FOL (cf. TLP 3.332f). He distinguished operations from functions and considered that it is only with operations that self-application comes into play (TLP 5.25f). However, the application of operations is a part of symbolic manipulation and is not something that is expressible by functions within a logical symbolism. Undecidability proofs, meanwhile, rest on diagonalization and, thus, on a formula that is intended to represent that the formula itself does (not) have a certain property. Gödel's formula G , for example, is intended to represent the property of unprovability of the formula G itself. On this basis, he proved that G cannot be captured in PA.¹⁰ This proof method gives priority to semantics (representation) over syntax (capturing). It is only this priority that makes it possible to prove meta-mathematically that an algorithmic proof conception is limited. Such reasoning cannot convince an advocate of the algorithmic proof conception since such an advocate instead places priority on syntax. In the case of conflict, said advocate would deny the definability of the formal property in question. Thus, given G were provable from the axioms of PA, the diagonal case would simply turn out to be such a case of conflict. Therefore, Wittgenstein would not infer that PA is inconsistent but instead would deny that G , in fact, represents its own unprovability (RFM I, appendix I, §§8, 10). This is also why Wittgenstein could not accept Gödel's undecidability proof as an proof of incompleteness."

... Lampert: [Lam19], §4.1 Wittgenstein's reaction to Gödel's undecidability proof.

Moreover, according to Lampert in [Lam19], Wittgenstein did not view such ‘conflicts’ as posing serious linguistic or philosophical concerns, since he argued that—from a rule-based perspective of constructive mathematical reasoning (compare §20.)—they were merely ‘the outcome of the fundamental mistake of mathematical logic, namely, the assertion that formal properties of mathematics and meta-mathematics can be expressed by propositional functions’:

“Wittgenstein analysed undecidability proofs as proofs by contradiction (cf. RFM I, appendix I, §14, and cf. PI §125 below). In the case of Gödel’s undecidability proof, he mainly considered the contradiction as one between a supposed proof of G and the fact that G represents its own unprovability (RFMI, appendix I, §8, 10, 11). However, his rejection also applies to the so-called syntactic version of Gödel’s proof since this version also relies on the assumption that the formal property of provability can be represented within L_A , which involves self-referential interpretations in the diagonal case. No proof of contradiction can be a compelling reason to give up the search for a decision procedure since an advocate of the algorithmic proof conception questions the assumption of representability for the formal property in question. Wittgenstein compared the contradiction arising in an undecidability proof to a paradox (RFM I, appendix I, §12f, §19). According to Wittgenstein’s analysis, so-called semantic paradoxes, such as the Liar paradox, as well as paradoxes of mathematical logic, such as Russell’s paradox, rely on the representation of formal properties by propositional functions (cf. TLP 3.33-3.334; WVC, p. 121; and PR, p. 207f.). The problem lies not with the specific properties (semantic properties vs. set-theoretical properties) but with the analysis of self-reference as something that is expressible by propositional functions and thus capable of being represented in a symbolism based on FOL. The distinction between meta- and object-language is not sufficient to prevent paradoxes, according to Wittgenstein’s analysis. Instead, it is the distinction between formal and material properties that must be considered. This distinction comprises both semantic paradoxes and the paradoxes of mathematical logic. It even applies to arithmetic properties and their meta-mathematical correlates. For Wittgenstein, the arithmetic and meta-mathematical interpretations in the language of L_A were not an “absolutely uncontroversial part of mathematics” ([Wang (1987)], p. 49; however, cf. also [Gödel (1931)], p. 149, footnote 14) but rather the outcome of the fundamental mistake of mathematical logic, namely, the assertion that formal properties of mathematics and meta-mathematics can be expressed by propositional functions. Wittgenstein’s algorithmic proof conception rules out such a possibility since it maintains that formal properties can be expressed only by symbolic properties of a proper notation. Wittgenstein believed in an algorithmic proof conception as the standard for a rigorous proof that can never be affected by any underlying intended interpretations of a logical symbolism to represent any properties, since such an interpretation necessarily extends beyond the realm of mere symbolic manipulations.”

... Lampert: [Lam19], §4.1 Wittgenstein’s reaction to Gödel’s undecidability proof.

15.H.m. Gödel’s reasoning, ironically, justifies Wittgenstein’s ‘notorious’ paragraph

Ironically, we note that the *evidence-based* reasoning in [An16]:

- not only justifies Wittgenstein’s insistence that the *meaning* (interpretation) of meta-mathematical propositions must be rule-based,
- but also Wittgenstein’s ‘notorious’ objection, in [Wi78], to the meta-mathematical conclusions that Gödel draws from his own reasoning in [Go31],
- which Lampert describes in [Lam19] as objecting to a ‘fundamental mistake of mathematical logic’, namely:
 - ‘the assertion that formal properties of mathematics and meta-mathematics can be expressed by propositional functions’;

since Wittgenstein's objection can now be seen to be entailed by Gödel's own proof, in [Go31] (p.25), that '17 Gen r is not κ – PROVABLE'!

For, this proof entails that if, say, a number-theoretic assertion over the domain \mathbb{N} of the natural numbers can be symbolically denoted by ' $(\forall x)R^*(x)$ ', where the number-theoretic relation $R^*(x)$ can be formally expressed in PA by some PA-formula $[R(x)]$ ⁴⁰⁶ such that, for any given natural number n (and corresponding PA-numeral $[\bar{n}]$):

- (1) if $R^*(n)$ holds in \mathbb{N} , then $[R(\bar{n})]$ is provable in PA;
- (2) if $\neg R^*(n)$ holds in \mathbb{N} , then $[\neg R(\bar{n})]$ is provable in PA;

we cannot claim, in the absence of a rule-based (*evidence-based*) proof that:

- if, under a *well-defined* interpretation of PA over \mathbb{N} , the PA-formula $[R(x)]$ interprets as an arithmetical relation over \mathbb{N} denoted symbolically by $R'(x)$,
 - so that the PA-formula $[(\forall x)R(x)]$ interprets as the arithmetical assertion over \mathbb{N} denoted symbolically by $(\forall x)R'(x)$,
- then the arithmetical assertion $(\forall x)R'(x)$ must *assert/mean* in \mathbb{N} what the number-theoretic assertion symbolically denoted by $(\forall x)R^*(x)$ *asserts/means* in \mathbb{N} ;

even though, for any natural number n :

- (1) $R^*(n)$ holds in \mathbb{N} if, and only if, $R'(n)$ holds in \mathbb{N} ;
- (2) $\neg R^*(n)$ holds in \mathbb{N} if, and only if, $\neg R'(n)$ holds in \mathbb{N} .

In other words, from the *evidence-based* perspective of this investigation:

- quantification of the formal arithmetical representation $[R(x)]$ of a number-theoretic relation $R^*(x)$ does not necessarily *assert/mean*, under interpretation, what
- quantification of the number-theoretic relation $R^*(x)$ *asserts/means*;

since, by [An16], Corollary 8.3 (p.42):

- the number-theoretic relation $R^*(x)$ can be algorithmically *computable*;
- whilst $[R(x)]$ interprets:
 - under Tarski's inductive definitions of the 'satisfiability' and 'truth' of the formulas of a formal language under a *well-defined* interpretation,
 - as an arithmetical relation, say $R'(x)$,
 - which can be algorithmically *verifiable*, but not algorithmically *computable*.

⁴⁰⁶We use square brackets to distinguish between an expression that denotes a PA-formula, and an expression that denotes a natural number or a number-theoretic proposition/relation/function in/over the domain \mathbb{N} of the natural numbers.

15.H.n. A phenomenological critique of Gödel's interpretation of his own formal argumentation

We consider Gödel's interpretation of his own formal argumentation in [Go31] from another perspective where even if we do—as Stathis Livadas apparently does in his phenomenological critique [Lvd16] of Gödel's argumentation—admit Gödel's claims:

- (i) of having finitarily constructed an *unprovable* PA formula $[(\forall x)R(x)]$ that interprets under any well-defined interpretation of PA as a *true* arithmetical proposition which *asserts* that 'The PA-formula $[(\forall x)R(x)]$ is PA-unprovable' (see §15.D.); and
- (ii) of having finitarily constructed an *unprovable* PA formula $[w]$ that interprets under any well-defined interpretation of PA as a *true* arithmetical proposition which *asserts* that 'PA is consistent' (see §15.H.);

as prima facie reasonable—and presumed formally defensible—Livadas argues that, nevertheless, since Gödel's incompleteness results appeal critically to interpretations of 'quantification over an indefinite horizon within the realms of arithmetic', it would follow that 'both Gödel's incompleteness results in the various forms of their proof can be seen from a certain angle as essentially due to the insufficiency of finitistic arithmetic means to represent meta-mathematical statements incorporating a non-rigorous finitistic content':

“Concerning Gödel's incompleteness results, quantification over an indefinite horizon within the realms of arithmetic is a critical factor in the generation of both incompleteness theorems by formally representing, through the application of universal quantifiers, the non-finitistic content of meta-mathematical statements within arithmetical calculus.⁸ In the general view of this article the non-finitistic meta-mathematical content of certain expressions and properties in formal arithmetical calculus can be associated with the kind of actual infinity freely generated through the continuous unity of temporal consciousness and presented as an objective whole in acts of reflection.

As it is known as main pillars in achieving Gödel's incompleteness results stand: (a) Gödel's complete arithmetization of formal (predicate) calculus (b) the complete arithmetization of meta-mathematical statements referring to expressions in the formal calculus and (c) the notion of the mapping of sets of meta-mathematical statements turned to expressions of the formal calculus onto arithmetical ones.

Accordingly, the formula $[(\forall x)\neg\text{Dem}(x, y)]$ is the arithmetical representation of the meta-mathematical statement 'for every x the sequence of formulas with Gödel number x is not a proof of the formula with Gödel number y '. By an ingenious technique Gödel constructed a universally quantified arithmetical formula (in S. C. Kleene's notation $A_p(\mathbf{p})$) which asserts of itself that it is not demonstrable (even though it is true) and corresponds to the meta-mathematical statement: 'For every x the sequence of formulas with Gödel number x is not a proof of the formula whose Gödel number is the Gödel number of the formula which is obtained by substituting in the place of numerical variable y the Gödel number of the formula $(\forall x)\neg\text{Dem}(x, \text{sub}(y, 13, y))$ '. This latter represents in turn the meta-mathematical statement: 'The formula with Gödel number $\text{sub}(y, 13, y)$ is not demonstrable'.⁹

In a definite sense by relying on the mapping of meta-mathematical statements onto arithmetical ones, in other words by arithmetizing a 'non-rigorous' discussion about mathematical objects Gödel essentially transposed meta-mathematical 'pathologies' of a non-finitistic content (those whose range of application is an indefinite horizon) onto arithmetical ones by means of a universal quantification over variables x with x being a Gödel number belonging to a certain (infinite) subset of N .

I note that in Gödel's original presentation it was proved that if the formal arithmetical system is (simply) consistent then $A_p(\mathbf{p})$ is not demonstrable and if the system is ω -consistent¹⁰ then $\neg A_p(\mathbf{p})$ is not demonstrable (ω -consistency implies simple consistency). Consequently, if the arithmetical system is ω -consistent then it is incomplete with $A_p(\mathbf{p})$ an example of an undecidable formula (Kleene 1980, pp. 207-208). At this point it is noteworthy that the notion of ω -consistency points indirectly to the views presented in earlier sections, namely those bearing to the fact that mathematical objects or relations in general possess an 'inner' horizon which is open to new insights, new possibilities of intuitive elaboration, even to a mental reconfiguration of apprehended objects with regard to all existing and possible interrelations referring in a significant part to the capacities of a subject's categorical intuition. Technically this has to do here with the fact that a system may be ω -inconsistent without being inconsistent. This means that while formula $(\exists x)P(x)$ and [any] member of the infinite set of $\neg P(0), \neg P(1), \neg P(2), \dots$ should be both demonstrable by ω -inconsistency definition, the formula $(\forall x)\neg P(x)$ may nonetheless not be demonstrable in which case the system in question is not inconsistent since in that case $(\exists x)P(x)$ and $(\forall x)\neg P(x)$ should be both demonstrable (Nagel and Newman 1958, p.91). This formal result clearly shows that even though we may have an infinitely proceeding series of identical formulas 'indexed' by corresponding values of variables (these formulas being demonstrable), yet a universal quantification over these values may not yield a demonstrable formula.

In fact, one can hardly interpret this paradoxical situation at the subjective meta-theoretical level than by admitting to some infinity factor underlying universal quantification over an indefinite horizon which is non-eliminable by a discrete 'stepwise' approximation. Moreover, one can hardly proceed to an objectivity of understanding such as $(\forall x)\neg P(x)$ through a generation of objectivities like $\neg P(0), \neg P(1), \neg P(2), \dots$ which correspond to 'real-world' or immanently induced apprehensions, than by admitting some kind of temporal unity that makes up for the deficiency between the temporal moments of objectifying acts $\neg P(0), \neg P(1), \neg P(2), \dots$ going on ideally ad infinitum and the temporal moment in which the expression $(\forall x)\neg P(x)$ becomes an objectivity of understanding in immediate presentation.

As a matter of fact, both Gödel's incompleteness results in the various forms of their proof can be seen from a certain angle as essentially due to the insufficiency of finitistic arithmetical means to represent meta-mathematical statements incorporating a non-rigorous finitistic content. As meta-mathematical statements are mapped **onto** corresponding arithmetical ones a possible means to formally express the non-finitistic meta-mathematical content is by the application of universal quantifiers with an indefinite scope in the intermediate stage of predicate calculus. In my approach, any universal quantification of an indefinite scope even one concerning the set of natural numbers in its entirety may be taken as ultimately conditioned on the assumption of an actual infinity in the present now independently of any spatiotemporal constraints and at the same time as conditional on a stepwise enactment of mathematical intuitions (concerning formal individuals or generally 'concrete' mathematical objects) progressing ideally *ad infinitum*. It is thanks to these subjectively founded conditions that there exists a possibility of extending indefinitely the scope of concrete mathematical act in preserving the essential invariability of corresponding mathematical objects. On these grounds, for instance, we can construct the undecidable formula $A_p(\mathbf{p})$ in a way that the (universally quantified) variable b does not stand with \mathbf{p} in the arithmetical relation $A(\mathbf{p}, b)$, where \mathbf{p} is the Gödel number of the formula $(\forall b)\neg(a, b)$. In the particular case this formal possibility is implemented by applying Cantor's diagonal method which is known to presuppose a meta-theoretical notion of an 'infinite' objective whole in presentational immediacy."

... Livadas: [Lod16], §4 The Question of Universal-Existential Quantification . . . , pp.22-24.

From the *evidence-based* perspective of this investigation, Livadas is apparently making the point here that:

- (a) Asserting the *truth/objectivity* of the arithmetical formula $[(\forall x)\neg P(x)]$ —under any *well-defined* interpretation of the arithmetic—formally represents, through the application of a universal quantifier, the non-finitistic content of a meta-mathematical statement, within arithmetical calculus. This can then be associated with the kind of actual infinity freely

generated through the continuous unity of temporal consciousness, and presented as an objective whole in acts of reflection.

- (b) Hence, asserting the *truth/objectivity* of the arithmetical formula $[(\forall x)\neg P(x)]$ —under any *well-defined* interpretation of the arithmetic—entails, and is entailed by, asserting the *truth/objectivity* of the non-terminating sequence of formulas $[\neg P(0)], [\neg P(1)], [\neg P(2)], \dots$ *jointly* (i.e., formally as algorithmically *computable* in the sense of §7.C., Definition 23; and informally in the sense of $[\neg P(0)] \& [\neg P(1)] \& [\neg P(2)], \dots$) under the interpretation;
- (c) However, it follows from Gödel’s Theorem VI in [Go31] that asserting the *truth/objectivity* of each of the non-terminating sequence of arithmetical formulas $[\neg P(0)], [\neg P(1)], [\neg P(2)], \dots$ *severally* (i.e., as algorithmically *verifiable* in the sense of §7.C., Definition 21)—under any putative interpretation of the arithmetic—would not entail the *truth/objectivity* of the formula $[(\forall x)\neg P(x)]$;
- (d) It thus follows that asserting the *truth/objectivity* of each of the non-terminating sequence of arithmetical formulas $[\neg P(0)], [\neg P(1)], [\neg P(2)], \dots$ *severally* (i.e., as algorithmically *verifiable* in the sense of §7.C., Definition 21)—under a *well-defined* interpretation of the arithmetic—does not entail the *truth/objectivity* of the sequence *jointly* (i.e., as algorithmically *computable* in the sense of §7.C., Definition 23) under the interpretation;
- (e) Moreover, the provability of the arithmetical formula $[(\exists x)P(x)]$ —which is merely an abbreviation for the arithmetical formula $[\neg(\forall x)\neg P(x)]$ —is consistent with the provability of each of the formulas $[\neg P(0)], [\neg P(1)], [\neg P(2)], \dots$ *severally* (i.e., as algorithmically *verifiable* in the sense of §7.C., Definition 21) in the arithmetic;

If so, Livadas seems to conclude that, from a phenomenological perspective, Gödel cannot therefore justifiably claim that his ‘formally undecidable’ arithmetical proposition is *unprovable* but *true* under any *well-defined*—hence *finitary*—interpretation of the arithmetic since:

“... one can hardly interpret this paradoxical situation at the subjective meta-theoretical level than by admitting to some infinity factor underlying universal quantification over an indefinite horizon which is non-eliminable by a discrete ‘stepwise’ approximation”.

... Livadas: [Lvd16], §4 *The Question of Universal-Existential Quantification ...*, p.23.

Livadas’ ‘paradoxical situation’ refers to:

“... the views presented in earlier sections, namely those bearing to the fact that mathematical objects or relations in general possess an ‘inner’ horizon which is open to new insights, new possibilities of intuitive elaboration, even to a mental reconfiguration of apprehended objects with regard to all existing and possible interrelations referring in a significant part to the capacities of a subject’s categorical intuition. Technically this has to do here with the fact that a system may be ω -inconsistent without being inconsistent. This means that while formula $(\exists x)P(x)$ and [any] member of the infinite set of $\neg P(0), \neg P(1), \neg P(2), \dots$ should be both demonstrable by ω -inconsistency definition, the formula $(\forall x)\neg P(x)$ may nonetheless not be demonstrable ...”.

... Livadas: [Lvd16], §4 *The Question of Universal-Existential Quantification ...*, p.23.

The significance of Livadas’ ‘paradoxical situation’ in the above phenomenological argument emerges if we interpret the above para, from the *evidence-based* perspective of this investigation, as suggesting that:

- despite having admitted both of Gödel’s claims §15.H.n.(1) and §15.H.n.(2); and

- although Gödel’s assumption of ω -consistency
 - in the second part ([Go31], p.26, ‘2. Neg(17 Gen r) is not κ -provable’) of his metamathematical proof of the existence of a ‘formally undecidable’ arithmetical proposition;
- entails interpreting the universal quantifier non-finitarily as Aristotle’s particularisation (see §7., Definition 20; and §8.D., Theorem 8.12),
- denial of such an assumption, *and* the non-finitarity that it entails (see §8.D., Corollary 8.10),
- could, thereby, admit instead ω -inconsistency for arithmetic;
 - by Corollary 8.4 in [An16] (see also §2.F.: Corollary 2.20, Corollary 2.21, and Corollary 2.22); and, independently,
 - by §12.B.f., Theorem 12.6;
- an admittance, moreover, which does not entail non-finitary consequences.

Part IV

WHERE *EVIDENCE-BASED* REASONING CHALLENGES CURRENT PARADIGMS

We conclude this investigation by analysing the arguments where *evidence-based* reasoning challenges current paradigms in respect of:

- Cantor’s Continuum Hypothesis (§16.);
- Gödel’s and Rosser’s proofs of ‘undecidability’ (§17.);
- Non-standard models of PA (§18.);
- Goodstein’s argument (§19.);
- The logical and semantic paradoxes (§20.);
 - The mythical ‘set-theoretical’ limits of fractal constructions (§20.C.);
 - The mythical completability of metric spaces (§20.D.b.);
- Lucas’ and Penrose’s Gödelian Arguments (§21.);
 - A Definitive Turing Test (§21.E.);
- Prime divisibility and integer factorisation (§22.);
 - Estimating primes in an arithmetical progression (§22.C.);
 - Estimating twin primes (§22.D.);
- The *EPR* paradox (§23.A.);
 - The Bohr-Einstein debate (§23.B.);
 - Dimensionless constants (§23.D.);
 - Conjugate properties (§23.D.f.);
 - Entangled particles (§23.D.g.);
 - Schrödinger’s cat ‘paradox’ (§23.D.h.);
- The Church-Turing Thesis and quantum computing (§24.);
- The Travelling Salesman Problem (§25.);
- The search for extra-terrestrial intelligence, SETI/METI (§26.);
- The Cognitive Sciences (§27.);
- The philosophy of mathematics education (§28.).

CHAPTER 15. PARADIGM CHALLENGING CONSEQUENCES

16. The significance of *evidence-based* reasoning for Cantor's Continuum Hypothesis

The set-theoretical perspective on Cantor's Continuum Hypothesis CH⁴⁰⁷ is well-known.

- Kurt Gödel showed in 1939⁴⁰⁸ that CH is consistent with the usual Zermelo-Fraenkel (ZF) axioms for set theory *if* ZF is consistent. On this assumption, he then defined a putative model of ZF in which both the Axiom of Choice (AC) and CH would hold.
- Paul Cohen showed in 1963⁴⁰⁹ that the negations of AC and CH are also consistent with ZF; in particular, he defined a putative model of ZF in which CH would fail whilst AC would hold *if* ZF is consistent.

We now argue that—since PA is finitarily consistent (see §2.C., 2.16), and since there can be no *evidence-based* assignment of a *truth* value to the ZF axiom of infinity⁴¹⁰—there is a preferential *evidence-based* arithmetical perspective of CH which is based on distinguishing between algorithmically *verifiable* number-theoretic functions and algorithmically *computable* number-theoretic functions⁴¹¹.

We shall appeal to Gödel's β -function, which uniquely corresponds each real number to an algorithmically *verifiable* arithmetical function.

Since PA is first-order, both the algorithmically *verifiable* arithmetical functions and the algorithmically *computable* arithmetical function are denumerable. We conclude that both the natural numbers and the reals are also denumerable; thereby illustrating the (Downwards) Löwenheim-Skolem Theorem (see §7.K.).

From a more practical perspective, the significance of an *evidence-based* interpretation of the Continuum Hypothesis for the computer sciences, and the development of mechanical intelligences, is highlighted by the, seemingly illusory, constraining influences of current paradigms.

For instance, Shai Ben-David, Pavel Hrubeš, Shay Moran, Amir Shpilka and Amir Yehudayoff argue that current paradigms suggest 'Learnability can be undecidable':

"The mathematical foundations of machine learning play a key role in the development of the field. They improve our understanding and provide tools for designing new learning paradigms. The advantages of mathematics, however, sometimes come with a cost. Gödel and Cohen showed, in a nutshell, that not everything is provable. Here we show that machine learning shares this fate. We describe simple scenarios where learnability cannot be proved nor refuted using the standard axioms of mathematics. Our proof is based on the fact the continuum hypothesis cannot be proved

⁴⁰⁷There is no set whose cardinality is strictly between the cardinality \aleph_0 of the integers and the cardinality 2^{\aleph_0} of the real numbers.

⁴⁰⁸[Go40].

⁴⁰⁹[Co66].

⁴¹⁰Which asserts the existence of a completed infinity in every model of ZF.

⁴¹¹The distinction was introduced—and its significance highlighted—in [An16]. Since set-theoretic functions are defined extensionally, it is not obvious how—or even whether—this distinction can be reflected within ZF.

nor refuted. We show that, in some cases, a solution to the 'estimating the maximum' problem is equivalent to the continuum hypothesis. The main idea is to prove an equivalence between learnability and compression."

... Ben-David et al: [Dvd19], Abstract

"Identifying the learnable is a fundamental goal of machine learning. To achieve this goal, one should first choose a mathematical framework that allows a formal treatment of learnability. This framework should be rich enough to capture a wide variety of learning problems. Then, one should find concrete ways to characterize learnability within this framework. This paradigm has been successfully applied in many contexts of machine learning. In this work, however, we show that this paradigm fails in a well studied learning model. We exhibit a simple problem where learnability cannot be decided using the standard axioms of mathematics (that is, of Zermelo–Fraenkel set theory with the axiom of choice, or ZFC set theory). We deduce that there is no dimension-like quantity that characterizes learnability in full generality."

... Ben-David et al: [Dvd19], Opening paragraph

16.A. Gödel's β -function

We note that Gödel's β -function is defined as ([Me64], p.131):

$$\beta(x_1, x_2, x_3) = rm(1 + (x_3 + 1) \star x_2, x_1)$$

where $rm(x_1, x_2)$ denotes the remainder obtained on dividing x_2 by x_1 .

We also note that:

Lemma 16.1. *For any non-terminating sequence of values $f(0), f(1), \dots$, we can construct natural numbers b_k, c_k such that:*

$$(i) \ j_k = \max(k, f(0), f(1), \dots, f(k));$$

$$(ii) \ c_k = j_k!;$$

$$(iii) \ \beta(b_k, c_k, i) = f(i) \text{ for } 0 \leq i \leq k.$$

Proof This is a standard result ([Me64], p.131, Proposition 3.22). □

Now we have the standard definition ([Me64], p.118):

Definition 39. *A number-theoretic function $f(x_1, \dots, x_n)$ is said to be representable in the first order Peano Arithmetic PA if, and only if, there is a PA formula $[F(x_1, \dots, x_{n+1})]$ with the free variables $[x_1, \dots, x_{n+1}]$, such that, for any specified natural numbers k_1, \dots, k_{n+1} :*

$$(i) \ \text{if } f(k_1, \dots, k_n) = k_{n+1} \text{ then PA proves: } [F(k_1, \dots, k_n, k_{n+1})];$$

$$(ii) \ \text{PA proves: } [(\exists_1 x_{n+1}) F(k_1, \dots, k_n, x_{n+1})].$$

The function $f(x_1, \dots, x_n)$ is said to be strongly representable in PA if we further have that:

$$(iii) \ \text{PA proves: } [(\exists_1 x_{n+1}) F(x_1, \dots, x_n, x_{n+1})]. \quad \square$$

We also have that:

Lemma 16.2. *$\beta(x_1, x_2, x_3)$ is strongly represented in PA by $[Bt(x_1, x_2, x_3, x_4)]$, which is defined as follows:*

$$[(\exists w)(x_1 = ((1 + (x_3 + 1) \star x_2) \star w + x_4) \wedge (x_4 < 1 + (x_3 + 1) \star x_2))].$$

Proof This is a standard result ([Me64], p.131, proposition 3.21). □

16.B. An *evidence-based* arithmetical perspective on Cantor's Continuum Hypothesis

From an *evidence-based* perspective every real number is algorithmically *verifiable* by definition, hence *well-defined* by §7.F., Definition 25.

Further, by §7.G., Theorem 7.2, there are *well-defined* real numbers that are algorithmically *verifiable* but not algorithmically *computable*.

Moreover, by §7.I., Theorem 7.5, every real number is *specifiable* in PA.

Comment 150. It is not at all obvious how, or even whether, an algorithmically *verifiable* real number can be defined, or even merely treated, as *unspecifiable* within a theory, and *yet* have properties that can be entailed by the theory.

In other words, unless postulation of an *unspecified* element within a theory can be shown not to invite contradiction, the putative existence of any such element, either within the theory or in the domain of any putative interpretation of the theory (as in the case of Aristotle's particularisation in §7., Definition 20), would, for instance, be no different in principle from postulation of the dubious (see, for instance, §20.C., Case 2) existence of a 'limiting' figure corresponding to the definition of a Cantor Set.

By convention, if we denote the cardinality of the natural numbers by \aleph_0 and, since each $r(i)$ can have two possible values, the cardinality of the putative set $\{r(n)\}$ of *specifiable* reals by 2^{\aleph_0} , it follows that:

Theorem 16.3. *The cardinality 2^{\aleph_0} of the real numbers cannot exceed the cardinality \aleph_0 of the integers.*

Proof. Let $\{r(n)\}$ be the denumerable sequence defined by the denumerable sequence of digits in the binary decimal expansion $\sum_{n=1}^{\infty} r(n) \cdot 10^{-n}$ of a putatively *specifiable* real number \mathbb{R} in the interval $0 < \mathbb{R} \leq 1$ where, for any specified i , $r(i)$ is either 0 or 1.

By §16.A., Lemma 16.1, for any *specified* natural number k , we can define natural numbers b_k, c_k such that, for any $1 \leq n \leq k$:

$$\beta(b_k, c_k, n) = r(n).$$

By §16.A., Lemma 16.2, $\beta(b_k, c_k, n)$ is uniquely represented in the first order Peano Arithmetic PA by $[Bt(b_k, c_k, n, x)]$ such that, for any $1 \leq n \leq k$:

$$\text{If } \beta(b_k, c_k, n) = r(n) \text{ then PA proves } [Bt(b_k, c_k, n, r(n))].$$

We now define the arithmetical formula $[R(b_k, c_k, n)]$ for any $1 \leq n \leq k$ by:

$$[R(b_k, c_k, n) = r(n)] \text{ if, and only if, PA proves } [Bt(b_k, c_k, n, r(n))].$$

Hence every putatively *specifiable* real number \mathbb{R} in the interval $0 < \mathbb{R} \leq 1$ can be uniquely corresponded to an algorithmically *verifiable* arithmetical formula $[R(x)]$ since:

For any k , the primitive recursivity of $\beta(b_k, c_k, n)$ yields an algorithm $AL_{(\beta, \mathbb{R}, k)}$ that provides objective evidence for deciding the unique value of each formula in the finite sequence $\{[R(1), R(2), \dots, R(k)]\}$ by evidencing the truth under a sound interpretation of PA for:

$$\begin{aligned}
& [R(1) = R(b_k, c_k, 1)] \\
& [R(b_k, c_k, 1) = r(1)] \\
& [R(2) = R(b_k, c_k, 2)] \\
& [R(b_k, c_k, 2) = r(2)] \\
& \dots \\
& [R(k) = R(b_k, c_k, k)] \\
& [R(b_k, c_k, k) = r(k)].
\end{aligned}$$

The correspondence is unique because, if \mathbb{R} and \mathbb{S} are two different, putatively *specifiable*, reals in the interval $0 < \mathbb{R}, \mathbb{S} \leq 1$, then there is always some m for which:

$$r(m) \neq s(m).$$

Hence we can always find corresponding arithmetical functions $[R(n)]$ and $[S(n)]$ such that:

$$[R(n) = r(n)] \text{ for all } 1 \leq n \leq m.$$

$$[S(n) = s(n)] \text{ for all } 1 \leq n \leq m.$$

$$[R(m) \neq S(m)].$$

Since PA is first order, the cardinality of the reals cannot, therefore, exceed that of the integers.

The theorem follows. \square

We conclude, seemingly paradoxically, that—although the Continuum Hypothesis is independent of the axioms of ZF if ZF is consistent—when interpreted over the domain \mathbb{R} of the real numbers, CH follows from the axioms of PA (which is finitarily provable as consistent by §2.C.a., Theorem 2.16):

Corollary 16.4. $\aleph_0 \longleftrightarrow 2^{\aleph_0}$ \square

Now, one possible way of resolving such a paradoxical conclusion could be to heed the cautionary remarks by Thoralf Skolem (see §7.K.)—about unrestrictedly corresponding, meta-mathematically, putatively *specifiable* mathematical entities across domains of different axiom systems—in his 1922 address delivered in Helsinki before the Fifth Congress of Scandinavian Mathematicians, where Skolem improved upon both the argument and statement of Löwenheim's 1915 theorem ([Lo15], p.235, Theorem 2)—subsequently labelled as the (downwards) Löwenheim-Skolem Theorem ([Sk22], p.293).

16.C. Wittgenstein's perspective on real numbers and Cantor's diagonal procedure

A notable philosophical perspective that can be viewed as implicitly heeding Skolem's dictum whilst seeking to differentiate between interpreting §16.B., Corollary 16.4⁴¹² set-theoretically, and interpreting it arithmetically, is that of Ludwig Wittgenstein. As elaborated upon by Livingston in [Liv10]:

“Now, it is familiar that Wittgenstein held, in general, a dim view of the purported *results* of various forms of the “diagonal procedure,” including both Cantor's multiple infinities and the truth of Gödel's “self-referential” sentence. Do these doubts, expressed prominently in the *Remarks*

⁴¹²§16.B., Corollary 16.4: $\aleph_0 \longleftrightarrow 2^{\aleph_0}$.

on the *Foundations of Mathematics*, imply that there is not a very similar concern about the relationship of finite symbolism to infinitary techniques operative in Wittgenstein's own thoughts about rules and symbols? I think not, for the following reasons. In his critical remarks about the Gödel sentence as well as about Cantor's multiple infinities, Wittgenstein emphasizes that the existence of a procedure—even one with no fixed end, like the procedure of writing down numbers in Arabic numerals—does not imply the existence of a superlative *object*, either a "huge number" or a completed list of decimal expansions that itself contains "infinitely many" members. To a certain extent at least, these suspicions extend to the 'diagonal procedure' itself. Though Cantor can, with some justice, say how one *can* generate a decimal expansion that, as one can show, does not appear anywhere on an "infinite list" of expansions, he has not *in fact* generated it; diagonalization is always in fact the "outcome" of an infinite procedure and cannot be said to have finished. However, Wittgenstein does not deny that there *is* such a procedure, and even that we can speak of it, with some justice, as one that shows (by giving sense to the proposition) that there is, for any set of decimal expansions, one that is not in the set (*RFM* II-29). Cantor has given us a procedure that allows us to say: *given* any series of numerical symbols, we *can* (i.e. we have a method that lets us) generate a different one. However, in understanding the possibility and implications of this procedure, we must also keep in mind that there is a difference between series of numerical *symbols* and series of *numbers* in the mathematical sense. *A series in the mathematical sense is not a sequence of signs but a method for generating sequences of signs.*⁹ There are analogies between the two uses, but they are different; and given the difference, Wittgenstein suggests, the existence of a sign ("S₀") that expresses the unlimited possibility—the unlimitedness of the method—of generating sequences of signs does not by itself ground a further calculus with this sign, for instance one relating it to "other" infinities or other sizes of infinity. Nevertheless, as we have seen, it is just this ambiguity between sequences of signs and methods for generating sequences of signs upon which the claim of diagonalization to establish "positive" results depends. Diagonalization intervenes upon what are in fact sequences of signs (series in the non-mathematical sense) to produce a new number, a new sequence of signs which may itself be unlimited. What operates in this ambiguity, and creates the "crossing" at infinity (real or illusory) between procedures and their symbolization that is essential to diagonalization, is our presumed *infinitary* capacity to produce symbols according to well-defined rules."

... Livingston: [*Liv10*], p.35.

Noting that there is an 'ambiguity between sequences of signs and methods for generating sequences of signs upon which the claim of diagonalization to establish "positive" results depends', and which allows us 'our presumed *infinitary* capacity to produce symbols according to well-defined rules', Livingston seeks to clarify that:

"In adducing these distinctions and casting doubt on the positive results of diagonalization, Wittgenstein's point is emphatically not, however, to show the nonexistence or invalidity of diagonalization as an (infinitary) *technique*. Rather, it is to emphasize the extent to which this procedure or technique, as infinitary as it is, has a place within a human life, and does not derive its meaning or sense from any other source than this life itself. Much later, in *RFM*, Wittgenstein comes back to this point:

The concept of the rule for the formation of an infinite decimal is—of course—not a specifically mathematical one. It is a concept connected with a rigidly determined *activity* in human life. The concept of this rule is not more mathematical than that of: following the rule. Or again: this latter is not less sharply defined than the concept of such a rule itself.—For the expression of the rule and its sense is only part of the language-game: following the rule. (*RFM* VII-42, p.409)

Again, Wittgenstein is not here denying that there is a valid concept of the rule for the formation of something that is indeed infinite. He is, rather, affirming that this formation—even in its strictness and rigidity—necessarily takes place as part of a human life, and gains its meaning and sense from this life. As it is capable of such infinite results, it would not, it seems, be quite right to call such a life, or the practice of following a rule within it (the language-game) that brings

these about, "finite." Rather, the practice is *precisely* a technique: something of which beings with a finite spatiotemporal extent are capable, but whose *extension* is in principle without limit. It is thus neither the finitude of language nor the infinitude of meaning that makes possible its effect, but rather the gulf between them, in which Wittgenstein recognizes the openness of a human life."

... Livingston: [Liv10], pp.35-37

Livingston's remarks can be viewed as ascribing to Wittgenstein, essentially, the *evidence-based* argument that, since both our *primary* conceptual metaphors (in the sense of §13.E.⁴¹³), rooted in an external reality, and the *secondary* conceptual metaphors that are rooted *solely* in the representation within a symbolic language of our *primary* conceptual metaphors, are physically manifested in our brains, they are necessarily 'finite' in substance; even though, he concludes, any putative, Platonic, interpretations of their symbolic representations in a language may be viewable as assigning characteristics within the language that could be viewed as '*completed infinities*' within the language:

"There are, I think, two preliminary conclusions that can be drawn so far. The first is exegetical: Wittgenstein was certainly not in 1939, and probably never was, a finitist. That is, he *never* held that the finite character of language implied the non-existence or non-reality of infinite procedures. Rather, his focus is uniformly on the problem of the *grammar* of the infinite procedure: that is, just *how it is* that finite signs handled by finite beings gain the sense of infinity. This is none other than the radically posed question of the later Wittgenstein's thought: the question of the nature of a technique or practice. And it leads to the second conclusion, which is not exegetical but philosophical: that the infinity of technique is not an extension or intensification of the finite; nor is it a superlative or transcendent object that lies "beyond" all finite procedures. The infinity of technique enters a human life, rather, at the point of what might seem at first a radical paradox: that of its capture in finite signs, the crossing of syntax and semantics wherever the infinite rule is thought and symbolized as finite."

... Livingston: [Liv10], pp.35-37

We note further that, in her 2020 reappraisal [F120] of Wittgenstein's perspective of how we should interpret formal mathematical arguments that seek to establish the putative '*existence*' of algorithmically *uncomputable* real numbers by Cantor's diagonal procedure, Juliet Floyd argues that:

"Mathematical knowledge cannot be explained by an ontology of causally inert Platonistic *objects*: following Wittgenstein, we must bury this kind of Ontology (Putnam 1994; 2012, 449). But can we then still be "realists" about mathematics? Putnam said "Yes", offering "modal structuralism": mathematics characterizes "possible conceptual structures" (1967; 1975b; 2012, 223ff.; Cook and Hellman eds. 2018). By Putnam's "indispensability" argument, since mathematical structures play a central role in physics we must be "realists" about them, taking them to show us aspects of possible states of affairs that are or are not realized (2012, 58ff., 66, 381n). There are many difficulties with this view, especially about sets and properties (Putnam 1980; 2012, 58ff.; 2015, 240ff.). Generally, it seems "...odd to describe the fact that a state of affairs is 'possible' as a further state of affairs" (2015, 387; cf. 2012, 66, 381n); perhaps the notion of "possibility" should be taken as primitive (2015, 482). But whether *mathematical* states of affairs are "states of affairs" matters less than the interpretation of modality, which is our focus here.

Putnam denied that Wittgenstein was a radical conventionalist, anti-realist, or verificationist (2012, Part Four). He nevertheless dismissed certain of Wittgenstein's most memorable remarks on God, Cantor and set theory, taking them to express such views (2012, 200ff, 444). He was wrong to do so. What follows offers a more palatable reading of the remarks, not fully defended but synthesized from a recent book which presents and analyzes Wittgenstein's annotations to Hardy's textbook *A*

⁴¹³§13.E.: *Recognising the strengths and limitations of ZF and PA.*

Course of Pure Mathematics (1941) in light of Wittgenstein's extensive, though unfinished writings on the real numbers 1940-1944 (Floyd and Mühlhölzer 2020, hereafter "FM"). We argue that (the later) Wittgenstein framed a *non-extensionalist* view of the real numbers, and defend that view, avoiding Putnam's unwanted conclusions. Wittgenstein rightly insisted that a non-extensional approach to the real numbers shows us genuine, i.e., *real* aspects of these numbers and our concepts of them (Floyd 2017a, 364; FM §§8.2-8.3). This reframes Putnam's "modal structuralism", aligning it with his thesis of conceptual relativity (2012, 64ff.; 2015 469ff.). The real numbers, in reality, have differing aspects. Some reveal themselves only to the extensional point of view, and others only to the non-extensional point of view."

... Floyd: [F120].

From the *evidence-based* perspective of this investigation, we shall argue that Floyd's assessment of Wittgenstein's philosophy in [F120] reflects, and is entailed by, the Complementarity Thesis (§1., Thesis 1); which proffers the view that:

- Mathematics is to be considered as a set of precise, symbolic, languages (as argued in §13.⁴¹⁴),
- intended to *serve* Philosophy and the Natural Sciences (as argued in §13.C.⁴¹⁵),
- by *unambiguously expressing* and *effectively communicating*,
- in a finite and unambiguous manner,
- relations between elements that are external to the language,
 - where we need to recognise the strengths and limitations of the first-order languages ZF and PA (as argued in §13.E.⁴¹⁶),
 - in defining differing 'mathematically expressible' aspects of putative 'real' numbers (as argued in §20.C., Case 20.C.a.⁴¹⁷ to §20.C., Case 20.C.d.⁴¹⁸) which are:
 - 'revealed' only to a Platonic, extensional, 'point of view' in ZF, and
 - 'revealed' only to the *finitary*, non-extensional, 'point of view' in PA as is:
 - explicit in §7.I., Theorem 7.5⁴¹⁹;
 - explicitly argued in §7.I.a.⁴²⁰; and
 - implicitly argued for in §16.B.⁴²¹

For instance, such a view seems implicit in Floyd's concept of what she informally refers to as 'plasticity'; where she argues that ignoring 'plasticity in our modes of thinking and speaking' could lead to uncritical acceptance of untenable philosophical and meta-mathematical conclusions.

Conclusions such as the 'existence' of non-standard models that, in the case of PA, for instance:

⁴¹⁴§13.: *What is mathematics?*

⁴¹⁵§13.C.: *Mathematics must serve Philosophy and the Natural Sciences.*

⁴¹⁶§13.E.: *Recognising the strengths and limitations of ZF and PA.*

⁴¹⁷§20.C., Case 20.C.a.: **Case 1: Interpretation as a virus cluster.**

⁴¹⁸§20.C., Case 20.C.d.: **Case 4: Interpretation as a political revolution.**

⁴¹⁹§7.I., Theorem 7.5: *Every real number is specifiable in PA.*

⁴²⁰§7.I.a.: *Evidence-based reasoning does not admit Cantor's theorem.*

⁴²¹§16.B.: *An evidence-based arithmetical perspective on Cantor's Continuum Hypothesis.*

- Kurt Gödel drew without supporting evidence—and invalidly, as we argue in §15.⁴²²—from his own formal argumentation in Theorems VI and XI of [Go31]; and
- Richard Kaye drew—also invalidly, as we argue in §18.⁴²³—from the Compactness theorem in [Ka91] and [Ka11].

Conclusions moreover which, in each case, were ostensibly persuasive in influencing Hilary Putnam's admittance, into his subsequent argumentation—challenging "Metaphysical Realism", and seeking to ground his "Internal Realism"—an implicit acceptance of precisely such an—albeit disquieting, and essentially Platonic—'existence of non-standard models':

"What is it to "specify the whole use" of a language, to single out or fix an interpretation (Putnam 1980, 24)? It is a matter of "fitting" interpretations to the world by considering not only models in the mathematicians' sense, but also everyday language, be it mathematical or not (Floyd and Putnam 2000; Floyd and Putnam 2008). Overlooking this plasticity in our modes of thinking and speaking, Putnam (1980) invoked the existence of non-standard models (Gödel, Skolem-Lowenheim) not only to challenge "Metaphysical Realism" but to ground "Internal Realism"."

... Floyd: [F120], I. Plasticity.

Floyd notes that, by admitting some of Gödel's—debatable by §15.—philosophical and metamathematical interpretations of [Go31], Putnam's subsequent argumentation, seeking to justify his ostensible 'surrendering' of plasticity, could not faithfully reflect their implicit implication—that the 'lesson here is plasticity: not simply of mental and/or computational processes but also of phraseology in relation to an evolving world':

"He surrendered this for two main reasons. First, there is no general computational set of mechanisms fixing interpretations to accompanying uses of language: reductive functionalism is wrong (Putnam 2012, 58f., 72ff.). Second, for Gödelian reasons, no survey of reason's reach through language as a whole is possible (Putnam 1985). What is to count as a "use" of language—much less the "whole use" of one—is not something that is surveyable or expressible once and for all for a group of speakers, come what may, but something that requires detailed investigation, criticism, argument, and an openness to further elaboration.

No reference of a word is *automatically* fixed, be it by procedures, causal chains, associations of speakers, stipulated axioms, functional mental states, mathematical models, metaphysical ontology or even the description of "practices". *This* is the "realistic realism" of Putnam's post-1990 phase, indebted to Diamond's "realistic spirit" (1991; compare Putnam 1999; Putnam 2004; Putnam 2012 31, 357).

The lesson here is plasticity: not simply of mental and/or computational processes but also of phraseology in relation to an evolving world. This drives our typings of things, even our formalizations of theories, unfolding through time in a social setting where we are constantly discussing our discussions, as well as interacting with experts and the world (Putnam's semantic externalism). Given Gödel, we cannot close off discussions of consistency of our mathematics once and for all: our concepts cannot be surveyed as a whole, undynamically.^{1"}

... Floyd: [F120], I. Plasticity.

Floyd makes a significant—and bold, from the *evidence-based* perspective of this investigation, in view of the paradigm-challenging §17.D.⁴²⁴, and §8.G., Corollary 8.21⁴²⁵—admission, in

⁴²²§15.: *Gödel 1931 in hindsight.*

⁴²³§18.: *The case against non-standard models of PA.*

⁴²⁴§17.D.: *Rosser's original argument implicitly presumes ω -consistency.*

⁴²⁵§8.G., Corollary 8.21: *Rosser's Rule C is stronger than Gödel's ω -consistency.*

her footnote #1 referring to Putnam’s above argumentation, where she apparently re-affirms her commitment to avoiding uncritical acceptance of finitarily disquieting philosophical and meta-mathematical conclusions drawn from Gödel’s formal reasoning in [Go31], and J. Barkley Rosser’s formal argumentation in [Ro36]:

“Putnam (2012, 371) chides Wittgenstein for being “tempted” to reduce understanding of mathematical propositions to grasp of their proof procedures in his 1937 remarks on Gödel (1978 I Appendeix III). Floyd and Putnam 2000 argued against this interpretation, and I at least have not changed my mind on this. Putnam points out that such a reduction would deny that Rosser’s (1936) improved Gödel’s incompleteness proof. Rosser proved, of a sentence CON(NT), that a theory of arithmetic is (simply) consistent if and only if that sentence is true, and that if number theory is (simply) consistent, then that proposition cannot be proved in it. Putnam objects that “every mathematician in the world sees the face of number theory based on Peano’s axioms in number theory based on Peano’s axioms plus CON(NT)” (2012, 371). I believe Wittgenstein would not *disallow* this “face” of necessity, which is surely there to be seen. However, it is also relevant that this “face” does not come for free. As Wittgenstein suggested in his (1938)—even if inexpertly—constraints on the successful formulation of “consistent” require sensitive logical treatment (cf. Löb (1955)).”

... Floyd: [Fl20], I. Plasticity.

The significance of Floyd’s admission for *evidence-based* reasoning is that:

- whilst §12.B.d., Definition 36⁴²⁶, and §12.B.e., Corollary 12.4⁴²⁸, refute Putnam’s remark censuring “Wittgenstein for being “tempted” to reduce understanding of mathematical propositions to grasp of their proof procedures”;
- Anand [An16] validates Wittgenstein’s reported contention that ‘constraints on the successful formulation of “consistent” require sensitive logical treatment’; since PA admits *two*—hitherto unsuspected, and subtly distinguished *only* by §2., Definition 7⁴²⁹, and §2., Definition 10⁴³⁰—*well-defined* interpretations of PA—the *weak*, standard, interpretation $\mathcal{I}_{PA(\mathbb{N}, SV)}$, and a *strong*, finitary, interpretation $\mathcal{I}_{PA(\mathbb{N}, SC)}$ —such that:
 - §2.B.a., Theorem 2.7: *The axioms of PA are always algorithmically verifiable as true under the interpretation $\mathcal{I}_{PA(\mathbb{N}, SV)}$, and the rules of inference of PA preserve the properties of algorithmically verifiable satisfaction/truth under $\mathcal{I}_{PA(\mathbb{N}, SV)}$. ([An16], Theorems 5.6, p.40); and*
 - §2.C.a., Theorem 2.15: *The axioms of PA are always algorithmically computable as true under the interpretation $\mathcal{I}_{PA(\mathbb{N}, SC)}$, and the rules of inference of PA preserve the properties of algorithmically computable satisfaction/truth under $\mathcal{I}_{PA(\mathbb{N}, SC)}$ ([An16], Theorems 6.7. p.41).*

⁴²⁶§12.B.d., Definition 36: *An atomic formula $[A(x)]$ of PA is satisfied under $\mathcal{I}_{PA(PA, W)}$ if, and only if, for any substitution of a specified PA-numeral $[n]$ for the variable $[x]$, there is a deterministic algorithm⁴²⁷ which will evidence that the formula $[A(n)]$ is provable in PA.*

⁴²⁸§12.B.e., Corollary 12.4: *The weak standard interpretation $\mathcal{I}_{PA(\mathbb{N}, SV)}$, and the weak ‘Wittgensteinian’ interpretation $\mathcal{I}_{PA(PA, W)}$, are both weak models of PA.*

⁴²⁹§2., Definition 7: *A number-theoretical relation $F(x)$ is algorithmically verifiable if, and only if, for any given natural number n , there is an algorithm $AL_{(F, n)}$ which can provide objective evidence for deciding the truth/falsity of each proposition in the finite sequence $\{F(1), F(2), \dots, F(n)\}$.*

⁴³⁰§2., Definition 10: *A number theoretical relation $F(x)$ is algorithmically computable if, and only if, there is an algorithm AL_F that can provide objective evidence for deciding the truth/falsity of each proposition in the denumerable sequence $\{F(1), F(2), \dots\}$.*

whence:

- §2.B.a., Theorem 2.8: *If the PA formulas are algorithmically verifiable as true or false under $\mathcal{I}_{PA(\mathbb{N}, SV)}$, then PA is consistent.*
- §2.C.a., Theorem 2.16: *PA is strongly consistent.*

Remarking upon Wittgenstein's perspective with respect to real numbers, Floyd notes that if 'we are to draw the idea of an actually infinite object *in* to mathematics, . . . we must sharply separate the idea of order from that of collection':

"What is central for understanding Wittgenstein's remarks on God, Cantor, Dedekind and so on is his *non-extensionalism* about the real numbers (FM *passim*). It is not that Wittgenstein believes in intensions or disbelieves in extensions: he never attempts to *refute* the extensional point of view, even when he sometimes goes overboard with a hostile tone. Rather, he takes extensionalism to show us one of several "faces" of our concept of *real number*, one which tends to occlude concepts of the particular real numbers we know as "familiar friends": π , $\sqrt{2}$, e , etc.⁴

Wittgenstein strictly distinguishes between sequences of numbers that the extensionalist considers to be, in Cantor's sense, "finished" [*fertig*]*—*these are the "extensions"*—*from the techniques or rules of development by means of which such entities may be produced, assessed, or individuated; these are, let us say, "expansions" [*Entwicklungen*, "developments"]. In these terms, the decimal expansion for $1/3$ (0.33333 . . .) is conceived as a technique for developing digits. If we are interested in *particular* real numbers (like π), we will need to focus on such techniques, the "expansions", or else geometrical considerations, applications in physics or algebra. There are techniques specific to each of these ways. In particular, there are contingent features of the decimal expansion mode of representation we must attend to, such as the fact that not every real number can be named (e.g., .999 . . . and 1.0 "denote" the same real number).⁵ By contrast the extensionalist's interest is only in the results, the produced *sequences* (let us say), and not the possible processes or conceptual motifs or definitions leading to them. From the extensional point of view expansions are mere "illustrations": perhaps useful to know, as knowing how to plane wood helps to make a table, but inessential nonetheless (FM §5.5).

We have the notion of extension (set) in mathematics for a reason: to *suppress* the diversity of actual human techniques and procedures of proof and measurement used in mathematics of the real numbers. If we are to draw the idea of an actually infinite object *in* to mathematics, we have no choice. To accomplish this we must sharply separate the idea of order from that of collection, forging criteria of sameness of cardinality (through the notions of injection, bijection and surjection, isomorphic embedding, etc.) and adopt an extensionalist view of what a function or series is, i.e., *not* conceive of it as an expansion or manner of "associating" one domain or individual number with another (through "inputs" and "outputs")."

. . . Floyd: [F120], II. *Non-extensionalism*.

From the *evidence-based* perspective of this investigation, we would view such a Wittgensteinian perspective as seeking to recognise the differentiation that, formally:

- 'arithmetical' real numbers can, when treated as *non-terminating* Cauchy sequences, be *well-defined* as specifiable *intensionally* in PA by the Specifiability Theorem for Reals (§7.I., Theorem 7.5⁴³¹); whereas
- 'set-theoretical' real numbers can, further, be axiomatically *postulated* as specifiable *extensionally* only as putative *completions* of Cauchy sequences under any putative, *well-defined*, interpretation of the corresponding set theory in which the sequences are *well-defined*.

⁴³¹§7.I., Theorem 7.5: *Every real number is specifiable in PA.*

However, since any set theory that admits an axiom of infinity cannot have a *well-defined* (in the sense of §7.F., Definition 26⁴³²) interpretation, such an *evidence-based* recognition entails that ‘arithmetical’ real numbers are *qualitatively* different from ‘set-theoretical’ real numbers.

Admittance of such *qualitative* differentiation is also entailed by the paradigm-challenging consequence of *evidence-based* reasoning—that PA cannot be conservatively extended as a set theory, as follows from §19.A., Corollary 19.3⁴³³ (as also, independently, from §15.C., Lemma 15.1⁴³⁴).

Such recognition is also the essence of Skolem’s dictum in §7.K. cautioning about the dangers of conflating entailments of formal systems under different interpretations (see §2.D.), or over different domains (as illustrated strikingly, in the case of Goodstein’s argument, by §19., Theorem 19.1⁴³⁵, and §19., Corollary 19.2⁴³⁶).

Moreover, it is not entirely unreasonable to view such recognition as implicitly intuited by Floyd in her assessment that ‘Wittgenstein’s fundamental logical point’ essentially asserts ‘that real (domains of) numbers have many different faces’:

“Of course set theory is shot through and through with impure articulations: ideas of choice, rules, procedures, infinite games and extensions, just as in the above quoted remark about God. Textbooks frequently mix extensional and non-extensionalist language—a sin of Hardy’s (1941), according to Wittgenstein (FM §5.6). This, however, cannot fudge the distinction in perspectives. Wittgenstein rightly emphasizes that in taking up the extensional point of view we *erase* the idea of a procedure or conceptual *motif*, picturing something as completed, done. What we have then has no *action*, no *movement* at all (Wittgenstein 2009 §§193-4). Yet in the tendency to revert to the language of process, of “writing down digits without end”, rule and movement, creep their way in to our talk about concepts. Erasing movement is difficult, conceptually, though necessary to the purely extensional point of view. Yet extensionalism cannot erase or make irrelevant the interest of our particular, local procedures, how it is that we become acquainted with, show someone, write down digits of, bring into play, or refer to a particular real number such as π . In fact, the “friction” of technique is needed for the *interest* of the extensional perspective.

We tend to reverse the perspectives, getting into a “strange conflict with ourselves” (Wittgenstein 2005, 765). We regard our particular activities as “shadowed” by the extension. But to be shadowed is to be. A shadow may not model or picture what it is the shadow of, it may not allow us to recognize the “faces”, the conceptual aspects, of what it shadows.

This is Wittgenstein’s fundamental logical point. The real (domains of) numbers have many different faces. They do not appear homogeneous and clear-cut in the ways the extensional point of view suggests with its notions of *cuts* or *decimal expansions unrestricted by rules or techniques of producing them* or—above all—the illustration of the real domain via points of the straight line.”

... Floyd: [F120], II. Non-extensionalism.

⁴³²§7.F., Definition 26: *A mathematical concept is well-defined if, and only if, it can be defined in terms of algorithmic verifiability.*

⁴³³§19.A., Corollary 19.3: *The subsystem ACA_0 of second-order arithmetic is not a conservative extension of PA.*

⁴³⁴§15.C., Lemma 15.1: *The structure of the finite ordinals under any putative interpretation of ZF is not isomorphic to the structure \mathbb{N} of the natural numbers.*

⁴³⁵§19., Theorem 19.1: *Goodstein’s sequence $G_o(m_o)$ over the finite ordinals in any putative model \mathbb{M} of ACA_0 terminates with respect to the ordinal inequality ‘ $>_o$ ’ even if Goodstein’s sequence $G(m)$ over the natural numbers does not terminate with respect to the natural number inequality ‘ $>$ ’ in \mathbb{M} .*

⁴³⁶§19., Corollary 19.2: *The relationship of terminating finitely with respect to the transfinitely defined ordinal relation ‘ $>_o$ ’ over the set of finite ordinals does not entail the relationship of terminating finitely with respect to the finitarily defined natural number relation ‘ $>$ ’ over the set of natural numbers.*

Analysing the geometrical significance of Wittgenstein's view that the domains of 'real' numbers can have 'many faces', Floyd highlights Wittgenstein's cautionary remark that although 'we may think of them as an "aggregate", or else "individually", as suggested by G. H. Hardy in [Har41], 'we must beware of imagining "phantasmagoric" applications':

"In geometry extensional confusions abound, as was emphasized by Hobson, a major twentieth century English textbook author of *The Theory of Functions of a Real Variable and the Theory of Fourier's Series* (1921), who brought modern analysis into the Cambridge curriculum (Hardy 1934). In his presentation of the theory, Hobson always stressed the importance of the non-extensional point of view (1907, 1921 *passim*, FM §8.4). We can take what we regard as a purely arithmetical (i.e., non-geometric) result—e.g., that $\sqrt{2}$ is irrational—to "apply" to geometry. We may then accept (for example) that the diagonal of a unit square, transposed onto the straight line, does not end in a rational point, and this gives us a procedure to "determine" a particular point in a few unproblematic geometrical steps. However, this differs strikingly from the "procedure" of Dedekind cuts, which "determines" a point by approaching it from below and from above *via* a procedure *consisting* of infinitely many steps, a procedure which, considered as an "application" of analysis, *obviously* does not come to an end. Both Cantor and Dedekind take it to be an *axiom* that for every real number on the geometrical line there *corresponds* a representation which is a cut (or, for Cantor, a limit of a Cauchy sequence of rational numbers). This is not something provable, it is instead a kind of "Church's thesis" for the line (Floyd 2013a, 1029; FM §8.4).

What is merely an "illustration", and what a true "application" of a concept? The point comes up right away in Wittgenstein's annotations to Hardy. Hardy states that the geometrical line is merely an "illustration", with no systematic significance for analysis (1941, 2). Wittgenstein balks at this, stressing that while "illustration" is inessential, "application" is not (FM §§3.1-2, §5.5). He does not mean by this "application in physics", as Putnam does. What he means is that geometrical considerations have ceased to function in anything like a straightforward way in modern analysis since Dedekind and Cantor: analysis is severed from the notion of quantity (FM §3.1). The idea of decimal expansions of real numbers as "finished" smoothly corresponds with the geometrical image of the straight line: the finished expansions represent points on the line, and to consider only the rational numbers leaves open *gaps*: all the expansions that are neither finite nor periodic from some place on. From this point of view the filling of these gaps with irrational numbers appears to be "prejudged"; yet this "gap" imagery can be misleading in being circular (Wittgenstein 2005, 738; FM Chapter 2). For it is necessary to the extensional point of view *to* regard the shift from considering the rationals to the reals as a widening of the *extension* of the concept "real number"; it cannot regard the shift in any other way.

Wittgenstein points to a characteristic tension in our concept of the continuum as represented by the real numbers: we may think of them as an "aggregate", or else "individually" (Hardy 1941, §16). Thinking of them as an aggregate, we must beware of imagining "phantasmagoric" applications (Wittgenstein 2015 MS 126, 127f., FM §3.8). This could point to a kind of conflict, as Putnam supposes. But instead we might say that there are different *aspects*: considering real numbers as individuals and as magnitudes. Bernays (1957, 4):

The conflicting aspects of the concepts to be determined [for analysis] are, on the one hand, the intended homogeneity of the idea of the continuum and, on the other hand, the requirement of conceptual distinctness of the measures of magnitudes. From an arithmetical point of view, every element of the number sequence is an individual with its very specific properties; from a geometric point of view we have here only the succession of repeating similar things. The task of formulating a theory of the continuum is not simply descriptive, but a reconciliation of two diverging tendencies (1957, 4).

Characterizing the reals extensionally, through the Dedekindian approach, the rational numbers are folded into the reals, remodeled. We might then say that there is a resulting set of "ambiguities" in our statements about numbers, one which is harmless because relations between propositions

are preserved in the final remodeling, so that we are not in “any doubt” as to whether “ $1/2$ ” refers to a real number or a rational number in any particular context (Hardy 1941, 14). But “here,” Wittgenstein remarks, “it is unclear what ‘interpretation’ means” (FM §5.2). We might say, from an extensional point of view, that there is an isomorphic embedding of the rationals in the reals. But why not also say that we have “remodeled” our concept of real number, translating it so as to see the aspect of the rational numbers *in it*?”

... Floyd: [FL20], II. Non-extensionalism.

From the *evidence-based* perspective of this investigation, Wittgenstein’s caution—that thinking of the real numbers as an aggregate, which can be treated as constituting an actual real line, might foster “phantasmagoric” applications—can be viewed as intuitively anticipating the mythical physical conclusions that are admitted by current scientific paradigms as possible entailments of mathematically postulated, extensional, limits of Cauchy sequences, as considered, for instance, in §20.C., Case 20.C.a., to §20.C., Case 20.C.d. (op. cit.).

Moreover, such a perspective also seems implicit in Wittgenstein’s interpretation of Cantor’s diagonal argument as—according to Floyd—to how ‘Cantor’s method of proof might be deployed as a *technique of argument*’:

“The extensional point of view is well and good, but it shows us only one side of our multi-dimensional concept of *real number*. It is not a “foundation”, but rather a *horizon* within which we can project, articulate and model conceptual possibilities in mathematics (Mühlhölzer 2019). Extensionalism has a tendency toward totalization, making it seem as if the non-extensional point of view is inadequate in being “limited”, is not “really getting at” what the real numbers *are*. It can only represent the difference between the two points of view as a difference *in extension*. This “skew” form of expression, as Wittgenstein writes, leads to “hocus pocus” (RFM II §20).

Putnam (and many others) unfortunately take Wittgenstein’s 1937/38 remarks on Cantor’s diagonal argument (RFM II) to argue (constructively, even finitistically) that the notion of “uncountability” is “meaningless” because “there is no set of irrational numbers (and *a fortiori* no set of real numbers)” (2012, 200, 443, 446).

Wittgenstein’s interest, however, is not in establishing an extensional range for the reals, but in carefully calibrating different ways Cantor’s method of proof might be deployed as a *technique of argument* (FM Chapters 7-8; Chapter 7 gives a line-by-line reading of the remarks). This technique is orthogonal to the non-extensional/extensional distinction, in no way *forcing* us to take up the extensional point of view. This should be clear from the many adaptations of the diagonal technique in logic that occurred after Cantor’s (1891) proof: these concern such notions as *definability*, *proof*, and so on, turning the activity of listing out decimal expansions upon the activity of listing out sequences of words, or definitions, which may (but need not) be regarded extensionally, as finite sequences (FM Chapter 8).⁶

In his 1937/38 remarks Wittgenstein correctly points out that we may regard the diagonal method non-extensionally, as a technique for constructing new decimal expansions (compare Hobson 1921 §60). *Pace* Putnam, Wittgenstein explicitly *defines* a number-concept X as “uncountable” [*unabzählbar*⁷] if

... it has been settled [*festgesetzt*] that, whatever numbers falling under this concept you arrange in a series, the diagonal number of this series is also to fall under that concept (RFM II §10; FM Chapter 7).

Wittgenstein’s concept of “uncountable” is in a sense broader than the usual notion of “uncountable” familiar from the extensional point of view (a concept is “uncountable” extensionally speaking if there exists no bijection between it and the set of natural numbers). For every extensionally conceived “uncountable” set (such as the reals), regarded as generated through the technique of diagonalization, is also “uncountable” in Wittgenstein’s sense.

One may rightly gloss Cantor's argument as one concerning "all" real numbers: one can, even *should* see "the face of necessity" in transitioning to uncountability conceived extensionally, as Cantor does. Cantor shows that the real numbers are not countable: that their cardinality is greater than that of the natural numbers. Yet this gloss, so far as the diagonal argument goes, is neither a logical *must* (Putnam) nor a *mere* "stipulation", as Putnam saddles Wittgenstein with saying (2012, 446). The better angels of plasticity are *à propos*. Before Cantor's diagonal argument, simply being told that the real numbers are "uncountable" in the extensional sense of ("there is no bijection from this set to the natural numbers") would have been mathematically (and physically) empty. But after Cantor has shown us the diagonal method and built his theory of cardinality around it, what once seemed empty now may be regarded as true. —This however does not imply (as analogously it does, according to Putnam, in the case of the transition from pre-Einstein to post-Einstein physics) that we have learned more about a single "space" or "state of affairs" (of mathematical possibility). To drive the point home, let us turn to Turing."

... Floyd: [F120], III. Cantor's diagonal argument.

Thus, from the *evidence-based* perspective of this investigation, Floyd's view of Cantor's diagonal argument as establishing *à propos* that what 'once seemed empty now may be regarded as true', is implicitly reflected in the argument in §13.E.⁴³⁷ that:

- whilst any *well-defined* model of PA is intended to unambiguously express, and categorically communicate, those of our *primary* conceptual metaphors that correspond to properties and relations—viewed as 'objective knowledge' in the sense of Gualtiero Piccinini's *factually grounded beliefs* ([Pic19]; see also §5.A.⁴³⁸)—between elements of a commonly accepted external reality on the basis of physical phenomena that we observe, measure, and can conceptualise symbolically in a mathematical language;
- any putative, necessarily Platonic, model of ZF is intended to, in addition, formally express those of our *secondary* metaphors that correspond to our perceptions of formal properties and relations—between formal terms and formulas of our language—which need not be grounded in our *primary* conceptual metaphors, but which can be introduced into the language—and viewed as 'subjective knowledge' in the sense of an individual's intuitively *justified true beliefs* ([Pic19]; see also §5.A.)—without inviting contradiction.

Comment 151. It may be pertinent to note here that, in an *insightful* paper [Kma08] from the *evidence-based* perspective of this investigation, philosopher Vojtěch Kolman cogently argues that:

- (a) Hilbert's solvability thesis is not refuted by Gödel's incompleteness theorems;
- (b) Unlike arithmetic, set theory does not have a constructive model that admits categorically communicable assignments of truth/falsity to assertions such as CH;
- (c) The Continuum Hypothesis, unlike Hilbert's Second Problem, "does not constitute a *genuine* definite mathematical problem," because it is an "inherently vague or indefinite one, as are propositions of higher set theory more generally":

"Continuum has had an intricate historical development, from the Pythagorean definition of proportion by means of a reciprocal subtraction, through the Euclidian theory of points constructible by means of a ruler and compass, to the Cartesian idea of numbers as roots of polynomials. By grasping real numbers as *arbitrary* (Cauchy) sequences, rather than as sequences that are in some sense law-like, Cantor believed himself to have won the whole game by simple "fiat". But this was no more substantiated than

⁴³⁷§13.E.: *Recognising the strengths and limitations of ZF and PA.*

⁴³⁸§5.A.: *What is knowledge?*

it would have been for the Greeks to define real numbers as points constructible by whatever means, or for us now to say that everything true is provable. Obviously, this would dispose of problems like the quadrature of the circle, the axiomatizability of arithmetic, or the "Entscheidungsproblem", but it would also dispose of the whole of mathematics—insofar as it is understood as an enterprise of solving problems somehow related to human lives rather than as a pure science indulged in for its own sake. Hence, the reason for retaining and developing the difference between the broader (and vaguer) and the narrower (more limited) sphere of methods lies in the fact that it mirrors the general process of *explaining* something complicated through something less complicated.

Set theory runs into problems because of its failure to keep these differences apart. Set theorists believe, on the one hand, that the Continuum Hypothesis is either true or false whether we know it or not, but, on the other hand, the only specific idea they can give us about its standard model is one loosely connected to Zermelo's full-formalism, by which it is, however, undecidable, i.e. neither true nor false. So, because the only criterion of truth is the incomplete and possibly inconsistent full-formalism, we must face the possibility that the status of questions like "how big is the continuum?" may be similar to that of questions like "how many hairs does Othello have?", not because we do not yet know the answer, but because no answer is available. This deficit does not make such questions human-independent, but only deeply fictitious, the reason for which, again, is not that they are still undecided (such a decision is not difficult to make, e.g., by endorsing $V = L$) but because nothing really important hinges on them.

My conclusion may resemble the position of (Feferman, 1998, p.7), according to whom the Continuum Hypothesis, unlike Hilbert's Second Problem, "does not constitute a *genuine* definite mathematical problem," because it is an "inherently vague or indefinite one, as are propositions of higher set theory more generally." I have attempted, however, to be more specific about where the difference between set theory and arithmetic comes from. The so-called iterative hierarchy, described in a pseudo-constructive manner by Zermelo's axioms, is not a model in the same sense in which the standard model of arithmetic is, because the concept of subset is left unexplained, along with the range of quantification and the respective (\forall)-rule.²⁴

To sum up: Hilbert's solvability thesis is not refuted by Gödel's incompleteness theorems, nor by the Continuum Hypothesis; however, they oblige us to rephrase it as follows: every problem is (potentially) solvable if it is endowed with well-defined truth-conditions, or, as Zermelo would put it, with a "reasonable" concept of truth."

... Kolman: [Kma08], §4, pp.98-99.

In the concluding section of [F120], Floyd seeks to illustrate 'the complexity of the shifts that occur in transitions between the extensional and the non-extensional points of view' by scrutinising how Wittgenstein's perspective on Cantor's diagonal argument was influenced by, and in turn influenced, Turing's use of the argument; with particular reference to Turing's, unarguably 'constructive', differentiation between 'computable' and 'uncomputable' numbers in a way that avoids of any objectionable use of a 'generalized law of the excluded middle':

"In his most famous paper (1936) Turing framed a *non-extensional* diagonal argument to apply his analysis of "computable real number" to Hilbert's *Entscheidungsproblem*. He thereby established that there is no algorithm for deciding in general whether one sentence follows from another in first order logic: there is no "logical machine" for determining validity (even for God). It is likely that Wittgenstein had Turing's diagonal argument in mind in 1937/38 and in 1944, when he wrote the aforementioned remarks (Floyd 2017b, FM Chapter 8). It is worth scrutinizing, as it shows us the complexity of the shifts that occur in transitions between the extensional and the non-extensional points of view.

Wittgenstein's 1937/38 remarks on Cantor (RFM II) present the diagonal argument, applied to decimal expansions of real numbers, as a way of constructing an ever-expanding list of expansions:

it shows that a final expansion of real decimal expansions is not possible, so long as we accept each iterated diagonal expansion as belonging in turn to the list. This is a perfectly legitimate, constructible manner of arguing; in fact, Hobson held that it "completes" Cantor's original proof by showing that it applies quite generally to all particular real numbers conceived non-extensionally (Hobson 1907, 25). Notably, in this way of regarding the argument, the generalized use of the law of excluded middle is not necessary (on the use of this law in mathematics, see FM Chapter 4).

Turing's diagonal argument, which he calls an "application of the diagonal process", refers to Hobson's textbook on analysis (1936, 246n (§8)), utilizing a non-extensional, rather than an extensional mode of proof (JF 2012; FM Chapters 7-8). Turing's analysis of "computable real number" in terms of his machines is thus, in Hobson's sense, "complete", in that it offers an analysis of what it is to take a "step" in a formal system of logic that does not take a stand on whether or not one accepts the law of excluded middle, or the extensional point of view. After all: it is not part of our notion of taking a "step" in a formal system that one is or is not a constructivist, an intuitionist, or an extensionalist. And it is this notion of "step" that Turing had to analyze.

This could not have been done by writing down another formal system: Turing had to shift the *aspect* under which we regard formal systems (Floyd 2017b). A Turing machine has a double-face. From the extensionalist perspective, it is a collection of quintuples. But from the non-extensional perspective, it is a command that may be followed in the manner of a human computer reckoning digits of a real number according to a fixed rule, "mechanically", expanding a process or procedure of unfolding an expansion through time. As Wittgenstein cogently remarked in 1947, "Turing's 'Machines'. These are *humans* who calculate" (1980 §1096). He immediately reformulated Turing's diagonal argument (1980 §§1096-7; cf. Floyd 2012):

Let $N = F(K, n)$ be the form of the law for the development of decimal expansions [*Decimalbrüchen*]. N is the n th place in the K th development. The diagonal law is then

$$N = F(n, n) = \text{Def } F'(n).$$

To prove that $F'(n)$ cannot be one of the rules $F(K, n)$. Assume it is the 100th. Then the formation rule of

$$\begin{aligned} F(1) &\text{ runs } F(1, 1) \\ F(2) &[\text{runs}] F(2, 2) \text{ etc.} \end{aligned}$$

But the rule for the formation of the 100th place of $F'(n)$ will run $F(100, 100)$; that is, it tells us only that the 100th place is supposed to be equal to itself, and so for $n = 100$ it is *not* a rule.

The rule of the game runs "Do the same as . . ."—and in the special case it becomes "Do the same as you are doing".

In what sense *cannot* $F'(n)$ be one of the rules $F(k, n)$? In the non-extensional sense, as Wittgenstein also remarks, that "a command only makes sense in certain positions" (1980, §1096). To assume that $F'(n)$ is some *particular* rule (such as the 100th) makes the command empty. For it says that $F'(100) = F(100) = F(100, 100)$, but at 100 we are told to "calculate $F(100)$ ". This is like drawing a card in a game that says "Do what you do!", or "Write what you write!"⁸

Embedded in a context where we are already doing or writing, "Do what you are doing!" may of course be meaningful, may "fit" the application of a concept (suppose one is encouraging a learner, practically, to learn how to sign her name or calculate digits of π). It is not a contradictory command: unlike the more familiar Halting Argument, Turing does not argue by contradiction by building negation *into* the machine (Floyd 2012). Non-extensionally speaking, however, it cannot be *followed* in this general logical context. If you draw a card in a game that says "Do What You Do!" you would not know what to do, could not "decide the question" of the next step. Even God could not.⁹

What is the argument's conclusion? Wittgenstein says it is that *there is a rule that is unlike the other rules on the list*. In other words, we have expanded our structuring of the concept "decimal

expansion", refusing to allow the assumed 100th diagonal expansion to belong to the concept of "computable real number". In this way, the computable real numbers are *not* "uncountable" in Wittgenstein's 1937/38 non-extensional sense. And this corresponds to what Turing shows: the diagonal machine's expansion is definable, but not "computable". Therefore the diagonal technique, applied here, does *not* imply that we have "transcended" or "diagonalized out of" the class of computable numbers.

Of course this particular proof does not work if one considers the decimal expansions extensionally, that is, if one severs the results of the expansion rules from the rules themselves. Then all the expansions lie spread before us and nothing seems to prevent the unaltered diagonal $F'(n)$, $n = 1, 2, \dots$, of the given series from occurring in the series itself "somewhere". As soon as one conceives of the expansions as commands, however—i.e., non-extensionally—the situation changes radically."

... Floyd: [F120], IV. Turing and Wittgenstein's diagonal argument.

What is significant in the above analysis is Floyd's remark that, when expanding 'our structuring of the concept "decimal expansion", refusing to allow the assumed 100th diagonal expansion to belong to the concept of "computable real number"' merely recognises the applicability of Wittgenstein's observation 'that *there is a rule that is unlike the other rules on the list*'.

From the *evidence-based* perspective of this investigation, we would express Wittgenstein's observation formally by asserting that Cantor's diagonal argument establishes:

- not every Cauchy sequence is algorithmically *computable* (by a deterministic Turing-machine) in the sense of §2., Definition 10⁴³⁹;
- since some Cauchy sequences may be algorithmically *verifiable* in the sense of §2., Definition 7⁴⁴⁰, but not algorithmically *computable* (see §7.G., Theorem 7.2⁴⁴¹),
 - since, for some unspecified, but specifiable (by Turing's diagonal argument, as considered above), natural number n , the $(n + 1)$ th term in the sequence requires 'a *rule that is unlike the other rules on the list*' used to determine the first n terms of the sequence.

The above analysis, moreover, illustrates 'the complexity of the shifts that occur in transitions between the extensional and the non-extensional points of view', as reflected further in Floyd's observation that:

"Gödel held that Turing's analysis offers us "a kind of miracle" in being "absolute", i.e., independent of any particular formal system: the class of computable functions does not change depending upon the strength of the axiomatic system in which one works (1946, 1). Wittgenstein would reply that it is no miracle, but rather an intentional feature of the design, which shows the advantage of the non-extensionalist aspect of Turing's "machines". Turing's parameter for a "step" in a formal system is widely applicable, for it does not depend upon any of the particular written forms in which sets of equations and formalisms may be packaged (this is also the case with Wittgenstein's

⁴³⁹§2., Definition 10: A number theoretical relation $F(x)$ is algorithmically computable if, and only if, there is an algorithm AL_F that can provide objective evidence for deciding the truth/falsity of each proposition in the denumerable sequence $\{F(1), F(2), \dots\}$.

⁴⁴⁰§2., Definition 7: A number-theoretical relation $F(x)$ is algorithmically verifiable if, and only if, for any given natural number n , there is an algorithm $AL_{(F, n)}$ which can provide objective evidence for deciding the truth/falsity of each proposition in the finite sequence $\{F(1), F(2), \dots, F(n)\}$.

⁴⁴¹§7.G., Theorem 7.2: There are well-defined number theoretic functions that are algorithmically verifiable but not algorithmically computable.

1947 rendition). This is *why* it applies regardless of whether the system utilizes the law of excluded middle or not, or whether we embrace bivalence metatheoretically. It is “encompassing”, not in the extensional way, but with respect to conceptual plasticity. This is advantageous. It means that if we wish to empirically apply the concepts *result of computational process* or *result of a step in a formal system*, our attribution is and should be semantically “sensitive” in the Putnam-Travis sense (2012, 514ff.): whether or not someone or something has “computed” a step must be “fit” to the case. The point is, once again, plasticity.

This point is logically robust. Lexicographically, the activities of all Turing Machines may be joined together in a single Universal Machine which does the work of all, operating on and altering its own commands (Turing 1936 §§6-7). For this very reason, we cannot diagonalize out of the class of Turing computable real numbers. Turing shows us that the notion of a *partial* function is more general, for purposes of the theory, than the notion of a *universal* one: not all command structures yield given an output for every input. Certain inputs have no “sense”. If one tried to apply Cantor’s diagonal method to a listing of the Universal Machine’s commands, one would be defeated, for, like Swiss Cheese, there would be holes, preventing the application of the technique. Let us represent the expansions in terms of “0”, “1” and use “↓” for “undefined”, to show this. Then a table listing the commands of the Universal Turing Machine would look like this:

$$\begin{array}{cccccccc}
 \downarrow & 0 & 1 & \downarrow & 0 & 0 & \dots & \\
 0 & 0 & \downarrow & \downarrow & 1 & 1 & \dots & \\
 1 & 1 & 0 & 0 & 1 & 1 & \dots & \\
 0 & 1 & \downarrow & \downarrow & \downarrow & 1 & \dots & \\
 & & & \cdot & & & & \\
 & & & \cdot & & & & \\
 & & & \cdot & & & &
 \end{array}$$

Whether from a non-extensional or an extensional point of view, one sees immediately that Cantor’s technique will fail to apply here.”

... Floyd: [F120], IV. Turing and Wittgenstein’s diagonal argument.

What is significant in the above analysis from the *evidence-based* perspective of this investigation is Floyd’s remark, that ‘Turing’s parameter for a “step” in a formal system is widely applicable, for it does not depend upon any of the particular written forms in which sets of equations and formalisms may be packaged ... it applies regardless of whether the system utilizes the law of excluded middle or not’.

Significant, since attempting to avoid appeal to the law of the excluded middle—either formally in a language such as PA that admits first-order logic, or under any of its *well-defined* interpretations ([An16], Theorem 5.6⁴⁴², p.40; and [An16], Theorem 6.7⁴⁴³, p.41)—is not only unnecessary, but implicitly admits an ‘illusory’ divide between arithmetical *computability* and arithmetical *provability* which:

- by the Provability Theorem for PA ([An16], Theorem 7.1⁴⁴⁴, p.41), are meta-mathematically equivalent;

⁴⁴²[An16], Theorem 5.6 (see also §2.B.a., Theorem 2.7): *The axioms of PA are always algorithmically verifiable as true under the interpretation $\mathcal{I}_{PA(\mathbb{N}, SV)}$, and the rules of inference of PA preserve the properties of algorithmically verifiable satisfaction/truth under $\mathcal{I}_{PA(\mathbb{N}, SV)}$.*

⁴⁴³[An16], Theorem 6.7 (see also §2.C.a., Theorem 2.15): *The axioms of PA are always algorithmically computable as true under the interpretation $\mathcal{I}_{PA(\mathbb{N}, SC)}$, and the rules of inference of PA preserve the properties of algorithmically computable satisfaction/truth under $\mathcal{I}_{PA(\mathbb{N}, SC)}$.*

⁴⁴⁴[An16], Theorem 7.1 (see also §2.E.b., Theorem 2.17): *A PA formula $[F(x)]$ is PA-provable if, and only if, $[F(x)]$ is algorithmically computable as always true in \mathbb{N} .*

- as entailed by the *finitary* proof of consistency for PA in [An16], Theorem 6.8⁴⁴⁵ (p.41; see also §2.C.a., Theorem 2.16⁴⁴⁶); which, moreover,
 - further entails that the first-order logic FOL,
 - in which the law of the excluded middle is a theorem,
 - is *finitarily* consistent (see §8.D., Theorem 8.13⁴⁴⁷).

That admitting such an ‘illusory’ divide can also mislead is seen in Floyd’s concluding remarks that ‘that there is no sharp conceptual dichotomy to be drawn between software, hardware and data’, and that ‘the so-called Turing Test for mentality is not primarily epistemic, a matter of seeing whether we can be fooled as to who is a machine and who is a person. Rather, it is social, part of what Turing conceived of as the “variety” of “searches” characterizing intelligence, including what he called “the cultural search”, conducted by *humans*, not by machines’:

“This importance of the non-extensional point of view explains the ubiquity or indefinite applicability of computational processes and modelling in our world. For it shows that there is no sharp conceptual dichotomy to be drawn between software, hardware and data: the Universal Machine can “adapt” to its own outputs, inputs, and internal commands without limit, in the manner of our computers and certain biological and physical and social processes today (Davis 2017). Turing himself reported that he had drawn from Wittgenstein’s lectures a lesson about the importance of everyday language, i.e., evolving phraseology, as a factor in the evolution of logical “types”, software and even logic itself (Turing 1944, Floyd 2013b). The point connects directly with Putnam’s semantic externalism and his “realism”.

Turing’s Wittgenstein-inspired “realistic spirit” confirms the importance of its vision of plasticity in thought and word for philosophy. The view has many applications. It allows us to see, for example, that reductive functionalism about meaning and the mind was always wrong: one cannot get that theory out of Turing’s mathematical work. A corollary is that the so-called Turing Test for mentality is not primarily epistemic, a matter of seeing whether we can be fooled as to who is a machine and who is a person. Rather, it is social, part of what Turing conceived of as the “variety” of “searches” characterizing intelligence, including what he called “the cultural search”, conducted by *humans*, not by machines (1948, Floyd 2017b). After the first, contested part of the Turing Test is conducted, the human players must sit down with one another and review, in language, what they are inclined (and not inclined) to say and do, how they look at, regard, the concepts. Their evolving emotions and responses, the social setting of “fitting” of “phraseology” to reality, forms part of the experiment itself. This is its “realism”.¹⁰

... Floyd: [F120], IV. Turing and Wittgenstein’s diagonal argument.

‘Mislead’, since §21.E.⁴⁴⁸ defines a definitive, *evidence-based*, Turing Test⁴⁴⁹ which—even though ‘conducted by *humans*’—appeals only to a formal—and not any ‘social’ or ‘cultural’—differentiation between algorithmic *verifiability* (§2., Definition 7), and algorithmic *computability* (§2., Definition 10), for effectively differentiating between a human and a mechanical intelligence.

⁴⁴⁵[An16], Theorem 6.8: *PA is consistent*.

⁴⁴⁶§2.C.a., Theorem 2.16: *PA is strongly consistent*.

⁴⁴⁷§8.D., Theorem 8.13: *The first-order logic FOL is finitarily consistent*.

⁴⁴⁸§21.E.: *Are you a man or a machine: A Definitive Turing Test*.

⁴⁴⁹§21.E., Query 22: *Can you prove that, for any well-defined numeral $[n]$, Gödel’s arithmetic formula $[R(n)]$ is a theorem in the first-order Peano Arithmetic PA, where $[R(x)]$ is defined by its Gödel number r in eqn.12, and $[(\forall x)R(x)]$ is defined by its Gödel number $17Gen\ r$ in eqn.13, on p.25 of [Go31]? Answer only either ‘Yes’ or ‘No’.*

CHAPTER 16. PARADIGM CHALLENGING CONSEQUENCES

17. The significance of *evidence-based* reasoning for Rosser's 'extension' of Gödel's Theorem

We note that, in his seminal 1931 paper, Gödel constructively defined a Peano Arithmetic P , and a P -formula $[R(x)]$ (in his argument, Gödel refers to this formula only by its 'Gödel number 'r'; [Go31], p.25, Eqn.(12)), such that ([Go31], Theorem VI, p.24, p.25(1) & p.26(2)):

Lemma 17.1. *If P is ω -consistent, both $[(\forall x)R(x)]$ and $[\neg(\forall x)R(x)]$ are not P -provable. \square*

Of course, since every ω -consistent system is necessarily simply consistent, Gödel's conclusion is significant only if there is an ω -consistent language that seeks to formally express all our true propositions about the natural numbers.

The issue of whether there is, or can be, a finitarily provable ω -consistent system of Arithmetic at all, appears to have been widely (an exception being [K152], pp.212-213) treated as inconsequential⁴⁵⁰ following J. Barkley Rosser's 1936 paper ([Ro36]), in which he claimed that Gödel's reasoning can be 'extended' to arrive at Gödel's intended result (i.e., construction of a formally undecidable arithmetical proposition in P) by assuming only that P is simply consistent (i.e., without assuming that P is ω -consistent).

For instance, in a relatively recent paper [SS17], Saeed Salehi and Payam Seraji argue that (see also §8.G., Corollary 8.21):

"... Gödel's original first incompleteness theorem did not assume the soundness of the theory in question, and he introduced the notion of ω -consistency for that purpose. Later it was found out that the weaker notion of l -consistency suffices for the theorem (see e.g. [3] or [12]). By generalizing this equivalent notion to higher degrees (Π_n in general) we will prove some generalizations of Gödel's first incompleteness theorem for definable theories below. Finally, Rosser's Trick proves Gödel's result without assuming the l -consistency of the theory. So, Gödel-Rosser's Incompleteness Theorem, assuming only the consistency of the theory, states that *any consistent and RE theory containing PA is incomplete*. It is tempting to weaken the condition of recursive enumerability of the theory in this theorem; but we will see below that this is not possible. We can thus argue that Gödel-Rosser's theorem is optimal in a sense."

... Salehi and Seraji: [SS17], 1 Introduction and Preliminaries.

However, we now analyse various expositions of Rosser's argument (*vis à vis* Gödel's reasoning), and show that they either implicitly appeal to Rosser's Rule C (which entails Aristotle's particularisation; see §8.G., Lemma 8.20), or tacitly to the weaker assumption (see §8.D.) that P is ω -consistent.

17.A. Rosser and formally undecidable arithmetical propositions

Although both Gödel's proof and Rosser's argument are complex, and not easy to unravel, the former has been extensively analysed, and its formal arguments validated⁴⁵¹, in a number of

⁴⁵⁰See, for instance, [Be59], p.595; [Wa63], p.19 (Theorem 3) & p.25; [Me64], p.144; [Sh67], p.132 (Incompleteness Theorem); [EC89], p.215; [BBJ03], p.224 (Gödel's first incompleteness theorem).

⁴⁵¹Possibly because Gödel's remarkably self-contained 1931 paper—it neither contained, nor needed, any formal citations—remains unsurpassed in mathematical literature for thoroughness, clarity, transparency and soundness of exposition (despite the critique in §15.A., concerning mainly Gödel's interpretation of his own formal reasoning in [Go31]).

expositions of Gödel's number-theoretic reasoning (e.g., [K152], [Me64], p.143; [EC89], p.210-211).

In sharp contrast, Rosser's widely cited argument does not appear to have received the same critical scrutiny, and its number-theoretic expositions generally remain either implicit or sketchy⁴⁵² (an exception being [Me64], Proposition 3.32, pp.145-146; see also §17.E.).

17.B. Wang's outline of Rosser's argument

Wang, for instance, states that ([Wa63], p.337) from the formal provability of:

$$(i) \neg(x)(B(x, \bar{q}) \supset (Ey)(y \leq x \ \& \ B(y, n(\bar{q}))))$$

in his formal system of first-order Peano Arithmetic Z, we may infer the formal provability of:

$$(ii) (Ex)(B(x, \bar{q}) \ \& \ \neg(Ey)(y \leq x \ \& \ B(y, n(\bar{q}))))$$

Comment 152. We note that although Wang does not explicitly define the interpretation of the formal Z-formula ' $(Ex)F(x)$ ' as 'There is some x such that $F(x)$ ', this interpretation appears implicit in his discussion and definition of ' $(Ev)A(v)$ ' in terms of Hilbert's ε -function ([Wa63], p.315(2.31); see also p.10 & pp.443-445) as a property of the underlying logic of Wang's Peano Arithmetic Z, and is obvious in the above argument.

In other words Wang implicitly implies that the interpretation of existential quantification cannot be specific to any particular interpretation of a formal mathematical language, but must necessarily be determined by the predicate calculus that is to be applied uniformly to all the mathematical languages in question.

However, the inference (ii) from (i) appears to assume that the following deduction is valid for some *unspecified* \bar{j} :

$$\begin{aligned} & \neg(x)(B(x, \bar{q}) \supset (Ey)(y \leq x \ \& \ B(y, n(\bar{q})))) \\ \bullet & (Ex)\neg(B(x, \bar{q}) \supset (Ey)(y \leq x \ \& \ B(y, n(\bar{q})))) \\ \star & \neg(B(\bar{j}, \bar{q}) \supset (Ey)(y \leq \bar{j} \ \& \ B(y, n(\bar{q})))) \\ & B(\bar{j}, \bar{q}) \ \& \ \neg(Ey)(y \leq \bar{j} \ \& \ B(y, n(\bar{q}))) \\ & (Ex)(B(x, \bar{q}) \ \& \ \neg(Ey)(y \leq x \ \& \ B(y, n(\bar{q})))) \end{aligned}$$

Thus, Wang's conclusion appears to implicitly *assume* both Aristotle's particularisation (\bullet) and Rosser's Rule C (\star); entailing, ipso facto, that Z is ω -consistent (see §8.G.).

⁴⁵²See, for instance, [K152], pp.212-213; [Be59], pp.593-595 (which focuses on Rosser's argument, and treats Gödel's proof of his Theorem VI ([Go31], p.24) as a, secondary, weaker result); [Wa63], p.337; [Sh67], p.232 (curiously, this introductory text contains *no* reference to Gödel or to his 1931 paper!); [Rg87], p.98; [EC89], p.215 and p.217, Ex.2; [Sm92], p.81; [BBJ03], p.226 (this introductory text, too, focuses on Rosser's argument, and treats Gödel's argument as more of a historical curiosity!).

17.C. Beth's outline of Rosser's argument

Similarly, in his outline of a formalisation of Rosser's argument, Beth implicitly concludes ([Be59], p.594 (ij)) that from the formal provability of:

$$(i) \neg(q)[G_1(m^0, q, m^0) \rightarrow (s)\{B(s, q) \rightarrow (Et)[t \leq s \ \& \ (Er)\{H(q, r) \ \& \ B(t, r)\}\}]]$$

in his formal system of first-order Peano Arithmetic P, we may infer the formal provability of:

$$(ii) (Eq)[G_1(m^0, q, m^0) \ \& \ (s)\{B(s, q) \ \& \ (t)[t \leq s \rightarrow (r)\{H(q, r) \rightarrow \overline{B(t, r)}\}\}]]$$

Comment 153. We note that, in this case, Beth explicitly defines the interpretation of the formal P-formula '(Ex)' as 'There is a value of x such that' ([Be59], p.178).

Thus Beth, too, implies that the interpretation of existential quantification in formalised axiomatics cannot be specific to any particular interpretation of a formal mathematical language, but must necessarily be determined by the predicate calculus that is to be applied uniformly to all the mathematical languages in question.

However, again, the inference (ii) from (i) appears to assume that the following deduction is valid for some *unspecified* \bar{j} :

$$\begin{aligned} & \neg(q)[G_1(m^0, q, m^0) \rightarrow (s)\{B(s, q) \rightarrow (Et)[t \leq s \ \& \ (Er)\{H(q, r) \ \& \ B(t, r)\}\}]] \\ \bullet & (Eq)\neg[G_1(m^0, q, m^0) \rightarrow (s)\{B(s, q) \rightarrow (Et)[t \leq s \ \& \ (Er)\{H(q, r) \ \& \ B(t, r)\}\}]] \\ \star & \neg[G_1(m^0, \bar{j}, m^0) \rightarrow (s)\{B(s, \bar{j}) \rightarrow (Et)[t \leq s \ \& \ (Er)\{H(\bar{j}, r) \ \& \ B(t, r)\}\}]] \\ & G_1(m^0, \bar{j}, m^0) \ \& \ (s)\{B(s, \bar{j}) \ \& \ (t)[t \leq s \rightarrow (r)\{H(\bar{j}, r) \rightarrow \overline{B(t, r)}\}\}]] \\ & (Eq)[G_1(m^0, q, m^0) \ \& \ (s)\{B(s, q) \ \& \ (t)[t \leq s \rightarrow (r)\{H(q, r) \rightarrow \overline{B(t, r)}\}\}]] \end{aligned}$$

Thus, Beth's conclusion, too, appears to implicitly *assume* both Aristotle's particularisation (•) and Rosser's Rule C (★); entailing, ipso facto, that Z is ω -consistent (see §8.G.).

17.D. Rosser's original argument *implicitly* presumes ω -consistency

Now, Rosser's claim in his 'extension' ([Ro36]) of Gödel's argument ([Go31]) is that, whereas Gödel's argument assumes that his Peano Arithmetic, P , is ω -consistent, Rosser's assumes only that P is simply consistent.

However, Rosser's original argument (also a sketch) appears to *implicitly* presume that the system of Peano Arithmetic in question is ω -consistent.

For instance, Rosser defines a P -formula $R(x, y)$ and concludes ([Ro36], p.234) that:

- (i) If, for any specified natural number n , the formula $[\neg R(n, a)]$ in Gödel's Peano Arithmetic P whose Gödel-number is:

$$Neg(Sb(r \begin{matrix} u \\ Z(n) \end{matrix} \begin{matrix} v \\ Z(a) \end{matrix}))$$

is P_κ -provable under the given premises;

Comment 154. Gödel defines ‘ P_κ -provable’ to mean provable from the axioms of P and an arbitrary class, κ , of P -formulas—including the case where κ is empty—by the rules of deduction of P .

(ii) Then, if P is simply consistent, the P -formula $[(\forall u)\neg R(u, a)]$ whose Gödel-number is:

$$uGen(Neg(Sb(r \overset{v}{Z(a)})))$$

is P_κ -provable;

(iii) Since:

“... the formal analogue of $(z)[z = 0 \vee z = 1 \vee \dots \vee z = x \vee (Ew)[z = x + w]]$ is provable in P and hence in P_κ , and so $Bew_\kappa(uGen(Neg(Sb(r \overset{v}{Z(a)}))))$ ”.

However, we note that Rosser’s argument in (iii) above would need to assume Rosser’s Rule C (as we highlight in §17.E.) in any proof sequence in P that involves an existentially quantified P -formula such as ‘ $(Ew)[z = x + w]$ ’, and which yields his conclusion (ii).

By §8.G., this would imply, however, that P is ω -consistent!

17.E. Mendelson’s proof highlights where Rosser’s argument presumes ω -consistency

We analyse Mendelson’s meticulously detailed expression ([Me64], p.145, Proposition 3.32) of Rosser’s argument—since it is more transparent than Kleene’s ([Kl52], Theorem 29, pp.208-209)—and highlight where it tacitly presumes⁴⁵³ that P is ω -consistent.

Now, Gödel defines a formal Peano Arithmetic P , and a primitive recursive relation, $q(x, y)$, that holds if, and only if, x is the Gödel-number of a well-formed P -formula, say $[H(w)]$ —which has a single free variable, $[w]$ —and y is the Gödel-number of a P -proof of $[H(x)]$.

So, for any natural numbers h, j :

(a) $q(h, j)$ holds if, and only if, j is the Gödel-number of a P -proof of $[H(h)]$.

Rosser’s argument defines an additional primitive recursive relation, $s(x, y)$, which holds if, and only if, x is the Gödel-number of $[H(w)]$, and y is the Gödel-number of a P -proof of $[\neg H(x)]$.

Hence, for any natural numbers h, j :

(b) $s(h, j)$ holds if, and only if, j is the Gödel-number of a P -proof of $[\neg H(h)]$.

Further, it follows from Gödel’s Theorems V ([Go31], p.22) and VII ([Go31], p.29) that the primitive recursive relations $q(x, y)$ and $s(x, y)$ are instantiationally equivalent to some arithmetical relations, $Q(x, y)$ and $S(x, y)$, such that, for any natural numbers h, j :

⁴⁵³Compare with the, subsequent (in later editions), explicit assumption that is referenced as ‘the, ostensibly ‘formal’, argument offered as validation of Rule C in standard texts, such as [Me15]’ in §8.G., Comment 92.

- (c) If $q(h, j)$ holds, then $[Q(h, j)]$ is P-provable;
- (d) If $\neg q(h, j)$ holds, then $[\neg Q(h, j)]$ is P-provable;
- (e) If $s(h, j)$ holds, then $[S(h, j)]$ is P-provable;
- (f) If $\neg s(h, j)$ holds, then $[\neg S(h, j)]$ is P-provable;

Now, whilst Gödel defines $[H(w)]$ as:

$$[(\forall y)\neg Q(w, y)],$$

Rosser's argument defines $[H(w)]$ as:

$$[(\forall y)(Q(w, y) \rightarrow (\exists z)(z \leq y \wedge S(w, z)))],$$

Further, whereas Gödel considers the P-provability of the Gödelian proposition,:

$$[(\forall y)\neg Q(h, y)],$$

Rosser's argument considers the P-provability of the proposition:

$$[(\forall y)(Q(h, y) \rightarrow (\exists z)(z \leq y \wedge S(h, z)))].$$

We note that, by definition:

- (i) $q(h, j)$ holds if, and only if, j is the Gödel-number of a P-proof of:

$$[(\forall y)(Q(h, y) \rightarrow (\exists z)(z \leq y \wedge S(h, z)))];$$

- (ii) $s(h, j)$ holds if, and only if, j is the Gödel-number of a P-proof of:

$$[\neg((\forall y)(Q(h, y) \rightarrow (\exists z)(z \leq y \wedge S(h, z)))].$$

17.E.a. Where Mendelson's proof tacitly assumes ω -consistency

- (a) We assume, first, that r is the Gödel-number of some proof sequence in P for the Rosser proposition $[(\forall y)(Q(h, y) \rightarrow (\exists z)(z \leq y \wedge S(h, z)))].$

Hence $q(h, r)$ is true, and $[Q(h, r)]$ is P-provable.

However, we then have that $[Q(h, r) \rightarrow (\exists z)(z \leq r \wedge S(h, z))]$ is P-provable.

Further, by Modus Ponens, we have that $[(\exists z)(z \leq r \wedge S(h, z))]$ is P-provable.

Now, if P is simply consistent, then $[\neg((\forall y)(Q(h, y) \rightarrow (\exists z)(z \leq y \wedge S(h, z))))]$ is not P-provable.

Hence, $s(h, n)$ does not hold for any natural number n , and so $\neg s(h, n)$ holds for every natural number n .

It follows that $[\neg S(h, n)]$ is P-provable for every P-numeral $[n]$.

Hence, $[\neg((\exists z)(z \leq r \wedge S(h, z)))]$ is also P-provable—a contradiction.

Hence, $[(\forall y)(Q(h, y) \rightarrow (\exists z)(z \leq y \wedge S(h, z)))]$ is not P-provable if P is simply consistent.

(b) We assume next that r is the Gödel-number of some proof-sequence in P for the proposition $[\neg((\forall y)(Q(h, y) \rightarrow (\exists z)(z \leq y \wedge S(h, z)))]$.

Hence $s(h, r)$ holds, and $[S(h, r)]$ is P-provable.

However, if P is simply consistent, $[(\forall y)(Q(h, y) \rightarrow (\exists z)(z \leq y \wedge S(h, z)))]$ is not P-provable.

Hence, $\neg q(h, n)$ holds for every natural number n , and $[\neg Q(h, n)]$ is P-provable for all P-numerals $[n]$.

(i) The foregoing implies $[y \leq r \rightarrow \neg Q(h, y)]$ is P-provable, and we consider the following deduction ([Me64], p.146):

- | | |
|--|--------------------------|
| (1) $[r \leq k]$ | ... <i>Hypothesis</i> |
| (2) $[S(h, r)]$ | ... <i>By 3(b)</i> |
| (3) $[r \leq k \wedge S(h, r)]$ | ... <i>From (1), (2)</i> |
| (4) $[(\exists z)(z \leq k \wedge S(h, z))]$ | ... <i>From (3)</i> |

(ii) From (1)-(4), by the Deduction Theorem, we have that $[r \leq k \rightarrow (\exists z)(z \leq k \wedge S(h, z))]$ is provable in P for any P-numeral $[k]$;

(iii) Now, $[k \leq r \vee r \leq k]$ is P-provable for any P-numeral $[k]$;

(iv) Also, $[(k \leq r \rightarrow \neg Q(h, k)) \wedge (r \leq k \rightarrow (\exists z)(z \leq k \wedge S(h, z)))]$ is P-provable for any P-numeral $[k]$.

(v) Hence $[(\neg(k \leq r) \vee \neg Q(h, k)) \wedge (\neg(r \leq k) \vee (\exists z)(z \leq k \wedge S(h, z)))]$ is P-provable for any P-numeral $[k]$.

(vi) Hence $[\neg Q(h, k) \vee (\exists z)(z \leq k \wedge S(h, z))]$ is P-provable for any P-numeral $[k]$.

(vii) Hence $[(Q(h, k) \rightarrow (\exists z)(z \leq k \wedge S(h, z)))]$ is P-provable for any P-numeral $[k]$.

(viii) Now, (vii) contradicts our assumption that $[\neg((\forall y)(Q(h, y) \rightarrow (\exists z)(z \leq y \wedge S(h, z)))]$ is P-provable.

(ix) Hence $[\neg((\forall y)(Q(h, y) \rightarrow (\exists z)(z \leq y \wedge S(h, z)))]$ is not P-provable if P is simply consistent.

However, the claimed contradiction in (viii) *only* follows if we assume that P is ω -consistent, and *not* if we assume only that P is simply consistent.

In other words, Mendelson's step (viii) implicitly appeals to Rosser's Rule *C*, and assumes that the formula $[\neg(\forall y)(Q(h, y))]$ entails the formula $[\neg(Q(h, k))]$ for some *unspecified* term $[k]$ of P—which entails that Aristotle's particularisation holds in any model of P (see §8.G.)—without justifying that such a $[k]$ can, indeed, be *specified* in P without inviting contradiction.

We note that the appeal to Rosser's Rule *C* in Mendelson's step (viii) is obscured in Kleene's proof of 'Rosser's form of Gödel's theorem' ([K152], Theorem 29, pp.208-209), where he appeals to an earlier lemma *169 in order to conclude from $\vdash \forall b[b < \mathbf{k} \supset \neg \mathbf{A}(\mathbf{q}, b)]$ that $\vdash \forall b[\neg \mathbf{A}(\mathbf{q}, b) \vee \exists c(c \leq b \ \& \ \mathbf{B}(\mathbf{q}, c))]$.

That Kleene implicitly appeals to Rosser's Rule C in his proof is seen in his introductory remarks to his Theorem 29, where he explicitly appeals to Aristotle's particularisation (see §7., Definition 20) in his interpretation of the Rosser formula:

"We have given the original Gödel form of the theorem first, as the proof is intuitively simpler and follows the heuristic outline. Rosser 1936 has shown, however, that by using a slightly more complicated example of an undecidable formula, the hypothesis of ω -consistency can be dispensed with, and the incompleteness proved from the (simple) consistency alone. Consider the formula $\forall b[\neg\mathbf{A}(a, b) \vee \exists c(c \leq b \ \& \ \mathbf{B}(a, c))]$. This has a Gödel number, call it q . Now consider the formula $\mathbf{A}_q(\mathbf{q})$, i.e.

$$\mathbf{A}_q(\mathbf{q}): \quad \forall b[\neg\mathbf{A}(\mathbf{q}, b) \vee \exists c(c \leq b \ \& \ \mathbf{B}(\mathbf{q}, c))]$$

We can interpret the formula $\mathbf{A}_q(\mathbf{q})$ from our perspective of the Gödel numbering as asserting that to any proof of $\mathbf{A}_q(\mathbf{q})$ there exists a proof of $\neg\mathbf{A}_q(\mathbf{q})$ with an equal or smaller Gödel number, which under the hypothesis of simple consistency implies that $\mathbf{A}_q(\mathbf{q})$ is unprovable."

... Kleene: [K152], p.208.

CHAPTER 17. PARADIGM CHALLENGING CONSEQUENCES

18. The significance of *evidence-based* reasoning for non-standard models of PA

Once we accept as logically sound the set-theoretically based meta-argument⁴⁵⁴ that a first-order Peano Arithmetic PA (e.g., the theory S defined in [Me64], pp.102-103) can be forced—by appeal to the Compactness Theorem—into admitting non-standard models which contain an ‘infinite’ integer, then the set-theoretical properties of the algebraic and arithmetical structures of such putative models should perhaps follow without serious foundational reservation (as argued, for instance, in [Ka91]; [Bov00]; [BBJ03], ch.25, p.302; [KS06]; [Ka11])⁴⁵⁵.

Compactness Theorem: “If every finite subset of a set of sentences has a model, then the whole set has a model.”

... Boolos, Burgess & Jeffrey: [BBJ03], p.147

From an *evidence-based* perspective, however, there is a cogent case *against* concluding from such arguments the existence of non-standard models of PA (see also §7.K.; [Gaf04]).

18.A. The ambiguity in admitting an ‘infinite’ constant

To see this we need to first highlight, and eliminate, an ambiguity in the classical argument postulating the existence of non-standard models of arithmetic as is usually found in standard texts⁴⁵⁶:

“**Corollary.** There is a non-standard model of \mathbf{P} with domain the natural numbers in which the denotation of every nonlogical symbol is an arithmetical relation or function.

Proof. As in the proof of the existence of nonstandard models of arithmetic, add a constant ∞ to the language of arithmetic and apply the Compactness Theorem to the theory

$$\mathbf{P} \cup \{\infty \neq \mathbf{n} : n = 0, 1, 2, \dots\}$$

to conclude that it has a model (necessarily infinite, since all models of \mathbf{P} are). The denotations of ∞ in any such model will be a non-standard element, guaranteeing that the model is non-standard. Then apply the arithmetical Löwenheim-Skolem theorem to conclude that the model may be taken to have domain the natural numbers, and the denotations of all nonlogical symbols arithmetical.”

... Boolos, Burgess & Jeffrey: [BBJ03], p.306, Corollary 25.3.

⁴⁵⁴By which we mean arguments such as in [Ka91] or [Cho18], where the meta-theory is taken to be a set-theory such as ZF or ZFC, and the logical consistency of the meta-theory is not considered relevant to the argumentation.

⁴⁵⁵Or accepted as paradigms that, as Melvyn B. Nathanson despairingly notes in [Na08] (see also §20.) are, generally, uncritically inherited in good faith; such as, for instance: “*It is a well-known fact that first-order Peano Arithmetic (PA1) is not categorical, i.e. it does not uniquely describe the sequence of the natural numbers that is typically viewed as the ‘intended model’ of arithmetic. Indeed, PA1 equally describes structures that strictly contain the sequence of the natural numbers but are not isomorphic to it, and these are known as the non-standard models of arithmetic.*” ... Novaes: [Nus19], §1 Introduction.

⁴⁵⁶cf. [HP98], p.13, §0.29; [Me64], p.112, Ex. 2.

18.A.a. We cannot force PA to admit a transfinite ordinal

The ambiguity lies in a possible interpretation of the symbol ∞ as a ‘completed’ infinity (such as Cantor’s first transfinite ordinal ω) in the context of non-standard models of PA. To eliminate this possibility we establish trivially that, and briefly examine why:

Theorem 18.1. *No model of PA can admit a transfinite ordinal under the standard interpretation of the first-order logic FOL⁴⁵⁷.*

Proof. Let $[G(x)]$ denote the PA-formula:

$$[x = 0 \vee \neg(\forall y)\neg(x = Sy)]$$

This translates in every model of PA, as the algorithmically *verifiable* assertion:

If x denotes an element in the domain of a model of PA, then either x is 0, or x is a ‘successor’.

Comment 155. We note that $[\neg(\forall y)\neg(x = Sy)]$ is algorithmically *verifiable* as always true under any interpretation of PA; i.e., ‘It is false that, for any specified natural number $n > 0$, there is a deterministic algorithm which will *evidence* that n is not the successor of $n - 1$ ’ is a true statement since, ‘For any specified natural number $n > 0$, there is a deterministic algorithm which will *evidence* that n is the successor of $n - 1$ ’ is a true statement.

Further, in every model of PA, if $G^*(x)$ denotes the interpretation of $[G(x)]$:

- (a) $G^*(0)$ is true;
- (b) If $G^*(x)$ is true, then $G^*(Sx)$ is true.

Hence, by Gödel’s completeness theorem:

- (c) PA proves $[G(0)]$;
- (d) PA proves $[G(x) \rightarrow G(Sx)]$.

Gödel’s Completeness Theorem: In any first-order predicate calculus, the theorems are precisely the logically valid well-formed formulas (*i. e. those that are true in every model of the calculus*).

Further, by Generalisation:

- (e) PA proves $[(\forall x)(G(x) \rightarrow G(Sx))]$;

Generalisation in PA: $[(\forall x)A]$ follows from $[A]$.

Hence, by Induction:

- (f) $[(\forall x)G(x)]$ is provable in PA.

⁴⁵⁷For purposes of this investigation we may take FOL to be the first order predicate calculus K as defined in [Me64], p.57.

Induction Axiom Schema of PA: For any formula $[F(x)]$ of PA:
 $[F(0) \rightarrow ((\forall x)(F(x) \rightarrow F(Sx)) \rightarrow (\forall x)F(x))]$

Thus, except 0, every element in the domain of any model of PA is a ‘successor’. Further, the standard PA axioms ensure that x can only be a ‘successor’ of a unique element in any model of PA.

Since Cantor’s first limit ordinal ω is not the ‘successor’ of any ordinal in the sense required by the PA axioms, and since there are no infinitely descending sequences of ordinals⁴⁵⁸ in a model—if any—of a first order set theory such as ZF, the theorem follows. \square

18.A.b. Why we cannot force PA to admit a transfinite ordinal

Theorem 18.1 reflects the fact that we can define the usual order relation ‘ $<$ ’ in PA so that every instance of the PA Axiom Schema of Finite Induction, such as, say:

$$(i) [F(0) \rightarrow ((\forall x)(F(x) \rightarrow F(Sx)) \rightarrow (\forall x)F(x))]$$

yields the weaker PA theorem:

$$(ii) [F(0) \rightarrow ((\forall x)((\forall y)(y < x \rightarrow F(y)) \rightarrow F(x)) \rightarrow (\forall x)F(x))]$$

Now, if we interpret PA without relativisation in ZF⁴⁵⁹— i.e., numerals as finite ordinals, $[Sx]$ as $[x \cup \{x\}]$, etc.— then (ii) always translates in ZF as a theorem (*Principle of Transfinite Induction*):

$$(iii) [F(0) \rightarrow ((\forall x)((\forall y)(y \in x \rightarrow F(y)) \rightarrow F(x)) \rightarrow (\forall x)F(x))]$$

However, (i) does not always translate similarly as a ZF-theorem, since the following is not necessarily provable in ZF:

$$(iv) [F(0) \rightarrow ((\forall x)(F(x) \rightarrow F(x \cup \{x\})) \rightarrow (\forall x)F(x))]$$

Example: Define $[F(x)]$ as ‘ $[x \in \omega]$ ’.

We conclude that, whereas the language of ZF admits as a constant the first limit ordinal ω which would interpret in any putative model of ZF as the (‘completed’ infinite) set ω of all finite ordinals:

Corollary 18.2. *The language of PA admits of no constant that interprets in any well-defined model of PA as the set N of all natural numbers.* \square

We note that it is the non-logical Axiom Schema of Finite Induction of PA which does not allow us to introduce—contrary to what is suggested by standard texts⁴⁶⁰—an ‘actual’ (or ‘completed’) infinity disguised as an arbitrary constant (usually denoted by c or ∞) into either the language, or any *well-defined* model, of PA.

⁴⁵⁸cf. [Me64], p.261.

⁴⁵⁹In the sense indicated by Feferman [Fe92].

⁴⁶⁰eg. [HP98], p.13, §0.29; [Ka91], p.11 & p.12, fig.1; [BBJ03]. p.306, Corollary 25.3; [Me64], p.112, Ex. 2; [Sri08], p.74.

Comment 156. For instance, in his *A Course on Mathematical Logic*, Shashi Mohan Srivastava uncritically follows current paradigms when—contradicting Corollary 18.2 (as also §2.E.b., Corollary 2.18; §19.A., Corollary 19.3 and Theorem 19.4)—he notes:

“... some interesting results without proof.

Theorem 5.3.9 *Peano arithmetic PA has an interpretation in an extension by definitions of ZF. [6]*

Theorem 5.3.10 *Each of Peano arithmetic PA and ZF-Infinity has a faithful interpretation in an extension by definitions of the other. In particular, PA is consistent if and only if ZF-Infinity is consistent. [6, Exercise 30, p.149]."*

... Srivastava: [Sri08], p.74.

18.B. Forcing PA to admit denumerable descending dense sequences

The significance of §18.A.b., Theorem 18.1, is seen in the next two arguments, which attempt to implicitly bypass the Theorem’s constraint by appeal to the Compactness Theorem for forcing a non-standard model onto PA⁴⁶¹.

However, we argue in both cases that applying the Compactness Theorem constructively—even from a classical perspective—does not logically yield a non-standard model for PA with an ‘infinite’ integer as claimed⁴⁶².

18.C. An argument for a non-standard model of PA

The first is Laureano Luna’s argument⁴⁶³ that we can define a non-standard model of PA with an infinite descending chain of successors, where the only non-successor is the null element 0:

1. Let $\langle \mathbb{N}$ (*the set of natural numbers*); $=$ (*equality*); S (*the successor function*); $+$ (*the addition function*); $*$ (*the product function*); 0 (*the null element*) \rangle be the structure that serves to define a model of PA, say M .
2. Let $T[M]$ be the set of PA-formulas that are satisfied or true in M .
3. The PA-provable formulas form a subset of $T[M]$.
4. Let Γ be the countable set of all PA-formulas of the form $[c_n = S_{c_{n+1}}]$, where the index n is a natural number.
5. Let T be the union of Γ and $T[M]$.
6. $T[M]$ plus any finite set of members of Γ has a model, e.g., M itself, since M is a model of any finite descending chain of successors.
7. Consequently, by Compactness, T has a model; call it M' .
8. M' has an infinite descending sequence with respect to S because it is a model of Γ .
9. Since PA is a subset of T , M' is a non-standard model of PA.

⁴⁶¹eg. [Ln08]; [Ka91], pp.10-11, p.74 & p.75, Theorem 6.4.

⁴⁶²And as suggested also by standard texts in such cases; eg. [BBJ03]. p.306, Corollary 25.3; [Me64], p.112, Ex. 2.

⁴⁶³[Ln08].

18.C.a. Why the argument in §18.C. is logically fragile

However if—as claimed in §18.C.(6) above— M is a model of $T[M]$ plus any finite set of members of Γ , and the PA term $[c_n]$ is well-defined for any specified natural number n , then:

1. All PA-formulas of the form $[c_n = Sc_{n+1}]$ are PA-provable,
2. Γ is a proper sub-set of the PA-provable formulas, and
3. T is identically $T[M]$.

Reason: The argument cannot be that some PA-formula of the form $[c_n = Sc_{n+1}]$ is true in M , but not PA-provable, as this would imply that if PA is consistent then $PA + [\neg(c_n = Sc_{n+1})]$ has a model other than M ; in other words, it would presume that which is sought to be proved, namely that PA has a non-standard model!

Consequently, the postulated model M' of T in §18.C.(7) by ‘Compactness’ is the model M that defines $T[M]$. However, M has no infinite descending sequence with respect to S , even though it is a model of Γ .

Hence the argument does not establish the existence of a non-standard model of PA with an infinite descending sequence with respect to the successor function S .

18.D. A formal argument for a non-standard model of PA

The second is Richard Kaye’s more formal argument⁴⁶⁴:

“Let $Th(\mathbb{N})$ denote the complete \mathcal{L}_A -theory of the standard model, i.e. $Th(\mathbb{N})$ is the collection of all true \mathcal{L}_A -sentences. For each $n \in \mathbb{N}$ we let \underline{n} be the closed term $(\dots(((1+1)+1)+\dots+1))$ (n 1s) of \mathcal{L}_A ; $\underline{0}$ is just the constant symbol 0. We now expand our language \mathcal{L}_A by adding to it a new constant symbol c , obtaining the new language \mathcal{L}_c , and consider the following \mathcal{L}_c -theory with axioms

$$\rho \text{ (for each } \rho \in Th(\mathbb{N}))$$

and

$$c > \underline{n} \text{ (for each } n \in \mathbb{N})$$

This theory is consistent, for each finite fragment of it is contained in

$$T_k = Th(\mathbb{N}) \cup \{c > \underline{n} \mid n < k\}$$

for some $k \in \mathbb{N}$, and clearly the \mathcal{L}_c -structure (\mathbb{N}, k) with domain \mathbb{N} , 0, 1, +, \cdot and $<$ interpreted naturally, and c interpreted by the integer k , satisfies T_k . Thus by the compactness theorem $\cup_{k \in \mathbb{N}} T_k$ is consistent and has a model M_c . The first thing to note about M_c is that

$$M_c \models c > \underline{n}$$

for all $n \in \mathbb{N}$, and hence it contains an ‘infinite’ integer.”

... Kayes: [Ka91], pp.10-11.

⁴⁶⁴Attributed by Kaye as essentially Skolem’s argument in [Sk34].

18.D.a. Why Kaye's argument too is logically fragile

We note again that, from an arithmetical perspective, any application of the Compactness Theorem to PA cannot, first, ignore currently accepted computationalist doctrines of objectivity (see, for instance, [Mu91], §1 Introduction; [Lob59], p.165) that underlie the *evidence-based* reasoning introduced in [An16] (see §7.C.) and, second, contradict the constructive assignment of satisfaction and truth to the atomic formulas of PA (therefore to the compound formulas under Tarski's inductive definitions) in terms of either algorithmical *verifiability* or algorithmic *computability*.

Accordingly, from an arithmetical perspective we can only conclude by the Compactness Theorem that if $Th(\mathbb{N})$ is the \mathcal{L}_A -theory of the standard model (interpretation), then we may consistently add to it the following as an additional—not necessarily independent—axiom:

$$(\exists y)(y > x).$$

In other words, even from the *evidence-based* arithmetical perspective of [An16] (see §2.) anchored *strictly within* the framework of classical logic⁴⁶⁵, we *can* conclude incontrovertibly by the Compactness Theorem that (cf., [Ka91], p.10-11):

Lemma 18.3. *If the collection $Th(\mathbb{N})$ of all true \mathcal{L}_A -sentences is the \mathcal{L}_A -theory of the standard model of Arithmetic, then we may consistently add to it the following as an additional—not necessarily independent—axiom:*

$$(\exists y)(y > x).$$

Proof. By §2., Definition 10, $(\exists y)(y > x)$ is algorithmically *computable* as always true in the standard model of Arithmetic considered above—whence all of its instances are in $Th(\mathbb{N})$. \square

However, we cannot conclude (contrary to the argument, for instance, in [Ka91], p.10-11) by the Compactness Theorem that $\cup_{k \in \mathbb{N}} T_k$ is consistent and has a model M_c which contains an 'infinite' integer:

Theorem 18.4. *The Compactness Theorem does not entail that:*

$$(*) \cup_{k \in \mathbb{N}} \{Th(\mathbb{N}) \cup \{c > \underline{n} \mid n < k\}\}$$

is consistent and has a model M_c which contains an 'infinite' integer.

Proof. The condition ' $k \in \mathbb{N}$ ' in (*) above requires, first of all, that we must be able to extend $Th(\mathbb{N})$ by the addition of a 'relativised' axiom (cf. [Fe92]; [Me64], p.192), such as:

$$(\exists y)((x \in \mathbb{N}) \rightarrow (y > x)).$$

Only then may we conclude that if a model M_c of:

$$\{Th(\mathbb{N}) \cup (\exists y)((x \in \mathbb{N}) \rightarrow (y > x))\}$$

exists, then it must have an 'infinite' integer c such that:

⁴⁶⁵**Classical logic:** By 'classical logic' we mean the standard first-order predicate calculus FOL where the Law of the Excluded Middle is a theorem, but we do not assume that FOL is ω -consistent; i.e., we do not assume that Aristotle's particularisation (see §7., Definition 20) must hold under any interpretation of the logic.

$$M_c \models c > \underline{n}$$

for all $n \in \mathbb{N}$.

However, even this would not yield a model for $Th(\mathbb{N})$, since every model of $Th(\mathbb{N})$ is by definition a model of (the provable formulas of) PA and, by the categoricity of PA by §2.E.b., Theorem 2.18—as also independently by §18.A.a., Theorem 18.1—we cannot introduce a ‘completed’ infinity such as c into either PA or any model of PA. \square

We note that, as Kaye’s argument stands, it seeks to violate finitariness by adding a new constant c to the language \mathcal{L}_A of PA that is not definable in \mathcal{L}_A and, ipso facto, adding an atomic formula $[c = x]$ to PA whose satisfaction under any interpretation of PA is not algorithmically *verifiable*!

Since the atomic formulas of PA are algorithmically *verifiable* under the standard interpretation⁴⁶⁶, the above conclusion too postulates that which it seeks to prove!

Moreover, the postulation would be false if $Th(\mathbb{N})$ were categorical.

⁴⁶⁶See §2.B., Theorem 2.2.

CHAPTER 18. PARADIGM CHALLENGING CONSEQUENCES

19. The significance of *evidence-based* reasoning for Goodstein's Theorem

The significance of Skolem's cautionary remarks in [Sk22] (see §7.K.) is further seen if note that, for any natural number m , R. L. Goodstein ([Gd44]) uses the properties of the hereditary representation of m to construct a sequence $G(m) \equiv \{g_1(m), g_2(m), \dots\}$ of natural numbers by an unusual, but valid, algorithm.

Hereditary representation: The representation of a number as a sum of powers of a base b , followed by expression of each of the exponents as a sum of powers of b , etc., until the process stops. For example, we may express the hereditary representations of 266 in base 2 and base 3 as follows:

$$266_{[2]} \equiv 2^{8_{[2]}} + 2^{3_{[2]}} + 2 \equiv 2^{2^{(2^{2^0} + 2^0)}} + 2^{2^{2^0 + 2^0}} + 2^{2^0}$$

$$266_{[3]} \equiv 2 \cdot 3^{4_{[3]}} + 2 \cdot 3^{3_{[3]}} + 3^{2_{[3]}} + 1 \equiv 2 \cdot 3^{(3^{3^0} + 3^0)} + 2 \cdot 3^{3^0} + 3^{2 \cdot 3^0} + 3^0$$

We shall ignore here the peculiar manner of constructing the individual members of the Goodstein sequence, since these are not germane to understanding the essence of Goodstein's argument. We need simply accept for now that $G(m)$ is *well-defined* over the structure \mathbb{N} of the natural numbers, and has the following properties:

- (i) For any specified natural number $k > 0$ we can construct a hereditary representation—denoted⁴⁶⁷ by $g_k(m)_{[k+1]}$ —of $g_k(m)$ in the base $[k + 1]$;

Example: The hereditary representations of the first two terms $g_1(266) = 266$ and $g_2(266) = (3^{81} + 83)$ of $G(266)$ are⁴⁶⁸:

$$g_1(266)_{[2]} \equiv 2^{2^{2+1}} + 2^{2+1} + 2$$

$$g_2(266)_{[3]} \equiv 3^{3^{3+1}} + 3^{3+1} + 2$$

- (ii) We can also *well-define* a Goodstein Functional Sequence:

$$G(m)_{[x]} \equiv \{g_k(m)_{[(k+1) \leftrightarrow x]} : k > 0\} \text{ over } \mathbb{N}$$

by replacing the base $[k + 1]$ in $g_k(m)_{[k+1]}$ with the variable x for each $k > 0$ ⁴⁶⁹.

Example: The first two terms of $G(266)_{[x]}$ are thus:

$$g_1(266)_{[2 \leftrightarrow x]} \equiv x^{x^{x+1}} + x^{x+1} + x$$

$$g_2(266)_{[3 \leftrightarrow x]} \equiv x^{x^{x+1}} + x^{x+1} + 2$$

⁴⁶⁷From a pedantic perspective the denotation should, of course, be: $(g_k(m))_{[k+1]}$.

⁴⁶⁸*Notation:* For ease of expression, we shall henceforth express ' a^0 ' as '1', and ' a^{b^0} ' as ' a ' unless indicated to the contrary.

⁴⁶⁹*Notation:* We prefer the notation \leftrightarrow to that of the usual 'base bumping' function (cf. [Cai07]) as it seems to make the argument slightly more transparent.

(iii) We can show that some member of Goodstein’s sequence $G(m)$ evaluates to 0 if, and only if, there is some natural number z such that for any specified natural number $k > 0$:

- If $g_k(m)_{[(k+1) \leftrightarrow z]} > 0$ in $G(m)_{[z]}$,
- Then $g_k(m)_{[(k+1) \leftrightarrow z]} > g_{k+1}(m)_{[(k+2) \leftrightarrow z]}$.

The proof of (iii)—which depends, of course, on the peculiar nature of Goodstein’s algorithm—is tedious, but fairly straightforward (see §19.B.). The main point to note is that the proof is *finitary* and appeals only to the *arithmetical* properties of the natural numbers.

The question arises:

Query 16. *Are we free to postulate the existence of such a natural number z , and conclude from Goodstein’s Theorem (classical) that some member of $G(m)$ must evaluate to 0 in \mathbb{N} ?*

Goodstein’s Theorem (classical): Every Goodstein sequence defined over the natural numbers terminates in 0.

Though it appears absurd, the following theorem in the *weak*, second-order, Peano Arithmetic ACA_0 shows that this is precisely the freedom to which the, *transfinite*, ordinal-based argument for Goodstein’s Theorem (classical) *curiously* lays claim (albeit implicitly)!

Theorem 19.1. *Goodstein’s sequence $G_o(m_o)$ ⁴⁷⁰ over the finite ordinals in any putative model \mathbb{M} of ACA_0 terminates with respect to the ordinal inequality ‘ $>_o$ ’ even if Goodstein’s sequence $G(m)$ over the natural numbers does not terminate with respect to the natural number inequality ‘ $>$ ’ in \mathbb{M} .*

Proof. Since PA is *finitarily* consistent (see §2.C.a., Theorem 2.16) and categorical (see §2.E.b., Corollary 2.18), and Laurie Kirby and Jeff Paris have shown in [KP82] that Goodstein’s Theorem (classical) is unprovable in PA, we may—without inviting immediate inconsistency—assume for the moment that, for some *unspecified* natural number m , Goodstein’s sequence $G(m) \equiv \{g_k(m)_{[(k+1)]} : k > 0\}$ of natural numbers *does not terminate* with respect to the natural number inequality ‘ $>$ ’ in any putative model \mathbb{M} of the *weak* second-order Peano Arithmetic ACA_0 .

Further, let n_{max} be the largest term amongst the first n terms of $G(m)$. It is tedious but straightforward to show that, by our assumption, n_{max} is a monotonically increasing sequence. Hence there is *no* natural number z such that:

$$g_k(m)_{[(k+1) \leftrightarrow z]} > g_{k+1}(m)_{[(k+2) \leftrightarrow z]} \text{ for all } k > 0.$$

Consider next Goodstein’s ordinal number sequence $G_o(m_o) \equiv \{g_k(m_o) : k > 0\}$ over the finite ordinals.

Goodstein shows that, in the arithmetic of *transfinite* ordinals, the axiomatically postulated *transfinite* ordinal ω is such that:

⁴⁷⁰**Notation:** For convenience of expression, we shall henceforth denote by m_o the ordinal (set) in \mathbb{M} corresponding to the natural number m in \mathbb{M} ; by ‘ $+_o$ ’ and ‘ $>_o$ ’ the function/relation letters relating to ordinals in \mathbb{M} that correspond to the function/relation letters ‘ $+$ ’ and ‘ $>$ ’ that correspond to the natural numbers in \mathbb{M} , etc.

$$g_k(m_o)_{[(k+1) \leftrightarrow \omega]} >_o g_{k+1}(m_o)_{[(k+2) \leftrightarrow \omega]} \text{ for all } k > 0.$$

Since there are no infinite descending sequences of ordinals with respect to the *transfinitely defined* ordinal relation ' $>_o$ ', Goodstein's ordinal number sequence $G_o(m_o)$ must terminate finitely with respect to the *transfinite* ordinal relation ' $>_o$ ' in any putative model \mathbb{M} of ACA_0 . \square

Comment 157. In other words, assuming ZF is consistent entails that, since PA is *finitarily* consistent (see §2.C.a., Theorem 2.16), and Laurie Kirby and Jeff Paris have shown in [KP82] that Goodstein's Theorem (*classical*) is unprovable in PA:

- Goodstein's Theorem over the finite ZF ordinals would interpret as *true* over \mathbb{N} , even if Goodstein's Theorem over the natural numbers is assumed as *false* over \mathbb{N} .

We conclude that there can be no mathematical or meta-mathematical proof of consistency for ZF.

Moreover, since the finite ordinals can be meta-mathematically put into a 1-1 correspondence with the natural numbers, it follows that⁴⁷¹:

Corollary 19.2. *The relationship of terminating finitely with respect to the transfinitely defined ordinal relation ' $>_o$ ' over the set of finite ordinals does not entail the relationship of terminating finitely with respect to the finitarily defined natural number relation ' $>$ ' over the set of natural numbers.* \square

19.A. The subsystem ACA_0

We note that ACA_0 is defined (see [Fe97], pp.12-13) as an 'extension' of PA with the PA variables, say $[m], [n], \dots$, ranging now over the ACA_0 numerals; with additional set variables $[X], [Y], [Z], \dots$ ranging over ACA_0 sets; and with an additional arithmetical Comprehension Axiom schema where, if $[\varphi(n)]$ is a formula with a free numeral variable $[n]$ —and possibly other free variables such as, say, $[m]$ and $[X]$, but not the set variable $[Z]$ —the Comprehension Axiom for $[\varphi]$ is the formula that defines sets in ACA_0 by:

$$[(\forall m)(\forall X)(\exists Z)(\forall n)(n \in Z \leftrightarrow \varphi(n))]$$

It now immediately follows from §19., Corollary 19.2, that:

Corollary 19.3. *The subsystem ACA_0 of second-order arithmetic is not a conservative extension of PA.*

We note that the *curious* conclusion of Goodstein's Theorem reflects the circumstance that the 'truth' of the Comprehension Axioms of ACA_0 under an interpretation is not *well-definable*, since they contain an existential quantifier that is intended to admit Aristotle's particularisation under any interpretation.

We thus again conclude, independently of §19., Corollary 19.3, that:

⁴⁷¹See also §15.C., Lemma 15.1: The structure of the finite ordinals under any putative *well-defined* interpretation of ZF is not isomorphic to the structure \mathbb{N} of the natural numbers.

Theorem 19.4. *The subsystem ACA_0 of second-order arithmetic is not a conservative extension of PA.*

Proof. By §2.C.a., Theorem 2.16, PA is consistent and has a model. If ACA_0 is a conservative extension of PA, then it too is consistent⁴⁷² and has a model which admits Aristotle’s particularisation, and which is also a model of PA. However, by §8.D., Corollary 8.11, Aristotle’s particularisation cannot hold in any model of PA. The theorem follows. \square

We note that §19.A., Theorem 19.4, contradicts conventional paradigms⁴⁷³:

“In other words, ACA_0 is a *conservative extension* of first order arithmetic. This may also be expressed by saying that Z_1 , or equivalently PA, is the *first order part* of ACA_0 .”

... Simpson: [Sim06], §1.3, REMARK 1.3.3, p.8.

“As a logical footnote to that, the system \mathbf{ACA}_0 , which I described here, is a conservative extension of Peano Arithmetic, even though it employs second order concepts.”

... Feferman: [Fe97], p.18.

“It is a classical result of proof theory that the system \mathbf{ACA}_0 is a conservative extension of the first-order system of Peano Arithmetic \mathbf{PA} .”

... Feferman: [Fe02], p.18.

Comment 158. The broader question of whether *any* set theory can be treated as a conservative extension of PA is insightfully addressed by Alfredo Roque Freire in a relatively recent preprint [Fri19], where —reflecting [An16], Corollary 7.2 (*PA is categorical with respect to algorithmic computability*⁴⁷⁴)—he cogently argues, and categorically claims, that although ‘it is possible to have extensions of PA not interpretable in a given set theory ST’, the possibility for ‘a random extension of arithmetic to be interpretable in ST is zero’:

“This article starts criticizing the understanding that finite set theory (ZF_{Hfin}) is the set theoretic equivalent of arithmetic (PA). We argue that ‘a version of set theory’ should be a subtheory of our axioms for set theory. However, we prove that no subtheory of any extension of Zermelo set theory is bi-interpretable with any extension of PA. Further, we show that, for every well-founded interpretation of recursive extensions of PA in extensions of ZF, the interpreted version of arithmetic has more theorems than the original. This theorem expansion is not complete however. We continue by defining the coordination problem. In summary, we consider two independent communities of mathematicians responsible for deciding over new axioms for ZF and PA. How likely are they to be coordinated regarding PA’s interpretation in ZF? We prove that it is possible to have extensions of PA not interpretable in a given set theory ST. We further show that a random extension of arithmetic to be interpretable in ST is zero.”

... Freire: [Fri19], Abstract.

⁴⁷²“If T' is a conservative extension of T , then T' is consistent iff T is consistent.” ... Shoenfield: [Sh67], p.42.

⁴⁷³Paradigms that, as Melvyn B. Nathanson despairingly notes in [Na08] (see also §20.) are, generally, uncritically inherited in good faith; such as, for instance (since ACA_0 is a weak subsystem of the second-order Peano Arithmetic (PA2)):

“It is a well-known fact that first-order Peano Arithmetic (PA1) is not categorical, i.e. it does not uniquely describe the sequence of the natural numbers that is typically viewed as the ‘intended model’ of arithmetic. Indeed, PA1 equally describes structures that strictly contain the sequence of the natural numbers but are not isomorphic to it, and these are known as the non-standard models of arithmetic. It is equally well known that second-order Peano Arithmetic (PA2) in turn, is categorical in that it is satisfied only by the intended model of arithmetic, namely the series of natural numbers, and by models isomorphic to the intended one.” ... Novaes: [Nov19], §1 Introduction.

⁴⁷⁴See also §2.E.b., Corollary 2.18

What is particularly interesting from the *evidence-based* perspective of this investigation is that—reflecting Theorem 19.1, Corollary 19.2 in §19., and Corollary 19.3 in §19.A.⁴⁷⁵—Freire arrives at his conclusion that, contrary to ‘the common intuition, it means that there are fundamental differences between set theories and arithmetic’, *without*, prima facie, making a distinction between ‘for all’ and ‘for any’ as is highlighted in §7.C. (Definition 21 and Definition 23) as necessary for any unequivocal, essentially *evidence-based*, interpretation of the universal quantifier ‘ \forall ’ and its corresponding negation:

“The study of the relationship between ZF and PA models goes back to Ackermann’s demonstration that PA and ZF_{fin} (ZF without the infinity axiom) are mutually interpretable¹ [1]. The representation of numbers by ordinals goes back to the origins of set theory with Cantor. Conversely, the interpretation I_A of membership as an arithmetic relation was proposed by Ackermann. Together, [these] two interpretations long supported the notion that ZF_{fin} is the set theory equivalent of arithmetic. However, Kaye and Wong in [9] have shown that Ackerman’s interpretation is not “invertible”. When we apply I_A and then the ordinal interpretation to ZF_{fin} we get a proper extension of the theory. The composed interpretation, therefore, loses information. On the other hand, Kaye and Wong proved that if we add that ‘all sets are hereditary finite’, then the new set theory ZF_{Hfin} is bi-interpretable² with PA.

We note, however, that ZF_{Hfin} is incompatible with the original ZF system, i.e. we would no longer be talking about a ZF subtheory. I will briefly advocate that the theory ZF_{Hfin} should not count as a weaker version of ZF. Thus, in order to find a weaker version of ZF, we should restrict ourselves to subtheories of ZF. Nonetheless, I will prove that there is no such theory corresponding to PA. Contrarily to the common intuition, it means that there are fundamental differences between set theories and arithmetic.³

Theorem 1. *No subtheory of any extension of ZF is bi-interpretable with any extension of PA.*⁴

¹ A interpretation of T_1 in T_2 is a mapping I of formulas of T_1 in T_2 such that: if $\alpha, \beta \in LT_1$, then (a) $(\neg\alpha)^I = \neg\alpha^I$, (b) $(\alpha \vee \beta)^I = \alpha^I \vee \beta^I$; if $P(x_1, x_2, \dots, x_n)$ is a predicate in T_1 , then (c) $P^I(x_1, x_2, \dots, x_n)$ is a fixed formula of T_2 ; a formula $U(z)$ in T_2 is such that $(\forall x(\alpha))^I = \forall x(U(x) \rightarrow \alpha^I)$. Lastly, I is such that, for every theorem ϕ of T_1 , the formula ϕ^I is a theorem of T_2 [8]. Two theories T_1 and T_2 are mutually interpretable if there is a interpretation of T_1 in T_2 and a interpretation of T_2 in T_1 .

² Theories T_1 and T_2 are bi-interpretable when (i) there is a interpretation I of T_1 in T_2 and a interpretation J of T_2 in T_1 and (ii) applying I followed by J (or J followed by I) in a arbitrary formula α results in a equivalent formula in T_2 (or T_1 in the second case).

³ Each theorem presented in the introduction will be proved in the further sections of the paper.

⁴ This theorem is related to techniques to be further developed in *Bi-interpretation as condition for isomorphism in set theories* (in preparation in joint work with Hamkins) [6]. Important developments with respect to arithmetic and set theory can be found in Enayat’s [3] and Friedman’s & Visser’s [5].
 ... Freire: [Fri19], §1. Introduction.

19.B. Goodstein’s sequence

For any given natural number m we can express Goodstein’s sequence $G(m)$ so that each term is expressed in it’s hereditary representation:

$$G(m) \equiv \{g_1(m)_{[2]}, g_2(m)_{[3]}, g_3(m)_{[4]}, \dots\} \tag{19.1}$$

where the first term $g_1(m)_{[2]}$ denotes the unique hereditary representation of the natural number m in the natural number base [2]:

$$\text{e.g., } g_1(9)_{[2]} \equiv 1.2^{(1.2^{1.2^0} + 1.2^0)} + 0.2^{(1.2^{1.2^0} + 0.2^0)} + 0.2^{1.2^0} + 1.2^0$$

and if $n > 1$ then $g_{(n)}(m)_{[n+1]}$ is defined recursively from $g_{(n-1)}(m)_{[n]}$ as below.

⁴⁷⁵As also the distinction sought to be highlighted in §13.E. *Recognising the strengths and limitations of ZF and PA.*

19.B.a. The recursive definition of Goodstein’s Sequence

For $n > 1$ let the $(n - 1)^{th}$ term $g_{(n-1)}(m)$ of the Goodstein sequence $G(m)$ be expressed syntactically by its hereditary representation as:

$$g_{(n-1)}(m)_{[n]} \equiv \sum_{i=0}^l a_i \cdot n^{i_{[n]}} \tag{19.2}$$

where:

- (a) $0 \leq a_i < n$ over $0 \leq i \leq l$;
- (b) $a_l \neq 0$;
- (c) for each $0 \leq i \leq l$ the exponent i too is expressed syntactically by its hereditary representation $i_{[n]}$ in the base $[n]$; as also are all of its exponents and, in turn, all of their exponents, etc.

We then define the n^{th} term of $G(m)$ as:

$$g_n(m) = \sum_{i=0}^l (a_i \cdot (n + 1)^{i_{[n \leftrightarrow (n+1)]}}) - 1 \tag{19.3}$$

19.B.b. The hereditary representation of $g_n(m)$

Now we note that:

- (a) if $a_0 \neq 0$ then the hereditary representation of $g_n(m)$ is:

$$g_n(m)_{[n+1]} \equiv \sum_{i=1}^l (a_i \cdot (n + 1)^{i_{[n \leftrightarrow (n+1)]}}) + (a_0 - 1) \tag{19.4}$$

- (b) whilst if $a_i = 0$ for all $0 \leq i < k$, then the hereditary representation of $g_n(m)$ is:

$$g_n(m)_{[n+1]} \equiv \sum_{i=k+1}^l (a_i \cdot (n + 1)^{i_{[n \leftrightarrow (n+1)]}}) + c_{k[n+1]} \tag{19.5}$$

where:

$$\begin{aligned} c_k &= a_k \cdot (n + 1)^{k_{[n \leftrightarrow (n+1)]}} - 1 \\ &= (a_k - 1) \cdot (n + 1)^{k_{[n \leftrightarrow (n+1)]}} + \{(n + 1)^{k_{[n \leftrightarrow (n+1)]}} - 1\} \\ &= (a_k - 1) \cdot (n + 1)^{k_{[n \leftrightarrow (n+1)]}} + n \{(n + 1)^{k_{[n \leftrightarrow (n+1)]} - 1} + (n + 1)^{k_{[n \leftrightarrow (n+1)]} - 2} \dots + 1\} \end{aligned}$$

and so its hereditary representation in the base $(n + 1)$ is given by:

$$c_{k[n+1]} \equiv (a_k - 1) \cdot (n + 1)^{k_{1[n+1]}} + n \{(n + 1)^{k_{2[n+1]}} + (n + 1)^{k_{3[n+1]}} \dots + 1\}$$

where $k_{1[n+1]} \equiv k_{[n \leftrightarrow (n+1)]}$ and $k_1 > k_2 > k_3 > \dots \geq 1$.

19.B.c. Goodstein's argument in arithmetic

For $n > 1$ we consider the difference:

$$d_{(n-1)} = \{g_{(n-1)}(m)_{[n]} - g_n(m)_{[n+1]}\}$$

Now:

(a) if $a_0 \neq 0$ we have:

$$d_{(n-1)} = \sum_{i=0}^l (a_i \cdot n^{i_{[n]}}) - \sum_{i=1}^l (a_i \cdot (n+1)^{i_{[n \leftrightarrow (n+1)]}}) - (a_0 - 1) \tag{19.6}$$

(b) whilst if $a_i = 0$ for all $0 \leq i < k$ we have:

$$\begin{aligned} d_{(n-1)} = & \sum_{i=k}^l (a_i \cdot n^{i_{[n]}}) - \sum_{i=(k+1)}^l (a_i \cdot (n+1)^{i_{[n \leftrightarrow (n+1)]}}) - \\ & (a_k - 1) \cdot (n+1)^{k_{1[n+1]}} - \\ & n \{ (n+1)^{k_{2[n+1]}} + (n+1)^{k_{3[n+1]}} \dots + 1 \} \end{aligned} \tag{19.7}$$

Further:

(c) if in equation 19.6 we replace the base $[n]$ by the variable $[z]$ in each term of:

$$\sum_{i=0}^l a_i \cdot n^{i_{[n]}} \tag{19.8}$$

and, similarly, the base $[n+1]$ also by the variable $[z]$ in each term of:

$$\sum_{i=k+1}^l (a_i \cdot (n+1)^{i_{[n \leftrightarrow (n+1)]}}) + (a_0 - 1) \tag{19.9}$$

then we have:

$$\begin{aligned} d'_{(n-1)} &= \sum_{i=0}^l (a_i \cdot z^{i_{[n \leftrightarrow z]}}) - \sum_{i=1}^l (a_i \cdot z^{i_{[n \leftrightarrow z]}}) - (a_0 - 1) \\ &= 1 \end{aligned} \tag{19.10}$$

since $(i_{[n \leftrightarrow (n+1)]})_{[(n+1) \leftrightarrow z]} \equiv i_{[n \leftrightarrow z]}$;

(d) whilst if in equation 19.7 we replace the bases similarly, then we have:

$$\begin{aligned} d'_{(n-1)} &= \sum_{i=k}^l (a_i \cdot z^{i_{[n \leftrightarrow z]}}) - \sum_{i=(k+1)}^l (a_i \cdot z^{i_{[n \leftrightarrow z]}}) - \\ & (a_k - 1) \cdot z^{k_{1[(n+1) \leftrightarrow z]}} - n \{ z^{k_{2[(n+1) \leftrightarrow z]}} + z^{k_{3[(n+1) \leftrightarrow z]}} \dots + 1 \} \\ &= a_k \cdot z^{k_{[n \leftrightarrow z]}} - (a_k - 1) \cdot z^{k_{1[(n+1) \leftrightarrow z]}} - n(z^{k_{2[(n+1) \leftrightarrow z]}} + z^{k_{3[(n+1) \leftrightarrow z]}} \dots + 1) \\ &= z^{k_{1[(n+1) \leftrightarrow z]}} - n(z^{k_{2[(n+1) \leftrightarrow z]}} + z^{k_{3[(n+1) \leftrightarrow z]}} \dots + 1) \end{aligned} \tag{19.11}$$

where $k_{1[(n+1) \leftrightarrow z]} \equiv k_{[n \leftrightarrow z]}$, and $k_{1[(n+1) \leftrightarrow z]} > k_{2[(n+1) \leftrightarrow z]} > k_{3[(n+1) \leftrightarrow z]} > \dots \geq 1$.

We consider now the sequence:

$$G(m)_{[z]} \equiv (g_1(m)_{[2 \leftrightarrow z]}, g_2(m)_{[3 \leftrightarrow z]}, g_3(m)_{[4 \leftrightarrow z]}, \dots)$$

obtained from Goodstein’s sequence by replacing the base $[n + 1]$ in each of the terms $g_n(m)_{[n+1]}$ by the base $[z]$ for all $n \geq 1$.

Clearly if $z > n$ for all non-zero terms of the Goodstein sequence, then $d'_{(n-1)} > 0$ in each of the cases—equation 19.10 and equation 19.11—since we have in equation 19.11:

$$d'_{(n-1)} \geq (z^k - (z - 1)(z^{(k-1)} + z^{(k-2)} + z^{(k-3)} + \dots + 1)) = 1$$

The sequence $G(m)_{[z]}$ is then a descending sequence of natural numbers, and must terminate finitely in \mathbb{N} , if $z > n$.

Since $g_n(m)_{[(n+1) \leftrightarrow z]} \geq g_n(m)_{[n+1]}$ if $z > n$, Goodstein’s sequence $G(m)$ too must terminate finitely in \mathbb{N} if $z > n$.

Obviously, since we can always find a $z > n$ for all non-zero terms of the Goodstein sequence if it terminates finitely in \mathbb{N} , the condition that we can always find some $z > n$ for all non-zero terms of any Goodstein sequence is equivalent to the assumption that any Goodstein sequence terminates finitely in \mathbb{N} .

From an *evidence-based* perspective, Goodstein’s (vacuously true) argument is that, assuming the arithmetic of the finite ordinals is a conservative extension of the arithmetic of the natural numbers, we can always find some $z > n$ —with respect to the natural number relation $>$ —for all non-zero terms of any Goodstein sequence over the natural numbers since, if n_o is the finite ordinal corresponding to the natural number n , then the transfinte ordinal ω is such that $\omega >_o n_o$ with respect to the ordinal relation $>_o$ for all non-zero terms of any Goodstein sequence when expressed similarly over the finite ordinals!

Moreover, the assumption—*invalid* by §19.A., Corollary 19.3⁴⁷⁶—that the arithmetic of the finite ordinals is a conservative extension of the arithmetic of the natural numbers, is implicitly—and *misleadingly*—endorsed in Shawn Hedman’s Oxford Scholarship Online 2020 textbook: *A First Course in Logic: An introduction to model theory, proof theory, computability, and complexity*.

Although Hedman *validly illustrates* that for ‘any Goodstein sequence a_1, a_2, a_3, \dots ’ of natural numbers, ‘the corresponding sequence of ordinals $b_1 > b_2 > b_3 \dots$ is decreasing’ (presumably *within* some *well-defined* set theory), he *invalidly*—in view of §19., Theorem 19.1⁴⁷⁷— **concludes** that, since this latter sequence can be *defined* as ‘finite’ with respect to the corresponding set theory, the sequence a_1, a_2, a_3, \dots too must be evidenced as finite in \mathbb{N} :

“We consider sequences of non-negative integers known as *Goodstein sequences*. Given any natural number n , there is a unique Goodstein sequence that begins with n as its first term. Let us denote this sequence s_n . The bestway to describe these sequences is to provide an example. Suppose $n = 14$. Let a_1, a_2, a_3, \dots denote the terms of the sequence s_{14} . Then $a_1 = 14$

... Goodstein sequences possess the following charming property.

⁴⁷⁶Also by §19.A., Theorem 19.4.

⁴⁷⁷Also by §15.C., Lemma 15.1: The structure of the finite ordinals under any putative *well-defined* interpretation of ZF is not isomorphic to the structure \mathbb{N} of the natural numbers.

Theorem 8.34 (Goodstein) Every Goodstein sequence converges to zero.

Proof Let $s_n = (a_1, a_2, a_3, \dots)$ be an arbitrary Goodstein sequence.

We define a sequence b_1, b_2, b_3, \dots of ordinals as follows. For each $m \in \mathbb{N}$, let b_m be the ordinal obtained by replacing each occurrence of $(m+1)$ with ω in the total base $(m+1)$ representation of a_m . For example, if s_n is s_{14} , then:

$$\begin{aligned} a_1 &= 2^{(2+1)} + 2^2 + 2 & \text{implies } b_1 &= \omega^{(\omega+1)} + \omega^\omega + \omega \\ a_2 &= 3^{(3+1)} + 3^3 + 2 & \text{implies } b_2 &= \omega^{(\omega+1)} + \omega^\omega + 2 \\ a_3 &= 4^{(4+1)} + 4^4 + 1 & \text{implies } b_3 &= \omega^{(\omega+1)} + \omega^\omega + 1 \\ a_4 &= 5^{(5+1)} + 5^5 & \text{implies } b_4 &= \omega^{(\omega+1)} + \omega^\omega. \end{aligned}$$

Note that the sequence of b_i s is decreasing. Continuing, we see that

$$\begin{aligned} b_5 &= 5 \cdot \omega^\omega + 5 \cdot \omega^5 + 5 \cdot \omega^4 + 5 \cdot \omega^3 + 5 \cdot \omega^2 + 5 \cdot \omega + 5 \\ b_6 &= 5 \cdot \omega^\omega + 5 \cdot \omega^5 + 5 \cdot \omega^4 + 5 \cdot \omega^3 + 5 \cdot \omega^2 + 5 \cdot \omega + 4, \text{ and so forth.} \end{aligned}$$

Increasing the base in the sequence of a_i s has no effect on the sequence of b_i s. Because we subtract 1 at each stage, b_{i+1} is necessarily smaller than b_i . This observation proves the theorem.

For any Goodstein sequence a_1, a_2, a_3, \dots , the corresponding sequence of ordinals $b_1 > b_2 > b_3 \dots$ is decreasing. By Exercise 4.22, this latter sequence must be finite. This is easily proved by induction on ordinals. We conclude that the sequence a_1, a_2, a_3, \dots must be finite. This only happens if $a_m = 0$ for some m . \square

...Hedman: [Hd06], §8.6 Goodstein sequences, p.383.

The flaw in Hedman's argument is that since Kirby and Paris have shown in [KP82] that Goodstein's Theorem (*classical*) is unprovable in PA, we cannot assume that the natural number sequence corresponding to a_1, a_2, a_3, \dots must terminate finitely for any *specified* sequence s_n if Goodstein's Theorem over \mathbb{N} is *also* not algorithmically *verifiable* as true.

In other words, even if we assume that the corresponding sequence $a_{1_o}, a_{2_o}, a_{3_o}, \dots$ of finite ordinals is monotonically increasing for some s_n , we can *yet* conclude—seemingly consistently but paradoxically⁴⁷⁸—that the corresponding sequence of transfinite ordinals $b_1 > b_2 > b_3 \dots$ *must* always terminate finitely for some postulated, but essentially unspecifiable, natural number m_n !

'Essentially unspecifiable', since Kirby and Paris have shown that the existence of such an m_n is not provable in PA; whence m_n cannot—even in principle—be algorithmically computed for each sequence s_n by virtue of the Provability Theorem for PA, Theorem 2.17.

⁴⁷⁸If we ignore §19.A., Corollary 19.3 and that, in a relatively recent preprint [Fri19], Alfredo Roque Freire argues set-theoretically (see §19.A., Comment 158) that 'there are fundamental differences between set theories and arithmetic'.

CHAPTER 19. PARADIGM CHALLENGING CONSEQUENCES

20. The significance of *evidence-based* reasoning for the philosophy of science

We briefly consider, from an *evidence-based* perspective, the significance for the physical sciences of the semantic and logical paradoxes⁴⁷⁹ which involve—either implicitly or explicitly—quantification over an infinitude.

Where such quantification is not, or cannot be, explicitly defined in formal logical terms—e.g., the classical expression of the Liar paradox as ‘This sentence is a lie’⁴⁸⁰—the paradoxes per se cannot be considered as posing serious linguistic or philosophical concerns from an *evidence-based* perspective of constructive mathematics.

Comment 159. Despite arguments in, essentially, inherited paradigms that seek ‘a strong connection between the argument of the existence of an undecidable sentence and the paradoxes’ as in Virgil Drăghici’s [Drg23] (see also [Drg18]):

“The fact that there is a strong connection between the argument of the existence of an undecidable sentence and the paradoxes was written down by Gödel himself, in the following terms: “The analogy of this argument with the Richard [antimony] leaps to the eye. It is closely related to the “Liar” too”; [Footnote] “Any epistemological [antimony] could be used for a similar proof of the existence of undecidable propositions.”⁸⁶

Let us develop this idea of the relation between Gödel’s results and the paradoxes.”

... Drăghici: [Drg23], §4.2.3 Gödel’s Theorem (via Paradoxes), p.215.

The practical significance of the semantic and logical paradoxes is, of course, that they illustrate the absurd extent to which languages of common discourse need to tolerate ambiguity; both for ease of expression and for practical—even if not theoretically unambiguous and effective—communication in non-critical cases amongst intelligences capable of a *lingua franca*⁴⁸¹.

⁴⁷⁹Although commonly referred to as the paradoxes of ‘self-reference’ (see [Kau87] for an unusual perspective on such ‘self-reference’), not all of them involve self-reference (e.g., the paradox constructed by Stephen Yablo [Ya93]. However, see [Gr121], *Introduction*, which seeks to admit a contrary perspective: “In this text I propose to demonstrate that the so-called “Yablo Paradox” does resort to circularity (and it is even possible that it resorts to self-reference)”).

⁴⁸⁰Or Lundgren’s ‘information liar paradox’: “This is not semantic information”, in [Lun17], §3, p.5.

⁴⁸¹The need for distinguishing between the roles that ‘natural’ languages play vis à vis the, essentially symbolic, ‘mathematical’ languages is also sought to be addressed by Philosopher Danielle Macbeth in [Mcb14]; where she remarks that ‘*If we are to understand the practice of mathematics as it contrasts with our everyday cognitive involvements in the world we need to understand much better than we currently do both the essential similarities and the profound differences between natural language, on the one hand, and the languages of mathematics, on the other*’:

“It has been assumed in particular that the symbolic languages of mathematics differ from natural languages only in their degree of rigor, clarity, and perspicuity, that a sentence of natural language can be translated without losing anything essential into a symbolic language of the appropriate sort.⁷ In fact, there are significant differences between the two sorts of languages, and these differences matter to how we should understand them. First, whereas natural language is first and foremost a spoken (or signed) language and a medium of communication, the symbolic languages of mathematics—for instance, the language of arithmetic and algebra, and Frege’s concept-script—are instead essentially written and serve primarily as a vehicle of reasoning. Spoken natural language is

Such absurdity is highlighted by the universal appreciation of Charles Dickens' Mr. Bumble's retort that 'The law is an ass'; a quote oft used to refer to the absurdities which sometimes surface⁴⁸² in cases when judicial pronouncements attempt to resolve an ambiguity by subjective fiat that appeals to the powers—and duties—bestowed upon the judicial authority for the practical resolution of precisely such an ambiguity, even when the ambiguity may be theoretically irresolvable!

In a thought-provoking Opinion piece, 'Desperately Seeking Mathematical Truth', in the August 2008 Notices of the American Mathematical Society, Melvyn B. Nathanson seeks to highlight the significance for the mathematical sciences when similar authority is vested by society—albeit tacitly—upon academic 'bosses' (a reference, presumably, to the collective of reputed—and respected—experts in any field of human endeavour):

"... many great and important theorems don't actually have proofs. They have sketches of proofs, outlines of arguments, hints and intuitions that were obvious to the author (at least, at the time of writing) and that, hopefully, are understood and believed by some part of the mathematical community.

But the community itself is tiny. In most fields of mathematics there are few experts. Indeed, there are very few active research mathematicians in the world, and many important problems, so the ratio of the number of mathematicians to the number of problems is small. In every field, there are "bosses" who proclaim the correctness or incorrectness of a new result, and its importance or unimportance.

Sometimes they disagree, like gang leaders fighting over turf. In any case, there is a web of semi-proved theorems throughout mathematics. Our knowledge of the truth of a theorem depends on the correctness of its proof and on the correctness of all of the theorems used in its proof. It is a shaky foundation."

... Nathanson: [Na08].

Nathanson's comments are intriguing, because addressing such ambiguity in critical cases—such as communication between mechanical artefacts, or a putative communication between terrestrial and extra-terrestrial intelligences—is the very *raison d'être* of mathematical activity!

Of course, it *would* be a matter of serious concern if the word 'This' in the English language sentence, 'This sentence is a lie', could be validly viewed as implicitly implying that:

- (a) there is a *well-defined* infinite enumeration of English language sentences;
 - (b) to each of which a truth-value can be assigned *finitarily* by the rules of a two-valued logic;
- and,

fully intelligible independent of written language; symbolic languages are not. Natural languages, at least those that are (as we say) living rather than dead, also evolve with use; they are constitutively social and historical. Symbolic languages by contrast are self-consciously created, often by a single individual, and they have no inherent tendency to change with use. Finally, as Wittgenstein reminds us in the *Philosophical Investigations*, natural language is enormously versatile. We do all sorts of things in and with natural language. As Frege reminds us in his little monograph *Begriffsschrift*, symbolic languages are instead special purpose instruments designed for particular purposes and useless for others. If we are to understand the practice of mathematics as it contrasts with our everyday cognitive involvements in the world we need to understand much better than we currently do both the essential similarities and the profound differences between natural language, on the one hand, and the languages of mathematics, on the other."

... Macbeth: [Mcb14], Introduction, p. 9.

⁴⁸²See www.shazbot.com/lawass/.

(c) in which ‘This’ refers uniquely to a particular sentence in the enumeration.

In 1931, Kurt Gödel used the above perspective in his seminal paper on ‘formally undecidable’ arithmetical propositions:

- (i) to show how the infinitude of formulas, in a formally defined Peano Arithmetic P ([Go31], pp.9-13), could be *finitarily* enumerated and referenced uniquely by natural numbers ([Go31], p.13-14);
- (ii) to show how P -provability values could be *finitarily* assigned to P -formulas by the rules of a two-valued logic ([Go31], p.13); and,
- (iii) to *finitarily* construct a P -formula which interprets as an arithmetical proposition that could, debatably (see §15.E.), be viewed—under any *well-defined*⁴⁸³ interpretation of the Peano Arithmetic P —as expressing the sentence, ‘This P -sentence is P -unprovable’ ([Go31], p.37, footnote 67), *without* inviting a ‘Liar’ type of contradiction.

We note that where the quantification can be made explicit—e.g., Russell’s paradox or Yablo’s paradox—the significance of the question whether such quantification is *well-defined* or not is immediately obvious.

Russell’s paradox: Define the set S by $\{All\ x : x \in S\ \text{iff}\ x \notin x\}$; then $S \in S$ iff $S \notin S$.

Yablo’s paradox: Defining the sentence S_i for all $i \geq 0$ as ‘For all $j > i$, S_j is not true’ seems to lead to a contradiction ([Ya93]).

For instance, in Russell’s case it could be cogently argued from an *evidence-based* perspective that the contradiction itself establishes that S cannot be *well-defined* over the range of the quantifier.

In Yablo’s case it could, as cogently, be argued that truth values cannot be *finitarily* assigned to any sentence covered by the quantification since, in order to decide whether or not S_i can be assigned the value ‘true’ for any specified $i \geq 0$, we first need to decide whether or not S_{i+1} has already been assigned the value ‘true’!

Comment 160. In other words, an *evidence-based* assignment of ‘truth’-values-by-convention⁴⁸⁴ to the propositions of a symbolic language⁴⁸⁵, and an *evidence-based* interpretation of quantification such as detailed in §7.C. (*Evidence-based quantification*) can, debatably, be viewed as adequate to address—if not also resolve—the broader issues raised by Michał Tomasz Godziszewski and Rafał Urbaniak in [GoU19]:

“What is somewhat less known, is that there is a way of handling the paradox which relies on finitistic assumptions. After all, if the world is finite, there aren’t enough things in the world to interpret all sentences from the Yablo sequence, and the last interpreted one is vacuously true without any threat of paradox.

The finitist owes us a story about how they make sense of arithmetic, and how the whole thing should be studied by formal methods. Formal tools for this task have

⁴⁸³In the sense of §7.F., *Well-definedness*.

⁴⁸⁴See §1., *The Complementarity Thesis*.

⁴⁸⁵Whether a mathematical language such as the Peano Arithmetic PA, or a language of common discourse such as English (see also §14., *Conflating ‘Proof’ with ‘Truth’ and ‘For any’ with ‘For all’*).

already been developed [4–6]. In what follows we’ll explain what it is, and we’ll use it to study the Yablo paradox in the finitistic setting. On this approach, it will turn out that things are as we expected: Yablo sentences are all false in potentially infinite domains, despite the fact that the framework is rich enough to incorporate sufficiently strong arithmetic.

There is, however, a glitch. We’ll argue that the way quantifiers are handled in this finitistic setting results in a somewhat scary arithmetical theory.

If your goal, as a finitist, is not to revise current mathematics, but to make sense of it in terms of potential infinity, this approach isn’t for you.

There is another formal approach to potential infinity developed in [9], which has already been used to obtain standard arithmetic, and to make sense of abstraction principles (in the neologist sense). In the third part of this paper we study how this framework handles Yablo’s paradox. It turns out that the price of making potential infinity digestible to classical mathematicians is that the Yablo paradox strikes back, even with more power than in the standard arithmetical setting."

... Godziszewski and Urbaniak: [GoU19], §1, Introduction, p.19.

‘Broader issues’ raised by Godziszewski and Urbaniak in [GoU19] that, from the narrower mathematical, *evidence-based*, focus of this investigation, we articulate as below but, in order to do them deserved justice, leave for further philosophical consideration elsewhere; such as:

- (a) Is there an intuitively unobjectionable way of handling the Yablo paradox which relies on finitistic (read *evidence-based*) assumptions?
- (b) Is it *necessary* to interpret all sentences from the Yablo sequence, such that the last interpreted one is vacuously true without any threat of paradox?
- (c) Is there a ‘finitist’ (read *evidence-based*) story that make sense of arithmetic, and how the whole thing should be studied by formal methods?
- (d) Are Yablo sentences necessarily all false in potentially infinite domains, where ‘the framework is rich enough to incorporate sufficiently strong arithmetic’?
- (e) Does the way quantifiers are handled in a finitistic setting—such as detailed in §7.C., (*Evidence-based quantification*)—qualify as resulting in a ‘somewhat scary arithmetical theory’, or as merely involving a paradigm shift in the way we intuitively interpret, and distinguish between, ‘For any’ and ‘For all’⁴⁸⁶?
- (f) Does making sense of a ‘potential infinity’ necessarily entail revising current mathematics?
- (g) Can it be legitimately claimed, that the price of ‘making potential infinity digestible to classical mathematicians’ in *evidence-based* quantification, is ‘that the Yablo paradox strikes back, even with more power than in the standard arithmetical setting’?

20.A. Is quantification currently interpreted constructively?

There are two issues involved here—not necessarily independent—highlighted by Timothy Gowers as follows:

“If you ask a philosopher what the main problems are in the philosophy of mathematics, then the following two are likely to come up: what is the status of mathematical truth, and what is the nature of mathematical objects? That is, what gives mathematical statements their aura of infallibility, and what on earth are these statements about?”

... Gowers: [Gow02].

⁴⁸⁶See also §14.B., *Conflating ‘For any’ with ‘For all’*.

The first issue is whether the currently accepted interpretations of formal quantification—essentially as defined by Hilbert ([Hi27]; see also §10.A.) in his formalisation of Aristotle’s logic of predicates in terms of his ε -function—can be treated as *well-defined* over an infinite domain.

Now, Brouwer ([Br08]) had emphatically—and justifiably so far as number theory was concerned (see §10.B.)—objected to such subjectivity, and asserted that Hilbert’s interpretations of formal quantification were non-constructive (hence not *well-defined* by §7.F., Definition 26).

Although Hilbert’s formalisation of the quantifiers (an integral part of his formalisation of Aristotle’s logic of predicates) appeared adequate, Brouwer rejected Hilbert’s interpretations of them on the grounds that the interpretations were open to ambiguity, and could not, therefore, be accepted as admitting categorical communication.

However, Brouwer’s rejection of the Law of the Excluded Middle LEM as a resolution of the objection was seen—also justifiably (see §11.B.a.)—as unconvincingly rejecting a comfortable interpretation that—despite its Platonic overtones—appeared intuitively plausible to the larger body of academics that was increasingly attracted to, and influenced by, the remarkably expressive powers provided by Cantor-inspired set theories, such as ZF, for expressing our conceptual mathematical metaphors unambiguously (the significance of which is highlighted in §13.E.).

Since Hilbert’s and Brouwer’s seminal works preceded that of Alan Turing, neither was able to offer his critics an alternative—and intuitively convincing—constructive definition of quantification based on the view—gaining currency today—that a simple functional language can be used for specifying *evidence* for propositions in a constructive logic (see [Mu91]).

Moreover, since Brouwer’s objections did not gain much currency amongst mainstream logicians, they were unable to influence Turing who, it is our contention, could perhaps have provided the necessary *well-defined* interpretations (introduced in [An12]) sought by Hilbert for number theory, had Turing not been influenced by Gödel’s powerful presentation—and Gödel’s persuasive Platonic, albeit (*contrary to accepted dogma*) logically rooted⁴⁸⁷, interpretation of his own formal reasoning in [Go31].

Thus, in his 1939 paper ([Tu39]) on ordinal-based logics, Turing applied his computational method—which he had developed in his 1936 paper ([Tu36])—in seeking partial completeness in interpretations of Cantor’s ordinal arithmetic (as defined in a set theory such as ZF)—rather than in seeking a categorical interpretation of PA. Turing perhaps viewed his 1936 paper as complementing and extending Gödel’s and Cantor’s reasoning:

“The well-known theorem of Gödel shows that every system of logic is in a certain sense incomplete, but at the same time it indicates means whereby from a system L of logic a more complete system L' may be obtained. By repeating the process we get a sequence of $L, L_1 = L', L_2 = L'_1, \dots$ each more complete than the preceding. ...

Proceeding in this way we can associate a system of logic with any constructive ordinal. It may be asked whether a sequence of logics of this kind is complete in the sense that to any problem A there corresponds an ordinal α such that A is solvable by means of the logic L_α . I propose to

⁴⁸⁷Although meriting a more complete discussion than is appropriate to the intent of this paper, it is worth noting that the rooting of Gödel’s Platonism can be cogently argued as lying—contrary to generally held opinions—purely in a logical, rather than philosophical, presumption: more specifically in Gödel’s belief that Peano Arithmetic is ω -consistent ([Go31], p.28). The belief seems unwittingly shared universally even by those who (cf. [Pas95], [Fe02]) accept Gödel’s formal arguments in [Go31] but claim to reject Gödel’s ‘Platonic’ interpretations of them.

investigate this question in a more general case, and to give some other examples of ways in which systems of logic may be associated with constructive ordinals."

... Turing: [Tu39], pp.155-156.

Perhaps Turing also did not see any cogent reason then to question the validity of Gödel's belief that systems of Arithmetic such as PA are ω -consistent (as hinted at in [Go31], p.28) and, consequently, Gödel's interpretation of his argument in [Go31] as having meta-mathematically *proven* that systems of Arithmetic such as PA are essentially incomplete!

Turing thus overlooked the fact that his 1936 paper ([Tu36]) conflicted with Gödel's and Cantor's interpretations of their own, formal, reasoning; and that [Tu36] admits a definition of satisfaction that yields the finitary interpretation $\mathcal{I}_{PA(\mathbb{N}, SC)}$ of PA (see §2.C.a., Theorem 2.16).

As a result, classical paradigms continued to essentially follow Hilbert's Platonically-influenced (hence, subjective) definitions and interpretations of the quantifiers (based on accepting Aristotle's particularisation as valid) when defining them under the standard interpretation $\mathcal{I}_{PA(\mathbb{N}, SV)}$ of PA.

Now, the latter definitions and interpretations (e.g., [Me64], pp.49-53) are, in turn, founded upon Tarski's analysis of the inductive definability of the truth of compound expressions of a symbolic language under an interpretation in terms of the satisfaction of the atomic expressions of the language under the interpretation ([Ta35]).

Tarski defines there the formal sentence P as True if and only if p —where p is the proposition expressed by P . In other words, the sentence 'Snow is white' is True if, and only if, it is *subjectively* true in all cases; and it is *subjectively* true in a particular case if, and only if, it expresses the *subjectively verifiable* fact that snow *is* white in that particular case. Thus, for Tarski the commonality of the satisfaction of the atomic formulas of a language under an interpretation is axiomatic (cf. [Me64], p.51(i)).

In this investigation we have highlighted the limitations of such subjectivity (see §7.C.) and, in the case of the 'standard' interpretation $\mathcal{I}_{PA(\mathbb{N}, SV)}$ of the Peano Arithmetic PA, seen how to avoid violation of such constraints (see §2.B.) by requiring that the axioms of PA, and its rules of inference, be interpretable as algorithmically *verifiable* propositions.

20.B. When is the concept of a completed infinity consistent?

The second issue is when, and whether, the concept of a completed infinity is consistent with the interpretation of a formal language.

Clearly, the consistency of the concept would follow immediately in any putative, *well-defined*, interpretation of the axioms (and rules of inference) of a set theory such as the Zermelo-Fraenkel (see [BF58]) first-order theory ZF (whether such an interpretation exists at all is, of course, another question).

In view of the perceived power of ZFC as an unsurpassed language of rich and adequate expression of mathematically expressible abstract concepts precisely, it is not surprising that many of the semantic and logical paradoxes depend on the implicit assumption that the domain over which the paradox quantifies can always be treated as a *well-defined* mathematical object that can be formalised in ZFC, even if this domain is not explicitly defined set-theoretically.

This assumption is rooted in the questionable⁴⁸⁸ belief, expressed unapologetically (see §11.E.) by set-theorist Saharon Shelah (see also [Ma18] and [Ma18a]), that ZF can essentially express all mathematical ‘truths’:

“My feeling is that ZFC exhausts our intuition except for things like consistency statements, so a proof means a proof in ZFC.”

... Shelah: [She91], p.3

A similar thesis is, curiously, reflected as ‘fact’ in John R. Steel’s *Mathematics Needs New Axioms*:

“It is a familiar but remarkable fact that all mathematical languages can be translated into the language of set theory, and all theorems of ‘ordinary’ mathematics can be proved in ZFC.”

... Steel: [FFMS], p.423.

The belief that the set theory ZF is a lingua franca of *verifiable* mathematics—despite the essential non-verifiability of the axiom of infinity in any *evidence-based* interpretation of the theory⁴⁸⁹—is reflected in recent arguments by Sieg and Walsh on the *verifiability* of formalizations of the Cantor-Bernstein Theorem in ZF, via the *proof assistant* AProS which ‘allows the direct construction of formal proofs’—containing quantifiers—‘that are humanly intelligible’:

“The objects of proof theory are proofs, of course. This assertion is however deeply ambiguous. Are proofs to be viewed as formal derivations in particular calculi? Or are they to be viewed as the informal arguments given in mathematics?—The contemporary practice of proof theory suggests the first perspective, whereas the programmatic ambitions of the subject’s pioneers suggest the second. We will later mention remarks by Hilbert (in sections 5 and 7) that clearly point in that direction. Now we refer to Gentzen who inspired modern proof theoretic work; his investigations and insights concern *prima facie* only formal proofs. However, the detailed discussion of the proof of the infinity of primes in his [Gentzen, 1936, pp. 506-511] makes clear that he is very deeply concerned with *formalizing* mathematical practice. The crucial problem is finding the atomic inference steps involved in informal arguments. The inference steps Gentzen brings to light are, perhaps not surprisingly, the introduction and elimination rules for logical connectives, including quantifiers.

Gentzen specifies in [Gentzen, 1936, p. 513] the concept of a *deduction* and adds in parentheses *formal image of a proof*; i.e., deductions are viewed as formal images of mathematical proofs and are obtained by formalizing the latter. The process of formalization is explained as follows: “The words of ordinary language are replaced by particular *signs*, the logical inference steps [are replaced by] rules that form new formally presented statements from already proved ones.” Only in this way, he claims, is it possible to obtain a “rigorous treatment of proofs”. However, and that is strongly emphasized, “The objects of proof theory shall be the *proofs* carried out in mathematics proper.” [Gentzen, 1936, p. 499] For us, the formalization of proofs is the quasi-empirical starting point for uncovering *proof methods in mathematics*; formal rigor is not to be considered a foe of simplicity or understanding.

When extending the effort from logical to mathematical reasoning one is led to the task of devising additional tools for the *natural formalization of proofs*. Such tools should serve to directly reflect standard mathematical practice and preserve two central aspects of that practice, namely, (1) the axiomatic and conceptual organization in support of proofs and (2) the inferential mechanisms

⁴⁸⁸Questionable’ since we see how—in the case of Goodstein’s Theorem—such a belief leads to a curious conclusion (see §19., Theorem 19.1).

⁴⁸⁹An intriguing, but debatable, unconscionable origin of such belief is tacit in Lakoff and Núñez’s arguments in [LR00] (see also §27.), where they view set theory as the language of the conceptual metaphors by which, they claim, the embodied brain brings mathematics into being.

for logically structuring them. Thus, the natural formalization in a deductive framework *verifies* theorems relative to that very framework, but it also deepens our understanding and isolates core ideas; the latter lend themselves often, certainly in our case, to a diagrammatic depiction of a proof's conceptual structure. . . .

We chose as the deductive framework Zermelo-Fraenkel set theory ZF. One can clearly choose different ones, for example, Higher Order Logic, Martin L of's Type Theory or Feferman's Explicit Mathematics. The language of set theory is, however, the *lingua franca* of contemporary mathematics and ZF its foundation. So it seems both important and expedient to use ZF for the project of formalizing proofs naturally."

. . . Sieg and Walsh: [SW17].

The reason such a belief—clearly ambiguous in the absence of explicit, *evidence-based*, definitions of *weak* and *strong* quantification (as defined *finitarily* in §7.C.) that must necessarily precede any formal definition of mathematical truth (see §10.C. and §10.F.)—does not seem unreasonable is that it reflects conventional wisdom (see also §2.E.) which—for over a generation—has been explicitly echoed in standard texts and literature with increasing certitude:

- "It is not at all obvious at first glance that every mathematical discipline can be reduced to a formalized theory of the standard type. The crucial point here consists in carrying out such a reduction for the general theory of sets, since as we know from the work of Frege and his followers, and in particular from Whitehead and Russell's *Principia Mathematica*, the whole of mathematics can be formalized within set theory." . . . "

. . . Tarski: ([Ta39], p.164)

- "... NBG apparently can serve as a foundation for all present-day mathematics (i.e., it is clear to every mathematician that every mathematical theorem can be translated and proved within NBG, or within extensions of NBG obtained by adding various extra axioms such as the Axiom of Choice) . . . "

. . . Mendelson: ([Mc64], p.193)

- "Today set theory plays a role similar to that played by Euclidean geometry for over over 15 centuries (up to the time of the construction of mathematical analysis by Newton and Leibniz). Namely, it is a universal axiomatic theory for modern mathematics. . . .

We conjecture that set theory will remain the most useful and inspiring universal theory on which all of mathematics can be based."

. . . Marek and Mycielski: ([MM01], p.459 & p.467 respectively)

- "Such is the case, for instance, with the formal systems considered in works on set theory, such as the one known as ZFC, which are adequate for formalizing essentially all accepted mathematical proofs."

. . . Boolos, Burgess, and Jeffrey: ([BBJ03], p.225)

- "The system of set theory introduced by Zermelo in [Zermelo, 1908] was intended to show, 'how the entire theory created by Cantor and Dedekind can be reduced to a few definitions and seven principles, or axioms, which appear to be mutually independent.' In the last section we described an expanded frame for our formalization project: a definitional extension of ZF together with a flexible rule-based inferential mechanism. The latter includes not only I- and E- rules for the logical connectives, but also for defined notions. This mechanism is absolutely critical, if one wants to reflect mathematical practice and exploit the conceptual, hierarchical organization of parts of mathematics that are represented in set theory. . . . We consider the basic frame for our project we just described as level 0 of the hierarchy. This conservative extension of ZF can be further expanded to level 1, where relations and functions are introduced as set theoretic objects. That is in full harmony with Zermelo's view of set theory as 'that branch of mathematics whose task is to investigate mathematically the fundamental notions 'number', 'order', and 'function', taking them in their pristine, simple form, and to develop thereby the logical foundations of all of arithmetic and analysis; thus it constitutes an indispensable component of the science of mathematics.' [Zermelo, 1908, p. 261]

A little more than ten years later, Hilbert discussed in 1920 Zermelo's axiom system and claims that it is the 'most comprehensive mathematical system'. He supports that claim by a penetrating observation:

The theory which results from the development of the consequences of this axiom system [Zermelo's] encompasses all mathematical theories (like number theory, analysis, geometry), in the sense that the relations which obtain between the objects of these mathematical disciplines are represented in a perfectly corresponding way by relations which obtain within a subdomain of Zermelo's set theory. [Hilbert, 2013, p. 292]"

... *Sieg and Walsh: [SW17].*

It is a belief that, curiously, is tacitly shared by computer scientists, such as Sanjeev Arora and Boaz Barak, whose discipline epitomises constructive mathematical practices:

"Mathematics can be axiomatized using for example the Zermelo Frankel system, which has a finite description."

... *Arora and Barak: ([Ar09], pp.2.24(60), Ex.6, Ch.2.)*

who apparently conflate the recursive definability of a first-order language with the recursive definability of any *putative* interpretation of the language.

From this it is but a short step to non-constructive perspectives—such as Gödel's Platonic, and equally unjustified (as analysed in §15.), interpretation of his own formal reasoning in his 1931 paper ([Go31])—which unjustifiably conclude (see §18.) that PA must have non-standard models.

However, it is our contention that both of the above foundational issues need to be reviewed carefully, and that we need to recognize explicitly (see §13.E.) the limitations on the ability of a highly expressive mathematical language such as ZF to communicate effectively; and the limitations on the ability of a categorical mathematical language such as PA to adequately express abstract concepts—such as those involving Cantor's first limit ordinal ω (see §18.A.a.).

Prima facie, the semantic and logical paradoxes—as also the seeming paradoxes associated with 'fractal' constructions such as the Cantor ternary set, and the constructions described below—seem to arise out of a blurring of this distinction, and an attempt to ask of a language more than it is designed to deliver.

20.C. Mythical 'set-theoretical' limits of fractal constructions

For instance, consider the claim (e.g., [Bar88], p.37, Theorem 1) that fractal 'constructions'—such as the Cantor ternary set, which is defined classically as a 'putative' set-theoretical limit (see [Ru53], p34; [Bar88], pp.44-45) of an iterative process in the 'putative' completion of a metric space—yield valid mathematical objects (sets) in the 'limit' (*presumably in some Platonic mathematical model*).

Now, the Cantor Set T_∞ is defined as the putative 'fractal' limit of the set of points obtained by taking the closed interval $T_0 = [0, 1]$, and:

- (a) removing the open middle third to yield the set $T_1 = \{[0, \frac{1}{3}] \cup [\frac{2}{3}, 1]\}$,
- (b) then removing the middle third of each of the remaining closed intervals to yield the set $T_2 = [0, \frac{1}{9}] \cup [\frac{2}{9}, \frac{1}{3}] \cup [\frac{2}{3}, \frac{7}{9}] \cup [\frac{8}{9}, 1]$,
- (c) repeating the process ad infinitum.

To see why such a limit needs to be treated as ‘putative’ from an *evidence-based* perspective⁴⁹⁰, consider an equilateral triangle BAC of height h and side s (see Figs.1-3):

- (i) Divide the base BC in half and construct two isosceles triangles of height $h.d$ and base $s/2$ on BC , where $1 \geq d > 0$.
- (ii) Iterate the construction on each constructed triangle ad infinitum.
- (iii) Thus, the height of each of the 2^n triangles on the base BC at the n 'th construction is $h.d^n$, and the base of each triangle $s/2^n$.
- (iv) Hence, the total area of all these triangles subtended by the base BC is $s.h.d^n/2$.
- (v) Now, if $d = 1$, the total area of all the constructed triangles after each iteration remains constant at $s.h/2$, although the total length of all the sides opposing the base BC increases monotonically.
- (vi) However, if $1 > d > 0$ (see Fig.1-Fig.3), it would appear that, geometrically, the base BC of the original equilateral triangle will always be the ‘limiting’ configuration of the sides opposing the base BC .

This is indeed so if $0 < d < 1/2$ (Fig.1), since the total length of all the sides opposing the base BC at the n 'th iteration—say l_n —yields a Cauchy sequence whose limiting value is, indeed, the length s of the base BC .

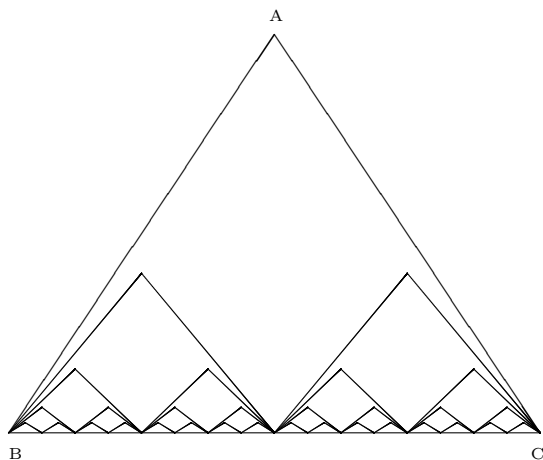

However, if $d = 1/2$ (Fig.2), the total length of all the sides opposing their base on BC is always $2s$; which, by definition, also yields a Cauchy sequence whose limiting value is $2s$.

⁴⁹⁰Compare with Lakoff and Núñez’s analysis of a similar ‘length paradox’ in [LR00], p.325-333.

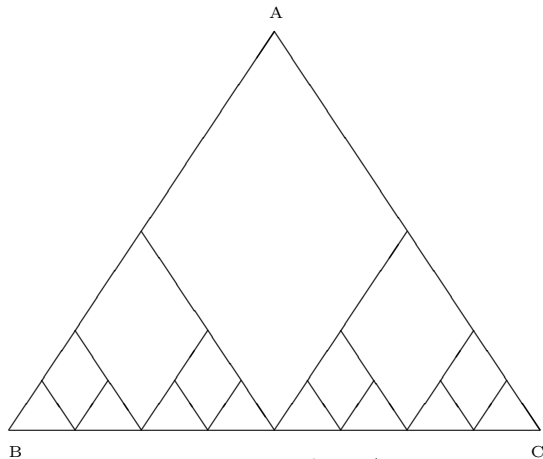

Fig.2: $l_n = 2s$ if $d = 1/2$

Finally, if $1 > d > 1/2$ (Fig. 3), the total length of all the sides opposing their base on BC is a monotonically increasing value.

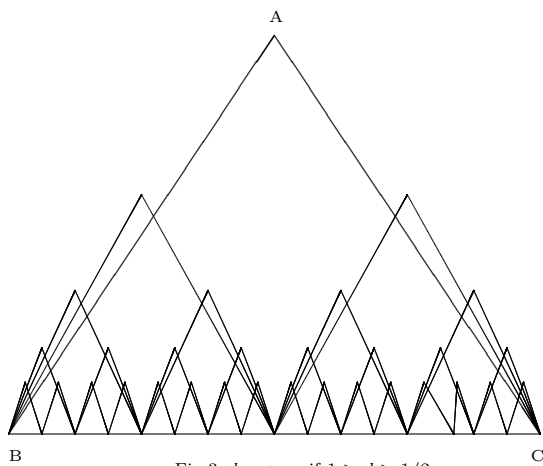

Fig.3: $l_n \rightarrow \infty$ if $1 > d > 1/2$

Consider now:

20.C.a. Case 1: Interpretation as a virus cluster

Let the area BAC denote the population size of a virus cluster, where each virus cell has a ‘virulence’ measure h/s .

Let each triangle at the n ’th iteration denote a virus cluster—with a virulence factor $h.d^n/(s/2^n)$ —that reacts to the next generation anti-virus by splitting into two smaller clusters with inherited virulence $h.d^{n+1}/(s/2^{n+1})$.

We then have that:

- (a) If $d < 1/2$, the effects of the virus can—in a sense—be contained and eventually ‘eliminated’, since both the total population of the virus, and its virulence in each cluster, decrease monotonically;
- (b) If $d = 1/2$, the effects of the virus can be ‘contained’, but never ‘eliminated’ since, even though the total population of the virus decreases monotonically, its virulence in each cluster remains constant, albeit at a containable level, until the virus suffers a sudden, dinosaur-type, extinction at the ‘limiting’ point as $n \rightarrow \infty$;
- (c) However, if $d > 1/2$, the effects of the virus can neither be ‘contained’ nor ‘eliminated’ since, even though the total population of the virus decreases monotonically, its virulence

in each cluster resists containment by increasing monotonically until, again, the virus suffers a sudden, dinosaur-type, extinction at the ‘limiting’ point as $n \rightarrow \infty$.

20.C.b. Case 2: Interpretation as an elastic string

Let the base BC denote an elastic string, stretched iteratively into the above configurations. We then have that:

- (a) If $d < 1/2$, the elastic will, in principle, eventually return to its original state;
- (b) If $d > 1/2$, then the elastic must break at some point, into two pieces of elastic that is apparently ‘normal’, and invites no untoward curiosity, since it forms part of our everyday experience;
- (c) However, what if $d = 1/2$? If such an experiment could be done in a lab feasibly then, at some point, the molecular structure of the elastic must break down and, as in the case of the splitting of an atom, the molecules of the elastic would transform into some other substance that *cannot* be taken to correspond to the putative limit of its associated Cauchy sequence.

In other words, we are confronted with a two-dimensional version of Zeno’s *paradoxical* arguments ([Rus37], pp.347-353), one way of resolving which is by admitting the possibility that such an elastic ‘length’ undergoes a ‘steam-to-water-like’ phase change in the ‘limit’ that need not correspond (see §7.I.a.) to the putative limit of its associated Cauchy sequence; where we note that, by definition, the sequence $\{a_0, a_1, a_2, \dots\}$ where $a_0 = 1$ and $a_i = 3$ for all $i \geq 1$, is a Cauchy sequence whose mathematical limit is 3!

Comment 161. The *paradoxical* nature of §20.C.b., Case 2, lies in the observation that, in Zeno’s case, it could be argued that in a purely Platonic world of ideas, Zeno’s mythical arrow could never hit its mythical target; but by admitting a mythical Cauchy limit for the sequence of points traversed by the arrow’s head, the Platonic world could be made to mirror an actualised reality. The same argument in this case, however, would imply that although the iterations of the opposing sides of a mythical triangulated rubber band BAC could never coincide with the base BC in a Platonic world, by similarly admitting a Cauchy limit for the sequence of the lengths of the iterations of BAC, the Platonic world would mirror an actualised reality, and entail that $3=2!$

20.C.c. Case 3: Interpretation as a quantum chimera

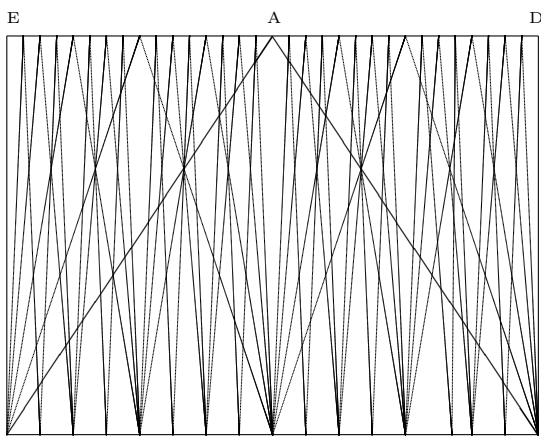

Fig.4: If $d = 1$ then as $l_n \rightarrow \infty$ the area $s.h/2 \rightarrow$ area $s.h$

To see the extent of divergence between postulated set-theoretical, and perceived geometrical, limits of fractal constructions, we consider the square $BCDE$, and the set-theoretically ‘space-filling’ (compare [Bar88], pp.240-247) curves defined by the re-iterative splitting of the triangle ABC if $d = 1$ ((see §20.C.(v) and Fig.4).

Now although, after each iteration, the total area of all the upright triangles on the base BC , and of all the inverted triangles on the base DE , remains constant at $s.h/2$ in each case, geometrically the ‘limiting’ configuration of the disjoint areas ‘subtended’ by the ‘space-filling curve’ on each of the bases BC and DE , respectively, will still be $s.h/2$, the area ‘occupied’ by the ‘space-filling curve’ on each of the bases BC and DE , respectively, will be the area $s.h$.

In other words since, from an *evidence-based* perspective:

- any *well-defined* point (in the sense of §7.F., Definition 25) of $BCDE$ must fall into some iterated triangle by §16.B., Theorem 16.3;
- and the base $h/(2^n)$ of each triangle at the n^{th} iteration $\rightarrow 0$ as $n \rightarrow \infty$;
- the putative ‘space-filling’ limit of the defined geometric construction consists of two ‘self-adjointing’ (i.e., self-contacting without self-crossing) curves which abut, but do not cross, each other at any point; and each of which (by definition in the technical sense) intersects itself everywhere and ‘clearly’ covers the square $ABCD$. Hence each is surjective onto $BCDE$.

We note, moreover, that admitting $BCDE$ as the putative, ‘space-filling’, fractal limit of the geometric construction in Fig.4 would entail, paradoxically⁴⁹¹, that the points of $BCDE$ can be well-ordered!

From an *evidence-based* perspective, we thus have a fractal construction where, as in the Banach-Tarski Theorem, the area $BCDE$ maps in the putative limit into two equal, disjoint, areas $BCDE/2$ each of which, however, ‘occupies’ the same metric space as $BCDE$.

Banach-Tarski Theorem: Given a solid ball in 3-dimensional space, there exists a decomposition of the ball into a finite number of disjoint subsets, which can then be put back together in a different way to yield two identical copies of the original ball.

Similarly, from an *evidence-based* perspective of quantum phenomena (see §23.C.; also §23.B.d.), such a putative limit would interpret as a situation where the mathematical representations of two physical objects—for instance, two ‘fluids’ of massless particles with opposing polarity, corresponding to the disjoint areas sub-tended on the two bases BC and DE respectively—ultimately come to occupy the same physical space during a putative interaction/separation!

The question arises:

Query 17. *In what evidence-based mathematical sense of a metric ‘space’ can Fig.4 be described mathematically as defining a space-filling curve?*

⁴⁹¹A *seeming* paradox even in set theory, according to Markus Pantsar: “In set theoretic geometry it follows from the axiom of choice that in three-dimensional space we can take a solid ball, break it into non-overlapping pieces, and proceed to form two balls equal to the original ball. Although this is called the Banach-Tarski *paradox*, it is not really a paradox, but rather an extremely unintuitive result. As such, however, it does work like a paradox, intuitiveness being a strong argument for set theory.”

...Pantsar: [Pan09], §5.3 Why IF logic, Footnote 136.

20.C.d. Case 4: Interpretation as a political revolution

The significance of Query 17 for the mathematical modelling of real-life based gedanken is seen in the following:

Let the area BAC denote the contiguous population size $s.h/2$ of a rebellious movement R in a country with total population denoted by $BCDE$ in Fig.4; where R splits into two identical, disjoint, cells, each of reduced population $s.h/4$, when it is persecuted beyond a level $L/2$ by the population surrounding it, where we assume that the persecution level from the surrounding population in the country drops temporarily to below $L/4$ after the split.

Let each triangle at the n 'th iteration denote a rebellious cell of size $s.h/2^{n-1}$, which reacts when the persecution level from the surrounding population crosses $L/2^{n-1}$, by again splitting identically into two disjoint cells.

We then have that any reactive persecution of R , administered as above, will eventually result in a revolution where R takes over the entire country, since the total size of the, increasingly dispersed, rebelling population remains constant at $s.h/2$, but the persecution level tends to 0!

20.D. Algorithmically *verifiable* but not algorithmically *computable* Cauchy sequences

We note that §7.G., Theorem 7.2 shows that Cauchy sequences which are defined as algorithmically *verifiable*, but not algorithmically *computable*, can correspond to 'essentially incompletable' real numbers (such as, for instance, the fundamental dimensionless constants considered in [An15], §4) whose Cauchy sequences cannot, in a sense, be known 'completely' even to Laplace's 'intellect' (see §7.I.a.).

The above example now show further that—and why—the numerical values of *even* some algorithmically *computable* Cauchy sequences may also need to be treated as formally specifiable, first-order, non-terminating processes:

- (a) which are 'eternal work-in-progress' (see §7.I.a.), and
- (b) which cannot be uniquely identified by a putative 'Cauchy limit' without limiting the ability of such sequences to model phase-changing physical phenomena faithfully!

Comment 162. We note that the set-theoretically defined Specker sequences (see [Smm05]; also §7.G.; §7.I.), too, are algorithmically *computable*, monotonically increasing, bounded sequences of rational numbers, whose supremum is taken to Platonically define putative, *uncomputable*, real numbers—even though the sequences themselves are not Cauchy sequences in the constructive (algorithmic) sense. They too, thus, need to be treated as formally specifiable, first-order, non-terminating processes.

Specker sequence: Let A be any recursively enumerable set of natural numbers that is not decidable, and let (a_i) be an algorithmically *computable* enumeration of A without repetition. Define a sequence (q_n) of rational numbers with the rule:

$$q_n = \sum_{i=0}^n 2^{-a_i-1}.$$

In view of §7.I., Theorem 7.5, the gedanken in §20.C.a. to §20.C.d. highlight the disquieting issue sought to be raised, for instance, by Lakoff and Núñez in [LR00] (p.325-333), Simpson in [Sim88] and, most forcefully, by Krajewski in [Kr16]:

"Examples of possible theological influences upon the development of mathematics are indicated. The best known connection can be found in the realm of infinite sets treated by us as known or graspable, which constitutes a divine-like approach. Also the move to treat infinite processes as if they were one finished object that can be identified with its limits is routine in mathematicians, but refers to seemingly super-human power."

... Krajewski: [Kr16].

The disquiet can be expressed as (see also §13.; [Fe98]):

Query 18. *Since the raison d'être of a mathematical language is—or ideally should be—to express our abstractions of natural phenomena precisely, and communicate them unequivocally, in what sense can we sensibly admit an interpretation of a mathematical language that constrains all the above cases by 'limiting' configurations in a putative, set-theoretical, 'completion' of Euclidean Space?*

Comment 163. The 'epistemological status of scientific thought experiments' raised by Query 18 is also addressed, albeit obliquely, by Lorenzo Sartori in his paper [Srt23]; where he seeks to argue that 'the distinction between the internal and the external validity of an experiment' ought to be treated as complementary, and in some sense 'crucial', to the corresponding distinction vis à vis 'thought experiments':

"Philosophers have debated at length the epistemological status of scientific thought experiments. I contend that the literature on this topic still lacks a common conceptual framework, a lacuna that produces radical disagreement among the participants in this debate. To remedy this problem, I suggest focusing on the distinction between the internal and the external validity of an experiment, which is also crucial for thought experiments. I then develop an account of both kinds of validity in the context of thought experiments. I show that we can naturally conceptualise internal validity in terms of games of make-believe. Then, I argue that external validity is best defined as accurate representation of a target system. Finally, I turn back to the current debate on thought experiments and show that my diarchic account provides a general framework that can be shared by the competing philosophical views, as well as a fruitful guide for their reconciliation."

... Sartori: [Srt23], Abstract.

In subsequent personal correspondence, Sartori clarifies that:

"The point of my article is that, when we engage with thought experiments (and also scientific models), like we do when we extrapolate from an experimental context to another scenario of application, what is true about the experimental or model's scenario is not necessarily truth *simpliciter* of the designated target system in the real world to which we intend to apply our results. Thus, the inferences that we perform about the imagined scenario of the thought experiment do not need to be the same inferences that guide us from the internally valid results to the externally valid ones."

... Sartori: Personal communication on 23rd January 2023.

20.D.a. Mathematical intuition vs mathematical monsters

The essence of the issue sought to be raised in §20.D., Query 18 (and also in §13., and in §28.) is the pedagogical challenge (see also §28.C.) in differentiating between the ontological (and epistemological) status of:

- what we express symbolically as our primary conceptual mathematical metaphors, and

- what we express symbolically as the secondary conceptual mathematical metaphors that arise from our subsequent perception of the symbolic expression/s of our primary conceptual mathematical metaphors,

The challenges faced in explicating such differentiation were implicitly addressed by Solomon Feferman in his *Mathematical Intuition Vs. Mathematical Monsters*, where he seeks to distinguish between counter-intuitive interpretations of terms and their properties in formal systems that do not admit a finitary interpretation, and counter-intuitive interpretations of terms and their properties in formal systems that are finitarily interpretable:

“The appearance of monsters was a direct result of the nineteenth century program for the rigorous foundation of analysis and its arithmetization, i.e. for the triumph of number over geometry, at the hands most notably of Bolzano, Cauchy, Weierstrass, Dedekind and Cantor. That program grew in response to the increasing uncertainty as to what it was legitimate to do and say in mathematics, and especially in analysis. One could no longer rely on calculations that looked right, or depend on physical applications to justify the mathematics. The completed program of arithmetization substituted the real number system for the measurement line and “ ϵ, δ ” definitions and proofs for limit concepts and arguments. The central notions which then emerged for functions were those of continuity and differentiability (both at a point or in a region) and integrability. In those terms, the notion of a curve in n dimensions was defined simply as a continuous map f on a closed interval $[a, b]$ to n -dimensional space R^n , and the tangent to such a curve at a point was then defined in terms of the derivatives of the components of f , when those exist. Use of these precise explications sufficed to verify rigorously many of the intuitively evident properties of continuous functions and curves in the prior informal sense, e.g. that a continuous f from $[a, b]$ to the real numbers R takes on a maximum and minimum on that interval, and that for differentiable f , such extrema can be located among the points where the tangent to its curve is horizontal. Of course, it was familiar and expected that reasonable functions could have isolated points of discontinuity and that a continuous function could have isolated points where there is no tangent to its graph. It was thus a surprise when Weierstrass produced an example of a function which is everywhere continuous and nowhere differentiable. Then Peano produced an example of a space-filling curve, i.e. a continuous function from the closed interval $[0, 1]$ to R^2 whose range is the unit square $[0, 1] \times [0, 1]$, thus violating the intuition that a curve is a one-dimensional object. Moreover, there is no reasonable assignment of length as a measure to Peano’s curve. It was to such objects that Poincaré was reacting as “monsters”.

By contrast to Poincaré, the mathematician Hans Hahn (one of the principals in the Vienna Circle and the teacher of Kurt Gödel) argued against intuition in mathematics in a famous 1933 essay, “The crisis in intuition”.⁸ Asserting its complete unreliability, he made use of a number of mathematical monsters to support his critique. Hahn’s main target was the Kantian view of space as one of the forms of pure intuition.⁹ Besides presenting simplified examples of a continuous curve without a tangent at any point and of a space-filling curve (in a form due to Hilbert), Hahn also described examples challenging intuitive topological concepts. One, due to Brouwer, is that of a map of three “countries” which meet each other at every point of their boundaries. Another, due to Sierpinski, produces a curve which intersects itself at every point. Typically, these objects are constructed as limits of reasonably well-behaved functions. For example, the Peano-Hilbert space-filling “curve” is a limit of curves that first go through every quadrant of the unit square, then more quickly through every sub-quadrant, and so. The Sierpinski “curve” is obtained by successively deleting the interior of an inscribed equilateral triangle within an initial such triangle; it is the skeleton of what’s left in the limit.¹⁰

Hahn draws the following conclusion from such examples in his essay:

Because intuition turned out to be deceptive in so many instances, and because propositions that had been accounted true by intuition were repeatedly proved false by logic, mathematicians became more and more sceptical of the validity of intuition. They learned that it is unsafe to accept any mathematical proposition, much less to

base any mathematical discipline on intuitive convictions. Thus a demand arose for the expulsion of intuition from mathematical reasoning, and for the complete formalization of mathematics. That is to say, every new mathematical concept was to be introduced through a purely logical definition; every mathematical proof was to be carried through by strictly logical means. . . . The task of completely formalizing mathematics, of reducing it entirely to logic, was arduous and difficult; it meant nothing less than a reform in root and branch. Propositions that had formerly been accepted as intuitively evident had to be painstakingly proved.¹¹

As to this last, Hahn cited the example of the Jordan curve theorem, according to which every simple closed curve in the plane is the boundary of two open connected regions, one (the "interior") being bounded, the other (the "exterior") unbounded. It had been pointed out by Camille Jordan that it is necessary to formulate explicitly this bit of tacit intuitively obvious knowledge for the proper development of complex analysis, but it turned out to be devilishly difficult to prove even for reasonably well-behaved simple closed curves, namely those with polygonal boundary; after several faulty attempts by Jordan and others, it was finally proved in general for continuous boundaries in 1905 by Oswald Veblen. Note, however, that the problem with intuition in this case was not due to a challenge by a monster, but rather the apparent necessity to use complicated rigorous methods even for intuitively simple results."

... Feferman: [Fe98], §2: *Geometrical and topological monsters*.

Feferman forcefully argues that:

- without denying the conceptual utility
- of 'the geometrical and topological monsters that are supposed to demonstrate the unreliability of intuition',
- these ought, actually, to be interpreted additionally as
- serving 'counterexamples to intuitively expected results when certain notions are used as explications which serve various purposes well enough but which do not have all expected properties'
- that we are seeking to adequately express (and, ideally, effectively communicate) symbolically:

"Without in the least bit denying the necessity of developing mathematics—in particular analysis and topology—in a rigorous manner, evidently (in view of my remarks in section 1) I disagree with those who, like Hahn and others, believe that intuition has no value and that it must be expelled from mathematics. What, then, is one to say about the geometrical and topological monsters that are supposed to demonstrate the unreliability of intuition? The answer is simply that these serve as counterexamples to intuitively expected results when certain notions are used as explications which serve various purposes well enough but which do not have all expected properties. Unless one thinks that curves, for example, are laid up in a Platonic heaven as continuous functions from an interval to R^n , the arithmetized notion of curve must be treated as a model of an intuitive concept which itself isolates and describes in an idealized form certain aspects of experience. An explication that is closer to most ordinary experience requires of a curve that it is at least piece-wise differentiable. That less-stringent definitions of this notion may be valuable in modelling unusual parts of experience such as Brownian motion or fractal geometry (see ftn. 10) is not thereby denied; no one explication need be assumed to fit its purpose in all theories. Similarly, while the use of homeomorphism as the mathematical definition of the conceptual rubber sheet stretching of a sphere and other familiar surfaces (such as tori, etc.) serves to verify many expected properties (e.g. forms of connectedness, "hole"-iness, etc.), it does not model fully the informal concept. Thus one does not meet the kind of pathology represented by the Alexander horned sphere in the restriction

to differentiable manifolds and diffeomorphisms between them. Of course, special applications of topology in scientific modeling may require more delicate distinctions, as, for example, René Thom's "catastrophe" theory required a central focus on singularities of differentiable mappings.

Though it is understandable for the time, given the continuing deep influence of Kant's views through the work of the neo-Kantians in philosophy, it seems to me that Hahn's focus on the Kantian account of geometric intuition is misplaced so far as mathematics is concerned, and that the examples brought forward against the unreliability of intuition serve a quite different and more general purpose. Namely, it is standard mathematical practice to seek best possible results of an expected kind, and one way to achieve such is to make weakest possible assumptions on the given data. In this respect the mathematical monsters serve simply to provide counter-examples to further possible improvements."

... Feferman: [Fe98], §2: *Geometrical and topological monsters.*

Feferman's conclusion reflects a thesis of this investigation (see §13.E.) that:

- although a first-order set theory such as ZFC might be acceptable as an adequate foundation for symbolic expression of all the conceptual mathematical metaphors that we can *conceive*,
- it is only a Peano Arithmetic such as the first-order PA upon which we can rely to isolate those of our conceptual mathematical metaphors that can be communicated effectively:

"Simply put, the conflict between common-sense geometrical intuition and the Banach-Tarski paradox seems so egregious that it may force one to question the very basic intuitions about arbitrary sets which lead one to accept the principles lying behind the paradox, namely the principles of Zermelo-Fraenkel Set Theory together with the Axiom of Choice—or, if not that, then at least the relevance of those principles to applicable mathematics.

If common-sense and set-theoretical intuitions are in actual conflict, then one or the other must be rejected (but see the Appendix below). Few would argue for the rejection of the set-theoretical position, on the grounds that it is the best current foundation of mathematics we have and it thereby accounts in a systematic and coherent way for all the mathematics that is used in physical applications. The supporter of set theory may argue that even though non-measurable sets don't actually arise in such applications it is not reasonable to exclude AC just on that account, since its manifold uses otherwise to obtain results in accord with everyday mathematical intuition justify it pragmatically.²⁰ This way of defending set theory, including AC, is a version of the Quine-Putnam indispensability arguments. Against that, I have made the case that all, or almost all, of scientifically applicable mathematics can be formalized in a system *W* conservative over Peano Arithmetic and thus do not require the assumption of any essentially set-theoretical notions and principles at all.²¹ The cases of applications that are not at present covered involve highly speculative models in quantum theory. So one can come down on the side of common-sense intuition in a full rejection of set theory, while saving the mathematics needed for scientific applications. No doubt, the silent majority will not opt for either extreme, but will continue to accept, at least tacitly, the set-theoretical way of thinking in everyday mathematics while ignoring its bizarre consequences."

... Feferman: [Fe98], §3: *Paradoxical decomposition of sets.*

"To conclude, I return to the question raised in the introduction: to what extent do the challenges raised by monsters to the reliability of intuition undermine its uses in its everyday roles in research, teaching and the development of mathematics? I have argued that intuition is essential for all of these, but that intuition is not enough. In the end, to be sure, everything must be defined carefully and statements must be proved. And one service that the monsters lurking around the corners provide is forcing us to don such armor for our own protection. But if the proofs themselves produce such monsters, then the significance of *what* is proved requires closer attention, and that has to be dealt with on a case-by-case basis."

... Feferman: [Fe98], §4: *Conclusion.*

20.D.b. The mythical completability of metric spaces

As also remarked upon vividly by Jon Awbrey:

“Our thoughts live in natural and artificial languages the way fish swim in natural and artificial bodies of water.

One of the lessons most strikingly impressed on me by my first year physics course and the mass of collateral reading I did at the time was to guard against the errors that arise from “projecting the properties and structures of any language or symbol system on the external world”. This was mentioned especially often in discussions of quantum mechanics—it was a common observation that our difficulties grasping wave-particle duality might be due to our prior conditioning to see the world through the lenses of our subject-predicate languages and logics. Soon after, I learned about the Sapir-Whorf hypothesis, and today I lump all these cautionary tales under the heading of GRAM (“Grammar Recycled As Metaphysics”).”

... Awbrey: [Aw18].

From the *evidence-based* perspective of §20., we can now hypothesise:

Thesis 9. *There are no infinite processes, i.e., nothing corresponding to infinite sequences, in natural phenomena.*

Thesis 10. *If:*

(a) *a physical process is representable by a Cauchy sequence (as in the above cases §20.C.a., §20.C.b.);*

and:

(b) *we accept that there can be no infinite processes, i.e., nothing corresponding to infinite sequences, in natural phenomena;*

then:

(c) *in the absence of an extraneous, evidence-based, proof of ‘closure’ which determines the behaviour of the physical process in the limit as corresponding to a ‘Cauchy’ limit, the physical process must tend to a discontinuity (singularity) which has not been reflected in the Cauchy sequence that seeks to describe the behaviour of the physical process.*

The *significance* of such insistence on *evidence-based* reasoning for the physical sciences is that we may then be prohibited from claiming legitimacy for a mathematical theory which seeks to represent a physical process based on the assumption that the limiting behaviour of *every* physical process which can be described by a Cauchy sequence in the theory must *necessarily* correspond to—and so be constrained by—the behaviour of the Cauchy limit of the corresponding sequence.

Comment 164. The argument that ‘every Cauchy sequence of rational numbers cannot be postulated as defining a real number by the usual set-theoretical arguments’ is implicit in physicist Nicolas Gisin’s unusual, intuitionistic interpretation of ‘real numbers’ as ‘the hidden variables of classical physics’ in [Gi19]; where he argues (see also [Gi20]) that ‘real numbers should not be considered as “physical real” and classical mechanics, like quantum physics, is indeterministic’ (see also §7.I.a.).

For instance the existence of Hawking radiation in cosmology is posited on the assumption that ‘*the consistent extension of this local thermal bath has a finite temperature at infinity*’:

“Hawking radiation is required by the Unruh effect and the equivalence principle applied to black hole horizons. Close to the event horizon of a black hole, a local observer must accelerate to keep from falling in. An accelerating observer sees a thermal bath of particles that pop out of the local acceleration horizon, turn around, and free-fall back in. The condition of local thermal equilibrium implies that the consistent extension of of this local thermal bath has a finite temperature at infinity, which implies that some of these particles emitted by the horizon are not reabsorbed and become outgoing Hawking radiation.”

... https://en.wikipedia.org/wiki/Hawking_radiation. (Accessed 04/06/2018, 08:00 IST.)

As we have demonstrated in Fig. 2 (§20.C.) and §20.C.b., Case 2(c), *the consistent extension of the state of a stretched elastic string—as defined in Fig. 2—does not have a limiting mathematical value at infinity* which can be taken to correspond to its putatively limiting physical state.

The gedanken in §20.D.c. further illustrates that a mathematical singularity need not constrain a physical theory from positing a well-definable value for a limiting state of a physical process, contrary to what conventional wisdom accepts in the limiting cases of Einstein’s equations for General Relativity:

“The Big Bang is probably the most famous feature of standard cosmology. But it is also an undesirable one. That’s because the classical model of the universe, described by Einstein’s equations, breaks down in the conditions of the Big Bang, which include an infinite density and temperature, or what physicists call a singularity.”

... Padmanabhan: [Pd17].

Moreover, we shall argue (in §20.D.c.) that introduction of a, normally *weak*, anti-gravitational field whose strength can, however, accept quantum states that cause a universe to explode and implode in a predictable way at their corresponding ‘mathematical’ singularities, yields a mathematical model of a universe:

- (1) That recycles endlessly from Big Bang to Ultimate Implosion;
- (2) Which is time-reversal invariant; and
- (3) In which the existence of ‘dark energy’ is intuitively unobjectionable.

Whether or not such features can be made to apply to the physical universe we inhabit is a separate issue that lies beyond the focus of the *evidence-based* perspective of this investigation.

However, it is worthwhile noting some of the barriers that mathematical ‘singularities’ are perceived as imposing upon our ability to faithfully comprehend, and mathematically represent, the laws of nature.

For instance, as queried by Thanu Padmanabhan in [Pd17]:

“But what if there was no singularity? Since the 1960s, physicists have been working on describing the universe without a Big Bang by attempting to unify gravitational theory and quantum theory into something called quantum gravity. Physicists John Wheeler and Bryce deWitt were the first to apply these ideas to a hypothetical pre-geometric phase of the universe, in which notions of space and time have not yet-emerged from some as-yet unknown structure. This heralded the study of quantum cosmology, in which physicists attempted to describe the dynamics of simple toy

models of the universe in quantum language. Needless to say, several different, but related, ideas for the description of the pre-geometric phase mushroomed over the decades. The unifying theme of these models is that the classical universe arises, without any singularity, through a transition from a pre-geometric phase to one in which spacetime is described by Einstein's equations. The main difficulty in constructing such a description is that we do not have a complete theory of quantum gravity, which would allow us to model the pre-geometric phase in detail."

... Padmanabhan: [Pd17].

The issue is highlighted further by Padmanabhan in [Pd17a]:

"I will now raise a question which, at the outset, may sound somewhat strange. Why does the universe expand and, thereby, give us an arrow of time? To appreciate the significance of this question, recall that Eq. (9) is invariant under time reversal $t \rightarrow -t$. (After all, Einstein's equations themselves are time reversal invariant.) To match the observations, we have to choose a solution with $\dot{a} > 0$ at some fiducial time $t = t_{fid} > 0$ (say, at the current epoch), thereby breaking the time-reversal invariance of the system. This, by itself, is not an issue for a laboratory system. We know that a particular solution to the dynamical equations describing the system need not respect all the symmetries of the equations. But, for the universe, this is indeed an issue.

To see why, let us first discuss the case of $(\rho + 3p) > 0$ for all t . The choice $\dot{a} > 0$, at any instant of time, implies that we are postulating that the universe is expanding at that instant. Then Eq. (9) tells us that the universe will expand at all times in the past and will have a singularity ($a = 0$) at some finite time in the past (which we can take to be $t = 0$ without loss of generality). The structure of Eq. (9) prevents us from specifying the initial conditions at $t = 0$. So, if you insist on specifying the initial conditions and integrating the equations forward in time, you are forced to take $\dot{a} > 0$ at some time $t = \epsilon > 0$, thereby breaking the time reversal symmetry. The universe expands at present 'because' we chose it to expand at some instant in the past. This expansion, in turn, gives us an arrow of time [where] either t or a can be used as a time coordinate. But why do we have to choose the solution with $\dot{a} > 0$ at some instant? This is the essence of the so called expansion problem [6]. An alternative way of posing the same question is the following: How come a cosmological arrow of time emerges from the equations of motion which are time-reversal invariant?

In a laboratory, we can usually take another copy of the system we are studying and explore it with a time-reversal choice of initial conditions, because the time can be specified by degrees of freedom external to the system. We cannot do it for the universe because we do not have extra copies of it handy and—equally importantly—there is nothing external to it to specify the time. So the problem, as described, is specific to cosmology.

So far we assumed that $(\rho + 3p) > 0$, thereby leading to a singularity. Since meaningful theories must be nonsingular, we certainly expect a future theory of gravity—possibly a model for quantum gravity—to eliminate the singularity [effectively leading to $(\rho + 3p) < 0$. Can such a theory solve the problem of the arrow of time? This seems unlikely. To see this, let us ask what kind of dynamics we would expect in such a 'final' theory. The classical dynamics will certainly get modified at the Planck epoch, to govern the evolution of an (effective) expansion factor. The solutions could, for example, have a contracting phase (followed by a bounce) or could start from a Planck-size universe at $t = -\infty$, just to give two non-singular possibilities. While we do not know these equations or their solutions, we can be confident that they will still be time-reversal invariant because quantum theory, as we know it, is time-reversal invariant.

So except through a choice for initial conditions (now possibly at $t = -\infty$), we still cannot explain how the cosmological arrow of time emerges. Since quantum gravity is unlikely to produce an arrow of time, it is a worthwhile pursuit to try and understand this problem in the (semi) classical context."

... Padmanabhan: [Pd17a].

In other words, the arguments in §20.C.a. and §20.C.b. suggest that:

Thesis 11. *The perceived barriers that inhibit mathematical modelling of a cyclic universe—one which admits broken symmetries, dark energy, and an ever-expanding multiverse—in a mathematical language that admits unambiguous communication are illusory; they arise out of an attempt to ask of the language selected for such representation more than the language is designed to deliver.*

Comment 165. The relevance of §20.D.b., Theses 9-11⁴⁹² for current efforts seeking to address unresolved issues concerning permissible infinitary reasoning in inherited mathematical paradigms⁴⁹³, is reflected in Rafael-Andrés Alemañ-Berenguer's [Brg23], where he argues that 'the observational data of cosmology seemed to favour an infinite volume, although the delicate physical and metaphysical problems that such an option implies have rarely been highlighted':

"The finitude or infinity of the universe divided the ancient philosophers fueling a debate intertwined with the subtleties of the very concept of infinity and the plausibility of its realization in the physical world. While the 19th century took the first steps in the formal domain of mathematical infinity, the question of the size of the cosmos remained open pending better empirical evidence. At the end of the 20th century, the observational data of cosmology seemed to favour an infinite volume, although the delicate physical and metaphysical problems that such an option implies have rarely been highlighted."

... Alemañ-Berenguer: [Brg23], Abstract.

Alemañ-Berenguer concludes that:

"The most pertinent way of dealing with infinity has been a source of confusion in science and philosophy from the very origins of these disciplines. Mathematicians, as so many other times, demonstrated sufficient ability to establish themselves as pioneers in the task of mastering the formal management of infinite sets, although their work, more than a century and a half later, is far from finished. However, the elegance and depth of the mathematical discoveries about infinite quantities left their possible existence in the natural world unclear. That was a question that could only be answered empirically and, in the absence of data to settle the query, this problem remained to be resolved.

The development of modern science—so-called from Galileo and Newton onwards—had to deal with the same ambiguities as the ancient philosophers due to a lack of formal tools with which to bridle the concept of infinity. This was, other than being identified with divine omnipotence, associated with ideal models very useful for the simplification of calculations. Infinity was as well taken as a distinctive sign of the limits of applicability of the theory applied (and perhaps also as a warning of a future theory that would replace it). In other words, and using a more Aristotelian language, for theoretical reasons in the natural sciences it was accepted—and taken advantage from—potential infinity with the same serenity with which actual infinity was rejected on empirical grounds.

Modern cosmology, that started in 1917 with the first applications of general relativity to the universe, came to completely change such a quiet landscape. The cosmic geometry went forth, opening up three possible scenarios in two of which the spatial volume of the universe appeared to be necessarily infinite. When astronomical observations ruled out the possibility of a cosmos with positive curvature, at the end of the 20th century, the remaining options invited us to think of an infinite extension. This

⁴⁹²See also Query 18 in §20.D.: *Algorithmically verifiable but not algorithmically computable Cauchy sequences.*

⁴⁹³Which admit mathematical limits of Cauchy sequences as essential when seeking to unambiguously express, and categorically communicate, the conceptual metaphors formed in our minds by our sensory perceptions of natural phenomena; albeit *uncritically*, as argued in §20.B.: *When is the concept of a completed infinity consistent?*, and illustrated by Cases 1-4 in 20.B.: *Mythical 'set-theoretical' limits of fractal constructions.*

circumstance contained not a few inconveniences, both theoretical (What sense does the actual infinity make in the physical world?) and empirical (How could the value of a magnitude that by definition is incommensurable be calibrated?).

However, the difficulties implied by open cosmological models refused to go away. Spatial infinity would entail an infinite amount of uniformly distributed matter, otherwise we would have an infinite amount of absolutely empty space, something with very little physical meaning. But then the problem of temporal evolution would reappear: going back to the initial moment of the Big Bang, the type of countable infinity associated with the amount of matter would not correspond to the non-countable infinity that characterizes the continuity of space.

The only reasonable way out seems to direct us towards a cosmological model with null or slightly negative curvature, as indicated by the observations, which at the same time presents a finite spatial volume to avoid the aforementioned problems. This could only be achieved, in the current framework, either by relaxing some of the conditions that lead to the FLRW family of geometries, such as homogeneity in the distribution of matter (a requirement, on the other hand, not infrequently discussed), or by resorting to considerations that are not merely geometric, such as topological properties. These new research directions take us into a vast territory of possibilities, the vast majority of which we can barely glimpse today.

Be that as it may, in the cosmological field, theoretical work will have to wait for new and more precise observational data to guide its path. Meanwhile, the question of the actual infinity, clearly expressed in the volume of our universe, will remain open and no one knows how long it will be unsolved or what future consequences for our image of the cosmos the solution will entail."

... Alemañ-Berenguer: [Brg23], §6, Conclusions.

20.D.c. Case 5: Modelling the states of the total energy in a universe that recycles

"Both general relativity and Newtonian gravity appear to predict that negative mass would produce a repulsive gravitational field."

... Anti-gravity: <https://en.wikipedia.org/wiki/Anti-gravity>; accessed 08/06/2018, 10:13:00.

To illustrate why an *evidence-based* perspective—towards interpreting the propositions of a mathematical model realistically—would view such barriers as illusory, we consider the following gedanken.

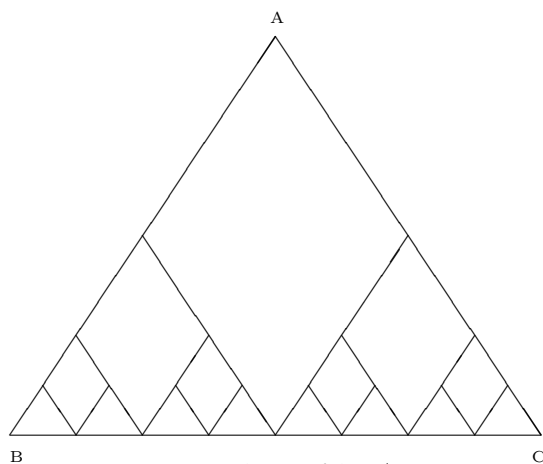

Case 5: We treat Fig.2 in §20.C. (reproduced above as Fig 2a) as a mathematical representation of the ‘confinement parameter’ that determines the state of the total energy s , in a *finite* universe \mathcal{U} , which is subject to two constantly unequal and opposing—assumed additive—forces due to:

1. A *strong* confinement field G (induced by matter), whose state is determined by a single discrete dimensionless constant, defined as an Einsteinian gravitational, or confinement strength, constant (gsp), which is always $\frac{1}{2}$; and
2. A *weak* anti-confinement field R (induced by anti-matter), whose state is determined by discrete dimensionless values, defined as the Einsteinian repulsive, or anti-confinement strength, ‘cosmological constants’ (asp), where:

- (a) $asp = 1 > gsp$ when \mathcal{U} is in an *exploding* state at event e_0 ;
- (b) $asp = \frac{1}{3} + \frac{2}{3}(1 - \frac{1}{n+1}) > gsp$ when \mathcal{U} is in an *imploding* state at event e_n for $n \geq 1$;
- (c) $asp = \frac{1}{3} < gsp$ when \mathcal{U} is in a *steady* state:
 - i. during which events, denoted by e'_n, e''_n, \dots ,
 - ii. occur *between* events e_n and e_{n+1} ;
 - iii. where $e'_n < e_m$ is an abbreviation for ‘event e'_n occurs causally before event e_m ’.

and where the following are assumed to hold:

- (3) Classical laws of nature (see §23.D.c., Thesis 19) determine the nature and behaviour of all those properties of the physical world that are both *determinate* and *predictable*, and are therefore mathematically describable at any event $e(n)$ by *algorithmically computable* functions from a putatively specifiable initial state at event $e(0)$;
- (4) Neo-classical (quantum) laws of nature (see §23.D.d., Thesis 20) determine the nature and behaviour of those properties of the physical world that are *determinate* but *not predictable*, and are therefore mathematically describable at any event $e(n)$ only by functions that are *algorithmically verifiable* but not *algorithmically computable* from any putatively specifiable initial state at event $e(0)$;
- (5) There can be no infinite processes, i.e., nothing corresponding to infinite sequences, in natural phenomena;
- (6) All laws of nature are subject to *evidence-based* accountability as follows (see §20.D.b., Thesis 9):
 - (a) If a physical process is representable by a Cauchy sequence (as in the above cases in §20.C.a. and §20.C.b.), then:
 - (i) in the absence of an extraneous, *evidence-based*, proof of ‘closure’ which determines the behaviour of the physical process in the limit as corresponding to a ‘Cauchy’ limit;
 - (ii) the physical process *must* be taken to tend to a discontinuity (singularity) due to ‘hidden’ variables (in the sense of §23.B.a.) which have *not* been reflected in the Cauchy sequence that seeks to describe the behaviour of the physical process.

A: We then define:

- (1) The total, say s , units of energy of the universe \mathcal{U} is:

- (a) in an *exploding* state at event e_0 ;
 - (b) in a *steady* state between events e_n and e_{n+1} for $n \geq 1$;
 - (c) in an *imploding* state at events e_n for $n \geq 1$.
- (2) The state of the anti-confinement field in \mathcal{U} at an event is defined with reference to Fig.2a as follows:
- (a) Initially at the Big Bang event e_0 , where the energy s is in an unstable *exploding* state, the anti-confinement field strength:
 - (i) is determined by the ratio $asp = \frac{s}{s} = 1 > gsp$ of the absolute value of the total energy s of the universe, and the absolute value of a confinement parameter represented by the length BC where, for convenience, we define the length BC as s ;
 - (ii) which also corresponds to the limiting case of the confinement parameter as $n \rightarrow \infty$ in Fig.2a.
 - (b) Between events e_n and e_{n+1} for $n > 0$, where the energy s is in a *steady* state, the anti-confinement field strength:
 - (i) is determined by the ratio $asp = \frac{s}{l_n} = \frac{1}{3} < gsp$,
 - (ii) where the confinement parameter $l_n = 3s$ is represented by the cumulative perimeter lengths of all the triangles on their common base BC in Fig.2a.
 - (c) At event e_n for $n \geq 1$, where the energy s is in an unstable *imploding* state, the anti-confinement field strength:
 - (i) is determined by $asp = \frac{s}{l_n} + \frac{2}{3}(1 - \frac{1}{n+1}) > gsp > \frac{1}{3}$;
 - (ii) where $\frac{2}{3}(1 - \frac{1}{n+1}) > \frac{1}{3}$ is defined as the implosion constant at event e_n .

B: We further define:

- (1) At event e_0 the universe \mathcal{U} explodes and expands ‘instantaneously’—in a water-to-steam like phase change—to a *steady* state termed as event e'_0 where:
 - (a) The strength of the confinement field, $gsp = \frac{1}{2}$,
 is now greater than:
 - (b) The strength of the anti-confinement field, $asp = \frac{s}{3s} = \frac{1}{3}$.
- (2) At any event e'_0 the total energy s of the universe \mathcal{U} —which we assume can neither be created nor destroyed—is subjected to a confinement field due to gravitational effects that gradually concentrates:
 - (a) some energy to form isolated matter;
 - (b) some isolated matter to form stars;
 - (c) some stars to form supernovas;
 - (d) some supernovas to form ‘black holes’;

- (e) some ‘black hole’ to form the first ‘critical black hole’:
- (i) which we define as event e_0'' where $e_0'' \geq e_0$;
 - (ii) during which matter is gradually drawn into the ‘black hole’,
 - (iii) until, at event e_1 , a ‘critical’ proportion of the total energy s of the parent universe corresponding to the state BAC has been drawn into the ‘critical black hole’:
 - (a) which proportion, without loss of generality, we may take as $\frac{1}{2}$ in this example;
 - (b) where we treat event e_1 as a singularity corresponding to the mid-point of BC ;
 - (c) such that this energy ($\frac{s}{2}$) has now been ‘confined’ into an imploding state with $asp = \frac{1}{3} + \frac{2}{3}(1 - \frac{1}{2}) = \frac{2}{3} > gsp$;
 - (i) and is extinguished in an ‘instantaneous’ implosion, defined as the event $e_1 \geq e_0''$,
 - (ii) which forms an electromagnetically disconnected, independent, universe;
 - (iii) which, without loss of generality, we treat as the splitting of the energy s of the parent universe \mathcal{U} into two disconnected, isomorphic but not identical, twin sub-universes corresponding to the states $BAC_{1,1}$ and $BAC_{1,2}$ in Fig.2,
 - (iv) that are situated in common, universal, confinement and anti-confinement fields G and R ;
 - (v) and which, without loss of generality, we assume obey identical laws of nature;
 - (vi) where the total energy s is now divided equally between the twin states $BAC_{1,1}$ and $BAC_{1,2}$;
 - (vii) where, without loss of generality, we may assume that the distribution of particles and their anti-particles between the twin states $BAC_{1,2}$ and $BAC_{1,1}$ is not necessarily symmetrical.

(3) Whence it follows that:

- (1) The total of any Hawking—or other, similarly putative⁴⁹⁴—energy radiated back into the ‘observable’ universe \mathcal{U} corresponding to the state BAC during the period, defined as event e_0'' , between the creation of the ‘critical black hole’ and its eventual extinction at event e_1 (corresponding to the mid-point of BC):
 - (a) is *not* $s/2$ (as conventional wisdom would expect in such a model);
 - (b) but, if at all, only a tiny fraction of the total energy—which is now $s/2$ —of each sub-universe;
 - (c) although each sub-universe:
 - (i) unaware of its isomorphic sibling,
 - (ii) and under the illusion that it is still the entire parent universe,

⁴⁹⁴Putative’ since the existence of such energy may be only on the basis of the debatable—see §20.D.b.—mathematical assumption that the limit of the mathematical representations of a sequence of physical phenomena must necessarily correspond to the putative behaviour of the physical phenomena in the putative limiting state.

- (iii) with merely ‘black hole’ concentrates of energy within it,
 - (iv) which it believes will gradually extinguish once all the energy has seeped back into its domain as a result of a putative Hawking, or similar, radiation,
 - (v) continues to lay claim to the energy of its extinguished sibling as ‘dark energy’,
 - (vi) by an ‘unknowably’ misapplied appeal to the law of preservation of the total energy s of the original universe corresponding to the state BAC ;
- (2) Although the universe \mathcal{U} is time-reversal invariant, each of the twin (isomorphic but not identical) sub-universes corresponding to the states $BAC_{1,1}$ and $BAC_{1,2}$ need not be time-reversal invariant, since the ratio of particles to their anti-particles in each of the twin sub-universes may no longer be symmetrical;
- (3) Each sub-universe in turn forms the *next* ‘critical black hole’ singularity;
- (a) that implodes similarly at—assumed without loss of generality as a common—event e_2 ,
 - (b) into two, isomorphic but electro-magnetically disconnected, twin sub-universes with equal, but asymmetrical, division of energy;
- (4) The universe at event e_2 is a ‘multiverse’ of mutually disconnected 2^2 sub-universes corresponding to the states $\{BAC_{2,1}, BAC_{2,2}, BAC_{2,3}, BAC_{2,4}\}$;
- (a) and so on ad infinitum.

C: In other words, the n^{th} implosion at event e_n , for $n > 1$, is when the universe \mathcal{U} is confined into the imploding state with a monotonically increased imploding anti-confinement strength $asp = \frac{1}{3} + \frac{2}{3}(1 - \frac{1}{n+1}) > \frac{1}{3}$; and its energy divides further—corresponding to each of the 2^n triangles $BAC_{n,i}$ on the base BC , where $1 \leq i \leq 2^n$, dividing further into two similar sub-triangles—where:

- (1) The total energy corresponding to each of the 2^n triangles *after* the event e_n is $s/2^{n-1}$ for $n > 0$;
- (2) The strength of the anti-confinement field within each sub-universe remains constant at $asp = 1/3$ between events e_n and e_{n+1} , which is below the minimum imploding $asp = \frac{2}{3}$ of event e_1 .

D: We thus have a mathematical model of an exploding and then imploding universe:

- (1) That can be viewed as recycling endlessly in *either* direction of time;
- (2) Whose state—exploding, steady, or imploding—at any event e is determined by the strength of an anti-confinement field that—in the direction of time chosen in this example—regularly impels \mathcal{U} to split itself into a monotonically increasing number of isomorphic, but electromagnetically disconnected, sub-universes, all situated in a common confinement/anti-confinement field:
 - (a) where the laws of nature remain unchanged;
 - (b) where, for $n > 0$, the total energy within each sub-universe at event e_n has decreased monotonically to $s/2^{n-1}$ due to persisting imploding effects of assumed gravitational/anti-gravitational forces;

- (c) that will further split each sub-universe into two at event e_{n+1} as illustrated in Fig.2 if the strength of the anti-confinement field is in the state $1 > asp > \frac{1}{3}$;
- (3) Where the energy within each sub-universe during the steady state between events e_n and e_{n+1} appears as ‘dark’ to its siblings:
- (a) since it is disconnected from, and disappears forever beyond, their event-horizon at an implosion;
- (b) and because each sub-universe, unaware of its siblings, assumes that—since energy can neither be created nor destroyed—the total energy s of the universe must remain constant within their illusory ‘universe’, either as visible or as ‘dark’ energy;
- (c) where the distribution of matter outside the critical black hole within each sub-universe may be perceived at any instant by an observer within the sub-universe as accelerating away from the observer in an apparently expanding ‘universe’ whose boundary is quantified by an ever-increasing value which also tends to a discontinuity as $n \rightarrow \infty$, corresponding to the *virulence* of the virus cluster considered in §20.C.a., Case 1(c), Fig.3;
- (d) where any two, isomorphic but electro-magnetically disconnected, twin sub-universes have equal, but asymmetrical, division of energy;
- (4) Where each sub-universe during the steady state between events e_n and e_{n+1} is expanding at an accelerating rate since the ‘cosmological constant’ $asp = \frac{1}{3} > 0$;
- (5) The energy within each sub-universe at the limiting Zeno-type phase-change point—describable mathematically as ‘ $n \rightarrow \infty$ ’—implodes finally to a ‘dark point’ in BC ;
- (6) Where the energy within the universe as a whole experiences a steam-to-water phase-changing collapse into the original Big Bang configuration represented by an exploding anti-gravitational state $asp = 1$ denoted by BC ;
- (a) thus triggering the next cycle of its rebirth (in the chosen time direction of this example);

20.D.d. Asking of a language more than it is designed to deliver

To summarise briefly, in this investigation we have argued for the plausibility of the thesis (§20.D.b., Thesis 10) that if:

- (a) a physical process is representable by a Cauchy sequence; and
- (b) we accept that there can be no infinite processes, i.e., nothing corresponding to infinite sequences, in natural phenomena;

then:

- (c) in the absence of an extraneous, *evidence-based*, proof of ‘closure’ which determines the behaviour of the physical process in the limit as corresponding to a ‘Cauchy’ limit;
- (d) the physical process *must* tend to a discontinuity (singularity) which has not been reflected in the Cauchy sequence that seeks to describe the behaviour of the physical process.

We have highlighted the practical significance of our thesis for the physical sciences by defining an, *in principle verifiable*, mathematical model in §20.C., Fig.2 that can be interpreted as describing the putative behaviour under a well-defined iteration of:

- (1) a virus cluster (§20.C.a.);
- (2) an elastic string (§20.C.b.);
- (3) a quantum chimera (§20.C.c.);
- (4) a political revolution (§20.C.d.);

where the physical process in each case can be ‘seen’ to tend to an ‘ultimate’ discontinuity (singularity) which has not been reflected in the Cauchy sequence that seeks to describe the behaviour of the process.

We have then highlighted the theoretical significance of our thesis for a realistic philosophy of science by showing that Fig.2 can also be interpreted as representing the, *essentially unverifiable*, state of the total energy of:

- (5) a finite Universe \mathcal{U} (§20.D.c.):
 - (a) that recycles endlessly from Big Bang to Ultimate Implosion; and
 - (b) in which the existence of ‘dark energy’ is mathematically and intuitionistically unobjectionable.

Moreover, the only assumptions we have made are that \mathcal{U} obeys Einstein’s equations and classical quantum theory, and that:

Thesis 12. *The anti-matter in \mathcal{U} produces a repulsive, anti-gravitational, field:*

- (a) *that is consistent with both general relativity and Newtonian gravity;*
- (b) *whose state at any instant is either exploding, steady, or imploding;*
- (c) *whose ‘energy anti-confinement’ strength at any instant is determined by an anti-gravitational dimensionless ‘cosmological constant’ asp that can assume any of three values $asp = 1$ (exploding at the instant of the Big Bang), $asp = \frac{1}{3}$ (steady between an explosion and an implosion) or $asp = \frac{1}{3} + \frac{2}{3}(1 - \frac{1}{n+1})$ (imploding at the instant of the extinguishing of the n^{th} ‘critical black hole’ for all $n \geq 1$);*
- (d) *which constantly opposes the ‘energy confinement’ strength of the Newtonian gravitational field whose state is determined at any instant by only one dimensionless gravitational constant⁴⁹⁵ $gsp = \frac{1}{2}$.*

⁴⁹⁵Which could be viewed as corresponding to the gravitational constant, denoted by G , common to both Newton’s law of universal gravitation and Einstein’s general theory of relativity; whose value in Planck units is defined as 1, and whose measured value is expressed in the *International System of Units* as approximately $6.674 \times 10^{-11} N.kg^{-2}.m^2$.

Comment 166. We note that the assumption of a ‘variable’ cosmological constant in the above, artificially-constructed mathematical model of a putatively ‘recycling’ universe that, consequently, can theoretically—and *not* ‘unnaturally’—admit ‘black holes’, ‘multiverses’, ‘dark matter’ and ‘inflation’, may be consistent with other speculative theories about the origin, and nature, of the universe we inhabit. As Sabine Hossenfelder remarks in [Hos18a]:

“... As much as I want to believe that the laws of nature are beautiful, I don’t think our sense of beauty is a good guide; in contrast, it has distracted us from other, more pressing questions. Like the one that Steven Weinberg pointed out: that we do not understand the emergence of the macroscopic world. Or, as Xiao-Gang Wen reminded me, that we do not understand quantum field theory. Or, as the issue of the multiverse and naturalness shows, that we do not understand what it means for a law of nature to be probable.

... yes, I think nature has more beauty in store for us. But beauty, like happiness, can’t be found by complaining about its absence.

...

There’s yet another way to postulate new physics and then hide it, which is to introduce fields that either become relevant only at very large distances or in the very early universe, both of which are hard to test. Such inventions are acceptable today because they too explain numerological coincidences.

In general relativity, the cosmological constant (CC) is a free parameter. This means there is no deeper principle from which the constant can be calculated—it has to be fixed by measurement. The accelerated expansion of the universe shows that the CC is positive and that its value is related to an energy scale comparable to the mass of the heaviest known neutrino. That is, for particle physicists, it is a very small energy scale (see Figure 14).¹⁸

If the CC is nonzero, a space-time that does not contain any particles is no longer flat. The cosmological constant is therefore often interpreted as a vacuum with nonzero energy density and pressure.

General relativity doesn’t tell us anything about the value of the CC. In quantum field theory, however, we can calculate the vacuum energy density—and it comes out to be infinitely large. But in the absence of gravity this doesn’t matter: we never measure absolute energies anyway, we merely measure energy differences. In the standard model without gravity we can therefore use suitable mathematical procedures to remove the infinity and get a physically meaningful result.

In the presence of gravity, however, the infinite contribution becomes physically relevant because it would cause an infinite curvature of space-time. This clearly doesn’t make sense. Further inspection luckily shows that the vacuum energy is unbounded only if one extrapolates the standard model up to infinitely high energies. And since we expect this extrapolation to break down at the Planck energy (at the latest), the vacuum energy should instead be a power of the Planck energy. That’s better—at least it’s finite. But still it’s much too large to be compatible with observation. A cosmological constant that large would have ripped us apart or would have recollapsed the universe long ago.

However, we can simply choose the free constant in general relativity so that when it is added to the contribution from quantum field theory (whatever that is), the result agrees with observation. Hence, the expectation that the sum is somewhere at the Planck energy is—again—based on a naturalness argument. If we were able to do the calculation, so the story goes, we would be unlikely to find two large numbers that almost but not exactly cancel, leaving behind merely the small value we measure.

The cosmological constant is therefore not natural, to use physics-speak. It requires fine-tuning. Its small value is not beautiful. There’s nothing wrong with this constant—it’s just that physicists don’t like it.

You'd think a constant would be the simplest assumption a theory can possibly have. But the belief that the value of the CC requires an explanation is an excuse for theoreticians to devise new laws of nature. Weinberg led the way for doing this with the anthropic principle, and part of the community is now busy inventing probability distributions for the multiverse. Another well-used way to explain the value of a constant is to make it dynamic, so that it can change over time. If set up nicely, the dynamic constant may prefer a small value, which supposedly explains something. Such generalized versions of the CC are referred to as dark energy.

If dark energy isn't just a CC, then the universe's acceleration changes slightly over time. There's no evidence for that. But there is an extensive literature on conjectured dark energy fields, like chameleon fields, dilaton fields, moduli, cosmons, phantom fields, and quintessence. Experiments are under commission.

And these are not the only invisible fields that cosmologists play with. There is also the inflaton field, the field used to puff up the early universe.

Inflation—The universe's rapid expansion right after the big bang—is a courageous extrapolation into the past, back to the time when the density of matter was much higher than the densities we have probed.

To make predictions coming from inflation, however, one first has to specify what the inflaton—the field invented to make inflation happen—does. This requires giving inflaton a potential energy, which will depend on several parameters. Once a potential is chosen, one can use inflation to calculate the distribution of the density fluctuations in the early universe. The result depends on the parameters in the potential, and for some of the simplest models the calculation fits well with observation.¹⁹ The same inflation models are also in good agreement with other observed properties of the cosmic microwave background.²⁰

...Hossenfelder: [Hos18a], Chapter 9, *The Universe, All There Is, and the Rest: Feeble Fields and Fifth Forces*, pp.208-211.

Since it is conventional wisdom (see [BCST], [Vi11], [Chr97], [NG91]) that the existence of anti-matter which could produce a repulsive, anti-gravitational, field is admitted by both general relativity and Newtonian gravity, we conclude from §20.D.b., Thesis 10, and §20.D.d., Thesis 12, that the commonly perceived barriers to modelling the behaviour of such a universe \mathcal{U} unambiguously in a mathematical language may be illusory, and reflect merely an attempt to ask of the language selected for such representation more than it is designed to deliver unequivocally.

More specifically, from the perspective of the *evidence-based* reasoning introduced in [An16] (see §2.), it can reasonably be argued that the commonly perceived barriers to modelling the behaviour of such a universe \mathcal{U} realistically in a mathematical language may reflect the fact that:

- (i) since the real numbers are defined by conventional wisdom in set-theoretical terms as the postulated limits of Cauchy sequences in a second-order *dichotomous*⁴⁹⁶ arithmetic such as ACA_0 ,
- (ii) the prevailing language of choice for representing physical phenomena and their associated abstractions (conceptual metaphors) mathematically is generally some language of Set Theory,

⁴⁹⁶Since we show how—in the case of Goodstein's Theorem—such a belief leads to a dichotomous conclusion in §19., Theorem 19.1.

- (iii) which admits axioms—such as an axiom of infinity—whose veridicality cannot be *evidence-based* under any putative, *well-defined*, interpretation of the theory,
- (iv) and in which the *dichotomy* highlighted in ACA_0 could admit a contradiction under any putative, *well-defined*, interpretation of the theory.

20.D.e. Have we reached the limits of what *can* be physically *evidenced*?

We note that Fig.2 in §20.C. is not a unique model for the ‘confinement’ properties of the universe \mathcal{U} . For instance, we could have started essentially similar iterations with a square $ABCD$ of side s .

Moreover, it is not necessary that each ‘black hole’ create isomorphic sub-universes; an assumption intended only to illustrate that an event such as an Ultimate Implosion is well-definable mathematically.

However, since the Ultimate Implosion is defined as corresponding to a mathematical limit as $n \rightarrow \infty$, and we postulate that there are no infinite processes in physical phenomena, it follows that the law determining such an Ultimate Implosion (as also the point of implosion of a ‘black hole’) may be of an essentially ‘unknowable’ quantum nature; in which case we cannot even assume in principle that a universe such as \mathcal{U} can be shown to *actually* exist on the basis of *evidence-based* reasoning, nor whether or not it would recycle identically each time (in either direction).

It may thus be worth considering further, by the principle of Ockham’s razor, whether the above simplistic mathematical model of the properties of a universe \mathcal{U} —which, defined as obeying Einstein’s equations and quantum theory, seems to fit our known experimental observations—can be taken to suggest that, as implicitly argued by physicist Sabine Hossenfelder, we may have reached the foundations of physics beyond which the laws of nature are essentially ‘unknowable’:

“So you want to know what holds the world together, how the universe was made, and what rules our existence goes by? The closest you will get to an answer is following the trail of facts down into the basement of science. Follow it until facts get sparse and your onward journey is blocked by theoreticians arguing whose theory is prettier. That’s when you know you’ve reached the foundations.

The foundations of physics are those ingredients of our theories that cannot, for all we presently know, be derived from anything simpler. At this bottommost level we presently have space, time, and twenty-five particles, together with the equations that encode their behaviour. ...

In the foundations of physics we deal only with particles that cannot be further decomposed; we call them “elementary particles.” For all we presently know, they have no substructure. But the elementary particles can combine to make up atoms, molecules, proteins—and thereby create the enormous variety of structures we see around us. It’s these twenty-five particles that you, I, and everything else in the universe are made of.

But the particles themselves aren’t all that interesting. What is interesting are the relations between them, the principles that determine their interaction, the structure of the laws that gave birth to the universe and enabled our existence. In our game, it’s the rules we care about, not the pieces. And the most important lesson we have learned is that nature plays by the rules of mathematics.”

... Hossenfelder: [Hos18a], p.6.

From the broader, multi-disciplinary, *evidence-based* perspective of this investigation, we view Hossenfelder as essentially arguing further—in [Hos18]—that committing intellectual and physical resources to seeking experimental verification for the putative existence of physical objects, or of a ‘Theory’, should:

- (a) only follow if such putative objects, or the putative elements of the ‘Theory’, can be theoretically defined—even if only in principle—in a categorical mathematical language, such as the first-order Peano Arithmetic, which has a finitary *evidence-based* interpretation that can, conceivably, admit unambiguous communication between any two intelligences—whether human or mechanistic;
- (b) and not merely on the basis that they can be conceptualised metaphorically and represented in a set-theoretical language such as ZF which, even though first-order, has no *evidence-based* interpretation that would admit unambiguous communication.

20.D.f. The crisis in physics is not only about physics

The issue, Hossenfelder passionately argues in her blog, is not only about physics.

“The crisis in physics is not only about physics

In the foundations of physics, we have not seen progress since the mid 1970s when the standard model of particle physics was completed. Ever since then, the theories we use to describe observations have remained unchanged. Sure, some aspects of these theories have only been experimentally confirmed later. The last to-be-confirmed particle was the Higgs-boson, predicted in the 1960s, measured in 2012. But all shortcomings of these theories—the lacking quantization of gravity, dark matter, the quantum measurement problem, and more—have been known for more than 80 years. And they are as unsolved today as they were then.

The major cause of this stagnation is that physics has changed, but physicists have not changed their methods. As physics has progressed, the foundations have become increasingly harder to probe by experiment. Technological advances have not kept size and expenses manageable. This is why, in physics today we have collaborations of thousands of people operating machines that cost billions of dollars.

With fewer experiments, serendipitous discoveries become increasingly unlikely. And lacking those discoveries, the technological progress that would be needed to keep experiments economically viable never materializes. It’s a vicious cycle: Costly experiments result in lack of progress. Lack of progress increases the costs of further experiment. This cycle must eventually lead into a dead end when experiments become simply too expensive to remain affordable. A \$40 billion particle collider is such a dead end.

The only way to avoid being sucked into this vicious cycle is to choose carefully which hypothesis to put to the test. But physicists still operate by the “just look” idea like this was the 19th century. They do not think about which hypotheses are promising because their education has not taught them to do so. Such self-reflection would require knowledge of the philosophy and sociology of science, and those are subjects physicists merely make dismissive jokes about. They believe they are too intelligent to have to think about what they are doing.

The consequence has been that experiments in the foundations of physics past the 1970s have only confirmed the already existing theories. None found evidence of anything beyond what we already know.

But theoretical physicists did not learn the lesson and still ignore the philosophy and sociology of science. I encounter this dismissive behavior personally pretty much every time I try to explain to a cosmologist or particle physicists that we need smarter ways to share information and make

decisions in large, like-minded communities. If they react at all, they are insulted if I point out that social reinforcement—aka group-think—befalls us all, unless we actively take measures to prevent it.

Instead of examining the way that they propose hypotheses and revising their methods, theoretical physicists have developed a habit of putting forward entirely baseless speculations. Over and over again I have heard them justifying their mindless production of mathematical fiction as “healthy speculation”—entirely ignoring that this type of speculation has demonstrably not worked for decades and continues to not work. There is nothing healthy about this. It’s sick science. And, embarrassingly enough, that’s plain to see for everyone who does not work in the field.

This behavior is based on the hopelessly naïve, not to mention ill-informed, belief that science always progresses somehow, and that sooner or later certainly someone will stumble over something interesting. But even if that happened—even if someone found a piece of the puzzle—at this point we wouldn’t notice, because today any drop of genuine theoretical progress would drown in an ocean of “healthy speculation”.

And so, what we have here in the foundation of physics is a plain failure of the scientific method. All these wrong predictions should have taught physicists that just because they can write down equations for something does not mean this math is a scientifically promising hypothesis. String theory, supersymmetry, multiverses. There’s math for it, alright. Pretty math, even. But that doesn’t mean this math describes reality.

Physicists need new methods. Better methods. Methods that are appropriate to the present century.

...I have said many times that looking at the history of physics teaches us that resolving inconsistencies has been a reliable path to breakthroughs, so that’s what we should focus on. I may be on the wrong track with this, of course. ...

Why don’t physicists have a hard look at their history and learn from their failure? Because the existing scientific system does not encourage learning. Physicists today can happily make career by writing papers about things no one has ever observed, and never will observe. This continues to go on because there is nothing and no one that can stop it."

... *Hossenfelder*: [Hos19].

Hossenfelder’s concerns were shared at a workshop in Munich in December 2015: “Why Trust a Theory? Reconsidering Scientific Methodology in Light of Modern Physics”:

“In a 2014 letter to *Nature* entitled “Scientific method: Defend the integrity of physics,” the noted cosmologists George Ellis and Joseph Silk expressed criticism of what they described as a dangerous tendency to soften principles of scientific reasoning in contemporary fundamental physics. This letter spurred the organization of a workshop in Munich in December 2015 entitled “Why Trust a Theory? Reconsidering Scientific Methodology in Light of Modern Physics.” The workshop brought together leading physicists, historians, and philosophers of science to discuss and debate a range of pressing epistemological issues that confront contemporary fundamental physics. The majority of the contributions to this book are based on talks delivered at this meeting. As such, what the reader will find is the fruits of a sustained and constructive critical engagement between the various contributors that has taken place both in print and in person. Additional contributions were solicited by the editors with the aim of ensuring as full and balanced presentation as possible of the various positions in the debate.”

... *Dardashti, Dawid and Thébault*: [DDT19], Preface.

According to Helge Kragh, one concern is ‘whether certain recent developments in theoretical physics belong to science proper’:

"In May 2008, there appeared in *New Scientist* an article with the provocative question: "Do we need to change the definition of science?" (Matthews, 2008). Six years later, *Nature* published the article "Scientific method: Defend the integrity of physics" (Ellis & Silk, 2014). Both articles discussed essentially the same question, namely whether certain recent developments in theoretical physics belong to science proper. For more than a decade there has been an ongoing and often heated dispute in the physics community, and also in some corners of the philosophical community, concerning the scientific status of theories such as superstring physics and multiverse hypotheses. These theories are cultivated by a fairly large number of professional physicists and, by ordinary sociological standards, are undoubtedly to be counted as scientific. But are they also scientific from an epistemic point of view, or does their status as branches of physics require an extension or revision of the traditional meaning of science?

The classical demarcation problem between science and non-science (which may or may not include pseudoscience) has taken a new turn with the appearance of fundamental and highly mathematical theories that may not be experimentally testable in the ordinary sense. So why believe in them? According to the philosopher Dudley Shapere (2000, pp. 159–61), "physics is in fact approaching, or perhaps has reached, the stage where we can proceed without the need to subject our further theories to empirical test." He asks, "Could empirical enquiry, which has guided upto a certain point science in its history, lead at that point to a new stage wherein empiricism itself is transcended, outgrown, at least in a particular domain?" More than a few physicists would presently respond affirmatively to Shapere's question. It should be noted that the demarcation problem and the traditional criteria of falsifiability and empirical testability are discussed not only by physicists but also in some other branches of science. For example, biologists have questioned these criteria and suggested, in striking analogy to the debate concerning multiverse physics, that methodological norms of what constitutes good science are not only irrelevant but actually detrimental to the progress of their science (Yang, 2008).

What it is all about can be summarized in the notion of "epistemic shifts," meaning claims that the basic methodological and epistemological rules of science are in need of revision (Kragh, 2011). These rules may be appropriate for most science and have been appropriate for all science until recently, but in some areas of modern physics they are no longer adequate and should therefore be replaced by other norms for the evaluation of theories. A proposed shift in epistemic standards may be of such a drastic nature that it challenges the very meaning of science as traditionally understood. In this case it effectively implies a new demarcation line separating what counts as science and what does not. This is what Steven Weinberg (2007) alluded to when he, referring to the string-based multiverse, said that "we may be at a new turning point, a radical change in what we accept as a legitimate foundation for a physical theory."

Another way of illustrating the notion of an epistemic shift is to compare it to Thomas Kuhn's idea of revolutions separated by different paradigms. Richard Dawid (2013, p. 124) speaks of the debate in the physics community as "a paradigm shift regarding the understanding of scientific theory assessment." According to the original version of Kuhn's philosophy of science, paradigm shifts include different criteria for what counts as acceptable science and also for evaluating theories. Rival paradigms carry with them rival conceptions of science; for this reason alone they are incommensurable. In principle, no rational argument can decide whether one paradigm is superior to a competing paradigm. The rhetoric of epistemic shifts has become part of modern physics. "We are in the middle of a remarkable paradigm shift in particle physics," asserts one physicist, referring to the anthropic string landscape (Schellekens, 2008, p. 1). According to another physicist, the multiverse promises "a deep change of paradigm that revolutionizes our understanding of nature" (Barrau, 2007, p. 16).

The purpose of this chapter is not to reexamine the recent debate concerning string theory and multiverse cosmology, but rather to look at it through the sharp lenses of the history of science. Although knowledge of the history of the physical sciences is of no direct relevance to the ongoing debate, it is of some indirect relevance. It may serve the purpose of correcting various mistakes and placing the subject in a broader historical perspective. Physicists may think that super-strings and the multiverse have ushered in a uniquely new situation in the history of science, but they are mistaken. There have been several cases in the past of a somewhat similar nature, if not of quite

the same scale. I modestly suggest that modern fundamental physics can in some sense learn from its past. Before turning to this past I shall briefly review what is generally and for good reasons considered the most important of the traditional standards of theory evaluation—namely that a theory must be testable."

... Kragh: [Kra19], pp.13-15

Kragh ruefully notes that, despite 'what is generally and for good reasons considered the most important of the traditional standards of theory evaluation—namely that a theory must be testable'—and everyone agreeing 'that actual and present testability, involving present instrument technologies or those of a foreseeable future, is preferable', that is where the agreement ends:

"To speak of the "definition" of science is problematic. There simply is no trustworthy methodological formulation that encapsulates in a few sentences the essence of science and is valid across all periods and all disciplines. Nonetheless, some criteria of science and theory choice are relatively stable, enjoy general acceptance, and have been agreed upon since the early days of the scientific revolution (Kuhn, 1977). Almost all scientists subscribe to the belief that testability is more than just a desideratum that scientists have happened to agree upon and that suited science at a certain stage of development. They consider it a *sine qua non* for a theory being scientific that it must be possible to derive from it certain consequences that can be proved right or false by means of observation or experiment. If there are no such consequences, the theory does not belong to the domain of science. In other words, although empirical testability is not a sufficient criterion for a theory being scientific, it is a necessary one. Einstein was a great believer in rationalism and mathematical simplicity and yet he was convinced that "Experience alone can decide on truth" (Einstein, 1950, p. 17). He is followed in this belief by the large majority of modern physicists, who often go to great lengths to argue that their theories, however speculative and mathematical they may appear to be, do connect with empirical reality. Lee Smolin (2004, p. 70) echoed Einstein when he concluded about the opposing views of string theory and loop quantum gravity that, "Because this is science, in the end experiment will decide."

Physicists working with string theory, multiverse cosmology, or related areas of fundamental physics are routinely accused of disregarding empirical testability and of replacing this criterion with mathematical arguments. These accusations are not quite fair (Johansson & Matsubaru, 2009; Dawid, 2013, p. 154). On the one hand, most physicists in these fields readily accept the importance of testability, admitting that empirical means of assessment have a higher epistemic status than non-empirical means. On the other hand, they stress the value of the latter methods, which sometimes may be the only ones available. At the same time they maintain that their theories have—or in the near future will have—consequences that at least indirectly can be tested experimentally. They have not really abandoned the commonly accepted view of experiment as the final arbiter of physical theory. "The acid test of a theory comes when it is confronted with experiments," two string theorists say (Burgess & Quevedo, 2007, p. 33). Unfortunately, the necessary experiments are in most cases unrealistic for the time being, but what matters to them is that predictions from the theories are not beyond empirical testability in principle.

Although one can identify a consensus view concerning testability, it is to some extent rhetorical and of limited practical consequence. It is one thing to agree that theories of physics must be testable, but another thing to determine the meaning of the concept of testability where there is no corresponding consensus. Everyone agrees that actual and present testability, involving present instrument technologies or those of a foreseeable future, is preferable, but that is where the agreement ends."

... Kragh: [Kra19], pp.15-16

Kragh traces the roots of the present disquietude to the dichotomy between the demands of 'empirical testability' and 'the principle of plenitude, which essentially states that whatever is conceived as possible must also have physical reality':

“As mentioned, empirical testability is an almost universally accepted criterion of science. But even with respect to this most sacred of the defining features of science, we find in the history of science a few exceptions. It is, after all, not a necessary ingredient of science. Dawid (2013, p. 97) argues that the role played by non-empirical theory assessment in modern fundamental physics is a continuation of earlier tendencies to be found in post-World War II particle physics. This is undoubtedly correct—think of the development of S-matrix or “bootstrap” theory in the 1950s and 1960s—but in my view there is no reason to restrict the historical perspective to the era of quantum and relativity physics. There are also inspiration and instruction to be found in other and earlier examples from the history of physics.

During the early decades of the nineteenth century Romantic natural philosophy (known as Naturphilosophie) made a great impact on physics and the other sciences in Northern Europe (Cunningham & Jardine, 1990; Kragh, 2011, pp. 26–34). In this grand attempt to revolutionize science and base it on an entirely new foundation, speculations and aesthetic sentiments were not just considered legitimate parts of science, they were necessary parts and even more fundamental than empirical investigations. The philosopher Friedrich Schelling, the spiritual leader of the Naturphilosophie movement, even founded a Journal of Speculative Physics as a means of promoting and communicating the new science. At the time the term “speculation” did not have the pejorative meaning it typically has today but rather was largely synonymous with “intuition.” It was a fundamental assumption of the new speculative physics that mind and nature coexisted as a unity, such that one was unable to exist without the other. Schelling and those who followed his thinking were not necessarily against experiments, but they thought that measuring the properties of objects and phenomena was of no great importance since it provided no understanding of the inner working of nature. In some cases natural philosophers went so far as to completely deny that observation and experiment could lead to any real insights into nature’s secrets. The sort of nature that could be empirically investigated was regarded as a dull wrapping that contained and obscured the real, non-objective nature. The only way to recognize the latter was by taking the route of speculative physics—that is, to be guided by the intuitive mind of the genius. The laws of nature were thought to coincide with the laws of reason; they were true a priori and for this reason it made no sense to test them by means of experiment. Before dismissing Romantic natural philosophy as nothing but pseudo scientific and metaphysical nonsense, it should be recalled that some of the greatest physicists of the time were much influenced by this movement. Examples include H. C. Ørsted and Michael Faraday, the two celebrated pioneers of electromagnetism; another example is J. Ritter, the discoverer of ultraviolet radiation. Nonetheless, one cannot conclude from the case that good physics can flourish in the absence of experimental testing of theories. Neither Ørsted, nor Faraday, nor Ritter subscribed to Schelling’s more extreme ideas and especially not to his disrespect of experiment. Ørsted’s belief in a unity of electric and magnetic forces was rooted in the Romantic philosophy, but it was only when he verified it experimentally in 1820 that he turned it into a scientific discovery.

More than a century later we meet a very different version of rationalistic physics in the context of “cosmophysics,” an ambitious attempt to formulate a complete and final theory of the universe and all what is in it. The leading cosmophysicists of the 1930s were two of Britain’s most reputed scientists, Arthur Eddington and E. Arthur Milne. Although their world systems were quite different, both aimed at reconstructing the very foundation of physics; they did so by basing physics on a priori principles from which the laws of nature could be uniquely deduced by pure reason. Experimental tests played but an insignificant role, being subordinated logical and mathematical arguments. Milne seriously believed that when his system of world physics (as he called it) was completed there would be no contingent elements at all in the laws of nature; it would then turn out that the laws were no more arbitrary than the theorems of geometry. A mathematician knows whether a theorem is true or not without consulting nature. Likewise, Milne (1948, p. 10) wrote that “it is sufficient that the structure [of world physics] is self-consistent and free from contradiction.” Eddington’s idiosyncratic fundamental theory promised a way to deduce unambiguously all the laws and constants of nature from epistemic and mathematical considerations. In his bold attempt to unify cosmology and the quantum world, mathematics played a role no less elevated than in Milne’s theory (Eddington, 1936, p. 3; Durham, 2006):

It should be possible to judge whether the mathematical treatment and solutions are correct, without turning up the answer in the book of nature. My task is to show that our theoretical resources are sufficient and our methods powerful enough to calculate [of nature] the constants exactly—so that the observational test will be the same kind of perfunctory verification that we apply to theorems in geometry.

Of course, neither Milne nor Eddington could afford the luxury of disregarding experiments altogether. But they argued that experiments did not reveal the true laws of nature and consequently could not be used to test the laws. Eddington famously calculated the precise values of many of the constants of nature such as the fine-structure constant, the proton-to-electron mass ratio, and the cosmological constant. When experiments failed to agree with the predicted values he arrogantly maintained that the theory was correct; any discrepancy between theory and experiment must lie with the latter. The theories of Milne, Eddington, and their few followers shared the same fate as the revolutionary Romantic natural philosophers: they were unproductive mistakes and are today relegated to the long list of grand failures in the history of science. All the same they are of some relevance in that aspects of the same aspirations and rationalist methods can still be found in modern physics. The most extreme version is probably the Platonic “mathematical universe hypothesis” proposed by Max Tegmark (2014). Likewise, the history of string theory includes examples that show at least some similarity to the earlier ideas of cosmophysics. Referring to the theory of superstrings, John Schwarz (1998, p. 2) wrote, “I believe that we have found the unique mathematical structure that consistently combines quantum mechanics and general relativity. So it must almost certainly be correct.”

Unfortunately the prediction of supersymmetric particles remained unverified, but this did not worry Schwarz too much: “For this reason, even though I do expect supersymmetry to be found, I would not abandon this theory if supersymmetry turns out to be absent” (p. 2). Thus one can conclude from the history of physics that fundamental theories, to be successful from a physical (and not merely mathematical) point of view, must have some connection to empirical reality. The historical record of such theories suggests that empirical testability is a necessary condition for progress. But this is as far as the historical argument can go. Because one can observe some regularity in the past—say, that all physically progressive theories have been actually testable—there is no guarantee that the regularity will continue in the future. Many of the arguments in string theory and multiverse physics rely implicitly on two philosophical principles that can be traced back to Leibniz in the late seventeenth century. One is the doctrine of a pre-established harmony between the mathematical and physical sciences, making pure mathematics the royal road to progress and unification in physics (Kragh, 2015). The other is the principle of plenitude, which essentially states that whatever is conceived as possible must also have physical reality. The plenitude principle is a metaphysical claim that translates potential existence into real existence. In its more modern formulation it is often taken to mean that theoretical entities exist in nature insofar that they are consistent with the fundamental laws of physics. Since numerous universes other than ours are consistent with the equations of string theory they must presumably exist (Susskind, 2006, p. 268). The ontological plenitude principle has played a most important role in the history of science and ideas, including modern theoretical physics from Dirac’s positron to Higgs’s boson. Although in many cases it has been dramatically fruitful, it cannot be justified by reference to its historical record. For every example of success, there is one of failure. If the former are better known than the latter, it is because history is written by the victors. In this case, as in many others, the history of science is ambiguous. It does not speak unequivocally in favor of either the principle of plenitude or a pre-established relationship between mathematics and physics; nor does it speak unequivocally against the doctrines.”

... Kragh: [Kra19], pp.20-23

From the *evidence-based* perspective of the Complementarity Thesis (§1., Thesis 1) of this investigation the deeper, foundational, issue intuited here by Hossenfelder—which needs to be addressed from a philosophical perspective concerning cognition that verily transcends that of physics—is that of a mathematical education (see §28.) which ignores the need for *evidence* when claiming that the provable propositions of a formal mathematical theory that

admits—unarguably unambiguous—symbolic representation of our primary and secondary conceptual metaphors in the language of the theory, *must* interpret as true in the structure, say *ExternalReality*, which gave birth to the primary conceptual metaphors that the theory was initially intended, and designed, to represent symbolically—even when there is no *evidence-based* interpretation of our secondary conceptual metaphors in the *ExternalReality*!

Consequently, as Hossenfelder emphasises and rhetorically queries ([Hos19]):

- "... what we have here in the foundation of physics is a plain failure of the scientific method. All these wrong predictions should have taught physicists that just because they can write down equations for something does not mean this math is a scientifically promising hypothesis. String theory, supersymmetry, multiverses. There's math for it, alright. Pretty math, even. But that doesn't mean this math describes reality."
- "Why don't physicists have a hard look at their history and learn from their failure? Because the existing scientific system does not encourage learning. Physicists today can happily make career by writing papers about things no one has ever observed, and never will observe."

However, from an *evidence-based* perspective, the failures which Hossenfelder ascribes to individual limitations—in transcending the scientific method of one's education—seem more systemic; they seem symptomatic of a mathematical education in which postulation of putative mathematical limits—such as that, say, of Hawking's radiation, or of Einstein's equations of General Relativity at the putative 'Big Bang'—might mistakenly be taught, and accepted, as describing a plausible reality.

Mistakenly since the mathematical states which such mathematical/Cauchy limits postulate are purely platonic; and, in the absence of experiential evidence to the contrary, the actual physical phenomena that corresponds to what the extrapolated mathematical limits purport to describe might, sometimes (see §20.C.a. to §20.D.c.), be discontinuities corresponding to phase changes of the system that are not reflected in (and, conceivably, not expressible in), and therefore not entailed by, the postulates of the theory.

So, might the systemic failure be not of the scientific method, but of *fragile* (see §7.B.) philosophic underpinnings of a classical mathematical education (see also §28.) that we might—innocently and unquestioningly—have committed to in our formative years?

CHAPTER 20. PARADIGM CHALLENGING CONSEQUENCES

21. The significance of *evidence-based* reasoning for the Gödelian Thesis and a Turing Test

In his seminal 1931 paper [Go31] on formally undecidable arithmetical propositions, Kurt Gödel informally argues that, in a formal language as basic as Peano Arithmetic—which is considered as the foundation for all, significant, formal mathematical languages—there are well-defined formulas which can be recognised as intuitively true under a classical interpretation of the Arithmetic, but which are not formally provable within the Arithmetic.

The question immediately arises:

Query 19. *Does recognition of the ‘truth’ of Gödel’s formally undecidable arithmetical proposition under the classical standard interpretation of a Peano Arithmetic imply that such recognition cannot be duplicated in any artificially constructed mechanism or organism whose design is based on classical logic?*

Query 19 suggests further that:

Thesis 13. (Gödelian Thesis) *Gödel’s construction of an arithmetical proposition that is not provable in Peano Arithmetic, but true under interpretation if the Arithmetic is consistent, entails that there can be no mechanistic model of human reasoning.*

We note that Lucas and Penrose essentially address Query 19 in their Gödelian Arguments for their respective theses (§21.A., Thesis 14, and §21.B., Thesis 15).

However, both Arguments—as considered by their respective authors—have been criticized widely (see, for instance, [Pic03], [FG12], [Avr20], [Bu20], [Chg20], [Ksh20]⁴⁹⁷, [Hlb20], [Kr20], [Raa20], [Ruc20], [Vss20])—and, as we shall show, not unreasonably—by mathematicians, computer scientists, and philosophers; the *only* consensus among experts in these fields being that Lucas’ and Penrose’s specific argumentations fail to sustain their respective claims.

As remarked by John Burgess:

“...the consensus view of logicians today seems to be that the Lucas—Penrose argument is fallacious, though as I have said elsewhere, there is at least this much to be said for Lucas and Penrose, that logicians are not unanimously agreed as to where precisely the fallacy in their argument lies. There are at least three points at which the argument may be attacked.”

... Burgess: [Bur10], p.131-132

Hannes Leitgeb too remarks that both Lucas’ and Penrose’s arguments for their respective Mechanistic Theses are yet to be accepted as sound:

“In a nutshell: what mathematicians mean when they speak of proof and provability, and what they do when they actually decide whether something is a proof, seems to differ substantially from what we called derivation and derivability in a formal system. “Real” provability does not seem to

⁴⁹⁷“In the present section, our tasks are, first, to provide a sharp(ish) formulation of mechanism; second, to give a correspondingly sharp rendering of Lucas’s famous Gödelian anti-mechanist argument; and finally, to topple this argument from several angles.” ... Kashtan: [Ksh20], p.219.

be relativized to any formal system but is rather absolute and informal (as was emphasized by Gödel himself, and later again by John Myhill in his "Some Remarks on the Notion of Proof"—see Myhill 1960).¹⁷ So how exactly does absolute/informal proof and provability relate to proof and provability in formal systems?

Surprisingly, some information about this can be derived from the Incompleteness Theorems again. On their basis, it turns out to be possible to prove significant statements even about computability, the human mind, and the in-principle proving capabilities of human mathematicians. Indeed, this is a point at which artificial intelligence and cognitive science meet logic and the philosophy of mathematics. And logical methods are found to throw some light even on provability in the sense of mathematical practice (or at least on something close to that).¹⁸

Let

- T be the set of *true arithmetical* statements,
- K be the set of *humanly knowable arithmetical* statements,
- S_e be the set of all arithmetical statements *enumerated by the computer (Turing machine) e* according to the program of that computer,
- K' be the set of *humanly knowable* statements.

...

Here are two arguments for theses that are philosophically important, where each of the arguments relies on one of the Incompleteness Theorems:

...

Thesis 1: Mechanistic Thesis $\rightarrow K \neq T$

...

Thesis 2: Mechanistic Thesis (and provability conditions) \rightarrow ' $K = S_e$ ' is not a member of K' .

...

Both thesis 1 and thesis 2 are material implications. By classical propositional logic, they can be reformulated in terms of the following disjunctions:

The Mechanistic Thesis is false or $K \neq T$.

and

The Mechanistic Thesis is false (or the provability conditions are false) or ' $K = S_e$ ' is not a member of K' .

The former thesis says: Either what we can know in principle about arithmetic surpasses the powers of any Turing machine, or there are arithmetical statements A and $\neg A$ for which we are for principled reasons unable to decide whether A is true or $\neg A$ is true. This is Kurt Gödel's famous dichotomy which he himself derived from his Incompleteness Theorems in his Gödel(1995).¹⁹ The other thesis amounts to, if we ignore the part on the provability conditions (which one would need to make much more precise anyway): Either what we can know in principle about arithmetic surpasses the powers of any Turing machine, or for principled reasons we cannot know which Turing machine enumerates all and only those arithmetical truths that we can know to be true.

Is it perhaps possible to do better than these theses? That is: Is it possible to argue on the basis of the Incompleteness Theorems in favour of one of the disjuncts rather than "merely" in favour of the disjunctions from above? John Lucas (1961) and Roger Penrose (1989) thought so, when they tried to argue in such a manner just for the falsity of the Mechanistic Thesis, but careful philosophical and logical analysis of their arguments (which is still ongoing) indicates that none of their arguments is sound."

... *Leitgeb*: [Lei10], §8.

An almost isolated, and unusually empathetic, perspective towards Lucas' and Penrose's anti-mechanist Gödelian arguments is sought to be projected by Paula Quinon in her recent rebuttal of Stanislaw Krajewski's [Kr20]:

“The Lucas' anti-mechanist argument based on Gödel's incompleteness theorems consists of two parts. Firstly, Gödel's results establish that each sufficiently rich consistent theory admits a Gödel sentence and also that none such theory can prove its own consistency.

Let T be a consistent theory containing arithmetic, let ϕ_T be the Gödel's sentence for the theory T .

$$\begin{aligned} \text{Con}(T) &\rightarrow T \not\vdash \phi_T \\ \text{Con}(T) &\rightarrow T \not\vdash \text{Con}(T) \end{aligned}$$

Moreover, it is broadly known that an inconsistent theory proves any sentence, but Gödel's incompleteness theorems do not apply to an inconsistent theory.

Secondly, human mathematicians can work with subsequent increasingly stronger theories,

$$\begin{aligned} T_1 &= T \cup \text{Con}(T) \\ T_2 &= T_1 \cup \text{Con}(T_1) \end{aligned}$$

⋮

$$T_{n+1} = T_n \cup \text{Con}(T_n)$$

which—for some defenders of the anti-mechanist argument—signifies that human mathematicians outperform machines. Krajewski objects to this view claiming that the construction of the hierarchy can be fully mechanised. In consequence, he claims that the ability to construct and work with the hierarchy of increasingly stronger theories alone is not sufficient for formulating the anti-mechanist argument. As stated by Krajewski, additional assumptions are missing.

In addition to Gödel's results, at least two assumptions that are not self-evident are used in the above reasoning. First, every exact proof of our consistency can be formalized, second, it is possible to express “our consistency”. [...] If this is accepted, one could question the second point. It is not clear at all how one can express “our consistency”. Basically there are two options to express this: either (i) by the common sense statement “I am consistent” or (ii) by a formal counter-part to this statement. Let us consider them in turn.

In case (i) we refer to a common sense statement, which have no connection to formal considerations. Hao Wang (1974, pp. 317–320) reflected on just this statement and believed that it is not provable. [...] If that were possible, it would mean that we are not machines, or that we are not even equivalent to machines in the realm of proof-producing reasoning. We certainly may believe that, but it is no more than a general feeling.

In case (ii) we consider the formal counterpart to a loose statement expressing consistency [...]. The usual meaning of the statement refers to the will to avoid contradictions, to the reliability of our vision of the world, to the claim that the methods used by mathematicians are unfailing. The sentence *Cons* or any other similar arithmetical formula is rather far from those ideas. Thus, while something is strictly proved, it is unclear to what extent the conclusion conveys our consistency. (2020, pp.47–48)

Krajewski's reasoning can be reconstructed as follows. Applying the formal predicate "being consistent" can only apply to a formal theory. Applying the formal predicate "being consistent" to anything else than a formal theory is a categorical mistake. In consequence, if "consistency" is to be a predicate applying to on the human mind, the mind must have certain formal properties and needs to be identified with a theory. The following options exist:

- If human mind is a theory and it is consistent, then as to all other theories, a Gödel's sentence applies to it and the human mind encounters the same constraints as any theory (a machine).
- If the human mind is a theory and it is inconsistent, then Gödelian argument limitations do not apply at all.

If the human mind is a theory, a human disposing of a mind cannot know—from the formal point of view—if it is consistent or not. In consequence, in order to prove that the human mind outperforms a machine, a second extra-formal additional assumption needs to be made. It has to be assumed that the human mind is indeed consistent. This assumption can be done in one of the two ways. "Case (i)", "I am consistent" cannot be formalised. "Case (ii)", there exists a formal counterpart of "I am consistent".

My analysis of "case (i)" is in line with the analysis of Krajewski. If "I am consistent" is an informal statement, it is useless for any formal proof. And here we speak of being able to prove more than a machine. Whereas Lucas' argument is supposed to be a formal proof of the superiority of the human mind over a machine.

My analysis of "case (ii)" differs from Krajewski's analysis. His argument returns to the idea that each formalisation of the informal "I am consistent" remains—maybe more informed or more precise—but is still an informal account. As such it is useless for any formal proof. I think that the conclusion from (ii) is different. An agent can find a formal counterpart of the statement "I am consistent", or rather "the theory constituting my mind is consistent". The frame-work of the Carnapian explications enables us to understand how it can be done.

I also assume that an agent can recognise their own consistency. This insight is available to a human being, while it is—on the grounds of the second of Gödel's incompleteness theorem—unavailable to a machine. This extra-formal assumption is necessary for formulating an anti-mechanist argument against the computability of the mind. It is also exactly at this point where a vicious circle occurs. We are in the act of proving that the human mind outperforms a machine, and so one cannot in this proof assume that human mind is consistent.

Another possible extra-formal assumption that can be made in order to enable the anti-mechanist argument based on Gödel's incompleteness theorem, is the ability to refer to the intended model of arithmetic.¹⁴ Instead of assuming that the human mind is consistent (i.e., assuming that the theory underlying all human reasoning is a consistent theory, which does not prove both a ϕ and a $\neg\phi$, for every ϕ), in order to use Gödel's incompleteness theorems to support the anti-mechanist argument, one can assume that the human mind is able to refer to the intended model of arithmetic. The assumption that the human mind can refer to the intended model of arithmetic disables the possibility that the Gödel sentences get to have non-standard Gödel numerals.

In the way it is usually interpreted—in particular in the context of philosophical argumentation supporting the anti-mechanist argument that the human mind is non-computable—Gödel's incompleteness theorems provide us with the information from the perspective of a formal system. The semantical aspect is taken for granted. When the model-theoretical reasoning is applied, Gödel's incompleteness theorems indicate that there exist non-standard models in which the (non-standard) Gödel number of the proof for Gödel's incompleteness theorems has its (semantical) reference. It also means, that there exist models where the Gödel (non-standard) number of the proof for the negation of Gödel's first theorem, has an interpretation as a (non-standard) natural number.

What is famously referred to by Gödel's platonism is his belief that there is a model of arithmetic in which all arithmetical truths are satisfied. This is obviously not the intended model of arithmetic that humans have privileged cognitive access to, but the model of arithmetic in objective mathematics (Gödel, *1951)."

... Quonon: [Quon20], §8. *The Lucas-Penrose Argument and Extra-Formal Concepts.*

However Quonon's effort—in defence of anti-mechanism—to introduce 'extra-formal' assumptions that would allow a human intelligence to refer reliably to an 'intuitive truth', and an 'intended' model of arithmetic (see [QZ07]; also the excerpt quoted in §7.K.), is weakened by her treating these:

- as adjunct—possibly dichotomous—insights which could conceivably be constrained by Gödel's reasoning, but which are unavailable to a machine intelligence 'on the grounds of the second of Gödel's incompleteness theorem';
- rather than as necessary, *pre-formal*, insights that, as argued by Markus Pantsar in [Pan09] (and along similar lines by Roman Murawski in [Mur20]), must not only precede formal reasoning, and be a justification for it (as argued in §1.A.), but also be, in turn, validated as a Carnapian explication by a well-defined Tarskian interpretation of the arithmetic as is implicitly posited in the Complementarity Thesis (§1., Thesis 1; also §13.C.).

We shall show that this reflects the curious situation that not only Lucas' and Penrose's Arguments against reductionism, but also the common critiques of the Arguments, are equally fragile because they base their argumentations on the same assumption; they all appeal uncritically to classically inherited paradigms in which it is assumed—albeit implicitly—that there is a 'humanly knowable' arithmetical truth which is 'absolute' in some sense, and not well-definable under any Tarskian interpretation of the first-order Peano Arithmetic PA.

In order to, therefore, highlight the fragility of the implicit assumptions underlying Lucas' and Penrose's Gödelian Arguments, as well as those of their common critiques, we shall treat the following as informal summaries of the substance of Lucas' (see §21.A.) and Penrose's (see §21.B.) respective arguments, and those of their common critiques:

- (a) *Lucas*: If we can treat intuitive arithmetical truth as well-defined meta-mathematically, then Gödel's reasoning entails that there can be no mechanistic model of human reasoning.

Common critique: Since intuitive arithmetical truth is not well-definable meta-mathematically, we cannot conclude formally from Gödel's reasoning—as Lucas seemingly does—that there can be no mechanistic model of human reasoning.

- (b) *Penrose*: Gödel's construction of a formally unprovable, but Platonically/intuitively true, arithmetical proposition entails that, unlike human reasoning, no mechanistic reasoning can assign unique Tarskian satisfiability and truth values recursively to the propositions of any Peano Arithmetic under its standard interpretation.

Common critique: If we can only assign unique Tarskian satisfiability and truth values Platonically/intuitively to the propositions of a Peano Arithmetic under its standard interpretation, then we cannot conclude formally from Gödel's reasoning—as Penrose seemingly does—that there can be no mechanistic model of human reasoning.

However, since the relatively recent paper [An16] shows that, from an *evidence-based* perspective (see §2.), arithmetical truth is well-definable both meta-mathematically and mathematically (in two, hitherto unsuspected, ways—see §2.(1a) and §2.(1b)), we shall argue the thesis that Lucas’s Gödelian Argument (see §21.A.) is essentially validated (see §21.D.).

Moreover, we shall argue that if we replace ‘Platonically/intuitively’ by ‘non-recursively’, then Penrose’s Gödelian Argument (see §21.B.) too can be treated as essentially validated by the evidence-based paradigm within which the arguments of [An16] are situated.

21.A. Lucas’ perspective on the Gödelian Argument

An affirmative anti-mechanist argument for Query 19 was originally offered by Lucas in his 1961 paper [Lu61], where he essentially argued—purely on non-formal, philosophical, grounds—the thesis that Gödel’s seminal 1931 paper [Go31] on formally undecidable arithmetical propositions entails:

Thesis 14. (Lucas’ Gödelian Thesis) *There can be no mechanistic model of human reasoning.*

The best perspective of what Lucas’ Gödelian argument is, and what it is not, is provided by Lucas himself in his 1996 revisiting of the Argument in [Lu96], where we note in particular his conclusion:

“Thus, though the Gödelian formula is not a very interesting formula to enunciate, the Gödelian argument argues strongly for creativity, first in ruling out any reductionist account of the mind that would show us to be, au fond, necessarily unoriginal automata, and secondly by proving that the conceptual space exists in which it (is) intelligible to speak of someone’s being creative, without having to hold that he must be either acting at random or else in accordance with an antecedently specifiable rule”.

... Lucas: [Lu96].

One reason Lucas’ Gödelian Thesis 14 has not received the consideration it deserves from purists could be that Lucas’, essentially informal, perspective uncritically assumes, in his following argument, that finitary arithmetical provability entails a *unique*, preferred, arithmetical truth under interpretation over the domain \mathbb{N} of the natural numbers:

“... in the case of First-order Peano Arithmetic there are Gödelian formulae (many, in fact infinitely many, one for each system of coding) which are not assigned truth-values by the rules of the system, and which could therefore be assigned either TRUE or FALSE, each such assignment yielding a logically possible, consistent system. These systems are random variants, all satisfying the core description of Peano Arithmetic. But among them there is one, the one that assigns TRUE to all the Gödelian formulae which is reasonable, characterizing standard arithmetic, although not more in accordance with the specification of Peano Arithmetic than any of the others. So there is some sort of reasonableness, picking out this one instantiation of the specification in preference to all the others which is reasonable and right, though not any more in accordance with the antecedently formulated rules than any other instantiation.”

... Lucas: [Lu96].

Comment 167. Lucas’ above argumentation in [Lu96]—as distinct from his Gödelian Thesis 14—was logically debatable even at the time, as noted by Burgess in [Bur10] (pp.131-132). It is now falsified by the *evidence-based* paradigm introduced in [An16] (see §2.), which shows that PA has, in fact, *two* constructively defined interpretations over the domain \mathbb{N} of the natural numbers (see §2.(1a) and §2.(1b)), and which further establishes PA as categorical (see §2.E.b., Corollary 2.18).

21.A.a. The cognitive significance of Lucas' Gödelian Argument

The cognitive significance of Lucas' original Gödelian argument is highlighted by Jason Megill:

"One reason Lucas's argument has received so much attention is that if the argument succeeds, the widely influential Computational Theory of Mind is false. Likewise, if the argument succeeds, then "strong artificial intelligence" is false; it is impossible to construct a machine that can perfectly mimic our cognitive abilities. But there are further implications; for example, a view in philosophy of mind known as Turing machine functionalism claims that the human mind is a Turing machine, and of course, if Lucas is right, this form of functionalism is false. (For more on Turing machine functionalism, see Putnam (1960)). So clearly there is much at stake."

... Megill: [Meg]

The ramifications of Lucas' thesis (§21.A., Thesis 14)—against a reductionist account of the mind—also raise issues for the natural sciences that lie, and deserve consideration, beyond the formal argumentation of this investigation.

Validating such a thesis could, conceivably, also have broader economic significance globally, particularly in areas relating to the development of strategic and infra-structural products, facilities, and services that are based on the proposed replication of human intelligence by artificial mechanisms or organisms.

However, we shall restrict ourselves here to only the immediate, formal, consequences of addressing the Mechanist's counter-argument against the Gödelian Thesis 13 (see also [An07a], [An07b] and [An07c]):

"The Mechanist claims to have a model of the mind. We ask him whether it is consistent: if he cannot vouch for its consistency, it fails at the first examination; it just does not qualify as a plausible representation, since it does not distinguish those propositions it should affirm from those that it should deny, but is prepared to affirm both indiscriminately. We take the Mechanist seriously only if he will warrant that his purported model of the mind is consistent. In that case it passes the First Public Examination, but comes down at the Second, because knowing that it is consistent, we know that its Gödelian formula is true, which it cannot itself produce as true. More succinctly, we can, if a Mechanist presents us with a system that he claims is a model of the mind, ask him simply whether or not it can prove its Gödelian formula (according to some system of Gödel numbering). If he says it can, we know that it is inconsistent, and would be equally able to prove that 2 and 2 make 5, or that $0 = 1$, and we waste little time on examining it. If, however, he acknowledges that the system cannot prove its Gödelian formula, then we know it is consistent, since it cannot prove every well-formed formula, and knowing that it is consistent, know also that its Gödelian formula is true.

In this formulation we have, essentially, a dialogue between the Mechanist and the Mentalist, as we may call him, with the Mechanist claiming to be able to produce a mechanist model of the Mentalist's mind, and the Mentalist being able to refute each particular instance offered."

... Lucas: [Lu96].

Comment 168. We note that Lucas implicitly argues here that if the first-order Peano Arithmetic PA is consistent, then we can treat arithmetical truth as well-definable meta-mathematically under the *weak*, standard, interpretation $\mathcal{I}_{PA(\mathbb{N}, SV)}$ (see §2.B.) of PA.

This has attracted the valid criticism that since the *weak*, standard, interpretation $\mathcal{I}_{PA(\mathbb{N}, SV)}$ of PA is not finitary, arithmetical truth cannot be treated as well-definable meta-mathematically under the standard interpretation.

However, since [An16] also (see §2.(1a)-(1b)) *well-defines* arithmetical truth finitarily such that the axioms of PA interpret as true under a *strong*, finitary, interpretation $\mathcal{I}_{PA(\mathbb{N}, SC)}$ of PA, and

the rules of inference of PA preserve such truth under the interpretation $\mathcal{I}_{PA(\mathbb{N}, SC)}$ (see §2.C.a., Theorem 2.15)—whence PA is finitarily consistent (see §2.C.a., Theorem 2.16)—we can strengthen Lucas’ argument (see §13(a)) by eliminating its reliance upon the definition of arithmetical truth under the standard, non-finitary, interpretation $\mathcal{I}_{PA(\mathbb{N}, SV)}$ of PA.

The Mechanist’s argument can now be viewed, and refuted, from a broader perspective (than that of [An07a], [An07b] and [An07c]) which admits an *evidence-based*, Wittgensteinian, distinction between:

- (1) meta-mathematically proven, i.e., algorithmically *verifiable* (see §2., Definition 7), ‘truth’; and
- (2) mathematically proven, i.e., algorithmically *computable* (see §2., Definition 10), ‘truth’;

to which §21.D., Theorem 21.1 appeals.

In other words, the importance of differentiating (as detailed in [An16]; see also §2.) between:

- (i) the *strong*, algorithmically *computable*, ‘truth’—of the provable formulas of a formal mathematical language L —definable by *finitary mathematical* reasoning from the axioms and rules of inference of L under a *strong evidence-based* interpretation; and
- (ii) the *weak*, algorithmically *verifiable*, ‘truth’—of the provable formulas of L —definable *only* by *non-finitary meta-mathematical* reasoning from the axioms and rules of inference of L under a *weak evidence-based* interpretation;

is implicit in, and an essential component of, Timm Lampert’s interpretation of Ludwig Wittgenstein’s objection (in the latter’s ‘notorious’ paragraph in [Wi78]; see §12.B.) to the conclusions that Gödel drew from his undifferentiated *mathematical* and *meta-mathematical* reasoning in his ‘undecidability’ paper [Go31]:

“The most crucial aspect of any comparison of two different types of unprovability proofs is the question of what serves as the “criterion of unprovability” (I, §15). According to Wittgenstein, such a criterion should be a purely syntactic criteria independent of any meta-mathematical interpretation of formulas. It is algorithmic proofs relying on nothing but syntactic criteria that serve as a measure for assessing meta-mathematical interpretations, not vice-versa.”

... Lampert: [Lam17].

From the *evidence-based* perspective of this investigation, the distinction can be viewed as formalising the intent Lampert ascribes to Wittgenstein’s objection—towards conflating mathematical and meta-mathematical entailments—by showing that:

- (a) whereas the Mechanist correctly argues (see [An07a]) that, for any *specified* numeral $[n]$, a Turing machine can always *mathematically* prove that Gödel’s arithmetic formula $[R(n)]$ (as defined in §21.D., Theorem 21.1) is a theorem in the classical first-order Peano Arithmetic PA;
- (b) *no* Turing machine can *mathematically* prove that the arithmetical formula $[R(x)]$ with Gödel number r (as defined in §21.D., Theorem 21.1)—or, equivalently by Generalisation, the PA-formula $[(\forall x)R(x)]$ with Gödel number $17Gen\ r$ —is a theorem in PA; and, ipso facto, *meta-mathematically* conclude—as a human intelligence *can*—that a mechanical intelligence too *could*, for any *unspecified* numeral $[n]$, prove that Gödel’s arithmetic formula $[R(n)]$ is a theorem in PA.

Moreover, the distinction now admits:

- A formal validation (see §21.D., Theorem 21.1) of the Gödelian Argument (Thesis §21., 13); and
- A definitive Turing Test (see §21.E., Query 22) that seeks to affirmatively answer Alan Turing’s earlier, but related, query—in his 1950 paper on computing machinery and intelligence (see [Tu50])—as to whether it is possible to definitively differentiate between a human intelligence and a mechanical intelligence.

21.B. Penrose’s perspective on the Gödelian Argument

The broader scientific, and philosophical, dimensions of Lucas’ perspective on the Gödelian Argument—which can be viewed as seeking to answer §21., Query 19, affirmatively—were reviewed, and sought to be addressed more extensively, by Penrose (in [Pe90] and [Pe94]) from a more formal mathematical perspective, where he addresses the Gödelian Argument (Thesis §21., 13) from the perspective of Turing’s seminal 1936 paper [Tu36] on computable numbers, by essentially addressing the question:

Query 20. *Are the concepts ‘non-algorithmic’ and ‘non-constructive’ necessarily synonymous in classical logic and mathematics?*

Penrose’s perspective is based on a strongly Platonist thesis that sensory perceptions simply mirror aspects of an ‘ideal’ universe that exists, and will continue to exist, independent of any observer (see [Pe90], pp.123-128, pp.146-151).

On this view, individual consciousness would be a discovery of what there is, or can conceivably be, in such a universe; and be independent of the language in which such discovery is expressed. It follows that recognition of intuitive truth would be individually asserted—and, implicitly, fallible—correlations between the unverifiable—and, ipso facto, infallible—intuitive experiences of an individual consciousness, and the formal expressions of a communicable language.

The issue, then, is whether classical logic can adequately formalise intuitive truth, to make it infallible, or whether such recognition is essentially fallible.

Penrose apparently believes in a Platonic mathematical reality which manifests itself, first, in thought as conceptual metaphors which originate in the human mind consequent to sensory experience; and, second, in the representation of *only some* such metaphors in a *well-defined* language of *effective* communication.

From an *evidence-based* perspective, we could express this as:

Thesis 15. (Penrose’s Gödelian Thesis) *Any formal system of logic cannot completely assign unique Tarskian truth values of satisfiability and truth to the propositions of any language that seeks to adequately represent, and unequivocally communicate, an individual’s perception of a Platonic mathematical reality.*

Penrose seems to support such a view—when highlighting the ‘ethereal’ presence, and non-verifiable properties, of ‘non-algorithmic’ (see [Pe90], p.168), and implicitly non-constructive mathematical metaphors (such as those for four-dimensional manifolds)—by appeal to the view that such metaphors correspond to objects of our mathematical intuition which have an ‘objective reality’ that has been accepted in our formal languages as *essential* to classical mathematics (see [Pe90], p.123-8).

For instance, as argued forcefully by Gödel in [Go64]:

“As far as the epistemological situation is concerned, it is to be said that by a proof of undecidability a question loses its meaning only if the system of axioms under consideration is interpreted as a hypothetico-deductive system; i.e., if the meanings of the primitive terms are left undetermined. In geometry, e.g., the question as to whether Euclid’s fifth postulate is true retains its meaning if the primitive terms are taken in a definite sense, i.e., as referring to the behaviour of rigid bodies, rays of light, etc. The situation in set theory is similar, the difference is only that, in geometry, the meaning usually adopted today refers to physics rather than to mathematical intuition and that, therefore, a decision falls outside the range of mathematics. On the other hand, the objects of transfinite set theory, conceived in the manner explained on p. 262 and in footnote 14, clearly do not belong to the physical world and even their indirect connection with physical experiences is very loose (owing primarily to the fact that set-theoretical concepts play only a minor role in the physical theories of today).

But, despite their remoteness from sense experience, we do have something like a perception also of the objects of set theory, as is seen from the fact that the axioms force themselves upon us as being true. I don’t see any reason why we should have less confidence in this kind of perception, i.e., in mathematical intuition, than in sense perception, which induces us to build up physical theories and to expect that future sense perceptions will agree with them and, moreover, to believe that a question not decidable now has meaning and may be decided in the future. The set-theoretical paradoxes are hardly any more troublesome for mathematics than deceptions of the senses are for physics. That new mathematical intuition leading to a decision of such problems as Cantor’s continuum hypothesis are perfectly possible was pointed out earlier (pp. 264-5).

It should be noted that mathematical intuition need not be conceived of as a faculty giving an *immediate* knowledge of the objects concerned. Rather it seems that, as in the case of physical experience, we *form* our ideas also of those objects on the basis of something else which *is* immediately given. Only this something else here is *not*, or not primarily, the sensations. That something besides the sensations actually is immediately given follows (independently of mathematics) from the fact that even our ideas referring to physical objects contain constituents qualitatively different from sensations or mere combinations of sensations, e.g., the idea of object itself, whereas, on the other hand, by our thinking we cannot create any qualitatively new elements, but only reproduce and combine those that are given. Evidently the “given” underlying mathematics is closely related to the abstract elements contained in our empirical ideas.⁴⁰ It by no means follows, however, that the data of this second kind, because they cannot be associated with actions of certain things upon our sense organs, are something purely subjective, as Kant asserted. Rather they, too, may represent an aspect of objective reality, but, as opposed to the sensation, their presence in us may be due to another kind of relationship between ourselves and reality.

However, the question of the objective existence of the objects of mathematical intuition (which, incidentally, is an exact replica of the question of the objective existence of the outer world) is not decisive for the problem under discussion here. The mere psychological fact of the existence of an intuition which is sufficiently clear to produce the axioms of set theory and an open series of extensions of them suffices to give meaning to the question of the truth or falsity of propositions like Cantor’s continuum hypothesis. What, however, perhaps more than anything else, justifies the acceptance of this criterion of truth in set theory is the fact that continued appeals to mathematical intuition are necessary not only for obtaining unambiguous answers to the questions of transfinite set theory, but also for the solution of the problems of finitary number theory⁴¹ (of the type of Goldbach’s conjecture),⁴² where the meaningfulness and unambiguity of the concepts entering into

them can hardly be doubted. This follows from the fact that for every axiomatic system there are infinitely many undecidable propositions of this type."

... Gödel: [Go64], pp.271-272.

Although Penrose's (and Gödel's) arguments represent only one, and perhaps an arguably (see, for instance, [Psy95]) extreme, point of view, they serve to emphasise that classical mathematics does not adequately legitimise the acceptance into a theory of even formally definable mathematical, 'computer-independent', *completed* structures such as the Mandelbrot set (cf. [Pe90], p.147); as distinct from those, such as Cantor's transfinite ordinals, which are unarguably and essentially non-constructive.

Reason: Such concepts can be argued as expressing what may be termed as *secondary*, 'abstract', conceptual metaphors which are rooted *only* in—unarguably physical—sensory perceptions by a human intelligence of the symbolic expressions of a *particular* mathematical language; rather than in any *primary* conceptual metaphors of putative objects, in our commonly accepted external reality, corresponding to which such symbolic expressions might be unarguably claimed as referring.

Comment 169. The following analysis by cognitive scientists George Lakoff and Rafael Núñez offers an appropriate perspective for viewing our primary conceptual metaphors as the source domain, and our secondary conceptual metaphors as referring to postulated, abstract, subjective visualisations in the target domain:

"We hypothesize that the idea of actual infinity in mathematics is metaphorical, that the various instances of actual infinity make use of the ultimate metaphorical *result* of a process without end. Literally, there is no such thing as the result of an endless process: If a process has no end, there can be no "ultimate result." But the mechanism of metaphor allows us to conceptualize the "result" of an infinite process—in the only way we have for conceptualizing the result of a process—that is, in terms of a process that does not end.

We hypothesize that all cases of actual infinity—infinite sets, points at infinity, limits of infinite series, infinite intersections, least upper bounds—are special cases of a single general conceptual metaphor in which processes that go on indefinitely are conceptualized as having an end and an ultimate result. We call this metaphor the *Basic Metaphor of Infinity*, or the BMI for short. The target domain of the BMI is the domain of processes without end—that is, what linguists call imperfective processes. The effect of the BMI is to add a metaphorical completion to the ongoing process so that it is seen as having a result—an infinite thing.

The source domain of the BMI consists of an ordinary iterative process with an indefinite (though finite) number of iterations with a completion and resultant state. The source and target domains are alike in certain ways:

- Both have an initial state.
- Both have an iterative process with an unspecified number of iterations.
- Both have a resultant state after each iteration.

In the metaphor, the initial state, the iterative process, and the result after each iteration are mapped onto the corresponding elements of the target domain. But the crucial effect of the metaphor is *to add to the target domain the completion of the process and its resulting state*. This metaphorical addition is indicated in boldface in the statement of the metaphor that follows. It is this last part of the metaphor that allows us to conceptualize the ongoing process in terms of a completed process—and so to produce the concept of actual infinity."

... Lakoff and Núñez: [LR00], p.158.

Now, we note that Penrose appears to base his thesis on, amongst others, a classical consequence of Gödel's reasoning and conclusions; namely Tarski's Theorem that we cannot express Tarskian definitions (see §2.A.) of the 'satisfiability', and 'truth', of the formulas of a first-order Peano Arithmetic under its standard interpretation recursively (see [Pe90], p.159).

Tarski's Theorem (see [Me64], p.151): The set Tr of Gödel-numbers of the formal expressions of a first order Peano Arithmetic that are true in the standard model is not arithmetical.

He concludes from this that, although we may follow a common, intuitive, process for discovering common, mathematically expressible, aspects of the universe, not *all* our mathematically expressible discoveries are definable recursively in terms of classical algorithms (see [Pe90], p.533, p.548).

Moreover, Penrose's arguments also appear to imply further, albeit implicitly, that our recognition of intuitive 'arithmetical truth'—even when this is accepted as being adequately formalised by the classical Tarskian definitions of the 'satisfiability' and 'truth' of formal expressions under the *standard* interpretation $\mathcal{I}_{PA(\mathbb{N}, SV)}$ (see §2.B.) of a Peano Arithmetic such as PA—is 'absolutely' non-constructive (cf. [Pe90], p.145-6).

Thus, Penrose not only does not question the classical expression of Church's Thesis (see [Pe90], p.64-65; also §21.F.) as a *strong* identity which, essentially, postulates that every effectively computable number-theoretic function is algorithmically *computable* (compare with §7.F., Definition 25, Definition 28, and Theorem §7.H.b., 7.3), he seems to conclude from his arguments, concerning the inadequacy of classical logic, that there are 'non-algorithmic', 'non-constructive', ways of acquiring mathematical insight and knowledge (see [Pe90], pp.538-541); which we, however, can now see as appealing to *weakly* constructive algorithmic *verifiability*.

Church-Turing Thesis (see [Me64], p.147, p.227): A number-theoretic function is effectively computable (partially) if, and only if, it is (partially) recursive.

In other words, as is evidenced in his discussion of Lucas' Gödelian argument (see [Pe90], p.539), Penrose does not appear to entertain the possibility (evidenced in [An16]; see §2.) that what he terms as 'non-algorithmic' could be algorithmically *verifiable* in the sense of §2., Definition 7 and, therefore, intuitionistically acceptable as constructive; his arguments seem to, implicitly, treat the terms 'non-algorithmic' and 'non-constructive' as synonymous.

We note that Martin Davis critically reviews this particular aspect of Penrose's argument, by essentially arguing that there is a polynomial equation $P = 0$ which—by the Provability Theorem for PA (see §2.E.b., Theorem 2.17)—is algorithmically *verifiable* (see §2., Definition 7) as always false, but not algorithmically *computable* (see §2., Definition 10) as always false:

"... Gödel's incompleteness theorem (in a strengthened form based on work of J. B. Rosser as well as the solution of Hilbert's tenth problem) may be stated as follows: There is an algorithm which, given any consistent set of axioms, will output a polynomial equation $P = 0$ which in fact has no integer solutions, but such that this fact can not be deduced from the given axioms. Here then is the true but unprovable Gödel sentence on which Penrose relies and in a particularly simple form at that. Note that the sentence is provided by an algorithm. If insight is involved, it must be in convincing oneself that the given axioms are indeed consistent, since otherwise we will have no reason to believe that the Gödel sentence is true."

... Davis: [Da95].

To be fair to Penrose, though (see [An07b]; [An07c]), the real ‘Wittgensteinian’ issue—which we seek to highlight in this paper—is not whether there is an algorithm that outputs a polynomial equation $[P(x_1, x_2 \dots, x_n) \neq 0]$ which is unprovable in PA, even though $[P(a_1, a_2 \dots, a_n) \neq 0]$ is PA-provable for any *given* set of numerals $[a_1, a_2 \dots, a_n]$, but whether, for any given set of natural number values for its free variables, the fact that $P = 0$ has no integer solutions can be determined in a classically ‘non-algorithmic’, yet ‘constructive’ in the sense of algorithmically *verifiable* (see §2., Definition 7), way.

21.C. Distinguishing between quantification over *specified* and *unspecified* values of a variable

From the *evidence-based* perspective (see §2.) of this investigation, we argue that what Penrose views as the essentially ‘non-algorithmic’ and ‘non-constructive’ aspects of mathematical concepts may simply be manifestations of a removable ambiguity in the classical Tarskian definitions of the satisfiability, and truth, of the formulas of a formal language under an interpretation (see, for instance, §2.A.b.) which do not distinguish between quantification over *specified* and *unspecified* values of a variable.

Moreover, eliminating the ambiguity yields an alternative to the classically accepted—albeit misleading in view of §2.E.b., Corollary 2.18, that PA is categorical—postulation of Platonic non-standard elements, in Platonic set-theoretical models of the first-order Peano Arithmetic PA (in the mistaken belief that they are entailments of Gödel’s formal reasoning in his seminal 1931 paper [Go31]); an alternative with putatively far-reaching implications for the foundations of philosophy, logic, mathematics, computability and the natural sciences (see, for instance, the argumentation in [An15a]).

Thus we note that, in the proof of Theorem VI of his 1931 paper (see [Go31], p.24), Gödel argues that, in any consistent system P which formalises Peano’s Arithmetic, we can well-define an expression of the system, say $[R(x)]$, such that $[R(n)]$ is P -provable for any *specified* numeral $[n]$, but $[R(x)]$ —and ipso facto $[(\forall x)R(x)]$ by Generalisation—are not P -provable.

The classical interpretation of this is that although $[(\forall x)R(x)]$ is not P -provable, it is true under its standard interpretation by Tarski’s definitions.

We argue, however, that by implications which are implicit in Tarski’s definitions (see §2.A.), $[R(n)]$ may be viewed alternatively as an expression—definable as algorithmically *verifiable* (see §2., Definition 7)—whose standard interpretation $R^*(n)$ can only be asserted as holding for *any specified* natural number n , but $R^*(n)$ cannot be asserted as holding for *any unspecified* natural number n ; i.e., $[R(n)]$ cannot be defined as algorithmically *computable* (see §2., Definition 10).

In other words, we admit the possibility in *evidence-based* reasoning that, for instance (see §7.C.), if the PA formula $[(\forall x)F(x)]$ ⁴⁹⁸ is intended to be read *weakly* under an interpretation as: ‘*For any specified x , $F^*(x)$ is decidable*’, where the formula $[F(x)]$ interprets as the arithmetical relation $F^*(x)$, then it must be consistently interpreted *weakly* in terms of algorithmic *verifiability*.

We note that, from an *evidence-based* perspective, §21.B., Query 20, is now expressible as:

⁴⁹⁸For ease of exposition we consider, without loss of generality, only the case of a PA-formula with a single variable.

Query 21. *Are the concepts ‘algorithmically verifiable’ and ‘non-constructive’ necessarily synonymous in classical logic and mathematics?*

Comment 170. We note that if we treat the informal concept of ‘constructivity’ as expressible formally by ‘well-definedness’ (see §7.F., Definition 25), then §21.C., Query 21, admits a negative answer from an *evidence-based* perspective of ‘effective computability’ (see §7.H.b., Definition 28).

21.D. *Evidence-based* validation of Lucas’ and Penrose’s Gödelian Theses

We note that §21., Query 19, also raises the question of whether—as implicitly implied by the Gödelian Thesis (§21., Thesis 13)—there is a distinction between our ability to express our *evidence-based* abstractions of natural phenomena precisely, and our *evidence-based* ability to communicate them unequivocally.

Comment 171. The question of whether there is a distinction between our ability to express our *evidence-based* abstractions of natural phenomena precisely, and our *evidence-based* ability to communicate them unequivocally has, of course, been addressed from various perspectives over the years. Amongst them, an intriguing perspective is that of Wilfried Sieg and John Byrnes in their 1999 paper [SB99], where their conclusion can be viewed as implicitly—albeit obliquely—alluding to the question as an ‘exciting topic’:

“Gödel, in a Note from 1972, spotted a “philosophical error” in Turing’s work and claimed that Turing’s argument in the 1936 paper was intended to show that “mental procedures cannot go beyond mechanical procedures”; he considered the argument as “inconclusive”. The reference to Turing’s paper is to page 250 and obviously, from Gödel’s subsequent argument, to the passage:

We will also suppose that the number of states of mind which need to be taken into account is finite. The reasons for this are of the same character as those which restrict the number of symbols. If we admitted an infinity of states of mind, some of them will be “arbitrarily close” and will be confused. Again, the restriction is not one which seriously affects computation, since the use of more complicated states of mind can be avoided by writing more symbols on the tape.

Crucial is the remark, “the restrictions is not one which seriously affects computation”; the notion to be explicated is for Turing *mechanical* computation, not mental procedure. The charge of a “philosophical error” is particularly surprising as Turing discusses (on pp. 253-254) a modification of the earlier argument and avoids altogether the introduction of “the ‘state of mind’ by considering a more physical and definite counterpart to it”. The further discussion in Turing’s paper is both amusing and informative:

It is always possible for the computer [computer, in our terminology] to break off from work, to go away and forget all about it, and later to come back and go on with it. If he does this he must leave a note of instructions (written in some standard form) explaining how the work is to be continued. This note is the counterpart of the “state of mind”. We will suppose that the computer works in such a desultory manner that he does never more than one step at a sitting. The note of instructions must enable him to carry out one step and write the next note. Thus the state of progress of the computation is completely determined by the note of instructions and the symbols on the tape.

In sum, it is right that Turing does not give a conclusive argument for Gödel’s claim, but it has to be added in all fairness that Turing did not (intend to) argue for it. Even in his later work, dealing explicitly with mental processes, Turing does not argue that “mental procedures cannot go beyond mechanical procedures”, when the latter are made precise by (Turing-) machine computations. But that is a different, exciting topic.”

... *Sieg and Byrnes: [SB99], Concluding Remarks.*

We consider, therefore, how *evidence-based* reasoning validates the common, anti-reductionist, core of Lucas’ and Penrose’s Gödelian Theses.

We reiterate that the introduction of *evidence-based* reasoning into the, seemingly conflicting, classical (Hilbert’s) and intuitionistic (Brouwer’s) interpretations of quantification yields two—hitherto unsuspected and essentially different—well-defined interpretations of the first-order Peano Arithmetic PA, over the structure N of the natural numbers, which are complementary, and not contradictory (see [An15], §1.1 and §2.1).

The former yields the *weak* standard interpretation $\mathcal{I}_{PA(N,SV)}$ of PA over \mathbb{N} (see §2.B.; also the corresponding definition in [Me64], p.107 and p.49), which is *non-finitarily* defined *relative* to the assignment of *weak*, algorithmically *verifiable*, Tarskian truth values (see §2.A.a., Definitions 12 to 16) to the compound formulas of PA under $\mathcal{I}_{PA(N,SV)}$ (see §2.B.a., Theorem 2.7). However, though *well-defined*, the interpretation $\mathcal{I}_{PA(N,SV)}$ does not *well-define* a model of PA (see §2.F., Corollary 2.23).

The latter yields the *strong* finitary interpretation $\mathcal{I}_{PA(N,SC)}$ of PA over N , which is *finitarily* well-defined *relative* to the assignment of *strong*, algorithmically *computable*, Tarskian truth values to the compound formulas of PA under $\mathcal{I}_{PA(N,SC)}$ (see §2.C.a., Theorem 2.15). The *well-definedness* of $\mathcal{I}_{PA(N,SC)}$ follows from the *finitary* proof of consistency for PA in [An16] (see §2.C.a., Theorem 2.16).

The complementarity can also now be viewed as validating the common anti-reductionist core of Lucas’ and Penrose’s Gödelian Arguments, if we treat the Gödelian Thesis (i.e., §21., Thesis 13) as essentially the claim that (see [An16], Thesis 1):

Theorem 21.1. *There can be no mechanist model of human reasoning if the standard interpretation $\mathcal{I}_{PA(N,SV)}$ of the first-order Peano Arithmetic PA can be treated as circumscribing the ambit of human reasoning about ‘true’ arithmetical propositions, and the finitary interpretation $\mathcal{I}_{PA(N,SC)}$ of PA can be treated as circumscribing the ambit of mechanistic reasoning about ‘true’ arithmetical propositions.*

Proof. We note that Kurt Gödel has shown *meta-mathematically* how to construct an arithmetical formula with a single variable, say $[R(x)]$ —Gödel refers to this formula only by its Gödel number r in [Go31] (p.25(12))—such that:

- $[R(x)]$ is not PA-provable; but
- $[R(n)]$ is PA-provable for any *specified* PA numeral $[n]$.

Hence, for any *specified* numeral $[n]$, Gödel’s primitive recursive relation $x B^\Gamma [R(n)]^\neg$ must hold for some algorithmically *computable* natural number m :

- where $x B y$ denotes Gödel’s primitive recursive relation (see [Go31], p. 22(45)):

‘ x is the Gödel-number of a proof sequence in PA whose last term is the PA formula with Gödel-number y ’;

- and $\ulcorner [R(n)] \urcorner$ denotes the Gödel-number of $[R(n)]$;

We also note (see §7.G., Theorem 7.2), that we cannot conclude finitarily from Tarski’s definitions (see §2.A.) whether, or not, a quantified PA formula $[(\forall x)F(x)]$ is algorithmically *verifiable* as always true, under $I_{PA(N,SV)}$, if $[F(x)]$ is algorithmically *verifiable* (see §2., Definition 7) under $\mathcal{I}_{PA(N,SV)}$, but not algorithmically *computable* (see §2., Definition 10) under $\mathcal{I}_{PA(N,SC)}$.
Now:

- (i) Since Gödel has shown *meta-mathematically* that the PA-formula $[R(n)]$ is PA-provable for any *specified* PA-numeral $[n]$, it follows that:
 - (a) For any *specified* natural number n , there is always a deterministic algorithm which will provide evidence that the interpretation $R^*(n)$ of $[R(n)]$ under $\mathcal{I}_{PA(N,SV)}$ is an algorithmically *verifiable* true arithmetical proposition.

Moreover:

- (ii) By §2.F., Corollary 2.20, the formula $[\neg(\forall x)R(x)]$ is provable in PA. Hence, since PA is *finitarily* consistent (see §2.C.a., Theorem 2.16), we can *mathematically* conclude, under $\mathcal{I}_{PA(N,SC)}$, that:
 - (a) There is no deterministic algorithm which, for any *specified* numeral $[n]$, will provide evidence that the interpretation $R^*(n)$ of $[R(n)]$ under $\mathcal{I}_{PA(N,SC)}$ is an algorithmically *computable* true arithmetical proposition.

However:

- (iii) Since PA is also *non-finitarily* consistent (see §2.B.a., Theorem 2.8), we cannot contradict (i)(a) by *non-finitarily* interpreting quantification under $\mathcal{I}_{PA(N,SV)}$ and *mathematically* concluding from the PA-provability of the formula $[\neg(\forall x)R(x)]$ either that:
 - (a) For some *unspecified* natural number n , there is a deterministic algorithm which provides evidence that the interpretation $R^*(n)$ of $[R(n)]$ under $\mathcal{I}_{PA(N,SV)}$ is not an algorithmically *verifiable* true arithmetical proposition.

or that:

- (b) For some *unspecified* natural number n , there is no deterministic algorithm which will provide evidence that the interpretation $R^*(n)$ of $[R(n)]$ under $\mathcal{I}_{PA(N,SV)}$ is an algorithmically *verifiable* true arithmetical proposition.

Instead:

(iv) By §2.F., Corollary 2.21, we can only conclude, under $\mathcal{I}_{PA(N,SV)}$, that the PA-provability of the formula $[\neg(\forall x)R(x)]$ implies that we cannot *mathematically* conclude from the axioms and rules of inference of PA that:

- (a) For any *specified* natural number n , there is always a deterministic algorithm which will provide evidence that the interpretation $R^*(n)$ of $[R(n)]$ under $\mathcal{I}_{PA(N,SV)}$ is an algorithmically *verifiable* true arithmetical proposition.

If we now assume that the *strong*, finitary, interpretation $\mathcal{I}_{PA(N,SC)}$ of PA (see §2.C.) can be treated as circumscribing the ambit of mechanistic reasoning about ‘true’ arithmetical propositions, whence any mechanical witness can only reason *mathematically*—i.e., *finitarily* from the PA axioms and rules of inference, as in (iv) (see §2.E.b., Theorem 2.17)—then although, for any *specified* numeral $[n]$, a mechanical witness can give evidence under the *finitary* interpretation $\mathcal{I}_{PA(N,SC)}$ that the PA formula $[R(n)]$ holds in N , no mechanical witness can conclude *finitarily* under the *finitary* interpretation $\mathcal{I}_{PA(N,SC)}$ of PA that, for any *unspecified* numeral $[n]$, the PA formula $[R(n)]$ holds in N since, by §2.F., Corollary 2.21, the formula $[\neg(\forall x)R(x)]$ is provable in PA.

Whereas, if we assume that the *weak*, standard, interpretation $\mathcal{I}_{PA(N,SV)}$ of PA (see §2.B.) can be treated as circumscribing the ambit of human reasoning about ‘true’ arithmetical propositions—so a human witness can also reason *meta-mathematically*, i.e., *non-finitarily*, from the PA axioms and rules of inference, as in (i)—then a human witness can conclude under the *non-finitary* standard interpretation $\mathcal{I}_{PA(N,SV)}$ of PA that, for any *unspecified* numeral $[n]$, the PA formula $[R(n)]$ must hold in N .

The theorem follows. □

We conclude this investigation into some significant consequences of the *evidence-based* paradigm introduced in [An16] (see §2.) by noting that §21.D., Theorem 21.1, entails:

Corollary 21.2. *Although no mechanical intelligence can evidence that Gödel’s formula $[(\forall x)R(x)]$ is algorithmically verifiable, a human intelligence can evidence that $[(\forall x)R(x)]$ is algorithmically verifiable.*

Proof. Since $[\neg(\forall x)R(x)]$ is provable in PA (see §2.F., Corollary 2.20), it is therefore ‘true’ under both the interpretations $\mathcal{I}_{PA(N,SV)}$ and $\mathcal{I}_{PA(N,SC)}$ of PA in the following sense:

- (a) Under $\mathcal{I}_{PA(N,SV)}$ the formula $[\neg(\forall x)R(x)]$ interprets as:
 - There is no algorithm which will evidence that $[(\forall x)R(x)]$ is algorithmically *verifiable* as a true arithmetical proposition;
- (b) Under $\mathcal{I}_{PA(N,SC)}$ the formula $[\neg(\forall x)R(x)]$ interprets as:
 - There is no algorithm which will evidence that $[(\forall x)R(x)]$ is algorithmically *computable* as a true arithmetical proposition.

The corollary follows since Gödel has shown *meta-mathematically* that $[(\forall x)R(x)]$ is algorithmically *verifiable*. □

We compare Corollary 21.2 with Giovanni Iorio Giannoli's conditional conclusion in [Gia97] which, from the *evidence-based* perspective of this investigation can, albeit debatably, be viewed as instancing the misleading influence of Gödel's interpretation of his own formal reasoning as detailed in §15.A.:

"To exhibit its own semantic aptitudes, it would seem that AI must quite banally show:

- that those unprovable sentences can be implemented (inasmuch as they are sentences, sequences of signs) as physical states of particular machines;
- that these machines are capable of "Gödelizing" such sentences (transforming every sign into the corresponding Gödel number);

and finally, once the arithmetic of natural numbers has been implemented in such machines:

- that these machines are thereby capable of checking that the Gödelian interpretation of the sentences in question, obtained as described, produces relations between numbers according to the implemented rules (and that these unprovable sentences are therefore "true" in the conventionally accepted sense).

Put this way, no machine would be capable of providing a proof of Gödelian formulas; some machines, however, would be able simply to *verify* the value of such formulas, in the conventional, bookkeeping sense just set forth."

... Giannoli: [Gia97], §6. *Conclusions*.

21.E. Are you a man or a machine: A Definitive Turing Test

In a philosophically prophetic 1950 paper, 'Computing Machinery and Intelligence' [Tu50], Alan Turing posed, and broadly analysed, the question: 'Can machines think'. He proposed a test—his 'Imitation Game', subsequently labelled as a Turing Test (TT)—which, Turing argued, could serve as a basis for designing tests that could effectively differentiate between a human being and any mechanical artefact designed to mimic a 'human computer', such as the discrete-state machines defined in Turing's seminal 1936 paper on computable numbers [Tu36].

1. The Imitation Game.

It is played with three people, a man (A), a woman (B), and an interrogator (C) ... The object of the game for the interrogator is to determine which of the other two is the man and which is the woman. ...

We now ask the question, 'What will happen when a machine takes the part of A in this game?'

... Turing: [Tu50], p.433.

Turing's intent here seems very clear. He is not interested in distinguishing—either qualitatively or quantitatively—between whether a woman is as, or more, intelligent than a man, or any discrete-state machine; that would be like putting the cart before the horse.

Rather, Turing's interest is in any features—in this case only verbally expressed 'intelligent' responses—that would enable an interrogator to logically differentiate between a man and a woman, or a discrete-state machine and a woman.

Comment 172. We note the legal definition of 'brain death' has made Turing's query 'Can machines think?' irrelevant. Since brain activity has—albeit under controlled circumstances—been shown capable of predicting human intent to act in response to stimuli before the intended action (see [GDGGR], [GDGGP]), both humans and machines *can* today be defined as 'thinking'

in Turing’s intended sense—as distinct from being ‘conscious’, or being ‘aware’, in a cognitive sense—so long as their respective ‘brains’ are able to show some measurable processing activity: neuronic (nerve-cell based) in one case, and what might be defined as ‘meuronic’ (micro-processor based) in the other.

In other words, Turing’s implicit intent in [Tu50] can be viewed as seeking to distinguish between the logical reasoning abilities of a human being and an android (i.e., an ‘intelligence’ whose brain functions are circumscribed by the limitations of Turing’s discrete state machines) even if the two—when functioning as intended by evolutionary or by mechanical design, respectively—may be indistinguishable on the basis of physical features (whether external or internal), or social interactions/behaviour.

Comment 173. We further note that by divorcing the ‘Turing Test’ from Turing’s intent when describing the ‘*Imitation Game*’, and conflating ([Mil14], for one, being an exception) a test designed to recognise intelligence/intelligent behaviour with a test designed to recognise differentiable ‘intelligences’, subsequent deliberations on TT (see, for instance, [Frn00], [SCA00], [Pic03]⁴⁹⁹, [Coh05], [Gr17]) have come to be considered—not without reason—as amongst the most disputed topics in artificial intelligence, philosophy of mind, and the cognitive sciences.

Reflecting Turing’s intent, §21.D., Corollary 21.2, can now be interpreted as yielding a Yes/No Turing Test (Query 22) that seeks to distinguish between a logician, treated as representative of human intelligence, and a Turing machine, treated as representative of mechanical intelligence.

Query 22. (Turing Test) *Can you prove that, for any well-defined numeral $[n]$, Gödel’s arithmetic formula $[R(n)]$ is a theorem in the first-order Peano Arithmetic PA, where $[R(x)]$ is defined by its Gödel number r in eqn.12, and $[(\forall x)R(x)]$ is defined by its Gödel number $17Gen\ r$ in eqn.13, on p.25 of [Go31]? Answer only either ‘Yes’ or ‘No’.*

Logician: Yes.

Reason: By Gödel’s *meta-mathematical* reasoning on p.26(2) of [Go31], a logician can conclude that, if a numeral $[n]$ is well-defined, then the formula $[R(n)]$ is a theorem in PA; even though the formula $[(\forall x)R(x)]$ is *not* a theorem in PA.

Turing Machine: No.

Reason: By §2.F., Corollary 2.20, the formula $[\neg(\forall x)R(x)]$ is provable in PA and so, by the Provability Theorem for PA (§2.E.b., Theorem 2.17), *no* Turing machine can *prove* that the formula $[(\forall x)R(x)]$ with Gödel number $17Gen\ r$ is a theorem in PA and, ipso facto, conclude that, for any well-definable numeral $[n]$, Gödel’s arithmetic formula $[R(n)]$ is a theorem in PA.

We note that, as remarked by Marcin Miłkowski, conventional wisdom—apropos differentiating between a human mind and a TM—mostly seeks to compare their respective abilities to *compute* number-theoretic functions by positing various *computational models* of the mind:

⁴⁹⁹For Turing, the Turing test was not an “operational definition of ‘thinking’ or ‘intelligence’ or ‘consciousness’” (as sometimes maintained, e.g. by Hodges, 1983, p. 415)—the test only gave a sufficient condition for a machine to be considered intelligent, or thinking (Turing, 1950, p. 435). “Intelligence” and “thinking” were used interchangeably by Turing. ... Piccinini: [Pic03]

“2. Two senses of “is”, and some senses of “mind”

In philosophy of mathematics, and in most early discussions in philosophy of mind, only one sense of the claim that the mind is (or is not) a TM was taken into account. Namely, it was held that all that is required for the mind to be a TM is that the set of functions computable by the mind is exactly the same as the set of TM-computable functions. For this reason, it is more apt to talk of *computable function equivalence* rather than of strict identity. Note also that computable function equivalence does not imply that the mind is an abstract entity, which would be implied by the literal strict identity claim that the mind is a TM.

It is the computable function equivalence that is presupposed in the discussions over the arguments in favour or against the claim that in contradistinction to the TM, the human mind is capable of, say, ascertaining the truth of Gödel sentences, as argued by Lucas [23]. In other words, what is relevant in this discussion is whether mathematicians are able to compute all TM-computable functions, and whether the TM is capable of computing of all human-computable functions.

Interestingly enough, the equivalence of computable functions was also presupposed in early functionalist discussions in the philosophy of mind [40]. Let us suppose that there exists a computational model M that explains the operation of the human mind H. If M is equivalent with respect to the functions computed by H, it is weakly equivalent in the sense defined by Jerry Fodor [16]: namely, input / output relationships of M will be isomorphic to input / output relationships of H. Computable functions equivalence is not enough to make sense of the third objection I mentioned at the outset. Namely, the objection that focuses on the architecture of the human as dramatically different from that of a TM would obviously miss the point, as computable function equivalent machines simply need not be architecturally equivalent.¹ To understand the last objection, which cannot be dismissed as simply nonsensical, we need a stronger rendering of “is” in the thesis that the human mind is a TM.

Following Fodor again, we can talk of strong equivalence: the model M is strongly equivalent to its target T if and only if (a) M is weakly-equivalent to T; and (b) the way the input is transformed into the output is the same in M and T. The second criterion is admittedly quite vague and the distinction proposed by Fodor was immediately criticized by philosophers who tried to show that strong equivalence collapses to weak equivalence [44]. Instead of discussing their criticism, in what follows, I will propose another way of understanding strong equivalence, which is in line with the current theory of mechanistic explanation that has gained considerable attention in the philosophy of science [24]. I will namely define strong equivalence as the equivalence of the computational models being implemented, where implementation is rendered in a mechanistic way. This the focus of section 3 below.

The mechanistic sense of “is”, i.e., the implementation equivalence, is what is presupposed in the architecture objection.² It is important to note that only strongly-equivalent models are explanatory of the human mental processes in a way relevant for cognitive science. All that the weak equivalence requires is that the set of functions is the same, and for that reason, the weakly-equivalent computational model is not explanatory of some of the psychological properties of the human mind. It may be used to describe some part of the functioning of the human mind but it cannot be used to predict some of its activity that is of interest for cognitive research."

... Milkowski: [Mil14], §2. Two senses of “is”, and some senses of “mind”.

From the *evidence-based* perspective of this investigation, however, Query 22 suggests that what we should treat as relevant in the above discussion is:

- whether mathematicians are able to correctly *identify* the *algorithmically computable* truth values assigned by a TM to arithmetical sentences, and whether the TM is capable of correctly *identifying* the *algorithmically verifiable* truth values assigned by a human mind to arithmetical sentences;

and not whether or not the respective abilities of a human mind and a TM to *compute* number-theoretic functions are equivalent.

Comment 174. In his musings [Grn22] from a general mathematician’s perspective—where he seeks to address the query ‘*Do Proofs Yield Objective Truth, Or Are They Culturally Robust At Best*’—Andrew Granville essentially defines a ‘modified’ Turing Test as Query 22 above, where ‘we set the machine up against a Fields’ medalist, ask them both a tough but doable question’.

However, in the absence of a distinction between algorithmic *verifiability* (§2., Definition 7) and algorithmic *computability* (§2., Definition 10)—and an *evidence-based* definition of effective computability (§7.H.a., Definition 28) which entails that *evidence-based* reasoning does not admit the classical Church-Turing Thesis (see §7.H.b., Theorem 7.3)—Granville seemingly endorses Turing’s unjustifiable conclusion, to the effect that ‘since computers are universal (via the Church-Turing thesis) they can perfectly imitate anything that can be computed including human interaction’:

“Eventually we will need to play Turing’s “imitation game” [43] with machine created proofs; that is, their proofs should be indistinguishable from great human proofs. So we set the machine up against a Fields’ medalist, ask them both a tough but doable question, and see whether we can determine whose proof is whose.⁵⁶ Turing [43] notes that since computers are universal (via the Church-Turing thesis) they can perfectly imitate anything that can be computed including human interaction, so inevitably this will be doable (and indeed computers will eventually be able to perfectly imitate each other).⁵⁷”

... Granville: [Grn22], §11. *The future of proof. Computer proofs and a modified Turing test.*

21.E.a. Does Query 22 yield a definitive Turing Test?

The question arises:

Query 23. *Does Query 22 yield a definitive Turing Test?*

The issue here is that, in order to establish the above test as definitive, we might need to make allowance for the fact that:

- a Turing machine can verify the PA-provability of the formula $[R(n)]$ for any *specified* PA-numeral in a finite time by means of Gödel’s primitive recursive formula xBy ([Go31], Definition 45, p.22);
- even though it cannot do so for all the PA-numerals in a finite time (since $[R(x)]$ is not PA-provable).

The underlying problem was treated as an unsurmountable barrier by Lucas:

“If the only thing that will budge the Mechanists is a rule-governed inference which cannot be resisted on pain of inconsistency, then they cannot be made to see the general applicability of Gödelian arguments. All that can be done is to refute each and every particular claim they put forward.”

... Lucas: [Lu96].

We entertain the possibility, however, that §21.E., Query 22, might be capable of a refinement that avoids semantic ambiguities by forcing the response ‘No’ formally from the Turing Machine in a finite time.

We thus address the question:

Query 24. *Can a Turing machine be forced to reply in a finite time whether or not a partial recursive function $F(x_1, \dots, x_n)$ is effectively computable as total?*

21.F. Turing's Halting problem

We note that classical theory holds:

- (a) Every Turing-computable function $F(x_1, \dots, x_n)$ is partial recursive, and, if $F(x_1, \dots, x_n)$ is total, then $F(x_1, \dots, x_n)$ is recursive (see [Me64], p.233, Corollary 5.13).
- (b) Every partial recursive function $F(x_1, \dots, x_n)$ is Turing-computable (see [Me64], p.237, Corollary 5.15).

From this, classical theory concludes that the following, essentially unverifiable (since it treats the notion of 'effective computability' as intuitive, and not definable formally) but refutable, theses (informally referred to as the Church-Turing Thesis CT) are equivalent (see [Me64], p.237):

Church's Thesis: A number-theoretic function $F(x_1, \dots, x_n)$ is effectively computable if, and only if, $F(x_1, \dots, x_n)$ is recursive (see [Me64], p.227).

Turing's Thesis: A number-theoretic function $F(x_1, \dots, x_n)$ is effectively computable if, and only if, $F(x_1, \dots, x_n)$ is Turing-computable (see [BBJ03], p.33).

We note however that, even classically, the above equivalence does not hold strictly, and needs further qualification. The following argument highlights this, where $F(x_1, \dots, x_n)$ is any number-theoretic function:

- (i) Assume Church's Thesis. Then:
 - If $F(x_1, \dots, x_n)$ is Turing-computable then it is partial recursive. *If $F(x_1, \dots, x_n)$ is total*, then it is both recursive (see [Me64], p.227) and, by our assumption, effectively computable.
 - If $F(x_1, \dots, x_n)$ is effectively computable then, by our assumption, it is recursive. Hence, by definition, $F(x_1, \dots, x_n)$ is partial recursive and Turing-computable.
- (ii) Assume Turing's Thesis. Then:
 - If $F(x_1, \dots, x_n)$ is recursive, it is partial recursive and Turing-computable. Hence, by our assumption, $F(x_1, \dots, x_n)$ is effectively computable.
 - If $F(x_1, \dots, x_n)$ is effectively computable then, by our assumption, it is Turing-computable. Hence it is partial recursive and, *if $F(x_1, \dots, x_n)$ is total*, then it is recursive.

The question arises:

Query 25. (Turing's Halting problem) *Is it always decidable by a Turing machine whether or not a specified partial recursive function $F(x_1, \dots, x_n)$ is total?*

Turing addressed this issue in his seminal paper on computable numbers (see [Tu36]), where he showed ([Tu36], pp.133-134) by contradiction that the Halting problem (§21.F., Query 25) is unsolvable by a Turing machine, in the sense that whether or not a partial recursive function is total is not always decidable by a Turing machine:

“Let us suppose that there is such a process; that is to say, that we can invent a machine \mathcal{D} which, when supplied with the S.D of any computing machine \mathcal{M} will test this S.D and if \mathcal{M} is circular will mark the S.D with the symbol “ u ” and if it is circle-free will mark it with “ s ”. By combining the machines \mathcal{D} and \mathcal{U} we could construct a machine \mathcal{H} to compute the sequence β' . The machine \mathcal{D} may require a tape. We may suppose that it uses the E -squares beyond all symbols on F -squares, and that when it has reached its verdict all the rough work done by \mathcal{D} is erased.

The machine \mathcal{H} has its motion divided into sections. In the first $N - 1$ sections, among other things, the integers $1, 2, \dots, N - 1$ have been written down and tested by the machine \mathcal{D} . A certain number, say $R(N - 1)$, of them have been found to be the D.N's of circle-free machines. In the N -th section the machine \mathcal{D} tests the number N . If N is satisfactory, *i.e.*, if it is the D.N of a circle-free machine, then $R(N) = 1 + R(N - 1)$ and the first $R(N)$ figures of the sequence of which a D.N is N are calculated. The $R(N)$ -th figure of this sequence is written down as one of the figures of the sequence β' computed by \mathcal{H} . If N is not satisfactory, then $R(N) = R(N - 1)$ and the machine goes on to the $(N + 1)$ -th section of its motion.

From the construction of \mathcal{H} we can see that \mathcal{H} is circle-free. Each section of the motion of \mathcal{H} comes to an end after a finite number of steps. For, by our assumption about \mathcal{D} , the decision as to whether N is satisfactory is reached in a finite number of steps. If N is not satisfactory, then the N -th section is finished. If N is satisfactory, this means that the machine $\mathcal{M}(N)$ whose D.N is N is circle-free, and therefore its $R(N)$ -th figure can be calculated in a finite number of steps. When this figure has been calculated and written down as the $R(N)$ -th figure of β' , the N -th section is finished. Hence \mathcal{H} is circle-free.

Now let K be the D.N of \mathcal{H} . What does \mathcal{H} do in the K -th section of its motion? It must test whether K is satisfactory, giving a verdict “ s ” or “ u ”. Since K is the D.N of \mathcal{H} and since \mathcal{H} is circle-free, the verdict cannot be “ u ”. On the other hand the verdict cannot be “ s ”. For if it were, then in the K -th section of its motion \mathcal{H} would be bound to compute the first $R(K - 1) + 1 = R(K)$ figures of the sequence computed by \mathcal{H} . The computation of the first $R(K - 1)$ figures would be carried out all right, but the instructions for calculating the $R(K)$ -th would amount to “calculate the first $R(K)$ figures computed by $[\mathcal{H}]$ and write down the $R(K)$ -th”. This $R(K)$ -th figure would never be found. *I.e.*, \mathcal{H} is circular, contrary both to what we have found in the last paragraph and to the verdict “ s ”. Thus both verdicts are impossible and we conclude that there can be no machine \mathcal{D} .”

... Turing: [Tu36], p.133.

“We can show further that *there can be no machine \mathcal{E} which, when supplied with the S.D of an arbitrary machine \mathcal{M} , will determine whether \mathcal{M} ever prints a given symbol (0 say).*”

... Turing: [Tu36], p.134.

Since a number-theoretic function is Turing-computable if, and only if, it is partially Markov-computable (see [Me64], p.233, Corollary 5.13 & p.237, Corollary 5.15), Turing's argument for his Halting Theorem asserts that it is essentially unverifiable algorithmically whether, or not, a Turing machine that computes a *specified* n -ary number-theoretic function $F(x_1, \dots, x_n)$ will always yield a computation for every *specified* n -ary sequence of natural numbers (for which it is defined) as input.

In other words, there may be some n -ary number-theoretic function $F(x_1, \dots, x_n)$ such that, for some *unspecified* n -ary sequence of natural numbers as input, any Turing machine that computes $F(x_1, \dots, x_n)$ will go into a non-terminating loop (which would cause the circular motion of the putative machine \mathcal{H} in the K -th section in the previous quote from [Tu36], p.133), where:

Definition 40. (Non-terminating loop) *A non-terminating loop is any repetition of the instantaneous tape description of a Turing machine during a computation.*

“An instantaneous tape description describes the condition of the machine and the tape at a given moment. When read from left to right, the tape symbols in the description represent the symbols on the tape at the moment. The internal state q_s in the description is the internal state of the machine at the moment, and the tape symbol occurring immediately to the right of q_s in the tape description represents the symbol being scanned by the machine at the moment.”

... Mendelson: ([Me64], p.230, footnote 1).

In other words, a non-terminating loop can be described as a ‘consecutive repeating state cycle in a Turing machine’:

“A consecutive repeating state cycle in a Turing machine occurs when a finite sequence of standard machine instructions $\{I_i\}$ is executed by the Turing machine two consecutive times: $I_1 \rightarrow I_2 \rightarrow \dots \rightarrow I_k \rightarrow I_1 \rightarrow I_2 \dots \rightarrow I_k$ and the machine configuration before the first instruction I_1 is executed equals the machine configuration after the instruction I_k has completed its execution a second time.”

... Fiske: [Fi19], 7 Two Research Problems.

21.F.a. The Halting-decidability problem for T

We shall now show why—challenging current paradigms—the Halting problem (§21.F., Query 25) cannot be conflated with (see [Me64], p.256) the problem of whether or not it is *effectively* decidable that a *specified* computation of a partial recursive function $F(x_1, \dots, x_n)$ is *effectively* decidable.

Comment 175. We note that the computational distinction between the two (i.e., §21.F., Query 25 and §21.F.a., Query 26) has been highlighted by Joel David Hamkins and Theodor Nenu in their recent preprint [HN24] (albeit with a differing attribution/terminology; and from a classical perspective which—contrary to the *evidence-based* perspective of §21.F.b., Theorem 21.3—seemingly treats the two as mathematically equivalent):

“The prima facie case against the Turing attribution, to be sure, consists of the observation that nearly all of the things attributed to Turing in the quotes above are not actually to be found in Turing’s paper. He doesn’t define or even discuss the halting problem as a decision problem; the phrase “halting problem” does not occur in his paper; there is no theorem in the paper called the Halting Theorem or any theorem or statement making an equivalent or even similar assertion; indeed, the word “halt” is absent; he does not discuss the halting of his machines at all, and makes no provision for the computational processes undertaken by his machines ever to stop; in particular, he has no convention as in contemporary accounts of a *halt* state for the machines; none of the notation $\phi_e(x) \downarrow, \mathcal{K}_0$, and \mathcal{W}_e occurs in Turing’s paper, nor does any equivalent notation appear for these ideas; he doesn’t use the undecidability of the halting problem to resolve the Entscheidungsproblem, but rather another undecidable decision problem; there are no remarks about the self-contemplative nature of Turing machines; and there is nothing like the self-referential proof of undecidability that we gave earlier to be found in Turing’s paper. All his undecidability arguments proceed instead in multi-step reductions ultimately through the undecidability of his circle-free problem, which is not even computably equivalent to the halting problem, but rather strictly harder in the hierarchy of computational strength.

The Turing attribution for the undecidability of the halting problem has been challenged by a number of Turing scholars, including Jack Copeland [Cop04, p. 40], who explicitly claims that crediting Turing with stating and proving the halting theorem is erroneous. Copeland—as well as many others, e.g. Petzold [Pet08, p.179]—views Martin Davis as the mathematician to whom we should attribute the result under discussion. This is primarily owed to Davis’s influential book from 1958, *Computability and Unsolvability*, where the phrase *the halting problem* first appears in the literature:

[L]et Z be a simple Turing machine. We may associate with Z the following decision problem:

To determine, of a given instantaneous description α , whether or not there exists a computation of Z that begins with α .

That is, we wish to determine whether or not Z , if placed in a given initial state, will eventually halt. We call this problem the halting problem for Z . [Dav58, p. 70]

This quote of Davis is followed by a proof of the undecidability of the halting problem for Turing machines. We would note that Kleene seems, however, to have already had the self-referential argument earlier in his classic book from 1952, *Introduction to Metamathematics*:

[As an example of an unsolvable decision problem,] there is no algorithm for deciding whether any given machine, when started from any given initial situation, eventually stops. For if there were, then, given any number x , we could first decide whether x is the Gödel number of machine \mathcal{M}_x , and if so whether \mathcal{M}_x started scanning x in standard position with the tape elsewhere blank eventually stops, and if so finally whether x , 1 is scanned in standard position in the terminal situation. [Kle52, p. 382]

We shall explain in our nuanced conclusion the reasons why nevertheless one may find it reasonable to offer a qualified attribution for the undecidability of the halting problem to Turing, even if the first clear articulation of the problem and the now-familiar self-referential proof of halting undecidability may be due to Kleene and Davis."

... Hamkins and Nenu: [HN24], §3. *The prima facie case against the Turing attribution.*

" We would like to remark on a rather curious aspect about the situation here. Although as we mentioned, Turing is commonly credited with proving the undecidability of the halting problem, nevertheless the central undecidability result in his paper concerns the circle-free problem, which in fact is strictly harder than the halting problem in the hierarchy of Turing degrees. The claim that it is undecidable, therefore, would be a strictly weaker result.

Let us explain. The circle-free decision problem has a natural logical complexity of Π_2^0 , that is, with quantifier complexity $\forall\exists$, since a given program is circle-free if and only if for every natural number k , there is a stage at which the program has produced at least k output digits. The halting problem, in contrast, has simpler complexity Σ_1^0 , an arithmetical existential \exists assertion, since any given instance of halting is witnessed by the length of the halting computation itself.

Indeed, the circle-free problem is a complete Π_2^0 problem, meaning that every $\forall\exists$ problem reduces to the circle-free problem, and this shows that the Π_2^0 classification cannot be simplified. To see this, let us reduce an arbitrary Π_2^0 assertion $\forall n\exists k\phi(n, k, x)$, where ϕ has only bounded quantifiers, to the circle-free problem. Let e be the program which on input x systematically considers $n = 0$ and then $n = 1$ and $n = 2$ and so on in turn. For each n , it looks for a k for which $\phi(n, k, x)$. If found, then e produces another digit on the output tape, say, digit 1, and then moves on to $n + 1$. The original assertion $\forall n\exists k\phi(n, k, x)$ is true for x if and only if program e is circle-free. So we have reduced any given Π_2^0 statement to the circle-free problem.

In particular, this means that the circle-free problem is Turing equivalent not to the halting problem, but to the double jump $0''$, the double halting problem, that is, the halting problem relativized to the halting problem. This is the version of the halting problem for oracle programs having access to an oracle for the ordinary halting problem. This is strictly harder than the halting problem, since it is the halting problem for oracle programs that know how to solve the ordinary halting problem. Since the circle-free problem is thus strictly harder than the halting problem, it means that for Turing to have proved that it is undecidable is actually a weaker result than

proving that the halting problem itself is undecidable."

... Hamkins and Nenu: [HN24], §4.4. Circle-free problem is harder than the halting problem, p.9.

Query 26. (Halting-decidability problem for T) *Given a Turing machine T , can one effectively decide, given any instantaneous description α , whether or not there is a computation of T beginning with α ?*

which can also be expressed as:

Query 27. (Halting-decidability problem for T) *Is it always possible to effectively determine whether a Turing machine T will halt or not when computing a specified partial recursive function $F(x_1, \dots, x_n)$?*

We shall now answer Query 27 affirmatively (see §21.F.b., Theorem 21.3) by showing—as a consequence of the Provability Theorem for PA (§2.E.b., Theorem 2.17)—that whether or not a Turing machine will always halt when computing a partial recursive function $F(x_1, \dots, x_n)$ is effectively decidable by a trio ($T_1 // T_2 // T_3$) of Turing machines operating in parallel.

Now, we note that any Turing machine T can be provided with an auxiliary infinite tape (see [Rg87], p.130) to effectively recognise a non-terminating looping situation at the register, i.e. tape description, level; it simply records every instantaneous tape description at the execution of each machine instruction on the auxiliary tape, and compares the current instantaneous tape description with the record.

Moreover, T can be meta-programmed to abort the impending non-terminating loop *if* an instantaneous tape description is repeated, and to return a meta-symbol indicating self-termination.

Comment 176. It is convenient to visualise the tape of such a Turing machine as that of a two-dimensional virtual-teleprinter, which maintains a copy of every instantaneous tape description in a random-access memory during a computation.

21.F.b. Forcing a Turing machine to decide effective computability

It now follows from the Provability Theorem for PA (§2.E.b., Theorem 2.17) that:

Theorem 21.3. (Forced Halting Theorem) *It is always possible to effectively determine whether a Turing machine will halt or not when computing any partial recursive function $F(x_1, \dots, x_n)$.*

Proof. We assume that the partial recursive function $F(x_1, \dots, x_n)$ is obtained from a recursive function $G(x_1, \dots, x_n)$ by means of the unrestricted μ -operator⁵⁰⁰; in other words, that (see [Me64], p.214):

$$F(x_1, \dots, x_n) = \mu y (G(x_1, \dots, x_n, y) = 0).$$

⁵⁰⁰Where ‘ μy ’ interprets as ‘The least y such that ...’.

If $[H(x_1, \dots, x_n, y)]$ expresses $\neg(G(x_1, \dots, x_n, y) = 0)$ in PA we have, by definition, that any interpretation $H^*(x_1, \dots, x_n, y)$ of $[H(x_1, \dots, x_n, y)]$ in \mathbb{N} is instantiationally equivalent to $\neg(G(x_1, \dots, x_n, y) = 0)$ (see [Me64], §2, p.117).

We now consider the PA-provability and Turing computability of the arithmetical formula $[H(x_1, \dots, x_n, y)]$ by a Turing machine T that inputs every *specified* sequence of numerals $\{[a_1], \dots, [a_n]\}$ of PA simultaneously into the parallel trio $(T_1 // T_2 // T_3)$ of Turing machines, as below:

- (a) Let Q_1 be the meta-assertion that the PA-formula $[H(a_1, \dots, a_n, y)]$ is not algorithmically *verifiable* as always true under interpretation in \mathbb{N} .

It follows that there is some *unspecified* finite k such that $H^*(a_1, \dots, a_n, k)$ does not hold in \mathbb{N} ; and so $G(a_1, \dots, a_n, k)$ holds.

Since $G(a_1, \dots, a_n, y)$ is recursive, any Turing machine T_1 that computes $G(a_1, \dots, a_n, y)$ will halt and return the value 0 at $y = k$.

- (b) Let Q_2 be the meta-assertion that the PA-formula $[H(a_1, \dots, a_n, y)]$ is algorithmically *verifiable* as always true, but not algorithmically *computable* as always true, under interpretation in \mathbb{N} .

Hence, for any *specified* $[k]$, the formula $[H(a_1, \dots, a_n, k)]$ interprets as true in \mathbb{N} , but there is no Turing machine that, for any *specified* $[k]$, computes the formula $[H(a_1, \dots, a_n, k)]$ as ‘true’ under interpretation in \mathbb{N} .

Now it follows from the Provability Theorem for PA (§2.E.b., Theorem 2.17) that, since every *specified* instantiation $[H(a_1, \dots, a_n, k)]$ of the PA-formula $[H(a_1, \dots, a_n, y)]$ is algorithmically *computable* as true under interpretation in \mathbb{N} , the formula $[H(a_1, \dots, a_n, k)]$ is PA-provable.

However, since $[H(a_1, \dots, a_n, y)]$ is not algorithmically *computable* as always true under interpretation in \mathbb{N} , any Turing machine T_2 that computes the value of $[y]$ at which $[H(a_1, \dots, a_n, y)]$ is true cannot return the value ‘true’ for all *specified* values of $[y]$.

Hence T_2 must necessarily initiate a non-terminating loop at some *unspecified* $[y = k']$ and halt, since its auxiliary tape will return the symbol for self-termination at $[y = k']$.

- (c) Finally, let Q_3 be the meta-assertion that the PA-formula $[H(a_1, \dots, a_n, y)]$ is algorithmically *computable* as always true under interpretation in \mathbb{N} .

Hence the Turing machine T_2 will return the value ‘true’ on any *specified* input for $[y]$.

By the Provability Theorem for PA (§2.E.b., Theorem 2.17), the formula $[H(a_1, \dots, a_n, y)]$ is therefore PA-provable.

Let h be the Gödel-number of $[H(a_1, \dots, a_n, y)]$. We consider, then, Gödel’s primitive recursive number-theoretic relation xBy (see [Go31], p.22, definition 45), which holds if, and only if, x is the Gödel-number of a proof sequence in PA for the PA-formula whose Gödel-number is y . It follows that there is some *unspecified* finite k'' such that any Turing

machine T_3 , which computes the characteristic function of xBh , will halt and return the value 0 ('true') for $x = k''$.

Since Q_1 , Q_2 and Q_3 are mutually exclusive and exhaustive, it follows that, when run simultaneously over the sequence $1, 2, 3, \dots$ of values for y , one of the parallel trio ($T_1 // T_2 // T_3$) of Turing machines will always halt for some *unspecified* finite value of y . Moreover:

- If T_1 halts, then a Turing machine will halt when computing the partial recursive function $F(x_1, \dots, x_n)$, and T_1 will report that $F(x_1, \dots, x_n)$ is algorithmically *decidable* as *not* a total function.
- If T_2 halts, then a Turing machine will not halt when computing the partial recursive function $F(x_1, \dots, x_n)$, and T_2 will report that it is not algorithmically *decidable* whether or not $F(x_1, \dots, x_n)$ is a total function.

Comment 177. We note that a human intelligence would, however, *know* that $F(x_1, \dots, x_n)$ is algorithmically *verifiable* as total by specification in this case, but not algorithmically *computable*—hence not algorithmically *decidable* as total.

- If T_3 halts, then a Turing machine will not halt when computing the partial recursive function $F(x_1, \dots, x_n)$, and T_3 will report that $F(x_1, \dots, x_n)$ is algorithmically *decidable* as a total function.

The theorem follows. □

We note that Theorem 21.3 immediately yields a more insightful proof of Turing's Halting Theorem by answering §21.F.a., Query 26 (Halting-decidability problem for T) affirmatively:

Corollary 21.4. (Halting-decidability Theorem for T) *Given a Turing machine T , one can effectively decide, given any instantaneous description α , whether or not there is a computation of T beginning with α .* □

In other words, treating ($T_1 // T_2 // T_3$) as an Oracle machine, we now have an *evidence-based* proof of Turing's Halting Theorem (see §21.F., Query 25):

Corollary 21.5. (Turing's Halting Theorem) *Whether or not a specified partial recursive function $F(x_1, \dots, x_n)$ is total is not always decidable by a Turing machine.* □

21.F.c. Why some algorithmically *verifiable* functions are *essentially* uncomputable

We note that the Forced Halting Theorem (§21.F.b., Theorem 21.3) entails that some algorithmically *verifiable* functions are *essentially* uncomputable (even by what are termed as 'quantum' computers).

Theorem 21.6. (Essential Uncomputability Theorem) *Some functions that are algorithmically verifiable, but not algorithmically computable, are essentially uncomputable.*

Proof. We note that:

- (i) By Turing's Halting Theorem (§21.F.b., Corollary 21.5), there is some partial recursive function, say $F(x_1, \dots, x_n) = \mu y(G(x_1, \dots, x_n, y) = 0)$, *all* of whose instantiations are *not* algorithmically *computable* by any Turing machine.

By the Forced Halting Theorem (§21.F.b., Theorem 21.3), we can define a trio ($T_1 // T_2 // T_3$) of Turing machines such that:

- If T_1 halts, then a Turing machine will halt when computing the partial recursive function $F(x_1, \dots, x_n)$, and T_1 will report that $F(x_1, \dots, x_n)$ is algorithmically *decidable* as *not* a total function.
 - If T_2 halts, then a Turing machine will not halt when computing the partial recursive function $F(x_1, \dots, x_n)$, and T_2 will report that it is not algorithmically *decidable* whether or not $F(x_1, \dots, x_n)$ is a total function.
 - If T_3 halts, then a Turing machine will not halt when computing the partial recursive function $F(x_1, \dots, x_n)$, and T_3 will report that $F(x_1, \dots, x_n)$ is algorithmically *decidable* as a total function.
- (ii) We consider the case where $F(x_1, \dots, x_n)$ is algorithmically *verifiable*, but *not* algorithmically *computable*, as total; whence only T_2 will halt.
- (iii) Now, by [Go31], Theorem VII, we can define a Turing machine T_3 that monitors some primitive recursive Gödel β -function (see §16.A.), say $F_3(x_1, \dots, x_n)$, whose values are identical to those of $F(x_1, \dots, x_n)$ *before* T_2 reports its first halting state.
- (iv) Since the values of $F(x_1, \dots, x_n)$ are algorithmically *verifiable*, it is total, and we assume that $F_3(x_1, \dots, x_n)$ can also correctly compute some values of $F(x_1, \dots, x_n)$ *beyond* the first halting state of T_2 .
- (v) However, since the values of $F(x_1, \dots, x_n)$ are *not* algorithmically *computable*, it follows that T_3 too must halt for some input beyond the halting point of T_2 and report that $F(x_1, \dots, x_n)$ is not computable by $F_3(x_1, \dots, x_n)$ at that input; at which point we can consider extending T_3 by some T_4 , just as we replaced T_2 with T_3 .
- (vi) Since the values of $F(x_1, \dots, x_n)$ are not algorithmically *computable*, it follows that the above path—which would correspond to a putative, algorithmically *verifiable*, computation of $F(x_1, \dots, x_n)$ —is *essentially* non-terminating, since it cannot terminate at some node which defines a Gödel β -function whose values can be *claimed* (compare with the argument in §7.I.a., Theorem 7.6) as *always* identical to those of $F(x_1, \dots, x_n)$ *beyond* that node.

The theorem follows. □

21.G. On the Collatz conjecture and similar, open, arithmetical problems

The practical significance⁵⁰¹ of the distinction between Turing's Halting Theorem (§21.F.b., Corollary 21.5) and the Halting-decidability Theorem for T (§21.F.b., Corollary 21.4) is seen

⁵⁰¹For the computer sciences in general, and the development of self-modified learning by artificial intelligences in particular (see, for instance, [AAB19] from the perspective of §24.).

in the paper presented (see [Fil19a]) at the Logic Colloquium 2019, where Michael Stephen Fiske essentially seeks an answer to the Halting-decidability Problem for T (see §21.F.a., Query 26/Query 27) by considering a class of *evolving* ‘quantum, self-modifiable machines’:

“Among the fundamental questions in computer science, at least two have a deep impact on mathematics. What can computation compute? How many steps does a computation require to solve an instance of the 3-SAT problem? Our work addresses the first question, by introducing a new model called an *ex-machine*. The ex-machine executes Turing machine instructions and two special types of instructions. *Quantum random instructions* are physically realizable with a quantum random number generator. *Meta instructions* can add new states and add new instructions to the ex-machine. A countable set of ex-machines is constructed, each with a finite number of states and instructions; each machine can compute a Turing incomputable language, whenever the quantum randomness measurements behave like unbiased Bernoulli trials. In 1963, Alan Turing posed the halting problem for Turing machines and proved that his problem is unsolvable for Turing machines. Consider an enumeration $\mathcal{E}_\alpha(i) = (\mathcal{M}_i, T_i)$ of all Turing machines \mathcal{M}_i and initial tapes T_i . Does there exist an ex-machine \mathcal{X} that has at least one evolutionary path $\mathcal{X} \rightarrow \mathcal{X}_1 \rightarrow \mathcal{X}_2 \rightarrow \dots \mathcal{X}_m$, so at the m th stage ex-machine \mathcal{X}_m can correctly determine for $0 \leq i \leq m$ whether \mathcal{M}_i ’s execution on tape T_i eventually halts?”

... Fiske: [Fil19], Abstract.

Fiske begins by introducing what he terms as a ‘*quantum random, self-modifiable machine*’:

“2 The Ex-Machine

We introduce a *quantum random, self-modifiable machine* that adds two special instructions to the Turing machine [97]. Before the quantum random and meta instructions are defined, we present some preliminary notation, the standard instructions, and a Collatz machine example.

\mathbb{Z} denotes the integers. \mathbb{N} and \mathbb{N}^+ are the non-negative and positive integers, respectively. The finite set $Q = \{0, 1, 2, \dots, n-1\} \subset \mathbb{N}$ represents the ex-machine states. This representation of the ex-machine states helps specify how new states are added to Q when a meta instruction is executed. Let $\mathbf{U} = \{a_1, \dots, a_n\}$, where each a_i represents a distinct symbol. The set $A = \{0, 1, \#\} \cup \mathbf{U}$ consists of alphabet (tape) symbols, where $\#$ is the blank symbol and $\{0, 1, \#\} \cap \mathbf{U}$ is the empty set. In some ex-machines, $A = \{0, 1, \#, Y, N, a\}$, where $a_i = Y, a_2 = N, a_3 = a$. In some ex-machines, $A = \{0, 1, \#\}$, where \mathbf{U} is the empty set. The alphabet symbols are read from and written on the tape. The ex-machine tape T is a function of $T : \mathbb{Z} \rightarrow A$ with an initial condition: before the ex-machine starts executing, there exists an $N > 0$ so that $T(k) = \#$ when $|k| > N$. In other words, before the ex-machine starts executing, all tape squares contain blank symbols, except for a finite number of tape squares. When this initial condition holds for tape T , we say that tape T is *finitely bounded*.

2.1 Standard Instructions

Definition 2.1. Execution of Standard Instructions

The standard ex-machine instructions \mathcal{S} satisfy $\mathcal{S} \subset Q \times A \times Q \times A \times \{-1, 0, 1\}$ and a uniqueness condition: If $(q_1, \alpha_1, r_1, a_1, y_1) \in \mathcal{S}$ and $(q_2, \alpha_2, r_2, a_2, y_2) \in \mathcal{S}$ and $(q_1, \alpha_1, r_1, a_1, y_1) \neq (q_2, \alpha_2, r_2, a_2, y_2)$, then $q_1 \neq q_2$ or $\alpha_1 \neq \alpha_2$. A standard instruction $I = (q, a, r, \alpha, y)$ is similar to a Turing machine tuple [30, 75, 97]. When the ex-machine is in state q and the tape head is scanning alphabet symbol $a = T(k)$ at tape square k , instruction I is executed as follows:

- The ex-machine state moves from state q to state r .
- The ex-machine replaces alphabet symbol a with alphabet symbol α so that $T(k) = \alpha$. The rest of the tape remains unchanged.
- If $y = -1$, the ex-machine moves its tape head one square to the left on the tape and is subsequently scanning the alphabet symbol $T(k-1)$ in tape square $k-1$.

- If $y = +1$, the ex-machine moves its tape head one square to the right on the tape and is subsequently scanning the alphabet symbol $T(k + 1)$ in tape square $k + 1$.
- If $y = 0$, the ex-machine does not move its tape head and is subsequently scanning the alphabet symbol $T(k) = \alpha$ in tape square k .

Remark 2.1. A Turing machine [97] has a finite set of states Q , a finite alphabet A , a finitely bounded tape, and a finite set of standard ex-machine [sic] instructions that are executed according to definition 2.1. In other words, an ex-machine that uses only standard instructions is computationally equivalent to a Turing machine. Hence, an ex-machine with only standard instructions will be called a standard machine or a Turing machine."

... Fiske: [Fi19], 2.1 Standard Instructions.

Fiske then defines the Collatz function, Collatz conjecture, and a Collatz (Turing) machine that computes the Collatz ‘orbit’ (sequence):

“The Collatz conjecture has an interesting relationship to Turing’s halting problem, which will be discussed further in section 7. Furthermore, there is a generalisation of the Collatz function that is unsolvable for a standard machine [25].

Definition 2.2 Collatz Conjecture

Define the Collatz function $f : \mathbb{N}^+ \rightarrow \mathbb{N}^+$, where $f(n) = \frac{n}{2}$ when n is even and $f(n) = 3n + 1$ when n is odd. Zero iterations of f is $f^0(n) = n$. k iterations of f is represented as $f^k(n)$. The orbit of n with respect to f is $\mathcal{O}(f, n) = \{f^k(n) : k \in \mathbb{N}\}$. Observe that $f(5) = 16$, $f^2(5) = 8$, $f^3(5) = 4$, $f^4(5) = 2$, $f^5(5) = 1$, so $\mathcal{O}(f, 5) = \{5, 16, 8, 4, 2, 1\}$. The Collatz conjecture states that for any positive integer n , $\mathcal{O}(f, n)$ contains 1."

... Fiske: [Fi19], 2.1 Standard Instructions.

Fiske further defines a set of *Machine Instructions* 1 for a Collatz (Turing) machine that, for each specified n , computes the orbit $\mathcal{O}(f, n)$:

“We specify a Turing machine that for each n computes the orbit $\mathcal{O}(f, n)$. The standard machine halts if the orbit $\mathcal{O}(f, n)$ contains 1. Set $A = \{0, 1, \#, E\}$. Set $Q = \{a, b, c, d, e, f, g, h, i, j, k, l, m, n, p, q\}$ where $a = 0$, $b = 1$, $c = 2$, ..., $n = 13$, $p = 14$, and $q = 15$.

Machine instructions 1 shows a list of standard instructions that compute $\mathcal{O}(f, n)$. The initial tape is $\# \#1^n\#$, where it is understood that the remaining tape squares, beyond the leftmost $\#$ and rightmost $\#$, contain only blank symbols. The space means the tape head is scanning the $\#$ adjacent to the leftmost 1 [sic]. The initial state is q .

Machine Instructions 1. Collatz Machine

...

With input $\# \#1^n\#$, the execution of the Collatz machine halts (i.e., moves to the halting state h) if the orbit $\mathcal{O}(f, n)$ reaches 1. Below shows the Collatz machine executing the first ten instructions with initial tape $\# \#11111\#$ and initial state q . Each row shows the current tape and machine state after the instruction in that row has been executed. The complete execution of the Collatz machine is shown in the appendix 8. It computes $\mathcal{O}(f, 5)$."

... Fiske: [Fi19], 2.1 Standard Instructions.

Fiske then introduces his concept of ‘*quantum random instructions*’, by identifying select machine states that appeal to an oracle (as in the case of his *Random Walk* ex-machine) for an essentially unpredictable value—from the computing ex-machine’s perspective—that is to be substituted in the currently scanned cell:

“2.2 Quantum Random Instructions

Repeated trials are called *quantum random Bernoulli trials* [37] if there are only two possible outcomes for each trial (i.e., quantum random measurement) and the probability of each outcome remains constant for all trials. *Unbiased* means the probability of both outcomes is the same. Below are the formal definitions.

Axiom 1. Unbiased Trials.

Consider the bit sequence $(x_1x_2\dots)$ in the infinite product space $\{0,1\}^{\mathbb{N}}$. A single outcome x_i of a bit sequence $(x_1x_2\dots)$ generated by quantum randomness is unbiased. The probability of measuring a 0 or a 1 are equal: $P(x_1 = 1) = p(x_i = 0) = \frac{1}{2}$.

Axiom 2. Stochastic Independence.

History has no effect on the next quantum random measurement. Each outcome x_i is independent of the history. No correlation exists between previous or future outcomes. This is expressed in terms of the conditional probabilities: $P(x_i = 1 \mid x_1 = b_1, \dots, x_{i-1} = b_{i-1}) = \frac{1}{2}$ and $P(x_i = 0 \mid x_1 = b_1, \dots, x_{i-1} = b_{i-1}) = \frac{1}{2}$ for each $b_i \in \{0,1\}$.

...

The quantum random instructions \mathcal{R} are subsets of $Q \times A \times Q \times \{-1,0,1\} = \{(q, a, r, y) : q, r \text{ are in } Q \text{ and } a \text{ in } A \text{ and } y \text{ in } \{-1,0,1\}\}$ that satisfy a uniqueness condition defined below.

Definition 2.3. Execution of Quantum Random Instructions

The quantum random instructions \mathcal{R} satisfy $\mathcal{R} \subset Q \times A \times Q \times \{-1,0,1\}$ and the following uniqueness condition: If $(q_1, \alpha_1, r_1, y_1) \in \mathcal{R}$ and $(q_2, \alpha_2, r_2, y_2) \in \mathcal{R}$ and $(q_1, \alpha_1, r_1, y_1) \neq (q_2, \alpha_2, r_2, y_2)$, then $q_1 \neq q_2$ or $\alpha_1 \neq \alpha_2$. When the tape head is scanning alphabet symbol a and the ex-machine is in state q , the quantum random instruction (q, a, r, y) executes as follows:

- The ex-machine measures a quantum random source that returns a random bit $b \in \{0,1\}$. (It is assumed that the quantum measurements satisfy unbiased Bernoulli trial axioms 1 and 2.)
- On the tape, alphabet symbol a is replaced with random bit b . (This is why A always contains both symbols 0 and 1.)
- The ex-machine state changes to state r .
- The ex-machine moves its tape head left if $y = -1$, right if $y = +1$, or the tape head does not move if $y = 0$.

Machine instructions 2 lists a random walk machine that has only standard instructions and quantum random instructions. Alphabet $A = \{0, 1, \#, E\}$. The states are $Q = \{0, 1, 2, 3, 4, 5, 6, h\}$, where the halting state $h = 7$. A valid initial tape contains only blank symbols; that is, $\# \# \#$. The valid initial state is 0.

There are three quantum random instructions: $(0, \#, 0, 0)$, $(1, \#, 1, 0)$ and $(4, \#, 4, 0)$. The random instruction $(0, \#, 0, 0)$ is executed first. If the quantum random source measures a 1, the machine jumps to state 4 and the tape head moves to the right of tape square 0. If the quantum random source measures a 0, the machine jumps to state i and the tape head moves to the left of tape square 0. Instructions containing alphabet symbol E provide error checking for an invalid initial tape or initial state; in this case, the machine halts with an error.

Machine Instructions 2. Random Walk

...

Below are 31 computational steps of the ex-machine’s first execution. This random walk machine never halts when the initial tape is blank and the initial state is 0. The first quantum random instruction executed is $(0, \#, 0, 0)$. The quantum random source measured a 0, so the execution

of this instruction is shown as $(0, \#, 0, 0_{qr}, 0)$. The second quantum random instruction executed is $(1, \#, 1, 0)$. The quantum random source measured a 1, so the execution of instruction $(1, \#, 1, 0)$ is shown as $(1, \#, 1, 1_{qr}, 0)$.

2nd Execution of Random Walk Machine. Computational Steps 1-31.

...

Below are the 31 steps of the ex-machine's second execution. The first quantum random instruction executed is $(0, \#, 0, 0)$. The quantum random bit measured was 1, so the result of this instruction is shown as $(0, \#, 0, 1_{qr}, 0)$. The second quantum random instruction executed is $(1, \#, 1, 0)$, which measured a 0, so the result of this instruction is shown as $(1, \#, 1, 0_{qr}, 0)$.

1st Execution of Random Walk Machine. Computational Steps 1-31.

...

The first and second executions of the random walk ex-machine verify our statement in the introduction: in contrast with the Turing machine, the execution behaviour of the same ex-machine may be distinct at two different instances, even though each instance of the ex-machine starts its execution with the same input on the tape, the same initial states and same initial instructions. Hence, the ex-machine is a discrete, non-autonomous dynamical system."

... Fiske: [Fi19], 2.2 Quantum Random Instructions.

It is not, however, obvious whether the appeal to an oracle for an essentially unpredictable value—from the computing ex-machine's perspective—that is to be substituted in the currently scanned cell in the above argumentation is to be made at:

- the occurrence of the pre-defined halting state of the Collatz machine;
- an 'abnormal' halt at other than the defined halting state of the Collatz machine; or
- 'a consecutive repeating state cycle' that does not reach a halting point (compare with §21.F., Definition 40, 'non-terminating loop'), where:

"A consecutive repeating state cycle in a Turing machine occurs when a finite sequence of standard machine instructions $\{I_i\}$ is executed by the Turing machine two consecutive times: $I_1 \rightarrow I_2 \rightarrow \dots I_k \rightarrow I_1 \rightarrow I_2 \dots I_k$ and the machine configuration before the first instruction I_1 is executed equals the machine configuration after the instruction I_k has completed its execution a second time."

... Fiske: [Fi19], 7 Two Research Problems.

The necessity—for Fiske's ex-machines—of an equal probability for each outcome in Fiske's Axiom 1 (Unbiased Trials) and Axiom 2 (Stochastic Independence) is also not obvious.

In other words, his description of a *Random Walk* ex-machine as 'a discrete, non-autonomous dynamical system' might still apply if we were to relax Axiom 1 and Axiom 2, and treat his 'quantum random source' alternatively as, for instance:

1. an idealised, eternally computing, Turing machine,
2. situated in a stabilised, globally accepted, International Standards locale,
3. that outputs only the 0's and 1's encountered in the non-terminating computation of the binary representation of an irrational number, say, π ,
4. which are then sequentially released on demand on-line,

5. as a π -based—albeit *seemingly* random—source of the bits 0 and 1 to intending ex-machines.

However, even if we were to relax Fiske’s stipulation—that his *quantum random* source must be constricted by an equal probability for each outcome in his Axiom 1 (Unbiased Trials) and Axiom 2 (Stochastic Independence)—a source of π -based, *seemingly* random (compare §7.G., Definition 27), bits as in 1-5 above would still not eliminate (since π is algorithmically *computable*) the perceived practical barrier that:

“Overall, the ex-machine uses quantum randomness as a computational tool. Hence, part of our goal was to use axioms 1 and 2 for our quantum random instructions, because the axioms are supported by the empirical evidence of various quantum random number generators [1, 5, 61, 64, 77, 93, 101, 102]. In practice, however, a physical implementation of a quantum random number generator can only generate a finite amount of data and only a finite number of statistical tests can be performed on the data. Due to these limitations, one goal of quantum random theory [72, 14, 15, 16, 96], besides general understanding, is to certify the mathematical properties, assumed about actual quantum random number generators, and assure that the theory is a reasonable extension of quantum mechanics [8, 9, 10, 51, 52, 53, 84, 85, 36, 4, 24, 59].”

... Fiske: [Fi19], 3 Quantum Randomness.

In other words, to obtain a number that could qualify as a ‘quantum random number’, we would have to assume, for instance, that a digital clock monitors the emission of radio-active particles from, say, an eternally replenished uranium source \mathcal{U} , where each tick of the clock is represented by a 0 if there is no emission since the previous tick, and a 1 if there is such an emission; and let $0 < \rho_1 < 1$ be the putative real number defined by the emissions of \mathcal{U} .

From the *evidence-based* perspective of this investigation, the sequence ρ_1 could then be treated as *relatively* random (see §7.G., Definition 27) vis à vis the ex-machine, since experimental observations confirm that such emission (compare with Bell’s Inequality Theorem in [B164]; see also §23.B.):

- *cannot* be defined as obeying the laws of *classical* (see §23.D.c., Thesis 19) mechanics—by which ρ_1 would be both algorithmically *verifiable* (hence its value would be *deterministic at each measurement*), *and* algorithmically *computable* (hence its value would also be *predictable before* each measurement);
- but *could* be defined as obeying the laws of *neo-classical* (see §23.D.d., Thesis 20) quantum mechanics—in which case ρ_1 could be algorithmically *verifiable* (hence its value would be *deterministic at each measurement*⁵⁰²), but not algorithmically *computable* (hence its value would be *unpredictable before* each measurement, albeit constrained by a determinate probability distribution).

Comment 178. In other words, a *relatively* random number-theoretic sequence can be defined (see §7.G., Definition 27) as algorithmically *verifiable*, but not algorithmically *computable* (see §7.G., Theorem 7.2). It cannot thus be represented—nor defined—as a partial recursive function; since the latter always defines, and is defined by, some deterministic Turing machine (see [Me64], p.237; [K152], p.373). However—complementing the Provability Theorem for PA which models algorithmically *computable* functions arithmetically (see §3.)—any *relatively* random sequence—such as, *prima facie*, that defined by one of Chaitin’s Ω constants (see §7.G., Theorem 16.3)—*can* be defined within PA in terms of Gödel’s β -functions (see §16.B.).

⁵⁰²Reflected by the value of the corresponding, ‘collapsed’, Schrödinger wave-function.

We note that Fiske’s development of his ex-machine as ‘a discrete, non-autonomous dynamical system’ is apparently to further introduce special meta instructions that would enable ‘the ex-machine to self-modify its instructions’:

Comment 179. It is, again, not obvious here whether such self-modification is to be made at:

- the occurrence of the pre-defined halting state of the ex-machine;
- an ‘abnormal’ halt at other than the defined halting state of the ex-machine; or
- ‘a consecutive repeating state cycle’ that does not reach a halting point (compare with §21.F., Definition 40, *non-terminating loop*’).

“2.3 Meta Instructions

Meta instructions are the second type of special instructions. The execution of a meta-instruction enables the ex-machine to self-modify its instructions. This means that an ex-machine’s meta-instructions can add new states, add new instructions or replace instructions. Formally, the meta-instructions \mathcal{M} satisfy $\{\mathcal{M} \subset \{(q, a, r, \alpha, y, J)\} : q \in Q \text{ and } r \in R \cup \{|Q|\} \text{ and } a, \alpha \in A \text{ and instruction } J \in \mathcal{S} \cup \mathcal{R}\}$.

Define $\mathcal{I} = \mathcal{S} \cup \mathcal{R} \cup \mathcal{M}$, as the set of standard, quantum random, and meta instructions. To help describe how a meta instruction modifies \mathcal{I} , the *unique state, scanning symbol condition* is defined: for any two distinct instructions chosen from \mathcal{I} at least one of the first two coordinates must differ. More precisely, all 6 of the following uniqueness conditions must hold:

1. If $(q_1, \alpha_1, r_1, \beta_1, y_1)$ and $(q_2, \alpha_2, r_2, \beta_2, y_2)$ are both in \mathcal{S} , then $q_1 \neq q_2$ or $\alpha_1 \neq \alpha_2$.
2. If $(q_1, \alpha_1, r_1, \beta_1, y_1) \in \mathcal{S}$ and $(q_2, \alpha_2, r_2, y_2) \in \mathcal{R}$ or vice versa, then $q_1 \neq q_2$ or $\alpha_1 \neq \alpha_2$.
3. If $(q_1, \alpha_1, r_1, y_1)$ and $(q_2, \alpha_2, r_2, y_2)$ are both in \mathcal{R} , then $q_1 \neq q_2$ or $\alpha_1 \neq \alpha_2$.
4. If $(q_1, \alpha_1, r_1, y_1) \in \mathcal{R}$ and $(q_2, \alpha_2, r_2, a_2, y_2, J_2) \in \mathcal{M}$ or vice versa, then $q_1 \neq q_2$ or $\alpha_1 \neq \alpha_2$.
5. If $(q_1, \alpha_1, r_1, \beta_1, y_1) \in \mathcal{S}$ and $(q_2, \alpha_2, r_2, a_2, y_2, J_2) \in \mathcal{M}$ or vice versa, then $q_1 \neq q_2$ or $\alpha_1 \neq \alpha_2$.
6. If $(q_1, \alpha_1, r_1, a_1, y_1, J_1)$ and $(q_2, \alpha_2, r_2, a_2, y_2, J_2)$ are both in \mathcal{M} , then $q_1 \neq q_2$ or $\alpha_1 \neq \alpha_2$.

Before a valid machine instruction starts, it is assumed that the standard, quantum random and meta instructions $\mathcal{S} \cup \mathcal{R} \cup \mathcal{M}$ always satisfy the unique state, scanning symbol condition. This condition assures that there is no ambiguity on what instruction should be executed when the machine is in state q and is scanning tape symbol a . Furthermore, the execution of a meta-instruction preserves this uniqueness condition.

Definition 2.4. Execution of Meta Instructions

A meta instruction (q, a, r, α, y, J) in \mathcal{M} is executed as follows.

- The first five coordinates (q, a, r, α, y) are executed as a standard instruction according to definition 2.1 with one caveat. State q may be expressed as $|Q| - c_1$ and state r may be expressed as $|Q|$ or $|Q| - c_2$, where $0 < c_1, c_2 \leq |Q|$. When (q, a, r, α, y) is executed, if q is expressed as $|Q| - c_1$, the value of q is instantiated to the current value of $|Q|$ minus c_1 . Similarly, if r is expressed as $|Q|$ or $|Q| - c_2$, the value of state r is instantiated to the current value of $|Q|$ or $|Q|$ minus c_2 , respectively.
- Subsequently, instruction J modifies \mathcal{I} , where instruction J has one of two forms: $J = (q, a, r, \alpha, y)$ or $J = (q, a, r, y)$.
- For both forms, if $\mathcal{I} \cup \{J\}$ still satisfies the unique state, scanning symbol condition, then \mathcal{I} is updated to $\mathcal{I} \cup \{J\}$.

- Otherwise, there is an instruction I in \mathcal{I} whose first two coordinates q, a , are equal to instruction J 's first two coordinates. In this case, instruction J replaces instruction I in \mathcal{I} . That is, \mathcal{I} is updated to $\mathcal{I} \cup \{J\} - \{I\}$."

... Fiske: [Fi19], 2.3 Meta Instructions

Fiske illustrates *how* his ‘new states are instantiated and added’ to the existing states of an ex-machine \mathcal{X} during a computation—still without explicitly specifying *when*, and *why*, such additions are to be made—in a process that he describes as invoking a ‘simple type of *self-reflection*’ that ‘poses no obstacles in physical realizations’:

“In regard to definition 2.4, example 1 shows how instruction I is added to \mathcal{I} and how new states are instantiated and added to Q .

Example 1. Adding New States

Consider the meta instruction $(q, a_1, |Q| - 1, \alpha_1, y_1, J)$, where $J = (|Q| - 1, a_2, |Q|, \alpha_2, y_2)$. After the standard instruction $(q, a_1, |Q| - 1, \alpha_1, y_1)$ is executed, this meta instruction adds one new state $|Q|$ to the machine states Q and also adds the instruction J , instantiated with the current value of $|Q|$.

...

Let \mathcal{X} be an ex-machine. The instantiation of $|Q| - 1$ and $|Q|$ in a meta instruction I invokes *self-reflection* about \mathcal{X} 's current number of states, at the moment when \mathcal{X} executes I . This simple type of self-reflection poses no obstacles in physical realizations. In particular, a LISP implementation [70] along with quantum random bits measured from [101] simulates all executions of the ex-machines provided therein."

... Fiske: [Fi19], 2.3 Meta Instructions

However, Fiske does implicitly suggest his intent in his remark that if an ‘ex-machine \mathcal{X}_0 with tape T_0 ’ does self-modify its instructions during an execution, *and halt*, then it can be said to have *evolved* to an ‘ex-machine \mathcal{X}_1 with tape S_1 ’:

“Definition 2.7. Evolving an ex-machine

Let $T_0, T_1, T_2 \dots T_{i-1}$ each be a finitely bounded tape. Consider ex-machine \mathcal{X}_0 with finite initial conditions. \mathcal{X}_0 starts executing with tape T_0 and evolves to ex-machine \mathcal{X}_1 with tape S_1 . Subsequently, \mathcal{X}_1 starts executing with tape T_1 and evolves to \mathcal{X}_2 with tape S_2 . This means that when ex-machine \mathcal{X}_1 starts executing on tape T_1 , its instructions are preserved after the halt with tape S_1 . The ex-machine evolution continues until \mathcal{X}_{i-1} starts executing with tape T_{i-1} and evolves to ex-machine \mathcal{X}_i with tape S_i . One says that ex-machine \mathcal{X}_0 with finitely bounded tapes $T_0, T_1, T_2 \dots T_{i-1}$ evolves to ex-machine \mathcal{X}_i after i halts."

... Fiske: [Fi19], 2.3 Meta Instructions

Now, if we treat Fiske’s ex-machine \mathcal{X}_0 as defining the partial recursive function, say $(\mu x)(F_0(x) = a_0)$ then, *for some k_0 , defined by the instruction set for \mathcal{X}_0 , and such that $F_0(k_0) \neq a_0$* , the above process constructs an ex-machine \mathcal{X}_1 that defines some ‘*random*’ partial recursive function, say $(\mu x)(F_1(x) = a_1)$ such that \mathcal{X}_1 will first compute \mathcal{X}_0 , *halt* and return the value k_0 , *before* computing \mathcal{X}_1 by the modified instruction set for \mathcal{X}_1 .

Iterating the process, we obtain the non-terminating sequence (Fiske’s ‘*evolutionary path*’ of \mathcal{X}_0) of, ‘*randomly*’ defined, non-deterministic ex-machines, $\mathcal{X}_0 \rightarrow \mathcal{X}_1 \rightarrow \mathcal{X}_2 \dots \rightarrow \mathcal{X}_n \dots$, such that each $i \geq 0$ defines a partial recursive function $(\mu x)F_i(x) = a_i$ and some ‘*random*’ k_i for which $F_i(k_i) \neq a_i$, and at which the instruction set of \mathcal{X}_i is modified to that of \mathcal{X}_{i+1} .

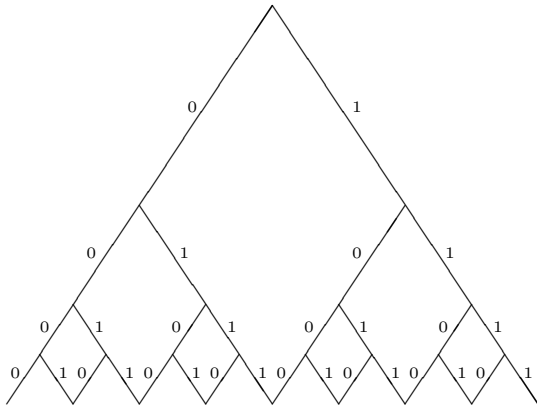

Fig. 5: Infinite binary tree. A graphical representation of $\{0, 1\}^{\mathbb{N}}$

Fiske notes that, if his ‘*random*’ modifications to the existing machine states and instructions at each halt in the above process appeal to an oracle (such as a ‘random’ walk machine) that supplies only binary values, then the result of running \mathcal{X}_0 repeatedly on tape T_0 would yield an infinite binary tree structure such as Fig. 5 above (corresponding to Figure 3 in [Fi19]) where, at each k_i , \mathcal{X}_i would halt and, essentially, define two different partial recursive functions to be computed by two distinctly different self-modified ex-machines, say $\mathcal{X}_{(i+1)_a}$ and $\mathcal{X}_{(i+1)_b}$.

Comment 180. We note that there seems no imperative that the *random* values supplied by the oracle (such as Fiske’s random walk machine) be binary and, prima facie, Fiske’s construction should hold even if the *random* values supplied by the oracle were *n*-ary instead of binary.

However, Fiske notes further that, for a particular string in the language $L \in \mathcal{L} = \bigcup_{L \in \mathcal{a}^*} \{L\}$, where $\mathbf{a}^* = \{\mathbf{a}^n : n \in \mathbb{N}\}$, some ex-machine could, conceivably, oscillate indefinitely—even periodically—between halting states that accept the string, and those that do not:

“In order to define the halting syntax for the language in \mathcal{L} that an ex-machine computes, choose alphabet set $A = \{\#, 0, 1, N, Y, \mathbf{a}\}$.

Definition 4.2. Language L in \mathcal{L} that ex-machine \mathcal{X} computes

Let \mathcal{X} be an ex-machine. The language L in \mathcal{L} that \mathcal{X} computes is defined as follows. A valid initial tape has the form $\# \mathbf{a}^n \#$. The valid initial tape $\# \#$ represents the empty string. After machine \mathcal{X} starts executing with initial tape $\# \mathbf{a}^n \#$, string \mathbf{a}^n is in \mathcal{X} ’s language if ex-machine \mathcal{X} halts with tape $\# \mathbf{a}^n \# Y \#$. String \mathbf{a}^n is not in \mathcal{X} ’s language if \mathcal{X} halts with tape $\# \mathbf{a}^n \# N \#$.

The use of special alphabet symbols Y and N —to decide whether \mathbf{a}^n is in the language or not in the language—follows [63].

For a particular string $\# \mathbf{m}^m \#$, some ex-machine \mathcal{X} could first halt with $\# \mathbf{a}^m \# N \#$ and in a second computation with input $\# \mathbf{a}^m \#$ could halt with $\# \mathbf{a}^m \# Y \#$. This oscillation of halting outputs could continue indefinitely and in some cases the oscillation can be periodic. In this case, \mathcal{X} ’s language would not be well-defined according to definition 4.2.”

... Fiske: [Fi19], 4 Computing Ex-Machine Languages

To eliminate such ex-machines whose halting output never stabilises, Fiske defines a class of ex-machines as evolutions of a fundamental ex-machine \mathfrak{D} , with 15 specified initial instructions, that compute languages L that are subsets of $\{\mathbf{a}^* = \{\mathbf{a}^n : n \in \mathbb{N}\}\}$; where the expression \mathbf{a}^n represents a string of n consecutive \mathbf{a} ’s. He then notes that:

“There is a subtle difference between \mathfrak{D} and an ex-machine \mathcal{X} whose halting output never stabilises. In contrast to the Turing machine, two different instances of the ex-machine \mathfrak{D} can evolve two to

two different machines and compute distinct languages according to definition 4.2. However, after \mathcal{D} has evolved to a new machine $\mathcal{D}(a_0 a_1 \dots a_m x)$ as a result of a prior execution with input tape $\# \mathbf{a}^m \#$, then for each i with $0 \leq i \leq m$, machine $\mathcal{D}(a_0 a_1 \dots a_m x)$ always halts with the same output when presented with input tape $\# \mathbf{a}^i \#$. In other words, $\mathcal{D}(a_0 a_1 \dots a_m x)$'s halting output stabilises on all input strings \mathbf{a}^i where $0 \leq i \leq m$. Furthermore, it is the ability of $\mathcal{D}(a_0 a_1 \dots a_m x)$ to exploit the non-autonomous behaviour of its two quantum random instructions that enables an evolution of $\mathcal{D}(a_0 a_1 \dots a_m x)$ to compute languages that are Turing incomputable."

... Fiske: [Fi19] 4 Computing Ex-Machine Languages.

Fiske then formally concludes that:

Lemma 4.1. *Whenever i satisfies $0 \leq i \leq m$, string \mathbf{a}^i is in $\mathcal{D}(a_0 a_1 \dots a_m x)$'s language if $a_i = 1$; string \mathbf{a}^i is not in $\mathcal{D}(a_0 a_1 \dots a_m x)$'s language if $a_i = 0$. Whenever $n > m$, it has not yet been determined whether string \mathbf{a}^n is in $\mathcal{D}(a_0 a_1 \dots a_m x)$'s language or not in its language.*

Definition 4.3. Define \mathcal{U} as the union of $\mathcal{D}(x)$ and all ex-machines $\mathcal{D}(a_0 \dots a_m x)$ for each $m \in \mathbb{N}$ and for each $a_0 \dots a_m$ in $\{0, 1\}^{m+1}$. In other words,

$$\mathcal{U} = \{\mathcal{D}(x)\} \cup \bigcup_{m=0}^{\infty} \bigcup_{a_0 \dots a_m \in \{0,1\}^{m+1}} \{\mathcal{D}(a_0 a_1 \dots a_m x)\}$$

Theorem 4.2. *Each language L_f in \mathcal{L} can be computed by the evolving sequence of ex-machines $\mathcal{D}(x), \mathcal{D}(f(0)x), \mathcal{D}(f(0)f(1)x), \dots, \mathcal{D}(f(0)f(1) \dots f(n)x), \dots$*

Corollary 4.3. *Given function $f : \mathbb{N} \rightarrow \{0, 1\}$, for any arbitrary large n , the evolving sequence of ex-machines $\mathcal{D}(f(0)f(1) \dots f(n)x), \mathcal{D}(f(0)f(1) \dots f(n)f(n+1)x), \dots$ computes language L_f .*

Corollary 4.4. *Moreover, for each n , all ex-machines $\mathcal{D}(x), \mathcal{D}(f(0)x), \mathcal{D}(f(0)f(1)x), \dots, \mathcal{D}(f(0)f(1) \dots f(n)x)$ combined have used only a finite amount of tape, finite number of states, finite number of instructions, finite number of executions of instructions and only a finite amount of quantum random information measured by the quantum random instructions."*

... Fiske: [Fi19] 4 Computing Ex-Machine Languages.

Fiske argues further that:

"Since the set of all Turing machines is countable and each Turing machine only recognizes a single language *most* (in the sense of Cantor's hierarchy of infinities [19]) languages L_f are not computable with a Turing machine. More precisely, the set of languages L_f computable with a Turing machine is a computable set, while the set of all languages \mathcal{L} is an uncountable set.

For each non-negative integer n , define the language tree $\mathcal{L}(a_0 a_1 \dots a_n) = \{L_f : f \in \{0, 1\}^{\mathbb{N}} \text{ and } f(i) = a_i \text{ for } i \text{ satisfying } 0 \leq i \leq n\}$. Let Ψ denote this 1-to-1 correspondence, where $\mathcal{L} \xrightarrow{\Psi} \{0, 1\}^{\mathbb{N}}$ and $\mathcal{L}(a_0 a_1 \dots a_n) \xrightarrow{\Psi} \mathcal{S}(a_0 a_1 \dots a_n)$.

Since the two random axioms 1 and 2 are satisfied, each finite path $f_0 f_1 \dots f_n$ is equally likely and there are 2^{n+1} of these paths. Thus, each path of length $n + 1$ has probability $2^{-(n+1)}$. These uniform probabilities on finite strings of the same length can be extended to the Lebesgue measure μ on probability space $\{0, 1\}^{\mathbb{N}}$ [37, 38]. Hence, each subset $\mathcal{S}(a_0 a_1 \dots a_n)$ has measure $2^{-(n+1)}$. That is, $\mu(\mathcal{S}(a_0 a_1 \dots a_n)) = 2^{-(n+1)}$ and $\mu(\{0, 1\}^{\mathbb{N}}) = 1$. Via the Ψ correspondence between each language tree $\mathcal{L}(a_0 a_1 \dots a_n)$ and subset $\mathcal{S}(a_0 a_1 \dots a_n)$, uniform probability measure μ induces a uniform probability measure ν on \mathcal{L} , where $\nu(\mathcal{L}(a_0 a_1 \dots a_n)) = 2^{-(n+1)}$ and $\nu(\mathcal{L}) = 1$.

Theorem 4.5. *For functions $f : \mathbb{N} \rightarrow \{0, 1\}$, the probability that language L_f is Turing incomputable has measure 1 in (ν, \mathcal{L}) ."*

... Fiske: [Fi19] 4 Computing Ex-Machine Languages.

Corollary 4.6. *$\mathcal{D}(x)$ is not a Turing machine. Each ex-machine $\mathcal{D}(a_0 a_1 \dots a_m x)$ in \mathcal{U} is not a Turing machine."*

... Fiske: [Fi19] 4 Computing Ex-Machine Languages.

21.G.a. Representing fundamental physical constants by Fiske’s ex-machines \mathfrak{D}

Now, one of the challenging issues in physics is to mathematically define some fundamental dimensionless constants whose values cannot be calculated theoretically, but can only be determined experimentally since, from the *evidence-based* perspective of this investigation (see §23.D., Thesis 16), such constants are only representable mathematically by real numbers that are algorithmically *verifiable*, but not algorithmically *computable*.

Fiske’s Theorem 4.2 and Corollary 4.3 now suggest (compare §7.I.; also §16.B.) that, from a computational perspective, each such dimensionless constant could be viewed as the putative computation of an appropriate ex-machine \mathfrak{D} , since every real number could, presumably, be computed by some ex-machine \mathfrak{D} . As remarked by Fiske:

“At first glance, the results from the prior section may seem paradoxical. Even though there are only a computable number of initial ex-machines in \mathcal{U} , the ex-machines evolving from $\mathfrak{D}(x)$ can compute languages L_f where each $f : \mathbb{N} \rightarrow \{0, 1\}$ corresponds to a particular instance selected from an uncountable number of infinite paths in the infinite binary tree (i.e., $\{0, 1\}^{\mathbb{N}}$ is uncountable [18]). With initial state 0 and initial tape # $\#a^n\#$, for every n and m with $n > m$, each ex-machine $\mathfrak{D}(a_0a_1 \dots a_m x)$ has an uncountably infinite number of possible execution behaviors. On the other hand, a Turing machine with the same initial state 0 and initial tape # $\#a^n\#$ always has exactly one execution behavior. Hence, a Turing machine can only have a countable number of execution behaviors for all initial tapes # $\#a^n\#$, where $n > m$.”

... Fiske: [Fi19] 5 Some $\mathfrak{D}(x)$ Observations Based on Cantor and Gödel.

Fiske remarks upon the peculiarity, ‘that the countable set \mathcal{U} of ex-machines can evolve to compute an uncountable number of languages L_f ’, by drawing an analogy to the definition of real numbers in elementary analysis (see, for instance, [La29]), whereby ‘each real number can be realized as a sequence of rational numbers, even though the real numbers are uncountable. Furthermore, each rational number in that sequence is representable with a finite amount of information (bits)’.

However, from the *evidence-based* perspective of this investigation, the analogy that Fiske seeks to draw can be viewed as essentially the argument in §7.I., Theorem 7.5, that every real number is specifiable in PA; and, moreover, that (see §7.I.a.) *evidence-based* reasoning does not admit Cantor’s theorem.

In other words, from an *evidence-based* perspective, §7.I., Theorem 7.5 implies that real numbers do not exist in some Platonic, set-theoretic, universe of points that constitute a line, but are arithmetical constructs identifiable as specific number-theoretic definitions that are algorithmically *verifiable* (hence *well-defined*), but not necessarily algorithmically *computable*.

As illustrated by the gedanken in §20.C., they assume significance (which can, debatably, be termed as ‘existence’) mathematically only when such a definition is made explicit formally in an argumentation (compare with Brouwer’s parallel perspective cited in §7.L.).

Thus, if the intent is *not* to postulate the existence of a notional ‘halting’ state—i.e., a *completed evolutionary path* whose limiting state can be treated as *the* real number ‘*computed/realized*’ by a ‘quantum algorithm’ (a postulation that could violate §7.I.a., Theorem 7.6)—corresponding to the Cauchy limit of the Cauchy sequence defined by a quantum algorithm for an evolving sequence of ex-machines, then Fiske is justified in asserting that his formal conclusions entail:

“... each language L_f can be computed (i.e., realized) by the evolving sequence of ex-machines $\mathfrak{D}(x), \mathfrak{D}(f(0)x), \mathfrak{D}(f(0)f(1)x), \dots, \mathfrak{D}(f(0)f(1) \dots f(n)x), \dots$, where for each n , all ex-machines

$\mathfrak{D}(x), \mathfrak{D}(f(0)x), \mathfrak{D}(f(0)f(1)x), \dots, \mathfrak{D}(f(0)f(1)\dots f(n)x)$ have used only a finite amount of tape, finite number of states, finite number of instructions, finite number of executions of instructions and a finite amount of quantum random information has been measured."

... Fiske: [Fi19] 5 Some $\mathfrak{D}(x)$ Observations Based on Cantor and Gödel.

since such ‘computations’ can be treated as trivially instantiating Gödel’s primitive recursive ‘ β -function’ Lemma 1 in [Go31] (compare with §21.F.c., Theorem 21.6):

“If f is an arbitrary sequence of natural numbers and k is an arbitrary natural number, then there exists a pair of natural numbers n, d such that $f^{(n,d)}$ and f coincide in their first k terms."

... Gödel: [Go31], Lemma 1, p.31

This suggests that the ‘evolving’ value of an ‘essentially incompletable’ (see §7.I.a.) dimensionless ‘quantum’ constant could, conceivably, be viewed as being determined somehow by an n -ary, weighted, ‘random’ probability function that, at each evolution of the sequence of ex-machines $\mathfrak{D}(x), \mathfrak{D}(f(0)x), \mathfrak{D}(f(0)f(1)x), \dots$, determines the ‘Heisenberg’ probability of the ‘halting’ value at the next evolution of an ex-machine in the sequence.

21.G.b. An *evidence-based* perspective of the ‘decidability’ of the Collatz conjecture

Finally, apropos the decidability of the Collatz conjecture, which apparently motivated him to consider the development of *quantum random, self-modifiable machines* such as his *evolving* ex-machines \mathcal{X} and \mathfrak{D} , Fiske concludes:

“In [42], the main theorem shows that the consecutive repeating state cycles characterize the periodic points of a Turing machine. A periodic point that does not reach a halting state indicates that the Turing machine execution is immortal (i.e., never halts). Can this consecutive repeating state cycle theorem or an extension of this theorem be used to help an ex-machine find a proof? If the standard $\sqrt{2}$ machine writes symbols on the tape in a periodic sequence, this indicates that $\sqrt{2}$ is rational. If an ex-machine can construct rules which prove that the standard $\sqrt{2}$ machine never halt, then these ex-machine rules provide a proof that the $\sqrt{2}$ is irrational.

...

Transform Collatz machine 1’s execution of each individual orbit $\mathcal{O}(f, n)$ into a single ex-machine computation that collectively makes a determination about all individual orbits. That is, find an ex-machine computation that evolves to a decision whether 1 is in $\mathcal{O}(f, n)$ for all $n \in \mathbb{N}$. Is it possible to accomplish this with an ex-machine computation? If it is impossible, why?

Consider the augmentation of Collatz machine 1 to an enumerated Collatz machine \mathcal{E} . The standard machine \mathcal{E} iterates over the odd numbers 3, 5, 7, ... \mathcal{E} first writes # # 111# on the input tape and hands this computation over to Collatz machine 1. After Collatz machine 1 halts at 1, then \mathcal{E} updates the input tape to # # 11111#, representing 5, and hands this to the Collatz machine again. After the Collatz machine halts at 1, then \mathcal{E} updates the input tape to # # 1111111#, and so on. If the Collatz conjecture is true, this execution of \mathcal{E} never halts and \mathcal{E} iterates over every odd number."

... Fiske: [Fi19] 7 Two Research Problems.

Fiske observes that:

At least part of the challenge with machine \mathcal{E} seems to be that there could exist some n such that n ’s Collatz orbit reaches a periodic attractor that does not contain 1. Another possibility is that there exists some u whose Collatz orbit aperiodically oscillates and never reaches 1. In this case, u ’s orbit does not have an upper bound. That is, $\sup \mathcal{O}(f, u) = \infty$. In both cases, the orbit of n and the orbit of u do not halt at 1. If the conjecture is true, how does one distinguish these two

different types of immortal orbits from the enumerated Collatz machine that halts at 1 for each odd output, but is also immortal?

Is it possible to transform (either by human ingenuity or by ex-machine evolution or a combination) this enumerated Collatz machine \mathcal{E} into a non-vacuous, explicit Turing machine so that an immortal proves or disproves that the Collatz conjecture is true? If this transformation exists, does there exist an ex-machine that can construct this transformation?"

... Fiske: [Fi19] 7 Two Research Problems.

However, from the *evidence-based* perspective of this investigation—which admits the Provability Theorem for PA (see §2.E.b., Theorem 2.17) and identifies the algorithmically *computable* number-theoretic functions as precisely the PA-provable formulas—the putative ‘challenge with machine \mathcal{E} ’ faced by Fiske in differentiating between:

- (i) the case where ‘some n such that n ’s Collatz orbit reaches a periodic attractor that does not contain 1’; and
- (ii) the case where there exists some u whose Collatz orbit aperiodically oscillates and never reaches 1. In this case, u ’s orbit does not have an upper bound. That is, $\sup \mathcal{O}(f, u) = \infty$.

dissolves if we note that (see also the observations in §3.):

- (ia) the case (i) corresponds to the operation of the Turing machine T_2 in the proof of Theorem 21.3 in §21.F.b.; whilst
- (iia) the case (ii) corresponds to the operation of the Turing machine T_3 in the proof of Theorem 21.3 in §21.F.b..

We can then argue that:

1. The Collatz function $f(n) = n/2$ if n is even, and $f(n) = 3n + 1$ if n is odd.
 - 1a. For each $n \geq 1$, we then have the non-terminating, recursive, Collatz sequence:

$$C(n) = c(n, 1), c(n, 2), c(n, 3), \dots$$
 where $c(n, 1) = f(n)$ and, for $i > 1$:

$$c(n, i + 1) = c(n, i)/2 \text{ if } c(n, i) \text{ is even;}$$

$$c(n, i + 1) = 3c(n, i) + 1 \text{ if } c(n, i) \text{ is odd.}$$
2. Define $D(n)$ as the least i such that $c(n, i) = 1$.
 - 2a. Thus $D(n)$ is a partial recursive function, which is Turing-computable (but not necessarily Turing-determinate for all n).
 - 2c. *Reason*: Turing’s Halting Theorem (§21.F.b., Corollary 21.5) states that it is not always decidable by a Turing machine whether or not a specified partial recursive function is *total*.
 - 2d. In other words, there are partial recursive functions $F(n)$ such that, for some value m , no Turing machine T that computes $F(n)$ will output a value for $F(m)$.

3. The Collatz conjecture is then that any Turing machine T which accepts $D(n)$ will, for any m , output a value of $D(m)$ and halt.
4. Now:
 - 4a. The Halting-decidability Theorem for T (§21.F.b., Corollary 21.4) entails that, given a Turing machine T , one can effectively decide, given any instantaneous description α , whether or not there is a computation of T beginning with α .
 - 4b. Hence, it is always possible to effectively determine whether a Turing machine T will halt or not when computing a specified partial recursive function.
5. So:
 - 5a. If it is determined by the Halting-decidability Theorem for T (§21.F.b., Corollary 21.4) that T accepts $D(n)$, and halts for all n (corresponding to case (c) in §21.F.b., Theorem 21.3), then the Collatz conjecture is proved.
 - 5b. However, if it is determined that T accepts $D(n)$, but does not halt for some m , then the Collatz conjecture is:
 - either decidable as false (corresponding to case (a) in §21.F.b., Theorem 21.3);
 - or algorithmically undecidable (corresponding to case (b) in §21.F.b., Theorem 21.3).

We conclude that the following is an immediate consequence of the Halting-decidability Theorem for T (§21.F.b., Corollary 21.4):

Corollary 21.7. (Collatz Decidability Theorem) *Whether the Collatz conjecture is decidable or not is effectively decidable.* □

We note that:

- If the Collatz conjecture were proved to be undecidable (corresponding to case (b) in §21.F.b.), the reason would be that, for any specified m , there would be some, m -specific, Turing machine T_m which would compute $D(m)$ and halt; so $D(n)$ would be *algorithmically verifiable*.
- However, there would be no Turing machine T that accepts $D(n)$ and halts for all n ; so $D(n)$ would *not* be *algorithmically computable*.

21.H. An *evidence-based* perspective of Deutsch’s Church-Turing principle

The theoretical significance of the distinction between Turing’s Halting Theorem (§21.F.b., Corollary 21.5) and the Halting-decidability Theorem for T (§21.F.b., Corollary 21.4) is seen in a seminal paper [Deu85] by David Deutsch, *Quantum theory, the Church-Turing principle and the universal quantum computer*; where he articulates a ‘Church-Turing principle’ that essentially seeks to differentiate between classical Turing-computability, and what he terms as a ‘class of model computing machines that is the quantum generalization of the class of Turing

machines' which 'could, in principle, be built and would have many remarkable properties not reproducible by any Turing machine' ([Deu85], Abstract).

From the *evidence-based* perspective of this investigation, Deutsch's perspective can be viewed as essentially that:

- The Church-Turing hypothesis is a mathematical assertion;
- The Church-Turing principle is a physical principle (law);
- Classical physics seeks to model physical processes in terms of continuous functions;
- Turing machines seek to model physical processes in terms of discrete number-theoretic functions;
- Both classical physics and Turing machines do not obey the strong form of the Church-Turing principle;
- Both quantum theory and a class of model computing machines that is the quantum generalization of the class of Turing machines are compatible with the physical Church-Turing principle;
- Quantum computing machines do not claim to compute non-recursive functions;
- Quantum computers can model 'quantum parallelism';
- Quantum computers can perform some probabilistic tasks faster than any classical computer (Turing machine);
- The intuitive explanation of the properties that distinguish quantum computers from classical computers is consistent with Everett's 'many-world' interpretation of quantum theory;
- Quantum complexity theory allows a physically more reasonable description of the 'complexity' or 'knowledge' in a physical system than does classical complexity theory.

For instance, Deutsch argues that:

"... Intuitively, a computing machine is any physical system whose dynamical evolution takes it from one of a set of 'input' states to one of a set of 'output' states. The states are labelled in some canonical way, the machine is prepared in a state with a given input label and then, following some motion, the output state is measured. For a classical deterministic system the measured output label is a definite function f of the prepared input label; moreover the value of that label can in principle be measured by an outside observer (the 'user') and the machine is said to 'compute' the function f .

Two classical deterministic computing machines are '*computationally equivalent*' under given labellings of their input and output states if they compute the same function under those labellings. But quantum computing machines, and indeed classical stochastic computing machines, do not 'compute functions' in the above sense: the output state of a stochastic machine is random with only the probability distribution function for the possible outputs depending on the input state. The output state of a of a quantum machine, although fully determined by the input state is not an observable and so cannot in general discover its label. Nevertheless, the notion of computational equivalence can be generalized to apply to such machines also."

... Deutsch: [Deu85], §1 *Computing machines and the Church-Turing principle*, p.2.

However, from the *evidence-based* perspective of this investigation, the outputs of both a stochastic and a quantum machine would be viewed as ‘relatively random’ (see §7.G., Definition 27) if, and only if:

- they were determined completely by their inputs
- which, in both cases, were mathematically expressible in terms of functions, and relations,
- at least one of which is, necessarily, algorithmically *verifiable* (hence determinate), but not algorithmically *computable* (hence unpredictable).

The significance of such an *evidence-based* perspective is seen in Deutsch’s further reasoning that:

“Again we define computational equivalence *under given labellings*, but it is now necessary to specify more precisely what is to be labelled. As far as the input is concerned, labels must be given for each of the possible ways of preparing the machine, which correspond, by definition, to all the possible input states. This is identical with the classical deterministic case. However, there is an asymmetry between input and output because there is an asymmetry between preparation and measurement: whereas a quantum system can be prepared in any desired permitted input state, measurement cannot in general determine its output state; instead one must measure the value of some observable. (Throughout this paper I shall be using the Schrödinger picture, in which the quantum state is a function of time but observables are constant operators.) Thus what must be labelled is the set of ordered pairs consisting of an output observable and a possible measured value of that observable (in quantum theory, a Hermitian operator and one of its eigenvalues). Such an ordered pair contains, in effect, the specification of a possible experiment that could be made on the output, together with the possible result of that experiment.

Two computing machines are computationally equivalent under given labellings if in any possible experiment or sequence of experiments in which their inputs were prepared equivalently under the input labellings, and observables corresponding to each other under the output labellings were measured, the measured values of these observables for the two machines would be statistically indistinguishable. That is, the probability distribution functions for the outputs of the two machines would be identical."

...Deutsch: [Deu85], §1 Computing machines and the Church-Turing principle, p.2.

since the output of both machines would be viewed as corresponding to:

- an algorithmically *verifiable* (hence determinate), but not algorithmically *computable* (hence unpredictable), ‘observable’;
 - where the Hermitian operator which is determined by the input (program);
 - determines the permissible, algorithmically *computable*, values into which the output observable ‘collapses’ upon interpretation (corresponding to a physical measurement);
 - with the precise, algorithmically *computable*, ‘observed’ value depending deterministically upon the precision (comparable to the length of a specified finite sequence of non-negative integers in the determination of the sequence’s unique Gödel β -function, as detailed in §16.A.);
 - admitted by the ‘observer’ at the ‘measurement’.

We note that Deutsch seeks to distinguish here between classical, deterministic, Turing machines, and seemingly ‘non-deterministic’ quantum machines, purely on the basis of how their outputs are to be interpreted and presented by the machine’s program.

In other words, both classical Turing machines and quantum machines are deterministic in the sense that:

- whereas the former computes the ‘output’ values of partial recursive functions whose ‘input’ arguments are natural numbers,
- the latter computes the ‘output’ quantum states of functions whose ‘input’ arguments are ordered pairs corresponding to the quantum state of an ‘observable’ before a measurement.

However, whereas any output computed by a classical Turing machine for a given input is a unique natural number, the output computed by a quantum machine is a unique ordered pair (quantum state) that, when interpreted by the machine as a ‘measurement’, does not yield a unique value but a probability distribution for a range of values into which the ‘quantum state’ of the ‘observable’ can ‘collapse’ upon ‘measurement’.

Since both classical Turing machines and quantum machines have finite alphabets and finite programs—i.e., the set of permissible machine states that uniquely define the operations of the machine—the latter can be uniquely coded by Gödel-numbers as detailed in [Go31], pp.13-14 (see §29.B.), to yield a number-theoretic relation $g(n)$ that holds if, and only if, n is the Gödel number of a computing machine.

Moreover, such Gödel-numbering entails that $g(n)$ is computable by a classical Turing machine, say \mathcal{G} , so as to yield the set $C(\mathcal{T})$ of permissible machine states—say ‘ \mathcal{T} -computable functions’—that define the operations of the computing machine—whether classical or quantum—Gödel-numbered by n that are computable by Turing’s universal computing machine \mathcal{T} .

As expressed by Deutsch, a ‘function f is \mathcal{M} -computable if \mathcal{M} can compute f when prepared with some program’; where he further notes that ‘for functions from the integers \mathbb{Z} to themselves’ the set $C(\mathcal{T})$ ‘also known as the set of recursive functions, is denumerable and therefore infinitely smaller than the set of all functions from \mathbb{Z} to \mathbb{M} ’.

However, he concludes from this that ‘although logic does not forbid the physical computation of arbitrary functions, it seems that physics does’:

“In the sense just described, a given computing machine \mathcal{M} computes at most one function. However, there ought to be no fundamental difference between altering the input state in which \mathcal{M} is prepared, and altering systematically the constitution of \mathcal{M} so that it becomes a different machine \mathcal{M}' computing a different function. To formalize such operations, it is often useful to consider machines with two inputs, the preparation of one constituting a ‘program’ determining which function of the other is to be computed. To each such machine \mathcal{M} there corresponds a set $C(\mathcal{M})$ of ‘ \mathcal{M} -computable functions’. A function f is \mathcal{M} -computable if \mathcal{M} can compute f when prepared with some program.

The set $C(\mathcal{M})$ can be enlarged by enlarging the set of changes in the constitution of \mathcal{M} that are labelled as possible \mathcal{M} -programs. Given two machines \mathcal{M} and \mathcal{M}' it is possible to construct a composite machine whose set of computable functions contains the union of $C(\mathcal{M})$ and $C(\mathcal{M}')$.

There is no purely logical reason why one could not go on *ad infinitum* building more powerful computing machines, nor why there should exist any function that is outside the computable set of every physically possible machine. Yet although logic does not forbid the physical computation

of arbitrary functions, it seems that physics does. As is well known, when designing computing machines one rapidly reaches a point when adding additional hardware does not alter the machine's set of computable functions (under the idealization that the memory capacity is in effect unlimited); moreover, for functions from the integers \mathbb{Z} to themselves the set $C(\mathcal{M})$ is always contained in $C(\mathcal{T})$, where \mathcal{T} is Turing's universal computing machine (Turing 1936). $C(\mathcal{T})$ itself, also known as the set of recursive functions, is denumerable and therefore infinitely smaller than the set of all functions from \mathbb{Z} to \mathbb{Z} ."

... Deutsch: [Deu85], §1 Computing machines and the Church-Turing principle, pp.2-3.

From the *evidence-based* perspective of this investigation, Deutsch's conclusion that Turing's universal computing machine entails:

- 'when designing computing machines one rapidly reaches a point when adding additional hardware does not alter the machine's set of computable functions (under the idealization that the memory capacity is in effect unlimited)',
- even though there 'is no purely logical reason why one could not go on *ad infinitum* building more powerful computing machines, nor why there should exist any function that is outside the computable set of every physically possible machine'

suggests that the 'arbitrary' functions contemplated by Deutsch might be what we have termed as 'quantum' functions (see §23.D., Thesis 16) that are algorithmically *verifiable* but not algorithmically *computable* (by \mathcal{T}); and which Deutsch further refers to as 'functions which may in principle be computed by a real physical system':

"Church (1936) and Turing (1936) conjectured that these limitations on what can be computed are not imposed by the state-of-the-art in designing computing machines, nor by our ingenuity in constructing models for computation, but are universal. This is called the 'Church-Turing hypothesis'; according to Turing,

Every 'function which would naturally be regarded as computable' can be computed by the universal Turing machine. (1.1)

The conventional, non-physical view of (1.1) interprets it as the quasi-mathematical conjecture that all possible formalizations of the intuitive mathematical notion of 'algorithm' or 'computation' are equivalent to each other. But we shall see that it can also be regarded as asserting a new physical principle, which I shall call the Church-Turing *principle* to distinguish it from other implications and connotations of the conjecture (1.1).

Hypothesis (1.1) and other formulations that exist in the literature (see Hofstadter (1979) for an interesting discussion of various versions) are very vague by comparison with physical principles such as the laws of thermodynamics or the gravitational equivalence principle. But it will be seen below that my statement of the Church-Turing principle (1.2) is manifestly physical, and unambiguous. I shall now show that it has the same epistemological status as other physical principles.

I propose to reinterpret Turing's 'functions which would naturally be regarded as computable' as the functions which may in principle be computed by a real physical system. For it would surely be hard to regard a function 'naturally' as computable if it could not be computed in Nature, and conversely. To this end I shall define the notion of '*perfect simulation*'. A computing machine \mathcal{M} is capable of perfectly simulating a physical system \mathcal{S} , under a given labelling of their inputs and outputs, if there exists a program $\pi(\mathcal{S})$ for \mathcal{M} that renders \mathcal{M} computationally equivalent to \mathcal{S} under that labelling. In other words, $\pi(\mathcal{S})$ converts \mathcal{M} into a 'black box' functionally indistinguishable from \mathcal{S} ."

... Deutsch: [Deu85], §1 Computing machines and the Church-Turing principle, p.3.

Such an interpretation of Deutsch's intent seems, *prima facie*, consistent with Deutsch's postulation of a Church-Turing principle which 'is so strong that it is *not* satisfied by Turing's machine in classical physics':

"I can now state the physical version of the Church-Turing principle:

'Every finitely realizable physical system can be perfectly simulated by a universal model computing machine operating by finite means.' (1.2)

This formulation is both better defined and more physical than Turing's own way of expressing it (1.1), because it refers exclusively to objective concepts such as 'measurement', 'preparation' and 'physical system', which are already present in measure theory. It avoids terminology like 'would naturally be regarded', which does not fit well into the existing structure of physics.

The 'finitely realizable physical systems' referred to in (1.2) must include any physical object upon which experimentation is possible. The 'universal computing machine' on the other hand, need only be an idealized (but theoretically permitted) finitely specifiable model. The labelling implicitly referred to in (1.2) must also be finitely realizable.

The reference in (1.1) to a specific universal computing machine (Turing's) has of necessity been replaced in (1.2) by the more general requirement that this machine operate by 'finite means'. 'Finite means' can be defined axiomatically, without restricting assumptions about the form of physical laws (cf. Gandy 1980). If we think of a computing machine as proceeding in a sequence of steps whose duration has a non-zero lower bound, then it operates by 'finite means' if (i) only a finite subsystem (though not always the same one) is in motion during any one step, and (ii) the motion depends only on the state of a finite subsystem, and (iii) the rule that specifies the motion can be given finitely in the mathematical sense (for example as an integer). Turing machines satisfy these conditions, and so does the universal quantum computer \mathcal{Q} (see §2).

The statement of the Church-Turing principle (1.2) is stronger than what is strictly necessitated by (1.1). Indeed it is so strong that it is *not* satisfied by Turing's machine in classical physics. Owing to the continuity of classical dynamics, the possible states of a classical system necessarily form a continuum. Yet there are only countably many ways of preparing a finite input for \mathcal{T} . Consequently \mathcal{T} cannot perfectly simulate any classical dynamical system. (The well studied theory of the 'simulation' of continuous systems by \mathcal{T} concerns itself not with perfect simulation in my sense but with successive discrete approximation.)"

... Deutsch: [Deu85], §1 Computing machines and the Church-Turing principle, pp.3-4.

However, Deutsch's belief that owing 'to the continuity of classical dynamics, the possible states of a classical system necessarily form a continuum', whence the universal Turing machine ' \mathcal{T} cannot perfectly simulate any classical dynamical system', needs qualification.

For instance, if we accept that any physical measurement of an 'unpredictable' observable whose values range over the real continuum \mathbb{R} can only be made to a precision whose level is indexed by, say, a finite natural number $p_\alpha \geq 0$ that specifies the physical limitation level of the observer's sensory apparatus α , then:

Comment 181. It seems pertinent to note that, as argued by Diederik Aerts et al in [Aetal] (see also §23.B.d., para (3)), reference to an 'observable' in this context could implicitly entail an extraneous, and avoidable, ontological commitment to the putative existence of a (platonic) 'potential entity' in the universe we inhabit, say U , with misleading philosophical and mathematical consequences which, in any *well-defined* mathematical model M that seeks to represent U faithfully, may not be falsifiable either in M , or under any *well-defined* interpretation of M in U .

- although the value of any such observable *before* measurement can, in principle, be assumed mathematically as a putative, algorithmically *verifiable* but not algorithmically *computable*, real number, say r ,

- such that $|r| = a_0 + \sum_{i=1}^{\infty} \frac{a_i}{10^i}$, where $a_0 \geq 0$ is an integer and a_i is either 0 or 1,
- any physically measured value of r can—even in principle—only be assumed upto a maximum number of terms in the above sequence (the latter can, thus, be treated as defining p_α);
 - whence $|r| = \sum_{i=1}^{p_\alpha} \frac{a_i}{10^i} + \sum_{i=p_\alpha+1}^{\infty} \frac{a_i}{10^i}$,
 - where $\sum_{i=1}^{p_\alpha} \frac{a_i}{10^i}$ denotes the measurable part of r to the precision p_α .

Now, we can define a unique, primitive recursive, Gödel β -function $\beta_{p_\alpha}(n)$ such that $\beta_{p_\alpha}(i) = a_i$ for all $1 \leq i \leq p_\alpha$.

Moreover, $\beta_{p_\alpha}(n)$ defines a Turing machine, say $T_{\beta_{p_\alpha}}$ which can be uniquely Gödel-numbered by an integer, say $\ulcorner T_{\beta_{p_\alpha}} \urcorner$.

Thus, under the assumption—made, for instance, in the definition of a putative quantum computer—that the instantaneous tape description of a Turing machine admits of an infinite tape:

- the non-terminating binary sequence a_0, a_1, \dots defining any algorithmically *computable* real number r ,
 - such that $|r| = a_0 + \sum_{i=1}^{\infty} \frac{a_i}{10^i}$, where $a_0 \geq 0$ is an integer and a_i is either 0 or 1,

can be referenced by the Gödel number, say $\ulcorner T \urcorner$, of the Turing machine T that computes it, and admitted as an input of a universal Turing machine;
- whilst, for any specified natural number $p_\alpha > 0$, any algorithmically *verifiable*, but not algorithmically *computable*, real number r ,
 - such that $|r| = \sum_{i=1}^{p_\alpha} \frac{a_i}{10^i} + \sum_{i=p_\alpha+1}^{\infty} \frac{a_i}{10^i}$,
 - where $\sum_{i=1}^{p_\alpha} \frac{a_i}{10^i}$ denotes the measurable part of r ,
 - * to the integral precision level p_α
 - * to which an observer’s sensory apparatus α
 - * which measures r is calibrated,

can be referenced by the Gödel number, say $\ulcorner T_{\beta_{p_\alpha}} \urcorner$, of the unique Turing machine $T_{\beta_{p_\alpha}}$ that computes the unique Gödel β -function for the sequence $a_0, a_1, \dots, a_{p_\alpha}$; and the non-terminating sequence defining the β -function admitted as an input.

In other words, we can treat the real number computed by $T_{\beta_{p_\alpha}}$ as a p_α -approximation value into which the value r of an ‘unpredictable’ observable ‘collapses’ upon a measurement with precision index p_α .

What is also problematic, from an *evidence-based* perspective, is Deutsch’s further postulation that ‘every real (dissipative) finite physical system can be perfectly simulated’ (see, for instance, Diederik Aerts’ argument—in §23.B.c. and §23.B.d.—regarding the physical impossibility of ‘exact replicability’ of spatially separated experiments) by a universal quantum computer \mathcal{Q} :

"... In §3, I shall show that it is consistent with our present knowledge of the interactions present in Nature that every real (dissipative) finite physical system can be perfectly simulated by the universal quantum computer \mathcal{Q} . Thus quantum theory is compatible with the strong form (1.2) of the Church-Turing principle."

... Deutsch: [Deu85], §1 *Computing machines and the Church-Turing principle*, p.4.

We note that Deutsch seeks to validate his postulation of the physical Church-Turing principle by arguing 'that (1.2) is an empirical assertion', on the grounds that 'since the number of possible programs for a universal computer is infinite, no experiment could in general verify that none of them can simulate a system that is thought to be a counter-example to (1.2)':

"I now return to my argument that (1.2) is an empirical assertion. The usual criterion for the empirical status of a theory is that it be experimentally falsifiable (Popper 1959), i.e. that there exist potential observations that would contradict it. However, since the deeper theories we call 'principles' make reference to experiment only *via* other theories, the criterion of falsifiability must be applied indirectly in their case. The principle of conservation of energy, for example, is not in itself contradicted by any conceivable observation because it contains no specification of how to measure energy. The third law of thermodynamics whose form

'No finite process can reduce the entropy or temperature of a finitely realizable physical system to zero' (1.3)

bears a certain resemblance to that of the Church-Turing principle, is likewise not directly refutable: no temperature measurement of finite accuracy could distinguish absolute zero from an arbitrarily small positive temperature. Similarly, since the number of possible programs for a universal computer is infinite, no experiment could in general verify that none of them can simulate a system that is thought to be a counter-example to (1.2)."

... Deutsch: [Deu85], §1 *Computing machines and the Church-Turing principle*, p.4.

where he further argues that 'there is no *a priori* reason why physical laws should respect the limitations of the mathematical processes we call 'algorithms' (i.e. the functions $C(\mathcal{T})$)' and that 'there is nothing paradoxical or inconsistent in postulating physical systems which compute functions not in $C(\mathcal{T})$ ':

"But all this does not place 'principles' outside the realm of empirical science. On the contrary, they are essential frameworks within which directly testable theories are formulated. Whether or not a given physical theory contradicts a principle is first determined by logic alone. Then, if the directly testable theory survives crucial tests but contradicts the principle, that principle is deemed refuted, albeit indirectly. If all known experimentally corroborated theories satisfy a restrictive principle, then that principle is corroborated and becomes, on the one hand, a guide in the construction of new theories, and on the other, a means of understanding more deeply the content of existing theories.

It is often claimed that every 'reasonable' *physical* (as opposed to mathematical) model for computation, at least for the deterministic computation of functions from \mathbb{Z} to \mathbb{Z} , is equivalent to Turing's. But this is not so; there is no *a priori* reason why physical laws should respect the limitations of the mathematical processes we call 'algorithms' (i.e. the functions $C(\mathcal{T})$). Although I shall not in this paper find it necessary to do so, there is nothing paradoxical or inconsistent in postulating physical systems which compute functions not in $C(\mathcal{T})$. There could be experimentally testable theories to that effect: e.g. consider any recursively enumerable non-recursive set (such as the set of integers representing programs for terminating algorithms on a given Turing machine). In principle, a physical theory might have among its implications that a certain physical device \mathcal{F} could compute in a specified time whether or not an arbitrary integer in its input belonged to that set. This theory would be experimentally refuted if a more pedestrian Turing-type computer, programmed to enumerate the set, ever disagreed with \mathcal{F} . (Of course the theory would have to

make other predictions as well, otherwise it could never be non-trivially *corroborated*, and its structure would have to be such that its exotic predictions about \mathcal{F} could not naturally be severed from its other physical content. All this is logically possible.)"

... Deutsch: [Deu85], §1 *Computing machines and the Church-Turing principle*, pp.4-5.

Now, from an *evidence-based* perspective, the only functions that are not in $C(\mathcal{T})$ are number-theoretic functions that, by definition, are algorithmically *verifiable* but not algorithmically *computable*.

Moreover, since the ‘value’ of a measurable physical observable must be *evidence-based*, every function that seeks to mathematically represent a measurable physical observable must be algorithmically *verifiable* for it be defined as ‘effectively computable’ (see §7.H.b., Definition 28).

From such a perspective, Deutsch’s speculation that ‘there is nothing paradoxical or inconsistent in postulating physical systems which compute functions not in $C(\mathcal{T})$ ’ might only be viewable as ‘logically possible’ in the absence of an *evidence-based* definition of ‘effective computability’.

For it is only the absence of such definition which seemingly allows him to argue that ‘the laws of physics ‘happen to’ permit the existence of physical models for the operations of arithmetic such as addition, subtraction and multiplication’; and that the ‘reason why we are confident that the machines we call calculators do indeed compute the arithmetic functions they claim to compute is not that we can ‘check’ their answers’, but that the ‘theory, including its assertion that the abstract functions of arithmetic are realized in Nature, is empirical’:

Nor, conversely, is it obvious *a priori* that any of the familiar recursive functions is in reality computable. The reason we find it possible to construct, say, electronic calculators, and indeed why we can perform mental arithmetic, cannot be found in mathematics or logic. *The reason is that the laws of physics ‘happen to’ permit the existence of physical models for the operations of arithmetic such as addition, subtraction and multiplication.* If they did not, these familiar operations would be non-computable functions. We might still know *of* them and invoke them in mathematical proofs (which would presumably be called ‘non-constructive’) but we could not perform the

If the dynamics of some physical system did depend on a function not in $C(\mathcal{T})$, then that system could in principle be used to compute the function. Chaitin (1977) has shown how the truth values of all ‘interesting’ non-Turing decidable propositions of a given formal system might be tabulated very efficiently in the first few significant digits of a single physical constant.

But if they were, it might be argued, we could never know because we could not check the accuracy of the ‘table’ provided by Nature. This is a fallacy. The reason why we are confident that the machines we call calculators do indeed compute the arithmetic functions they claim to compute is not that we can ‘check’ their answers, for this is ultimately a futile process of comparing one machine with another: *Quis custodiet ipsos custodes?* The real reason is that we believe the detailed physical theory that was used in their design. That theory, including its assertion that the abstract functions of arithmetic are realized in Nature, is empirical."

... Deutsch: [Deu85], §1, *Computing machines and the Church-Turing principle*, p.5.

However, from the *evidence-based* perspective of the Complementarity Thesis (see §1., Thesis 1) underlying this investigation:

- it is not that ‘the laws of physics ‘happen to’ permit the existence of physical models for the operations of arithmetic such as addition, subtraction and multiplication’;

- it is that the ‘operations of arithmetic such as addition, subtraction and multiplication’, amongst other *well-definable* mathematical expressions, allow us to:
 - faithfully express, and categorically communicate,
 - without any ontological entailment (see §23.B.d.),
 - conceptual metaphors (as described by Lakoff and Núñez in [LR00]; see also §27.),
 - corresponding to our physical observations/measurements,
 - in a mathematical language that admits, both:
 - * functions that are algorithmically *computable* (hence *deterministic* and *predictable*); as well as
 - * functions that are algorithmically *verifiable* but not algorithmically *computable* (hence *deterministic* but *essentially unpredictable*).

Moreover, from the *evidence-based* perspective of this investigation, although Deutsch *can* justifiably claim ‘that classical physics and the classical universal Turing machine do not obey the Church-Turing principle in the strong physical form’, he *cannot*, in the absence of a plausible, alternative, *evidence-based* definition of ‘*effective computability*’, justifiably claim without qualification that every ‘existing general model of computation is effectively classical’, nor ‘that classical physics is false’, without contradicting §7.H.b., Definition 28:

“Every existing general model of computation is effectively classical. That is, a full specification of its state at any instant is equivalent to the specification of a set of numbers, all of which are in principle measurable. Yet according to quantum theory there exist no physical systems with this property. The fact that classical physics and the classical universal Turing machine do not obey the Church-Turing principle in the strong physical form (1.2) is one motivation for seeking a truly quantum model. The more urgent motivation is, of course, that classical physics is false.

... Deutsch: [Deu85], 2 Quantum computers.

21.I. Kalmár’s perspective on the Church-Turing Thesis

We note that the reasoning in the proof of §21.F.b., Theorem 21.3, further entails that (for a more direct proof see §7.H.b., Theorem 7.3):

Corollary 21.8. *The classical Church-Turing thesis is false in any interpretation of the first-order Peano Arithmetic PA that admits evidence-based reasoning.*

Moreover, it is essentially similar to Kalmár’s argument in [Km59] (p.74).

In other words—excepting that it would always calculate the function $g(n)$ constructively (even in the absence of a uniform procedure) within a fixed postulate system—the reasoning used in §7.H.b., Theorem 21.3 is, essentially, the same as Selmer Bringsjord’s concise expression, of Kalmár’s argument, in the former’s narrational case against Church’s Thesis:

“First, he draws our attention to a function g that isn’t Turing-computable, given that f is⁵⁰³:

$$g(x) = \mu y (f(x, y) = 0) = \text{the least } y \text{ such that } f(x, y) = 0 \text{ if } y \text{ exists; and } 0 \text{ if there is no such } y$$

⁵⁰³Bringsjord notes that the original proof can be found on page 741 of Kleene [Kl36].

Kalmár proceeds to point out that for any n in \mathbb{N} for which a natural number y with $f(n, y) = 0$ exists, ‘an obvious method for the calculation of the least such y ... can be given,’ namely, calculate in succession the values $f(n, 0), f(n, 1), f(n, 2), \dots$ (which, by hypothesis, is something a computist or TM can do) until we hit a natural number m such that $f(n, m) = 0$, and set $y = m$.

On the other hand, for any natural number n for which we can prove, not in the frame of some fixed postulate system but by means of arbitrary—of course, correct—arguments that no natural number y with $f(n, y) = 0$ exists, we have also a method to calculate the value $g(n)$ in a finite number of steps.

Kalmár goes on to argue as follows. The definition of g itself implies the tertium non datur, and from it and CT we can infer the existence of a natural number p which is such that

- (*) there is no natural number y such that $f(p, y) = 0$; and
- (**) this cannot be proved by any correct means.

Kalmár claims that (*) and (**) are very strange, and that therefore CT is at the very least implausible."

... Bringsjord: [Br93].

Kalmár himself argues further to the effect that the proposition stating that, for this p , there is a natural number y such that $f(p, y) = 0$, would then be *absolutely* undecidable in the sense that:

“... the problem if this proposition holds or not, would be unsolvable, not in Gödel’s sense of a proposition neither provable nor disprovable in the frame of a fixed postulate system, nor in Church’s sense of a problem with a parameter for which no general recursive method exists to decide, for any given value of the parameter in a finite number of steps, which is the correct answer to the corresponding particular case of the problem, “yes” or “no”. As a matter of fact, the problem, if the proposition in question holds or not, does not contain any parameter and, supposing Church’s thesis, *the proposition itself can be neither proved nor disproved*, not only in the frame of a fixed postulate system, but *even admitting any correct means*. It cannot be proved for it is false and it cannot be disproved for its negation cannot be proved. According to my knowledge, this consequence of Church’s thesis, viz. the existence of a proposition (without a parameter) which is undecidable in this, *really absolute sense*, has not been remarked so far.

However, this “absolutely undecidable proposition” has a defect of beauty: we can decide it, for we know, it is false. Hence, *Church’s thesis implies the existence of an absolutely undecidable proposition which can be decided viz., it is false, or, in another formulation, the existence of an absolutely unsolvable problem with a known definite solution*, a very strange consequence indeed."

... Kalmár: [Km59], p. 75.

Comment 182. In an intriguing perspective that treats the case against acceptance of *absolutely undecidable propositions* as ‘a case in favor of optimism’, V. Alexis Peluce remarks in [Plc20]:

“In his 1995 and, revised in 2013, *Verificationism Then and Now*, Per Martin-Löf presents a case in favor of optimism. Making use of several laws for which he provides philosophical justification, he argues:

[T]here are no absolutely undecidable propositions. And why does this follow from [the third law, the claim that if a proposition cannot be known to be true then it can be known to be false]? Well, suppose that we had a proposition which could neither be known to be true nor be known to be false. Then, in particular, it cannot be known to be true, so, by the third law, it can instead be known to be false. But that contradicts the assumption that the proposition could not be known to be false either. (2013, pp. 12–13)

Imagine that a given proposition is absolutely undecidable, which is just to say that the associated problem is unsolvable in the sense we used above. In terms of knowledge, given that it is in fact absolutely unsolvable, this means that it cannot be known to be true and it cannot be known to be false. But, if a proposition cannot be known to be true, then, Martin-Löf argues, it can be known to be false. This is in virtue of his third law. The thought is that if it is impossible that a is a proof of A for any a , then we can conclude a refutation of A . But, if we have a refutation of the proposition in question, then the problem is not absolutely unsolvable, which contradicts our original assumption. Therefore, there are no absolutely undecidable propositions. Call the above articulation of optimism constructive optimism.

There is a clear step worth examining in more detail, that from the impossibility of knowing the truth of the proposition we can move to the possibility of knowledge of its falsehood. This, however, will be the focus of the second half of this paper. Let us first turn to a different sort of objection to Martin-Löf's argument. Solomon Feferman, in "Are there Absolutely Unsolvable Problems? Gödel's Dichotomy", comments:

Indeed, Per Martin-Löf has proved exactly that, in the form: There are no propositions which can neither be known to be true nor known to be false [...]. However, this is established on the basis of the constructive explanation of the notions of "proposition", "true", "false", and "can be known". (2006, p. 147)

Feferman continues:

For the non-constructive mathematician, Martin-Löf's result would be translated roughly as: "No propositions can be produced of which it can be shown that they can neither be proved constructively nor disproved constructively". For the non-constructivist this would seem to leave open the possibility that there are absolutely unsolvable problems A "out there", but we cannot produce ones of which we can show that they are unsolvable. (2006, p. 147)

Feferman's point here is that while Martin-Löf's argument succeeds at establishing optimism for the constructivist, it falls short of establishing optimism *tout court*. He goes on to present examples of problems that are "absolutely unsolvable from the standpoint of practice" (Feferman, 2006, p. 149).

Feferman argues that the non-constructive mathematician can evade Martin-Löf's target conclusion of optimism by reinterpreting it in a way that fits within a non-constructive world view. If pessimism or optimism is to be established *tout court*, the reasoning would go, it must be done so independent of a constructive philosophy of mathematics. This can be interpreted in two ways, however. The first emphasizes the constructivist portion of Martin-Löf's reasoning. The second emphasizes the philosophical, where this is understood as something non-mathematically neutral, content of Martin-Löf's argument."

... Peluce: [Plc20], *Martin Löf's Constructive Optimism*.

21.J. Is the brain a Turing machine?

We note that the proposed Turing Test in §21.E. (Query 22) only seeks to differentiate between human and mechanistic *intelligences*. It does not address the more fundamental question of whether an organic brain is, or is not, essentially a Turing machine.

The distinction is not always obvious, or respected. For instance, as remarked upon in a 2014 BBC interview by Stephen Hawking (see also [Sha06]):

"I believe there is no deep difference between what can be achieved by a biological brain and what can be achieved by a computer. It therefore follows that computers can, in theory, emulate human intelligence—and exceed it."

... Hawking: *Stephen Hawking—Will AI kill or save humankind?*

Although consideration of the issue lies beyond the scope and competence of this investigation, nevertheless, if we posit that all outputs of sensory organs can only be received/perceived and/or transmitted as digital pulses to/by the brain then, from the *evidence-based* perspective of this investigation, one *could* speculate that an organic brain *can* be modeled by a Turing machine, and *strongly* hypothesise that:

Hypothesis 2. *Whilst an organic brain can evidence that an arithmetical proposition is algorithmically computable as true under an interpretation, only the sensory organs (such as those of sight, smell, hearing, taste and touch) can evidence that an arithmetical proposition is algorithmically verifiable as true under an interpretation.*

In other words, whilst the brain functions can be treated as essentially digital, and representable completely by a Turing machine, the functions of the sensory organs could be treated as essentially analog, and representable only by geometrical models that cannot always be represented completely in their limiting cases by a Turing machine.

Nevertheless, the *evidence-based* perspective of this investigations suggests the possibility that—assuming the intuitive meaning of ‘the state of a physical process’—we can tentatively define what it means for a process to be ‘analog’:

Definition 41. (Analog process) *A physical process is analog if, and only if, it’s states can be represented mathematically only by a number-theoretic function that is algorithmically verifiable, but not algorithmically computable.*

Definition 42. (Digital process) *A physical process is digital if, and only if, it’s states can be represented mathematically by a number-theoretic function that is algorithmically computable.*

Comment 183. We note, however, that the above definitions may be at variance with the term ‘analog’ as used, for example, by Piccinini in [Pic15] where he notes that:

“... the notion of analog modeling is a semantic notion—it defines ‘analog’ in terms of a representational relation between the model and the target system. True, analog computers (like other analog models) are typically used to model other systems. Also true, the history of analog modeling is intertwined with the history of analog computing properly so called (Care 2010). But, as we saw in Chapter 3, computation does not require representation.”

... Piccinini: [Pic15], §1, Disambiguating ‘Analog’.

Thus, as suggested by §20.C., Cases 20.C.a. to 20.C.d., and §20.D., Case 20.D.c., some geometric models of physical phenomena can only be defined in terms of algorithmically *verifiable*, but not algorithmically *computable*, functions (compare with the putative mathematical representation of quantum phenomena posited in §23.A.).

Comment 184. Such a perspective can be viewed as implicit in Marcin Miłkowski’s query (compare §21.E.) in [Mil14]: *Is the mind a Turing machine? How could we tell?*, which addresses—within the broader issue of Church’s Thesis (compare §7.H.b., Theorem 7.3)—whether the mind:

- treated as the source of the conceptual metaphors
 - that correspond, initially, to ‘analog’ processes sought to be ‘captured’ by organic/mechanical sensory perceptions/perceptors,
 - and subsequently sought to be represented symbolically

- in an appropriate language of adequate expression
- and, ideally, of categorical communication,
- is, or functions as, an ‘analog’ computer;

where we note the similarity between the above issue, and that of whether a sports television broadcasting system:

- treated as the source of the images and sound projected digitally on a home TV,
 - that correspond, initially, to ‘analog’ processes sought to be ‘captured’ by mechanical sensors (cameras/microphones) on a playing field,
 - and subsequently represented symbolically
 - in an appropriate language of adequate expression
 - and categorical communication,
- is, or functions as, an ‘analog’ computer.

“I. Introduction

In philosophical discussions, it is often assumed that the computational theory of mind implies that it is a Universal Turing Machine (UTM). The reason why the UTM has been proposed as a model of the mind is that it is *the* standard model of computation, and that is a *universal* machine—i.e., any other digital computer may be simulated by the UTM. Were the mind unable to compute everything that the UTM can, the UTM would still be able to simulate it. Of course, this makes the truth of the Church-Turing thesis vital for the explanatory value of computational modelling of cognition. Or so it seems.

In recent years, several criticisms of the proposed identity of the mind and the UTM have been raised. First, it was argued that the UTM requires an infinite tape, which is physically impossible (or impossible for a physical part of the brain). Second, some have claimed that there are physical systems capable of hyper-Turing computation, so the UTM might not be the strongest model of computation available. Some theorists claim, for example, that brains are hypercomputational analogue machines that need to be modelled as using genuine reals (as opposed to TM-computable reals). Third, it was argued that the UTM is not a good candidate for explaining the intricacies of the human mind as it has a completely different architecture: so, while the set of functions computed by the machine could be the same as the one computed by the mind, it would differ dramatically in terms of speed and space requirements. A related objection is that brains are analogue computers that cannot be modelled directly as the UTM.

Are these strong objections? Do they undermine the general claim that the mind is a Turing Machine (TM)? To answer these two questions, one needs to understand what it is for a system to be a TM (due to limitations of space, in what follows I will set the universality of the machine aside). Otherwise, there is a danger of serious equivocation in arguments in favour of certain theories of the mind [14].

It is important to distinguish two senses in which one could say that a physical system “is” a TM:

- (1) when a physical system has a function that could be simulated with a TM (functional sense);
- (2) when a physical system is a mechanism best described as a TM (mechanistic sense).

In this paper, I enumerate conditions that must be fulfilled to qualify a physical system to be a TM in both senses and show differences between the two. I then argue that the first two objections are relevant for the functional sense of “is” (which is also implicated

by the mechanistic sense), and the last one can be understood only in the mechanistic sense.

I briefly review how these objections would be elaborated (though the space prohibits any further discussion in detail). I argue that the first two are not really relevant for computationalism in the theory of cognition, and that the last one is plausible: I justify the view that the mind does not seem to be a UTM in the mechanistic sense at all because of its architecture; and proper computational explanations in cognitive science require that the architecture be matched strictly. It transpires that the philosophically popular UTM is not a good candidate for a scientific model of the mind, even if we accept the standard computational theory of mind. To defeat computationalism, one should look beyond the TMs."

... *Milkowski*: [Mil14].

We note that Hypothesis 2 could, conceivably, offer in support the experimental observations and conclusions by Humberto Maturana, Jerome Lettvin, Warren McCulloch, and Walter Pitts in [LMMP], where they investigate the behaviour of a frog:

"I. INTRODUCTION

A. Behavior of a Frog

A frog hunts on land by vision. He escapes enemies mainly by seeing them. His eyes do not move, as do ours, to follow prey, attend suspicious events, or search for things of interest. If his body changes its position with respect to gravity or the whole visual world is rotated about him, then he shows compensatory eye movements. These movements enter his hunting and evading habits only, e.g., as he sits on a rocking lily pad. Thus his eyes are actively stabilized. He has no fovea, or region of greatest acuity in vision, upon which he must center a part of the image. He has only a single visual system, retina to colliculus, not a double one such as ours where the retina sends fibers not only to colliculus but to the lateral geniculate body which relays to cerebral cortex. Thus, we chose to work on the frog because of the uniformity of his retina, the normal lack of eye and head movements except for those which stabilize the retinal image, and the relative simplicity of the connection of his eye to his brain.

The frog does not seem to see or, at any rate, is not concerned with the detail of stationary parts of the world around him. He will starve to death surrounded by food if it is not moving. His choice of food is determined only by size and movement. He will leap to capture any object the size of an insect or worm, providing it moves like one. He can be fooled easily not only by a bit of dangled meat but by any moving small object. His sex life is conducted by sound and touch. His choice of paths in escaping enemies does not seem to be governed by anything more devious than leaping to where it is darker. Since he is equally at home in water and on land, why should it matter where he lights after jumping or what particular direction he takes? He does remember a moving thing providing it stays within his field of vision and he is not distracted."

... *Maturana, Lettvin, McCulloch, Pitts*: [LMMP].

Maturana, Lettvin, McCulloch, and Pitts sought to verify/challenge the assumption that 'the eye mainly senses light, whose local distribution is transmitted to the brain in a kind of copy by a mosaic of impulses':

"D. Initial Argument

The assumption has always been that the eye mainly senses light, whose local distribution is transmitted to the brain in a kind of copy by a mosaic of impulses. Suppose we held otherwise, that the nervous apparatus in the eye is itself devoted to detecting certain patterns of light and their changes, corresponding to particular relations in the visible world. If this should be the case, the laws found by using small spots of light in the retina may be true and yet, in a sense, be misleading. Consider, for example, a bright spot appearing in a receptive field. Its actual

and sensible properties include not only intensity, but the shape of the edge, its size, curvature, contrast, etc.

We decided then how we ought to work. First, we should find a way of recording from single myelinated and unmyelinated fibers in the intact optic nerve. Second, we should present the frog with as wide a range of visible stimuli as we could, not only spots of light but things he would be disposed to eat, other things from which he would flee, sundry geometrical figures, stationary and moving about, etc. From the variety of stimuli we should then try to discover what common features were abstracted by whatever groups of fibers we could find in the optic nerve. Third, we should seek the anatomical basis for the grouping."

... Maturana, Lettvin, McCulloch, Pitts: [L MMP].

Their experiments showed 'that the eye speaks to the brain in a language already highly organized and interpreted, instead of transmitting some more or less accurate copy of the distribution of light on the receptors':

"VII. GENERAL DISCUSSION

What are the consequences of this work? Fundamentally, it shows that the eye speaks to the brain in a language already highly organized and interpreted, instead of transmitting some more or less accurate copy of the distribution of light on the receptors. As a crude analogy, suppose we have a man watching the clouds and reporting them to a weather station. If he is using a code, and one can see his portion of the sky too, then it is not difficult to find out what he is saying. It is certainly true that he is watching a distribution of light; nevertheless, local variations of light are not the terms in which he speaks nor the terms in which he is best understood. Indeed, if his vocabulary is restricted to types of things that he sees in the sky, trying to find his language by using flashes of light as stimuli will certainly fail. Now, since the purpose of a frog's vision is to get him food and allow him to evade predators no matter how bright or dim it is about him, it is not enough to know the reaction of his visual system to points of light. To get useful records from individual receptors (the rods and cones), assuming that they operate independently and under no reflex control, this stimulus may be adequate. But when one inspects responses that are a few nervous transformations removed from the receptors, as in the optic nerve, that same choice of stimulus is difficult to defend. It is equivalent to assuming that all of the interpretation is done further on in the nervous system. But, as we have seen, this is false."

... Maturana, Lettvin, McCulloch, Pitts: [L MMP].

They concluded that, apropos the operations of the eye (ergo, conceivably, of other sensory organs), 'the language in which they are best described is the language of complex abstractions from the visual image':

"VIII. CONCLUSION

The output from the retina of the frog is a set of four distributed operations of the visual image. These operations are independent of the level of general illumination and express the image in terms of 1) local sharp edges and contrast, 2) the curvature of edge of a dark object, 3) the movement of edges, and 4) the local dimming produced by movement or rapid general darkening. Each group of fibers serving one operation maps the retina continuously in a single sheet of endings in the frog's brain. There are four such sheets in the brain, corresponding to the four operations, and their maps are in registration. When all axonal connections between eye and brain are broken and the fibers grow back, they reconstitute the original retinal maps and also arrange themselves in depth in the original order with no mistakes. If there is any randomness in the connections of this system, it must be at a very fine level indeed. In this, we consider Sperry (14) completely right.

We have described each of the operations on the retinal image in terms of what common factors in a large variety of stimuli cause response and what common factors have no effect. What, then,

does a particular fiber in the optic nerve measure? We have considered it to be how much there is in a stimulus of that quality which excites the fiber maximally, naming that quality.

The operations thus have much more the flavor of perception than of sensation, if that distinction has any meaning now. That is to say that the language in which they are best described is the language of complex abstractions from the visual image. We have been tempted, for example, to call the convexity detectors “bugperceivers.” Such a fiber (operation 2) responds best when a dark object, smaller than a receptive field, enters that field, stops, and moves about intermittently thereafter. The response is not affected if the lighting changes or if the background (say a picture of grass and flowers) is moving, and is not there if only the background, moving or still, is in the field. Could one better describe a system for detecting an accessible bug?"

... Maturana, Lettvin, McCulloch, Pitts: [L MMP].

Following their work, the accepted paradigm today is, apparently, that Maturana, Lettvin, McCulloch and Pitts have:

“... conclusively demonstrated that “analog processes in the eye were doing at least part of the interpretive work” in image processing as opposed to “the brain computing information digital neuron by digital neuron using the exacting implement of mathematical logic”, ...”

... Wikipedia: https://en.wikipedia.org/wiki/Walter_Pitts, downloaded 25/11/2019.

As reported by science writer Amanda Geffer for a lay reader, in a tribute to Walter Pitts in her *Nautilus* blogpage *The Man Who Tried to Redeem the World with Logic*:

“At the time, biologists believed that the eye was like a photographic plate that passively recorded dots of light and sent them, dot for dot, to the brain, which did the heavy lifting of interpretation. Lettvin decided to put the idea to the test, opening up the frog’s skulls and attaching electrodes to single fibers in their optic nerves.

Together with Pitts, McCulloch and the Chilean biologist and philosopher Humberto Maturana, he subjected the frogs to various visual experiences—brightening and dimming the lights, showing them color photographs of their natural habitat, magnetically dangling artificial flies—and recorded what the eye measured before it sent the information off to the brain. To everyone’s surprise, it didn’t merely record what it saw, but filtered and analyzed information about visual features like contrast, curvature, and movement. “The eye speaks to the brain in a language already highly organized and interpreted,” they reported in the now-seminal paper “What the Frog’s Eye Tells the Frog’s Brain,” published in 1959.

The results shook Pitts’ worldview to its core. Instead of the brain computing information digital neuron by digital neuron using the exacting implement of mathematical logic, messy, analog processes in the eye were doing at least part of the interpretive work.”

... Geffer: *Nautilus*, February 5, 2015, <http://nautil.us/issue/21/information/the-man-who-tried-to-redeem-the-world-with-logic>

21.J.a. Awareness is *not* an emergent *state*

The issue of whether, or not, we first realise (become aware of), and only subsequently interpret (become self-aware of having ‘experienced’) empirical processes, too (see Comment 112), can be viewed as complementing—and being illuminated by, when placed within a broader perspective of—philosopher Hans Radder’s cogently argued analysis of the issue of ‘emergence’ in [Rdd22]:

“If we want to make sense of the emergence of the meaning of *empirical* concepts, we need an appropriate account of the notion of experience and the processes through which it can be acquired. This account will be provided in in this section. My summary explanation exploits the results of a variety of studies, both by me and by many other authors.

We empirically engage the world by means of the cognitive processes of perception, observation and experiment. Actually realizing such processes requires that we, as human organisms, interact

with the world. An important feature of these interactions is that they are always mediated. This is obviously the case in those observational and experimental scientific practices that depend on the use of a great variety of instruments, both simple and complex. Just think of the routine uses of thermometers, microscopes, brain scanners, and the numerous other instruments. In addition, these practices may include the uses of glasses, contact lenses or hearing aids that some of the observers or experimenters wear. What is more, allegedly ‘unaided’ observation is mediated as well, namely through the particular characteristics of the human organism, which constitutes an instrument that affords humans a specific access to the world. Bats and dogs, for instance, experience the world quite differently from humans, because of the much greater impact of their auditory (bats) and olfactory (dogs) interaction with their surroundings.

Yet, there is an important further distinction between the ‘unaided’ human instrument, the organism, and the other instruments mentioned. The uses and results of thermometers, microscopes and brain scans require a conceptual interpretation. Consider the case of a simple mercury thermometer. Its successful use requires an interpretation that tells us that the temperature measurement has been performed under the right conditions and that the indicated position n on the numerical scale means that the temperature of the measured object is n degrees. Human observers, in contrast, are self-interpreting instruments. In the case of human observations (both fully ‘unaided’ and the ones aided by glasses etc.), we apply this interpretation ourselves. Like the ‘reading’ of a thermometer, these interpretations are only seemingly direct. In fact, they depend on first learned and then routinely (and usually non-consciously) applied interpretation, a fact that will become explicit when someone else challenges the correctness or veracity of our observation.

Such ‘unaided’ observation is often called ‘perception’. Because of the similarities between perceptions mediated by the human organism and the observations and experiments that depend on ‘external’ instruments, I take them together within a general conception of ‘experience’ and related notions, such as ‘empirical’ processes and ‘empirical’ concepts. These notions are meant to cover the different kinds of empirically engaging the world (perceiving, observing and experimenting).² As various studies of embodied, embedded cognition and many analyses of concrete empirical practices have shown, both ordinary perception and scientific observation and experimentation are complex, spatiotemporal processes. In addition to conceptual interpretation, successful realization of these processes requires specific interventions in the material and social world.³

Thus conceived, this usage of the term ‘empirical’ (systems, processes, concepts) implies a radical departure from the empiricist tradition. The idea that acquiring experience requires no more than ‘keeping one’s eyes open in an unprejudiced way’ is fully inadequate. More specifically, we need to get rid of the inappropriate dichotomy between experience on the one hand and ideas, concepts and theories on the other. The primary reason is that, in actual practices, these notions prove to be inextricably entangled, a point that has been confirmed by a variety of well-developed philosophical arguments.⁴ As we will see throughout the subsequent sections, this conception of experience and empirical processes entails a view of conceptual meaning and its emergence that differentiates it from other philosophical views of these topics, such as empiricism or Platonism.

² For detailed arguments supporting the claims made in this section and for refutations of a range of actual and possible counterarguments, see Radder (2012[1984/1988], Chap. 3), (1996, Chaps. 2 and 6), (2006, part 1) and (2021).

³ For some of the many relevant studies, see Hanson (1972), Shapere (1982), Hacking (1983), Heelan (1983), Kosso (1989), Galison (1997), O’Regan and Noë (2001), Anderson (2003), Vallor (2009), Bem and Looren de Jong (2013, Chap. 9), Brewer (2015) and Boyd (2018).

⁴ Decades ago, Hanson (1972) and Shapere (1982) already argued that observation is never direct or unmediated, because it essentially depends on specifiable background information. See also Westphal (2015) for an in-depth criticism of Willard Van Orman Quine’s radical empiricism and a detailed exposition and defense of Wilfrid Sellars’s critique of the myth of the given. I think that many, if not most, present-day philosophers agree with the view that experience is always mediated, even if debate continues about its precise philosophical and practical implications. See, for instance, Franklin (2015), who agrees that what we know influences what we observe and admits that the implied practical problems (e.g., concerning the design and interpretation of experiments) can be mitigated but not fully avoided. At the same time, he argues that theory-ladenness does not entail the philosophical thesis of the incommensurability of paradigms or worldviews.⁴

... Radder: [Rdd22], §2 *Realizing and Interpreting Empirical Processes*.

We could thus argue that:

- apropos the mind-brain dualism articulated by René Descartes in the 17th century,

- reflected implicitly in *the* putative, non-material, ‘Je’ in the expression ‘Je pense, donc je suis’,

the above hypothesis (§21.J., Hypothesis 2) suggests that we could, then, further qualify Descartes’ well-known aphorism:

- by the anti-emergent hypothesis (Hypothesis 3),
- that awareness is *not* an emergent *state* of an intelligence,
- but an innate *ability* to express and communicate sensory perceptions ‘sensorially’ (not necessarily symbolically).

Hypothesis 3. (Awareness) *Awareness is the primary conceptual metaphor that corresponds to the ability of an intelligence to reactively express sensory perceptions ‘sensorially’—i.e., not necessarily consciously or symbolically—in the first person as ‘I sense’.*

and, further, that:

Hypothesis 4. (Self-awareness) *Self-awareness is the secondary conceptual metaphor that corresponds to the innate ability of an intelligence to proactively/symbolically postulate the existence of an id that can be subjectively identified as aware, and which is implicit in the expression ‘I sense, therefore I am’.*

In other words, Hypotheses 3 and 4 suggest that:

- Intelligences which can protect themselves, their habitats, and/or their species from life-threatening situations ‘sensorially’ can be treated as being aware; whilst
- Intelligences which can, further, answer the Turing Test (see §21.E., Query 22) affirmatively could be treated as being self-aware.

Comment 185. Hypothesis 3 ought to be viewed, and perhaps suitably modified, to reflect the broader cosmological perspective on the ‘nebulous’ nature of both ‘emergence’ and ‘information’⁵⁰⁴—with respect to the existence of both terrestrial, and (hypothetical?) extra-terrestrial, life and ‘intelligence’—that is offered by Adam Frank, David Grinspoon and Sara Walker in [FGW22]; where they conclude that ‘there have been forms of cognitive activity (i.e. Vernadsky’s cultural biogeochemical energy) on the planet for much longer than there have been animal nervous systems’, and that if ‘the microbes which form planetary feedback loops can be said to collectively know things about their world then, perhaps, it may be possible and useful to ask if this knowing is integrated into higher scale, emergent behaviours which would represent planetary intelligence’:

“Ever since Erwin Schrodinger’s essential book ‘What Is Life’ popularized the need to find the underlying physical principles which make living systems different from non-living ones (Schrodinger, 2012), researchers have attempted to find them. The hope has always been to find the first principle ‘laws of life’ similar to what has been found for fundamental laws of nature in other areas of physics. However, 70 years after the publication of ‘What Is Life’, no such foundational laws have been found. For some researchers, like Stuart Kaufmann, laws cannot be found because life, and its evolutionary processes, is fundamentally non-ergodic (Kauffman, 2019). This

⁵⁰⁴‘Information’ as distinct from, but antecedent to, what we have considered as ‘knowledge’ in §5.A.: *What is knowledge?*

view implies that biological systems do not explore all available phase space volumes (perhaps because the phase space volume is too large at the physical scale of chemistry or other evolutionary processes), but instead chart contingent paths through them. For Kauffman and others, life is an *emergent property* of the physiochemical systems from which it is constructed.

A standard view of emergence is to say, ‘the whole is greater than the parts’, such that properties and behaviours at collective scales cannot be predicted from, or reduced to, consideration of the parts alone. While emergence is most often regarded as a property of complex systems, e.g. biological and technological, it is also apparent in physics. Phillip Andersen, a Nobel Laureate in Physics for his work on condensed matter, famously wrote in an essay titled ‘More is Different’ (Anderson, 1972) that ‘The ability to reduce everything to simple fundamental laws does not imply the ability to start from those laws and reconstruct the universe’. It is also important to note, however, that emergent properties are not antagonistic to the reductionist view: in fact, it is by virtue of the fact that reductionism is possible that we can observe emergent properties at all.

It is also noteworthy that emergence is often associated with some degree of top-down causation where the emergent system creates modes of behaviour in its subsystems that would not be possible without the new and previously unpredicted higher-level rules (Ellis *et al.*, 2012).

Thus, planetary intelligence, in the mode presupposed by Margulis, Vernandsky and others would necessarily be an emergent, *collective property of the subsystems comprising the biosphere*, that in turn induces new modes of behaviour on individual parts (e.g. organisms). Importantly, this implies by extension that life is not a scale-specific phenomenon, but instead one that emerges from chemistry and drives the organization of matter from the properties of cells to the planetary scale. The natural boundary for these processes is, therefore, planetary. Our suggestion is that intelligence, as the mechanism that controls the function, decision-making and seeming goal-directedness of many living processes is also not scale-specific, and is a general phenomenon that operates even at the planetary scale."

... Frank, Grinspoon and Walker: [FGW22], § Emergence.

“The view of life as an emergent phenomenon does not, however, imply that ‘law-like’ general principles for life cannot be found. The ability to articulate such law-like patterns is particularly important for an effort to use the properties of Earth’s biosphere to understand life on other worlds (Walker *et al.*, 2018). In this pursuit, we regard it is essential to recognize that life involves a critical new quantity/property which non-living systems do not: the active use of information (Walker *et al.*, 2016). Information flows appear in living systems from cells to ecosystems to cities, and also downward in the form of networks of connection that constrain the behaviour and function between system components and subsystems. A perspective focusing on networks and information flow offers the possibility for developing a more general approach to understanding how law-like behaviours appear (emerge) in living systems. For example, studies of the biochemical networks at three levels of scale (cells, ecosystems and the biosphere) reveal a network structure that is common across scales of biological organization, including individuals and communities, and is distinct from random networks (Walker *et al.*, 2016; Kim *et al.*, 2019). This implies deeper levels of network structure in living systems than has been understood so far. This should be the case as these properties are now known to be universal across biochemical networks, they depend on size (i.e. the number of compounds which are nodes in the network), and they do not depend on the scale of organization. The emergence of intelligence operating on the scale of planetary behaviour/function would best be described via information flowing through the technosphere’s/biosphere’s geochemical and geophysical networks (Fig. 3), which can take different forms including processes at higher-scales constraining and determining the behaviour of lower-level entities (e.g. as happens in social systems,

where our decisions are dependent on cultural and societal context)."

... Frank, Grinspoon and Walker: [FGW22], § Information and networks.

"If information is organizing the biosphere, where and in what ways is that information used? Does the importance of information in generating life's form and function also imply the presence of agents and agency beyond that of individual intelligent organisms operating within the global network? At what levels of organization can agency be said to appear? Does such agency imply intelligence?"

From the perspective of these questions, the definition of information must include not only the physical criteria proposed by Shannon, i.e. measures of noise in communication channels. Instead, the definition of information we are interested in must also focus on the role of *meaning*. In living systems, information always carries a semantic aspect—its meaning—even if it is something as simple as the direction of a nutrient gradient in chemotaxis (Wadhams and Armitage, 2004). The definition and dynamics of semantic information represents a growing research domain with many applications (Kolchinsky and Wolpert, 2018). For example, these questions might be better cast in terms of causal structure rather than as 'informational' in the Shannon sense (Ay and Poloni, 2007). Many of these approaches would be well suited to our questions. Thus, a consideration of planetary intelligence would recognize the centrality of semantic information flows (as well as syntactic i.e. Shannon flows) or causal structure, across biospheric and technospheric networks."

... Frank, Grinspoon and Walker: [FGW22], § Semantic versus syntactic information.

"Once a species capable of constructing a technological civilization appears, intelligence by most definitions exists on a planet. As we will see, however, this does not imply it is meaningful to discuss the existence of a *planetary intelligence* as the dominant driver of planetary evolution in such a world. Life on Earth emerged almost 4 billion years ago. By 3 billion years ago, collectives of single-celled organisms existed in large enough quantities to begin affecting the coupled geophysical/geochemical systems (Lenton and Watson, 2011). The formation of methanogens, for example, is believed to have changed atmospheric chemistry sufficiently to alter the Earth's radiative properties and trigger the first global glaciation or 'snowball Earth phase'. In addition, for the first two billion years of Earth's evolution, its atmosphere consisted primarily of N₂ and CO₂ with O₂ acting only as a trace gas. It was the evolution of oxygenic photosynthesis by cyanobacteria that led to the atmosphere's Great Oxygenation Event (GOE) approximately 2.5 billion years ago (Catling, 2014). The GOE made O₂ abundant in Earth's biogeochemical networks with profound consequences such as allowing for far more energetic modes of metabolism (Lenton and Watson, 2011).

Microbes also play an essential role in Gaian and Earth Systems Science descriptions of planetary evolution through the establishment of feedback loops which maintain the planet in stable dynamic equilibria. Known and proposed examples of such feedbacks abound: climate regulation through biologically enhanced rock weathering (Zeebe and Caldeira, 2008); the maintenance of O₂ partial pressures below 30% through methane-producing microbes (Lenton and Watson, 2000; Berner *et al.*, 2003); climate regulation through cloud-albedo control linked to algal gas emissions (Charlson *et al.*, 1987); the biological transfer of selenium from the ocean to the land as dimethyl selenide (Watson and Liss, 1998).

Given the critical role of microbes in establishing these feedback loops, when formulating questions of planetary intelligence one can first ask if microbes, or their communal networks, possess anything like cognition. In other words, do microbes or their collectives 'know' anything about the world, rather than just bumping into it? This leads us to ask what is meant by knowing or, more formally, to consider the nature of cognition across all forms of life. A succinct definition is given by Shettleworth (1993) who sees cognition as 'the mechanisms by which animals acquire, process, store, and act on information from the environment'. A more extensive definition is given by Lyon (Lyon2015).

Biological cognition is the complex of sensory and other information-processing mechanisms an organism has for becoming familiar with, valuing and interacting with its environment in order to meet existential goals, the most basic of which are survival (growth or thriving) and reproduction.

There is now considerable evidence that bacteria exhibit a range of behaviours associated with cognition in the sense given above. Signal Transduction (ST), the most basic form of sense perception, is known to occur in bacteria in multiple forms allowing them to sense and respond to a wide array of environmental cues. Bacteria can also communicate through a process known as Auto-Induction where they stimulate changes in their genetic expression when certain environmental molecules reach threshold concentrations (Miller and Bassler, 2001). This is the basis of the much discussed process of bacterial *quorum sensing* where advantageous genetic changes in populations are induced at concentrations dependent on population density. Equally important was the discovery of rich social behaviours in species like *Myxococcus xanthus* ('the primate of eubacteria', Lyon, 2015) which has proven capable of structured, multi-dimensional swarming (Kaiser and Warrick, 2014), pack-like predation (Berleman and Kirby, 2009), and the use of chemical cues to lure faster-moving prey (Shi and Zusman, 1993). Memory and learning, both bedrock conceptions of cognition, have also both been shown to be present in the bacterial toolkit of behaviours (Wolf *et al.*, 2008).

From this perspective, there have been forms of cognitive activity (i.e. Vernadsky's cultural biogeochemical energy) on the planet for much longer than there have been animal nervous systems, and certainly far pre-dating the appearance of the genus *homo*. If the microbes which form planetary feedback loops can be said to collectively know things about their world then, perhaps, it may be possible and useful to ask if this knowing is integrated into higher scale, emergent behaviours which would represent planetary intelligence."

... Frank, Grinspoon and Walker: [FGW22], § Planetary intelligence before technological species: biosphere networks.

CHAPTER 21. PARADIGM CHALLENGING CONSEQUENCES

22. The significance of *evidence-based* reasoning for Number Theory and Integer Factorising

The significance of *evidence-based* reasoning for distinguishing between algorithmically *verifiable* and algorithmically *computable* number-theoretic functions, as in §2., Definitions 7 and 10 is that, without extending the language in which number-theoretic functions and relations are expressed, it provides a formal foundation for placing in perspective, and complementing, an uncomfortably counter-intuitive entailment in number theory—namely §22.A., Theorem 22.3—which has been treated by conventional wisdom (see §22.A.a.) as sufficient for concluding that the prime divisors of an integer *cannot* be proven to be mutually independent.

However, we shall show that such informally perceived barriers are, in this instance, illusory (§22.A.b.); and that admitting the above distinction illustrates:

- (a) *Why* the prime divisors of an integer *are* mutually independent (see §22.A.c., Theorem 22.12);
- (b) *Why* the *pre-formal* probability that the *signature* (Definition 43) of a *specified* integer n —which determines whether n is a prime, or not—yielded by the simultaneous spins of the $\pi(\sqrt{n})$ Bazeris wheels where p_i is the i 'th prime, and B_i has p_i faces (Fig.4), is $O(\log_e n)$ (Theorem 22.14); thus *pre-formally* suggesting a lower bound for the time $\tilde{O}(\log_e^{15/2} n)$ proven *formally* by Agrawal et al in [AKS04], and improved to $\tilde{O}(\log_e^6 n)$ by Lenstra and Pomerance in [LP11], for *determining* whether a *specified* integer n is a prime or not.
- (c) *Why* it can be cogently argued that determining a factor of a *specified* integer deterministically cannot be polynomial time (see §22.A.f., Theorem 22.16).

Definition 43. (Signature of a natural number) The⁵⁰⁵ *signature* of a *specified* integer n is the sequence of residues $\langle a_{n,i} \rangle$ where $n + a_{n,i} \equiv 0 \pmod{p_i}$ for all primes p_i such that $1 \leq i \leq \pi(\sqrt{n})$.

Definition 44. (Value of a natural number) The *value* of a *specified* integer n is any well-defined interpretation—over the domain of the natural numbers—of the (unique) numeral $[n]$ that represents n in the first-order Peano Arithmetic PA.

22.A. Are the prime divisors of an integer mutually independent?

We begin by addressing the query:

Query 28. *Are the prime divisors of an integer n mutually independent?*

⁵⁰⁵Unique since, if $p^2_{\pi(\sqrt{m})+1} > m \geq p^2_{\pi(\sqrt{m})}$ and $p^2_{\pi(\sqrt{n})+1} > n \geq p^2_{\pi(\sqrt{n})}$ have the same signature, then $|m - n| = c_1 \cdot \prod_{i=1}^{\pi(\sqrt{m})} p_i = c_2 \cdot \prod_{i=1}^{\pi(\sqrt{n})} p_i$; whence $c_1 = c_2 = 0$ since $\prod_{i=1}^k p_i > (\prod_{i=2}^{k-2} p_i) \cdot p_k^2 > p_{k+1}^2$ for $k > 4$ by appeal to Bertrand's Postulate $2 \cdot p_k > p_{k+1}$; and the uniqueness is easily verified for $k \leq 4$.

Definition 45. *Two events are independent if the occurrence of one event does not influence (and is not influenced by) the occurrence of the other.*

Intuitively, the prime divisors of an integer *seem* to be mutually independent by virtue of the Fundamental Theorem of Arithmetic:

Theorem 22.1. (Fundamental Theorem of Arithmetic) *Every positive integer $n > 1$ can be represented in exactly one way as a product of prime powers:*

$$n = p_1^{n_1} p_2^{n_2} \cdots p_k^{n_k} = \prod_{i=1}^k p_i^{n_i}$$

where $p_1 < p_2 < \dots < p_k$ are primes and the n_i are positive integers (including 0).

Moreover, the prime divisors of n can also be *seen* to be mutually independent in the usual, linearly displayed, Sieve of Eratosthenes, where whether an integer n is crossed out as a multiple of a prime p is *obviously* independent (in the sense of Definition 45) of whether it is also crossed out as a multiple of a prime $q \neq p$:

$$E(\mathcal{I}), E(2), E(3), E(\mathcal{A}), E(5), E(\mathcal{G}), E(7), E(\mathcal{S}), E(\mathcal{O}), E(\mathcal{X}\mathcal{O}), E(11), \dots$$

Despite such compelling evidence, conventional wisdom appears to accept as definitive the counter-intuitive conclusion (addressed in §22.A.a.) that, although we can *see* it as true, we cannot mathematically prove the following proposition as *true*.

Proposition 22.2. (Prime independence) *Whether or not a prime p divides an integer n is independent of whether or not a prime $q \neq p$ divides the integer n ; and the pre-formal probability of n being a prime is $\prod_{i=1}^{\pi(\sqrt{n})} (1 - \frac{1}{p_i})$.*

Pictorial proof. The following model of the Sieve of Eratosthenes illustrates *pre-formally* that whether an integer n is crossed out as a multiple of a prime p is *pictorially* seen, and *evidenced*, to be independent of whether it is also crossed out as a multiple of a prime $q \neq p$.

- (a) If the job of generating all the primes less than, say the integer N^2 , were to be illustrated convincingly to all fresh recruits in the military, here's how they might go about it!

They could line up a bunch of N recruits and order them to march in tandem, with the sergeant-major yelling the question 'Prime?' to them at every step.

The 1'st recruit would be ordered to yell NO SIR at every 2nd step. The 2nd recruit is to yell NO SIR at every 3rd step. The 3rd recruit is to yell NO SIR at every 4th step, and so on (i.e., the N 'th recruit must yell NO SIR at every $(N + 1)$ th step).

If we make a diagram representing such a parade on paper, we shall see that every now and then there is a step, say n , when no recruit in the marching line yells NO SIR.

If such a step n (i.e., when no recruit yells NO SIR) is less than N^2 , then that step is a prime number.

Why is n a prime if no recruit yells NO SIR?

Because if the k 'th recruit had yelled NO SIR at the n 'th step, then n would have been a multiple of k , and so not a prime.

Now if, instead of imagining a line of N recruits, we were to imagine starting with one recruit at the first step, and adding an additional recruit *only* when no recruit in the marching line yells NO SIR, then their endless parade would hypothetically generate *all* the primes.⁵⁰⁶

- (b) In other words, the distribution of the primes is as random as that of tossing a coin, or a six-faced die.

We know that statistically, the probability of getting heads with any toss of a coin is $\frac{1}{2}$, and that the probability of getting a particular number with a six-faced die is $\frac{1}{6}$.

We also know that if we toss a coin and roll a die at the same time, the probability of getting heads on the coin and 3 on the die is $\frac{1}{2} \cdot \frac{1}{6} = \frac{1}{12}$.

Reason: The tossing of a coin and the rolling of a die are not connected, and so they are mutually independent actions (events).

Further, of the 12 possible outcomes:

(heads & 1) or (tails & 1),
 (heads & 2) or (tails & 2),
 (heads & 3) or (tails & 3),
 (heads & 4) or (tails & 4),
 (heads & 5) or (tails & 5),
 (heads & 6) or (tails & 6)

only 1 of the 12 is (heads & 3).

By similar reasoning, it can be shown that whether or not a prime p divides any integer n is independent of whether or not a prime q divides n if p is not equal to q .

Now it can easily be seen that n is a prime if, and only if, n is not divisible by any prime less than or equal to \sqrt{n} .

It then follows that the *pre-formal* probability of a *specified* n being a prime is $\prod_{i=1}^{\pi(\sqrt{n})} (1 - \frac{1}{p_i})$ ⁵⁰⁷, where, p_i is the i 'th prime, and $\pi(\sqrt{n})$ is the number of primes not exceeding \sqrt{n} . \square

Comment 186. The perspective that §22.A., Proposition 22.2 is explicitly proven *pictorially*—hence implicitly proven *mathematically* (as validated by §22.A.c., Theorem 22.12)—is suggested by the examples of *pictorial proofs* in number-theorist Manjul Bhargava's 2019 presentation [Bha19].

A more compelling argument (implicit in the Complementarity Thesis 1 in §1.) for the primacy of *pre-formal* reasoning and proofs is presented cogently by philosopher Markus Pantsar in [Pan09], which we quote at length considering the significance, in particular, of §22.A., Proposition 22.5:

“... It is of course an indisputable fact that the formal theories of mathematics did not just suddenly appear to human beings. We know that it took the work of some of the most brilliant minds in ancient Greece to find an unambiguous presentation for the mathematical knowledge of the time, which in turn was based on centuries, even millennia, of earlier study. Although this presentation was mostly written in a natural language, and would not be recognized as formal by a modern reader, it was still essentially formal mathematics. Ambiguous considerations based on observations were replaced by exact definitions, axioms and rules of proof. However, all this was based

⁵⁰⁶See §22.H., Appendix, for a graphical display of the algorithms based, essentially, on this model.

⁵⁰⁷See Theorem 3.11 of [this preprint](#).

on something—it did not appear via an epiphany. Obviously no written account of the process exists, but we can safely assume that, for example, Euclid’s formal concept of the “point” as an entity without dimensions was not the original concept of “point”. Rather, it was an idealization that the mathematicians needed and developed. When we think of a direct route from one house to another, we are essentially thinking of a line segment between two points. Of course houses are not points and routes are not lines—nothing physical is—but they correspond to the same *idea*.¹⁰¹ This idea of a straight line between two objects is quite clearly preformal, just like the ideas of circles, natural numbers and probabilities are. We do not need to know anything about the formal mathematical presentations of these concepts to be able to have—and even successfully *use*—their pre-formal ideas. That is of course because formal mathematics was developed to be a maximally unambiguous study of such existing pre-formal concepts. Pre-formal concepts were not *replaced* by formal ones, they were *clarified* by them.¹⁰²

What kinds of areas belong to pre-formal mathematics and can we hope to give a satisfying account of it? Certainly these are not easy questions to answer, and I do not pretend to give a comprehensive explanation here. It seems that almost anything concerning mathematics as a human endeavour can be considered to belong to pre-formal mathematics—aside from the formal part, of course. In this way, every physical object is potentially an object of pre-formal geometry, and every quantity is an object of preformal arithmetic, or some other area of mathematics. Pre-formal mathematics can be thought to include the unconscious element of mathematical invention, and it can be thought to include dividing a pile of apples into smaller piles. However, clearly not *everything* we do with such objects can be considered to be pre-formal mathematics: an activity only becomes mathematical once we are trying to find out general truths about the objects and the relations between them—the ultimate phase of this activity being the formalization of mathematics.¹⁰³ Even so, admittedly, these considerations make pre-formal mathematics a vast and somewhat vague field. But in lack of a better account, there should be nothing troubling about using the one given here. The point I want to make is that the domain of mathematical thinking is much larger than the mere formal part.¹⁰⁴ This is important when we consider the problems of reference and truth in mathematics. The exact nature and scope of pre-formal mathematics should not matter a great deal, as long as we are more or less along the right lines. I do not believe it can be plausibly argued that we are not.

The pre-formal element can be witnessed everywhere, but nowhere more visibly than in education. The examples here will be simplified and, again, in no way do I claim them to be accurate and complete descriptions of the learning process in mathematics. But they should be plausible enough to give us some philosophical perspective into mathematical thinking. How do we initially learn about, for example, triangles? The teacher draws a triangle on the blackboard and we start examining its properties. This way we learn that the sum of angles of a triangle is that of two right angles. But of course at this stage we never *really* deal with a mathematical triangle, only an imperfect drawing of one. We did not prove that the sum of the angles is that of two right angles, either—we probably just had a visual presentation that convinced us.

Moreover, this does not need to be visual. In Hadamard’s example (1954, p. 62):

... everybody understands that, intersecting two parallel lines by two other parallel ones, the segment thus determined are equal two by two; everybody knows that [...] But as long as it is not consciously enunciated, none of its consequences [...] can be deduced.

This purely verbal presentation seems to be perfectly valid. However, in both cases, in the purely formal sense, we did not acquire any mathematical knowledge—we did not prove anything. Still, it would not make sense to claim that we did not gain any knowledge. In the first example, we did learn a property of triangles that we did not know before. We just did not make the knowledge *formally rigorous* by proving it

from axioms, which is what formal mathematics does. This gives us a characterization of the basic distinction between formal and pre-formal mathematical thinking: any mathematical thinking, and knowledge, *that is not formally rigorous is pre-formal*.¹⁰⁵ This does not mean that we are unable to gain mathematical knowledge pre-formally. The sum of the angles of a Euclidean triangle, for example, is a mathematical *truth* that most of us initially learn pre-formally. We do not justify it rigorously in axiomatic systems until much later, but we undoubtedly have knowledge of it all along. Moreover, it is knowledge unlike memorizing a fact like “Nicholas II was the last Tsar of Russia”. Clearly we learn it by establishing general connections between concepts like triangle and angle, rather than relying only on an authority to give us correct information. Indeed, not surprisingly, the way these connections are established pre-formally mirrors the way they are proved formally. This is the important point here: *formal mathematics is designed to prove just such mathematical truths*.

¹⁰¹ Here I do not use the word “idea” in any Platonist sense, but rather in the most general sense we use it outside metaphysics.

¹⁰² Tarski speaks about formalized languages, which corresponds to my argument here. In mathematics (for the most part) we are concerned with meaningful, interpreted languages, not arbitrary formal rules of symbol manipulation—which is what formal languages ultimately are for the extreme formalist. We will return to this question later.

¹⁰³ For an example, an illuminating one is a passage on mathematical knot theory by Crowell and Fox (1963 p. 3), quoted by Shapiro (2000a, p. 35):

Mathematics never proves anything about anything except mathematics, and a piece of rope is a physical object and not a mathematical one. So before worrying about proofs, we must have a mathematical definition of what a knot is. [...] The definitions should define mathematical objects that approximate the physical objects under consideration as closely as possible.

In this quote the authors are quite clearly concerned with formalizing the pre-formal, in this case physical, concept of knots.

¹⁰⁴ For a reference in the psychological study of mathematics, one can consult Davis 1984, which emphasizes how people think about mathematics, how they process it through meanings. Also relevant is Tall (ed.) 1994, a collection of articles that focuses on advanced mathematical thinking and the role of various non-formal elements in it. For philosophical studies Lakatos 1978 is relevant when it comes to the classification of the different stages of mathematical thinking.

¹⁰⁵ Here we deal with the term “rigorous” somewhat loosely. It could be that the results of formal mathematics are not completely rigorous, either, due to problems like the unprovability of consistency. On the other hand, pre-formal mathematical thinking can also be rigorous, even though this may not be unambiguously established until it is formalized. Nevertheless, the distinction between formal and pre-formal rigor here should not be problematic, which I want to emphasize with the concept “formally rigorous”, which means proof from a specified set of formal axioms according to formal rules of proof.[¶]

... Pantsar: [Pan09], §1.3 Truth and Proof.

Comment 187. (see also §15.D.): We further note that such an *unprovable-but-intuitively-true* pictorial proof makes a *stronger* assumption than that in Gödel’s similar claim for his arithmetical formula $[(\forall x)R(x)]$ —whose Gödel-number is $17Gen\ r$ —in [Go31], p.26(2). *Stronger*, since Gödel does not assume his proposition to be *intuitively true*, but shows that though the arithmetical formula with Gödel-number $17Gen\ r$ is not provable in his Peano Arithmetic P yet, for any P -numeral $[n]$, the formula $[R(n)]$ whose Gödel-number is $Sb\left(r\ \begin{matrix} 17 \\ Z(n) \end{matrix}\right)$ is P -provable, and therefore *meta-mathematically true* under any well-defined Tarskian interpretation of P (see §2.A.).

Expressed in computational terms (see §2.F., Corollary 2.21), under any well-defined interpretation of P , Gödel’s formula $[R(x)]$ translates as an arithmetical relation, say $R'(x)$, such that $R'(n)$ is algorithmically *verifiable*, but not algorithmically *computable*, as always true over N , since $[(\forall x)R(x)]$ is P -provable (see §2.F., Corollary 2.20).

Formally, however, we argue that a perspective which denies Proposition 22.2 is based on perceived barriers that reflect, and are peculiar to, *only* the argument that:

Theorem 22.3. *There is no deterministic algorithm that, for any specified n , and any specified prime $p \geq 2$, will evidence that the probability $\mathbb{P}(p \mid n)$ that p divides n is $\frac{1}{p}$, and the probability $\mathbb{P}(p \nmid n)$ that p does not divide n is $1 - \frac{1}{p}$.*

Proof. By a standard result in the Theory of Numbers ([Ste02], Chapter 2, p.9, Theorem 2.1⁵⁰⁸), we cannot define a probability function for the probability that a random n is prime over the probability space $(1, 2, 3, \dots)$. \square

In other words, treating Theorem 22.3 as an absolute barrier does not admit the possibility—which has consequences for the resolution of outstanding problems in both the theory of numbers (see §22.C.b., Theorem 22.48, and §22.D., Theorem 22.56) and computational complexity (see §22.A.f., Theorem 22.16)—that Proposition 22.2 is algorithmically *verifiable*, but not algorithmically *computable*, as *true*, since we shall show that:

Theorem 22.4. *For any specified n , there is a deterministic algorithm that, for any specified prime $p \geq 2$, will evidence that the probability $\mathbb{P}(p \mid n)$ that p divides n is $\frac{1}{p}$, and the probability $\mathbb{P}(p \nmid n)$ that p does not divide n is $1 - \frac{1}{p}$.*

Proof. Take i as p in §22.A.c., Corollary 22.7 and Corollary 22.8. \square

The significance of Proposition 22.2 is that it immediately entails:

Proposition 22.5. (P \neq NP by Eratosthenes sieve) $P \neq NP$

Proof. By the Prime Number Theorem and Mertens' Theorem, the expected number of primes $\leq \sqrt{n}$ is $O(\frac{\sqrt{n}}{\log_e \sqrt{n}})$. Moreover, any computational process that successfully identifies a prime divisor of n must necessarily appeal to at least one logical operation for identifying such a factor.

Since n is a prime if, and only if, it is not divisible by any prime $p \leq \sqrt{n}$, it follows that if, for instance, $n = p^k$ for some $k \geq 2$, then determining p may require at least one logical operation for algorithmically testing each prime $\leq \sqrt{n}$ deterministically if, for some n , the prime p is the one that is tested last in the particular method of testing the primes $\leq \sqrt{n}$.

Since any algorithmically deterministic method of testing the primes $\leq \sqrt{n}$ must be independent of n , and always have some prime p that is tested last for any *specified* n , the algorithm cannot be guaranteed to always determine in polynomial time that p is a prime factor of n if $n = p^k$ for some $k \geq 2$.

Since the primes to be tested if p is tested last, and $n = p^k$, are of order $O(\sqrt{n}/\log_e n)$, the number of computations required by any deterministic algorithm that always computes a prime factor of n cannot be polynomial-time—i.e. of order $O((\log_e n)^c)$ for any c —in the length of the input n . \square

Comment 188. See also:

- §4.A.a., Theorem 4.3 (SAT is not in P or NP), for an independent, *evidence-based*, *arithmetical* proof that SAT is not in P or NP since there is an arithmetical formula that is algorithmically *verifiable* as a tautology, but not recognisable as a tautology by any Turing-machine.
- §4.B.b., Corollary 4.5 (P \neq NP by separation), for an independent, *evidence-based*, proof that if P is the class of problems that admit algorithmically *computable* solutions, and NP is the class of problems that admit algorithmically *verifiable* solutions, then P \neq NP.
- §22.A.f., Theorem 22.16 (FACTORISATION is not in P), for an independent, *evidence-based*, *arithmetical* proof that P \neq NP, since factorisation is not deterministically 'polynomial time'.

⁵⁰⁸Compare with the informal argument in [HL23], pp.36-37; also with those in §22.3(i).

22.A.a. Current paradigms

We note that the justification for current paradigms denying §22.A., Proposition 22.2 appears to be more *faith-based* than *evidence-based*, since it is expressed:

(i) either explicitly, but without formal proof:

(a) “Here is the code of the algorithm. ... the input x is a product of two prime numbers, ϕ is a polynomial in just one variable, and gcd refers to the greatest-common-divisor algorithm expounded by Euclid around 300 B.C. ...

* Repeat until exit:

* $a :=$ a random number in $1, \dots, x - 1$;

* if $gcd(b, x) > 1$ then exit.

Exiting enables carrying out the two prime factors of x ...

How many iterations must one expect to make through this maze before exit? How and when can the choice of the polynomial ϕ speed up the exploration? ...

Note that we cannot consider the events $b \equiv 0 \pmod{p}$ and $b \equiv 0 \pmod{q}$ to be independent, even though p and q are prime, because $b = \phi a$ and ϕ may introduce bias.”

... Regan: [Re16].

(b) “... the probabilities are not independent. ... The probability that a number n is divisible by a prime p is $1/p$, if concerning n we know only that it is large compared with p . If we know that n is near N^2 and not divisible by any prime smaller than p , then the probability that n is divisible by p is not $1/p$, but f/p .”

... Furry: [Fu42].

(c) “Prof. E. M. Wright, some months ago, sent me privately a proof on somewhat similar lines that that the probabilities could not be independent for primes greater than $n^{0.76}$.”

... Cherwell: [Che42].

(d) “Find the probability that x , a large integer chosen at random, is a prime number. ... If the integer x is not divisible by any prime p which does not exceed $x^{1/2}$, x itself must be a prime—and so divisibility by primes exceeding $x^{1/2}$ is, in fact, not independent of the smaller primes.”⁵⁰⁹

... Pólya: [Pol59].

(ii) or implicitly, by arguing—as, for instance, in [Ste02], Chapter 2, p.9, Theorem 2.1—that a proof to the contrary must entail a contradiction.

22.A.b. Illusory barriers

However, we shall show in §22.A.c. that the barriers faced by current paradigms in addressing Query 28 unequivocally are illusory; they dissolve if we differentiate between the following probabilities:

(i) The probability $P_1(n \in \phi)$ of selecting an integer that has the property ϕ from a specified set S of integers;

Example 1: If N is the domain of the natural numbers, what is the probability of selecting an integer $n \in N$ that has the property of being a prime?

⁵⁰⁹It is not obvious whether Pólya’s—rather curious—perspective is unconsidered, or whether it falls within the criteria of information that we hold to be true—short of Platonic belief—since it can be treated as self-evident.

We note classical theory postulates that since we cannot define a precise ratio of primes to composites in \mathbb{N} , but only an order of magnitude such as $O(\frac{1}{\log_e n})$, the probability $P_1(p) \equiv P_1(n \in \mathbb{N} \text{ is a prime})$ of *selecting* an integer that has the property of being a prime obviously cannot be defined over \mathbb{N} .

Comment 189. However, we note that such postulation contradicts the *pre-formal* argument that: (a) choosing a point *randomly* in the interval $(0, 1)$ can be done *finitarily*; and that (b) this *uniquely* identifies a column in the bar graph whose columns are defined by:

$$\{(\sum_1^n \frac{1}{2^n}, 0), (\sum_1^n \frac{1}{2^n}, 2^{n+1}), (\sum_1^{n+1} \frac{1}{2^{n+1}}, 2^{n+1}), (\sum_1^{n+1} \frac{1}{2^{n+1}}, 0); n = 1, 2, 3, \dots\}$$

where (c) the probability of selecting a column c_i by choosing a *random* point in the bar graph equals the probability of selecting a column c_j , where $1 \leq i, j$, since each of the columns is of unit area; which thus entails that (d) the integer n is *randomly* selected from \mathbb{N} with equal Kolmogorov probability (see [CD19], *Random Events and Classical Probabilities*); whence (e) the probability that a randomly selected point in the interval $(0, 1)$ *well-defines* an *unspecified* integer n is 1; and so (f) the probability of *selecting* an integer $n \in \mathbb{N}$ that has the property of being a prime is $1.O(\frac{1}{\log_e n})$.

- (ii) The probability $P_2(n \in \phi)$ that an *unspecified* integer, in a *specified* set S of integers, *has* the property ϕ ;

Example 2: If N^+ is the set of positive integers, what is the probability that an unspecified integer $n \in N^+$ secreted in a black box is even?

We note that since any $n \in N^+$ is either odd or even, the probability $P_2(p) \equiv P_2(n \in N^+ \text{ is even})$ that the *unspecified* integer $n \in N^+$ secreted in the black box *has* the property of being even must be $\frac{1}{2}$.

We note that the probability $P_2(p) \equiv P_2(n \in N^+ \text{ is even})$ cannot *depend* upon the probability $P_1(p) \equiv P_1(n \in N^+ \text{ is even})$ of *selecting* an integer $n \in N^+$ that has the property of being even, as the latter would require⁵¹⁰ that $\sum_{i=1}^{\infty} P_2(i \in N^+ \text{ is even}) = 1$, which is not the case in this example.

Comment 190. Such *dependence* would also appear to eerily echo the *curious* argument (see §23.B.)—preferred by the Copenhagen interpretation of quantum theory—that whether or not the putative cat *is* alive—and not just *known* to be alive—at any moment in Schrödinger’s famous *gedanken*, would depend ultimately open whether or not we were to open the *box* at *that* moment!

- (iii) The probability $P_3(n \in \phi)$ of *determining* that a *specified* integer n has the property ϕ .

Example 3: I give you a 5-digit combination lock along with a 10-digit integer n . The lock only opens if you set the combination to a proper factor of n which is greater than 1. What is the probability that a specified combination will open the lock.

We note that this is the basis for RSA encryption, which provides the cryptosystem used by many banks for securing their communications.

It is the basis we shall use to illustrate that the probability $P_3(p|n)$ of *determining* that a prime p divides a *specified* integer n is $\frac{1}{p}$, and is independent of whether or not a prime $q \neq p$ divides n .

⁵¹⁰See Steuding [Ste02], Chapter 2, p.9, Theorem 2.1.

22.A.c. Why the prime divisors of an integer are mutually independent

We define the probability $P_3(p|n)$ of *determining* (in the sense detailed in §22.A.b.(iii)), by the spin of a modified Bazerics Cylinder, that a prime p divides a *specified* integer n , and show it is independent of whether or not a prime $q \neq p$ divides n .



Fig.1. An i -faced Bazerics wheel B_i and a j -faced Bazerics wheel B_j .

Definition 46. (Bazerics Cylinder) A modified Bazerics Cylinder is a set of polygonal wheels—not necessarily identical (such as B_i and B_j in Fig. 1)—rotating independently on a common spindle, whose faces are coded with, say, integer values 0 to $i - 1$ and 0 to $j - 1$ respectively, where the event $B_i(u)$ (Fig 2) is the value $0 \leq u \leq i - 1$ yielded by a spin of a single i -faced Bazerics wheel B_i , and the event $B_{ij}(u, v)$ (Fig, 3) is the value (u, v) —where $0 \leq u \leq i - 1$ and $0 \leq v \leq j - 1$ —yielded by simultaneous, but independent, spins of an i -faced Bazerics wheel B_i and a j -faced Bazerics wheel B_j .

Hypothesis 5. The event yielded by the simultaneous spins of a set of Bazerics wheels is random.

(1) We consider first, for any *specified* $n > i > 1$, the probability $P_3(B_i(u))$ —over the probability space $(0, 1, 2, \dots, i - 1)$ (see also §22.B.a.)—of *determining* that the spin of the Bazerics wheel B_i —with faces numbered $0, 1, 2, \dots, i - 1$ —yields the event $B_i(u)$.

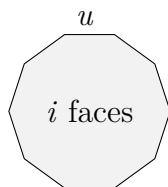

Fig.2. The event $B_i(u)$ for a single i -faced Bazerics wheel B_i

We conclude by Hypothesis 5 that, for any $0 \leq u \leq i - 1$:

Lemma 22.6. $P_3(B_i(u)) = \frac{1}{i}$.

Now, if $n \equiv u \pmod{i}$ where $i > u \geq 0$, then i divides n if, and only if, $u = 0$. The probability $P_3(i|n)$ of *determining* by the spin of a Bazerics wheel whether the event i divides n is thus:

Corollary 22.7. $P_3(i|n) = P_3(B_i(0)) = \frac{1}{i}$.

Hence the probability $P_3(i \nmid n)$ of similarly *determining* that the event i does not divide n is:

Corollary 22.8. $P_3(i \nmid n) = 1 - \frac{1}{i}$.

(2) We consider next, for any *specified* $n > i$, $j > 1$ where $i \neq j$, the joint probability $P_3(B_{ij}(u, v))$ of *determining* whether the simultaneous, but independent, spins of the pair of Bazerian wheels (Fig.3) B_i —with faces numbered $0, 1, 2, \dots, i - 1$ —and B_j —with faces numbered $0, 1, 2, \dots, j - 1$ —yields the event $B_{ij}(u, v)$.



Fig.3. The event $B_{ij}(u, v)$ for a set of two Bazerian wheels B_i and B_j .

Since the two events $B_i(u)$ and $B_j(v)$ are mutually independent by definition, we conclude by Hypothesis 5 that⁵¹¹:

Lemma 22.9. $P_3(B_{ij}(u, v)) = P_3(B_i(u)).P_3(B_j(v)) = \frac{1}{ij}$.

(3) We conclude further by Hypothesis 5, Lemma 22.6, Corollary 22.7, and Lemma 22.9, that:

Lemma 22.10. $P_3(i|n \ \& \ j|n) = P_3(i|n).P_3(j|n)$ if, and only if, $n > i, j > 1$ and i, j are co-prime.

Proof. We note that:

(a) The assumption that i, j be co-prime is sufficient. Thus, if i, j are co-prime, and:

$$n \equiv u \pmod{i}, \quad n \equiv v \pmod{j}, \quad n \equiv w \pmod{ij}$$

where $i > u \geq 0$, $j > v \geq 0$, $ij > w \geq 0$, then the ij integers $v.i + u.j$ are all incongruent and form a complete system of residues⁵¹².

Hence $i|n$ and $j|n$ if, and only if, $u = v = 0$.

It follows that $P_3(i|n \ \& \ j|n) = P_3(B_{ij}(0, 0))$.

By Corollary 22.7, $P_3(i|n) = P_3(B_i(0)) = \frac{1}{i}$ and $P_3(j|n) = P_3(B_j(0)) = \frac{1}{j}$.

By Lemma 22.9, $P_3(B_{ij}(0, 0)) = \frac{1}{ij}$.

Hence, if i, j are co-prime, then $P_3(i|n \ \& \ j|n) = P_3(i|n).P_3(j|n)$.

(b) The assumption that i, j be co-prime is necessary.

For instance, if $j = 2i$, then $i|n$ and $j|n$ if, and only if, $v = 0$.

Hence $P_3(i|n \ \& \ j|n) = P_3(B_j(0))$

By Corollary 22.7, $P_3(i|n) = P_3(B_i(0)) = \frac{1}{i}$ and $P_3(j|n) = P_3(B_j(0)) = \frac{1}{j}$.

Hence $P_3(i|n \ \& \ j|n) \neq P_3(i|n).P_3(j|n)$.

⁵¹¹Grinstead and Snell [GS97], Chapter 4, §4.1, Definition 4.2, p.141.

⁵¹²Hardy and Wright [HW60], p.52, Theorem 59.

The lemma follows. □

(4) We thus conclude from Lemma 22.10 that:

Corollary 22.11. *If p and q are two unequal primes, $P_3(p|n \ \& \ q|n) = P_3(p|n) \cdot P_3(q|n)$.* □

We thus have a model-theoretic argument that (for a proof-theoretic argument see §22.B.b., Corollary 22.25):

Theorem 22.12. *The prime divisors of an integer are mutually independent.* □

22.A.d. On the probability of *determining* that a *specified* integer n is a prime

We consider the compound event where $B_i(0)$ does not occur for any of a set of $\pi(\sqrt{n})$ Bazerics wheels (Fig.4).

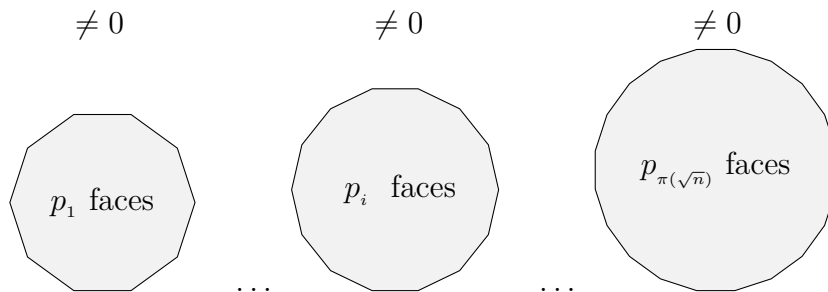

Fig.4. The event where $B_i(0)$ does not occur for any of a set of $\pi(\sqrt{n})$ Bazerics wheels.

Now, even though we cannot define the probability $P_1(n \text{ is a prime})$ of *selecting* an integer n from the set N of all natural numbers that has the property of being prime⁵¹³, since we have by Corollary 22.8 that the probability $P_3(i \nmid n)$ of *determining* by the spin of a Bazerics wheel that a prime $p < n$ does not divide a *specified* n is $1 - \frac{1}{p}$, it follows from Theorem 22.12 that:

Theorem 22.13. *The probability $P_3(n \text{ is co-prime to } p \leq \sqrt{n})$ ⁵¹⁴ of *determining* that n is not divisible by any prime $p \leq \sqrt{n}$ is $\prod_{i=1}^{\pi(\sqrt{n})} (1 - \frac{1}{p_i})$.*

Proof. By §22.A.c., Definition 46, Hypothesis 5, and Lemma 22.9, the probability that $B_i(0)$ does not occur for any i in a simultaneous spin of the $\pi(\sqrt{n})$ Bazerics wheels—where p_i is the i 'th prime and B_i has p_i faces (Fig. 4)—is $\prod_{i=1}^{\pi(\sqrt{n})} (1 - \frac{1}{p_i})$.

If k is such that $k \not\equiv 0 \pmod{p}$ for any prime $p \leq \sqrt{n}$, then the probability $P_3(k \text{ is co-prime to } p \leq \sqrt{n})$ of *determining* by the simultaneous spin of the above $\pi(\sqrt{n})$ Bazerics wheels that k is not divisible by any prime $p \leq \sqrt{n}$ is $\prod_{i=1}^{\pi(\sqrt{n})} (1 - \frac{1}{p_i})$.

In the particular case where n is such that $n \not\equiv 0 \pmod{p}$ for any prime $p \leq \sqrt{n}$, the probability $P_3(n \text{ is co-prime to } p \leq \sqrt{n})$ of *determining* by the simultaneous spin of the above $\pi(\sqrt{n})$ Bazerics wheels that n is not divisible by any prime $p \leq \sqrt{n}$ is $\prod_{i=1}^{\pi(\sqrt{n})} (1 - \frac{1}{p_i})$. The theorem follows. □

⁵¹³See §22.A.a. (2)(i).

⁵¹⁴See §22.A.a. (2)(iii).

22.A.e. Why determining primality is deterministically ‘polynomial time’

We now have that:

Theorem 22.14. *The minimum number of events needed for pre-formally concluding that the signature yielded by simultaneous spins of the $\pi(\sqrt{n})$ Bazeris wheels—where p_i is the i 'th prime and B_i has p_i faces (Fig.4)—is that of a number not divisible by any prime $p \leq \sqrt{n}$ is of order $O(\log_e n)$.*

Proof. By Theorem 22.13, the expected number of events which *determine* that a *specified* n is not divisible by any prime $p \leq \sqrt{n}$ in a set of k simultaneous spins of the $\pi(\sqrt{n})$ Bazeris wheels⁵¹⁵—where p_i is the i 'th prime and B_i has p_i faces (Fig.4)—is $k \cdot \prod_{i=1}^{\pi(\sqrt{n})} (1 - \frac{1}{p_i})$; which—by Mertens' Theorem⁵¹⁶ $\prod_{p \leq x} (1 - \frac{1}{p}) \sim \frac{e^{-\lambda}}{\log_e x}$ —is ≥ 1 if $k \geq \frac{e^\lambda}{2} \cdot \log_e n$. The lemma follows by Definition 43 for minimum k . \square

We note the standard definition:

Definition 47. *A deterministic algorithm computes a number-theoretical function $f(n)$ in polynomial-time⁵¹⁷ if there exists k such that, for all inputs n , the algorithm computes $f(n)$ in $\leq (\log_e n)^k + k$ steps.*

By Definition 47, we further conclude that:

Corollary 22.15. *Pre-formally concluding whether the signature yielded by simultaneous spins of the $\pi(\sqrt{n})$ Bazeris wheels—where p_i is the i 'th prime and B_i has p_i faces (Fig.4)—is that of a prime, or not, can be simulated by a deterministic algorithm in polynomial time $O(\log_e n)$.⁵¹⁸*

Proof. Let $r(n)$ be the ratio $\pi(n)/\pi_{\text{coprime}}(n)$ of the number $\pi(n)$ of primes $\leq n$ and the number $\pi_{\text{coprime}}(n)$ of integers $\leq n$ and co-prime to n . By the Prime Number Theorem and Theorem 22.13, $\lim_{n \rightarrow \infty} r(n) = e^{-\lambda}$. Hence $r(n)$ is bounded by some constant c . The corollary follows by Theorem 22.14. \square

22.A.f. FACTORISATION is not deterministically ‘polynomial-time’

Given that n is composite, it follows from §22.A.c., Theorem 22.12, that (see also §4.A., Theorem 4.3, for an independent *logical* proof that $P \neq NP$ since SAT is not deterministically ‘polynomial time’):

Theorem 22.16. (FACTORISATION is not in P) *$P \neq NP$ since there are integers n such that no deterministic algorithm can compute a prime factor of n in polynomial-time.*

⁵¹⁵We note that this is *not* equivalent to the throws of a $\prod_{i=1}^{\pi(\sqrt{n})} p_{\pi(\sqrt{i})}$ -sided die, each of whose faces is equally possible as a key to the code in question, since such throws do not use the fact—Theorem 22.12—that the prime divisors of n are mutually independent.

⁵¹⁶Hardy and Wright [HW60], p. 351, Theorem 22.8; where $\lambda = 0.57722\dots$ is the Euler-Mascheroni constant and $\frac{e^\lambda}{2} = 0.89053\dots$

⁵¹⁷cf. Cook [Cook], p.1; also Brent [Brn00], p.1, fn.1: “For a polynomial-time algorithm the expected running time should be a polynomial in the length of the input, i.e. $O((\log N)^c)$ for some constant c ”.

⁵¹⁸We note that, in a seminal paper ‘PRIMES is in P’, Agrawal et al [AKS04] have shown that deciding whether an integer n is a prime or not can be done in polynomial time $\tilde{O}(\log^{15/2} n)$; improved to $\tilde{O}(\log_e^6 n)$ by Lenstra and Pomerance in [LP11].

Proof. By the Prime Number Theorem and Mertens' Theorem, the expected number of primes $\leq \sqrt{n}$ is $O(\frac{\sqrt{n}}{\log_e \sqrt{n}})$. Moreover, any computational process that successfully identifies a prime divisor of n must necessarily appeal to at least one logical operation for identifying such a factor.

Since n is a prime if, and only if, it is not divisible by any prime $p \leq \sqrt{n}$, it follows that if, for instance, $n = p^k$ for some $k \geq 2$, then determining p may require at least one logical operation for algorithmically testing each prime $\leq \sqrt{n}$ deterministically if, for some n , the prime p is the one that is tested last in the particular method of testing the primes $\leq \sqrt{n}$.

Since any algorithmically deterministic method of testing the primes $\leq \sqrt{n}$ must be independent of n , and always have some prime p that is tested last for any *specified* n , the algorithm cannot be guaranteed to always determine in polynomial time that p is a prime factor of n if $n = p^k$ for some $k \geq 2$.

Since the primes to be tested if p is tested last, and $n = p^k$, are of order $O(\sqrt{n}/\log_e n)$, the number of computations required by any deterministic algorithm that always computes a prime factor of n cannot be polynomial-time—i.e. of order $O((\log_e n)^c)$ for any c —in the length of the input n . \square

Comment 191. See also:

- §4.A.a., Theorem 4.3 (SAT is not in P or NP), for an independent, *evidence-based, arithmetical* proof that SAT is not in P or NP since there is an arithmetical formula that is algorithmically *verifiable* as a tautology, but not recognisable as a tautology by any Turing-machine.
- §4.B.b., Corollary 4.5 (P \neq NP by separation), for an independent, *evidence-based*, proof that if P is the class of problems that admit algorithmically *computable* solutions, and NP is the class of problems that admit algorithmically *verifiable* solutions, then P \neq NP.
- §22.A., Proposition 22.5 (P \neq NP by Eratosthenes sieve), for an independent, *pictorial* proof that the prime divisors of an integer are mutually independent by §22.A., Proposition 22.2; whence the Prime Number Theorem and Mertens' Theorem further entail that P \neq NP.

22.B. Formal properties of the residues $r_i(n)$.

We give formal proofs of the foregoing considerations by defining the residues $r_i(n)$ for all $n \geq 2$ and all $i \geq 2$ as below:

Definition 48. $n + r_i(n) \equiv 0 \pmod{i}$ where $i > r_i(n) \geq 0$.

Since each residue $r_i(n)$ cycles over the i values $(i - 1, i - 2, \dots, 0)$, these values are all incongruent and form a complete system of residues⁵¹⁹ \pmod{i} .

It immediately follows that:

Lemma 22.17. $r_i(n) = 0$ if, and only if, i is a divisor of n . \square

⁵¹⁹[HW60], p.49.

22.B.a. The probability model $\mathbb{M}_i = \{(0, 1, 2, \dots, i-1), r_i(n), \frac{1}{i}\}$

By the standard definition of the probability $\mathbb{P}(e)$ of an event e ⁵²⁰, we have by §22.B., Lemma 22.17, that:

Lemma 22.18. *For any $n \geq 2$, $i \geq 2$ and any specified integer $i > u \geq 0$:*

- the probability $\mathbb{P}(r_i(n) = u)$ that $r_i(n) = u$ is $\frac{1}{i}$;
- $\sum_{u=0}^{i-1} \mathbb{P}(r_i(n) = u) = 1$;
- and the probability $\mathbb{P}(r_i(n) \neq u)$ that $r_i(n) \neq u$ is $1 - \frac{1}{i}$. □

By the standard definition of a probability model, we conclude that:

Theorem 22.19. *For any $i \geq 2$, $\mathbb{M}_i = \{(0, 1, 2, \dots, i-1), r_i(n), \frac{1}{i}\}$ yields a probability model for each of the values of $r_i(n)$. □*

Corollary 22.20. *For any specified n , i and u such that $r_i(n) = u$, the probability that the roll of an i -sided cylindrical die will yield the value u is $\frac{1}{i}$ by the probability model defined in Theorem 22.19 over the probability space $(0, 1, 2, \dots, i-1)$. □*

Corollary 22.21. *For any $n \geq 2$ and any prime $p \geq 2$, the probability $\mathbb{P}(r_p(n) = 0)$ that $r_p(n) = 0$, and that p divides n , is $\frac{1}{p}$; and the probability $\mathbb{P}(r_p(n) \neq 0)$ that $r_p(n) \neq 0$, and that p does not divide n , is $1 - \frac{1}{p}$. □*

We also note the standard definition⁵²¹:

Definition 49. *Two events e_i and e_j are mutually independent for $i \neq j$ if, and only if, $\mathbb{P}(e_i \cap e_j) = \mathbb{P}(e_i) \cdot \mathbb{P}(e_j)$.*

22.B.b. The prime divisors of any integer n are mutually independent

We further note that:

Lemma 22.22. *If $n \geq 2$ and $n > i, j > 1$, where $i \neq j$, then:*

$$\mathbb{P}((r_i(n) = u) \cap (r_j(n) = v)) = \mathbb{P}(r_i(n) = u) \cdot \mathbb{P}(r_j(n) = v)$$

where $i > u \geq 0$ and $j > v \geq 0$.

Proof. We note that:

- (i) If $n \geq 2$ and $n > i, j > 1$, where $i \neq j$, then we can always determine a unique pair of residues $r_i(n) = u$ and $r_j(n) = v$, where $i > u \geq 0$, $j > v \geq 0$, i divides $n + u$, and j divides $n + v$.
- (ii) There are i, j pairs (u, v) such that $i > u \geq 0$ and $j > v \geq 0$.

⁵²⁰See [Ko56], Chapter I, §1, Axiom III, pg.2.

⁵²¹See [Ko56], Chapter VI, §1, Definition 1, pg.57 and §2, pg.58.

(iii) The compound probability that the simultaneous roll of one i -sided cylindrical die and one j -sided cylindrical die will yield the values u and v , respectively, is thus $\frac{1}{i \cdot j}$ by the probability model for such a simultaneous event as defined over the probability space $\{(u, v) : i > u \geq 0, j > v \geq 0\}$, where we note that:

- the probability $\mathbb{P}((r_i(n) = u) \cap (r_j(n) = v))$ that $r_i(n) = u$ and $r_j(n) = v$ is $\frac{1}{i \cdot j}$;
- $\sum_{\text{All } (u,v): i > u \geq 0, j > v \geq 0} \mathbb{P}((r_i(n) = u) \cap (r_j(n) = v)) = 1$;

(iv) By §22.B.a., Lemma 22.18, the product of the probability $\frac{1}{i}$ that the roll of an i -sided cylindrical die will yield the value u , and the probability $\frac{1}{j}$ that the roll of a j -sided cylindrical die will yield the value v , is $\frac{1}{i \cdot j}$.⁵²²

(v) It follows that:

$$\mathbb{P}((r_i(n) = u) \cap (r_j(n) = v)) = \frac{1}{i \cdot j}$$

$$\mathbb{P}(r_i(n) = u) \cdot \mathbb{P}(r_j(n) = v) = \left(\frac{1}{i}\right) \left(\frac{1}{j}\right).$$

The lemma follows. □

Corollary 22.23. $\mathbb{P}((r_i(n) = 0) \cap (r_j(n) = 0)) = \mathbb{P}(r_i(n) = 0) \cdot \mathbb{P}(r_j(n) = 0)$. □

Since, by §22.B., Lemma 22.17, $r_i(n) = 0$ if, and only if, i is a divisor of n , it follows from Corollary 22.23 that:

Theorem 22.24. *If i and j are co-prime and $i \neq j$, then whether, or not, i divides any specified natural number n is independent of whether, or not, j divides n .*

Proof. We note that

(i) By Corollary 22.22, we have that:

$$\mathbb{P}((r_i(n) = 0) \cap (r_j(n) = 0)) = \frac{1}{i \cdot j}$$

$$\mathbb{P}(r_i(n) = 0) \cdot \mathbb{P}(r_j(n) = 0) = \left(\frac{1}{i}\right) \left(\frac{1}{j}\right).$$

(ii) Further, if i and j are co-prime, and $n + r_{i \cdot j}(n) \equiv 0 \pmod{i \cdot j}$, then the $i \cdot j$ integers $r_j(n) \cdot i + r_i(n) \cdot j$ are all incongruent and form a complete system of residues. It follows that $n = a \cdot i$ —whence i divides n —and also $n = b \cdot j$ —whence j divides n —if, and only if $r_i(n) = r_j(n) = r_{i \cdot j}(n) = 0$.

The lemma follows. □

We thus have a formal proof of the model-theoretic argument §22.A.c., Theorem 22.12, that:

Corollary 22.25. *The prime divisors of any integer n are mutually independent.* □

⁵²²In other words, the compound probability of determining u and v correctly from the simultaneous roll of one i -sided cylindrical die and one j -sided cylindrical die, is the product of the probability of determining u correctly from the roll of an i -sided cylindrical die, and the probability of determining v correctly from the roll of a j -sided cylindrical die.

22.B.c. Density of integers not divisible by primes $Q = \{q_1, q_2, \dots, q_k\}$

We conclude further from §22.B.b., Corollary 22.25 that:

Lemma 22.26. *The asymptotic density of the set of all integers that are not divisible by any of a specified set of primes $Q = \{q_1, q_2, \dots, q_k\}$ is:*

$$\prod_{q \in Q} (1 - 1/q). \quad \square$$

It follows that:

Lemma 22.27. *The expected number of integers in any interval (a, b) that are not divisible by any of a specified set of primes $Q = \{q_1, q_2, \dots, q_k\}$ is:*

$$(b - a) \prod_{q \in Q} (1 - 1/q). \quad \square$$

22.B.d. The function $\pi_H(n)$

In particular, the expected number $\pi_H(n)$ of integers $\leq n$ that are not divisible by any of the first k primes p_1, p_2, \dots, p_k is:

Corollary 22.28. $\pi_H(n) = n \cdot \prod_{i=1}^k (1 - \frac{1}{p_i})$.

It follows that:

Corollary 22.29. *The expected number of primes $\leq p_{\pi(\sqrt{n})+1}^2$ is:*

$$\pi_H(p_{\pi(\sqrt{n})+1}^2) = p_{\pi(\sqrt{n})+1}^2 \prod_{i=1}^{\pi(\sqrt{n})} (1 - \frac{1}{p_i})$$

with cumulative standard deviation:

$$p_{\pi(\sqrt{n})+1} \sqrt{\prod_{i=1}^{\pi(\sqrt{n})} (1 - \frac{1}{p_i}) (1 - \prod_{i=1}^{\pi(\sqrt{n})} (1 - \frac{1}{p_i}))}. \quad \square$$

We conclude that $\pi_H(n)$ is a non-heuristic approximation of the number of primes $\leq n$ ⁵²³:

Lemma 22.30. $\pi(n) \approx \pi_H(n) = n \cdot \prod_{i=1}^{\pi(\sqrt{n})} (1 - \frac{1}{p_i})$.

22.B.e. The function $\pi_L(n)$

It also follows immediately from Theorem 22.27 that:

Corollary 22.31. *The expected number of primes in the interval $(p_{\pi(\sqrt{n})}^2, p_{\pi(\sqrt{n})+1}^2)$ is:*

$$(p_{\pi(\sqrt{n})+1}^2 - p_{\pi(\sqrt{n})}^2) \prod_{i=1}^{\pi(\sqrt{n})} (1 - \frac{1}{p_i})$$

with standard binomial deviation:

$$\sqrt{(p_{\pi(\sqrt{n})+1}^2 - p_{\pi(\sqrt{n})}^2) \prod_{i=1}^{\pi(\sqrt{n})} (1 - \frac{1}{p_i}) (1 - \prod_{i=1}^{\pi(\sqrt{n})} (1 - \frac{1}{p_i}))}. \quad \square$$

⁵²³Fig.6 in §22.G. compares the values of $\pi(n)$ and $\pi_H(n)$ for $4 \leq n \leq 3000$.

It further follows from Lemma 22.27 and Corollary 22.31 that:

Corollary 22.32. *The number $\pi(p_{\pi(\sqrt{n})+1}^2)$ of primes less than $p_{\pi(\sqrt{n})+1}^2$ is cumulatively approximated by:*

$$\pi_L(p_{\pi(\sqrt{n})+1}^2) = \sum_{j=1}^{\pi(\sqrt{n})} \{(p_{j+1}^2 - p_j^2) \prod_{i=1}^j (1 - \frac{1}{p_i})\}$$

with cumulative standard deviation:

$$\sum_{j=1}^{\pi(\sqrt{n})} \sqrt{(p_{j+1}^2 - p_j^2) \prod_{i=1}^j (1 - \frac{1}{p_i}) (1 - \prod_{i=1}^j (1 - \frac{1}{p_i}))}. \quad \square$$

We conclude that $\pi_L(n)$ is the cumulative non-heuristic approximation of the number of primes $\leq n$ ⁵²⁴:

Lemma 22.33. $\pi(n) \approx \pi_L(n) = \sum_{j=1}^n \prod_{i=1}^{\pi(\sqrt{j})} (1 - \frac{1}{p_i})$.

It immediately follows from Lemma 22.30 and Lemma 22.33 that:

Corollary 22.34. $\pi_L(n) > \pi_H(n)$ for all $n \geq 9$.

22.B.f. The interval (p_n^2, p_{n+1}^2)

It follows immediately from the definition of $\pi(x)$ as the number of primes less than or equal to x that:

Lemma 22.35. $\prod_{i=1}^{\pi(\sqrt{x})} (1 - \frac{1}{p_i}) = \prod_{i=1}^{\pi(\sqrt{x+1})} (1 - \frac{1}{p_i})$ for $p_n^2 \leq x < p_{n+1}^2$. □

We can thus generalise the number-theoretic function of Lemma 22.33 as the real-valued function:

Definition 50. $\pi_L(x) = \pi_L(p_n^2) + (x - p_n^2) \prod_{i=1}^n (1 - \frac{1}{p_i})$ for $p_n^2 \leq x < p_{n+1}^2$. □

We note that the graph of $\pi_L(x)$ in the interval (p_n^2, p_{n+1}^2) for $n \geq 1$ is now a straight line with gradient $\prod_{i=1}^n (1 - \frac{1}{p_i})$, as illustrated in §22.G., Fig.5 where we defined $\pi_L(x)$ equivalently by:

$$\pi_L(x) = (x - p_n^2) \prod_{i=1}^n (1 - \frac{1}{p_i}) + \sum_{j=1}^{n-1} (p_{j+1}^2 - p_j^2) \prod_{i=1}^j (1 - \frac{1}{p_i}) + 2$$

22.B.g. The functions $\pi_L(x)/\frac{x}{\log_e x}$ and $\pi_H(x)/\frac{x}{\log_e x}$

We consider next the function $\pi_L(x)/\frac{x}{\log_e x}$ in the interval (p_n^2, p_{n+1}^2) :

$$\pi_L(x)/\frac{x}{\log_e x} = (\pi_L(p_n^2) + (x - p_n^2) \prod_{i=1}^n (1 - \frac{1}{p_i}))/\frac{x}{\log_e x}$$

This now yields the derivative $(\pi_L(x) \cdot \frac{\log_e x}{x})'$ in the interval (p_n^2, p_{n+1}^2) as:

$$\begin{aligned} &\pi_L(x) \cdot (\frac{\log_e x}{x})' + (\pi_L(x))' \cdot \frac{\log_e x}{x} \\ &(\pi_L(p_n^2) + (x - p_n^2) \prod_{i=1}^n (1 - \frac{1}{p_i})) \cdot (\frac{\log_e x}{x})' + (\pi_L(p_n^2) + (x - p_n^2) \prod_{i=1}^n (1 - \frac{1}{p_i}))' \cdot \frac{\log_e x}{x} \\ &(\pi_L(p_n^2) + (x - p_n^2) \prod_{i=1}^n (1 - \frac{1}{p_i})) \cdot (\frac{1}{x^2} - \frac{\log_e x}{x^2}) + (\prod_{i=1}^n (1 - \frac{1}{p_i})) \cdot \frac{\log_e x}{x} \end{aligned}$$

⁵²⁴Fig.6 in §22.G. compares the values of $\pi(n)$ and $\pi_L(n)$ for $4 \leq n \leq 3000$.

Since $p_n^2 \leq x < p_{n+1}^2$, by Mertens'⁵²⁵ and Chebyshev's Theorems we can express the above as:

$$\begin{aligned} &\sim (\pi_L(p_n^2) + \frac{e^{-\gamma}(x-p_n^2)}{\log_e n}) \cdot (\frac{1}{x^2} - \frac{\log_e x}{x^2}) + \frac{e^{-\gamma} \cdot \log_e x}{x \cdot \log_e n} \\ &\sim (\frac{\pi_L(p_n^2)}{x} + \frac{e^{-\gamma}}{\log_e n} (1 - \frac{p_n^2}{x})) \cdot \frac{(1 - \log_e x)}{x} + \frac{e^{-\gamma} \cdot \log_e x}{x \cdot \log_e n} \\ &\sim (\frac{\pi_L(p_n^2)}{p_n^2} \cdot \frac{p_n^2}{x} + \frac{e^{-\gamma}}{\log_e n} (1 - \frac{p_n^2}{x})) \cdot \frac{(1 - 2 \cdot \log_e p_n)}{p_n^2} + \frac{2 \cdot e^{-\gamma} \cdot \log_e p_n}{p_n^2 \cdot \log_e n} \end{aligned}$$

Since each term $\rightarrow 0$ as $n \rightarrow \infty$, we conclude that the function $\pi_L(x)/\frac{x}{\log_e x}$ does not oscillate but tends to a limit as $x \rightarrow \infty$ since:

Lemma 22.36. $(\pi_L(x)/\frac{x}{\log_e x})' \in o(1)$. □

We further conclude that:

Corollary 22.37. $\pi_L(n) = \sum_{j=1}^n \prod_{i=1}^{\pi(\sqrt{j})} (1 - \frac{1}{p_i}) \sim a \cdot \frac{n}{\log_e n}$ for some constant a . □

We note that $a > 2 \cdot e^{-\gamma}$ ⁵²⁶, since $\prod_{i=1}^{\pi(\sqrt{j})} (1 - \frac{1}{p_i}) \geq \prod_{i=1}^{\pi(\sqrt{n})} (1 - \frac{1}{p_i})$ for all $1 \leq j \leq n$, and it follows from Definition 22.28 that:

Corollary 22.38. $\pi_H(n) = n \cdot \prod_{i=1}^{\pi(\sqrt{n})} (1 - \frac{1}{p_i}) \sim 2 \cdot e^{-\gamma} \cdot \frac{n}{\log_e n}$ ⁵²⁷. □

22.C. Primes in an arithmetic progression

The significance of the distinction between algorithmic *verifiability* and algorithmic *computability*, which yields §22.B.b., Corollary 22.25, is further seen in the following, elementary, proof of Dirichlet's Theorem—which is the assertion that if a and d are co-prime and $1 \leq a < d$, then the arithmetic progression $a + m \cdot d$, where $m \geq 1$, contains an infinitude of (Dirichlet) primes.

We first note that, by §22.B.b., Lemma 22.22:

Lemma 22.39. *If p_i and p_j are two primes where $i \neq j$ then, for any $n \geq 2$, $\alpha, \beta \geq 1$, we have:*

$$\mathbb{P}((r_{p_i^\alpha}(n) = u) \cap (r_{p_j^\beta}(n) = v)) = \mathbb{P}(r_{p_i^\alpha}(n) = u) \cdot \mathbb{P}(r_{p_j^\beta}(n) = v)$$

where $p_i^\alpha > u \geq 0$ and $p_j^\beta > v \geq 0$. □

Now, the $p_i^\alpha \cdot p_j^\beta$ numbers $d \cdot p_i^\alpha + c \cdot p_j^\beta$, where $p_i^\alpha > c \geq 0$ and $p_j^\beta > d \geq 0$, are all incongruent and form a complete system of residues⁵²⁸ mod $(p_i^\alpha \cdot p_j^\beta)$. It follows that $n = a \cdot p_i^\alpha$ —whence p_i^α divides n —and also $n = b \cdot p_j^\beta$ —whence p_j^β divides n —if, and only if $r_{p_i^\alpha}(n) = r_{p_j^\beta}(n) = 0$.

If $u = 0$ and $v = 0$ in Lemma 22.39, so that both p_i and p_j are prime divisors of n , we immediately conclude that:

$$\mathbb{P}((r_{p_i^\alpha}(n) = 0) \cap (r_{p_j^\beta}(n) = 0)) = \frac{1}{p_i^\alpha \cdot p_j^\beta}$$

⁵²⁵[HW60], Theorem 429, p.351.

⁵²⁶Where $2 \cdot e^{-\lambda} \approx 1.12292 \dots$; [?], p.13.

⁵²⁷By Mertens' Theorem; since $\log_e \pi(\sqrt{n}) \sim (\log_e \sqrt{n} - \log_e \log_e \sqrt{n})$ by the Prime Number Theorem.

⁵²⁸[HW60], p.52, Theorem 59.

$$\mathbb{P}(r_{p_i^\alpha}(n) = 0) \cdot \mathbb{P}(r_{p_j^\beta}(n) = 0) = \left(\frac{1}{p_i^\alpha}\right) \left(\frac{1}{p_j^\beta}\right).$$

Corollary 22.40. $\mathbb{P}((r_{p_i^\alpha}(n) = 0) \cap (r_{p_j^\beta}(n) = 0)) = \mathbb{P}(r_{p_i^\alpha}(n) = 0) \cdot \mathbb{P}(r_{p_j^\beta}(n) = 0).$ □

It also immediately follows that §22.B.b., Corollary 22.25, can be extended to prime powers in general:

Theorem 22.41. *For any two primes $p \neq q$ and natural numbers $n, \alpha, \beta \geq 1$, whether or not p^α divides n is independent of whether or not q^β divides n .* □

22.C.a. The asymptotic density of Dirichlet integers

We note next that:

Lemma 22.42. *For any co-prime natural numbers $1 \leq a < d = q_1^{\alpha_1} \cdot q_2^{\alpha_2} \dots q_k^{\alpha_k}$ where:*

$$q_1 < q_2 < \dots < q_k \text{ are primes and } \alpha_1, \alpha_2 \dots \alpha_k \geq 1 \text{ are natural numbers;}$$

the natural number n is of the form $a + m \cdot d$ for some natural number $m \geq 1$ if, and only if:

$$a + r_{q_i^{\alpha_i}}(n) \equiv 0 \pmod{q_i^{\alpha_i}} \text{ for all } 1 \leq i \leq k$$

where $0 \leq r_i(n) < i$ is defined for all $i > 1$ by:

$$n + r_i(n) \equiv 0 \pmod{i} .$$

Proof. First, if n is of the form $a + m \cdot d$ for some natural number $m \geq 1$, where $1 \leq a < d = q_1^{\alpha_1} \cdot q_2^{\alpha_2} \dots q_k^{\alpha_k}$, then:

$$\begin{aligned} n &\equiv a \pmod{d} \\ \text{and : } n + r_{q_i^{\alpha_i}}(n) &\equiv 0 \pmod{q_i^{\alpha_i}} \text{ for all } 1 \leq i \leq k \\ \text{whence : } a + r_{q_i^{\alpha_i}}(n) &\equiv 0 \pmod{q_i^{\alpha_i}} \text{ for all } 1 \leq i \leq k \end{aligned}$$

Second:

$$\begin{aligned} \text{If : } a + r_{q_i^{\alpha_i}}(n) &\equiv 0 \pmod{q_i^{\alpha_i}} \text{ for all } 1 \leq i \leq k \\ \text{and : } n + r_{q_i^{\alpha_i}}(n) &\equiv 0 \pmod{q_i^{\alpha_i}} \text{ for all } 1 \leq i \leq k \\ \text{then : } n - a &\equiv 0 \pmod{q_i^{\alpha_i}} \text{ for all } 1 \leq i \leq k \\ \text{whence : } n &\equiv a \pmod{d} \end{aligned}$$

The Lemma follows. □

By §22.B.a., Lemma 22.18, it immediately follows that:

Corollary 22.43. *The probability that $a + r_{q_i^{\alpha_i}}(n) \equiv 0 \pmod{q_i^{\alpha_i}}$ for any $1 \leq i \leq k$ is $\frac{1}{q_i^{\alpha_i}}$.* □

By §22.C., Lemma 22.39, and §22.C., Theorem 22.41, it further follows that:

Corollary 22.44. *The joint probability that $a + r_{\alpha_i}(n) \equiv 0 \pmod{q_i^{\alpha_i}}$ for all $1 \leq i \leq k$ is $\prod_{i=1}^k \frac{1}{q_i^{\alpha_i}}$. \square*

We conclude by Lemma 22.42 that:

Corollary 22.45. *The asymptotic density of Dirichlet integers, defined as numbers of the form $a + m.d$ for some natural number $m \geq 1$ which are not divisible by any specified set of primes $\mathbb{R} = \{r_1, r_2, \dots, r_l\}$, where $1 \leq a < d = q_1^{\alpha_1} \cdot q_2^{\alpha_2} \dots q_k^{\alpha_k}$ is:*

$$\prod_{i=1}^k \frac{1}{q_i^{\alpha_i}} \cdot \prod_{r \in \mathbb{R} \ \& \ r \neq q_i} \left(1 - \frac{1}{r}\right).$$

Proof. Since a, d are co-prime, we have by Lemma 22.42 that if n is of the form $a + m.d$ for some natural number $m \geq 1$, where $1 \leq a < d = q_1^{\alpha_1} \cdot q_2^{\alpha_2} \dots q_k^{\alpha_k}$, we have that:

$$\begin{aligned} n &\equiv a \pmod{q_i} && \text{for all } 1 \leq i \leq k \\ \text{whilst: } n + r_i(n) &\equiv 0 \pmod{i} && \text{for all } 1 \leq i \\ \text{whence: } a + r_{q_i}(n) &\equiv 0 \pmod{q_i} && \text{for all } 1 \leq i \leq k \\ r_{q_i}(n) &\neq 0 && \text{for all } 1 \leq i \leq k \\ \text{and: } q_i &\nmid n && \text{for all } 1 \leq i \leq k \end{aligned}$$

Hence, if n is of the form $a + m.d$ for some natural number $m \geq 1$, where $1 \leq a < d = q_1^{\alpha_1} \cdot q_2^{\alpha_2} \dots q_k^{\alpha_k}$ and $(a, d) = 1$, the probability that $q_i \nmid n$ for all $1 \leq i \leq k$ is 1.

By §22.B.a., Lemma 22.26, §22.B.a., Lemma 22.27 and §22.C., Theorem 22.41, the asymptotic density of Dirichlet numbers of the form $a + m.d$ which are not divisible by any specified set of primes $\mathbb{R} = \{r_1, r_2, \dots, r_l\}$ is thus:

$$\prod_{i=1}^k \frac{1}{q_i^{\alpha_i}} \cdot \prod_{r \in \mathbb{R} \ \& \ r \neq q_i} \left(1 - \frac{1}{r}\right)$$

The Corollary follows. \square

Corollary 22.46. *The expected number of Dirichlet integers in any interval (a, b) is:*

$$(b - a) \prod_{i=1}^k \frac{1}{q_i^{\alpha_i}} \cdot \prod_{i=1}^k \left(1 - \frac{1}{q_i}\right)^{-1} \cdot \prod_{r \in \mathbb{R}} \left(1 - \frac{1}{r}\right). \quad \square$$

22.C.b. An elementary proof of Dirichlet's Theorem

Since n is a prime if, and only if, it is not divisible by any prime $p \leq \sqrt{n}$, it follows that the number $\pi_{(a,d)}(n)$ of Dirichlet primes, of the form $a + m.d$ for some natural number $m \geq 1$ and $1 \leq a < d = q_1^{\alpha_1} \cdot q_2^{\alpha_2} \dots q_k^{\alpha_k}$, that are less than or equal to any $n \geq q_k^2$ is cumulatively approximated by the Dirichlet prime counting function:

Definition 51. $\pi_D(n) = \sum_{l=1}^n \left(\prod_{i=1}^k \frac{1}{q_i^{\alpha_i}} \cdot \prod_{i=1}^k \left(1 - \frac{1}{q_i}\right)^{-1} \cdot \prod_{j=1}^{\pi(\sqrt{l})} \left(1 - \frac{1}{p_j}\right) \right).$

We conclude that:

Lemma 22.47. $\pi_{(a,d)}(n) \approx \pi_D(n) \rightarrow \infty$ as $n \rightarrow \infty$.

Proof. If a, d are co-prime and $1 \leq a < d = q_1^{\alpha_1} \cdot q_2^{\alpha_2} \dots q_k^{\alpha_k}$, we have for any $n \geq q_k^2$:

$$\begin{aligned} \pi_D(n) &= \sum_{l=1}^n \left(\prod_{i=1}^k \frac{1}{q_i} \cdot \prod_{i=1}^k \left(1 - \frac{1}{q_i}\right)^{-1} \cdot \prod_{j=1}^{\pi(\sqrt{l})} \left(1 - \frac{1}{p_j}\right) \right) \\ &= \prod_{i=1}^k \frac{1}{q_i} \cdot \prod_{i=1}^k \left(1 - \frac{1}{q_i}\right)^{-1} \cdot \sum_{l=1}^n \prod_{j=1}^{\pi(\sqrt{l})} \left(1 - \frac{1}{p_j}\right) \\ &\geq \prod_{i=1}^k \frac{1}{q_i} \cdot \prod_{i=1}^k \left(1 - \frac{1}{q_i}\right)^{-1} \cdot n \cdot \prod_{j=1}^{\pi(\sqrt{n})} \left(1 - \frac{1}{p_j}\right) \end{aligned}$$

Since, by Mertens' Theorem, $\prod_{p \leq x} \left(1 - \frac{1}{p}\right) \sim \frac{e^{-\lambda}}{\log_e x}$, we have that:

$$n \cdot \prod_{j=1}^{\pi(\sqrt{n})} \left(1 - \frac{1}{p_j}\right) \sim \frac{2e^{-\gamma}n}{\log_e(n)} \rightarrow \infty \text{ as } n \rightarrow \infty.$$

the lemma follows. □

Since $p_{n+1}^2 - p_n^2 \rightarrow \infty$ as $n \rightarrow \infty$, we conclude further that:

Theorem 22.48. (Dirichlet's Theorem) *There are an infinity of primes in any arithmetic progression $a + m.d$ where $(a, d) = 1$ ⁵²⁹.* □

22.D. An elementary proof that there are infinite twin-primes

The significance of §22.B.b., Corollary 22.25, and of *evidence-based* reasoning, for the theory of numbers is further highlighted by the following, elementary, proof that there are an infinitude of twin primes.

We define $\pi_2(n)$ as the number of integers $p \leq n$ such that both p and $p + 2$ are prime. In order to estimate $\pi_2(n)$, we first define:

Definition 52. *An integer n is a $\mathbb{T}\mathbb{W}(k)$ integer if, and only if, $r_{p_i}(n) \neq 0$ and $r_{p_i}(n) \neq 2$ for all $1 \leq i \leq k$, where $0 \leq r_i(n) < i$ is defined for all $i > 1$ by:*

$$n + r_i(n) \equiv 0 \pmod{i}.$$

We note that:

Lemma 22.49. *If n is a $\mathbb{T}\mathbb{W}(k)$ integer, then both n and $n + 2$ are not divisible by any of the first k primes $\{p_1, p_2, \dots, p_k\}$.*

Proof. The lemma follows immediately from Definition 52 and Lemma 22.17. □

Since each residue $r_i(n)$ cycles over the i values $(i - 1, i - 2, \dots, 0)$, these values are all incongruent and form a complete system of residues *mod* i .

It thus follows from Definition 52 that the asymptotic density of $\mathbb{T}\mathbb{W}(k)$ integers over the set of natural numbers is:

Lemma 22.50. $\mathbb{D}(\mathbb{T}\mathbb{W}(k)) = \prod_{i=2}^k \left(1 - \frac{2}{p_i}\right)$. □

We also have that:

⁵²⁹Compare [HW60], p.13, Theorem 15*.

Lemma 22.51. *If $p_k^2 \leq n \leq p_{k+1}^2$ is a $\mathbb{TW}(k)$ integer, then n is a prime and either $n + 2$ is also a prime, or $n + 2 = p_{k+1}^2$.*

Proof. By Definition 52 and §22.B., Definition 48:

$$\begin{aligned} r_{p_i}(n) &\neq 2 \text{ for all } 1 \leq i \leq k \\ n + 2 &\neq \lambda \cdot p_i \text{ for all } 1 \leq i \leq k, \lambda \geq 1 \end{aligned}$$

Hence n is prime; and either $n + 2$ is divisible by p_{k+1} , in which case $n + 2 = p_{k+1}^2$, or it is a prime. \square

If we define $\pi_{\mathbb{TW}(k)}(n)$ as the number of $\mathbb{TW}(k)$ integers $\leq n$, by Lemma 22.50 the expected number of $\mathbb{TW}(k)$ integers in any interval (a, b) is given by:

Lemma 22.52. $\pi_{\mathbb{TW}(k)}(b) - \pi_{\mathbb{TW}(k)}(a) \approx (b - a) \prod_{i=2}^k (1 - \frac{2}{p_i})$. \square

Since n is a prime if, and only if, it is not divisible by any prime $p \leq \sqrt{n}$, it follows from Lemma 22.51 that $\pi_{\mathbb{TW}(k)}(p_{k+1}^2) - \pi_{\mathbb{TW}(k)}(p_k^2)$ is at most one less than the number of twin-primes in the interval $(p_{k+1}^2 - p_k^2)$.

Lemma 22.53. $\pi_{\mathbb{TW}(k)}(p_{k+1}^2) - \pi_{\mathbb{TW}(k)}(p_k^2) + 1 \geq \pi_2(p_{k+1}^2) - \pi_2(p_k^2) \geq \pi_{\mathbb{TW}(k)}(p_{k+1}^2) - \pi_{\mathbb{TW}(k)}(p_k^2)$ \square

Now, by Lemma 22.52 the expected number of $\mathbb{TW}(k)$ integers in the interval $(p_{k+1}^2 - p_k^2)$ is given by:

Lemma 22.54. $\pi_{\mathbb{TW}(k)}(p_{k+1}^2) - \pi_{\mathbb{TW}(k)}(p_k^2) \approx (p_{k+1}^2 - p_k^2) \prod_{i=2}^k (1 - \frac{2}{p_i})$. \square

We conclude that the number $\pi_2(p_{k+1}^2)$ of twin primes $\leq p_{k+1}^2$ is given by the cumulative, non-heuristic, approximation:

Lemma 22.55. $\sum_{j=1}^k (\pi_2(p_{j+1}^2) - \pi_2(p_j^2)) = \pi_2(p_{k+1}^2) \approx \sum_{j=1}^k (p_{j+1}^2 - p_j^2) \prod_{i=2}^j (1 - \frac{2}{p_i})$. \square

We further conclude that:

Theorem 22.56. (Twin Prime Theorem) $\pi_2(n) \rightarrow \infty$ as $n \rightarrow \infty$.

Proof. We have that, for $k \geq 2$:

$$\begin{aligned} \sum_{j=1}^k (p_{j+1}^2 - p_j^2) \prod_{i=2}^j (1 - \frac{2}{p_i}) &= \sum_{j=9}^{p_{k+1}^2} \prod_{i=2}^{\pi(\sqrt{j})-1} (1 - \frac{2}{p_i}) \\ &\geq (p_{k+1}^2 - 9) \cdot \prod_{i=2}^k (1 - \frac{2}{p_i}) \\ &\geq (p_{k+1}^2 - 9) \cdot \prod_{i=2}^k (1 - \frac{1}{p_i}) (1 - \frac{1}{(p_i-1)}) \\ &\geq (p_{k+1}^2 - 9) \cdot \prod_{i=2}^k (1 - \frac{1}{p_i}) (1 - \frac{1}{p_{i-1}}) \\ &\geq (p_{k+1}^2 - 9) \cdot \prod_{i=2}^k (1 - \frac{1}{p_{i-1}})^2 \\ &\geq (p_{k+1}^2 - 9) \cdot \prod_{i=1}^k (1 - \frac{1}{p_i})^2 \end{aligned}$$

Now, by Mertens' Theorem, we have that:

$$(p_{k+1}^2 - 9) \cdot \prod_{i=1}^k (1 - \frac{1}{p_i})^2 \sim (p_{k+1}^2 - 9) \cdot (\frac{e^{-\gamma}}{\log_e k})^2$$

$$\rightarrow \infty \text{ as } n \rightarrow \infty$$

The theorem follows by Lemma 22.55. □

22.D.a. The Generalised Prime Counting Function: $\sum_{j=1}^n \prod_{i=a}^{\pi(\sqrt{j})} (1 - \frac{b}{p_i})$

We note that the argument of §22.D., Theorem 22.56, is a special case of the behaviour as $n \rightarrow \infty$ of the Generalised Prime Counting Function $\sum_{j=1}^n \prod_{i=a}^{\pi(\sqrt{j})} (1 - \frac{b}{p_i})$, which estimates the number of integers $\leq n$ such that there are b values that cannot occur amongst the residues $r_{p_i}(n)$ for $a \leq i \leq \pi(\sqrt{j})$ ⁵³⁰:

Theorem 22.57. (Generalised Prime Counting Theorem) $\sum_{j=1}^n \prod_{i=a}^{\pi(\sqrt{j})} (1 - \frac{b}{p_i}) \rightarrow \infty$ as $n \rightarrow \infty$ if $p_a > b \geq 1$.

Proof. For $p_a > b \geq 1$, we have that:

$$\begin{aligned} \sum_{j=1}^n \prod_{i=a}^{\pi(\sqrt{j})} (1 - \frac{b}{p_i}) &\geq \sum_{j=p_a^2}^n \prod_{i=a}^{\pi(\sqrt{j})} (1 - \frac{b}{p_i}) \\ &\geq \sum_{j=p_a^2}^n \prod_{i=a}^{\pi(\sqrt{n})} (1 - \frac{b}{p_i}) \\ &\geq (n - p_a^2) \cdot \prod_{i=a}^{\pi(\sqrt{n})} (1 - \frac{b}{p_i}) \\ &\geq (n - p_a^2) \cdot \prod_{i=a}^n (1 - \frac{b}{p_i}) \end{aligned}$$

The theorem follows if:

$$\log_e(n - p_a^2) + \sum_{i=a}^n \log_e(1 - \frac{b}{p_i}) \rightarrow \infty$$

(i) We note first the standard result for $|x| < 1$ that:

$$\log_e(1 - x) = - \sum_{m=1}^{\infty} \frac{x^m}{m}$$

For any $p_i > b \geq 1$, we thus have:

$$\log_e(1 - \frac{b}{p_i}) = - \sum_{m=1}^{\infty} \frac{(b/p_i)^m}{m} = -\frac{b}{p_i} - \sum_{m=2}^{\infty} \frac{(b/p_i)^m}{m}$$

Hence:

$$\sum_{i=a}^n \log_e(1 - \frac{b}{p_i}) = - \sum_{i=a}^n (\frac{b}{p_i}) - \sum_{i=a}^n (\sum_{m=2}^{\infty} \frac{(b/p_i)^m}{m})$$

(ii) We note next that, for all $i \geq a$:

$$c < (1 - \frac{b}{p_a}) \rightarrow c < (1 - \frac{b}{p_i})$$

⁵³⁰Thus $b = 1$ yields a non-heuristic estimate for the number $\pi(n)$ of primes $\leq n$, and $b = 2$ an estimate for the number of TW primes (Definition 52) $\leq n$. We note that the Prime Number Theorem $\pi(n) \sim n/\log_e n$ suggests that $\pi(n)$ can have various non-heuristic estimations for finite values of n .

It follows for any such c that:

$$\sum_{m=2}^{\infty} \frac{(b/p_i)^m}{m} \leq \sum_{m=2}^{\infty} \left(\frac{b}{p_i}\right)^m = \frac{(b/p_i)^2}{1-b/p_i} \leq \frac{b^2}{c.p_i^2}$$

Since:

$$\sum_{i=1}^{\infty} \frac{1}{p_i^2} = O(1)$$

it further follows that:

$$\sum_{i=a}^n \left(\sum_{m=2}^{\infty} \frac{(b/p_i)^m}{m}\right) \leq \sum_{i=a}^n \left(\frac{b^2}{c.p_i^2}\right) = O(1)$$

(iii) From the standard result⁵³¹:

$$\sum_{p \leq x} \frac{1}{p} = \log_e \log_e x + O(1) + o(1)$$

it then follows that:

$$\begin{aligned} \sum_{i=a}^n \log_e \left(1 - \frac{b}{p_i}\right) &\geq -\sum_{i=a}^n \left(\frac{b}{p_i}\right) - O(1) \\ &\geq -b.(\log_e \log_e n + O(1) + o(1)) - O(1) \end{aligned}$$

The theorem follows since:

$$\log_e(n - p_a^2) - b.(\log_e \log_e n + O(1) + o(1)) - O(1) \rightarrow \infty$$

and so:

$$\log_e(n - p_a^2) + \sum_{i=a}^n \log_e \left(1 - \frac{b}{p_i}\right) \rightarrow \infty$$

□

22.E. The functions $\pi(x)$ and $\frac{x}{\log_e x}$: A historical perspective

Fig.1: The asymptotic behaviour of the primes

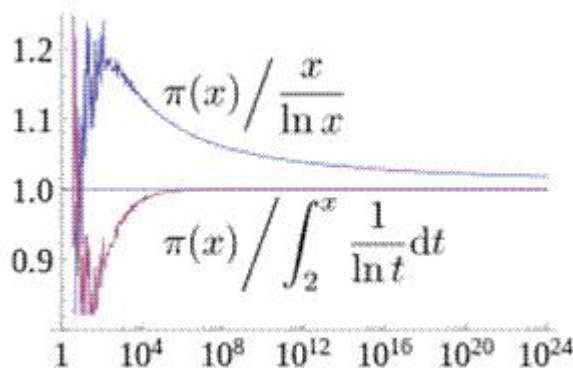

Fig.1: Graph showing ratio of the prime-counting function $\pi(x)$ to two of its approximations, $\frac{x}{\ln x}$ and $Li(x)$. As x increases (note x axis is logarithmic), both ratios tend towards 1. The ratio for $\frac{x}{\ln x}$ converges from above very slowly, while the ratio for $Li(x)$ converges more quickly from below.⁵³²

⁵³¹[HW60], p.351, Theorem 427.

⁵³²cf. [Prime Number Theorem](#). (2014, June 10). In Wikipedia. Retrieved 09:53, July 9, 2014.

We note that Adrien-Marie Legendre and Carl Friedrich Gauss are reported⁵³³ to have independently conjectured in 1796 that, if $\pi(x)$ denotes the number of primes less than x , then $\pi(x)$ is asymptotically equivalent to $\frac{x}{\log_e x}$.

Around 1848/1850, Pafnuty Lvovich Chebyshev proved that $\pi(x) \asymp \frac{x}{\log_e x}$, and confirmed that if $\pi(x)/\frac{x}{\log_e x}$ has a limit, then it must be 1⁵³⁴.

The question of whether $\pi(x)/\frac{x}{\log_e x}$ has a limit at all, or whether it oscillates, was answered—it has a limit—first by Jacques Hadamard and Charles Jean de la Vallée Poussin independently in 1896, using advanced argumentation involving functions of a complex variable⁵³⁵; and again independently by Paul Erdős and Atle Selberg⁵³⁶ in 1949/1950, using only elementary—but still abstruse—methods without involving functions of a complex variable.

22.E.a. A better heuristic approximation to $\pi(x)$: The integral $Li(x)$

Fig.2: The distribution of the primes

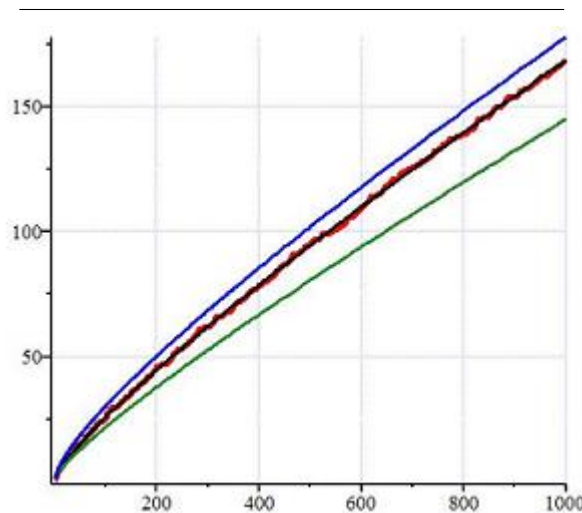

Fig.2: The above graph compares the actual number $\pi(x)$ (red) of primes $\leq x$ with the distribution of primes as estimated variously by the functions $Li(x)$ (blue), $R(x)$ (black), and $\frac{x}{\log_e x}$ (green), where $R(x)$ is Riemann’s function $\sum_{n=1}^{\infty} \frac{\mu(n)}{(n)} li(x^{1/n})$.⁵³⁷

We also note that, reportedly⁵³⁸:

“In a handwritten note on a reprint of his 1838 paper ‘Sur l’usage des séries infinies dans la théorie des nombres’, which he mailed to Carl Friedrich Gauss, Peter Gustav Lejeune Dirichlet conjectured (under a slightly different form appealing to a series rather than an integral) that an even better approximation to $\pi(x)$ is given by the offset logarithmic integral $Li(x)$ defined by:

$$Li(x) = \int_2^x \frac{1}{\log_e t} \cdot dt = li(x) - li(2).$$
⁵³⁹

⁵³³cf. **Prime Number Theorem**. (2014, June 10). In Wikipedia. Retrieved 09:53, July 9, 2014; see also [Grn95].

⁵³⁴[Dic52], p.439; see also [HW60], p.9, Theorem 7 and p.345, §22.4 for a proof of Chebychev’s Theorem.

⁵³⁵[Dic52], p.439; see also [Ti51], Chapter III, p.8 for details of Hadamard’s and de la Vallée Poussin’s proofs of the Prime Number Theorem.

⁵³⁶See [HW60], p.360, Theorem 433 for a proof of Selberg’s Theorem.

⁵³⁷cf. **How Many Primes Are There?** In *The Prime Pages*. Retrieved 10:29, September 27, 2015.

⁵³⁸cf. **Prime Number Theorem**. (2014, June 10). In Wikipedia. Retrieved 09:53, July 9, 2014.

⁵³⁹Where $li(x) = \int_0^x \frac{1}{\log_e t} \cdot dt$.

We further note that in 1889 Jean de la Vallée Poussin proved⁵⁴⁰ (cf. Fig.1):

$$\text{"...that } Li(x) \text{ represents } \pi(x) \text{ more exactly than } \frac{x}{\log_e x} \text{ and its remaining approximations } \frac{x}{\log_e x} + \frac{x}{\log_e^2 x} + \dots + \frac{(m-1)!x}{\log_e^m x} \text{"}$$

We note that all the known approximations of $\pi(n)$ for finite values of n are derived from real-valued functions that are only known to be asymptotic to $\pi(x)$, such as $\frac{x}{\log_e x}$, $Li(x)$ and Riemann's function $R(x) = \sum_{n=1}^{\infty} \frac{\mu(n)}{(n)} li(x^{1/n})$.

Consequently, the degree of approximation for finite values of n is determined only heuristically, by conjecturing upon an error term in the asymptotic relation that can be seen to yield the closest approximation upon comparison with the actual values of $\pi(n)$ within a finite range of values of n (eg. Fig.2, where $n = 1000$).

22.F. A non-heuristic cumulative approximation of $\pi(n)$ for *all* values of n

The question arises: Is there a function which approximates $\pi(n)$ non-heuristically for all values of n ?

In this investigation we shall address the above question by showing that the asymptotic density⁵⁴¹ of integers co-prime to the first k primes, p_1, p_2, \dots, p_k , over the set of natural numbers, is:

$$\prod_{i=1}^k \left(1 - \frac{1}{p_i}\right);$$

and that the expected number of such integers in the interval (a, b) is thus:

$$(b - a) \prod_{i=1}^k \left(1 - \frac{1}{p_i}\right),$$

where the binomial standard deviation of the expected number of integers co-prime to p_1, p_2, \dots, p_k in any interval of length $(b - a)$ is:

$$\sqrt{(b - a) \prod_{i=1}^k \left(1 - \frac{1}{p_i}\right) \left(1 - \prod_{i=1}^k \left(1 - \frac{1}{p_i}\right)\right)}.$$

22.G. Expected number of primes in the interval $(p_{\pi(\sqrt{n})}^2, p_{\pi(\sqrt{n})+1}^2)$

Taking (a, b) as the interval $(p_{\pi(\sqrt{n})}^2, p_{\pi(\sqrt{n})+1}^2)$, we conclude, for instance, that cumulative non-heuristic estimates of the number $\pi(p_{\pi(\sqrt{n})+1}^2)$ of primes less than $p_{\pi(\sqrt{n})+1}^2$ are given by $\pi_H(n) = \sum_{j=1}^n \prod_{i=1}^{\pi(\sqrt{j})} \left(1 - \frac{1}{p_i}\right) = n \cdot \prod_{i=1}^{\pi(\sqrt{n})} \left(1 - \frac{1}{p_i}\right)$ (green in Fig.6) and $\pi_L(n) = \sum_{j=1}^n \prod_{i=1}^{\pi(\sqrt{j})} \left(1 - \frac{1}{p_i}\right)$ (red in Fig.6), where:

(i) $\pi_H(p_{\pi(\sqrt{n})+1}^2) = p_{\pi(\sqrt{n})+1}^2 \prod_{i=1}^{\pi(\sqrt{n})} \left(1 - \frac{1}{p_i}\right)$ estimates $\pi(p_{\pi(\sqrt{n})+1}^2)$ with standard deviation:

$$p_{\pi(\sqrt{n})+1} \sqrt{\prod_{i=1}^{\pi(\sqrt{n})} \left(1 - \frac{1}{p_i}\right) \left(1 - \prod_{i=1}^{\pi(\sqrt{n})} \left(1 - \frac{1}{p_i}\right)\right)}.$$

⁵⁴⁰[Dic52], p.440.

⁵⁴¹cf. [Ste02], Chapter 2, p.10.

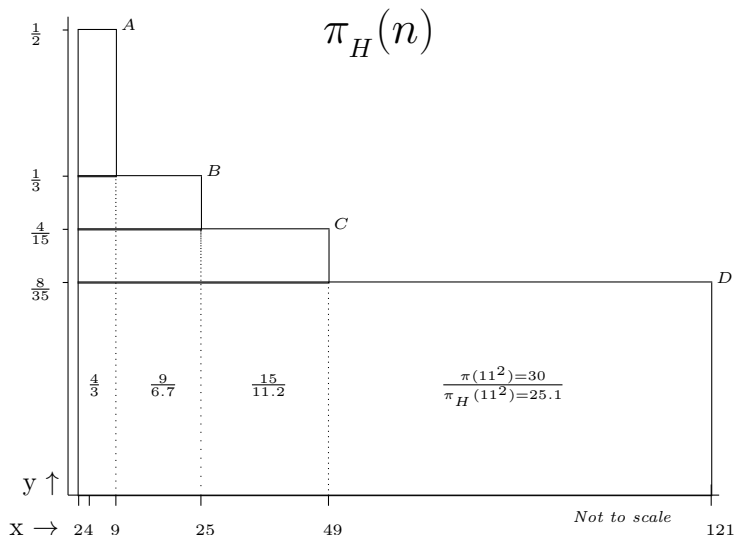

Fig.3: The overlapping rectangles A, B, C, D, \dots in fig. $\pi_H(n)$ represent $\pi_H(p_{j+1}^2) = p_{j+1}^2 \cdot \prod_{i=1}^j (1 - \frac{1}{p_i})$ for $j \geq 1$. Figures within each rectangle are the primes and estimated primes corresponding to the functions $\pi(n)$ and $\pi_H(n)$, respectively, within the interval $(1, p_{j+1}^2)$ for $j \geq 2$.

(ii) $\pi_L(p_{\pi(\sqrt{n})+1}^2) = \sum_{j=1}^{\pi(\sqrt{n})} \{(p_{j+1}^2 - p_j^2) \prod_{i=1}^j (1 - \frac{1}{p_i})\}$ estimates $\pi(p_{\pi(\sqrt{n})+1}^2)$ with cumulative standard deviation:

$$\sum_{j=1}^{\pi(\sqrt{n})} \sqrt{(p_{j+1}^2 - p_j^2) \prod_{i=1}^j (1 - \frac{1}{p_i}) (1 - \prod_{i=1}^j (1 - \frac{1}{p_i}))}.$$

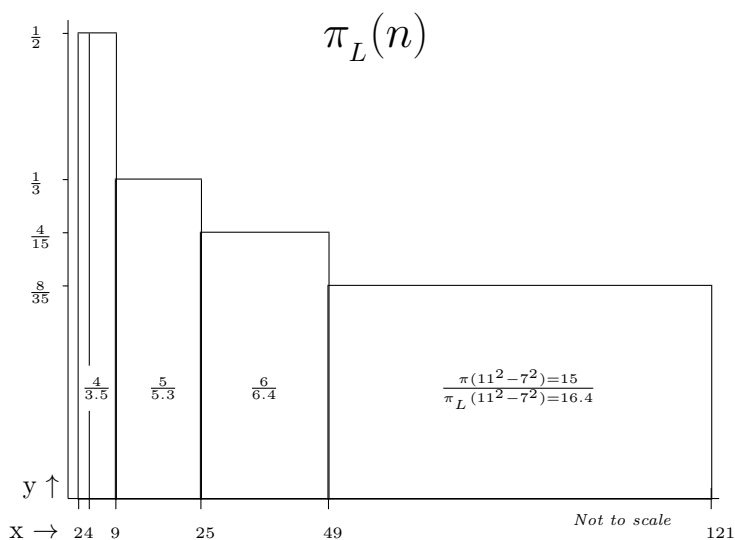

Fig.4: The rectangles in fig. $\pi_L(n)$ represent $(p_{j+1}^2 - p_j^2) \prod_{i=1}^j (1 - \frac{1}{p_i})$ for $j \geq 1$. Figures within each rectangle are the primes corresponding to the functions $\pi(n)$ and $\pi_L(n)$ within the interval (p_j^2, p_{j+1}^2) for $j \geq 2$. The area under the curve is $\pi_L(x) = (x - p_n^2) \prod_{i=1}^n (1 - \frac{1}{p_i}) + \sum_{j=1}^{n-1} (p_{j+1}^2 - p_j^2) \prod_{i=1}^j (1 - \frac{1}{p_i}) + 2$.

(iii) and, more generally, cumulative non-heuristic approximations of the number $\pi(n)$ of primes less than or equal to n are depicted in Fig.5 by the prime counting

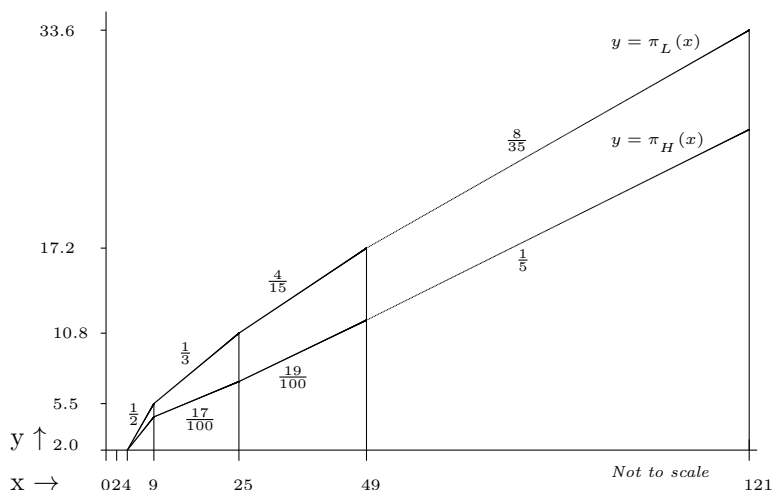

Fig.5: Graph of: (i) $y = \pi_H(x) = x \cdot \prod_{i=1}^{\pi(\sqrt{x})} (1 - \frac{1}{p_i})$; and of: (ii) $y = \pi_L(x) = (x - p_n^2) \prod_{i=1}^n (1 - \frac{1}{p_i}) + \sum_{j=1}^{n-1} (p_{j+1}^2 - p_j^2) \prod_{i=1}^j (1 - \frac{1}{p_i}) + 2$ in the interval (p_n^2, p_{n+1}^2) . Note that the gradient of $y = \pi_L(x)$ in the interval (p_n^2, p_{n+1}^2) is $\prod_{i=1}^n (1 - \frac{1}{p_i}) \rightarrow 0$.

functions $\pi_L(n)$ and $\pi_H(n)$ (cf. Fig.3 and Fig.4)⁵⁴²:

$$\pi(n) \approx \pi_H(n) = \sum_{j=1}^n \prod_{i=1}^{\pi(\sqrt{j})} (1 - \frac{1}{p_i}) = n \cdot \prod_{i=1}^{\pi(\sqrt{n})} (1 - \frac{1}{p_i}) \sim 2e^{-\lambda} \frac{n}{\log_e n}. \quad 543$$

$$\pi(n) \approx \pi_L(n) = \sum_{j=1}^n \prod_{i=1}^{\pi(\sqrt{j})} (1 - \frac{1}{p_i}) \sim a \cdot \frac{n}{\log_e n} \rightarrow \infty, \quad a > 2 \cdot e^{-\gamma} \approx 1.12292 \dots;$$

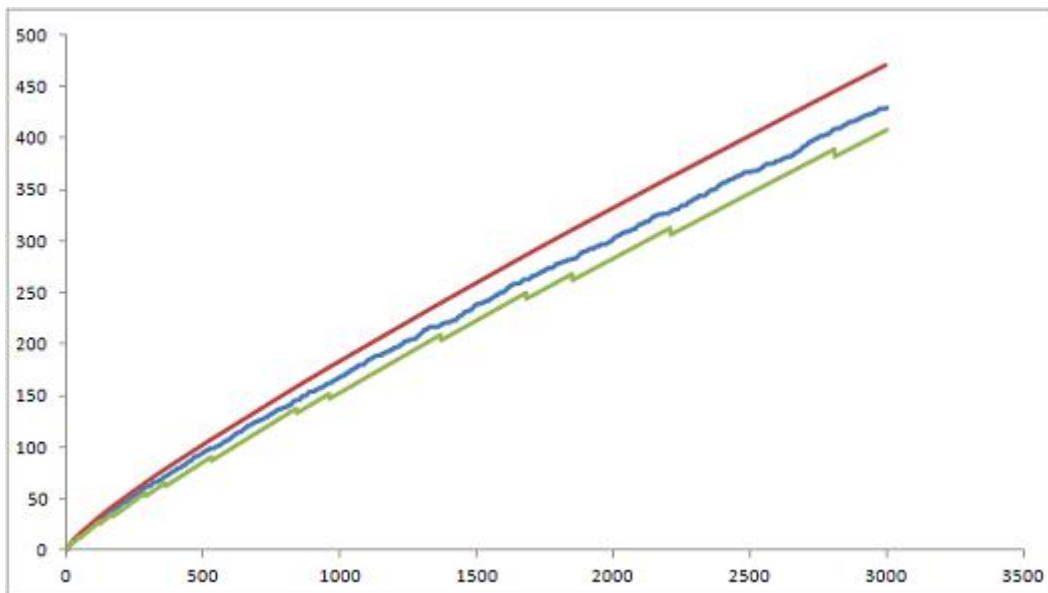

Fig.6: **An anomaly?**: The above graph compares the non-heuristically estimated values of $\pi_L(n) = \sum_{j=1}^n \prod_{i=1}^{\pi(\sqrt{j})} (1 - \frac{1}{p_i})$ (red) and $\pi_H(n) = \sum_{j=1}^n \prod_{i=1}^{\pi(\sqrt{j})} (1 - \frac{1}{p_i}) = n \cdot \prod_{i=1}^{\pi(\sqrt{n})} (1 - \frac{1}{p_i})$ (green) vs the actual values of $\pi(n)$ (blue) for $4 \leq n \leq 3000$.

Query 29. (a) Which is the least n such that $\pi_H(n) > \pi(n)$ (as entailed by the Prime Number Theorem)? (b) Which is the largest n such that $\pi(n) > \pi_H(n)$?

⁵⁴²Compare [HL23], pp.36-37.

⁵⁴³Query: Which is the least n such that $\pi_H(n) > \pi(n)$ (as implied by the Prime Number Theorem)?

22.H. Appendix I: The residue function $r_i(n)$

We graphically illustrate how the residues $r_i(n)$ (§22.B., Definition 48):

$$n + r_i(n) \equiv 0 \pmod{i} \text{ where } i > r_i(n) \geq 0$$

occur naturally as values of:

- A: The natural-number based residue sequences R_i ;
- B: The natural-number based residue sequences $E(n)$;

and as the output of:

- C: The natural-number based algorithm $E_{\mathbb{N}}$;
- D: The prime-number based algorithm $E_{\mathbb{P}}$;
- E: The prime-number based algorithm $E_{\mathbb{Q}}$.

A: The natural-number based sequences $R_i(n)$

Density: For instance, the residues $r_i(n)$ can be defined for all $n \geq 1$ as the values of the sequences $R_i(n)$, defined for all $i \geq 1$, as illustrated below in Fig.7⁵⁴⁴, where:

- For any $i \geq 2$, each sequence $R_i(n)$ cycles through the values $(i - 1, i - 2, \dots, 0)$ with period i ;
- For any $i \geq 2$ the asymptotic density—over the set of natural numbers—of the set $\{n\}$ of integers that are divisible by i is $\frac{1}{i}$; and the asymptotic density of integers that are not divisible by i is $\frac{i-1}{i}$.

Sequence:	R_1	R_2	R_3	R_4	R_5	R_6	R_7	R_8	R_9	R_{10}	R_{11}	$\dots R_n$
$n = 1$	0	1	2	3	4	5	6	7	8	9	10	$\dots n-1$
$n = 2$	0	0	1	2	3	4	5	6	7	8	9	$\dots n-2$
$n = 3$	0	1	0	1	2	3	4	5	6	7	8	$\dots n-3$
$n = 4$	0	0	2	0	1	2	3	4	5	6	7	$\dots n-4$
$n = 5$	0	1	1	3	0	1	2	3	4	5	6	$\dots n-5$
$n = 6$	0	0	0	2	4	0	1	2	3	4	5	$\dots n-6$
$n = 7$	0	1	2	1	3	5	0	1	2	3	4	$\dots n-7$
$n = 8$	0	0	1	0	2	4	6	0	1	2	3	$\dots n-8$
$n = 9$	0	1	0	3	1	3	5	7	0	1	2	$\dots n-9$
$n = 10$	0	0	2	2	0	2	4	6	8	0	1	$\dots n-10$
$n = 11$	0	1	1	1	4	1	3	5	7	9	0	$\dots n-11$
n	r_1	r_2	r_3	r_4	r_5	r_6	r_7	r_8	r_9	r_{10}	r_{11}	$\dots 0$

Fig.7: The natural-number based residue sequences $R_i(n)$

⁵⁴⁴For r_i read $r_i(n)$; for R_i read $R_i(n)$.

B: The natural-number based sequences $E(n)$

Primality: The residues $r_i(n)$ can also be viewed alternatively as values of the associated sequences, $E(n) = \{r_i(n) : i \geq 1\}$, defined for all $n \geq 1$, as illustrated below in Fig.8, where:

- The sequences $E(n)$ highlighted in red correspond to a prime⁵⁴⁵ p (since $r_i(p) \neq 0$ for $1 < i < p$) in the usual, linearly displayed, Eratosthenes sieve:

$E(1), E(2), E(3), E(4), E(5), E(6), E(7), E(8), E(9), E(10), E(11), \dots$

- The sequences highlighted in cyan identify a crossed out composite n (since $r_i(n) = 0$ for some $i < i < n$) in the usual, linearly displayed, Eratosthenes sieve.

- The ‘boundary’ residues $r_1(n) = 0$ and $r_n(n) = 0$ are identified in cyan.

Sequence:	R_1	R_2	R_3	R_4	R_5	R_6	R_7	R_8	R_9	R_{10}	R_{11}	...	R_n
$E(1)$:	0	1	2	3	4	5	6	7	8	9	10	...	n-1
$E(2)$:	0	0	1	2	3	4	5	6	7	8	9	...	n-2
$E(3)$:	0	1	0	1	2	3	4	5	6	7	8	...	n-3
$E(4)$:	0	0	2	0	1	2	3	4	5	6	7	...	n-4
$E(5)$:	0	1	1	3	0	1	2	3	4	5	6	...	n-5
$E(6)$:	0	0	0	2	4	0	1	2	3	4	5	...	n-6
$E(7)$:	0	1	2	1	3	5	0	1	2	3	4	...	n-7
$E(8)$:	0	0	1	0	2	4	6	0	1	2	3	...	n-8
$E(9)$:	0	1	0	3	1	3	5	7	0	1	2	...	n-9
$E(10)$:	0	0	2	2	0	2	4	6	8	0	1	...	n-10
$E(11)$:	0	1	1	1	4	1	3	5	7	9	0	...	n-11
...													
$E(n)$:	r_1	r_2	r_3	r_4	r_5	r_6	r_7	r_8	r_9	r_{10}	r_{11}	...	0
...													

Fig.8: The natural-number based residue sequences $E(n)$

C: The output of a natural-number based algorithm $E_{\mathbb{N}}$

We give below in Fig.9 the output for $1 \leq n \leq 11$ of a natural-number based algorithm $E_{\mathbb{N}}$ that computes the values $r_i(n)$ of the sequence $E_{\mathbb{N}}(n)$ for only $1 \leq i \leq n$ for any given n .

Divisors:	1	2	3	4	5	6	7	8	9	10	11	...	n	...
$E_{\mathbb{N}}(1)$:	0													
$E_{\mathbb{N}}(2)$:	0	0												
$E_{\mathbb{N}}(3)$:	0	1	0											
$E_{\mathbb{N}}(4)$:	0	0	2	0										
$E_{\mathbb{N}}(5)$:	0	1	1	3	0									
$E_{\mathbb{N}}(6)$:	0	0	0	2	4	0								
$E_{\mathbb{N}}(7)$:	0	1	2	1	3	5	0							
$E_{\mathbb{N}}(8)$:	0	0	1	0	2	4	6	0						
$E_{\mathbb{N}}(9)$:	0	1	0	3	1	3	5	7	0					
$E_{\mathbb{N}}(10)$:	0	0	2	2	0	2	4	6	8	0				
$E_{\mathbb{N}}(11)$:	0	1	1	1	4	1	3	5	7	9	0			

⁵⁴⁵Conventionally defined as integers that are not divisible by any smaller integer other than 1.

...
 $E_{\mathbb{N}}(n): r_1 r_2 r_3 r_4 r_5 r_6 r_7 r_8 r_9 r_{10} r_{11} \dots 0$
 ...

Fig.9: The output of the natural-number based algorithm $E_{\mathbb{N}}$

D: The output of the prime-number based algorithm $E_{\mathbb{P}}$

Fig.10 gives the output for $2 \leq n \leq 31$ of a prime-number based algorithm $E_{\mathbb{Q}}$ that computes the values $q_i(n) = r_{p_i}(n)$ of the sequence $E_{\mathbb{P}}(n)$ for only each prime $2 \leq p_i \leq n$ for any given n .

Prime:	p_1	p_2	p_3	p_4	p_5	p_6	p_7	p_8	p_9	p_{10}	p_{11}	$\dots p_n \dots$
Divisor:	2	3	5	7	11	13	17	19	23	29	31	$\dots p_n \dots$
$E_{\mathbb{P}}(2):$	0											
$E_{\mathbb{P}}(3):$	1	0										
$E_{\mathbb{P}}(4):$	0	2										
$E_{\mathbb{P}}(5):$	1	1	0									
$E_{\mathbb{P}}(6):$	0	0	4									
$E_{\mathbb{P}}(7):$	1	2	3	0								
$E_{\mathbb{P}}(8):$	0	1	2	6								
$E_{\mathbb{P}}(9):$	1	0	1	5								
$E_{\mathbb{P}}(10):$	0	2	0	4								
$E_{\mathbb{P}}(11):$	1	1	4	3	0							
$E_{\mathbb{P}}(12):$	0	0	3	2	10							
$E_{\mathbb{P}}(13):$	1	2	2	1	9	0						
$E_{\mathbb{P}}(14):$	0	1	1	0	8	12						
$E_{\mathbb{P}}(15):$	1	0	0	6	7	11						
$E_{\mathbb{P}}(16):$	0	2	4	5	6	10						
$E_{\mathbb{P}}(17):$	1	1	3	4	5	9	0					
$E_{\mathbb{P}}(18):$	0	0	2	3	4	8	16					
$E_{\mathbb{P}}(19):$	1	2	1	2	3	7	15	0				
$E_{\mathbb{P}}(20):$	0	1	0	1	2	6	14	18				
$E_{\mathbb{P}}(21):$	1	0	4	0	1	5	13	17				
$E_{\mathbb{P}}(22):$	0	2	3	6	0	4	12	16				
$E_{\mathbb{P}}(23):$	1	1	2	5	10	3	11	15	0			
$E_{\mathbb{P}}(24):$	0	0	1	4	9	2	10	14	22			
$E_{\mathbb{P}}(25):$	1	2	0	3	8	1	9	13	21			
$E_{\mathbb{P}}(26):$	0	1	4	2	7	0	8	12	20			
$E_{\mathbb{P}}(27):$	1	0	3	1	6	12	7	11	19			
$E_{\mathbb{P}}(28):$	0	2	2	0	5	11	6	10	18			
$E_{\mathbb{P}}(29):$	1	1	1	6	4	10	5	9	17	0		
$E_{\mathbb{P}}(30):$	0	0	0	5	3	9	4	8	16	28		
$E_{\mathbb{P}}(31):$	1	2	4	4	2	8	3	7	15	27	0	
...												
$E_{\mathbb{P}}(n):$	q_1	q_2	q_3	q_4	q_5	q_6	q_7	q_8	q_9	q_{10}	q_{11}	$\dots 0$
...												

Fig.10: The output of the prime-number based algorithm $E_{\mathbb{P}}$

E: The output of the prime-number based algorithms $E_{\mathbb{P}}$ and $E_{\mathbb{Q}}$

We give below in Fig.11 the output for $2 \leq n \leq 121$ of the two prime-number based algorithms:

- $E_{\mathbb{P}}$ (whose output $\{q_i(n) = r_{p_i}(n) : 1 \leq i \leq \pi(n)\}$ is shown only partially, partly in cyan);
 and

- $E_{\mathbb{Q}}$ (whose output $q_i(n) = \{r_{p_i}(n) : 1 \leq i \leq \pi(\sqrt{n})\}$ is highlighted in black and red, the latter indicating the generation of a prime sequence⁵⁴⁶).

Prime:	p_1	p_2	p_3	p_4	p_5	p_6	p_7	p_8	p_9	p_{10}	p_{11}	$\dots p_n \dots$
Divisor:	2	3	5	7	11	13	17	19	23	29	31	$\dots p_n \dots$
Function:	Q_1	Q_2	Q_3	Q_4	Q_5	Q_6	Q_7	Q_8	Q_9	Q_{10}	Q_{11}	\dots

$E_{\mathbb{Q}}(2):$	0	(Prime by definition)										
$E_{\mathbb{Q}}(3):$	1	0										
$E_{\mathbb{Q}}(4):$	0	2										
$E_{\mathbb{Q}}(5):$	1	1	0									
$E_{\mathbb{Q}}(6):$	0	0	4									
$E_{\mathbb{Q}}(7):$	1	2	3	0								
$E_{\mathbb{Q}}(8):$	0	1	2	6								
$E_{\mathbb{Q}}(9):$	1	0	1	5								
$E_{\mathbb{Q}}(10):$	0	2	0	4								
$E_{\mathbb{Q}}(11):$	1	1	4	3	0							
$E_{\mathbb{Q}}(12):$	0	0	3	2	10							
$E_{\mathbb{Q}}(13):$	1	2	2	1	9	0						
$E_{\mathbb{Q}}(14):$	0	1	1	0	8	12						
$E_{\mathbb{Q}}(15):$	1	0	0	6	7	11						
$E_{\mathbb{Q}}(16):$	0	2	4	5	6	10						
$E_{\mathbb{Q}}(17):$	1	1	3	4	5	9	0					
$E_{\mathbb{Q}}(18):$	0	0	2	3	4	8	16					
$E_{\mathbb{Q}}(19):$	1	2	1	2	3	7	15	0				
$E_{\mathbb{Q}}(20):$	0	1	0	1	2	6	14	18				
$E_{\mathbb{Q}}(21):$	1	0	4	0	1	5	13	17				
$E_{\mathbb{Q}}(22):$	0	2	3	6	0	4	12	16				
$E_{\mathbb{Q}}(23):$	1	1	2	5	10	3	11	15	0			
$E_{\mathbb{Q}}(24):$	0	0	1	4	9	2	10	14	22			
$E_{\mathbb{Q}}(25):$	1	2	0	3	8	1	9	13	21			
$E_{\mathbb{Q}}(26):$	0	1	4	2	7	0	8	12	20			
$E_{\mathbb{Q}}(27):$	1	0	3	1	6	12	7	11	19			
$E_{\mathbb{Q}}(28):$	0	2	2	0	5	11	6	10	18			
$E_{\mathbb{Q}}(29):$	1	1	1	6	4	10	5	9	17	0		
$E_{\mathbb{Q}}(30):$	0	0	0	5	3	9	4	8	16	28		
$E_{\mathbb{Q}}(31):$	1	2	4	4	2	8	3	7	15	27	0	
$E_{\mathbb{Q}}(32):$	0	1	3	3	1	7	2	6	14	26	30	
$E_{\mathbb{Q}}(33):$	1	0	2	2	0	6	1	5	13	25	29	
$E_{\mathbb{Q}}(34):$	0	2	1	1	10	5	0	4	12	24	28	
$E_{\mathbb{Q}}(35):$	1	1	0	0	9	4	16	3	11	23	27	
$E_{\mathbb{Q}}(36):$	0	0	4	6	8	3	15	2	10	22	26	
$E_{\mathbb{Q}}(37):$	1	2	3	5	7	2	14	1	9	21	25	
$E_{\mathbb{Q}}(38):$	0	1	2	4	6	1	13	0	8	20	24	
$E_{\mathbb{Q}}(39):$	1	0	1	3	5	0	12	18	7	19	23	
$E_{\mathbb{Q}}(40):$	0	2	0	2	4	12	11	17	6	18	22	
$E_{\mathbb{Q}}(41):$	1	1	4	1	3	11	10	16	5	17	21	
$E_{\mathbb{Q}}(42):$	0	0	3	0	2	10	9	15	4	16	20	
$E_{\mathbb{Q}}(43):$	1	2	2	6	1	9	8	14	3	15	19	
$E_{\mathbb{Q}}(44):$	0	1	1	5	0	8	7	13	2	14	18	
$E_{\mathbb{Q}}(45):$	1	0	0	4	10	7	6	12	1	13	17	
$E_{\mathbb{Q}}(46):$	0	2	4	3	9	6	5	11	0	12	16	

⁵⁴⁶For informal reference and perspective, formal definitions of both the prime-number based algorithms $E_{\mathbb{P}}$ and $E_{\mathbb{Q}}$ are given in this preprint *Factorising all $m \leq n$ is of order $\Theta(\sum_{i=2}^n \pi(\sqrt{i}))$* . See also *A Minimal Prime Generating Theorem that suggests the Prime Difference is $O(\pi(p(n)^{1/2})$* .

$E_Q(47)$:	1	1	3	2	8	5	4	10	22	11	15
$E_Q(48)$:	0	0	2	1	7	4	3	9	21	10	14
$E_Q(49)$:	1	2	1	0	6	3	2	8	20	9	13
$E_Q(50)$:	0	1	0	6	5	2	1	7	19	8	12
$E_Q(51)$:	1	0	4	5	4	1	0	6	18	7	11
$E_Q(52)$:	0	2	3	4	3	0	16	5	17	6	10
$E_Q(53)$:	1	1	2	3	2	12	15	4	16	5	9
$E_Q(54)$:	0	0	1	2	1	11	14	3	15	4	8
$E_Q(55)$:	1	2	0	1	0	10	13	2	14	3	7
$E_Q(56)$:	0	1	4	0	10	9	12	1	13	2	6
$E_Q(57)$:	1	0	3	6	9	8	11	0	12	1	5
$E_Q(58)$:	0	2	2	5	8	7	10	18	11	0	4
$E_Q(59)$:	1	1	1	4	7	6	9	17	10	28	3
$E_Q(60)$:	0	0	0	3	6	5	8	16	9	27	2
$E_Q(61)$:	1	2	4	2	5	4	7	15	8	26	1
$E_Q(62)$:	0	1	3	1	4	3	6	14	7	25	0
$E_Q(63)$:	1	0	2	0	3	2	5	13	6	24	30
$E_Q(64)$:	0	2	1	6	2	1	4	12	5	23	29
$E_Q(65)$:	1	1	0	5	1	0	3	11	4	22	28
$E_Q(66)$:	0	0	4	4	0	12	2	10	3	21	27
$E_Q(67)$:	1	2	3	3	10	11	1	9	2	20	26
$E_Q(68)$:	0	1	2	2	9	10	0	8	1	19	25
$E_Q(69)$:	1	0	1	1	8	9	16	7	0	18	24
$E_Q(70)$:	0	2	0	0	7	8	15	6	22	17	23
$E_Q(71)$:	1	1	4	6	6	7	14	5	21	16	22
$E_Q(72)$:	0	0	3	5	5	6	13	4	20	15	21
$E_Q(73)$:	1	2	2	4	4	5	12	3	19	14	20
$E_Q(74)$:	0	1	1	3	3	4	11	2	18	13	19
$E_Q(75)$:	1	0	0	2	2	3	10	1	17	12	18
$E_Q(76)$:	0	2	4	1	1	2	9	0	16	11	17
$E_Q(77)$:	1	1	3	0	0	1	8	18	15	10	16
$E_Q(78)$:	0	0	2	6	10	0	7	17	14	9	15
$E_Q(79)$:	1	2	1	5	9	12	6	16	13	8	14
$E_Q(80)$:	0	1	0	4	8	11	5	15	12	7	13
$E_Q(81)$:	1	0	4	3	7	10	4	14	11	6	12
$E_Q(82)$:	0	2	3	2	6	9	3	13	10	5	11
$E_Q(83)$:	1	1	2	1	5	8	2	12	9	4	10
$E_Q(84)$:	0	0	1	0	4	7	1	11	8	3	9
$E_Q(85)$:	1	2	0	6	3	6	0	10	7	2	8
$E_Q(86)$:	0	1	4	5	2	5	16	9	6	1	7
$E_Q(87)$:	1	0	3	4	1	4	15	8	5	0	6
$E_Q(88)$:	0	2	2	3	0	3	14	7	4	28	5
$E_Q(89)$:	1	1	1	2	10	2	13	6	3	27	4
$E_Q(90)$:	0	0	0	1	9	1	12	5	2	26	3
$E_Q(91)$:	1	2	4	0	8	0	11	4	1	25	2
$E_Q(92)$:	0	1	3	6	7	12	10	3	0	24	1
$E_Q(93)$:	1	0	2	5	6	11	9	2	22	23	0
$E_Q(94)$:	0	2	1	4	5	10	8	1	21	22	30
$E_Q(95)$:	1	1	0	3	4	9	7	0	20	21	29
$E_Q(96)$:	0	0	4	2	3	8	6	18	19	20	28
$E_Q(97)$:	1	2	3	1	2	7	5	17	18	19	27
$E_Q(98)$:	0	1	2	0	1	6	4	16	17	18	26
$E_Q(99)$:	1	0	1	6	0	5	3	15	16	17	25
$E_Q(100)$:	0	2	0	5	10	4	2	14	15	16	24
$E_Q(101)$:	1	1	4	4	9	3	1	13	14	15	23
$E_Q(102)$:	0	0	3	3	8	2	0	12	13	14	22

$E_{\mathbb{Q}}(103)$:	1	2	2	2	7	1	16	11	12	13	21	
$E_{\mathbb{Q}}(104)$:	0	1	1	1	6	0	15	10	11	12	20	
$E_{\mathbb{Q}}(105)$:	1	0	0	0	5	12	14	9	10	11	19	
$E_{\mathbb{Q}}(106)$:	0	2	4	6	4	11	13	8	9	10	18	
$E_{\mathbb{Q}}(107)$:	1	1	3	5	3	10	12	7	8	9	17	
$E_{\mathbb{Q}}(108)$:	0	0	2	4	2	9	11	6	7	8	16	
$E_{\mathbb{Q}}(109)$:	1	2	1	3	1	8	10	5	6	7	15	
$E_{\mathbb{Q}}(110)$:	0	1	0	2	0	7	9	4	5	6	14	
$E_{\mathbb{Q}}(111)$:	1	0	4	1	10	6	8	3	4	5	13	
$E_{\mathbb{Q}}(112)$:	0	2	3	0	9	5	7	2	3	4	12	
$E_{\mathbb{Q}}(113)$:	1	1	2	6	8	4	6	1	2	3	11	
$E_{\mathbb{Q}}(114)$:	0	0	1	5	7	3	5	0	1	2	10	
$E_{\mathbb{Q}}(115)$:	1	2	0	4	6	2	4	18	0	1	9	
$E_{\mathbb{Q}}(116)$:	0	1	4	3	5	1	3	17	22	0	8	
$E_{\mathbb{Q}}(117)$:	1	0	3	2	4	0	2	16	21	28	7	
$E_{\mathbb{Q}}(118)$:	0	2	2	1	3	12	1	15	20	27	6	
$E_{\mathbb{Q}}(119)$:	1	1	1	0	2	11	0	14	19	26	5	
$E_{\mathbb{Q}}(120)$:	0	0	0	6	1	10	16	13	18	25	4	
$E_{\mathbb{Q}}(121)$:	1	2	4	5	0	9	15	12	17	24	3	
...												
$E_{\mathbb{Q}}(n)$:	q_1	q_2	q_3	q_4	q_5	q_6	q_7	q_8	q_9	q_{10}	q_{11}	...
...												
Prime:	p_1	p_2	p_3	p_4	p_5	p_6	p_7	p_8	p_9	p_{10}	p_{11}	... p_n ...
Divisor:	2	3	5	7	11	13	17	19	23	29	31	... p_n ...

Fig.11: The output of the prime-number based algorithms $E_{\mathbb{P}}$ and $E_{\mathbb{Q}}$

22.H.a. An elementary equivalence for Goldbach’s Conjecture

We consider the significance of the prime-number based algorithms $E_{\mathbb{P}}$ for Goldbach’s Conjecture⁵⁴⁷ (GC):

Proposition 22.58. (Goldbach’s Conjecture) *For all natural numbers $n > 2$, there are primes p and q such that $2n = p + q$.*

Since $|n - p| = |q - n|$, GC is equivalent to the assertion that every natural number $n > 2$ is equidistant from two primes⁵⁴⁸; whence, for any specified $n \in \mathbb{N}$ such that (see Fig.11):

$$n + r_{p_i}(n) \equiv 0 \pmod{p_i} \text{ for } p_i > r_{p_i}(n) \geq 0 \text{ and } 1 \leq i \leq \pi(\sqrt{n}) \tag{1}$$

and, ipso facto:

$$n + r_{p_i}(n) \equiv 0 \pmod{p_i} \text{ for } p_i > r_{p_i}(n) \geq 0 \text{ and } 1 \leq i \leq \pi(\sqrt{2n}) \tag{2}$$

Let $k_n \in \mathbb{N}$ be the smallest integer such that:

$$r_{p_i}(n) + k_n \not\equiv 0 \pmod{p_i} \text{ for all } 1 \leq i \leq \pi(\sqrt{2n}) \tag{3}$$

$$r_{p_i}(n) - k_n \not\equiv 0 \pmod{p_i} \text{ for all } 1 \leq i \leq \pi(\sqrt{2n}) \tag{4}$$

Then GC is equivalent to the assertion that $k_n < n$ for $n > 2$ ⁵⁴⁹; since this yields the primes:

$$n + k_n \not\equiv 0 \pmod{p_i} \text{ for all } 1 \leq i \leq \pi(\sqrt{2n}) \tag{5}$$

$$n - k_n \not\equiv 0 \pmod{p_i} \text{ for all } 1 \leq i \leq \pi(\sqrt{2n}) \tag{6}$$

⁵⁴⁷[HW60], §2.8, p.19, *If $n > 4$ is even, then n is the sum of two odd primes.*; see also [Dic52], Vol. I, p.421.

⁵⁴⁸See, for instance, [Goldbach’s conjecture](#) in Wikipedia.

⁵⁴⁹Whence GC is algorithmically *verifiable* even if it is not algorithmically *computable* (see §2.)!

CHAPTER 22. PARADIGM CHALLENGING CONSEQUENCES

23. The significance of *evidence-based* reasoning for the physical sciences

The significance of *evidence-based* reasoning for the physical sciences is that it admits, for instance, the hypothesis that the paradoxical element which surfaced as a result of the *EPR* argument, due to the perceived conflict (as implied by Bell's inequality in [Bl64]) between:

- the, seemingly essential, non-locality required by current interpretations of Quantum Mechanics; and
- the essential locality required by current interpretations of Classical Mechanics;

merely reflects an ambiguity in current paradigms which, when interpreting the meaning and truth of a formal mathematical argument, fail to recognise that some determinate physical phenomena may not be expressible recursively. As noted, for instance, by Patrizia Piredda in her 2021 essay [Prd21]⁵⁵⁰:

“Also in physics, it is no rare occurrence that the established concepts of our language may suddenly appear inadequate to define new experiences, and yet we cannot help but use them since “we have no other language than this.”^[1] This was the case as the subatomic particles were discovered. Since the beginning of the twentieth century, when Planck discovered action quanta, “a state of confusion had arisen in physics. The old rules, whereby nature had been successfully described for more than two centuries, would no longer fit the new findings.”^[2] In this new *Weltanschauung*, the idea of a perfectly ordered and objectively knowable world, and the “the beauty and completeness of the old physics seemed destroyed, without anyone having been able, from the often disparate experiments, to gain a real insight into new and different sorts of connection.”^[3]”

... Piredda: [Prd21].

In other words (see §1., Thesis 1), the perceived conflict between our mathematical representations—and subsequent interpretations—of classical and quantum phenomena may simply reflect that some determinate physical phenomena may not be expressible by recursive functions, even though the observed probabilities of the occurrence of such phenomena may be expressible mathematically by recursive functions such as, for instance, Schrödinger's wave function or Heisenberg's matrices.

Comment 192. Prima facie, the above *evidence-based* perspective—of a ‘perceived conflict’ which pertains only to an ambiguity in current paradigms of our mathematical representations, and subsequent interpretations, of classical and quantum phenomena, and not to our perceptions, measurements, and recording of such phenomena—can be viewed as implicit in N. Gurappa's thesis [Grp17] that ‘Schrödinger's wave function can naturally be realized as an ‘*instantaneous resonant spatial mode*’ in which quantum particle moves’:

“... Schrödinger's wave function can naturally be realized as an ‘*instantaneous resonant spatial mode*’ in which quantum particle moves and hence the Born's rule is derived after identifying its origin. This realization facilitates the visualization of ‘*what's really going on?*’ in the Young's double-slit experiment which is known to be the central

⁵⁵⁰See also [Prd23].

mystery of quantum mechanics. Also, an actual mechanism underlying the ‘*spooky-action-at-a-distance*’, another mystery regarding the entangled quantum particles, is revealed. Wheeler’s delayed choice experiments, delayed choice quantum eraser experiment and delayed choice entanglement swapping experiments are unambiguously and naturally explained at a single quantum level without violating the causality. The reality of Nature represented by the quantum mechanical formalism is conceptually intuitive and is independent of *the measurement problem*."

... Gurappa: [Grp17], Abstract.

where Gurappa concludes that in our mathematical representations of quantum phenomena—as distinct from their reality—‘particles are not living in R^3 Euclidean space’:

“In conclusion, I have interpreted the Schrödinger wave function or equivalently the state vector of a quantum particle as an Instantaneous Resonant Spatial Mode (IRSM) and shown how the quantum formalism is related to the Nature of reality. Both particle and its IRSM are created simultaneously such that the particle flies in IRSM. This non-dualistic picture is analogous to the objects moving in the curved space-time of general theory of relativity. Thus, wave function does not have any resemblance to classically known waves though it obeys Schrödinger’s wave equation. Unlike in Newtonian mechanics, a complete knowledge about the initial state and hence the state at any later moment is unavailable to experimental observation This is because of the fact that the particles are not living in R^3 Euclidean space and also due to the inner-product interaction of IRSM. Most importantly, quantum mechanics itself is not a probabilistic theory since all the quantum phenomenon considered in the present paper were explained at a single quantum mechanical level. It was shown that the Born’s probabilities are equivalent to observed frequencies arising due to the nature of doing the experiments. Einstein was indeed correct in saying, “God does not play [with dice]”.

The most important conclusion one can draw from non-duality is that Nature is not retro[causal] and respects [causality] at least at the level of quantum mechanics. Towards the end, I remarked about the HBT effect and also pointed out on the possible origin of non-linear Schrödinger equation. The explanations given for the Young’s double slit experiment, Wheeler’s delayed choice experiment and spooky action at a distance at a single quantum level seems to be sufficient for the unambiguous understanding of all known quantum mechanical phenomena so far.

Since the present non-dualistic interpretation is a visualization of [the] nature of reality reflected within the quantum formalism, it will go through both time-dependent and relativistic quantum mechanics. In the relativistic case, the IRSM is such that, apart from obeying the usual quantum mechanical commutation relations, it takes care of the cosmic speed limit for its resonant particle, though it itself can change instantaneously. Without much difficulty, it can be seen that the registered physical phenomena are independent of [any] relative frame of reference. . . . Finally, the important essence of the present paper is, “Nature does not have to play [dice] in order to run our [causal] quantum mechanical Universe”.

... Gurappa: [Grp17], Concluding paragraph.

In his preprint [Grp18], Gurappa further emphasises this point by remarking that the ‘main purpose for the existence of the spooky action in the quantum world’, in our mathematical interpretations of quantum phenomena, is apparently ‘to maintain strictly the conservation laws even in the absence of exchange interactions’:

“The EPR idea of treating two distant particles, which had interacted initially and no more [interact] by any known physical mechanism, as two independent systems like in the case of classical physics can not hold to be true in the quantum world as pointed out by Bohr. This aspect was elegantly shown with the use of simple commutation

relations and also, the missing mathematical argument for Bohr's reply is provided. In this approach, it becomes extremely transparent that even the quantum world, whose physical phenomena are based on the canonical quantum commutation relations, is bound to obey the conservation laws which naturally give [rise] to the existence of Einstein's spooky action-at-a-distance among the entangled particles.

To visualize physically 'How entangled particles are able to communicate even though they are well-separated? (or) How actually the spooky-action-at-a-distance is becoming possible?', will necessarily depend on the physical reality of the Schrödinger wave function. In a recent paper, I gave a new non-dualistic interpretation for the quantum formalism where the Schrödinger wave function is interpreted as an 'instantaneous resonant spatial mode'¹⁴. This new interpretation unambiguously resolves the well-known paradoxes and puzzles in quantum mechanics at a single quantum level and provides a natural mechanism for the Einstein's spooky action-at-a-distance. Nature seems to be perfectly stubborn not to violate the conservation laws. Certainly, this instantaneous spooky action is not carried out by some physical carriers which require the exchange of energy and momentum between entangled particles because, we know that energy-momentum transport can't be superluminal and is bound to the Cosmic speed limit in accordance with the special theory of relativity. The main purpose for the existence of the spooky action in the quantum world [is apparently] to maintain strictly the conservation laws even in the absence of exchange interactions."

... Gurappa: [Grp18], §3, Summary.

23.A. Some determinate physical phenomena may not be expressible recursively

In particular, we show how some perceived anomalies—such as the *EPR* paradox—in our mathematical descriptions of quantum behaviour may dissolve if a physicist could cogently argue that:

- (i) All properties of physical reality are deterministic, but not necessarily mathematically predictable—in the sense that any physical property could have one, and only one, value at any time $t(n)$, where the value is completely determined by some natural law which need not, however, be representable by algorithmically *computable*—and ipso facto predictable—number-theoretic functions.
- (ii) There are elements of such a physical reality whose properties at any time $t(n)$ can be treated as determined completely in a deterministic mathematical model in terms of their putative properties at some earlier time $t(0)$.
 - (a) Such properties are predictable mathematically in the model since they are representable by algorithmically *computable* functions.
 - (b) The values of any two such functions with respect to their variables are, by the definition of algorithmic *computability* (see §2., Definition 10), independent of each other and must, therefore, obey Bell's inequality, which applies *only* to classical, algorithmically *computable* functions and relations.
 - (c) The Laws of Classical Mechanics determine the nature and behaviour of such physical reality only, and circumscribe the limits of reasoning and cognition in any emergent mechanical intelligence with awareness (in the sense of §21.J.a., Hypothesis 3) which, by current definitions (see §21.E., Query 22 (Turing Test)), may be treated as essentially Turing machines.

- (iii) There could be elements of such a physical reality whose properties at any time $t(n)$ cannot be theoretically determined completely in any deterministic mathematical model from their putative properties at some earlier time $t(0)$ (for reasons addressed by Query 30 in §23.D.g.).
- (a) Such properties are unpredictable mathematically in the model since they are only representable mathematically by algorithmically *verifiable*, but not algorithmically *computable*, functions.
 - (b) The values of any two such functions with respect to their variables could, by the definition of algorithmic *verifiability* (see §2., Definition 7), admit dependence upon each other; in which case they need not obey Bell's inequality.
 - (c) The Laws of Quantum Mechanics determine the nature and behaviour of such physical reality, and circumscribe the limits of reasoning and cognition in any emergent humanlike (i.e., organically evolved) intelligence.

Comment 193. The above *evidence-based* perspective—of ‘perceived anomalies’ which pertain only to ambiguities in current paradigms of the mathematical representations, and subsequent interpretations, of our conceptual metaphors corresponding to classical and quantum phenomena, and not to our perceptions, measurements, and recording of such phenomena—can also be viewed as implicit in Patrizia Piredda’s observation in [Prd21]⁵⁵¹ that ‘the very concept of certainty was no longer applicable because the concept of reality had changed’:

“Contrary both to common sense and the foundation of logic, according to which an object cannot be and not be at the same time and therefore one thing cannot be two things, in quantum physics it turns out that the electrons behave in a peculiar way, sometimes as a particle and sometimes as a wave. This logical absurdity was confirmed by the experiments that led Niels Bohr to formulate the principle of complementarity, according to which the experiment itself determines the “nature” of the particle, and Werner Heisenberg to theorise the uncertainty principle, according to which we cannot experimentally determine with certainty both the position or velocity of a particle: we can only predict either velocity or its probable position within a limited area.^[4] Faced with this discovery, physicists realised that many of the certainties on which the classical scientific method is based, such as the concepts of objectivity, space, time, and neutral observation, were no longer adequate: the very concept of certainty was no longer applicable because the concept of reality had changed.”

... Piredda: [Prd21].

Comment 194. It may be pertinent to note here that, in an insightful paper [Dks17], Dennis Dieks argues that, historically, it was von Neumann who first sought to mathematically prove as impossible ‘*that the same physical quantities, with the same mutual relations, are present . . . , if in addition to the wave function yet other variables (“hidden parameters”) exist*’; concluding that it ‘*is therefore not, as is often assumed, a question of interpretation of quantum mechanics—the system of quantum mechanics would have to be objectively false in order that another description of the elementary process than the statistical one be possible*’.

From the *evidence-based* perspective of §23., we would argue that Dieks’ thesis that:

- (a) von Neumann’s mathematical perspective has been seriously misinterpreted as erroneous (and misleadingly treated as an inexplicable lapse of judgment) by counter-perspectives that, in turn, seemingly appeal to unsustainable—if not unfalsifiable—philosophical reasoning; and that

⁵⁵¹See also [Prd23].

- (b) von Neumann's mathematical argument may need revisiting;

is validated if we interpret von Neumann's proof as presciently establishing (as highlighted by Query 30 in §23.D.g.) that:

- (i) Our observations of quantum phenomena cannot be faithfully expressed mathematically by the assumption of classical 'hidden' functions and relations that are algorithmically *computable*, since '*the very idea of the introduction of such variables is to have the possibility of ensembles without statistical spreads, namely ensembles in which the hidden parameters possess fixed values*'; whence such '*hidden-variable theories must possess a structure that deviates fundamentally from that of quantum mechanics*';
- (ii) Assuming that quantum phenomena can be faithfully expressed mathematically by admitting neo-classical 'hidden' functions and relations that are algorithmically *verifiable*, but not algorithmically *computable* (see §2., Definitions 7 and 10, respectively), does not entail an interpretation of quantum mechanics such that '*the system of quantum mechanics would have to be objectively false in order that another description of the elementary process than the statistical one be possible*':

"According to what has become a standard history of quantum mechanics, von Neumann in 1932 succeeded in convincing the physics community that he had proved that hidden variables were impossible as a matter of principle. Subsequently, leading proponents of the Copenhagen interpretation emphatically confirmed that von Neumann's proof showed the completeness of quantum mechanics. Then, the story continues, Bell in 1966 finally exposed the proof as seriously and obviously wrong—this rehabilitated hidden variables and made serious foundational research possible. It is often added in recent accounts that von Neumann's error had been spotted almost immediately by Grete Hermann, but that her discovery was of no effect due to the dominant Copenhagen Zeitgeist. We shall attempt to tell a more balanced story. Most importantly, von Neumann did not claim to have shown the impossibility of hidden variables tout court, but argued that hidden-variable theories must possess a structure that deviates fundamentally from that of quantum mechanics. Both Hermann and Bell appear to have missed this point; moreover, both raised unjustified technical objections to the proof. Von Neumann's conclusion was basically that hidden-variables schemes must violate the "quantum principle" that all physical quantities are to be represented by operators in a Hilbert space. According to this conclusion, hidden-variables schemes are possible in principle but necessarily exhibit a certain kind of contextuality. As we shall illustrate, early reactions to Bohm's theory are in agreement with this account. Leading physicists pointed out that Bohm's theory has the strange feature that particle properties do not generally reveal themselves in measurements, in accordance with von Neumann's result. They did not conclude that the "impossible was done" and that von Neumann had been shown wrong."

... Dieks: [Dks17], Abstract.

"From the general validity of the expression $Exp(R) = \mathbf{Tr}(UR)$ it follows as a corollary that there are no completely dispersion-free ensembles for quantum quantities: whatever choice we make for the operator U , it is always possible to find operators R in Hilbert space such that the statistical spread of R , calculated with U via the trace formula, does not vanish.¹⁶ This excludes hidden variables: indeed, the very idea of the introduction of such variables is to have the possibility of ensembles without statistical spreads, namely ensembles in which the hidden parameters possess fixed values. If such parameters existed, the spreads actually predicted by quantum mechanics would have to result from averaging over dispersion-free ensembles, corresponding to sub-quantum dispersion-free states. But von Neumann's proof shows that, given his premises, there are *no* such finer-grained states.

Von Neumann himself summarizes the result of his no-hidden-variables proof as follows [24, p. 171]:

“it is impossible that the same physical quantities, with the same mutual relations, are present (i.e. that our premises **I** and **II** hold), if in addition to the wave function yet other variables (“hidden parameters”) exist.

It would not help if in addition to the familiar quantities that are represented by operators in quantum mechanics new, still undiscovered quantities existed: for already in the case of the familiar quantities the quantum mechanical relations (i.e. **I**, **II**) must fail. It is therefore not, as is often assumed, a question of interpretation of quantum mechanics—the system of quantum mechanics would have to be objectively false in order that another description of the elementary process than the statistical one be possible.¹⁷”

... Dieks: [Dks17], §3 The Impossibility Proof, p.12.

23.A.a. Describable but not predictable

We note that functions which are algorithmically *verifiable*, but not algorithmically *computable*, would fall into the category of ‘strange’ and ‘incomputable’ functions considered by scientist Jonathan Bartlett in his *Describable but Not Predictable: Mathematical Modeling and Non-Naturalistic Causation*.

Bartlett’s criteria (which he proposes in §2, p.115 of [Brt18], and defends elsewhere) for distinguishing between naturalistic (presumably physically grounded) abstract concepts (which may be taken to correspond to Lakoff and Núñez’s *primary* conceptual metaphors in [LR00]; see also §27.) and non-naturalistic (presumably non-physically grounded) abstract concepts (which may be taken to correspond to Lakoff and Núñez’s *secondary* conceptual metaphors in [LR00]; see also §27.) is that of “computability”, since:

“Under this rubric, physical processes are those whose results can, at least in principle, be calculated by computational systems, while non-physical processes are those which cannot.”

... Bartlett: [Brt18], §2, p.115.

Bartlett argues that the cited functions defined by him as ‘strange’—vis à vis the usual ‘well-behaved’ functions of classical theory—might “be important to helping researchers think about causality”; and that whilst “strange functions should not be introduced lightly, there is no reason to avoid them in models. The preference for well-behaved functions is just that—a preference”:

“5 Using Incomputable Functions in Modeling

As we have seen, by expanding our view of mathematics beyond the typical well-behaved functions, we can incorporate models of non-mechanical (i.e., non-naturalistic) causes and modes of operation into mathematical descriptions. Such mathematical descriptions would enable better integration between naturalistic and non-naturalistic causes at work in a system. For a system to be mathematical does not mean that it must be predictive or even computational. Many functions in mathematics are not computable, and in fact, computability may only cover a very small proportion of them.

One may wonder, why bother with mathematics at all? Mathematics is just a formalization of logic. Using mathematics requires that a person distill their ideas into the most rigorous and abstract form. Additionally, because mathematics as a discipline is well-studied, boiling ideas down into mathematical forms, even if incalculable, allows mathematical tools to be used to analyze and reason from these ideas. It also makes it easier to combine different ideas. If each idea is expressed mathematically, then the combination of these ideas can be more readily determined.

One of the advantages of our well-behaved functions is that their long-term behavior can be arbitrarily extrapolated from limited observations. Additionally, with a finite set of observations,

it is difficult to distinguish a strange function from a more well-behaved nearby function, especially within the limited data set. A major issue with using strange functions in modeling is determining whether or not such a function is what is being observed or if its more well-behaved nearby function is at work.

Therefore, what is required for establishing a strange function as the basis for an observed effect is a *logical* reason for preferring the function. That is, there must be something in the nature of the causal relationships that would indicate the usage of a strange function in the model. One other thing that may indicate that a strange function is indeed required is the need to continually change the model with more and more data. This may indicate that a strange function is at play, and the causal relationships should be investigated to see if a strange function may properly model what is happening.

Since this paper only presents a small smattering of the known strange functions, more and more modeling power will be available by understanding more and more strange functions and how they relate to causality. The ones presented here were picked because the author could see ways in which they may be important to helping researchers think about causality. Additionally, more functions may be available by simple creative construction. Once the strictures of well-behaved functions are removed, and a person gets acquainted with the nature of strange functions, the ability to construct definitions of new strange functions to match the causality in question will be increased.

While strange functions should not be introduced lightly, there is no reason to avoid them in models. The preference for well-behaved functions is just that—a preference. There is no reason why reality must conform to our preferences. Linear components in models are better-behaved than non-linear components, but that doesn't mean our models must always contain linear components. The goal of modeling for science is to provide a deeper understanding of the nature of the subject under investigation. Other goals (such as using models for engineering) may substitute similar well-behaved functions in order to simplify calculations, but science, as an attempt to learn more about the true nature of reality, should in most cases prefer whatever function is the truest model of reality."

... Bartlett: [Brt18], §5, pp.123-124.

Bartlett further argues that even “though strange functions are not always calculable or predictive, they do lend themselves to reasoning about relationships”:

“6 Testing Models that Use Strange Functions

One of the key features of science is testability. As pointed out in Bartlett (2016), the two main features of methodological naturalism that made it successful were that it defined the scope of inquiry and it provided a system of justification. With well-behaved functions, the system of justification is fairly straightforward. The model will predict how a system will behave for tests that have not been performed yet; the experimenter will then perform the tests and see if the results match the model within a margin of error. With strange functions, however, the models do not always predict behavior. Therefore, the system of justification used will have to be modified in order to accommodate strange functions.

However, before we look at how we can test our new models, we should think about why it is that we test models in the first place. The goal of testing is to allow reality to push back on our ideas. That is, we have ideas about the nature of reality, but our ideas must *conform* to external reality, not the other way round. Testing is done to make sure that reality has a chance to give us feedback on the truth of our ideas.

We should recognize that testing is not an absolute truth-teller. It is more a sanity check than a rigid determiner of truth. For a finite set of data points, there are infinitely many functions that would be within the margin of error for those data points (Kukla, 1996). So how might someone decide between two empirically-equivalent theories? As it stands, our scientific ideas do not emanate entirely from empiricism. If they did,, then this would be a problem. Instead, empiricism

provides the dataset that we use to establish rationalistic models, and it provides additional data to validate such models. But the models themselves are based on logical relationships between entities under investigation.

Therefore the key to testing is not that the data points must be uniquely determined by the theory, but rather that the theory must flow from a proposed logical relationship between entities and the data must be consistent with it within a margin of error.

Even though strange functions are not always calculable or predictive, they do lend themselves to reasoning about relationships, otherwise they would not be considered functions. Therefore, it is possible to find patterns that are true with a strange function that may be tested for, even if the strange function itself is not directly testable. In the next section, we shall look at a specific example."

... Bartlett: [Brt18], §6, pp.124-125.

Bartlett concludes by observing that ‘randomness’, which can be treated as a ‘strange’ property of an infinite sequence, has been “used to determine if a mutation is in *response* to a selective pressure or if the mutation preceded the selection”:

7 Randomness as an Exemplar Strange Function

While strange functions generally have not been given much scientific weight, one in particular has been used regularly—randomness. While randomness is not well-behaved like most of the functions within science, the willingness of scientists operating under methodological naturalism to use it probably stems from the fact that it does not appear on the surface to imply teleology (though see Bartlett (2008) for an alternative view). Therefore, its adoption in the scientific community as a viable model allows us to demonstrate the utility of strange functions in scientific modeling.

Randomness is actually a property of an infinite sequence. Therefore, no finite sequence of events can prove that the sequence is random. Additionally, randomness is not predictive. Therefore, including randomness in the model does not help to predict any specific outcome. Thus, randomness matches what we have called strange functions.

Since randomness doesn’t predict a specific outcome and cannot be tested directly, how was it included in scientific theories? Basically, if a model of an event has multiple possible outcomes, and the outcomes proceed in an order that is statistically stable but does not point toward any other structure, then the suggestion of randomness is quite appropriate.

For instance, in a Poisson distribution, the mean is equal to the variance. Therefore one can “test” for such a distribution by checking the means against the variance. If they are close, then the suggestion that the process is a random process following a Poisson distribution can be maintained. There are many different ways that the mean can equal the variance, but if our formal reasoning leads us to expect such a distribution, and the distribution’s characteristic features match our expectations, then the test can be considered confirmed. This is used, for instance, in the Luria-Delbrück experiment where the test for randomness is used to determine if a mutation is in *response* to a selective pressure or if the mutation preceded the selection."

... Bartlett: [Brt18], §7, p.125.

However, unlike that of the functions sought to be described by Bartlett in [Brt18], the ‘strange’ *relative randomness* (see §7.G., Definition 27) of functions that are algorithmically *verifiable*, but not algorithmically *computable*, is not—and does not describe the behaviour of non-naturalistic mathematical entities—entailed by the mathematical theory in which they are defined, but by the behaviour of the naturalistic physical phenomena that such functions seek to represent mathematically.

In an unusual, ‘intuitionistic’, interpretation of ‘real numbers’ as ‘the hidden variables of classical physics’, physicist Nicolas Gisin argues in [Gi19] (see also [Gi20]) that ‘real numbers, are not all given at once, but are processes that develop in time’:

“We argued that classical physics theory can quite naturally and intuitively be considered as an indeterministic theory supplemented with additional variables and that these additional variables are nothing but our familiar real numbers. This is interesting from several points of view.

First, it allows one to discuss additional variables outside the framework of quantum mechanics. Next, it shows that the infamous quantum measurement problem is not restricted to quantum theory, but is actually present in all indeterministic theories [2]. Third, it illustrates possible classical limits of knowledge.

Finally, our discussion illustrates the important role played by classical mathematics. Indeed, in classical mathematics, formalized following Hilbert’s huge influence at the beginning of last century, the digits of all real numbers are assumed to be all given at once. This translates in classical physics, in particular in chaotic classical dynamical systems, by the assumption that all the future is given at once, i.e., encoded in the real-valued initial conditions. However, classical (Platonistic) mathematics is not the only form of mathematics. There is also intuitionistic mathematics, a form of mathematics much less known than classical mathematics, but a quite well-developed mathematics in which numbers, in particular real numbers, are not all given at once, but are processes that develop in time. Brouwer, the father of intuitionism, named these processes choice sequences [3, 5, 6, 16]. Clearly, if physics is expressed in the language of intuitionistic mathematics, then one concludes very naturally that classical physics is indeterministic. The fact is that, historically, Hilbert won his debate with Brouwer (and Einstein won his debate with Bergson), hence physicists use classical/Platonistic mathematics and time was expelled from physics. But there is no logical nor empirical necessity for this state of affair. It illustrates what everyone speaking more than one language knows, namely that different languages make certain thoughts easier to express in one language than in another, like determinism is easier to express in the classical mathematics language and indeterminism easier in intuitionistic mathematics [4].

Finally, let us come back to the question raised in the introduction: is it scientific to believe that scientific theories limit human knowledge? Almost all colleagues would answer in the negative. However, most may conclude that scientific theories should be deterministic, as, if not, the future would be intrinsically unknowable. Here we argued on the contrary for indeterminism, as, if not, past real-valued initial conditions would be intrinsically unknowable. For me, there is nothing unscientific in claiming that the future is open, hence that there are limits to our knowledge of the future, but actual physical parameters of our scientific theories should be, at least in principle, knowable.”

... Gisin: [G19], Conclusion.

We note that, if we do not limit Gisin’s reasoning to the self-imposed, and unnecessary, constraints of intuitionistic mathematics (highlighted in §11.B.), but to those imposed by *evidence-based* reasoning (highlighted in §11.C.), we can view Gisin as implicitly positing that all our knowledge of physical phenomena must, necessarily, be representable mathematically by algorithmically *verifiable* (in the sense of §2., Definition 7; and therefore *determinate*) functions which can be viewed as ‘evolving’ in time⁵⁵², even if some such functions are algorithmically *uncomputable* (in the sense of §2., Definition 7; and therefore *unpredictable*).

In this investigation we seek to formally define the common language and logic (in the sense of §1., Definition 1) of such functions. We then suggest a perspective from which to view the anomalous philosophical issues underlying some current concepts of quantum phenomena such as:

- EPR paradox (§23.A.);
- Bell’s inequalities (§23.B.);

⁵⁵²A perspective that is further elaborated upon in [SG24].

- Indeterminacy (§23.B.b.);
- Uncertainty (§23.B.c.);
- Fundamental dimensionless constants (§23.D.);
- Conjugate properties (§23.D.f.);
- Entanglement (§23.D.g.);
- Schrödinger’s cat paradox (§23.D.h.).

Such a perspective can be viewed as, essentially, seeking⁵⁵³ what Philip Goyal insightfully analyses in [Gyl22] as a methodology of ‘reconstruction’ for ‘elucidating physically-obscure features of a theory’s mathematical formalism by deriving these features from a set of physical principles and auxiliary assumptions’:

“A physical theory must balance two very different demands. On the one hand, it must allow us to better *grasp* some aspect of the workings of the physical world; or—as it would have been common to say in a bygone era—to better understand the mind of God. On the other hand, it must actually *work*—it must provide a conceptual and mathematical framework of some generality within [which] one can describe actual laboratory experiments and can make precise, novel predictions that conform to the brute facts of experience¹.

In the *developmental* phase of a theory, if push comes to shove, the demand for workability usually wins out. Consequently, a freshly developed physical theory is inevitably a *compromise*, which can manifest in several ways. One manifestation is that certain mathematical features of the theory’s formalism may lack clear physical motivation or meaning. Once the theory has been tested and the physics community is sufficiently convinced that its formalism captures some basic regularities in nature’s workings, there usually follows a *reflective* phase in which efforts are made to elucidate these physically-obscure features.

Reconstruction is a methodology for elucidating physically-obscure features of a theory’s mathematical formalism by deriving these features from a set of physical principles and auxiliary assumptions. An ideal reconstruction is one that traces these features back either to extant broadly-accepted fundamental physical principles or desiderata, or to newly-formulated physical principles of a widely-accepted type (such as symmetry, compositional, or extremal principles). The target of reconstruction varies according to whether one wishes to elucidate the physical basis of a specific feature of a theory’s formalism, or the formalism as a whole.

The process of reconstruction—especially wholesale reconstruction of a theory’s formalism—can be viewed as the construction of a *metatheory* that yields an existing theoretical formalism (or part thereof) as an output. From this perspective, the existing theory’s formalism is *data*, a brute fact that one seeks to understand through the principles of the metatheory. That is, reconstruction *iterates* the theory-building process: the original theory explains patterns in the brute facts of sensory experience; in turn, the metatheory elucidates the physical meaning of the mathematical features and structures in the thus-devised theory².

The reconstruction of a theory (or a part thereof) tends to require concepts, mathematical tools, and sometimes ways of thinking about the physical phenomena of interest, that are quite different from those that were employed in the theory’s development. Accordingly, successful reconstruction of a theory must usually await the development of the appropriate concepts, mathematical tools, or new ways of thinking, and may not be achieved until many decades after the theory’s formulation.

⁵⁵³See, for instance §23.D.g., Query 30: *What would introducing experimental observations—which implicitly subsume ‘free will’—into a mathematical model entail?*

The degree to which a reconstruction enhances a theory's intelligibility depends on the extent to which the theory in question was shaped by general physical principles. In the case of Newtonian mechanics, which was substantially shaped by general principles (such as the principle of inertia and Galileo's principle of relativity), reconstructive work has tended to clarify interconnections between parts of the theory³ without shaking its deeper conceptual foundations. In contrast, Faraday–Maxwell electromagnetism was largely shaped by Faraday's imaginative and detailed engagement with electromagnetic phenomena rather than by new general principles comparable in scope to those that underpin classical mechanics. Here reconstruction had a correspondingly greater impact: Einstein's reconstruction of the Lorentz transformations—a mathematical structure that was abstracted from Maxwell's equations only decades after their formulation—led to a profound reconceptualization of the nature of space and time, and to the addition of light alongside matter in the inventory of fundamental physical entities.

Since its formulation almost a century ago, quantum theory has stubbornly resisted elucidation. It is broadly—if not universally—accepted that the theory violates numerous basic convictions about the constitution of the physical world and its relation to observers, convictions that sustained the development of classical physics for three centuries. Ideally, one would like to know what aspects of the classical conception of physical reality can be retained, what aspects need to be modified, and which abandoned; and to be in possession of an overarching conception of physical reality (analogous to the mechanico-geometric conception which underpins classical physics (Berghofer et al. 2021)) which renders these changes intelligible. However, although traditional elucidative methods (such as no-go theorems, reformulations and interpretations) have provided valuable insights, we still lack a comprehensive, compelling account of just what kind of physical reality is so extraordinarily elegantly encoded in the mathematical formalism of the theory.

In this paper, I argue that, in order to make further decisive progress, a new elucidative strategy is called for, one based on reconstruction of the quantum formalism. In particular, I propose a *two-step reconstruction-based strategy*:

1. *Reconstruct the quantum formalism.* First, reconstruct the quantum formalism, with the specific goal of distilling the full physical content of the formalism into physical principles and assumptions that can be expressed in natural language and that are amenable to philosophical reflection.
2. *Interpret the reconstruction.* Second, reflect on the principles and assumptions of the reconstruction, bringing to bear whatever philosophical traditions may be appropriate.

Ideally, the second, reflective step will yield a set [of] physical principles and assumptions that can be laid alongside those that comprise the classical conceptual framework, enabling a point-by-point comparison which makes clear what aspects of the classical framework have been retained, modified, or abandoned. Ideally, it will also yield an overarching conception of physical reality which broadly motivates this new set of physical principles and assumptions.

This reconstruction-based interpretive strategy has many advantages over most traditional elucidative approaches. In particular, the reconstructive step potentially makes the full content of the formalism available for philosophical reflection. Hence, in the reflective step, it is possible to simultaneously take into account a larger number of the non-classical features of quantum theory. In contrast, traditional elucidative approaches take most or all of the quantum formalism as a given and typically only seek to offer explanation of specific aspects of the theory. As a result, they each harness only a small fraction of the physical content of the formalism, and generate fragmentary insights which are difficult to unify into a coherent conception of reality.

A reconstruction-based interpretative strategy is particularly timely: the *quantum reconstruction program* has galvanized the efforts of many in the quantum foundations community over the last twenty or so years, during which period several detailed reconstructions of key parts of the quantum formalism have been developed. Philosophical reflection on certain reconstructions has already been carried out, and some intriguing insights into long-standing puzzles have already recently been obtained. One of the broader aims of this paper is to stimulate the kind of collaborative

work that will likely be needed to fully harvest the fruits of the quantum reconstruction program."

... Goyal: [Gyl22], §1, Introduction.

23.B. EPR, Bohm's *hidden variables*, and Bell's equations

Now, amongst the philosophically disturbing features of the standard Copenhagen interpretation of Quantum Theory are its essential indeterminateness, and its essential separation of the world into 'system' and 'observer'.

For instance, the following remarks by Sheldon Goldstein et al in 2011 upon an accepted implication of 'orthodox formulations of quantum theory' suggest that the implication is yet philosophically disturbing:

"It is a general principle of orthodox formulations of quantum theory that measurements of physical quantities do not simply reveal pre-existing or predetermined values, the way they do in classical theories. Instead, the particular outcome of the measurement somehow "emerges" from the dynamical interaction of the system being measured with the measuring device, so that even someone who was omniscient about the states of the system and device prior to the interaction couldn't have predicted in advance which outcome would be realized."

... Goldstein et al: [Sh+11].

As highlighted in 1935 by Erwin Schrödinger's famously caustic observation, regarding the philosophical consequences of the proposed mathematical interpretation of the ψ -function if taken to imply that the objective state of nature is essentially probabilistic⁵⁵⁴:

"One can even set up quite ridiculous cases. A cat is penned up in a steel chamber, along with the following device (which must be secured against direct interference by the cat): in a Geiger counter there is a tiny bit of radioactive substance, so small, that perhaps in the course of the hour one of the atoms decays, but also, with equal probability, perhaps none; if it happens, the counter tube discharges and through a relay releases a hammer which shatters a small flask of hydrocyanic acid. If one has left this entire system to itself for an hour, one would say that the cat still lives if meanwhile no atom has decayed. The ψ -function of the entire system would express this by having in it the living and dead cat (pardon the expression) mixed or smeared out in equal parts."

... Schrödinger: [Sc35], §5.

Schrödinger's *gedanken* was essentially an acknowledgement of a philosophical consequence of the, seemingly paradoxical, mathematical consequence of such an interpretation that was highlighted earlier in 1935 by Albert Einstein, Boris Podolsky and Nathan Rosen:

"The elements of the physical reality cannot be determined by *a priori* philosophical considerations, but must be found by an appeal to results of experiments and measurements. A comprehensive definition of reality is, however, unnecessary for our purpose. We shall be satisfied with the following criterion, which we regard as reasonable. *If, without in any way disturbing a system, we can predict with certainty (i.e., with probability equal to unity) the value of a physical quantity, then there exists an element of physical reality corresponding to this physical quantity.* It seems to us that this criterion, while far from exhausting all possible ways of recognizing a physical reality, at least provides us with one such way, whenever the conditions set down in it occur. Regarded not as a necessary, but merely as a sufficient, condition of reality, this criterion is in agreement with classical as well as quantum-mechanical ideas of reality.

To illustrate the ideas involved let us consider the quantum-mechanical description of the behavior of a particle having a single degree of freedom. The fundamental concept of the theory is the concept of state, which is supposed to be completely characterized by the wave function ψ , which

⁵⁵⁴However, see §23.D.h. for an alternative, *evidence-based*, interpretation.

is a function of the variables chosen to describe the particle's behavior. Corresponding to each physically observable quantity A there is an operator, which may be designated by the same letter.

If ψ is an eigenfunction of the operator A , that is, if

$$\psi' \equiv A\psi = a\psi \quad (1)$$

where a is a number, then the physical quantity A has with certainty the value a whenever the particle is in the state given by ψ . In accordance with our criterion of reality, for a particle in the state given by ψ for which Eq. (1) holds, there is an element of physical reality corresponding to the physical quantity A . Let, for example,

$$\psi = e^{(2\pi i/h)p_0 x}, \quad (2)$$

where h is Planck's constant, p_0 is some constant number, and x the independent variable. Since the operator corresponding to the momentum of the particle is

$$p = (h/2\pi i)\partial/\partial x, \quad (3)$$

we obtain

$$\psi' = p\psi = (h/2\pi i)\partial\psi/\partial x = p_0\psi. \quad (4)$$

Thus, in the state given by Eq. (2), the momentum has certainly the value p_0 . It thus has meaning to say that the momentum of the particle in the state given by Eq. (2) is real.

On the other hand if Eq. (1) does not hold, we can no longer speak of the physical quantity A having a particular value. This is the case, for example, with the coordinate of the particle. The operator corresponding to it, say q , is the operator of multiplication by the independent variable.

Thus,

$$q\psi = x\psi \neq a\psi. \quad (5)$$

In accordance with quantum mechanics we can only say that the relative probability that a measurement of the coordinate will give a result lying between a and b is

$$P(a, b) = \int_a^b \bar{\psi}\psi dx = \int_a^b dx = b - a. \quad (6)$$

Since this probability is independent of a , but depends only upon the difference $b - a$, we see that all values of the coordinate are equally probable.

A definite value of the coordinate, for a particle in the state given by Eq. (2), is thus not predictable, but may be obtained only by a direct measurement. Such a measurement however disturbs the particle and thus alters its state. After the coordinate is determined, the particle will no longer be in the state given by Eq. (2). The usual conclusion from this in quantum mechanics is that *when the momentum of a particle is known, its coordinate has no physical reality*.

More generally, it is shown in quantum mechanics that, if the operators corresponding to two physical quantities, say A and B , do not commute, that is, if $AB \neq BA$, then the precise knowledge of one of them precludes such a knowledge of the other. Furthermore, any attempt to determine the latter experimentally will alter the state of the system in such a way as to destroy the knowledge of the first.

From this follows that either (1) *the quantum-mechanical description of reality given by the wave function is not complete* or (2) *when the operators corresponding to two physical quantities do not commute the two quantities cannot have simultaneous reality*. For if both of them had simultaneous

reality—and thus definite values—these values would enter into the complete description, according to the condition of completeness. If then the wave function provided such a complete description of reality, it would contain these values; these would then be predictable. This not being the case, we are left with the alternatives stated.

In quantum mechanics it is usually assumed that the wave function *does* contain a complete description of the physical reality of the system in the state to which it corresponds. At first sight this assumption is entirely reasonable, for the information obtainable from a wave function seems to correspond exactly to what can be measured without altering the state of the system. We shall show, however, that this assumption, together with the criterion of reality given above, leads to a contradiction."

... *Einstein, Podolsky and Rosen: [EPR35], p.777-778.*

In other words, Albert Einstein, Boris Podolsky and Nathan Rosen argue that accepting Quantum Theory, but denying these features of the Copenhagen interpretation, logically entails accepting:

- Either that the world is non-local (thus contradicting Special Relativity);

Comment 195. "Non-local' ... means that there exist interactions between events that are too far apart in space and too close together in time for the events to be connected even by signals moving at the speed of light."

... *Shelson et al: [Sh+11].*

- Or that Quantum Theory is not a complete theory, thus implicitly implying that there could be 'hidden variables' which would eliminate the need for accepting these features as necessary to any well-defined interpretation of Quantum Theory.

Comment 196. "Traditionally, the phrase 'hidden variables' is used to characterize any elements supplementing the wave function of orthodox quantum theory."

... *Sheldon et al: [Sh+11].*

"In a complete theory there is an element corresponding to each element of reality. A sufficient condition for the reality of a physical quantity is the possibility of predicting it with certainty, without disturbing the system. In quantum mechanics in the case of two physical quantities described by non-commuting operators, the knowledge of one precludes the knowledge of the other. Then either (1) the description of reality given by the wave-function in quantum mechanics is not complete or (2) these two quantities cannot have simultaneous reality. Consideration of the problem of making predictions concerning a system on the basis of measurements made on another system that had previously interacted with it leads to a result that if (1) is false then (2) is also false. One is thus led to conclude that the description of reality as given by a wave function is not complete."

... *Einstein, Podolsky and Rosen: [EPR35], p.777*

In his 1949 '*Discussions with Einstein on Epistemological Problems in Atomic Physics*', Niels Bohr describes his immediate response to [EPR35], quoting from an article that he had published a few months thereafter:

"Due to the lucidity and apparently incontestable character of the argument, the paper of Einstein, Podolsky and Rosen created a stir among physicists and has played a large role in general philosophical discussion. Certainly the issue is of a very subtle character and suited to emphasise how far, in quantum theory, we are beyond the reach of pictorial visualisation. It will be seen, however, that we are here dealing with problems of just the same kind as those raised by Einstein in previous discussions, and, in an article which appeared a few months later, I tried to show that from the point of view of complementarity the apparent inconsistencies were completely removed.

The trend of the argumentation was in substance the same as that exposed in the foregoing pages, but the aim of recalling the way in which the situation was discussed at that time may be an apology for citing passages from my article.

Thus, after referring to the conclusions derived by Einstein, Podolsky and Rosen on the basis of their criterion, I wrote:

Such an argumentation, however, would hardly seem suited to affect the soundness of quantum-mechanical description, which is based on a coherent mathematical formalism covering automatically any procedure of measurement like that indicated. The apparent contradiction in fact discloses only an essential inadequacy of the customary viewpoint of natural philosophy for a rational account of physical phenomena of the type with which we are concerned in quantum mechanics. Indeed the *finite interaction between object and measuring agencies* conditioned by the very existence of the quantum of action entails - because of the impossibility of controlling the reaction of the object on the measuring instruments, if these are to serve their purpose - the necessity of a final renunciation of the classical ideal of causality and a radical revision of our attitude towards the problem of physical reality. In fact, as we shall see, a criterion of reality like that proposed by the named authors contains - however cautious its formulation may appear - an essential ambiguity when it is applied to the actual problems with which we are here concerned.

As regards the special problem treated by Einstein, Podolsky and Rosen, it was next shown that the consequences of the formalism as regards the representation of the state of a system consisting of two interacting atomic objects correspond to the simple arguments mentioned in the preceding in connection with the discussion of the experimental arrangements suited for the study of complementary phenomena. In fact, although any pair q and p , of conjugate space and momentum variables obeys the rule of non-commutative multiplication expressed by (2), and can thus only be fixed with reciprocal latitudes given by (3), the difference $q_1 - q_2$ between two space-co-ordinates referring to the constituents of the system will commute with the sum $p_1 + p_2$ of the corresponding momentum components, as follows directly from the commutability of q_1 with p_2 and q_2 with p_1 . Both $q_1 - q_2$ and $p_1 + p_2$ can, therefore, be accurately fixed in a state of the complex system and, consequently, we can predict the values of either q_1 or p_1 if either q_2 or p_2 respectively, are determined by direct measurements. If, for two parts of the system, we take a particle and a diaphragm, like that sketched in Fig. 5, we see that the possibilities of specifying the state of the particle by measurements on the diaphragm just correspond to the situation described above, where it was mentioned that, after the particle has passed through the diaphragm, we have in principle the choice of measuring either the position of the diaphragm or its momentum and, in each case, to make predictions as to subsequent observations pertaining to the particle. As repeatedly stressed, the principal point is here that such measurements demand mutually exclusive experimental arrangements.

The argumentation of the article was summarised in the following passage:

From our point of [view] we now see that the wording of the above-mentioned criteria of physical reality proposed by Einstein, Podolsky, and Rosen contains an ambiguity as regards the meaning of the expression 'without in any way disturbing a system.' Of course there is in a case like that just considered no question of a mechanical disturbance of the system under investigation during the last critical stage of the measuring procedure. But even at this stage there is essentially the question of *an influence on the very conditions which define the possible types of predictions regarding the future behaviour of the system.* Since these conditions constitute an inherent element of the description of any phenomena to which the term "physical reality" can be properly attached, we see that the argumentation of the mentioned authors does not justify their conclusion that quantum-mechanical description is essentially incomplete. On the contrary, this description, as appears from the preceding discussion, may be characterised as a rational utilisation of all possibilities of unambiguous interpretation

of measurements, compatible with the finite and uncontrollable interaction between the objects and the measuring instruments in the field of quantum theory. In fact, it is only the mutual exclusion of any two experimental procedures, permitting the unambiguous definition of complementary physical quantities, which provide room for new physical laws, the coexistence of which might at first sight appear irreconcilable with the basic principles of science. It is just this entirely new situation as regards the description of physical phenomena that the notion of *complementarity* aims at characterising.

Regarding these passages, I am deeply aware of the inefficiency of expression which must have made it very difficult to appreciate the trend of the argumentation aiming to bring out the essential ambiguity involved in a reference to physical attributes of objects when dealing with phenomena where no sharp distinction can be made between the behaviour of the objects themselves and their interaction with the measuring instruments. I hope, however, that the present account of the discussion with Einstein in the foregoing years, which contributed so greatly to make us familiar with the situation in quantum physics, may give a clearer impression of the necessity of a radical revision of basic principles for physical explanation in order to restore logical order in this field of experience.

Einstein's own views at that time are presented in an article *Physics and Reality*, published in 1936 in the *Journal of the Franklin Institute*. Starting from a most illuminating exposition of the gradual development of the fundamental principles in the theories of classical physics and their relation to the problem of physical reality, Einstein here argues that the quantum-mechanical description is to be considered merely a means of accounting for the average behaviour of a large number of atomic systems and his attitude to the belief that it should offer an exhaustive description of the individual phenomena is expressed in the following words: "To believe this is logically possible without contradiction; but it is so very contrary to my scientific instinct that I cannot [forgo] the search for a more complete conception."

Even if such an attitude might seem well-balanced in itself, it nevertheless implies a rejection of the whole argumentation exposed in the preceding, aiming to show that, in quantum mechanics, we are not dealing with an arbitrary renunciation of a more detailed analysis of atomic phenomena, but with a recognition that such an analysis is *in principle* excluded. The peculiar individuality of the quantum effects presents us, as regards the comprehension of well-defined evidence, with a novel situation unforeseen in classical physics and irreconcilable with conventional ideas suited for our orientation and adjustment to ordinary experience. It is in this respect that quantum theory has called for a renewed revision of the foundation for the unambiguous use of elementary concepts, as a further step in the development which, since the advent of relativity theory, has been so characteristic of modern science."

... Bohr: [Boh49].

Although Bohr does not here identify precisely what classical paradigm Einstein is defending, which is being challenged by a '*novel situation unforeseen in classical physics and irreconcilable with conventional ideas suited for our orientation and adjustment to ordinary experience*', the fundamental point of his difference with Einstein's epistemological perspective which emerges from the above is apparently an implicit perception that:

- Any mathematical representation of Einstein's 'more complete conception'—of a putative universe that admits all of our conceptual metaphors which faithfully reflect observations of the elements of physical reality—would necessarily admit only classical algorithmically *computable* functions and relations (which are necessarily both *determinate* and *predictable* by §2.E.b., Theorem 2.17);
- Any mathematical representation—of a putative universe that admits all of our conceptual metaphors which faithfully reflect observations of the elements of physical reality—must

admit functions and relations corresponding to experimental observations of quantum phenomena that are essentially *unpredictable* (as experimentally verified subsequently by Bell's inequalities).

In 1952 David Bohm proposed ([Bo52]) an alternative mathematical development of the existing Quantum Theory:

"The usual interpretation of the quantum theory is self-consistent, but it involves an assumption that cannot be tested experimentally, viz., that the most complete possible specification of an individual system is in terms of a wave function that determines only probable results of actual measurement processes. The only way of investigating the truth of this assumption is by trying to find some other interpretation of the quantum theory in terms of at present "hidden" variables, which in principle determine the precise behavior of an individual system, but which are in practice averaged over in measurements of the types that can now be carried out. In this paper and in a subsequent paper, an interpretation of the quantum theory in terms of just such "hidden" variables is suggested. It is shown that as long as the mathematical theory retains its present general form, this suggested interpretation leads to precisely the same results for all physical processes as does the usual interpretation. Nevertheless, the suggested interpretation provides a broader conceptual framework than the usual interpretation, because it makes possible a precise and continuous description of all processes, even at the quantum level. This broader conceptual framework allows more general mathematical formulations of the theory than those allowed by the usual interpretation. Now, the usual mathematical formulation seems to lead to insoluble difficulties when it is extrapolated into the domain of distances of the order of 10-13 cm or less. It is therefore entirely possible that the interpretation suggested here may be needed for the resolution of these difficulties. In any case, the mere possibility of such an interpretation proves that it is not necessary for us to give up a precise, rational, and objective description of individual systems at a quantum level of accuracy."

... Bohm: [Bo52], Abstract.

We note that by stating '*the usual mathematical formulation seems to lead to insoluble difficulties when it is extrapolated into the domain of distances of the order of 10-13 cm or less*', Bohm is implicitly implying here that:

- (a) Current interpretations of Quantum Theory reflect a conflict between our mathematical representation of the behaviour of physical phenomena in limiting cases, and their actual behaviour in such cases (as addressed in §20.D. by Query 18); and that
- (b) A resolution of the conflict requires us to seek a mathematical representation of the behaviour of physical phenomena—in *limiting* cases—other than that presently circumscribed by both the tacit, and explicit, assumptions which underlie current mathematical formulations of Quantum Theory.

If so, this is a crucial—possibly less appreciated, and perhaps even unsuspected—observation that is also implicit in [EPR35], and one whose critically limiting consequences—for the theoretical sciences in achieving a coherent philosophical perspective of our commonly accepted external reality—we highlight in §20.C.a. (Case 1) to §20.C.d. (Case 4).

Moreover, from the *evidence-based* perspective of [An16] (see §2.), we suggest that the resolution suggested by Bohm might be achievable by:

- insisting upon *evidence-based* reasoning for the interpretation of our mathematical formulations of physical phenomena (see §12.); and

- distinguishing between phenomena which might only be mathematically representable by algorithmically *verifiable*, but not algorithmically *computable*, functions and relations (see §7.G.).

Historically, Bohm's interpretation eliminated the need for indeterminism and the separation of the world into 'system' and 'observer'.

Comment 197. For instance, experiments show that when a stream of photons pass sequentially through an appropriately designed double-slit apparatus, cumulatively their passage records an interference pattern upon a 'sensor' screen placed across their path beyond the double-slit. A pattern that, however, is not observed if *any* attempt is made to identify which slit an individual photon actually passes through.

This suggests that, if treated as a 'particle' under the Bohm-de Broglie interpretation⁵⁵⁵, each photon's path *obeys* (is 'guided' by) a law that can be represented as a 'wave'.

An *evidence-based* perspective of the *double-slit* experiment under the Bohm-de Broglie interpretation

From the *evidence-based* perspective of this investigation, the preceding could now be visualised—in a *gedanken* (thought experiment)—as the 'wave' that precedes the bow of a ship moving across an ocean; except that the ship moves discretely (not continuously), and can be treated as 'existing' *only* at each crest of the wave (comparable to, for instance, the 'existence' of electrons apropos the 'tunneling' effect 'observed' in, and critical for the functioning of, semi-conductors).

If, now, a measuring 'buoy' were to be placed in the ocean that interacts with the ship as a sensor (i.e., as an 'observer' to locate its putative 'position'), the interaction introduces a new relation between the components of the *gedanken* that must destroy/alter the original guiding 'wave' at the interaction (in an essentially unpredictable manner as entailed by Heisenberg's uncertainty principle on the basis of repeated physical observations).

Moreover, such an interaction must prevent not only the subsequent emergence of an interference pattern on a screen—which can be treated as recording a photon's 'presence' *only* if a 'crest' of the guiding 'wave' intersects the screen—but also determination of any 'initial' values of the state of the photon that could be expressed as an algorithmically *computable* function which would predict the future path of the photon⁵⁵⁶.

In other words, since any knowledge of the past, or putative future, path of the photon can only be expressed mathematically as a function on the basis of physical measurements, the path of the photon can only be treated as represented by an algorithmically *verifiable*, but not algorithmically *computable*, function that is deterministic, but not predictable.

The ability to probabilistically predict the future path of the photon, after an interaction, then reflects the fact that any finite sequence of natural numbers obeys an *intrinsic* 'law'—given by its associated, *unique*, Gödel's β -sequence⁵⁵⁷—which algorithmically *computes* all the subsequent

⁵⁵⁵An interpretation that, from the *evidence-based* perspective of this investigation, is more faithful to the 'digital' (i.e., 'discrete' as opposed to 'continuous') nature of how we seemingly not only sense, but actually record and categorically communicate (by means of mathematical languages such as Church's λ -calculus or its 'equivalent' by §2.E.b., Theorem 2.17, the first-order Peano Arithmetic PA), our perceptions of the universe we inhabit.

⁵⁵⁶If we assume that the previous path of the photon was dictated by an algorithmically *computable* function; such as, for instance, the *unique* Gödel β -function (see §16.A.) associated with any 'arithmetisation' that associates *unique* Gödel numbers to each past value of the function; since the path of the photon can then be treated as *uniquely* discrete from 'crest' to 'crest' (or, alternatively, from 'interaction' to 'interaction') and not continuous.

⁵⁵⁷See §16.A.: *Gödel's β -function*.

elements of the sequence *uniquely*, *provided* there is no external interaction that obeys a different law—such as, say, Schrödinger’s equation—for determination of the immediately succeeding member of the sequence after the interaction.

If we, further, hypothesise that:

- (i) like ‘infinite’ processes (see §20.D.b., Thesis 9), ‘point’ particles do not exist in natural phenomena, but every particle in the double-slit experiment is a ‘viscous’ object with a finite ‘radius’ r ; and
- (ii) such a viscous object—akin to, say, a drop of mercury on a plane surface—can, in principle, be separated into two by a sharp ‘blade’, but not by a ‘thin’ (relative to r) ‘filament wire’;

then this could account for the differing interference patterns perceived when one of the two slits is blocked in the double-slit experiment.

Comment 198. We speculatively offer for consideration, without further comment, whether a recent attempt, by N. Gurappa [Grp22], to provide a *non-dualist* foundation for the double-slit phenomena, when perceived as a *limiting* case ‘of the relative frequency of detection’, could—when viewed from the *gedanken* in §20.C. and §20.D., Cases 20.C.a. to 20.D.c.—be compatible with the above *evidence-based* perspective of the essential ‘discreteness’ in our observation, and symbolic expression, of natural phenomena :

“A new ‘wave-particle non-dualistic interpretation at a single-quantum level’ is presented by showing the physical nature of Schrödinger’s wave-function as an ‘instantaneous resonant spatial mode’ to which a particle’s motion is confined. The initial phase associated with a state vector is identified as related to a particular eigenstate of an observable and hence, the Born rule is derived as a limiting case of the relative frequency of detection along with an augmentation of a geometrical interpretation. This derivation automatically resolves the measurement problem. The Copenhagen interpretation is shown to be the statistical average of the non-dualistic interpretation. The position eigenvalues of a moving particle’s eigenstate lie on a classical path of least action—resulting in the equality of quantum mechanical and classical times. This equality reveals the emergence of classical world from the underlying quantum world. “What’s really happening?” in Young’s double-slit experiment is explained at a single-quantum level. An interference experiment is proposed to verify the instantaneous nature of the wave-function.”

... Gurappa: [Grp22], Abstract

However, the Bohm-de Broglie interpretation appealed unappealingly to:

- hidden variables⁵⁵⁸; and, presumably,
- hidden natural laws that—we may reasonably presume further as reflecting the mathematical paradigms of the day—were implicitly assumed by Bohm to be representable only by well-defined classical algorithmically *computable* functions which could, in principle, be considered as having pre-existing or predetermined mathematical values over the domain over which the functions are well-defined.

Comment 199. We note an objection of current paradigms to Bohm’s interpretation is that:

⁵⁵⁸“This terminology is, however, particularly unfortunate in the case of the de Broglie-Bohm theory, where it is in: the supplementary variables—definite particle positions—that one finds an image of the manifest world of ordinary experience”. [Sh+11].

"...any hidden-variable theory faces the bijection problem $\aleph_0 \not\leftrightarrow 2^{\aleph_0}$ for quantum states and their measurements, a paradox that affects Everett's multiverse interpretation as well as any hidden-variable theory in QM, relativistic and non-relativistic alike."

... Gauthier: [Ga15], Ch.5, §5.17.1, *Arithmetical Foundations for Physical Theories*, p.114.

We show in §16., though, that the objection dissolves once we recognise the denumerability of both algorithmically *verifiable* number-theoretic functions (§2., Definition 7) and algorithmically *computable* number-theoretic functions (§2., Definition 10).

Moreover, in 1964 John Stewart Bell proved theoretically ([B164]) that:

- (i) Any interpretation of Quantum Theory which appeals to local hidden variables in the above, classical, algorithmically *computable*, sense must necessarily be non-local—i.e., admit information between two spatially separated locations to travel faster than the speed of light—which would conflict with the deterministic mathematical representation of the laws of Special Relativity;
- (ii) It can be experimentally verified whether our physical reality admits local hidden variables in the above sense.

I. Introduction "The paradox of Einstein, Podolsky and Rosen [1] was advanced as an argument that quantum mechanics could not be a complete theory but should be supplemented by additional variables. These additional variables were to restore to the theory causality and locality [2]. In this note that idea will be formulated mathematically and shown to be incompatible with the statistical predictions of quantum mechanics. It is the requirement of locality, or more precisely that the result of a measurement on one system be unaffected by operations on a distant system with which it has interacted in the past, that creates the essential difficulty. There have been attempts [3] to show that even without such a separability or locality requirement no "hidden variable" interpretation of quantum mechanics is possible. These attempts have been examined elsewhere [4] and found wanting. Moreover, a hidden variable interpretation of elementary quantum theory [5] has been explicitly constructed. That particular interpretation has indeed a grossly non-local structure. This is characteristic, according to the result to be proved here, of any such theory which reproduces exactly the quantum mechanical predictions."

... Bell: [B164], pp.195-199.

II. Formulation "With the example advocated by Bohm and Aharanov [6], the EPR argument is the following. Consider a pair of spin one-half particles formed somehow in the singlet spin state and moving freely in opposite directions. Measurements can be made, say, by Stern-Gerlach magnets, on selected components of the spins $\vec{\sigma}_1$ and $\vec{\sigma}_2$. If measurement of the component $\vec{\sigma}_1 \cdot \vec{a}$, where \vec{a} is some unit vector, yields the value +1 then, according to quantum mechanics, measurement of $\vec{\sigma}_2 \cdot \vec{a}$ must yield the value -1 and vice versa. Now we make the hypothesis [2], and it seems one at least worth considering, that if the two measurements are made at places remote from one another the orientation of one magnet does not influence the result obtained with the other. Since we can predict in advance the result of measuring any chosen component of $\vec{\sigma}_2$, by previously measuring the same component of $\vec{\sigma}_1$, it follows that the result of any such measurement must actually be predetermined. Since the initial quantum mechanical wave function does *not* determine the result of an individual measurement, this predetermination implies the possibility of a more complete specification of the state.

Let this more complete specification be effected by means of parameters λ . It is a matter of indifference in the following whether λ denotes a single variable or a set, or even a set of functions, and whether the variables are discrete or continuous. However we write as if λ were a single continuous parameter. The result A of measuring $\vec{\sigma}_1 \cdot \vec{a}$ is then determined by \vec{a} and λ , and the result B of measuring $\vec{\sigma}_2 \cdot \vec{b}$ in the same distance is determined by \vec{b} and λ and:

$$A(\vec{a}, \lambda) = \pm 1, B(\vec{b}, \lambda) = \pm 1 \quad (1)$$

The vital assumption [2] is that the result B for particle 2 does not depend on the setting \vec{a} , of the magnet for particle 1, nor A on \vec{b} .

If $\rho(\lambda)$ is the probability distribution of λ then the expectation value of the product of the two components $\vec{\sigma}_1 \cdot \vec{a}$ and $\vec{\sigma}_2 \cdot \vec{b}$ is

$$P(\vec{a}, \vec{b}) = \int d\lambda \rho(\lambda) A(\vec{a}, \lambda) B(\vec{b}, \lambda) \quad (2)$$

This should equal the quantum mechanical expectation value, which for the singlet state is

$$\langle \vec{\sigma}_1 \cdot \vec{a} \vec{\sigma}_2 \cdot \vec{b} \rangle = -\vec{a} \cdot \vec{b}. \quad (3)$$

But it will be shown that this is not possible.

Some might prefer a formulation in which the hidden variables fall into two sets, with A dependent on one and B on the other; this possibility is contained in the above, since λ stands for any number of variables and the dependences thereon of A and B are unrestricted. In a complete physical theory of the type envisaged by Einstein, the hidden variables would have dynamical significance and laws of motion; our λ can then be thought of as an initial values of these variables at some suitable instant."

... Bell: [B164], pp.195-199.

“VI. Conclusion In a theory in which parameters are added to quantum mechanics to determine the results of individual measurements, without changing the statistical predictions, there must be a mechanism whereby the setting of one measuring device can influence the reading of another instrument, however remote. Moreover, the signal involved must propagate instantaneously, so that such a theory could not be Lorentz invariant."

... Bell: [B164], pp.195-199.

The significance of Bell’s argumentation for the *EPR* paradox—and Bohr’s interpretation of it—lay in the fact that Bell’s argument did not refer to any particular theory of local hidden variables.

However, what it showed conclusively was that nature violates the most general assumptions behind *any* mathematical theory that admits *only* classical, algorithmically *computable* functions and relations—which are both *determinate* and *predictable*—for faithfully representing our conceptual metaphors of experimental observations.

In other words, no combination of local deterministic and local ‘random’ hidden variables—classically assumed as mutually independent—can reproduce in such a theory the phenomena predicted by quantum mechanics and repeatedly observed in experiments.

Moreover, Bell defined inequalities that could distinguish between the expected behaviour of entangled particles under the hypothesis of a quantum theory that appeals to local hidden variables in the above sense, and their expected behaviour under a quantum theory that is not constrained by such local, algorithmically *computable*, hidden variables.

When put to the test, the overwhelming results of various experiments designed to study the actual behaviour of entangled particles has subsequently been accepted⁵⁵⁹ as conclusively

⁵⁵⁹In recognition, the Royal Swedish Academy of Sciences awarded the *Nobel Prize in Physics 2022* to Alain Aspect, John F. Clauser, and Anton Zeilinger “for experiments with entangled photons, establishing the violation of Bell inequalities and pioneering quantum information science”.

showing that quantum theory cannot admit any local, algorithmically *computable*, hidden variables.

In a 1985 BBC radio interview, Bell apparently sought to place his argumentation in a broader philosophical perspective by reportedly remarking that the *EPR* argument might yet be salvaged by appeal to non-local hidden variables which—presumably reflecting the mathematical paradigms of the day and age—could also be taken to define only algorithmically *computable* functions and relations that, again, are both *determinate* and *predictable*.

Such a solution however, he argued, might demand a philosophically unaffordable, and psychologically inhuman, price: *super-determinism*. Thus:

“There is a way to escape the inference of superluminal speeds and spooky action at a distance. But it involves absolute determinism in the universe, the complete absence of free will. Suppose the world is super-deterministic, with not just inanimate nature running on behind-the-scenes clockwork, but with our behavior, including our belief that we are free to choose to do one experiment rather than another, absolutely predetermined, including the ‘decision’ by the experimenter to carry out one set of measurements rather than another, the difficulty disappears. There is no need for a faster-than-light signal to tell particle *A* what measurement has been carried out on particle *B*, because the universe, including particle *A*, already ‘knows’ what that measurement, and its outcome, will be.”

... Bell: Quotation from [DB93], pp.45-46; reportedly an adaptation from the edited transcript of a 1985 BBC radio interview with John Stewart Bell.

From an *evidence-based* perspective (see 7.C.), we shall now argue that it is essentially the illusory barrier of *super-determinism* that has prevented classical mechanics and quantum mechanics from being seen as two, complementary and not contradictory, pieces of the key that would allow us to correspond—without appealing to non-locality—every element of physical reality to a unique, algorithmically *verifiable* but not necessarily algorithmically *computable* (see §7.G.), physical quantity in some putative mathematical representation of a putative universe which could admit all of our conceptual metaphors that faithfully reflect observations of the elements of physical reality (in the sense of §13.C.).

Comment 200. We note that, in a recent preprint [Alr24], Valia Allori cogently argues that ‘there are no valid reasons to endorse superdeterminism’:

“It is commonly accepted that the violation of Bell’s inequality shows that reality is nonlocal. That is, it is possible for the mutual influence between arbitrarily distant systems to be instantaneous. The pilot-wave theory is a deterministic theory of particles which reproduces all the predictions of quantum theory, including the violation of the above-mentioned inequality, and which is explicitly nonlocal. Many have resisted this nonlocality conclusion because they think that nonlocality is in tension with the special theory of relativity, according to which everything, including influences, travels at most at the velocity of light. This is the reason why some are willing to deny an assumption used to derive Bell’s inequality, namely statistical independence, which was taken so far to be undeniable, in order to save locality. Hidden variable theories in which statistical independence is false are called superdeterministic. In this paper I wish to compare and contrast these two strategies. On the one hand we have the pilotwave theory, which is nonlocal and in which statistical independence is true, and on the other hand we have superdeterministic theories which are local but violate statistical independence.”

... Allori: [Alr24], §1. Introduction.

“Let’s grant that Bell’s theorem has proven that reality is nonlocal. One theory which respects this theorem is the pilot-wave theory, a hidden variable theory which is

explicitly nonlocal. In this theory position is the only genuine property and in general experiments do not measure something other than the system-apparatus interaction. That is, operators represent contextual properties, which are not genuine natural properties. Some have tried to resist the nonlocality conclusion by rejecting the hypothesis of statistical independence: all experimental results are determined by the type of experiment we wanted to make. These superdeterministic hidden variable theories would then be local, but they would be such that making experiments on a sample will not give us information about the type of system under investigation. I have shown that this makes superdeterministic theories uninformative, unfalsifiable, and unconfirmable. Moreover, rejecting statistical independence makes sense only assuming that all hidden variables are contextual: they are not genuine properties which can be revealed by measurements. Nonetheless, even if the pilot-wave theory and superdeterminist theories are both contextual, their similarities end there. And while there is a reason for the contextuality of the pilot-wave theory, no such reason exists in superdeterministic theories, whose contextuality is therefore mysterious and ad hoc. It has been argued that retaining locality would be a desideratum for making quantum mechanics and relativity compatible. However, since locality has to come together with superdeterminism, it is not going to help with much at all. Therefore, I believe that there are no valid reasons to endorse superdeterminism."

... Allori: [Atr24], §6. Conclusions.

Prima facie, Allori implicitly assumes here that the hidden variables of the pilot-wave theory can *only* evidence themselves in a mathematical model as algorithmically *computable* functions that, by definition, are *both* deterministic and predictable; which would entail nonlocality in the model if statistical independence is essential.

However, as we argue in the next section, this does not admit the possibility that, since the nature of any measurements at the quantum scale are, by the very definition of an experimental model (see §23.D.g., Query 30), statistically independent, the hidden variables of the pilot-wave theory can only evidence themselves in the mathematical model as algorithmically *verifiable* (hence deterministic) functions which are algorithmically *uncomputable* (hence unpredictable); which would not entail nonlocality in the model whilst preserving statistical independence.

23.B.a. An *evidence-based* perspective of *EPR*, Bohm's *hidden variables*, and Bell's equations

In other words, our foundational investigations into the (apparently unrelated) area of evidence-based and finitary interpretations of the first order Peano Arithmetic PA ([An16]) (see §2.) now suggest that:

- If our above presumption concerning an implicit consideration by Bohm and Bell—of *only* functions that are implicitly assumed to be classically *computable* algorithmically—is correct;

Comment 201. The following quote from [EPR35] supports our presumption that Einstein's—and presumably Bohm's—'more complete conception' of reality than that admitted by quantum theory demanded that all laws of nature—whether accessible to a mathematical representation explicitly, or implicitly as associated hidden variables—must be both *determinate* and *predictable*; thus implying that the functions and relations representing these laws mathematically are necessarily algorithmically *computable*:

"A comprehensive definition of reality is, however, unnecessary for our purpose. We shall be satisfied with the following criterion, which we regard as reasonable. *If, without in any way disturbing a system, we can predict with certainty (i.e., with probability equal to unity) the value of a physical quantity, then there exists an element of physical reality corresponding to this physical quantity.*"

... *op. cit.*

- and Bell's λ (in [B164], # II, Formulation) is essentially a Tarskian interpretation that corresponds the algorithmically *computable* functions and relations of one mathematical language into putative algorithmically *computable* functions and relations of another, such that the latter can admit the probability distribution in Bell's equation (2) (in [B164], pp.196-199) which, however, appeals to an integration that is definable—albeit implicitly—*only* over algorithmically *computable* functions in classical real analysis;
- then the hidden variables in the Bohm-de Broglie interpretation of Quantum Theory could as well be presumed to involve natural laws which are mathematically representable *only* by functions that are algorithmically *verifiable* (see §2., Definition 7), but not algorithmically *computable* (see §2., Definition 10)—hence mathematically determinate but unpredictable even by Laplace's *vast intelligence* (see §7.I.a.);

Comment 202. In other words, if Bell's parameter λ in [B164] (# II, Formulation) associates the result A of measuring $\vec{\sigma}_1 \cdot \vec{a}$ with putative, algorithmically *verifiable* but not algorithmically *computable*, functions:

$$A(\vec{a}, \lambda) = \pm 1, B(\vec{b}, \lambda) = \pm 1$$

then the probability distribution ρ of λ cannot be assumed to yield the expectation value of the product of the two components $\vec{\sigma}_1 \cdot \vec{a}$ and $\vec{\sigma}_2 \cdot \vec{b}$ as defined in [B164], equation (2).

Comment 203. That Bell assumes 'unjustified'⁵⁶⁰ properties of 'expectation value functions' in [B164]—which could be interpreted as introducing a 'circularity' in his reasoning—is cogently argued by Joy Christian in a preprint [Chs24]:

"Bell's theorem [1] is an impossibility argument (or "proof") that claims that no locally causal and realistic hidden variable theory envisaged by Einstein [2] that could "complete" quantum theory can reproduce all of the predictions of quantum theory. But some such claims of impossibility in physics are known to harbor unjustified assumptions. In this paper, I show that Bell's theorem against locally causal hidden variable theories is no exception. It is no different, in this respect, from von Neumann's theorem against all hidden variable theories [3], or the Coleman-Mandula theorem overlooking the possibilities of supersymmetry [4]. The implicit and unjustified assumptions underlying the latter two theorems seemed so innocuous to many that they escaped notice for decades. By contrast, Bell's theorem has faced skepticism and challenges by many from its very inception (cf. footnote 1 in [5]), including by me [5–16], because it depends on a number of questionable implicit and explicit physical assumptions that are not difficult to recognize [10, 16]. In what follows, I bring out one such assumption and demonstrate that Bell's theorem is based on a circular argument [9]. It unjustifiably assumes the additivity of expectation values for dispersion-free states of hidden variable theories for non-commuting observables involved in the Bell-test experiments [17], which is tautologous to assuming the bounds of ± 2 on the Bell-CHSH sum of expectation values. Its premises thus assume in a different guise what it sets out to prove. Once this oversight is ameliorated from Bell's argument, the local-realistic bounds on the Bell-CHSH sum of expectation values work out to be $\pm 2\sqrt{2}$ instead of ± 2 , thereby mitigating the conclusion of Bell's theorem. As a result, what is ruled out by the Bell-test experiments is not local realism but the additivity of expectation values, which does not hold for non-commuting observables in dispersion-free states of hidden variable theories to begin with."

... Christian: [Chs24], §1, Introduction.

- in which case Bohm's interpretation might avoid being held as admitting 'non-locality' by Bell's reasoning.

⁵⁶⁰As emphasised by Professor Christian in a personal communication with the author.

From the *evidence-based* perspective of [An16] (see §2.), we thus conclude from *EPR*'s and Bell's argumentations that:

- If any putative, well-defined, mathematical model $M(U)$ of a putative universe U (such as, for instance, the putative universe defined mathematically in §20.D.c.) which seeks to faithfully describe some states of the universe U at any time t —starting from a putative time t_0 —admits interactions with elements that are not defined in the model $M(U)$ —such as the the measurement $\vec{\sigma}_1 \cdot \vec{a}$;

Comment 204. We note that admitting such extraneous interactions into the mathematical model U of the putative universe being considered⁵⁶¹ is prohibited in [EPR35], whose argument is predicated on the stipulation that in any complete mathematical representation of our observations of physical phenomena “we can predict with certainty (i.e., with probability equal to unity) the value of a physical quantity”.

- then, by definition, it is incomplete and must admit a conservative extension U_1 of U with a well-defined mathematical model $M_1(U)$ that admits the extraneous measurement $\vec{\sigma}_1 \cdot \vec{a}$;

Conservative extension: A theory T_2 is a (proof theoretic) conservative extension of a theory T_1 if the language of T_2 extends the language of T_1 ; that is, every theorem of T_1 is a theorem of T_2 , and any theorem of T_2 in the language of T_1 is already a theorem of T_1 .

- and, moreover, U_1 must similarly admit a conservative extension U_2 of U_1 with a well-defined mathematical model $M_2(U)$ that admits the extraneous measurement $\vec{\sigma}_2 \cdot \vec{b}$.

Comment 205. That the criteria of what can be, and what cannot be, treated as a conservative extension of a formal mathematical theory is misleading from an *evidence-based* perspective, and not *well-defined* in current paradigms of classical mathematics, is highlighted by §19., Corollary 19.3 and, independently, by §19.A., Theorem 19.4.

Suffice to say that neither [EPR35] nor Bell's [Bl64] address the question—implicit in Bell's formal expression of the *EPR* paradox as above—of whether the interpretation λ admits algorithmically *verifiable* functions and relations, or whether it—and *EPR*—implicitly assume that the mathematical models of U , U_1 , and U_2 must admit *only* algorithmically *computable* functions and relations.

Nor do they seem to admit the perspective that any mathematical theory—intended to unambiguously represent the conceptual metaphors (in the sense of [LR00]; see also §27.) that seek to faithfully describe our observations of physical phenomena—must:

- not only have a well-defined *proof-theoretic* logic (in the sense of §12., Definition 32) that unambiguously assigns *evidence-based* values—of formal *provability* from the axiomatic assumptions of the theory—to the formal propositions of the theory;
- but also admit a well-defined *model-theoretic* logic (in the sense of §12., Definition 33) that unambiguously assigns *evidence-based* values—of *truth* under an interpretation—to the formal propositions of the theory.

⁵⁶¹Compare: §23.D.g., Query 30.

From an *evidence-based* perspective, the significance of Bell’s argumentation is that it highlights the fact that the *EPR* paradox, and other paradoxes of quantum theory, are only *local* mathematical paradoxes (as highlighted further in §20.) in the mathematical language in which the theory seeks to faithfully represent the conceptual metaphors that reflect our sensory perceptions of an external reality; they should not be conflated with any philosophical considerations of the nature and substance of our sensory perceptions of the external reality.

The fact that we can admit functions and relations which are algorithmically *verifiable* but not algorithmically *computable* (see §7.G.)—hence interpretable as ‘deterministic’ but not ‘predictable’—into a well-defined, categorical, mathematical theory such as the first-order Peano Arithmetic PA illustrates this point.

In other words, from an *evidence-based* perspective, the *EPR* paradox simply shows that any mathematical theory which seeks to faithfully represent the conceptual metaphors that reflect our sensory perceptions of an external reality is incomplete in the sense that it cannot predict—in the sense of formal provability from the logic and axiomatic assumptions of the theory—the consequences of a relationship between the terms of the theory, and elements that are not axiomatically defined as terms of the theory, but which might be capable of being introduced post-facto as terms into a conservative extension of the theory—as is suggested in the *evidence-based* mathematical interpretation of Schrödinger’s *gedanken* in §23.D.h. (see also §23.D.g., Query 30).

23.B.b. Dissolving the Bohr-Einstein debate

The significance of *evidence-based* reasoning is also highlighted in the case of the Bohr-Einstein debate (see [Boh49]; [Ei36]; [Ei36a], §5, p.371), on whether or not every element of physical reality can be corresponded—without appealing to non-locality—to a unique physical quantity in some putative mathematical representation of a putative universe which admits all of our conceptual metaphors that faithfully reflect observations of the elements of physical reality.

It turns out that the debate dissolves (compare with the dissolution of the, foundationally parallel, Poincaré-Hilbert debate in §2.D.; see also §13.F.(1)-(3)) since:

- (a) **Einstein’s contention** is validated if we accept that every conceivable state of energy distribution must occur at some instant in the mathematical model, say $M(\mathcal{U})$, considered in §20.D.c. of a putative finite Universe \mathcal{U} that recycles endlessly from Big Bang to Ultimate Implosion, and which admits:
- all of our conceptual metaphors which faithfully reflect observations of the elements of physical reality;
 - Einstein’s equations;
 - classical quantum theory;
 - neo-classical functions and relations that are algorithmically *verifiable* but not algorithmically *computable* (whence the universe is *determinate* but not *predictable*, and therefore no cycle of states from a Big Bang to an Ultimate Implosion can ever be repeated recursively);
 - locality in all interactions (since there is no separation of ‘system’ and ‘observer’ *within* the putative—essentially *determinate* but *unpredictable*—universe \mathcal{U} , mathematically represented by $M(\mathcal{U})$, that would require some values to be determinate only at some future instant of ‘observation’ *after* an ‘interaction’);

whilst:

- (b) **Bohr's contention**, supported by the experimental evidence provided by Bell's inequalities, is also validated if we accept that:
- no mathematical representation, say L ,
 - of a putative universe, say U , that admits all of our conceptual metaphors (see [LR00]; see also §27.) which faithfully reflect observations of the elements of physical reality in U ,
 - can admit only classical algorithmically *computable* functions and relations (which are necessarily both *determinate* and *predictable* by §2.E.b., Theorem 2.17), since:
 - every observation (which we can informally view as corresponding to Carnap's *explicandum* in [Ca62a]) of a physical process in U ,
 - that is sought to be formally represented (in the sense of §13.C.) by a classical—presumably first-order, categorical, and therefore determinate and predictable—mathematical representation in L (which we can informally view as corresponding to Carnap's *explicatum* in [Ca62a]),
 - such that any well-defined model M_L of L can be said to *empirically* model U ,
 - is an *empirical* meta-statement about L , and ipso facto about M_L ,
 - that cannot be unrestrictedly assumed to be well-definable within L , or within M_L (see §3.; also §15.H.),
 - without risking the paradoxes of impredicativity (see §20.C.).

As argued in §20.C., Cases §20.C.a. to §20.D.c.:

- any classical representation of some physical processes of U in a first-order mathematical language L ,
- could entail Cauchy sequences and associated Cauchy limits within L ,
- at points corresponding to observations in U ,
- which might constitute discontinuities in the state of the process within U ,
- but which are not discontinuities within the mathematical representation L of the system U , or within any of the well-defined models M_L of L ,
- since any observations by an observer in U cannot be assumed well-definable within the intended mathematical representation L of U , or within any of the well-defined models M_L of L ,
- without risking the paradoxes of impredicativity (see §20.C.).

Thus, one could conceivably argue that the consequences of any interaction between an observer in U with that which is sought to be observed in U :

- can only be subject to deterministic probabilistic laws,

- that entail only the probable states of the physical process after an observational interaction whose consequences are not well-definable—hence predictable—within any mathematical representation L of U and/or any of the well-defined models M_L of L .

Moreover, any observation of a physical process in U is an interaction which, essentially, adds (as implicitly argued in [EPR35]) new—hence unpredictable—elements to an existing quantum-mathematical description L of U ; elements which would thus be determinate, but unpredictable, in any conservatively extended, quantum-mechanical, representation L_1 of L , to even a notional, omnipotent, ‘external’ observer in U of the model M_{L_1} of L_1 —as argued in §23.D.h., Thesis 23 (see also §23.D.g., Query 30).

Comment 206. In other words, the question of whether, and to what extent, any Model M_L of L succeeds in faithfully representing the structure U mathematically (in the sense of Carnap’s *explicatum* and *explicandum* in [Ca62a]), is an *empirical* question for the cognitive sciences (cf. [LR00]; see also §27.) that cannot be assumed to be theoretically decidable mathematically (compare also §1., Definition 1).

The significance of this distinction is highlighted by Mihir Singh’s insightful thesis in [Mhr23]; where he, too, argues that Einstein’s and Bohr’s perspectives on how our observations of quantum phenomena ought to be interpreted should be treated as complementing each other within our inherited ‘classical conceptual framework’ by only ‘widening of the scope of the framework in several instances’; such as, for instance, distinguishing between *classic* algorithmically *computable* functions—which can be interpreted as representing phenomena that are both deterministic and predictable; and *Gödelian* functions that are algorithmically *verifiable* but not algorithmically *computable* (as described in §23.A.a.)—which can be interpreted as representing phenomena that are deterministic but not predictable.

Such a distinction could be viewed as corresponding to Singh’s ascribing to Bohr proposal of ‘*a new way in which these classical concepts are applied, a new way in which the classical conceptual framework is used to interpret and explain phenomena, the principle of complementarity, according to which different conceptual explanations took place mutually exclusively such that the different parts of explanation taken together form a complete description of the quantum process*’.

Moreover, Singh cogently challenges conventional perspectives; which he seemingly perceives as doing less than justice to Bohr’s insights—and their complementarity to those of Einstein—by ascribing a discordancy between ‘*two different lights in which Bohr’s idea of classical concepts is perceived. In one case, upon his insistence on the use of classical conceptual framework to order, communicate and visualise classical phenomena, it appears that Bohr posits unchanging indispensable categories. On the other hand, by including the widening of the scope of the framework or by talking about alteration in view points, it appears that these categories appear to be changing according to Bohr. We argue that the problem is only an apparent one which vanishes upon a closer analysis*’:

“Ever since the first experiments, which would later be identified as quantum mechanical experiments, it was clear that the classical physical theories which had been the canon of physical science since a very long time would be inadequate to give a proper account of the physical phenomena that was observed in those experiments. For physics of the time, a revolutionary physical theory was not something new as Einstein, through his monumental papers in 1905, had already established that the classical physical theories were not sacrosanct. Within two decades of the revolution in the study of spacetime, a new revolution occurred in the study of matter, motivated by various, apparently disconnected experiments. The Quantum Mechanical framework was thus developed as a physical theory based on these experimental evidences, while having almost no standard metaphysical background that was agreed upon by the pioneers of the field. The theory that came about was a mathematical formalism developed without any metaphysical structure to inform its mathematics, and hence the task of

understanding of the theory in physical or metaphysical terms became an a posteriori objective which the early developers of the mathematical formalism of the theory and the philosophers of science of the age had to take up.

The mathematical formalism of the theory was such that, having evolved in view of phenomena alone, it did not immediately lead to any unambiguous metaphysical interpretation. One could not simply read off the ontology and the dynamics, the metaphysical structure, and the causal relations directly from the mathematical framework . . . Rather, it proved to be very difficult to do so in view of certain novel principles which appeared to be running under the experimental observations and the resulting mathematical structure of the theory. Amongst many problems of the theory were the problems of non-locality and instantaneous action motivated by correlations that were impossible, as Bell later proved, to explain through a local causal mechanism, the problem of the ontological status and reality of the wavefunction, the problem of superposition which disallowed the existence of definite values of various properties of the quantum entities unless observed under specific experimental conditions, and not to mention the uncertainty principle that disallowed certain pairs of properties to have exact values simultaneously.

In this regard, the question of a complete change in the conceptual framework that was used to understand physical theories as such became a relevant proposal. Schrödinger in one of his correspondences with Bohr talks about the “the introduction of new concepts” (cited in (Bitbol & Osnaghi, 2016)) that would change the very way in which we think about matter, space, time and so on. Before the development of the quantum mechanical framework, the physical science enterprise had relied on the classical conceptual framework to construct theories which were required to explain new physical phenomena that could not be incorporated in the previous physical theories. This was also so because in most of the cases before the development of the physical theory the metaphysical structure of the world was considered before, and the theory generally precipitated as the mathematical formalism informed by the metaphysical structure that was assumed. As a result the conceptual framework as such was never questioned [from] within . . . as it was presupposed in theory building, and no previous observations had challenged it to the extent that quantum mechanical experiments suggested. On the other hand, quantum mechanics, having been developed with experimental evidence in view alone and without having a prior mathematical picture, required a posterior application of the classical conceptual framework in the explanation of the metaphysical structure of the theory. Hence it became imperative to either find a consistent metaphysical visualisation of the complete quantum picture, or change the very concepts that are used in that metaphysical picture and find new quantum concepts, as suggested by Schrödinger in his letter above, to explain the world in a completely different way.

In this regard, Bohr, as a philosopher-physicist, was persistent on the indispensability of the classical conceptual framework. Throughout his academic life, Bohr remained adamant that the classical concepts and classical concepts alone constitute the framework that can be used to explain any physical phenomena. The physical description then must be given in terms of those very classical concepts. But, at the same time, for Bohr there was something inherent in quantum mechanics that did not allow for an unambiguous application of the classical conceptual framework in its entirety. Therefore, for him, quantum mechanics came along with a recognition that the classical conceptual framework, although necessary and being the only conceptual framework that can be used to provide a physical description, was limited and could not give a complete physical description of the quantum phenomena in the way that was possible in classical physics. This then led him to propose a new way in which these classical concepts are applied, a new way in which the classical conceptual framework is used to interpret and explain phenomena, the principle of complementarity, according to which different conceptual explanations took place mutually exclusively such that the different parts of explanation taken together form a complete description of the

quantum process.

Recent attempts at the interpretation of quantum mechanics have seen a shift away from Bohr. The rejection of thought that a Bohrian doctrine is often faced with can be rightly pointed out to the questions that an interpretation of quantum mechanics is supposed to answer. In the recent past, evaluation of every philosophical doctrine on quantum theory has presupposed a set end, an interpretation of quantum mechanics culminating in a metaphysics of quantum theory. To this end, the Bohrian doctrines have not fared well against the other interpretations of quantum mechanics. But this is not to be seen as a defeat of Bohrian thought. Rather, it is a mark of philosophical closed-mindedness that disallows raising questions which are unconventional and unorthodox."

... Singh: [Mhr23], §1 Introduction.

"Having looked at the problem that Bohr was facing and an outline of the epistemological thesis that we will develop in a later section, let us go over to Bohr's own writings and try to understand what is it that he had in mind when he talked about conceptual frameworks and the persistence of the classical concepts. Although expositions of Bohrian Philosophy in general are available in abundance which try to look at the various strands of arguments arising from Bohr (Folse (1985), Honner (1982), Bitbol and Osnaghi (2016), Bitbol (2017), Cuffaro (2010), (Camilleri, 2007) to mention a few), an independent exposition will help us understand the existing problem with all the required clarity.

Bohr's doctrines are not concerned with the questions of ontology, or of dynamics, as much as they are concerned with the new epistemological problems that arise from the Quantum Mechanical framework. Hence, for Bohr, the primary question was not one of a consistent metaphysical structure of the quantum theory, instead Bohr was concerned with questions like: Whether physical description of phenomena in quantum mechanics resemble the physical description of phenomena in classical physical theories? In this regard, we may even consider Bohr to be some sort of a meta-metaphysicist, in that his doctrines appear to constraint any future metaphysics of Quantum Mechanics. It is precisely this constraint that we will consider here, a constraint which we will call the doctrine of classical concepts.

Even though Bohr does not explicitly list what he considers to be the classical conceptual framework, or the conceptual schema on which the metaphysics of classical physical theories is based, we can easily take it from his writings that for him the classical conceptual framework stands for the concepts that we use in classical physics, constituting of concepts like position, momentum, particles, waves, energy, and so on. For Bohr, the primary problem with quantum mechanics is that we cannot unambiguously apply the classical conceptual framework to develop a metaphysics of quantum mechanics, in fact, it is difficult to explain simplest experiments without running into troubles, for example, the simultaneous application of the concept of position and momentum to the quantum entity.

At the same time, the constraint that Bohr applies to the metaphysics of quantum mechanics is an indispensability doctrine. To begin understanding the doctrine, let us begin with a fundamental idea of Bohrian thought:

"all knowledge presents itself within a conceptual framework." (Bohr, 1958)

Therefore, we see that for Bohr, there is nothing as 'raw' information that we receive when we observe a phenomena, therefore, whenever we try to theorise or conceptualise the workings that may be behind the phenomena, the phenomena itself is concept-laden. In its very being as knowledge, it is required that the phenomena and the information we receive from it is necessarily within a conceptual framework. In so far we consider this statement, Bohr's thought appear[s] to resoundingly correspond with Kantian or Pragmatic thought. Studies in this direction can be found in abundance. Since a parallel with either school is not our concern in this paper, we would skip this and move forth.

But Bohr was not satisfied with the mere association of a conceptual framework with knowledge, for him, the conceptual framework that persists and pervades all physical descriptions was the classical conceptual framework, the same classical conceptual framework that is used to provide a physical description in classical theories.

“...our interpretation of the experimental material rests essentially upon the classical concepts.” (BOHR, 1928)

There were multiple arguments which Bohr mobilises to this end. One of these arguments is the argument of communicability.

“... the requirement of communicability of the circumstances and results of experiments implies that we can speak of well defined experiences only within the framework of ordinary concepts” (Bohr, 1937)

In so far as we have to communicate the description of the experimental apparatus, and the results of the experiments, we must do so within the classical conceptual framework, the framework of ordinary concepts or the framework that we utilise in the explanation of ordinary things. We will take a look at this argument in greater detail later.

We also see that Bohr, in his correspondence with Schrödinger, upon the urge by the latter to shift to a new conceptual framework, tries to argue saying “The ‘old’ experimental concepts seem to me to be inseparably connected with the foundation of man’s powers of visualising.” (quoted in (Bitbol & Osnaghi, 2016)) This points to another way in which the argument is made for the classical concepts, that is the classical concepts become as essential part of our physical description because they are inherently linked with our powers of visualisation and pictorialisation. This points to the fact that the very idea of classical concepts must somehow be related to something inherent in pictorialisation, which we will later see to be the aspect of spatiality.

Given this, we also see Bohr insisting upon the widening of the scope of the framework in several instances.

“As our knowledge becomes wider, we must always be prepared, therefore, to expect alterations in the points of view best suited for the ordering of our experience.” (Bohr, 1934)

Since its inception, quantum mechanics challenged many metaphysical presumptions of the classical physical theories. How could we then apply the classical conceptual framework to provide a physical description of the quantum theory? This is where we see the introduction of the principles of complementarity, which allows the application of the classical conceptual categories in complement to each other, such that complementary categories cannot be simultaneously applied but the application of the categories to describe different parts of the quantum phenomena provides a complete physical description of the phenomena. This constitutes a new way of physical description of phenomena:

“a new mode of description designated as complementary in the sense that any given application of classical concepts precludes the simultaneous use of other classical concepts which in a different connection are equally necessary for the elucidation of the phenomena.” (Bohr, 1934)

Therefore, we see two different lights in which Bohr’s idea of classical concepts is perceived. In one case, upon his insistence on the use of classical conceptual framework to order, communicate and visualise classical phenomena, it appears that Bohr posits unchanging indispensable categories. On the other hand, by including the widening of the scope of the framework or by talking about alteration in view points, it appears that these categories appear to be changing according to Bohr. We argue that the problem is only an apparent one which vanishes upon a closer analysis.

Bohr in his insistence upon the alteration of the point of view is not talking about a change in the classical conceptual framework or the categories that constitute it.

Rather, Bohr is talking about an alteration in the way in which these categories (hence, the classical conceptual framework) are applied to provide a physical description of the phenomena. The change is thus in the application of the conceptual framework not the framework itself. The same is reflected in the following statement by Bohr in (Bohr, 1958):

The extension of physical experience in our days has, however, necessitated a radical revision of the foundation for the unambiguous use of our most elementary concepts . . .

The revision does not take place in the elementary physical concepts themselves, rather it takes place in the way in which we have learned to use them.

Given this understanding of Bohr, we see that the idea of a fixed classical conceptual framework, in that it is constituted by classical concepts that are present in the classical physical theories, is one that is necessary. But there appears to be no coherent justification of the same apart from fragmented references to language, visualisation, etc. We would base this necessity on the idea of physicality seen as spatio-temporality."

. . . Singh: [Mhr23], §2 Bohr's Classical Concepts: Fixed or Moving?

23.B.c. Aerts' 'overlooked solution' to the Einstein-Podolsky-Rosen paradox

Prima facie, the above argumentation (see also §24.) is essentially that outlined by Massimiliano Sassoli de Bianchi in [Bia18] and [Bia19], if we treat processes that are representable mathematically only by algorithmically *verifiable*, but not by algorithmically *computable*, functions and relations, as corresponding to those reportedly considered by Diederik Aerts in [Ae82]:

- where spatial separation in a physical process/experiment need not necessarily imply disconnection in the corresponding mathematical representation/model of the process/experiment;

and

- where, 'while describing the situation of bipartite systems formed by separate quantum entities, he was able to prove, this time in a perfectly constructive way, that quantum mechanics is structurally unable to describe these situations':

"To explain Aerts' solution, it is important to emphasize that EPR's reasoning is an *ex absurdum* one, that is, a reasoning which starts from certain premises and reaches a contradiction. What EPR have shown is that if their premises are assumed to be correct, then quantum theory has to be considered incomplete, as unable to describe all elements of reality of a physical system. Those who have taken seriously this conclusion thus tried to find remedies, for instance by supplementing the theory with additional variables for the quantum states, to allow position and velocity to have simultaneous definite values and escape the limitations of Heisenberg's uncertainty relations. This hidden variables program, however, subsequently met the obstacle of so called *no-go theorems*, drastically limiting the class of admissible hidden-variable theories.^{31–36}

The premise that was part of the EPR reasoning, as we explained, is that for two quantum entities that have interacted and flown apart, it was natural to expect that their spatial separation was equivalent to an experimental separation. In addition to that, EPR applied the quantum formalism to describe the situation, which means they implicitly also assumed that quantum mechanics is able to describe a system formed by *separate physical entities*. But since this produced a contradiction, one is forced to conclude that the assumption is incorrect, that is, that quantum mechanics is unable to describe separate entities.

Now, one may object that this is too strong a conclusion, in the sense that the only mistake committed by EPR was to expect that spatial separation would necessarily imply disconnection.

This expectation, as we know today has been overruled by numerous experiments, showing that by making sufficient efforts and taking all necessary precautions, experimental situations can indeed be created where microscopic entities, after having interacted, can remain interconnected, even when arbitrarily large spatial distances separate them. The mistake of EPR was therefore to think about a situation where there is no experimental separation between two entities, as a situation of actual experimental separation.

So, apparently problem solved: EPR-like experiments, like those performed by the group of Alain Aspect, have precisely shown that in the situation considered by EPR[,] quantum mechanics does actually provide the correct description of two quantum entities flying apart, since Bell's inequalities are violated, in accordance with the quantum predictions. Thus, one would be tempted to conclude that EPR reasoning is not valid. Well, yes and no. Yes, because at their time the possibility of producing these non-local/non-spatial states was a truly remarkable and totally unexpected possibility, based on classical prejudices, so the EPR *ex absurdum* reasoning was indeed applied to a wrong experimental situation, if such situation is considered to be correctly described by an entangled state. No, because the possibility of producing and preserving entangled states has very little to do with EPR's reasoning per se. Indeed, one can in principle also assume that experiments could be performed where instead of making efforts to preserve the quantum connectedness of the two flying apart entities, an effort is made instead to obtain the opposite situation of two flying apart entities eventually becoming perfectly disconnected, i.e., separated.

Experiments of this kind have never been worked out consciously, but these would indeed correspond to situations leading to the EPR paradox. In other words, the incompleteness of quantum mechanics is not revealed in the physical situation of quantum entities flying apart and remaining non-separate, as these are the situations which are perfectly well described by the quantum formalism (as the violation of Bell's inequalities proves), and there is no contradiction/paradox in this case, but by the experimental situations that can provide a disconnection, and which in the setting of EPR-like experiments would be interpreted as "badly performed experiments". These are precisely the situations that quantum mechanics would be unable to describe, certainly not by means of entangled states, as[,] if we assume it can, then we reach a contradiction.

Having clarified that the logical reasoning of EPR is not directly affected by the experimental discovery of entangled states, the question thus remains about the completeness of the quantum formalism, in relation to its ability to describe separate physical entities. It is here that Aerts' work join[s] the game. Indeed, among the topics of his doctoral research there was that of elaborating a mathematical framework for the general description of separate mathematical quantities. Aerts approached the issue using Piron's axiomatic approach to quantum mechanics, a very general formalism which was precisely:³⁷ "obtained by taking seriously the realistic point of view of Einstein and describing a physical system in terms of 'elements of reality.'" This allowed him to view the EPR work from a completely new angle. Indeed, while describing the situation of bipartite systems formed by separate quantum entities, he was able to prove, this time in a perfectly constructive way, that quantum mechanics is structurally unable to describe these situations."

... de Bianchi: [Bia18], §IV, *The Solution*, p. 7-9.

Thus, from the *evidence-based* perspective of this investigation, Aerts' argument is that:

- the 'shortcoming of quantum theory in describing separate systems cannot be detected at the level of states'
 - which are 'perfectly well described in quantum mechanics by so-called product states, that is, states of the tensor product $\psi \otimes \phi$,
 - * which are, presumably, algorithmically *computable*;
- 'but at the level of the properties,
 - which in the quantum formalism are described by orthogonal projection operators',

- * which, too, are implicitly presumed algorithmically *computable*
- if ‘certain properties of a bipartite system formed by separate components cannot be represented by algorithmically *computable* orthogonal projection operators’,
- * since such properties might be representable mathematically only in terms of some function or relation that is algorithmically *verifiable*, but not algorithmically *computable*.

As de Bianchi notes further:

“EPR were right about the incompleteness of quantum mechanics, but not for the reason they believed: quantum mechanics is incomplete because [it is] unable to describe separate physical systems. Of course, depending on the viewpoint adopted, this can be seen as a weak or strong trait of the theory. If separate systems exist in nature, then it is a weak trait, if they don’t, then it is a strong trait. We will come back on that in the conclusive section, but let us now sketch the content of Aerts’ constructive proof, which is actually quite simple.

Note that despite the simplicity of the proof, it usually comes as a surprise that quantum mechanics would have this sort of shortcoming. Indeed, the first reaction I usually get, when discussing Aerts’ result with colleagues, is that this cannot be true, as separate systems are perfectly well described in quantum mechanics by so-called product states, that is, states of the tensor product $\psi \otimes \phi$, where $\psi \in \mathcal{H}_A$ and $\phi \in \mathcal{H}_B$, with \mathcal{H}_A the Hilbert (state) space of entity A and \mathcal{H}_B that of entity B , the Hilbert space \mathcal{H} of the bipartite system formed by A and B being isomorphic to $\mathcal{H}_A \otimes \mathcal{H}_B$. This is correct, and in fact the shortcoming of quantum theory in describing separate systems cannot be detected at the level of the states, as in a sense there is an overabundance of them, but at the level of the properties, which in the quantum formalism are described by orthogonal projection operators. In fact, it is precisely this overabundance of states that produces a deficiency of properties, in the sense that certain properties of a bipartite system formed by separate components be represented by orthogonal projection operators.

Technically speaking, the only difficulty of Aerts’ proof is that one needs to work it out in all generality, independently of specific representations, like the tensorial one, so that one can be certain that its conclusions are inescapable.^{11–14,16} Without entering into all details, the demonstration goes as follows. First, one has to define what it means for two entities A and B to be experimentally separate. As we mentioned already, this means that measurements individually performed on them do not influence each other. In other words, separate entities are such that their measurements are *separate measurements*. More precisely, two measurements \mathcal{M}_A and \mathcal{M}_B are separate if they can be performed together without influencing each others [measurement]. This means that: (1) the execution of \mathcal{M}_{AB} on the bipartite entity formed by A and B corresponds to the execution of \mathcal{M}_A on A and of \mathcal{M}_B on B , and (2) the outcomes of \mathcal{M}_{AB} are given by all possible couples of outcomes obtained from \mathcal{M}_A and \mathcal{M}_B .

What Aerts then shows is that there is no self-adjoint operator O_{AB} that can represent such measurement \mathcal{M}_{AB} ."

... de Bianchi: [Bia18], §V, Aerts’ Proof, p.9-10.

We note that, in his more technical ‘proof’ in [Ae82], based on his original doctoral thesis, Aerts explicitly restricts the *properties* attributed to physical phenomena to what ‘we know at this moment and we hope that these properties will remain interesting properties in the future’; and seeks to distinguish between the ‘*actual*’ and ‘*potential*’ properties of an ‘*entity*’:

“We have to remark that from a logical point of view there are two possible conclusions. Either quantum mechanics is considered to be wrong and then it should be replaced by a theory that makes it possible to describe separated entities (for example the theory proposed in this article) or

otherwise we believe that quantum mechanics can describe all entities that appear in nature, but then we have to conclude that separated entities do not exist.

Our opinion is that this choice is not a metaphysical one, because we define separated entities by means of separated questions. The definition of separated questions is experimentally verifiable, and it is very easy to find examples of separated questions. It is these separated question[s] that cannot be described by quantum mechanics. One can argue further and say that perhaps separated questions do exist but no separated entities. We can remark then that although in this paper we only treat the case of two separated entities, it is really the separated questions that cannot be described by quantum mechanics (see Ref. 9). In Section 6.1 we also show that the concept of separated entities is not an idealization, once we agree that the concept of entity is a good idealization.

2. THE CONCEPT OF ENTITY

Physics describes the phenomena that take place. The universe is what we call the collection of all these phenomena. One way to understand this universe is to concentrate on certain phenomena that “strike the eye,” certain phenomena that we can experience without being forced to experience all the other phenomena that are taking place. We give names to these phenomena. For example: rain, tree, electron, Since we can experience such a phenomena apart from all other phenomena, it makes sense to attribute *properties* to the phenomena and to study these properties.

We shall study the set of properties that we want to attribute in this way to a certain phenomena. The “thing” described by this set of properties, and which is an idealization of the phenomena in the sense explained above, we shall call an “*entity*.”

By the set of properties of a[n] entity, we do not mean the set of all possible properties that we could attribute to the phenomena defining the entity. No, we restrict ourselves to those properties that we know at this moment and we hope that these properties will remain interesting properties in the future. It seems to us that we cannot do more. Hence the set of properties of an entity is a well-defined set which is complete in the sense that it contains really all that we know about the phenomenon. Among the properties of an entity, some are “*actual*,” the entity has them “*in acto*,” and others are “*potential*,” the entity has the possibility of obtaining them. The *evolution* of the entity is the changing of actual properties into potential properties and potential properties into actual properties. In physics we say that the state of the entity changes. Hence the *state* of the entity is the collection of all actual properties.”

... Aerts: [Ae82], §1, Introduction and §2, The Concept of Entity, p.1134-1135.

From the *evidence-based* perspective of this investigation, Aerts’ distinction between:

- *actual* properties of an entity; and
- *potential* properties of an entity;

could be viewed as reflecting the distinction between:

- (*actual*) properties that are mathematically expressible by algorithmically *computable* functions and relations; and
- (*potential*) properties that are mathematically expressible only by algorithmically *verifiable* functions and relations, but not by algorithmically *computable* functions and relations.

In a subsequent 2014 paper [AdB14], Aerts and de Bianchi review their earlier work, clarifying and explaining—in an illuminating, inter-disciplinary, *Introduction*, excerpted at length below—how, and why, their perspective ought to be viewed as:

- complementing, and not contradicting;

Comment 207. Compare with the argument seeking dissolution of the, foundationally parallel, Poincaré-Hilbert debate in §2.D.; and with the argument in §11. that Hilbert’s and Brouwer’s interpretations of quantification are complementary and not contradictory (see also §13.F.(i)-(iii)).

- current paradigms concerning the possibility of a cognitive grounding for the quantum mechanical formalisations of quantum phenomena that, by admitting:
 - a lack of knowledge which ‘is not to be understood in a subjective sense, as it results from an *objective* condition of *lack of control* regarding the way a potential interaction is actualized during a measurement’,
 - and ‘the possibility of describing degenerate observables’,
 - could ‘render useless the idea that quantum probabilities would necessarily have an ontological nature’:

“One of the major problems of quantum mechanics, since its inception, has been that of explaining the origin of the statistical regularities predicted by its formalism. Simplistically, we could say that two diametrically opposite approaches to this problem stand out: the *instrumentalist* and the *realist*. According to the former, the solution of the problem is equivalent to its elimination: quantum probabilities are not required to be further explained, as what really matters in a physical theory is its predictive power, expressed by means of a *rule of correspondence* between the formalism of the theory and the results of the measurements, performed in the laboratories; and quantum mechanics is equipped with an extremely effective rule of this kind: the so-called *Born rule*, first stated by Max Born in the context of scattering theory [1].

While for the instrumentalist (by virtue of necessity and because of the difficulty of finding a coherent picture) it is unnecessary, if not wrong, to explain the predictive power of the Born rule, for the realist explanation must precede prediction, and one cannot settle for simply checking that the Born rule makes excellent correspondences: one also has to explain the reason of such success, possibly deriving the rule from first principles, even if this is at the price of having to postulate the existence of new *elements of reality*, which so far have remained *hidden* to our direct observation, in accordance with Chatton’s anti-razor principle: “no less than is necessary” [2].

The main way to do this, is to create a *model*, in which the different terms of the quantum formalism possibly find a correspondence, receiving in this way a better interpretation and explanation; and if the additional explanations contained in the model are able to produce new predictions, the model can also become a candidate for an upgraded version of the theory, providing a more refined correspondence with the experiments, through which in turn the model can be tested and possibly refuted.

Among the major obstacles that have prevented the development of new explicative models for quantum mechanics, and more specifically for quantum probabilities, there are the famous *no-go theorems* about hidden-variables, which restrict the permissible hidden-variable models explaining the origin of quantum randomness [3], [4], [5], [6], [7], [8]. So much so that, over time, this has led many physicists to believe that the nature of quantum probabilities would be *ontological*, and not *epistemic*, that is, that they would be quantities not explainable as a condition of lack of knowledge about an objective deeper reality.

The no-go theorems, which all draw their inspiration from von Neumann’s original proof [3], affirm that quantum probabilities cannot reflect a lack of knowledge about “better defined states” of a quantum entity, so that quantum observables would be interpretable as averages over the physical quantities deterministically associated with these hypothetical better defined states (much in the spirit of classical statistical mechanics). As a consequence, if quantum probabilities are explainable

as a lack of knowledge about an underlying reality, such reality cannot be associated with an improved specification of the actual states of the quantum entities.

Therefore, to bypass the obstacle of the no-go theorems, one must think of the hidden-variables not as elements of reality that would make a quantum mechanical state a more “dispersion free” state, but as something describing a different aspect of the reality of a quantum entity interacting with its environment, and in particular with a measuring system. This possibility was explored by one of us, in the eighties of the last century, by showing that if hidden-variables are associated, rather than with the state of the quantum entity, with its interaction with the measuring system, one can easily derive the Born rule of correspondence and render useless the idea that quantum probabilities would necessarily have an ontological nature [9].

This preliminary 1986 study has generated over the years a number of works (see [10], [11], [12], [13], [14], [15], [16], [17], [18], [19], [20], [21] and the references cited therein) further exploring the explicative power contained in this approach to the measurement problem, today known as the *hidden-measurement approach*, or *hidden-measurement interpretation*. More precisely, the very natural idea that was brought forward at that time, and subsequently developed, is that in a typical quantum measurement the experimenter is in a situation of *lack of knowledge* regarding the specific measurement interaction which is selected at each run of the measurement. And since these different potential measurement interactions would not in general be equivalent, as to the change they induce on the state of the measured entity, they can produce different outcomes, although each individual interaction can be considered to act deterministically (or almost deterministically, and we will specify in the following in detail what we mean by ‘almost deterministically’).

We emphasize that this condition of lack of knowledge is not to be understood in a subjective sense, as it results from an *objective* condition of *lack of control* regarding the way a potential interaction is actualized during a measurement, as a consequence of the irreducible fluctuations inherent to the experimental context, and of the fact that the operational definition of the measured physical quantity does not allow the experimental protocol to be altered, in order to reduce them [22].

The purpose of the present article is to put forward, for the first time, a complete self-consistent hidden-measurement modelization of a quantum measurement process, valid for arbitrary N -dimensional quantum entities, which will fully highlight the explicative power contained in the hidden-measurement interpretation. But to fully appreciate the novel aspects contained in this work, it will be useful to first recall what has been proven in the past, and what are the points that still needed to be clarified and elaborated.

What was initially proved in [9], [23], is that hidden-measurement models could in principle be constructed for arbitrary quantum mechanical entities of finite dimension, and the possibility of constructing hidden-measurement models for infinite-dimensional entities was afterwards demonstrated by Coecke [12]. However, these proofs, although general, were only about that aspect of a measurement that we may call the “naked measurement”, corresponding to the description of the pure “potentiality region” of contact between the states of the entity under investigation and those describing the measuring apparatus. A measurement, however, is known to contain much more structure than just that associated with such “potentiality region”.

What we are here referring to is the *structure of the set of states* of the measured entity (which is Hilbertian for quantum entities, but could be non-Hilbertian for entities of a more general nature [24], [25]), and how these states relate, *geometrically*, to those describing the measuring system. This is what in the standard Hilbertian formalism is described by means of the so-called (Dirac) *transformation theory*, which allows to calculate, for a given state, not only the probabilities associated with a single observable, but also those associated with all possible observables one may choose to measure. And of course, to obtain a complete description of a measurement process, also this additional geometric information, associated with the “generalized rotations in Hilbert space”, needed to be taken into account, and incorporated in the mathematical modelization.

This, however, was only possible to do (until the present work) in the special situation of two-dimensional entities, like spin- $\frac{1}{2}$ entities, and for higher-dimensional entities it was not at all

obvious to understand how to transform the state relative to a given measurement context (defined by a given observable), when a different measurement context (defined by a different observable) was considered.

This “transformationally complete” two-dimensional model has been extensively studied over the years, and is today known by different names. One of these names is *spin quantum-machine*, with the term “machine” referring to the fact that the model is not just an abstract construct, but also the description of a macroscopic object that can be in principle constructed in reality, thus allowing to fully visualize how quantum and quantum-like probabilities arise. Another name for the model is ϵ -model [17], [19], [26], where the ϵ refers to a parameter in the model that can be continuously varied, describing the transition between quantum and classical measurements, passing through measurement situations which are neither quantum nor classical, but truly intermediary. A third name is *sphere-model* [16], where the term “sphere” refers to the *Bloch sphere*, the well known geometrical representation of the state space of a two-dimensional quantum entity (qubit).

In fact, the possibility of representing the full measurement process (not just its “naked part”) of two-dimensional entities, in terms of hidden-measurement interactions, is related to the existence of a complete representation of the complex quantum states (the vectors in the two-dimensional Hilbert space $\mathcal{H} = \mathbb{C}^2$) in a real two-dimensional unit sphere, or in a three-dimensional unit ball, if also density operators are considered. Such representation was not available for higher dimensional entities, and this was the reason why a complete representation for the full measurement process was still lacking.

In retrospect, we can say that this technical difficulty did not favor the spread of the hidden-measurement ideas, and possibly promoted a certain suspicion about the true reach of this interpretation, as a candidate to solve the measurement problem. In this regard, we can mention the fact that when presenting the spin machine-model to an audience, the objection was sometimes raised that this kind of models could only be conceived for two-dimensional quantum entities, because of Gleason’s theorem [5] and an article by Kochen and Specker [7]. Indeed, Gleason’s theorem is only valid for a Hilbert space with more than two dimensions, hence not for the two-dimensional complex Hilbert space that is used in quantum mechanics to describe the spin of a spin- $\frac{1}{2}$ entity. And in addition to that, Kochen and Specker constructed in the above mentioned work a spin model for the spin of a spin- $\frac{1}{2}$ entity, proposing also a real macroscopic realization for it, but also pointing out, on different occasions, that such a real model could only be constructed for a quantum entity with a Hilbert space of dimension not larger than two.

Afterwards, some effort was given to clarify this dimensionality issue, and counter act the prejudice about the impossibility of a hidden-measurement model beyond the two-dimensional situation. In [27], for example, a mechanistic model was proposed for a macroscopic physical entity whose measurements give rise to a description in a three-dimensional (real) Hilbert space, a situation where Gleason’s theorem is already fully applicable. However, although certainly sufficient to make the point of the *non sequitur* of the no-go theorems in a simple and explicit example, the model was admittedly not particularly elegant, and a bit *ad hoc*, and this may have prevented a full recognition of its consequences, as to the status of the hidden-measurement interpretation.

In the same period, Coecke also proposed a more general approach, showing that a complete representation of the measurement process, and not just of its “naked” part, was possible also for a general N -dimensional quantum entity [11]. This was undoubtedly an important progress, as for the first time it was possible to affirmatively answer the question about the existence of a generalization of the two-dimensional sphere-model to an arbitrary number of dimensions. However, although Coecke could successfully show that an Euclidean real representation of the complex states of a quantum entity was possible, and that in such representation the hidden-measurements could also be incorporated, the number of dimensions he used to do this was not optimal. Indeed, he represented a N -dimensional complex Hilbert space in a N^2 -dimensional real Euclidean space, and for the $N = 2$ case this gave an Euclidean representation in \mathbb{R}^4 , whereas the Bloch sphere lives in \mathbb{R}^3 . So, strictly speaking, Coecke’s model was not the natural generalization of the sphere-model, but a different model whose mathematics was less immediate and the physics less transparent.

To complete this short overview, a more recent work of Sven Aerts [21] should also be mentioned, in which the author successfully formalized the hidden-measurement approach within the general ambit of an *interactive probability model*, showing how to characterize, in a complex Hilbert space, the hidden-measurement scheme, deriving the Born rule from a *principle of consistent interaction*, used to partition the apparatus' states.

Now, for those physicists who from the beginning evaluated in a positive way the explicative power contained in the hidden-measurement interpretation, all the mentioned results incontrovertibly showed that there was a way to go to find more advanced models. But we can also observe that the approach remained difficult to evaluate by those who were less involved in these developments, mainly for the lack of a natural higher-dimensional generalization of the $N = 2$ sphere-model representation, and the fact that it was known that the two-dimensional situation was, in a sense, a "degenerate" one, as it excluded the possibility of sub-measurements, and Gleason's theorem did not apply.

This situation started to change recently. Indeed, in the ambit of so-called *quantum models of cognition and decision* (an emerging transdisciplinary field of research where quantum mechanics is intensively used and investigated [28], [29]) we could provide a very general mechanistic-like modelization of the "naked part" of a measurement process, including the possibility of describing degenerate observables, which is something that was not done in the past [24], [25]. In that context, we also succeeded to show that the uniform average over the measurement interactions, from which the Born rule was derived, could be replaced by a much ampler averaging process, describing a much more general condition of lack of knowledge in a measurement, in what was called a *universal measurements*. In other terms, what we could prove is that quantum measurements are interpretable as universal measurements having a Hilbertian structure, which in part could explain the great success of the quantum statistics in the description of a large class of phenomena (like for instance those associated with human cognition [29], [28], [24], [25]).

Once we completed this more detailed analysis of the "potentiality region" of a measurement process (which, as a side benefit, allowed us to propose a solution to the longstanding Bertrand's paradox [30]), we became aware of the existence of some very interesting mathematical results, exploiting the generators of $SU(N)$ (the special unitary group of degree N) to generalize the Bloch representation of the states of a quantum entity to an arbitrary number N of dimensions [31], [32], [33], [34], [35], [36]. This was precisely the missing piece of the puzzle that we needed in order to complete the modelization of a quantum measurement process, by also including the entire structure of the state space. Contrary to the model proposed by Coecke, this generalized Bloch representation was carried out in a $(N^2 - 1)$ -dimensional real Euclidean space, that is, a space with an optimal number of dimensions, which reduces exactly to the standard Bloch sphere (or ball) when $N = 2$. In other terms, it is the natural generalization of the two-dimensional Bloch sphere representation.

Bringing together our recent results regarding the modelization of the "naked part" of a measurement process [24], [25], with the new mathematical results on the generalized Bloch representation [31], [32], [33], [34], [35], [36], we are in a position to present, in this article, what we think is the natural N -dimensional generalization of the sphere-model, providing a self-consistent and complete modelization of a general finite-dimensional quantum measurement, also incorporating the full Hilbertian structure of the set of states, and the description of how the quantum entity enters into contact with the "potentiality region" of the measuring system, and subsequently reemerges from it, thus producing an outcome. To our opinion, the modelization has now reached a very clear physical and mathematical expression, describing what possibly happens—"behind the macroscopic scene"—during a quantum measurement process, thus offering a challenging solution to the central (measurement) problem of quantum theory.

Before describing how the article is organized, a last remark is in order. The hidden-measurement interpretation can certainly be understood as a hidden-variable theory. However, it should not be understood as a tentative to resurrect classical physics. Quantum mechanics is here to stay, and cannot be replaced by classical mechanics. However, we also think that there are aspects of the theory which can, and need to, be demystified, and that only when this is done the truly deeper

aspects of what the theory reveals to us, about our physical reality, can be fully appreciated. When hidden-measurements are used to explain how probabilities enter quantum mechanics, the measurement problem can be solved in a convincing way, and an explanation is given for that part of quantum physics. This, however, requires us to accept that quantum observations cannot be understood only as processes of pure discovery, and that the non-locality of elementary quantum entities is in fact a manifestation of a more general condition of *non-spatiality*"

... Aerts/de Bianchi: [AdB14], §1, Introduction.

The *evidence-based* perspective of this investigation suggests that the continuously varying parameter ' ϵ ' in the above description could be taken to reflect our 'ignorance' of the state—of the putative 'entity' sought to be observed in a measurement—that would yield its finally measured value, where:

- 'lack of knowledge is not to be understood in a subjective sense, as it results from an *objective* condition of *lack of control* regarding the way a potential interaction is actualized during a measurement, as a consequence of the irreducible fluctuations inherent to the experimental context, and of the fact that the operational definition of the measured physical quantity does not allow the experimental protocol to be altered, in order to reduce them';
- 'the ϵ refers to a parameter in the model that can be continuously varied, describing the transition between quantum and classical measurements, passing through measurement situations which are neither quantum nor classical, but truly intermediary';
- 'the quantum entity enters into contact with the "potentiality region" of the measuring system, and subsequently reemerges from it, thus producing an outcome';
- 'hidden-measurements are used to explain how probabilities enter quantum mechanics, the measurement problem can be solved in a convincing way, and an explanation is given for that part of quantum physics';

and where ϵ could, therefore, be interpreted as a function that is algorithmically *verifiable* (hence deterministic), but not algorithmically *computable* (hence unpredictable):

- whence its value at any instant before measurement could not be represented mathematically by the experimenter, even in principle, in terms of an algorithmically *computable* real number (see §7.I.a.);
- since such representability could entail knowledge that would attract the paradoxes of impredicativity (as highlighted in §23.B.b.);
- and, moreover, since the limiting state represented by such a function could correspond (compare §20.C.b.(c)) to a mathematical discontinuity at the measurement, where the value/state of the function 'collapses' (as determined by the corresponding ψ -function) into a state that is mathematically representable in terms of algorithmically *computable* real numbers.

Prima facie, the above interpretation could be viewed as implicit in [AdB14]:

"It is worth emphasizing that the above description of a measurement, although formulated in Hilbert space and not explicitly mentioning the hidden-interactions, is fully compatible with the logic of the hidden-measurement interpretation. Indeed, a measurement context, associated with a given observable, can be understood as a collection of potential interactions, which once selected (actualized) can bring a given initial state into a predetermined final state, corresponding to the outcome of the measurement. In other terms, the hidden-interactions are those elements of reality producing the quantum transition, so that, in a sense, we can say that the standard Hilbert space formulation of quantum mechanics already contains, in embryo, the hidden-measurement modelization."

... Aerts/de Bianchi: [AdB14], §2, Operator-states and Lüders-von Neumann formula.

Informally, the underlying perspective here would be that:

- (i) If U is the universe we inhabit:
 - and T is, say, the Taj Mahal,
 - whilst D is a set of categorical engineering specifications,
 - for building a physical model M of T in which we can perform repeated destructive experiments;
- (ii) Then, as observers that exist in U :
 - whilst we can talk categorically about the properties of T representable in M ;
 - we can only conjecture/postulate;
 - on the basis of statistical correlations,
 - between what we observe in U ,
 - and what we measure in M ;
 - to what extent M is a representative model;
 - not of T ;
 - but of *that* part of T ;
 - which we can observe in U ;
 - and well-define in D ;
 - without destroying T .

Thus:

- (a) If there are *hidden* features H of T that are not observable in U , but which essentially influence any measurements that we make concerning T in U , then such features, by definition, are not represented/representable in D or M .
- (b) Since it is axiomatic that the only 'true' model of T is T itself then, as Aerts has—albeit implicitly—argued above, repeated 'destructive' measurements in M are essentially separated spatially, and cannot, even in principle, yield deterministic definitions of all such properties H that can be built into a more complete model M' of T , even though T itself might exist in a deterministic universe.

- (c) We conclude that even if such a universe can be said to obey deterministic physical laws which can be postulated as independent of us, since we can reflect them mathematically in D by algorithmically *computable* (hence deterministic and predictable) functions and relations, the property of being *predictable* is only well-defined with respect to M , and makes no sense in U in cases where, as Aerts has argued, it is not falsifiable in M since it involves spatial separation in destructive experiments upon M .
- (d) Moreover, the most that we can claim from our observations is that there might be deterministic physical laws that are not representable in D by algorithmically *computable* (hence stochastically *deterministic* and *predictable* in repeated destructive experiments on M) functions and relations but, as shown in [An16] (Theorem 2.1, p.37), such laws might be representable in D by functions and relations that are algorithmically *verifiable* (hence stochastically *deterministic* by repeated destructive experiments on M ⁵⁶²), but (see also Bohr’s argument in §23.B.) *not* algorithmically *computable* (hence stochastically *unpredictable* by repeated destructive experiments on M) as would be required by Bell’s inequalities.

23.B.d. An *evidence-based* ‘ontological’ perspective of Aerts’ ‘overlooked solution’ to *EPR*

We recall that this investigation essentially seeks to consider both formal, and informal, consequences of introducing the concepts of ‘evidence-based’ (in the sense of, for instance, Chetan Murthy and Martin Löb as detailed in §2.) and ‘well-definedness’ (in the sense of §7.F., Definition 26) as necessary, and sufficient, standards of rigour for finitary mathematical reasoning in mathematics, philosophy, and the natural sciences (whose respective domains we seek to differentiate in §13. and §13.C.).

From such a perspective, an issue of immediate significance that could benefit from clarification is that of ontological commitment in Aerts’ ‘overlooked solution’ to *EPR*.

1. For instance, we would view any ontological commitments—in this context—as concerning the *putative* existence of what we informally refer to as ‘entities’/‘properties’/‘laws’ in the *actual* universe we inhabit, vis à vis the *well-definability* of corresponding ‘entities’/‘properties’/‘laws’ in a *well-defined* mathematical model of that which we seek to observe and/or measure in the *actual* universe we inhabit.
2. Thus, the most important aspect of Aerts’ argumentation would be the insight that, since no experiment or observation in the *actual* universe we inhabit can be exactly replicated physically, all measurements of physical phenomena that we observe and/or record can only be of a statistical nature; albeit with some acceptable variance—from any theoretical prediction—that would allow two separate/distinct instances of the physical phenomena—sought to be studied by *actual* experiment and/or observation—to be treated as theoretically identical.

Such would be the case, both, whether premised:

- (i) on the philosophical assumption in classical mechanics that the *actual* universe we inhabit can be consistently treated as merely an/one instantiation, of an *intuitively*

⁵⁶²As suggested, for instance, in §23.D.g., Query 30.

potential universe, which obeys *putative* laws—in the *intuitively potential* universe—that can always be *intuitively* treated as both deterministic and predictable;

(ii) or on the negation of this assumption in quantum mechanics.

3. From Aerts' argumentation, we conclude that such an *intuitively potential* universe—as envisaged in 2(i)—is essentially problematic and/or impossible.

In other words, we need to be very explicit—at each step in any argumentation—whether we are referring:

- (i) to observable and/or measurable properties of *putative* entities (observables) in the *actual* universe we inhabit (on the basis of our *actual* observations/measurements);

Comment 208. We note that, in [Aetal], Aerts et al propose a *conceptuality interpretation* that seeks to 'explain the strange behavior of quantum and relativistic entities' by suggesting a cognitive description of such *putative* entities as 'concepts' that are not grounded in any *well-definable* mathematical representation of some corresponding, pre-existing, reality; but which can, nevertheless, be assumed to correspond to what is physically 'sensed' by any sensory 'apparatus'—whether of an organic or inorganic nature—at the moment of a physical observation/measurement.

or:

- (ii) to *well-definable* entities/properties/laws in *well-definable potential* universes in a *well-defined* mathematical model which, under interpretation, would be consistent with what we *actually* can, or do, observe and/or measure in our *actual* universe.

4. Prima facie, no matter which philosophical assumption, 2(i) or 2(ii), we prefer as our premise, any *well-defined* mathematical representation/model of the conceptual metaphors that we can correspond faithfully (in some sense of 'faithfully') to physical phenomena—which we observe and record in our *actual* universe—ideally demands that:

- (i) The *well-defined* mathematical representation/model must admit *gedanken* which can be *well-defined* as 'exactly replicated' in the representation/model;
- (ii) The *well-defined* mathematical representation of *putative* classical laws—which can reliably be assumed to be governing the *actual* universe we inhabit at, say, the 'macro' scale, and which are suggested by what we observe and/or measure in the *actual* universe we inhabit—should be both *well-definable* as *deterministic* and *predictable* within the representation/model.

Moreover, they must yield results in a classical *gedanken* (within the representation/model) that are consistent with both Bell's inequalities (within the representation/model), and the *actual* statistical results of any corresponding physical experiments (in our *actual* universe).

- (iii) The *well-defined* mathematical representation of *putative* quantum laws—which can reliably be assumed to be governing the *actual* universe we inhabit at, say, the 'micro' scale, and which are suggested by what we observe and/or measure in the *actual* universe we inhabit—should be *well-definable* as *essentially unpredictable* within the representation/model.

- Moreover, these too must yield results in a quantum gedanken (within the representation/model) that are consistent with both Bell's inequalities (within the representation/model), and the *actual* statistical results of the corresponding physical experiments (in our *actual* universe).
- (iv) The *well-defined* mathematical representation/model must establish that the assumption that classical laws govern physical phenomena at the 'macro' scale in our *actual* universe *complements*, and does not *contradict*, the assumption that quantum laws govern physical phenomena at the 'micro' scale in our *actual* universe.
5. Now, post-Turing, our observations of physical phenomena in our *actual* universe has established that:
- (i) algorithmically *computable* number theoretic functions, which are *finitarily* both *determinate* and *predictable*, can be taken to *well-define* and mathematically represent the *putative* laws of classical mechanics (which we postulate as obeyed in the *actual* universe we inhabit at both the 'macro' and 'micro' scale) faithfully in the sense of 4(ii);
- (ii) algorithmically *computable* number theoretic functions, which are both *determinate* and *predictable*, cannot be taken to *well-define* and mathematically represent the, similarly *putative*, laws of quantum mechanics faithfully in the sense of 4(iii).
6. The challenge, then, has been to determine whether we can:
- (i) *well-define* number theoretic functions that are further *well-definable* as *essentially unpredictable* (in a *well-defined* mathematical representation/model), yet which can be taken to mathematically represent the *putative* laws of quantum mechanics faithfully in the sense of 4(iii); and
- (ii) *well-define* a mathematical representation/model such that it can *well-define* 'exact replicability' of theoretical experiments in the representation/model.
7. Challenge 6(i) is met by Schrödinger's ψ function; the standard Copenhagen interpretation of which, following Bohr, we take to postulate that:
- (i) the *well-defined* ψ -function yields a probability distribution for the values—in any *well-defined* representation/model—which can be taken to correspond to the physical observations and/or measurement of *actual* experiments that a quantum gedanken is intended to represent ideally in the representation/model;
- (ii) the *well-defined* probability distribution for the outcome of a repeated—but not necessarily 'exactly replicable'—quantum gedanken in any *well-definable* mathematical model is *all* that is theoretically 'knowable' about that which we seek to observe and/or measure in the gedanken (in the *well-defined* mathematical representation/model).
8. Treating postulation 7(ii) as necessary, however, requires us to commit—on philosophical grounds—to the thesis (which admits uncomfortable 'non-locality' as essential) that:

- (i) any *well-defined* mathematical representations of the *putative* quantum laws determining some of our *actual* observations and/or measurements are only *well-definable* as *essentially probabilistic*, and therefore *essentially non-deterministic*, in the representation/model; whence
- (ii) admitting 6(ii) in the representation/model would contradict the applicable Bell's inequalities.

9. However, based on mathematical and logical considerations of a foundational nature in [An16] (see §2.), such a postulation, though sufficient to its immediate intent, is not necessary; since it follows from [An16] that:

- (i) The first-order Peano Arithmetic PA admits *well-defined* formal arithmetical functions that are algorithmically *computable* under interpretation over the domain of the natural numbers.

Comment 209. By virtue of the Provability Theorem for PA (§2.E.b., Theorem 2.17), we shall treat as extrapolatable (albeit, without formal proof) that such functions are capable of yielding *well-defined* real functions that are, further, *well-definable* as, both, *determinate* and *predictable*, in any *well-defined* mathematical theory of the real numbers based on PA.

- (ii) The first-order Peano Arithmetic PA also admits—hitherto unsuspected—*well-defined* formal arithmetical functions that are algorithmically *verifiable*, but not algorithmically *computable*, under interpretation over the domain of the natural numbers.

Comment 210. By virtue of the Provability Theorem for PA (§2.E.b., Theorem 2.17), we shall treat as extrapolatable (albeit, without formal proof) that such functions are capable of yielding *well-defined* real functions that are, further, *well-definable* as *determinate*, but *essentially unpredictable*, in any *well-defined* mathematical theory of the real numbers based on PA—thereby admitting both 6(i) and 6(ii).

- (iii) Contradicting current paradigms, the first-order Peano Arithmetic PA is categorical.

Comment 211. It thus both uniquely defines, and is uniquely defined by, the structure of the natural numbers (which—as argued in §7.I. and §7.I.a.—yields *well-defined* real numbers that can be treated as corresponding to what we *actually* observe and/or measure physically in the universe we inhabit).

10. Since PA serves as a foundation for the mathematical representation of *well-defined* real numbers (see [La29]), we take it as admitting the argument (in §23.B.b.) that the debate between Albert Einstein and Niels Bohr dissolves from the perspective where we treat:

- (i) Einstein as justifiably asserting that all natural laws must be capable of being treated philosophically as *deterministic* in the *actual* universe we inhabit—even if they do not yield *predictable* results in physical experiments—since they *can* be mathematically represented by *well-defined* algorithmically *verifiable* functions.

Hence we *can* consistently ascribe *putative* spatial existence to postulated *potential* entities, in our *actual* universe, that correspond to *mathematical* entities (i.e., ‘terms’ of a formal theory) which are definable by algorithmically *verifiable* functions in any mathematical representation/model of a *potential* universe.

- (ii) Bohr as justifiably asserting that some natural laws in the *actual* universe we inhabit yield *essentially unpredictable* results in physical experiments; since they *cannot* be mathematically represented by *well-defined* algorithmically *computable* functions.

Hence we *cannot* consistently ascribe *putative* spatial existence to postulated *potential* entities, in our *actual* universe, that correspond to *mathematical* entities (i.e., ‘terms’ of a formal theory) which are definable by algorithmically *computable* functions in any mathematical representation/model of a *potential* universe.

11. Moreover, since all assertions about the representation of physical phenomena in a *well-defined* mathematical model must be capable of *evidence-based* verification (within the model) that can be corresponded ‘faithfully’ to statistical verification in what the mathematical assertions represent in our *actual* universe, we cannot admit elements in the model that are not *well-defined* and which cannot, consequently, be taken to correspond to some *putative*, and not merely *intuitively potential*, ‘observable’ entity whose existence we can consistently postulate in our *actual* universe.

Comment 212. In other words—unlike any *putative* model in the language of set theory, which can have no *well-defined* model if it contains an axiom of infinity—a *well-defined* arithmetical—hence computational by virtue of the Provability Theorem for PA (§2.E.b., Theorem 2.17)—model of our *actual* universe does not admit reference to (i.e. cannot commit us ontologically to) elements in the model that are not *well-definable* in the language of arithmetic and/or computability (as argued in §3., §7.I., and §7.I.a.).

The ontological significance of admitting an axiom of infinity in formal languages that seek to represent our conceptual metaphors—corresponding to our observations/measurements of physical phenomena in the universe we inhabit—is highlighted by Feferman in [Fe02] on p.6 (Poincaré vs. the logicians and the Cantorians: from paradoxes to practice); on p.9 (Weyl’s predicative development of analysis); on p.11 (Predicativity sidelined: 1920-1950); and on p.23 (Rethinking predicativity II: 1970-1996).

23.C. How *evidence-based* reasoning dissolves the *EPR* ‘paradox’

The underlying perspective of §23. is thus that:

- (1) Classical physics assumes that all the observable laws of nature can be mathematically represented in terms of *well-defined* functions that are algorithmically *computable* (see §2., Definition 10).
 - (a) Since the functions are well-defined, their values are pre-existing and predetermined as mappings that are capable of being known in their infinite totalities to an omniscient intelligence such as, for instance, Laplace’s *vast intelligence*.
- (2) However, the overwhelming experimental verification of the mathematical predictions of Quantum Theory suggests that the actual behavior of the real world cannot be assumed as pre-existing and predetermined in this sense.
 - (a) In other words, the consequences of some experimental interactions are theoretically incapable of being completely known in advance even to an omniscient intelligence, such as Laplace’s *vast intelligence*.

- (b) All observable laws of nature cannot, thus, be represented mathematically in terms of functions that are algorithmically *computable* (Definition 10).
- (3) It follows that:
- (a) Either there is no way of representing all the observable laws of nature mathematically in a deterministic model;
- (b) Or all the observable laws of nature *can* be represented mathematically in a deterministic model—but in terms of functions that are ‘computable’ in the *weak* sense of being algorithmically *verifiable* (Definition 7) (hence well-defined by Definition 25) but not necessarily ‘computable’ in the classically *strong* sense of being algorithmically *computable* (see §2., Definition 10).
- (4) The Copenhagen interpretation appears to favour option (3)(a); and hold that there is no way of representing all the observable laws of nature mathematically in a deterministic model.
- (a) In other words, the interpretation is not overly concerned with the seemingly essential non-locality of Quantum Theory, and its conflict with the deterministic mathematical representation of the laws of Special Relativity.
- (5) The Bohm-de Broglie interpretation appears to reject option (3)(a); and to propose a way of representing all the observable laws of nature mathematically in a deterministic model and, presumably, in terms of functions that the interpretation—reflecting the paradigms of the times—implicitly presumes to be necessarily algorithmically *computable*.
- (a) However, the Bohm-de Broglie interpretation has not so far been viewed as being capable of mathematically avoiding the seemingly essential non-local feature of Quantum Theory implied by Bell’s inequalities.
- (6) In this paper we propose (3)(b); that the apparently non-local feature of Quantum Theory may actually be indicative of a non-constructive and ‘counter intuitive-to-human-intelligence’ phenomena in nature that could, however, be mathematically represented by functions that:
- (a) Are algorithmically *verifiable* (see §2., Definition 7);
- (b) But not algorithmically *computable* (see §2., Definition 10).

23.C.a. *EPR* paradox: An implicit mathematical ambiguity in interpreting quantification non-constructively

We shall thus argue that if we avoid conflating a mathematical model M_L of a mathematical language L that seeks to admit representations of physical phenomena *before* a measurement with a, post-facto, mathematical model M_{L_1} of a conservative extension L_1 of L that seeks to represent the phenomena which *predicts* the measurement and its consequences (see §23.B.), then the *EPR* paradox is essentially a mathematical argument whose paradoxical conclusion reflects an implicit, foundational, mathematical ambiguity in interpreting quantification (see §7.C.; also [An15], [An15p]), and whose roots lie in the assumption of conventional Gödelian wisdom, which postulates that:

- (i) The ‘true’ sentences of the model M_L cannot be defined algorithmically,
- (ii) But are an essential feature of the structure $M_L = \langle A, \alpha \rangle$,
- (iii) Which is defined by a non-empty domain A , and an algebra α defined over A .

However, we hold that such a non-constructive perspective implicitly implies (see §2.A.) that the concept of ‘truth’ must then be both ‘absolute’ and ‘exist’ Platonically, in the sense of needing to be discovered by some witness-dependent means—eerily akin to a spiritual, and necessarily subjective, ‘revelation’—if the domain A is infinite.

23.C.b. Truth-values must be a computational convention

In other words, we reject such a Platonic faith in an ‘absolute’ mathematical ‘truth’ that is accessible only subjectively, and propose instead the *evidence-based* perspective that (see §1., Thesis 1; also §7.C. and §11.C.):

- (i) The ‘true’ sentences of M_L must be defined as objective assignments,
- (ii) By a computational convention that is witness-independent,
- (iii) In terms of the Tarskian ‘satisfaction’ and ‘truth’ of the corresponding formulas of L under a constructive interpretation over the domain A .

23.C.c. A finitary perspective of the structure \mathbb{N} of the natural numbers

The perspective we choose for addressing these issues is that of the structure \mathbb{N} , defined by:

- $\{N$ (*the set of natural numbers*);
- $=$ (*equality*);
- S (*the successor function*);
- $+$ (*the addition function*);
- $*$ (*the product function*);
- 0 (*the null element*)}

which serves for a definition of the standard interpretation $\mathcal{I}_{PA(\mathbb{N}, SV)}$ of the first-order Peano Arithmetic PA.

Our reason for choosing PA as the basis for our perspective is that PA is a categorical mathematical language of both adequate expression (see §2.E.b., Corollary 2.18) and effective communication (see §2.E.b., Theorem 2.17)⁵⁶³.

Moreover, PA forms the foundational bedrock (see, for instance, [La29]) on which all formal mathematical languages that admit rational and real numbers and, ultimately, all of geometry, are grounded; as noted by Richard Zach in his review of ‘*Hilbert’s Program Then and Now*’:

⁵⁶³In contrast to a first-order set theory such as ZF, which can only be termed as a language of adequate expression, but not a language of effective communication (see §13.E.).

“2 HILBERT’S PROGRAM THEN

2.1 Hilbert’s early work on foundations

Hilbert’s work on the foundations of mathematics can be traced to his work on geometry of the 1890s which resulted in his influential textbook *Foundations of Geometry* [1899]. One philosophical advance of this work was the development of Hilbert’s conception of the axiomatic method. Hilbert believed that the proper way to develop any scientific subject rigorously required an axiomatic approach. In providing an axiomatic treatment, the theory would be developed independently of any need for intuition, and it would facilitate an analysis of the logical relationships between the basic concepts and the axioms. Of basic importance for an axiomatic treatment are, so Hilbert [*believed?*], investigation of the independence and, above all, of the consistency of the axioms. In his 1902 lectures on the foundations of geometry, he puts it thus:

Every science takes its starting point from a sufficiently coherent body of facts is given. It takes form, however, only by *organizing* this body of facts. This organization takes place through the *axiomatic method*, i.e., one constructs a *logical structure of concepts* so that the relationships between the concepts correspond to relationships between the facts to be organized.

There is arbitrariness in the construction of such a structure of concepts; we, however, *demand* of it:

- 1) completeness, 2) independence, 3) consistency. [Hilbert, 2004, 540]

From the time of his work on geometry forward, the last consideration, consistency, was of special importance in Hilbert’s conception of the axiomatic method in general and the foundations of mathematics in particular. Hilbert was heavily influenced by the foundational views of late-19th century mathematicians, in particular, Cantor, Dedekind, and Kronecker. He shared with Dedekind and Cantor the view that mathematical activity should be free of constraints, which led to his view, highlighted in his correspondence with Frege, that consistency of an axiomatic theory guarantees the existence of the structure described, and is in this sense sufficient to justify the use of the theory. And he shared with Kronecker a recognition that elementary arithmetic has a privileged role in mathematics, although he was of course opposed to the converse espoused by Kronecker, viz., that the natural numbers, and constructions based on elementary arithmetic, exhaust legitimate mathematics. These two influences in Hilbert’s thought are at the root of his investigations of consistency.

Proofs of consistency for the axioms of geometry can be given by providing an interpretation of the system in the real plane, and thus the consistency of geometry is reduced to the consistency of analysis. Analysis, of course, itself requires justification. In [1900b], Hilbert approached the problem from the axiomatic standpoint by proposing an axiomatization of the real numbers. In order to show the consistency of this system, Hilbert expressly rejected the construction of a model, e.g., a construction based on Dedekind cuts of rationals, as an option. He considered the construction of the reals from the rationals and ultimately the natural numbers using the “genetic method” as insufficient: “Despite the high pedagogical and heuristic value of the genetic method, for the final presentation and the complete logical grounding of our knowledge the axiomatic method deserves the first rank” [Hilbert, 1900b, 1093]. Hilbert thus was after a direct consistency proof of analysis, i.e., one not based on reduction to another theory. He proposed the problem of finding such a proof as the second of his 23 mathematical problems in his address to the International Congress of Mathematicians in 1900 [1900a].”

... Zach: [Zac07], pp.412-413.

In other words the *strong*, finitary, consistency of PA (see §2.C.a., Theorem 2.16) can provide the sound foundation needed by any computational language in which mechanical artefacts record their observations—of a putative ‘common’ external world—that reflect and extend what is directly experienced, or conjectured as indirectly observable, by our sensory perceptions, and

in which applied science attempts to mathematically model the putative laws of nature that our conceptual metaphors (see [LR00]; also §27.) of such observations suggest.

23.C.d. Functions that are algorithmically *verifiable* but not algorithmically *computable*

From the point of view of a finitary mathematical philosophy (see §1., Thesis 1)—which is the constraint within which an applied science ought to ideally operate—the significant difference between algorithmic *verifiability* and algorithmic *computability* could be expressed by saying that:

- (a) We may treat the decimal representation of a real number as corresponding to a physically measurable limit⁵⁶⁴—and not only to a mathematically definable limit—if and only if such representation is definable by an algorithmically *computable* function (see §7.I.a.).

We note that although every algorithmically *computable* relation is algorithmically *verifiable*, the converse is not true (see §7.G., Theorem 7.2).

23.C.e. Some well-known functions that are algorithmically *verifiable* but not algorithmically *computable*

We further note that:

- (i) All the mathematically defined functions known to, and used by, science are algorithmically *computable*, including those that define transcendental numbers such as π , e , etc. They can be *computed* algorithmically as they are all definable as the limit of some well-defined infinite series of rationals.
- (ii) The existence of mathematical constants that are defined by functions which are algorithmically *verifiable* but not algorithmically *computable*—suggested most famously by Georg Cantor’s diagonal argument—has been a philosophically debatable deduction.

Such existential deductions have been viewed with both suspicion and scepticism by scientists such as Henri Poincaré, L. E. J. Brouwer, etc., and disputed most vociferously on philosophical grounds by others such as Ludwig Wittgenstein ([Wi78]).

- (iii) A constructive definition of an arithmetical Boolean function $[(\forall x)R(x)]$ ⁵⁶⁵ that is true under any well-defined interpretation of his Peano Arithmetic P —hence algorithmically *verifiable*—but not provable in P —hence algorithmically not *computable* (see §2.F., Corollary 2.21)—was given by Kurt Gödel in his 1931 paper on formally undecidable arithmetical propositions ([Go31]).
- (iv) The definition of a number-theoretic function that is algorithmically *verifiable* but not algorithmically *computable* was also given by Alan Turing in his 1936 paper on computable numbers ([Tu36]).

He defined a halting function, say $H(n)$, that is 0 if, and only if, the Turing machine with code number n halts on input n . Such a function is mathematically well-defined, but assuming that it defines an algorithmically *computable* real number leads to a contradiction, Turing concluded the mathematical existence of algorithmically *uncomputable* real numbers.

⁵⁶⁴In the sense of a physically ‘completable’ infinite sequence (as needed to resolve Zeno’s paradox).

⁵⁶⁵Gödel refers to this formula only by its Gödel-number ‘17Gen r ’ ([Go31], p.25, eqn.13).

- (v) A definition of a number-theoretic function that is algorithmically *verifiable* but not algorithmically *computable* was given by Gregory Chaitin ([Ct82]); he defined a class of constants—denoted by Ω —which is such that if $C(n)$ is the n^{th} digit in the decimal expression of an Ω constant, then the function $C(x)$ is algorithmically *verifiable* but not algorithmically *computable*.

23.D. Are some physical constants algorithmically *uncomputable*?

The question arises: Are some physical constants representable by real numbers which are definable only by algorithmically *verifiable* but not algorithmically *computable* functions?

The possibility is suggested by the following perspective of one of the challenging issues in physics, which seeks to theoretically determine the magnitude of some fundamental dimensionless constants:

“... the numerical values of dimensionless physical constants are independent of the units used. These constants cannot be eliminated by any choice of a system of units. Such constants include:

- α , the fine structure constant, the coupling constant for the electromagnetic interaction ($\approx 1/137.036$). Also the square of the electron charge, expressed in Planck units. This defines the scale of charge of elementary particles with charge.
- μ or β , the proton-to-electron mass ratio, the rest mass of the proton divided by that of the electron (≈ 1836.15). More generally, the rest masses of all elementary particles relative to that of the electron.
- α_s , the coupling constant for the strong force (≈ 1)
- αG , the gravitational coupling constant ($\approx 10^{-38}$) which is the square of the electron mass, expressed in Planck units. This defines the scale of the mass of elementary particles.

At the present time, the values of the dimensionless physical constants cannot be calculated; they are determined only by physical measurement. This is one of the unsolved problems of physics. ...

The list of fundamental dimensionless constants decreases when advances in physics show how some previously known constant can be computed in terms of others. A long-sought goal of theoretical physics is to find first principles from which all of the fundamental dimensionless constants can be calculated and compared to the measured values. A successful ‘Theory of Everything’ would allow such a calculation, but so far, this goal has remained elusive.”

... Dimensionless physical constant - Wikipedia

From the perspective of Section 23.C.c., we could now suggest that:

Thesis 16. (Dimensionless constants) *Some of the dimensionless physical constants are only representable in a mathematical language as ‘unmeasurable’ real numbers that are defined by quantum functions which are algorithmically verifiable, but not algorithmically computable.*

In other words, we cannot treat such constants as denoting—even in principle—a measurable limit, as we could a constant that is representable mathematically by a real number that is definable by algorithmically *computable* functions.

One reason why dimensionless physical constants may not be representable in a mathematical language L as ‘measurable’ real numbers might be that they are determined by the mathematical model M_L of the physical phenomena sought to be represented by the model.

If so, the value of a dimensionless constant in a mathematical model M_L of physical phenomena *before* a measurement must differ with the value of the dimensionless constant in a post-facto mathematical model M_{L_1} of the phenomena which *predicts* the measurement and its consequences.

In other words, if the values of some dimensionless constants are defined by ‘quantum’ functions which are algorithmically *verifiable*, but not algorithmically *computable*, then they are of an *evolving* nature (compare with Gisin’s perspective in [Gi19] and [Gi20]) that is *relatively random* (see §7.G., Definition 27); they *unfold* only as, and when, a measurement in a model M_L —of a mathematical theory L that seeks to faithfully represent observations of some physical phenomena—is integrated into a model M_{L_1} of a conservative extension L_1 of the theory L (in the sense of §23.B.a.).

23.D.a. Completed Infinities

From the point of view of mathematical philosophy, this distinction would be expressed by the theses (the significance of this is highlighted in §20.C.; see also §7.I.a., Theorem 7.6):

Thesis 17. (Unmeasurable constants) *Whilst a symbol for an ‘unmeasurable’ physical constant may be introduced into a physical theory as a primitive term without inviting inconsistency in the theory, the sequence of digits in the decimal representation of the ‘measure’ of an ‘unmeasurable’ physical constant cannot be treated in the mathematical language of the theory as a ‘completed’ infinite sequence whose ‘measure’ is the Cauchy limit of the sequence.*

Thesis 18. (Measurable constants) *The sequence corresponding to the decimal representation of the ‘measure’ of a ‘measurable’ physical constant, when introduced as a primitive term into a physical theory, can be treated as a ‘completed’ infinite sequence, whose ‘measure’ is the Cauchy limit of the sequence in the mathematical language of the theory, without inviting inconsistency.*

23.D.b. Zeno’s arguments

We note that Zeno’s paradoxical arguments ([Rus37], pp.347-353; as qualified, however, by §20.C.b.) highlight the philosophical and theological dichotomy between our essentially ‘continuous’ perception of the physical reality that we seek to capture with our measurements, and the essential ‘discreteness’ of any mathematical language of arithmetic in which we seek to express such measurements categorically.

The *evidence-based* distinction between algorithmically *verifiable* and algorithmically *computable* arithmetical functions could be seen as reflecting the dichotomy mathematically.

23.D.c. Classical laws of nature

The *evidence-based* distinction between algorithmic *verifiability* (see §2., Definition 7) and algorithmic *computability* (see §2., Definition 10) suggests that classical mechanics *could* be held as complete with respect to the algorithmically *computable* representation of our observations of physical phenomena, in the sense that:

Thesis 19. (Classical laws) *Classical laws of nature determine the nature and behaviour of all those properties of the physical world which are mathematically describable completely at any moment of time $t(n)$ by algorithmically computable functions from a given initial state at time $t(0)$.*

In other words, classical laws are characterised by the property that if a physical process is representable by a Cauchy sequence, then the limit of the sequence corresponds to a limiting state of the physical process.

23.D.d. Neo-classical laws of nature

Moreover, the distinction further suggests that:

Thesis 20. (Neo-classical laws) *Neo-classical laws of nature determine the nature and behaviour of those properties of the physical world which are describable completely at any moment of time $t(n)$ by algorithmically verifiable functions; however such properties are not completely describable by algorithmically computable functions from any given initial state at time $t(0)$.*

In other words, neo-classical laws are characterised by the property that if a physical process is representable by a Cauchy sequence, then the limit of the sequence need not correspond to a limiting state of the physical process; which may require an additional, conceivably probabilistic, law to *deterministically* govern the permissible states of the physical process at the limit.

Since such behaviour follows fixed laws and is thus determinate (even if not algorithmically predictable by classical laws, since their limiting states are revealed only as probabilities), the hypothetical universe considered in §20.D.c. suggests that Albert Einstein could have been justified in his belief (in the sense of §13.F.), reiterated in 1943 to William Hermanns:

“As I have said so many times, God doesn’t play dice with the world”.

... Hermanns: [Her83], p.58.

Comment 213. ‘Justified’ from the *evidence-based* perspective of this investigation if, by ‘play dice’, Einstein’s belief/remark could be interpreted:

- as intending that the probabilities considered in current quantum-mechanical descriptions of physical processes *cannot* be taken to be defined over a probability space *globally* (compare §22.A., Theorem 22.3);
- but allowing the possibility that such probabilities may be definable in terms of *locally* definable probability spaces—as argued in the case of defining the probability of an integer n being a prime (see §22.A., and §22.A.d.).

The consequences of such a qualification for the physical sciences could, conceivably, be as far-reaching as those that are argued for computability theory (see §22.A.e. and §22.A.f.) and the theory of numbers (see §22.C.b.; also §22.D. and §22.D.a.).

A putative model for such behaviour is also considered by Frank Waaldjik in [W103]:

“The second way to model our real world is to assume that it is deterministic. ... It would be worthwhile to explore the consequences of a deterministic world with incomplete information (since under the assumption of determinacy in the author’s eyes this comes closest to real life). That is a world in which each infinite sequence is given by an algorithm, which in most cases is completely unknown. We can model such a world by introducing two players, where player I picks algorithms and hands out the computed values of these algorithms to player II, one at a time. Sometimes player I discloses (partial) information about the algorithms themselves. Player II can of course construct her or his own algorithms, but still is confronted with recursive elements of player I about which she/he has incomplete information.”

... Waaldjik: [W103], §1.5, p.5.

where Waaldjik further emphasises the need for a universally common, constructive, foundation for the mathematical representation of elements of reality such as those considered in this investigation:

“Our investigations lead us to consider the possibilities for ‘reuniting the antipodes’. The antipodes being classical mathematics (CLASS) and intuitionism (INT). . . . It therefore seems worthwhile to explore the ‘formal’ common ground of classical and intuitionistic mathematics. If systematically developed, many intuitionistic results would be seen to hold classically as well, and thus offer a way to develop a strong constructive theory which is still consistent with the rest of classical mathematics. Such a constructive theory can form a conceptual framework for applied mathematics and information technology. These sciences now use an ad-hoc approach to reality since the classical framework is inadequate. . . . [and can] easily use the richness of ideas already present in classical mathematics, if classical mathematics were to be systematically developed along the common grounds before the unconstructive elements are brought in.”

... Waaldjik: [W103], §1.6, p.5.

“... we propose that Laplacian determinism be seen in the light of constructive mathematics and Church’s Thesis. This means amongst other things that infinite sequences (of natural numbers; a real number is then given by such an infinite sequence) are never ‘finished’, instead we see them developing in the course of time. Now a very consequent, therefore elegant interpretation of Laplacian determinism runs as follows. Suppose that there is in the real world a developing-infinite sequence of natural numbers, say α . Then how to interpret the statement that this sequence is ‘uniquely determined’ by the state of the world at time zero? At time zero we can have at most finite information since, according to our constructive viewpoint, infinity is never attained. So this finite information about α supposedly enables us to ‘uniquely determine’ α in its course of time. It is now hard to see another interpretation of this last statement, than the one given by Church’s Thesis, namely that this finite information must be a (Turing-)algorithm that we can use to compute $\alpha(n)$ for any $n \in \mathbb{N}$).

With classical logic and omniscience, the previous can be stated thus: ‘for every (potentially infinite) sequence of numbers $(a_n)_{n \in \mathbb{N}}$ taken from reality there is a recursive algorithm α such that $\alpha(n) = a_n$ for each $n \in \mathbb{N}$. This statement is sometimes denoted as ‘ \mathbf{CT}_{phys} ’, . . . this classical omniscient interpretation is easily seen to fail in real life. Therefore we adopt the constructive viewpoint. The statement ‘the real world is deterministic’ can then best be interpreted as: ‘a (potentially infinite) sequence of numbers $(a_n)_{n \in \mathbb{N}}$ taken from reality cannot be apart from every recursive algorithm α (in symbols: $\neg \forall \alpha \in \sigma_{\omega REC} \exists n \in \mathbb{N} [\alpha(n) \neq a_n]$).’”

... Waaldjik: [W103], §7.2, p.24.

23.D.e. Incompleteness: Arithmetical analogy

The distinction also suggests that neither classical mechanics, nor neo-classical quantum mechanics, could be described as ‘mathematically complete’ with respect to the algorithmically *verifiable* behaviour of the physical world.

- (a) The analogy here is that Gödel showed in 1931 ([Go31]) that any formal arithmetic is not mathematically complete with respect to the algorithmically *verifiable* properties of the natural numbers⁵⁶⁶.
- (b) However it can be shown that the first-order Peano Arithmetic PA *is* both complete and categorical ([An16], Corollary 7.2, p.41) with respect to the algorithmically *computable* properties of the natural numbers.

In this sense, the *EPR* paper may not be entirely wrong in concluding that:

“Returning now to the general case contemplated in Eqs. (7) and (8), we assume that ψ_k and ϕ_r are indeed eigenfunctions of some non-commuting operators P and Q , corresponding to the

⁵⁶⁶Which—as shown in [An12] and [An16]—are the ones sought to be captured by the standard interpretation of PA.

eigenvalues p_k and q_r respectively. Thus, by measuring either A or B we are in a position to predict with certainty, and without in any way disturbing the second system, either the value of the quantity P (that is p_k) or the value of the quantity Q (that is q_r). In accordance with our criterion of reality, in the first case we must consider the quantity P as being an element of reality, in the second case the quantity Q is an element of reality. But, as we have seen, both wave functions ψ_k and ϕ_r belong to the same reality.

Previously we proved that either (1) the quantum-mechanical description of reality given by the wave function is not complete or (2) when the operators corresponding to two physical quantities do not commute the two quantities cannot have simultaneous reality. Starting then with the assumption that the wave function does give a complete description of the physical reality, we arrived at the conclusion that two physical quantities, with non-commuting operators, can have simultaneous reality. Thus the negation of (1) leads to the negation of the only other alternative (2). We are thus forced to conclude that the quantum-mechanical description of physical reality given by wave functions is not complete.

One could object to this conclusion on the grounds that our criterion of reality is not sufficiently restrictive. Indeed, one would not arrive at our conclusion if one insisted that two or more physical quantities can be regarded as simultaneous elements of reality *only when they can be simultaneously measured or predicted*. On this point of view, since either one or the other, but not both simultaneously, of the quantities P and Q can be predicted, they are not simultaneously real. This makes the reality of P and Q depend upon the process of measurement carried out on the first system, which does not disturb the second system in any way. No reasonable definition of reality could be expected to permit this.

While we have thus shown that the wave function does not provide a complete description of the physical reality, we left open the question of whether or not such a description exists. We believe, however, that such a theory is possible."

... Einstein, Podolsky and Rosen: [EPR35], p.780

Comment 214. In an extraordinarily insightful and cross-disciplinary 2002 doctoral thesis [Grg02a] (and [Grg02b])—which we quote at some length (including footnotes), albeit without comment, to better convey the author's intent—renown art educator and painter Ian Greig shares a lay perspective—which apparently is subliminally reflected in his painting⁵⁶⁷—where

⁵⁶⁷“The lyrical paintings of Ian Greig visualise the invisible links that entwine physical and metaphysical worlds. Seeking meaning in colour, form and rhythm, the Sydney artist approaches painting as a poetic gesture; a means of siphoning the aesthetic and philosophical currency of the world around us. Greig’s subterranean landscapes prompt a meditation on the corporeal experience of the natural world as well as the intangible micro realm of fluctuating energy, waves and vibrations. Greig’s creative process is fluid and organic. Without any preconceived ideas of the outcomes, he works intuitively, engaging with the behaviour of oil paint through a melange of surface effects. Fine layers of paint create crystalline veils that conceal what lies beneath the surface and, in doing so, reveal a hidden world beyond appearances. Amorphous forms and limber brushstrokes dance in and out of recognition while vivid colour mingles and melts in kaleidoscopic formations, creating embryonic worlds surging into existence. Each painting appears as if we are squinting through glass at a distant landscape on a rainy day, the raindrops slowly coming into focus and conjuring new terrain—an ambiguous domain of transcendent realities and elusive truths. The fundamental force of gravity is an ever-present feature in these drippy, visceral configurations, and yet there is a lightness to Greig’s paintings as they capture an ephemeral floating world of surface reflection and light refraction. Echoing the undulations of light and shadow that ripple across the reflective surfaces of creeks and ponds, the works evoke shifting perspectives, spatial illusions and abstract realities. Here the distinction between energy and matter fades away, as each painted form merges into one another like sunlight through water. These plays of light and colour suggest a sense of the auditory, where synaesthetic gestures of visual rhythms, timbres and tonalities resemble fleeting musical reverberations. For Greig, the only sound that matters exists in the fractal border between simplicity and complexity. ‘Negotiating this border’, he says, ‘is the hardest thing.’ Although inspired by the natural world, these paintings do not look outwards to the physical landscape but gaze inwards, probing metaphysical depths that, at times, have a cosmological dimension—an awareness of the presence of the infinitely large and the

he seeks a holistic view of what he terms as a ‘complementarity’⁵⁶⁸ that is ‘encountered when any theory consists of two individually complete constructs; when these constructs preclude one another in a description of the situation to which they both apply, in that their combination into a single description would lead to a logical contradiction; and when both constitute a complete description of that situation’.

Greig concludes that:

- (a) *Thus the classical conception of observation as a separation between object and instrument, and an absence of appreciable disturbance, is an idealisation which breaks down in quantum physics;*
- (b) *The quantum postulate thus represents the demise of the classical view of the universe; a demise with sublime implications [which] signifies that the mathematical description cannot exactly correspond with the physical reality at the quantum level;*
- (c) *Nevertheless, the "...feelings of loss" precipitated by this situation are mitigated [...] by our discovery of the quantum of action which has led to a deeper and more satisfying sense of correspondence between our knowledge of reality through physics and reality-in-itself, in that although reality-in-itself is not disclosable, the success of physics in coordinating our experience with that reality is due to the fact that "...the fundamental logical principle in nature is identical with that in all active constructions of human reality".*

Presenting the unrepresentable: An artist’s contrasting conception of incompleteness as ‘complementarity’

“Bohr’s 1927 formulation of complementarity is considered an event of such import that it marks a turning point in the intellectual landscape of the twentieth century.⁸²¹ Initially intended as a response to the dichotomy between the classical and quantum descriptions of physical phenomena, the significance of complementarity has extended far beyond the context in which it was first announced. As Holton (1973) notes, Bohr’s proposal “...was nothing less than an attempt to make it the cornerstone of a new epistemology.”⁸²² To this extent, says Bohr, when confronting situations that are reminiscent of those in quantum physics, it is not that those situations are “vague analogies” of a principle basic only to physics; rather, the situation in physics is but one reflection of an all-pervasive principle.⁸²³ His notion of complementarity is not restricted solely to the paradoxical combination of quantum and classical theories, and Bohr, emphasising the universal significance of the role of complementarity, wanted to further extend his “conceptual means,” saying, “...the nature of our consciousness brings about a complementary relationship, in all domains of knowledge, between the analysis of a concept and its immediate application.”⁸²⁴ Regarded by Heisenberg as primarily a philosopher rather than a physicist,⁸²⁵ Bohr’s writings reveal a dialogue with various philosophical positions such as Kantian metaphysics, Machian positivism, Wittgensteinian linguistics, and Eastern philosophy, and Bohr’s own epistemology anticipates contemporary trends in philosophy such as anti-foundationalism and deconstruction.⁸²⁶ While his philosophical influences remain the subject of debate, Bohr’s central preoccupation was the relationship between words and the world, between language and experience, between subject and object, constantly stressing:

infinitely small intertwined. This convergence of the micro and the macro, the empirical and the speculative, provokes a quiet contemplation of the infinite indiscernible forces operating within and around us all. Ian Greig has exhibited with Arthouse Gallery since 1997 and been involved in over fifty group exhibitions spanning twenty years. Currently the Postgraduate Coordinator at the National Art School in Sydney, Greig completed his doctoral thesis in “The Aesthetics of the Sublime in Twentieth Century Physics” in 2002. He has lectured, written, given many public talks and is an accomplished speaker on the subject of art theory. Greig’s work is held in public and private collections throughout Australia, UK, Spain and Canada including Government House, SA and Artbank.” ... *ARTINFO Blog: IAN GREIG Not Fade Away, January 31, 2019.*

⁵⁶⁸Comparable in intent to the Complementarity Thesis (§1., Thesis 1) of this investigation.

"We are suspended in language in such a way that we cannot say what is up and what is down."⁸⁷⁷

Accorded a significance "... as broad as it is profound and revolutionary in its implications, both in the field of physics itself and in more general conceptual and metaphoric terms,"⁸⁷⁸ complementarity, and Bohr's own outlook, as commentators such as Plotnitsky (1994), and Honner (1987), note, offers an all-embracing vision which, being neither purely philosophical nor purely physical, provides an alternative way of proceeding on such questions as mind, truth, and reality, "... not only in science, but also in psychology, theology, anthropology, and so on."⁸²⁹ Says Honner: "Complementarity comes into play as soon as the practical univocity of our ordinary descriptive concepts breaks down, as soon as we are no longer present to that object to which we point as we utter our word for it, as soon as we use our words to attempt to describe the significance of experience."⁸³⁰ Despite the everyday functionality of language, in stressing the complementarity of *psyche* and *physis*, Bohr reveals the difficulties of going beyond 'pointing' at nature to 'conceptualising' about nature, a situation that eludes 'totalisation' or 'closure'.⁸³¹

In this paper I argue that the significance of complementarity can also be seen in aesthetic terms as a theory of representation which, in acknowledging the losses in representation and incompleteness of knowledge introduced via the quantum of action and the uncertainty relations, purports to present the unrepresentable. Complementarity, says Bohr, is "... a new mode of description ..." intended to encompass the conflictual aspects of quantum phenomena that cannot be achieved by classical theories; aspects considered complementary features, mutually exclusive but equally necessary for a complete description and analysis of quantum processes.⁸³² Rather than integrating these conflictual aspects in the form of classical synthesis, complementarity engages incompatible systems of representation without resolving their incompatibility. As such, complementarity breaks with the representational epistemology of classical physics and deconstructs the foundations of science, pointing to the inability of physics, in the way it constructs, describes, and interprets its objects, to achieve closure.⁸³³

With complementarity, Bohr radically transforms the aesthetics of physics.⁸³⁴ While commentators such as Miller note that Bohr's prescription of complementarity presents a new way for 'seeing' nature which has altered forever our picture of the world, they fail to note the sublime implications of this development.⁸³⁵ Bohr's response to the crisis of representation precipitated by the loss of visualisability in atomic physics has had a profound impact on our understanding of how physicists' description of reality relates to the physical world.⁸³⁶ Via a prescription which places restrictions on all perceptual metaphors, complementarity introduces an abstract aesthetic into the description of nature which displaces the beauty and completeness of classical descriptions and puts forward the unrepresentable in presentation of itself. But unlike Heisenberg's mathematical resolution, Bohr accords priority to our subjective experience of the unrepresentable. For Bohr, understanding what we can say is as important as the investigation of nature itself.⁸³⁷ Rejecting Heisenberg's operational presupposition that nature must imitate a mathematical scheme, Bohr felt compelled to seek a new conceptual framework for the description of quantum phenomena, one that acknowledges the describer as well as the object of description.⁸³⁸

Bohr posits the framework of complementarity as the logical condition for the description and comprehension of experience in quantum physics.⁸³⁹ Scientific explanation can no longer be guided solely by the classical paradigm of a continuous space-time framework, but must acknowledge the limitations of the application of such a framework.⁸⁴⁰ The question raised by the distinction between classical and quantum description is whether the essential continuity that underpins classical description remains fundamentally incompatible with the essential discontinuity and discreteness of atomic

processes, or whether one of the two antithetical views could be incorporated into the other, much as Newton had done in showing celestial physics to be no different from terrestrial physics.⁸⁴¹ Rather than attempting to reconcile the dichotomies, Bohr proposes that we acknowledge the complementarity of representations of events in these two different languages, and that in the ordinary language available for communicating the results of experiments it is only possible to express the wholeness of nature through a complementary mode of description.⁸⁴²

Intended to "... provide a frame wide enough to embrace the account of fundamental regularities of nature which cannot be comprehended within a single picture,"⁸⁴³ complementarity constitutes Bohr's aesthetic preference for continuity and discontinuity to exist side by side.⁸⁴⁴ As "... an exhaustive description of new experience,"⁸⁴⁵ complementarity enables a non-unitary account of the description of physical reality corresponding to the phenomenology of the diversity of aesthetic experience. According to such aestheticians as Gombrich (1960), and Scruton (1974), multiplicity of aspect is a central feature of aesthetic perception. As a projection of imaginative constructs, aesthetic perception denies the view that properties inhere in the objects themselves and is identified instead as a kind of 'seeing as' wherein aesthetic perceptions of the same object conflict in the sense that they cannot be combined in a single perceptual experience of that object.⁸⁴⁶ Acknowledging that "All new experience makes its appearance within the frame of our customary points of view and forms of perception," Bohr bases complementarity on an understanding of how science discloses the subjective character of reality.⁸⁴⁷ Like Wittgenstein's famous 'ambiguous figure', the duck/rabbit drawing,⁸⁴⁸ complementarity is an emblem of resistance to stable interpretations, remaining always to be explained. Analogous to the Cubist aesthetic with which it is often associated,⁸⁴⁹ complementarity introduces a perceptual perspectivism into the depiction of quantum processes which enacts a certain irreducible loss in representation as classically understood.⁸⁵⁰ As Bohr says, while the concepts of classical physics provided "... pictures and ideas embodied in common language, adapted to our orientation in daily-life events,"⁸⁵¹ in quantum physics "... a complete elucidation of one and the same object may require diverse points of views which defy a unique description."⁸⁵²

Complementarity thus undermines one of the most enduring ideals in physics and philosophy alike, the notion of synthesis, including the synthesis of the microscopic and macroscopic pictures of the world.⁸⁵³ The complementary information derived from the quantum realm, even though they represent equally essential aspects of knowledge, says Bohr, "... cannot be combined into a single picture by means of ordinary concepts."⁸⁵⁴ For Plotnitsky, such a situation aligns complementarity with a deconstructive anti-aesthetic that rejects any claim to both a unifying aesthetic principle or to a unifying epistemological principle, such as that desired by Einstein.⁸⁵⁵ The "epistemological dadaism" of complementarity, as Feyerabend describes it, is practised *against* the underlying, established philosophical or aesthetic principles.⁸⁵⁶ Only under the conditions of "radical incompleteness," says Plotnitsky, can complementarity offer complete descriptions of its data.⁸⁵⁷

The logical conditions for complementary description arise from the fact that the two conceptual components of classical causality—space-time description and energy-momentum conservation—are mutually exclusive and can only be coordinated through the limitations imposed by the indeterminacy relations.⁸⁵⁸ Any increase in knowledge of position, for instance, is accompanied by a decrease in knowledge of momentum and vice versa. As Rosenfeld explains: "Contradiction arises when one tries to apply both of them to the same situation ... However, if one reflects on the use of all physical concepts, one soon realizes that any such concept can be used only within a limited domain of validity."⁸⁵⁹ Complementarity is thus encountered when any theory consists of two individually complete constructs; when these constructs preclude one another in a description of the situation to which they both apply, in that their combination into a single description would lead to a logical contradiction; and when both constitute a

complete description of that situation.⁸⁶⁰ In imposing a limit to representation, the confrontation with complementarity compels us to recognise that our knowledge of a physical system cannot in principle be total or complete.⁸⁶¹ As Kafatos and Nadeau put it, "Knowledge here can never be complete in the classical sense because we are unable to simultaneously apply the mutually exclusive constructs which constitute the complete description."⁸⁶²

Complementarity is an inevitable consequence of the quantum postulate which introduces a fundamental discontinuity, or individuality, into subatomic processes and which provides the basis for representation and understanding in the atomic domain.⁸⁶³ In prescribing a limit to the accuracy of our knowledge of the quantum world, the quantum postulate brings into sharp focus the restrictions that language imposes on imagery.⁸⁶⁴ "The fundamental postulate of the quantum of action," says Bohr, "forces us to adopt a new mode of description designated as complementary in the sense that any given application of classical concepts precludes the simultaneous use of other classical concepts which in a different connection are equally necessary for the elucidation of phenomena."⁸⁶⁵ In the decay of a hydrogen atom Bohr observed that the magnitude of the energy levels emitted by an electron is determined by Planck's constant of action which attributes to any atomic process an essential classical discontinuity.⁸⁶⁶ Since the quantum of action is a universal constant of nature, adopting a new mode of description is not, as Rosenfeld notes, "... something that depends on any free choice, about which we can have this or that opinion. It is a problem which is imposed upon us by Nature."⁸⁶⁷

Planck's constant is one of the defining characteristics of the Universe.⁸⁶⁸ Discovered in 1900 by Planck to account for the radiation of energy, Bohr in 1913 used Planck's constant to establish a link between electromagnetic quanta and atomic structure, and in 1924 de Broglie used Planck's constant to calculate the wavelength of matter waves, formulating for electrons in orbit an analog of Planck's proportionality between energy and frequency. In 1925 Pauli found that the directional components of particle 'spin' are also 'quantised', and in 1926 Heisenberg found that all observable quantities are subject to random fluctuations in their values of a magnitude determined by Planck's constant, a limitation which applies to all measurements.⁸⁶⁹ In all cases Planck's constant signifies the break with sense perceptions at the atomic level. In preventing a precise knowledge of all the properties of a quantum system which may be presumed to exist in the absence of measurement, Planck's constant constitutes the inextricable connection between the quantum system and the measuring apparatus, between the microscopic and the macroscopic.⁸⁷⁰

Planck's constant is a central factor in understanding the wave and particle modes of existence. While taking Planck's constant to be zero decouples the wave and particle concepts—resulting in a one-to-one correspondence between mathematical theory and physical reality—its non-zero value indicates the impossibility of understanding atomic phenomena by relying on sense perceptions, since these lead to paradoxical conclusions.⁸⁷¹ An objective description for events in space and time is possible only when dealing with objects or processes on a comparatively large scale (where Planck's constant can be regarded as infinitely small), but when experiments approach the region where the quantum of action becomes a significant factor difficulties arise with the application of visualisable concepts derived from the macroscopic world.⁸⁷²

The congruence of epistemology and metaphysics in complementarity arises from the quantum of action which, as the symbol of the fundamental discontinuity in nature and the limits of experience lying at the heart of physics, not only problematises the strict causality implied by classical physics, but also the classical metaphysics with which classical physics is complicit, a finding that resonates throughout twentieth-century physics. Whereas perception is generally understood to be a 'passivity', rather than an 'activity', in which the reception of data is not itself affected by the process of reception, observation of the quantum of action involves an unavoidable 'disturbance' of the object

which precludes the possibility of a sharp distinction being made between the object and the instrument of observation. Thus the classical conception of observation as a separation between object and instrument, and an absence of appreciable disturbance, is an idealisation which breaks down in quantum physics.⁸⁷³ "The hard lesson here from the point of view of classical epistemology," observe Kafatos and Nadeau, "is that there is no godlike perspective from which we can know physical reality 'absolutely in itself.'"⁸⁷⁴ Hence, there can be no 'outside' perspective.⁸⁷⁵

The quantum postulate thus represents the demise of the classical view of the universe; a demise with sublime implications.⁸⁷⁶ Its presence signifies that the mathematical description cannot exactly correspond with the physical reality at the quantum level. That is, say Kafatos and Nadeau, "... as long as the quantum of action is fact, there can be no one-to-one correspondence between physical theory and physical reality."⁸⁷⁷ Nevertheless, the "... feelings of loss" precipitated by this situation are mitigated, they suggest, by our *discovery* of the quantum of action which has led to a deeper and more satisfying sense of correspondence between our knowledge of reality through physics and reality-in-itself, in that although reality-in-itself is not disclosable, the success of physics in coordinating our experience with that reality is due to the fact that "... the fundamental logical principle in nature is identical with that in all active constructions of human reality."⁸⁷⁸

⁸²¹ Holton, (1973), *Thematic Origins of Scientific Thought*, p. 115

⁸²² *ibid*, p. 150

⁸²³ Bohr, *Essays 1958-1962*, "Quantum Physics and Philosophy", p. 7, cited in Holton, (1973), *ibid*, p.150

⁸²⁴ Bohr, *Atomic Theory and the Description of Nature*, in Honner, (1994), "Description and Deconstruction" in Faye and Folse, *Niels Bohr and Contemporary Philosophy*, p. 148

⁸²⁵ Heisenberg, "Quantum theory and its Interpretation" in Rozental (1967), *Niels Bohr: His Life and Work*. p. 95.

⁸²⁶ Honner, (1987), *The Description of Nature; Niels Bohr and the Philosophy of Quantum Physics*, p.153

⁸²⁷ Shimony, (1988), "Physical and Philosophical Issues in the Bohr-Einstein Debate" in Feshbach, *Niels Bohr: Physics and the World*, p. 298

⁸²⁸ Plotnitsky, (1994), *Complementarity: Anti-Epistemology After Bohr and Derrida*, p. 72. Complementarity, says Plotnitsky, "in its mathematics, its physics, its thinking, and in its understanding of how physics works," effects a radical break at all levels with the idea of continuum, a central feature of Western physics, philosophy, mathematics, and metaphysics, since Aristotle. This "continuum of continuum" implies the entire history of Western philosophy, and is especially significant for Hegel, as it was for Aristotle, Kant, Spinoza, Leibniz, Descartes, as well as for Newton and Maxwell. "Interactively with the mathematics and physics of continuum, this continuum is Einstein's continuity as well" (p. 146).

⁸²⁹ Honner, (1987), *op cit*, p. 214

⁸³⁰ Honner, (1994), "Description and Deconstruction" in Faye and Folse, *op cit*, p. 148

⁸³¹ *ibid*, p. 148

⁸³² Plotnitsky, (1994), *op cit*, p. 5; Bohr, *ATDN*, p. 10, in Honner, *op cit*, p. 54

⁸³³ Miller, (1984), *Imagery in Scientific Thought*, p. 260; Folse, (1985), *The Philosophy of Niels Bohr*, p.254; Honner, (1994), *op cit*, p. 143-144; Plotnitsky, *op cit*, p. 6

⁸³⁴ Williams, (1987), *Surrealism, Quantum Philosophy, and World War I*, p. 251. She writes, "Bohr also changed the aesthetics of physics. Quantum physics was less materialistic than classical physics. A unit of matter could not be exactly located. Waves and particles were human conceptualisations, not exact images of nature. Bohr gave a non-materialistic science a new importance by his focus upon the limitations of all images. Physics therefore developed away from its recent associations with the material world."

⁸³⁵ Miller, (1984), *Imagery in Scientific Thought*, p. 260; Miller, (1996), *Insights of Genius*, p. 321; Folse, (1985), *The Philosophy of Niels Bohr*, p. 203

⁸³⁶ Faye and Folse, (1994), *op cit*, p. xv

⁸³⁷ *ibid*, p. 229; Honner, (1994), *op cit*, p. 151

⁸³⁸ Honner, (1987), *op cit*, p. 222. As Heisenberg puts it, Bohr felt compelled "... to escape into the philosophy." (Folse, 1985, p. 95-96).

⁸³⁹ Bohr, in Kafatos and Nadeau (1990), *The Conscious Universe*, p. 83

⁸⁴⁰ Honner, (1987), *op cit*, p. 215

⁸⁴¹ The complementarity of continuity and discontinuity is both conceptually and metaphorically central to Bohr's framework, as it affects all specific complementarities in quantum mechanics—not only the wave-particle complementarity but also the complementarity of coordination and causality. The complementarity of coordination and causality involves the interaction of continuous and discontinuous processes with the result that the quantum postulate cannot be justified in classical—causal or continuous—terms. According to Plotnitsky (1994), the connection between causality and "the great role of the idea of continuity" was a crucial aspect for Bohr in its relation to all perception, interpretation, conceptualisation, and theory. For Bohr, "every notion, or rather every word, we use is based on the idea of continuity, and becomes ambiguous as this idea fails." Plotnitsky points out that the relationships between continuity and discontinuity has always been a central problem in the history of philosophy, mathematics, and physics alike, and had particular significance for Hoffding, as well as for Kant, Hegel, Husserl, Heidegger and Derrida. (p. 123-124, 282)

⁸⁴² Holton, (1973), *Thematic Origins of Scientific Thought*, p. 118. According to Holton (1978), Bohr is the "best example of a major spirit of science in our century refusing to favour one polar position or the other" (p. 140, an observation noted by Honner, p. 163). Holton notes that Bohr's dialectical approach and his ability to exploit the clash between antithetical positions is reflected in his favorite saying from Schiller: "Only wholeness leads to clarity / And truth lies in the abyss." (p. 148). Following from this, Plotnitsky argues that not only are the standard complementarities of quantum mechanics to be considered—the wave-particle complementarity; the kinematic-dynamic (position-momentum) complementarity; and the complementarity of coordination and causation—but can

also include such complementarities as idealisations and deidealisations; continuity and discontinuity; randomness and causality; completeness and incompleteness; as well as the interpenetrating relations of the inside and the outside; difference and identity (or similarity); and localisation and globalisation. (See chapter 5, p. 121).

⁸⁴³ Bohr, (1958), p. 78, cited in Honner, (1987), op cit, p. 54

⁸⁴⁴ Miller, (1996), op cit, p. 390

⁸⁴⁵ Bohr, (1958), p. 88, cited in Honner, op cit, p. 56

⁸⁴⁶ Jardine, (2000), *The Scenes of Inquiry*, p. 222. See Gombrich, (1960), *Art and Illusion: A Study in the Psychology of Pictorial Presentation*; and Scruton, (1974), *Art and Imagination: A Study in the Philosophy of the Mind*, chap. 8. The analogy with Wittgenstein's example of the same drawing being seen as either a duck or a rabbit is discussed in terms of the relation between perception and imagination that incorporate issues raised in the last chapter. That perceptual experience always involves interpretation, or judgement, gives rise to the view that all seeing is a form of 'seeing as.' That there is no definitive theory to explain the relation between 'seeing as' and mental imagery, the passage from perception to thought, only adds to the complexities of the issue as Scruton's analysis makes clear. Maintaining that all perception involves presuppositions about the world, Scruton assesses the issue of 'aspect perception' as a form aesthetic experience, a process where the transference of the imagination to experience can confer the attribute of 'properties' to the aesthetic object. He concludes that the relation between 'seeing as' and perception mirrors the relation between imagination and belief, wherein 'seeing as' is like an 'unasserted' visual experience, the embodiment of a thought which, if asserted, amounts to a genuine perception in the same way as imagination, if 'asserted', amounts to a belief. (p. 120)

⁸⁴⁷ Bohr, ATDN, p. 49, in Kafatos and Nadeau (1990), op cit, p. 855

⁸⁴⁸ Wittgenstein, *Philosophical Investigations*, part 11, section xi, cited in Mitchell, (1994), *PictureTheory*, p. 50

⁸⁴⁹ While the Cubist's destruction of Euclidean space as a pictorial reality is usually associated with developments in relativity theory (see, for instance, Gablik, 1976, *Progress in Art*, p. 81), Berger, (1980), argues that Cubism's development of an art of interactions analogous to the complementarity of phenomena in quantum physics represents a revolutionary new paradigm in the history of art equivalent to the difference between modern physics' conception of reality with that of the classical Newtonian view (Success and Failure of Picasso, p. 69). Conrad, (1998), similarly claims that Picasso's way of seeing put Heisenberg's principle into practice: "His art created uncertainty." (p. 164). See also Gablik, (1976), *Progress in Art*, who aligns Cubism's destruction of Euclidean space as a pictorial reality with developments in relativity theory (p. 81).

⁸⁵⁰ See Plotnitsky, op cit, p. 5

⁸⁵¹ Bohr, (1953), in Chevalley, (1994), "Niels Bohr's Words and the Atlantis of Kantianism", in Faye and Folse, *Niels Bohr and Contemporary Philosophy*, p. 41

⁸⁵² Bohr, (1929), in Chevalley, *ibid*, p. 41

⁸⁵³ Plotnitsky, (1994), op cit, p. 137

⁸⁵⁴ Bohr, (ATDN), in Plotnitsky, *ibid*, p. 137-138

⁸⁵⁵ Plotnitsky, *ibid*, p. 148

⁸⁵⁶ *ibid*, p. 281, 148

⁸⁵⁷ *ibid*, p. 148

⁸⁵⁸ Kafatos and Nadeau (1990), op cit, p. 84. While complementarity is most often associated with the relationship between wave and particle pictures, Bohr's initial presentation (the 1927 Como paper) suggest that he intended complementarity to refer to the deeper question of the complex relationship between space-time descriptions and claims of causality in microphysical systems. He regards the complementarity of coordination and causality as "indispensable" for an understanding of nature, and consequently the complex connection between the wave-particle duality and the complementarity of a system's kinematic and dynamic properties remains a problematic issue in both the philosophy and interpretation of quantum mechanics. (Faye and Folse, 1994, p. xvi). While in classical physics causality and space-time can be combined in a single mechanical description of a system, independent of the manner of its observation, the quantum of action restricts description of microphysical systems to terms involving their interactions with the measuring apparatus. Says Honner (1987), "Complementarity is applied more broadly to those deeper realities which, by virtue of the indivisibility of the quantum of action, are inseparable from our interaction with them" (p. 57).

⁸⁵⁹ Rosenfeld, in Kafatos and Nadeau (1990), *ibid*, p. 84

⁸⁶⁰ Kafatos and Nadeau, *ibid*, p. 84. Alternatively, Honner (1987) identifies three fundamental suppositions in Bohr's prescription of complementarity: (1) Some kind of conceptual framework is a necessary condition of the possibility of ordering experience. (2) It is a necessary condition of the possibility of objective description of processes at the boundaries of human experience that concepts related to more normal experience be employed. (3) Our position as observers in a domain of experience where unambiguous application of concepts depends essentially on the conditions of observation demands the use of complementary descriptions if the description is to be exhaustive. (op cit, p. 194)

⁸⁶¹ *ibid*, p. 83

⁸⁶² *ibid*, p. 84. Writes Bohr, "The very nature of quantum theory thus forces us to regard the space-time coordination and the claim of causality, the union of which characterizes the classical theories, as complementary but exclusive features of the description, symbolizing the idealization of observation and definition respectively. Just as relativity theory has taught us that the convenience of distinguishing sharply between space and time rests solely on the smallness of velocities ordinarily met with compared to the speed of light, we learn from the quantum theory that the appropriateness of our visual space-time descriptions depends entirely on the small value of the quantum of action compared to the actions involved in ordinary sense perception. Indeed, in the description of atomic phenomena, the quantum postulate presents us with the task of developing a 'complementary' theory the consistency of which can be judged only by weighing the possibilities of definition and observation." (*Atomic Theory and the Description of Nature*, p. 54-55, cited in Kafatos and Nadeau, p. 81)

⁸⁶³ Plotnitsky, (1994), op cit, p. 65

⁸⁶⁴ Miller, (1984), op cit, p. 252

⁸⁶⁵ Bohr, "Causality and Complementarity" in Kafatos and Nadeau (1990), op cit, p. 79

⁸⁶⁶ Gibbins, (1987), *Particles and Paradoxes*, p. 55

⁸⁶⁷ Rosenfeld, (1961), "Niels Bohr's Contributions to Epistemology" in Kafatos and Nadeau (1990), op cit, p. 81

⁸⁶⁸ Barrow, (1998), *Impossibility*, p. 23. In 1900 Planck applied a restriction supplementing existing theory that could not account for the radiation spectrum of energy from a hot object. In the hope of calculating a spectrum that conformed to experiment, he specified, in what he described as "an act of sheer desperation," that the energy carried by radiation could only be a whole number of energy units, a restriction which would then allow the artificial unit of energy to become infinitesimally small. (Kafatos and Nadeau, 1990, p. 27). Planck's "mathematical trick" was a common approach to problems that do not yield sensible solutions, as Lindley (1993) explains: "solve instead a slightly different problem that does have a neat answer, and then let the difference vanish while hoping to retain the neat form of solution." (p. 64). However, Planck found that the precise answer could be obtained, not by making his unit of energy infinitely small, but by keeping its value finite. By imposing the requirement that each electromagnetic oscillation carries energy only in multiples of a specific unit, he obtained perfect agreement with results. This unit is known as Planck's constant. Since energy is proportional to frequency, Planck's constant is the 'constant of

proportionality' between them and defines the amount of energy carried by each quanta of energy associated with a particular wavelength. It has a value of just 6.6252×10^{-34} joule/sec, (Bergstein, 1972, p. 9) or 6.55×10^{-27} erg seconds. (Gribbin, 1995, p. 17). In the system of units based on the centimeter, gram, and second, used by physicists as the fundamental units of length, mass, and time, "Planck's constant is 6.626 thousandth millionth millionth millionth millionths, a decimal point followed by twenty-six zeros and then 6626." (Weinberg, 1992, p. 73).

⁸⁶⁹ Davies and Gribbin, (1991), *The Matter Myth*, p. 202; Pagels, (1982), *The Cosmic Code*, p. 89. The uncertainty (Δx) in position is related to that in momentum (Δp) and expressed mathematically by the relation: $((\Delta x) \times (\Delta p) \geq h$; or alternatively: $\Delta x \Delta p > h/4\pi$. (Rae, (1986), op cit, p. 11). For a clear exposition of the relationship between Planck's constant and the indeterminacy relations see Bergstein, (1972), *Quantum Physics and Ordinary Language*, p. 8-12. Because Planck's constant is so small, we do not notice this uncertainty for macroscopic objects. Thus if Planck's constant were equal to zero, rather than being a small number, it would be possible to measure both the position and momentum of a particle, since the uncertainty relation would be zero, and position and momentum would commute. As Kafatos and Nadeau (1990), put it, "A particle would have no wave properties, and a wave no particle properties—mathematical map and the corresponding physical landscape would be in perfect accord." (p. 48) But because Planck's constant is not zero, this is impossible, and all such measurements in quantum mechanics are subject to similar limitations.

⁸⁷⁰ Miller, (1996), *Insights of Genius: Imagery and Creativity in Science and Art*, p. 122

⁸⁷¹ Kafatos and Nadeau (1990), op cit, p. 48

⁸⁷² Heisenberg, (1958), *Physics and Philosophy*, p. 164

⁸⁷³ Murdoch, (1987), *Niels Bohr's Philosophy of Physics*, p. 95

⁸⁷⁴ Kafatos and Nadeau (1990), op cit, p. 82

⁸⁷⁵ *ibid*, p. 81. According to Plotnitsky, the revolutionary nature of complementarity stems from Bohr's realisation that any comprehensive description of the situation presented by the quantum postulate, a situation "completely foreign to the classical theories," entails dispensing with both classical physics and classical metaphysics. Since complementarity replaces causality as the most general framework for linking observations, in the quantum description, says Plotnitsky, "Whatever is observed can be understood only in terms of effects without classical causes, whether open or hidden, interpretable or uninterpretable, nameable or unnameable." (p. 69).

⁸⁷⁶ *ibid*, p. 136-137

⁸⁷⁷ *ibid*, p. 137

⁸⁷⁸ *ibid*.*

... Greig: [*Grg02a*], CHAPTER 4 *Complementarity: Presenting the unrepresentable*, pp.120-128.

23.D.f. Conjugate properties

The above also suggests that:

Thesis 21. (Conjugate properties) *The nature and behaviour of two conjugate properties F_1 and F_2 of a particle P that are determined by neo-classical laws are described mathematically at any time $t(n)$ by two algorithmically verifiable, but not algorithmically computable, functions f_1 and f_2 .*

- (a) In other words, it is the very essence of the neo-classical laws determining the nature and behaviour of the particle that—at any time $t(n)$ —we can only determine either $f_1(n)$ or $f_2(n)$, but not both.
- (b) Hence measuring either one makes the other indeterminate as we cannot go back in time. This does not contradict the assumption that any property of an object must obey some deterministic natural law for any possible measurement that is made at any time.

23.D.g. Entangled particles

The above similarly suggests that:

Thesis 22. (Entangled particles) *The nature and behaviour of an entangled property of two particles P and Q are determined by neo-classical laws, and are describable mathematically at any time $t(n)$ by two algorithmically verifiable—but not algorithmically computable—functions f_1 and g_1 .*

- (a) In other words, it is the very essence of the neo-classical laws determining the nature and behaviour of the entangled properties of two particles that—at any time $t(n)$ —determining the state of one immediately gives the state of the other without measurement if the properties are entangled in a known manner.

- (b) This does not contradict the assumption that any property of an object must obey some deterministic natural law for any possible measurement that is made at any time. Nor does it require any information to travel from one particle to another consequent to a measurement.

Comment 215. In a provocatively titled preprint: “Quantum mechanics requires “conspiracy””, physicist Ovidiu Cristinel Stoica seeks to address, and resolve, some outstanding grey areas of quantum mechanics—in particular those having a bearing on ‘quantum entanglement’—from both mathematical and philosophical perspectives:

“Quantum states containing records of incompatible outcomes of quantum measurements are valid states in the tensor product Hilbert space. Since they contain false records, they conflict with the Born rule and with our observations. I show that excluding them requires a fine-tuning to a zero-measure subspace of the Hilbert space that seems “conspiratorial”, in the sense that

- it depends on future events, in particular of future choices of the measurement settings,
- it depends on the evolution law (normally thought to be independent of the initial conditions),
- it violates statistical independence (even in interpretations that satisfy it in the context of Bell’s theorem, like standard quantum mechanics, pilot-wave theories, collapse theories, many-worlds etc.).

Even the innocent assumption that there are measuring devices requires this kind of fine tuning.

These results are independent of the interpretation of quantum mechanics.

To explain away this apparent fine-tuning, I propose that an yet unknown law or superselection rule may restrict the full tensor product Hilbert space to this very special subspace.”

... Stoica: [Stc22], Abstract.

From the *evidence-based* perspective of this investigation, at the core of these issues lie the following—amongst other⁵⁶⁹—considerations of what is entailed by Query 30, which is implicit in Patrizia Piredda’s observation in [Prd21]⁵⁷⁰ that ‘each experiment produces a result that will later constitute the probability fork in subsequent experiments. Forecasting, therefore, forces the observer to take into account the perturbation as a critical contributing factor of the outcome of any experiment’:

“While in classical physics phenomena are observed in relation to a given place and time to deduce the laws that regulate their development in accordance with the cause-effect paradigm, without too much worrying about the way and means used to carry out the measurement, in quantum physics, the impossibility of any intuitive knowledge of phenomena deprives the spatiotemporal determination of its usual sense. The perturbation of the subatomic system procured by the means of observation acquires a fundamental role since each experiment produces a result that will later constitute the probability fork in subsequent experiments. Forecasting, therefore, forces the observer to take into account the perturbation as a critical contributing factor of the outcome of any experiment.[5] This factor imposes to drop the claim that we can know both the position and the speed of a particle in the same experiment, because the more precisely we determine the former, the less precisely can we determine the latter and vice versa. This discovery originally

⁵⁶⁹See, for instance, §24.A., *An evidence-based perspective of Deutsch’s Church-Turing principle in his quantum computer*.

⁵⁷⁰See also [Prd23].

seemed so absurd with respect to the knowledge of the physical world that even Einstein rejected it, claiming that destroying the laws of locality and speed (based on the principles of identity and non-contradiction) would challenge his special theory of relativity, which proved—according to Einstein—that the QM was true but incomplete.[6] For Einstein, therefore, “God does not play dice” and the moon exists regardless of whether we look at it or not. All physical phenomena exist objectively and therefore what we know about them is not influenced by our means of observation.[7] The experiments of classical physics cannot be applied in the quantum world because this faces us “with an epistemological problem quite new in natural philosophy, where all description of experiences has so far been based upon the assumption, already inherent in ordinary conventions of language, that it is possible to distinguish sharply between the behaviour of objects and the means of observation.”[8]

... Piredda: [Prd21].

The following—complementary though seemingly contradictory—perspective suggests that the phenomenon of quantum entanglement merely reflects the fact that all our experience indicates nature follows deterministic laws that may not always be representable as predictable in any mathematical model of, essentially select, natural phenomena.

‘Essentially select’, since no mathematical model can sensibly claim to model the Universe.

Moreover, a brief reflection should show that the issue cannot be that fundamental particles act differently depending on whether or not they are being observed; but that the mere act of observing must alter that which is being observed in some way—no matter how minuscule (occasionally referred to as the ‘butterfly effect’)—that, at the micro level, must be essentially unpredictable even if deterministic.

Reason: If we accept that the passage of time is one-directional, and that the universe is in a state of constant flux (change) at the micro level, then we must concede that no experiment can ever be exactly replicated.

Whilst this may not be significant at the macro level (which is why assuming that the laws of nature can be treated as deterministic permits treating them as algorithmically predictable), it must clearly be significant at the micro level (which is why even assuming that the laws of nature can be treated as deterministic at the micro level only permits treating them as statistically predictable).

In other words, the underlying issue may simply be one of reconciling:

- our experience that physical phenomena at the macro level can be faithfully described in a mathematical model, say *Classical*, by functions and relations that are both deterministic (algorithmically *verifiable*) and predictable (algorithmically *computable*); with
- our experience that physical phenomena at the micro level can be faithfully described in a mathematical model, say *Quantum*, only by functions and relations that are deterministic (algorithmically *verifiable*) but not predictable (algorithmically *uncomputable*).

The need for such reconciliation is seemingly quite straightforward.

If we seek to introduce the results of an interaction between an external agent (observer), and an element of the phenomena which both the models—*Classical* and *Quantum*—were originally intended, by definition, to represent mathematically by means of deterministic and predictable functions and relations, we need to appropriately represent introduction of a discontinuity—caused by the interaction that, by the very definition of an ‘external agent’, was not part of the original model—into a revised model.

Now, our experience shows that:

- at the macro level, the perturbation (discontinuity) caused by any such interaction (observation / measurement) is such that we only need to introduce an additional function or relation which is *both* deterministic, and predictable, into the original model to ensure that, over any reasonable passage of time (not eternity; since we have no evidence to suggest that the laws of nature must remain unchanged eternally), the revised model continues to ‘faithfully’ represent subsequent observations / measurements of the phenomena.
- at the micro level, the perturbation (discontinuity) caused by any such interaction (observation / measurement) is such that we can *only* introduce an additional function or relation which is deterministic, but not predictable, into the model to ensure that, over any reasonable passage of time (not eternity), the revised model continues to ‘faithfully’ represent subsequent observations / measurements of the phenomena.

The only difference between the two is in how we interpret the term ‘faithful’.

- In *Classical* models, the revised model continues to ‘faithfully’ represent subsequent observations / measurements of the phenomena by means of functions and relations that remain algorithmically *computable*.

They are thus both determinate and predictable as to representing a reasonably future measurement / observation.

- In Quantum models, the revised model continues to ‘faithfully’ represent reasonably future observations / measurements of the phenomena by means of functions and relations that are now *only* algorithmically *verifiable*, but not necessarily algorithmically *computable*.

They are thus determinate as to representing a reasonably future measurement (which entails *entanglement*) but not precisely (uniquely) predictable of any reasonably future measurement; except within a range of values that depend upon, and reflect, the—essentially limited—nature of the discontinuity, caused by the observation / measurement / interaction, which is now sought to be introduced into the original model.

The following rhetorical query seeks to address the significance of the distinction between algorithmic *verifiability* and algorithmic *computability* in the above context:

Query 30. *What would introducing experimental observations—which implicitly subsume ‘free will’—into a mathematical model entail?*

1. What we⁵⁷¹ initially seek to *express* in a mathematical language⁵⁷² is a putative, deterministic and (ideally) predictable, model of our *subjective* conceptual metaphors of that which we perceive, or of that which we can conceive⁵⁷³, as the ‘common universe’ we inhabit.

⁵⁷¹When wearing a philosopher’s hat; see §13.C.

⁵⁷²When wearing a mathematician’s hat; see §13.C.

⁵⁷³On the basis of our sensory perceptions/observations/measurements when wearing the natural scientist’s hat; see §13.C.

2. Any such model can be claimed to *faithfully* represent our common sensory perceptions of the ‘universe’ if, and only if, it can be *categorically* communicated. It cannot be dependent upon any *one* individual’s subjective conceptual metaphors of the ‘universe’ we inhabit.
3. Such a model, by definition, is a *permanent* mathematical construction that *cannot* be dependent upon whether I *subsequently* choose to introduce an ‘observer’—with or without a *free will*—into the model that was not *already* part of the model.

Comment 216. Such a perspective is not uncommon. For instance, amongst the various interviews recorded in her cogently, and passionately, argued book ‘Lost in Math’ [Hos18a], iconoclastic physicist Sabine Hossenfelder attributes the following remarks to physicist Steven Weinberg during an interview in the latter’s office in Austin:

“What I don’t like about quantum mechanics is that it’s a formalism for calculating probabilities that human beings get when they make certain interventions in nature that we call experiments. And a theory should not refer to human beings in its postulates. You would like to understand macroscopic things like experimental apparatuses and human beings in terms of the underlying theory. You don’t want to see them brought in on the level of axioms of the theory.”

... Hossenfelder: [Hos18a], Chapter 6, *The Incomprehensible Comprehensibility of Quantum Mechanics: A Losing Game*, p.124.

Comment 217. Such a perspective is also implicit in philosopher E. Brian Davies’ compelling argument *against* the assumption that a, putatively ‘future’, Theory of Everything (TOE) is feasible which, by definition, would admit introduction of an ‘observer’ into a ‘current’ experiment at the level of quanta.

‘*Against*’, since any TOE would implicitly admit the ‘time-travel’ paradox where I may, at *any* instant of time, choose whether or not to introduce an ‘observer’—with or without a *free will*—into a model of the TOE that could then—seemingly miraculously—be treatable as a pre-existing ‘element’ of the TOE:

“If one examines what physicists do in their daily research, one finds that they build mathematical models. Each of these is highly simplified, because otherwise one could not use it to make predictions. In different situations they use different models, choosing the appropriate one on the basis of their experience and the scientific understanding of the time. No model which currently exists can be regarded as true: each has a domain of applicability in which it gives a useful approximation to reality. In spite of the fact that Newtonian mechanics has been ‘superseded’ by both quantum theory and general relativity, it continues to be used as much as it ever was, because it is much simpler than its successors, and the differences are expected to be tiny in most everyday situations, such as designing car engines or putting telecommunications satellites into orbit.

Although all physicists build models of restricted validity, many believe that these are in principle derivable from a future TOE, probably by a multi-stage process. When one examines the facts, even finding the boiling point of water from the fundamental laws governing oxygen and hydrogen atoms is far beyond present capabilities, more than one hundred years after Maxwell laid down the foundations of statistical mechanics. As another example, the existence of the fullerene molecules was discovered experimentally, in spite of the fact that they involved only one type of atom, carbon, whose quantum mechanical properties were thoroughly established. Computational chemists could verify that the structures existed according to the laws of SQM *after* they had been discovered, but that is different from predicting their existence. We still do not know if quite new forms of carbon molecule might still appear.

There is a radical alternative to the reductionist doctrine. It states that the universe is not governed by mathematical laws, and there need not exist any TOE.

We created mathematics to enable us to understand the world around us, and the longer we persist with the scientific enterprise the more successful we will be. Science consists of the building of partial models, many of them mathematical, and progress consists of creating useful new models or discovering new connections between old models. Our undoubted successes in this enterprise do not imply that eventually everything will be explained this way. Isaac Newton believed that ‘nature is simple’ and many theoretical physicists share his faith, but it is much less popular among those in the life sciences.

One of the consequences of adopting a reductionist viewpoint is that one accepts that every phenomenon has only one true explanation—it is a mathematical consequence of the ultimate laws combined with the initial conditions. These may be so complex that we can only solve the equations approximately, or have to work upwards through a hierarchy of less fundamental theories, but no other explanation holds water. Biologists regard such ideas as absurd, because they use the word explanation quite differently. For them, understanding is something achieved by a human being, and different explanations of the same fact can co-exist without any of them having priority in an absolute sense. For a criticism of reductionism and an amusing discussion of five reasons why a frog might jump into a pond, see Rose ([1997], pp. 8–13).

To claim that mathematics is a human creation is to be an anti-Platonist, or, as some would say, a mathematical anti-realist. It is perfectly possible to be an empiricist as far as mathematically-based theories are concerned but a realist when discussing physical entities. A mathematical empiricist can believe that bacteria, DNA and atoms exist, and that ‘dinosaurs had four legs before humans existed to count these’. References to the past necessarily use concepts understood in the present. Unless one is a creationist, the statement about dinosaurs is correct as soon as all of the concepts involved have been formulated clearly enough for us to understand it. In particular we have to agree about which of their appendages we will call legs; since their front and rear limbs have different structures, our use of the word ‘leg’ presupposes that we consider function to be more important than anatomy, within certain limits."

... : Davies: [Dav05a], Introduction.

4. In other words, the model is assumed to obey laws that do *not* admit prediction of the *consequences*, of any interaction with an ‘observer’, that I may seek to subsequently introduce into the model *at will*; since that would constitute introducing a mathematical discontinuity that was not *already* ‘built’ into the original model.

Comment 218. Such a ‘mathematical discontinuity’ can be viewed as corresponding to what Spiridon Dumitru intriguingly refers to as ‘a transmission process for information’ in his informal essay [Dmt22]:

“Accordingly, for a measured physical system, the “*situation existing before the measurement*” regards the intrinsic properties of that system. The quantitative details of respective properties play the role of ‘*input data*’ (entrance information) within the measurement. Additionally, for the same system, the measurement results are accumulated in ‘*output data*’ (received information) which are provided by measuring process. So, the whole measurement looks as a transmission process for information, while the measuring device appears as a communication channel (regarded as in [17]). Thus, an overview of a measurement can be depicted through (1).

$$\begin{bmatrix} \textit{input} \\ \textit{data} \end{bmatrix} \Rightarrow \begin{bmatrix} \textit{communication} \\ \textit{channel} \end{bmatrix} \Rightarrow \begin{bmatrix} \textit{output} \\ \textit{data} \end{bmatrix} \quad (1)$$

We recall that this scheme was applied (see [18] and Appendices E and H from [4]) in describing non-quantum measurements for the fluctuations of thermodynamic-

macroscopic quantities considered as classical random variables."

... Dumitru: [Dmt22], §E, *Separate Theoretical Descriptions of QMS in terms of Information Theory*.

5. Classical mechanics implicitly postulates that any putative introduction of such an 'observer' for interacting with, and determining, the *macro* nature of the model, does not also introduce an 'essential' mathematical discontinuity; it *only* requires the putative introduction of an additional, algorithmically computable, law that would admit a unique, mathematically predictable, revised model of the 'universe' which, thereafter, contains *that particular* 'observer' as a well-defined feature of the model which, necessarily, subsumes the earlier model.
6. Such a postulation has been consistently perceived as consistent with both quantum mechanics *and* experimental observations.

Comment 219. For instance, as Hossenfelder describes—colourfully and vividly in lay terms—the mathematics of classical interactions which admit quantum behaviour:

"... There's a good reason we never witness quantum behavior in everyday life. For large objects—like cats or brains or computers—the quantum-typical properties fade away extremely quickly. Such objects are part of warm and wiggly environments, and the constant interactions scramble up quantum links between parts of the system. This scrambling—called decoherence—quickly converts quantum states to normal probability distributions, even in the absence of a measurement apparatus. Decoherence thus explains why we don't observe superpositions of large things."

... Hossenfelder: [Hos18a], Chapter 6, *The Incomprehensible Comprehensibility of Quantum Mechanics: Everything Is Amazing and Nobody's Happy*, p.123.

7. Quantum mechanics implicitly postulates that any putative introduction of such an 'observer' for interacting with, and determining, the *micro* nature of the model introduces an 'essential' mathematical discontinuity; it requires the putative introduction of an additional, algorithmically verifiable, law that does not admit a unique, mathematically predictable, revised model of the 'universe' which, thereafter, contains *that particular* 'observer' as a well-defined feature of a model that, necessarily, must subsume the earlier model.
8. *Reason*: Any observer that I introduce on the basis of my free will, post the formulation of a model, could not have existed in the original. Hence any interactions between the 'observer' and the original model, post such introduction, must also be consistently evidenced as consistent with experimental observations.

Comment 220. Prima facie, such a perspective can be perceived as necessary for addressing the antipathy, towards 'decoherence', reflected in the following remarks that Hossenfelder attributes to Weinberg in [Hos18a]:

"You can very well understand quantum mechanics in terms of an interaction of the system you're studying with an external environment which includes an observer, ... But this involves a quantum mechanical system interacting with a macroscopic system that produces the decoherence between different branches of the initial wave function. And where does that come from? That should be described also quantum mechanically. And, strictly speaking, within quantum mechanics itself there is no decoherence."

... Hossenfelder: [Hos18a], Chapter 6, *The Incomprehensible Comprehensibility of Quantum Mechanics: A Losing Game*, pp.126-127.

Comment 221. Justifying Weinberg’s disquiet, Daniela Frauchiger and Renato Renner illustrate—in a cogently argued paper [FrRe18]—how the putative introduction of an ‘observer’ into an already well-defined model can collaterally admit an *unintended* doctrine of ‘alternative facts’ (as cautioned in the Author’s Preface on p.7):

“In the Gedankenexperiment proposed in this article, multiple agents have access to different pieces of information, and draw conclusions by reasoning about the information held by others. In the general context of quantum theory, the rules for such nested reasoning may be ambiguous, for the information held by one agent can, from the viewpoint of another agent, be in a superposition of different “classical” states. Crucially, however, in the argument presented here, the agents’ conclusions are all restricted to supposedly unproblematic “classical” cases. For example, agent \overline{W} only needs to derive a statement about agent F in the case where, conditioned on his own information \overline{w} , the information z held by F has a well-defined value (Table 3). Nevertheless, as we have shown, the agents arrive at contradictory statements.

Current interpretations of quantum theory do not agree on the origin of this contradiction (cf. Table 4). To compare the different views, it may therefore be useful to rephrase the experiment as a concrete game-theoretic decision problem. Suppose that a casino offers the following gambling game. One round of the experiment of Box 1 is played, with the gambler in the role of agent W, and the roles of \overline{F} , F, and \overline{W} taken by employees of the casino. The casino promises to pay €1000 to the gambler if F’s random value was $r = \text{heads}$. Conversely, if $r = \text{tails}$, the gambler must pay €500 to the casino. It could now happen that, at the end of the game, $w = \text{ok}$ and $\overline{w} = \overline{\text{ok}}$, and that a judge can convince herself of this outcome. The gambler and the casino are then likely to end up in a dispute, putting forward arguments taken from Table 3.

Gambler: “The outcome $w = \text{ok}$ proves, due to (4), that S was not prepared in state $|\rightarrow\rangle_S$. This means that $r = \text{heads}$ and hence the casino must pay me €1000.”

Casino: “The outcome $\overline{w} = \overline{\text{ok}}$ implies, due to (6), that our employee observed $z = +\frac{1}{2}$. This in turn proves that S was not prepared in state $|\downarrow\rangle_S$. But this means that $r = \text{tails}$, so the gambler must pay us €500.”

How should the judge decide on this case? Could it even be that both assertions must be accepted as two “alternative facts” about what the value r was? We leave it as a task for further research to explore what the different interpretations of quantum mechanics have to say about this game.

Theorem 1 may be compared to earlier no-go results, such as^{7,8,9,10,41,42,43}, which also use assumptions similar to (Q) and (S) (although the latter is often implicit). These two assumptions are usually shown to be in conflict with additional assumptions about reality, locality, or freedom of choice. For example, the result of ref.⁹, which is as well based on an extension of Wigner’s argument, asserts that no theory can fulfil all of the following properties: (i) be compatible with quantum theory on all scales, (ii) simultaneously assign definite truth values to measurement outcomes of all agents, (iii) allow agents to freely choose measurement settings, and (iv) be local. Here, we have shown that Assumptions (Q) and (S) are already problematic by themselves, in the sense that agents who use these assumptions to reason about each other as in Fig.3 will arrive at inconsistent conclusions.

Another noticeable difference to earlier no-go results is that the argument presented here does not employ counterfactual reasoning. That is, it does not refer to choices that could have been made but have not actually been made. In fact, in the proposed experiment, the agents never make any choices (also no delayed ones, as e.g., in Wheeler’s “delayed choice” experiment⁶³). Also, none of the agents’ statements refers to values that are no longer available at the time when the statement is made (cf. Table 3)."

... Frauchiger and Renner: [FrRe18], Discussion.

9. Now, any attempt at the ‘exact’ repetition of a quantum interaction, in a controlled experiment, reveals that—due to unavoidable sensitive dependence on initial conditions (the ‘butterfly effect’⁵⁷⁴)—the experiment does not yield what can be claimed mathematically as ‘identical’ results.

However, it also reveals that the results are not totally random, but yield a deterministic set of values that obey quantum laws as determined, say, by Schrödinger’s equation.

10. In other words, experimental observations show that, introduction of an ‘observer’ into a model at the quantum level, identifies a set of putative states.

Each of these is a putative, revised, model in which the ‘observer’ is now a well-defined feature of the revised model (which can be viewed as corresponding to one of the ‘many’ putative models of a ‘many worlds’ theory).

Comment 222. Prima facie, such a perspective might also avoid the antipathy to a ‘many worlds’ theory reflected in the following remarks that Hossenfelder attributes to Weinberg in [Hos18a]; if we replace the concept of ‘many-histories’ by a concept of ‘many-putative-mathematical-models’:

“Now, there is an attempt to deal with this, which denies decoherence and contemplates treating human beings completely quantum mechanically just like everything else, and that’s the many-histories approach. In the many-histories approach, if you start with a pure wave function, it’s always a pure wave function. But as time evolves, it has many terms in it, each one of which contains a description of observers, and the observers in each term think they’re seeing something different—like one observer sees the spin [of a particle as] up and the other sees the spin down.

And while you could live with the history of the universe splitting into two branches, in this many-histories approach you have an endless continual production of unimaginably large numbers of histories of the universe.

Well . . . that might be the way things are, and I don’t know anything logically inconsistent about it. But it’s so repulsive to imagine this vast number of histories.”

... Hossenfelder: [Hos18a], Chapter 6, *The Incomprehensible Comprehensibility of Quantum Mechanics: A Losing Game*, pp.127.

11. If, now, the intention is to identify the unique model which is the outcome of the introduction, of an actual ‘observer’, into the original model, then one would have to introduce, along with the ‘observer’, a ‘sensor’ that can identify which of the states was the actual outcome of the experiment (corresponding to what is termed as the collapse of the wave function).

Comment 223. In other words, the algorithmically *verifiable* (but not necessarily algorithmically *computable*) function/s, say F_i , mathematically representing the ‘actual’ observation/measurement of a physical phenomena (not necessarily only at the quantum level) in the ‘current’ model $M_{(t-1)}$ are uniquely defined by all past values of the phenomena, at any finite set of measurements $\{F_0, F_1, \dots, F_{(t-1)}\}$, already incorporated into that particular model $M_{(t-1)}$; and are both deterministic and predictable⁵⁷⁵ as to future values if the phenomena remains ‘unobserved’.

⁵⁷⁴“In chaos theory, the butterfly effect is the sensitive dependence on initial conditions in which a small change in one state of a deterministic nonlinear system can result in large differences in a later state.” ... Wikipedia: [Butterfly effect](#).

⁵⁷⁵With properties similar to those of the primitive recursive, algorithmically *computable*, number-theoretic Gödel β -function defined in [Go31], Theorem VII; see also §16.A.

However, any introduction of a discontinuity into the model $M_{(t-1)}$, corresponding to a physical measurement must, itself, reflect the underlying, deterministic, physical laws; and must consequently introduce into the revised post-measurement model M_t a predictable probability spectrum for the next value that has been experimentally observed as definable by Schrödinger's equations and which, when physically measured at time t , can be associated as the 'next' physical measurement of the phenomena at time t in the model M_t .

This last measurement then yields a value F_t that must necessarily differ from any putative value of the 'unobserved' phenomena in the model $M_{(t-1)}$ at time t ; unless the difference between the two can be treated as below any measurable threshold (as is the case in phenomena represented mathematically by algorithmically *computable* functions in classical physics).

Comment 224. The significance, and need, of such a *simple*, and natural, perspective for an intuitively plausible introduction of an 'observer' into mathematical descriptions/modelling of quantum experiments can be seen, for instance, in Jeffrey Alan Barrett and Isaac Goldbring's preprint [BaG23].

Barrett and Goldbring address the plausibility of a prevailing—*complex*, counter-intuitive and seemingly non-falsifiable—formulation of Bohmian Mechanics that admits the *eerie* introduction of an 'observer' as a 'space invader' into the, implicitly *finitary*, mathematical description/modelling of a quantum experiment; where both 'the wave function $\psi(q, t)$ and the particle configuration $Q(t)$ evolve in $3N$ -dimensional configuration space, where N is the number of particles in the system one wishes to describe', as follows:

“Following Bell's (1987) formulation of the theory, Bohmian mechanics can be characterized by four rules:

1. *Representation of states:* The complete physical state of a system S at time t is given by the wave function $\psi(q, t)$ over configuration space and a point in configuration space $Q(t)$.
2. *Interpretation of states:* The position of every particle is always determinate and is given by the current configuration $Q(t)$.
- 3I. *Linear dynamics:* The wave function evolves in the standard unitary way

$$i\hbar \frac{\partial \psi(q, t)}{\partial t} = \hat{H} \psi(q, t)$$

where \hat{H} is the Hamiltonian.

- 3II. *Particle dynamics:* Particles move according to

$$\frac{dQ_k(t)}{dt} = \frac{1}{m_k} \frac{\text{Im} \psi^*(q, t) \nabla_k \psi(q, t)}{\psi^*(q, t) \psi(q, t)} \Big|_{Q(t)}$$

where m_k is the mass of particle k and $Q(t)$ is the current particle configuration.

4. *Distribution postulate:* The probability density of the configuration $Q(t_0)$ is $|\psi(q, t_0)|^2$ at an initial time t_0 .

Both the wave function $\psi(q, t)$ and the particle configuration $Q(t)$ evolve in $3N$ -dimensional configuration space, where N is the number of particles in the system one wishes to describe. The $3N$ -coordinates of the configuration $Q(t)$ give the position of each particle at time t . One can think of the probability density $|\psi(q, t)|^2$ as describing the density of a compressible fluid in configuration space. The wave function evolves according to the linear dynamics (rule 3I), and as the compressible fluid flows about in configuration space, it carries the point representing the particle configuration $Q(t)$ as described by the particle dynamics (rule 3II). As a result, the configuration moves in configuration space as if it were a massless particle carried by the probability current.

In contrast with collapse theories like the standard von Neumann (1932) theory and GRW (1986), the dynamics in Bohmian mechanics is both deterministic and

time-reversal symmetric for a broad range of simple physical systems. If one knows the wave function at time t and the Hamiltonian \hat{H} , then rule 3I determines the wave function at all future and past times. And in many situations if one knows how the wave function evolves and the particle configuration $Q(t)$ at a time, then rule 3II determines the positions of the particles at all future and past times. But there are some situations where the theory is less well behaved. Before considering what can go wrong, it is important to understand how probability works in the theory.

Quantum probabilities are purely epistemic in Bohmian mechanics. They result from a physical observer not knowing the initial particle configuration. The dynamics has the property that if the epistemic probability density for the particle configuration is ever given by the standard epistemic quantum probabilities $|\psi(q, t)|^2$, then it will continue to be until one makes a measurement. After a measurement, it will be given by the effective wave function, a notion introduced and discussed by Dürr, Goldstein, and Zanghì (1992).¹ The distribution postulate (rule 4) stipulates that the epistemic probability density for the particle configuration at time t_0 is $|\psi(q, t_0)|^2$. It is this statistical boundary condition together with how the dynamics works that yields the standard quantum probabilities as epistemic probabilities over particle configurations.

Rule 4 is crucial to the empirical adequacy of the theory. If particles were not distributed in this way, the theory would not predict the standard quantum probabilities. And if an observer ever knew the particle configuration with more precision than allowed by the standard quantum probabilities, she would be able to predict the results of her future measurements more precisely than allowed by the standard quantum probabilities.

Some proponents of Bohmian mechanics do not like having to assume a special boundary condition like rule 4 as a part of the theory. As a result, there is a long tradition of seeking to derive something like rule 4 from the Bohmian dynamics and some collection of general epistemic principles.² On this approach, one treats the wave function and configuration as independent then argues that one can expect rule 4 to be eventually satisfied under the dynamics.

Allowing the wave function and particle configuration to be independent provides a broader range of physical possibilities, but it also allows for physical situations where the behavior of a system is radically underdetermined by its state. We will briefly discuss determinism in classical mechanics then consider what can happen in a Bohmian system when the wave function and particle position are logically independent."

... Barrett and Goldring: [BaG23], §1. Bohmian Mechanics.

Barrett and Goldring then seek an alternative interpretation of Bohmian Mechanics, which appeals to non-finitary, non-standard, real analysis for postulation of precisely such an ‘observer’ as an *eerily* physical manifestation—of a Zeno-type ‘discontinuity’ (in the sense of §23.D.b.; see also §20.D., Query 18, §20.D.b., Thesis 10, and §20.D.c.)—at the purported physical limit of the putative measurements of a quantum phenomena over a non-terminating sequence of ‘instants’:

“In his discussion of determinism in classical mechanics, John Earman showed how a particle might move beyond every spatial location in a finite time and how a particle might move to any specified spatial region without having been at any spatial location a finite time earlier (1986, 34–5). Following Mather and MaGehee (1975), Earman further showed how each phenomenon might occur as the result of physically possible forces (1986, 35–7). A simple example suffices to illustrate the idea.

Consider a one-dimensional universe containing a single particle that starts at a location x_0 , as specified by an inertial observer, then moves one meter to the right in 1/2 second, another meter to the right in the next 1/4 second, another meter to

the right in the next 1/8 second, and so on. After 1 second the particle will be beyond any specified location to the right and hence not spatially located at all. This phenomenon is sometimes called a *reverse space invader*. And inasmuch as classical mechanics is time-reversal symmetric, this process is reversible. In that case, a particle that is not at any spatial location one second ago moves to location x_0 , the spatial part of its trajectory mirroring that of a reverse space invader. This is a *space invader*. Reverse space invaders pose a problem for principles like the conservation of mass, energy, momentum, and charge; space invaders pose a direct problem for determinism.

Classical mechanics allows that a space invading particle might appear come flying in at any time disturbing the predicted behavior of an otherwise deterministic system. While one might seek to recover determinism by imposing constraints on classical mechanics that would eliminate such phenomena, Earman showed that finding plausible physical constraints that do so is more difficult than one might at first imagine (1986, 37–53). He concluded:

Newtonian space-time, whose structure is rich enough to support the possibility of determinism in classical worlds, nevertheless proves to be a none too friendly environment. The principle irritant derives from the possibility of arbitrary fast causal signals, threatening to trivialize domains of dependence. (1986, 52)

As we shall see, at least part of the problem regarding domains of dependence results from classical mechanics' use of the reals \mathbb{R} to model the spacetime continuum. While we will focus here on Bohmian mechanics, on[e] moral of the story is that the hyperreals ${}^*\mathbb{R}$ provide a natural model for the continuum that is particularly well suited to handling classical invader-type phenomena.^{3"}

... Barrett and Goldring: [BaG23], §2. *Classical Invaders*.

12. Addition of this state, to the revised model, would now give a deterministic model that can be claimed as consistent with experimental observation only upto the last 'observation/measurement', but no further (i.e., even though the model itself is deterministic, its future values cannot be uniquely predicted after a—discontinuity inducing—experimental observation).

Comment 225. Such a perspective can be viewed as illuminating, if not also complementing, Shan Gao's 'interpretation of the wave function in terms of random discontinuous motion of particles (RDMP)' in his preprint [Gao23], *if* we selectively substitute 'models' for 'worlds':

"According to the many-worlds interpretation of quantum mechanics (MWI), all results occur after a measurement. This seems to make an observer-independent understanding of the Born probabilities impossible. In this paper, I propose a new way to solve the problem of probability in MWI. It is suggested that different worlds exist in different sets of instants, and all worlds exist in a time-division multiplexing way during an arbitrarily short time interval. Since there is only one world at each instant, the Born probabilities can be understood in the usual way. Moreover, since there are many worlds during a time interval, MWI also gives predictions different from those of single-world quantum theories. Finally, it is pointed out that this version of MWI introduces no additional ontologies and postulates when assuming a plausible realist interpretation of the wave function."

... Gao: [Gao23], *Abstract*.

Gao can then be seen as seeking to reasonably—even if not falsifiably—resolve 'the problem of probability in MWI' by satisfying the requirement that 'the ontology of MWI should contain beables (i.e. physical items existing in space and time), and the probabilities in MWI should be attached to alternatives and related to genuine uncertainties':

"It has been a puzzle whether MWI gives predictions different from those of single-world unitary quantum theories such as Bohm's theory (Bohm, 1952). If the answer

is yes, then how can MWI also agree with the Born rule? The above version of MWI may help answer this puzzle. The theory agrees with the Born rule (for the original measurer M); M obtains only one result at every instant after the measurement, and the probability of M obtaining this result is equal to the Born probability. But still all results occur after a measurement; different results are obtained by different successors of M, and they coexist in a time-division multiplexing way during an arbitrarily short time interval. In this sense, the probability of every result occurring is one during any time interval after the measurement, or in other words, the probability that there will be successors of M who obtain a possible result is one. Then, MWI and single-world unitary quantum theories will give different predictions about small-probability results: the former predicts that there will be successors who obtain small-probability results with certainty, while the latter predicts that the small-probability results will almost never occur (see also Gao, 2021a, 2022c). Note that this conclusion is independent of an analysis of the conscious experience of observers (Gao, 2022b).

Vaidman (2022) recently asked: why is MWI not in the consensus? I think the answer may be found from the opinions of the strongest but respectable opponents of MWI such as Tim Maudlin. On Maudlin's (2014) view, the ontology of MWI should contain beables (i.e. physical items existing in space and time), and the probabilities in MWI should be attached to alternatives and related to genuine uncertainties. Since the current formulation of MWI does not satisfies these requirements, it is not in the consensus. However, the above version of MWI satisfies these requirements. In this theory, the ontology is particles in space and time, and their random discontinuous motion forms a time division multiverse, in which different worlds exist in different sets of instants or different time subflows. Moreover, the Born probabilities indeed come from real randomness, and the Born rule can also be naturally derived from the picture of RDM of particles. Now, if the strongest opponents of MWI are also satisfied with it, then hopefully we will reach a consensus in understanding quantum mechanics in the near future."

... Gao: [Gao23], p.4.

However, such a putative, underlying, complementarity between the perspective of the preceding paragraphs (1) to (12), and the thesis Gao seemingly seeks to argue in [Gao23], is obscured by what can be viewed as Gao's—seemingly unintended and implicitly counter to his intent—conflation between:

- (a) 'different results are obtained by different successors of M' when iterating an experiment of a quantum phenomena; where the probability distribution of the observed results 'obtained by different successors of M' must obey Born probabilities and Born's rule; and
- (b) 'different results are obtained by different successors of M' when making a putative, subsequent, measurement by a 'successor' of M of that whose properties were sought to be 'measured' by the original experiment; where the probability that the subsequent observation by a 'successor' of M has a definite value somewhere within the predicted range (irrespective of the probability of such a value occurring) is one.

13. In other words, the essence of quantum phenomena can be expressed by saying that they obey physical laws which are algorithmically verifiable upto any observation (i.e., deterministic upto), but not algorithmically computable beyond (i.e., unpredictable beyond); even though the 'current' model, at any 'observation', is expressed in terms of unique functions⁵⁷⁶ that are algorithmically computable (hence deterministic and predictable), but whose values cannot claim to be experimentally verifiable beyond the last observation.

⁵⁷⁶With properties similar to those of Gödel's primitive recursive, algorithmically computable, number-theoretic, β -function defined in [Go31], Theorem VII; see also §16.A.

Comment 226. We note that, in his insightful preprint [Stc22], Stoica too seeks to address, and proffer—albeit tentatively—an intriguing mathematical resolution for these issues:

“Quantum mechanics, like other theories, is formulated from a God’s-eye perspective. But, as parts of the world we observe, we are limited to a worm’s-eye perspective. If in the present time we would be part of a random state of the universe, this would most likely contain incompatible records, from which we would never be able to guess the laws of quantum mechanics, in particular the Born rule.

An example of such a state is one containing n records of repeated spin measurement of the same silver atom, so that the n records of the outcomes are random values $\pm\frac{1}{2}$, and not the same value repeated n times. This state is a valid state in the tensor product Hilbert space. But the records it contains could not come from actual repeated quantum measurements. We never observe such states.

The simple fact that we exist and could discover quantum mechanics indicates that the physical law is user-friendly enough to allow our memories to form and be reliable, to reflect the evolution of our universe so that we can guess its laws, including the Born rule. We are led to a “*the universe does not mislead us*” metaprinciple:

Metaprinciple NMU (Non-Misleading Universe). The records of the experimental results and the memories of the observers reflect the actual history of the universe.

Without this, science and even life would be impossible. But Metaprinciple NMU, as we shall see, requires severe restrictions of the possible states. We will see that this fine-tuning contradicts several of our most cherished common sense beliefs.

...

Belief 1 (Universality). Quantum mechanics, including the Born rule and the results of quantum experiments, respect Metaprinciple NMU for all initial conditions.

Belief 2 (Subsystems Independence). Let A and B be two subsystems with no common parts. If A can possibly be in the state α and B can possibly be in the state β , the combined system can possibly be in the state $\alpha \otimes \beta$.

Belief 3 (No Input From Future). Initial conditions are independent of future events in the history, in particular of future choices of the measurement settings.

Belief 4 (No Input From Evolution Law). Initial conditions are independent of the evolution law of the system.

Belief 5 (For-Granted Memory). In the standard tensor product Hilbert space formulation of quantum mechanics, past events leave reliable records in the present state without requiring conspiratorial fine-tuning.

...

Theorem 1. *To ensure Metaprinciple NMU for the Born rule, the initial states have to belong to a zero-measure subspace of the Hilbert space, in a way that contradicts Beliefs 1, 2, 3, 4, and 5.*

...

Corollary 1. *The state of any subsystem S is not completely independent of the state of the rest of the universe, in the sense that there are forbidden states of the form $\Psi \otimes \varepsilon$, where Ψ is the state of S and ε is the state of the rest of the universe. Therefore, the tensor product Hilbert space contains too many states.*

...

Theorem 1 and Corollary 1 are in tension not only with common sense beliefs, but also with some of our assumptions about quantum mechanics. Therefore, even though

I proved them mathematically, I will provide additional explanations and address possible objections."

... *Stoica*: [Stc22].

What we have argued above is that in order to claim a physical phenomena follows a putative, deterministic and predictable, law, we need observation and/or measurement of the phenomena to be replicated exactly so that—within acceptable statistical limits—the outputs of repeated observations/measurements can be treated as following a putative, deterministic and predictable, law that can be expressed by algorithmically *computable* functions⁵⁷⁷. This is the experience that underpins classical physics⁵⁷⁸.

However, where replication of the phenomena itself introduces an unavoidable, and unpredictable, discontinuity due to a ‘butterfly effect’—hence an individually unmeasurable but statistically quantifiable variation into the very phenomena that is to be replicated—the outputs of repeated measurements cannot be treated, even in principle, as following a putative, deterministic and predictable, law (except as a matter of faith).

Comment 227. We note that an interpretation such as paragraphs #1-13 above—which admits the perceived cause of the unpredictability in any mathematical model of quantum phenomena, even in a deterministic universe, as due to a discontinuity introduced by a ‘free will’ measurement *into* the model (see # 9)—cannot, in principle, admit any doctrine of *realism* even in classical mechanics.

Reason: Even our perceived laws of classical mechanics may not hold over eons, since they too are mathematical expressions that may be unpredictable in a distant future—as a result of discontinuities introduced in the classical mathematical models in which such laws are sought to be framed—due to a distant ‘butterfly effect’ of our ‘free-will’ measurements that could, conceivably, be obscured by the questionable (see §20.D., Query 18) assumption that (see §20.D.b., Thesis 10):

The limiting behaviour of *every* physical process which can be described by a Cauchy

⁵⁷⁷In the sense of §2., Definition 10.

⁵⁷⁸Justifiably from the *evidence-based* perspective of this investigation since, as philosopher Ferenc Csátári remarks in [Csr19] that, post-Galileo:

“... measurement can be regarded as the instrumental approach to epistemology, where what is given and what is achieved both have major words. The concept likewise encompasses the theoretical grounding of procedures for quantification, the actual experimental aptitude for showing up quantities, the institutional-instrumental endeavors for calibration and the individual measuring acts of engineering or social data collections.”

... *Csátári*: [Csr19], *Introduction*, p.xii

“There are two major tasks an experiment must deal with. First, in an experiment we must independently manipulate agents to see the manipulation’s effect on the observed phenomenon. Second, the experiment must hold disturbances, i.e. agents and phenomena that are not objects of the given observation, under its control.⁸ For all this we need a (most probably artificial) apparatus, which allows for independent manipulation and isolation. The view that science should progress by actively intervening into natural processes (through experiments) rather than passive observation is called the Galilean revolution by Trendler (*ibid.*, 587).”

... *Csátári*: [Csr19], §4.1 *Anatomy of a Non-Revolution*, pp.90-91.

What we have argued above is that the seemingly ‘paradoxical’ nature of, essentially inherited, interpretations of quantum behaviour dissolves if Csátári’s criteria (attributed by him to Maxwell), that ‘experiment must hold disturbances, i.e. agents and phenomena that are not objects of the given observation, under its control’, is held to apply equally if we seek to similarly claim—in Csátári’s sense—that quantum ‘measurement can be regarded as the instrumental approach to epistemology’.

sequence in the theory must *necessarily* correspond to—and so be constrained by—the behaviour of the Cauchy limit of the corresponding sequence.

Comment 228. We could also view such a perspective—of an interpretation as in paragraphs #1-13 above—as resonating with, if not implicit in, the underlying thesis of [Gpt18]; where Amitabha Gupta—when wearing his philosopher’s hat (see §13.C.)—seemingly argues that any ‘realistic’ interpretation of our mathematical representations of physical phenomena must, at heart, implicitly appeal to a ‘Platonic’—albeit ‘subjective’—interpretation that can, however, be made intuitionistically unobjectionable by ‘reorienting internal realism around the hermeneutics’.

Reason: From an *evidence-based* perspective of ‘mathematics’⁵⁷⁹ under the Complementarity Thesis (§1., Thesis 1), any form of ‘realism’ necessarily identifies (conflates?):

- (a) the mathematical expressions of our conceptual metaphors seeking to describe our sensory perceptions of two distinct physical phenomena; with
- (b) the sensory perceptions that the conceptual metaphors seek to, initially, unambiguously express and, subsequently, categorically communicate within an intelligence with a lingua franca.

For instance, a water ripple may be identified, both mathematically and visually, with a sinusoidal curve. However a directly ‘unobservable’ physical phenomena, identifiable only mathematically as a sinusoidal curve, need not correspond to a putative visualisation of the phenomena as a ripple; since such a visualisation cannot be evidenced as corresponding to a sensory perception that has anything in common with the sensory perception of a water ripple.

“We have already stated that unlike CM with its approach of “**point-values**,” (as **exact descriptions** of measurement results of its observables or quantities), in QM observables or quantities (such as particles, e.g., electrons) can be interpreted and understood as **waves** and are assigned a **probability** to each event describable.

A wave is specified by its: (i) frequency, (ii) wavelength, (iii) phase or wave velocity, (iv) amplitude and (v) intensity. It must be pointed out that the **particle waves** are a bit different from **water waves**, since they involve complex numbers rather than real numbers like the height of the water in the wave. So the usual wave equation does not apply to particles.

A particle is localized at a point in space, whereas a **wave spreads over a large volume**. It is, as suggested by Teller (1979), a “description with **spread**.”

... Gupta: [Gpt18], §Quantum Mechanics (QM) Treats Observables or Quantities as “Spread Out” (Instead of “Point Values” as in CM).

In other words, although:

- the visualisation of our sensory perception of a water ripple, if categorically communicable as a mathematical expression, can be treated as corresponding to an ‘objective’ expression, *and* subsequent visualisation, of a common, uniquely identifiable, physical phenomena amongst an intelligence with a lingua franca;
- any putative visualisation of an ‘unobservable’ as a water ripple, even if categorically communicable as a similar mathematical expression, is necessarily ‘subjective’, and cannot be treated as corresponding to an ‘objective’ expression, *and* subsequent visualisation, of a common, uniquely identifiable, physical phenomena amongst the intelligence

⁵⁷⁹See §13. *What is mathematics?*

The underlying issue, Gupta highlights, is ‘the question as to what form of realism is appropriate for dealing [with] these aberrant problems in quantum mechanics’.

Problems such as, for instance, an intuitively unobjectionable interpretation of the double-slit experiment, where he suggests a—prima facie intuitionistically unobjectionable—perspective that seeks to reorient ‘internal realism around the hermeneutics’⁵⁸⁰:

“A detailed discussion on double-slit experiment, keeping in mind the necessity of using *QM descriptions* in terms of observations and experiments, has been carried out, revealing some of the counterintuitive results of the experiment—how a mere act of observation and measurement seems to change the results of the experiment, violation of some of the laws of classical logic, inherent uncertainty, inability to measure accurately some of the *complementary* properties, quantum entanglement (that the quantum state of each particle cannot be described independently), etc., and exposing that the experiment leads to a personalist (“subjective”) probabilistic approach to quantum theory, that consciousness causes wave function collapse and that photons can behave as either particles or waves, but cannot be observed as both at the same time. This has led to the question as to what form of realism is appropriate for dealing these aberrant problems in quantum mechanics.

To begin with, one feels justified in claiming that reality completely exists, independent of any conscious entity to observe it—the *Objective Reality view*, affirming that the scientific theories are “mirror of nature,” often called, **Metaphysical or External Realism**. Then, one acknowledges that the thesis that **Reality is dynamically generated**. To justify this, we have undertaken the task of answering the question as to how from **subjective cognition, objective reality can be inferred**. First, the view that “conceptual scheme” plays a central role in scientific theorizing and that “there are no ‘scheme-independent’” facts in all perception, including observations in natural science, such as QM (“Internalist Descriptivist Theory Versus Putnam’s Internal Realism and the Approach to Reference” to “Criticisms of Putnam on His Views on Metaphysical or External Realism and Internal Realism” sections). Second, some details of actual scientific practices, reviewing specifically the *acts of scientific observation* in “instrumental context of laboratory” (provided in “The Scope of Hermeneutics in Natural Science”, “Re-Orienting Internal Realism Around the Hermeneutics: Hermeneuticized Internal Realism: An Example” sections), show that **with the help of a theory/conceptual scheme in scientists’ heads**, scientists actually interact with the world they are [in to] create the phenomena of meaning and reference of scientific terms in thought, about **the objective external world**. The interaction between the instrument and the natural phenomenon should no longer be viewed merely in terms of the physical relationship of cause and effect but as an *intentional*, i.e., a linguistic relation between signifier and signified. The answer to this issue draws inspiration from the work of some leading quantum physicists (in “Leading Quantum Physicists vouching for Phenomenological and Hermeneutic approach to Science” section) and Kuhn (“Thomas Kuhn: Hermeneutic revelation and the Historical Approach” section).

One answer to this problem mentioned above is based on the assumption that terms in a mature science refer “**rigidly**” (vide Kripke and Putnam, “Internal Realism and the Problem of Rigid Reference” section) which essentially try to look at the question as to how does conceptual scheme/theory hookup to the objects and their relations in the world or hook into a reality of infinitely many things and how conceptual schemes of a scientist actually **interact** (vide Heelan) with the world such that the problem of meaning and reference could be resolved.

⁵⁸⁰Which, strictly speaking, should also admit the possibility that the ‘internal realism’ and the ‘hermeneutics’ in this case could be significantly different if we do not treat a fundamental particle mathematically as a ‘point’-particle that is ‘localized at a point in space’. The significance of this is highlighted in §1.H.d. *Does the volume of water obey Fermat’s Last Theorem?*

The form of realism to cope with these questions constitute, in my estimation, **the Hermeneuticized Internal Realism** (“Re-orienting Internal Realism Around the Hermeneutics: Hermeneuticized Internal Realism: An Example” section), which results from reorienting internal realism around the hermeneutics. This shows how “‘conceptual scheme’-dependent objective concepts” emerge from scientific experiments and observations.”

... Gupta: [Cpt18], §Introduction.

In other words, we can view Einstein’s purported⁵⁸¹ remark, ‘God does not play with dice’, as arguing only for the existence of putative, deterministic, laws governing physical phenomena; his belief does not entail that our observations of such phenomena must also be expressible mathematically by functions that are algorithmically *computable* (hence predictable).

Comment 229. In the following informal 1950 letter to Schrödinger, Einstein can be viewed as emotionally seeking to articulate his belief⁵⁸² that—in order to avoid risking the deleterious effects of, essentially self-imposed and intellectually misleading, constraints that not only deny our immediate intuitions of sensory perceptions, but seemingly admit of no non-absurd interpretations of quantum phenomena—what we experience as a common reality compels us to accept the thesis that all natural phenomena obey deterministic laws; irrespective of whether or not we are able to articulate such laws predictably, or only statistically:

“Dear Schrödinger,

You are the only contemporary physicist, besides Laue, who sees that one cannot get around the assumption of reality—if only one is honest. Most of them simply do not see what sort of risky game they are playing with reality—reality as something independent of what is experimentally established. They somehow believe that the quantum theory provides a description of reality, and even a complete description; this interpretation is, however, refuted most elegantly by your system of radioactive atom + Geiger counter + amplifier + charge of gunpowder + cat in a box, in which the ψ -function of the system contains the cat both alive and blown to bits. Is the state of the cat to be created only when a physicist investigates the situation at some definite time? Nobody really doubts that the presence or absence of the cat is something independent of the act of observation. But then the description by means of the ψ -function is certainly incomplete, and there must be a more complete description. If one wants to consider the quantum theory as final (in principle), then one must believe that a more complete description would be useless because there would be no laws for it. ...

You are completely right to emphasize that the complete description cannot be built on the concept of acceleration, nor, it seems to me, can it be built on the particle concept. Only one of the tools of our trade remains—the field concept, but God knows whether this will stand firm. I think it is worthwhile to hold on to this, i.e. the continuum, as long as one has no really sound arguments against it.

But it seems certain to me that the fundamentally statistical character of the theory is simply a consequence of the incompleteness of the description. This says nothing about the deterministic character of the theory; that is a thoroughly nebulous concept anyway, so long as one does not know how much has to be given in order to determine the initial state.

It is rather rough to see that we are still in the stage of our swaddling clothes, and it is not surprising that the fellows struggle against admitting it.

⁵⁸¹See, for instance, N. Gurappa, [Grp17], concluding paragraph.

⁵⁸²See also Sunny Kumar Labh’s informal ‘A Critique of Quantum Theory and the Reality of Schrödinger’s Cat’ in [Lbh23].

Best regards!

Yours,

A. Einstein"

... *Albert Einstein: [Ei50], Letter # 17, p.39.*

In other words, Einstein's belief can be viewed as implicitly, and intuitively, subscribing—beyond mere faith—to both of what Markus Weckström terms in [Wck23] as the 'Two Roots of Perspectivism':

"Scientific perspectivism, or perspectival realism, is a position opposing both relativism and objectivist realism, holding roughly that the world studied by the sciences is "as it is", mind-independently (contra relativism), while emphasizing that the truth of scientific knowledge claims nonetheless depends on the particular vantage point from which they are asserted (contra objectivism). Therefore, a central challenge of perspectivism is to ascertain how can "our scientific knowledge claims be perspectival, while also being about the world as it is" (Massimi 2016, emphasis original). Or more precisely, the challenge may be construed in two steps as follows. First, the perspectivist begins from acknowledging what Giere (2006) and Hacking (1999) have dubbed the "contingency thesis", and which, in the words of Shapin (1975), states that "Reality seems capable of sustaining more than one account of it". And second, the actual problem is then to elaborate an account of scientific knowledge containing both a "realist part", specifying why "claims generated by scientific practice are claims about the world", and a "perspectival part" justifying the view that "these claims are not unconditional but relative to a set of humanly constructed concepts" (Giere 2013)."

... *Weckström: [Wck23], §1. Introduction.*

Moreover, the purportedly unbridgeable gap in the implicit distinction raised by Query 30⁵⁸³—between what a scientific experiment seeks to 'perceive', and what limits that which a scientific experiment seeks to 'perceive'—can also be viewed as essentially reflecting Weckström's perspective; *if* his 'two roots of perspectivism' are taken as seeking to illustrate "why our scientific knowledge of natural systems cannot be divorced from the perspective of its production, even though the sciences can still be thought of as speaking of the world as it is":

"Thus Rosen took the epistemological questions of biology, and especially those related to the apparent plurality of available descriptions, as "the primary questions on which the resolution of all the other questions essentially depend" (Rosen 1978, emphasis original). The central instrument by which he addressed such questions was the concept of the modeling relation, employed actually in two distinct roles (Pattee 2007): both for conceptualizing our own knowledge, or epistemology, of organisms and of other natural systems (especially in *Life Itself*), and for conceptualizing the organism as a natural system perceiving its surroundings and manifesting model-governed behaviours (especially in *Anticipatory Systems*). This dual role of the modeling relation is an interesting observation as such, and I have studied its ramifications elsewhere (Weckström, forthcoming).

In the present paper, my aim is to show that the modeling relation in its former, epistemological role implies, or can be elaborated into, an account of scientific knowledge in which both a perspectival part and a realist part can be distinguished and defended. That is, my intention is not to say that Rosen himself was a perspectivist, but rather to employ his theoretical-epistemological framework for developing a position of perspectival realism. In doing so, I identify two distinct reasons, to be called two roots of perspectivism, why our scientific knowledge of natural systems cannot be divorced from the perspective of its production, even though the sciences can still be thought of as speaking of the world as it is. The first of these roots amounts

⁵⁸³§23.D.g., Query 30: *What would introducing experimental observations—which implicitly subsume 'free will'—into a mathematical model entail?*

to the dualism between a system and its environment, which a scientist necessarily imposes when focusing on the former, and which unavoidably results in perspectival inclusions and exclusions. However, the specification of the first root also provides the basis for defending the view that within a perspective, there are reasons to believe that such knowledge is about the world as it is. The second root amounts to the complexity of complex systems, and it renders the perspectival lessons of the first root remarkably more pressing. Especially here insights from biology become crucial. As I try to show besides developing the argument, perspectivism thus understood couples in interesting ways to a range of traditional issues in philosophy of science, and as I discuss towards the end of the paper, Rosen's relational language exemplifies how perspectival epistemology might suggest novel ways of doing robust theoretical science of complex natural phenomena."

... Weckström: [Wck23], §1. Introduction.

Further, from the *evidence-based* perspective of this investigation (as implicit in the Complementarity Thesis 1 in §1.⁵⁸⁴), Weckström's thesis can be viewed as seeking to categorically communicate his remarkable 'formalisation' of two, cogently expressed, 'axioms' for his 'Two Roots of Perspectivism':

"My last question, which I would like to tie to the encapsulation of the conclusions, is this: how do the above considerations relate to the existing literature on scientific perspectivism? It seems to me that the relation is largely *complementary*. To see this, let us observe that for instance Massimi (2018) in her analysis of different kinds of perspectival truth repeatedly employs the phrase "science maps onto nature", in this word order. This is of course the correct order in an analysis of truth, and to some extent it reflects the tradition in philosophy of science which has, with all legitimacy and importance, emphasized questions such as "Science says there are electrons, are there?" or "Science says water is viscous, is it?".

But the problem faced by Rosen was the exact opposite: he was troubled of how well Nature maps onto science. In particular, his impression was that if a living organism is mapped onto the language of science, something very important does not come along (its relational organization due to which it is a *living* organism; see e.g. 1991, pp. 11-23). In the present paper, I have investigated perspectivism mainly from this inverse direction, beginning from natural systems and not from claims about them. Thus, as a complementary way of understanding perspectivism, such an approach might suggest something like the following: knowledge is perspectival because of that what it leaves to the world, and what it therefore cannot project back onto it. In this vein, I summarize my conclusions below as a system of two "axioms" of the acquisition of knowledge, each yielding both a "realist part" and a "perspectival part" as "theorems". These are of course not axioms and theorems in the logician's sense, but regarding them metaphorically in that way puts, it seems to me, the elements of the account into correct order and relations.

1. The first root of perspectivism: "Axioms" of extraction

Knowledge of natural systems is based on the extraction of systems out of the ambience. This procedure imposes a system-environment dualism, such that the entailment relations characterizing the system are included into the description (e.g. as conceptualized state transitions), while the entailment relations of the environment remain non-conceptualized and become in a typical case manifest as unaccounted or vaguely accounted influences on system states. With a genuine system extracted out of the ambience, it is possible to engage into a commuting modeling relation.

1.1 REALIST PART

As in the traditional realist's argument, it would be miraculous if in a commuting modeling relation the "scientist's path", consisting of encoding,

⁵⁸⁴See also §13.C.a: *The 'unreasonable' effectiveness of mathematics*.

inferential entailment, and decoding, would coincide by accident with the “natural path”, consisting of causal entailments of the world. Moreover, whenever the paths do not coincide, the elements of the scientist’s path are to be replaced or modified, implying that at least when an already extracted system is concerned, it is the world from which the model acquires its form, and not the other way around.

1.2 PERSPECTIVAL PART

Where and how the system-environment boundary arises depend on the scientist’s aims and manner of interacting with the world, and is thereby perspectival. Knowledge obtained about a particular extracted system is valid only to the extent that the excluded environmental entailments remain absent or within appropriate limits.

2. The second root of perspectivism: “Axioms” of complexity

The characteristic property of complex systems is that no single family of observables, related to one another by a single mode of entailment, suffices as a description of a system. The reason for this is that in complex systems entailments themselves are entailed in non-trivial ways by other entailments within the same system. Therefore, what enters into a scientific description of a complex system is in the general case a subsystem of the original system. For the above reasons, a subsystem extracted out of a complex system behaves differently from a subsystem embedded into the intact total system.

2.1 REALIST PART

By adjusting experimental circumstances, and the scope and accuracy of the claims, it is possible to enter into commuting modeling relations with subsystems of complex systems. Therefore, realist knowledge about subsystems of complex systems is obtainable in the sense of 1.1.

2.2 PERSPECTIVAL PART

Claims about intact complex systems on the basis of subsystems are perspectival in the sense of 1.2, albeit remarkably more strongly so because the excluded “environment” generally consists in entailment relations upon which the character and integrity of the intact complex system, and hence also the character of the subsystem itself, essentially depend.

Thus, this scheme seems to imply that while many things can be said about the world (1.2) and about complex systems of the world (2.2), there is no need to allow that anything could be said about them (1.1 and 2.1), and this is indeed how I would like to encapsulate the basic spirit of scientific perspectivism.”

... Weckström: [Wck23], §6. Conclusion.

Accordingly, we have argued further that assuming the introduced discontinuity *does* follow putative laws that are deterministic—even if not predictable—would not be inconsistent with experiments⁵⁸⁵ which suggest that it is *only* the mathematical representations of the observed law which could be treated as probabilistically determinate (obeying Schrödinger’s equations and Heisenberg’s Uncertainty Principle).

Comment 230. We note that such an *evidence-based* perspective could be viewed as, essentially, seeking to distinguish between:

- the conceptual metaphors that we mathematically express in classical mechanics, and interpret as faithfully representing, putatively deterministic, laws of nature which we treat as ‘classical laws’ based on our observations/recordings of experiments that we *can*—without inviting immediate inconsistency between theory and observation—postulate as replicable identically; and

⁵⁸⁵Including those that are taken to validate Bell’s Theorems as favouring the Copenhagen interpretation of quantum phenomena.

- the conceptual metaphors that we mathematically express in quantum mechanics, and interpret as faithfully representing, *also* putatively deterministic, laws of nature which we treat as ‘quantum laws’ based on our observations/recordings of experiments that we *cannot*—without inviting immediate inconsistency between theory and observation—postulate as replicable identically.

It may be pertinent to note that, according to Piredda’s account in [Prd21]⁵⁸⁶, at least Heisenberg seemed aware of the possibility of linguistic ambiguities underlying—and possibly entailing—the perceived anomalous nature of quantum mechanics, since he ‘immediately realised that the words used to describe the physical phenomena of classical mechanics could no longer describe the phenomena of quantum mechanics’; and, in contrast to the interpretation of metaphors statically as in classical mechanics, ‘in quantum mechanics it is the dynamic interpretation of metaphors that play ‘a very important role in science because its “instability” can successfully convey a new discovery in an intuitive and yet precise way, without being bridled into the rigidity of a concept”:

“Heisenberg immediately realised that the words used to describe the physical phenomena of classical mechanics could no longer describe the phenomena of quantum mechanics. Nevertheless, the only language we possess and on which we must necessarily rely to communicate is the ordinary one. This makes it is very difficult to overcome the obstacle represented by the concepts that we receive from our tradition although “it usually takes a long time before a new concept is accepted in general” and therefore “we must use words like ‘divide’, or ‘consist of’, or ‘number of particles’, and at the same time we learn from observations that these words have only a very limited applicability.”[11]

The language of classical physics is strongly connected to ordinary language but it fails to describe the quantum world: for example, the simple word “path” is perfectly understandable in the ordinary realm of physics when we are dealing with stones, or grass, etc., but it is not really understandable when it has to do with electrons. In a cloud chamber, for instance, what we see is not the path of an electron, but, if we are quite honest, only a sequence of water droplets in the chamber. Of course we like to interpret this sequence as a path of the electron, but this interpretation is only possible with restricted use of such words as position and velocity.[12]

The problem, therefore, lies not in the concepts themselves but in the way in which they are used. Heisenberg thinks that language is used in two fundamental ways, statically and dynamically.[13] The static use of concepts is defined by logic, whereby each word refers to one single fact or object of reality: the static use of concepts constitutes the basis of a certain system of knowledge since it prevents any ambiguous use of words. This, however, can only be valid on a theoretical level because in everyday life concepts are used mostly but not exclusively in accordance with their universal meaning (identity between word and thing). They are often used to indicate also different things in different ways, and in different practices.

On the one hand, therefore, static concepts refer to knowledge that we have already acquired and accepted as certain and universal: these concepts are essential because without them we could not build any epistemological system. On the other hand, however, the dynamic use of concepts, i.e. a metaphorical use, is equally fundamental because otherwise a large part of everyday communication would be impossible. The dynamic use is therefore necessary every time something new is experienced that cannot be described through traditional concepts and parameters.

Heisenberg, not unlike other physicists, often uses metaphors not to fall into the *cul de sac* of the stable meaning of concepts generally used in the language of classic mechanics. In order to speak about new phenomena concerning subatomic physics, he creates new metaphors which later on, as they are used over and over again to

⁵⁸⁶See also [Prd23].

represent the same phenomena, lose their innovative power and become in turn common and stable expressions. This is why we speak today about spin, flavours of quarks, entanglement and so on not thinking of these expressions as metaphors but as physical concepts. As Heisenberg suggests, metaphor plays a very important role in science because its “instability” can successfully convey a new discovery in an intuitive and yet precise way, without being bridled into the rigidity of a concept.”^[8]

... Piredda: [Prd21].

In other words, assuming that even quantum phenomena obey putative laws that are deterministic only entails—by Ockham’s minimality—that the results of any observation/measurement of the phenomena could be expressible by putative Gödel β -functions⁵⁸⁷ that are algorithmically *verifiable*⁵⁸⁸ as to putative past values, but only ‘statistically’ computable—not algorithmically *computable*—as to observable future values.

Prima facie, such an interpretation would not be inconsistent with the experience that underpins quantum physics.

Not unreasonably, it can also be viewed as consistent with—and prima facie reflecting—Huw Price and Ken Wharton’s hypothesis in [PW23] that a ‘constrained retrocausal collider bias is the origin of entanglement’:

“In this piece, written for a general audience, we propose a mechanism for quantum entanglement. The key ingredient is the familiar statistical phenomenon of collider bias, or Berkson’s bias. In the language of causal models, a collider is a variable causally influenced by two or more other variables. Conditioning on a collider typically produces non-causal associations between its contributing causes, even if they are actually independent. It is easy to show that this phenomenon can produce associations analogous to Bell correlations, in suitable post-selected ensembles. It is also straightforward that such collider artefacts may become real connections, resembling causality, if a collider is ‘constrained’ (e.g., by a future boundary condition). We consider the time-reversed analogues of these points in the context of retrocausal models of QM. Retrocausality yields a collider at the source of an EPR-Bell particle pair, and in this case constraint of the collider is possible by normal methods of experimental preparation. It follows that connections resembling causality may be expected to emerge across such colliders, from one branch of the experiment to the other. Our hypothesis is that this constrained retrocausal collider bias is the origin of entanglement. The piece is based on a suggestion we first made in arXiv:2101.05370v4 [quant-ph].”

... Price/Wharton: [PW23], Abstract.

Price and Wharton conclude [PW23] by cogently arguing that, and why, their ‘retrocausality’ thesis is a more intuitive, consistent, interpretation of QM which, moreover, supports Schrödinger’s perspective—reflecting Einstein, Podolsky and Rosen’s argumentation in [EPR35]⁵⁸⁹—of ‘QM as an unavoidably fuzzy picture of a sharper reality’:

“This means that if nature wants retrocausality without retrosignalling (and without the paradoxes that retrosignalling would lead to), it is going to need black boxes—places in nature where observers like Charlie can’t see the whole story. In normal circumstances, such black boxes would seem like another kind of magic. Charlie is a clever guy, after all. What’s to stop him taking a peek inside any kind of box?

But in the quantum case, many readers will already know the answer to this question. What’s to stop Charlie taking a peek is Werner Heisenberg, or more precisely his famous Uncertainty Principle. Ever since Heisenberg, quantum theory has been built on the idea that there are new

⁵⁸⁷See §16.A.: *Gödel’s β -function*.

⁵⁸⁸In the sense of §2., Definition 7.

⁵⁸⁹See §23.B., *EPR, Bohm’s hidden variables, and Bell’s equations*.

limits to what it is possible to know about physical reality. One of the central questions is whether this is just a restriction on our knowledge of reality, or whether reality itself is somehow fuzzy. As Schrödinger put it in 1935, after describing his famous Cat Experiment: ‘There is a difference between a shaky or out-of-focus photograph and a snapshot of clouds and fog banks.’ [Schrödinger 1935b]

The Cat Experiment was supposed to support the out-of-focus photograph option, the view that the Uncertainty Principle is just a restriction on our knowledge of reality. Schrödinger thought it was obvious that the cat couldn’t actually be somehow neither alive nor dead. Like Einstein, Schrödinger favoured the view that the quantum description is incomplete, and that reality contains further details, hidden behind Heisenberg’s veil.

In the decades since 1935, most physicists who care about these issues have concluded that Einstein and Schrödinger were wrong. Bell’s Theorem, together with the quantum predictions being confirmed by Clauser, Aspect, Zeilinger and many others, has often been interpreted as showing that the spooky action at a distance which Einstein hoped to avoid with additional ‘hidden variables’, is an inevitable part of the quantum world.

Retrocausality is already the most interesting challenge to that view. By taking the first option on Schrödinger’s list—by treating QM as an unavoidably fuzzy picture of a sharper reality—it can allow the kind of quantum black boxes needed to avoid retrosignalling and paradoxes. How satisfying, then, if it also explains the other thing that Schrödinger put his finger on in 1935, when he invented the term ‘entanglement’, and called it ‘the characteristic trait of quantum mechanics.’⁵⁰

... Price/Wharton: [PW23], §9: *Avoiding causal loops and signalling.*

We conclude by quoting at length⁵⁹⁰ from a recent preprint [Odn24]; where philosopher Jessica Oddan seemingly seeks to circumvent the limitations which Query 30 implicitly highlights for any putative axiomatic—presumably first-order—mathematical theory that seeks to coherently model our observations of quantum phenomena, but which can be viewed as ‘resistant to revision while [its] physical interpretation was not’.

Thus, Oddan’s program⁵⁹¹ aims at a ‘Reconstruction of quantum theory’ that ‘subverts the importance of interpretation and instead focuses on developing an abstract generalization of the fundamental features of quantum mechanics through the derivation of the formalism’ that can ‘separate formalism and physical interpretation because the mathematics was resistant to revision while physical interpretation was not’:

“There are many advantages to axiomatization as a methodology, whether Hilbert’s more formal notion of axiomatization or later von Neumann’s more flexible version. Ultimately, axiomatization as a methodology is understood to lend epistemic credibility as a semiformal means of parsing out fundamental and easily understandable constraints (axioms stipulated from physical postulates) that give rise to some solution or collection of solutions. Axiomatization provides a more directed means of inference tracking, particularly in the physical sciences. Part of the trustworthiness of axiomatization is being able to find mistakes within a derivation from a set of axioms. This derivation facilitates the finding of mistakes in our reasoning. If the stipulated axioms are resistant to revision, like Hilbert stressed, then it is more likely that the resulting derivations and conclusions of those derivations will preserve that resistance to revision as well.

The significance of how an axiomatization is ordered has been highlighted throughout the historical story. The key distinction between ‘optimal’ axiomatization and ‘practical’ axiomatization is whether the physical postulates help us to identify the analytic machinery, or if the analytic

⁵⁹⁰Albeit—in view of §1.A. (*Pre-formal mathematics*) and §1.J. (*Validating knowledge, truth, and proof in pre-formal mathematics*)—without inadvertently misleading comments/commentary on a yet nascent, but intriguing and seemingly insightful, perspective.

⁵⁹¹As noted in her [homepage](#).

machinery gives us insights into what the physical postulates are. The optimal version begins with the stipulation of physical postulates which are then given a mathematical formulation. The practical version is the inverse. It was important for Hilbert et al. to separate formalism and physical interpretation because the mathematics was resistant to revision while physical interpretation was not. Hilbert et al., and particularly Hilbert, wanted to remove any specifics of meaning in order to de-empiricize a theory, thus transforming it into a pure mathematical exercise¹³. However, I argue that in the context of reconstructions the ordering of an axiomatization, though it was significant for Hilbert et al., is important not due to when analytic machinery and physical content is ordered but rather that the connection is stipulated at all. And so, the designation of optimal versus practical ordering is not the important insight we get from following such a procedure.

Rather, the insight we get by distinguishing between formalism and physical content is pinpointing where our mathematics applies to the physical world. What is significant is not that we stipulate mathematical formalism before physical content or the inverse. It is the specification that some mathematical feature x is representative of some physical insight y . The insight desired, however, is relative to the goals one has in performing an axiomatization. If we are, e.g., looking for physical insight, then as we see in reconstructions it becomes important to seek out the formalism–physical content connection. In other axiomatizations this connection may be less important such as those axiomatizations where understanding of the mathematical formalism is being sought. Von Neumann uses physical insights in his trace function case in order to search for the right mathematics. Axiomatization provides the methodological structure to facilitate the bridging of our mathematics to what it purports to represent. It is important that it is the physical axioms in reconstructions that are taken to be unlikely to be revised, rather than mathematical formalism, which is a feature that is distinctive in how axiomatization is used.¹⁴ Though the physical principle is unlikely to be revised, this is not necessarily the case for how that physical principle is mathematically formulated as an axiom. How those physical principles are formulated as axioms is dependent on the choice of researchers. The methodology of reconstructions also cements the importance of physical intuitions that guide researchers in the choice of formalism, not only at the level of axioms but at the framework level. Axiomatization provides the semi-formal structure to aid researchers in specifying the connection between physical ideas and their mathematical representations.

¹³ To de-empiricise a theory was to disentangle empirical content from the analytic machinery. This was successful when a formalism was identified whose structure represented the important relations of the theory without empirical content.

¹⁴ This relates to how reconstructions are also distinct from the standard interpretational project in quantum mechanics: the standard interpretational approach accepts the formalism of quantum mechanics and instead aims to provide a physical interpretational of that formalism."

... Oddan: [Odn24], §5.3 Inference tracking, pp.15-16.

the goal being ‘characterization of [such] axiomatization as a practical, provisional, meta–mathematical methodology which aims to order and orient an area of knowledge’:

“In “Hilbert–Style Completion: On von Neumann and Hidden Variables in Quantum Mechanics” (2022) Mitsch offers a nuanced interpretation of Hilbert’s axiomatic method. Mitsch’s elucidation of the role that axiomatization plays in the development of theories is directly applicable to the reconstruction programme. I apply this understanding to demonstrate that Mitsch’s conception of axiomatization is the best means of understanding the value of the methodology. I also argue that a context–dependent understanding of axiomatization complements Mitsch’s. In particular, Mitsch’s description of axiomatization as a provisional, practical,¹⁵ meta-mathematical procedure concerned with orienting and ordering an area of inquiry aligns with my conception of the methodology. With this understanding in mind, what we see is that reconstructions of quantum theory successfully use axiomatization in a way that has and will continue to clarify and develop quantum theory.

Mitsch argues that Hilbert’s axiomatic method was both provisional and practical, rather than a strict formalization “in the service of radical epistemological or metaphysical goals” (2022, p. 2).¹⁶ According to Mitsch, the goal of an axiomatization is a meta-mathematical one, wherein the relationship between mathematics and reality is addressed “insofar as an axiomatization will identify necessary physical assumptions based on the theorems central to an area of inquiry” (2022,

p. 6). In contrast, the mathematician determines what propositions result from a given set of axioms.

This meta-mathematical project proceeds, in the Hilbertian tradition (Mitsch 2022, p. 6):

1. The identification of central theorems and concepts of an area of knowledge.
2. The identification of a formalism whose structure reflects the above area of knowledge.
3. The determination of the necessity of the candidate axioms based on the formalism.

Mitsch calls the relations between candidate axioms the “uniqueness question: are the other axioms sufficient for deciding the structure of the formalism w.r.t. the candidate axiom?” (2022, p. 6). Uniqueness questions determine if and when the collection of axioms is representative for the theory while admitting no other realizations (Mitsch 2022, p. 20). An axiomatic completion is achieved when all uniqueness questions are answered, in which case the axiomatic structure of the theory of the area of knowledge is completely determined (Mitsch 2022, p. 6). However, Mitsch maintains that axiomatic completions, even if they are successful, are provisional—they “generate provisional representations of reality insofar as axiomatic completions rely on fallible steps” (2022, p. 7). This is because the central theorems and concepts are liable to change within the theory of an area of knowledge. Axiomatic completions are also practical as “they are a tool meant to generate helpful representations of a field of knowledge” (Mitsch 2022, p. 7) while simultaneously orienting and ordering a theory (Mitsch 2022, p. 8). A theory is *oriented* when the independence of propositions is surveyed and an axiomatization orients an area of inquiry by directing our attention to certain physical, epistemological, or mathematical considerations (Mitsch 2022, p. 29). A theory is *ordered* when the lack of contradictions between propositions is guaranteed. An axiomatic completion of a theory is successful when it is able to both orient and order an area of knowledge alongside its mathematical investigation (Mitsch 2022, p. 8).

Mitsch’s description of axiomatization is a nuanced reading of axiomatization as a liberalized methodology that is pragmatically useful, in contrast with the notion of axiomatization as a strict formalization. He concludes that “von Neumann effectively summarized and clarified where we *had been*—in physics as well as in mathematics—in an effort to identify where we *could go*” (2022, p. 30). I concur with this understanding of the methodological role that axiomatization has to play in the development and exploration of theories. For my purposes, I am primarily interested in Mitsch’s characterization of axiomatization as a practical, provisional, meta-mathematical methodology which aims to order and orient an area of knowledge. This is precisely how we should understand the role that axiomatization plays in the reconstruction programme. Individual reconstructions should be taken as provisional, alternative formulations of quantum mechanics. The methodology of reconstructions should be understood as a predominantly meta-mathematical process which enriches both our mathematical and physical conceptions in foundations of quantum theory.

¹⁵ Mitsch is not referring to ‘practical’ in the sense of the ordering of analytic machinery and physical concepts that I have outlined prior from Hilbert et al. Rather, ‘practical’ refers more to the notion that axiomatization contributes to scientific progress (Mitsch 2022, p. 3).

¹⁶ Mitsch disagrees with Lacki that Hilbert was interested in axiomatization strictly in terms of logical clarification and rational reconstruction (2022, p. 3). Rather, Mitsch interprets Hilbert as having a more pragmatic and liberal idea of what axiomatization could achieve.
 ... Oddan: [Odn24], §6 Reconstructions as Axiomatic Completions, pp16-17.

23.D.h. Schrödinger’s cat ‘paradox’

If $[F(x)]$ is an algorithmically *verifiable* but not algorithmically *computable* Boolean function, we can take the query:

- (i) Is $F(n) = 0$ for all natural numbers?

as corresponding to the Schrödinger question:

(ii) Is the cat dead or alive at any given time t ?

We can then argue that there is no mathematical paradox involved in the assertion that the cat is both dead and alive at a select moment of time, if we take this to mean that:

Thesis 23. (Schrödinger's cat) *I may either assume the cat in Schrödinger's gedanken to be alive until a given time t (in the future), or assume the cat to be dead until the time t , without arriving at any logical contradiction in my existing Quantum description of nature.*

In other words:

- (a) Once we accept Quantum Theory as a valid description of nature, then there is no paradox in stating that the theory essentially cannot predict the state of the cat at any moment of future time.
- (b) The inability to predict such a state does not arise out of a lack of sufficient information about the laws of the system that Quantum theory is describing, but stems from the very nature of these laws.

The mathematical analogy for the above would be:

- (c) Once we accept that Peano Arithmetic is *strongly* consistent (see §2.C.a., Theorem 2.16) and categorical (see §2.E.b., Corollary 2.18) then we cannot deduce from the axioms of PA whether $F(n) = 0$ for all natural numbers, or whether $F(n) = 1$ for some natural number.

CHAPTER 23. PARADIGM CHALLENGING CONSEQUENCES

24. The significance of *evidence-based* reasoning for quantum computing

We begin by noting that, *prima facie*, it is the *well-definability* (see §7.F., Definition 26) of a ‘self-modifying’ Turing machine—essentially such as in §3.(c)—that Michael Stephen Fiske considers in [Fi19] (see §21.G.).

Contrastingly—from the *evidence-based* perspective of the Provability Theorem for PA (§2.E.b., Theorem 2.17), and the proposed definition of the neo-classical laws determining ‘quantum phenomena’ based upon §23.D.c., Thesis 19, and §23.D.d., Thesis 20:

- the claim in [AAB19], by a 78-member team of researchers, to have successfully reached the threshold of quantum supremacy by **building**⁵⁹² at Google AI Quantum, Mountain View, California, USA, a:

‘...high-fidelity processor capable of running quantum algorithms in an exponentially large computational space ...’

... Arute, Arya, Babbush, et al: [AAB19], §The future.

- apparently *assumes* such *well-definability* and implicitly appeals—as their experiment seemingly suggests—to a putative computability of functions:
 - that are algorithmically *verifiable*, but not algorithmically *computable* (see §7.G., Theorem 7.2; also §7.I.a., Theorem 7.6);
 - and which violate both the classical Church-Turing Thesis (see §7.H.b., Theorem 7.3), as well as the ‘physical version of the Church-Turing principle’ (see §21.H.) defined by David Deutsch as (compare with Jack Copeland’s *Thesis M* in [Cop04], p.106):

“Every finitely realizable physical system can be perfectly simulated by a universal model computing machine operating by finite means”

... Deutsch: [Deu85], p.99.

If so, the above claim in [AAB19] could prove fragile (see also §4.B.c.) if:

- given the absence of a formal, mathematical, definition, of what constitutes a ‘quantum process’, which does not appeal to Deutsch’s ‘physical version of the Church-Turing principle’,

it were to *implicitly* entail a mathematical model of a self-modifying Turing machine that can evolve (*prima facie*, as suggested by Deutsch in [Deu85], and by Fiske in [Fi19]) into a non-Turing machine that violates the classical Church-Turing Thesis, and which could claim (contradicting §21.F.c., Theorem 21.6) to achieve ‘quantum supremacy’ by computing an algorithmically *verifiable*, but not algorithmically *computable*, function (see §7.G.) in polynomial time:

⁵⁹²Structured, *prima facie*, essentially as in Deutsch, [Deu85] (see also Fiske, [Fi19]; §21.G.).

"The extended Church-Turing thesis formulated by Bernstein and Vazirani⁵⁵ asserts that any 'reasonable' model of computation can be efficiently simulated by a Turing machine. Our experiment suggests that a model of computation may now be available that violates this assertion. We have performed random quantum circuit sampling in polynomial time using a physically realizable quantum processor (with sufficiently low error rates), yet no efficient method is known to exist for classical computing machinery."

... Arute, Arya, Babbush, et al: [AAB19], §The future.

In other words, from the *evidence-based* perspective of this investigation:

- which seeks to constrain the postulation of natural laws by the physical sciences,
- for their observations/measurements of physical phenomena,
- to that which can mathematically be both *well-defined* and categorically communicated (see §13.E.)

the argumentation in [AAB19] may need to recognise, and admit, that every *well-defined* mathematical function is, by definition, algorithmically *verifiable*.

Moreover:

- (a) Classical laws governing natural phenomena (see §23.D.c., Thesis 19) could be characterised by the property that:
 - if a physical process subject to such a law is representable by a Cauchy sequence,
 - then the mathematical limit of the sequence can be treated as corresponding to a limiting state of the physical process (as illustrated by the various Zeno-type paradoxes).
- (b) Neo-classical laws governing natural phenomena (see §23.D.d., Thesis 20) could be characterised by the property that:
 - if a physical process subject to such a law is representable by a Cauchy sequence,
 - then the mathematical limit of the sequence need not correspond similarly to a limiting state of the physical process; and
 - any mathematical representation of such a limiting physical state may, for instance, require an additional, conceivably probabilistic, law to govern the permissible states of the physical process at the limit.
- (c) Consequently, neo-classical behaviour could follow fixed laws and thus be *deterministic*, but not necessarily algorithmically *predictable* as in the case of classical laws since, for instance:
 - the physical limiting states revealed to a witness (observer) W at a measurement,
 - might only be the mathematical representations—in terms of probability 'waves'—reflecting physical laws that determine the expected quantum states at a discontinuity,
 - such as, for instance, the prospective discontinuity considered in each of the gedanken §20.C., Cases 20.C.a. to 20.C.d.,

- that is imminent at the measurement due to local factors which (contradicting Roger Colbeck and Renato Renner’s thesis in [CR12]) cannot be reflected in the representation without inviting (see §20.⁵⁹³) paradoxes of impredicativity.
- (d) In which case, as argued by Matthew F. Pusey, Jonathan Barrett, and Terry Rudolph, in [PBR12]:
- Schrödinger’s wave function could mathematically represent a natural law,
 - grounded in the physical behaviour of a particle,
 - such as, say, at a measurement that affects the behaviour of the particle in a way that can be described as a discontinuous limit,
 - which could be termed as a phase change,
 - as detailed, for instance, in §20.C., Cases 20.C.a. to 20.C.d., and §20.D.b., Case 20.D.c.,
 - that could be viewed as corresponding to the collapse of the wave function,
 - which, consequently, cannot be interpreted as a statistical tool that reflects our *essential* ignorance of even a *putative* physical state of the particle sought to be measured.

“Quantum states are the key mathematical objects in quantum theory. It is therefore surprising that physicists have been unable to agree on what a quantum state truly represents. One possibility is that a pure quantum state corresponds directly to reality. However, there is a long history of suggestions that a quantum state (even a pure state) represents only knowledge or information about some aspect of reality. Here we show that any model in which a quantum state represents mere information about an underlying physical state of the system, and in which systems that are prepared independently have independent physical states, must make predictions which contradict those of quantum theory.”

... Pusey/Barrett/Rudolph: [PBR12], Abstract.

From the *evidence-based* perspective of this investigation (see §1., Thesis 1), one could even seek to express this as:

- (e) *even* if a universe U were to be completely determinate—such as, say, the hypothetical, time-reversible, universe considered in §20.D.c.—in the sense that all its laws were definable recursively;
- (f) *and* its classical laws algorithmically *computable* in U , and therefore—by the Provability Theorem for PA (§2.E.b., Theorem 2.17)—*provable* as well-formed propositions in any formal language L that sought to represent U unambiguously, and to communicate its laws categorically;
- (g) there would *still* be well-formed propositions of L that would be *unprovable* in L , but which a witness W of/within U would interpret as algorithmically *verifiable* quantum laws that are *true* in U , but are not necessarily definable in L as well-defined propositions;
- (h) since any such definition might invite inconsistency through (see §20.) impredicativity;
- (i) whence Bell’s inequalities (see [B164]; also §23. and §23.B.), which are expressed in the language of L , *would be taken to apply only to properties that are definable within L .*

⁵⁹³See also §23.D.g. *Entangled particles*, Query 28. *What would introducing experimental observations—which implicitly subsume ‘free will’—into a mathematical model entail?*

24.A. An *evidence-based* perspective of Deutsch's Church-Turing principle in his quantum computer

We therefore consider, from the foregoing perspective, the significance of David Deutsch's claim ([Deu85], §2, p.5; see also §21.H.) that every 'existing general model of computation is effectively classical'; where Deutsch is not-so-implicitly implying that classical physics is false:

"It is argued that underlying the Church-Turing hypothesis there is an implicit physical assertion. Here, this assertion is presented explicitly as a physical principle: 'every finitely realizable physical system can be perfectly simulated by a universal model computing machine operating by finite means'. Classical physics and the universal Turing machine, because the former is continuous and the latter discrete, do not obey the principle, at least in the strong form above. A class of model computing machines that is the quantum generalization of the class of Turing machines is described, and it is shown that quantum theory and the 'universal quantum computer' are compatible with the principle. Computing machines resembling the universal quantum computer could, in principle, be built and would have many remarkable properties not reproducible by any Turing machine. These do not include the computation of non-recursive functions, but they do include 'quantum parallelism', a method by which certain probabilistic tasks can be performed faster by a universal quantum computer than by any classical restriction of it. The intuitive explanation of these properties places an intolerable strain on all interpretations of quantum theory other than Everett's. Some of the numerous connections between the quantum theory of computation and the rest of physics are explored. Quantum complexity theory allows a physically more reasonable description of the 'complexity' or 'knowledge' in a physical system than does classical complexity theory."

... Deutsch: [Deu85], Abstract.

Deutsch argues further that:

Albert (1983) has described a quantum mechanical measurement 'automaton' and has remarked that its properties on being set to measure itself have no analogue among classical automata. Albert's automata, though they are not general purpose computing machines, are true quantum computers, members of the general class that I shall study in this section.

In this section I present a general, fully quantum model for computation. I then describe the universal quantum computer \mathcal{Q} , which is capable of perfectly simulating every finite, realizable physical system. It can simulate ideal closed (zero temperature) systems, including all other instances of quantum computers and quantum simulators, with arbitrarily high but not perfect accuracy. In computing strict functions from \mathbb{Z} to \mathbb{Z} it generates precisely the classical recursive functions $C(\mathcal{T})$ (a manifestation of the correspondence principle). Unlike \mathcal{T} , it can simulate any finite classical discrete stochastic process perfectly. Furthermore, as we shall see in §3, it [h]as many remarkable and potentially useful capabilities that have no classical analogues.

Like a Turing machine, a model quantum computer \mathcal{Q} , consists of two components, a finite processor and an infinite memory, of which only a finite portion is ever used. The computation proceeds in steps of fixed duration T , and during each step only the processor and a finite part of the memory interact, the rest of the memory remaining static.

The processor consists of M 2-state observables

$$\{\hat{n}_i\} \quad (i \in \mathbb{Z}_M) \tag{2.1}$$

where \mathbb{Z}_M is the set of integers from 0 to $M - 1$. The memory consists of an infinite sequence

$$\{\hat{m}_i\} \quad (i \in \mathbb{Z}_M) \tag{2.2}$$

of 2-state observables. This corresponds to the infinitely long memory 'tape' in a Turing machine. I shall refer to the $\{\hat{n}_i\}$ collectively as \hat{n} , and to the $\{\hat{m}_i\}$ as \hat{m} . Corresponding to Turing's 'tape

position' is another observable \hat{x} which has the whole of \mathbb{Z} as its spectrum. The observable \hat{x} is the 'address' number of the currently scanned tape location. Since the 'tape' is infinitely long, but will be in motion during computations, it must not be rigid or it could not be made to move 'by finite means'. A mechanism that moved the tape according to signals transmitted at finite speed between adjacent segments only would satisfy the 'finite means' requirement and would be sufficient to implement what follows. Having satisfied ourselves that such a mechanism is possible, we shall not need to model it explicitly. Thus the state of \mathcal{Q} is a unit vector in the space \mathcal{H} spanned by the simultaneous eigenvectors:

$$|x; \mathbf{n}; \mathbf{m}\rangle \equiv |x; n_0, n_1 \dots n_{M-1}; \dots m_{-1}, m_0, m_1 \dots\rangle \tag{2.3}$$

of \hat{x} , $\hat{\mathbf{n}}$ and $\hat{\mathbf{m}}$, labelled by the corresponding eigenvalues x , \mathbf{n} and \mathbf{m} . I call (2.3) the '*computational basis states*'. It is convenient to take the spectrum of our 2-state observables to be \mathbb{Z}_2 , i.e. the set $\{0, 1\}$, rather than $\{-\frac{1}{2}, +\frac{1}{2}\}$ as is customary in physics. An observable with spectrum $\{0, 1\}$ has a natural interpretation as a 'one-bit' memory element.

The dynamics of \mathcal{Q} are summarized by a constant unitary operator \mathbf{U} on \mathcal{H} . \mathbf{U} specifies the evolution of any state $|\psi(t)\rangle \in \mathcal{H}$ (in the Schrödinger picture at time t) during a single computational step

$$|\psi(nT)\rangle = \mathbf{U}^n |\psi(0)\rangle \quad (n \in \mathbb{Z}^+) \tag{2.4}$$

$$\mathbf{U}^\dagger \mathbf{U} = \mathbf{U} \mathbf{U}^\dagger = \hat{1}. \tag{2.5}$$

We shall not need to specify the state at times other than non-negative integer multiples of T . The computation begins at $t = 0$. At this time \hat{x} and $\hat{\mathbf{n}}$ are prepared with the value zero, the state of a finite number of the $\hat{\mathbf{m}}$ is prepared as the 'program' and 'input' in the sense of §1 and the rest are set to zero. Thus

$$\left. \begin{aligned} |\psi(0)\rangle &= \sum_m \lambda |0; \mathbf{0}; \mathbf{m}\rangle, \\ \sum_m |\lambda_m|^2 &= 1, \end{aligned} \right\} \tag{2.6}$$

where only a finite number of the λ_m are non-zero and λ_m vanishes whenever an infinite number of the \mathbf{m} are non-zero.

To satisfy the requirement that \mathcal{Q} operate 'by finite means', the matrix elements of \mathbf{U} take the following form:

$$\langle x'; \mathbf{n}'; \mathbf{m}' | \mathbf{U} | x; \mathbf{n}; \mathbf{m} \rangle = [\delta_{x'}^{x+1} \mathbf{U}^+ (\mathbf{n}', m'_x | \mathbf{n}, m_x) + \delta_{x'}^{x-1} \mathbf{U}^- (\mathbf{n}', m'_x | \mathbf{n}, m_x)] \prod_{y \neq x} \delta_{m'_y}^{m_y} \tag{2.7}$$

The continued product on the right ensures that only one memory bit, the x th, participates in a single computational step. The terms $\delta_{x'}^{x \pm 1}$ ensure that during each step the tape position x cannot change by more than one unit, forward or backwards, or both. The functions $U^\pm (\mathbf{n}', m'_x | \mathbf{n}, m_x)$, which represent a dynamical motion depending only on the 'local' observables $\hat{\mathbf{n}}$ and \hat{m}_x , are arbitrary except for the requirement (2.5) that \mathbf{U} be unitary. Each choice defines a different quantum computer, $\mathcal{Q}[\mathbf{U}^+, \mathbf{U}^-]$.

Turing machines are said to '*halt*', signalling the end of the computation, when two consecutive states are identical. A 'valid' program is one that causes the machine to halt after a finite number of steps. However, (2.4) shows that two consecutive states of a quantum computer \mathcal{Q} can never be identical after a non-trivial computation. (This is true of any reversible computer.)

Moreover, \mathcal{Q} must not be observed before the computation has ended since this would, in general, alter its relative state. Therefore, quantum computers need to signal actively that they have halted. One of the processor's internal bits, say \hat{n}_0 , must be set aside for this purpose. Every valid \mathcal{Q} -program sets n_0 to 1 when it terminates but does not interact with \hat{n}_0 otherwise. The observable \hat{n}_0 can then be periodically observed from the outside without affecting the operation of \mathcal{Q} . The analogue of the classical condition for a program to be valid would be that the expectation value of \hat{n}_0 must go to one in a finite time. However, it is physically reasonable to allow a wider

class of \mathcal{Q} -programs. A \mathcal{Q} -program is valid if the expectation value of its *running time* is finite."

...Deutsch: [Deu85], 2 *Quantum computers*.

However, since Deutsch's mathematical model of his physical 'quantum' computer \mathcal{Q} in [Deu85], by definition, can compute only algorithmically *computable* functions, his above argument—that ' \mathcal{Q} must not be observed before the computation has ended since this would, in general, alter its relative state'—entails (see Aerts' argument as detailed in §23.B.c. and §23.B.d.) the untenable conclusion that:

- (i) The making, or not making, of a physical measurement/observation in the *actual* universe that we inhabit,
 - which can be treated as corresponding to that which is sought to be represented mathematically as the computation of a *well-defined*, algorithmically *computable*, mathematical function f in a well-defined mathematical model M of U ,
- (ii) by a physical 'quantum' computer \mathcal{Q} ,
 - which admits *relatively* random (see §7.G., Definition 27) inputs/outputs,
- (iii) can influence and/or determine the computational complexity of the *well-defined*, algorithmically *computable*, mathematical function f ,
 - in the well-defined mathematical *model* M of U ,
 - in which \mathcal{Q} is not well-definable (since a *relatively* random output cannot be realised in M)!

'Untenable' since the underlying perspective⁵⁹⁴ here is that:

- (iv) If U is the universe we inhabit:
 - and T is, say, the Taj Mahal,
 - whilst D is the set of categorical engineering specifications,
 - for building a physical model M of T in which we can perform repeated destructive experiments;
- (v) Then, as observers that exist in U :
 - whilst we can talk categorically about the properties of T representable in M ;
 - we can only conjecture/postulate;
 - * on the basis of statistical correlations,
 - * between what we observe in U ,
 - * and what we measure in M ;
 - to what extent M is a representative model;

⁵⁹⁴See also how this addresses the issues raised by: §23.D.g., **Query 30**. *What would introducing experimental observations—which implicitly subsume 'free will'—into a mathematical model entail?*

- * not of T ;
 - * but of *that* part of T ;
 - which we can observe in U ;
 - and well-define in D ;
 - without destroying T .
- (vi) We cannot, however, claim that any unpredictable structural change in T instantaneously causes a corresponding structural change in M !

In other words:

- (a) If there are *hidden* features H of T that are not observable in U , but which essentially influence any measurements that we make concerning T in U , then such features, by definition, are not represented/representable in D or M .
- (b) Since it is axiomatic that the only ‘true’ model of T is T itself then, as Diederik Aerts and Massimiliano Sassoli de Bianchi have, albeit implicitly, argued in [AdB14] (see §23.B.c.), repeated ‘destructive’ measurements in M are essentially separated spatially, and cannot, even in principle, yield deterministic definitions of all such properties H that can be built into a more complete model M' of T , even though T itself might exist in a deterministic universe.
- (c) The conclusion being that even if such a universe can be said to obey deterministic physical laws that can be postulated as independent of us, since we can reflect them mathematically in D by algorithmically *computable* (hence deterministic and predictable) functions and relations, the property of being *predictable* is only well-defined with respect to M , and makes no sense in U in cases where, as Aerts and de Bianchi have argued, it is not falsifiable in M since it involves spatial separation in destructive experiments upon M ⁵⁹⁵.
- (d) The most that we can claim from our observations is that there might be deterministic physical laws that are not representable in D by algorithmically *computable* (hence stochastically *deterministic* and *predictable* in repeated destructive experiments on M) functions and relations but, as shown in [An16] (Theorem 2.1, p.37), such laws might be representable in D by functions and relations that are algorithmically *verifiable* (hence stochastically *deterministic* by repeated destructive experiments on M), but (see also Bohr’s argument in §23.B.) *not* algorithmically *computable* (hence stochastically *unpredictable* by repeated destructive experiments on M) as would be required by Bell’s inequalities.

24.A.a. Deutsch’s *oracle* argument appeals to algorithmically *verifiable*, but not algorithmically *computable*, functions

In a subsequent paper [DJ92], David Deutsch and Richard Jozsa sought to justify the argumentation of [Deu85] by introducing the concept of a mathematical ‘oracle’ that—from the *evidence-based* perspective of this investigation—can *apparently* carry out computations on algorithmically *verifiable*, but not algorithmically *computable* functions which, by definition, could not be computed by a Turing machine:

⁵⁹⁵See also how this issue is addressed by: §23.D.g., Query 30. *What would introducing experimental observations—which implicitly subsume ‘free will’—into a mathematical model entail?*

“A class of problems is described which can be solved more efficiently by quantum computation than by any classical or stochastic method. The quantum computation solves the problem with certainty in exponentially less time than any classical deterministic computation.

The operation of any computing machine is necessarily a physical process. Nevertheless, the standard mathematical theory which is used to study the possibilities and limitations of computing (e.g. based on Turing machines) disallows quantum mechanical effects, in particular the presence of coherent superpositions during the computational evolution. A suitable notion of a *quantum computer*, which, like the Turing machine, is idealized as functioning faultlessly and having an unlimited memory capacity, but which is able to exploit quantum effects in a programmable way, has been formulated by one of us (Deutsch 1985). Quantum computers cannot compute any function which is not turing-computable, but they do provide new modes of computation for many classes of problem. In this paper we demonstrate the importance of quantum processes for issues in computational complexity. We describe a problem which can be solved more efficiently by a quantum computer than by any classical computer. The quantum computer solves the problem with certainty in exponentially less time than the expected time of any classical stochastic computer.

Let U_f be a device that computes a function $f : Z_m \rightarrow Z_n$. Given an input i , U_f will, after some time, output the value of f_i . In general terms the class of computational task which we shall be considering involves being given U_f and then using it to determine some property $G[f]$ (that is, some function of the sequence $f(0), f(1), \dots, f(m-1)$) in the least possible time.

In the analysis of this type of task, it is often an excellent approximation that the internal workings of U_f are inaccessible, in which case U_f is known as an *oracle* for f . The approximation would be nearly exact if U_f were a new type of physical object with an unknown law of motion.

If U_f were simply a program for evaluating f on our computer, making the approximation is tantamount to assuming that there is no faster method of obtaining $G[f]$ from the program U_f (e.g. by a textual analysis) than actually executing U_f to obtain sufficiently many values $f(i)$ to determine $G[f]$. It seems obvious that this is true for all properties G —obvious, but like $P \neq NP$, hard to prove.

If U_f were a ROM (read-only memory) containing a sequence of m integers from Z_n , the approximation is that there is no faster way of obtaining $G[f]$ from U_f than reading from the ROM sufficiently many values $f(i)$ to determine $G[f]$. This is clearly not true in general—there could be physical ways of measuring $G[f]$ directly, like measuring the total spin if the values of values $f(i)$ were stored as individual spin values—but it is a good description in many realistic situations.

It is useful to classify computational tasks into evaluations of *functions* and solutions of *problems*. In the case of functions, the task is to obtain the unique output that is the specified function of the input. For example, U_f , as we have defined it, evaluates the function f . In the case of solving problems the task is to obtain any one output that has a specified property. For example, to find a factor of a given composite number is a problem. Finding the least prime factor is a function evaluation.

When a classical deterministic (Turing) computer solves a problem, it always does so by evaluating a function. For example, a factorization program will always find the same factor of a given input. Which factor it finds could be specified by an additional constraint, narrowing the task to a function evaluation. Therefore when solving problems a classical computer cannot help performing a harder computational task than the one it was set.

A stochastic computer (i.e. one containing a hardware random number generator) need not always evaluate functions because the course of its computation, and therefore its output, need not be uniquely determined by the input. However, this gives a stochastic computer little advantage over a Turing one in solving problems, for if every possible output of a stochastic computation has the specified property that solves the problem, what is the purpose of choosing numbers randomly in

the course of the computation? One reason might be that there is a deterministic algorithm for solving the problem, which takes a parameter, and the running time depends on the parameter. If most values of the parameter give a short running time, but there are exceptional ones, which cannot easily be predicted, which give a long running time, it might be desirable to choose the parameter randomly if one wanted to reduce the expectation value of the running time.

A quantum computer (Deutsch 1985) is one in which quantum-mechanical interference can be harnessed to perform computations. Such a computation also need not necessarily evaluate functions when it is solving problems, because the state of its output might be a coherent superposition of states corresponding to different answers, each of which solves the problem. This allows quantum computers to solve problems by methods which are not available to any classical device.

Let us assume that, however U_f works, its operation is a coherent quantum mechanical process. Of course all physical processes conform to this assumption at some sufficiently complete level of description, possibly including their environment. But we mean that U_f can conveniently be made part of the coherent computation of a quantum computer.

Let \mathcal{H}_{mn} be a Hilbert space of dimension mn and let

$$\{|i, j\rangle\} (i \in \mathbf{Z}_m, j \in \mathbf{Z}_n) \tag{1}$$

be a fixed orthonormal basis in \mathcal{H}_{mn} . Suppose that U_f operates by accepting input in any state $|k, 0\rangle$ of the basis, representing the value k , and converting it to output in the state $|k, f(k)\rangle$, from which the value $f(k)$ can be read off with probability 1. More generally, we may suppose that U_f effects the unitary evolution

$$|i, j\rangle \xrightarrow{U_f} |i, j + f(i)\rangle, \tag{2}$$

where the addition in the expression $j + f(i)$ is performed modulo n . Then, by the linearity of quantum evolution, U_f will evolve the input state

$$m^{-\frac{1}{2}}(|0, 0\rangle + \dots + |m - 1, 0\rangle) \tag{3}$$

to the output state

$$m^{-\frac{1}{2}}(|0, f(0)\rangle + \dots + |m - 1, f(m - 1)\rangle). \tag{4}$$

Thus, by running U_f only once, we have in some sense computed all m values of f , in superposition. Elementary quantum measurement theory shows that no quantum measurement applied to the system in the state (4) can be used to obtain more than one of the m values $f(0), \dots, f(m - 1)$. However, it is possible to extract some joint properties $G[f(0), \dots, f(m - 1)]$ of the m values, by measuring certain observables which are not diagonal in the basis (1). This is called the method of *computation by quantum parallelism* and is possible only with computers whose computations are coherent quantum quantum processes. For examples see Deutsch (1985) and Jozsa (1991)."

... Deutsch/Jozsa: [DJ92], pp.553-555.

From the *evidence-based* perspective of this investigation, we note the dichotomy in the above argument, which we treat as essentially postulating that, for an appropriate, algorithmically *computable*, function f :

- (i) we can design a physical quantum computer with an associated oracle U_f such that, for any given natural number m , it can be in the physical states, say (3') and (4'),
- (ii) which are mathematically representable by the algorithmically *computable* formulas (3) and (4) respectively in Deutsch's above argument,

- (iii) where the formula (3) mathematically entails that the algorithmically *computable* formula (4) *cannot* (as is argued for integer factorisation in §22.A.f., Theorem 22.16) be computed in deterministic polynomial time (number of discrete computational steps/operations mathematically) in m ,
- (iv) even though U_f claims, *without evidence*, to have evolved state (3') to state (4') in deterministic polynomial time (discrete computational steps/operations physically) in m since, as argued by Deutsch and Jozsa in [DJ92]:
- elementary quantum theory shows that no physical quantum measurement applied to the system in the putative physical state (4') can be used to obtain more than one of the m values $f(0), \dots, f(m-1)$,
 - whence any physical measurement seeking to *evidence* the *actual* (in the sense of §23.B.d.) machine state (4'),
 - would result in ‘destroying the information about f ’ contained in the physically ‘unmeasured’ state (4').

Deutsch and Jozsa seek to justify this dichotomy by differentiating between classical and quantum computing, and arguing further that there are problems for which ‘quantum parallelism gives a solution with certainty in a given time, and it is absolutely more efficient than any classical or stochastic method’:

“To date, all known computational tasks which can be performed more efficiently by quantum parallelism than by any classical method have the following two properties. Firstly, the answer is not obtained with certainty in a given time; that is, there is a certain probability that the program will report that it has failed., destroying the information about f , so that in general it has to be run repeatedly before the answer is obtained. Secondly, although on some occasions it runs faster than any classical algorithm, the quantum algorithm is on average no more efficient than a classical one. It can be shown (Deutsch 1985) that the second property must hold for at least one choice of input in the quantum computation of any function.

It is the purpose of this communication to describe a problem for which quantum parallelism gives a solution with certainty in a given time, and it is absolutely more efficient than any classical or stochastic method.

The problem is as follows: Given a natural number N and an oracle U_f for a function $f : \mathbf{Z}_{2N} \rightarrow \mathbf{Z}_2$, find a true statement in the list:

- (A) f is not a constant function (at 0 or 1);
- (B) the sequence $f(0), \dots, f(2N-1)$ of values of f does not contain exactly N zeros.

Note that for any f , at least one of (A) or (B) is always true. It may be that both are true, in which case either (A) or (B) is an acceptable solution. That is why the solution of this problem is not necessarily tantamount to the computation of a function. A stochastic or quantum algorithm for solving it may have the property that when (A) and (B) are both true, it returns either answer, randomly. But when only one of them is true, the algorithm must return that one with certainty.

Consider first the classical solution. We repeatedly run U_f to calculate values of f in some order, say $f(\mathbf{\Pi}(0)), f(\mathbf{\Pi}(1)), f(\mathbf{\Pi}(2)), \dots$ where $\mathbf{\Pi}$ is a permutation on \mathbf{Z}_{2N} . This is always achieved in at most $N+1$ invocations of U_f , though many functions f will require fewer invocations. Representing a function f by the $2N$ -sequence $f(\mathbf{\Pi}(0)), \dots, f(\mathbf{\Pi}(2N-1))$ of zeros and ones, we have the results of table 1.

Hence, given a large number of random f s, the average number of invocations of U_f required to solve the problem for each f is

$$\frac{N+1}{2^{N-1}} + \sum_{n=2}^N n\left(\frac{1}{2}\right)^{n-1} = 3 - \frac{1}{2^{N-1}} \tag{5}$$

i.e. approximately three invocations for large N . If we are exceptionally unlucky, or if the f s are not presented randomly, but perversely by someone who knows what algorithm we are going to use, we shall require $N + 1$ invocations. With a classical stochastic computer we can choose the permutations Π randomly, a process which requires $O(\ln(N))$ steps on average, and can thereby expect to solve the problem in approximately three invocations, though again in unlucky cases this may rise to $N + 1$ invocations, plus an overhead of $O(N\ln(N))$ steps.

Now we present a method of solution using quantum parallelism. Let S be the unitary operation defined by

$$S|i, j\rangle = (-1)^j|i, j\rangle. \tag{6}$$

This operation can be performed by a quantum computer (cf. Deutsch 1985) fixed number of steps, independent of N and f . The state

$$|\phi\rangle = \frac{1}{\sqrt{2^N}} \sum_{i=0}^{2^N-1} |i, 0\rangle \tag{7}$$

can be prepared, starting with the ‘blank’ input $|0, 0\rangle$, in $O(\ln(N))$ steps, independently of f . For example, if $2N$ is a power of two, this could be done by applying the elementary one-bit transformation

$$|x\rangle \rightarrow \frac{1}{\sqrt{2}}(|x\rangle + (-1)^x|1-x\rangle) \quad (x \in \mathbf{Z}_2) \tag{8}$$

successively to each of the $\log_2(2N)$ bits that hold the value i in (7).

Given a quantum oracle U_f , apply the three operations U_f, S, U_f successively to the memory locations prepared in the state $|\phi\rangle$. Then, from (1), (6) and (7) the evolution is

$$\begin{aligned} |\phi\rangle &\xrightarrow{U_f} \frac{1}{\sqrt{2^N}} \sum_{i=0}^{2^N-1} |i, f(i)\rangle \\ &\xrightarrow{S} \frac{1}{\sqrt{2^N}} \sum_{i=0}^{2^N-1} (-1)^{f(i)} |i, f(i)\rangle \\ &\xrightarrow{U_f} \frac{1}{\sqrt{2^N}} \sum_{i=0}^{2^N-1} (-1)^{f(i)} |i, 0\rangle \equiv |\psi\rangle. \end{aligned} \tag{9}$$

The magnitude of the inner product

$$|\langle\phi|\psi\rangle| = \frac{1}{2^N} \left| \sum_{i=0}^{2^N-1} (-1)^{f(i)} \right| \tag{10}$$

is zero when statement (B) is false, and unity when statement (A) is false. Therefore if, after performing the operations in (9), we measure the projection observable $|\langle\phi|\psi\rangle|$, and the outcome is 0, we can be sure that $|\psi\rangle$ was not parallel to $|\phi\rangle$, and hence that (A) is true. And if the outcome is 1, we can be sure that $|\psi\rangle$ was not orthogonal to $|\phi\rangle$, and hence that (B) is true. The outcome must be either 0 or 1, because those are the only eigenvalues of any projection observable. Therefore the procedure cannot fail to establish the truth of either (A) or (B).

The measurement of $|\phi\rangle\langle\phi|$ can be performed in $O(\ln)$ steps, by first performing the inverse of the transformation which prepared $|\phi\rangle$ from a blank input $|0, 0\rangle$, and then measuring the observable $|0, 0\rangle\langle 0, 0|$, which is simply a matter of measuring each bit independently. The oracle U_f is invoked exactly twice in (9), and no other invocations are required. This is a clear improvement over the

worse case ($N + 1$ invocations) for either of those methods. Note that the problem is solved on each occasion with certainty."

... Deutsch/Jozsa: [DJ92], pp.555-557.

However, we note that the physical operation of any quantum computer in the problem considered above in [DJ92]—where f is, albeit implicitly, assumed to be an algorithmically *computable* function—is essentially equivalent to:

- (a) a finite (albeit within a potentially infinite) sequence of, say $2N$, masked light bulbs $b_{i1}, b_{i2}, \dots, b_{i2N}$ —grouped in a combination of $\log_2(2N)$ qubits and/or qubit registers—where each bulb is either on, or off, at any instant of time t_i ; and
- (b) a program that sequentially determines the state of the sequence of bulbs at any instant.

We note further that, since we are only interested in the $2N$ values $f(0), f(1), \dots, f(2N - 1)$, the above argument can be modified to accommodate the more general case, in *evidence-based* reasoning, where:

- (c) the Church-Turing Thesis is false (see §7.H.b., Theorem 7.3); and
- (d) Deutsch’s Church-Turing principle is entailed by the definition §7.H.b., Definition 28, of *effective computability*;

“Every finitely realizable physical system can be perfectly simulated by a universal model computing machine operating by finite means.”

... Deutsch: [Deu85], Church-Turing principle, p.99.

- (e) since the number-theoretic function f can be an algorithmically *verifiable*, but not necessarily algorithmically *computable*, function where:

- for any natural number n , we can consider instead of f the unique, primitive recursive, algorithmically *computable*, Gödel β -function $g_{f,n}$ (see §16.A.) such that $f(i) = g_{f,n}(i)$ for all $0 \leq i \leq 2N \leq n$.

From the *evidence-based* perspective of this investigation, the assumption of an ‘oracle’ that, for any requested natural number n , can provide the value of $f(n)$, would thus either involve assuming prior knowledge of that which is to be computed if f is algorithmically *computable*, or to the contradiction that this can be done in deterministic polynomial time otherwise (i.e., if f is algorithmically *verifiable*, but not algorithmically *computable*).

Comment 231. From an *evidence-based* perspective, the significance of the assumption of such a putative ‘oracle’ as a sine qua non for quantum computing is reflected in the query raised by Davide Castelvecchi in his explanatory article [Cst18] on Daniela Frauchiger and Renato Renner’s paradigm-challenging paper [FrRe18] (see also §23.D.g., Query 30):

“In 1967, the physicist Eugene Wigner proposed a version of the [Schrödinger’s cat] paradox in which a physicist friend lived inside a box with a measuring device that could return one of two results, such as a coin showing heads or tails. Does the wavefunction collapse when Wigner’s friend becomes aware of the result?”

... Castelvecchi: [Cst18].

24.A.b. Why Deutsch’s ‘oracle’ argument cannot appeal to ‘information loss’

We note that, since every switching ON/OFF of a bulb necessarily generates some ‘noise’⁵⁹⁶, we may reasonably assume that, in principle, this ‘noise’ is detectable by an oracle which can, moreover, record the bulbs’ physical state $\dots b_{i1}b_{i2}\dots b_{i2N}\dots$ at any time t_i as $r_{i1}r_{i2}\dots r_{i2N}$, where $b_{ij} = r_{ij}$ for $i \geq 0, 1 \leq j \leq 2N$.

Thus, given a quantum oracle U_f , consecutive application of the three operations U_f, S, U_f successively to the memory locations prepared in the state $|\phi_{t_0}\rangle$ —as described in the above excerpt from [DJ92] as (9)—can be viewed as yielding the evolution:

$$\begin{aligned}
 |\phi_{t_0}\rangle &= \frac{1}{\sqrt{(2N)}} \sum_{i=0}^{2N-1} |i, 0\rangle && \text{Knowledge state at } t_0 \\
 &\dots b_{01}b_{02}\dots b_{02N}\dots && \text{Bulbs' state at } t_0 \\
 &r_{01}r_{02}\dots r_{02N} && \text{Recorded state at } t_0 \\
 |\phi_{t_0}\rangle &\xrightarrow{U_f} \frac{1}{\sqrt{(2N)}} \sum_{i=0}^{2N-1} |i, f(i)\rangle && \text{Knowledge state at } t_1 \\
 &\dots b_{11}b_{12}\dots b_{12N}\dots && \text{Bulbs' state at } t_1 \\
 &r_{11}r_{12}\dots r_{12N} && \text{Recorded state at } t_1 \\
 &\xrightarrow{S} \frac{1}{\sqrt{(2N)}} \sum_{i=0}^{2N-1} (-1)^{f(i)} |i, f(i)\rangle && \text{Knowledge state at } t_2 \\
 &\dots b_{21}b_{22}\dots b_{22N}\dots && \text{Bulbs' state at } t_2 \\
 &r_{21}r_{22}\dots r_{22N} && \text{Recorded state at } t_2 \\
 &\xrightarrow{U_f} \frac{1}{\sqrt{(2N)}} \sum_{i=0}^{2N-1} (-1)^{f(i)} |i, 0\rangle \equiv |\psi\rangle. && \text{Knowledge state at } t_3 \\
 &\dots b_{31}b_{32}\dots b_{32N}\dots && \text{Bulbs' state at } t_3 \\
 &r_{31}r_{32}\dots r_{32N} && \text{Recorded state at } t_3
 \end{aligned} \tag{9'}$$

In other words, even if the $2N$ bulbs are masked, and assuming that the status of each bulb can be either ON (defined mathematically as bulb-status 0 when the bulb is on) or OFF (defined mathematically as bulb status 1 when the bulb is off) with equal probability, we can reasonably assume that our knowledge of the initial physical ‘state’ $\dots b_{01}b_{02}\dots b_{02N}\dots$ of the masked sequence of bulbs at time t_0 is given by:

$$|\phi_{t_0}\rangle = \frac{1}{\sqrt{(2N)}} \sum_{i=0}^{2N-1} |i, 0\rangle$$

Clearly there is no loss in the information content of the recording $r_{i1}r_{i2}\dots r_{i2N}$ which, *by definition*, is created by—and therefore cannot in any way alter/affect—the bulbs’ physical state $\dots b_{i1}b_{i2}\dots b_{i2N}\dots$.

Moreover, since the recorded states in the evolution (9’) described above would, effectively, be measurements of the states of the ‘quantum’ computer during computation, they would contradict Deutsch’s stricture:

⁵⁹⁶Defined, for instance, as by Gil Kalai: [Kli19], §2.4, Noisy quantum circuits.

"... \mathcal{Q} must not be observed before the computation has ended since this would, in general, alter its relative state."

... Deutsch: [Deu85], 2 Quantum computers.

From the *evidence-based* perspective of this investigation, we would further argue that, since all the operations of the 'quantum' computer in the above example are, in principle, determined by *algorithmically computable* instructions defined by U_f and S , we may conclude from the above perspective/gedanken that the computational complexity of the problem considered above in [DJ92] is also determined completely by theoretical, *algorithmically computable*, functions; and is not dependent upon any physical features, of the 'quantum' computer, that are not represented completely in the mathematical formulation of the problem⁵⁹⁷.

Comment 232. The significance of 'noise'—implicitly treated in [Kli19]⁵⁹⁸ as both a theoretical, and practical, limiting barrier when attempting to physically construct, essentially Deutschian, 'quantum' computers⁵⁹⁹—is highlighted by Gil Kalai:

"... Quantum systems are inherently noisy; we cannot accurately control them, and we cannot accurately describe them. In fact, every interaction of a quantum system with the outside world amounts to noise.

Model 5 – Noisy quantum computers: A noisy quantum circuit has the property that every qubit is corrupted in every "computer cycle" with a small probability t , and every gate is t -imperfect. Here, t is a small constant called the rate of noise.

Here, in a "computer cycle" we allow several non-overlapping gates to perform in parallel. We do not specify the precise technical meaning of "corrupt" and " t -imperfect," but the following intuitive explanation (for a restricted form of noise called depolarizing noise) could be useful. When a qubit is corrupted then its state is replaced by a uniformly distributed random state on the same Hilbert state. A gate is t -imperfect if with probability t the state of the qubits that are involved in the gate is replaced by a uniformly random state in the associated Hilbert space.

Theorem 1: "The threshold theorem." If the error rate is small enough, noisy quantum circuits allow the full power of quantum computing.

The threshold theorem was proved around 1995 by Aharonov and Ben-Or (1997), Kitaev (1997), and Knill, Laflamme, and Zurek (1998). The proof relies on quantum error-correcting codes first introduced by Shor (1995) and Steane (1996).

A common interpretation of the threshold theorem is that it shows that large-scale quantum computers are possible in principle. A more careful interpretation is that if we can control noisy intermediate-scale quantum systems well enough, then we can build large-scale universal quantum computers. As we will see, there are good reasons for why we cannot control the quality of noisy intermediate-scale quantum systems well enough."

... Kalai: [Kli19], §2.4, Noisy quantum circuits.

⁵⁹⁷See also how this issue is addressed by: §23.D.g., **Query 30**. *What would introducing experimental observations—which implicitly subsume 'free will'—into a mathematical model entail?*

⁵⁹⁸Implicitly', since [Kli19] does not address the issue raised by §23.D.g., **Query 30**.

⁵⁹⁹Such as that reported, in [AAB19], to have been constructed by a 78-member team of researchers, who have—albeit controversially (see, for instance, [Kli22])—claimed to have successfully reached the threshold of quantum supremacy by **building** at Google AI Quantum, Mountain View, California, USA, a:

'... high-fidelity processor capable of running quantum algorithms in an exponentially large computational space ...'

... Arute, Arya, Babbush, et al: [AAB19], §The future.

In an inaugural address [Kli22], Kalai further emphasises the argument that ‘even a quantum computer operating on a single qubit is inherently noisy’:

“Quantum computers are new type of computers based on quantum physics. When it comes to certain computational objectives, the computational ability of quantum computers is tens, and even hundreds of orders of magnitude faster than that of the digital computers we are familiar with, and their construction will enable us to break most of the current cryptosystems. While quantum computers represent a future technology, which captivates the hearts and imaginations of many, there is also an ongoing dispute over the very possibility of their existence.

My theory asserts that quantum computers are inherently noisy. Their robust components represent a low-level (classical) computational ability, and they necessarily exhibit chaotic behavior.”

... Kalai: [Kli22], Preface.

Kalai’s thesis is that the unavoidable level of ‘noise’ in ‘quantum’ computers is, thus, such that it makes quantum error-correcting codes infeasible⁶⁰⁰

“My argument for the impossibility of quantum computers lies within the scope of quantum mechanics and does not deviate from its principles. In essence, the argument is based on computational complexity and its interpretation, and it is discussed in-depth in my papers which also include a discussion of general conclusions that derive from my argument and relate to quantum physics, alongside suggestions of general laws of nature that express the impossibility of quantum computation.

My argument mostly deals with understanding quantum computers on the intermediate scale (known as NISQ computers, an abbreviation of Noisy Intermediate Scale Quantum), that is, quantum computers of up to at most several hundreds of qubits. It is expected that on this scale we will be able to construct quantum codes of a quality sufficient for the construction of bigger quantum computers. It is further expected that on this scale the quantum computer will achieve computations far beyond the ability of powerful classical computers, that is, will achieve quantum computational supremacy. The Google’s Sycamore computer is an example of a noisy intermediate-scale quantum computer.

As specified later, it is my argument that NISQ computers cannot be controlled. Hence:

1. Such systems cannot demonstrate significant quantum computational advantage.
2. Such systems cannot be used for the creation of quantum error-correcting codes.
3. Such systems lead to non-stationary and even chaotic distributions.

Regarding the first item, let me remind the audience that computational complexity theory provides tools for studying the computational power of models and physical computational devices. The reason NISQ computers cannot support quantum supremacy is that when we use computational complexity tools to understand the computational power of NISQ computers, we discover that they describe a very low-level computational class. This low-level computational class does not allow for any complicated computations, much less computational supremacy. My analysis draws computational conclusions for NISQ computers based on their mathematical model’s asymptotic behavior.

Regarding the second item, the reason it is impossible to build quantum error-correcting codes is that it requires an even lower noise level than that required for demonstrating quantum supremacy. The meaning of the infeasibility of quantum error-correcting codes is that even a quantum computer operating on a single qubit is inherently noisy. It is to be noted that the argument that the noise level required for error-correcting

⁶⁰⁰In Rohit Parikh’s sense: see [Pa71].

codes is lower than the level required for quantum supremacy is generally accepted by both theoreticians and experimental physicists."

... Kalai: [Kli22], *The argument against quantum computers*.

From the *evidence-based* interpretation of quantum theory suggested by Thesis 19 in §23.D.c. (*Classical laws of nature*), and Thesis 20 in §23.D.d. (*Neo-classical laws of nature*), Kalai's thesis can be treated as corresponding to the thesis that:

Thesis 24. (Quantum Noise) *The mathematical 'order' of the 'noise' level in a 'quantum' computation is inversely proportional to the mathematical 'order' of the number of qubits in the 'quantum' computer.*

if we assume that the number of qubits in a 'quantum' computer limits the number of initial values of the *algorithmically-computable* Gödel β -function (see §16.A.)—currently being computed by the 'quantum' computer—which mirror⁶⁰¹ the initial values of the *algorithmically-verifiable* (neo-classical) quantum function that represents the—physically measured—quantum phenomena that is being appealed to—albeit implicitly—for introducing the quantum randomness in the *algorithmically-computable* Gödel β -function *actually* being computed by the 'quantum' computer.

24.A.c. Why is quantum computing faster than classical computing?

The question arises: How would such a perspective account for the observed quantitative computational advantages of quantum computing—such as those reported in [AAB19]—over classical computing?

We note that current paradigms—such as that of Deutsch and Jozsa in [DJ92]—view such advantages as reflecting a significant qualitative differentiation in the theoretical foundations underlying the technology, rather than only incremental quantitative technological improvements in the implementation of an existing theory:

"It is interesting to compare the computational complexity of this problem relative with classical and quantum computers. In the classical case, polynomial equivalence class complexity theory (Garey & Johnson 1979) is based on deterministic (DTM) and non-deterministic (NDTM) Turing machine models. We first note the result (referred to as (*)) that for any classical solution of our problem, using a DTM, there exists a function $f : \mathbf{Z}_{2N} \rightarrow \mathbf{Z}_2$ which requires at least $N + 1$ invocations of the oracle. To see this, suppose that a DTM can solve the problem for every f using only $M \ll N$ invocations. Let f_c be a constant function so that statement (A) is false and the machine must conclude that statement (B) is true. Then for any M invocations, for inputs chosen in any way whatsoever, there exists a function g which agrees with f_c at all M choices, and has exactly N zero values. Since, by assumption, the M values constitute the only information that the DTM has about the function, it cannot distinguish U_{f_c} from U_g , i.e. it cannot conclude that statement (B) is true. The same argument applies to NDTMs, showing that the decision problem of whether B is true or not, is not in the class NP (though the corresponding problem for A is in NP but not in P).

To assess the complexity of the problem consider first an idealized situation in which the oracle is deemed to deliver its result in one computational step, and not to contribute to the size of the problem's input. Then the problem is specified by giving N , which has size $O(\ln N)$. Hence by (*), *exponential* time is required for its solution. The quantum solution, requiring only two invocations, and a time of $O(\ln N)$ to set up the input state, solves the problem in *polynomial* time. Thus the problem is in QP , the quantum analogue of the class P ."

... Deutsch/Jozsa: [DJ92], pp.557-558.

The question, as Krzysztof Wójtowicz addresses in [Wo09], is then:

⁶⁰¹See §23.D.g., Query 30, para 13.

“Why is such an increase in speed possible? This is because in QCT we make use of some special features of the quantum world. In the classical model (Turing machine) we only transform 0-1 sequences in a mechanical way, not appealing to the laws of quantum mechanics.¹⁶ We do not need quantum mechanics in order to explain, how the 0-1 strings of bits evolve within the Turing machine (or the classical computer). Things are quite different in the case of quantum algorithms.”

... Wójtowicz; [Wo09], §1.2. *Decidable problems*, p.319.

where:

“A Turing machine could be made of wood or steel and powered by horses or by steam, as no quantum phenomena are in use.”

... Wójtowicz; [Wo09], §1.2. *Decidable problems*, p.319, footnote 16.

From the foregoing *evidence-based* perspective, we would argue, however, that the claimed polynomial-time computation attributed to ‘only two invocations’ of a *physical* oracle U_f in a quantum computer by supposing that:

“... U_f operates by accepting input in any state $|k, 0\rangle$ of the basis, representing the value k , and converting it to output in the state $|k, f(k)\rangle$, from which the value $f(k)$ can be read off with probability 1.”

... Deutsch/Jozsa: [DJ92], pp.554-555.

is illusory; and that any appeal to a *notional* oracle—as described in the evolution of state (3) to state (4) in [DJ92]—cannot influence the *actual* computational complexity in physically determining which of (A) or (B) is true in the problem posed in [DJ92].

In other words, we posit that any reduction in computational time by a quantum computer—such as claimed in [DJ92], [Wo09], and [AAB19]—results:

- (a) from only quantitative technological improvements in the quality and quantity of the sub-routines built into the underlying circuitry:
 - that are independent of any particular value of the function being computed; and
 - which appeal to proofs within a formal first-order theory of Peano arithmetic such as PA for the validity of each sub-routine; and
 - which, by the Provability Theorem for PA (§2.E.b., Theorem 2.17), do not take into account the ‘computational time’ equivalent of each such proof;
- (b) not from any qualitative physical reductions in computational time resulting from a physical ‘quantum’ phenomena that is, both, essential to the physical computation, and is representable mathematically only statistically (such as, for instance, by Schrödinger’s ψ -function).

Comment 233. We note that, in the specialised field of quantum machine learning (QML), computer scientist Ewin Tang cogently demonstrates—in her paper [Tang19] and essay [Tang22]—that currently accepted ‘quantum’ computing has no significant advantage over classical (Turing-machine based) computing; since, purportedly, understanding ‘whether quantum machine learning algorithms present a genuine computational advantage over classical approaches is challenging’:

“Will quantum computers someday give super-polynomial speedups for machine learning on classical data? Current evidence suggests that certain other tasks, such as factoring, admit paradigm-shifting quantum speedups. One might then hope that, since quantum systems implicitly manipulate exponentially large matrices, one can harness nature’s inherent linear algebra processor to manipulate data exponentially faster than it is possible to do with classical computers. Researchers have put forth many proposals to gain a computational advantage with quantum machine learning (QML) algorithms for domains ranging from recommendation systems¹ to topological data analysis², but these proposals typically require unique assumptions that make the comparison to classical algorithms difficult. So, our understanding of speedups in this space is much murkier than it might appear at first glance³.

To shed light on these quantum advantage proposals we developed a new framework for analysing QML algorithms, which can produce formal evidence against an exponential quantum advantage. The idea is to find ‘dequantized’ versions of QML algorithms, which are fully classical algorithms that, on classical data, perform only polynomially slower than their quantum counterparts. The existence of a dequantized algorithm means that its quantum counterpart cannot give exponential speedups on classical data.”

... Tang: [Tang22].

Of interest to the above, *evidence-based*, perspective critiquing putative ‘quantum’ computing, is Tang’s conclusion in [Tang22] that, at present, ‘existence of a dequantized algorithm means that its quantum counterpart cannot give exponential speedups on classical data’; and, further, that ‘the main application of dequantization is to demonstrate barriers to quantum advantage’:

“Dequantization has two main limitations. First, this technique fails catastrophically when applied to data coming from quantum systems⁹: for example, quantum principal component analysis can be dequantized, yet it produces exponential speedups when the classical algorithm only gets access to the input state’s measurement data without amplitudes¹⁰. Dequantized algorithms cannot work without being given an explicit list of amplitudes, suggesting that QML has the best chance of achieving large speedups whenever classical computation cannot get access to this data (which occurs when input states come from quantum circuits and other physical quantum systems).

Second, dequantization does not yet rule out the possibility of large polynomial speedups on classical data, which could still lead to significant performance improvements in practice with sufficiently good quantum computers. This is still an area of active research.

Finally, one may expect that these exponential speed-ups of dequantized algorithms may improve over existing classical algorithms. However, we are unaware of any settings where dequantized algorithms give advantage. The reasons for this are subtle, and resemble the difficulties in finding applications for QML algorithms. Right now, the main application of dequantization is to demonstrate barriers to quantum advantage, but we hope that the analogies between quantum linear algebra and classical linear algebra will blossom into a fruitful exchange of ideas between the two fields.”

... Tang: [Tang22].

Although Tang notes ‘that QML has the best chance of achieving large speedups whenever classical computation cannot get access to this data (which occurs when input states come from quantum circuits and other physical quantum systems)’, §23.D.g., Query 30, highlights the problems associated with introducing, and treating, such data/inputs as representing physical phenomena which obey quantum laws.

We would further argue from the *evidence-based* perspective of this investigation, as reflected in §23.D.c., Thesis 19 and 23.D.d., Thesis 20, that:

Thesis 25. (Computational equivalence) *Any polynomial-time computation by a quantum computing device can be executed in polynomial time by a classical Turing machine.*

where we note that the mathematical representations of stochastic processes, such as the result of tossing a coin interminably, cannot be verified/computed by a quantum computer since such processes are assumed—and their representations defined—to be both indeterminate (have no algorithmically *verifiable* ‘past’) and unpredictable (have no algorithmically *computable* ‘future’).

Moreover, we could then tentatively define a quantum computer functionally by, say:

Definition 53. (Quantum verifier) *A physical device is a quantum verifier if it verifies only the first m values of an algorithmically verifiable, but not algorithmically computable, number-theoretic function f whose unique Gödel β -function for m is g_m , where $g_i = f_i$ for $0 \leq i \leq m$, and the value $f(i)$ is determined by a probability function governed by a function such as Schrödinger’s ψ -function.*

Definition 54. (Knowledge verifier) *A physical device is a knowledge verifier if, for any given m , it can verify the first m values of an algorithmically computable, number-theoretic, function f whose unique Gödel β -function for m is g_m , where $g_i = f_i$ for $0 \leq i \leq m$.*

Definition 55. (Quantum computer) *A physical device is a quantum computer if, and only if, it is a quantum verifier.*

Lemma 24.1. *A classical computer is a knowledge verifier but not a quantum verifier.*

Lemma 24.2. *A quantum computer is a knowledge verifier and a quantum verifier.*

24.A.d. The significance of *information loss* in quantum computing

The significance of the evolution §24.A.b.(9′)—in the context of the putative phenomena of ‘information loss’ when measuring the computation of a quantum computer under current paradigms—is vividly illustrated/explained by Krzysztof Wójtowicz’s lucid, albeit philosophically oriented, perspective of Deutsch’s reasoning in [Wo09] and [Wo19], where his focus is primarily the question of ‘*how* a quantum computation might, conceivably, enable us to make use of the very special features of the quantum world’ in quantum computation theory (QCT):

“From the classical point of view, the basic unit of information is a bit, which is either 0 or 1. A full description of the state of the bit is therefore given by a single number: 0 or 1.

In QCT, the basic unit of information is a qubit—the quantum counterpart of the bit. Qubits are much more complicated than bits, they cannot be described by the Boolean values 0 and 1, as they can occupy more states. The classical Boolean values have their counterparts—two distinguished (basic) states of the qubit, usually denoted by $|0\rangle$ and $|1\rangle$. But qubits can be also in a superposition of $|0\rangle$ and $|1\rangle$ —i.e. they are (speaking in informal terms) somehow in both states at the same time. Such a superposition is described by the expression $a_0|0\rangle + a_1|1\rangle$, where the co-efficients a_0 and a_1 are two complex numbers such that $|a_0|^2 + |a_1|^2 = 1$. From the formal point of view, a qubit is a vector of length 1 in a two-dimensional complex Hilbert space.¹⁷ A physical realization of a qubit is e.g. a photon (there are numerous other examples), but in this paper we are not interested in the “hardware”, but rather in the theoretical foundations of QCT.¹⁸

The classical computation consists of computational steps, transforming the initial 0 – 1 sequence of bits.¹⁹ We just put the initial dat[a] on the tape of the Turing machine, and start the process.

After a finite number of steps (provided the machine indeed halts, but here we restrict our attention only to such cases) the machine enters the terminal state, and the tape contains the solution. Of course, at any moment of the computation, the tape contains a certain finite 0 – 1 string.

The technical details are not of primary importance here and will often be omitted. What is really interesting is *how* a quantum computation enables us to make use of the very special features of the quantum world."

... Wójtowicz: [Wo09], pp.320-321.

Wójtowicz outlines the basic notions of QCT, in relatively non-technical terms, thus:

"In QCT we consider not only single qubits, but also strings of qubits—quantum registers. Such registers have some quite special properties, which have no counterpart in the classical world. Quantum algorithms make use of these properties, and this makes them (at least in some cases) extremely powerful in comparison with the available classical algorithms.

A single qubit has the form $a_0|0\rangle + a_1|1\rangle$ —i.e. we need 2 complex numbers to describe its state. How many complex parameters are needed to describe the state of a quantum register—e.g. a system of 10 photons? Consider first a system of 10 points on the plane, and imagine that we are interested in the positions of the points only. For each of the points, we need two parameters (x, y) in order to describe its position, so 20 parameters are sufficient to provide a complete description of the system of 10 points. This is quite obvious: every point has a position on its own, independent of the other points, and in order to describe the position of a single point we do not have to worry about the other points (why should we?). Therefore, one might be tempted to think, that we also need 20 parameters in order to describe the quantum system of 10 qubits (photons). But in the quantum world things are not always so simple: it can happen, that the qubits constituting the quantum register do not have a state on their own. That means, that the register of 10 qubits is in a certain state *as a whole*, but it does not make sense to speak of the states of the individual qubits. In such cases we speak of quantum entanglement (a notion, which will be defined in a more precise way later). Because of that fact, the description of the quantum system is much more complicated than a person trying to apply intuitions from classical physics might expect. The dimension of the system increases exponentially with the increase of the number of qubits: in the general case, the description of the quantum register consisting of n qubits requires 2^n parameters (as this is the dimension of the Hilbert space needed to provide the description).²⁰ Of course, we could not even dream of writing down such a description for $n = 100$.

This is very different from the case of classical bits of information. To understand the underlying mechanism, consider the example of two qubits treated as one single quantum system. The states of the qubits are $a_0|0\rangle + a_1|1\rangle$ and $b_0|0\rangle + b_1|1\rangle$ correspondingly. The state of the quantum register can be written as a product (a tensor product) of these two states:

$$(a_0|0\rangle + a_1|1\rangle) \otimes (b_0|0\rangle + b_1|1\rangle)$$

(we will [henceforth] omit the symbol \otimes). If we treat this as an algebraic expression and perform the multiplication, we obtain:

$$a_0b_0|0\rangle|0\rangle + a_0b_1|0\rangle|1\rangle + a_1b_0|1\rangle|0\rangle + a_1b_1|1\rangle|1\rangle$$

To simplify the notation, we will write $|00\rangle$ instead of $|0\rangle|0\rangle$; $|01\rangle$ instead of $|0\rangle|1\rangle$ *etc.* The result is:

$$a_0b_0|00\rangle + a_0b_1|01\rangle + a_1b_0|10\rangle + a_1b_1|11\rangle.$$

The vectors $|00\rangle, |01\rangle, |10\rangle, |11\rangle$ form a basis for the 2-qubit quantum register. The vector $a_0b_0|00\rangle + a_0b_1|01\rangle + a_1b_0|10\rangle + a_1b_1|11\rangle$ describes the state of the 2-qubit register, such that the first qubit is in the state $a_0|0\rangle + a_1|1\rangle$, and the second in the state $b_0|0\rangle + b_1|1\rangle$. In general, the state of any two-qubit register can be described as : $c_{00}|00\rangle + c_{01}|01\rangle + c_{10}|10\rangle + c_{11}|11\rangle$ (where $c_{00}, c_{01}, c_{10}, c_{11}$ are complex numbers satisfying the condition $|c_{00}|^2 + |c_{01}|^2 + |c_{10}|^2 + |c_{11}|^2 = 1$).

Of course, the state $a_0b_0|00\rangle + a_0b_1|01\rangle + a_1b_0|10\rangle + a_1b_1|11\rangle$ is simply a product of the two states: $(a_0|0\rangle + a_1|1\rangle)(b_0|0\rangle + b_1|1\rangle)$. But not every state of the 2-qubit register can be represented as a tensor product: in most cases, the vector $c_{00}|00\rangle + c_{01}|01\rangle + c_{10}|10\rangle + c_{11}|11\rangle$ does not allow for such a factorization.²¹ In such cases we say, that the two qubits are *entangled*. The presence of entanglement is a very special feature of quantum systems and has no classical counterpart.²²

For three (and more) qubits, the situation is analogous: consider the system consisting of three qubits: $a_0|0\rangle + a_1|1\rangle$, $b_0|0\rangle + b_1|1\rangle$, $c_0|0\rangle + c_1|1\rangle$. Again, we multiply them just like algebraic equations, obtaining the product, which can be written down (using the obvious abbreviations, e.g. $|010\rangle$ instead of $|0\rangle|1\rangle|0\rangle$ etc.) as:

$$a_0b_0c_0|000\rangle + a_0b_0c_1|001\rangle + a_0b_1c_0|010\rangle + a_0b_1c_1|011\rangle + a_1b_0c_0|100\rangle + a_1b_0c_1|101\rangle + a_1b_1c_0|110\rangle + a_1b_1c_1|111\rangle.$$

The eight vectors $|000\rangle, |001\rangle, |010\rangle, |011\rangle, |100\rangle, |101\rangle, |110\rangle, |111\rangle$ form a base of a 3-qubit register, and in the general case, the state of such a register can be presented as:

$$a_{000}|000\rangle + a_{001}|001\rangle + a_{010}|010\rangle + a_{011}|011\rangle + a_{100}|100\rangle + a_{101}|101\rangle + a_{110}|110\rangle + a_{111}|111\rangle$$

If such an expression cannot be presented as a tensor product of three qubits $a_0|0\rangle + a_1|1\rangle$, $b_0|0\rangle + b_1|1\rangle$, $c_0|0\rangle + c_1|1\rangle$ we are again confronted with quantum entanglement: the qubits forming the register do not have a state of their own.²³ In the general case of an entangled n -qubit register, we need 2^n components in order to describe the state of this register (the dimensions of the corresponding Hilbert space is 2^n).²⁴ That shows in particular, that the computer simulation of the evolution of a quantum system in an efficient way is not possible: to describe the evolution of a system of n qubits, we would have to store (and describe the evolution of) 2^n values at once. Of course, this is not possible in the case of e.g. 300 qubits."

... Wójtowicz: [Wo09], pp.321-323.

Wójtowicz notes that a classical computation ‘consists of Boolean gates, and each gate transforms the initial string of bits into an output (which is another string of bits)’, whereas the ‘quantum counterpart of such a Boolean gate is a quantum gate, which acts either on one qubit or on a quantum register’:

“We can view a classical computation as a action of a Boolean network on initial data.²⁵ Such a circuit consists of Boolean gates, and each gate transforms the initial string of bits into an output (which is another string of bits). The quantum counterpart of such a Boolean gate is a quantum gate, which acts either on one qubit or on a quantum register. The actions of a quantum gate on a qubit can be described as:

$$V : a_0|0\rangle + a_1|1\rangle \rightarrow b_0|0\rangle + b_1|1\rangle,$$

where $a_0|0\rangle + a_1|1\rangle$ is the input (the initial state of the qubit), and $b_0|0\rangle + b_1|1\rangle$ is the output, i.e. the final state of the qubit (remember that a_0, a_1, b_0, b_1 are complex coefficients). In the general case a quantum gate transforms an n -qubit register, giving another register as an output.

A quantum computation consists of a sequence of such transitions, performed on a quantum register. These quantum gates manipulate the information stored in the qubit, or in the quantum register (the system of qubits). From the mathematical point of view, quantum gates are linear unitary operators, i.e. they preserve the norm of the quantum state (but these technical details are not important here).²⁶

Every quantum gate is a linear operator on the appropriate Hilbert space (the dimension of this space is 2^n , where n is the size of the register). Due to the linearity of the operator, it is sufficient to define the action of the operator on the basic states $|0\rangle$ and $|1\rangle$ of the particular qubits.²⁷ A simple example is the Hadamard gate H , which acts in the following way:

$$\begin{aligned} |0\rangle &\rightarrow 1/\sqrt{2}(|0\rangle + |1\rangle), \\ |1\rangle &\rightarrow 1/\sqrt{2}(|0\rangle - |1\rangle).^{28} \end{aligned}$$

A straightforward computation shows, that $H^2 = \text{Id}$."

... Wójtowicz: [Wo09], pp.323-324.

Noting that every ‘quantum gate is a linear operator on the appropriate Hilbert space’, Wójtowicz defines a Hadamard gate H mathematically; and further notes its ‘strange property’ that, whereas its application once as a classically random device—in a coin-tossing *gedanken*—gives us an output with the expected classical probability, ‘performing it twice gives us a deterministic outcome’:

“Now consider the following thought experiment, which will give us some insight into the peculiarities of the quantum world and of quantum computation. Imagine a random device, which—independently of the input (which is 0 or 1) gives us as output 0 or 1 with the same probability 1/2 (e.g. a fair coin toss). If such an operation is performed twice (i.e. we simply concatenate two such devices M) it is quite obvious, that the output will likewise be random: we just feed the first device with the input 0 or 1, perform the random operation, observe the output, pass the output to the second device, perform the second random operation and observe the output. Of course the second output is random, regardless of the first outcome.

This is how the classical coin works. However, in the quantum world, strange things happen: we can set up a random operation U , with the strange property, that performing it twice gives us a deterministic outcome. This is of course very counterintuitive, as our intuitions are modeled by the classical (i.e. macroscopic) world. A classical coin like this does not exist. But the “quantum coin” acts in the following way:

$$\begin{aligned} U(0) &= 0 \text{ or } 1 \text{ with probability } 1/2, \\ U(1) &= 0 \text{ or } 1 \text{ with probability } 1/2. \end{aligned}$$

But(!)

$$\begin{aligned} U^2(0) &= 1, \\ U^2(1) &= 0. \end{aligned}$$

... Wójtowicz: [Wo09], p.325.

Wójtowicz then uses as an analogy Louis H. Kauffman’s ‘square root of negation’ ([Kau87], p.72; [KC19]) to illustrate, and argue, that we can ‘harness quantum mechanics in order to produce effective information processing procedures’, so that the outcome of a ‘measurement allows us to “extract” information about the state of the system before the measurement’ in Deutsch’s algorithm:

“From the logical point of view, the operation U^2 is the negation. So U can be viewed as the square root of the negation. In classical logic, such a logical operation does not exist. But there is a quantum device, which acts exactly in this way—i.e. it can be (in a sense) viewed as an experimental realization of $\sqrt{\text{NOT}}$.

What is its formal counterpart? Consider the operator U , defined as:

$$\begin{aligned} U : |0\rangle &\rightarrow \frac{1}{2}(1 - i)|0\rangle + \frac{1}{2}(1 + i)|1\rangle \\ U : |1\rangle &\rightarrow \frac{1}{2}(1 + i)|0\rangle + \frac{1}{2}(1 - i)|1\rangle \end{aligned}$$

A straightforward computation shows, that $UU|0\rangle = 1$, and $UU|1\rangle = 0$. $U^2(p) = \neg p$, so U is the square root of the negation.

But why do we claim, that $\sqrt{\text{NOT}}$, acting e.g. on photons is a random device? There is no sign of randomness in the definition of the operator U . Indeed, U acts on the vectors in the Hilbert space in a purely deterministic way. But in order to “extract” the information from the quantum system we have to perform a measurement. A measurement is probabilistic in nature, as stated by one of the basic postulates of quantum mechanics (which we remind here in a simplified form, concerning only qubits):

- If we perform the measurement on a qubit, being in the state $a_0|0\rangle + a_1|1\rangle$, there are two possible outcomes: 0 and 1. The probability of obtaining the result 0 equals $|a_0|^2$, and the probability of obtaining 1 equals $|a_1|^2$. After the measurement the state of the quantum system is projected onto one of the basic states: if the outcome was 0 (resp. 1), the state after the measurement is projected onto $|0\rangle$ (resp. $|1\rangle$).²⁹

In particular, we usually cannot learn from the outcome of the measurement, what was the state of the system before the measurement (we cannot tell whether the state was e.g. $\frac{1}{2}(1-i)|0\rangle + \frac{1}{2}(1+i)|1\rangle$ or rather $\frac{1}{2}i|0\rangle + \sqrt{\frac{3}{4}}|1\rangle$). For example, if the outcome of the measurement was 0, the only information about the state of the system *before* the measurement, is that $a_0 \neq 0$. After the measurement the state of the system collapses to $|0\rangle$ (and of course the outcome of the next measurement will be 0 with probability 1). So (with few exceptions), the act of measurement causes changes in the state of the system."

... Wójtowicz: [Wo09], pp.325-326.

Ostensibly, the above argument seems to implicitly imply that the physical act of measurement of a quantum phenomena *cannot* be represented in any mathematical model of the phenomena in a way that would allow us to ‘learn from the outcome of the measurement, what was the state of the system before the measurement’⁶⁰².

If so, this would entail that—contrary to what is claimed—the operator U is *not* the formal counterpart of: ‘a quantum device, which acts exactly in this way—i.e. it can be (in a sense) viewed as an experimental realization of $\sqrt{\text{NOT}}$ ’.

Comment 234. We note that, from the *evidence-based* perspective of this investigation, a quantum phenomena *can*, however, be viewed (see §23.D.c., Thesis 19, and §23.D.d., Thesis 20) as represented mathematically by functions which are algorithmically *verifiable* (hence determinate), but not algorithmically *computable* (hence not predictable).

Moreover, the assumption that the physical act of measurement of a quantum phenomena cannot be represented in any mathematical model of the phenomena would not admit the significance of the central Complementarity Thesis (§1., Thesis 1) of this investigation; nor that of the distinction between the interdependent roles of natural scientists, philosophers, and mathematicians, as suggested in §13.C.

Presumably aware of what may be seen as the implicit implications of the above argumentation, Wójtowicz seeks to further explain the actions of the physical $\sqrt{\text{NOT}}$ operator thus:

“Let us turn back to $\sqrt{\text{NOT}}$. It transforms $|0\rangle$ to $\frac{1}{2}(1-i)|0\rangle + \frac{1}{2}(1+i)|1\rangle$. If we now perform the measurements, we will obtain 0 or 1 with equal probabilities $\frac{1}{2}$. That means, that the procedure consisting of:

1. preparing the quantum system in the state $|0\rangle$,

⁶⁰²Compare with the perspective addressed by: §23.D.g., **Query 30**. *What would introducing experimental observations—which implicitly subsume ‘free will’—into a mathematical model entail?*

2. applying the $\sqrt{\text{NOT}}$ operation to this system,
3. performing the measurement,

is a purely random procedure, just like tossing a random coin. But if we *do not* perform the measurement after the first application of $\sqrt{\text{NOT}}$, but apply $\sqrt{\text{NOT}}$ again, the whole procedure will transform 0 into 1 and 1 into 0 in a deterministic way. This looks strange, but remember, that we do not perform the measurement after the first application of the $\sqrt{\text{NOT}}$ gate, but we transfer the result to the second gate—and the measurement is performed *after* the second application of $\sqrt{\text{NOT}}$. Of course, if we measured the state of the quantum state after the first $\sqrt{\text{NOT}}$, the state of the quantum system would collapse (become either $|0\rangle$ or $|1\rangle$), so the input of the second gate would be either $|0\rangle$ or $|1\rangle$, and the second measurement would yield either 0 or 1 with the same probability.

As was already mentioned before, in the general case the measurement does not give any information about the state of the system *before* the measurement. So, if we perform a quantum computation and afterwards perform the measurement of the system, we usually will not be able to tell, what was the state of the system *before* the measurement. That means, that in the general case during the measurement we lose the information that was obtained in course of the computation. But in some interesting cases, some additional information about the evolution of the system will make it possible to deduce the final state of the system from the result of the measurement—and in these cases we will be able to harness quantum mechanics in order to produce effective information processing procedures."

... Wójtowicz: [Wo09], pp.326-327.

However, if we accept that the actual *physical* state—as well as the *physical* act of measurement—of a quantum phenomena *cannot* be represented in any classical mathematical model of the phenomena—i.e. a model which admits only algorithmically *computable* functions/relations (in the sense of §2., Definition 10)—then we note the anomaly in the claim that (see also §24.A.b.) *choosing* to remain ignorant of the outcome of a *physical* quantum measurement is equivalent to the outcome being *essentially unknowable*; a claim implicit in the above argumentation, which is essentially that:

- (i) the *physical* (circuit) operator $\sqrt{\text{NOT}}$ transforms the *physical* state of a system S , denoted symbolically by $|0\rangle$, to a *metaphysical* (abstract) state k_0 of our *knowledge* of the system,
- (ii) *represented* mathematically within a formal system L by $\frac{1}{2}(1 - i)|0\rangle + \frac{1}{2}(1 + i)|1\rangle$;

since:

- (iii) if we choose then to perform a *physical* measurement m_0 on the *physical* system S ,
- (iv) we will obtain a new *physical* state of S , denoted by 0 or 1, each with equal probability $\frac{1}{2}$,
- (v) on the basis of a single measurement,

whilst:

- (vi) if we choose not to perform the *physical* measurement m_0 on the *physical* system S ,
- (vii) we can treat the new *physical* state of S as being denoted by $\frac{1}{2}(1 - i)|0\rangle + \frac{1}{2}(1 + i)|1\rangle$;

where:

- (viii) we have prior (*metaphysical*) mathematical *knowledge* that the *physical* operation of $\sqrt{\text{NOT}}$ transforms the *physical* state of the system, denoted symbolically by $|0\rangle$,
- (ix) under a mathematically well-defined probability distribution within L ,
- (x) which is *postulated* as mathematically representing—within L —the *physical* measurements of repeated, non-terminating, *physical* application of the *physical* (circuit) operator $\sqrt{\text{NOT}}$ to the *physical* state of the system S denoted by $|0\rangle$.

In other words, Wójtowicz seems to be essentially arguing that the *physical* outcome of a *physical* (circuit) operator $\sqrt{\text{NOT}}$ *physically* transforming the *physical* state of a system S does not constitute a *measurement* even if—as argued in §24.A.b.—the *putative* transformed *physical* state of S can, in principle, be recorded faithfully.

Comment 235. From the *evidence-based* perspective of this investigation, however:

- (a) *choosing to measure* the system S at the step denoted by §24.A.d.(iii) simply means that we have appealed to the oracle to transform our *ignorance* of the algorithmically *computable* state of the system at that point to *knowledge* of the state that is already known/available to the oracle (and, in principle, to us, since the state is assumed algorithmically *computable*), as we *need* this knowledge for completing the desired computation;
- (b) *choosing not to measure* the system S at the step denoted by §24.A.d.(vi) simply means that we have *not* appealed to the oracle to transform our *ignorance* of the algorithmically *computable* state of the system at that point to *knowledge* of the state that is already known/available to the oracle (and, in principle, to us, since the state is assumed algorithmically *computable*), as we *do not need* this knowledge for completing the desired computation;

From a logical perspective, the difference here is between *choosing* to know ‘*the x*’—denoted symbolically by ‘ ιx ’ (see [Me64], p.85)—and *choosing* to know *only* that ‘there exists *an x*’—denoted symbolically by ‘ $\exists x$ ’ (see [Me64], p.45).

Obviously, any computation that only requires knowledge of the latter for completing a computation *could* be significantly faster than one where we, unnecessarily, compute the former.

Moreover, use of a *physical* (circuit) operator $\sqrt{\text{NOT}}$ *physically* for transforming the *physical* state of a system S is not essential to quantum computation per se, but is only needed where the algorithmically *computable* state, whose knowledge the oracle is called upon to furnish, appeals to the formal representation of the *physical* $\sqrt{\text{NOT}}$ operation in the language of algorithmically *computable* functions.

Wójtowicz argues further that admitting such a distinction between the *physical* state of a system (i.e., what it *actually* is in Aerts’ sense; see §23.B.d.), and *knowledge* of the *physical* state of a system, ‘allows us to “extract” information about the state of the system before the measurement’:

“Two simple examples may illuminate the point:

- (a) Consider one qubit, which is known *in advance* to be in one of the two states from the computational basis (i.e. it is either $|0\rangle$ or $|1\rangle$), but we do not know which one). Of course, in that case the outcome of the measurement gives us information about the internal state.
- (b) Consider a 2-qubit quantum register, which is known *in advance* to be in one of the two states:

$$\Phi_0 : 1/\sqrt{2}(|00\rangle + |01\rangle),$$

$$\Phi_1 : 1/\sqrt{2}(|10\rangle + |11\rangle),$$

If we perform the measurement on the *first* qubit, we will obtain the complete information about the state of the *whole* register, as we could obtain 0 only when the state of the register is Φ_0 (and analogously, *only* Φ_1 can result in obtaining 1). That means, that in some cases the outcome of the measurement allows us to “extract” information about the state of the system before the measurement. We can make use of this fact in quantum algorithms, the simplest of which is Deutsch’s algorithm.”

... Wójtowicz: [Wo09], pp.326-327.

Wójtowicz then seeks to illustrate how the above distinction admits significant quantitative advantages of quantum computing over classical, Turing-machine based, computing (which could, arguably, be taken to account for the fewer computational steps evidenced in [AAB19]):

“2.4 Examples of quantum algorithms³⁰

Stated in colloquial terms, we have to decide, whether a coin is a genuine coin or not (in which case it has two tails or two heads). Of course, classically we have to look at the coin twice. The mathematical counterpart is as follows: for a given function $f : \{0, 1\} \rightarrow \{0, 1\}$, we have to find out, whether the function is constant ($f(0) = f(1)$ —this corresponds to the fake coin), or whether it is balanced ($f(0) \neq f(1)$ —a genuine coin). How many function evaluations are necessary in order to find out, whether f is constant or balanced? Classically—of course two: we have to evaluate both the values $f(0)$ and $f(1)$, and then compare them. In the quantum world we can do this in one quantum step.

Consider a quantum “black box” U_f , which acts on a two-qubit register in the following way:

$$U_f : |x\rangle|y\rangle \rightarrow |x\rangle|y \oplus f(x)\rangle,$$

where \oplus is addition *modulo* 2 (i.e. $0 \oplus 0 = 0; 0 \oplus 1 = 1; 1 \oplus 0 = 1; 1 \oplus 1 = 0$).³²

The Deutsch algorithm proceeds as follows (to simplify matters I will omit all the coefficients like $1/\sqrt{2}, \frac{1}{2}$ etc.):

1. We prepare two qubits in initial states $|0\rangle$ and $|0\rangle - |1\rangle$, so the state of the register can be written down as the product $|0\rangle(|0\rangle - |1\rangle)$. We apply the Hadamard gate to the first qubit, and identity (i.e. do nothing) to the second qubit:³³

$$H : |0\rangle(|0\rangle - |1\rangle) \rightarrow (|0\rangle + |1\rangle)(|0\rangle - |1\rangle)$$

2. Now we apply the quantum gate U_f . A straightforward computation shows, that:

$$U_f : (|0\rangle + |1\rangle)(|0\rangle - |1\rangle) \rightarrow ((-1)^{f_0}|0\rangle + (-1)^{f_1}|1\rangle)(|0\rangle - |1\rangle).$$

The state of the first qubit is therefore

$$(-1)^{f_0}|0\rangle + (-1)^{f_1}|1\rangle$$

(the state of the second qubit is $|0\rangle - |1\rangle$, but that is of no further relevance to our problem). There are two possibilities:

- (i) If $f(0) = f(1)$, then the state of the first qubit is either $|0\rangle + |1\rangle$ (this happens when $f(0) = f(1) = 0$), or $-(|0\rangle + |1\rangle)$ (this happens when $f(0) = f(1) = 1$).
- (ii) If $f(0) \neq f(1)$, then the state of the first qubit is either $|0\rangle - |1\rangle$, or $-(|0\rangle - |1\rangle)$.

Now we apply the Hadamard gate again to the first qubit. The result is:

- if (i) was the case: $|0\rangle$ or $-|1\rangle$,

- if (ii) was the case: $|1\rangle$ or $-|1\rangle$.

If we now perform the measurement on the first qubit, we obtain either 0 or 1, and in this particular case we are able to deduce, whether (i) or (ii) took place. This is because we knew in advance, that the qubit had to be in one of four particular states before the final measurement. Observe, that in this algorithm we evaluated the function f *only once*. The measurement is performed *after* the algorithm terminates—otherwise we would cause the measured qubit to collapse and therefore destroy the computation."

... Wójtowicz: [Wo09], pp.328-329.

Wójtowicz notes further that such quantitative advantages of quantum computing over classical, Turing-machine based, computing, could, conceivably, also translate into qualitative advantages of reducing non-deterministic polynomial time computations to deterministic polynomial-time:

"The Deutsch algorithm is interesting, but it seems somehow artificial, and the increase in speed (1 call of the function f instead of 2 calls) is not very spectacular. But it has an interesting generalization: the Deutsch-Jozsa algorithm. Here we have a function $f: \{0, 1\}^n \rightarrow \{0, 1\}$ (so any 0–1 sequence of the length n is mapped either on 0 or 1). We know in advance, that f is either constant (all the values of f are 0 or all the values are 1), or balanced (which means, that f takes as many times the value 0 as the value 1). In the classical algorithm we have to call f approximately 2^{n-1} times.³⁴ But the Deutsch-Jozsa algorithm solves the problem in polynomial time."

... Wójtowicz: [Wo09], pp.329-330.

The consequences, Wójtowicz notes, could provide 'a theoretical possibility of cracking the RSA code, the security of which rests on the assumption, that factoring is hard' (an assumption sought to be justified by the argumentation in §22.A.f.; as a consequence of the *evidence-based* proof—in §22.A.c., Theorem 22.12—that the prime divisors of an integer are mutually independent):

"The by far most impressive example of a quantum algorithm is Shor's algorithm,³⁵ which can be called one of the cornerstones of quantum computation theory. Shor's algorithm shows, how a problem believed to be hard becomes easy by referring to quantum mechanics.

The algorithm deals with the factorization problem, which belongs to the class **NP**: given a solution we can check within a polynomial time whether it in fact is the desired solution, but factoring a number into primes is a complicated task (try this with e.g. 1062347—which is not a very big number). Every known classical algorithm for factoring requires an exponentially increasing number of steps. This fact is exploited in cryptographic protocols: the security of these protocols relies on the assumption, that factoring is intractable. We will not go into the technical details of Shor's algorithm—it consists of a classical and a quantum part. In the classical part we exploit some number-theoretic results (concerning finding prime factors by determining a period of a certain function). The problem of factorization reduces to the problem of finding the period of a certain periodic function. This problem can be solved efficiently by Shor's quantum algorithm. In particular, Shor's algorithm provides a theoretical possibility of cracking the RSA code, the security of which rests on the assumption, that factoring is hard."

... Wójtowicz: [Wo09], p.330.

The significance of the *evidence-based* argumentation highlighting—and challenging as above—the implicit premises in current paradigms concerning the claimed (as in [AAB19]) quantitative, and qualitative, advantages of quantum computing over classical, Turing-machine based, computing lies in Wójtowicz concluding remarks (see also [Wo19]) that 'the area of quantum computing has a profound impact on our understanding of some classical philosophical and methodological notions' that could impact on 'the status of mathematical knowledge compatible with the advances in QCT':

“Quantum computers could be very powerful—so why there are none of them available? Not going into technical details, quantum registers are extremely fragile. One of the most technical problems is to prevent the surrounding environment from interacting with the qubit registers. In a sense, we have to encapsulate the quantum computer and prevent it from losing the information in the environment (a decoherence, which would destroy the computation). That means, that there are formidable technical problem to be overcome before a quantum computer can be build.³⁶

But in spite of these practical problems, I think that the area of quantum computing has a profound impact on our understanding of some classical philosophical and methodological notions. These issues will be discussed in the subsequent paper. In particular, I will discuss the philosophical impact which this theory has on philosophy of mathematics, and—in particular—I will examine the thesis, that the best explanation of the status of mathematical knowledge compatible with the advances in QCT is offered by the quasi-empiricist stance (which incorporates mathematical knowledge into our “web of belief”, including also scientific knowledge)."

... Wójtowicz: [Wo09], pp.330-331.

24.A.e. A philosophical perspective of quantum computing

In a 2019 continuation [Wo19] of his earlier, more technical, paper [Wo09], Wójtowicz seeks to discuss:

“... the philosophical significance of quantum computation theory for philosophy of mathematics, in particular for the following issues: the nature of mathematical proof; the potential empirical aspects of mathematics and the realism-antirealism debate (in the context of the indispensability argument)."

... Wójtowicz: [Wo19], Introduction, p.173.

where he remarks that:

“The investigations within the paper concern mainly quantum computation, but they apply to the general problem of the relationship between mathematics and physics. I argue, that the possibility of quantum proofs present serious difficulties for the recently much discussed Enhanced Indispensability Argument (EIA) for mathematical realism—and propose a way of solving the emerging problems. In particular, I claim that the best philosophical account is quasi-empiricism in Quine’s manner. The paper therefore gives a support for the realistic account of mathematics."

... Wójtowicz: [Wo19], Introduction, p.173.

Wójtowicz also comments on his intent in [Wo19]:

“One of the motivations for investigating quantum-computational models is the intractability of many computational (combinatorial, number-theoretical, graph-theoretical etc.) problems.¹ An important example of such a intractable problem is factorization, where no quick, (i.e. polynomial) classical algorithm is known—but there is a quick quantum algorithm [Shor, 1994]."

... Wójtowicz: [Wo19], §1. General remarks on quantum algorithms, p.174.

From the *evidence-based* perspective of this investigation, the significance of Wójtowicz’s intent lies in his recurring appeal to the premise that:

- Shor’s algorithm is an instance of a quantum algorithm; and
- the class of problems decidable by quantum algorithms is exactly the class of (Turing) decidable problems;

more so since §22.A.f., Theorem 22.16, argues that factorization is not decidable by a deterministic Turing machine in polynomial time!

For instance, Wójtowicz, notes that:

“A natural set of complex computational problems arises, when we consider simulating the behavior of quantum systems. Usually, the computer simulation of the evolution of a quantum system is impossible because we need exponentially many coefficients even to describe the quantum system in question.² So the computation corresponding to the evolution of the quantum system is extraordinarily complex. But this gives us the possibility to exploit the specific features of the quantum world in order to solve computational problems.

The general idea here is—broadly speaking—to reverse the way we usually conceive the relationship between the physical system and the computer simulation: instead of providing a computer simulation of the physical system, we use the physical system to perform a physical simulation of the (mathematical) computational process.³

So consider a computational problem P which corresponds (in some identifiable way) to the evolution of a quantum system $Q(P)$. In particular—the final state of the evolution of the quantum system $Q(P)$ corresponds to the result of the computation P . In such situations we could exploit the (quick) quantum evolution instead of the (slow) computation to solve the computational problem P . Trivially, such a correspondence obtains, when we start with a quantum system Q , and consider its computer simulation P_Q (then of course $Q(P_Q) = Q$). But this is not the point: the crucial question is, whether there are any MATHEMATICALLY MOTIVATED computational problems P (i.e. problem which arise within ordinary mathematics, and not for the purpose of describing quantum systems) for which such quantum systems $Q(P)$ exist. This is indeed the case—as demonstrated by the famous Shor’s algorithm for factoring numbers.”

... Wójtowicz: [Wo19],§1. General remarks on quantum algorithms, pp.174-175.

Now, an explicit thesis of *evidence-based* argumentation is that we cannot ‘reverse the way we usually conceive the relationship between the physical system and the computer simulation’⁶⁰³, so that ‘instead of providing a computer simulation of the physical system’ (i.e., appealing to *evidence-based* reasoning in the sense of [An16]; see also §7.C.), we use ‘the physical system to perform a physical simulation of the (mathematical) computational process’ (i.e., appeal to *faith-based* reasoning in the sense of §7.B.).

We could thus argue (see also §24.A.g.) that—reflecting inherited mathematical paradigms—Wójtowicz is here, implicitly and unwittingly, conflating a ‘physical system’ with the ‘formal system of first-order Peano Arithmetic PA’.

An unsuspected, putative, conflation which could then allow Wójtowicz to further, curiously, suggest that an ‘algorithm’ can be conceived in some sense as the mathematical ‘counterpart’ of the motion of a ‘system of photons’:

“Quantum algorithms are mathematical counterparts of certain quantum processes (such as for example a system of photons passing through a system of half-silvered mirrors).⁴ They exploit the peculiarities of the quantum world (entanglement and superposition). The class of problems decidable by quantum algorithms is exactly the class of (Turing) decidable problems, so in particular—unsolvable problems remain unsolvable. But—at least in some cases—there can be an enormous increase in computational speed, and this makes them particularly attractive.⁵”

... Wójtowicz: [Wo19],§1. General remarks on quantum algorithms, p.175.

We shall argue, however, that from the *evidence-based* perspective of this investigation, quantum algorithms in Deutsch and Wójtowicz’s sense can be viewed as, essentially, admitting proof assistants during their computation that appeal—not to any physical system, but—only to the formal, first-order, system of Peano Arithmetic PA for validating algorithmically *computable* functions/relations by appeal to equivalent provable formulas of PA as admitted by the Provability Theorem for PA ([An16], Theorem 7.1, p.41; see also §2.E.b., Theorem 2.17):

⁶⁰³See also how this issue is addressed by: §23.D.g., **Query 30**. *What would introducing experimental observations—which implicitly subsume ‘free will’—into a mathematical model entail?*

Provability Theorem for PA: A PA formula $[F(x)]$ is PA-provable if, and only if, $[F(x)]$ is algorithmically *computable* as always true in \mathbb{N} .

especially if, at some points, the computation only requires knowledge that ‘there exists *an* x ’—denoted symbolically by ‘ $\exists x$ ’ (see [Me64], p.45).⁶⁰⁴ for completing a computation rather than knowledge of ‘*the* x ’—denoted symbolically by ‘ ιx ’ (see [Me64], p.85).

An unsuspected, but possibly intuited, putative conflation as above could also account for Wójtcowicz’s reservation:

“However, there are no quantum computers available, because the technical problems to be overcome are formidable (due to the fragility of quantum states, which have to be isolated from their environment, i.e. the external world). It may well be the case, that even the impressive Shor’s factoring algorithm remains just a purely theoretical possibility. There is also a perhaps deeper, conceptual problem: the class of known interesting quantum algorithms is limited. Factorization is not NP-complete, so even if we had a quantum computer available, Shor’s algorithm would not give us a general method of solving NP-complete problems. It far from obvious, that a quantum algorithm for solving NP-complete problems (e.g. SAT) will ever be found.⁶”

... Wójtcowicz: [Wo19],§1. *General remarks on quantum algorithms*, pp.175-176.

Moreover, the appeal of a perspective that would make such a putative conflation natural, and psychologically difficult for philosophy and the natural sciences to resist unyieldingly in a Wittgensteinian sense—given the existing mathematical paradigms that do not insist upon *evidence-based* reasoning (as argued in [An16]; see also §1., Thesis 1)—could then be seen in Wójtcowicz’s remarks that:

“The emergence of (applicable) quantum computers would certainly lead to major changes in science and technology. And even the theoretical possibility inspires us to reconsider philosophical questions concerning the nature of mathematical knowledge, the role of mathematical proofs and the relationships between mathematics and science. We face the question of the relationships between mathematics and the mathematical notion of computation on one hand—and the laws of physics and the “computational resources” of the universe on the other. And even if these considerations have the character of a thought experiment, they can shed new light on fundamental philosophical problems.”

... Wójtcowicz: [Wo19],§1. *General remarks on quantum algorithms*, p.176.

24.A.f. What, precisely, is the role of proof assistants in quantum computing?

Although Wójtcowicz emphasises the critical role of proof assistants in what he terms as ‘quantum assisted proofs’ (QAP), but—in the absence of an *evidence-based* perspective of the complementarity of mathematical proof, mathematical truth, and computability that is entailed by the Complementarity Thesis (§1., Thesis 1) and the Provability Theorem for PA ([An16], Theorem 7.1, p.41; see also §2.E.b., Theorem 2.17)—his concluding remarks in [Wo19] evidence his ambivalence as to from where, precisely, such proof assistants draw the assumed validity of the ‘assistance’ they offer during the course of a computation:

“Quantum computation is a quickly developing area. However, there are no quantum computers, and there are also theoretical limitations to quantum algorithms. It might well happen, that Shor’s factoring algorithm will remain the most spectacular theoretical achievement for a long time—and

⁶⁰⁴We need to note the caveat here that, in *evidence-based* reasoning, the meaning of that which is sought to be represented formally as ‘ ιx ’ and ‘ $\exists x$ ’, by what is denoted symbolically as ‘ ιx ’ and ‘ $\exists x$ ’, need not be the meaning of any subsequent, *well-defined*, interpretation of the formulas ‘ ιx ’ and ‘ $\exists x$ ’ (see, for instance, §15.H.m.).

also that quantum computers of a practical importance will never be built.³⁶ Nevertheless, quantum computation theory is philosophically intriguing, also for philosophy of mathematics.

The possibility of “oracle-like QAPs” poses some difficulties for the pro-realistic EIA. I have argued, that they are best explained within the holistic account, where traditional theorems, computer-assisted theorems, “quantum theorems” etc. are all integrated within one coherent system of knowledge.

There has been an extensive discussion concerning the role of empirical procedures in mathematics [e.g. Baker, 2008]—and the hypothetical QAPs would constitute an important theoretical and philosophical novelty. I hope, that the thought experiment presented here contributes to the discussion concerning the empirical aspects of mathematics and the interplay between physical and mathematical knowledge."

... Wójtowicz: [Wo19], 5. Concluding remarks, pp.189-190.

From the *evidence-based* perspective of this investigation, the value of Wójtowicz’s philosophical analysis of quantum computing—in the following, copious, extracts from [Wo19]—thus lies as much in the putative role that he ascribes to proof assistants in the course of a computation, as in the challenges he describes that face his—what can reasonably be viewed, from an *evidence-based* perspective, as a contrived—attempt to force a ‘quasi-empiricist’ explanation for the putative effectiveness of such proof assistants in quantum computation within an inherited paradigm that appeals to *faith-based* reasoning (as sought to be distinguished in §7.B. and §7.C.):

“The standard scheme of using mathematics as an explanatory tool is (more or less) as follows:

1. We are presented with a physical (biological, chemical etc.) phenomenon S .
2. We learn, that there is a theorem α (of standard mathematics M).
3. We see, that α (including its proof) helps us to explain the phenomenon S .
4. (And—being adherents of EIA—we consider this fact to be an important argument in the discussion).

But what if α is proved via a QAP? A QAP certainly does not offer any understanding or explanation, attributed usually to traditional proofs. The only information we could get from a QAP is the fact, that a sentence α can be demonstrated, and nothing more. An “oracle proof” would not preserve the explanatory virtues of the theorem α , being a part of the mathematical theory. This would weaken the pro-realistic argument (as one of the premises of EIA would lose its fundamentals).

... Wójtowicz: [Wo19], §4.2. “Quantum theorems” as empirical data, p.187.

We note that Wójtowicz’s subsequent argumentation in [Wo19] depends critically upon the—fragile, since lacking any apparent justification—assumption that a QAP *cannot* appeal to an oracle which can access the theorems of the first-order Peano Arithmetic PA, but *must* necessarily appeal to an “oracle proof” that ‘would not preserve the explanatory virtues of the theorem α ’.

For instance, it admits Wójtowicz’s argument that a “quantumly proved theorem” such as α can be ‘believed’ as an *intuitive mathematical truth*, since our ‘system of beliefs (including mathematical beliefs) has to fit the data, and these data include in particular the outcomes of the experiments, including (quantum) computer simulations’:

“To overcome this difficulty, I propose to view these new results (i.e. quantumly demonstrated propositions) not as full-fledged mathematical theorems, but rather as available empirical data, which have to be explained. So they would become rather a part of the *explanandum*, not the *explanans*.

Let M be standard mathematics³¹, and α a QAP-proved theorem. Accepting $M + \alpha$ better fits and explains the empirical data (including the quantum experiment yielding α) than other choices. Even if we refrain from accepting the quantum process as a legitimate mathematical proof, and even if we share the doubts resulting from the “explanatoriness postulate” (on which EIA rests), we are entitled to include α into our system of beliefs. This rests on the fact, that we equipped the physical experiment (performed for example on a system of photons flying around) with a semantics: we interpret the results of the experiment as information about the provability of α .³² Of course, in this case $M + \alpha$ fits the empirical data well, and is a very natural rounding out of our knowledge. But its acceptance does not follow from the fact, that α is mathematically reliable (e.g. completes a theory in a mathematically natural way, fits the mathematical intuitions of the experts etc.), but rather from the fact, that $M + \alpha$ proves to be a good tool in physics.³³

To give a better feeling for this way of viewing “quantumly proved theorems”, consider the case, where the status of a mathematical claim α is unknown (i.e. we have no proof and do not even know, whether it is consistent with M). It might be the case, that $M + \alpha$ suits the purposes of physics (it provides better methods of describing and explaining certain phenomena, it has a better predictive power etc.)—but as we do not know, whether it is consistent, we have an uneasy feeling about it.³⁴ Now, if we prove, that $M + \alpha$ is (relatively) consistent, the methodological obstacle is overcome. But what is the mathematical status of α ? We haven’t proved α (perhaps it is even independent from M , so unprovable). Should we accept α as a new mathematical axiom only because it suits the purposes of physics?

Consider now a different situation, where we use a (relatively) consistent theory $M + \alpha$ in physics, and—later on— α happens to be proved by a QAP. This would give us perhaps an even stronger belief in the consistency of $M + \alpha$ (than just having the “old fashioned” metamathematical proof, e.g. by some exotic forcing or model-theoretic arguments).

Consider the following two situations:

- (i) We know, that $M + \alpha$ is relatively consistent (but do not know, whether α is provable within M)—and it fits the empirical data well.
- (ii) We have a QAP of α .

Is there—from the point of view of the EIA-realist—an important difference between (i) and (ii)? Anyway, we have already decided to make use of $M + \alpha$ as a tool in science, and—being EIA-realists—we included $M + \alpha$ into our system of beliefs (in particular, accepting its ontological commitments). $M + \alpha$ was accepted before the QAP of α , and its provability within M becomes a question of the internal logical structure of $M + \alpha$ —not the question of accepting α .

I claim, that this way of viewing quantumly proved theorems gives a better philosophical explanation of the status of $M + \alpha$ from the point of view of mathematical realism based on the indispensability argument. In particular, it solves the problem of the lack of explanatoriness, which presents a difficulty for the EIA-realist. Our system of beliefs (including mathematical beliefs) has to fit the data, and these data include in particular the outcomes of the experiments, including (quantum) computer simulations. Ultimately—from the point of view of EIA-realism—what matters is the fact, that mathematical sentences gain the status of truths *via* the empirical theory they are part of—not via conceptual, *a priori* insights.³⁵

... Wójtowicz: [Wo19], §4.2. “Quantum theorems” as empirical data, pp.187-189.

However, the *evidence-based* perspective of this investigation demands that *intuitive mathematical truth* (such as that sought to be putatively ascribed to the axioms of a formal mathematical theory) be definable:

- as formal, *evidence-based*, assignments-by-convention under Tarski's definitions of the 'satisfaction', and 'truth', of mathematical formulas under a *well-defined* (i.e., *evidence-based*) interpretation; and
- as distinctly different in nature and substance from the empirical 'truths' putatively ascribed statistically on the basis of our observations to properties exhibited with reliable predictability in physical phenomena that can, subsequently, be expressed/represented in a formal mathematical language;

Prima facie, Wójtowicz's 'quasi-empiricism'—reflecting current mathematical paradigms—seems to—disconcertingly, since without apparent justification—equate the latter with *intuitive mathematical truth*.

If so, such an interpretation of 'quasi-empiricism' would, however, entail that *intuitive mathematical truth* is not only of a statistical nature, but falsifiable!

Given the putative constraints of an inherited *faith-based* mathematical paradigm, the justification for Wójtowicz's attempt to tolerate such a philosophically disquieting perspective into his argumentation can be viewed as lying in his perception that:

- not only is the possibility of quantum computation 'exciting' in itself for the peculiarities it compels us to accommodate, and place in a coherent perspective; but
- that we 'can even imagine, that one of the big mathematical open problems (say, Riemann's hypothesis or Goldbach's conjecture) is proved with the help of a QAP, which would surely be sensational':

"The (theoretical) possibility of quantum computation, and executing quantum assisted proofs (for which I will use the acronym QAP) is very exciting. In order to understand the peculiarities of the possible QAP, let us exhibit its most important features. In general, it would consist of the following steps.

1. The mathematical (conceptual) phase. Consider a computational problem P (e.g. factoring numbers). Our task is to define a quantum system $Q(P)$, which is connected to P in an explicit way—in particular there is a way of identifying the outcome of P from the outcome of $Q(P)$. Here we reverse the usual way of viewing the relationship between real-world situations and computer simulations. Instead of running a computer simulation to find out, what would happen in a physical situation (e.g. whether a bridge would break down), we perform the physical experiment in order to learn, what the outcome of the (perhaps extraordinarily long) computation would be. This problem becomes interesting, when P has a natural mathematical motivation, and arises within a natural mathematical context. In this case, finding a corresponding quantum system $Q(P)$ would allow us to solve P .

2. The experimental phase consists of:

- (a) Preparing the quantum system $Q(P)$ in an appropriate initial state.
- (b) Initiating the quantum process. The crucial feature of this process is that during this computation we cannot in any way interfere with it, as this would destroy the process (so we have to wait patiently for the outcome).
- (c) Performing the final measurement. This means, roughly speaking, that we extract the available information from the quantum system.

The outcome of the experiment with the use of $Q(P)$ yields a solution of the problem P ."

... Wójtowicz: [Wo19], §2. *Quantum-assisted proofs (QAPs)*, pp.176-177.

Wójtowicz's seems to ascribe any unsettling aspects of his philosophical perspective to the 'peculiarities' of executing quantum assisted proofs (QAPs), which may be viewed as resulting from reversing 'the usual way of viewing the relationship between real-world situations and computer simulations'.

According to Wójtowicz's analysis, such a 'peculiarity' would, *prima facie*, be the claim of quantum computing that even if a computational problem ' P has a natural mathematical motivation, and arises within a natural mathematical context', such as 'factoring numbers', finding a corresponding physical representation—quantum system— $Q(P)$ 'would allow us to solve P ' where, even in the absence of 'a computer simulation to find out, what would happen in a physical situation (e.g. whether a bridge would break down), we perform the physical experiment in order to learn, what the outcome of the (perhaps extraordinarily long) computation would be.'

If so, such a claim would—from the *evidence-based* perspective of this investigation—contradict the Provability Theorem for PA ([An16], Theorem 7.1, p.41; see also §2.E.b., Theorem 2.17):

Provability Theorem for PA: A PA formula $[F(x)]$ is PA-provable if, and only if, $[F(x)]$ is algorithmically *computable* as always true in \mathbb{N} .

since it apparently posits that we can have an algorithmic proof of an arithmetical theorem, by appeal to the physical properties of a quantum system (computer), even when the algorithm is not entailed by the formal proof of the theorem.

It also ignores Thoralf Skolem's cautionary remarks (see §7.K.) against inviting paradox⁶⁰⁵ by conflating entailments of formal systems under different interpretations (as evidenced, for instance, in §2.D.), or over different domains.

Moreover, it admits the 'untenable' argument (see §24.A.d.) that 'measurements have a probabilistic nature, so in general we cannot identify the state of the quantum system before the measurement, and the information is lost':

"A natural question follows: measurements have a probabilistic nature, so in general we cannot identify the state of the quantum system before the measurement, and the information is lost.⁷ This is true—but in some cases, it is possible to "extract" enough information from the quantum system. For example, if we knew in advance (i.e. before the measurement), that the qubit could have been only in one of the two basic states, then the measurement would give us complete information. A similar situation can happen with more complicated n -qubit registers: if we know in advance, that they are in one of few possible states, appropriate measurements will enable us to identify it.⁸ This is crucial for quantum algorithms."

... Wójtowicz: [Wo19], §2. *Quantum-assisted proofs (QAPs)*, p.177.

Wójtowicz notes further that, with respect to 'quantum-assisted proofs of some mathematical theorems' the 'outcome might differ from the outcome of the classical computation in one important respect: we would not be able to know which of the theoretically possible computational paths was the successful one':

"Many mathematical problems involve a complex computational part, so a quick computational method might settle some of such problems (as it happens in the case of ordinary computer assisted proofs). In particular, we might get quantum-assisted proofs of some mathematical theorems. The

⁶⁰⁵See, for instance, Goodstein's argument in §19., Theorem 19.1.

outcome might differ from the outcome of the classical computation in one important respect: we would not be able to know which of the theoretically possible computational paths was the successful one. Indeed, there are quantum algorithms, which do not always exhibit CONCRETE solutions, but rather provide some general information about the problem. For example, the quantum algorithm presented in [Harrow et al., 2009] allows to get some information about systems of equations: the algorithm outputs a quantum state with certain properties, and not explicitly the solution.⁹ In order to “extract” the solution from this state we would have to perform a large number of measurements. But sometimes we are interested not in the exact solution, but in some general property of it, which might be established by performing just few measurements.¹⁰

... Wójtowicz: [Wo19], §2. *Quantum-assisted proofs (QAPs)*, pp.177-178.

We note that Wójtowicz is essentially arguing the point made in §24.A.e. that, at some points, a quantum computation may only require *logical* knowledge that ‘there exists *an x*’—denoted symbolically by $\exists x$ (see [Me64], p.45), rather than knowledge of ‘*the x*’—denoted symbolically by ιx (see [Me64], p.85), if ‘we are interested not in the exact solution’, for which ‘we would have to perform a large number of measurements’, but in some general property of it, which might be established by performing just few measurements’.

However, Wójtowicz then seems to implicitly assume—apparently as an ‘axiomatic’ feature of quantum computations—that even if such knowledge yields computation times ‘exponentially quicker [than] classical algorithms’, it is not entailed by *logical* reasoning alone from the mathematical representation of the state of the quantum system being computed, but is the outcome of ‘a kind of “quantum non-constructive existence argument”’ for which we ‘have to rely strongly [on] physical theories in order to treat these procedures as reliable’:

“In some cases, solving a computational problem is an essential part of a proof.¹¹ So we might get a QAP of a possibly important mathematical theorem. The situation becomes philosophically even more interesting, when we consider logical problems in their combinatorial (number-theoretic) formulation/disguise. Formal proofs can be encoded as numbers (via arithmetization of syntax), So—ultimately—the question whether there is a formal proof of a sentence α within a formal theory T becomes a computational problem. Usually this is not a decidable problem (and will not become “quantumly decidable” either¹²), but we can always check, whether a given string σ of symbols is a formal proof of α within T —and we can also check, whether there is a proof of α within a given finite set of strings S). A quick computational procedure would allow us to find answer to questions like: “Is there a proof of α within T of the length bounded by n ?” (T being for example ZFC or PA or RCA_0 or any other formal theory of interest). At least in the case of some open problems, the answer would be positive.¹³ But then, from our point of view, after the process terminates, only a big “YES!” is displayed on the screen Even if it happened only in one single case, i.e. even if one such a quantum demonstration of the existence of a formal proof succeeded only once, the question of the status of such knowledge would become philosophically intriguing.

So, in general we might think of two possible scenarios:

1. A “direct” QAP: i.e. a computation, which solves a computational problem, yielding a proof of a mathematical theorem α .¹⁴
2. A “meta-QAP”: the computation has a direct metamathematical interpretation, yielding a positive answer to the question “Is there a formal proof of α within T of length bounded by n ?”¹⁵

Could either of these processes be considered a proof of α ? We cannot even dream of reading out any details of this proof from the process, as measurements cannot be performed during the computation. In particular, in the “meta-QAP” case we would be confronted with a kind of “quantum non-constructive existence argument”: we only learn, that such a formal proof (of the length $\leq n$) exists—and NOTHING MORE.

Observe the following crucial features of a potential QAP:

1. It is quick (it might even be exponentially quicker than the classical algorithms).
2. We have no insight into the process—we only can perform the final measurement.
3. We have to rely strongly on physical theories in order to treat these procedures as reliable.

We are therefore faced with a situation, where we exploit some physical processes (resources) in order to solve computationally difficult problems. The analyses given here apply to all cases, in which these three conditions are met.¹⁶ In some cases such a computational support can lead to new important results. Indeed, this was exactly the case of computer-assisted proofs (CAPs). The most famous example is probably the proof of the four-color theorem (4CT).¹⁷ Its computer-assisted proof was presented in [Appel and Haken, 1977; Appel et al., 1997]. As the proof required the use of a computer (in its original form, they needed ca. 1200 hours), several methodological, conceptual and philosophical questions concerning the proof and the epistemological status of 4CT arose.¹⁸ The fundamental question is whether this CAP REALLY is a mathematical proof, i.e. whether the four color HYPOTHESIS turned into a mathematical THEOREM.

The problem becomes more intricate in the case of QAP's. We can even imagine, that one of the big mathematical open problems (say, Riemann's hypothesis or Goldbach's conjecture) is proved with the help of a QAP, which would surely be sensational. But even if α is just an ordinary mathematical problem, the philosophical status of α remains to be examined."

... Wójtowicz: [Wo19], §2. *Quantum-assisted proofs (QAPs)*, pp.178-180.

We note that Wójtowicz's remark that we 'are therefore faced with a situation, where we exploit some physical processes (resources) in order to solve computationally difficult problems' implicitly appeals to a putative 'intuitive-empirical' truth that, in turn, would admit a Platonic ontology in any *well-defined* interpretation of formal mathematical systems such as the first-order Peano Arithmetic PA.

However, such a perspective seems fragile, since by the minimalism of Ockham's Razor, the *evidence-based* perspective of this investigation—which views mathematics as, essentially, *evidenced-based* languages (see §12. and §13.)—is arguably shown as sufficient to its intended purpose of serving the minimal needs of philosophy and the natural sciences to:

- first, faithfully represent (in languages such as the first-order set theory ZF), conceptual metaphors corresponding to their observations of physical phenomena; and,
- second, categorically communicate (in languages such as the first-order Peano Arithmetic PA), some of these representations;

without recourse to a Platonic ontology.

Comment 236. We note that, from the *evidence-based* perspective of this investigation:

(a) Any first-order set theory, such as ZF, which includes an axiom of infinity cannot have a *well-defined* (in the sense of §7.F., Definition 26) assignment of 'satisfaction' and 'truth' to its formulas under any *well-defined* Tarskian interpretation, since.

- ZF can admit only algorithmically *computable* terms and provable/unprovable formulas;
- ZF cannot admit a *well-defined* interpretation that admits Platonic elements;
- Assuming that ZF is consistent only entails, by postulated definition, that, for any ZF-formula $[F]$, we cannot have that both of $[F]$ and $[\neg F]$ are ZF-provable;

- Rosser’s argument in [Ro36] entails that ZF is essentially incomplete if it admits Rosser’s Rule C (see §8.G.); in which case, however:
 - we *can* always extend ZF conservatively by further addition of axioms that entail additional terms in ZF which, under any *putative* interpretation of ZF, *could* then be claimed to correspond to only non-finitary, Platonically conceivable, mathematical objects in the putative domain of the interpretation.

(b) On the other hand, PA cannot admit an interpretation that admits non-finitary, Platonically conceived, elements, since:

- PA has a *well-defined* assignment of ‘satisfaction’ and ‘truth’ to PA-formulas under a *well-defined*, finitary, Tarskian interpretation over the domain \mathbb{N} of the natural numbers (by [An16], Theorem 6.7, p.41; see also §2.C., Theorem 2.15);
- Any PA-numeral $[n]$ interprets in a putative domain \mathbb{N} of the natural numbers as the natural number n ;
- Any natural number n in the putative domain \mathbb{N} can, in turn, be interpreted as an abbreviation for a putative heap of, say, n grains of sand:
 - if we assume, not unreasonably, that the grains of sand in a putative expanding universe—such as, say, the one we *actually* inhabit—is not limited by a specified natural number;
- PA is categorical (by [An16], Corollary 7.2, p.41; see also §2.E.b., Corollary 2.18).

Moreover, from such a perspective, the fragility of Wójtowicz’s philosophical perspective—as reflected in his remark that we ‘can even imagine, that one of the big mathematical open problems (say, Riemann’s hypothesis or Goldbach’s conjecture) is proved with the help of a QAP’—is further seen in the *evidence-based* argument that:

- even without quantum computing as it is currently interpreted in [Deu85] and [Wo09], and [Wo19];
- for at least ‘open’ arithmetical problems such as Goldbach’s conjecture and the Collatz conjecture (see §21.G.b.);
- the Halting-decidability Theorem for T (§21.F.b., Corollary 21.4),
 - as distinct from Turing’s Halting Theorem (§21.F.b., Corollary 21.5);
- entails that, by the Forced Halting Theorem (§21.F.b., Theorem 21.3):
 - either the conjecture is *formally provable* in PA,
 - and therefore algorithmically *computable* as true by the Provability Theorem for PA ([An16], Theorem 7.1, p.41; see also §2.E.b., Theorem 2.17);
 - or, if not so, the *decidability* of:
 - whether the conjecture is algorithmically *computable* as *false* under any *well-defined* interpretation of PA,
 - or, if not so, whether the conjecture is neither algorithmically *verifiable* as *true*, nor as *false*, under any *well-defined* interpretation of PA,
 - and therefore *undecidable* on the basis of *evidence-based* reasoning (by Turing’s Halting Theorem, §21.F.b., Corollary 21.5).

- is *decidable* on the basis of *evidence-based* reasoning (by the Halting-decidability Theorem for T , §21.F.b., Corollary 21.4).

The most unsettling philosophical challenge faced by current paradigms of the nature and role that proof assistants play in the course of a quantum computation is that of interpreting the significance of the admission, or denial, of ‘access during the quantum process to the temporary state of the computation’.

As described by Wójtowicz’s—no less challenged from the perspective of §24.A.d.—attempt to place it in a coherent philosophical perspective, the challenge reflects that:

“...The differences between classical computers and quantum computers are much deeper, as we have no access during the quantum process to the temporary state of the computation. A classical computer performs the computations we could also perform. So in principle we could proceed with the proof in the traditional way. We can stop the computation at any stage, examine the temporary state and continue with the process—so in particular, we could analyze fragments of the computation, and reconstruct an ordinary proof (so the computer would serve as heuristic device). We could imagine a group of 1000 mathematicians examining a computer assisted proof, but in the case of QAPs, the situation is radically different. A quantum proof is a kind of black box—as there are no knowable intermediate states: regardless of the size of the quantum circuit, we only have access to the final outcome (through measurement). And quantum phenomena, like entanglement and interference are built into the procedure.

From the epistemological point of view, the “minimal item” is the experiment conceived as a whole. QAPs are not even partially verifiable or acceptable in any way—we have to accept them as certain wholes, as “atomic procedures”. A part (usually a significant part) of the information, which is present during the quantum computation, is definitely lost in the final step and cannot be retrieved in any way. The quantum system does not “remember” which of the computational paths involved (simulated in the experiment) corresponds to the successful proof. In a sense, we are presented with a kind of empirical oracle, which can answer some questions, leading to the acceptance of a sentence α . Maybe it can even answer questions of the kind “Does T formally prove α within n steps?”—but the answers can only be ‘YES’ and ‘NO’ (or perhaps: ‘YES’ and ‘TRY A LARGER n ’)—without giving any hints concerning the structure and general ideas of the proof.²⁰”

... Wójtowicz: [Wo19], §3. Are there empirical proofs?, p.182.

However, as we have argued in §24.A.e., the need for:

‘a kind of empirical oracle, which can answer some questions, leading to the acceptance of a sentence α ’

dissolves if we replace it with:

‘a kind of formal oracle—appealing, for instance, to such as the first-order Peano Arithmetic PA—which can answer some questions, leading to the acceptance of a sentence α .’

24.A.g. Can we treat PA as Deutsch’s and Wójtowicz’s quantum oracle?

In other words, by the Provability Theorem for PA ([An16], Theorem 7.1, p.41; see also §2.E.b., Theorem 2.17), we can now reasonably posit that:

Thesis 26. (Quantum algorithm) *The quantum algorithm appealed to in Deutsch’s quantum computer in [DJ92] is a provable formula of PA.*

Thesis 27. (Quantum oracle) *The quantum oracle appealed to in Deutsch's quantum computer in [DJ92] is the first-order Peano Arithmetic PA.*

Moreover:

- (i) The making, or not making, of a physical measurement/observation in the *actual* universe that we inhabit,
 - which can be treated as corresponding to that which is sought to be represented mathematically as the computation of a *well-defined*, algorithmically *computable*, mathematical function f in a well-defined mathematical model M of U ,
- (ii) by a physical ‘quantum’ computer \mathcal{Q} ,
 - which admits *relatively* random (see §7.G., Definition 27) inputs/outputs,
- (iii) *cannot* influence and/or determine the computational complexity of the *well-defined*, algorithmically *computable*, mathematical function f ,
 - in the well-defined mathematical *model* M of U ,
 - in which \mathcal{Q} is not well-definable (since a *relatively* random output cannot be realised in M);

since the underlying perspective here is that:

- (iv) If U is the universe we inhabit:
 - and T is, say, the Taj Mahal,
 - whilst D is the set of categorical engineering specifications,
 - for building a physical model M of T in which we can perform repeated destructive experiments;
- (v) Then, as observers that exist in U :
 - whilst we can talk categorically about the properties of T representable in M ;
 - we can only conjecture/postulate;
 - * on the basis of statistical correlations,
 - * between what we observe in U ,
 - * and what we measure in M ;
 - to what extent M is a representative model;
 - * not of T ;
 - * but of *that* part of T ;
 - which we can observe in U ;
 - and well-define in D ;
 - without destroying T .

- (vi) We cannot, however, claim that any unpredictable structural change in T instantaneously causes a corresponding structural change in M !

This reflects the *evidence-based* perspective⁶⁰⁶ of this investigation which, we iterate, is that:

- (a) *choosing to measure* the system S —at the step in Wójtowicz’s argument denoted by §24.A.d.(iii)—simply means that we have appealed to the oracle to transform our *ignorance* of the algorithmically *computable* state of the system at that point to *knowledge* of the state that is already known/available to the oracle (and, in principle, to us, since the state is assumed algorithmically *computable*), as we *need* this knowledge for completing the desired computation;
- (b) *choosing not to measure* the system S —at the step in Wójtowicz’s argument denoted by §24.A.d.(vi)—simply means that we have *not* appealed to the oracle to transform our *ignorance* of the algorithmically *computable* state of the system at that point to *knowledge* of the state that is already known/available to the oracle (and, in principle, to us, since the state is assumed algorithmically *computable*), as we *do not need* this knowledge for completing the desired computation;

From a logical perspective, the difference here is between *choosing to compute/determine/know ‘the x ’*—denoted symbolically by ‘ ιx ’ (see [Me64], p.85)—and *choosing to compute/determine/know only that ‘there exists an x ’*—denoted symbolically by ‘ $\exists x$ ’ (see [Me64], p.45).⁶⁰⁷

Obviously, any computation that only requires knowledge of the latter for completing a computation *could* be significantly faster than one where we, unnecessarily, compute the former.

For instance, determining that a specified integer n has more than one prime factor (primality) *can*—depending upon the specification—be done deterministically in polynomial time $O(\log_e n)$ (see §22.A.e., Corollary 22.15); whilst, by the argument of §22.A.f., Theorem 22.16, determining a prime factor of n (factorisation) *cannot* be done deterministically in polynomial time $O(\log_e n)$.

Moreover, use of a *physical* (circuit) operator $\sqrt{\text{NOT}}$ *physically* for transforming the *physical* state of a system S is not essential to quantum computation per se, but is only needed where the algorithmically *computable* state, whose knowledge the oracle is called upon to furnish, appeals to the formal representation of the *physical* $\sqrt{\text{NOT}}$ operation in the language of algorithmically *computable* functions.

⁶⁰⁶See also how this addresses the issues raised by: §23.D.g., **Query 30**. *What would introducing experimental observations—which implicitly subsume ‘free will’—into a mathematical model entail?*

⁶⁰⁷We note that in *evidence-based* reasoning, the meaning of that which is sought to be represented formally as ‘ $[\iota x]$ ’ and ‘ $[\exists x]$ ’ by what is denoted symbolically as ‘ ιx ’ and ‘ $\exists x$ ’ need not be the meaning of any subsequent, *well-defined*, interpretation of the formulas ‘ $[\iota x]$ ’ and ‘ $[\exists x]$ ’ (see, for instance, §15.H.m.).

CHAPTER 24. PARADIGM CHALLENGING CONSEQUENCES

25. The significance of *evidence-based* reasoning for TSP

We describe a *minimal*—albeit yet exponential-time—solution for the Travelling Salesman Problem (TSP) by identifying Optimal Focal Nodes which require less node-linked resources for linking to an existing network of focal nodes than other focal nodes that are not already linked to the network.

25.A. Overview: The problem of scheduling homing routes optimally

We consider the problem of scheduling homing routes optimally in administrative, judicial, political, medical, commercial, industrial, military, scientific and recreational applications

Definition 56. *A homing route is any route that links to each of the focal nodes in a network of focal nodes.*

As an instance of the possible application of the Optimal Focal Node method *OFN*, we consider the gamut of well-known problems—generically referred to as the ‘Travelling Salesman Problem’—involved in scheduling homing routes⁶⁰⁸ so as to optimise resource requirement in administrative, judicial, political, medical, commercial, industrial, military, scientific and recreational applications, all of which can be represented graphically as a set of $n \geq 2$ focal nodes in a k -dimensional space.

In such cases the available resources for n focal nodes generally consist of a data set D_n of k parameters. These parameters together completely determine the requirement of resources for linking any two focal nodes.

We consider the case where the sum of the resources consumed in linking any focal node X_m to any other focal node X_n can be represented by the Euclidean ‘distance’ metric between the co-ordinates $(x_{(m, 1)}, x_{(m, 2)}, \dots, x_{(m, k)})$ and $(x_{(n, 1)}, x_{(n, 2)}, \dots, x_{(n, k)})$ of the two focal nodes respectively in the k -dimensional space.

The common challenge in such cases is to represent an optimal homing route graphically by a k -dimensional simple closed curve $\vec{R}_{n_{min}}$ that links each of the focal nodes at minimal use of available resources⁶⁰⁹.

Clearly, given $n \geq 2$ and D_n , we can always determine by brute force an optimal homing route by first computing and then comparing all possible homing routes. Such brute force determination would obviously take exponential time since, for any given n , there can be $(n - 1)!$ possible homing routes covering each focal node once, starting from any given focal node.

We now describe an Optimal Focal Node method *OFN* showing how, given n and D_n , we can always build up an optimal homing route $\vec{R}_{n_{min}}$ inductively from a given starting focal node by first identifying, and then linking into an existing optimal homing route, only one Optimal Focal Node each time that is not already in the existing optimal homing route under construction.

⁶⁰⁸We note that any, or even each, of the focal nodes in any such route can also be a network of subsidiary nodes to which our Optimal Focal Node *OFN* method of determining an optimal homing route can be applied independently of, and without influencing, the determination of an optimal homing route for the main network under consideration.

⁶⁰⁹cf. [ABCC].

In other words, the *OFN* method identifies a focal node which requires less resources for linking to an existing route than any other focal node that is not already in the route.

Since the *OFN* method proceeds linearly from one optimal homing route to the next, the determination is accomplished in polynomial (rather than exponential) time of the order $O(n^3)$. This offers a considerable savings in both the scheduling costs, as also the operational costs since the entire operation is now scheduled optimally and conducted optimally at each Optimal Focal Node.

Such a definition of an Optimal Focal Node relative to an existing optimal homing route allows us to construct an optimal homing route that requires less node-linked resources than any other method discovered so far since it is mathematically the unique—and hitherto unsolved—solution to the Travelling Salesman Problem (and, ipso facto, its formal avatar, the *PvNP* problem⁶¹⁰).

This differentiates the *OFN* method from any other known method of constructing an optimal homing route heuristically, all of which can only claim to construct an optimal homing route that has a probability less than 100% of being an optimal solution to the Travelling Salesman Problem.

Without any loss of generality—and for ease of expression—we shall describe and illustrate the *OFN* method for cases with two parameters that can be represented on a plane by the usual co-ordinate notation (x, y) .

We note that determining the optimal homing route for two and three nodes is trivial since every homing route in these cases is unique and therefore optimal.

25.A.a. Overview: An Optimal Focal Node method for scheduling homing routes

Scheduling optimal homing routes for 7 focal nodes under the standard Euclidean metric

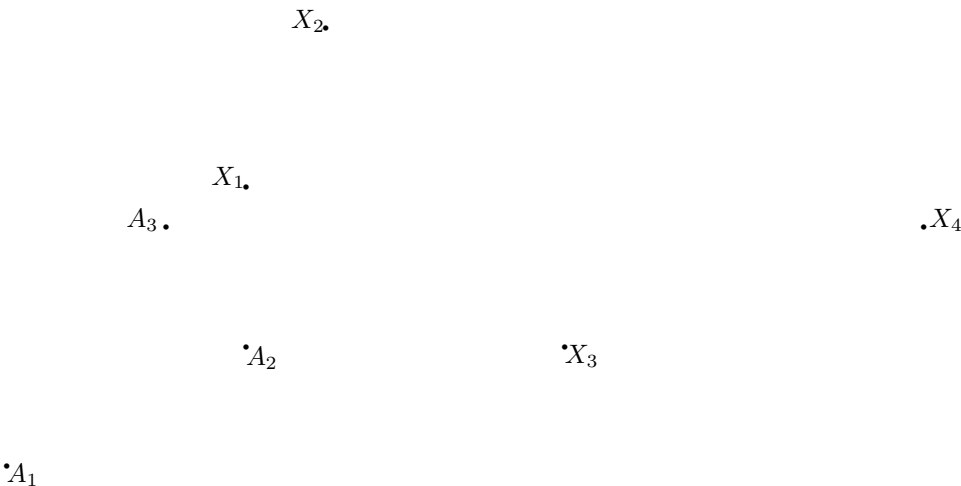

Ex. 1: $P_{(3)} = \{(a_1, b_1), (a_2, b_2), (a_3, b_3)\}$; $Q_{(4)} = \{(x_1, y_1), (x_2, y_2), (x_3, y_3), (x_4, y_4)\}$

1. Let $P_n = \{(a_1, b_1), (a_2, b_2), \dots, (a_n, b_n)\}$ be the co-ordinates of a set $\{A_1, A_2, \dots, A_n\}$ of $n \geq 2$ focal nodes on a plane.
2. Let $Q_r = \{(x_1, y_1), (x_2, y_2), \dots, (x_r, y_r)\}$ be a set $\{X_1, X_2, \dots, X_r\}$ of r focal nodes

⁶¹⁰For an independent solution to the *PvNP* problem see §22.A.f., Theorem 22.16; cf. also [Cook] for the standard formulation of the *PvNP* problem, and [Frt09] for a 2009 update on the status of the problem.

not in P_n .

3. Let $\vec{R}_{n_{min}} = \{(c_1, d_1) \rightarrow (c_2, d_2) \rightarrow \dots \rightarrow (c_m, d_m) \rightarrow (c_1, d_1)\}$ be an optimal homing route for covering P_n where, for any given $1 \leq i \leq m$ there is some $1 \leq j \leq n$ such that $c_i = a_j$ and $d_i = b_j$.

4. We note that such an optimal homing route exists trivially and uniquely for $n = 2$ ($\{A_1 \rightarrow A_2 \rightarrow A_1\}$ in Ex. 2) and for $n = 3$ ($\{A_1 \rightarrow A_2 \rightarrow A_3 \rightarrow A_1\}$ in Ex. 3), and always exists for $n > 3$.

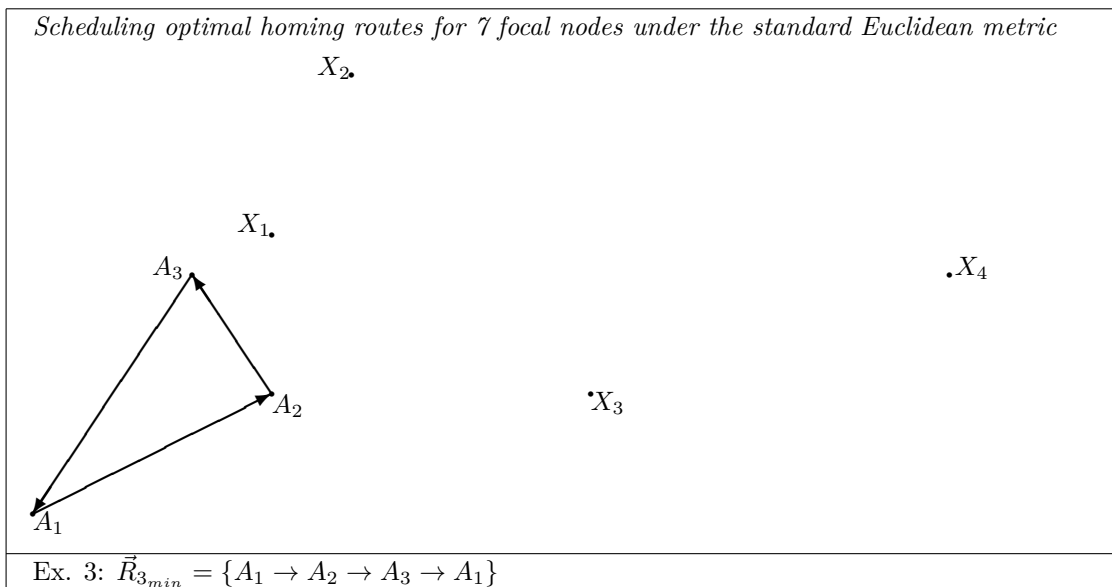
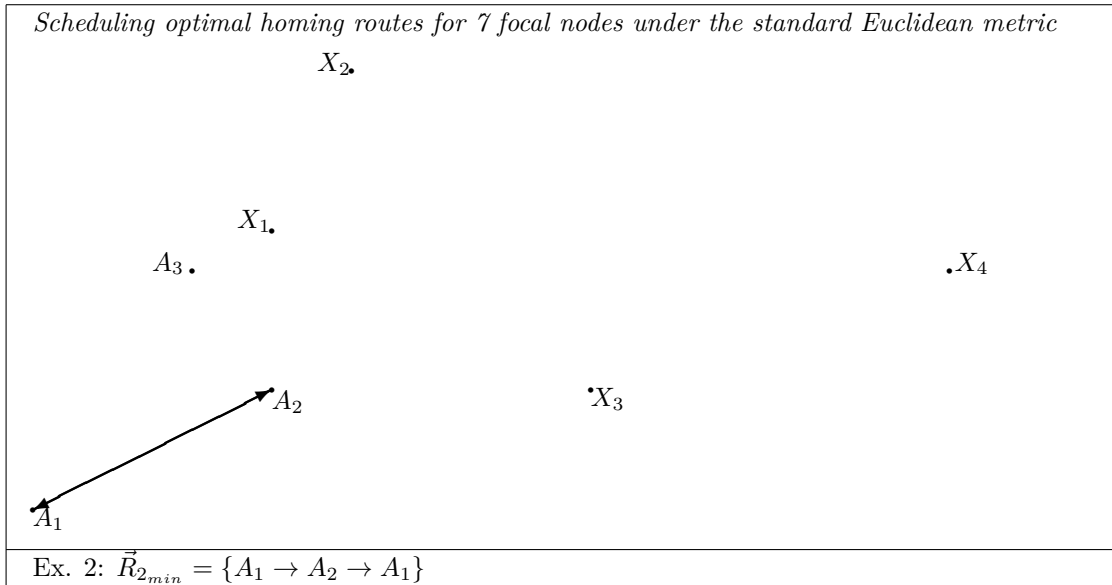

5. The uniqueness of the *OFN* method lies in identifying, as an Optimal Focal Node with respect to P_n , any focal node $A_{(m+1)} = (x_z, y_z)$ in Q_r that satisfies the following.

- (i) For any $1 \leq u \leq r, 1 \leq i \leq m$ let $d_{(u, i)}$ be the distance between the focal nodes (x_u, y_u) and (c_i, d_i) , and e_i be the distance between the focal nodes (c_i, d_i) and

$(c_{(i+1)}, d_{(i+1)})$.

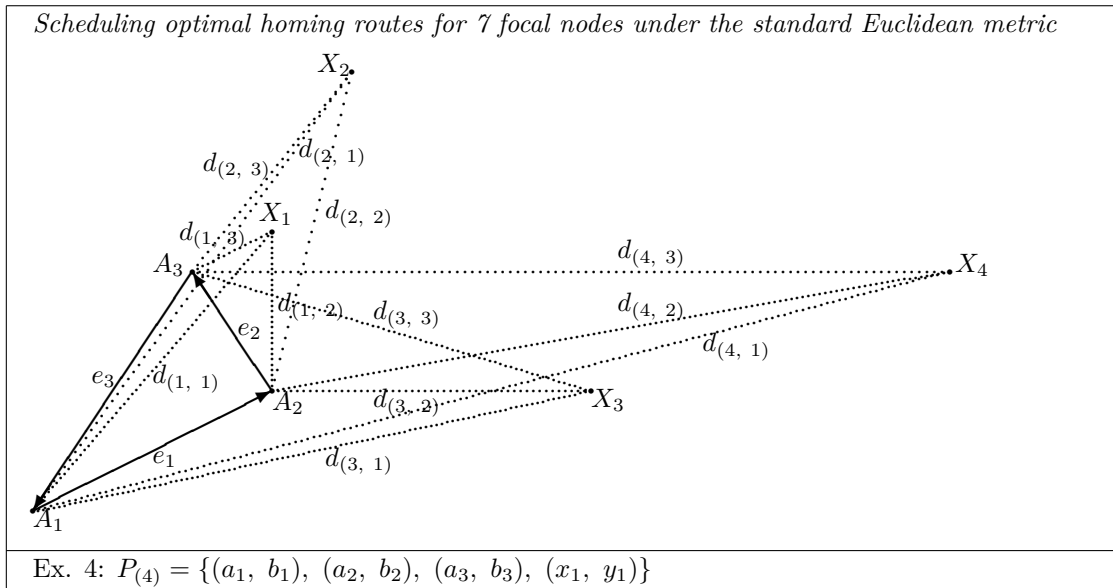

(ii) Let $(d_{(u, k_u)} + d_{(u, (k_u+1))} - e_{k_u})$ be a minimum of the set $\{1 \leq i \leq m : (d_{(u, i)} + d_{(u, (i+1))} - e_i)\}$ for some $i = k_u$.

We note that there may be more than one such minima. We further note that determining such a minima involves n computations and one sort.

The significance of this minima is that it is the minimum ‘length’ added to $\vec{R}_{n_{min}} = \{(c_1, d_1) \rightarrow (c_2, d_2) \rightarrow \dots \rightarrow (c_m, d_m) \rightarrow (c_1, d_1)\}$ by the addition of the focal node (x_u, y_u) to the configuration P_n .

(iii) Let $(d_{(z, k_z)} + d_{(z, (k_z+1))} - e_{k_z})$ be a minimum of the set $\{1 \leq u \leq r : (d_{(u, k_u)} + d_{(u, (k_u+1))} - e_{k_u})\}$ for some $u = z$.

We note that there may be more than one such minima. We further note that determining such a minima involves $n \times r$ computations and one sort.

The significance of this minima is that, of all the focal nodes considered in (ii) above, the focal node (x_z, y_z) adds the minimum ‘length’ to $\vec{R}_{n_{min}} = \{(c_1, d_1) \rightarrow (c_2, d_2) \rightarrow \dots \rightarrow (c_m, d_m) \rightarrow (c_1, d_1)\}$ when added to the configuration P_n .

6. The *OFN* method now identifies (x_z, y_z) as an Optimal Focal Node with respect to P_n . Adding (x_z, y_z) to $P_n = \{(a_1, b_1), (a_2, b_2), \dots, (a_n, b_n)\}$ yields the next configuration $P_{(n+1)} = \{(a_1, b_1), (a_2, b_2), \dots, (a_n, b_n), (a_{(n+1)}, b_{(n+1)})\}$.

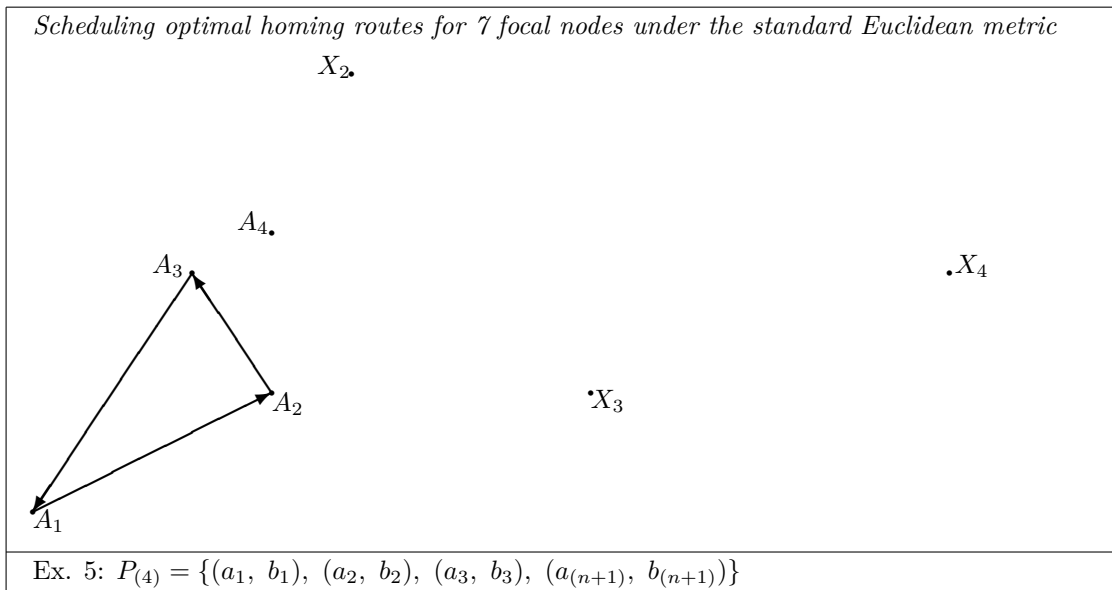

7. By virtue of the minimal definitions 5(i) to 5(iii) above, $\vec{R}_{(n+1)min} = \{(c_1, d_1) \rightarrow (c_2, d_2) \rightarrow \dots \rightarrow (c_{k_z}, d_{k_z}) \rightarrow (a_{(n+1)}, b_{(n+1)}) \rightarrow (c_{(k_z+1)}, d_{(k_z+1)}) \rightarrow \dots \rightarrow (c_m, d_m) \rightarrow (c_1, d_1)\}$ is now an optimal homing route of $P_{(n+1)}$.

8. The total *additional* computations required for determining the revised optimal homing route $\vec{R}_{(n+1)min}$ are thus:

(i) ${}^{(n+1)}C_2 = n(n + 1)/2$ for determining the set of Euclidean distances between any two of the $(n + 1)$ focal nodes in $P_{(n+1)}$, which is of the order $O(n^2)$.

(ii) $\sum_{i=1}^n (i \times (n + 1 - i)) = n(n + 1)(n + 2)/6$ for determining n Optimal Focal Nodes in $P_{(n+1)}$, which is of the order $O(n^3)$.

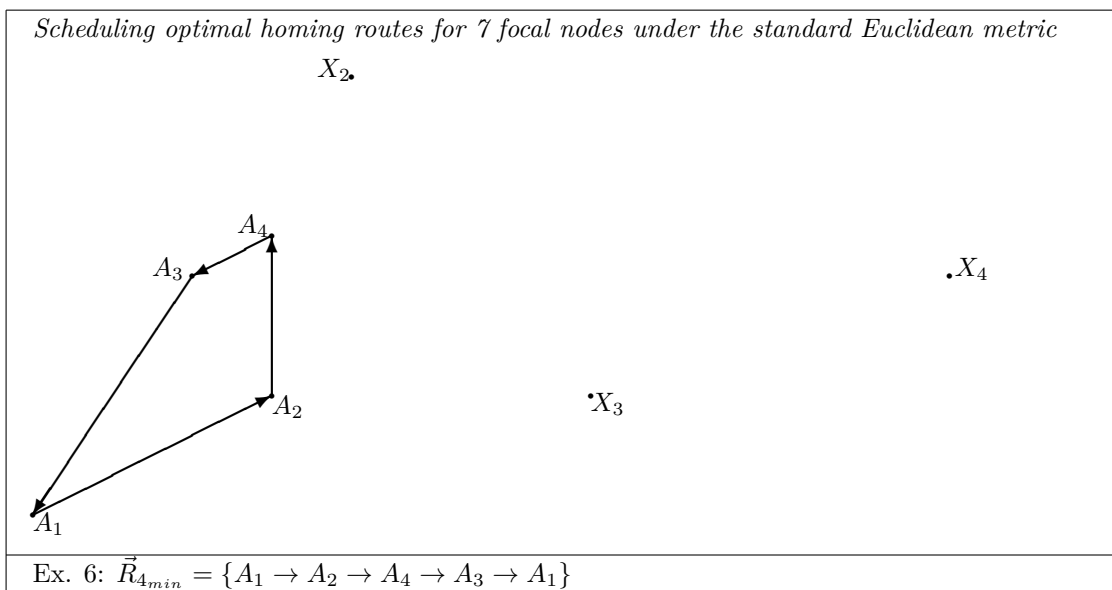

9. For example, in the case of the configuration $P_3 + Q_4$ above, the above method yields the

optimal homing route $\vec{R}_{(7)_{min}}$ for seven focal nodes in Ex.8 below in fifty six computations for determining Optimal Focal Nodes:

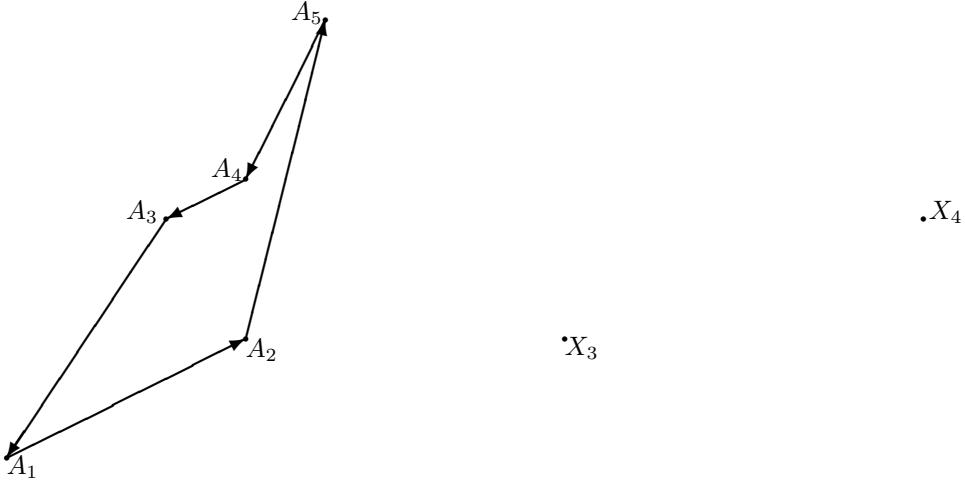
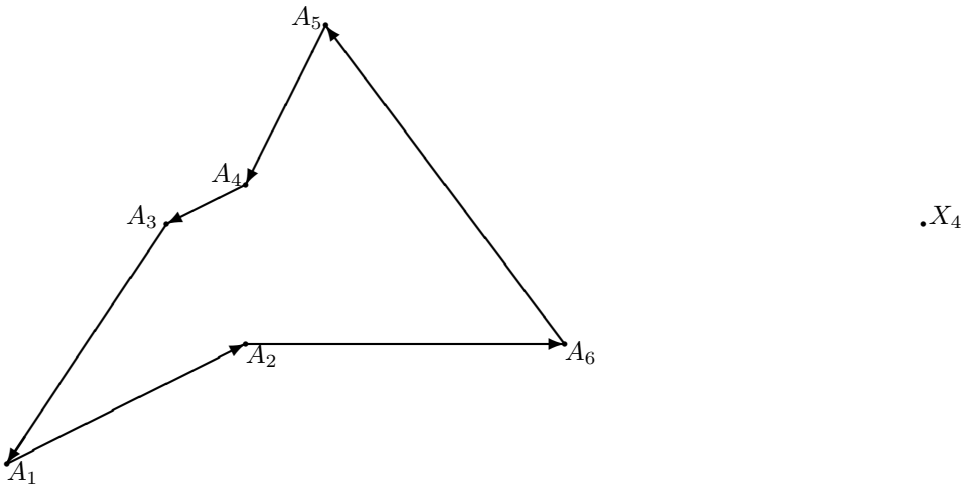
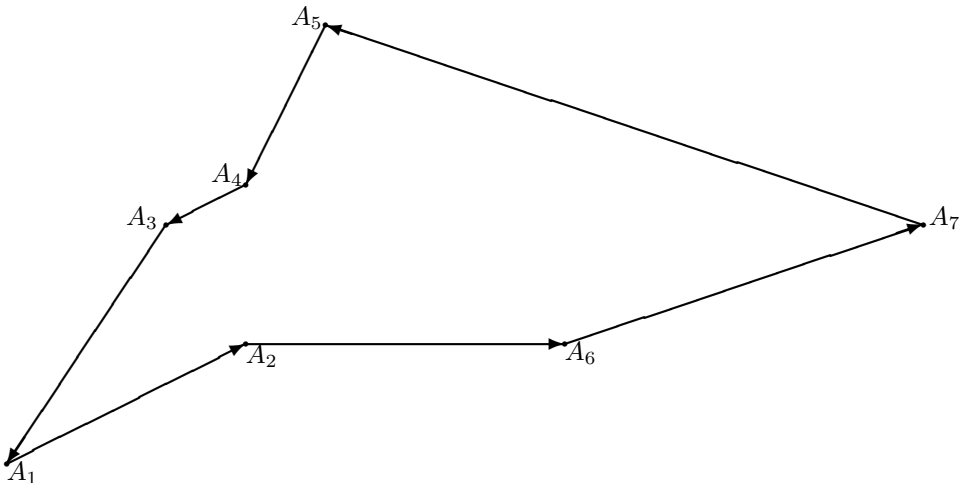
<p style="text-align: center;"><i>Scheduling optimal homing routes for 7 focal nodes under the standard Euclidean metric</i></p> 
<p>Ex. 7: $\vec{R}_{5_{min}} = \{A_1 \rightarrow A_2 \rightarrow A_5 \rightarrow A_4 \rightarrow A_3 \rightarrow A_1\}$</p>
<p style="text-align: center;"><i>Scheduling optimal homing routes for 7 focal nodes under the standard Euclidean metric</i></p> 
<p>Ex. 8: $\vec{R}_{6_{min}} = \{A_1 \rightarrow A_2 \rightarrow A_6 \rightarrow A_5 \rightarrow A_4 \rightarrow A_3 \rightarrow A_1\}$</p>
<p style="text-align: center;"><i>Scheduling optimal homing routes for 7 focal nodes under the standard Euclidean metric</i></p> 
<p>Ex. 9: $\vec{R}_{7_{min}} = \{A_1 \rightarrow A_2 \rightarrow A_6 \rightarrow A_7 \rightarrow A_5 \rightarrow A_4 \rightarrow A_3 \rightarrow A_1\}$</p>

10. We conjecture that, by induction, all optimal homing routes such as $\vec{R}_{(n+1)min}$ for the configuration $P_{(n+1)}$ are of equal length since:

(i) The optimal homing route \vec{R}_{3min} is a simple closed curve in which each focal node of the configuration P_3 occurs only once. If the optimal homing route \vec{R}_{nmin} is a simple closed curve in which each focal node of the configuration P_n occurs only once then, by the construction in §6 and §7 above, the optimal homing route $\vec{R}_{(n+1)min}$ for the configuration $P_{(n+1)}$ is a simple closed curve in which each focal node of $P_{(n+1)}$ occurs only once (whence we necessarily have $m = n$ in the representation of the optimal homing route \vec{R}_{nmin} in §3 above).

(ii) By definition, choice of a particular minima in §5(ii) and §5(iii) above for addition of a focal node to the configuration P_n for obtaining the configuration $P_{(n+1)}$ does not affect the length of the consequent optimal homing route $\vec{R}_{(n+1)min}$ for the configuration $P_{(n+1)}$.

25.B. The formal argument

Definition 57. *The Travelling Salesman Problem (TSP) asks whether, given a population P_n of cities C_1, C_2, \dots, C_n and the distances $d_{i,j}$ between each pair of cities C_i, C_j , what is the shortest possible route that visits each city exactly once and returns to the origin city?*

Definition 58. *A Hamiltonian Cycle is any route that links a given starting Node C to each of the Focal Nodes in a given network of Focal Nodes and returns to the starting Node.*

Definition 59. *A Minimal Resource Configuration MRC_C is any Resource Configuration that consumes Node-dependent minimal resources in linking a given starting Node C to each of the Focal Nodes in a given network of Focal Nodes and returning to the starting Node.*

Definition 60. *An absolute Minimal Resource Configuration AMRC is any minimum of all possible MRCs for a given network of Focal Nodes.*

Definition 61. *A Minimal Resource Configuration MRC is a Hamiltonian Cycle if, and only if, the resources required to link any two nodes in the MRC are finite.*

The formal argument relates to an Optimal Focal Node OFN method of practically and economically computing Minimal Resource Configurations for any given population P_n of n Focal Nodes and associated Node-linked resources, and verifying whether they correspond to Hamiltonian cycles for P_n , by identifying those Focal Nodes which require less Node-dependent resources for linking to an existing group of linked Focal Nodes as compared to any other Focal Nodes that are not already in the group; where we assume that any two Nodes are capable of being linked at some resource cost (which may be infinite—denoted by ∞ —where we axiomatically postulate for any numerals m, n the formal arithmetical rules that $\infty + \infty > \infty > n > -\infty > -\infty - \infty$ and $\infty + n = \infty + m$ if, and only if, $n = m$ ⁶¹¹).

⁶¹¹We note that any Turing Machine can be programmed to treat ∞ as a letter of its alphabet and to follow any such formal arithmetical rules—when well-defined axiomatically—during a computation.

Prima facie, this is a method for practically and economically computing for large populations P_n a Minimal Resource Configuration, and verifying whether it corresponds to a Hamiltonian cycle for P_n , in a computational time that is polynomial of the order $O(n^3)$.

Such solutions have many applications in administrative, judicial, political, medical, commercial, industrial, military, scientific, social and recreational areas, where the challenge is that of assessing the minimum resource requirements of a given population P_n in a practically and economically efficient manner.

Hitherto solutions to this challenge not only do not address the question of whether a computed Minimal Resource Configuration corresponds to a Hamiltonian cycle exists for the concerned population, but are further:

- (a) either not practically efficient for large populations P_n since they can only determine a practically viable Minimal Resource Configuration in computational time that is exponential—i.e., of the order $O(\text{constant}^n)$ —with respect to the size n of the population P_n ;
- (b) or not economically efficient for large populations P_n since they can only estimate, and not guarantee, a practically viable Minimal Resource Configuration that is polynomial in computational time —i.e., of the order $O(n^{\text{constant}})$ —with respect to the size n of the population P_n .

The present method computes for any given population P_n the existence of a Node-dependent Minimal Resource Configuration and verifies whether it could correspond to a Hamiltonian cycle in computational time that is polynomial—i.e., of the order $O(n^3)$ —with respect to the size n of the population P_n .

25.B.a. Population

The population P_n consists of n Focal Nodes C_1, C_2, \dots, C_n , each associated with k independent parameters.

The value of each parameter references a resource pool which determines the resources required by, or available to, the Focal Node for linking to another Focal Node of P_n .

These values are represented in a k -dimensional space as the co-ordinates corresponding to the point that represents the Focal Node as below:

$$\begin{aligned} C_1 &\equiv (x_{11}, x_{12}, \dots, x_{1k}) \\ C_2 &\equiv (x_{21}, x_{22}, \dots, x_{2k}) \\ &\dots \\ C_n &\equiv (x_{n1}, x_{n2}, \dots, x_{nk}) \end{aligned}$$

$$\left[\begin{array}{l} C_1 \equiv (0, 0) \\ C_2 \equiv (90, 45) \\ C_3 \equiv (60, 90) \\ C_4 \equiv (90, 105) \\ C_5 \equiv (120, 165) \\ C_6 \equiv (210, 39) \\ C_7 \equiv (345, 90) \end{array} \right]$$

Fig 1: 2-dimensional co-ordinate representation of resources: Population P_7 .

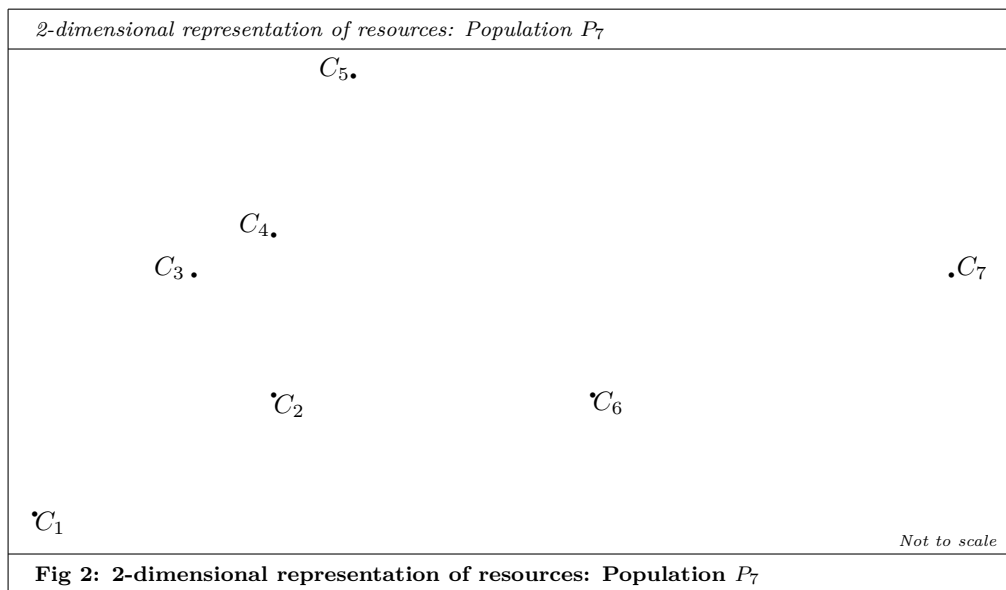

25.B.b. Resource requirements for linking two Nodes

In our Optimal Focal Node method a resource parameter x_{ij} may be static (constant for any linkage) or dynamic (with a provisional value initially, and a final value determined only at the time of linking of the Focal Node C_i to another Node C_j).

If the representing space is Euclidean, the resources r_{ij} required for linking the Focal Node C_i to the Focal Node C_j respectively is represented in terms of the Euclidean length metric d_{ij} and a local multiplier δ_{ij} (which may be infinite—denoted by ∞ —where we axiomatically postulate for any numerals m, n the formal arithmetical rules that $\infty + \infty > \infty > n > -\infty > -\infty - \infty$ and $\infty + n = \infty + m$ if, and only if, $n = m$ ⁶¹²), where:

$$d_{ij} = \sqrt{(x_{i1} - x_{j1})^2 + (x_{i2} - x_{j2})^2 + \dots + (x_{ik} - x_{jk})^2}$$

Fig 3: Euclidean length metric linking C_i to C_j in k -dimensional space

and:

$$r_{ij} = \delta_{ij} \sqrt{(x_{i1} - x_{j1})^2 + (x_{i2} - x_{j2})^2 + \dots + (x_{ik} - x_{jk})^2}$$

Fig 4: Resource required for linking C_i to C_j

The Optimal Focal Node method allows for the contingency that the requirement of resources for linking may be directional, and so we may have that $r_{ij} \neq r_{ji}$ if $\delta_{ij} \neq \delta_{ji}$.

Moreover, the Optimum Focal Node method does not require the representation to be limited to a Euclidean space. It only requires that representation be possible in a space in which some unique distance metric d_{ij} corresponding to the resource r_{ij} can be defined.

25.B.c. The Data Set D_n

We illustrate the Optimal Focal Node method by considering first the case where the Population P_n is represented by a 2-dimensional representation, $\delta_{ij} = \delta_{ji} = 1$ for all $1 \leq i, j, \leq n$, and the

⁶¹²We note that any Turing Machine can be programmed to treat ∞ as a letter of its alphabet and to follow any such formal arithmetical rules—when well-defined axiomatically—during a computation.

Data Set D_n that determines the ‘locations’ of the Focal Nodes and their associated resource parameters in the representation space is expressible as an $n \times n$ matrix:

	C_1	C_2	...	C_n
C_1	r_{11}	r_{12}	...	r_{1n}
C_2	r_{21}	r_{22}	...	r_{2n}
...
C_n	r_{n1}	r_{n2}	...	r_{nn}

Fig 5: The Data Set D_n for a 2-dimensional representation of the Population P_n .

(The corresponding Data Set in a k -dimensional space would be expressible as a k -dimensional $n \times n \times \dots \times n$ matrix.)

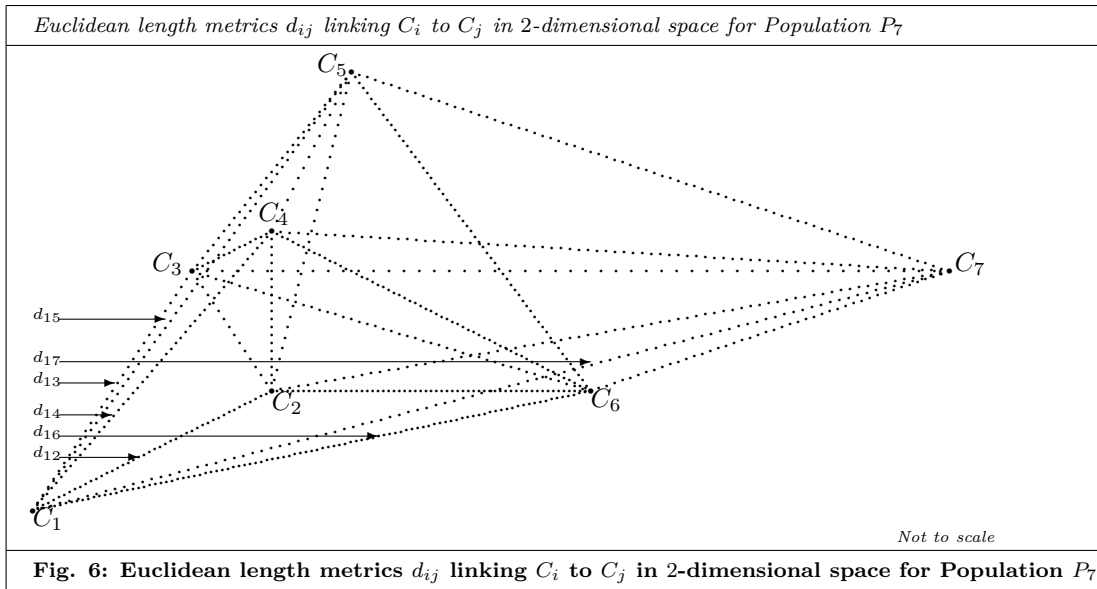

	C_1	C_2	C_3	C_4	C_5	C_6	C_7
C_1	$d_{11} = 0$	$d_{12} = 101$	$d_{13} = 108$	$d_{14} = 138$	$d_{15} = 204$	$d_{16} = 215$	$d_{17} = 357$
C_2	$d_{21} = 101$	$d_{22} = 0$	$d_{23} = 54$	$d_{24} = 60$	$d_{25} = 124$	$d_{26} = 120$	$d_{27} = 259$
C_3	$d_{31} = 108$	$d_{32} = 54$	$d_{33} = 0$	$d_{34} = 34$	$d_{35} = 96$	$d_{36} = 157$	$d_{37} = 285$
C_4	$d_{41} = 138$	$d_{42} = 60$	$d_{43} = 34$	$d_{44} = 0$	$d_{45} = 67$	$d_{46} = 134$	$d_{47} = 255$
C_5	$d_{51} = 204$	$d_{52} = 124$	$d_{53} = 96$	$d_{54} = 67$	$d_{55} = 0$	$d_{56} = 150$	$d_{57} = 237$
C_6	$d_{61} = 215$	$d_{62} = 120$	$d_{63} = 157$	$d_{64} = 134$	$d_{65} = 150$	$d_{66} = 0$	$d_{67} = 142$
C_7	$d_{71} = 357$	$d_{72} = 259$	$d_{73} = 285$	$d_{74} = 255$	$d_{75} = 237$	$d_{76} = 142$	$d_{77} = 0$

Fig 7: Lengths d_{ij} linking C_i to C_j in 2-dimensional space for Population P_7 .

25.B.d. Identifying Minimal Resource Configurations $MRC_{C_a} \vec{R}_{n_{min}}$ and $MRC_P \vec{R}_{n_{min}}$

The Optimal Focal Node method is designed to identify:

- (i) The existence of a Minimal Resource Configuration, $MRC_{C_a} \vec{R}_{n_{min}}$ (see Definition 59), with respect to an Initial Focal Node C_a that links all the n Focal Nodes in the configuration $P_{C_a,n}$ with linear segments in computational time of the order $O(n^3)$; and

- (ii) The existence of an absolute Minimal Resource Configuration, $\text{AMRC}_P \vec{R}_{n_{min}}$ (see Definition 60)—defined as the minimum of all the n Minimal Resource Configurations, $\text{MRC}_{C_a} \vec{R}_{n_{min}}$ —with respect to the population P_n that links all the n Focal Nodes of P_n with linear segments in computational time of the order $O(n^4)$.

25.B.e. Identifying $\text{MRC}_{C_a} \vec{R}_{2_{min}}$ for two Nodes

We begin by identifying a Minimal Resource Configuration, $\text{MRC}_{C_a} \vec{R}_{2_{min}}$, that requires the least resources to link two of the n Focal Nodes of P_n starting with the Initial Focal Node C_a .

We determine a minimal value of r_{aj} in the Data Set D_n , where $1 \leq j \leq n, j \neq a$.

Time Complexity for identifying a minimal value of r_{aj} : Identifying a minimal value of r_{aj} requires $O(n^2)$ computations in a 2-dimensional representation, and $O(n^k)$ computations in a k -dimensional representation.

If r_{aj} is a minimum for $j = b$, we then redesignate the Focal Node C_a as T_{2_1} relatively—in relation to the $\text{MRC}_{C_a} \vec{R}_{2_{min}}$ —and similarly redesignate the Focal Node C_b relatively as T_{2_2} .

$$\begin{aligned} T_{2_1} &= C_a \\ T_{2_2} &= C_b. \end{aligned}$$

Fig 8: Redesignating the Focal Nodes for $\text{MRC}_{C_a} \vec{R}_{2_{min}} = T_{2_1} \rightarrow T_{2_2} \rightarrow T_{2_1}$.

We then identify a MRC_{C_a} for a group of two Focal Nodes of the population P_n as the directed graph:

$$\vec{R}_{2_{min}} = T_{2_1} \rightarrow T_{2_2} \rightarrow T_{2_1}.$$

We further redesignate the route vectors relatively—in relation to the $\text{MRC}_{C_a} \vec{R}_{2_{min}}$ —as follows:

$$\begin{aligned} e_{2_{12}} &= d_{ab} \\ e_{2_{21}} &= d_{ba}. \end{aligned}$$

Fig 9: Redesignating the route vectors for $\text{MRC}_{C_a} \vec{R}_{2_{min}} = T_{2_1} \rightarrow T_{2_2} \rightarrow T_{2_1}$.

We can thus also express (with relation to the $\text{MRC}_{C_a} \vec{R}_{2_{min}}$):

$$\vec{R}_{2_{min}} = e_{2_{12}} + e_{2_{21}}.$$

Time Complexity for identifying $\vec{R}_{2_{min}}$: Identifying $\vec{R}_{2_{min}}$ requires $O(n^2)$ computations in a 2-dimensional representation, and $O(n^k)$ computations in a k -dimensional representation.

For the Population P_7 in Fig 1 and Fig 2 we have r_{ij} is a minimum for $i = 3, j = 4$ (see Fig 10):

	C_1	C_2	C_3	C_4	C_5	C_6	C_7	min
C_1		$r_{12} = 101$	$r_{13} = 108$	$r_{14} = 138$	$r_{15} = 204$	$r_{16} = 215$	$r_{17} = 357$	101
C_2	$r_{21} = 101$		$r_{23} = 54$	$r_{24} = 60$	$r_{25} = 124$	$r_{26} = 120$	$r_{27} = 259$	54
C_3	$r_{31} = 108$	$r_{32} = 54$		$r_{34} = 34$	$r_{35} = 96$	$r_{36} = 157$	$r_{37} = 285$	34
C_4	$r_{41} = 138$	$r_{42} = 60$	$r_{43} = 34$		$r_{45} = 67$	$r_{46} = 134$	$r_{47} = 255$	34

C_5	$r_{51} = 204$	$r_{52} = 124$	$r_{53} = 96$	$r_{54} = 67$		$r_{56} = 150$	$r_{57} = 237$	67
C_6	$r_{61} = 215$	$r_{62} = 120$	$r_{63} = 157$	$r_{64} = 134$	$r_{65} = 150$		$r_{67} = 142$	120
C_7	$r_{71} = 357$	$r_{72} = 259$	$r_{73} = 285$	$r_{74} = 255$	$r_{75} = 237$	$r_{76} = 142$		142
							Min $r_{ij} =$	34

Fig 10: Resources r_{ij} linking C_i to C_j in 2-dimensional space for Population P_7 .

$$\begin{aligned} T_{2_1} &= C_3 \\ T_{2_2} &= C_4. \end{aligned}$$

Fig 11: Redesignating the Focal Nodes for $MRC_{C_a} \vec{R}_{2_{min}} = T_{2_1} \rightarrow T_{2_2} \rightarrow T_{2_1}$ for P_7 .

$$\begin{aligned} e_{2_{12}} &= d_{34} \\ e_{2_{21}} &= d_{43}. \end{aligned}$$

Fig 12: Redesignating the route vectors for $MRC_{C_a} \vec{R}_{2_{min}} = T_{2_1} \rightarrow T_{2_2} \rightarrow T_{2_1}$.

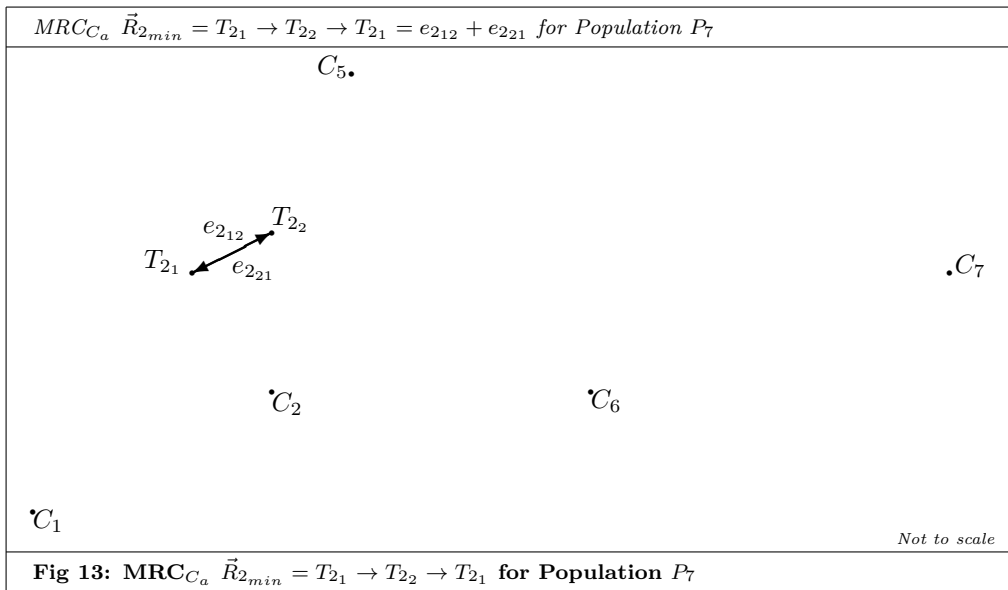

Fig 13: $MRC_{C_a} \vec{R}_{2_{min}} = T_{2_1} \rightarrow T_{2_2} \rightarrow T_{2_1}$ for Population P_7

25.B.f. Identifying a $MRC_{C_a} \vec{R}_{3_{min}}$ by identifying an Optimum Focal Node with respect to $\vec{R}_{2_{min}}$

To identify a $MRC_{C_a} \vec{R}_{3_{min}}$ for a group of three Focal Nodes of the population P_n , we first identify an Optimum Focal Node with respect to $\vec{R}_{2_{min}}$ as follows.

We compute the minimum of:

$$r_{bi} + r_{ia} - e_{2_{21}} \text{ for } C_i \notin \{T_{2_1}, T_{2_2}\}.$$

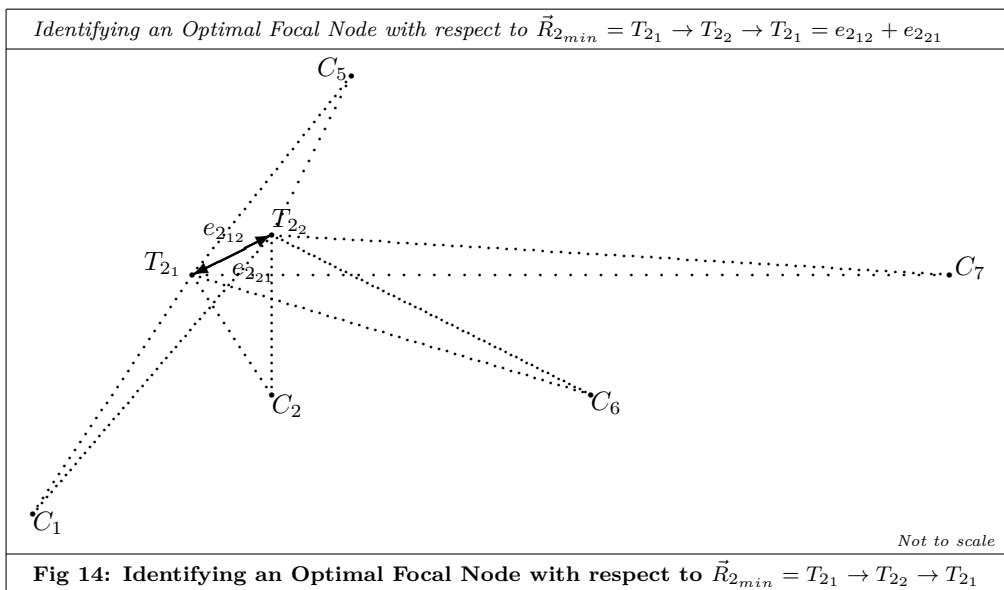

If $r_{bi} + r_{ia} - e_{221}$ is a minimum for $i = c$, we identify C_c as an Optimum Focal Node of P_n with respect to \vec{R}_{2min} .

We identify a MRC_{C_a} for a group of three Focal Nodes of the population P_n as the directed graph:

$$e_{212} + d_{bi} + d_{ia}$$

obtained by replacing the vector e_{221} in \vec{R}_{2min} by the vector $d_{bi} + d_{ia}$.

We then redesignate the Focal Nodes relatively—in relation to the MRC_{C_a} \vec{R}_{3min} —so that:

$$\vec{R}_{3min} = T_{31} \rightarrow T_{32} \rightarrow T_{33} \rightarrow T_{31} = e_{312} + e_{323} + e_{331}.$$

$$\begin{aligned} T_{31} &= C_a \\ T_{32} &= C_b \\ T_{33} &= C_c \end{aligned}$$

Fig 15: Redesignating the Focal Nodes for MRC_{C_a} $\vec{R}_{3min} = T_{31} \rightarrow T_{32} \rightarrow T_{33} \rightarrow T_{31}$.

We further redesignate the route vectors relatively—in relation to the MRC_{C_a} \vec{R}_{3min} —as:

$$\begin{aligned} e_{312} &= d_{ab} \\ e_{323} &= d_{bc} \\ e_{331} &= d_{ca}. \end{aligned}$$

Fig 16: Redesignating the route vectors for MRC_{C_a} $\vec{R}_{3min} = T_{31} \rightarrow T_{32} \rightarrow T_{33} \rightarrow T_{31}$.

Time Complexity for identifying \vec{R}_{3min} : Identifying \vec{R}_{3min} requires $O(n^2) + n$ computations in a 2-dimensional representation, and $O(n^k) + n$ computations in a k -dimensional representation.

For the Population P_7 in Fig 1 we have that $r_{ij} + r_{i(j+1)} - e_{221}$ is a minimum for $i = 2$.

i	j	$C_i T_{2_j} + C_i T_{2_{j+1}} - T_{2_j} T_{2_{j+1}}$	$C_i \notin \{T_{2_1}, T_{2_2}\}$	r_{ij} : Linking C_i to C_j
1	1	$C_1 T_{2_1} + C_1 T_{2_2} - T_{2_1} T_{2_2} = C_1 C_3 + C_1 C_4 - C_3 C_4$	$108 + 138 - 34$	212
2	1	$C_2 T_{2_1} + C_2 T_{2_2} - T_{2_1} T_{2_2} = C_2 C_3 + C_2 C_4 - C_3 C_4$	$54 + 60 - 34$	70
3	1	$C_3 T_{2_1} + C_3 T_{2_2} - T_{2_1} T_{2_2} = C_3 C_3 + C_3 C_4 - C_3 C_4$	NA	NA
4	1	$C_4 T_{2_1} + C_4 T_{2_2} - T_{2_1} T_{2_2} = C_4 C_3 + C_4 C_4 - C_3 C_4$	NA	NA
5	1	$C_5 T_{2_1} + C_5 T_{2_2} - T_{2_1} T_{2_2} = C_5 C_3 + C_5 C_4 - C_3 C_4$	$96 + 67 - 34$	129
6	1	$C_6 T_{2_1} + C_6 T_{2_2} - T_{2_1} T_{2_2} = C_6 C_3 + C_6 C_4 - C_3 C_4$	$157 + 134 - 34$	257
7	1	$C_7 T_{2_1} + C_7 T_{2_2} - T_{2_1} T_{2_2} = C_7 C_3 + C_7 C_4 - C_3 C_4$	$285 + 255 - 34$	506
				Min $r_{ij} = 70$ for $i=2$

Fig 17: Resources r_{ij} linking C_i to $\vec{R}_{2_{min}}$ in 2-dimensional space for Population P_7 .

$$\begin{aligned} T_{3_1} &= C_3 \\ T_{3_2} &= C_4 \\ T_{3_3} &= C_2 \end{aligned}$$

Fig 18: Redesignating the Focal Nodes for $MRC_{C_a} \vec{R}_{3_{min}} = T_{3_1} \rightarrow T_{3_2} \rightarrow T_{3_3} \rightarrow T_{3_1}$ for Population P_7 .

$$\begin{aligned} e_{3_{12}} &= d_{34} \\ e_{3_{23}} &= d_{42} \\ e_{3_{31}} &= d_{21}. \end{aligned}$$

Fig 19: Redesignating the route vectors for $MRC_{C_a} \vec{R}_{3_{min}} = T_{3_1} \rightarrow T_{3_2} \rightarrow T_{3_3} \rightarrow T_{3_1}$ for Population P_7 .

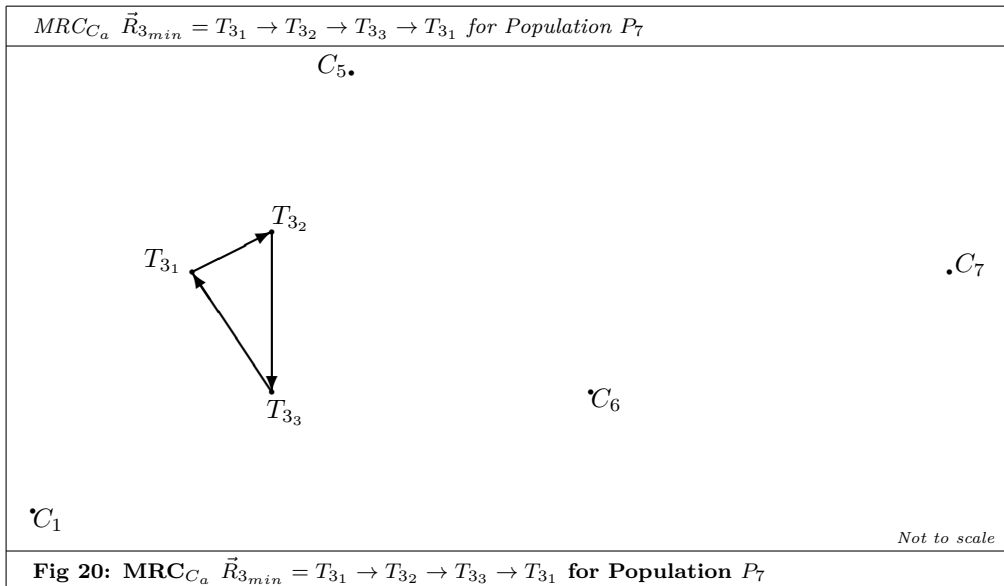

25.B.g. Identifying a $MRC_{C_a} \vec{R}_{4_{min}}$ by identifying an Optimum Focal Node with respect to $\vec{R}_{3_{min}}$

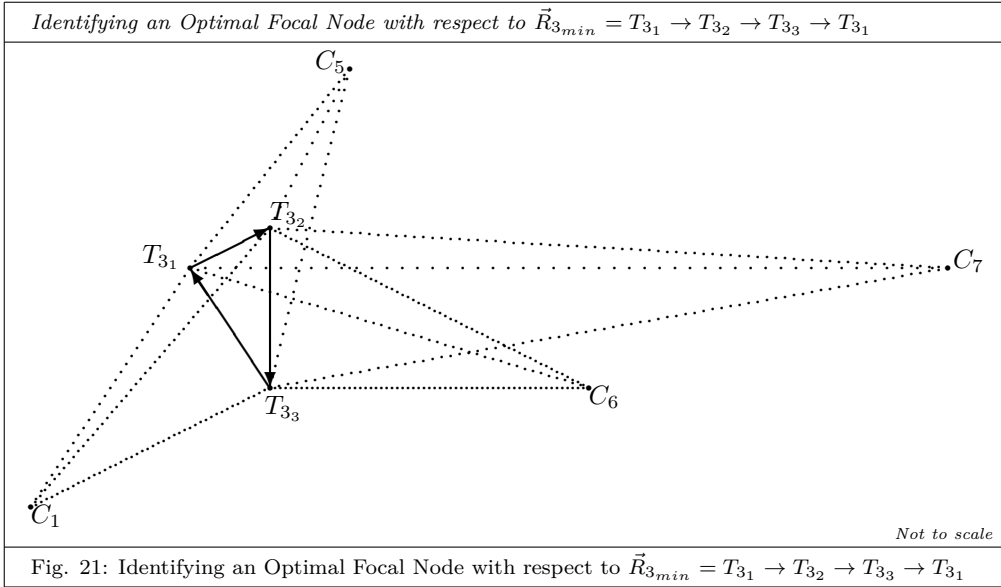

i	j	$C_i T_{3_j} + C_i T_{3_{j+1}} - T_{3_j} T_{3_{j+1}}$	$C_i \notin \{T_{2_1}, T_{2_2}, T_{2_3}\}$	r_{ij} : Linking C_i to $\vec{R}_{3_{min}}$
1	1	$C_1 T_{3_1} + C_1 T_{3_2} - T_{3_1} T_{3_2} = C_1 C_3 + C_1 C_4 - C_3 C_4$	108 + 138 - 34	212
1	2	$C_1 T_{3_2} + C_1 T_{3_3} - T_{3_2} T_{3_3} = C_1 C_4 + C_1 C_2 - C_4 C_2$	138 + 101 - 60	179
1	3	$C_1 T_{3_3} + C_1 T_{3_1} - T_{3_3} T_{3_1} = C_1 C_2 + C_1 C_3 - C_2 C_3$	101 + 108 - 54	159
2	1	$C_2 T_{3_1} + C_2 T_{3_2} - T_{3_1} T_{3_2} = C_2 C_3 + C_2 C_4 - C_3 C_4$	NA	NA
2	2	$C_2 T_{3_2} + C_2 T_{3_3} - T_{3_2} T_{3_3} = C_2 C_4 + C_2 C_2 - C_4 C_2$	NA	NA
2	3	$C_2 T_{3_3} + C_2 T_{3_1} - T_{3_3} T_{3_1} = C_2 C_2 + C_2 C_3 - C_2 C_3$	NA	NA
3	1	$C_3 T_{3_1} + C_3 T_{3_2} - T_{3_1} T_{3_2} = C_3 C_3 + C_3 C_4 - C_3 C_4$	NA	NA
3	2	$C_3 T_{3_2} + C_3 T_{3_3} - T_{3_2} T_{3_3} = C_3 C_4 + C_3 C_2 - C_4 C_2$	NA	NA
3	3	$C_3 T_{3_3} + C_3 T_{3_1} - T_{3_3} T_{3_1} = C_3 C_2 + C_3 C_3 - C_2 C_3$	NA	NA
4	1	$C_4 T_{3_1} + C_4 T_{3_2} - T_{3_1} T_{3_2} = C_4 C_3 + C_4 C_4 - C_3 C_4$	NA	NA
4	2	$C_4 T_{3_2} + C_4 T_{3_3} - T_{3_2} T_{3_3} = C_4 C_4 + C_4 C_2 - C_4 C_2$	NA	NA
4	3	$C_4 T_{3_3} + C_4 T_{3_1} - T_{3_3} T_{3_1} = C_4 C_2 + C_4 C_3 - C_2 C_3$	NA	NA
5	1	$C_5 T_{3_1} + C_5 T_{3_2} - T_{3_1} T_{3_2} = C_5 C_3 + C_5 C_4 - C_3 C_4$	96 + 67 - 34	129
5	2	$C_5 T_{3_2} + C_5 T_{3_3} - T_{3_2} T_{3_3} = C_5 C_4 + C_5 C_2 - C_4 C_2$	67 + 124 - 60	131
5	3	$C_5 T_{3_3} + C_5 T_{3_1} - T_{3_3} T_{3_1} = C_5 C_2 + C_5 C_3 - C_2 C_3$	124 + 96 - 54	166
6	1	$C_6 T_{3_1} + C_6 T_{3_2} - T_{3_1} T_{3_2} = C_6 C_3 + C_6 C_4 - C_3 C_4$	157 + 134 - 34	257
6	2	$C_6 T_{3_2} + C_6 T_{3_3} - T_{3_2} T_{3_3} = C_6 C_4 + C_6 C_2 - C_4 C_2$	134 + 120 - 60	194
6	3	$C_6 T_{3_3} + C_6 T_{3_1} - T_{3_3} T_{3_1} = C_6 C_2 + C_6 C_3 - C_2 C_3$	120 + 157 - 54	223
7	1	$C_7 T_{3_1} + C_7 T_{3_2} - T_{3_1} T_{3_2} = C_7 C_3 + C_7 C_4 - C_3 C_4$	285 + 255 - 34	506
7	2	$C_7 T_{3_2} + C_7 T_{3_3} - T_{3_2} T_{3_3} = C_7 C_4 + C_7 C_2 - C_4 C_2$	255 + 259 - 60	454
7	3	$C_7 T_{3_3} + C_7 T_{3_1} - T_{3_3} T_{3_1} = C_7 C_2 + C_7 C_3 - C_2 C_3$	259 + 285 - 54	490
				Min $r_{ij} = 129$ for $i=5, j=1$

Fig 22: Resources r_{ij} linking C_i to $\vec{R}_{3_{min}}$ in 2-dimensional space for Population P_7 .

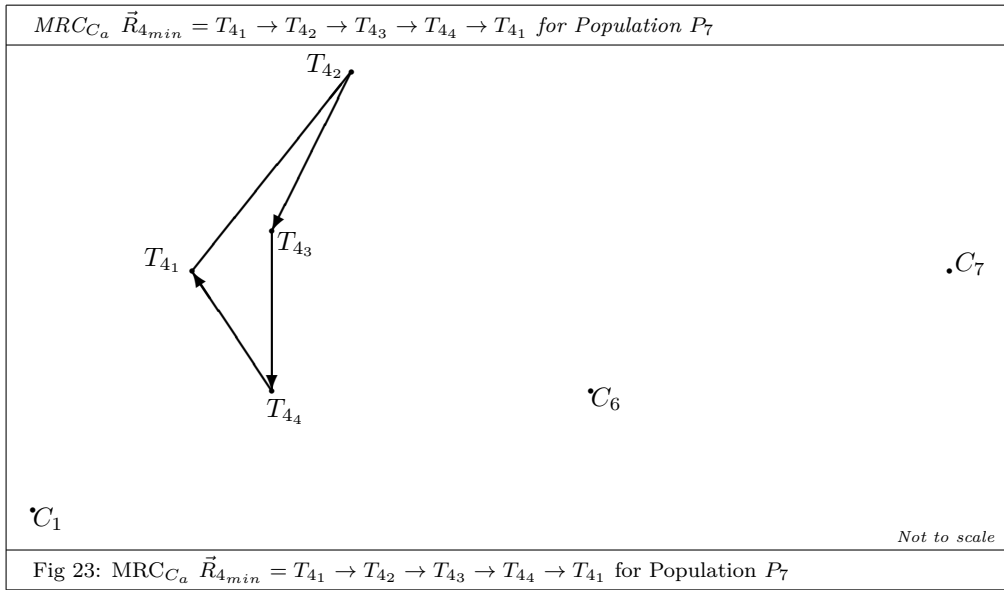

25.B.h. Identifying a $MRC_{C_a} \vec{R}_{5_{min}}$ by identifying an Optimum Focal Node with respect to $\vec{R}_{4_{min}}$

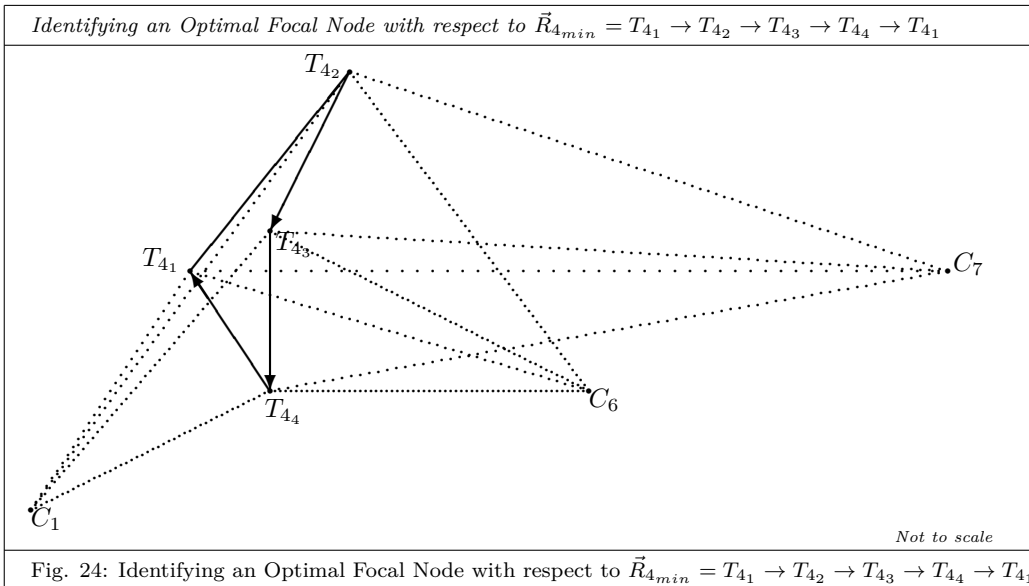

i	j	$C_i T_{4_j} + C_i T_{4_{j+1}} - T_{4_j} T_{4_{j+1}}$	$C_i \notin \{T_{4_1}, T_{4_2}, T_{4_3}, T_{4_4}\}$	r_{ij} : Linking C_i to $\vec{R}_{4_{min}}$
1	1	$C_1 T_{4_1} + C_1 T_{4_2} - T_{4_1} T_{4_2} = C_1 C_3 + C_1 C_5 - C_3 C_5$	$108 + 204 - 96$	216
1	2	$C_1 T_{4_2} + C_1 T_{4_3} - T_{4_2} T_{4_3} = C_1 C_5 + C_1 C_4 - C_5 C_4$	$204 + 138 - 67$	275
1	3	$C_1 T_{4_3} + C_1 T_{4_4} - T_{4_3} T_{4_4} = C_1 C_4 + C_1 C_2 - C_4 C_2$	$138 + 101 - 60$	179
1	4	$C_1 T_{4_4} + C_1 T_{4_1} - T_{4_4} T_{4_1} = C_1 C_2 + C_1 C_3 - C_2 C_3$	$101 + 108 - 54$	155
2	1	$C_2 T_{4_1} + C_2 T_{4_2} - T_{4_1} T_{4_2} = C_2 C_3 + C_2 C_5 - C_3 C_5$	NA	NA
2	2	$C_2 T_{4_2} + C_2 T_{4_3} - T_{4_2} T_{4_3} = C_2 C_5 + C_2 C_4 - C_5 C_4$	NA	NA
2	3	$C_2 T_{4_3} + C_2 T_{4_4} - T_{4_3} T_{4_4} = C_2 C_4 + C_2 C_2 - C_4 C_2$	NA	NA
2	4	$C_2 T_{4_4} + C_2 T_{4_1} - T_{4_4} T_{4_1} = C_2 C_2 + C_2 C_3 - C_2 C_3$	NA	NA

i	j	$C_i T_{4_j} + C_i T_{4_{j+1}} - T_{4_j} T_{4_{j+1}}$	$C_i \notin \{T_{4_1}, T_{4_2}, T_{4_3}, T_{4_4}\}$	r_{ij} : Linking C_i to $\vec{R}_{4_{min}}$
3	1	$C_3 T_{4_1} + C_3 T_{4_2} - T_{4_1} T_{4_2} = C_3 C_3 + C_3 C_5 - C_3 C_5$	NA	NA
3	2	$C_3 T_{4_2} + C_3 T_{4_3} - T_{4_2} T_{4_3} = C_3 C_5 + C_3 C_4 - C_5 C_4$	NA	NA
3	3	$C_3 T_{4_3} + C_3 T_{4_4} - T_{4_3} T_{4_4} = C_3 C_4 + C_3 C_2 - C_4 C_2$	NA	NA
3	4	$C_3 T_{4_4} + C_3 T_{4_1} - T_{4_4} T_{4_1} = C_3 C_2 + C_3 C_3 - C_2 C_3$	NA	NA
4	1	$C_4 T_{4_1} + C_4 T_{4_2} - T_{4_1} T_{4_2} = C_4 C_3 + C_4 C_5 - C_3 C_5$	NA	NA
4	2	$C_4 T_{4_2} + C_4 T_{4_3} - T_{4_2} T_{4_3} = C_4 C_5 + C_4 C_4 - C_5 C_4$	NA	NA
4	3	$C_4 T_{4_3} + C_4 T_{4_4} - T_{4_3} T_{4_4} = C_4 C_4 + C_4 C_2 - C_4 C_2$	NA	NA
4	4	$C_4 T_{4_4} + C_4 T_{4_1} - T_{4_4} T_{4_1} = C_4 C_4 + C_4 C_3 - C_2 C_3$	NA	NA
5	1	$C_5 T_{4_1} + C_5 T_{4_2} - T_{4_1} T_{4_2} = C_5 C_3 + C_5 C_5 - C_3 C_5$	NA	NA
5	2	$C_5 T_{4_2} + C_5 T_{4_3} - T_{4_2} T_{4_3} = C_5 C_5 + C_5 C_4 - C_5 C_4$	NA	NA
5	3	$C_5 T_{4_3} + C_5 T_{4_4} - T_{4_3} T_{4_4} = C_5 C_4 + C_5 C_2 - C_4 C_2$	NA	NA
5	4	$C_5 T_{4_4} + C_5 T_{4_1} - T_{4_4} T_{4_1} = C_5 C_2 + C_5 C_3 - C_2 C_3$	NA	NA
6	1	$C_6 T_{4_1} + C_6 T_{4_2} - T_{4_1} T_{4_2} = C_6 C_3 + C_6 C_5 - C_3 C_5$	$157 + 150 - 96$	211
6	2	$C_6 T_{4_2} + C_6 T_{4_3} - T_{4_2} T_{4_3} = C_6 C_5 + C_6 C_4 - C_5 C_4$	$150 + 134 - 67$	217
6	3	$C_6 T_{4_3} + C_6 T_{4_4} - T_{4_3} T_{4_4} = C_6 C_4 + C_6 C_2 - C_4 C_2$	$134 + 120 - 60$	194
6	4	$C_6 T_{4_4} + C_6 T_{4_1} - T_{4_4} T_{4_1} = C_6 C_2 + C_6 C_3 - C_2 C_3$	$120 + 157 - 54$	223
7	1	$C_7 T_{4_1} + C_7 T_{4_2} - T_{4_1} T_{4_2} = C_7 C_3 + C_7 C_5 - C_3 C_5$	$285 + 237 - 96$	426
7	2	$C_7 T_{4_2} + C_7 T_{4_3} - T_{4_2} T_{4_3} = C_7 C_5 + C_7 C_4 - C_5 C_4$	$237 + 255 - 67$	425
7	3	$C_7 T_{4_3} + C_7 T_{4_4} - T_{4_3} T_{4_4} = C_7 C_4 + C_7 C_2 - C_4 C_2$	$255 + 259 - 60$	454
7	4	$C_7 T_{4_4} + C_7 T_{4_1} - T_{4_4} T_{4_1} = C_7 C_2 + C_7 C_3 - C_2 C_3$	$259 + 285 - 54$	490
				Min $r_{ij} = 155$ for $i=1, j=4$

Fig 25: Resources r_{ij} linking C_i to $\vec{R}_{4_{min}}$ in 2-dimensional space for Population P_7 .

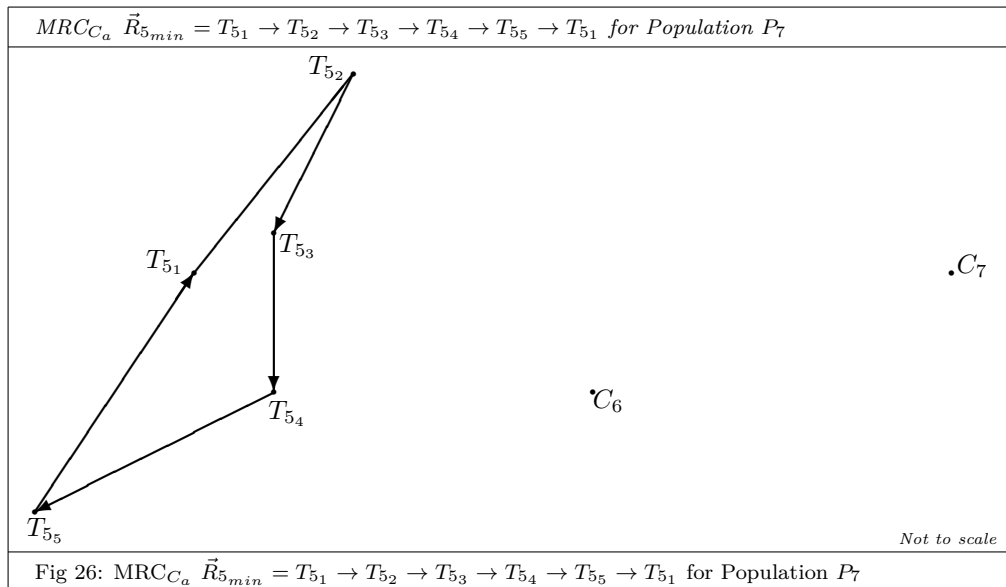

25.B.i. Identifying a $MRC_{C_a} \vec{R}_{6_{min}}$ by identifying an Optimum Focal Node with respect to $\vec{R}_{5_{min}}$

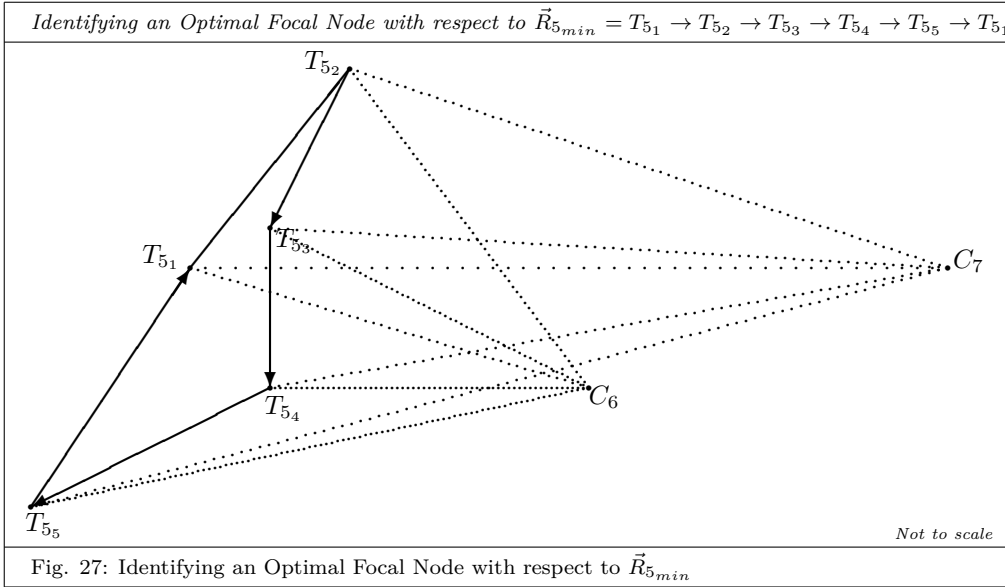

i	j	$C_i T_{5_j} + C_i T_{5_{j+1}} - T_{5_j} T_{5_{j+1}}$	$C_i \notin \{T_{5_1}, T_{5_2}, T_{5_3}, T_{5_4}, T_{5_5}\}$	r_{ij} : Linking C_i to $\vec{R}_{5_{min}}$
1	1	$C_1 T_{5_1} + C_1 T_{5_2} - T_{5_1} T_{5_2} = C_1 C_3 + C_1 C_5 - C_3 C_5$	NA	NA
1	2	$C_1 T_{5_2} + C_1 T_{5_3} - T_{5_2} T_{5_3} = C_1 C_5 + C_1 C_4 - C_5 C_4$	NA	NA
1	3	$C_1 T_{5_3} + C_1 T_{5_4} - T_{5_3} T_{5_4} = C_1 C_4 + C_1 C_2 - C_4 C_2$	NA	NA
1	4	$C_1 T_{5_4} + C_1 T_{5_5} - T_{5_4} T_{5_5} = C_1 C_2 + C_1 C_1 - C_2 C_1$	NA	NA
1	5	$C_1 T_{5_5} + C_1 T_{5_1} - T_{5_5} T_{5_1} = C_1 C_1 + C_1 C_3 - C_1 C_3$	NA	NA
2	1	$C_2 T_{5_1} + C_2 T_{5_2} - T_{5_1} T_{5_2} = C_2 C_3 + C_2 C_5 - C_3 C_5$	NA	NA
2	2	$C_2 T_{5_2} + C_2 T_{5_3} - T_{5_2} T_{5_3} = C_2 C_5 + C_2 C_4 - C_5 C_4$	NA	NA
2	3	$C_2 T_{5_3} + C_2 T_{5_4} - T_{5_3} T_{5_4} = C_2 C_4 + C_2 C_2 - C_4 C_2$	NA	NA
2	4	$C_2 T_{5_4} + C_2 T_{5_5} - T_{5_4} T_{5_5} = C_2 C_2 + C_2 C_1 - C_2 C_1$	NA	NA
2	5	$C_2 T_{5_5} + C_2 T_{5_1} - T_{5_5} T_{5_1} = C_2 C_1 + C_2 C_3 - C_1 C_3$	NA	NA
3	1	$C_3 T_{5_1} + C_3 T_{5_2} - T_{5_1} T_{5_2} = C_3 C_3 + C_3 C_5 - C_3 C_5$	NA	NA
3	2	$C_3 T_{5_2} + C_3 T_{5_3} - T_{5_2} T_{5_3} = C_3 C_5 + C_3 C_4 - C_5 C_4$	NA	NA
3	3	$C_3 T_{5_3} + C_3 T_{5_4} - T_{5_3} T_{5_4} = C_3 C_4 + C_3 C_2 - C_4 C_2$	NA	NA
3	4	$C_3 T_{5_4} + C_3 T_{5_5} - T_{5_4} T_{5_5} = C_3 C_2 + C_3 C_1 - C_2 C_1$	NA	NA
3	5	$C_3 T_{5_5} + C_3 T_{5_1} - T_{5_5} T_{5_1} = C_3 C_1 + C_3 C_3 - C_1 C_3$	NA	NA
4	1	$C_4 T_{5_1} + C_4 T_{5_2} - T_{5_1} T_{5_2} = C_4 C_3 + C_4 C_5 - C_3 C_5$	NA	NA
4	2	$C_4 T_{5_2} + C_4 T_{5_3} - T_{5_2} T_{5_3} = C_4 C_5 + C_4 C_4 - C_5 C_4$	NA	NA
4	3	$C_4 T_{5_3} + C_4 T_{5_4} - T_{5_3} T_{5_4} = C_4 C_4 + C_4 C_2 - C_4 C_2$	NA	NA
4	4	$C_4 T_{5_4} + C_4 T_{5_5} - T_{5_4} T_{5_5} = C_4 C_2 + C_4 C_1 - C_2 C_1$	NA	NA
4	5	$C_4 T_{5_5} + C_4 T_{5_1} - T_{5_5} T_{5_1} = C_4 C_1 + C_4 C_3 - C_1 C_3$	NA	NA
5	1	$C_5 T_{5_1} + C_5 T_{5_2} - T_{5_1} T_{5_2} = C_5 C_3 + C_5 C_5 - C_3 C_5$	NA	NA
5	2	$C_5 T_{5_2} + C_5 T_{5_3} - T_{5_2} T_{5_3} = C_5 C_5 + C_5 C_4 - C_5 C_4$	NA	NA
5	3	$C_5 T_{5_3} + C_5 T_{5_4} - T_{5_3} T_{5_4} = C_5 C_4 + C_5 C_2 - C_4 C_2$	NA	NA
5	4	$C_5 T_{5_4} + C_5 T_{5_5} - T_{5_4} T_{5_5} = C_5 C_2 + C_5 C_1 - C_2 C_1$	NA	NA
5	5	$C_5 T_{5_5} + C_5 T_{5_1} - T_{5_5} T_{5_1} = C_5 C_1 + C_5 C_3 - C_1 C_3$	NA	NA

i	j	$C_i T_{5_j} + C_i T_{5_{j+1}} - T_{5_j} T_{5_{j+1}}$	$C_i \notin \{T_{5_1}, T_{5_2}, T_{5_3}, T_{5_4}, T_{5_5}\}$	r_{ij} : Linking C_i to $\vec{R}_{5_{min}}$
6	1	$C_6 T_{5_1} + C_6 T_{5_2} - T_{5_1} T_{5_2} = C_6 C_3 + C_6 C_5 - C_3 C_5$	157 + 150 - 96	211
6	2	$C_6 T_{5_2} + C_6 T_{5_3} - T_{5_2} T_{5_3} = C_6 C_5 + C_6 C_4 - C_5 C_4$	150 + 134 - 67	217
6	3	$C_6 T_{5_3} + C_6 T_{5_4} - T_{5_3} T_{5_4} = C_6 C_4 + C_6 C_2 - C_4 C_2$	134 + 120 - 60	194
6	4	$C_6 T_{5_4} + C_6 T_{5_5} - T_{5_4} T_{5_5} = C_6 C_2 + C_6 C_1 - C_2 C_1$	120 + 215 - 101	234
6	5	$C_6 T_{5_5} + C_6 T_{5_1} - T_{5_5} T_{5_1} = C_6 C_1 + C_6 C_3 - C_1 C_3$	215 + 157 - 108	264
7	1	$C_7 T_{5_1} + C_7 T_{5_2} - T_{5_1} T_{5_2} = C_7 C_3 + C_7 C_5 - C_3 C_5$	285 + 237 - 96	426
7	2	$C_7 T_{5_2} + C_7 T_{5_3} - T_{5_2} T_{5_3} = C_7 C_5 + C_7 C_4 - C_5 C_4$	237 + 255 - 67	425
7	3	$C_7 T_{5_3} + C_7 T_{5_4} - T_{5_3} T_{5_4} = C_7 C_4 + C_7 C_2 - C_4 C_2$	255 + 259 - 60	454
7	4	$C_7 T_{5_4} + C_7 T_{5_5} - T_{5_4} T_{5_5} = C_7 C_2 + C_7 C_1 - C_2 C_1$	259 + 357 - 101	515
7	5	$C_7 T_{5_5} + C_7 T_{5_1} - T_{5_5} T_{5_1} = C_7 C_1 + C_7 C_3 - C_1 C_3$	357 + 285 - 108	534
				Min $r_{ij} = 194$ for $i=6, j=3$

Fig 28: Resources r_{ij} linking C_i to $\vec{R}_{5_{min}}$ in 2-dimensional space for Population P_7 .

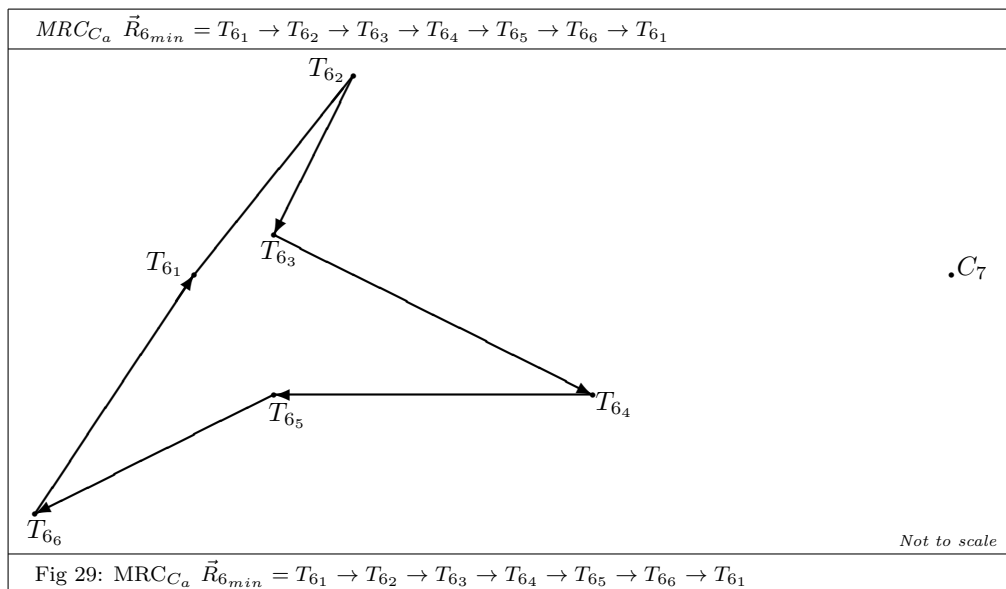

25.B.j. Identifying a $MRC_{C_a} \vec{R}_{7_{min}}$ by identifying an Optimum Focal Node with respect to $\vec{R}_{6_{min}}$

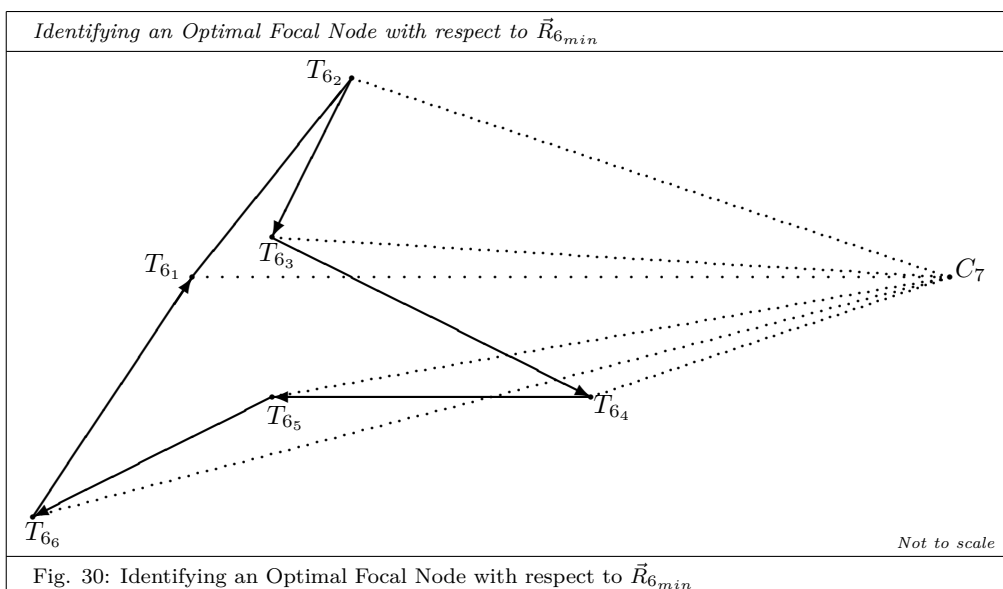

i	j	$C_i T_{6_j} + C_i T_{6_{j+1}} - T_{6_j} T_{6_{j+1}}$	$C_i \notin \{T_{6_1}, T_{6_2}, T_{6_3}, T_{6_4}, T_{6_5}\}$	r_{ij} : Linking C_i to $\vec{R}_{5_{min}}$
1	1	$C_1 T_{6_1} + C_1 T_{6_2} - T_{6_1} T_{6_2} = C_1 C_3 + C_1 C_5 - C_3 C_5$	NA	NA
1	2	$C_1 T_{6_2} + C_1 T_{6_3} - T_{6_2} T_{6_3} = C_1 C_5 + C_1 C_4 - C_5 C_4$	NA	NA
1	3	$C_1 T_{6_3} + C_1 T_{6_4} - T_{6_3} T_{6_4} = C_1 C_4 + C_1 C_6 - C_4 C_6$	NA	NA
1	4	$C_1 T_{6_4} + C_1 T_{6_5} - T_{6_4} T_{6_5} = C_1 C_6 + C_1 C_2 - C_6 C_2$	NA	NA
1	5	$C_1 T_{6_5} + C_1 T_{6_6} - T_{6_5} T_{6_6} = C_1 C_2 + C_1 C_1 - C_2 C_1$	NA	NA
1	6	$C_1 T_{6_6} + C_1 T_{6_1} - T_{6_6} T_{6_1} = C_1 C_1 + C_1 C_3 - C_1 C_3$	NA	NA
2	1	$C_2 T_{6_1} + C_2 T_{6_2} - T_{6_1} T_{6_2} = C_2 C_3 + C_2 C_5 - C_3 C_5$	NA	NA
2	2	$C_2 T_{6_2} + C_2 T_{6_3} - T_{6_2} T_{6_3} = C_2 C_5 + C_2 C_4 - C_5 C_4$	NA	NA
2	3	$C_2 T_{6_3} + C_2 T_{6_4} - T_{6_3} T_{6_4} = C_2 C_4 + C_2 C_6 - C_4 C_6$	NA	NA
2	4	$C_2 T_{6_4} + C_2 T_{6_5} - T_{6_4} T_{6_5} = C_2 C_6 + C_2 C_2 - C_6 C_2$	NA	NA
2	5	$C_2 T_{6_5} + C_2 T_{6_6} - T_{6_5} T_{6_6} = C_2 C_2 + C_2 C_2 - C_2 C_1$	NA	NA
2	6	$C_2 T_{6_6} + C_2 T_{6_1} - T_{6_6} T_{6_1} = C_2 C_1 + C_2 C_3 - C_1 C_3$	NA	NA
3	1	$C_3 T_{6_1} + C_3 T_{6_2} - T_{6_1} T_{6_2} = C_3 C_3 + C_3 C_5 - C_3 C_5$	NA	NA
3	2	$C_3 T_{6_2} + C_3 T_{6_3} - T_{6_2} T_{6_3} = C_3 C_5 + C_3 C_4 - C_5 C_4$	NA	NA
3	3	$C_3 T_{6_3} + C_3 T_{6_4} - T_{6_3} T_{6_4} = C_3 C_4 + C_3 C_6 - C_4 C_6$	NA	NA
3	4	$C_3 T_{6_4} + C_3 T_{6_5} - T_{6_4} T_{6_5} = C_3 C_6 + C_3 C_2 - C_6 C_2$	NA	NA
3	5	$C_3 T_{6_5} + C_3 T_{6_6} - T_{6_5} T_{6_6} = C_3 C_2 + C_3 C_1 - C_2 C_1$	NA	NA
3	6	$C_3 T_{6_6} + C_3 T_{6_1} - T_{6_6} T_{6_1} = C_3 C_1 + C_3 C_3 - C_1 C_3$	NA	NA
4	1	$C_4 T_{6_1} + C_4 T_{6_2} - T_{6_1} T_{6_2} = C_4 C_3 + C_4 C_5 - C_3 C_5$	NA	NA
4	2	$C_4 T_{6_2} + C_4 T_{6_3} - T_{6_2} T_{6_3} = C_4 C_5 + C_4 C_4 - C_5 C_4$	NA	NA
4	3	$C_4 T_{6_3} + C_4 T_{6_4} - T_{6_3} T_{6_4} = C_4 C_4 + C_4 C_6 - C_4 C_6$	NA	NA
4	4	$C_4 T_{6_4} + C_4 T_{6_5} - T_{6_4} T_{6_5} = C_4 C_6 + C_4 C_2 - C_6 C_2$	NA	NA
4	5	$C_4 T_{6_5} + C_4 T_{6_6} - T_{6_5} T_{6_6} = C_4 C_2 + C_4 C_1 - C_2 C_1$	NA	NA
4	6	$C_4 T_{6_6} + C_4 T_{6_1} - T_{6_6} T_{6_1} = C_4 C_1 + C_4 C_3 - C_1 C_3$	NA	NA
5	1	$C_5 T_{6_1} + C_5 T_{6_2} - T_{6_1} T_{6_2} = C_5 C_3 + C_5 C_5 - C_3 C_5$	NA	NA
5	2	$C_5 T_{6_2} + C_5 T_{6_3} - T_{6_2} T_{6_3} = C_5 C_5 + C_5 C_4 - C_5 C_4$	NA	NA
5	3	$C_5 T_{6_3} + C_5 T_{6_4} - T_{6_3} T_{6_4} = C_5 C_4 + C_5 C_6 - C_4 C_6$	NA	NA
5	4	$C_5 T_{6_4} + C_5 T_{6_5} - T_{6_4} T_{6_5} = C_5 C_6 + C_5 C_2 - C_6 C_2$	NA	NA
5	5	$C_5 T_{6_5} + C_5 T_{6_6} - T_{6_5} T_{6_6} = C_5 C_2 + C_5 C_1 - C_2 C_1$	NA	NA
5	6	$C_5 T_{6_6} + C_5 T_{6_1} - T_{6_6} T_{6_1} = C_5 C_1 + C_5 C_3 - C_1 C_3$	NA	NA
6	1	$C_6 T_{6_1} + C_6 T_{6_2} - T_{6_1} T_{6_2} = C_6 C_3 + C_6 C_5 - C_3 C_5$	NA	NA
6	2	$C_6 T_{6_2} + C_6 T_{6_3} - T_{6_2} T_{6_3} = C_6 C_5 + C_6 C_4 - C_5 C_4$	NA	NA
6	3	$C_6 T_{6_3} + C_6 T_{6_4} - T_{6_3} T_{6_4} = C_6 C_4 + C_6 C_6 - C_4 C_6$	NA	NA
6	4	$C_6 T_{6_4} + C_6 T_{6_5} - T_{6_4} T_{6_5} = C_6 C_6 + C_6 C_2 - C_6 C_2$	NA	NA
6	5	$C_6 T_{6_5} + C_6 T_{6_6} - T_{6_5} T_{6_6} = C_6 C_2 + C_6 C_1 - C_2 C_1$	NA	NA
6	6	$C_6 T_{6_6} + C_6 T_{6_1} - T_{6_6} T_{6_1} = C_6 C_1 + C_6 C_3 - C_1 C_3$	NA	NA
7	1	$C_7 T_{6_1} + C_7 T_{6_2} - T_{6_1} T_{6_2} = C_7 C_3 + C_7 C_5 - C_3 C_5$	$285 + 237 - 96$	426
7	2	$C_7 T_{6_2} + C_7 T_{6_3} - T_{6_2} T_{6_3} = C_7 C_5 + C_7 C_4 - C_5 C_4$	$237 + 255 - 67$	425
7	3	$C_7 T_{6_3} + C_7 T_{6_4} - T_{6_3} T_{6_4} = C_7 C_4 + C_7 C_6 - C_4 C_6$	$255 + 142 - 134$	263
7	4	$C_7 T_{6_4} + C_7 T_{6_5} - T_{6_4} T_{6_5} = C_7 C_6 + C_7 C_2 - C_6 C_2$	$142 + 259 - 120$	281
7	5	$C_7 T_{6_5} + C_7 T_{6_6} - T_{6_5} T_{6_6} = C_7 C_2 + C_7 C_1 - C_2 C_1$	$259 + 357 - 101$	515
7	6	$C_7 T_{6_6} + C_7 T_{6_1} - T_{6_6} T_{6_1} = C_7 C_1 + C_7 C_3 - C_1 C_3$	$357 + 285 - 108$	534
				Min $r_{ij} = 263$ for $i=7, j=3$

Fig 31: Resources r_{ij} linking C_i to $\vec{R}_{6_{min}}$ in 2-dimensional space for Population P_7 .

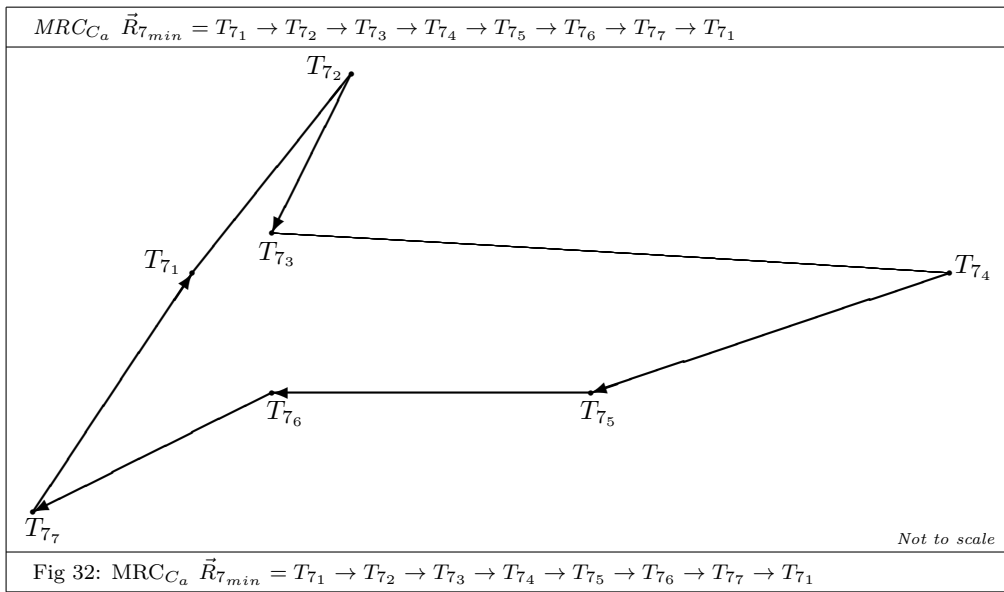

CHAPTER 25. PARADIGM CHALLENGING CONSEQUENCES

26. The significance of *evidence-based* reasoning for SETI

We briefly speculate that the issue of whether, or not, there is a universal language capable of admitting effective, and unambiguous, communication with an extra-terrestrial intelligence is intimately linked with the question of whether or not the first-order Peano Arithmetic PA is categorical, and whether it has an algorithmically *computable* model. This issue lies at the heart of the ‘constructivity’ debate that seeks to distinguish the computer sciences from other mathematical disciplines.

We shall address the question from the perspective of seekers of extra-terrestrial intelligence who may, conceivably, be faced with a situation where a lay person—whose financial support is sought for SETI/METI—may reasonably require a reassuring response to the question:

Query 31. *Is there a rational danger to humankind in actively seeking an extra-terrestrial intelligence?*

26.A. Is there a rational danger to humankind in actively seeking an extra-terrestrial intelligence?

The broader significance of this question from an anthropological perspective was addressed—in an article originally written in September 2006—by scientist David Brin, who feared that ‘*SETI has Taken a Worrisome Turn Into Dangerous Territory*’, and noted that:

“... In *The Third Chimpanzee*, Jared Diamond offers an essay on the risks of attempting to contact ETIs, based on the history of what happened on Earth whenever more advanced civilizations encountered less advanced ones ... or indeed, when the same thing happens during contact between species that evolved in differing ecosystems. The results are often not good: in inter-human relations slavery, colonialism, etc. Among contacting species: extinction.”

... Brin: [Bn08].

However, Kathryn Denning cogently argued in [Dng10] from a broader, social, perspective that, although scientists ‘may have the greatest access to the most significant antennas ... theirs is not the only game in town’; and that we may need to ‘step back, take a broader look at the cultural context, and then rethink our approach to the transmission debate’:

“For many years now, scientists and the public alike have been excited about the possibility of contact with an extraterrestrial intelligence, but also concerned about it. Such an event could be wonderful, and it could be dangerous, and it could be both. We do not know. Accordingly, there is perennial concern about deliberate transmissions from Earth—including both ‘de novo’ transmissions of the sort occurring now, or hypothetical future ‘reply’ transmissions which human beings might send in response to a signal from an extraterrestrial intelligence. Therefore, there has been a great deal of debate within and outside the SETI community, about these issues. Is it wise to attempt to attract the attention of extraterrestrial intelligences? Should transmissions be halted or regulated? Who speaks for Earth? What should we say? How should we say it? Who should decide?”

Several documents, produced by the International Academy of Astronautics SETI Permanent Study Group, explicitly address policy concerning transmissions from Earth.¹ Some of these have been under discussion and revision for many years, and represent substantial investments of

effort. Yet, they remain contentious. Moreover, times have changed since these debates began, not least because the requisite transmission technology is increasingly widespread, and access to it is easier for nonscientists to obtain, in exchange for payment. Transmissions are undertaken as commemorative acts or public-participation projects, by organizations as diverse as national space agencies, retailers, broadcasting corporations, or Internet-based media companies. At the same time, science in astrobiology and SETI is developing, and carefully targeted Active SETI is increasingly feasible, given the growing knowledge of extrasolar planets.

Transmissions² show no sign of abating, and neither do the discussions: editorials and articles appear in the popular science press and on the Internet,³ conferences are held,⁴ scientific papers are published⁵, and efforts to catalog the significance of different types of transmissions are made.⁶ Some argue for a moratorium or restriction on transmissions.⁷ Others argue that Active SETI projects should be prioritised and supported.⁸ Others just get involved in transmission projects because they seem like a neat idea.

But is everyone really talking about the same thing? Vakoch has observed that interstellar transmissions can be considered as scientific experiments, diplomatic action, or artistic expression,⁹ and this neatly points to one of the problems; however much we might wish to, we cannot simply define the arena as being one of these domains, and expect others to think the same way. Scientists may have the greatest access to the most significant antennas, but theirs is not the only game in town. Given that the rules of conduct, interaction, and evaluation are different for each domain—and frequently incommensurable—we have a problem. Moreover, attempts to solve the problem of whether or not people should transmit, by using quantitative logic, can take us only so far in answering what is fundamentally a social question about global citizenship.

How can we apply all our joint brain-power most constructively to this issue? Below, I propose that we step back, take a broader look at the cultural context, and then rethink our approach to the transmission debate. I suggest that our collective goal should be the strategic separation of knowable from unknowable risks, a careful focus on the principles that are most severely disputed though not often specified, and a commitment to learning about ways that have been used to resolve similar debates."

... Denning: [Dng10], §1. Introduction: the transmission debate.

Nearly a decade later, the issue was still alive, as remarked by science writer Steven Johnson who, in a 2017 Feature article for *The New York Times Magazine*, dramatically titled *Greetings, E.T. (Please Don't Murder Us.)*, reported on the 1974 *Arecibo* message, and the profoundly unsettling issues that were reflected in a continuing ambivalence towards the dangers of a resolute exploration of space that might invite the attentions of any malevolent intelligence the cosmos might nurture in its unfathomable depths:

"That 168 seconds of noise, now known as the *Arecibo* message, was the brainchild of the astronomer Frank Drake, then director of the organization that oversaw the *Arecibo* facility. The broadcast marked the first time a human being had intentionally transmitted a message targeting another solar system."

... Johnson: [Jo17].

The ambivalence became apparent immediately. As Johnson notes:

"It seemed to most of the onlookers to be a hopeful act, if a largely symbolic one: a message in a bottle tossed into the deep sea of space. But within days, the Royal Astronomer of England, Martin Ryle, released a thunderous condemnation of Drake's stunt. By alerting the cosmos of our existence, Ryle wrote, we were risking catastrophe. Arguing that "any creatures out there [might be] malevolent or hungry," Ryle demanded that the International Astronomical Union denounce Drake's message and explicitly forbid any further communications. It was irresponsible, Ryle fumed, to tinker with interstellar outreach when such gestures, however noble their intentions, might lead to the destruction of all life on earth.

Today, more than four decades later, we still do not know if Ryle's fears were warranted, because the Arecibo message is still eons away from its intended recipient, a cluster of roughly 300,000 stars known as M13."

... Johnson: [Jo17].

Nor has the ambivalence diminished. As noted by Johnson, even though scientists have, meanwhile 'spent far more energy trying to look for signs that other life might exist than they have signaling the existence of our own':

"Now this taciturn phase may be coming to an end, if a growing multidisciplinary group of scientists and amateur space enthusiasts have their own way. A newly formed group known as METI (Messaging Extra Terrestrial Intelligence), led by the former SETI scientist Douglas Vakoch, is planning an ongoing series of messages to begin in 2018."

... Johnson: [Jo17].

However, as Johnson observes further:

"...as messaging schemes proliferate, they have been met with resistance. The intellectual descendents of Martin Ryle include luminaries like Elon Musk and Stephen Hawking, and they caution that an assumption of interstellar friendship is the wrong way to approach the question of extraterrestrial life. They argue that an advanced alien civilization might well respond to our interstellar greetings with the same graciousness that Cortés showed the Aztecs, making silence the more prudent option."

... Johnson: [Jo17].

Comment 237. In a brief survey of the challenges faced, and gradually being overcome⁶¹³ in the quest to situate the emergence of life on Earth in a more appropriate perspective against our growing knowledge of the vastness of even the 'visible' portions of our universe, and the plethora of similar planets that, in principle, have the capacity to harbour life as we know it, astrophysicist Adam Frank notes, in a current essay *Alien life is no joke*, that after '*decades on the cultural margins, the question of life in the Universe beyond Earth is having its day in the sun. The next big multibillion-dollar space telescope (the successor to the James Webb) will be tuned to search for signatures of alien life on alien planets and NASA has a robust, well-funded programme in astrobiology*':

"In the early 1990s, it did seem that no one was very interested in the scientific possibilities for life beyond Earth. NASA's 1976 Viking landers conducted biology experiments on Mars that appeared to close the door on the Red Planet as a home for even microbial life. The trail for life of any kind seemed to have gone cold.

Then, in the mid-1990s, everything changed.

In 1995, scientists announced that they had discovered the first planet orbiting another star—an exoplanet. It was an epoch-making moment. After 2,500 years of arguing about the existence of other worlds, we'd finally proven that the planets in our solar system were not a rarity. Soon, exoplanets were being discovered across the sky. Now we know that pretty much every star you see at night hosts a family of worlds. The next big change came when scientists found a chunk of Mars in Antarctica. The meteorite blown off the red planet (from an ancient asteroid impact) appeared to have signs of fossil life. While that conclusion is no longer accepted, at the time it drove president Bill Clinton to direct NASA to go back to Mars and look for life. Between the discovery of exoplanets and the possibilities of ancient life on Mars, NASA got into astrobiology in a big way. Funding for new research opened up, allowing new and exciting ideas to be proposed and pursued.

⁶¹³In no small measure by broadening our connotation of, and approach to, SETI as the search for 'technosignatures' (see also [FGW22]).

Remarkably, when it comes to exoplanets, we are now also able to see exactly which planets are in their star's habitable zone, where liquid water (the key, we believe, for life) can exist. That means we know exactly where to look in our search for life (something Drake could only dream of).

Even more remarkably, astronomers have learned how to look for alien life on alien worlds using starlight that's traversed the world's atmosphere and is then absorbed by a variety of chemicals on the surface. This means we can search for biosignatures – signatures of chemicals that could be in a planets' atmosphere only because life has put it there.

Spectacular advances in the hunt for biosignatures have meant a profound refinement in the all-important standards of evidence. The earliest version of a biosignature was the presence of oxygen in an alien atmosphere. On Earth, oxygen is a significant atmospheric constituent only because photosynthetic organisms keep it there. Over the past decade, however, astronomers have discovered key mechanisms through which planets without life might generate oxygen-rich air. This was a crucial step in developing methods for evaluating false positives – the ways we think we've gained evidence for life but are, in fact, being fooled. Sophisticated statistical methods for evaluating false positives, as well as other challenges astrobiological evidence will present, are now a robust part of biosignature science.

All these new discoveries and new methods are transforming what we think of as SETI too. A new research field is rising that scientists are calling technosignatures, which embraces the 'classic' efforts of SETI while taking the search for intelligent life into new forms and new directions. (Some scientists still use SETI to refer to the field and that's OK. But for many, including myself, 'technosignatures' correctly captures all that is changing in the field.) Rather than planning for someone to set up a beacon announcing their presence (one premise of the first generation of SETI), we can now look directly at the planets where those civilisations might be just going about their business of 'civilisation-ing'. By searching for signatures of an alien society's day-to-day activities (a technosignature), we're building entirely new toolkits to find intelligent, civilisation-building life. . . .

In the end, what matters is that, after thousands of years of arguing over opinions about life in the Universe, our collective scientific efforts have taken us to the point where we can finally begin a true scientific study of the question. The next big space telescope NASA is planning will be called the Habitable Worlds Observatory. The name tells you all you need to know. We're going all in on the search for life in the Universe because we finally have the capabilities to search for life in the Universe."

... Frank: *Alien life is no joke*, In *aeon*, 30 April 2024.

26.B. So what's new? Unprecedented categorical communication

We shall restrict ourselves here to considering, from the *evidence-based* perspective of this investigation, only one aspect of this complex issue that may need to be reassessed in view of the argumentation of the paper [An16] published in the December 2016 issue of *Cognitive Systems Research*, which suggests:

The possibility of categorical communication between humans and extra-terrestrials.

Since the finitary proof of consistency for the first-order Peano Arithmetic PA ([An16], Theorem 6.8, p.41; see also §2.C.a., Theorem 2.16) entails that PA is a categorical language ([An16], Corollary 7.2, p.41; see also §2.E.b., Corollary 2.18), it raises the possibility of unambiguous and effective, essentially mechanical intelligence based, dialogue with an extra-terrestrial intelligence that, too, may be pro-actively seeking dialogue similarly.

The significance of this is that, historically:

There is no precedent where categorical communication between two spatially separated civilisations preceded first proximal contact;

which, in the case of a first contact between humankind and an extra-terrestrial intelligence, could be by the order of thousands of earthly years!

However, on the not unreasonable assumption that, to the best of our knowledge, the evolution of life anywhere in the cosmos can/ought to be treated as Darwinian, the issue raised by Ryle—of an implicit responsibility against engaging in any scientific endeavour that might jeopardise the survival of humankind—does need to be addressed anew, from the broadest multi-disciplinary perspective, *before* we attempt to investigate whether, and if so how, our ability to communicate categorically within our species can be extended to categorical communication between essentially different species.

In other words, it is not unreasonable to require that we proffer a definitive perspective on both the necessity, and the level, of the SETI/METI-associated responsibility for any implicit assumptions—such as, for instance, the various Theses 28 to 40—when posed the question:

Query 32. *Is fear of actively seeking an ETI merely paranoia, or does it have a rational component?*

raised by Marko Kovic's 2017 ZIPAR Policy Brief [Kov18], where his thesis is that '*METI (Messaging Extra Terrestrial Intelligence) is irrational and should be abandoned*' since:

"No one will answer our METI calls. All METI does is create (existential) risk for humankind."

... Kovic: [Kov18], Abstract.

26.C. Is it rational to fear communicating with an extra-terrestrial intelligence?

Shorn of paranoiac overtones, this fear can be expressed as the query:

Query 33. *Can we responsibly seek communication with an extra-terrestrial intelligence actively (as in the 1974 Aricebo message) or is there a logically sound possibility that we may be initiating a process which could imperil humankind at a future date?*

To place the issue in a debatable perspective, we need to make some reasonable assumptions. For instance, we may reasonably assume that:

Thesis 28. *Any communication with an extra-terrestrial intelligence will involve periods of upto thousands of years between the sending of a message and receipt of a response.*

Thesis 29. *We can only communicate with an essentially different form of extra-terrestrial intelligence in a platform-independent language of a mechanistically reasoning artificial intelligence.*

Thesis 30. *Nature is not malicious and so, for an ETI to be malevolent towards us, they must perceive us as an essentially different form of intelligence that threatens their survival merely on the basis of our communications.*

26.D. Recursive Arithmetic: The language of algorithms

Now, it is reasonable to assume that:

Thesis 31. *The language of algorithmically computable functions and relations is platform-independent.*

This is the algorithm-based machine-language defined by Gödel's recursive arithmetic ([Go31]), by Church's lambda calculus ([Ch36]), by Turing's computing machines ([Tu36]), and by Markov's theory of algorithms ([Mrk54]).

As Mandelbrot has shown ([Mn77]), the language appears sufficiently rich to model a number of complex natural phenomena observed by us ([Bar88], [BPS88], [PR86]), which earlier appeared intractable.

To simplify the issue within reason, we may thus assume that:

Thesis 32. *All natural phenomena which are observable by human intelligence, and which can be modelled by algorithms, are interpretable isomorphically by an extra-terrestrial intelligence.*

However, it is also reasonable to assume that:

Thesis 33. *There are innumerable, distinctly different, observable natural phenomena.*

In other words, the language of algorithms must admit—and require—denumerable primitive symbols for expressing natural phenomena.

Now, an extra-terrestrial intelligence which observes natural phenomena under an interpretation that—although structurally isomorphic to ours—uses different modes/means of observation, may not be able to recognise any of our symbolisms effectively. Hence:

Thesis 34. *A language of algorithms with a denumerable alphabet does not admit categorical communication with an ETI.*

26.E. First-order Peano Arithmetic PA: A universal language of Arithmetic

However, in his seminal 1931 paper on 'formally undecidable' arithmetical sentences, Kurt Gödel showed, essentially (compare [Go31], Theorem VII, p.29; see also §13.D.a., and [Me64], Proposition 3.23, p.131), that:

Lemma 26.1. *Every algorithmically computable number-theoretic function can be formally represented by some formula of a first-order Peano Arithmetic, PA.*

PA is the language defined over the structure \mathcal{N} of the natural numbers—namely, $\{N$ (*the set of natural numbers*); $=$ (*equality*); $'$ (*the successor function*); $+$ (*the addition function*); $*$ (*the product function*); 0 (*the null element*) $\}$.

The axioms and rules of inference of PA are:

PA₁: $[(x_1 = x_2) \rightarrow ((x_1 = x_3) \rightarrow (x_2 = x_3))]$;

PA₂: $[(x_1 = x_2) \rightarrow (x'_1 = x'_2)]$;

PA₃: $[0 \neq x'_1]$;

PA₄: $[(x'_1 = x'_2) \rightarrow (x_1 = x_2)]$;

PA₅: $[(x_1 + 0) = x_1]$;

PA₆: $[(x_1 + x'_2) = (x_1 + x_2)']$;

PA₇: $[(x_1 \star 0) = 0]$;

PA₈: $[(x_1 \star x'_2) = ((x_1 \star x_2) + x_1)]$;

PA₉: For any well-formed formula $[F(x)]$ of PA:

$[(F(0) \rightarrow (\forall x)(F(x) \rightarrow F(x')))] \rightarrow (\forall x)F(x)$.

Modus Ponens in PA: If $[A]$ and $[A \rightarrow B]$ are PA-provable, then so is $[B]$;

Generalisation in PA: If $[A]$ is PA-provable, then so is $[(\forall x)A]$.

PA is a good candidate for a language of universal communication with an ETI because—as Turing showed in 1936—its well-formed formulas can be expressed digitally, and—as Gödel showed in his 1931 paper—Peano Arithmetic has a finite alphabet with finitary rules for:

- (i) the formation of well-formed formulas;
- (ii) deciding whether a given formula is a well-formed formula;
- (iii) deciding whether a given formula is an axiom;
- (iv) deciding whether a finite sequence of formulas is a valid deduction/proof sequence;
- (v) deciding whether a formula is a consequence of the axioms (a theorem).

26.F. Communicating PA and its Theorems categorically

Moreover, since PA is categorical ([An16], Corollary 7.2, p.41; see also §2.E.b., Corollary 2.18) and can be expressed (as entailed by [An16], Theorem 7.1, Provability Theorem for PA, p.41; see also §2.E.b., Theorem 2.17) and beamed digitally, we may reasonably assume that:

Thesis 35. *Any advanced ETI can communicate with us by recognising that the signals we are beaming:*

- (a) *are not random;*
- (b) *contain a primer that defines PA;*
- (c) *contain theorems that describe common natural phenomena as observed by us.*

Carl Sagan obliquely suggested such a strategy in his novel, ‘Contact’ ([Sa85]). Whether, and how, it can be implemented—as suggested above—is an issue beyond the scope of the limited point sought to be addressed in this paper.

26.G. How we currently interpret PA

Currently, the *classical* standard interpretation $\mathcal{I}_{PA(\mathbb{N},S)}$ of PA ([Me64], p.107, *standard model*; see also §2.A.b.) is the one over the structure \mathbb{N} of the natural numbers, where the logical constants have their standard Tarskian interpretation ([Me64], §2, p.49; see also §2.A.):

- (a) the set of non-negative integers is the domain;
- (b) the integer 0 is the interpretation of the symbol [0];
- (c) the successor operation (addition of 1) is the interpretation of the [$'$] function;
- (d) ordinary addition and multiplication are the interpretations of [$+$] and [$*$];
- (e) the interpretation of the predicate letter [$=$] is the identity relation.

26.H. A malevolent ETI must interpret some of our true arithmetical propositions as false

Now, it is not unreasonable—albeit misleading, as we posit in §26.J., Thesis 38—to assume that (as detailed in §15.H.k.):

Thesis 36. *A malevolent ETI could perceive us as an essentially different form of intelligence that threatens their survival if they have an interpretation of PA that is essentially different to our standard interpretation $\mathcal{I}_{PA(\mathbb{N},S)}$ of PA.*

Thesis 37. *An ETI would perceive their interpretation $\mathcal{I}_{PA(\mathbb{N},ET)}$ of PA, over the structure \mathbb{N} of the natural numbers, as essentially different to our standard interpretation $\mathcal{I}_{PA(\mathbb{N},S)}$ of PA if, and only if, there is a PA formula which—from our perspective—would either interpret as ‘false’ under $\mathcal{I}_{PA(\mathbb{N},ET)}$ and ‘true’ under $\mathcal{I}_{PA(\mathbb{N},S)}$, or as ‘true’ under $\mathcal{I}_{PA(\mathbb{N},ET)}$ and ‘false’ under $\mathcal{I}_{PA(\mathbb{N},S)}$.*

26.I. The rational argument for not seeking an ETI pro-actively

In 1931 Gödel detailed an argument from which he concluded that:

- There is an ‘undecidable’ proposition in Peano Arithmetic;
- Two intelligences *can* logically interpret it and arrive at conflicting conclusions.

Once we accept the meta-mathematical and philosophical conclusions that Gödel draws from his formal reasoning in [Go31] as definitive, it *can* be argued that we must—on the basis of our experiences with conflicting belief-driven perspectives between different faiths and cultures on earth—be prepared—both politically and militarily—for the, admittedly far-fetched, possibility that an ETI may:

- Interpret Gödel’s formally ‘undecidable’ proposition as what we would term as ‘false’;
- Believe that any intelligence which interprets the proposition as what we would term ‘true’ (as we do under Gödel’s interpretation of his own formal reasoning in [Go31]; but see also §15.D.) could be a potential threat to it—hence one that must be exterminated!

26.J. Does PA lend itself to essentially different interpretations?

So, the question is: Does PA lend itself to essentially different interpretations?

This question of whether there is a PA formula which can interpret as false under a putative ‘non-standard’ interpretation $\mathcal{I}_{PA(\mathbb{N},NS)}$ of PA, but true under the classical ‘standard’ interpretation $\mathcal{I}_{PA(\mathbb{N},S)}$ (see §2.A.b.), is—almost universally—believed to have been settled

in the affirmative by Gödel in his seminal 1931 paper on formally ‘undecidable’ arithmetical propositions.

However, in this investigation we have shown, from an *evidence-based* (i.e., platform-independent) perspective, that—and why—this belief is misleading, and that we need to read the fine print of Gödel’s paper carefully (see §15.A.) to see why this belief is founded on an untenable assumption (see §18.) whose roots lie in the faith-based (see §7.B.) extrapolation of Aristotle’s particularisation to infinite domains.

Moreover, since we have shown that PA is categorical (see §2.E.b., Corollary 2.18), it would follow that:

Thesis 38. *Any extra-terrestrial intelligence which is capable of learning the language PA would interpret the satisfaction, and truth, of the formulas of PA—under a well-defined interpretation of PA—precisely as would a human intelligence.*

Finally, if we accept Thesis 28, Thesis 29, and Thesis 30, then it is reasonable to posit further that:

Thesis 39. *Since thousands, if not millions, of years would elapse before a putative first, spatially separated, contact with any extra-terrestrial intelligence, and any putative subsequent, proximal, contact between the two species:*

(a) *any species that survives over eons must evolve in harmony with its environment through intellectual evolution and respect for natural law;*

(b) *categorical communications between the two species in the interregnum would engender, and nurture, respect for life forms with:*

— *seemingly comparable respect for natural law; and*

— *the capacity for survival through intellectual evolution.*

In other words, on both temporal and spiritual grounds, our thoughts and explorations ought not to be fearfully limited by the false trails human societies have often followed in the past, but should be fearlessly guided by the lessons that current societies evince—by the direction of their present states of evolution—as having been learnt, no matter how hesitatingly and imperfectly, from past experiences; a direction that would suggest placing faith in the belief that:

Thesis 40. *Any extra-terrestrial intelligence would not rationally perceive us as being an essentially different form of intelligence that would necessarily be inimical to their interests and/or survival.*

We could even argue that an extra-terrestrial intelligence would be so far advanced, and so secure in its own evolution, that it would not behave irrationally when faced with evidence of a parallel cosmic evolution; and, moreover that we have a moral responsibility towards cosmic intelligence to leave a ‘time capsule’ that might, conceivably, outlast our species:

“Near the end of my conversation with Frank Drake, I came back to the question of our increasingly quiet planet: all those inefficient radio and television signals giving way to the undetectable transmissions of the internet age. Maybe that’s the long-term argument for sending intentional messages, I suggested; even if it fails in our lifetime, we will have created a signal that might enable an interstellar connection thousands of years from now.

Drake leaned forward, nodding. “It raises a very interesting, nonscientific question, which is: Are extraterrestrial civilizations altruistic? Do they recognize this problem and establish a beacon for the benefit of the other folks out there? My answer is: I think it’s actually Darwinian; I think evolution favors altruistic societies. So my guess is yes. And that means there might be one powerful signal for each civilization.” Given the transit time across the universe, that signal might well outlast us as a species, in which case it might ultimately serve as a memorial as much as a message, like an interstellar version of the Great Pyramids: proof that a technologically advanced organism evolved on this planet, whatever that organism’s ultimate fate.”

... Johnson: [Jo17].

Nevertheless—taking into consideration what is historically evident in human societies—there can be no definitive *scientific* perspective on what, eventually, *must* remain a globally *inclusive* political assessment:

“There is something about the METI question that forces the mind to stretch beyond its usual limits. You have to imagine some radically different form of intelligence, using only your human intelligence. You have to imagine time scales on which a decision made in 2017 might trigger momentous consequences 10,000 years from now. The sheer magnitude of those consequences challenges our usual measures of cause and effect. Whether you believe that the aliens are likely to be warriors or Zen masters, if you think that METI has a reasonable chance of making contact with another intelligent organism somewhere in the Milky Way, then you have to accept that this small group of astronomers and science-fiction authors and billionaire patrons debating semi-prime numbers and the ubiquity of visual intelligence may in fact be wrestling with a decision that could prove to be the most transformative one in the history of human civilization.

All of which takes us back to a much more down-to-earth, but no less challenging, question: Who gets to decide? After many years of debate, the SETI community established an agreed-upon procedure that scientists and government agencies should follow in the event that the SETI searches actually stumble upon an intelligible signal from space. The protocols specifically ordain that “no response to a signal or other evidence of extraterrestrial intelligence should be sent until appropriate international consultations have taken place.” But an equivalent set of guidelines does not yet exist to govern our own interstellar outreach.

One of the most thoughtful participants in the METI debate, Kathryn Denning, an anthropologist at York University in Toronto, has argued that our decisions about extraterrestrial contact are ultimately more political than scientific. “If I had to take a position, I’d say that broad consultation regarding METI is essential, and so I greatly respect the efforts in that direction,” Denning says. “But no matter how much consultation there is, it’s inevitable that there will be significant disagreement about the advisability of transmitting, and I don’t think this is the sort of thing where a simple majority vote or even supermajority should carry the day . . . so this keeps bringing us back to the same key question: Is it O.K. for some people to transmit messages at significant power when other people don’t want them to?”

In a sense, the METI debate runs parallel to other existential decisions that we will be confronting in the coming decades, as our technological and scientific powers increase. Should we create superintelligent machines that exceed our own intellectual capabilities by such a wide margin that we cease to understand how their intelligence works? Should we “cure” death, as many technologists are proposing? Like METI, these are potentially among the most momentous decisions human beings will ever make, and yet the number of people actively participating in those decisions—or even aware such decisions are being made—is minuscule.”

... Johnson: [Jo17].

Johnson's disquiet echoes a parallel uneasiness—albeit in a different discipline—expressed by mathematician Melvyn B. Nathanson who, in his 2008 essay ‘Desperately Seeking Mathematical Truth’ ([Na08]; see also §20.), cautioned about the consequences of treating as definitive debatable decisions in the very foundations of mathematics where, too, ‘the number of people actively participating in those decisions—or even aware such decisions are being made—is minuscule’. Similar disquiet is shared, as Johnson reports further, by Denning:

“When I asked Denning where she stands on the METI issue, she told me: “I have to answer that question with a question: Why are you asking me? Why should my opinion matter more than that of a 6-year-old girl in Namibia? We both have exactly the same amount at stake, arguably, she more than I, since the odds of being dead before any consequences of transmission occur are probably a bit higher for me, assuming she has access to clean water and decent health care and isn't killed far too young in war.” She continued: “I think the METI debate may be one of those rare topics where scientific knowledge is highly relevant to the discussion, but its connection to obvious policy is tenuous at best, because in the final analysis, it's all about how much risk the people of Earth are willing to tolerate. . . . And why exactly should astronomers, cosmologists, physicists, anthropologists, psychologists, sociologists, biologists, sci-fi authors or anyone else (in no particular order), get to decide what those tolerances should be?”

... Johnson: [Jo17].

Johnson concludes that:

“Wrestling with the METI question suggests, to me at least, that the one invention human society needs is more conceptual than technological: We need to define a special class of decisions that potentially create extinction-level risk. New technologies (like superintelligent computers) or interventions (like METI) that pose even the slightest risk of causing human extinction would require some novel form of global oversight. And part of that process would entail establishing, as Denning suggests, some measure of risk tolerance on a planetary level. If we don't, then by default the gamblers will always set the agenda, and the rest of us will have to live with the consequences of their wagers.

In 2017, the idea of global oversight on any issue, however existential the threat it poses, may sound naïve. It may also be that technologies have their own inevitability, and we can only rein them in for so long: If contact with aliens is technically possible, then someone, somewhere is going to do it soon enough. There is not a lot of historical precedent for humans voluntarily swearing off a new technological capability—or choosing not to make contact with another society—because of some threat that might not arrive for generations. But maybe it's time that humans learned how to make that kind of choice. This turns out to be one of the surprising gifts of the METI debate, whichever side you happen to take. Thinking hard about what kinds of civilization we might be able to talk to ends up making us think even harder about what kind of civilization we want to be ourselves.”

... Johnson: [Jo17].

CHAPTER 26. PARADIGM CHALLENGING CONSEQUENCES

27. The significance of *evidence-based* reasoning for Cognitive Science

27.A. Mathematical idea analysis

In their compelling narrative *Where Mathematics Comes From* ([LR00]), cognitive scientists Lakoff and Núñez attempt to address the nature of what is commonly accepted as the body of knowledge intuitively viewed as the domain of *abstract* mathematical ideas, by introducing the concept of *mathematical idea analysis* and enquiring:

Query 34. *How can cognitive science bring systematic scientific rigor to the realm of human mathematical ideas, which lies outside the rigor of mathematics itself?*

Lakoff and Núñez argue that:

- Mathematics needs to be understood from a cognitive perspective;
- Mathematics is the epitome of precision;
- Intellectual content of mathematics lies in its ideas, not symbols;
- Formal symbols merely characterise the nature and structure of mathematical ideas;
- Human ideas are grounded in sensory-motor mechanisms;
- Abstract human ideas make use of precisely formulatable cognitive mechanisms such as conceptual metaphors that import modes of reasoning from sensory-motor experience;
- It is *always* an empirical question what human ideas are like, mathematical or not.

They specifically attempt to address the issues:

- How can human beings understand the idea of actual infinity?
- Where do the laws of mathematics come from?
- Why does every proposition follow from a contradiction?

They argue that this involves a prior understanding of:

- Basic cognitive semantics;
- Understanding the cognitive structure of mathematics.

Mathematical idea analysis: Lakoff and Núñez' cognitive perspective

"We are cognitive scientists—a linguist and a psychologist—each with a long-standing passion for the beautiful ideas of mathematics. As specialists within a field that studies the nature and structure of ideas, we realized that despite the remarkable advances in cognitive science and a long tradition in philosophy and history, there was still no discipline of *mathematical idea analysis* from a cognitive perspective—no cognitive science of mathematics. . . .

A discipline of this sort is needed for a simple reason. Mathematics is deep, fundamental, and essential to the human experience. As such, it is crying out to be understood.

It has not been.

Mathematics is seen as the epitome of precision, manifested in the use of symbols in calculation and in formal proofs. Symbols are, of course, just symbols, not ideas. The intellectual content of mathematics lies in its ideas, not in the symbols themselves. In short, the intellectual content of mathematics does not lie where the mathematical rigor can be most easily seen—namely, in the symbols. Rather, it lies in human ideas.

But mathematics by itself does not and cannot *empirically* study human ideas; human cognition is simply not its subject matter. It is up to cognitive science and the neurosciences to do what mathematics itself cannot do—namely apply the science of mind to human mathematical ideas. . . .

One might think that the nature of mathematical ideas is a simple and obvious matter, that such ideas are just what mathematicians have consciously taken them to be. From that perspective, the commonplace formal symbols do as good a job as any at characterizing the nature and structure of those ideas. If that were true, nothing more would need to be said.

But those of us who study the nature of concepts within cognitive science know, from research in the field, that the study of human ideas is not so simple. Human ideas are, to a large extent, grounded in sensory-motor experience. Abstract human ideas make use of precisely formulatable cognitive mechanisms such as conceptual metaphors that import modes of reasoning from sensory-motor experience. It is *always* an empirical question what human ideas are like, mathematical or not.

The central question we ask is this: How can cognitive science bring systematic *scientific rigor* to the realm of human mathematical ideas, which lies outside the rigor of mathematics itself? Our job is to help make precise what mathematics itself cannot—the nature of mathematical ideas."

. . . Lakoff and Núñez: [LR00], Preface, pp.xi-xii.

Now, *prima facie* such a perspective faces a number of philosophical and mathematical challenges from *evidence-based* reasoning. For instance:

- "The intellectual content of mathematics lies in its ideas, not in the symbols themselves."

As compared to the *evidence-based* perspective of this investigation that mathematics is a set of formal languages (as detailed in §13.; see also §13.C.), what is the concept of 'mathematics' that Lakoff and Núñez have in mind? What is the assurance that both authors are referring to the same concept? To what does 'its' refer?

- "In short, the intellectual content of mathematics does not lie where the mathematical rigor can be most easily seen—namely, in the symbols. Rather, it lies in human ideas."

To what does the expression 'human ideas' refer in this context? From the *evidence-based* perspective of this investigation, are what Lakoff and Núñez refer to as 'human ideas' here conceptual metaphors that ought to be treated as what Pantsar terms as *pre-formal*

mathematics in [Pan09] (§4. Formal and pre-formal mathematics) (corresponding to Carnap's *explicandum*; see §13.C.); or ought they to be treated, classically, as what mathematicians would refer to as the interpretations of a formal mathematical language—over the domain in which the metaphors are formulated or defined—in Tarski's sense (as detailed in §2.A.)?

We note that this domain can also, again not unreasonably, be taken to be that of an informal interpretation of the first-order set theory ZFC over Lakoff and Núñez's conceptual metaphors, since a tacit thesis of this investigation (Thesis 41) is that their analysis establishes that all the abstract mathematical concepts dissected in Chapters 5 to 14 of [LR00]—including concepts involving 'potential' and 'actual' infinities—can be viewed as conceptual metaphors which are expressible (if treated as Carnap's *explicandum*) in the language of the first-order Set Theory ZFC; a perspective that would lend legitimacy to conventional wisdom which—as detailed in §20.B. (see also [Ma18])—is that all mathematical concepts are definable in ZFC.

- "...*human cognition is simply not its subject matter.*"

What can the term 'mathematics' refer to in this context? Would the authors accept that 'mathematics' is a set of formal, symbolic, languages? If so, how can a language per se have a subject matter?

- "*It is up to cognitive science and the neurosciences to do what mathematics itself cannot do—namely apply the science of mind to human mathematical ideas.*"

Do the authors mean ideas about the interpretations of mathematical symbols, or ideas expressible in mathematical symbols (where we would take the former to be the conceptual metaphors by which we intend to represent our sensory perceptions in a language)?

- "*One might think that the nature of mathematical ideas is a simple and obvious matter, that such ideas are just what mathematicians have consciously taken them to be.*"

Which mathematicians?

- Those (see §11.A.) who believe—without evidence—both that first-order logic is consistent, and that Hilbert's formal, ε -based, definitions of quantification will not lead to a fatal mathematical contradiction?
- Or those (see §11.B.) who—again without evidence—do not accept first-order logic as consistent (since they deny the Law of the Excluded Middle), whilst following Brouwer in denying legitimacy to Hilbert's formal definitions of quantification in mathematical reasoning?
 - * The former treat mathematical reasoning as manipulation of a selected, finite, set of identifiable symbols into patterns (termed 'proofs') obeying a well-defined set of finitary rules, without requiring the symbols or patterns to be necessarily associated with any meaning (interpretation). Mathematical ideas to them are precisely the formal properties of, and inter-relations between, such patterns. They do not need an interpretation into a non-symbolic universe.
 - * The latter treat mathematical reasoning as representing statements that can be interpreted as either 'true' or "false' with reference to *evidence-based* properties of objects in the physical universe.

- “*It is always an empirical question what human ideas are like, mathematical or not.*”

Does this mean that, for Lakoff and Núñez, ideas can be mathematical or not? If so, what would be a non-mathematical idea? Could an idea expressed in English be termed as an ‘English’ idea?

- “*Our job is to help make precise what mathematics itself cannot—the nature of mathematical ideas.*”

Would this not implicitly imply that ideas can exist in a Platonic universe of ideas?

Thus, from the *evidence-based* perspective of this investigation, it would seem that Lakoff and Núñez unwittingly conflate the use of the term ‘mathematics’ when referring to a set of formal, symbolic, languages (in the sense of §13.), with what is intended to be expressed or represented in such languages.

The distinction may be significant for Lakoff and Núñez’s *mathematical idea analysis*, especially if the goal of such analysis is ‘to provide a new level of understanding in mathematics’.

27.B. Extending Lakoff and Núñez’s intent on ‘understanding’

“ The purpose of of mathematical idea analysis is to provide a new level of understanding in mathematics. It seeks to explain *why* theorems are true on the basis of what they mean. It asks what ideas—especially what metaphorical ideas—are built into axioms and definitions. It asks what ideas are implicit in equations and how *ideas* can be expressed by mere numbers. And finally it asks what is the ultimate grounding of each complex idea. That, as we shall see, may require some complicated analysis:

1. tracing through a complex mathematical idea network to see what the ultimate grounding metaphors in the network are;
2. isolating the linking metaphors to see how basic grounded ideas are linked together;
3. figuring out how the immediate understanding provided by the individual grounding metaphors permits one to comprehend the complex idea as a whole.”

... Lakoff and Núñez: [LR00], Chapter 15, p.338.

However, in this informal interpretation of Lakoff and Núñez’s argumentation, we shall ignore such pedantries and, without engaging in technical niceties regarding cognition and cognitive semantics⁶¹⁴, for the purposes of this investigation attempt to informally extend Lakoff and Núñez’s intent on the nature of *understanding* by an individual mind⁶¹⁵ of a concept created in the mind by differentiating as below (compare with §13.F.):

- (a) *Subjective understanding* (compare with §13.F.(i)): which we view as an individual mind’s perspective involving pattern recognition of a selected set of truth assignments by the individual to declarative sentences of a symbolic language, based on the individual’s *uncritical personal* beliefs of a correspondence between:

⁶¹⁴For a critical review of Lakoff and Núñez’s concept of *mathematical idea analysis* from a cognitive perspective see [Md01].

⁶¹⁵Although Lakoff and Núñez restrict their considerations to the sensory perceptions of the human mind, we shall assume that their findings and conclusions would apply to the sensory perceptions of any intelligence that is capable of creating a mechanical intelligence which can reason as detailed in [An16].

- what is *believed* as true (as reflected by the truth assignments); and
 - what is perceived and *pronounced* as ‘factual’ (reflecting *uncritical* conclusions drawn from individual cognitive experience) in a common external world;
- (b) *Projective understanding* (compare with §13.F.(ii)): which we view as an individual mind’s perspective involving pattern recognition of a selected set of truth assignments by the individual to declarative sentences of a symbolic language, based on the individual’s *critical plausible* belief of a correspondence between:
- what is *assumed*, or *postulated*, as true (as reflected by the truth assignments); and
 - what is perceived and *projected* as ‘factual’ (reflecting *plausible* conclusions drawn from individual cognitive experience) in a common external world;
- (c) *Collaborative (objective) understanding* (compare with §13.F.(iii)): which we view as an individual mind’s perspective involving pattern recognition of a selected set of truth assignments by the individual to declarative sentences of a symbolic language, based on the individual’s *shared evidence-based* belief of a correspondence between:
- what is *accepted by convention* as true (as reflected by *evidence-based* truth assignments—such as those detailed in §2.B., §2.C., and §12.B.d.); and
 - what is perceived and *conjectured* as ‘factual’ (reflecting shared *evidence-based* cognitive experiences) in a common external world.

In other words, from an *evidence-based* perspective, the ‘understanding’ of an abstract mental concept—whether *subjective*, *projective*, or *collaborative*—is not limited, as Lakoff and Núñez appear to suggest, in merely identifying the conceptual metaphors that are used to describe the concept within a language; it must encompass, further, awareness of the *evidence-based* assignments of truth values to the declarative sentences of the language—in which the conceptual metaphors are expressed—that correspond, or are believed to correspond, to what is perceived or conjectured as ‘factual’ cognitive experiences in a common external world.

From the perspective of Information Theory, the distinction sought to be made here may be broadly viewed as that drawn by Björn Lundgren between ‘the property of being information and the property of being informative’:

“Ever since Luciano Floridi re-invigorated the veridicality thesis (that [semantic] information must be true, or truthful), the discussion of this issue has been expanding (see Floridi 2004, 2005; cf. Fetzer 2004; Dodig-Crnkovic 2005). Although Floridi claims that various critical comments have “been proved unjustified, and as a result, there is now a growing consensus” about his approach (Floridi 2012, p. 432, footnotes removed), the discussion has continued. Recently, I argued that Floridi’s proposed definitions suffer from counter-examples such that *the sentence x is information if, and only if, x is not information* (see Lundgren 2015a). The same idea was later developed and expanded by Macaulay Ferguson (2015), who furthermore argues that the choice of the definition of semantic information (between a veridical and an alethically neutral conception) is a dilemma because it is a choice between two paradoxes: information liar paradoxes and the Bar-Hillel Carnap paradox (BCP); both will be explained in this paper. This dilemma will serve as part of the dialectics of this essay.

The main aim of this essay is to argue for an alethically neutral conception of semantic information. This argument will be made by presenting counter-arguments against Floridi’s main arguments

for the veridicality thesis, as well as showing that a veridical conception of semantic information leads to a contradiction. I consider Floridi's arguments because he is currently the most influential proponent of the veridicality thesis and of a semantic conception of information. The main contribution of this essay is that an alethically neutral conception of semantic information can avoid the BCP, thus resolving the supposed dilemma between alethically neutral and veridical conceptions of semantic information. This is done by introducing a distinction between the property of being information and the property of being informative. Overall, combined with the other arguments, this speaks in favor of an alethically neutral conception of semantic information and against the veridicality thesis.

However, a preference for an alethically neutral conception over a veridical conception of semantic information does not mean that we cannot, or should not, retain the latter concept. I conclude that we should retain it as a subconcept of the former concept, i.e., as *veridical semantic information*."

... Lundgren: [Lun17], p.2.

Accordingly, we shall treat Lakoff and Núñez's *mathematical ideas* to refer not to some putative *content* of some abstract structure, conceived by an individual mind in a platonic domain of *ideas* some of which can be termed as of a mathematical nature, but to the pattern recognition of some selected set of 'truth' assignments to (presumed faithful⁶¹⁶) representations—of conceptual metaphors grounded in sensory motor perceptions—by an individual mind in an artificially constructed symbolic language that can be termed as 'mathematical'.

'Mathematical' in the sense that the language—in sharp contrast to languages of common discourse, which embrace ambiguity as essential for capturing and expressing the full gamut of any cognitive experience of our common external world⁶¹⁷—is designed to facilitate unambiguous pattern recognition of a narrowly selected aspect of a cognitive experience⁶¹⁸—and its effective communication to another mind—between the limited perception which was sought to be represented, and its representation at any future recall.

This reflects the underlying thesis of this investigation that (see §13.; also §13.C.):

- (i) Mathematics is to be considered as a set of precise, symbolic, languages.
- (ii) Any language of such a set, say the first order Peano Arithmetic PA (or Russell and Whitehead's PM in Principia Mathematica, or the Set Theory ZF), is intended to express—in a finite, unambiguous, and communicable manner—relations between elements that are external to the language PA (or to PM, or to ZF).
- (iii) Moreover, each such language is two-valued if we assume that a specific relation either holds or does not hold externally under any valid interpretation of the language.

27.C. How can human beings understand the idea of actual infinity?

Lakoff and Núñez's lack of an unambiguous perspective towards their use of the term 'mathematics' is also reflected in their analysis of how human beings understand the idea of actual infinity from a cognitive perspective:

⁶¹⁶By some effective procedure such as, for example, Tarski's inductive definitions of the satisfiability and truth of the formulas of a formal mathematical language under a Tarskian interpretation (as detailed in §2.A.).

⁶¹⁷The absurd extent to which languages of common discourse need to tolerate ambiguity; both for ease of expression and for practical—even if not theoretically unambiguous and effective—communication in non-critical cases amongst intelligences capable of a lingua franca, is briefly addressed in Chapter 20.

⁶¹⁸Compare this with Löb's remarks that: "While classical mathematics owes its development to a naive meta-physical conception of the physical world, from the constructivist point of view mathematics may rather be regarded to be an abstract reconstruction of a private phenomenological world." ... Löb: [Lob59], p.164.

“How can human beings understand the idea of actual infinity?”

... Núñez had begun an intellectual quest to answer these questions: How can human beings understand the idea of actual infinity?—infinity conceptualized as a thing, not merely as an unending process? What is the concept of actual infinity in its mathematical manifestations—points at infinity, infinite sets, infinite decimals, infinite intersections, transfinite numbers, infinitesimals? He reasoned that since we do not encounter actual infinity directly in the world, since our conceptual systems are finite, and since we have no cognitive mechanisms to perceive infinity, there is a good possibility that metaphorical thought may be necessary for human beings to conceptualize infinity. If so, new results about the structure of metaphorical concepts might make it possible to precisely characterize the metaphors used in mathematical concepts of infinity.

... We soon realized that such a question could not be answered in isolation. We would need to develop enough of the foundations of mathematical idea analysis so that the question could be asked and answered in a precise way. We would need to understand the cognitive structure not only of basic arithmetic but also of symbolic logic, the Boolean logic of classes, set theory, parts of algebra, and a fair amount of classical mathematics: analytic geometry, trigonometry, calculus, and complex numbers. That would be a task of many lifetimes. ...

So we adopted an alternative strategy. We asked, What would be the minimum background needed

- to answer Núñez’s questions about infinity,
- to provide a serious beginning for a discipline of mathematical idea analysis, ...

As a consequence, our discussion of arithmetic, set theory, logic, and algebra are just enough to set the stage for our subsequent discussions of infinity and classical mathematics. just enough for that job, but not trivial ...

... Lakoff and Núñez: [LR00], Preface, p.xii-p.xiii.

And as we shall see, Núñez was right about the centrality of conceptual metaphor to a full understanding of infinity in mathematics. There are two infinity concepts in mathematics—one literal and one metaphorical. The literal concept (“in-finity”—lack of an end) is called “potential infinity”. It is simply a process that goes on without end, like counting without stopping, extending a line segment indefinitely, or creating polygons with more and more sides. No metaphorical ideas are needed in this case. Potential infinity is a useful notion in mathematics, but the main event is elsewhere. The idea of “actual infinity,” where infinity becomes a *thing*—an infinite set, a point at infinity, a transfinite number, the sum of an infinite series—is what is really important. Actual infinity is fundamentally a metaphorical idea, just as Núñez had suspected. The surprise for us was that *all* forms of actual infinity—points at infinity, infinite intersections, transfinite numbers, and so on—appear to be special cases of just one Basic Metaphor of Infinity. This is anything but obvious. ...”

... Lakoff and Núñez: [LR00], Preface, p.xvi.

From the *evidence-based* perspective of this investigation, however, it is precisely because ‘we do not encounter actual infinity directly’, and ‘since we have no cognitive mechanisms to perceive infinity’, that mathematicians classically—following Hilbert—postulate an ‘idealised’ existence for such a concept by means of a—not necessarily *evidence-based*—‘definitional’ axiom in the sense of Hermann Weyl’s ‘implicit definition’ (see §12.A.a.) and then create symbols such as ∞ , ω , \aleph , etc., in a purely artificial mathematical universe.

The subjective—and arbitrary—postulational character of such axioms becomes evident if we view axioms not as implicit or explicit definitions, but as part of the rules of the logic that, reasonably, *seeks* to assign *unambiguous* truth values to the well-formed formulas of a language as proposed by Definitions 32, 33 and 34 in §12..

As further expressed by Weyl from an early-intuitionistic point of view:

“An arithmetical construction of geometry that respects the logical content of the geometric axioms is clearly a significant step toward a system of concepts explicitly defined on the basis of purely logical concepts. This quest to logicize mathematics gains further ground in the well-known theory of the irrationals due to Cantor, Dedekind, and Weierstrass in which the concept of the real numbers is reduced to that of the rational and, eventually, the natural numbers $1, 2, 3, \dots$. But the work of Dedekind and Cantor showed that the natural numbers and the associated operations of addition, multiplication, etc. are based on a discipline exceedingly close to pure logic: Cantor’s set theory. So we now consider set theory to be, from a logical standpoint, the genuine foundation of the mathematical sciences and, hence, we must turn to it if we wish to formulate principles of definition that suffice, not just for elementary geometry, but for mathematics as a whole.

Now, however, suspicions having been aroused by some contradictions (real or imagined), there is a clash of contrary opinions about the fundamental questions of set theory. In discussions of these questions, logico-mathematical and psychological points of view have often been mixed together.

In the development of the human intellect (*Geist*), the concept of set and number has passed through distinct stages. At the first stage, an actual aggregation (*eigentliche Inbegriffsvorstellung*) occurs when a unitary interest draws from the content of our consciousness the perceptions (*Vorstellungen*) of several separately observed (*für sich bemerkter*) objects and unites them. At this stage, the earliest numerals (e.g., 2, 3, and 4) designate immediately observable differentiations of the psychic act operating in the aggregation.

At the second stage, symbolic representations replace actual perceptions (*treten für die eigentlichen Vorstellungen symbolische ein*). The most significant product of this second period is the well-known symbolic procedure of counting, familiar to every child, through which sets (and not just the smallest) can be distinguished in terms of their cardinal number. Here a certain feeling for the possible is one of the essential formative elements. In our effort to cope with the external world, we do not feel constrained by the accidental limitations and shortcomings of our sense organs and cognitive faculties. Cantor’s introduction of his transfinite ordinals (an innovation motivated by the iterated formation of derived point-sets) perfectly illustrates the procedure characteristic of this second stage. Cantor placed a new element ω after the series $1, 2, 3, \dots$ and conceived the progressive extension of the domain of numbers as follows:

$$\begin{array}{c}
 1, 2, 3, \dots \\
 \omega, \omega + 1, \omega + 2, \dots \\
 (\omega 2), (\omega 2) + 1, (\omega 2) + 2, \dots \\
 \dots \dots \dots \\
 \omega^2, \omega^2 + 1, \omega^2 + 2, \dots \\
 \omega^2 + \omega \\
 \dots \dots \dots \\
 \omega^3, \dots \\
 \dots \dots \dots \\
 \omega^\omega, \dots \\
 \dots \dots \dots
 \end{array}$$

An actual perception of infinite sets—in the sense that their individual elements are simultaneously present as separately observed contents in our consciousness—is unattainable. It does not follow, though, that infinite sets are logically illegitimate. After all, an actual presentation to consciousness of a set with a large number of elements can be unattainable even when the set is finite. So it is true that “there is no actual infinity” only in the sense that the actual presence to consciousness of infinite manifolds is impossible.”

It is thus the axioms themselves that are, then, the conceptual metaphors for the symbols that are intended to represent the postulated Platonic entities. In the absence of *evidence-based* conventions, the symbols not only have no physical significance—as Weyl seeks to convey—but, as the examples in §20.C. have shown, they can be misleading as to the actual behaviour of physical systems in the limiting cases which are sought to be adequately expressed and unambiguously communicated in a mathematical language.

27.D. What does a mathematical representation reflect?

Nevertheless, the significance for *evidence-based* reasoning of Lakoff and Núñez’s analysis of those conceptual metaphors which are most appropriately represented in a mathematical language, lies in their conclusion that all representations of physical phenomena in a mathematical language are ultimately grounded not in any ‘abstract, transcendent’, genetically inherited, knowledge, but in conceptual metaphors that import modes of reasoning reflecting, and endemic to, human sensory-motor-experience.

What do the mathematical representations of the laws of arithmetic reflect?

“... We seek, *from a cognitive perspective*, to provide answers to such questions as, Where do the laws of arithmetic come from? Why is there a unique empty class and why is it a subclass of all classes? Indeed why, in formal logic, does every proposition follow from a contradiction? Why should anything at all follow from a contradiction?

From a cognitive perspective, these questions cannot be answered merely by giving definitions, axioms, and formal proofs. That just pushes the question one step further back. How are those definitions and axioms understood? To answer questions at this level requires an account of ideas and cognitive mechanisms. Formal definitions and axioms are *not* basic cognitive mechanisms; indeed, they themselves require an account in cognitive terms.

One might think that the best way to understand mathematical ideas would be simply to ask mathematicians what they are thinking. Indeed, many famous mathematicians, such as Descartes, Boole, Dedekind, Poincaré, Cantor, and Weyl, applied this method to themselves, introspecting about their own thoughts. Contemporary research on the mind shows that as valuable as this can be, it can at best tell a partial and not fully accurate story. Most of our thoughts and our system of concepts are part of the cognitive unconscious ... We human beings have no direct access to our deepest forms of understanding. The analytic techniques of cognitive science are necessary if we are to understand how we understand.

But the more we have applied what we know about cognitive science to understand the cognitive structure of mathematics, the more it has become clear that this romance cannot be true. Human mathematics, the only kind of mathematics that human beings know, cannot be a subspecies of an abstract, transcendent mathematics. Instead, it appears that mathematics as we know it arises from the nature of our brains and our embodied experience. As a consequence, *every* part of the romance appears to be false, for reasons that we will be discussing.

Perhaps most surprising of all, we have discovered that a great many of the most fundamental mathematical ideas are inherently metaphorical in nature:

- The *number line*, where numbers are conceptualized metaphorically as points on a line.
- Boole’s *algebra of classes*, where the formation of classes of objects is conceptualized metaphorically in terms of algebraic operations and elements: plus, times, zero, one, and so on.
- *Symbolic logic*, where reasoning is conceptualized metaphorically as mathematical calculation using symbols.

- *Trigonometric functions*, where angles are conceptualized metaphorically as numbers.
- The *complex plane*, where multiplication is conceptualized metaphorically in terms of rotation.

... None of what we have discovered is obvious. Moreover, it requires a prior understanding of a fair amount of basic cognitive semantics and of the overall cognitive structure of mathematics." ...

... Lakoff and Núñez: [LR00], Preface, pp.xiii-xvii.

We note that, from an *evidence-based* perspective, the ‘laws’ of a mathematical language (i.e., the axioms and rules of inference) are the ‘logical’ conventions (in the sense of §12.) that assign veridicality to mathematical assertions purporting to adequately express and unambiguously communicate properties about objects in the real world that are accessible to our senses.

Further, ‘logic’ is purely a convention that, in the sense of §12., artificially ‘completes’ the world of facts by adding non-facts (in the sense of ‘false propositions’).

27.E. Lakoff and Núñez’s cognitive argument

Moreover, from the *evidence-based* perspective of this investigation, a significant conclusion of Lakoff and Núñez’s cognitive argumentation is that:

“Mathematics as we know it has been created and used by human beings: mathematicians, physicists, computer scientists, and economists—all members of the species *Homo sapiens*. This may be an obvious fact, but it has an important consequence. Mathematics as we know it is limited and structured by the human brain and human mental capacities. The only mathematics we know or can know is a brain-and-mind based mathematics.

As cognitive science and neuroscience have learned more about the human brain and mind, it has become clear that the brain is not a general-purpose device. The brain and body co-evolved so that the brain could make the body function optimally. Most of the brain is devoted to vision, motion, spatial understanding, interpersonal interaction, coordination, emotions, language, and everyday reasoning. Human concepts and human language are not random or arbitrary; they are highly structured and limited, because of the limits and structure of the brain, the body, and the world." ...

... Lakoff and Núñez: [LR00], Introduction, p.1.

Accordingly—within the already noted limitations of their perspective of *mathematical idea analysis*—Lakoff and Núñez argue that any postulation of the existence of Platonic mathematical entities that are not ultimately grounded in metaphors reflecting our sensory motor perceptions is not supported by the findings of cognitive scientists.

Such postulation can only, therefore, be treated as an essentially unverifiable article of faith that reflects a *personal* belief (in the sense of §13.F.(i)) which can have no bearing on any application of mathematical reasoning to the understanding (in the sense of §27.B.) of what is common to either our mental concepts, or our external world (as argued persuasively by Krajewski on purely philosophical and mathematical grounds in [Kr16]—see Chapter 11.D.).

Moreover, Lakoff and Núñez argue further that their above *observation immediately raises two questions*:

1. Exactly what mechanisms of the human brain and mind allow human beings to formulate mathematical ideas and reason mathematically?

2. Is brain-and-mind based mathematics all that mathematics *is*? Or is there, as Platonists have suggested, a disembodied mathematics transcending all bodies and minds and structuring the universe—this universe and every possible universe?

Question 1 asks where mathematical ideas come from and how mathematical ideas are to be analyzed from a cognitive perspective. Question 1 is a scientific question, a question to be answered by cognitive science, the interdisciplinary science of the mind. As an empirical question about the human mind and brain, it cannot be studied purely within mathematics. And as a question for empirical science, it cannot be answered by an a priori philosophy or by mathematics itself. It requires an understanding of human cognitive processes and the human brain. Cognitive science matters to mathematics because only cognitive science can answer this question.

... We will be asking how normal human cognitive mechanisms are employed in the creation and understanding of mathematical ideas. Accordingly, we will be developing techniques of mathematical idea analysis.

But it is Question 2 that is at the heart of the philosophy of mathematics. It is a question that most people want answered. Our answer is straightforward:

- Theorems that human beings prove are within a human mathematical conceptual system.
- All the mathematical knowledge that we have or can have is knowledge within human mathematics.
- There is no way to know whether theorems proved by human mathematicians have any objective truth, external to human beings or any other beings.

The basic form of the argument is this:

1. The question of the existence of a Platonic mathematics cannot be addressed *scientifically*. At best, it can only be a matter of faith, much like faith in a God. That is, Platonic mathematics, like God, cannot in itself be perceived or comprehended via the human body, brain, and mind. Science alone can neither prove nor disprove the existence of a Platonic mathematics, just as it cannot prove or disprove the existence of a God.
2. As with the conceptualization of God, all that is possible for human beings is an understanding of mathematics in terms of what the human brain and mind afford. The only conceptualization that we can have of mathematics is a human conceptualization. Therefore, mathematics as we know it and teach it can only be humanly created and humanly conceptualized mathematics.
3. What human mathematics is, is an empirical scientific question, not a mathematical or a priori philosophical question.
4. Therefore, it is only through cognitive science—the interdisciplinary study of mind, brain, and their relation—that we can answer the question: What is the nature of the only mathematics that human beings know or can know?
5. Therefore, if you view the nature of mathematics as a scientific question, then mathematics *is* mathematics as conceptualized by human beings using the brain's cognitive mechanisms.
6. However, you may view the nature of mathematics itself not as a scientific question but as a philosophical or religious question. The burden of scientific proof is on those who claim that an external Platonic mathematics does exist, and that theorems proved in human mathematics are objectively true, external to the existence of any beings or any conceptual systems, human or otherwise. At present there is no known way to carry out such a scientific proof in principle. ... "

... Lakoff and Núñez: [LR00], Introduction, pp.1-3.

Lakoff and Núñez note that there is an important part of this argument that needs further elucidation:

“What accounts for what the physicist Eugene Wigner has referred to as “the unreasonable effectiveness of mathematics in the natural sciences” (Wigner, 1960)? How can we make sense of the fact that scientists have been able to find or fashion forms of mathematics that accurately characterize many aspects of the physical world and even make correct predictions? It is sometimes assumed that the effectiveness of mathematics as a scientific tool shows that mathematics itself exists *in the structure of the physical universe*. This, of course, is not a scientific argument with any empirical scientific basis.

... Our argument, in brief, will be that whatever “fit” there is between mathematics and the world occurs in the minds of scientists who have observed the world closely, learned the appropriate mathematics well (or invented it), and fit them together (often effectively) using their all-too-human minds and brains. ... ”

... Lakoff and Núñez: [LR00], Introduction, p.3.

Lakoff and Núñez then argue persuasively that any Platonic philosophy of mathematics is not supported by the findings of cognitive science, since it ignores that interpretation—a necessary prelude to understanding (as is implicit in the Complementarity Thesis 1 in §1.)—of those concepts which are expressed in a mathematical language involves identification—sometimes layers upon layers—of conceptual metaphors grounded, ultimately, in our sensory-motor experiences:

“Finally, there is the issue of whether human mathematics is an instance of, or an approximation to, a transcendental Platonic mathematics. This position presupposes a nonscientific faith in the existence of Platonic mathematics. We will argue that even this position cannot be true. The argument rests on analyses ... to the effect that human mathematics makes fundamental use of conceptual metaphor in characterizing mathematical concepts. Conceptual metaphor is limited to the minds of living beings. Therefore, human mathematics (which is constituted in significant part by conceptual metaphor) cannot be a part of Platonic mathematics, which—if it existed—would be purely literal.

Our conclusions will be:

1. Human beings can have no access to a transcendent Platonic mathematics, if it exists. A belief in Platonic mathematics is therefore a metaphor of faith, much like religious faith. There can be no scientific evidence for or against the existence of a Platonic mathematics.
2. The only mathematics that human beings know or can know is, therefore, *a mind-based mathematics*, limited and structured by human brains and minds. The only scientific account of the nature of mathematics is therefore an account, via cognitive science, of human mind-based mathematics. Mathematical idea analysis provides such an account.
3. Mathematical idea analysis shows that human mind-based mathematics uses conceptual metaphors as part of the mathematics itself.
4. Therefore human mathematics cannot be a part of a transcendent Platonic mathematics, if such exists. ... ”

... Lakoff and Núñez: [LR00], Introduction, p.4.

Lakoff and Núñez base their conclusions upon advances in cognitive science that have deepened understanding of how ‘human beings conceptualize abstract concepts in concrete terms, using ideas and modes of reasoning grounded in the sensory-motor system’:

“In recent years, there have been revolutionary advances in cognitive science—advances that have an important bearing on our understanding of mathematics. Perhaps the most profound of these new insights are the following:

1. *The embodiment of mind.* The detailed nature of our bodies, our brains, and our everyday functioning in the world structures human concepts and human reason. This includes mathematical concepts and mathematical reason.
2. *The cognitive unconscious.* Most thought is unconscious—not repressed in the Freudian sense but simply inaccessible to direct conscious introspection. We cannot look directly at our conceptual systems and at our low-level thought processes. This includes most mathematical thought.
3. *Metaphorical thought.* For the most part, human beings conceptualize abstract concepts in concrete terms, using ideas and modes of reasoning grounded in the sensory-motor system. The mechanism by which abstract is comprehended in terms of the concrete is called *conceptual metaphor*. Mathematical thought also makes use of conceptual metaphor, as when we conceptualize numbers as points on a line. . . . "

... Lakoff and Núñez: [LR00], Introduction, pp.4-5.

They argue that, contrary to the wisdom prevailing even in the cognitive sciences of the 1960's—when symbolic logic was thought by many to be endemic to abstract thinking—'symbolic logic is itself a mathematical enterprise that requires a cognitive analysis':

"...Insights of the sort we will be giving ... were not even imaginable in the days of the old cognitive science of the disembodied mind, developed in the 1960s and early 1970s. In those days, thought was taken to be the manipulation of purely abstract symbols and all concepts were seen as literal—free of all biological constraints and of discoveries about the brain. Thought, then, was taken by many to be a form of symbolic logic. As we shall see ... symbolic logic is itself a mathematical enterprise that requires a cognitive analysis. For a discussion of the differences between the old cognitive science and the new, see *Philosophy in the Flesh* (Lakoff & Johnson, 1999) and *Reclaiming Cognition* (Núñez & Freeman, eds., 1999). . . . "

... Lakoff and Núñez: [LR00], Introduction, p.5.

The central thesis of Lakoff and Núñez's argument in [LR00] is that mathematical reasoning 'layers metaphor upon metaphor' with such intricacy that 'it is the job of the cognitive scientist to tease them apart so as to reveal their underlying cognitive structure', since the 'cognitive science of mathematics asks questions that mathematics does not, and cannot, ask about itself':

"Mathematics, as we shall see, layers metaphor upon metaphor. When a single mathematical idea incorporates a dozen or so metaphors, it is the job of the cognitive scientist to tease them apart so as to reveal their underlying cognitive structure.

This is a task of inherent scientific interest. But it also can have an important application in the teaching of mathematics. We believe that revealing the cognitive structure of mathematics makes mathematics much more accessible and comprehensible. Because the metaphors are based on common experiences, the mathematical ideas that use them can be understood for the most part in everyday terms.

The cognitive science of mathematics asks questions that mathematics does not, and cannot, ask about itself. How do we understand such basic concepts as infinity, zero, lines, points, and sets using our everyday conceptual apparatus? How are we to make sense of mathematical ideas that, to the novice, are paradoxical—ideas like space-filling curves, infinitesimal numbers, the point at infinity, and non-well-founded sets (i.e., sets that "contain themselves" as members)? . . .

... we will be concerned not just with *what* is true but with what mathematical ideas *mean*, how they can be understood, and *why* they are true. We will also be concerned with the nature of mathematical truth from the perspective of a mind-based mathematics.

One of our main concerns will be the concept of infinity in its various manifestations: infinite sets, transfinite numbers, infinite series, the point at infinity, infinitesimals, and objects created by

taking values of sequences “at infinity,” such as space-filling curves. We will show that there is a single Basic Metaphor of Infinity that all of these are special cases of. This metaphor originates outside mathematics, but it appears to be the basis of our understanding of infinity in virtually all mathematical domains. When we understand the Basic Metaphor of Infinity, many classic mysteries disappear and the apparently incomprehensible becomes relatively easy to understand.”

...

... Lakoff and Núñez: [LR00], Introduction, pp.7-8.

Lakoff and Núñez emphasise that the results of their inquiry ‘are not results reflecting the conscious thoughts of mathematicians; rather, they describe the *unconscious* conceptual system used by people who do mathematics’:

The results of our inquiry are, for the most part, not mathematical results but results in the cognitive science of mathematics. They are results about the human conceptual system that makes mathematical ideas possible and in which mathematics makes sense. But to a large extent they are not results reflecting the conscious thoughts of mathematicians; rather, they describe the *unconscious* conceptual system used by people who do mathematics. The results of our inquiry should not change mathematics in any way, but they may radically change the way mathematics is understood and what mathematical results are taken to mean.

Some of our findings may be startling to many readers. Here are examples:

- Symbolic logic is not the basis of all rationality, and it is not absolutely true. It is a beautiful metaphorical system, which has some rather bizarre metaphors. It is useful for certain purposes but quite inadequate for characterizing anything like the full range of the mechanisms of human reason.
- The real numbers do not “fill” the number line. There is a mathematical subject matter, the hyperreal numbers, in which the real numbers are rather sparse on the line.
- The modern definition of *continuity* for functions, as well as the so-called *continuum*, do not use the idea of continuity as it is normally understood.
- So-called *space-filling curves* do not fill space.
- There is no absolute yes-or-no answer to whether $0.99999\dots = 1$. It will depend on the conceptual system one chooses. There is a mathematical subject matter in which $0.99999\dots = 1$, and another in which $0.99999\dots \neq 1$.

These are not new mathematical findings but new ways of understanding well-known results. They are findings in the cognitive science of mathematics—results about the role of the mind in creating mathematical subject matters.

Though our research does not affect mathematical results in themselves, it does have a bearing on the understanding of mathematical results and on the claims made by many mathematicians. Our research also matters for the philosophy of mathematics. *Mind-based mathematics*, as we describe it . . . , is not consistent with any of the existing philosophies of mathematics: Platonism, intuitionism, and formalism. Nor is it consistent with recent post-modernist accounts of mathematics as a purely social construction. Based on our findings, we will be suggesting a very different approach to the philosophy of mathematics. We believe that the philosophy of mathematics should be consistent with scientific findings about the only mathematics that human beings know or can know. We will argue . . . that the *theory of embodied mathematics* . . . determines an empirically based philosophy of mathematics, one that is coherent with the “embodied realism” discussed in Lakoff and Johnson (1999) and with “ecological naturalism” as a foundation for embodiment (Núñez, 1995, 1997).

Mathematics as we know it is human mathematics, a product of the human mind. Where does mathematics come from? It comes from us! We create it, but it is not arbitrary—not a mere historically contingent social construction. What makes mathematics nonarbitrary is that it

uses the basic conceptual mechanisms of the embodied mind as it has evolved in the real world. Mathematics is a product of the neural capacities of our brains, the nature of our bodies, our evolution, our environment, and our long social and cultural history." ...

... Lakoff and Núñez: [LR00], Introduction, pp.8-9.

27.F. The Veridicality of Mathematical Propositions

Based on our above interpretation of Lakoff and Núñez's analysis in [LR00], we could express a tacit thesis of this investigation as:

Thesis 41. *Those of our conceptual metaphors which we commonly accept as of a mathematical nature—whether grounded directly in an external reality, or in an internally conceptualised Platonic universe of conceived concepts (such as, for example, Cantor's first transfinite ordinal ω)—when treated as Carnap's explicandum, are expressed most naturally in the language of the first-order Set Theory ZFC.*

This reflects the *evidence-based* perspective of this investigation that (see §13.; also §13.C):

- Mathematics is a set of symbolic languages;
- A language has two functions—to express and to communicate mental concepts⁶¹⁹;
- The language of a first-order Set Theory such as ZFC is sufficient to adequately represent (Carnap's *explicatum*: see [Ca62a], also §1.) those of our mental concepts (Carnap's *explicandum*: see [Ca62a], also §1.; or what Pantsar terms as *pre-formal mathematics* in [Pan09] (§4. Formal and pre-formal mathematics)) whose definitions can be communicated unambiguously; whilst the first-order Peano Arithmetic PA best communicates such representations to an other categorically.

It also reflects Hermann Weyl's perspective that the 'genuine value and significance' of any mathematical language lies in the 'extent that its concepts can be interpreted intuitively without affecting the truth of our assertions about those concepts':

"Returning now to Richard's antinomy, we must acknowledge a kernel of truth in the apparent contradiction: set theory and logicized mathematics involve only countably many relation-concepts, but certainly not just countably many things or sets. This is primarily because the introduction of new sets is not limited to the extraction of subsets of a given set, as the aforementioned axiom allows, the elements of that subset being characterized by a definite property. There is also set formation through addition, multiplication, and exponentiation, operations whose possibility is posited by Zermelo's remaining axioms. There is absolutely no question of an antinomy here.

Might we say that mathematics is the science of ε and those relations definable from ε by means of the principles we have mentioned? Developments to date make this seem likely and perhaps this analysis really does correctly determine the logical content of mathematics. Consider, however, a set theoretically constructed conceptual system for logicized mathematics. It seems to me that this system will have genuine value and significance only to the extent that its concepts can be interpreted intuitively without affecting the truth of our assertions about those concepts."

... Weyl: [We10], p.10.

We would further conjecture that:

⁶¹⁹As this reflected in the structure and/or activity of the brain.

Thesis 42. *The need for adequately expressing such conceptual metaphors in a mathematical language reflects an evolutionary urge of an organic intelligence to determine which of the metaphors that it is able to conceptualise can be unambiguously communicated to another intelligence—whether organic or mechanical—by means of evidence-based reasoning and, ipso facto, can be treated as faithful representations of a commonly accepted external reality (universe).*

The conjecture is obliquely reflected in Daniel C. Dennett's remarks:

We and only we, among all the creatures on the planet, developed language. Language is very special when it comes to being an information handling medium because it permits us to talk about things that aren't present, to talk about things that don't exist, to put together all manner of concepts and ideas in ways that are only indirectly anchored in our biological experience in the world. Compare it, for instance, with a vervet monkey alarm call. The vervet sees an eagle and issues the eagle alarm call. We can understand that as an alarm signal, and we can see the relationship of the seen eagle and the behavior on the part of the monkey and on the part of the audience of that monkey's alarm call. That's a nice root case."

... Dennett: [De17].

Moreover, we may then need to consider whether:

- A plausible perspective as to what is, or is not, a valid mathematical concept would be to regard such concepts as those conceptual metaphors that:
 - (a) a '*formally undecidable*' (as argued in §15.C., and therefore ω -consistent by Gödel's 'informal' argument in [Go31], §1, pp.7-8) language—such as a first-order set theory ZFC—can adequately express subjectively (in the sense of §13.C.(1));

and, thereafter, which of these conceptual metaphors:

- (b) a *categorical* (and, as entailed by [An16], Theorem 7.2, therefore ω -inconsistent; see also §2.E.b., Corollary 2.18, and §2.F., Corollary 2.22) language—such as the first-order Peano Arithmetic PA—is able to unambiguously communicate objectively (in the sense of §13.C.(2)).

In other words, we may need to consider whether (in sharp contrast to the perspective offered by Penelope Maddy in [Ma18] and [Ma18a]):

- Set theory is most appropriately viewed as the foundation for those of our conceptual metaphors which can be adequately expressed in a first-order mathematical language;

whilst:

- Arithmetic is most appropriately viewed as the foundation for those of our conceptual metaphors which can be unambiguously communicated in a first-order mathematical language.

Such a perspective would reflect an underlying thesis of this investigation (see §13.), which is that mathematics ought to be viewed simply as a set of languages;

- some of adequate expression,

- and some of unambiguous and effective communication,

for Lakoff and Núñez’s conceptual metaphors; moreover⁶²⁰, that the veridicality of mathematical propositions can ultimately be grounded in only *those* conceptual metaphors whose formal representations within the language we can either:

- label as ‘finitarily true’ by convention if, and only if, they either correspond to *evidence-based* axioms and rules of inference (i.e., to some constructively well-defined logic by §1., Definition 1) of some language;

or:

- label as ‘experientially true’ by convention if, and only if, they are mappings of *evidence-based* observations of a commonly accepted external universe.

In other words, one may need to develop and isolate from these philosophies a more holistic perspective of ‘where mathematics comes from’, rather than the epistemically grounded perspective of conventional wisdom—as articulated, for instance, in [LR00] or [Shr13]—which ignores the distinction between the multi-dimensional nature of the logic of a formal mathematical language (see §1., Definition 1), and the one-dimensional nature of the veridicality of its assertions.

Such a synthesised view of ‘where mathematics comes from’ should, it seems, be able to offer complementary perspectives for the basic issues on which the various philosophies were founded. Such as, amongst others:

- the logicist’s identity of mathematics and logic;
- the formalist’s stress on the internal validity and self-sufficiency criteria of a theory;
- the intuitionist’s objection to passing from the negation of a general statement to an existential one without additional safeguards;
- the conventionalist’s contention that the rules of a language delineate its ontology;
- as also the nominalist’s scruples about the existence of classes of classes.

27.G. Where does the veridicality of mathematics come from?

We conclude with an, essentially 1966, soliloquy—underlying the roots of the Complementarity Thesis (§1., Thesis 1) of this investigation—which naïvely sought to address—from the perspective of Rudolf Carnap’s *explicatum* and *explicandum* (see [Ca62a])—some inherited, philosophically unsettling, issues that had influenced how classical paradigms sought to situate, within an all-encompassing perspective, the nature, and formation, of abstract mental concepts that were viewed as meaningful when expressed informally in the prevailing mathematical languages (corresponding to what Pantsar terms as *pre-formal mathematics* in [Pan09], §4, Formal and pre-formal mathematics), by addressing the query:

⁶²⁰As expressed by Tarski in a broader context ([Ta35]): ‘Snow is white’ is a true sentence if, and only if, snow *is* white.

Query 35. *Where does the veridicality of mathematical propositions come from?*

- (a) I form concepts. That much seems reasonably clear to me. Their location I assume to be in the commonly referred to intuition. Concept space may be a better name for it.
- (b) An analysis of these concepts I find to be a more difficult task than indicating their significance. So I intend to study merely the latter. However, I do take individuals, properties and facts as concepts.
- (c) Events in physical space, indeed the space itself, are perceived and digested by my senses, whence they transform into concepts.
- (d) My concepts I may map into a language. This map you may decode into your concepts.

Assuming that both of us accept a common external world, I can understand why language is so useful.

- (e) When I set up a language, there is what I talk about. Serious dispute cannot arise so long as my language faithfully refers to my concepts.
- (f) I may feel the need to include Pegasus among my concepts. Your stoutest efforts will not convince me to analyse the name out à la Russell. A description into non-trivial terms of my ontology I would consider inadequate. And the trivial description of ‘pegasises’ I would only agree to as an introduction of a name for a concept of being Pegasus—a concept antecedent to the being of Pegasus among my concepts.

Or I may protest altogether against the being of any ‘pegasises’ concept in my concept space, and refuse to admit discovery or creation of any such concept.

- (g) Confusion may sometimes arise. You may wrongly translate my language into your concepts. My conceptual scheme may contradict the external world. I may have concepts not accessible to you.

In the first case you would be mistaken. In the second I should be convicted of error—or possibly idealism! But who is to judge?

Of some interest is the third. This I see as the cause of all genuine ontological disputes. From philosophy through to theology.

Taken to be a question of individual concepts, ontology seems more a matter of taste, inclination and, above all, feeling and belief in this case.

So its interest as a problem is, after all, trivial. As it should be.

- (h) For, as long as I concern myself with ontology, restricting myself to a language constructed on the basis of my mental concepts, I shall for all practical purposes be dealing with the small aspect of the world which is conceptualised by my senses. And this, as Zeno’s reflections seem to indicate, can hardly be said to exhaust nature’s complexity (as sought to be illustrated in the gedanken detailed in §20.C.a. to §20.D.c.).

- (i) So I turn my back for the moment on concepts. All I am left with then is language, and possibly codifications of my perceptions of natural phenomena into language.

And my inability to grasp the totality of nature's concepts is contained in my use of variable names, and the transition from propositions to schemata.

And the test of any codifications as suitable for a faithful representation of my perceptions of natural phenomena will be the inclusion in it of the concepts that are within my grasp.

- (j) But what there 'is' in addition may, after all, depend on language in cases where empirical verification is lacking.

27.G.a. Russel's paradox?

For instance, we briefly consider Russell's paradox from a naïve *set-theoretical* perspective that seeks to adequately express some of our conceptual metaphors in a symbolic language.

- (a) Consider the ZFC expression:

$$(i) \ x \notin x.$$

If we suppose that there is a class 'a' in our language ZFC representing an individual entity 'a*'—that exists, or must necessarily exist, as the root of one of our conceptual metaphors—whose members are precisely those that satisfy (a)(i), then we would hold that, in this instance, we have discovered a true statement schema:

$$(ii) \ x \in a \leftrightarrow x \notin x,$$

which expresses a host of facts concerning 'a*' and all the various members of some pre-existing universe that the metaphors are *taken* to conceptualise.

But this belief is surely mistaken, for:

$$(iii) \ a \in a \leftrightarrow a \notin a,$$

is clearly false in ZFC.

- (b) Suppose, on the other hand, we say that we are merely defining a class 'a' in ZFC that represents an individual entity that may already exist—or might conceivably exist—as the root of our conceptual metaphors by:

$$(i) \ x \in a \text{ if, and only if, } x \notin x.$$

Though this should now be a true statement in our language ZFC about the metaphors, it may no longer be a statement about anything in the universe that the metaphors *aim* to conceptualise⁶²¹.

- (c) But if we treat definition as a creative activity for producing a larger 'conceivable' ontology, it is not surprising that we can arrive back at a paradoxical, but supposedly true, ZFC statement:

⁶²¹Compare Skolem's remarks in [Sk22], p.295; see also §23.B.

$$(i) a \in a \leftrightarrow a \notin a,$$

about the putative universe that the metaphors *claim* to conceptualise.

This position regarding creativity may differ but formally from our earlier Platonistic stand.

- (d) However, if we do not view definition as mere name-giving to newly born or already flourishing objects, then it is not easy to see what all the fuss is about.

For, if definition requires eliminability, then expressions such as ‘ $a \in a$ ’ and ‘ $a \notin a$ ’ are immediately suspect—since we are able to eliminate only ‘ $x \in a$ ’ from any expression.

And ‘ a ’ in isolation is merely a strange creature giving rise to pseudo-expressions which confuse us as to their admissibility into our formal language because of their familiar appearance (a point that we have illustrated when highlighting the fragility of the conventional arguments for the existence of non-standard models of Arithmetic in §18.).

But then, so too does Pegasus confuse us into sometimes creating a putative inhabitant of a putatively common Platonic world of permanent ideas and unactualised possibilities out of merely the subjective, and fleeting, conceptual metaphors created within our cognition with respect to the word ‘Pegasus’!

In other words, as Quine ([Qu53]) has compellingly argued, a name need not name anything that we would accept as the root of a grounded conceptual metaphor (even though a name might itself give rise to a consequent conceptual metaphor grounded on the ‘name’ itself).

For names belong to language essentially. And, even when patently absurd or vacuous—e.g., Squirle defined as a ‘square circle’, or ‘Louis XX’ defined as ‘the present king of France’—are easy to construct.

- (e) There is a fuss, for the contradictions still haunt some of us. So possibly we are loath to admit an error in our earliest ‘discovery’. The seeming ‘truth’ of the statement schema:

$$(i) x \in a \leftrightarrow x \notin x.$$

Now could it be that this reluctance to accept the negation of Cantor’s Comprehension Axiom is—as Lakoff and Núñez’s analysis of the origin of ‘mathematical’ conceptual metaphors seems to suggest—psychologically motivated?

For instance, as David Pereplyotchik remarks:

“There are, broadly speaking, three competing frameworks for answering the foundational questions of linguistic theory—cognitivism (e.g., Chomsky 1995, 2000), platonism (e.g., Katz 1981, 2000), and nominalism (e.g., Devitt 2006, 2008).

Platonism is the view that the subject matter of linguistics is an uncountable set of *abstracta*—entities that are located outside of spacetime and enter into no causal interactions. On this view, the purpose of a grammar is to lay bare the essential properties of such entities and the metaphysically necessary relations between them, in roughly the way that mathematicians do with numbers and functions. The question of which grammar a speaker cognizes is

to be settled afterward, by psychologists, using methods that are quite different from the *nonempirical* methods of linguistic inquiry.

The nominalist, too, denies that grammars are psychological hypotheses. But she takes the subject matter of linguistics to consist in concrete physical tokens—inscriptions, acoustic blasts, bodily movements, and the like. Taken together, these entities comprise public systems of communication, governed by social conventions. The purpose of a grammar, on this view, is to explain why some of these entities are, e.g., grammatical, co-referential, or contradictory, and why some entail, bind, or c-command others.

Cognitivism, by contrast, is the view that linguistics is a branch of psychology—i.e., that grammars are hypotheses about the language faculty, an aspect of the human mind/brain. A true grammar would be psychologically real, in the sense that it would correctly describe the tacit knowledge that every competent speaker has—a system of psychological states that is causally implicated in the use and acquisition of language."

... *Pereplyotchik*: [Per17].

The cause to which we are clinging so stubbornly—armed with Cantor's cardinals/ordinals, Russell's types, Zermelo's sets, amongst others—may be that starting from an ontological acceptance of some individuals and properties, we must somehow have the right to build up further properties into our putative universe. The paradoxes seem to prevent us from doing so with complete freedom.

- (f) But why do we not feel the need to a similar liberty in the other direction? Regarding individuals.

Why do we not feel as strongly or as readily that by defining all the properties that occur in our ontology for a new individual, we may enlarge our universe?

- (g) The path may not be any smoother. For suppose we intend to introduce the individual '*k*' into our ontology. And our ontology contains a property schema ' $P(x, y)$ '. (Which may, for example be '*y* loves *x*').

If our desire for liberty was sincere, we should feel free to then assign properties at will to the new entry.

But what happens?

- (h) Let us assign the $P(x, y)$'s to the entity '*k*' as follows:

(i) $P(x, k)$ if, and only if, $\neg P(x, x)$.

Since '*k*' is part of our ontology, do we have:

(ii) $P(k, k)$

or

(iii) $\neg P(k, k)$?

- (i) My point is that as long as we have the desire to construct new relations amongst existing entities, we should also have the equal desire to construct new entities out of existing relations.

That if we have the feeling we can discover all kinds of possible relations amongst the individuals, we should also feel we can discover all kinds of individuals enmeshed in our relations.

That the guidelines in one case should be as useful in the other. That if every open formula in individuals seems to define a predicate, then every open formula in predicates should define an individual. To take a very naïve view.

That we may be psychologically misled into feeling that a predicate open formula defines an entity known as the predicate of a predicate.

- (j) So maybe there is much to be said for the nominalist stand. And isn't the idea that every individual be equivalent to the set of all the predicates that it satisfies at the heart of Leibniz's notion of indiscernibles? As also at the heart of phenomenalism and positivism?
- (k) And where the external world is concerned, is it possible that quantum-interpreted phenomena may contain instances of plurality where the objects are indiscernibles⁶²²—notwithstanding Leibniz's contention?
- (l) And in spite of Russell's claim of having no content to his universe does not the fact that it has no indiscernibles give it content—at least in the form of a special characteristic?

27.G.b. An illustrative model: language and ontology

- (a) I have a concept of a possible universe that I should like to codify into language.
- (b) In my universe there are individuals, and there are properties. The landscape is otherwise deserted.
- (c) The individuals I shall name a, b, c, d, e . The properties F, G, H .
- (d) There are also (in some sense of being which is not entirely clear to me) facts in my universe. These I shall represent in my language as:

$F(a), F(b), G(b), G(c), G(e), H(b), H(c)$ and $H(e)$.

I shall call these true expressions in my language.

- (e) There are no such things (or whatever it is that facts are supposed to be) as non-facts in my universe. All the same, I admit certain expressions into my language—possibly for the sake of symmetry, but more so because tradition seems to demand such an action. These are:

$F(c), F(d), F(e), G(a), G(d), H(a)$, and $H(d)$.

I shall call these false expressions.

- (f) Though my language, containing these expressions, is thus two-valued, in my universe there are only facts.

⁶²²See §14.C..

- (g) A very natural question may be asked for any set of individuals. Is there a property satisfied by all the members of the set, and none others?

I think I must be very clear about the nature of my enquiry. I am not asking whether my language can countenance the introduction of a further expression purporting to be a property. Such an entry, like the introduction of false expressions, may not present formidable difficulties. But I am enquiring whether my universe already contains such a property.

- (h) Taking $\{a, b, d\}$, as the set, I find no property which gives rise to true expressions for this set only. My finding is, of course, empirical.
- (i) For the set $\{a, b\}$ however, the property F does give rise to true expressions; and no other individual satisfies F . And I may conveniently identify the set with F insofar as they are both names of the same entity.
- (j) What of the set $\{b, c, e\}$? Both G and H express facts for the members of this set only. But there is no unique property identifiable with this set. And, in passing, I may remark that such an event does not cause any concern usually. Properties with the same extension are tolerated easily.
- (k) I conclude that not every set of individuals can be identified with a unique property.

So, a set of individuals may not name anything in my universe.

- (l) A question of far greater significance is as to the nature of sets of properties. Classically these have been treated as being identifiable with a different quality of being in the universe from that of properties and individuals.
- (m) But though my language is prolific in sets, my universe is starved for entities. So I look for some more direct identifications for these sets than those suggested by precedent.

Surprisingly, I am successful—or so it seems. And my solution appears so natural that I begin to suspect that tradition may well have been merely disguising it.

- (n) For a set of properties, I ask the question whether any individual has just those properties, and none others.

For the set $\{F, G\}$ there is no such individual.

The set $\{F, G, H\}$ may be identified with the individual b , which is the only one satisfying all three properties.

Similarly, $\{F\}$ may be identified with a .

- (o) But now I consider the set $\{G, H\}$. Both c and e satisfy only this set. Which is a most surprising characteristic of my universe. It contains two indiscernibles!

(In spite of Leibniz, and Russell's subsequent backing of his ideas on the intuitive notion of equality, modern physics has made a universe with such characteristics rather feasible.

What is required for such a feature is that⁶²³ some set of properties be identified with a plurality of individuals.)

I find, then, that not every set of properties is identifiable with an individual.

- (p) So, if I contain myself to the ontology outlined, some sets of properties, as also of individuals, don't exist, while some do, and still others exhibit an ambiguous character.

But all this is peculiar to my universe. And not every universe need be of this type. The universe being constructed by an intuitionist may have differing qualities. Depending on the manner in which he sets up his intuitive concepts of individuals and relations, and expresses his facts.

- (q) But what is important to note—for I feel it has caused the greatest confusion—is that sets belong to language, and their corresponding existence in the universe lies in their identifiability, along the lines already indicated, with the entities of the universe.

Such identifiability may be empirically determinable, if the universe is capable of representation as above. Or it may be conventional, when the universe is being constructed.

27.G.c. Is the Russell-Frege definition of number significant?

- (a) I cannot countenance a predicate of predicates unreservedly.

I am able to cheerfully admit the existence of individuals in a universe.

I can also, hesitantly at first, embrace the seemingly necessary existence of properties.

- (b) But now I see two things.

That each property has an extension, in my language at least, of all the individuals satisfying it. And each individual has an extension of all the properties that it possesses.

And any class of individuals that I am able to construct in my language can only—if at all—be identifiable as the extension of a possible property satisfied by the members of the class. The existence of such a property—and hence the reflection of the fact of this existence, in my language—must remain an empirical truth—or a truth by convention.

And, similarly, any class of properties that I can produce in my language is not the reflection of some creature known as a predicate of predicates, but—at the most—the extension identifiable with a possible individual having only the properties contained in the class. The existence of such an individual is again, I dare say, an empirical fact—or a convention.

Now, why does my mind rebel at the thought of indiscriminately creating such individuals?

The reason is chiefly heuristic. As may be expected.

- (c) Given a set of individuals, and a two-valued language, I am able to construct 2^n distinct classes. If all these exist as properties, then each property is identifiable with some particular class of not more than n individuals. It is not even necessary to insist for the

⁶²³See, for instance, [Krs22].

moment that the class be evident to me. So long as I admit that it is a determined class in my language.

Clearly each individual is also identifiable with some class of not more than 2^n properties.

- (d) But now there are 2^{2^n} new individuals which are constructible—at least theoretically so—in my language (which may even embrace a class theory for the construction of its classes, if this is in some way thought possible).

If I try to introduce these in my universe, then the extensions of some of my previous properties will have to be enlarged.

In what sense can I then speak of a property as the static concept it usually is taken to be? Without divorcing it completely from my individuals? In which case, how may I even construct a new property? Unless, of course, I adopt a system of double book-keeping.

And, possibly, this is the reason that Cantor's axiom of comprehension, when applied to ontology, is invalid. As also the reason that a distinction needs to be drawn between classes and sets in set theory—which is, I believe, implicitly taken to be applicable to both language and ontology. Whether such a distinction has been validly and consistently made relative to the view that I have taken above is a different question. One well worth investigating.

- (e) But now I see a major defect in logicism.

$2(f)$ is defined to mean that there exists an x , and there exists a y , satisfying f , and x is not equal to y , and if there is some z satisfying f , then either z is equal to x , or z is equal to y .

The class, in my language of course, of f 's for which this is true is then identified with an object in the universe containing f over which x and y range.

Such an object, as I have already averred, I can only take to be an individual, say '2'.

But then it appears that every property which has only two true arguments in my universe must necessarily have '2' as one of these (amongst its) arguments! A patently unacceptable conclusion.

At least from an aesthetic point of view, so far as my common sense is concerned. But common sense is not a very reliable guide, and it remains to be seen whether this is also logically (in some sense of the word logic) unacceptable. As I feel it must be. The point is an important one and needs to be investigated.

- (f) So I do not accept the individual '2' as identifiable anyhow in my universe. Even though $2(f)$ is a meaningful, and very significant, sentential formula in my language. For it does contain the essence of the meaning-in-use of the number 'two'. And this, I believe, is the really outstanding achievement of logicism. Its analysis of the origin of the number concept ([Rus17], Chapter II, pp.11-19). But not its so-called logical construction of the concepts of the integers.

Of course Russell has, to my way of thinking, managed to cloud the issue by ascribing a different level of existence to the individuals constructed from classes of predicates. Which again appears to be a case of multiple standards, since not all classes of predicates—as I have tried to show earlier—need necessarily give rise to the type of difficulty discussed above. Some classes are easily and most naturally identifiable with individuals.

Russell's types are then seen to be nothing more than the setting up of various *synthetic* universes in a kind of chain formation. The lowest being a universe either set up by convention, or which is evident to my senses. The next—not by addition to the first—but rather by identification with expressions of the language in which I talk of my initial universe. And so on.

- (g) And of course the language I use to reflect my initial universe will contain expressions for all the possible entities and facts that could possibly occur in it, irrespective of what actually may be occurring at the time I discover/construct it. So Russell may quite readily, though unpardonably for having obfuscated the issue, claim that his universe—which actually contains all the members of the chain that I referred to above—has no content.

And whether we call it one universe or a chain of universes is hardly worth a debate.

So long as we can remember that all the successor universes have been constructed from language.

- (h) Which gives me enough reason to try and explain why language and ontology have so often been confused.

And my way of justifying the seeming prolificacy of language—which I already hinted at above—is this.

I think it would be readily agreed that in the external world there are facts—which may be said to have existence. To ascribe an existence to a non-fact in this universe seems to me somewhat far-fetched, despite McX and Wyman ([Qu53]).

Yet I am able, in my language about the external world, to create both factual and non-factual or false expressions.

And this seems a very fortuitous occurrence in view of my desire to communicate with, and be communicated to faithfully by, a fallible humanity.

So the expressions in my language seem—at least to my naïvely finite senses—to exceed the facts in the universe.

- (i) Which of course may be an assumption of a very basic and significant nature underlying all my mathematically conceived entities—hence giving a possible circularity to Cantor's Theorem that 2^n exceeds n for all numbers.

27.G.d. Conclusion

- (01) Discovery of what there 'is', or construction (by convention—other means if thought feasible) of what I feel should be, I take as the basic idea underlying all my mental activity.

- (02) Language, as the means by which such discovery, or construction, is expressed or conveyed to you.
- (03) Logical notions as the instruments used to extend what ‘is’ in any given case to what is possible or could have been possible—in addition to, or as alternative to—the given case.
- (04) So logic in effect symmetricises language—originally conceived as a carrier of only what there ‘is’, or, more precisely, of what I believe there ‘is’—into containing ‘more’ than what actually ‘is’, in terms of what is possible or conceivable.
- (05) Which gives me a freedom, on the basis of these conceivable entities, entertained by my language (corresponding to the expressions containing free variables, or sets as they are also called) and taking into account what already is, to construct by some means a ‘larger’, clearly artificial, universe.
- (06) Larger in the sense that a suitable construction immediately seems to give me Cantor’s Theorem—at least if I include all conceivable entities of the first into the second.
- (07) But my constructions necessarily give me a new universe. Though I may be able to map my initial ontology into it in some way.
- (08) And the obviously recursive procedure gives me a series of universes which Russell calls types.
- (09) Though there seems no meaningful way in which we can talk of all the universes being united into a universe of universes, with their various entities co-existing peaceably.
- (10) And the Continuum Hypothesis may be but a convention (as argued in §16.B.)—a relation between two successive universes—reflecting the *manner* in which one is constructed out of the other. A relation, then, (like Cantor’s) between what is taken ‘to be’ in a universe, and all that can be constructed from it by means of language.
- (11) And, so, in some sense what there ‘is’ does depend on language. At least in all the universes succeeding the initial. And on convention.
- (12) And whether this thing is what we call ‘mathematics’ depends on whether my initial universe has entities that are *only* expressible in a mathematical language.

CHAPTER 27. PARADIGM CHALLENGING CONSEQUENCES

28. The significance of *evidence-based* reasoning for mathematics education

We highlight the foundational significance of *evidence-based* reasoning and §1., Thesis 1, for mathematics education, and the philosophy of mathematics education, by briefly suggesting an alternative paradigm to that of Paul Ernest in [Er12], albeit towards the common goal that—as is implicit in linguist Andreea S. Calude’s [Cld11]—we need to ground mathematics education on firmer, consensual, *evidence-based* (see §2.) rather than contentious, faith-based (see §7.B.), foundations.

We argue the Thesis (§13., Thesis 4) that mathematics has no *intrinsic* content per se; it is merely a powerful⁶²⁴ set of languages that serves the needs of the natural sciences and their philosophies⁶²⁵ for:

- first, expressing those of our conceptual metaphors (corresponding to what Pantsar terms as *pre-formal mathematics* in [Pan09], §4, Formal and pre-formal mathematics) which can be *well-defined* in a mathematical language such as the first-order set theory, ZFC; and,
- second, identifying those conceptual metaphors which can be further communicated *categorically* in a mathematical language such as the first-order Peano Arithmetic PA which, by the Provability Theorem for PA (see §2.E.b., Theorem 2.17) models, and circumscribes, the reasoning ability of a Turing-machine based mechanical intelligence (see also §13.E.; §21.E., Query 22).

We argue, moreover, that:

- current set-theoretically founded mathematical paradigms appeal to faith-based reasoning (see §7.B.);
- which ascribes an illusory existence to what is sought to be defined unambiguously in mathematical symbolism (see §13.E.);
- only because they fail to admit such a distinction;
- primarily due to the misleading influence of three powerful, but false, dogmas inherited from Hilbert, Brouwer and Gödel (see §5.).

Classical paradigms about what mathematics *is*, and what it *is not*⁶²⁶, thus obscure that:

- whereas a philosophy of mathematics is a specialised part of a philosophy of linguistics (see §13.);
- a philosophy of mathematics education is a specialised part of a philosophy of education (which lies beyond the scope and competence of this investigation).

⁶²⁴The power of any such language being measured by the extent of its ability to *faithfully* and *unambiguously* express our abstract concepts symbolically, and communicate them *categorically*.

⁶²⁵Just as the various computer languages such as Ada, ALGOL, Basic, C, C+, C++, COBOL, Coq, Fortran, Java, Lisp, Pascal, Perl, Python etc. are interpreted in familiar day-to-day computational models that serve the needs of the emerging science of Artificial Intelligence.

⁶²⁶See §1.L., *What mathematics is and what it is not*.

28.A. The science of numbers: does language help or hinder?

The argument that mathematics is a specialised part of a philosophy of linguistics is implicit in linguist Andreea S. Calude's 2011 paper [Cld11], '*The science of numbers: does language help or hinder?*', where she:

"...examines Roy Harris' discussion of number and the language of science in his book *History, Science and the Limits of Language* in light of recent work in cognitive linguistics. While many of his points are valid, linguistic theory has since addressed some of these concerns by formulating usage-based, cognitive frameworks to explore and understand language phenomena. These accounts show how the language of mathematics is construed by recourse to processes such as metaphor and metonymy."

... Calude: [Cld11], Abstract.

Calude remarks further that 'science and language are not always deemed to work together as smoothly as we might like to imagine. In fact, some go as far as to claim that language imposes serious limits on the science we do'. She, thus, implicitly echoes the concerns:

- raised in §20.D., Query 18⁶²⁷, with respect to the gedanken considered in §20.C., Cases 20.C.a. to 20.C.d., and §20.D., Case 20.D.c.;
- as well as implicit in §20.D.b., Thesis 9⁶²⁸ and Thesis 10.

"The human propensity for communication together with the endeavour of understanding the natural world are considered to be, arguably, the most impressive triumphs of the human race. Yet science and language are not always deemed to work together as smoothly as we might like to imagine. In fact, some go as far as to claim that language imposes serious limits on the science we do. Whether or not we will ever be able to put this issue to rest or not, in an ironic twist of fate, it is perhaps the business of science to examine (if possible) the extent to which language provides a rich and free-reigning avenue of inquiry for scientific enterprise, or alternatively, a delimited and restricted one."

... Calude: [Cld11], §1, Introduction.

Moreover, from the *evidence-based* perspective of this investigation, Calude's analysis of Roy Harris' theory of 'Integrationism' echoes, and underscores, the two main underlying theses of this investigation:

- (i) the Complementarity Thesis (§1., Thesis 1), that *evidence-based* assignments-by-convention of, *both*, mathematical *provability* and mathematical *truth* are necessary, and sufficient, for effective communication of *meaningful* mathematical propositions; and
- (ii) the Mathematics Thesis (§13., Thesis 4), that mathematics is a set of languages intended to *effectively* communicate those of our conceptual metaphors that can be expressed mathematically;

by arguing that communication 'is a two-way interactive process between a sender and a receiver' where, in 'order to understand how language works and evolves, both sides must be scrutinized and explored':

⁶²⁷§20.D., Query 18: *Since the raison d'être of a mathematical language is—or ideally should be—to express our abstractions of natural phenomena precisely, and communicate them unequivocally, in what sense can we sensibly admit an interpretation of a mathematical language that constrains all the above cases by 'limiting' configurations in a putative, set-theoretical, 'completion' of Euclidean Space?*

⁶²⁸§20.D.b., Thesis 9: *There are no infinite processes, i.e., nothing corresponding to infinite sequences, in natural phenomena.*

“During the early 1980s, Roy Harris put forward an ambitious and bold critique of what he referred to (and still does, regrettably) as “orthodox linguistics”¹ and “traditional linguistics”. At that time, formal linguistics was beginning to feel comfortable in its laurels of high status under the reign of Noam Chomsky, and revel in the creativity of language and the Ideal language user. Harris’s observations are sketched in his book “*The Language Myth*” (1982). Two important criticisms were formulated by him under the “Telementation Fallacy” and the “Determinacy Fallacy”. I will discuss each one in turn below.

The Telementation Fallacy refers to the misguided assumption that people know which words refer to which ideas and that using such knowledge allows for the successful sending of an idea from one brain/person to another. Harris argued that it is not possible to send thoughts in this way because words are neither encoded, nor decoded in exactly the same manner by everyone. Inspired by the Firthian view of word meaning (Firth, 1957), Harris argued against the notion of idealistic communities which are presumed to share a public set of words and rules, and proposed instead a “demythologized linguistics which corresponds more realistically to our day-to-day communicational experience” (Harris, 2010). A subtle but important observation made by him (though not for the first time, see also Wittgenstein’s work) is that linguistics should not limit itself to describing and studying utterances from the speaker’s point of view alone. Communication is a two-way interactive process between a sender and a receiver. In order to understand how language works and evolves, both sides must be scrutinized and explored. Much of theoretical linguistics concerns itself with the speaker’s view point while backgrounding the role of the hearer.² However, the dialogic nature of communication has been and continues to be addressed (even) in theoretical linguistic work; see in particular papers by Wilson, Sperber and Blakemore in the area of Relevance Theory. More recently, linguistic research has benefitted from the proliferation of spoken corpora now available (see Leech (2000) for a review), where real conversational data provides more concrete information about whole exchanges.

Related to the Telementation Fallacy is the Determinacy Fallacy which is the false assumption that there is a fixed, public, and shared set of relations between words and their meanings (as for instance given in grammar books or dictionaries). Harris draws attention to the fluid and ever-changing nature of language, and to its emerging properties resulting from use. The meanings of words, Harris argues do not reside in the words themselves, but they emerge from their use (by a speaker/writer) and their interpretation (by a hearer/reader). Thus for instance, he cites with interest (though perhaps not with whole-hearted approval) the amusingly titled “category squish” first proposed by Ross (1972), whereby some words are more ‘nouny’, whereas others are more ‘verby’, having flexible syntactic categories, depending on context.

It is in response to these problematic qualms that Harris’s (1982) Integrationism arises. Its aim is to provide a culture-neutral and theory-neutral view of language, where the language system is understood as a social-construct (as opposed to a set of words and rules), and where language-*speakers* become language-*makers* (Harris 1980). Integrationism rests on two major Axioms:

Axiom 1. What constitutes a sign is not given independently of the situation in which it occurs or of its material manifestation in that situation.

Axiom 2. The value of the sign is a function of the integrational proficiency which its identification and interpretation presuppose. (Harris, 1993, p. 321)

This account appears to be very similar to Firth’s notions of collocation and context; one key difference is that for Harris, the ‘sign’ (words for instance) does not arrive at meaning through use alone, but through *both* its use by the speaker and its decoding by the hearer—it is in this sense that Harris’s theory is “integrationist”.

... Calude: [Cld11], §2, Integrationism.

We note that Harris’ theory can also be viewed as ‘integrationist’—in Calude’s sense—from the *evidence-based* perspective of this investigation, which views mathematics as, essentially,

evidenced-based languages (see §12. and §13.) that, arguably, are sufficient to their intended purpose of serving the minimal needs of philosophy and the natural sciences to:

- first, faithfully represent (in languages such as the first-order set theory ZF), conceptual metaphors corresponding to their observations of physical phenomena; and,
- second, categorically communicate (in languages such as the first-order Peano Arithmetic PA), some of these representations;

without recourse to a Platonic ontology.

Such a perspective could, moreover, be seen to ‘back up the main tenets of Integrationism and consolidate its validity’ by endorsing the argument ‘that even such words as *three*, *nineteen* and *five* are outside the realm of public shared knowledge, and that they do not exist independently of the communicative act’:

“Harris tackles the question whether “the ability to count and engage in other arithmetic operations is limited by the linguistic resources provided by one’s native language” (p. 31). In his view, this question is doomed from the start, because when examined carefully, the nature of the *counting process* is unclear (what can pass as true counting and what cannot? For example, would repeating the sequence 1-2-3-4-5 like a mantra qualify as counting, what about the process of matching elements one by one?). The notion of *number* is similarly problematic since “modern mathematicians” are guilty of a “double deception”: (1) “looking at numeracy through the distorting lens of semantics, in which numbers are viewed as primarily the meanings of number-words in a fixed code”, and (2) “taking the model of English or some other western language, in which number-words are already geared to a counting operation which is neutral as to *what* is being counted” (p. 43). We will consider each of these problems in turn.

The first deception cuts straight to the heart of the “Telementation fallacy” discussed earlier. It relates to the false assumption that number words (like other words) are part of a fixed code, which Harris takes to be a static, unchanging and also precisely defined, Aristotelian set of meanings. Number words make ideal candidates for Harris to pin his Integrationist framework upon because: “whereas we may well doubt whether everyone has the same idea of what *democracy* means, surely it beggars belief that we do not all agree about what the word *three* means” (p. 46). In other words, number-words are located at the most ‘fixed’ end of the language system. If it could be shown that even such words as *three*, *nineteen* and *five* are outside the realm of public shared knowledge, and that they do not exist independently of the communicative act, then this would back up the main tenets of Integrationism and consolidate its validity. This is precisely the task that Harris takes on. He argues that:

“... there is no such material thing anyone can point to as ‘the meaning’ of the word *nineteen*. The most that can be done is to point to a group of nineteen objects (perhaps nineteen buttons or nineteen teaspoons) as an example of how to apply the word *nineteen* when counting. But, for all that, neither the buttons nor the teaspoons are the number. No one supposes otherwise.” (p. 57).

Describing an instance of how *nineteen* might be used, does not really tell us what it means (outside of the communication act). So words, even such stable words as *nineteen*, only have meanings when grounded in interaction, by virtue of being part of a communicative act. Harris goes on to claim that assuming a fixed code approach to number-words leads mathematicians to be “in the awkward position of not knowing what they are talking about” (p. 61). This may appear a little harsh since the very fact that mathematicians manage to make their system work shows that there is some widespread consensus of what *nineteen* means, even if they might not be able to express it outside its use. Furthermore, empirical work supports the fact that mathematicians are not alone in being in such a converging position. A study in which participants were interviewed

by linguists eliciting specific wordforms shows that in the case of number words (such as *two*, *five*, *six*, *seven*, *thirteen*, and so on), 99% of the responses converge on the same words (see data from the LAMSAS, Kretzschmar et al., 1993). This cannot be simply chance, but we return to this issue below."

... Calude: [Cld11], §4, *The origin of mathematics and communication by numbers*.

Reflecting the Complementarity Thesis (§1., Thesis 1) of this investigation:

- that *evidence-based* assignments of ‘satisfaction’ and ‘truth’ are, both, necessary and sufficient to give a categorical ‘meaning’ to the ‘provable’ formulas of a formal first-order Peano Arithmetic, such as PA, under a well-defined interpretation (in the sense of admitting a unique model by §2.E.b., Corollary 2.18⁶²⁹) —

Calude notes (in the above quote) that describing ‘an instance of how *nineteen* might be used, does not really tell us what it means (outside of the communication act)’, and so ‘even such stable words as *nineteen*, only have meanings when grounded in interaction, by virtue of being part of a communicative act’. Moreover, ignoring such complementarity would, Calude remarks, lend credence (see also §11.D.e.) to Harris’ ‘claim that assuming a fixed code approach to number-words leads mathematicians to be “in the awkward position of not knowing what they are talking about”’.

At heart the issue, Calude seems to suggest, is that mathematicians might be ignoring the need for such complementarity merely because, for all practical purposes, they—mistakenly in view of the Provability Theorem for PA (§2.E.b., Theorem 2.17⁶³⁰)—may be resigned to accommodating a lack of complementarity since they could be viewing it as an impractical search (but see, for instance §2.E.) for ‘the Holy Grail notion of mathematics, namely the notion of ‘proof’ and the different ways in which this much cherished idea is understood’:

“In their defence, it must also be added that mathematicians are themselves aware that in spite of the observed convergence and stability regarding mathematical terms, the ever-changing nature of mathematics itself impinges on and greatly influences the language and the meanings used for its investigation. They realise that what is evolving is not just the object of their study, but also the language used in this endeavour; see Calude et al. (2004) and Calude (2001) for a discussion of the Holy Grail notion of mathematics, namely the notion of ‘proof’ and the different ways in which this much cherished idea is understood.

At its most extreme, the question which Harris proposes is a little difficult to answer: how do I really know that your *three* is the same as my *three*? Yet he assures us: “I do not propose to buttonhole my bank manager and try to persuade him of the error of his mathematical beliefs. As far as I am concerned he can entertain whatever beliefs he likes about numbers, provided that he does not make a mess of my bank account” (p. 46). But if “we recognize no autonomous systems of signs, either verbal or non-verbal” (p. 37), then how can we even talk about a “bank manager” or a “bank account” without worrying that we are being misunderstood? So there must be some consensus which Harris is prepared to grant. Just how much of a consensus remains unclear.”

... Calude: [Cld11], §4, *The origin of mathematics and communication by numbers*.

Calude further addresses such apparent—illusory from the *evidence-based* perspective of this investigation—‘limits of language’ by reviewing Harris’ analysis of ‘number-words’—as reflecting that ‘the human mind cannot cope with numbers except by means of a semantic

⁶²⁹§2.E.b., Corollary 2.18: *PA is categorical*.

⁶³⁰§2.E.b., Theorem 2.17: *A PA formula $[F(x)]$ is PA-provable if, and only if, $[F(x)]$ is algorithmically computable as always true in \mathbb{N} .*

trick’—from George Lakoff and Rafael Núñez’s perspective in [LR00] (see also §27.) of ‘how mathematics is abstract and disembodied, yet [at the same time] real’.

Calude observes that as ‘far as mathematics goes, it has been suggested (see for example Barton, 2008) that the metaphors which particular languages present their speakers with will influence the ‘kind of’ mathematical ideas they engage with’:

“In his final lecture/chapter, Harris explains that in analysing number-words, it becomes clear that “the human mind cannot cope with numbers except by means of a semantic trick" (p. 72). In languages where there is a boundary of how large number words can go, of the ‘one-two-many’ type, anything beyond the numbers for which there are specific words gets pushed into the vague and indeterminate “many/lots" category. In languages with no upper bound, like English, there is a recursive “trick" as Harris terms it, such that larger numbers can be expressed by syntactic (re)combinations of the smaller numbers, e.g., $83 = \text{“eighty-three”}$, composed by the word for “eight”, “ten” and “three”. This trick means that “the larger numbers are the same: they have no properties which cannot be defined in terms of smaller numbers and operations on these” (p. 72). While this observation is accurate, its interpretation depends on what one means by the mind “not being able to cope with numbers”. If the point is extended to grammar itself, it might be extrapolated that the mind “cannot cope with grammar” because it uses a similar “trick”, namely embeddedness. It might be said that given the way we build complex ideas and propositions by means of recursion, the brain “can similarly not cope with grammar” either. But what happens when we explore the nature of our “tricks” further?

A recent cognitive account of the “tricks” mathematicians employ in order to discuss their field is outlined in Lakoff and Núñez’s (2000) book. In line with Harris’s concerns, Lakoff and Núñez attempt to account for “how mathematics is abstract and disembodied, yet [at the same time] real” (2000: xv). Working within a cognitive linguistics framework, the authors place the metaphorical process at the heart of how we conceptualize our experience and make sense of the world around us. Just as we construe “ARGUMENTS as being WAR”, e.g., “Your claims are *indefensible*”, “He *attacked* every point I made”, “I tried to *take* his theory *down*” (Lakoff and Johnson, 1980), so too, we build metaphorical extensions in order to understand mathematical truths. According to Lakoff and Núñez, metaphors are used in most areas of mathematics, from number theory to geometry and topology. Here are some of their examples of how this process works:

- The *number line*, where numbers are conceptualized as points on a line.
- Boole’s *algebra of classes*, where the foundation of classes of objects is conceptualized metaphorically in terms of algebraic operations and elements: plus, times, zero, one, and so on.
- *Symbolic logic*, where reasoning is conceptualized metaphorically as mathematical calculation using symbols.
- *Trigonometric functions*, where angles are conceptualized metaphorically as numbers.
- The *complex plane*, where multiplication is conceptualized metaphorically in terms of rotation. (from Lakoff and Núñez 2000: xvi)

In particular, we use the metaphor “Numbers Are Things in The World” (2000: 80ff) in order to ground our understanding of numbers in something we are used to dealing with, namely real objects. Arithmetic can be thought of as “Object Construction” (in the way we think ten is *made of* five plus five) or as a “Walk Along a Path” (for instance 9 is *closer* on the number line to 10 than to 20).

But what of the cross-linguistic variation discussed earlier? The exciting observation to be made here is that language is both the limiting and the freeing vehicle through which humans express, distill and create thought, including mathematical thought. Naturally, not every language will use the same metaphors for grounding the various aspects of experience required. As far as mathematics goes, it has been suggested (see for example Barton, 2008) that the metaphors which

particular languages present their speakers with will influence the ‘kind of’ mathematical ideas they engage with. Barton et al. (2006) give an example from the field of topology to illustrate this scenario, namely the nomenclature of an “open set”. Open sets can be conceptualized in various ways: (1) in opposition to the idea of a closed set, (2) as an open door which lets in foreign objects, (3) as activating the notion of an open border, a point of entry, or (4) as an open field with no boundary at all. Depending on the language, one, some, or all of these conceptualizations may be available as grounding metaphors for understanding the notion of an open set, e.g., in English all of these are available, in Turkish only the first two seem readily available. If indeed topologists work on the basis of (subtly) different conceptualizations of the notion of “open set”, th[e]n it is possible that they are compelled to discover different (thought not incompatible) types of truths relating to these.

Thus in more general terms, Lakoff and Núñez (2000) conclude that mathematics “has a cultural dimension, which, from the perspective of embodied mathematics, is entirely natural [...] since mathematical ideas are products of human beings with normal human cognitive capacities living in a culture” (2000: 359). Furthermore, “many of the most important ideas in mathematics have come not out of mathematics itself, but arise from the more general aspects of culture” (2000: 358). The idea that mathematics itself evolves and is not a fixed entity fits par excellence with the view of language proposed by Harris, a dynamic and constantly evolving one. Lakoff and Núñez support Harris’s articulated concern for the code and the assumptions made with regard to its properties. However, their account takes us beyond the general worry expressed by Harris regarding the instability of code. They link the code to conceptualisations which might arise from it, and help explain how it is that mathematicians around the world come up with different ways of looking at what might be in essence the same phenomena.”

... Calude: [Cld11], §5, *Limits of language?*.

Calude concludes that the ‘exciting observation to be made here is that language is both the limiting and the freeing vehicle through which humans express, distill and create thought, including mathematical thought’.

From an *evidence-based* perspective, Calude’s final conclusion—that what ‘is most impressive is the creative ability to adapt our cognitive and linguistic tools in order to describe and categorize the different realities we each deal with, culturally and environmentally, which are themselves ever-changing’—can be viewed as reflecting the four underlying theses of this investigation, namely:

- the Complementarity Thesis (§1., Thesis 1);
- the Mathematics Thesis (§13., Thesis 4);
- the ZF Limiting Thesis (§13.E., Thesis 5⁶³¹); and
- the PA Limiting Thesis (§13.E., Thesis 6⁶³²):

“At the beginning of this article, I mentioned Harris’s Integrationism theory as a response to the dominating Chomskyan current, against the reign of the Ideal Speaker, I-Language, E-Language and the exciting potential of linguistic creativity. In spite of the backlash against the formalist school, linguists were perhaps not wrong to marvel at human creativity with regards to their language system. However, they may have been marvelling at the wrong kind of creativity. It is

⁶³¹§13.E., Thesis 5: *Evidence-based reasoning restricts the ability of highly expressive mathematical languages, such as the first-order Zermelo-Fraenkel Set Theory ZF, to categorically communicate abstract concepts such as those involving Cantor’s first limit ordinal ω .*

⁶³²§13.E., Thesis 6: *Evidence-based reasoning restricts the ability of effectively communicating mathematical languages, such as the first-order Peano Arithmetic PA, to well-define infinite concepts such as those involving Cantor’s first limit ordinal ω .*

not from the ability to create infinitely long sentences consisting of elements never heard before that is most impressive. What is most impressive is the creative ability to adapt our cognitive and linguistic tools in order to describe and categorize the different realities we each deal with, culturally and environmentally, which are themselves ever-changing."

... Calude: [Cld11], §6, *Final words*.

Similarly, we can treat Megan Selbach-Allen, Cathy Williams and Jo Boaler's observation in [AWB20]:

"Too often mathematics is viewed by students and the general public alike as a set of formulas and techniques. However, mathematicians know that it involves so much more than banal procedures and requires deep thought and creativity."

... Selbach-Allen/Williams/Boaler: [AWB20], *Synopsis*.

as also reflecting the need to recognise that, as posited in the Complementarity Thesis (§1., Thesis 1), *intuitive, pre-formal* (in Pantsar's sense in [Pan09]; see §1.A.), truth not only *logically* precedes (in the intuitive sense of 'cause' preceding 'effect'), but must be vividly illustrated⁶³³ and taught as *logically* preceding, *formal* formula and technique-based reasoning at the earliest stages of a mathematical education; since:

"When mathematics is presented as a set of procedures, students disengage and develop incorrect ideas about the subject and their own potential [1, 2]. An increasing body of research demonstrates that mathematics can and should be taught at lower grades in ways that appeal to students, promote equity and lead to high achievement [3, 4, 5]. Evidence from this work has shown that successful mathematics instruction promotes collaboration with students working together to solve problems, in multi-modal environments [6, 5, 7, 8]. At the cutting edge of mathematics research, success depends on whether you can make the case for your ideas through proof, argument and reasoning. The notion of right or wrong turns from a black and white concept into arguments mired in shades of gray. Creativity clearly exists in the work of research mathematicians. However, in K-12 mathematics classrooms in the US too often procedural fluency is valued over creativity to the detriment of students' mathematical growth [1]. Changing mathematics instruction to embrace creativity, problem solving, and multiple solution pathways has the potential to unlock mathematics for students [6, 1, 9]."

... Selbach-Allen/Williams/Boaler: [AWB20], §1, *Introduction*.

28.B. What is our 'first philosophy' in mathematics education?

The argument that a philosophy of mathematics education is a specialised part of a philosophy of education is addressed, for instance⁶³⁴, in the essay *What is our 'first philosophy' in mathematics education?*, where Paul Ernest queries:

"What theoretical bases underpin research and practice in mathematics education? For most of the late 20th century, the theoretical underpinnings of mathematics education were mathematics and psychology. But in the past two decades other disciplines have grown in importance, including philosophy, sociology and linguistics, and have been used by a growing number of researchers

⁶³³As, for instance, sought to be achieved in:

- the *evidence-based* (pictorial), *pre-formal*, proof of the Four Colour Theorem in §1.I.;
- the *evidence-based* (pictorial), *pre-formal*, 'Disembodied' proof of Fermat's Last Theorem in §1.E.; and:
- the *evidence-based* (pictorial), *pre-formal*, proof of Prime independence in §22.A.;

⁶³⁴See also Yushua, Bokhari, Mji, Wessels: [YBM04]; Luitel: [Lui19].

to underpin their work. My own concern has been to draw on the insights and theories that philosophy offers. But this raises a question: “which of the branches of philosophy demands priority in mathematics education”: what is our “first philosophy”, if such exists?

...

Can mathematics education have a first philosophy? Is there a branch of philosophy that is a *sine qua non* for mathematics education research and possibly its practice as well? Are there philosophical assumptions that cannot be avoided in pursuing any inquiries whatsoever in our field? Can these assumptions be located in one branch of philosophy? In this article, I argue that much is presupposed when we embark on research in mathematics education, including philosophical assumptions. Identifying a first philosophy for mathematics education, if one exists, is a vital task, because any theories we use rest on assumptions, both overt and covert. These assumptions must be cognizant of and consistent with such a first philosophy. This condition is important because, as I argue in the conclusion, some recently popular theories, such as radical constructivism, fail such a test.

Three candidates for a first philosophy for mathematics education research were mentioned above: ontology (representing metaphysics), epistemology and ethics. In addition, two further branches of philosophy are relevant, the philosophy of mathematics, which inquires into the nature of mathematics including its objects and knowledge, and critical theory, which considers the role of scientific and mathematical knowledge in society, as well as issues of social justice and social critique. I consider, below, the claims of each of these five candidates to be the first philosophy of mathematics education.

...

Perhaps the most frequently considered area of philosophy in mathematics education is the philosophy of mathematics. It is argued that understanding the nature of the subject of mathematics and its philosophical underpinnings is necessary, both for teaching the subject thoughtfully and for research in mathematics education.

...

The maverick tradition in the philosophy of mathematics has also challenged the traditional absolutist accounts of mathematical knowledge as certain, absolute, superhuman and incorrigible. The alternative fallibilist (Lakatos, 1976), humanist and social constructivist accounts view mathematical knowledge as fallible and humanly created. These accounts resonate with many of the most controversial theoretical developments in mathematics education, including radical constructivism, social constructivism, socio-cultural theory, postmodernism and critical mathematics education. Even the problem-solving and investigations movements in mathematical pedagogy have drawn on these newer philosophies of mathematics and their challenge to mathematical absolutism.

However, it is not just these newer developments in the philosophy of mathematics that are claimed to underpin mathematics education. The educational relevance of the philosophy of mathematics as a whole has been argued more widely: “Whether one wishes it or not, all mathematical pedagogy, even if scarcely coherent, rests on a philosophy of mathematics” (Thom, 1973, p. 204). Thus, as Hersh (1979) argues:

The issue, then, is not, What is the best way to teach? but, What is mathematics really all about? [...] Controversies about [...] teaching cannot be resolved without confronting problems about the nature of mathematics. (p. 34)

In discussing such philosophies of mathematics embedded in the mathematics curriculum I have shifted from referring to formal academic philosophies as discussed by professional philosophers (e.g., intuitionism, logicism, formalism), to discussing informal philosophies, perhaps better described as images of mathematics. There is an analogy here with Tall and Vinner’s (1981) distinction between concept definition (formal, explicit, publicly justifiable description) and concept image (visual and other representations and associations). Concept images represent a deep level of meaning, partly implicit, and may influence their holder’s dispositions and actions. Similarly, images of mathematics can include a wide range of representations and associations from sources

including philosophy and accounts of the nature of mathematics, but also including representations from the media, classroom presentations and parent, peer and other narratives about mathematics. Personal images of mathematics can utilize mental pictures, including visual, verbal, and narrative representations, originating from past experiences, social talk, etc., and include cognitive, affective and behavioural dimensions, including beliefs. Clearly, with all this variety of representations, a personal philosophy or image of mathematics cannot be the same as a fully articulated academic philosophy of mathematics."

... Ernest: [Er12], p.8 and p.9.

Since a teacher's belief system may be responsible for implicitly influencing the belief system of a student—sometimes unjustifiably and permanently (see §7.B.; also *Friend, Molinini: [FM15]*, pp.201-202)—the need for, and absence of, a holistic *evidence-based* perspective concerning the nature of mathematics as a whole has been a continuing concern of educationists. As highlighted further by Ernest:

“CONCEPTION OF THE NATURE OF MATHEMATICS

This is a teacher's belief system concerning the nature of mathematics as a whole. Such views form the basis of the philosophy of mathematics, although some of the views likely to be held by teachers may not have been elaborated into fully articulated philosophies. Teachers' conceptions of the nature of mathematics by no means have to be consciously held views; rather they may be implicitly held philosophies. The importance of such views of subject matter has been noted both across a range of subjects (Feinman-Nemser and Floden, 1986) and for mathematics in particular (Ernest 1985, 1987, 1988b; Lerman, 1983, 1986; Thom, 1973). Out of a number of possible variations, three philosophies of mathematics are distinguished because of their observed occurrence in the teaching of mathematics (Thompson, 1984), as well as for their significance in the academic study of the philosophy of mathematics (Benecerraf and Putnam, 1964; Davis and Hersh, 1980; Lakatos, 1976; Tymoczko, 1985). They are presented here in simplified form, and in practice teachers may combine elements from more than one of the views.

First of all, there is a dynamic, problem-driven view of mathematics as a continually expanding field of human enquiry. Mathematics is not a finished product, and its results remain open to revision (the problem solving view).

Secondly, there is the view of mathematics as a static but unified body of knowledge, consisting interconnecting structures and truths. Mathematics is a monolith, a static immutable product, which is discovered, not created (the Platonist view).

Thirdly, there is the view that mathematics is a useful but unrelated collection of facts, rules and skills (the instrumentalist view).

Teachers' views of the nature of mathematics may also be compounded with additional constructs, such as views of the relationship between different subject matter areas, for example. Is mathematics entirely distinct from other disciplines? Or are mathematics and other areas of knowledge interrelated or partly integrated, sharing concepts and methods of inquiry? The conception of knowledge as integrated is often associated with a problem solving view of mathematics, but there is no strict necessity behind this link.

The different philosophies of mathematics have practical classroom outcomes. For example, an active, problem solving view of mathematical knowledge can lead to the acceptance of children's methods and approaches to tasks. In contrast, a static Platonist or instrumentalist view of mathematics can lead to the teacher's insistence on there being a single 'correct' method for solving each problem. Again, a teacher's view of knowledge as integrated can lead to teaching in which mathematics and other subject matter areas are interrelated. The opposite view can result in an insistence that questions of mathematics and geography, for example, are dealt with separately during mathematics lessons and geography lessons.

Some of the main curriculum reform movements in mathematics have been based on views of mathematics. The Modern Maths movement of the early 1960's can be likened to the Platonist view through its stress on structure, the laws of number, and central and unifying concepts of mathematics, such as sets and functions. A second parallel can be drawn between the instrumentalist view and that underlying the Back-to-Basics movement. This movement emphasises basic numeracy as knowledge of facts, rules and skills, without regard for meaningful connections within this knowledge. More recently, the problem solving view of mathematics has been reflected in the recommendations of official bodies (NCTM, 1980; Cockcroft, 1982; HMI, 1985; National Curriculum Mathematics Working Group, 1987). Namely, that the processes and strategies of mathematical activity are central, and that the main aim of mathematics teaching is to empower children to become creative and confident solvers of problems.

Teachers' views of mathematics evidently affect the extent to which such curriculum innovations or movements take hold, through the way mathematics is taught (Cooney, 1988; Thom, 1973). For beliefs about mathematics are reflected in teachers' models of the teaching and learning of mathematics, and hence in their practices (Thompson, 1984).

...

THE IMPACT OF BELIEFS ON TEACHING MATHEMATICS

The teacher's view of the nature of mathematics provides a basis for his or her mental models of the teaching and learning of mathematics. For views of the nature of mathematics are likely to correspond to views of its teaching and learning. Thus, for example, the instrumental view of mathematics is likely to be associated with a transmission model of teaching, and with the strict following of a text or scheme. It may also be associated with the child's compliant behaviour and mastery of skills model of learning. Similar links can be conjectured between other views and models, for example:

Mathematics as a Platonist unified body of knowledge corresponds to a view of the teacher as explainer, and learning as the reception of knowledge, although an emphasis on the child constructing a meaningful body of knowledge, is also consistent with this view;

Mathematics as problem solving corresponds to a view of the teacher as facilitator, and learning as autonomous problem posing and solving, perhaps also as the active construction of understanding."

... Ernest: [Er06].

The thesis of this investigation (see §1., Thesis 1) suggests that classical set-theoretically founded paradigms conflate mathematical education with the teaching of *only* the grammar of formal mathematical languages.

In other words, as is reflected in [Er06] above, classical set-theoretically founded paradigms:

- seem to focus only on the first-order construction of grammatically correct, contradiction-free, provable set-theoretical propositions of the language;
- without *any* attempt to assign *evidence-based* meanings, in terms of *primary* conceptual metaphors, to the grammatically correct (provable/unprovable) propositions of the language since, if we accept §20.D.b., Thesis 9, there can be no *evidence-based* interpretation of a theory that contains an axiom of infinity;
- so any interpretation of the set-theoretically defined formulas of a mathematical language must essentially admit *secondary* conceptual metaphors;
- which *exist* only symbolically in the very propositions of the language whose meaning is sought from the perspective of an 'understanding' that seeks to avoid impredicativity;

- by planting the seeds of an inescapable impredicativity that must implicitly harbour contradiction, as is highlighted by the well-known logical, semantic, and mathematical paradoxes (see §20.)!

If so, it is uncertain to what extent one could, for instance:

- sustain the interest of one unfamiliar with the English language by teaching only, say, English vocabulary and grammar;
- and/or expect appreciation of the expressive and communicative power of the language for both practical applications (such as asking for directions) and literary pursuits (such as reading Shakespeare).

Moreover, this would suggest explicitly highlighting—as early as possible in any mathematical education—that the grammar of a language that teaches the construction of valid narrative and declarative sentences of a language does not inform what the sentences narrate and/or declare; but only that the language can be used to narrate and declare what we intend to talk about, and communicate, by means of the language.

Comment 238. Which would further suggest that Bertrand Russell’s oft-quoted explanatory remark which, it may not be entirely unreasonable to claim, has significantly influenced the mathematical perspective, and philosophy, of mathematics teachers and students over the years:

“... mathematics may be defined as the subject in which we never know what we are talking about, nor whether what we are saying is true.”

... Russell: [Rus17], p.74, paragraph 3.

might be more to the point if read today as:

“... mathematics may be defined as the subject in which we never talk about anything, nor claim that what we are saying is true.”

28.C. Math Anxiety

We conclude by remarking that, from the *evidence-based* perspective of [An16] (see §2.), the challenges, labeled as ‘math anxiety’, that inhibit the teaching of mathematics as a ‘live’ discipline could also:

- be a reflection of implicit, unreasonable, expectations in current mathematical education paradigms;
- of a median student’s innate ability, and motivation, to commit, in the absence of *evidence-based* and *explicit* interpretations that are encountered daily in the student’s life;
- to *subjectively* seeking an appreciation of the significance, and meaningful association, of the grammar and vocabulary of an unfamiliar language;
- apropos *implicit* interpretations which might, or might not, be what the language is intended to express and communicate.

“WHAT IS MATH ANXIETY?”

Math anxiety refers to feelings of fear, tension, and apprehension that many people experience when engaging with math (Ashcraft, 2002). Math anxiety is thought to be a trait-level anxiety and is distinguished from both test anxiety (Kazelski et al, 2001) and state anxiety (Hembree, 1990). For a math anxious student, math creates more than a feeling of dislike or worry; it also affects physiological outcomes, such as heart rate, neural activation, and cortisol

The various accounts explaining why individuals might develop math anxiety have been helpful in generating important programs of research. One shortcoming of these accounts, however, is that they do not explain why poor math abilities or negative learning experiences necessarily lead to math anxiety. After all, many students receive lower grades in math or learn under the same teachers as anxious students, and yet these students do not end up developing math anxiety. Conversely, we also find that there are many students who are both high achievers in math and highly math anxious (Lee, 2009). To reconcile this, we propose a novel Interpretation Account of how math anxiety develops and demonstrate how this new framework allows us to resolve some seemingly contradictory findings in the literature.

We draw from a large and disparate body of research to argue that students’ development of math anxiety is largely determined by how they interpret (i.e., appraise) previous math experiences and outcomes (rather than the outcomes themselves). That is, math anxiety derives not just from a student’s avoidance tendencies, reduced competency, or performance worries that shape the development of math anxiety but rather how individuals interpret their math-related experiences."

. . . Ramirez, Shaw, Maloney: [RSM18], p.151

Comment 239. We note that issues of ‘math anxiety—which include, but need to be differentiated from the more specific learning challenges due to Dyslexia and Dyscalculia (see Chinn: [Chn18])—seem to be of increasing concern to nations across the globe in societies increasingly dependent on the reliability of the mathematical languages that can provide the sound foundation (see, for instance, §2.E.b., Theorem 2.17) for the programming of mechanical intelligences in emerging products and services of critical economical, political, and military, interest to the state. See, for instance:

- *Uusimaki, Nason*: [UN04], Australia;
- *Yushua, Bokhari, Mji, Wessels*: [YBM04], Saudi Arabia;
- *Adnan, Zakaria* [AZ10], Malaysia;
- *Bekdemir*: [Bkd10], Turkey;
- *Tungosiamu*: [Tng10], Ghana;
- *Christie Blazer*: [Blz11], USA;
- *Boyd, Foster, Smith, Boyd*: [Byd14], Australia;
- *Realí, Jiménez-Leal, Maldonado-Carreño, Devine, Szücs*: [Rli16], Colombia;
- *Alam, Halder*: [AH18], India;
- *Orbach, Herzog, Fritz*: [OHF19], Germany;
- *Sorvo, Koponen, Viholainen, Rääkkönen, Peura, Tolvanen, Aro*: [Srv19], Finland;
- *Zhang, Jhao, Kong*: [ZZK19], China.

In a 2010 paper [Bib10], educationist Shashidhar Belbase seeks to place the issue of ‘maths anxiety’ within a broader perspective of the epistemological and philosophical foundations (see also §13.)—such as *Realist, Intuitionistic, Constructivist, Nominalistic, Logicistic, Formalist, Absolutist*, etc.—which underpin individual and collective perceptions, and attitudes, towards the teaching and learning of mathematics:

“Epistemological and Philosophical Foundation

What is the nature of mathematics? How this nature is perceived by an individual? What are personal epistemologies and philosophies? How these epistemologies and philosophies impact in

our understanding of mathematics? There are some questions we need to think in order discuss the relationship among images, anxieties and attitude toward mathematics.

The nature of mathematics can be viewed differently from different epistemological and philosophical perspectives. For *Realists*, mathematics is viewed as the science of numbers, sets, functions, etc., just as physical science is the study of ordinary physical objects, astronomical bodies, subatomic particles, and so on (Maddy, 1990). According to the *Realist* school, images of mathematics relate to the nature of mathematics as being fixed, epistemologically priori, and it is infallible. This epistemological perspective believes that mathematical knowledge is fixed, and it is out there that we have to discover it. Many mathematicians have this dominant image of mathematics, and their teaching and learning in the classroom is affected by such image influenced by their epistemological perspective and personal philosophy. *Intuitionism* is based on the idea that mathematics is a creation of the mind. The truth of a mathematical statement can only be conceived via mental construction that proves it to be true and the communication between mathematicians only serves as a means to create the same mental process in different minds. The image of mathematics from this epistemological perspective and philosophical lens is that mathematics is a mental creation; mathematical objects are created by the intuition of mind, irrespective of language in which one thinks (Iemhoff, 2008).

The epistemology and philosophy of *Constructivism* conceives that the learners actively construct their own knowledge, rather than passively receive it. *Constructivists* argue that the term knowledge is problematic because it evokes a static, rather than dynamic image of learning, and they prefer to talk about learning or knowing, interpreting and making sense of experiences. A popular conception of *Constructivism* claims that learners can only construct meaningful understanding in relation to their prior knowledge. The image of mathematics is viewed from this epistemological and philosophical lens as a co-construction of mathematical ideas through social critical discourse of various mathematical phenomena (Confrey & Kazak, 2006).

There exists a common feature of all the views just described, that is, that they all take mathematics to deal with abstract objects, whether one takes these to have an independent existence in their own right, or to be abstracted from our experience (Avigad, 2007). An alternative, as suggested by Avigad, is simply to deny such object's ontological status in the first place, and think of mathematics, instead, as a science governing the use of (relatively concrete) signs. The challenge then is to give an account of mathematical knowledge that explains what it is that gives certain manipulations of signs normative force and also explains the applicability of mathematics to the sciences. Positions that adopt such an approach fall under the rubric of *Nominalism* (Avigad, 2007). According to *Nominalism*, mathematical objects do not exist or, at least, they need not be taken to exist for us to make sense of mathematics (Bueno & Zalta, 2005).

Strawderman (2010) has proposed three domains to study mathematics anxiety: *social/motivational* domain, *intellectual/educational* domain, and *psychological/emotional* domain. Strawderman clarified that the *social/motivational* domain includes those forces that act upon a person through the agencies of family, friends, and society as a whole. The *intellectual/educational* domain is comprised of those influences that are cognitive in nature. These cognitive influences include but are not limited to, the knowledge and skills an individual has and or is expected to acquire and his or her perception of success or failure in them. The *psychological/emotional* domain is formed by the faculties that are affective in nature. It is largely comprised of the individual's emotional history, reactions to stimuli, and arousal states. Hence, the continuum associated with this domain is feelings. At either end of the feelings continuum lie anxiety and confidence. These domains of anxiety are related to attitude towards mathematics in terms of emotions, expectations and values (Hannula, 2002). These discussions lead us to conclude that images of mathematics are greatly shaped by the epistemological and philosophical perspectives of one who views mathematics either as priori or posteriori, absolute or relative, and concrete or nominal. These images are further associated with perceptions, feelings and anxiety of mathematics leading to negative or positive attitude toward mathematics."

... Belbase: [Bb10], §Epistemological and Philosophical Foundations, pp.5-6.

Belbase argues that treating an 'image of mathematics' as 'a representation of mathematics

that is either *social* or *personal*', is important for understanding why, for many pupils, their image about mathematics becomes 'influenced by dichotomous thought as [to whether] mathematics is *absolute* or *fallible*', with 'negative feelings about mathematics' as being 'difficult, cold, abstract, theoretical, and ultra-rational' as well as 'being *remote and inaccessible* to all but a few super-intelligent beings with 'mathematical minds':

"When I talk or think about images of mathematics, two things come into my mind: images as objects or images as abstraction. I think images as objects in relation to mathematics are related to symbols (+, -, %, [], Δ , π , <, =, >, $\sqrt{\quad}$, \sum , \int etc.) and images as abstraction are related to operations that go in our mind. The image as an object is static and it visualizes mathematics as a subject matter. The image as an abstraction is dynamic and it visualizes mathematics as a process or operation that goes on in our mind.

Tall and Vinner (1981) define a concept image as all the cognitive structures, conscious or unconscious, associated with a concept, including mental images and words. A concept, such as an apple, must allow for variability. If we imagine an object shaped like an apple that is purple, we can still believe that it is an apple. We have the freedom to recombine familiar ideas in novel ways. But, since we have never seen a purple apple, it is unlikely that we would form an image of one, when hearing the word apple (Browne, 2009). McGinn (2004) asserts that images are part of our active nature, since they are subject to the will of the viewer. Percepts belong to the passive part of thinking and imagination. In other words, one must make an effort to form an image of something, while the same may not hold true for just looking. That is to say that something that we see may have different mental image than that appears to us. McGinn classifies images as a distinct mental category, separating them from percepts. In mathematics, images represent perception in terms of nature of mathematics as viewed by a person. Lakoff and Nunez (2000) have argued that the conceptual metaphor plays a fundamental role in mathematical understanding because it provides a means to map ideas in one conceptual domain to corresponding ideas in another conceptual domain. For example, it makes possible for us to understand difficult ideas such as infinity.

Based on our experience, we all may develop different images in relation to mathematics and its nature. Specifically, we all have developed images of and about mathematics. Ernest (2008) argues that there are many components of learner attitudes and beliefs about mathematics. These attitudes and beliefs play an important role in problem solving and in learner participation in advanced mathematical studies and careers. According to Ernest, developing a positive image of mathematics leads a learner toward advancement and to the benefit of society.

In *absolutist* perspective, images of mathematics are viewed as an objective, absolute, certain, and incorrigible body of knowledge, which rests on the firm foundations of deductive logic. Among twentieth century philosophies, *Logicism*, *Formalism*, and, to some extent, *Intuitionism* and *Platonism* may be said to be *Absolutist* in this way (Ernest, 1991). However, Ernest (2008) claimed that absolutist philosophies of mathematics are not concerned about describing mathematics or mathematical knowledge as they are practiced or applied in the world around us.

Rensaa (2006) asserts that in the past few decades a new wave of epistemology and philosophy of mathematics have been gaining ground and these propose a non-absolutist account of mathematics. Kitcher and Aspray (1988) described this as the 'maverick' tradition that emphasizes the practice of, and human side of mathematics, and characterizes mathematical knowledge as historical, changing, and corrigible. Image of mathematics is viewed as falsifiable, contextual, and relative.

According to Ernest (1994), one of the innovations associated with a fallibilist view of mathematics is a reconceptualized view of the nature of mathematics. It is no longer seen as a body of pure and abstract knowledge which exists in a superhuman, objective realm. The perfection of mathematics is ideal and, therefore, the false image of perfection of mathematics must be dropped (Davis, 1972).

Before discussing the relationship of images of mathematics with values and epistemology it is necessary to indicate what we mean by an image of mathematics in this context. Taking an image

of mathematics is a representation of mathematics that is either *social* or *personal*. *Social images* of mathematics are public representations encompassing mass media representations including films, cartoons, pictures, popular music; presentations and displays in school mathematics classrooms and the related learning experiences relating to them; parent, peer, or other narratives about mathematics; and representations of mathematics utilizing any other semiotic education modes or means. These public images of mathematics may possibly have a significant impact in shaping children's attitudes toward mathematics (Ernest, 2008).

Ernest (2008) further claimed that *personal images* of mathematics are personal representations of mathematics utilizing some form of mental picture, visual, verbal, narrative or other personal representation, originating from past experiences of mathematics, or are from social talk or other representations of mathematics, which may potentially compromise cognitive affective and behavioral dimensions. To me, these *personal images* in relation to *social images* develop our perceptions, values, and attitudes towards mathematics. The conception of mathematics as it is represented in such images may vary across a range encompassing research mathematics and mathematicians, school mathematics, and mathematical applications in everyday or otherwise.

A widespread *public image* of mathematics in the West is that it is difficult, cold, abstract, theoretical, and ultra-rational, and, also important and largely masculine (Ernest, 2008). It also has the image of being *remote and inaccessible* to all but a few super-intelligent beings with 'mathematical minds' (Buerk, 1982; Buxton, 1981; Ernest, 1996; Lim & Ernest, 1998; Picker & Berry, 2000). For many people, this *negative image* of mathematics is also associated with anxiety and failure. When Brigid Sewell was gathering data on adult numeracy for the Cockcroft (1982) inquiry, she asked a sample of adults on the street if they would answer some questions. Half of them refused to answer further questions when they understood it was about mathematics, suggesting *negative attitudes*. Extremely *negative attitudes* such as '*mathephobia*' (Maxwell, 1989) probably only occur in a small minority in Western societies, and may not be significant at all in other countries. In fact, the world-wide consensus of mathematics educators is that school mathematics must counter that image, and offer instead something that is personally engaging, and useful, or motivating in some other way, if it is to fulfill its social functions (Howson & Wilson, 1986; NCTM, 1989; Skovsmose, 1994).

In a broad sense, images of mathematics as separated and connected to values that further lead us to formulation of a school mathematics either as *disconnected or connected* images of mathematics. Finally, teaching and learning of mathematics influenced by the *absolutist* epistemology and philosophy help students develop *separate (fragmented) image* of mathematics, while *fallibilist* epistemology and philosophy help students to develop a *connected (logically related) image*. However, for many pupils the image about mathematics become influenced by dichotomous thought as mathematics is *absolute* or *fallible*, they are gradually changing from *positive* to *negative* feelings through schools because of not being able to understand that they can create mathematical objects rather than imitate from others. Such negative feelings about mathematics, for instance, have been seen in reports from the United States, Australia, or closer in Norway (Ernest, 2008). Renssa (2006) also claimed in the same line as Ernest that pupil's images of mathematics and mathematicians are derived as a result of social experiences, either through school, peers, parents, or mass media. In real life the picture is more complex as these influences interact each other.

Within the public society, adults and parents' images of mathematics are important when it comes to influence children's perceptions. As stated by Ernest (1996) there is no doubt about impact of adult's and parents' perception and attitude toward mathematics on children's attitude to the subject. It indicates that how important parental encouragement is to children's learning of mathematics. Ferry et al. (2000) found in their research on family background context variable, parental encouragement in mathematics and science significantly influence learning experiences. Learning experiences, in turn, were found to significantly influence self-efficacy and outcome expectations. These results support the role of family context in Lent et al.'s social cognitive career development model (Lent et al., 1994). Children not having this support may therefore have a drawback when it comes to continuing with *negative images* of mathematics."

Belbase thus argues that, within ‘the public society, adults and parents’ images of mathematics are important when it comes to influence children’s perceptions’, indicating ‘how important parental encouragement is to children’s learning of mathematics’.

He concludes that children ‘not having this support may therefore have a drawback when it comes to continuing with *negative images* of mathematics’ that could, conceivably, result in a mathematical anxiety syndrome where ‘students under this anxiety have fear of mathematics class, homework, exam and any situation when comes with mathematics’:

“When I think or talk about mathematics anxiety, two things come to my mind: one is anxiety as progressive thinking and the other is anxiety as regressive thinking. To me all anxieties are not bad things. Anxieties can be both good and bad. If it promotes for progressive thinking (like when I am puzzling in a mathematics problem for a few days and I am trying to solve it in a variety of ways), then certainly it is good thing. But anxiety is mostly taken as regressive thinking in which a person having anxiety tries to go away or get rid of problem simply by avoiding it and taking it negatively.

Mathematics anxiety is an anxious state in response to mathematics-related situations that are perceived as threatening to self-esteem. Cemen (1987) proposed a model of mathematics anxiety reaction consisting of environmental antecedents (e.g., negative mathematics experiences, lack of parental encouragement), dispositional antecedents (e.g., negative attitudes, lack of confidence), and situational antecedents (e.g., classroom factors, instructional format) are seen to interact to produce an anxious reaction with its physiological manifestations (e.g., perspiring, increased heart beat). Many researchers (e.g., Ma, 1997; Richardson & Suinn, 1972; Tobias & Weissbrod, 1980) have reported the consequences of being anxious toward mathematics, including the inability to do mathematics, the decline in mathematics achievement, the avoidance of mathematics courses, the limitation in selecting college majors and future careers, and the negative feelings of guilt and shame. Ma (1997) claimed that mathematics anxiety is usually associated with mathematics achievement individually. A student’s level of mathematics anxiety can significantly predict his or her mathematics performance (Fennema & Sherman, 1977; Wigfield & Meece, 1988).

In their study Miller and Bichsel (2004) claimed that math anxiety appears to primarily impact visual working memory, contradicting previous findings that anxiety is primarily processed in verbal working memory and supporting the hypothesis that math anxiety does not function similarly to other types of anxiety. They referred to past researches which investigated the underlying cognitive processes that contribute to individual differences in math ability, the most investigated of which appears to be working memory. Many researchers in the past have shown that the processes involved in working memory, namely, temporary retrieval, processing, and storage, explain much of the variance in math ability (e.g., Adams & Hitch, 1998; Ashcraft, 1995; Miller & Bichsel, 2004). The concluding remarks can be made based on these claims that individuals who are more efficient and adept in carrying out these processes are likely to perform better on tests of math ability.

Miller and Bichsel (2004) identified two general types of anxiety: trait and state. They clarified that individuals experiencing trait anxiety have a characteristic tendency to feel anxious across all types of situations. In contrast, individuals possessing state anxiety tend to experience it only in specific personally stressful or fearful situations. Trait anxiety is more related to wide range of situations to which one feels a kind of threat, unsecured, and challenge all the time. In mathematics, students under this anxiety have fear of mathematics class, homework, exam and any situation when comes with mathematics. According to Spielberger et al. (1970), state anxiety reflects a transitory emotional state or condition of the human organism that is characterized by subjective, consciously perceived feelings of tension and apprehension, and heightened autonomic nervous system activity. Several past studies demonstrated that both state and trait anxiety affect task performance (e.g., Leon & Revelle, 1985; MacLeod & Donnellan, 1993; Miller & Bichsel, 2004). Concluding the findings from these researches, Miller and Bichsel stated that individuals with high trait anxiety show poorer performance on various tasks than low trait anxiety individuals. This difference tends to be exacerbated in a high state anxiety condition. With reference to research on impact of gender on math anxiety, Hembree (1990) found math anxiety being more predictive of

math performance in males than in females."

... Belbase: [Bib10], pp.5-12

In a study that investigated the causes underlying a sample of eighteen third-year Australian pre-service primary teachers' negative beliefs and anxiety about mathematics, Liisas Uusimaki and Rod Nason give examples which suggest that the roots of 'math anxiety' can be traced more to *how* mathematics is taught than to *what* is taught.

Essentially, what they found was that most of the participants' maths-anxiety could be attributed to their primary school experiences in enforced learning of mathematical structures *without*, apparently, any *evidence-based* interpretations of such symbolic expressions that would assign meanings to them from familiar day-to-day experience:

"Issue 1: Origins of negative beliefs and anxiety about mathematics

The analysis of data revealed that 66% of the participants ($n = 12$) perceived that their negative beliefs and anxiety towards mathematics emerged in primary school. Linda for example, remembers "exactly" what year in primary school she learnt to dislike mathematics.

When I was in Grade 5 and we started doing division and I was away the very first day they introduced division and I came back the next day and I had no clues what everyone else in the class seemed to know really well. And my teacher never took the time to actually sit down and go through it with me so I was trying to play catch up and I feel like I've been playing catch up every since ...

... Tina, for example, remembers the time in primary school as a time when,

I used to make lots of mistakes and I was always frightened... I vividly remember, actually in Grade 1, getting into huge trouble because I couldn't fit a puzzle together. I vividly remember that. Just absolutely getting caned by this teacher.

... Petra's comment about one of her secondary school mathematics teachers exemplified the type of comments made by these four participants about some of their secondary mathematics teachers.

I had a teacher called Mr O, a bit of a Hitler looking fellow but I just have visions of him throwing dusters at students you know to get their attentions and he just never explained anything ... just wrote it on the board and then you just copied it and then you just had to really go home and try and work it out so I was pretty stressed about that 'cause I kept thinking you need to talk about it, you need to go through it together and ask whether you understand it.

Only 11% of the participants ($n = 2$) identified tertiary education as the time when their negative beliefs and anxieties towards mathematics emerged. An important aspect of the comments made by these two participants was that their negative beliefs about mathematics was not traced back to how mathematics was taught but back to specific content of mathematics.

Issue 2: Situations causing most maths-anxiety

The participants felt most anxious about mathematics when they had to communicate their mathematical knowledge in some way (48%), for example, in test situations or verbal explanations. Also, causing a lot of anxiety was the teaching of mathematics in practicum situations (33%) due to insecure feelings of making mistakes or not being able to solve it correctly. For example, Rose explains that her most anxious moments are:

When I'm being called on to answer questions... and I don't know the right language and I try to answer the question as best I can but you don't really get your meaning across because you don't understand the language and you don't know what language to use.

Testing... Just when somebody tests my knowledge... It does and it makes me feel as if I don't know what I am talking about.

Issue 3: Types of mathematics causing maths-anxiety

Two strands from the Queensland Studies Authority (2003) syllabus caused most anxiety: 'algebra and patterns' (33%) and 'space' (31%). Number operations especially division, was also a concern (21%). The anxiety caused by these strands was well exemplified by Ann's response to Question 4.

Long division! Couldn't ever do that. Dividing. Can't do that. Times tables. You know how they used to learn the times tables. I still can't do them because they sing that song. One, ones are one and all that and I never had a very good memory so I could never learn them. I'm making myself sound really bad... And with addition and subtraction, I still use my fingers to count up things... I used to do it under my desk so the teacher couldn't see 'cos you're supposed to know just what 6 plus 6 is without counting it on your fingers sort of thing.

SUMMARY AND CONCLUSIONS

Most of the findings from this study regarding the causes of negative beliefs and anxieties about mathematics were consistent with the findings reported in the research literature. (e.g., Brown, McNamara, Hanley, & Jones, 1999; Carroll, 1998; Cornell, 1999; Nicol, Gooya, & Martin, 2002; Trujillo, & Hadfield, 1999). For example, this study found that the origin of maths-anxiety in most of these participants could be attributed to prior school experiences (cf., Levine, 1996; Martinez & Martinez, 1996). Whilst the literature suggests that negativity toward mathematics originates predominantly in secondary school (e.g., Brown, McNamara, Hanley, & Jones, 1999; Nicol, Gooya & Martin, 2002), data from this study suggests that negative experiences of the participants in this study most commonly originated in the early and middle primary school. The perceived reasons for these negative experiences are attributed to the teacher, particularly to primary school teachers (72%) rather than to specific mathematical content or to social factors such as family and peers.

Situations which caused most anxiety for the participants included communicating one's mathematical knowledge, whether in a test situation or in the teaching of mathematics such as that required on practicum. This is consistent with findings in the literature that suggests that maths-anxiety surface most dramatically when the subject is seen to be under evaluation (e.g., Tooke & Lindstrom, 1998). Specific mathematical concepts, such as algebra, followed by space and number sense, caused most concern amongst the participants.

Many of these findings have clear implications for the intervention program to follow this study. For example, the findings that many of the participants' maths-anxiety was teacher-caused indicate the need for the facilitator in the ensuing workshops to be warm, non-intimidating and supportive in nature. The findings also imply that the participants need to be provided with learning environments where they are able to: 1) freely explore and communicate about mathematics in a supportive group environment 2) explore and relearn basic mathematical concepts, and 3), apply this re-learned knowledge in real-life and authentic situations. As evidenced by the latent themes in the participants' responses, it is also clear that isolation and evaluation anxieties will not be allayed via merely arming pre-service teachers with content knowledge. This would act to further problematise the individual and dismiss the fundamental importance of the individual feeling part of an emerging mathematics community in which they perceive themselves to be supported."

... Uusimaki & Nason: [UN04], pp.372-375.

What ought to be particularly striking about the reported responses in the above study is that the challenge faced by math-anxious students in successfully finding:

- on their own, and without a given, appropriate, *evidence-based*—hence *verifiable*—interpretation into terms already familiar to the student;
- a meaning to what is taught essentially in an unfamiliar symbolic language of intended precise expression;
- that could entail a feeling of understanding the significance of that which a mathematical expression symbolises;

do not, *prima facie*, appear to have been encountered in the learning of, and achieving fluency in, the— far from precise—students’ mother tongues!

The pedagogical challenge in differentiating between the ontological (and epistemological) status of:

- what we express symbolically as our primary conceptual mathematical metaphors, and
- what we express symbolically as the secondary conceptual mathematical metaphors that arise from our subsequent perception of the symbolic expression/s of our primary conceptual mathematical metaphors,

is addressed by Feferman in his *Mathematical Intuition Vs. Mathematical Monsters*, where his conclusion that ‘explication of the basic concepts can only be tested holistically by the degree to which these theories are successful’, reflects the *evidence-based* perspective underlying the Complementarity Thesis (§1., Thesis 1) of this investigation:

“In the teaching of mathematics, both geometrical and physical intuition are constantly called upon at all levels for motivation of notions and results, and even in some cases for proofs. As examples of the latter, no proof of Pythagoras’ theorem can be more directly convincing than those involving dissection and rearrangement of figures, in some cases in combination with some elementary algebra. Given the geometrical and physical applications of the calculus, it is not surprising that the corresponding intuitions should be called on regularly in the teaching of that subject. But those same intuitions, suitably cultivated and extended, serve to carry one confidently into the study of analysis in higher dimensional spaces and then on into functional analysis. There too, as in linear algebra, geometrical intuition is frequently appealed to in the use of notions of vector addition, length, angle, projection, etc. And the near universal appearance of analogues of Pythagoras’ theorem in analysis and higher geometry is a linchpin in the extension of one’s intuition from familiar ground to the most diverse settings.

Topology serves to cultivate its own distinctive intuitions as rubber sheet geometry. Closed orientable surfaces in three dimensions provide a playing ground where one can adapt those intuitions to the notions and techniques of combinatorial topology in order to deal with less visualizable manifolds. And, as a final pedagogical example, a good current course in axiomatic set theory will start with the intuitive conception of the cumulative hierarchy and appeal to it to justify the Zermelo-Fraenkel axioms and various plausible extensions. Moreover, one returns to that in modified forms in the constructible and relative constructible hierarchies employed in various consistency and independence results.

Such examples can be multiplied a thousand-fold. The point here is not to enumerate them, but rather to recognize the ubiquity of intuition in the common experience of teaching and learning mathematics, and the reasons for that: it is essential for motivation of notions and results and to guide one’s conceptions via tacit or explicit analogies in the transfer from familiar grounds to unfamiliar terrain. In sum, no less than the absorption of the techniques of systematic, rigorous, logically developed mathematics, intuition is necessary for the understanding of mathematics.

Historically, and for the same reasons, it also played an essential role in the development of mathematics. The precise mathematical expression of various parts of our perceptual experience is mediated to begin with by intuitive concepts of point, line, curve, angle, tangent, length, area, volume, etc. These are not uniquely determined in some Platonic heaven. Mathematics models these concepts in more or less rigorous terms (sufficient unto the day), and then interweaves them to form more elaborate models or theories of physical experience as well as purely mathematical theories. The adequacy of explication of the basic concepts can only be tested holistically by the degree to which these theories are successful."

... Feferman: [Fe98], §1.

So perhaps, once we accept the thesis of this investigation (see §1., Thesis 1; also §13.) that:

- current paradigms of mathematical education are remiss in treating mathematics as a discipline;
- where ‘natural laws’ of logic/mathematics are to be discovered as is the case with the natural sciences;
- rather than as a language that avoids the ambiguities inherent in languages of common discourse;
- in areas where unambiguity of expression and categorical communication are de jure;

it might not be entirely unreasonable to posit that the challenges labeled as ‘math anxiety’ can be illuminated—and placed in a more appropriate perspective—by the challenges being faced in the persisting efforts to promote the, far more intuitive albeit artificial, language *Esperanto* as an additional auxiliary language at both national and international levels:

“The Challenge of Esperanto

We like to think that language is mankind’s greatest accomplishments, a defining quality that makes us human. Yet the languages we speak were not the result of a blueprint factory effort, or in any way a conscious contribution on our part. Whatever our first language is, we speak it spontaneously, and of course with the markers of its evolution over time.

Not so with invented, artificial languages, Esperanto perhaps being the best known. Millions know it to one degree or another. Fewer are highly functional in it, a language that was born in 19th century Poland from the belief of Ludovic Zamenhoff that language differences were a major contributor to violent struggle between different ethnic groups. The theory was that too many languages prevented mutual understanding, that the world in fact would be more peaceful if a language were chosen that everybody could understand.

...

For over thirty years I’ve studied Esperanto in an “on-again, off-again” way. Its cerebral charm still holds. I’ve always liked the sound of Esperanto, especially the balanced melodic influences of several natural languages. Much of the vocabulary is derived from Latin roots common to English. Yes, I know that beauty lies in the eye of the beholder, but the poetic rhythm and the easy logic of Esperanto are to me a happy mix.

The excessiveness of the dismissive humor or the cynical hostility that often greets the Esperantist is perplexing. The Esperanto movement has always been animated by the humanitarian impulse towards international and inter-ethnic friendship. Esperanto is often associated with the idealism of the world peace movement. Critics say that sperantists are “naïve simpletons.”

An easier criticism is that Esperanto, like any artificial language, makes communication too neutral, too antiseptic, even soulless. It doesn’t help that there’s no terra firma for Esperanto, the last

effort was in 1908 in the tiny neutral state of Morsenet, the orphan of a border dispute between the Netherlands and Prussia, where an unsuccessful uprising included a call for Esperanto to be an official language of what was to be called the state of Amikejo (Friendship Place). But in the tense, nationalistic, atmosphere of pre-war Europe, there was no possibility for success.

Critics of Esperanto say that there's a boring, sanitary neutrality that comes with speaking Esperanto. But Esperanto isn't as drab as a rainy day, or a concrete traffic barrier. Still, the color and life of the natural languages, is, well, missing. I'm thinking of the exasperating subjunctive of Spanish, the convoluted word order of German, the tonal challenges of Chinese, or the way Russian famously stacks up three or four consonants on top of each other every chance it gets.

The resulting ambiguity, or fuzziness of meaning, according to Arika Orent, in *In the Land of Invented Languages*, is not a flaw of natural language but a feature that gives it flexibility and suits our minds and the way we think. "Likewise," she says, "the fact that languages depend on arbitrary convention or cultural habit is a feature that allows us to rein in the fuzziness by establishing agreed-upon meanings at different levels of precision." In other words, language needs its idiosyncracies in order to do the enormous range of things we use it for.

My conclusion about Esperanto's lack of widespread adoption is that learning any language, including Esperanto, takes some time and effort, and most people simply aren't interested in the hard work of learning something new without a clear pay-off. Ironically, the cultural neutrality that is part of the Esperanto movement's mantra serves to limit its growth because languages tend to spread along with the cultures that give rise to them."

... Tom Thompson: *The Challenge of Esperanto*. In 'Omniglot: the online encyclopedia of writing systems & languages'.

The similarity—from a student's perspective—between the challenges faced by a student in learning a purely symbolic language such as mathematics, and in learning a spoken language such as French, is also remarked upon by Richard Barwell in [Bwl]:

"Let me begin, however, by inviting you to work on a problem.

A problem of mathematics and language: la chèvre de M. Séguin.

Il était une fois un fermier qui s'appelait M. Séguin. M. Séguin avait une chèvre, une bien belle chèvre. Chaque jour, M. Séguin se levait tôt le matin et amenait la chèvre au pré, pour qu'elle puisse brouter l'herbe. Elle avait faim ce chèvre! Dans le pré M. Séguin avait construit un abri qui protégeait la chèvre contre les intempéries. Il attachait la chèvre au coin de l'abri avec une corde. Il la laissait brouter toute la journée. L'abri était sur roues afin que M. Séguin puisse le bouger lorsque la chèvre avait fini de manger l'herbe à sa portée. Votre problème est celui-ci: quelle superficie de pré la chèvre peut-elle manger?

How did you get on? Did you read the problem right through to the end? Perhaps you know a little French and were able to make some sense of it. Did you work out what the problem is asking you to do? Can you work on the problem and report your findings in French? I have used this problem with secondary PGCE mathematics students. I present the problem verbally, much as it is written above. When I later ask the students how they felt when I did this, they often talk of feeling frustrated, angry, incompetent, disempowered and of switching off. They get an insight into what learning mathematics through a language only partially understood might feel like."

... Barwell: [Bwl].

28.C.a. Is mathematics a language?

The following excerpts are intended to briefly illustrate the dichotomy in current paradigms of mathematics education as to whether, and/or to what extent, mathematics ought to be (or even can be) treated—and taught—as a language (or as a second language).

"... If you think that mathematics *is* a language, you might see learning English as less important: if children can learn to speak mathematics, their proficiency in English might not matter. Whilst the idea that mathematics is a language is a useful metaphor, it should not be allowed to obscure the complex role of language in mathematics (see Pimm, 1987). Children's English *does* matter, as the Framework for Teaching Mathematics (DfES, 1999) acknowledges English provides the means for children to think about mathematics, as well as to express that thinking. If children are not supported to develop mathematical English, they are less likely to be able to participate fully in mathematics lessons, and so will have fewer opportunities to make progress in the subject."

... Barwell: [Bw].

"A range of useful examples of activities that support language development in relation to different aspects of mathematical discourse within mathematics teaching can be found in both *Access and Engagement in Mathematics* (DfES, 2005), and in *Secondary Mathematics and English as an Additional Language* (Driver, 2005)

Bilingual education and mathematics

In the section on *bilingualism and second language acquisition* Charlotte Franson highlights 5 key research findings concerning the education of bilingual learners in mainstream classrooms. These points can be related more specifically to mathematics:

- Point 1:** The learner's first language plays a significant role in the learning of the second language in terms of cognitive, linguistic and socio-cultural influences. ...
- Point 2:** Bilingual education can be very beneficial in the development of the second language. ...
- Point 3:** Most EAL and bilingual learners will develop a functional level of English in the first two years of schooling in English but they will need continued support to develop the cognitive academic language proficiency necessary for academic success. ...
- Point 4:** Learning a second language will not necessarily proceed in an orderly and systematic fashion. ...
- Point 5:** Learning a language and becoming bilingual is also about learning and living in different societies and cultures. ...

The assessment of mathematics and EAL

Assessment in mathematics covers a range of approaches, from nationally set standardised tests, to teachers' judgements of attainment based on systematic classroom observation. Assessment of the mathematical attainment of learners of EAL is, however, highly problematical, since any method of assessment relies to some extent on learners' use of English. In principle, for example, mathematics tests and examinations should not be proxy tests of English. In practice, this principle is difficult to implement. ..."

... Barwell: [Bw].

The significance of the Complementarity Thesis (§1., Thesis 1), and the Mathematics Thesis (§13., Thesis 4), is reflected in Anne Marie Helmenstine's concluding paragraph in *Why Mathematics Is a Language*, where she notes that '*modern elementary-high school curricula uses techniques from language education for teaching mathematics*'.

From the *evident-based* perspective of the two Theses, such techniques could, perhaps, be beneficially introduced also into the teaching of mathematics not only in higher school curricula, but also at under-graduate and graduate levels in universities, for alleviating 'math anxiety' (see §28.C.).

"Mathematics is called a language of science. Italian astronomer and physicist Galileo Galilei is attributed with the quote, "*Mathematics is the language in which God has written the universe.*" Most likely this quote is a summary of his statement in *Opere Il Saggiatore*:

[The universe] cannot be read until we have learnt the language and become familiar with the characters in which it is written. It is written in mathematical language, and the letters are triangles, circles and other geometric figures, without which means it is humanly impossible to comprehend a single word.

Yet, is mathematics truly a language, like English or Chinese? To answer the question, it helps to know what language is and how the vocabulary and grammar of mathematicians are used to construct sentences.

...

Key Takeaways: Why Math is a Language

- In order to be considered a language, a system of communication must have vocabulary, grammar, syntax, and people who use and understand it.
- Mathematics meets this definition of a language. Linguists who don't consider math a language cite its use as a written rather than spoken form of communication.
- Math is a universal language. The symbols and organization to form equations are the same in every country in the world.

...

What Is a Language?

There are multiple definitions of "language." A language may be a system of words or codes used within a discipline. Language may refer to a system of communication using symbols or sounds. Linguist Noam Chomsky defined language as a set of sentences constructed using a finite set of elements. Some linguists believe language should be able to represent events and abstract concepts.

Whatever definition is used, a language contains the following components:

- There must be a **vocabulary** of words or symbols.
- **Meaning** must be attached to the words or symbols.
- A language employs **grammar**, which is a set of rules that outline how vocabulary is used.
- A **syntax** organizes symbols into linear structures or propositions.
- A **narrative** or discourse consists of strings of syntactic propositions.
- There must be (or have been) a group of people who use and understand the symbols.

Mathematics meets all these requirements. The symbols, their meanings, syntax, and grammar are the same throughout the world. Mathematicians, scientists, and others use math to communicate concepts. Mathematics describes itself (a field called meta-mathematics), real-world phenomena, and abstract concepts.

...

The Argument Against Math as a Language

Not everyone agrees that mathematics is a language. Some definitions of "language" describe it as a spoken form of communication. Mathematics is a written form of communication. While it may be easy to read a simple addition statement aloud (e.g., $1 + 1 = 2$), it's much harder to read other equations aloud (e.g., Maxwell's equations). Also, the spoken statements would be rendered in the speaker's native language, not a universal language.

However, sign language would also be disqualified based on this criterion. Most linguists accept sign language as a true language. There are a handful of dead languages that no one alive knows how to pronounce or even read anymore.

A strong case for mathematics as a language is that modern elementary-high school curricula uses techniques from language education for teaching mathematics. Educational psychologist Paul Riccomini and colleagues wrote that students learning mathematics require “a robust vocabulary knowledge base; flexibility; fluency; and proficiency with numbers, symbols, words, and diagrams; and comprehension skills.”

...Helmenstine: [Hlm19].

Part V

APPENDICES

29. Appendix A: Some comments on standard definitions, notations, and concepts

We take Elliott Mendelson [Me64] (preferably over [Me15]), George Boolos et al [BBJ03], and Hartley Rogers [Rg87], as representative—in the areas that they cover—of standard expositions of classical first order logic and of effective computability.

1. Axioms and rules of inference of the first-order Peano Arithmetic PA

PA₁ $[(x_1 = x_2) \rightarrow ((x_1 = x_3) \rightarrow (x_2 = x_3))];$

PA₂ $[(x_1 = x_2) \rightarrow (x'_1 = x'_2)];$

PA₃ $[0 \neq x'_1];$

PA₄ $[(x'_1 = x'_2) \rightarrow (x_1 = x_2)];$

PA₅ $[(x_1 + 0) = x_1];$

PA₆ $[(x_1 + x'_2) = (x_1 + x_2)'];$

PA₇ $[(x_1 \star 0) = 0];$

PA₈ $[(x_1 \star x'_2) = ((x_1 \star x_2) + x_1)];$

PA₉ For any well-formed formula $[F(x)]$ of PA:
 $[F(0) \rightarrow ((\forall x)(F(x) \rightarrow F(x'))) \rightarrow (\forall x)F(x)].$

Generalisation in PA If $[A]$ is PA-provable, then so is $[(\forall x)A]$.

Modus Ponens in PA If $[A]$ and $[A \rightarrow B]$ are PA-provable, then so is $[B]$.

2. Church-Turing Thesis We note that classical theory holds that:

- (a) Every Turing-computable function F is partial recursive, and, if F is total, then F is recursive ([Me64], p.233, Corollary 5.13).
- (b) Every partial recursive function is Turing-computable ([Me64], p.237, Corollary 5.15).

From this, classical theory concludes that the following, essentially unverifiable (since it treats the notion of ‘effective computability’ as intuitive, and not definable formally) but refutable, theses (informally referred to as CT) are equivalent ([Me64], p.237):

Church’s Thesis: A number-theoretic function is effectively computable if, and only if, it is recursive ([Me64], p.227).

Turing’s Thesis: A number-theoretic function is effectively computable if, and only if, it is Turing-computable ([BBJ03], p.33).

3. **Conservative extension:** A theory T_2 is a (proof theoretic) conservative extension of a theory T_1 if the language of T_2 extends the language of T_1 ; that is, every theorem of T_1 is a theorem of T_2 , and any theorem of T_2 in the language of T_1 is already a theorem of T_1 .

4. **First-order language** ([Me64], p.29): A first-order language L consists of:

- (1) A countable set of symbols. A finite sequence of symbols of L is called an *expression* of L;
- (2) There is a subset of the expressions of L called the set of *well-formed formulas* (abbreviated ‘wffs’) of L;
- (3) There is an effective procedure (based on *evidence-based* reasoning) to determine whether a specified expression of L is a wff of L.

Moreover—reflecting the *evidence-based* perspective of this investigation as detailed in the proposed Definitions 32 to 34—we shall explicitly distinguish between a first-order language and:

- any *first-order theory* that seeks—on the basis of *evidence-based* reasoning—to assign the values ‘provable/unprovable’ to the well-formed formulas of the language under a *proof-theoretic logic*;
- any *first-order theory* that seeks—on the basis of *evidence-based* reasoning—to assign the values ‘true/false’ to the well-formed formulas of the language under a *model-theoretic logic*.

5. **First-order language with quantifiers** ([Me64], pp.56-57): A first-order language K with quantifiers is a first-order language whose alphabet consists of:

- (1) The propositional connectives ‘ \neg ’ and ‘ \rightarrow ’;
- (2) The punctuation marks ‘(,)’ and ‘,’;
- (3) Denumerably many individual variables x_1, x_2, \dots ;
- (4) A finite or denumerable non-empty set of predicate letters $A_j^n (n, j \geq 1)$;
- (5) A finite or denumerable, possibly empty, set of function letters $f_j^n (n, j \geq 1)$;
- (6) A finite or denumerable, possibly empty, set of individual constants $a_i (i \geq 1)$;

where the function letters applied to the variables and individual constants generate the *terms* as follows:

- (a) Variables and individual constants are terms;
- (b) If f_i^n is a function letter, and t_1, \dots, t_n are terms, then $f_i^n(t_1, \dots, t_n)$ is a term;
- (c) An expression of K is a term only if it can be shown (on the basis of *evidence-based* reasoning) to be a term on the basis of clauses (a) and (b).

Further:

- (d) The predicate letters applied to terms yield the *atomic formulas*, i.e., if A_i^n is a predicate letter and t_1, \dots, t_n are terms, then $A_i^n(t_1, \dots, t_n)$ is an atomic formula.

and:

- (e) The well-formed formulas (wffs) of K are defined as follows:
- (i) Every atomic formula is a wff;
 - (ii) If \mathcal{A} and \mathcal{B} are wffs and y is a variable, then ' $\neg\mathcal{A}$ ', ' $\mathcal{A} \rightarrow \mathcal{B}$ ' and ' $(\forall y)\mathcal{A}$ ' are wffs;
 - (iii) An expression of K is a wff of K only if it can be shown (on the basis of *evidence-based* reasoning) to be a wff on the basis of clauses (i) and (ii).

Moreover, we follow the convention that defines:

- (f) ' $\mathcal{A} \wedge \mathcal{B}$ ' as an abbreviation for ' $\neg(\mathcal{A} \rightarrow \mathcal{B})$ ';
- (g) ' $\mathcal{A} \vee \mathcal{B}$ ' as an abbreviation for ' $(\neg\mathcal{A}) \rightarrow \mathcal{B}$ ';
- (h) ' $\mathcal{A} \equiv \mathcal{B}$ ' as an abbreviation for ' $(\mathcal{A} \rightarrow \mathcal{B}) \wedge (\mathcal{B} \rightarrow \mathcal{A})$ ';
- (i) ' $(\exists x)\mathcal{A}$ ' as an abbreviation for ' $\neg((\forall x)\neg\mathcal{A})$ '.

6. **First-order theory with quantifiers** ([Me64], pp.56-57): A first-order theory S with quantifiers is a first-order language with quantifiers plus a set of rules—which we define as the *proof-theoretic logic* of S—that assigns *evidence-based* 'provability' values to the wffs of S by means of logical axioms, proper axioms, and rules of inference as follows:

I: If $\mathcal{A}, \mathcal{B}, \mathcal{C}$ are wffs of S, then the following logical axioms are designated as provable wffs of S:

- (1) $\mathcal{A} \rightarrow (\mathcal{B} \rightarrow \mathcal{A})$;
- (2) $(\mathcal{A} \rightarrow (\mathcal{B} \rightarrow \mathcal{C})) \rightarrow ((\mathcal{A} \rightarrow \mathcal{B}) \rightarrow (\mathcal{A} \rightarrow \mathcal{C}))$;
- (3) $(\neg\mathcal{B} \rightarrow \neg\mathcal{A}) \rightarrow ((\neg\mathcal{B} \rightarrow \mathcal{A}) \rightarrow \mathcal{B})$;
- (4) $(\forall x_i)\mathcal{A}(x_i) \rightarrow \mathcal{A}(t)$ if $\mathcal{A}(x_i)$ is a wff of S and t is a term of S free for x_i in $\mathcal{A}(x_i)$;
- (5) $(\forall x_i)(\mathcal{A} \rightarrow \mathcal{B}) \rightarrow (\mathcal{A} \rightarrow (\forall x_i)\mathcal{B})$ if \mathcal{A} is a wff of S containing no free occurrences of x_i .

II: The proper axioms of S which are to be designated as provable wffs of S vary from theory to theory.

A first-order theory in which there are no proper axioms is called the first-order logic FOL.

III: The rules of inference of any first-order theory are:

- (i) Modus ponens: If \mathcal{A} and $\mathcal{A} \rightarrow \mathcal{B}$ are provable wffs of S, then \mathcal{B} is a provable formula of S;
- (ii) Generalisation: If \mathcal{A} is a provable wff of S, then $(\forall x_i)\mathcal{A}$ is a provable wff of S.

IV: A wff \mathcal{A} of S is provable if, and only if:

- \mathcal{A} is a logical axiom of S; or
- \mathcal{A} is a proper axiom of S; or
- \mathcal{A} is the final wff of a finite sequence of wffs of S such that each formula of the sequence is:

- either an axiom of S ,
- or is a provable formula of S by application of the rules of inference of S to the formulas preceding it in the sequence.

Moreover, we define a first-order theory S with quantifiers as *well-defined model-theoretically* if, and only if, it has a *well-defined model* in the sense of the proposed Definitions 32 to 34.

7. **FOL:** For purposes of this investigation we take FOL to be a first-order predicate calculus such as the formal system K defined in [Me64], p.57.
8. **Hilbert's Second Problem:** In this investigation, we treat Hilbert's intent⁶³⁵ behind the enunciation of his Second Problem as essentially seeking a finitary proof for the consistency of arithmetic when formalised in a language such as the first-order Peano Arithmetic PA.

"When we are engaged in investigating the foundations of a science, we must set up a system of axioms which contains an exact and complete description of the relations subsisting between the elementary ideas of that science. . . . But above all I wish to designate the following as the most important among the numerous questions which can be asked with regard to the axioms: To prove that they are not contradictory, that is, that a definite number of logical steps based upon them can never lead to contradictory results. In geometry, the proof of the compatibility of the axioms can be effected by constructing a suitable field of numbers, such that analogous relations between the numbers of this field correspond to the geometrical axioms. . . . On the other hand a direct method is needed for the proof of the compatibility of the arithmetical axioms."

... Excerpted from Maby Winton Newson's English translation [Nw02] of Hilbert's address [Hi00] at the International Congress of Mathematicians in Paris in 1900.

9. **Interpretation** ([Me64], p.49): An *interpretation* of the:

- predicate letters;
- function letters; and
- individual and logical constants;

of a formal system S consists of:

- a non-empty set D , called the *domain* of the interpretation;

and an *evidence-based* assignment:

- to each predicate letter A_j^n of an n -place relation in D ;
- to each function letter f_j^n of an n -place operation in D (i.e., a function from D into D); and
- to each individual constant a_i of some fixed element of D .

⁶³⁵Compare Curtis Franks' thesis in [Fr09] that Hilbert's intent behind the enunciation of his Second Problem was essentially to establish the autonomy of arithmetical truth without appeal to any debatable philosophical considerations.

Given such an interpretation, variables are thought of as ranging over the set \mathbf{D} , and \neg , \rightarrow , and quantifiers are given their usual meaning.

Moreover, we define an interpretation as *well-defined* if, and only if, all the above assignments are *well-defined* in the sense of the proposed Definitions 32 to 34.

10. **Law of the Excluded Middle LEM** (cf., [Me64], p.4): For any well-formed formula P of a formal system S , $P \vee \neg P$ is a theorem of S .
11. **Model** ([Me64], p.49): An interpretation \mathcal{I} defines a *model* of a formal system S if, and only if, there is a set of rules—which we define as the *model-theoretic logic* of S —that assign *evidence-based* truth values of ‘satisfaction’, ‘truth’, and ‘falsity’ to the formulas of S under \mathcal{I} such that the axioms of S interpret as ‘true’ under \mathcal{I} , and the rules of inference of S preserve such ‘truth’ under \mathcal{I} .

Moreover, we define a model as *well-defined* if, and only if, it is defined by a *well-defined* interpretation in the sense of the proposed Definitions 32 to 34.

12. **Non-standard model**: A non-standard model of a formal system S is a model of S that admits elements in the domain D of the interpretation defining the model if, and only if, there is some element in D which is not definable in S .
13. **ω -consistency**: A formal system S is ω -consistent if, and only if, there is no S -formula $[F(x)]$ for which, first, $[\neg(\forall x)F(x)]$ is S -provable and, second, $[F(a)]$ is S -provable for any specified S -term $[a]$.
14. **Partial recursive**: Classically, a partial function F of n arguments is called partial recursive if, and only if, F can be obtained from the initial functions (zero function), projection functions, and successor function (of classical recursive function theory) by means of substitution, recursion and the classical, unrestricted, μ -operator.

F is said to come from G by means of the unrestricted μ -operator, where $G(x_1, \dots, x_n, y)$ is recursive, if, and only if, $F(x_1, \dots, x_n) = \mu y(G(x_1, \dots, x_n, y) = 0)$, where $\mu y(G(x_1, \dots, x_n, y) = 0)$ is the least number k (if such exists) such that, if $0 \leq i \leq k$, $G(x_1, \dots, x_n, i)$ exists and is not 0, and $G(x_1, \dots, x_n, k) = 0$.

We note that, classically, F may not be defined for certain n -tuples; in particular, for those n -tuples (x_1, \dots, x_n) for which there is no y such that $G(x_1, \dots, x_n, y) = 0$ (cf. [Me64], p.120-121).

15. **Tarski’s inductive definitions**: We shall assume that truth values of ‘satisfaction’, ‘truth’, and ‘falsity’ are assignable inductively to the compound formulas of a first-order theory S under the interpretation $\mathcal{I}_{S(\mathbb{D})}$ in terms of *only* the satisfiability of the atomic formulas of S over \mathbb{D} as usual (see [Me64], pp.50-51; also [Mu91]):
 - (a) If \mathcal{A} is an atomic well-formed formula $A_j^n(t_1, \dots, t_n)$ of S , and B_j^n is the corresponding relation of the interpretation (of S) with domain \mathbb{D} , then the sequence s satisfies \mathcal{A} if and only if $B_j^n(s^*t_1, \dots, s^*t_n)$, i.e., if the n -tuple (s^*t_1, \dots, s^*t_n) is in the relation B_j^n (where s^* is a function, determined by the sequence s , from the set of terms of S into \mathbb{D}).

- (b) A denumerable sequence s of \mathbb{D} satisfies $[\neg\mathcal{A}]$ under $\mathcal{I}_{S(\mathbb{D})}$ if, and only if, s does not satisfy $[\mathcal{A}]$;
- (c) A denumerable sequence s of \mathbb{D} satisfies $[\mathcal{A} \rightarrow \mathcal{B}]$ under $\mathcal{I}_{S(\mathbb{D})}$ if, and only if, either it is not the case that s satisfies $[\mathcal{A}]$, or s satisfies $[\mathcal{B}]$;
- (d) A denumerable sequence s of \mathbb{D} satisfies $[(\forall x_i)\mathcal{A}]$ under $\mathcal{I}_{S(\mathbb{D})}$ if, and only if, specified any denumerable sequence t of \mathbb{D} which differs from s in at most the i 'th component, t satisfies $[\mathcal{A}]$;
- (e) A well-formed formula $[\mathcal{A}]$ of \mathbb{D} is true under $\mathcal{I}_{S(\mathbb{D})}$ if, and only if, specified any denumerable sequence t of \mathbb{D} , t satisfies $[\mathcal{A}]$;
- (f) A well-formed formula $[\mathcal{A}]$ of \mathbb{D} is false under $\mathcal{I}_{S(\mathbb{D})}$ if, and only if, it is not the case that $[\mathcal{A}]$ is true under $\mathcal{I}_{S(\mathbb{D})}$.

The assumption of Aristotle's particularisation in [Me64] (implicitly), and in [Me15] (explicitly), is evidenced in Mendelson's assertions—following his formulation of Tarski's definitions (essentially as above)—that:

“Verification of the following consequences of the definitions above is left to the reader. (Most of the results are also obvious if one wishes to use only the ordinary intuitive understanding of the notions of truth and satisfaction). . . .

(V) (i) A sequence s satisfies $\mathcal{A} \wedge \mathcal{B}$ if and only if s satisfies \mathcal{A} and s satisfies \mathcal{B} . A sequence s satisfies $\mathcal{A} \vee \mathcal{B}$ if and only if s satisfies \mathcal{A} or s satisfies \mathcal{B} . A sequence s satisfies $\mathcal{A} \equiv \mathcal{B}$ if and only if s satisfies both \mathcal{A} and \mathcal{B} or s satisfies neither \mathcal{A} nor \mathcal{B} .

(ii) A sequence s satisfies $(\exists x_i)\mathcal{A}$ if and only if there is a sequence s' which differs from s in at most the i^{th} place such that s' satisfies \mathcal{A} .”

... Mendelson: [Me64], p.53.

“The plausibility of our definition of truth will be strengthened by the fact that we can derive all of the following expected properties I-XI of the notions of truth, falsity, and satisfaction. Proofs that are not explicitly given are left to the reader (or may be found in the answer to Exercise 2.12). **Most of the results are also obvious if one wishes to use only the ordinary intuitive understanding of the notions of truth, falsity, and satisfaction.** . . .

(V) †Consider an interpretation M with domain D .

- a. A sequence s satisfies $\mathcal{B} \wedge \mathcal{C}$ if and only if s satisfies \mathcal{B} and s satisfies \mathcal{C} .
- b. s satisfies $\mathcal{B} \vee \mathcal{C}$ if and only if s satisfies \mathcal{B} or s satisfies \mathcal{C} .
- c. s satisfies $\mathcal{B} \equiv \mathcal{C}$ if and only if s satisfies both \mathcal{B} and \mathcal{C} or s satisfies neither \mathcal{B} nor \mathcal{C} .
- d. s satisfies $(\exists x_i)\mathcal{B}$ if and only if there is a sequence s' that differs from s in at most the i^{th} component such that s' satisfies \mathcal{B} . (In other words $s = (s_1, s_2, \dots, s_i, \dots)$ satisfies $(\exists x_i)\mathcal{B}$ if and only if there is an element c in the domain D such that the sequence $(s_1, s_2, \dots, c, \dots)$ satisfies \mathcal{B} .)”

... Mendelson: [Me15], p.57-58.

16. **Total:** We define a number-theoretic function, or relation, as total if, and only if, it is effectively computable, or effectively decidable, respectively, for any specified set of natural number values assigned to its free variables. We define a number-theoretic function, or relation, as partial otherwise. We define a partial number theoretic function, or relation, as effectively computable, or decidable, respectively, if, and only if, it is effectively computable, or decidable, respectively, for any specified set of values assigned to its free variables for which it is defined (cf. [Me64], p.214).

17. **Weak standard interpretation of PA** (cf. [Me64], p.107): The *weak* standard interpretation $\mathcal{I}_{PA(\mathbb{N}, SV)}$ of PA over the domain \mathbb{N} of the natural numbers is the one in which the logical constants have their ‘usual’ interpretations in the first-order predicate logic FOL, and:

- (a) The set of non-negative integers is the domain;
- (b) The symbol $[0]$ interprets as the integer 0;
- (c) The symbol $[']$ interprets as the successor operation (addition of 1);
- (d) The symbols $[+]$ and $[\star]$ interpret as ordinary addition and multiplication;
- (e) The symbol $[=]$ interprets as the identity relation.

Comment 240. In this investigation, unless explicitly specified otherwise, we do not assume that Aristotle’s particularisation holds under the the standard interpretation $\mathcal{I}_{PA(\mathbb{N}, SV)}$ of PA or under any interpretation of FOL.

Reason: Contrary to what is *implicitly* suggested in standard literature and texts—Aristotle’s particularisation does not form any part of Tarski’s *inductive* definitions of the satisfaction, and truth, of the formulas of PA under the standard interpretation $\mathcal{I}_{PA(\mathbb{N}, SV)}$ of PA, but is an extraneous, generally *implicit*, assumption in the underlying first-order logic FOL.

Moreover, its inclusion not only makes $\mathcal{I}_{PA(\mathbb{N}, SV)}$ non-finitary (as argued by Brouwer in [Br08]), but the assumption of Aristotle’s particularisation does not hold in any model of PA and, ipso facto, of FOL!

18. **Weak standard model of PA:** The *weak* standard model of PA is the one defined by the classical standard interpretation $\mathcal{I}_{PA(\mathbb{N}, SV)}$ of PA over the domain \mathbb{N} of the natural numbers.

29.A. Appendix A1: Turing Algorithm

(Excerpted from Elliott Mendelson [Me64], pp.229-231.)

“Attempting to give a precise definition of effective computability, Turing [1936] proposed that a certain class of abstract machines could perform any “mechanical” computing procedure. Such machines are now called Turing machines in honour of their inventor, and can be described in the following way.

There is a two-way potentially infinite tape divided up into squares,

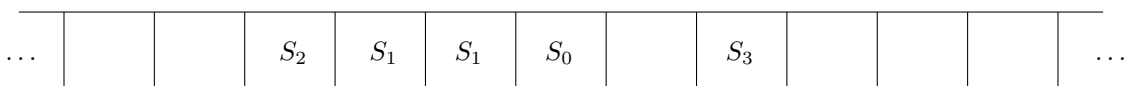

The tape is said to be potentially infinite in the sense that, although at any moment it is finite in length, additional squares always can be added to the right- and left-hand ends of the tape. There is a finite set of *tape symbols* S_0, S_1, \dots, S_n called the *alphabet* of the machine; at every moment, each square of the tape is occupied by at most one symbol. The machine has a finite set of *internal states* $\{q_0, q_1, \dots, q_m\}$. At any given moment, the machine is in exactly one of these states. Finally, there is a reading head which, at any given time, stands over some square of the tape. The machine does not act continuously, but only at discrete moments of time. If, at any moment t , the reading head is scanning (i.e., standing over) a square containing a symbol S_i and the machine is in the internal state q_j , then the action of the machine is determined, and it will do one of four things: (1) it may erase the symbol S_i and print a new symbol S_k ; (2) it may move left one square; (3) it may move right one square; (4) it may stop. In cases (1)-(3), the machine goes into a new internal state q_r , and is ready to act again at time $t+1$. We shall assume that the

symbol S_0 represents a blank, so that the reading head may always be assumed to be scanning a symbol. The first three actions of the machine just described can be represented by quadruplets: either (1) $q_j S_i S_k q_r$, or (2) $q_j S_i L q_r$, or (3) $q_j S_i R q_r$. The first two symbols stand for the present internal state and scanned symbol, the third symbol represents the action of the machine (print S_k , or move left, or move right one square), and the fourth symbol gives the internal state of the machine after the action has been performed.

If a tape is put into a Turing machine and the reading head is placed on a certain square, and if the machine is started off in one of its internal states, then the machine begins to operate on the tape: printing and erasing symbols and moving from one square to an adjacent one. If the machine ever stops, the resulting tape is said to be the output of the machine applied to the given tape. Now we can associate with any Turing machine T the following algorithm \mathcal{B} in the alphabet A of T . Take any word P in the alphabet A and print it from left to right in the squares of an empty tape. Place this tape in the machine with the reading head scanning the left-most square. Start the machine in the internal state q_0 . If the machine ever stops, the word of A appearing on the tape is the value of the algorithm \mathcal{B} . \mathcal{B} is called a *Turing algorithm*. (The word appearing on the tape is defined to be the sequence of symbols beginning with the left-most symbol and moving right to the right-most symbol. Remember that a blank symbol encountered in this motion is assumed to have the symbol S_0 printed in it). We have not specified yet the mechanism by which a machine knows when to stop; this will be done below.

Any Turing machine can be determined precisely by a finite set of quadruples of the three kinds: (1) $q_j S_i S_k q_r$; (2) $q_j S_i L q_r$; (3) $q_j S_i R q_r$, such that no two quadruples have the same first two symbols. In fact, we shall now define a *Turing machine* to be such a finite set of quadruples. The *alphabet* of any Turing machine is the set of tape symbols S_m appearing in any of the quadruples. The *internal states* of the machine are the symbols q_r appearing in the quadruples. We assume that q_0 is an internal state of every Turing machine.

An *instantaneous tape description* of a Turing machine T is a word such that (i) all symbols in the word but one are tape symbols S_m ; (ii) the only symbol which is not a tape symbol is an internal state q_s ; (iii) q_s is not the last symbol of the word.†

† An instantaneous tape description describes the condition of the machine and the tape at any given moment. When read from left to right, the tape symbols in the description represent the symbols on the tape at the moment. The internal state q_s in the description is the internal state of the machine at the moment, and the tape symbol occurring immediately to the right of q_s in the tape description represents the symbol being scanned by the machine at the moment.

We say that T *moves* one instantaneous tape description α into another one β (abbreviated $\alpha \xrightarrow{T} \beta$) if and only if either (a) α is of the form $P q_j S_i Q$, β is of the form $P q_r S_k Q$, and $q_j S_i S_k q_r$ is one of the quadruples of T ; or (b) α is of the form $P S_s q_j S_i Q$, β is $P q_r S_s S_i Q$, and $q_j S_i L q_r$ is one of the quadruples of T ; or (c) α is of the form $q_j S_i Q$, β is $q_r S_0 S_i Q$, and $q_j S_i L q_r$ is one of the quadruples of T ; or (d) α is of the form $P q_j S_i S_k Q$, β is $P S_i q_r S_k Q$, and $q_j S_i R q_r$ is one of the quadruples of T ; or (e) α is of the form $P q_j S_i$, β is $P S_i q_r S_0$, and $q_j S_i R q_r$ is one of the quadruples of T .‡

‡ Observe that, according to our intuitive picture, " T moves α into β " implies that if the condition at time t of the Turing machine and tape is described by α , then the condition at time $t+1$ is described by β . Notice that, according to clause (c), whenever the machine reaches the left-hand end of the tape and is ordered to move left, a blank square is attached to the tape on the left; similarly, by clause (e), a blank square is attached on the right when the machine reaches the right-hand end of the tape and has to move right.

We say that T *stops* at an instantaneous tape description α if and only if there is no instantaneous tape description β such that $\alpha \xrightarrow{T} \beta$. (This happens when $q_j S_i$ occurs in α but $q_j S_i$ are not the first two symbols of a quadruple of T .)

A *computation* of a Turing machine T is a finite sequence of instantaneous tape descriptions $\alpha_0, \dots, \alpha_m$ ($m \geq 0$) such that the internal state occurring in α_0 is q_0 ; for $0 \leq i < m$, $\alpha_i \xrightarrow{T} \alpha_{i+1}$; and T stops at α_m . This computation is said to begin with α_0 and end with α_m . The algorithm $\mathcal{B}_{T,C}$ in any alphabet C containing the alphabet A of T is defined as follows: for any words P, Q in C , $\mathcal{B}_{T,C}(P) = Q$ if and only if there is a computation of T which begins with the instantaneous tape description $q_0 P$ and ends with an instantaneous tape description of the form $R_1 q_j R_2$, where

$Q = R_1R_2$. An algorithm \mathcal{U} in an alphabet D is called Turing-computable if and only if there is a Turing machine T with alphabet A and an alphabet C containing $A \cup D$ such that $\mathcal{B}_{T,C}$ and \mathcal{U} are fully equivalent relative to D .

We let 1 stand for S_1 . Remember that \bar{m} stands for 1^{m+1} , for any natural number m . Also, let \star be an abbreviation of S_2 . Given a partial number-theoretic function $f(x_1, \dots, x_n)$, we say that a Turing machine T (whose alphabet A includes $\{1, \star\}$) *computes* f if and only if, for any natural numbers k_1, \dots, k_n , and any word Q , $\mathcal{B}_{T,A}(\overline{k_1 \star k_2 \star \dots \star k_n}) = Q$ if and only if Q is $R_1\overline{f(k_1, \dots, k_n)}R_2$, where both R_1 and R_2 are certain (possibly empty) words consisting only of S_0 's. (The form $R_1\overline{f(k_1, \dots, k_n)}R_2$ is allowed for the result since S_0 is interpreted as a blank.) The function f is called *Turing-computable* if and only if there is a Turing machine T which computes f ."

... Mendelson: [Me64], pp.229-231.

29.B. Appendix A2: Gödel-numbering

(Excerpted from [Go31], pp.13-14.)

"We now set up a one-to-one correspondence of natural numbers to the primitive symbols of the system P in the following manner:

"0"	...	1	"∨"	...	7	"("	...	11
"f"	...	3	"Π"	...	9	")"	...	13
"~"	...	5						

and furthermore, to the variables of n -th type we assign the numbers of the form p^n (where p is a prime number > 13). Thus, to every finite sequence of primitive symbols (hence also to every formula), there corresponds in a one-to-one fashion a finite sequence of positive integers. We map (again in a one-to-one fashion) the finite sequences of positive integers into the natural numbers by letting the number $2^{n_1} \cdot 3^{n_2} \cdot \dots \cdot p_k^{n_k}$ correspond to the sequence n_1, n_2, \dots, n_k , where p_k denotes the k -th prime number (according to magnitude). Hence a natural number is correlated in one-to-one fashion not only to every primitive symbol but also to every finite sequence of such symbols."

... Gödel: [Go31], pp.13-14.

30. Appendix B: Definitions, Queries, Theses, Lemmas, Theorems and Corollaries

30.A. Definitions

§1. **Definition 1. (Well-defined logic)** A finite set λ of rules is a well-defined logic of a formal mathematical language L if, and only if, λ assigns unique, evidence-based, values:

- (a) Of provability/unprovability to the well-formed formulas of L ; and
- (b) Of truth/falsity to the sentences of the Theory $T(U)$ which is defined semantically by the λ -interpretation of L over a given mathematical structure U that may, or may not, be well-defined; such that
- (c) The provable formulas interpret as true in $T(U)$.

§1.F.b. **Definition 2. (Isomorphic configuration)** Any two 'configurations' of a n -D hyper-object denoted by $\sum_1^j a_i \bar{u}_i$ and $\sum_1^j b_i \bar{v}_i$ are defined as isomorphic if, and only if, $b_i = r a_i$ and $u_i = r v_i$ for any rational $r > 0$ and $1 \leq i \leq j$.

§1.F.b. **Definition 3. (Uniqueness)** A n -D object \bar{a} is uniquely defined upto isomorphism if, and only if, any two 'configurations' $\sum_1^j a_i \bar{u}_i$ and $\sum_1^j b_i \bar{v}_i$ of \bar{a} are isomorphic.

- §1.F.b. **Definition 4. (Well-defined object)** A n -D hyper-object $\overline{x^n}$ is well-defined by the configuration $\mathbb{C}(\overline{x^n})$ if, and only if, $\mathbb{C}(\overline{x^n})$ is uniquely isomorphic.
- §2. **Definition 7. (Algorithmic verifiability)** A number-theoretical relation $F(x)$ is algorithmically verifiable if, and only if, for any specified natural number n , there is an algorithm $AL_{(F, n)}$ which can provide objective evidence for deciding the truth/falsity of each proposition in the finite sequence $\{F(1), F(2), \dots, F(n)\}$.
- §2. **Definition 8. (Integer specifiability)** An unspecified natural number n in \mathbb{N} is specifiable if, and only if, it can be explicitly denoted as a PA-numeral by a PA-formula that interprets as an algorithmically computable constant (natural number) in \mathbb{N} .
- §2. **Definition 9. (Deterministic algorithm)** A deterministic algorithm is a well-defined mechanical method, such as a Turing machine, that computes a mathematical function which has a unique value for any input in its domain, and the algorithm is a process that produces this particular value as output.
- §2. **Definition 10. (Algorithmic computability)** A number theoretical relation $F(x)$ is algorithmically computable if, and only if, there is an algorithm AL_F that can provide objective evidence for deciding the truth/falsity of each proposition in the denumerable sequence $\{F(1), F(2), \dots\}$.
- §2.A. **Definition 11.** If $[A]$ is an atomic formula $[A(x_1, x_2, \dots, x_n)]$ of a formal language S , then the denumerable sequence (a_1, a_2, \dots) in the domain \mathbb{D} of an interpretation $\mathcal{I}_{S(\mathbb{D})}$ of S satisfies $[A]$ if, and only if:
- (i) $[A(x_1, x_2, \dots, x_n)]$ interprets under $\mathcal{I}_{S(\mathbb{D})}$ as a unique relation $A^*(x_1, x_2, \dots, x_n)$ in \mathbb{D} for any witness $\mathcal{W}_{\mathbb{D}}$ of \mathbb{D} ;
 - (ii) there is a Satisfaction Method that provides objective evidence by which any witness $\mathcal{W}_{\mathbb{D}}$ of \mathbb{D} can objectively **define** for any atomic formula $[A(x_1, x_2, \dots, x_n)]$ of S , and any given denumerable sequence (b_1, b_2, \dots) of \mathbb{D} , whether the proposition $A^*(b_1, b_2, \dots, b_n)$ holds or not in \mathbb{D} ;
 - (iii) $A^*(a_1, a_2, \dots, a_n)$ holds in \mathbb{D} for any $\mathcal{W}_{\mathbb{D}}$.
- §2.A.a. **Definition 12.** A denumerable sequence s of \mathbb{D} satisfies $[\neg A]$ under $\mathcal{I}_{S(\mathbb{D})}$ if, and only if, s does not satisfy $[A]$;
- §2.A.a. **Definition 13.** A denumerable sequence s of \mathbb{D} satisfies $[A \rightarrow B]$ under $\mathcal{I}_{S(\mathbb{D})}$ if, and only if, either it is not the case that s satisfies $[A]$, or s satisfies $[B]$;
- §2.A.a. **Definition 14.** A denumerable sequence s of \mathbb{D} satisfies $[(\forall x_i)A]$ under $\mathcal{I}_{S(\mathbb{D})}$ if, and only if, given any denumerable sequence t of \mathbb{D} which differs from s in at most the i 'th component, t satisfies $[A]$;
- §2.A.a. **Definition 15.** A well-formed formula $[A]$ of \mathbb{D} is true under $\mathcal{I}_{S(\mathbb{D})}$ if, and only if, given any denumerable sequence t of \mathbb{D} , t satisfies $[A]$;
- §2.A.a. **Definition 16.** A well-formed formula $[A]$ of \mathbb{D} is false under $\mathcal{I}_{S(\mathbb{D})}$ if, and only if, it is not the case that $[A]$ is true under $\mathcal{I}_{S(\mathbb{D})}$.
- §2.B. **Definition 17.** An atomic formula $[A]$ of PA is satisfiable under the interpretation $\mathcal{I}_{PA(\mathbb{N}, SV)}$ if, and only if, $[A]$ is algorithmically verifiable under $\mathcal{I}_{PA(\mathbb{N}, SV)}$.
- §2.C. **Definition 18.** An atomic formula $[A]$ of PA is satisfiable under the interpretation $\mathcal{I}_{PA(\mathbb{N}, SC)}$ if, and only if, $[A]$ is algorithmically computable under $\mathcal{I}_{PA(\mathbb{N}, SC)}$.
- §4.A. **Definition 19 (SAT).** The Boolean satisfiability problem (SAT) is, given a formula, to check whether it is satisfiable.
- §7. **Definition 20. (Aristotle's particularisation)** If the formula $[\neg(\forall x)\neg F(x)]$ of a formal first order language L is defined as 'true' under an interpretation, then we may always conclude unrestrictedly that there must be some unspecified object s in the domain D of the interpretation such that, if the formula $[F(x)]$ interprets as the relation $F^*(x)$ in D , then the proposition $F^*(s)$ is 'true' under the interpretation.
- §7.C. **Definition 21. (Weak quantification)** A PA formula $[(\forall x)F(x)]$ is algorithmically verifiable as true under an interpretation if, and only if, $F^*(x)$ is algorithmically verifiable as always true.

- §7.C. **Definition 22. (Weak negation)** The PA formula $[\neg(\forall x)F(x)]$ is algorithmically verifiable as true under an interpretation if, and only if, there is no algorithm which will evidence that $[(\forall x)F(x)]$ is algorithmically verifiable as always true under the interpretation.
- §7.C. **Definition 23. (Strong quantification)** A PA formula $[(\forall x)F(x)]$ is algorithmically computable as true under an interpretation if, and only if, $F^*(x)$ is algorithmically computable as always true.
- §7.C. **Definition 24. (Strong negation)** The PA formula $[\neg(\forall x)F(x)]$ is algorithmically computable as true under an interpretation if, and only if, there is no algorithm which will evidence that $[(\forall x)F(x)]$ is algorithmically computable as always true under the interpretation.
- §7.F. **Definition 25. (Well-defined sequence)** A Boolean number-theoretical sequence $\{F^*(1), F^*(2), \dots\}$ is well-defined if, and only if, the number-theoretical relation $F^*(x)$ is algorithmically verifiable.
- §7.F. **Definition 26. (Well-definedness)** A mathematical concept is well-defined if, and only if, it can be defined in terms of algorithmic verifiability.
- §7.G. **Definition 27. (Relative randomness)** A number-theoretic sequence is relatively random if, and only if, it is algorithmically verifiable, but not algorithmically computable.
- §7.H.b. **Definition 28. (Effective computability)** A number-theoretic function $F^*(x_1, \dots, x_n)$ is effectively computable if, and only if, $F^*(x_1, \dots, x_n)$ is well-defined.
- §7.I. **Definition 29. (eb-real numbers)** A sequence of rational numbers is an eb-real number if, and only if, it is either a Cauchy sequence or a monotonically increasing, bounded, sequence.
- §7.I. **Definition 30. (Real number specifiability)** A real number \mathcal{R} in \mathbb{R} is specifiable if, and only if, it can be explicitly expressed as a PA-formula that is algorithmically verifiable.
- §11.C. **Definition 31. (Well-defined interpretation)** An interpretation \mathcal{I} of a formal language L , over a domain D of a structure \mathcal{S} , is constructively well-defined relative to an assignment of truth values $T_{\mathcal{I}}$ to the formulas of L if, and only if, the provable formulas of L interpret as true over D under \mathcal{I} relative to the assignment of truth values $T_{\mathcal{I}}$.
- §12. **Definition 32. (Proof-theoretic logic)** The proof-theoretic logic of a first-order theory S is a set of rules consisting of:
- a selected set of well-formed formulas of S labelled as ‘axioms/axiom schemas’ that are assigned the value ‘provable’; and
 - a finitary set of rules of inference in S ;
- that assign evidence-based values of ‘provable’ or ‘unprovable’ to the well-formed formulas of S by means of the axioms and rules of inference of S .
- §12. **Definition 33. (Model-theoretic logic)** The model-theoretic logic of a first-order theory S with a proof-theoretic logic is a set of rules that assign evidence-based truth values of ‘satisfaction’, ‘truth’, and ‘falsity’ to the well-formed formulas of S under an interpretation \mathcal{I} such that the axioms of S interpret as ‘true’ under \mathcal{I} , and the rules of inference of S preserve such ‘truth’ under \mathcal{I} .
- §12. **Definition 34. (Well-defined model)** The Theory $T(\mathcal{U})$ defined semantically by the λ -interpretation of a formal mathematical language \mathcal{L} over the structure \mathcal{U} is a constructively well-defined model of \mathcal{L} if, and only if, λ is a constructively well-defined Logic of \mathcal{L} . \square
- §12. **Definition 35. (Constructive mathematics)** Constructive mathematics is the study of formal mathematical languages that have a constructively well-defined logic. \square
- §12.B.d. **Definition 36. (Wittgensteinian interpretation)** An atomic formula $[A(x)]$ of PA is satisfied under $\mathcal{I}_{PA(PA, W)}$ if, and only if, for any substitution of a specified PA-numeral $[n]$ for the variable $[x]$, there is a deterministic algorithm which will evidence that the formula $[A(n)]$ is provable in PA.
- §12.B.d. **Definition 37.** The formula $[(\forall x)A(x)]$ of PA is true under $\mathcal{I}_{PA(PA, W)}$ if, and only if, $[A(x)]$ is satisfied under $\mathcal{I}_{PA(\mathbb{N}, W)}$.

§13.D.b. **Definition 38. (Meaning of a formula under interpretation)** If a number-theoretic relation $R(x_1, \dots, x_n)$ is expressible by a PA-formula $[A(x_1, \dots, x_n)]$ then, under any well-defined interpretation of PA, $A(x_1, \dots, x_n)$ means $R(x_1, \dots, x_n)$ if, and only if, $R(x_1, \dots, x_n)$ is the well-defined interpretation, under \mathcal{I} in \mathbb{N} , of some PA-formula that expresses $R(x_1, \dots, x_n)$ in PA.

§16.A. **Definition 39.** A number-theoretic function $f(x_1, \dots, x_n)$ is said to be representable in the first order Peano Arithmetic PA if, and only if, there is a PA formula $[F(x_1, \dots, x_{n+1})]$ with the free variables $[x_1, \dots, x_{n+1}]$, such that, for any specified natural numbers k_1, \dots, k_{n+1} :

- (i) if $f(k_1, \dots, k_n) = k_{n+1}$ then PA proves: $[F(k_1, \dots, k_n, k_{n+1})]$;
- (ii) PA proves: $[(\exists_1 x_{n+1})F(k_1, \dots, k_n, x_{n+1})]$.

The function $f(x_1, \dots, x_n)$ is said to be strongly representable in PA if we further have that:

- (iii) PA proves: $[(\exists_1 x_{n+1})F(x_1, \dots, x_n, x_{n+1})]$. □

§21.F. **Definition 40. (Non-terminating loop)** A non-terminating loop is any repetition of the instantaneous tape description of a Turing machine during a computation.

§21.J. **Definition 41. (Analog process)** A physical process is analog if, and only if, it's states can be represented mathematically by a number-theoretic function that is algorithmically verifiable.

§21.J. **Definition 42. (Digital process)** A physical process is digital if, and only if, it's states can be represented mathematically by a number-theoretic function that is algorithmically computable.

§22. **Definition 43. (Signature of a natural number)** The signature of a specified integer n is the sequence of residues $\langle a_{n,i} \rangle$ where $n + a_{n,i} \equiv 0 \pmod{p_i}$ for all primes p_i such that $1 \leq i \leq \pi(\sqrt{n})$.

§22. **Definition 44. (Value of a natural number)** The value of a specified integer n is any well-defined interpretation—over the domain of the natural numbers—of the (unique) numeral $[n]$ that represents n in the first-order Peano Arithmetic PA.

§22.A. **Definition 45.** Two events are independent if the occurrence of one event does not influence (and is not influenced by) the occurrence of the other.

§22.A.c. **Definition 46. (Bazeries Cylinder)** A modified Bazeries Cylinder is a set of polygonal wheels—not necessarily identical (such as B_i and B_j in Fig. 1)—rotating independently on a common spindle, whose faces are coded with, say, integer values 0 to $i - 1$ and 0 to $j - 1$ respectively, where the event $B_i(u)$ (Fig 2) is the value $0 \leq u \leq i - 1$ yielded by a spin of a single i -faced Bazeries wheel B_i , and the event $B_{i,j}(u, v)$ (Fig. 3) is the value (u, v) —where $0 \leq u \leq i - 1$ and $0 \leq v \leq j - 1$ —yielded by simultaneous, but independent, spins of an i -faced Bazeries wheel B_i and a j -faced Bazeries wheel B_j .

§22.A.e. **Definition 47.** A deterministic algorithm computes a number-theoretical function $f(n)$ in polynomial-time if there exists k such that, for all inputs n , the algorithm computes $f(n)$ in $\leq (\log_e n)^k + k$ steps.

§22.B. **Definition 48.** $n + r_i(n) \equiv 0 \pmod{i}$ where $i > r_i(n) \geq 0$.

§22.B.a. **Definition 49.** Two events e_i and e_j are mutually independent for $i \neq j$ if, and only if, $\mathbb{P}(e_i \cap e_j) = \mathbb{P}(e_i) \cdot \mathbb{P}(e_j)$.

§22.C.b. **Definition 51.** $\pi_D(n) = \sum_{l=1}^n (\prod_{i=1}^k \frac{1}{q_i} \cdot \prod_{i=1}^k (1 - \frac{1}{q_i})^{-1} \cdot \prod_{j=1}^{\pi(\sqrt{l})} (1 - \frac{1}{p_j}))$.

§22.D. **Definition 52.** An integer n is a $\mathbb{TW}(k)$ integer if, and only if, $r_{p_i}(n) \neq 0$ and $r_{p_i}(n) \neq 2$ for all $1 \leq i \leq k$, where $0 \leq r_i(n) < i$ is defined for all $i > 1$ by:

$$n + r_i(n) \equiv 0 \pmod{i}.$$

§24.A.c. **Definition 53. (Quantum verifier)** A physical device is a quantum verifier if it verifies only the first m values of an algorithmically verifiable, but not algorithmically computable, number-theoretic function f whose unique Gödel β -function for m is g_m , where $g_i = f_i$ for $0 \leq i \leq m$, and the value $f(i)$ is determined by a probability function governed by a function such as Schrödinger's ψ -function.

§24.A.c. **Definition 54. (Knowledge verifier)** A physical device is a knowledge verifier if, for any given m , it can verify the first m values of an algorithmically computable, number-theoretic, function f whose unique Gödel β -function for m is g_m , where $g_i = f_i$ for $0 \leq i \leq m$.

§24.A.c. **Definition 55. (Quantum computer)** A physical device is a quantum computer if, and only if, it is a quantum verifier.

30.B. Theses

§1. **Thesis 1 (Complementarity Thesis).** Mathematical ‘provability’ and mathematical ‘truth’ need to be interdependent and complementary, ‘evidence-based’, assignments-by-convention towards achieving:

- (1) The goal of proof theory, post Peano, Dedekind and Hilbert, which is:
 - to uniquely characterise each informally defined mathematical structure S (e.g., the Peano Postulates and their associated, classical, predicate logic),
 - by a corresponding, formal, first-order language L , and a set P of finitary axioms/axiom schemas and rules of inference (e.g., the first-order Peano Arithmetic PA and its associated first-order logic FOL),
 - which assign unique provability values (provable/unprovable) to each well-formed proposition of the language L without contradiction;
- (2) The goal of constructive mathematics, post Brouwer and Tarski, which must be:
 - to assign unique, evidence-based, truth values (true/false) to each well-formed proposition of the language L ,
 - under an, unarguably constructive, well-defined interpretation \mathcal{I} over the domain D of the structure S ,
 - such that the provable formulas of L are true under the interpretation.

§2.F. **Thesis 2 (Gödelian Thesis).** There can be no mechanist model of human reasoning if the assignment $\mathcal{I}_{PA(\mathbb{N}, SV)}$ can be treated as circumscribing the ambit of human reasoning about ‘true’ arithmetical propositions, and the assignment $\mathcal{I}_{PA(\mathbb{N}, SC)}$ can be treated as circumscribing the ambit of mechanistic reasoning about ‘true’ arithmetical propositions.

§8.B. **Thesis 3.** Hilbert’s ω -Rule of infinite induction is equivalent to Gentzen’s ω -Rule of infinite induction.

§13. **Thesis 4 (Mathematics Thesis).** Mathematics is a set of precise, symbolic, languages such that:

- (i) Any language of such a set, say the first order Peano Arithmetic PA (or Russell and Whitehead’s PM in *Principia Mathematica*, or the Set Theory ZF) is, ideally, intended to adequately express and effectively communicate—in a finite and unambiguous manner—relations between elements that are external to the language PA (or to PM , or to ZF).
- (ii) Moreover, each such language is two-valued if we assume that, again ideally, there is some evidence-based methodology that defines/determines whether a specific relation either holds (is true) or does not hold (is false) externally under any well-defined interpretation of the language.
- (iii) Further:
 - (a) A selected, finite, number of primitive formal assertions about a finite set of selected primitive relations of, say, a language \mathcal{L} are defined as axiomatically \mathcal{L} -provable;
 - (b) All assertions about relations that can be effectively defined in terms of the primitive relations are termed as \mathcal{L} -provable if, and only if, there is a finite sequence of assertions of \mathcal{L} , each of which is either a primitive assertion or which can effectively be determined in a finite number of steps as an immediate consequence of any two assertions preceding it in the sequence by a finite set of finitary rules of consequence;
 - (c) All \mathcal{L} -provable relations interpret as true under any well-defined interpretation of \mathcal{L} .

§13.E. **Thesis 5 (ZF Limiting Thesis).** Evidence-based reasoning restricts the ability of highly expressive mathematical languages, such as the first-order Zermelo-Fraenkel Set Theory ZF , to categorically communicate abstract concepts such as those involving Cantor’s first limit ordinal ω .

§13.E. **Thesis 6 (PA Limiting Thesis).** *Evidence-based reasoning restricts the ability of effectively communicating mathematical languages, such as the first-order Peano Arithmetic PA, to well-define infinite concepts such as those involving Cantor's first limit ordinal ω .*

§13.G.a. **Thesis 7.** *If there is no effective method for the unambiguous decidability of the assertions of a mathematical language L under any interpretation $\mathcal{I}_{L(D)}$ of L in the domain D of a language L' , then L can only be considered a mathematical language of subjective expression, but not a mathematical language of effective, and unambiguous, communication under interpretation in L' .*

§15.G.b. **Thesis 8.** *There can be no interpretation of Gödel's definition of his formally undecidable arithmetical proposition $[(\forall x)R(x, p)]$ over the domain \mathbb{N} of the natural numbers—whether expressed mathematically or in any language of common discourse—that could lead to a contradiction.*

§20.D.b. **Thesis 9.** *There are no infinite processes, i.e., nothing corresponding to infinite sequences, in natural phenomena.*

§20.D.b. **Thesis 10.** *If:*

(a) *a physical process is representable by a Cauchy sequence (as in the above cases §20.C.a., §20.C.b.);*

and:

(b) *we accept that there can be no infinite processes, i.e., nothing corresponding to infinite sequences, in natural phenomena;*

then:

(c) *in the absence of an extraneous, evidence-based, proof of 'closure' which determines the behaviour of the physical process in the limit as corresponding to a 'Cauchy' limit, the physical process must tend to a discontinuity (singularity) which has not been reflected in the Cauchy sequence that seeks to describe the behaviour of the physical process.*

§20.D.b. **Thesis 11.** *The perceived barriers that inhibit mathematical modelling of a cyclic universe—one which admits broken symmetries, dark energy, and an ever-expanding multiverse—in a mathematical language that admits unambiguous communication are illusory; they arise out of an attempt to ask of the language selected for such representation more than the language is designed to deliver.*

§20.D.d. **Thesis 12.** *The anti-matter in \mathcal{U} produces a repulsive, anti-gravitational, field:*

(a) *that is consistent with both general relativity and Newtonian gravity;*

(b) *whose state at any instant is either exploding, steady, or imploding;*

(c) *whose 'energy anti-confinement' strength at any instant is determined by an anti-gravitational dimensionless 'cosmological constant' asp that can assume any of three values $asp = 1$ (exploding at the instant of the Big Bang), $asp = \frac{1}{3}$ (steady between an explosion and an implosion) or $asp = \frac{1}{3} + \frac{2}{3}(1 - \frac{1}{n+1})$ (imploding at the instant of the extinguishing of the n^{th} 'critical black hole' for all $n \geq 1$);*

(d) *which constantly opposes the 'energy confinement' strength of the Newtonian gravitational field whose state is determined at any instant by only one dimensionless gravitational constant $gsp = \frac{1}{2}$.*

§21. **Thesis 13. (Gödelian Thesis)** *Gödel's construction of an arithmetical proposition that is not provable in Peano Arithmetic, but true under interpretation if the Arithmetic is consistent, entails that there can be no mechanistic model of human reasoning.*

§21.A. **Thesis 14. (Lucas' Gödelian Thesis)** *There can be no mechanistic model of human reasoning.*

§21.B. **Thesis 15. (Penrose's Gödelian Thesis)** *Any formal system of logic cannot completely assign unique Tarskian truth values of satisfiability and truth to the propositions of any language that seeks to adequately represent, and unequivocally communicate, an individual's perception of a Platonic mathematical reality.*

- §23.D. **Thesis 16. (Dimensionless constants)** *Some of the dimensionless physical constants are only representable in a mathematical language as ‘unmeasurable’ real numbers that are defined by functions which are algorithmically verifiable, but not algorithmically computable.*
- §23.D.a. **Thesis 17. (Unmeasurable constants)** *Whilst a symbol for an ‘unmeasurable’ physical constant may be introduced into a physical theory as a primitive term without inviting inconsistency in the theory, the sequence of digits in the decimal representation of the ‘measure’ of an ‘unmeasurable’ physical constant cannot be treated in the mathematical language of the theory as a ‘completed’ infinite sequence whose ‘measure’ is the Cauchy limit of the sequence.*
- §23.D.a. **Thesis 18. (Measurable constants)** *The sequence corresponding to the decimal representation of the ‘measure’ of a ‘measurable’ physical constant, when introduced as a primitive term into a physical theory, can be treated as a ‘completed’ infinite sequence, whose ‘measure’ is the Cauchy limit of the sequence in the mathematical language of the theory, without inviting inconsistency.*
- §23.D.c. **Thesis 19. (Classical laws)** *Classical laws of nature determine the nature and behaviour of all those properties of the physical world which are mathematically describable completely at any moment of time $t(n)$ by algorithmically computable functions from a given initial state at time $t(0)$.*
- §23.D.d. **Thesis 20. (Neo-classical laws)** *Neo-classical laws of nature determine the nature and behaviour of those properties of the physical world which are describable completely at any moment of time $t(n)$ by algorithmically verifiable functions; however such properties are not completely describable by algorithmically computable functions from any given initial state at time $t(0)$.*
- §23.D.f. **Thesis 21. (Conjugate properties)** *The nature and behaviour of two conjugate properties F_1 and F_2 of a particle P that are determined by neo-classical laws are described mathematically at any time $t(n)$ by two algorithmically verifiable, but not algorithmically computable, functions f_1 and f_2 .*
- §23.D.g. **Thesis 22. (Entangled particles)** *The nature and behaviour of an entangled property of two particles P and Q are determined by neo-classical laws, and are describable mathematically at any time $t(n)$ by two algorithmically verifiable—but not algorithmically computable—functions f_1 and g_1 .*
- §23.D.h. **Thesis 23. (Schrödinger’s cat)** *I may either assume the cat in Schrödinger’s gedanken to be alive until a given time t (in the future), or assume the cat to be dead until the time t , without arriving at any logical contradiction in my existing Quantum description of nature.*
- §24.A.b. **Thesis 24. (Quantum Noise)** *The mathematical ‘order’ of the ‘noise’ level in a ‘quantum’ computation is inversely proportional to the mathematical ‘order’ of the number of qubits in the ‘quantum’ computer.*
- §24.A.c. **Thesis 25. (Computational equivalence)** *Any polynomial-time computation by a quantum device can be executed in polynomial time by a classical Turing machine.*
- §24.A.g. **Thesis 26. (Quantum algorithm)** *The quantum algorithm appealed to in Deutsch’s quantum computer in [DJ92] is a provable formula of PA.*
- §24.A.g. **Thesis 27. (Quantum oracle)** *The quantum oracle appealed to in Deutsch’s quantum computer in [DJ92] is the first-order Peano Arithmetic PA.*
- §26.C. **Thesis 28.** *Any communication with an extra-terrestrial intelligence will involve periods of upto thousands of years between the sending of a message and receipt of a response.*
- §26.C. **Thesis 29.** *We can only communicate with an essentially different form of extra-terrestrial intelligence in a platform-independent language of a mechanistically reasoning artificial intelligence.*
- §26.C. **Thesis 30.** *Nature is not malicious and so, for an ETI to be malevolent towards us, they must perceive us as an essentially different form of intelligence that threatens their survival merely on the basis of our communications.*
- §26.D. **Thesis 31.** *The language of algorithmically computable functions and relations is platform-independent.*
- §26.D. **Thesis 32.** *All natural phenomena which are observable by human intelligence, and which can be modelled by algorithms, are interpretable isomorphically by an extra-terrestrial intelligence.*
- §26.D. **Thesis 33.** *There are innumerable, distinctly different, observable natural phenomena.*

- §26.D. **Thesis 34.** *A language of algorithms with a denumerable alphabet does not admit effective communication with an ETI.*
- §26.F. **Thesis 35.** *Any advanced ETI can communicate with us by recognising that the signals we are beaming:*
- (a) *are not random;*
 - (b) *contain a primer that defines PA;*
 - (c) *contain theorems that describe common natural phenomena as observed by us.*
- §26.H. **Thesis 36.** *A malevolent ETI could perceive us as an essentially different form of intelligence that threatens their survival if they have an interpretation of PA that is essentially different to our standard interpretation $\mathcal{I}_{PA(\text{Standard/Tarski})}$ of PA.*
- §26.H. **Thesis 37.** *An ETI would perceive their interpretation $\mathcal{I}_{PA(\text{Non-Standard/ET})}$ of PA as essentially different to our standard interpretation $\mathcal{I}_{PA(\text{Standard/Tarski})}$ of PA if, and only if, there is a PA formula which either interprets as false under $\mathcal{I}_{PA(\text{Non-Standard/ET})}$ and true under $\mathcal{I}_{PA(\text{Standard/Tarski})}$, or as true under $\mathcal{I}_{PA(\text{Non-Standard/ET})}$ and false under $\mathcal{I}_{PA(\text{Standard/Tarski})}$.*
- §26.J. **Thesis 38.** *Any extra-terrestrial intelligence which is capable of learning the language PA would interpret the satisfaction, and truth, of the formulas of PA—under a well-defined interpretation of PA—precisely as would a human intelligence.*
- §26.J. **Thesis 39.** *Since thousands, if not millions, of years would elapse before a putative first, spatially separated, contact with any extra-terrestrial intelligence, and any putative subsequent, proximal, contact between the two species:*
- (a) *any species that survives over eons must evolve in harmony with its environment through intellectual evolution and respect for natural law;*
 - (b) *categorical communications between the two species in the interregnum would engender, and nurture, respect for life forms with:*
 - *seemingly comparable respect for natural law; and*
 - *the capacity for survival through intellectual evolution.*
- §26.J. **Thesis 40.** *Any extra-terrestrial intelligence would not rationally perceive us as being an essentially different form of intelligence that would necessarily be inimical to their interests and/or survival.*
- §27.F. **Thesis 41.** *Those of our conceptual metaphors which we commonly accept as of a mathematical nature—whether grounded directly in an external reality, or in an internally conceptualised Platonic universe of conceived concepts (such as, for example, Cantor’s first transfinite ordinal ω)—when treated as Carnap’s explicandum, are expressed most naturally in the language of the first-order Set Theory ZFC.*
- §27.F. **Thesis 42.** *The need for adequately expressing such conceptual metaphors in a mathematical language reflects an evolutionary urge of an organic intelligence to determine which of the metaphors that it is able to conceptualise can be unambiguously communicated to another intelligence—whether organic or mechanical—by means of evidence-based reasoning and, ipso facto, can be treated as faithful representations of a commonly accepted external reality (universe).*

30.C. Hypotheses

- §1.I.b. **Hypothesis 1. (Minimality Hypothesis)** *Since four colours suffice for maps with fewer than 5 regions, we assume the existence of some m, n , in a putatively minimal planar map \mathcal{H} , which defines a minimal configuration of the region $\{A_m + B_n + C\}$ where:*
- (a) *any configuration of p contiguous, simply connected and bounded, areas can be 4-coloured if $p \leq m+n$, where $p, m, n \in \mathbb{N}$, and $m+n \geq 5$;*
 - (b) *any configuration of the $m+n$ contiguous, simply connected and bounded, areas of the region, say $\{A_m^- + B_n^-\}$, in a putative, sub-minimal, planar map \mathcal{M} before the creation of C —constructed finitarily by sub-dividing and annexing some portions from each area, say $c_{n,i}^-$, of B_n^- in \mathcal{M} —can be 4-coloured;*

(c) the region $\{A_m + B_n + C\}$ in the planar map \mathcal{H} is a specific configuration of $m + n + 1$ contiguous, simply connected and bounded, areas that cannot be 4-coloured (whence the area C necessarily requires a 5th colour by the Minimality Hypothesis).

§21.J. **Hypothesis 2.** *Whilst an organic brain can evidence that an arithmetical proposition is algorithmically computable as true under an interpretation, only the sensory organs (such as those of sight, smell, hearing, taste and touch) can evidence that an arithmetical proposition is algorithmically verifiable as true under an interpretation.*

§21.J.a. **Hypothesis 3. (Awareness)** *Awareness is the primary conceptual metaphor that corresponds to the ability of an organic intelligence to—not necessarily symbolically—express sensory perceptions in the first person as ‘I sense’.*

§21.J.a. **Hypothesis 4. (Self-awareness)** *Self-awareness is the secondary conceptual metaphor that corresponds to the ability of an organic intelligence to symbolically postulate the existence of an id that can be subjectively identified as aware, and which is implicitly expressible as ‘I sense, therefore I am’.*

§22.A.c. **Hypothesis 5.** *The event yielded by the simultaneous spins of a set of Bazerics wheels is random.*

30.D. Queries

§2.E. **Query 2.** *Are formal classical theories essentially unable to adequately express the extent and range of human cognition, or does the problem lie in the way formal theories are classically interpreted at the moment?*

§4.A. **Query 3 (Efficient P vs NP Separation).** *Is there an arithmetical formula F that is efficiently verifiable and not efficiently computable?*

§4.A. **Query 4 (Algorithmic P vs NP Separation).** *Is there an arithmetical formula F that is algorithmically verifiable but not algorithmically computable?*

§7.N. **Query 5.** *Does the introduction of implicit bounded quantifiers yield any computational advantage in Buss’ Bounded Arithmetics?*

§9.A. **Query 6.** *Can the above argument in §93 be extended to ordinals below ϵ_0 by defining higher order ordinals similarly in terms of the ordered n -tuples $(W, W_1, W_2, \dots, W_n)$, where $W_i = \omega_i^n \cdot x_{i,n} + \dots + \omega_i^4 \cdot x_{i,4} + \omega_i^3 \cdot x_{i,3} + \omega_i^2 \cdot x_{i,2} + \omega_i \cdot x_{i,1}$, and so on recursively?*

§10.F. **Query 7.** *Are both the interpretations $\mathcal{I}_{PA(\mathbb{N}, SV)}$ and $\mathcal{I}_{PA(\mathbb{N}, SC)}$ of PA over the structure \mathbb{N} well-defined, in the sense that the PA axioms interpret as true, and the rules of inference preserve truth, relative to each of the assignments of truth values T_V and T_C respectively?*

§13.D. **Query 8.** *When can a formal assertion claim, under a well-defined interpretation, to ‘mean’ what it represents?*

§13.D. **Query 9.** *When is an arbitrary number-theoretic function or relation representable in PA?*

§13.D.b. **Query 10.** *If a number-theoretic relation $R(x_1, \dots, x_n)$ is expressible by a PA-formula $[A(x_1, \dots, x_n)]$, when may we assert that, under a well-defined interpretation \mathcal{I} of PA, $A(x_1, \dots, x_n)$ ‘means’ $R(x_1, \dots, x_n)$?*

§13.D.b. **Query 11.** *When is a number-theoretic relation a well-defined interpretation of some PA-formula that expresses it in PA?*

§13.G.a. **Query 12.** *If an assertion of L is decidable as true/false under an interpretation $\mathcal{I}_{L(D)}$ in the domain D of L , then does such decidability also ensure an effective method of deciding its corresponding provability/unprovability in L ?*

§13.G.b. **Query 13.** *How can we assert that a PA formula (whether PA-provable or not) is true under the standard interpretation $\mathcal{I}_{PA(\mathbb{N}, SV)}$ of PA, so long as such truth remains effectively unverifiable under $\mathcal{I}_{PA(\mathbb{N}, SV)}$?*

§15.C. **Query 14.** *Can Gödel be held responsible for not distinguishing—in his seminal 1931 paper on formally undecidable propositions—between the implicit circularity in (masked by the non-constructive nature of) his set-theoretical proof of arithmetic undecidability in PM; and the lack of any circularity in his finitary proof of arithmetic undecidability in his Peano Arithmetic P ?*

- §15.G. **Query 15.** *Is there any natural number n for which $mBSUBn$ is true?*
- §19. **Query 16.** *Are we free to postulate the existence of such a natural number z , and conclude that some member of $G(m)$ must evaluate to 0 in \mathbb{N} ?*
- §20.C.c. **Query 17.** *In what evidence-based mathematical sense of a metric ‘space’ can Fig.4 be described mathematically as defining a space-filling curve?*
- §20.D. **Query 18.** *Since the *raison d’être* of a mathematical language is—or ideally should be—to express our abstractions of natural phenomena precisely, and communicate them unequivocally, in what sense can we sensibly admit an interpretation of a mathematical language that constrains all the above cases by ‘limiting’ configurations in a putative, set-theoretical, ‘completion’ of Euclidean Space?*
- §21. **Query 19.** *Does recognition of the ‘truth’ of Gödel’s formally undecidable arithmetical proposition under the classical standard interpretation of a Peano Arithmetic imply that such recognition cannot be duplicated in any artificially constructed mechanism or organism whose design is based on classical logic?*
- §21.B. **Query 20.** *Are the concepts ‘non-algorithmic’ and ‘non-constructive’ necessarily synonymous in classical logic and mathematics?*
- §21.C. **Query 21.** *Are the concepts ‘algorithmically verifiable’ and ‘non-constructive’ necessarily synonymous in classical logic and mathematics?*
- §21.E. **Query 22. (Turing Test)** *Can you prove that, for any well-defined numeral $[n]$, Gödel’s arithmetic formula $[R(n)]$ is a theorem in the first-order Peano Arithmetic PA, where $[R(x)]$ is defined by its Gödel number r in eqn.12, and $[(\forall x)R(x)]$ is defined by its Gödel number $17Gen\ r$ in eqn.13, on p.25 of [Go31]? Answer only either ‘Yes’ or ‘No’.*
- §21.E.a. **Query 23.** *Does Query 22 yield a definitive Turing Test?*
- §21.E.a. **Query 24.** *Can a Turing machine be forced to reply in a finite time whether or not a partial recursive function $F(x_1, \dots, x_n)$ is effectively computable as total?*
- §21.F. **Query 25. (Turing’s Halting Problem)** *Is it always decidable by a Turing machine whether or not a specified partial recursive function $F(x_1, \dots, x_n)$ is total?*
- §21.F.a. **Query 26. (Halting-decidability problem for T)** *Given a Turing machine T , can one effectively decide, given any instantaneous description α , whether or not there is a computation of T beginning with α ?*
- §21.F.a. **Query 27. (Halting-decidability problem for T)** *Is it always possible to effectively determine whether a Turing machine will halt or not when computing any partial recursive function $F(x_1, \dots, x_n)$?*
- §22.A. **Query 28.** *Are the prime divisors of an integer n mutually independent?*
- §22.G. **Query 29.** (a) *Which is the least n such that $\pi_H(n) > \pi(n)$ (as implied by the Prime Number Theorem)?*
 (b) *Which is the largest n such that $\pi(n) > \pi_H(n)$?*
- §23.D.g. **Query 30.** *What would introducing experimental observations—which implicitly subsume ‘free will’—into a mathematical model entail?*
- §26. **Query 31.** *Is there a rational danger to humankind in actively seeking an extra-terrestrial intelligence?*
- §26.A. **Query 32.** *Is fear of actively seeking an ETI merely paranoia, or does it have a rational component?*
- §26.C. **Query 33.** *Can we responsibly seek communication with an extra-terrestrial intelligence actively (as in the 1974 Aricebo message) or is there a logically sound possibility that we may be initiating a process which could imperil humankind at a future date?*
- §27.A. **Query 34.** *How can cognitive science bring systematic scientific rigor to the realm of human mathematical ideas, which lies outside the rigor of mathematics itself?*

30.E. Propositions, Lemmas, Theorems, Corollaries

(The symbol \square indicates an immediate consequence without a formal proof.)

§1.F.c. **Proposition 1.1.** *If $x^p + y^p = z^p$, where $1 < x < y < z \in \mathbb{N}$ and $p \in \mathbb{N}$ is a prime, then $p = 2$.*

§1.F.c. **Corollary 1.2. (Fermat's Last Theorem)** *If $x^n + y^n = z^n$, where $1 < x < y < z \in \mathbb{N}$, and $1 < n \in \mathbb{N}$, then $n = 2$.*

§1.I.b. **Proposition 1.3. (Four Colour Theorem)** *No planar map needs more than four colours.*

§1.I.b. **Proposition 1.4.** *If A_m is a set of m contiguous, simply connected, and bounded areas—of the minimal planar map \mathcal{H} —none of which shares a non-zero boundary segment with C ; and B_n is a set of n contiguous, simply connected and bounded, areas of \mathcal{H} , some of which share at least one, non-zero, boundary segment with C , then $m = 0$; and each area of the region B_n abuts the area C at least once.*

§1.I.b. **Corollary 1.5.** *No two areas $b_{n,i}$, $b_{n,j}$ of B_n in the minimal planar map \mathcal{H} can share two, distinctly separated, non-zero boundary segments.*

§1.I.b. **Corollary 1.14.** *No two areas $b_{n,i}$, $b_{n,j}$ of B_n in the minimal planar map \mathcal{H} can share a non-zero boundary segment that has no point in common with C if each area of B_n abuts the area C only once.*

§1.I.b. **Corollary 1.7.** *If each area of the region B_n abuts the area C only once, then some area $b_{n,i}$ of B_n in \mathcal{H} must share at least two, distinctly separated, non-zero, boundary segments with the area C .*

§1.I.b. **Corollary 1.15.** *No area $b_{n,i}$ of B_n in the minimal planar map \mathcal{H} can share two, distinctly separated, non-zero boundary segments with C .*

§1.I.c. **Theorem 1.10. (Four Colour Theorem)** *No chromatically differentiated planar map needs more than four colours.*

§2.A.b. **Lemma 2.1.** *Under the interpretation $\mathcal{I}_{PA(\mathbb{N}, S)}$, an atomic formula $A^*(x_1, x_2, \dots, x_n)$ is both algorithmically verifiable and algorithmically computable in \mathbb{N} by $\mathcal{W}_{(\mathbb{N}, S)}$.*

§2.B. **Theorem 2.2.** *The atomic formulas of PA are algorithmically verifiable as true or false under the algorithmically verifiable interpretation $\mathcal{I}_{PA(\mathbb{N}, SV)}$.*

§2.B.a. **Lemma 2.3.** *The PA axioms PA_1 to PA_8 are algorithmically verifiable as true over \mathbb{N} under the interpretation $\mathcal{I}_{PA(\mathbb{N}, SV)}$.*

§2.B.a. **Lemma 2.4.** *For any given PA formula $[F(x)]$, the Induction axiom schema $[F(0) \rightarrow ((\forall x)(F(x) \rightarrow F(x')))) \rightarrow (\forall x)F(x)]$ interprets as an algorithmically verifiable true formula under $\mathcal{I}_{PA(\mathbb{N}, SV)}$.*

§2.B.a. **Lemma 2.5.** *Generalisation preserves algorithmically verifiable truth under $\mathcal{I}_{PA(\mathbb{N}, SV)}$.*

§2.B.a. **Lemma 2.6.** *Modus Ponens preserves algorithmically verifiable truth under $\mathcal{I}_{PA(\mathbb{N}, SV)}$. \square*

§2.B.a. **Theorem 2.7.** *The axioms of PA are always algorithmically verifiable as true under the interpretation $\mathcal{I}_{PA(\mathbb{N}, SV)}$, and the rules of inference of PA preserve the properties of algorithmically verifiable satisfaction/truth under $\mathcal{I}_{PA(\mathbb{N}, SV)}$. \square*

§2.B.a. **Theorem 2.8.** *If the PA formulas are algorithmically verifiable as true or false under $\mathcal{I}_{PA(\mathbb{N}, SV)}$, then PA is consistent. \square*

§2.C. **Theorem 2.9.** *The atomic formulas of PA are algorithmically computable as true or as false under the algorithmically computable interpretation $\mathcal{I}_{PA(\mathbb{N}, SC)}$.*

§2.C. **Lemma 2.10.** *The formulas of PA are algorithmically computable finitarily as true or as false under $\mathcal{I}_{PA(\mathbb{N}, SC)}$.*

§2.C.a. **Lemma 2.11.** *The PA axioms PA_1 to PA_8 are algorithmically computable as true under the interpretation $\mathcal{I}_{PA(\mathbb{N}, SC)}$.*

§2.C.a. **Lemma 2.12.** *For any given PA formula $[F(x)]$, the Induction axiom schema $[F(0) \rightarrow ((\forall x)(F(x) \rightarrow F(x')))) \rightarrow (\forall x)F(x)]$ interprets as an algorithmically computable true formula under $\mathcal{I}_{PA(\mathbb{N}, SC)}$.*

§2.C.a. **Lemma 2.13.** *Generalisation preserves algorithmically computable truth under $\mathcal{I}_{PA(\mathbb{N}, SC)}$.*

§2.C.a. **Lemma 2.14.** *Modus Ponens preserves algorithmically computable truth under $\mathcal{I}_{PA(\mathbb{N}, SC)}$. \square*

- §2.C.a. **Theorem 2.15.** *The axioms of PA are always algorithmically computable as true under the interpretation $\mathcal{I}_{PA(\mathbb{N}, SC)}$, and the rules of inference of PA preserve the properties of algorithmically computable satisfaction/truth under $\mathcal{I}_{PA(\mathbb{N}, SC)}$.* \square
- §2.C.a. **Theorem 2.16.** *PA is strongly consistent.* \square
- §2.E.b. **Theorem 2.17. (Provability Theorem for PA)** *A PA formula $[F(x)]$ is PA-provable if, and only if, $[F(x)]$ is algorithmically computable as always true in \mathbb{N} .*
- §2.E.b. **Corollary 2.18.** *PA is categorical.* \square
- §2.F. **Lemma 2.19.** *If $\mathcal{I}_{PA(\mathbb{N}, M)}$ defines a model of PA over \mathbb{N} , then there is a PA formula $[F]$ which is algorithmically verifiable as always true over \mathbb{N} under $\mathcal{I}_{PA(\mathbb{N}, M)}$ even though $[F]$ is not PA-provable.*
- §2.F. **Corollary 2.20.** *The PA formula $[\neg(\forall x)R(x)]$ defined in Lemma 2.19 is PA-provable.* \square
- §2.F. **Corollary 2.21.** *In any well-defined model of PA, Gödel's arithmetical formula $[R(x)]$ interprets as an algorithmically verifiable, but not algorithmically computable, tautology over \mathbb{N} .*
- §2.F. **Corollary 2.22.** *PA is not ω -consistent.*
- §2.F. **Corollary 2.23.** *The classical standard interpretation $\mathcal{I}_{PA(\mathbb{N}, S)}$ of PA does not well-define a model of PA.*
- §4. **Theorem 4.1. (First Tautology Theorem)** *There is no deterministic Turing-machine that evidences Gödel's tautology $R^*(n)$ —when treated as a Boolean function—as an algorithmically computable truth.*
- §4. **Theorem 4.2. (Second Tautology Theorem)** *Gödel's tautology $R^*(n)$ is algorithmically verifiable as true.*
- §4.A. **Theorem 4.3. (SAT is not in P or NP)** *SAT is not in P or NP since there is an arithmetical formula that is algorithmically verifiable as a tautology, but not recognisable as a tautology by any Turing-machine.*
- §4.B.b. **Theorem 4.4.** *There is an arithmetical formula that is algorithmically verifiable, but not algorithmically computable, under any evidence-based interpretation of PA.*
- §4.B.b. **Corollary 4.5. (P \neq NP by separation)** *If P is the class of problems that admit algorithmically computable solutions, and NP is the class of problems that admit algorithmically verifiable solutions, then $P \neq NP$.*
- §4.B.c. **Theorem 4.6. (NP is algorithmically verifiable)** *If a number-theoretical formula $[F(n)]$ is in NP, then it is algorithmically verifiable.*
- §7. **Theorem 7.1.** *Hilbert's 'principle of excluded middle' is 'stronger than Aristotle's particularisation.*
- §7.G. **Theorem 7.2.** *There are well-defined number theoretic functions that are algorithmically verifiable but not algorithmically computable.*
- §7.H.b. **Theorem 7.3.** *The classical Church-Turing Thesis is false in any interpretation of the first-order Peano Arithmetic PA that admits evidence-based reasoning.*
- §7.I. **Corollary 7.4.** *Every eb-real number is not well-definable by a Cauchy sequence.*
- §7.I. **Theorem 7.5. (Specifiability Theorem for Reals)** *Every real number is specifiable in PA.*
- §7.I.a. **Theorem 7.6. (Invalid Cauchy Limit Theorem)** *The values of n for which Gödel's arithmetic formula $[R(x)]$, with Gödel number r as defined in [Go31], p.25, eqn.12, interprets as a true arithmetic proposition $R^*(n)$ in \mathbb{N} do not define the real number $c = \sum_{n=1}^{\infty} (1/10^n) = 0.c_1c_2\dots c_n\dots$; which is classically treated as defining the real number $1/9$.*
- §7.I.a. **Corollary 7.7.** *Every Cauchy sequence of rational numbers does not well-define an eb-real number.*
- §7.N. **Theorem 7.8. (Bounded Arithmetic Theorem)** *Weakening the PA Axiom Schema of Finite Induction formally in Buss' Bounded Arithmetic does not yield any computational advantage.*
- §8. **Proposition 8.1. (Algorithmic (weak) ω -Rule of infinite induction)** *If it is proved that the PA formula $[F(x)]$ interprets as an arithmetical relation $F^*(x)$ that is algorithmically computable as true for any specified natural number n , then the PA formula $[(\forall x)F(x)]$ can be admitted as an initial formula (axiom) in PA.*

§8. **Proposition 8.2. (Hilbert's (*strong*) ω -Rule of infinite induction)** *If it is proved that the PA formula $[F(x)]$ interprets as an arithmetical relation $F^*(x)$ that is algorithmically verifiable as true for any specified natural number n , then the PA formula $[(\forall x)F(x)]$ can be admitted as an initial formula (axiom) in PA.*

§8. **Proposition 8.3.** *If we meta-assume Hilbert's ω -rule of infinite induction for PA, then a consistent PA is ω -consistent.*

§8.B. **Proposition 8.4. (Gentzen's ω -rule of infinite induction)** *If the S_∞ -formula $[A(\bar{n})]$ interprets as true for any specified natural number n , then we may conclude that $[(\forall x)A(x)]$ is provable in S_∞ .*

§8.C. **Lemma 8.5.** *Assuming that PA admits Hilbert's ω -Rule of infinite induction is stronger than assuming that PA is ω -consistent. \square*

§8.D. **Lemma 8.6.** *If PA is consistent but not ω -consistent, then there is some PA formula $[F(x)]$ such that, under any interpretation—say $\mathcal{I}_{PA(N)}$ —of PA over \mathbb{N} :*

(i) *the PA formula $[\neg(\forall x)F(x)]$ interprets as an algorithmically verifiable true arithmetical proposition under $\mathcal{I}_{PA(N)}$;*

(ii) *for any specified numeral $[n]$, the PA formula $[F(n)]$ interprets as an algorithmically verifiable true arithmetical proposition under $\mathcal{I}_{PA(N)}$.*

§8.D. **Lemma 8.7.** *If PA is consistent and the interpretation $\mathcal{I}_{PA(N)}$ admits Aristotle's particularisation over \mathbb{N} , then:*

(i) *if the PA formula $[\neg(\forall x)F(x)]$ interprets as an algorithmically verifiable true arithmetical proposition under $\mathcal{I}_{PA(N)}$,*

(ii) *then there is some unspecified natural number m such that the interpreted arithmetical proposition $F^*(m)$ is algorithmically verifiable as false in \mathbb{N} .*

§8.D. **Corollary 8.8.** *If PA is consistent and Aristotle's particularisation holds over \mathbb{N} , then there can be no PA formula $[F(x)]$ such that, under any interpretation $\mathcal{I}_{PA(N)}$ of PA over \mathbb{N} :*

(i) *the PA formula $[\neg(\forall x)F(x)]$ interprets as an algorithmically verifiable true arithmetical proposition under $\mathcal{I}_{PA(N)}$;*

(ii) *for any specified numeral $[n]$, the PA formula $[F(n)]$ interprets as an algorithmically verifiable true arithmetical proposition under $\mathcal{I}_{PA(N)}$. \square*

§8.D. **Corollary 8.9.** *If PA is consistent and Aristotle's particularisation holds over \mathbb{N} , then PA is ω -consistent. \square*

§8.D. **Corollary 8.10.** *If Aristotle's particularisation holds over \mathbb{N} , then PA is consistent if, and only if, it is ω -consistent.*

§8.D. **Corollary 8.11.** *If PA is consistent but not ω -consistent, then Aristotle's particularisation does not hold in any interpretation of PA over \mathbb{N} . \square*

§8.D. **Theorem 8.12.** *Aristotle's particularisation does not hold in any interpretation of PA under which the PA-axioms interpret as true, and the PA rules of inference preserve such truth. \square*

§8.D. **Theorem 8.13.** *The first-order logic FOL is finitarily consistent.*

§8.D. **Corollary 8.14.** *The Law of the Excluded Middle $[P \vee \neg P]$ is a theorem of the first-order logic FOL. \square*

§8.D. **Corollary 8.15.** *The Law of the Excluded Middle does not entail Aristotle's particularisation. \square*

§8.E. **Corollary 8.16.** *Markov's principle: $\neg(\forall x)(f(x) = 0) \rightarrow (\exists n)(f(n) = 1)$, where $f(n)$ is a Boolean number-theoretic function such that $f(n) = 0$ or $f(n) = 1$, does not hold in PA.*

§8.F. **Lemma 8.17.** *The Axiom of Choice is true in any well-defined interpretation of the Zermelo-Fraenkel set theory ZF_ε that admits Aristotle's particularisation. \square*

§8.F. **Lemma 8.18.** *The postulation of an ‘unspecified’ object in Aristotelean particularisation is a stronger postulation than the Axiom of Choice.* \square

§8.G. **Lemma 8.19.** *If:*

(i) *from the P-provability of $[(\exists x)F(x)]$ we can always conclude the existence within a proof sequence of an unspecified P-term $[a]$ such that $[F(a)]$ is provable;*

then:

(ii) *we cannot have that a P-formula $[(\exists x)F(x)]$ is P-provable and also that $[\neg F(a)]$ is P-provable for any specified, constructively well-defined, term $[a]$ of P;*

§8.G. **Lemma 8.20.** *Rosser’s Rule C entails Aristotle’s particularisation.*

§8.G. **Corollary 8.21.** *Rosser’s Rule C is stronger than Gödel’s ω -consistency.*

§10.A. **Lemma 10.1.** *Aristotle’s particularisation holds under every well-defined interpretation of Hilbert’s ε -calculus L_ε .* \square

§10.A. **Lemma 10.2.** *The Law of the Excluded Middle (LEM) holds under every well-defined interpretation of Hilbert’s ε -calculus L_ε .*

§10.C. **Theorem 10.3.** *The Church-Turing Thesis entails Aristotle’s particularisation.* \square

§12.B.d. **Theorem 12.1.** *The atomic formulas of PA are algorithmically verifiable as true or false under the algorithmically verifiable, weak ‘Wittgensteinian’, interpretation $\mathcal{I}_{PA(\mathbb{N}, W)}$.*

§12.B.e. **Theorem 12.2.** *The interpretations $\mathcal{I}_{PA(\mathbb{N}, SV)}$ and $\mathcal{I}_{PA(PA, W)}$ of PA are isomorphic.*

§12.B.e. **Corollary 12.3.** *A formula of PA is true (by §12.B.d., Definition 36) under the weak ‘Wittgensteinian’ interpretation $\mathcal{I}_{PA(PA, W)}$ if, and only if, it is true (by §2.B., Definition 17) under the weak standard interpretation $\mathcal{I}_{PA(\mathbb{N}, SV)}$.* \square

§12.B.e. **Corollary 12.4.** *The weak standard interpretation $\mathcal{I}_{PA(\mathbb{N}, SV)}$, and the weak ‘Wittgensteinian’ interpretation $\mathcal{I}_{PA(PA, W)}$, are both weak models of PA.*

§12.B.f. **Theorem 12.5.** *The standard interpretation $\mathcal{I}_{PA(\mathbb{N}, SV)}$ of PA is a weak model of PA which admits theorems that are not algorithmically verifiable as true or false.*

§12.B.f. **Theorem 12.6.** *PA is not ω -consistent.*

§13.E.c. **Lemma 13.1.** *The Axiom of Choice is false in N.*

§13.E.d. **Theorem 13.2.** *Any model of ZF, in which the quantifiers are interpreted according to Aristotle’s particularisation, is a model of ZF_ε if the expression $[\varepsilon_x B(x)]$ is interpreted to yield Cohen’s symbol $\overline{\varepsilon}B$ whenever $[B(\varepsilon_x(B(x)))]$ interprets as true in the model.*

§13.E.d. **Corollary 13.3.** *ZF_ε has no model that admits Aristotle’s particularisation.*

§13.E.d. **Corollary 13.4.** *ZF has no model that admits Aristotle’s particularisation.*

§15.C. **Lemma 15.1.** *The structure of the finite ordinals under any putative interpretation of ZF is not isomorphic to the structure \mathbb{N} of the natural numbers.* \square

§15.H.f. **Theorem 15.2.** *Gödel’s P-formula $[(\forall x)R(x, p)]$ does not assert its own unprovability in P.*

§16.A. **Lemma 16.1.** *For any non-terminating sequence of values $f(0), f(1), \dots$, we can construct natural numbers b_k, c_k such that:*

(i) $j_k = \max(k, f(0), f(1), \dots, f(k));$

(ii) $c_k = j_k!;$

(iii) $\beta(b_k, c_k, i) = f(i)$ for $0 \leq i \leq k$.

§16.A. **Lemma 16.2.** *$\beta(x_1, x_2, x_3)$ is strongly represented in PA by $[Bt(x_1, x_2, x_3, x_4)]$, which is defined as follows:*

$$[(\exists w)(x_1 = ((1 + (x_3 + 1) \star x_2) \star w + x_4) \wedge (x_4 < 1 + (x_3 + 1) \star x_2))].$$

§16.B. **Theorem 16.3.** *The cardinality 2^{\aleph_0} of the real numbers cannot exceed the cardinality \aleph_0 of the integers.*

§16.B. **Corollary 16.4.** $\aleph_0 \longleftrightarrow 2^{\aleph_0}$ □

§17. **Lemma 17.1.** *If P is ω -consistent, then neither $[(\forall x)R(x)]$ nor $[\neg(\forall x)R(x)]$ are P -provable.* □

§18.A.a. **Theorem 18.1.** *No model of PA can admit a transfinite ordinal under the standard interpretation of the first-order logic FOL.*

§18.A.b. **Corollary 18.2.** *The language of PA admits of no constant that interprets in any well-defined model of PA as the set N of all natural numbers.* □

§18.D.a. **Lemma 18.3.** *If the collection $Th(\mathbb{N})$ of all true \mathcal{L}_A -sentences is the \mathcal{L}_A -theory of the standard model of Arithmetic, then we may consistently add to it the following as an additional—not necessarily independent—axiom:*

$$(\exists y)(y > x). \quad \square$$

§18.D.a. **Theorem 18.4.** *The Compactness Theorem does not entail that:*

$$(*) \cup_{k \in \mathbb{N}} \{Th(\mathbb{N}) \cup \{c > \underline{n} \mid n < k\}\}$$

is consistent and has a model M_c which contains an ‘infinite’ integer.

§19. **Theorem 19.1.** *Goodstein’s sequence $G_o(m_o)$ over the finite ordinals in any putative model \mathbb{M} of ACA_0 terminates with respect to the ordinal inequality ‘ $>_o$ ’ even if Goodstein’s sequence $G(m)$ over the natural numbers does not terminate with respect to the natural number inequality ‘ $>$ ’ in \mathbb{M} .*

§19. **Corollary 19.2.** *The relationship of terminating finitely with respect to the transfinitely defined ordinal relation ‘ $>_o$ ’ over the set of finite ordinals does not entail the relationship of terminating finitely with respect to the finitarily defined natural number relation ‘ $>$ ’ over the set of natural numbers.* □

§19.A. **Corollary 19.3.** *The subsystem ACA_0 of second-order arithmetic is not a conservative extension of PA.*

§19.A. **Theorem 19.4.** *The subsystem ACA_0 of second-order arithmetic is not a conservative extension of PA.*

§21.D. **Theorem 21.1.** *There can be no mechanist model of human reasoning if the standard interpretation $\mathcal{I}_{PA(N,SV)}$ of the first-order Peano Arithmetic PA can be treated as circumscribing the ambit of human reasoning about ‘true’ arithmetical propositions, and the finitary interpretation $\mathcal{I}_{PA(N,SC)}$ of PA can be treated as circumscribing the ambit of mechanistic reasoning about ‘true’ arithmetical propositions.*

§21.D. **Corollary 21.2.** *Although no mechanical intelligence can evidence that Gödel’s formula $[(\forall x)R(x)]$ is algorithmically verifiable, a human intelligence can evidence that $[(\forall x)R(x)]$ is algorithmically verifiable.*

§21.F.b. **Theorem 21.3. (Forced Halting Theorem)** *It is always possible to effectively determine whether a Turing machine will halt or not when computing any partial recursive function $F(x_1, \dots, x_n)$.*

§21.F.b. **Corollary 21.4. (Halting-decidability Theorem for T)** *Given a Turing machine T , one can effectively decide, given any instantaneous description alpha, whether or not there is a computation of T beginning with alpha.* □

§21.F.b. **Corollary 21.5. (Turing’s Halting Theorem)** *Whether or not a specified partial recursive function $F(x_1, \dots, x_n)$ is total is not always decidable by a Turing machine.* □

§21.F.c. **Theorem 21.6. (Essential Uncomputability Theorem)** *Some functions that are algorithmically verifiable, but not algorithmically computable, are essentially uncomputable.*

§21.G.b. **Corollary 21.7. (Collatz Decidability Theorem)** *Whether the Collatz conjecture is decidable or not is effectively decidable.* □

§21.I. **Corollary 21.8.** *The classical Church-Turing thesis is false in any interpretation of the first-order Peano Arithmetic PA that admits evidence-based reasoning.*

§22.A. **Theorem 22.1. (Fundamental Theorem of Arithmetic)** *Every positive integer $n > 1$ can be represented in exactly one way as a product of prime powers:*

$$n = p_1^{n_1} p_2^{n_2} \cdots p_k^{n_k} = \prod_{i=1}^k p_i^{n_i}$$

where $p_1 < p_2 < \dots < p_k$ are primes and the n_i are positive integers (including 0).

§22.A. **Proposition 22.2. (Prime independence)** Whether or not a prime p divides an integer n is independent of whether or not a prime $q \neq p$ divides the integer n .

§22.A. **Theorem 22.3.** There is no deterministic algorithm that, for any specified n , and any specified prime $p \geq 2$, will evidence that the probability $\mathbb{P}(p \mid n)$ that p divides n is $\frac{1}{p}$, and the probability $\mathbb{P}(p \nmid n)$ that p does not divide n is $1 - \frac{1}{p}$.

§22.A. **Theorem 22.4.** For any specified n , there is a deterministic algorithm that, for any specified prime $p \geq 2$, will evidence that the probability $\mathbb{P}(p \mid n)$ that p divides n is $\frac{1}{p}$, and the probability $\mathbb{P}(p \nmid n)$ that p does not divide n is $1 - \frac{1}{p}$.

§22.A. **Proposition 22.5. (P \neq NP by Eratosthenes sieve) P \neq NP.**

§22.A.c. **Lemma 22.6.** $P_3(B_i(u)) = \frac{1}{i}$.

§22.A.c. **Corollary 22.7.** $P_3(i \mid n) = P_3(B_i(0)) = \frac{1}{i}$.

§22.A.c. **Corollary 22.8.** $P_3(i \nmid n) = 1 - \frac{1}{i}$.

§22.A.c. **Lemma 22.9.** $P_3(B_{ij}(u, v)) = P_3(B_i(u)) \cdot P_3(B_j(v)) = \frac{1}{ij}$.

§22.A.c. **Lemma 22.10.** $P_3(i \mid n \ \& \ j \mid n) = P_3(i \mid n) \cdot P_3(j \mid n)$ if, and only if, $n > i, j > 1$ and i, j are co-prime.

§22.A.c. **Corollary 22.11.** If p and q are two unequal primes, $P_3(p \mid n \ \& \ q \mid n) = P_3(p \mid n) \cdot P_3(q \mid n)$. □

§22.A.c. **Theorem 22.12.** The prime divisors of an integer are mutually independent. □

§22.A.d. **Theorem 22.13.** The probability $P_3(n \text{ is co-prime to } p \leq \sqrt{n})$ of determining that n is not divisible by any prime $p \leq \sqrt{n}$ is $\prod_{i=1}^{\pi(\sqrt{n})} (1 - \frac{1}{p_i})$. □

§22.A.e. **Theorem 22.14.** The minimum number of events needed for determining that the signature yielded by simultaneous spins of the $\pi(\sqrt{n})$ Bazeris wheels—where p_i is the i 'th prime and B_i has p_i faces (Fig.4)—is that of a number not divisible by any prime $p \leq \sqrt{n}$ is of order $O(\log_e n)$. □

§22.A.e. **Corollary 22.15.** Determining whether the signature yielded by simultaneous spins of the $\pi(\sqrt{n})$ Bazeris wheels—where p_i is the i 'th prime and B_i has p_i faces (Fig.4)—is that of a prime, or not, can be simulated by a deterministic algorithm in polynomial time $O(\log_e n)$. □

§22.A.f. **Theorem 22.16. (FACTORISATION is not in P)** There are integers n such that no deterministic algorithm can compute a prime factor of n in polynomial-time.

§22.B. **Lemma 22.17.** $r_i(n) = 0$ if, and only if, i is a divisor of n . □

§22.B.a. **Lemma 22.18.** For any $n \geq 2$, $i \geq 2$ and any specified integer $i > u \geq 0$:

- the probability $\mathbb{P}(r_i(n) = u)$ that $r_i(n) = u$ is $\frac{1}{i}$;

- $\sum_{u=0}^{i-1} \mathbb{P}(r_i(n) = u) = 1$;

- and the probability $\mathbb{P}(r_i(n) \neq u)$ that $r_i(n) \neq u$ is $1 - \frac{1}{i}$. □

§22.B.a. **Theorem 22.19.** For any $i \geq 2$, $\mathbb{M}_i = \{(0, 1, 2, \dots, i-1), r_i(n), \frac{1}{i}\}$ yields a probability model for each of the values of $r_i(n)$. □

§22.B.a. **Corollary 22.20.** For any specified n , i and u such that $r_i(n) = u$, the probability that the roll of an i -sided cylindrical die will yield the value u is $\frac{1}{i}$ by the probability model defined in Theorem 22.19 over the probability space $(0, 1, 2, \dots, i-1)$. □

§22.B.a. **Corollary 22.21.** For any $n \geq 2$ and any prime $p \geq 2$, the probability $\mathbb{P}(r_p(n) = 0)$ that $r_p(n) = 0$, and that p divides n , is $\frac{1}{p}$; and the probability $\mathbb{P}(r_p(n) \neq 0)$ that $r_p(n) \neq 0$, and that p does not divide n , is $1 - \frac{1}{p}$. □

§22.B.b. **Lemma 22.22.** If $n \geq 2$ and $n > i, j > 1$, where $i \neq j$, then:

$$\mathbb{P}((r_i(n) = u) \cap (r_j(n) = v)) = \mathbb{P}(r_i(n) = u) \cdot \mathbb{P}(r_j(n) = v)$$

where $i > u \geq 0$ and $j > v \geq 0$.

§22.B.b. **Corollary 22.23.** $\mathbb{P}((r_i(n) = 0) \cap (r_j(n) = 0)) = \mathbb{P}(r_i(n) = 0) \cdot \mathbb{P}(r_j(n) = 0)$. □

§22.B.b. **Theorem 22.24.** If i and j are co-prime and $i \neq j$, then whether, or not, i divides any specified natural number n is independent of whether, or not, j divides n .

§22.B.b. **Corollary 22.25.** The prime divisors of any integer n are mutually independent. □

§22.B.c. **Lemma 22.26.** The asymptotic density of the set of all integers that are not divisible by any of a specified set of primes $Q = \{q_1, q_2, \dots, q_k\}$ is:

$$\prod_{q \in Q} (1 - 1/q). \quad \square$$

§22.B.c. **Lemma 22.27.** The expected number of integers in any interval (a, b) that are not divisible by any of a specified set of primes $Q = \{q_1, q_2, \dots, q_k\}$ is:

$$(b - a) \prod_{q \in Q} (1 - 1/q). \quad \square$$

§22.C. **Lemma 22.39.** If p_i and p_j are two primes where $i \neq j$ then, for any $n \geq 2$, $\alpha, \beta \geq 1$, we have:

$$\mathbb{P}((r_{p_i^\alpha}(n) = u) \cap (r_{p_j^\beta}(n) = v)) = \mathbb{P}(r_{p_i^\alpha}(n) = u) \cdot \mathbb{P}(r_{p_j^\beta}(n) = v)$$

where $p_i^\alpha > u \geq 0$ and $p_j^\beta > v \geq 0$. □

§22.C. **Corollary 22.40.** $\mathbb{P}((r_{p_i^\alpha}(n) = 0) \cap (r_{p_j^\beta}(n) = 0)) = \mathbb{P}(r_{p_i^\alpha}(n) = 0) \cdot \mathbb{P}(r_{p_j^\beta}(n) = 0)$. □

§22.C. **Theorem 22.41.** For any two primes $p \neq q$ and natural numbers $n, \alpha, \beta \geq 1$, whether or not p^α divides n is independent of whether or not q^β divides n . □

§22.C.a. **Lemma 22.42.** For any co-prime natural numbers $1 \leq a < d = q_1^{\alpha_1} \cdot q_2^{\alpha_2} \dots q_k^{\alpha_k}$ where:

$q_1 < q_2 < \dots < q_k$ are primes and $\alpha_1, \alpha_2 \dots \alpha_k \geq 1$ are natural numbers;

the natural number n is of the form $a + m \cdot d$ for some natural number $m \geq 1$ if, and only if:

$$a + r_{q_i^{\alpha_i}}(n) \equiv 0 \pmod{q_i^{\alpha_i}} \text{ for all } 1 \leq i \leq k$$

where $0 \leq r_i(n) < i$ is defined for all $i > 1$ by:

$$n + r_i(n) \equiv 0 \pmod{i} .$$

§22.C.a. **Corollary 22.43.** The probability that $a + r_{q_i^{\alpha_i}}(n) \equiv 0 \pmod{q_i^{\alpha_i}}$ for any $1 \leq i \leq k$ is $\frac{1}{q_i^{\alpha_i}}$. □

§22.C.a. **Corollary 22.44.** The joint probability that $a + r_{q_i^{\alpha_i}}(n) \equiv 0 \pmod{q_i^{\alpha_i}}$ for all $1 \leq i \leq k$ is $\prod_{i=1}^k \frac{1}{q_i^{\alpha_i}}$. □

§22.C.a. **Corollary 22.45.** The asymptotic density of Dirichlet integers, defined as numbers of the form $a + m \cdot d$ for some natural number $m \geq 1$ which are not divisible by any specified set of primes $\mathbb{R} = \{r_1, r_2, \dots, r_l\}$, where $1 \leq a < d = q_1^{\alpha_1} \cdot q_2^{\alpha_2} \dots q_k^{\alpha_k}$ is:

$$\prod_{i=1}^k \frac{1}{q_i^{\alpha_i}} \cdot \prod_{r \in \mathbb{R} \ \& \ r \neq q_i} (1 - \frac{1}{r}).$$

§22.C.a. **Corollary 22.46.** The expected number of Dirichlet integers in any interval (a, b) is:

$$(b - a) \prod_{i=1}^k \frac{1}{q_i^{\alpha_i}} \cdot \prod_{i=1}^k (1 - \frac{1}{q_i})^{-1} \cdot \prod_{r \in \mathbb{R}} (1 - \frac{1}{r}). \quad \square$$

§22.C.b. **Lemma 22.47.** $\pi_{(a,d)}(n) \approx \pi_D(n) \rightarrow \infty$ as $n \rightarrow \infty$.

- §22.C.b. **Theorem 22.48. (Dirichlet's Theorem)** *There are an infinity of primes in any arithmetic progression $a + m.d$ where $(a, d) = 1$.* \square
- §22.D. **Lemma 22.49.** *If n is a $\mathbb{TW}(k)$ integer, then both n and $n + 2$ are not divisible by any of the first k primes $\{p_1, p_2, \dots, p_k\}$.*
- §22.D. **Lemma 22.50.** $\mathbb{D}(\mathbb{TW}(k)) = \prod_{i=2}^k (1 - \frac{2}{p_i})$. \square
- §22.D. **Lemma 22.51.** *If $p_k^2 \leq n \leq p_{k+1}^2$ is a $\mathbb{TW}(k)$ integer, then n is a prime and either $n + 2$ is also a prime, or $n + 2 = p_{k+1}^2$.*
- §22.D. **Lemma 22.52.** $\pi_{\mathbb{TW}(k)}(b) - \pi_{\mathbb{TW}(k)}(a) \approx (b - a) \prod_{i=2}^k (1 - \frac{2}{p_i})$. \square
- §22.D. **Lemma 22.53.** $\pi_{\mathbb{TW}(k)}(p_{k+1}^2) - \pi_{\mathbb{TW}(k)}(p_k^2) + 1 \geq \pi_2(p_{k+1}^2) - \pi_2(p_k^2) \geq \pi_{\mathbb{TW}(k)}(p_{k+1}^2) - \pi_{\mathbb{TW}(k)}(p_k^2)$ \square
- §22.D. **Lemma 22.54.** $\pi_{\mathbb{TW}(k)}(p_{k+1}^2) - \pi_{\mathbb{TW}(k)}(p_k^2) \approx (p_{k+1}^2 - p_k^2) \prod_{i=2}^k (1 - \frac{2}{p_i})$. \square
- §22.D. **Lemma 22.55.** $\sum_{j=1}^k (\pi_2(p_{j+1}^2) - \pi_2(p_j^2)) = \pi_2(p_{k+1}^2) \approx \sum_{j=1}^k (p_{j+1}^2 - p_j^2) \prod_{i=2}^j (1 - \frac{2}{p_i})$. \square
- §22.D. **Theorem 22.56. (Twin Prime Theorem)** $\pi_2(n) \rightarrow \infty$ as $n \rightarrow \infty$.
- §22.D.a. **Theorem 22.57. (Generalised Prime Counting Theorem)** $\sum_{j=1}^n \prod_{i=a}^{\pi(\sqrt{j})} (1 - \frac{b}{p_i}) \rightarrow \infty$ as $n \rightarrow \infty$ if $p_a > b \geq 1$.
- §22.H.a. **Proposition 22.58. (Goldbach's Conjecture)** *For all natural numbers $n > 2$, there are primes p and q such that $2n = p + q$.*
- §24.A.c. **Lemma 24.1.** *A classical computer is a knowledge verifier but not a quantum verifier.*
- §24.A.c. **Lemma 24.2.** *A quantum computer is a knowledge verifier and a quantum verifier.*
- §26.E. **Lemma 26.1.** *Every algorithmically computable number-theoretic function can be formally expressed by some formula of a first-order Peano Arithmetic, PA.*

31. Acknowledgements

I am immensely grateful to Dr. Danko D. Georgiev [1], Professor Anthony Beavers [2], Professor Jean-Yves Beziau [3, 4, 6] and Professor Christian Retoré [5], for their personal interest, indulgence, and encouragement in providing me an opportunity in which to present before critical academic audiences some of the paradigm-challenging—and seemingly-heretical—perspectives offered in this investigation:

1. *Do Gödel's incompleteness theorems set absolute limits on the ability of the brain to express and communicate mental concepts verifiably?* Invited article in the Special Issue on *Minds, Brains and Mathematics*. In *NeuroQuantology*, [S.l.], v.2, n.2, 2004, pp.60-100. ISSN 1303-5150. DOI: 10.14704/nq.2004.2.2.39. [An04]
2. *Evidence-Based Interpretations of PA*. Presented in the *Symposium on Computational Philosophy* at the AISB/IACAP World Congress 2012-Alan Turing 2012, 2-6 July 2012, University of Birmingham, Birmingham, UK. [An12]
3. *A suggested mathematical perspective for the EPR argument*. Presented on 7th April at the workshop on 'Logical Quantum Structures' at UNILOG'2013, 4th World Congress and School on Universal Logic, 29th March 2013 - 7th April 2013, Rio de Janeiro, Brazil. [An13] [An13p]
4. *Aristotle's particularisation: The Achilles' heel of Hilbertian and Brouwerian perspectives of classical logic*. Presented on 6th April at the Contest on 'Scope of Logic Theorems' at UNILOG'2013, 4th World Congress and School on Universal Logic, 29th March 2013 - 7th April 2013, Rio de Janeiro, Brazil. [An13a] [An13b]
5. *Why Hilbert's and Brouwer's interpretations of quantification are complementary and not contradictory*. Presented on 10th June at the Epsilon 2015 workshop on 'Hilbert's Epsilon and Tau in Logic, Informatics and Linguistics', 10th June 2015 - 12th June 2015, University of Montpellier, France. [An15a] [An15b]
6. *Algorithmically Verifiable Logic vis à vis Algorithmically Computable Logic: Could resolving EPR need two complementary Logics?* Presented on 26th June at the workshop on 'Emergent Computational Logics' at UNILOG'2015, 5th World Congress and School on Universal Logic, 20th June 2015 - 30th June 2015, Istanbul, Turkey. [An15] [An15p]

I also take this opportunity to record my respect for the professional standards of the *three* Editors—Vasant Hanovar, Rajiv Khosla and Peter Èrdi—of *Cognitive Systems Research*, each of whom deliberated for between *two to six* months before accepting—in *toto*—for publication the paradigm-challenging—and seemingly-heretical—conclusions of the relatively short, 10-page, paper:

The truth assignments that differentiate human reasoning from mechanistic reasoning: The evidence-based argument for Lucas' Gödelian thesis. [An16]

I am also indebted to Professor Markus Pantsar for his critical comments that suggested the necessity for Definitions 2 - 4, in §1.F.b., when extrapolating the *pictorial* reconstruction of Fermat's putative argument in §1.F.b. to any *specified* value of $n > 3$.

I am indebted too to my erstwhile classmate—and ex-Professor of Geo-sciences at the Indian Institute of Technology, Mumbai—Chetan Mehta for his critical comments that suggested the need for the *pre-formal*, visual, reconstruction of Fermat's putative argument as in §1.F.b..

At a personal level I am indebted beyond measure and recompense to my wife, Dharini, who has steadfastly ensured—at no little personal cost—the time, space, and day to day physical and emotional resources that have been—often unreasonably—demanded of her for giving me the strength to pursue—over the 50+ years we have so far shared—a life-long investigation based simply on my intellectual convictions and faith.

If I have seen a little further it is by standing on the shoulders of Giants ... Isaac Newton: Attributed quote in <http://www.phrases.org.uk/meanings/268025.html>.

Prior to Isaac Newton's reported tribute in 1676 to René Descartes and Robert Hooke, in a letter to the latter, it was reportedly the 12th century theologian and author, John of Salisbury, who was recorded as having used

an even earlier version of this humbling admission—in a treatise on logic called *Metalogicon*, written in Latin in 1159, the gist of which is translatable as:

“Bernard of Chartres used to say that we are like dwarfs on the shoulders of giants, so that we can see more than they, and things at a greater distance, not by virtue of any sharpness of sight on our part, or any physical distinction, but because we are carried high and raised up by their giant size.

Dicebat Bernardus Carnotensis nos esse quasi nanos, gigantium humeris insidentes, ut possimus plura eis et remotiora videre, non utique proprii visus acumine, aut eminentia corporis, sed quia in altum subvenimur et extollimur magnitudine gigantea."

... Wikipedia: http://en.wikipedia.org/wiki/Standing_on_the_shoulders_of_giants.

Contrary to a contemporary interpretation of the remark ‘standing on the shoulders of’ as describing ‘building on previous discoveries’, it seems to me that what Bernard of Chartres apparently intended was to suggest that it doesn’t necessarily take a genius to see farther; only someone both humble and willing to:

- first, clamber onto the shoulders of a giant and have the self-belief to see things at first-hand as they appear from a higher perspective (achieved more by the nature of height—and the curvature of our immediate space as implicit in such an analogy—than the nature of genius); and,
- second, avoid trying to see things first through the eyes of the giant upon whose shoulders one stands (for the giant might indeed be a vision-blinding genius)!

It was this latter lesson that I was incidentally taught by—and one of the few that I learnt (probably far too well for better or for worse) from—two of my Giants, for *both* of whom teaching was a calling rather than a profession:

- My high-school teacher, late Mr. C. B. Nix-James, at the Cathedral and John Connon School, Mumbai; who instilled in me the need to always retain the ability to reason from first principles; and
- The late Professor Manohar S. Huzurbazar, in my final year of graduation in 1964 at the Institute of Science in Mumbai; who inspired me, in a memorable life-defining occasion, not only to always question—but resist accepting—that which was not *intuitively* plausible to me.

The occasion: Committed to Mr. Nix-James’ insistence on first principles, I had protested to Professor Huzurbazar that the axiom of infinity (in the set theory course that he had just begun to teach us) was not self-evident to me, as (he had explained in his introductory lecture) an axiom should seem if a formal theory were to make any kind of coherent sense under interpretation.

Whilst clarifying that his actual instruction to us had not been that an axiom should necessarily ‘seem’, but only that it should ‘be treated’, as self-evident, Professor Huzurbazar further agreed that the set-theoretical axiom of infinity was not really as self-evident as an axiom ideally ought to seem in order to be treated as self-evident.

To my natural response asking him if it seemed at all self-evident to him, he replied in the negative; adding, however, that he believed it to be ‘true’ despite its lack of an unarguable element of ‘self-evidence’.

It was his remarkably candid response to my incredulous—and youthfully indiscreet—query as to how an unimpeachably objective person such as he (which was his defining characteristic) could hold such a subjective belief that has shaped my thinking ever since.

He said that he had ‘*had*’ to believe the axiom to be ‘true’, since he could not teach us what he did with ‘conviction’ if he did not have such faith!⁶³⁶

Although I did not grasp it then, over the years I came to the realisation that committing to such a belief was the price he had willingly paid for a responsibility that he had recognised—and accepted—consciously at a very early age in his life (when he was tutoring his school going nephew, the renowned physicist Jayant V. Narlikar):

Nature had endowed both Mr. Nix-James, and Professor Huzurbazar, with the rare gift shared by great teachers—the capacity to reach out to, and inspire, students to learn beyond their instruction!

⁶³⁶To place in a wider context, and see the deeper significance of, Professor Huzurbazar’s commitment to an unintuitive ‘belief’, see the anecdote highlighted in [FM15] by Michèle Friend and Danielle Molinini, as related in §13.F.d. *The Case for Professors of Stupidity*.

It was a responsibility that Professor Huzurbazar bore unflinchingly and uncompromisingly, eventually becoming one of the most respected and sought after teachers of Modern Algebra (now Category Theory), Set Theory and Analysis of his times in India at both the graduate and post-graduate levels.

At the time, however, Professor Huzurbazar pointedly stressed that his belief should not influence me into believing the axiom to be true, nor into holding it as self-evident.

His words—spoken softly as was his wont—were: *Challenge it.*

Although I chose not to follow an academic career, he never faltered in encouraging me to question the accepted paradigms of the day—whenever I shared the direction of my reading and thinking (particularly on Logic and the Foundations of Mathematics)—on the few occasions that I met him over the next twenty years.

Moreover, even if the desired self-evident nature of the most fundamental axioms of mathematics (those of first-order Peano Arithmetic and Computability Theory) might eventually be accepted as formally inconsistent with a belief in the ‘self-evident’ truth of the axiom of infinity (as argued in §18.; see also §14.), I choose to believe that the shades of Professor Huzurbazar would rest more liberated than grieved by the demise of a compulsive belief.

Finally, I can only ascribe with gratitude the philosophical motivation underlying these investigations to what was once quoted to me half a century ago by another Giant—my erstwhile classmate, friend, mentor, and prematurely late Ashok Chadha:

‘Let not posterity view us as having spent the gift of life polishing the pebbles and tarnishing the diamonds’.

Bhupinder Singh Anand

Blog: <https://foundationalperspectives.wordpress.com/2009/07/06/hello-world/>

Part VI

BIBLIOGRAPHY

References

- [AAB19] Frank Arute, Kunal Arya, Ryan Babbush, *et al.* 2019. *Quantum supremacy using a programmable superconducting processor*. (Corresponding author: John M. Martinis.) In *Nature*, **574**, 505-510 (2019).
<https://datadryad.org/stash/dataset/doi:10.5061/dryad.k6t1rj8>
- [ABCC] David Applegate, Robert Bixby, Vašek Chvátal, William Cook. 1999. *Forschungsinstitut für Diskrete Mathematik, Report No. 99885*. Universität Bonn.
- [Abr19] Andrew Aberdein. 2019. *Evidence, Proofs, and Derivations*. In *ZDM Mathematics Education* 51, pp.825–834 (2019). <https://doi.org/10.1007/s11858-019-01049-5>
<https://arxiv.org/pdf/1904.02593.pdf>
- [AC24] Andrew Aberdein and Dan Cohen. 2024. *Virtue Theories of Argument*. In *Inquiry: Critical Thinking Across the Disciplines*, Online First April 9, 2024.
<https://doi.org/10.5840/inquiryct20244115>
- [AdB14] Diederik Aerts and Massimiliano Sassoli de Bianchi. 2014. *The extended Bloch representation of quantum mechanics and the hidden-measurement solution to the measurement problem* In *Annals of Physics*, Volume 351, December 2014, pp.975-1025, ScienceDirect, Elsevier Inc.
<https://doi.org/10.1016/j.aop.2014.09.020>
- [Adg19] David J. Adger. 2019. *Interview*. In *Talking Is Throwing Fictional Worlds at One Another*, Nautilus Biology Blog, September 19, 2019.
<https://nautil.us/talking-is-throwing-fictional-worlds-at-one-another-237548/>
- [Ae82] Diederik Aerts. 1982. *Description of many physical entities without the paradoxes encountered in quantum mechanics*. In *Foundations of Physics*, December 1982, Volume 12, Issue 12, pp.1131-1170, SpringerLink, Springer Nature Switzerland AG.
<https://www.vub.be/CLEA/aerts/publications/1982SepEntParQuant.pdf>
- [Aetal] Diederik Aerts, Massimiliano Sassoli de Bianchi, Sandro Sozzo and Tomas Veloz. 2018. *On the Conceptuality Interpretation of Quantum and Relativity Theories*. In *Foundations of Science*, Volume **25**, 5-54 (2020).
<https://doi.org/10.1007/s10699-018-9557-z>
- [AH18] Khabirul Alam and Ujjwal Kumar Halder. 2018. *Mathematics Anxiety of the Secondary Level Students in Relation to their Socio-Economic Status*. in *Review of Research*, Volume VII, Issue XII, September 2018, Laxmi Book Publishers, Solapur, India.
<http://oldror.lbp.world/ArticleDetails.aspx?id=5963>
- [AH77] Kenneth Appel and Wolfgang Haken. 1977. *Every planar map is four colorable. Part I: Discharging*. Illinois Journal of Mathematics, Volume 21, Issue 3 (1977), pp. 429-490, University of Illinois, Urbana-Champaign.
http://projecteuclid.org/download/pdf_1/euclid.ijm/1256049011
- [AHK77] Kenneth Appel, Wolfgang Haken and John Koch. 1977. *Every planar map is four colorable. Part II: Reducibility*. Illinois Journal of Mathematics, Volume 21, Issue 3 (1977), 491-567, University of Illinois, Urbana-Champaign.
http://projecteuclid.org/download/pdf_1/euclid.ijm/1256049012
- [Ahl53] Lars V. Ahlfors. *Complex Analysis*. McGraw-Hill Book Company, Inc., New York, USA.
- [AKS04] Manindra Agrawal, Neeraj Kayal, and Nitin Saxena. 2004. *PRIMES is in P*. In *Annals of Mathematics*. Volume 160, Issue 2, pp. 781–793.
<http://annals.math.princeton.edu/2004/160-2/p12>

- [Aky24] Ryota Akiyoshi. 2024. *A Note on Feferman and Takeuti: Their Thoughts on Predicativity and Finitism*. Research note archived on *Academia*.
<https://www.academia.edu/113754142/>
- [All17] Patrick Allo. 2017. *A Constructionist Philosophy of Logic*. In *Minds & Machines*, 27, 545–564 (2017).
<https://doi.org/10.1007/s11023-017-9430-9>
... <https://link.springer.com/article/10.1007/s11023-017-9430-9#Sec4>
- [Alr24] Valia Allori. 2024. *Hidden Variables and Bell’s Theorem: Local or Not?* Preprint. Version: 07 May 2024 10:46. *PhilSci Archive*, University of Pittsburgh, Philadelphia, USA.
<https://philsci-archive.pitt.edu/23378/1/dBB-vs-SD-info-revised-2.pdf>
- [Alz22] Simon Allzén. 2022. *Against methodological continuity and metaphysical knowledge*. *European Journal for Philosophy of Science* volume 13, Article number: 5 (2023). Springer Online.
<https://doi.org/10.1007/s13194-022-00505-6>
<https://link.springer.com/article/10.1007/s13194-022-00505-6>
- [An04] Bhupinder Singh Anand. 2004. *Do Gödel’s incompleteness theorems set absolute limits on the ability of the brain to express and communicate mental concepts verifiably?* Invited article in the Special Issue on *Minds, Brains and Mathematics*. In *NeuroQuantology*, [S.l.], v.2, n.2, 2004, pp.60-100. ISSN 1303-5150. DOI: 10.14704/nq.2004.2.2.39.
<https://www.neuroquantology.com/data-cms/articles/20191023051331pm39.pdf>
- [An07a] ... 2007. *The Mechanist’s Challenge*. *The Reasoner*, Vol(1)5 p5-6.
<https://research.kent.ac.uk/reasoning/wp-content/uploads/sites/1804/2019/06/TheReasoner-15.pdf>
- [An07b] ... 2007. *Why we shouldn’t fault Lucas and Penrose for continuing to believe in the Gödelian argument against computationalism - I*. *The Reasoner*, Vol(1)6 p3-4.
<https://research.kent.ac.uk/reasoning/wp-content/uploads/sites/1804/2019/06/TheReasoner-16.pdf>
- [An07c] ... 2007. *Why we shouldn’t fault Lucas and Penrose for continuing to believe in the Gödelian argument against computationalism - II*. *The Reasoner*, Vol(1)7 p2-3.
<https://research.kent.ac.uk/reasoning/wp-content/uploads/sites/1804/2019/06/TheReasoner-17.pdf>
- [An12] ... 2012. *Evidence-Based Interpretations of PA*. In *Proceedings of the Symposium on Computational Philosophy* at the AISB/IACAP World Congress 2012-Alan Turing 2012, 2-6 July 2012, University of Birmingham, Birmingham, UK.
<https://www.dropbox.com/s/qjqtuuwcpj34wci/>
- [An13] ... 2013. *A suggested mathematical perspective for the EPR argument*. Extended abstract of paper presented on 7th April at the workshop on ‘*Logical Quantum Structures*’ at UNILOG’2013, 4th World Congress and School on Universal Logic, 29th March 2013 - 7th April 2013, Rio de Janeiro, Brazil.
https://www.dropbox.com/s/cgwd1bpmaq8tzip/42_Resolving_EPR_UNILOG_2013_Extended_Abstract.pdf?dl=0
- [An13p] ... 2013. *A suggested mathematical perspective for the EPR argument*. Presentation on 7th April at the workshop on ‘*Logical Quantum Structures*’ at UNILOG’2013, 4th World Congress and School on Universal Logic, 29th March 2013 - 7th April 2013, Rio de Janeiro, Brazil.
https://www.dropbox.com/s/0fluoqnk2y4yzxm/42_Resolving_EPR_UNILOG_2013_Presentation.pdf?dl=0
- [An13a] ... 2013. *Aristotle’s particularisation: The Achilles heel of Hilbertian and Brouwerian perspectives of classical logic*. Paper presented on 6th April at the Contest on ‘*Scope of Logic Theorems*’ at UNILOG’2013, 4th World Congress and School on Universal Logic, 29th March 2013 - 7th April 2013, Rio de Janeiro, Brazil.
<http://www.uni-log.org/contest4.html>
- [An13b] ... 2013. *Aristotle’s particularisation: The Achilles heel of Hilbertian and Brouwerian perspectives of classical logic*. Presentation on 6th April at the Contest on ‘*Scope of Logic Theorems*’ at UNILOG’2013, 4th World Congress and School on Universal Logic, 29th March 2013 - 7th April 2013, Rio de Janeiro, Brazil.
https://www.dropbox.com/s/n6axrquez10uzysf/43_Achilles_Heel_Unilog_2013_Presentation.pdf?dl=0

- [An15] ... 2015. *Algorithmically Verifiable Logic vis à vis Algorithmically Computable Logic: Could resolving EPR need two complementary Logics?* Paper presented on 26th June at the workshop on ‘Emergent Computational Logics’ at UNILOG’2015, 5th World Congress and School on Universal Logic, 20th June 2015 - 30th June 2015, Istanbul, Turkey.
https://www.dropbox.com/s/lm9xeboi2e4que7/42_Resolving_EPR_UNILOG_2015_Full_Paper.pdf?dl=0
- [An15p] ... 2015. *Algorithmically Verifiable Logic vis à vis Algorithmically Computable Logic: Could resolving EPR need two complementary Logics?* Presentation on 26th June at the workshop on ‘Emergent Computational Logics’ at UNILOG’2015, 5th World Congress and School on Universal Logic, 20th June 2015 - 30th June 2015, Istanbul, Turkey.
https://www.dropbox.com/s/3uaiscas7h6tolk/42_Resolving_EPR_UNILOG_2015_Presentation.pdf?dl=0
- [An15a] ... 2015. *Why Hilbert’s and Brouwer’s interpretations of quantification are complementary and not contradictory.* Paper presented on 10th June at the Epsilon 2015 workshop on ‘Hilbert’s Epsilon and Tau in Logic, Informatics and Linguistics’, 10th June 2015 - 12th June 2015, University of Montpellier, France.
<https://sites.google.com/site/epsilon2015workshop/>
- [An15b] ... 2015. *Why Hilbert’s and Brouwer’s interpretations of quantification are complementary and not contradictory.* Presentation on 10th June at the Epsilon 2015 workshop on ‘Hilbert’s Epsilon and Tau in Logic, Informatics and Linguistics’, 10th June 2015 - 12th June 2015, University of Montpellier, France.
https://www.dropbox.com/s/w8g5e0vv4szh227/9_Why_Brouwer_was_justified_Presentation_Epsilon_2015.pdf?dl=0
- [An16] ... 2016. *The truth assignments that differentiate human reasoning from mechanistic reasoning: The evidence-based argument for Lucas’ Gödelian thesis.* In *Cognitive Systems Research*. Volume 40, December 2016, 35-45.
[doi:10.1016/j.cogsys.2016.02.004](https://doi.org/10.1016/j.cogsys.2016.02.004).
- [An21a] ... 2021. *Why did Fermat believe he had ‘a truly marvellous demonstration’ of FLT?* Preprint.
<https://www.dropbox.com/s/ficrf9tys7gyuvf/>.
- [An21b] ... 2021. *A Pre-formal Proof of Why No Planar Map Needs More Than Four Colours.* Preprint.
<https://philpapers.org/rec/ANAATP-2>.
- [An22d] ... 2022. *Why Four Colours Suffice: Why pre-formal ‘proofs’ entail formal proofs, and not vice versa.*
https://www.dropbox.com/s/3vzz7g4dfpsr8/49_Four_Colour_Submission_MPCPS_REVISION1_Epi_210923.pdf?dl=0
- [An22e] ... 2022. *Why the Perceived Flaw in Kempe’s 1879 Graphical ‘Proof’ of the Four Colour Theorem is Not Fatal When Expressed Geometrically.* Paper presented on 16th March 2022 to the Prof. P. C. Vaidya National Conference on Mathematical Sciences, 15-16 March 2022, Department of Mathematics, Sardar Patel University, Vallabh Vidyanagar - 388120, Gujarat, India.
<https://www.dropbox.com/s/fw6fpizpc32grkj/>
- [An22f] ... 2022. *Why the Perceived Flaw in Kempe’s 1879 Graphical ‘Proof’ of the Four Colour Theorem is Not Fatal When Expressed Geometrically.* Presentation on 16th March 2022 to the Prof. P. C. Vaidya National Conference on Mathematical Sciences, 15-16 March 2022, Department of Mathematics, Sardar Patel University, Vallabh Vidyanagar - 388120, Gujarat, India.
<https://www.dropbox.com/s/n7eww29476h0rey/>
- [An23] ... 2023. *A Geometrical Perspective of The Four Colour Theorem.* Paper **accepted** for the National Conference MSUMEC-I on Algebraic Graph Theory, Graph Theory and Analysis, 23–24 February 2023, Department of Mathematics, Manonmaniam Sundaranar University, Tirunelveli, Tamil Nadu, India.
<https://www.dropbox.com/s/w59q6gk4esitmez/>
- [And72] Philip W. Anderson. 1972. *More Is Different: Broken symmetry and the nature of the hierarchical structure of science.* In *Science*, 4th August 1972, Volume 177, Number 4047, American Association for the Advancement of Science.
- [Ar09] Sanjeev Arora and Boaz Barak. 2008. *Computational Complexity: A Modern Approach*. 2009. Princeton University Press, New Jersey, USA.
<http://www.cs.princeton.edu/theory/complexity/>

- [AR02b] Steve Awodey and Erich H. Reck. 2002. *Completeness and Categoricity. Part II: Nineteenth-century Axiomatics to Twentieth-century Metalogic*. In *History and Philosophy of Logic*, 23 (2002), 77-94, Taylor & Francis.
[<http://www.faculty.ucr.edu/reck/Awodey%20&%20Reck-CC,%20Part%20II.pdf>]
- [Arn10] Andrew Peter Arana. 2010. *Proof Theory in Philosophy of Mathematics*. In *Philosophy Compass*, Volume 5, Issue 4, Pages: 287-362, April 2010, Wiley Online Library.
<https://www.academia.edu/4710202/>
- [ArRm09] Mohammad Ardeshir and Rasoul Ramezani. 2009. *Decidability and Specker sequences in intuitionistic mathematics*. In *Mathematical Logic Quarterly*, Volume 55, Issue 6, December 2009, pp.637-648.
<https://doi.org/10.1002/malq.200710094>
<https://doi.org/10.1002/malq.200710094>
- [Art07] Sergei Artemov. 2007. *On Two Models of Provability*. In *Mathematical Problems from Applied Logics II*, pp.1-52, edited by Dov M. Gabbay, M. Zakharyashev, and S. S. Goncharov. *International Mathematical Series*, Volume 5, Springer, New York, NY..
https://www.academia.edu/25867241/On_Two_Models_of_Provability?email_work_card=title
- [AsZ12] Federico Aschieri and Margherita Zorzi. 2012. *Eliminating Skolem Functions in Peano Arithmetic with Interactive Realizability*. In *Proceeding of 4th Workshop on Classical Logic and Computation (CL&C'12 Icalp 2012)*, 8th July, 2012, Warwick, United Kingdom. *Electronic Proceedings in Theoretical Computer Science*, vol. 97, pp. 1-18. <10.4204/EPTCS.97.1>. <hal-00690270>
<https://hal.inria.fr/hal-00690270>
- [At17] Mark van Atten. 2017. *Predicativity and parametric polymorphism of Brouwerian implication*. Revised version of papers presented at the ASL meeting in Seattle in April 2017, at the workshop ‘*Critical Views of Logic*’ in Oslo in August 2017, at the ‘*Journées SND*’ in Paris in September 2017 and at the meeting ‘*Axiomatic Thinking*’ in Lisbon in October 2017.
[\[https://www.academia.edu/34894973/Predicativity_and_parametric_polymorphism_of_Brouwerian_implication\]](https://www.academia.edu/34894973/Predicativity_and_parametric_polymorphism_of_Brouwerian_implication)
- [At18] ... 2018. *The Creating Subject, the Brouwer-Kripke Schema, and infinite proofs*. Archived at arXiv:1805.00404v1 [math.HO].
[\[https://arxiv.org/pdf/1805.00404v1.pdf\]](https://arxiv.org/pdf/1805.00404v1.pdf)
- [At23] ... 2023. *Natural constructive proofs of A via $A \rightarrow B$, proof paradoxes, and impredicativity*. Preprint. Forthcoming in Ansten Klev and Shahid Rahman (eds), *The Architecture and Archaeology of Modern Logic*, Studies dedicated to Göran Sundholm. Springer.
<https://www.academia.edu/105058857/>
- [AT03] Mark van Atten and Robert Tragesser. 2003. *Mysticism and Mathematics: Brouwer, Gödel, and the Common Core Thesis*. In *Essays on Gödel's Reception of Leibniz, Husserl, and Brouwer*, Chapter 10, pp.173-187. Volume author: Mark van Atten. Part of the *Logic, Epistemology, and the Unity of Science* book series (LEUS, volume 35), Springer, Cham.
https://doi.org/10.1007/978-3-319-10031-9_10
- [Avg21] Jeremy Avigad. 2021. *Varieties of Mathematical Understanding*. In *Bulletin of the American Mathematical Society* (New Series), Published electronically: February 22, 2021 (to appear in print). DOI: <https://doi.org/10.1090/bull/1726>
<https://www.ams.org/journals/bull/0000-000-00/S0273-0979-2021-01726-5/S0273-0979-2021-01726-5.pdf>
- [Avg23] ... 2023. *The design of mathematical language*. Preprint. Version: 16 Jan 2023 21:00. *PhilSci Archive*, University of Pittsburgh, Philadelphia, USA.
http://philsci-archive.pitt.edu/21661/7/language_archive.pdf
- [Avr20] Arnon Avron. 2020. *The Problematic Nature of Gödel's Disjunctions and Lucas-Penrose's Theses*. In *Studia Semiotyczne (Semiotic Studies)*, t. XXXIV, nr 1(2020), s.243–266, Polskie Towarzystwo Semiotyczne, Warsaw, Poland. DOI: 10.26333/sts.xxxiv1.11
<http://studiasemiotyczne.pts.edu.pl/index.php/Studiasemiotyczne/article/view/202/196>
- [Aw18] Jon Awbrey. 2018. *Sign Relations, Triadic Relations, Relations • 8*. Blogpost in *Inquiry into Inquiry*, July 6, 2018.
<https://inquiryintoquery.com/2018/07/06/sign-relations-triadic-relations-relations-%e2%80%a2-8/#comments>

- [AWB20] Megan Selbach-Allen, Cathy Williams and Jo Boaler. 2020. *What Would the Nautilus Say? Unleashing Creativity in Mathematics!* in *Journal of Humanistic Mathematics*, Volume 10, Issue 2 (July 2020), pp.391-414. DOI: 10.5642/jhummath.202002.18.
<https://scholarship.claremont.edu/jhm/vol10/iss2/18/>
- [AZ10] Mazlini Adnan and Effandi Zakaria. 2010. *Exploring Beliefs of Pre-Service Mathematics Teachers: A Malaysian Perspective*. In *Asian Social Science*, Vol. 6, No. 10, October 2010, pp.152-159. Published by Canadian Center of Science and Education.
<http://citeseerx.ist.psu.edu/viewdoc/summary?doi=10.1.1.672.228>
- [Ba16] Andrej Bauer. 2016. *Five Stages of Accepting Constructive Mathematics*, Bull. Amer. Math. Soc. (N. S.), electronically published on October 3, 2016. DOI: <https://doi.org/10.1090/bull/1556>.
<https://doi.org/10.1090/bull/1556>
- [BaG23] Jeffrey Alan Barrett and Isaac Goldbring. 2023. *A Nonstandard Formulation of Bohmian Mechanics*. Preprint. Version: 15 Mar 2023 13:26. *PhilSci Archive*, University of Pittsburgh, Philadelphia, USA.
<http://philsci-archive.pitt.edu/21874/>
- [Bar88] Michael Barnsley. 1988. *Fractals Everywhere*. Academic Press, Inc. San Diego.
- [BBJ03] George S. Boolos, John P. Burgess, Richard C. Jeffrey. 2003. *Computability and Logic* (4th ed). Cambridge University Press, Cambridge.
- [BC05] Katherine Brading and Elena Castellani. 2005. *Symmetries and invariances in classical physics*. CiteSeer^X, The College of Information Sciences and Technology, The Pennsylvania State University, Pennsylvania, USA.
<http://citeseerx.ist.psu.edu/viewdoc/summary?doi=10.1.1.516.4606>
- [BCST] Itzhak Bars, Shih-Hung Chen, Paul J. Steinhardt, and Neil Turok. 2012. *Antigravity and the big crunch/big bang transition*. In *Physics Letters B*, Volume 715, Issues 1-3, (2012), pp.278–281, Elsevier B. V.
<https://doi.org/10.1016/j.physletb.2012.07.071>
- [Be59] Evert W. Beth. 1959. *The Foundations of Mathematics*. Studies in Logic and the Foundations of Mathematics. Edited by L. E. J. Brouwer, E. W. Beth, A. Heyting. 1959. North Holland Publishing Company, Amsterdam.
- [Bel61] E. T. Bell. 1961. *The Last Problem*. Martino Fine Books, Eastford, CT (2017), USA.
- [BF58] Paul Bernays and Abraham A. Fraenkel. 1958. *Axiomatic Set Theory*. Studies in Logic and the Foundations of Mathematics. Edited by L. E. J. Brouwer, E. W. Beth, A. Heyting. 1959. North Holland Publishing Company, Amsterdam.
- [BFS08] Jānis Bārzdīņš, Rūsiņš Freivalds, and Carl H. Smith. 2008. *Learning with belief levels*. In *Journal of Computer and System Sciences*, Volume 74, Issue 4, June 2008, Pages 527–545. ScienceDirect, Elsevier B. V., Amsterdam, Netherlands.
<https://www.sciencedirect.com/science/article/pii/S002200007000736>
- [BG11] Selmer Bringsjord and Naveen Sundar Govindarajalu. 2011. *In Defense of the Unprovability of the Church-Turing Thesis*. Paper presented in *Trends in Logic IX* at the 2011 *Studia Logica* International Conference: *Church Thesis: Logic, Mind, and Nature*, Kraków, Poland.
http://kryten.mm.rpi.edu/SB_NSG_CTNotprovable_091510.pdf
- [BG11a] Selmer Bringsjord and Naveen Sundar Govindarajalu. 2011. *In Defense of the Unprovability of the Church-Turing Thesis*. Presentation in *Trends in Logic IX* at the 2011 *Studia Logica* International Conference: *Church Thesis: Logic, Mind, and Nature*, Kraków, Poland.
http://kryten.mm.rpi.edu/PRES/KRAKOWCT0611/SB_NSG_Refutation_D-G_on_CT_v2.pdf
- [Bgh23] Philipp Berghofer. 2023. *Gettier and the a priori*. In *Ratio*, 00, 1–9. John Wiley & Sons Ltd. Bognor Regis, England, UK. <https://doi.org/10.1111/rati.12395>.
<https://onlinelibrary.wiley.com/doi/epdf/10.1111/rati.12395>

- [BH24] Corine Besson and Anandi Hattiangadi. 2024. *Deductive reasoning without rule following*. Invited plenary lecture at the *2024 Spring Meeting of the Association for Symbolic Logic*, The Sheraton, Times Square, New York, NY Eastern APA Meeting, January 15–18, 2024. In *The Bulletin of Symbolic Logic*, 2024;30(1):172-175. doi:10.1017/bsl.2024.19.
<https://doi.org/10.1017/bsl.2024.19>
- [Bha19] Manjul Bhargava. 2019. *Patterns in Numbers and Nature*. Keynote presentation at the Infosys Prize 2018 Presentation Ceremony, Jan 5, 2019, Bengaluru, India.
<http://www.infosys-science-foundation.com/attic.asp>
- [Bi66] Errett Bishop. 1966. *The Constructivization of Abstract Mathematical Analysis*. In *Proceedings of International Congress of Mathematicians*, 4 Classical Analysis, pp.308-313, Moscow, 1966.
<https://www.mathunion.org/fileadmin/ICM/Proceedings/ICM1966.1/ICM1966.1.ocr.pdf>
- [Bi18] ... xxxx. *How to Compile Mathematics into Algol*. Unpublished manuscript retrieved from the Department of Computer Science, University of Birmingham, UK.
[\[http://www.cs.bham.ac.uk/mhe/Bishop/Algol.pdf\]](http://www.cs.bham.ac.uk/mhe/Bishop/Algol.pdf)
- [Bia18] Massimiliano Sassoli de Bianchi. 2018. *On Aert's Overlooked Solution to the Einstein-Podolsky-Rosen Paradox*. In Eds. Diederik Aerts, Maria Luisa Dalla Chiara, Christian de Ronde, and Décio Krause, *Probing the Meaning of Quantum Mechanics*, pp.185-201. Proceedings of the *II International Workshop on Quantum Mechanics and Quantum Information. Physical, Philosophical and Logical Approaches*, CLEA, Brussels Free University, Belgium, 23-24 July 2015. arXiv:1805.02869v1 [quant-ph].
<https://arxiv.org/pdf/1805.02869.pdf>
- [Bia19] Massimiliano Sassoli de Bianchi. 2019. *On Aert's Overlooked Solution to the Einstein-Podolsky-Rosen Paradox*. In Eds. Diederik Aerts, Maria Luisa Dalla Chiara, Christian de Ronde, and Décio Krause, *Probing the Meaning of Quantum Mechanics*, pp.185-201. Proceedings of the *II International Workshop on Quantum Mechanics and Quantum Information. Physical, Philosophical and Logical Approaches*, CLEA, Brussels Free University, Belgium, 23-24 July 2015. World Scientific Publishing Co. Pte. Ltd., Singapore.
https://doi.org/10.1142/9789813276895_0010
- [Bkd10] Mehmet Bekdemir. 2010. *The pre-service teachers' mathematics anxiety related to depth of negative experiences in mathematics classroom while they were students*. In *Educational Studies in Mathematics*, December 2010, Volume 75, Issue 3, pp.311-328, Springer Netherlands.
<https://doi.org/10.1007/s10649-010-9260-7>
- [BKPS] Samuel R. Buss, Alexander S. Kechris, Anand Pillay, and Richard A. Shore. 2000. *The Prospects for Mathematical Logic in the Twenty-First Century*. Reports on the panel discussion at the annual meeting of the Association for Symbolic Logic held in Urbana-Champaign, June 2000. arXived 3 May 2002.
<https://ia800409.us.archive.org/0/items/arxiv-cs0205003/cs0205003.pdf>
- [Bl64] John Stewart Bell. 1964. *On the Einstein Podolsky Rosen Paradox*. Physics Vol 1, No. 3, pp.195-200, 1964. Reprinted in *J. S. Bell, Speakable and unspeakable in quantum mechanics*, Cambridge, 2004, p. 14-21.
https://cds.cern.ch/record/111654/files/vol1p195-200_001.pdf
- [Blb10] Shashidhar Belbase. 2010. *Images, Anxieties and Attitudes toward Mathematics*. Online Submission (<http://www.eric.ed.gov/PDFS/ED513587.pdf>), 2010
https://www.academia.edu/33929274/Images_Anxieties_and_Attitudes_toward_Mathematics?email_work_card=title
- [Bld16] Bernd Buldt. 2016. *On Fixed Points, Diagonalization, and Self-Reference*. In *Von Rang und Namen. Essays in Honour of Wolfgang Spohn*, ed. by Wolfgang Freitag et al., pp.47-63. Münster: Mentis.
http://opus.ipfw.edu/philos_facpubs/326
<https://core.ac.uk/download/pdf/47232161.pdf>
- [Bl07] John L. Bell. 2007. *Incompleteness in a General Setting*. In *Bulletin of Symbolic Logic*, Volume 13, Issue 1, March 2007, pp. 21-30 (Published online by Cambridge University Press: 15 January 2014). DOI: <https://doi.org/10.2178/bsl/1174668216>
<https://doi.org/10.2178/bsl/1174668216>

- [BLo08] Francis Bailly and Giuseppe Longo. 2008. *Phenomenology of Incompleteness: From Formal Deductions to Mathematics and Physics*. In: Rossella Lupacchini, Giovanna Corsi (eds) *Deduction, Computation, Experiment*, pp.243-271. Springer, Milano, Italy.
https://doi.org/10.1007/978-88-470-0784-0_13
- [Blz11] Christie Blazer. 2011. *Strategies for Reducing Math Anxiety*. Information Capsule. Volume 1102, Research Services, Miami-Dade County Public Schools, Florida, USA.
<https://eric.ed.gov/?id=ED536509>
- [Bn08] David Brin. 2006. *Shouting at the Cosmos... Or How SETI has Taken a Worrisome Turn Into Dangerous Territory*. In a Special Report for the *Lifeboat Foundation* blog.
<https://lifeboat.com/ex/shouting.at.the.cosmos>
- [Bo52] David Bohm. 1952. *A Suggested Interpretation of the Quantum Theory in Terms of 'Hidden Variables', I*. Physical Review 85 n.2, pp.166-179 (1952) and *A Suggested Interpretation of the Quantum Theory in Terms of 'Hidden Variables', II*. Physical Review 85 n.2, pp.180-193 (1952).
<https://journals.aps.org/pr/abstract/10.1103/PhysRev.85.166>
- [Boh49] Niels Bohr. 1949. *Discussions with Einstein on Epistemological Problems in Atomic Physics*. In Schlipp, P. A. (Ed.). *Albert Einstein: Philosopher-Scientist*. The Library of Living Philosophers, Volume VII, 1949, Tudor Publishing Co. (1951), New York.
[\[http://www.marxists.org/reference/subject/philosophy/works/dk/bohr.htm\]](http://www.marxists.org/reference/subject/philosophy/works/dk/bohr.htm)
- [Bov00] Andrey I. Bovykin. 2000. *On order-types of models of arithmetic*. Thesis submitted to the University of Birmingham for the degree of Ph.D. in the Faculty of Science, School of Mathematics and Statistics, The University of Birmingham, Edgbaston, Birmingham, B15 2TT, United Kingdom, 13 April 2000.
- [BP14] Christoph Benzmüller and Bruno Woltzenlogel Paleo. 2014. *Automating Gödel's Ontological Proof of God's Existence with Higher-order Automated Theorem Provers*. In T. Schaub et al. (Eds.), *Frontiers in Artificial Intelligence and Applications*, Ebook Volume 263: ECAI 2014, pp.93-98, IOS Press, Amsterdam, Netherlands.
<http://page.mi.fu-berlin.de/cbenzmueller/papers/C40.pdf>
- [BPS88] Michael F. Barnsley, Robert L. Devaney, Benoit B. Mandelbrot, Heinz-Otto Peitgen, Dietmar Saupe, Richard F. Voss, et al. 1988. *The Science of Fractal Images*. Editors: Heinz-Otto Peitgen and Dietmar Saupe. 1988. Springer-Verlag, New York Inc., USA.
- [BPu64] Paul Benacerraf and Hilary Putnam (eds.). 1964. *Philosophy of Mathematics: Selected Readings*. 1964. Prentice-Hall, Englewood Cliffs, New Jersey.
- [Br08] Luitzen Egbertus Jan Brouwer. 1908. *The Unreliability of the Logical Principles*. English translation in A. Heyting, Ed. L. E. J. Brouwer: *Collected Works 1: Philosophy and Foundations of Mathematics*. Amsterdam: North Holland / New York: American Elsevier (1975): pp. 107-111.
- [Br13] ... 1913. *Intuitionism and Formalism*. Inaugural address at the University of Amsterdam, October 14, 1912. Translated by Professor Arnold Dresden for the Bulletin of the American Mathematical Society, Volume 20 (1913), pp.81-96. 1999. Electronically published in Bulletin (New Series) of the American Mathematical Society, Volume 37, Number 1, pp.55-64.
- [Br23] ... 1923. *On the significance of the principle of the excluded middle in mathematics, especially in function theory*. Address delivered on 21 September 1923 at the annual convention of the Deutsche Mathematiker-Vereinigung in Marburg an der Lahn. In Jean van Heijenoort. 1967. Ed. *From Frege to Gödel: A source book in Mathematical Logic, 1878 - 1931*. Harvard University Press, Cambridge, Massachusetts.
- [Br27] ... 1927. *Intuitionistic reflections on formalism*. In Jean van Heijenoort. 1967. Ed. *From Frege to Gödel: A source book in Mathematical Logic, 1878 - 1931*. Harvard University Press, Cambridge, Massachusetts.
- [Brd13] Henk Barendregt. *Foundations of Mathematics from the Perspective of Computer Verification*. In *Mathematics, Computer Science and Logic—A Never Ending Story*, edited by Peter Paule, pp.1-49, Springer, Switzerland.
https://doi.org/10.1007/978-3-319-00966-7_1

- [Brg23] Rafael-Andrés Alemañ-Berenguer. 2023. *The Spatial Infinity of the Universe: The Neglected Problem of Coosmology*. Preprint. Version: 10 Feb 2023 14:57. *PhilSci Archive*, University of Pittsburgh, Philadelphia, USA. To appear in *Teorema: Revista Internacional de Filosofía*, Spain.
<http://philsci-archive.pitt.edu/id/eprint/21744>
- [Bri93] Selmer Bringsjord. 1993. *The Narrational Case Against Church's Thesis*. Easter APA meetings, Atlanta.
<http://www.rpi.edu/~brings/SELPAP/CT/ct/ct.html>
- [Brm07] Manuel Bremer. 2007. *Varieties of Finitism*. In *Metaphysica*. October 2007, Volume 8, Issue 2, pp 131-148. Springer, Netherlands.
- [Brn00] Richard P. Brent. 2000. *Recent Progress and Prospects for Integer Factorisation Algorithms*. In *Computing and Combinatorics*, Lecture Notes in Computer Science, Volume 1858, 2000, pp.3-22, Springer, New York/Heidelberg.
http://pub.math.leidenuniv.nl/~edixhovensj/public_html_rennes/cours/brent.pdf
- [Bro22] Kati Kish Bar-On. 2022. *From Philosophical Traditions to Scientific Developments: Reconsidering the Response to Brouwer's Intuitionism*. In *Synthese*, September 2022. Preprint. Version: 25 Sep 2022 13:04. *PhilSci Archive*, University of Pittsburgh, Philadelphia, USA.
<http://philsci-archive.pitt.edu/id/eprint/21200>
- [Bro22a] ... 2022. *Connecting the revolutionary with the conventional: Rethinking the differences between the works of Brouwer, Heyting, and Weyl*. To appear in *Philosophy of Science*.
<https://www.katikish.com/research>
- [Br08] Jeffrey Alan Barrett. 2008. *Approximate Truth and Descriptive Nesting*. In *Erkenntnis*, volume 68, pages 213–224 (2008). DOI 10.1007/s10670-007-9086-6. Preprint. Version: 19 Mar 2023 13:55. *PhilSci Archive*, University of Pittsburgh, Philadelphia, USA.
<http://philsci-archive.pitt.edu/21891/>
- [Brt18] Jonathan Bartlett. 2018. *Describable but Not Predictable: Mathematical Modeling and Non-Naturalistic Causation*. In J. Bartlett and E. Holloway (editors), *Naturalism and its Alternatives in Scientific Methodologies.*, pp.113-127, The Blyth Institute, Broken Arrow, UK.
https://journals.blythinstitute.org/ojs/index.php/edited_volumes/article/view/amnat-7/19
- [Bru02] Yuriy Brun. 2002. *The four-color theorem*. In *Undergraduate Journal of Mathematics*, May 2002, pp.21–28. MIT Department of Mathematics, Cambridge, Massachusetts, USA.
<http://people.cs.umass.edu/brun/pubs/pubs/Brun02four-color.pdf>
- [Bs97] Samuel R. Buss. 1997. *Bounded Arithmetic and Propositional Proof Complexity*. In *Logic of Computation*. pp. 67-122. Ed. H. Schwichtenberg. Springer-Verlag, Berlin.
<http://www.math.ucsd.edu/~sbuss/ResearchWeb/marktoberdor95/paper.pdf>
- [Bs98] ... 1998. *First-Order Proof Theory of Arithmetic*. In *Handbook of Proof Theory*, ed. S. R. Buss, 1998, pp.79-147. Elsevier B. V. Amsterdam, Netherlands.
<http://www.math.ucsd.edu/~sbuss/ResearchWeb/handbookII/>
- [Bu10] Jeff Buechner. 2010. *Are the Gödel incompleteness theorems limitative results for the neurosciences?* *Journal of Biological Physics* 36(1):23-44, Netherlands. DOI: 10.1007/s10867-009-9160-1
<https://rd.springer.com/article/10.1007%2Fs10867-009-9160-1>
- [Bu20] ... 2020. *Using Kreisel's Way Out to Refute Lucas-Penrose-Putnam Anti-Functionalist Arguments*. In *Studia Semiotyczne (Semiotic Studies)*, t. XXXIV, nr 1(2020), s.243–266, Polskie Towarzystwo Semiotyczne, Warsaw, Poland. DOI: 10.26333/sts.xxxiv1.11
<http://studiasemiotyczne.pts.edu.pl/index.php/Studiasemiotyczne/article/view/203/207>
- [Bur10] John Burgess. 2010. *On the Outside Looking In: A Caution About Conservativeness*. In *Kurt Gödel: Essays for his Centennial*. Edited by Solomon Feferman, Charles Parsons, and Stephen Simpson, *Lecture Notes in Logic*, Association for Symbolic Logic. Cambridge University Press, NY, USA.
- [Bwl] Richard Barwell. 20xx. *The role of language in mathematics*. Support materials, *National Association for Language Development in the Curriculum*. NALDIC Publications Group, Watford, UK.
<https://www.naldic.org.uk/Resources/NALDIC/docs/resources/documents/The%20Role%20of%20language%20in%20mathematics.pdf>

- [BW05] Henk Barendregt and Freek Wiedijk. 2005. *The challenge of computer mathematics*. In *Philosophical Transactions of The Royal Society A*, Volume 363, pp.2351-2375.
<https://royalsocietypublishing.org/doi/pdf/10.1098/rsta.2005.1650>
- [Byd14] Wendy Boyd, Alan Foster, Jubilee Smith and William Edgar Boyd. 2014. *Feeling Good about Teaching Mathematics: Addressing Anxiety amongst Pre-Service Teachers*. In *Creative Education*, Vol.5, No.4, March 2014, pp.207-217.
<http://www.scirp.org/journal/paperinformation.aspx?paperid=43692>
- [Ca37] Rudolf Carnap. 1937. *The Logical Syntax of Language*. Reprinted in 1959 from the first English translation in 1937 by Routledge and Kegan Paul Ltd., London. Littlefield, Adams & Co., New Jersey.
- [Ca62] ... 1962. *On the use of Hilbert's ε -operator in scientific theories*. In *Essays on the Foundations of Mathematics*. Edited by Y. Bar-Hillel, E. I. J. Posnanski, M. O. Rabin, and A. Robinson for The Hebrew University of Jerusalem. 1962. North Holland Publishing Company, Amsterdam: pp. 156-164.
- [Ca62a] ... 1962. *Logical Foundations of Probability*. Second Edition 1962. The University of Chicago Press, Chicago, Illinois, U.S.A.
- [Cai07] Andrés Eduardo Caicedo. 2007. *Goodstein's Theorem*. In *Revista Colombiana de Matemáticas*, Volume 41(2007)2, pp. 381-391.
<http://emis.impa.br/EMIS/journals/RCM/Articulos/878.pdf>
- [Cat07] Paola Cattabriga. *Observations concerning Gödel's 1931*. Abstract presented by title as a contributed talk to the 2006-7 ASL Winter Meeting. In *Bulletin of Symbolic Logic*, Vol. 13, Number 3, 2007, p.382.
<https://arxiv.org/pdf/math/0306038.pdf>
- [Cay79] Arthur Cayley. 1879. *On the Colouring of Maps*. Proceedings of the Royal Geographical Society and Monthly Record of Geography, New Monthly Series, Vol. 1, No. 4 (Apr., 1879).
<https://www.jstor.org/stable/1799998?refreqid=excelsior%3A8d25e3714824dadf86c153af680dc565&sseq=1>
- [CCS01] Cristian S. Calude, Elena Calude and Solomon Marcus. 2001. *Passages of Proof*. Workshop, Annual Conference of the Australasian Association of Philosophy (New Zealand Division), Auckland.
<http://arxiv.org/pdf/math/0305213.pdf>
- [CD19] Cristian S. Calude and Monica Dumitrescu. 2019. *Infinitesimal Probabilities Based on Grossone*. In *SN Computer Science*, (2020) 1:36. Springer Nature Singapore Pte. Ltd., Singapore.
<https://doi.org/10.1007/s42979-019-0042-8>
- [CG15] Willem Conradie and Valentin Goranko. 2015. *Logic and Discrete Mathematics: A Concise Introduction*. First edition, 2015. John Wiley and Sons Ltd., Sussex, United Kingdom.
<https://bcs.wiley.com/he-bcs/Books?action=index&bcsId=9628&itemId=1118751272>
- [CCZ15] Tianxin Cai, Deyi Chen, and Yong Zhang. 2015. *A new generalization of Fermat's Last Theorem*. In *Journal of Number Theory*, Volume 149, April 2015, Pages 33-45. Elsevier B. V.
<https://doi.org/10.1016/j.jnt.2014.09.014>
<https://doi.org/10.1016/j.jnt.2014.09.014>
- [Ch36] Church, Alonzo. 1936. *An unsolvable problem of elementary number theory*. In M. Davis (ed.). 1965. *The Undecidable*. Raven Press, New York. Reprinted from the Am. J. Math., Vol. 58, pp.345-363.
- [Cha05] Oswaldo Chateaubriand. 2005. *Logical Forms, Part II – Logic, Language, and Knowledge*. In *Coleção CLE*, Volume 42, Centre for Logic, Epistemology and the History of Science (CLE), Universidade Estadual de Campinas, Brazil.
<http://www.cle.unicamp.br/index.php/sites/default/files/publicacoes/CatalogosCLE-Colecao.pdf>
- [Che42] Lord Cherwell. 1942. *Number of Primes and Probability Considerations*. In *Nature* **150**, 120-121 (25 July 1942), p. 121. doi:10.1038/150120a0
<http://www.nature.com/nature/journal/v150/n3795/pdf/150120a0.pdf>
- [Chg20] Yong Cheng. 2020. *Gödel's Incompleteness Theorem and the Anti-Mechanist Argument: Revisited*. In *Studia Semiotyczne (Semiotic Studies)*, t. XXXIV, nr 1(2020), s.243–266, Polskie Towarzystwo Semiotyczne, Warsaw, Poland. DOI: 10.26333/sts.xxxiv.1.11
<http://studiasemiotyczne.pts.edu.pl/index.php/Studiasemiotyczne/article/view/204/198>

- [Chn18] Steve Chinn. 2018. *Maths Learning Difficulties and Dyscalculia*. Unique Ability Consulting, Mumbai, India.
www.uniqueabilityconsulting.com/downloads/Sample%20Pages%20of%20Maths%20Learning%20Difficulties%20And%20Dyscalculia%20.pdf
- [Cho18] Timothy Y. Chow. 2018. *The Consistency of Arithmetic*. In *The Mathematical Intelligencer*, November 2018, Springer, U.S.
<https://doi.org/10.1007/s00283-018-9837-z>
- [Chr97] G. Chardin. 1997. *Motivations for antigravity in General Relativity*. In *Hyperfine Interactions*. 1997. Volume 109, Issue 1-4, pp.83-94. Kluwer Academic Publishers.
<https://doi.org/10.1023/A:1012688930074>
- [Chs24] Joy Christian. 2024. *Bell's Theorem Begs the Question*. Preprint.
<https://doi.org/10.48550/arXiv.2302.09519>
- [Cip88] Barry A. Cipra. 1988. *Fermat's Last Theorem Remains Unproved*. in *Science*, New Series, Vol.240, No. 4857, (Jun. 3, 1988), pp. 1275-1276, Accessed October 10, 2020. American Association for the Advancement of Science, Washington DC, USA.
<https://www.jstor.org/stable/1701048>
- [Cl01] Andreea S. Calude. 2001. *The Journey of the Four Colour Theorem Through Time*. The New Zealand Mathematics Magazine, 2001, 38:3:27-35, Auckland, New Zealand.
<https://www.calude.net/andreea/4CT.pdf>
- [Cld11] ... 2011. *The science of numbers: does language help or hinder*. In *Language Sciences*, Volume 33, Issue 4, July 2011, pp.562-568. Elsevier Ltd.
<https://doi.org/10.1016/j.langsci.2011.04.008>
- [Cll19] Carlo Cellucci. 2019. *Diagrams in Mathematics*. in *Foundations of Science*, Volume 24, pages 583–604, (2019), Springer Nature. <https://doi.org/10.1007/s10699-019-09583-x>
<https://www.academia.edu/38154549/>
- [Co63] Paul J. Cohen. 1963. *The Independence of the Continuum Hypothesis I*. In *Proceedings of the National Academy of Sciences of the United States of America*, 50, pp.1143-1148, 1963.
- [Co64] ... 1964. *The Independence of the Continuum Hypothesis II*. In *Proceedings of the National Academy of Sciences of the United States of America*, 51(1), pp.105-110, 1964.
- [Co66] ... 1966. *Set Theory and the Continuum Hypothesis*. (Lecture notes given at Harvard University, Spring 1965) W. A. Benjamin, Inc., New York.
- [Co05] ... 2005. *Skolem and pessimism about proof in mathematics*. In *Philosophical Transactions of the Royal Society A: Mathematical, Physical and Engineering Sciences*, Volume 363, Issue 1835, September 2005, pp.2407-2418. Royal Society Publishing, UK.
<https://doi.org/10.1098/rsta.2005.1661>
- [Coh05] Paul. R. Cohen. 2005. *If Not Turing's Test, Then What?* In *AI Magazine*, Volume 26, Number 4 (2005), American Association for Artificial Intelligence.
<https://arizona.pure.elsevier.com/en/publications/if-not-turings-test-then-what>
- [Cook] Stephen Cook. 2000. *The P versus NP Problem*. Official description provided for the Clay Mathematical Institute, Cambridge, Massachusetts.
<http://www.claymath.org/sites/default/files/pvsnp.pdf>
- [Cop04] Jack Copeland. 2004. *The Church-Turing Thesis* Invited article in the Special Issue on *Minds, Brains and Mathematics*. In *NeuroQuantology*, [S.l.], v.2, n.2, 2004, pp.101-115. ISSN 1303-5150. DOI: 10.14704/nq.2004.2.2.40.
<https://www.neuroquantology.com/data-cms/articles/20191023051436pm40.pdf>
- [Cor73] John Corcoran. 1973. *Gaps Between Logical Theory and Mathematical Practice*. In M. Bunge (ed.), *The Methodological Unity of Science*, 23-50. 1973. D. Reidel Publishing Company, P.O. Box 17, Dordrecht, Holland.
<https://philpapers.org/rec/CORGBL>

- [Cr05] John N. Crossley. 2005. *What is Mathematical Logic?* A Survey. Address at the First Indian Conference on Logic and its Relationship with Other Disciplines held at the Indian Institute of Technology, Powai, Mumbai from January 8 to 12. Reprinted in *Logic at the Crossroads: An Interdisciplinary View - Volume I* (pp.3-18). ed. Amitabha Gupta, Rohit Parikh and Johan van Bentham. 2007. Allied Publishers Private Limited, Mumbai, India.
- [CR12] Roger Colbeck and Renato Renner. *Is a System's Wave Function in One-to-One Correspondence with its Elements of Reality?* In *Physical Review Letters*, Volume 108, issue 15, 13 April 2012. American Physical Society, USA.
<https://doi.org/10.1103/PhysRevLett.108.150402>
- [Cr105] Tony Crilly. 2005. *Arthur Cayley FRS and the four-colour map problem*. Notes and Records of The Royal Society 59(3):285-304. DOI: 10.1098/rsnr.2005.0097
<https://royalsocietypublishing.org/doi/10.1098/rsnr.2005.0097>
- [Crt23] Colin R. Caret. 2023. *Not so simple*. In *Asian Journal of Philosophy*, 2, 48 (2023), SpringerNature. <https://doi.org/10.1007/s44204-023-00100-3>
<https://link.springer.com/article/10.1007/s44204-023-00100-3>
- [Cry10] Leo Corry. 2010. *On the History of Fermat's Last Theorem: Fresh Views on an Old Tale*. In *Mathematische Semesterberichte*, 57 (1) (2010): 123-138.
https://www.leocorry.com/_files/ugd/e6fef7_3217854c9e8048e7b02f7cf154cb9d01.pdf
- [Cry17] ... 2017. *Hilbert's 6th Problem: Between the Foundations of Geometry and the Axiomatization of Physics*. In *Philosophical Transactions of the Royal Society (A)*, 376 (2018); 28 April 2018.
https://www.leocorry.com/_files/ugd/e6fef7_4586674091a145e4a154f2395f76a7aa.pdf
- [Cry22] ... 2022. *How Useful is the Term 'Modernism' for Understanding the History of Early Twentieth-Century Mathematics?* Preprint planned to appear in Moritz Epple and Falk Mueller (eds.) *Modernism in the Sciences, ca. 1900-1940*, Berlin, Akademie Verlag (Forthcoming).
https://www.leocorry.com/_files/ugd/e6fef7_2b0a116fef614e0e8d38d0ffdf9a786.pdf
- [Csr19] Ferenc Csátári. 2019. *Measurement and Meaning*. Rowman & Littlefield, Maryland, USA.
- [Csr24] ... 2024. *In Defense of a Constructive Truth Concept*. Preprint. Version: 15 Feb 2024 21:26. *PhilSci Archive*, University of Pittsburgh, Philadelphia, USA.
https://philsci-archive.pitt.edu/23087/1/Consrtrue_fcs_1.pdf
- [Cst18] Davide Castelvecchi. 2018. *Reimagining of Schrödinger's cat breaks quantum mechanics—and stumps physicists*. In *Nature*, 561, 446-447 (2018). doi: <https://doi.org/10.1038/d41586-018-06749-8>.
<https://www.nature.com/articles/d41586-018-06749-8/>
- [Ct75] Gregory J. Chaitin. 1975. *A Theory of Program Size Formally Identical to Information Theory*. In *Journal of the ACM (JACM)* Volume 22 Issue 3, July 1975, pp. 329-340. Association for Computing Machinery, New York, NY, USA.
<https://dl.acm.org/citation.cfm?id=321894>
- [Ct82] ... 1982. *Gödel's Theorem and Information*. *International Journal of Theoretical Physics* (1982) 21, pp. 941-954. Kluwer Academic Publishers-Plenum Publishers.
<https://doi.org/10.1007/BF02084159>
- [CU93] Stephen Cook and Alisdair Urquhart. 1993. *Functional interpretations of feasibly constructive arithmetic*. In *Annals of Pure and Applied Logic*, Volume 63 (1993) pp.103-200. North-Holland, Elsevier Science Publishers B.V., Holland.
<https://core.ac.uk/reader/81955515>
- [Da64] Martin Davis. 1964. *The Undecidable: Basic Papers on Undecidable Propositions, Unsolvability Problems and Computable Functions*. 2004 Edition. Dover Publications Inc., N.Y.
- [Da82] ... 1958. *Computability and Unsolvability*. 1982 ed. Dover Publications, Inc., New York.
- [Da95] ... 1995. *Is mathematical insight algorithmic?* In *Behavioral and Brain Sciences*, 13 (4), 659-60.
- [DaS14] Ricardo J. Da Silva. 2014. *Gödel's Incompleteness Theorems, Set Theory and David Hilbert's Program*. In *EPISTEME NS*, VOL. 34, No. 1, 2014, pp. 19-40.
<https://www.academia.edu/78082463/>

- [Dav05] E. B. Davies. 2005. *Pluralism in mathematics*. In *Philosophical Transactions of the Royal Society A: Mathematical, Physical and Engineering Sciences*, Volume 363, pp.2449-2460. Royal Society, UK.
<https://doi.org/10.1098/rsta.2005.1657>
- [Dav05a] ... 2005. *Some Remarks on the Foundations of Quantum Theory*. In *The British Journal for the Philosophy of Science*, 2005, Volume 56, Number 3, pp.521-539. The University of Chicago Press, Chicago, Illinois, U.S.A. doi:10.1093/bjps/axi129
<https://www.journals.uchicago.edu/doi/10.1093/bjps/axi129>
- [Daw15] Ryan Dawson. 2015. *Leaving Mathematics As It Is: Wittgenstein's Later Philosophy of Mathematics*. PhD Thesis for Doctorate of Philosophy, School of Philosophy, University of East Anglia, UK.
https://ueaeprints.uea.ac.uk/id/eprint/57209/1/Leaving_Mathematics_As_It_Is_Wittgenstein's_Philosophy_of_Mathematics__130615.pdf
- [DB93] Paul C. W. Davies and Julian R. Brown. 1986. *The Ghost in the Atom: A Discussion of the Mysteries of Quantum Physics*, 1993, Cambridge University Press, Cambridge, UK.
<https://searchworks.stanford.edu/view/321919>
- [Dck20] Leonard Eugene Dickson. 1920. 'History of the Theory of Numbers (Volume II) Diophantine Analysis.' Carnegie Institution of Washington, Publication No. 256, Vol. II. 1950, Chelsea Publishing Company, New York, N. Y. USA.
- [DDR95] Henri Darmon, Fred Diamond and Richard Taylor. 1995. *Fermat's Last Theorem*. In *Current Developments in Mathematics*, Volume 1995, pp.1-154. International Press, Inc., Somerville, Maryland, U.S.A.
https://intlpress.com/site/pub/files/_fulltext/journals/cdm/1995/1995/0001/CDM-1995-1995-0001-a001.pdf
- [DDT19] Radin Dardashti, Richard Dawid and Karim Thebault. 2019. *Why Trust a Theory? Epistemology of Fundamental Physics*. Cambridge University Press, UK.
- [De17] Daniel C. Dennett. 2017. *A Difference That Makes a Difference*. In *Edge*, 22nd Nov-ember 2017.
https://www.edge.org/conversation/daniel_c_dennett-a-difference-that-makes-a-difference
- [Deu85] David Deutsch. 1985. *Quantum Theory, the Church-Turing principle and the universal computer*. In *Proceedings of the Royal Society A: Mathematical, Physical and Engineering Sciences*, Volume 400, Issue 1818, 8 July 1985, pp.97-117. Royal Society, UK.
<https://www.cs.princeton.edu/courses/archive/fall04/cos576/papers/deutsch85.pdf>
- [Dev94] Keith Devlin. 1994. *Fermat's Last Theorem*. In *Math Horizons*, Vol. 1, No. 2 (Spring 1994), pp. 4-5. Accessed October 10, 2020. Mathematical Association of America, Washington DC, USA.
<http://www.jstor.org/stable/25677961>
- [DG08] Nachum Dershowitz and Yuri Gurevich. 2008. *A Natural Axiomatization of Computability and Proof of Church's Thesis*. In *The Bulletin of Symbolic Logic*, Volume 14, Number 3, September 2008, pp.299-350. DOI: <https://doi.org/10.2178/bsl/1231081370>
<https://doi.org/10.2178/bsl/1231081370>
- [Dic52] Leonard Eugene Dickson. 1952. *History of the Theory of Numbers: Volume I*. Chelsea Publishing Company, New York, N. Y.
- [Di70] Jean Dieudonné. 1970. *The Work of Nicholas Bourbaki*. In *The American Mathematical Monthly*, vol. 77, 1970, pp. 134-145.
- [DJ92] David Deutsch and Richard Jozsa. 1992. *Rapid Solution of Problems by Quantum Computation*. In *Proceedings of the Royal Society A: Mathematical, Physical and Engineering Sciences*, Volume 439, Issue 1907, 08 December 1992, pp.553-558. Royal Society, UK.
<https://qudev.phys.ethz.ch/static/content/courses/phys4/studentspresentations/djalgo/DeutschJozsa.pdf>
- [Dks17] Dennis Dieks. 2017. *Von Neumann's Impossibility Proof: Mathematics in the Service of Rhetorics*. In *Studies in History and Philosophy of Science Part B: Studies in History and Philosophy of Modern Physics*, Volume 60, 1 Nov 2017, pp.136-148. Elsevier B. V.
<https://doi.org/10.1016/j.shpsb.2017.01.008>

- [Dmt22] Spiridon Dumitru. 2022. *Possible Perspective for Quantum Mechanics Interpretation: An Essay-Suggestion*. In *European Journal of Applied Physics*, 4(5), 55–62. doi.org/10.24018/ejphysics.2022.4.5.212
<https://doi.org/10.24018/ejphysics.2022.4.5.212>
- [Dng10] Kathryn Denning. 2010. *Unpacking the great transmission debate*. In *Acta Astronautica*, Volume 67, Issues 11–12, December 2010, Pages 1399-1405. ScienceDirect, Elsevier. <https://doi.org/10.1016/j.actaastro.2010.02.024>
<https://www.academia.edu/827151/>
- [DP17] Vilnis Detlovs and Karlis Podnieks. 2017. *Introduction to Mathematical Logic*. Hyper-textbook version for students released: May 24, 2017. University of Latvia, Riga, Latvia.
https://dspace.lu.lv/dspace/bitstream/handle/7/34986/Detlovs_Podnieks_Math_Logic.pdf?sequence=1&isAllowed=y
- [Drg18] Virgil Drăghici. 2018. *The Reflexivity of a Language (Some Comments on Gödel and Wittgenstein)* In *International Journal of Communication Research*, Volume 8, Issue 3, July / September 2018.
https://ijcr.eu/articole/415_04%20Virgil%20DRAGHICI.pdf
- [Drg23] ... 2023. *Mathematical Logic*. Universitatea Babeş-Bolyai, Presa Universitară Clujeană, Cluj-Napoca, Romania.
<https://www.academia.edu/115990116/>
- [Du14] Marie Duží. 2014. *A procedural interpretation of the Church-Turing Thesis*. In *Church's Thesis: Logic, Mind and Nature*, Eds. Adam Olszewski, Bartosz Brożek, Piotr Urbańczyk, Copernicus Center Press, Krakow.
- [Dvd19] Shai Ben-David, Pavel Hrubeš, Shay Moran, Amir Shpilka and Amir Yehudayoff. 2019. *Learnability can be undecidable*. In *Nature Machine Intelligence*, volume 1, pages44–48 (2019).
<https://www.nature.com/articles/s42256-018-0002-3>
- [Dvk18] P. P. Divakaran. 2018. *The Mathematics of India: Concepts, Methods, Connections*. Springer Nature, Switzerland.
<https://b-ok.cc/book/3596379/5c1ae4>
- [Ebr20] Matthias Eberl. 2020. *Infinity is Not a Size*. In Martin Blichá and Igor Sedlar, eds. *The Logica Yearbook 2020*, pp.33-48, College Publications. College Publishing Ltd, UK.
<https://doi.org/10.48550/arXiv.2208.13732>
- [EC89] Richard L. Epstein, Walter A. Carnielli. 1989. *Computability: Computable Functions, Logic, and the Foundations of Mathematics*. Wadsworth & Brooks, California.
- [Ei36] Albert Einstein. 1936. *Physics and reality*. *Journal of the Franklin Institute*, Volume 221, Issue 3, March 1936, Pages 349-382, Elsevier B. V.
[https://doi.org/10.1016/S0016-0032\(36\)91047-5](https://doi.org/10.1016/S0016-0032(36)91047-5)
- [Ei36a] ... 1936. *Physics and reality*. Translated by Jean Piccard, Academia upload.
https://www.academia.edu/8226298/PHYSICS_AND_REALITY_by_A._Einstein
- [Ei50] ... 1950. *Letters on Wave Mechanics*. Letter # 17, p.39. Edited by K. Przibram for the Austrian Academy of Sciences. Vienna, 1963. Published 1967 by Philosophical Library Inc., New York. USA.
<https://archive.org/details/lettersonwavemec0000karl/page/38/mode/2up?q=einstein%27s+1950+letter>
- [EPR35] Albert Einstein, Boris Yakovlevich Podolsky, Nathan Rosen. 1935. *Can Quantum-Mechanical Description of Physical Reality be Considered Complete?*. *Physical Review* 47 (10): 777-780.
<https://journals.aps.org/pr/pdf/10.1103/PhysRev.47.777>
- [Er06] Paul Ernest. 2006. *The Knowledge, Beliefs and Attitudes of the Mathematics Teacher: a model*. In *Journal of Education for Teaching*, pp.13-33, Published online: 07 Jul 2006, Taylor and Francis, London, UK.
<https://doi.org/10.1080/0260747890150102>
- [Er12] ... 2012. *What is our 'first philosophy' in mathematics education?* In *For the Learning of Mathematics*, 32, 3 (November, 2012) FLM Publishing Association, Fredericton, New Brunswick, Canada.
<https://flm-journal.org/Articles/4F2131EE356F3901F87BE5DC0529.pdf>

- [Fe60] Solomon Feferman. 1960. *Arithmetization of metamathematics in a general setting*. In *Fundamenta Mathematicae*, Volume 49, i960, Issue 1, pp.35-92. Institute of Mathematics, Polish Academy of Sciences
<http://matwbn.icm.edu.pl/ksiazki/fm/fm49/fm4915.pdf>
- [Fe92] ... 1992. *What rests on what: The proof-theoretic analysis of mathematics*. Invited lecture, 15th International Wittgenstein Symposium: *Philosophy of Mathematics*, held in Kirchberg/Wechsel, Austria, 16-23 August 1992.
<http://math.stanford.edu/feferman/papers/whatrests.pdf>
- [Fe94] ... 1994. *Deciding the Undecidable: Wrestling with Hilbert's Problems*. Lecture to a general audience at Stanford University, May 13, 1994.
<http://math.stanford.edu/feferman/papers/deciding.pdf>
- [Fe97] ... 1997. *The significance of Hermann Weyl's 'Das Kontinuum'*. The second of Solomon Feferman's three lectures for the conference, *Proof Theory: History and Philosophical Significance*, held at the University of Roskilde, Denmark Oct. 31-Nov. 1, 1997.
<http://math.stanford.edu/feferman/papers/DasKontinuum.pdf>
- [Fe98] ... 1998. *Mathematical Intuition Vs. Mathematical Monsters*. Expanded version of a paper presented by invitation to the Twentieth World Congress of Philosophy, Boston, MA, August 8-11, 1998. In *Synthese*, December 2000, Volume 125, Issue 3, pp. 317–332.
<https://link.springer.com/article/10.1023/A%3A1005223128130>
- [Fe99] ... 1999. *Does Mathematics Need New Axioms?* In *The American Mathematical Monthly*, Vol. 106, No. 2, Feb., 1999, pp. 99-111, DOI: 10.2307/2589047.
<http://www.jstor.org/stable/2589047>
- [Fe00] ... 2000. *Does Reductive Proof Theory Have A Viable Rationale?* In *Erkenntnis* **53**, pp.63-69, September 2000, SpringerNature.
<http://math.stanford.edu/feferman/papers/reductive.pdf>
- [Fe02] ... 2002. *Predicativity*.
<http://math.stanford.edu/feferman/papers/predicativity.pdf>
- [Fe06] ... 2006. *Are There Absolutely Unsolvable Problems? Gödel's Dichotomy*. *Philosophia Mathematica* (2006) 14 (2): 134-152.
<http://math.stanford.edu/feferman/papers/dichotomy.pdf>
- [Fe06a] ... 2006. *The nature and significance of Gödel's incompleteness theorems*. Lecture delivered for the Princeton Institute of Advanced Study Gödel Centenary Program, Nov. 17, 2006.
<https://math.stanford.edu/feferman/papers/Godel-IAS.pdf>
- [Fe08] ... 2008. *Lieber Herr Bernays!, Lieber Herr Gödel! Gödel on finitism, constructivity and Hilbert's program*. in *Special Issue: Gödel's dialectica Interpretation* *Dialectica*, Volume 62, Issue 2, June 2008, pp. 245-290.
<http://math.stanford.edu/feferman/papers/bernays.pdf>
- [FF98] Rudolf Fritsch and Gerda Fritsch. 1998. *The Four Color Theorem: History, Topological Foundations and Idea of Proof*, Translated from the 1994 German original by Julie Peschke., New York: Springer, doi:10.1007/978-1-4612-1720-6, ISBN 978-0-387-98497-1, MR 1633950
- [FFMS] Solomon Feferman, Harvey M. Friedman, Penelope Maddy and John R. Steel. 2000. *Discussion: Does Mathematics Need New Axioms?* In *The Bulletin of Symbolic Logic*, Vol. 6, No. 4 (Dec., 2000), pp. 401-446, DOI: 10.2307/420965.
<http://www.jstor.org/stable/420965>
- [FG12] Vincenzo Fano and Pierluigi Graziani. 2012. *Mechanical Intelligence and Gödelian Arguments*. In *The Legacy of A. M. Turing*, edited by Evandro Agazzi, pp.48-71, *Papers presented at the Conference of the International Academy of Philosophy of Science—Urbino, 25-27 September 2012*, FrancoAngeli, Milano, Italy.
https://www.academia.edu/26300494/Mechanical_intelligence_and_Godelian_Arguments

- [FGW22] Adam Frank, David Grinspoon and Sara Walker. 2022. *Intelligence as a planetary scale process*. In *International Journal of Astrobiology*, Volume 21, Issue 2, April 2022, pp.47-61. doi:10.1017/S147355042100029X
<https://doi.org/10.1017/S147355042100029X>
- [Fi19] Michael Stephen Fiske. 2019. *Quantum Random Self-Modifiable Computation*. Paper presented at the *Logic Colloquium 2019*, European Summer Meeting of the Association for Symbolic Logic, August 11-16, Prague, Czech Republic.
<https://arxiv.org/pdf/1807.01369.pdf>
- [Fi19a] Michael Stephen Fiske. 2019. *Quantum Random Self-Modifiable Computation*. Presentation at the *Logic Colloquium 2019*, European Summer Meeting of the Association for Symbolic Logic, August 11-16, Prague, Czech Republic.
https://lc2019.cz/static/public/slides/Tuesday/room-5/fiske/lc2019_qrsm.pdf?53f9cedf95d973a025de
- [Fl20] Juliet Floyd. 2020. *Aspects of the Real Numbers: Putnam, Wittgenstein, and Non-Extensionalism*. Draft of an unpublished article shared with this author in a private email dated 9th May 20020 (*to be treated as non-citeable work in progress*).
- [Flo19] Vera Flocke. 2019. *Carnap's Defense of Impredicative Definitions*. In *The Review of Symbolic Logic*, Volume 12, Issue 2, June 2019, pp.372-404. Cambridge University Press, UK.
<https://doi.org/10.1017/S1755020318000370>
- [FM15] Michèle Friend and Daniele Molinini. 2015. *Using Mathematics to Explain a Scientific Theory*. In *Philosophia Mathematica*, Volume 24, Issue 2, 1 June 2016, Pages 185–213.
<https://doi.org/10.1093/phimat/nkv022>
- [For10] Giambattista Formica. *Von Neumann's Methodology of Science: From Incompleteness Theorems to Later Foundational Reflections*. In *Perspectives on Science*, Volume 18, Issue 4, Winter 2010, p.480-499, The MIT Press, Cambridge, MA, USA.
https://doi.org/10.1162/POSC_a_00019
- [FP00] Juliet Floyd and Hilary Putnam. 2000. *A Note on Wittgenstein's 'Notorious Paragraph' about the Gödel Theorem*. In *The Journal of Philosophy* 45, 11: 624-632.
https://www.academia.edu/450656/JF_2000_w_HP_A_Note_on_Wittgensteins_Notorious_Paragraph_About_the_G%C3%B6del_Theorem
- [Fr09] Curtis Franks. 2009. *The Autonomy of Mathematical Knowledge: Hilbert's Program Revisited*. Cambridge University Press, New York.
- [Fra94] Pasquale Frascolla. 1994. *Wittgenstein's Philosophy of Mathematics*. 2006 edition, Taylor & Francis, UK.
<https://b-ok.cc/book/495019/43925e>
- [Frd01] Michael Friedman. 2001. *Dynamics of Reason*. Lecture Notes, March 1, 2001. Stanford Kant Lectures, Center for the Study of Language and Information, Stanford University, California, USA.
<https://web.stanford.edu/group/cslipublications/cslipublications/site/1575862921.shtml>
- [Fre18] Rodrigo A. Freire. 2018. *Interpretation and Truth in Set Theory*. In Eds. Walter Carnielli and Jacek Malinowski, *Contradictions, from Consistency to Inconsistency*, pp.183-205. Part of Trends in Logic, Studia Logica Library, SpringerLink.
https://link.springer.com/chapter/10.1007/978-3-319-98797-2_9
- [Fri19] Alfredo Roque Freire. 2019. *Does set theory really ground arithmetic truth?* arXiv:1911.10628 [math.LO]. Version 2, 13 Dec 2019.
<https://arxiv.org/abs/1911.10628v2>
- [Frn00] Robert M. French. 2000. *The Turing Test: The First Fifty Years*. In *Trends in Cognitive Sciences*, 4(3):115-122.
[https://www.cell.com/trends/cognitive-sciences/fulltext/S1364-6613\(00\)01453-4](https://www.cell.com/trends/cognitive-sciences/fulltext/S1364-6613(00)01453-4)
- [FrRe18] Daniela Frauchiger and Renato Renner. 2018. *Quantum theory cannot consistently describe the use of itself*. In *Nature Communications*, volume 9, Article number: 3711 (2018).
<https://www.nature.com/articles/s41467-018-05739-8>

- [Frt03] Lance Fortnow. 2003. *Computation Beyond Turing Machines?* Blog post in *Computational Complexity*, Tuesday, April 08, 2003.
<https://blog.computationalcomplexity.org/2003/04/computation-beyond-turing-machines.html>
- [Frt09] ... 2009. *The Status of the P Versus NP Problem*. Communications of the ACM, Volume 52, Issue 9 (September 2009).
- [Frt13] ... 2013. *The Golden Ticket: P, NP, and the Search for the Impossible*. Princeton University Press, Princeton, NJ. ISBN 9780691156491.
- [Fu42] W. H. Furry. 1942. *Number of Primes and Probability Considerations*. In *Nature* **150**, 120-121 (25 July 1942), p. 120, doi:10.1038/150120a0
<http://www.nature.com/nature/journal/v150/n3795/pdf/150120a0.pdf>
- [FV22] James Duncan Fraser and Peter Vickers. 2022. *Knowledge of the Quantum Domain: An Overlap Strategy*. In *The British Journal for the Philosophy of Science*, SN: 0007-0882, doi: 10.1086/721635.
<https://doi.org/10.1086/721635>
- [Ga15] Yvon Gauthier, 2015, *Towards an Arithmetical Logic: The Arithmetical Foundations of Logic*, Studies in Universal Logic, DOI 10.1007/978-3-319-22087-1, Birkhäuser, Springer International Publishing AG Switzerland.
- [Gaf04] Haim Gaifman. 2004. *Non-standard models in a broader perspective*. In A. Enayat and R. Kossak (eds), *Nonstandard Models of Arithmetic and Set Theory*, Contemporary Mathematics vol. 361, pp.1-22, American Mathematical Society, Providence, Rhode Island.
https://www.researchgate.net/publication/246964147_Non-Standard_Models_in_a_Broader_Perspective
- [Gaf06] ... 2006. *Naming and Diagonalization, from Cantor to Gödel to Kleene*. in *Logic Journal of the IGPL*, Volume 14, Issue 5, October 2006, Pages 709–728.
<https://doi.org/10.1093/jigpal/jzl006>
- [Gal18] Brian Gallagher. 2018. *Are Suicide Bombings Really Driven By Ideology*. Blogpost in *Nautilus*, May 24, 2018.
- [Gam18] David Gamez. 2018. *Human and Machine Consciousness*. Open Book Publishers, Cambridge, UK.
<https://doi.org/10.11647/OBP.0107>
<https://doi.org/10.11647/OBP.0107>
- [Gao23] Shan Gao. 2023. *Many Worlds with both "And" and "Or"*. Preprint. Version: 09 Mar 2023 14:58. *PhilSci Archive*, University of Pittsburgh, Philadelphia, USA.
<http://philsci-archive.pitt.edu/21855/>
- [Gd44] R. L. Goodstein. 1944. *On the Restricted Ordinal Theorem*. *J. Symb. Logic* 9, 33-41.
- [GDGGR] Andres F. Salazar-Gomez, Joseph DelPreto, Stephanie Gil, Frank H. Guenther, and Daniela Rus. 2017. *Correcting robot mistakes in real time using EEG signals*. Presented at the *2017 IEEE International Conference on Robotics and Automation (ICRA)*, May 29 - June 3, Singapore.
https://www.researchgate.net/publication/318694733_Correcting_robot_mistakes_in_real_time_using_EEG_signals
- [GDGGP] ... 2017. *Correcting robot mistakes in real time using EEG signals*. Presentation.
https://www.youtube.com/watch?time_continue=71&v=Zd9WhJPa2Ok
- [Gi19] Nicolas Gisin. *Real numbers are the hidden variables of classical mechanics*. In *Quantum Studies: Mathematics and Foundations* (2019). SpringerLink, Springer Nature Switzerland AG.
<https://doi.org/10.1007/s40509-019-00211-8>
- [Gi20] ... *Mathematical languages shape our understanding of time in physics*. In *Nature Physics*, Volume 16, pp.114-116. Springer Nature Limited.
<https://doi.org/10.1038/s41567-019-0748-5>
- [Gia97] Giovanni Iorio Giannoli. 1997. *Checking the Truth*. In *Il cannocchiale. Rivista di studi filosofici*, n. 2, p. 81-104. Archived at *Filosofia TorVergata*, Department of Philosophical Research, University of Rome Tor Vergata, Rome, Italy.
<https://mondodomani.org/ftvold/a-giannoli02.htm>

- [Gna14] Mihai Ganea. 2014. *An Interpretation of the Church-Turing Thesis*. Preprint archived in *Academia*. <https://www.academia.edu/5836588>
- [Gnt08] Georges Gonthier. 2008. *Formal Proof—The Four Color Theorem*. Notices of the AMS, December 2008, Volume 55, Number 11, pp.1382-1393. <http://www.ams.org/notices/200811/tx081101382p.pdf>
- [Go31] Kurt Gödel. 1931. *On formally undecidable propositions of Principia Mathematica and related systems I*. Translated by Elliott Mendelson. In M. Davis (ed.). 1965. *The Undecidable*. Raven Press, New York.
- [Go33] ... 1933. *On Intuitionistic Arithmetic and Number Theory*. Translated by Martin Davis from the German original. In M. Davis (ed.). 1965. *The Undecidable*. Raven Press, New York.
- [Go40] ... 1940. *The Consistency of the Axiom of Choice and of the Generalised Continuum-Hypothesis with the Axioms of Set Theory*. 1940. Princeton University Press, Princeton, New Jersey.
- [Go51] ... 1951. *Some basic theorems on the foundations of mathematics and their implications*. Gibbs lecture. In *Kurt Gödel, Collected Works III*, pp.304-323. 1995. *Unpublished Essays and Lectures*. Solomon Feferman et al (ed.). Oxford University Press, New York.
- [Go64] ... 1964. *What Is Cantor's Continuum Problem?*. In Paul Benacerraf and Hilary Putnam (eds.). 1964. *Philosophy of Mathematics: Selected Readings*, 1964, pp.258-273. Prentice-Hall, Englewood Cliffs, New Jersey.
- [GoU19] Michał Tomasz Godziszewski and Rafał Urbaniak. 2019. *Infinite Liar in a (Modal) Finitistic Setting*. In: M. Khan and A. Manuel (eds), *Logic and Its Applications: Indian Conference on Logic and its Applications ICLA 2019*, Lecture Notes in Computer Science (pp.18-29), vol 11600. Springer, Berlin, Heidelberg. https://doi.org/10.1007/978-3-662-58771-3_3
<https://www.academia.edu/72182506/>
- [Gow02] William Timothy Gowers. 2002. *Does Mathematics Need a Philosophy?* Talk presented in 2002 before the Cambridge University Society for the Philosophy of Mathematics and Mathematical Sciences (CUSPOMMS). Published in *18 Unconventional Essays on the Nature of Mathematics*. pp.182-200. Editors: Hersh Reuben (Ed.). 2006. Springer-Verlag New York.
<https://www.dpmms.cam.ac.uk/~wtg10/philosophy.html>
- [Gpt18] Amitabha Gupta. 2018. *Some Aspects of the Arcane Nature of Quantum Mechanical Theory and Distinctive Forms of Realism Arising Out of It*. In *Journal of Indian Council of Philosophical Research*, (2019) 36:295–338.
<https://doi.org/10.1007/s40961-018-0166-6>
- [Gr17] Roderich Groß, Yue Gu, Wei Li, and Melvin Gauci. 2017. *Generalizing GANs: A Turing Perspective*. 31st Conference on Neural Information Processing Systems (NIPS 2017), Long Beach, CA, USA.
<http://papers.nips.cc/paper/7211-generalizing-gans-a-turing-perspective.pdf>
- [Grd21] Robert Gardner. 2021. *The Four-Colour Problem*. Lecture notes on *Graph Theory 1*, Fall 2020 (Revised 17/01/2021), Department of Mathematics and Statistics, East Tennessee State University, Johnson City, Indiana, USA.
<https://faculty.etsu.edu/gardnerr/5340/notes-Bondy-Murty-GT/Bondy-Murty-GT-11-1.pdf>
- [Grf21] Job de Grefte. 2021. *Knowledge as Justified True Belief*. In *Erkenntnis*, February 2021. Springer Nature.
<https://doi.org/10.1007/s10670-020-00365-7>
- [Grg02a] Ian Greig. 2002. *The aesthetics of the sublime in twentieth century physics*. PhD Thesis, Part 1, University of South Australia.
<https://www.academia.edu/38331916/>
- [Grg02b] Ian Greig. 2002. *The aesthetics of the sublime in twentieth century physics*. PhD Thesis, Part 2, University of South Australia.
<https://www.academia.edu/38331901/>

- [Grl21] Jesús Eduardo Granados Gurrola. 2021. *An Analysis of Yablo's Paradox from the Theory of Recursion*. Thesis for Master in Philosophy of Science, National Autonomous University of Mexico, Mexico City, Mexico.
https://docs.google.com/document/d/11tvkzVmgCeK_g0XeyLTizXXuPK_KyVnopv011u1HcLQ/edit
- [Grn95] Andrew Granville. 1995. *Harald Cramér and the distribution of prime numbers*. Scandinavian Actuarial Journal, Volume 1995, Issue 1, pp.12-28. DOI:10.1080/03461238.1995.10413946.
- [Grn22] ... 2022. *Do Proofs Yield Objective Truth, Or Are They Culturally Robust At Best?* Preprint.
<https://dms.umontreal.ca/~andrew/PDF/AG.Musings.pdf>
- [Grp17] N. Gurappa. *On the Foundations of Quantum Mechanics: Wave-Particle Non-Duality and the Nature of Physical Reality*. Preprint, arXiv:1710.09270v2 [physics.gen-ph]
<https://doi.org/10.48550/arXiv.1710.09270>
- [Grp18] ... *An Algebraic Way of Simultaneously Analyzing Both Einstein, Podolsky and Rosen Paper and Bohr's Reply to It*. Preprint, ResearchGate, February 2018. DOI: 10.13140/RG.2.2.11245.49127
<http://dx.doi.org/10.13140/RG.2.2.11245.49127>
- [Grp22] ... 2022. *Derivation of Born's Rule and the Behavior of a Single-Quantum in Young's Double-Slit Experiment*. Preprint, ResearchGate, March 2022.
<http://dx.doi.org/10.13140/RG.2.2.13399.75685>
- [GS97] Charles M. Grinstead and J. Laurie Snell. 2003. *Introduction to Probability, The CHANCE Project* Version dated 4 July 2006 of the Second Revised Edition, 1997, American Mathematical Society, Rhode Island, USA.
<https://math.dartmouth.edu/~prob/prob/prob.pdf>
- [Gu19] Yuri Gurevich. *Unconstrained Church-Turing thesis cannot possibly be true*. arXiv:1901.04911v1 [cs.LO]
<https://arxiv.org/pdf/1901.04911.pdf>
- [Gyl22] Philip Goyal. 2022. *The Role of Reconstruction in the Elucidation of Quantum Theory*. Preprint. To appear in *Phenomenology and QBism: New Approaches to Quantum Mechanics*, ed. Philipp Berghofer and Harald A. Wiltsche, Routledge Studies in the Philosophy of Mathematics and Physics. Preprint. Version: 13 Nov 2022 14:55. *PhilSci Archive*, University of Pittsburgh, Philadelphia, USA.
<http://philsci-archive.pitt.edu/21405/>
- [HA28] David Hilbert and Wilhelm Ackermann. 1928. *Principles of Mathematical Logic*. Translation of the second edition of the *Grundzüge Der Theoretischen Logik*. 1928. Springer, Berlin. 1950. Chelsea Publishing Company, New York.
- [Han06] Robert Alan Hanna. 2006. *Rationality and logic*. The MIT Press, Cambridge, MA, USA.
<https://direct.mit.edu/books/book/2561/Rationality-and-Logic>
- [Har40] G. H. Hardy. 1940. *A Mathematician's Apology*. First Electronic Edition, Version 1.0, March 2005. University of Alberta Mathematical Sciences Society, Alberta, Canada.
<http://www.math.ualberta.ca/~mss/misc/A%20Mathematician's%20Apology.pdf>
- [Har41] ... 1941. *A Course of Pure Mathematics*. Cambridge University Press, Cambridge, UK.
- [Hd06] Shawn Hedman. 2006. *A First Course in Logic*. 2006 edition published to Oxford Scholarship Online: November 2020, Oxford Texts in Logic 1, Oxford University Press Inc., New York, USA. DOI:10.1093/oso/9780198529804.001.0001
<https://oxford.universitypressscholarship.com/view/10.1093/oso/9780198529804.001.0001/isbn-9780198529804>
- [He04] Catherine Christer-Hennix. 2004. *Some remarks on Finitistic Model Theory, Ultra-Intuitionism and the main problem of the Foundation of Mathematics*. ILLC Seminar, 2nd April 2004, Amsterdam.
- [Hei76] Jean van Heijenoort. 1976. *From Frege to Gödel: A Source Book in Mathematical Logic, 1879-1931*. 1976 Edition. Harvard University Press, Cambridge, Massachusetts.
- [Hej18] Bohdan Hejna. 2018. *Information Transfer and Thermodynamic Point of View on Goedel Proof*. In *Ontology in Information Science*, Ed.Ciza Thomas, March 2018, pp.279-300, IntechOpen Limited, London, UK.
<http://dx.doi.org/10.5772/intechopen.68809>

- [Her83] William Hermanns and Albert Einstein. 1983. *Einstein and the Poet: In Search of the Cosmic Man*. Biography and Autobiography, Branden Press, 1983.
https://en.wikiquote.org/wiki/Albert_Einstein
- [Hi00] David Hilbert. 1900. *Mathematical Problems*. An address delivered before the *International Congress of Mathematicians* at Paris in 1900. The French translation by M. L. Laugel “*Sur les problèmes futurs des mathématiques*” appeared in *Compte Rendu du Deuxième Congrès International des Mathématiciens*, pp. 58-114, Gauthier-Villars, Paris, 1902. Dr. Maby Winton Newson translated this address into English with the author’s permission for *Bulletin of the American Mathematical Society* 8 (1902), 437-479. A reprint appears in *Mathematical Developments Arising from Hilbert’s Problems*, edited by Felix Brouder, American Mathematical Society, 1976. The original address “*Mathematische Probleme*” appeared in *Göttinger Nachrichten*, 1900, pp. 253-297, and in *Archiv der Mathematik und Physik*, (3) 1 (1901), 44-63 and 213-237. An HTML version of Dr. Newson’s translation was prepared for the web by D. Joyce with only minor modifications, mainly, more complete references.
<https://mathcs.clarku.edu/~djoyce/hilbert/problems.html#prob2>
- [Hi25] ... 1925. *On the Infinite*. Text of an address delivered in Münster on 4th June 1925 at a meeting of the Westphalian Mathematical Society. In Jean van Heijenoort. 1967. Ed. *From Frege to Gödel: A source book in Mathematical Logic, 1878 - 1931*. Harvard University Press, Cambridge, Massachusetts.
- [Hi27] ... 1927. *The Foundations of Mathematics*. Text of an address delivered in July 1927 at the Hamburg Mathematical Seminar. In Jean van Heijenoort. 1967. Ed. *From Frege to Gödel: A source book in Mathematical Logic, 1878 - 1931*. Harvard University Press, Cambridge, Massachusetts.
- [Hi30] ... 1930. *Die Grundlegung der elementaren Zahlenlehre*. In *Mathematische Annalen*. Vol. 104 (1930), pp. 485-494.
- [HL23] G.H. Hardy and J.E. Littlewood. 1923. *Some problems of ‘partitio numerorum.’ III: On the expression of a number as a sum of primes*, *Acta Mathematica*, December 1923, Volume 44, pp.1-70.
<http://fuchs-braun.com/media/8cdd73c813c342f8fff80d1fffff0.pdf>
- [Hlb20] Štěpán Holub. 2020. *Understandin, Expression and Unwelcome Logic*. In *Studia Semiotyczne (Semiotic Studies)*, t. XXXIV, nr 1(2020), s.243–266, Polskie Towarzystwo Semiotyczne, Warsaw, Poland. DOI: 10.26333/sts.xxxiv1.11
<http://studiasemiotyczne.pts.edu.pl/index.php/Studiasemiotyczne/article/view/205/199>
- [Hlm19] Anne Marie Helmenstine. 2019. *Why Mathematics Is a Language*. In the online blog *ThoughtCo*, Jun. 27, 2019.
<https://www.thoughtco.com/why-mathematics-is-a-language-4158142>
- [Hmg79] Richard W. Hamming. 1979. *The Unreasonable Effectiveness of Mathematics*. Talk given at the meeting of the Northern California Section of the Mathematical Association of America, February 24, 1979. In *The American Mathematical Monthly*, 87 (2): 81–90. doi:10.2307/2321982.
https://www.imsc.res.in/~sitabhra/teaching/mm12/hamming_unreasonable_effectiveness.pdf
- [HN24] Joel David Hamkins and Theodor Nenu. 2024. *Did Turing prove the undecidability of the halting problem?* Preprint (version 1) archived at arXiv:2407.00680v1 [math.LO], Cornell University, Ithaca, New York, USA.
<https://doi.org/10.48550/arXiv.2407.00680>
- [Hos18] Sabine Hossenfelder. 2018. *The Overproduction Crisis in Physics and Why You Should Care About It*. Blogpost in *BackReaction*, Friday, May 18, 2018.
<http://backreaction.blogspot.in/2018/05/the-overproduction-crisis-in-physics.html>
- [Hos18a] ... 2018. *Lost in Math: How Beauty Leads Physics Astray*. Basic Books, New York.
- [Hos19] ... 2019. *The crisis in physics is not only about physics*. Blogpost in *BackReaction*, Wednesday, October 30, 2019.
<http://backreaction.blogspot.com/2019/10/the-crisis-in-physics-is-not-only-about.html?>
- [HP98] Petr Hájek and Pavel Pudlák. 1998. *Metamathematics of First-Order Arithmetic*. Volume 3 of *Perspectives in Mathematical Logic Series*, ISSN 0172-6641. Springer-Verlag, Berlin, 1998.
- [Hr97] Reuben Hersh. 1997. *What is Mathematics, Really?* Oxford University Press Inc., New York.

- [Hrs01] Michael Harris. 2001. *Contexts of Justification: I Know What You Mean*. See *Other publications, #2*, on author's web-page (Downloaded 15/05/2021).
<http://www.math.columbia.edu/harris/website/publications>
- [Hrs19] ... 2019. *Why the Proof of Fermat's Last Theorem Doesn't Need to Be Enhanced*. In *Quanta Magazine*, June 2019. See *Other publications, #21*, on author's web-page (Downloaded 15/05/2021).
<http://www.math.columbia.edu/harris/website/publications>
- [Htt23] Anandi Hattiangadi. 2023. *Logical Conventionalism and the Adoption Problem*. In *Aristotelian Society Supplementary Volume*, Volume 97, Issue 1, June 2023, Pages 47–81, <https://doi.org/10.1093/arisup/akad008>
<https://www.academia.edu/103705958/>
- [HW60] G. H. Hardy and E. M. Wright. 1960. *An Introduction to the Theory of Numbers*. 4th edition. Clarendon Press, Oxford.
- [Hyt59] Arend Heyting. 1959. *Some Remarks on Intuitionism*. In *Constructivity in Mathematics*, 69–71. Amsterdam: North-Holland.
- [Isc11] Daniel Isaacson. 2011. *Necessary and Sufficient Conditions for Undecidability of the Gödel Sentence and its Truth*. In D. DeVidi et al. (eds.), *Logic, Mathematics, Philosophy: Vintage Enthusiasms: Essays in Honour of John L. Bell*, The Western Ontario Series in Philosophy of Science, Volume 75, DOI 10.1007/978-94-007-0214-1_7, Springer Dordrecht.
<https://www.academia.edu/3575864/>
- [Jo17] Steven Johnson. 2017. *Greetings, E.T. (Please Don't Murder Us.)* Feature article in *The New York Times Magazine*, June 28, 2017.
<https://www.nytimes.com/2017/06/28/magazine/greetings-et-please-dont-murder-us.html>
- [Ka91] Richard Kaye. 1991. *Models of Peano Arithmetic*. Oxford Logic Guides, 15. Oxford Science Publications. The Clarendon Press, Oxford University Press, New York, 1991.
- [Ka11] ... 2011. *Tennenbaum's theorem for models of arithmetic*. In *Set Theory, Arithmetic, and Foundations of Mathematics*. Eds. Juliette Kennedy & Roman Kossak. Lecture Notes in Logic (No. 36). pp.66-79. Cambridge University Press, 2011. Cambridge Books Online.
<http://dx.doi.org/10.1017/CBO9780511910616.005>
- [KA19] Décio Krause and Jonas R. B. Arenhart. 2015. *The Logical Foundations of Scientific Theories: Languages, Structures, and Models*. Series *Routledge Studies in the Philosophy of Mathematics and Physics*, December 12, 2019, Routledge, London.
- [Kap16] Doukas Kapantais. 2016. *A Refutation of the Church-Turing Thesis According to Some Interpretation of What the Thesis Says*. In: Vincent C. Müller (Ed.) *Computing and Philosophy*. Selected Papers from IACAP 2014. Synthese Library (Studies in Epistemology, Logic, Methodology, and Philosophy of Science), Volume 375, pp.45-62. Springer, Cham. DOI: 10.1007/978-3-319-23291-1_4
https://link.springer.com/chapter/10.1007%2F978-3-319-23291-1_4
- [Kau87] Louis H. Kauffman. 1987. *Self-reference and recursive forms*. In *Journal of Social and Biological Structures*, Volume 10, Issue 1, January 1987, pp.53-72.
[https://doi.org/10.1016/0140-1750\(87\)90034-0](https://doi.org/10.1016/0140-1750(87)90034-0)
- [KP82] Laurie Kirby and Jeff Paris. 1982. *Accessible Independence Results for Peano Arithmetic*. Special article in the *Bulletin of the London Mathematical Society*, Volume 14, Issue 4, July 1982. <https://doi.org/10.1112/blms/14.4.285>
<http://www.cs.tau.ac.il/nachumd/term/Kirbyparis.pdf>
- [KC19] Louis H. Kauffman and Arthur M. Collings. 2019. *The BF Calculus and the Square Root of Negation*. arXiv e-print, math.LO, 1905.12891.
<https://arxiv.org/pdf/1905.12891.pdf><https://arxiv.org/pdf/1905.12891.pdf>
- [Kl36] Stephen Cole Kleene. 1936. *General Recursive Functions of Natural Numbers*. Math. Annalen vol. 112 (1936) pp.727-766.
- [Kl52] ... 1952. *Introduction to Metamathematics*. North Holland Publishing Company, Amsterdam.

- [Kli19] Gil Kalai. 2019. *The Argument against Quantum Computers*. arXiv:1908.02499v1 [quant-ph], [v1] Wed, 7 Aug 2019.
<https://doi.org/10.48550/arXiv.1908.02499>
- [Kli22] ... 2022. *The Quantum Computer—A Miracle or Mirage*. Inaugural address at the *Hungarian Academy of Science*, Budapest, 15 June, 2022.
<https://gilkalai.wordpress.com/2022/11/05/>
- [Km59] László Kalmár. 1959. *An Argument Against the Plausibility of Church's Thesis*. In Heyting, A. (ed.) *Constructivity in Mathematics*. North-Holland, Amsterdam.
- [Kma08] Vojtěch Kolman. 2008. *What do Gödel theorems tell us about Hilbert's solvability thesis?* In: M. Peliš (ed.), *Logica Yearbook 08*, College Publications, London 2009, pp. 83–94.
<https://www1.cuni.cz/~kolmanv/Yearbook.pdf>
- [Kma18] ... 2018. *Intuition and the End of All –Isms*. In *Organon F*. Volume 25, No. 3, pp.392-409, Institute of Philosophy of the Slovak Academy of Sciences, Bratislava, Slovak Republic.
<http://www.klemens.sav.sk/fiusav/organon/?q=sk/intuition-and-end-all-isms>
- [Kmp79] Alfred Bray Kempe. 1879. *On the Geographical Problem of the Four Colours*. In *American Journal of Mathematics*, 2 (3): 193-220, doi:10.2307/2369235, JSTOR 2369235
... <https://www.jstor.org/stable/pdf/2369235.pdf?refreqid=excelsior%3Aeb4ea47b11ca0d59c5a10b3747d31b93>
- [Kn63] G. T. Kneebone. 1963. *Mathematical Logic and the Foundations of Mathematics: An Introductory Survey*. D. Van Norstrand Company Limited, London.
- [Knd13] Juliette Kennedy. 2013. *On Formalism Freeness: Implementing Gödel's 1946 Princeton Bicentennial Lecture*. In *The Bulletin of Symbolic Logic*, Volume 19, Number 3, Sept. 2013. DOI:10.2178/bsl.1903030
<https://www.academia.edu/58886640/>
- [Knd17] ... 2017. *Gödel's Reception of Turing's Model of Computability: The "Shift of Perception" in 1934*. In J. Kari et al. (Eds.), *Unveiling Dynamics and Complexity*, Proceedings of the 13th Conference on Computability in Europe, CiE 2017, Turku, Finland, June 12-16, 2017. LNCS 10307, pp. 42–49, 2017, Springer International Publishing AG. DOI: 10.1007/978-3-319-58741-7 5
<https://www.academia.edu/81069386/>
- [Ko25] Andrei Nikolaevich Kolmogorov. 1925. *On the principle of excluded middle*. In Jean van Heijenoort. 1967. Ed. *From Frege to Gödel: A source book in Mathematical Logic, 1878 - 1931*. Harvard University Press, Cambridge, Massachusetts.
- [Ko56] ... 1933. *Foundations of the Theory of Probability*. Second English Edition. Translation edited by Nathan Morrison. 1956. Chelsea Publishing Company, New York.
http://www.socsci.uci.edu/~bskyrms/bio/readings/kolmogorov_theory_of_probability_small.pdf
- [Kov18] Marko Kovic. 2018. *METI (Messaging Extra Terrestrial Intelligence) is irrational and should be abandoned*. A ZIPAR Policy Brief, July 2017, Zurich Institute of Public Affairs Research, Zurich, Switzerland.
<https://zipar.org/analysis/meti-messaging-extra-terrestrial-intelligence-irrational/#easy-footnote-13-1280>
- [Kr14] Stanislaw Krajewski. 2014. *Is Church's Thesis unique?* In Adam Olszewski, Bartosz Brożek, Piotr Urbańczyk (Editors), *Church's Thesis: Logic, Mind and Nature*, 2014, pp.113-135, Copernicus Center Press, Kraków, Poland.
https://www.academia.edu/9945977/Is_Churchs_Thesis_unique?email_work_card=title
- [Kr16] ... 2016. *Theological Metaphors in Mathematics*. In *Studies in Logic, Grammar and Rhetoric. The Journal of University of Białystok*. 44 (57) 2016. Berlin: De Gruyter.
https://www.academia.edu/23648167/THEOLOGICAL_METAPHORS_IN_MATHEMATICS
- [Kr19] ... 2016. *Mathematical Models in Theology. A Buber-inspired Model of God and its Application to "Shema Israel"*. In *Journal of Applied Logics-IfColog Journal of Logics and their Applications*. Special Issue *Concept of God*, Guest Editors: Stanislaw Krajewski and Ricardo Silvestre, Issue 6, Volume 6, pp.1007-1020, September 2019.
https://www.researchgate.net/publication/332510794_Mathematical_models_in_theology_A_Buber-inspired_model_of_God_and_its_application_to_Shema_Israel

- [Kr20] ... 2020. *On the Anti-Mechanist Arguments Based on Gödel's Theorem*. In *Studia Semiotyczne (Semiotic Studies)*, t. XXXIV, nr 1(2020), s.243–266, Polskie Towarzystwo Semiotyczne, Warsaw, Poland. DOI: 10.26333/sts.xxxiv1.11
<http://studiasemiotyczne.pts.edu.pl/index.php/Studiasemiotyczne/article/view/199/205>
- [Kra19] Helge Kragh. 2019. *Fundamental Theories and Epistemic Shifts: Can the History of Science Serve as a Guide?* In *Why Trust a Theory? Epistemology of Fundamental Physics*. Cambridge University Press, UK.
<https://arxiv.org/ftp/arxiv/papers/1702/1702.05648.pdf>
- [Krn22] Arnon Keren. 2022. *Disagreement, Progress, and the Goal of Philosophy*. Preprint. Version: 27 Dec 2022 18:32. *PhilSci Archive*, University of Pittsburgh, Philadelphia, USA. Forthcoming in *Synthese*.
<http://philsci-archive.pitt.edu/21588/>
- [Krp13] Saul A. Kripke. 2013. *The Church-Turing "Thesis" as a Special Corollary of Gödel's Completeness Theorem*. In *Computability: Turing, Gödel, Church and Beyond*. Eds. B. Jack Copeland, Carl J. Posy and Oron Shagrir. First paperback edition, 2015, The MIT Press, Cambridge, Massachusetts, USA.
- [Krs22] Décio Krause. 2022. *Quantifying over indiscernibles*. Preprint. Version: 12 Sep 2022 16:28. *PhilSci Archive*, University of Pittsburgh, Philadelphia, USA.
<http://philsci-archive.pitt.edu/id/eprint/21153>
- [KS06] Roman Kossak and James H. Schmerl. 2006. *The structure of models of Peano arithmetic*. Oxford Logic Guides, 50. Oxford Science Publications. The Clarendon Press, Oxford University Press, Oxford, 2006.
- [Ksh20] David Kashtan. 2020. *Diagonal Anti-Mechanist Arguments*. In *Studia Semiotyczne (Semiotic Studies)*, t. XXXIV, nr 1(2020), s.243–266, Polskie Towarzystwo Semiotyczne, Warsaw, Poland. DOI: 10.26333/sts.xxxiv1.11
<http://studiasemiotyczne.pts.edu.pl/index.php/Studiasemiotyczne/article/view/206/200>
- [La29] Yehezkel-Edmund Landau. 1929. *Foundations of Analysis*. 1951. Translation into English by F. Steinhardt of the German-language book *Grundlagen Der Analysis* by Edmund Landau. 2nd Edn. 1960. Chelsea Publishing Company, New York.
- [Lam17] Timm Lampert. 2017. *Wittgenstein and Gödel: An Attempt to Make "Wittgenstein's Objection" Reasonable*. In *Philosophia Mathematica*. nkx017.
<https://doi.org/10.1093/philmat/nkx017>
- [Lam19] ... 2019. *Wittgenstein's Conjecture*. In *Philosophy of Logic and Mathematics: Proceedings of the 41st International Ludwig Wittgenstein Symposium*, pp.515-534. Publications of the Austrian Ludwig Wittgenstein Society—New Series, 27, Edited by Gabriele M. Mras, Paul Weingartner and Bernhard Ritter, DeGruyter, 2020.
<https://doi.org/10.1515/9783110657883>
- [Lap02] Pierre Simon, Marquis de Laplace. 1902. *A Philosophical Essay on Probabilities*. First Edition, 1902. Translated from the sixth French Edition by Frederick Wilson Truscott and Frederick William Emory. Chapman & Hall, Limited, London.
<https://archive.org/details/philosophicaless00lapliala/page/n11>
- [Lbh23] Sunny Kumar Labh. 2023. *Einstein's 1950 Letter to Erwin Schrödinger*. Published on-line in *Cantor's Paradise*, Medium Publications, A Medium Corporation, San Francisco, CA, USA.
<https://www.cantorsparadise.com/einsteins-1950-letter-to-erwin-schr%C3%B6dinger-ec6eb8d9624a>
- [LbP10] Reinhard Laubenbacher and David Pengelley. 2010. "Voici ce que j'ai trouvé." *Sophie Germain's grand plan to prove Fermat's Last Theorem*. In *Historia Mathematica*, Volume 37, Issue 4, November 2010, Pages 641-692. Elsevier B. V. <https://doi.org/10.1016/j.hm.2009.12.002>
<https://www.sciencedirect.com/science/article/pii/S0315086009001347>
- [Lei09] Hannes Leitgeb. 2009. *On Formal and Informal Provability*. In Eds. Otávio Bueno and Øystein Linnebo, *New Waves in Philosophy of Mathematics*, pp.263-299, Palgrave Macmillan, UK.
<https://www.palgrave.com/gp/book/9780230219427>

- [Lei10] ... 2010. *Logic in Philosophy of Mathematics*. In *Journal of the Indian Council of Philosophical Research* (2010).
https://www.academia.edu/5766303/Logic_and_Philosophy_of_Mathematics?email_work_card=title
- [Li64] A. H. Lightstone. 1964. *The Axiomatic Method*. Prentice Hall, NJ.
- [Liv09] Paul M. Livingston 2009. *Derrida and Formal Logic: Formalising the Undecidable*. Author's October 22, 2009, revision of his original article in *Derrida Today*, Volume 3, Issue 2, November 2010 (Deconstruction and Science), pp.221-239. Edinburgh University Press, UK.
<http://www.unm.edu/~pmliving/Derrida%20and%20Formal%20Logic.pdf>
- [Liv10] ... 2010. *Wittgenstein, Turing, and the "Finitude" of Language*. In *Linguistic and Philosophical Investigations*, Volume 9, 2010, pp.215-247. Addleton Academic Publishers.
<https://www.deepdyve.com/lp/addleton-academic-publishers/wittgenstein-turing-and-the-finitude-of-language-LQuZF6zUZ2>
- [Liv12] ... 2012. *Realism and the Infinite*. Unpublished paper, cited with the author's permission.
[https://www.unm.edu/~pmliving/Livingston%20-%20Realism%20and%20the%20Infinite%20\(draft\).pdf](https://www.unm.edu/~pmliving/Livingston%20-%20Realism%20and%20the%20Infinite%20(draft).pdf)
- [Liy22] Yu Li. 2022. *Gödel's Incompleteness Theorem Revisited*. Text of article presented on Saturday 9th April at the *Unilog 2022 Congress*, April 6-11, Orthodox Academy of Crete, Chania, Crete.
www.pauljorion.com/blog/2022/04/12/
- [LMMP] Jerome Lettvin, Humberto Maturana, Warren McCulloch, and Walter Pitts. 1959. *What the Frog's Eye Tells the Frog's Brain*. In *Proceedings of the Institute of Radio Engineers*, vol. 47: pp. 1940–1951. Reprinted in: *The Mind: Biological Approaches to its Functions*, Editors: William C. Corning, Martin Balaban, 1968, pp.233-258.
<https://neuromajor.ucr.edu/courses/WhatTheFrogsEyeTellsTheFrogsBrain.pdf>
- [Ln08] Laureano Luna. 2008. *On non-standard models of Peano Arithmetic*. *The Reasoner*, Vol(2)2 p7.
[https://www.kent.ac.uk/secl/researchcentres/reasoning/TheReasoner/vol2/TheReasoner-2\(2\).pdf](https://www.kent.ac.uk/secl/researchcentres/reasoning/TheReasoner/vol2/TheReasoner-2(2).pdf)
- [Lo15] Leopold Löwenheim. 1915. *On possibilities in the calculus of relatives*. In Jean van Heijenoort. 1967. Ed. *From Frege to Gödel: A source book in Mathematical Logic, 1878 - 1931*. Harvard University Press, Cambridge, Massachusetts.
- [Lob59] Martin H. Löb. 1959. *Constructive Truth*. In Heyting, A. (ed.) *Constructivity in Mathematics*. North-Holland, Amsterdam.
- [Lon14] Bruce Raymond Long. 2014. *Information is intrinsically semantic but alethically neutral*. In *Synthese*, September 2014, Volume 191, Issue 14, pp 3447–3467.
<https://doi.org/10.1007/s11229-014-0457-7>
- [LP11] H. W. Lenstra Jr. and Carl Pomerance. 2011. *Primality testing with Gaussian periods*. Archived version 20110412, Dartmouth College, US.
<https://www.math.dartmouth.edu/~carlp/aks041411.pdf>
- [LR00] George Lakoff and Rafael E. Núñez. 2000. *Where Mathematics Comes From*. Basic Books, NY, USA.
- [Lu61] John Randolph Lucas. 1961. *Minds, Machines and Gödel*. *Philosophy*, XXXVI, 1961, pp.112-127; reprinted in *The Modeling of Mind*. Kenneth M.Sayre and Frederick J.Crosson, eds., Notre Dame Press, 1963, pp.269-270; and *Minds and Machines*, ed. Alan Ross Anderson, Prentice-Hall, 1964, pp.43-59.
<https://doi.org/10.1017/S0031819100057983>
- [Lu96] ... 1996. *The Gödelian Argument: Turn Over the Page*. In *Etica E Politica*, 5 (1):1 (2003).
<https://philarchive.org/rec/LUCTGA>
- [Lui19] Laxman Luitel. 2019. *Nature of Mathematical and Pedagogical Practices* In *Proceedings of the Tenth International Mathematics Education and Society Conference*, Hyderabad, India, 2019.
https://www.researchgate.net/publication/331113612_Nature_of_Mathematics_and_Pedagogical_Practices
- [Lun17] Björn Lundgren. 2017. *Does semantic information need to be truthful?* In *Synthese*, October 2017. DOI:10.1007/s11229-017-1587-5.
<https://doi.org/10.1007/s11229-017-1587-5>

- [Lus62] Eugene C. Luschei. 1958. *The Logical Systems of Lesniewski*. Studies in Logic and the Foundations of Mathematics. Edited by L. E. J. Brouwer, E. W. Beth, A. Heyting. 1959. North Holland Publishing Company, Amsterdam.
- [Lvd16] Stathis Livadas. 2016. *What is the Nature of Mathematical-Logical Objects?* In *Axiomathes*, **27**, 79-112 (2017), SpringerLink.
<https://doi.org/10.1007/s10516-016-9294-2>
- [LW23] Mateusz Łęłyk and Bartosz Wcisło. 2023. *Universal properties of truth*. arXiv:2304.00370v1 [math.LO].
<https://arxiv.org/pdf/2304.00370.pdf>
- [Lzr23] Dustin Lazarovici. 2023. *Why the Book of Nature is Written in the Language of Mathematics*. Forthcoming in: Bassi, A., Goldstein, S., Tumulka, R., and Zanghì, N. (eds.), *Physics and the Nature of Reality: Essays in Memory of Detlef Dürr*. Heidelberg: Springer. Preprint. Version: 27 Jul 2023 17:36. *PhilSci Archive*, University of Pittsburgh, Philadelphia, USA.
<http://philsci-archive.pitt.edu/22343/>
- [Ma08] Penelope Maddy. 2008. *How Applied Mathematics Became Pure*. In *The Review of Symbolic Logic*, Volume 1, Number 1, June 2008.
<http://www.socsci.uci.edu/~pjmaddy/bio/how%20applied%20math%20rsl.pdf>
- [Ma18a] ... 2015. *Set-theoretic Foundations*. In A. Caicedo et al, eds., *Foundations of Mathematics*. Proceedings of the *Logic at Harvard* conference in honor of W. Hugh Woodin's 60th birthday, March 27-29, 2015, at Harvard University. In *Contemporary Mathematics*, Volume: 690; 2017. 322 pp, American Mathematical Society, Providence, Rhode Island, USA.
<https://bookstore.ams.org/conm-690/>
- [Ma18] ... 2018. *What do we want a foundation to do? Comparing set-theoretic, category-theoretic, and univalent approaches*. To appear in S. Centrone, D. Kant, and D. Sarikaya, eds., *Reflections on Foundations: Univalent Foundations, Set Theory and General Thoughts*.
<https://faculty.sites.uci.edu/pjmaddy/bibliography/>
- [Mat13] Ásgeir Berg Matthíasson. 2013. *A Chalet on Mount Everest: Interpretations of Wittgenstein's Remarks on Gödel*. MSc Thesis, Institute for Logic, Language and Computation, University of Amsterdam, Holland.
<https://www.ilc.uva.nl/Research/Publications/Reports/MoL-2013-26.text.pdf>
- [Mcb14] Danielle Macbeth. 2014. *Realizing Reason: A Narrative of Truth and Knowing*. Oxford University Press, Oxford, UK.
- [McK12] Brendan D. McKay. 2012. *A Note on the History of the Four-Colour Conjecture*. In *Journal of Graph Theory*, Volume 722, Issue 3, Published online in Wiley Online Library March 2013, Wiley Periodicals, Inc.
<https://arxiv.org/pdf/1201.2852.pdf>
- [Md01] James J. Madden. 2001. *Book Review: Where Mathematics Comes From*. Notices of the AMS, Volume 48, Number 10, November 2001, p.1182.
<http://www.ams.org/notices/200110/rev-madden.pdf>
- [Me64] Elliott Mendelson. 1964. *Introduction to Mathematical Logic*. First edition. Van Norstrand, Princeton.
- [Me90] ... 1990. *Second Thoughts About Church's Thesis and Mathematical Proofs*. In *The Journal of Philosophy*, Vol.87, No.5 (May 1990), pp.225-233.
<https://www.jstor.org/stable/2026831?seq=1>
- [Me15] ... 2015. *Introduction to Mathematical Logic*. Sixth edition. Chapman & Hall, London, UK.
- [Meg] Jason Megill. *The Lucas-Penrose Argument about Gödel's Theorem*. In *Internet Encyclopedia of Philosophy*. Web resource.
<https://www.iep.utm.edu/lp-argue/>
- [Mhr23] Mihir Singh. 2023. *Classical Concepts and the Bohrian Epistemological Thesis*. Preprint. Version: 21 June 2024 14:34. *PhilSci Archive*, University of Pittsburgh, Philadelphia, USA.
<https://philsci-archive.pitt.edu/23291/1/Original%20Manuscript.pdf>

- [Mil14] Marcin Miłkowski. 2014. *Is the mind a Turing machine? How could we tell*. In *Church's Thesis. Logic, Mind, and Nature*, edited by Adam Olszewski, Bartosz Brożek, and Piotr Urbańczyk, pp.305-333. Copernicus Center Press, Kraków.
https://www.academia.edu/1825490/Is_the_mind_a_Turing_machine_How_could_we_tell
- [Mlf87] Per Martin-Löf. 1987. *Truth of a proposition, evidence of a judgement, validity of a proof*. In *Synthese*, Volume 73, pp.407–420 (1987). <https://doi.org/10.1007/BF00484985>
<https://github.com/michael/martin-lof>
- [Mlf08] ... 2008. *The Hilbert-Brouwer controversy resolved?* In: van Atten M., Boldini P., Bourdeau M., Heinzmann G. (eds) *One Hundred Years of Intuitionism (1907–2007)*, Publications of the Henri Poincaré Archives. Birkhäuser Basel, Switzerland. https://doi.org/10.1007/978-3-7643-8653-5_15
<http://archive-pml.github.io/martin-lof/pdfs/Hilbert-Brouwer-Controversy-Resolved-2008.pdf>
- [Mly22] Corey J. Maley. 2022. *Medium Independence and the Failure of the Mechanistic Account of Computation*. Preprint. Version: 24 Dec 2022 16:05. *PhilSci Archive*, University of Pittsburgh, Philadelphia, USA.
http://philsci-archive.pitt.edu/21586/1/Maley_MIAndTheFailureOfMAC.pdf
- [MM01] V. Wiktor Marek and Jan Mycielski. 2001. *Foundations of Mathematics in the Twentieth Century*. The American Mathematical Monthly, Vol. 108, No. 5 (May, 2001), pp. 449-468, Mathematical Association of America, DOI: 10.2307/2695803.
<http://www.jstor.org/stable/2695803>
- [Mn77] Mandelbrot, Benoit B. 1977. *The Fractal Geometry of Nature*. W. H. Freeman and Company, New York.
- [Mo52] Andrzej Mostowski. 1952. *Sentences Undecidable in Formalized Arithmetic: An Exposition of the Theory of Kurt Gödel*. Studies in Logic and the Foundations of Mathematics. Edited by L. E. J. Brouwer, E. W. Beth, A. Heyting. 1952. North Holland Publishing Company, Amsterdam.
- [Mon17] Stella Moon. 2017. *Isaacson's thesis and Wilkie's theorem*. MSc Thesis in partial fulfillment of the requirements for the degree of MSc in Logic at the Universiteit van Amsterdam.
<https://eprints.ilic.uva.nl/1549/1/MoL-2017-13.text.pdf>
- [Mor12] Christopher Moore. 2012. *P vs. NP, Phase Transitions, and Incomputability in the Wild*. Presentation given on 18th June 2012 at the Turing Centenary Workshop on *The Incomputable* at the Kavli Royal Society International Center at Chicheley Hall, Chicheley, Buckinghamshire, UK.
- [Mrk54] Markov, Andrey Andreevich. *The Theory of Algorithms*. 1960. American Mathematical Society Translations, series 2, 15, 1-14.
- [MS05] Maria Emilia Maietti and Giovanni Sambin. 2005. *Toward a minimalist foundation for constructive mathematics*. Clarendon Press, Oxford.
- [Mt09] Maria Emilia Maietti. 2009. *A minimalist two-level foundation for constructive mathematics*. Dipartimento di Matematica Pura ed Applicata, University of Padova.
- [Mu91] Chetan R. Murthy. 1991. *An Evaluation Semantics for Classical Proofs*. Proceedings of Sixth IEEE Symposium on Logic in Computer Science, pp. 96-109, (also Cornell TR 91-1213), 1991.
<http://www.nuprl.org/documents/Murthy/EvaluationSemantics.pdf>
- [Mur06] Roman Murawski. 2006. *Troubles With (The Concept Of) Truth In Mathematics*. In *Logic and Logical Philosophy*, Volume 15 (2006), 285–303. DOI: 10.12775/LLP.2006.017.
<https://philpapers.org/rec/MURTWT>
- [Mur20] ... 2020. *Proof vs Truth in Mathematics*. In *Studia Humana*, Volume 9:3/4 (2020), pp.10—18, University of Information, Technology and Management, Rzeszow, Poland.
http://studiahumana.com/pliki/wydania/10443-Voulme9_Issue3-4-02_paper.pdf
- [Mycl] Jan Mycielski. *Russell's Paradox and Hilbert's (much forgotten) View of Set Theory*. Unpublished draft.
<http://spot.colorado.edu/~jmyciel/>

- [Na08] Melvyn B. Nathanson. 2008. *Desperately Seeking Mathematical Truth*. Opinion in the August 2008 *Notices of the American Mathematical Society*, Vol. 55, Issue 7.
<https://arxiv.org/pdf/0809.1372>
- [Ndr24] Alexander Niederklapfer. 2024. *What is Fundamental in Fundamental Physics?* Preprint. Version: 25 May 2024 14:14. *PhilSci Archive*, University of Pittsburgh, Philadelphia, USA.
<https://philsci-archive.pitt.edu/23474/>
- [NG91] Michael Martin Nieto and T. Goldman. *The arguments against "antigravity" and the gravitational acceleration of antimatter*. In *Physics Letters B*, Volume 205, Issue 5, (1991), pp.221–281, Elsevier B. V.
[https://doi.org/10.1016/0370-1573\(91\)90138-C](https://doi.org/10.1016/0370-1573(91)90138-C)
- [Nnj18] Sean Evans Nanjwenge. 2018. *The Four Colour Theorem*. Independent thesis Basic level (degree of Bachelor), Linnaeus University, Faculty of Technology, Department of Mathematics, Växjö, Sweden.
<http://lnu.diva-portal.org/smash/get/diva2:1213548/FULLTEXT01.pdf>
- [Nv64] P. S. Novikov. 1964. *Elements of Mathematical Logic*. Oliver & Boyd, Edinburgh and London.
- [Nvs09] Catarina Dutilh Novaes. 2009' *Surprises in Logic*. Preprint in *Academia*, 2009.
<https://www.academia.edu/119726939/>
- [Nvs19] ... 2019. *Axiomatizations of arithmetic and the first-order/second-order divide*. In *Synthese*, 2019, DOI: 10.1007/s11229-014-0636-6
<https://research.vu.nl/ws/portalfiles/portal/122162061/>
- [Nw02] Maby Winton Newson. 1902. *Mathematical Problems: Lecture delivered before the International Congress of Mathematicians at Paris in 1900 by Professor David Hilbert*. In *Bulletin of the American Mathematical Society* 8 (1902), 437-479. HTML version provided at:
<http://aleph0.clarku.edu/~djoyce/hilbert/problems.html>
- [Odn24] Jessica Oddan. 2024. *Reconstructions of Quantum Theory: Methodology and the Role of Axiomatization*. Preprint (09 Apr 2024 18:34). Preprint. Version: 09 Apr 2024 18:34. *PhilSci Archive*, University of Pittsburgh, Philadelphia, USA.
https://philsci-archive.pitt.edu/23276/1/Axiom_EJPS.pdf
- [OHF19] Lars Orbach, Moritz Herzog and Annemarie Fritz. 2019. *Relation of State- and Trait-Math Anxiety to Intelligence, Math Achievement and Learning Motivation*. In *Journal of Numerical Cognition*. 5(3), Accepted 16/04/2019.
<https://www.psycharchives.org/handle/20.500.12034/2062>
- [Ola23] Paul Ola. 2023. *The Method of Resolving the Inconsistencies that Stymie Scientific fields*. Preprint. Version: 14 Mar 2023 16:39. *PhilSci Archive*, University of Pittsburgh, Philadelphia, USA.
<http://philsci-archive.pitt.edu/21851/>
- [OWJ06] Adam Olszewski, Jan Woleński, and Robert Janusz (Eds). 2006. *Church's Thesis after 70 Years*. Frankfurt: Ontos Verlag, 2006.
<https://b-ok.asia/book/2474673/1338cb?regionChanged>
- [Own06] David Owens. 2006. *Testimony and Assertion*. In *Philosophical Studies*, 130:105–129 (2006), Springer Link. DOI 10.1007/s11098-005-3237-x
<https://www.academia.edu/1409579/>
- [Pa71] Rohit Parikh. 1971. *Existence and Feasibility in Arithmetic*. In *The Journal of Symbolic Logic*, Vol.36, No. 3 (Sep., 1971), pp. 494-508.
- [Pan09] Markus Pantsar. 2009. *Truth, Proof and Gödelian Arguments: A Defence of Tarskian Truth in Mathematics*. In Eds. Marjaana Kopperi, Panu Raatikainen, Petri Ylikoski, and Bernt Österman, *Philosophical Studies from the University of Helsinki 23*, Department of Philosophy, University of Helsinki, Finland.
<https://helda.helsinki.fi/bitstream/handle/10138/19432/truthpro.pdf?sequence=2>
- [Pan19] ... 2019. *Cognitive and Computational Complexity: Considerations from Mathematical Problem Solving*. In *Erkenntnis* (2019), Springer Nature, Switzerland.
<https://doi.org/10.1007/s10670-019-00140-3>

- [Pas95] Charles Parsons. 1995. *Platonism and Mathematical Intuition in Kurt Gödel's Thought*. The Bulletin of Symbolic Logic, Volume 1, Number 1, March 1995, pp. 44-74.
- [PBC20] Jonathan Phillips, Wesley Buckwalter, Fiery Cushman, Ori Friedman, Alia Martin, John Turri, Laurie Santos, Joshua Knobe. 2020. *Knowledge before Belief*. In *Behavioral and Brain Sciences*, pp.1-37. Published online by Cambridge University Press, 08 September 2020, doi:10.1017/S0140525X20000618 <https://www.dartmouth.edu/~phillab/downloads/KnowledgeBeforeBelief.pdf>
- [PBR12] Matthew F. Pusey, Jonathan Barrett, and Terry Rudolph. 2012. *On the reality of the quantum state*. In *Nature Physics*, **8**, pp.475-478. <https://www.nature.com/articles/nphys2309>
- [Pd17] Thanu Padmanabhan. 2017. *The Universe Began With a Big Melt, Not a Big Bang*. In *Nautilus*, Issue 053, October 5, 2017. <http://nautil.us/issue/53/monsters/the-universe-began-with-a-big-melt-not-a-big-bang>
- [Pd17a] ... 2017. *Do We Really Understand the Cosmos?* Comptes Rendus Physique 18, 275-291 (2017). <https://arXiv.org/pdf/1611.03505.pdf>
- [Pdn92] Karlis Podnieks. 1992. *What is Mathematics: Gödel's Theorem and Around*. An extended translation of the 2nd edition of the author's book *Around Gödel's theorem*, published in 1992 in Russian (online copy). This hyper-textbook version for students released: January 25, 2015. University of Latvia, Riga, Latvia. https://dspace.lu.lv/dspace/bitstream/handle/7/5306/Podnieks_What_is_Mathematics_Goedel.pdf?sequence=1&isAllowed=y
- [Pdn15] ... 2015. *Fourteen Arguments in Favour of a Formalist Philosophy of Real Mathematics*. In *Baltic Journal of Modern Computing*, Vol. 3 (2015), No. 1, pp. 1-15. University of Latvia, Riga, Latvia. https://www.bjmc.lu.lv/fileadmin/user_upload/lu_portal/projekti/bjmc/Contents/3_1_1_Podnieks.pdf
- [Pe90] Roger Penrose. 1990. *The Emperor's New Mind: Concerning Computers, Minds and the Laws of Physics*. 1990, Vintage edition. Oxford University Press.
- [Pe94] ... 1994. *Shadows of the Mind: A Search for the Missing Science of Consciousness*. Oxford University Press.
- [Pel18] Abel-Luis Peralta. 2018. *How a Robot Would Handle The Gödel's Undecidable Sentence*. In *Academia*. https://www.academia.edu/38017798/How_a_Robot_Would_Handle_The_G%C3%B6dels_Undecidable_Sentence
- [Pel19] ... 2019. *Encrypted Misconstructions Behind the Gödel's Numbers*. In *Academia*. https://www.academia.edu/38098959/Encrypted_Misconstructions_Behind_the_G%C3%B6dels_Numbers
- [Per17] David Pereplyotchik. 2017. *The Ontology, Epistemology and Methodology of Linguistics*. Article dated December 1, 2017 in 'The Brains Blog'. <http://philosophyofbrains.com/2017/12/01/1-ontology-epistemology-methodology-linguistics.aspx>
- [PG21] Alexander C. Paseau and Owen Griffiths. 2021. *Is English consequence compact?* In *Thought: A Journal of Philosophy*. Volume 10, Issue 3, September 2021, Pages 188-198, Wiley Online Library. DOI: 10.1002/tht3.492 <https://onlinelibrary.wiley.com/doi/epdf/10.1002/tht3.492>
- [Pic03] Gualtiero Piccinini. 2003. *Alan Turing and the Mathematical Objection* In *Minds and Machines*, Volume 13, Issue 1, February 2003, pp.23-48. Kluwer Academic Publishers, Netherlands. https://www.academia.edu/2410438/Alan_Turing_and_the_Mathematical_Objection
- [Pic11] ... 2011. *The Physical Church-Turing Thesis: Modest or Bold?* In *The British Journal for the Philosophy of Science*, Volume 62, No. 4, December 2011, pp.733-769. Oxford University Press. https://www.academia.edu/2795908/The_Physical_Church_Turing_Thesis_Modest_or_Bold
- [Pic15] ... 2015. *Physical Computation: A Mechanistic Account*. Oxford University Press, United Kingdom. <https://www.oxfordscholarship.com/view/10.1093/acprof:oso/9780199658855.001.0001/acprof-9780199658855>
- [Pic19] ... 2019. *Knowledge as Factually Grounded Belief*. Forthcoming in the *American Philosophical Quarterly*. (Preprint cited by permission of the author). <https://www.dropbox.com/s/cw9e9wuj6ee61vo/>

- [Plc20] V. Alexis Peluce. 2020. *On Martin-Löf's Constructive Optimism*. In *Studia Semiotyczne (Semiotic Studies)*, t. XXXIV, nr 1(2020), s.243–266, Polskie Towarzystwo Semiotyczne, Warsaw, Poland. DOI: 10.26333/sts.xxxiv1.11
<http://studiasemiotyczne.pts.edu.pl/index.php/Studiasemiotyczne/article/view/207/201>
- [Pnc20] Vasil Penchev. 2020. *A class of examples demonstrating that P is different from NP in the "P vs NP" problem*. arXiv:2005.01412v1 [cs.CC], Thu, 30 Apr 2020.
<https://arxiv.org/ftp/arxiv/papers/2005/2005.01412.pdf>
- [Pol59] George Pólya. 1959. *Heuristic Reasoning in the Theory of Numbers*. In *The American Mathematical Monthly*, Vol. 66, No. 5 (May, 1959), pp. 375-384, DOI: 10.2307/2308748.
<http://www.jstor.org/stable/2308748>
- [Pos13] Carl J. Posy. 2013. *Computability and Constructibility*. In *Computability: Turing, Gödel, Church and Beyond*. Eds. B. Jack Copeland, Carl J. Posy and Oron Shagrir. First paperback edition, 2015, The MIT Press, Cambridge, Massachusetts, USA.
- [Ppn19] David Papineau. 2019. *The disvalue of knowledge*. In *Synthese*, (2021) 198:5311–5332
<https://rdcu.be/dH6Zh>
- [PR86] 1986. Peitgen, Hans-Otto & Richter, Peter H. 1986. *The Beauty of Fractals*. 1986. Springer-Verlag, Berlin.
- [Prd21] Patrizia Piredda. 2021. *Heisenberg's Dynamic Concepts. The Metaphor beyond the Limits of Language*. In *Academia Letters*, Article 1384. <https://doi.org/10.20935/AL1384>.
<https://doi.org/10.20935/AL1384>
- [Prd23] ... 2023. "When language goes on holiday": Reflection on the problems of language in Quantum Mechanics through Wittgenstein's philosophy. In *Perspectives*, Vol.8, No.1, 2023, pp.263-281. DOI: 10.20873/rpv8n1-66
<https://doi.org/10.20873/rpv8n1-67>
- [Psy95] *Symposium on Roger Penrose's Shadows of the Mind*. In *Psyche*, Vol. 2(9). June 1995.
<http://journalpsyche.org/archive/volume-2-1995-1996/>
- [Ptt98] Fabrice Pataut. 1998. *Incompleteness, constructivism and truth*. In *Logic and Logical Philosophy*, Volume 6 (1998), pp.63–76, Nicolaus Copernicus University. doi:<http://dx.doi.org/10.12775/LLP.1998.004>
<https://apcz.umk.pl/czasopisma/index.php/LLP/article/view/LLP.1998.004>
- [Pu71] Hilary Putnam. 1971. *Philosophy of Logic (Essays in Philosophy)*. Harper and Row, New York.
- [PW23] Huw Price and Ken Wharton. 2023. *Why entanglement?* Preprint at arXiv:2212.06986 [quant-ph].
<https://arxiv.org/abs/2212.06986v3>
- [Qu53] Willard Van Orman Quine. 1953. *On What There Is*. In *From a Logical Point of View*. Harvard University Press, Cambridge, Massachusetts.
- [Qu63] ... 1963. *Set Theory and its Logic*. Harvard University Press, Cambridge, Massachusetts.
- [Qun19] Paula Quinon. 2019. *Can Church's thesis be viewed as a Carnapian explication?* In *Synthese* (2019). <https://doi.org/10.1007/s11229-019-02286-7>
<https://link.springer.com/article/10.1007%2Fs11229-019-02286-7>
- [Qun20] ... 2020. *The Anti-Mechanist Argument Based on Gödel's Incompleteness Theorems, Indescribability of the Concept of Natural Number and Deviant Codings*. In *Studia Semiotyczne (Semiotic Studies)*, t. XXXIV, nr 1(2020), s.243–266, Polskie Towarzystwo Semiotyczne, Warsaw, Poland. DOI: 10.26333/sts.xxxiv1.11
<http://studiasemiotyczne.pts.edu.pl/index.php/Studiasemiotyczne/article/view/208/202>
- [QZ07] Paula Quinon and Konrad Zdanowski. 2007. *The Intended Model of Arithmetic. An Argument from Tennenbaum's Theorem*. In S. Barry Cooper, Benedikt Löwe and Andrea Sorbi (eds.), *Computation and Logic in the Real World*, Proceedings of the Third Conference on Computability in Europe, CiE 2007, Siena, Italy, June 18-23, 2007. SpringerLink Lecture Notes in Computer Science book series (LNCS, volume 4497).
https://www.impan.pl/kz/files/PQKZ_Tenn.pdf

- [Ra02] Ran Raz. 2002. *P \neq NP, Propositional Proof Complexity, and Resolution Lower Bounds for the Weak Pigeonhole Principle*. ICM 2002, Vol. III, 1-3.
- [Raa04] Panu Raatikainen. 2004. *Conceptions of Truth in Intuitionism*. In *History and Philosophy of Logic*, 25 (MAY 2004), 131–145, Taylor & Francis.
<https://doi.org/10.1080/014453401625669>
- [Raa05] ... 2005. *On the philosophical relevance of Gödel's incompleteness theorems*. In *Revue Internationale de Philosophie*, 59 (4):513-534 (2005).
<https://philpapers.org/archive/RAAOTP.pdf>
- [Raa20] ... 2020. *Remarks on the Gödelian Anti-Mechanist Arguments*. In *Studia Semiotyczne (Semiotic Studies)*, t. XXXIV, nr 1(2020), s.243–266, Polskie Towarzystwo Semiotyczne, Warsaw, Poland. DOI: 10.26333/sts.xxxiv1.11
<http://studiasemiotyczne.pts.edu.pl/index.php/Studiasemiotyczne/article/view/209/203>
- [Rch83] Fred Richman. 1983. *Church's thesis without tears*. In *The Journal of Symbolic Logic*, Volume 48 , Issue 3 , September 1983 , pp. 797 - 803, DOI: <https://doi.org/10.2307/2273473>
<https://doi.org/10.2307/2273473>
- [Rdd22] Hans Radder. 2022. *Empirical Concepts: Their Meaning and its Emergence*. *Global Philosophy* (2023) 33:8.
<https://rdcu.be/c4dJQ>
- [Re16] Kenneth W. Regan. (2016, June 29) *Getting to the Roots of Factoring*. In *Gödel's Lost Letter and P = NP*. Web log post.
<https://rjlipton.wordpress.com/2016/06/29/getting-to-the-roots-of-factoring/>
- [Rg87] Hartley Rogers Jr. 1987. *Theory of Recursive Functions and Effective Computability*. MIT Press, Cambridge, Massachusetts.
- [Rgrs] Leo Rogers. 2011. *The Four Colour Theorem*. Survey for 11-16 year olds on the University of Cambridge's Millenium Mathematics Project weblog 'NRICH'.
<https://nrich.maths.org/6291>
- [Rit15] Colin J. Rittberg. 2015. *How Woodin changed his mind: new thoughts on the Continuum Hypothesis*. In *Archive for History of Exact Sciences*, March 2015, Volume 69, Issue 2, pp. 125-151. Springer Berlin Heidelberg, Germany.
<https://doi.org/10.1007/s00407-014-0142-8>
- [RJHH] Stefan Rass, Max-Julian Jakobitsch, Stefan Haanz and Moritz Hiebler. 2024. *Computer-Aided Verification of P/NP Proofs: A survey and discussion*. In *IEEE Access*, doi: 10.1109/ACCESS.2024.3355540.
<https://ieeexplore.ieee.org/stamp/stamp.jsp?tp=&arnumber=10403917>
- [Rli16] Florencia Reali, William Jiménez-Leal, Carolina Maldonado-Carreño, Amy Devine and Dénes Szücs. 2016. *Examining the Link between Math Anxiety and Math Performance in Colombian Students*. In *Colombian Journal of Psychology*, Volume 25, Issue 2, pp.369-379, 2016.
<https://revistas.unal.edu.co/index.php/psicologia/article/view/54532/61954>
- [Ro36] J. Barkley Rosser. 1936. *Extensions of some Theorems of Gödel and Church*. In M. Davis (ed.). 1965. *The Undecidable*. Raven Press, New York. Reprinted from *The Journal of Symbolic Logic*. Vol.1. pp.87-91.
- [Ro53] ... 1953. *Logic for Mathematicians*. McGraw Hill, New York.
- [Rot88] Brian Rotman. 1988. *Towards a Semiotics of Mathematics*. In *Semiotica* 72 (1-2):1-36, published on-line in 1988. Also published in *18 Unconventional Essays on the Nature of Mathematics*, pp.182-200. Editors: Hersh Reuben (Ed.). 2006. Springer-Verlag New York.
<https://doi.org/10.1515/semi.1988.72.1-2.1>
- [RS17] Michael Rathjen and Wilfried Sieg. 2017. *Proof Theory*. Article dated November 14, 2017 uploaded by Wilfried Sieg to Research Gate, November 22, 2017.
https://www.researchgate.net/publication/321226347_Proof_Theory

- [RSM18] Gerardo Ramirez, Stacey T. Shaw, and Erin A. Maloney. 2018. *Math Anxiety: Past Research, Promising Interventions, and a New Interpretation Framework*. In *Educational Psychologist*, 53(3), 145-164, Routledge. DOI: 10.1080/00461520.2018.1447384.
<https://www.tandfonline.com/doi/abs/10.1080/00461520.2018.1447384?journalCode=hedp20>
- [RSSp] Neil Robertson, Daniel Sanders, Paul Seymour, and Robin Thomas. 1995. *The four-colour theorem*. Pre-publication summary of [RSST].
<http://vlsicad.eecs.umich.edu/BK/Slots/cache/www.math.gatech.edu/thomas/FC/fourcolor.html>
- [RSST] ... 1997. *The four-colour theorem*. *Journal of Combinatorial Theory, Series B*, Volume 70, Issue 1, May 1997, Pages 2-44.
<https://citeseerx.ist.psu.edu/viewdoc/download?doi=10.1.1.137.9439&rep=rep1&type=pdf>
- [Ru53] Walter Rudin. 1953. *Principles of Mathematical Analysis*. McGraw Hill, New York.
- [Ruc20] Rudy Rucker. 2020. *A Note on the Lucas Argument*. In *Studia Semiotyczne (Semiotic Studies)*, t. XXXIV, nr 1(2020), s.243-266, Polskie Towarzystwo Semiotyczne, Warsaw, Poland. DOI: 10.26333/sts.xxxiv1.11
<http://studiasemiotyczne.pts.edu.pl/index.php/Studiasemiotyczne/article/view/201/195>
- [Rus08] Bertrand Russell. 1908. *Mathematical logic as based on the theory of types*. In Jean van Heijenoort. 1967. Ed. *From Frege to Gödel: A source book in Mathematical Logic, 1878 - 1931*, pp.150-182. Harvard University Press, Cambridge, Massachusetts.
- [Rus17] ... 1917. *Mathematics and the Metaphysicians*. In *Mysticism and Logic, and other Essays*, Chapter V, p.74, George Allen & Unwin Ltd., UK.
https://en.wikisource.org/wiki/Mysticism_and_Logic_and_Other_Essays/Chapter_05
- [Rus37] ... 1937. *The Principles of Mathematics*. Second Edition, 1937. George Allen & Unwin Ltd., London.
- [Sa85] Sagan, Carl. 1985. *Contact*. Pocket Books, New York.
- [SB99] Wilfried Sieg and John Byrnes. 1999. *Gödel, Turing, and K-Graph Machines*. In: Cantini, A., Casari, E., Minari, P. (eds) *Logic and Foundations of Mathematics*. Synthese Library, vol 280. Springer, Dordrecht. https://doi.org/10.1007/978-94-017-2109-7_4
https://www.researchgate.net/publication/2316999_Godel_Turing_and_K-Graph_Machines
- [Sc35] Erwin Schrödinger. *Die gegenwärtige Situation in der Quantenmechanik, Naturwissenschaften*. 23: pp. 807-812; 823-823, 844-849. (1935). English translation: John D. Trimmer, *The present situation in Quantum Mechanics*, Proceedings of the American Philosophical Society 124, pp. 323-38 (1980), reprinted in *Quantum Theory and Measurement*, p. 152 (1983).
<http://www.tuhh.de/rzt/rzt/it/QM/cat.html#sect5>
- [SCA00] Ayse Pinar Saygin, Ilyas Cicekli, and Varol Akman. 2000. *Turing Test: 50 Years Later*. In *Minds and Machines*, 10: 463-518, 2000. Kluwer Academic Publishers, Netherlands.
https://www.researchgate.net/publication/2435828_Turing_test_50_years_later#fullTextFileContent
- [SD21] Wilfried Sieg and Farzaneh Derakhshan. 2021. *Human-Centered Automated Proof Search*. In *Journal of Automated Reasoning*, Volume 65, Issue 8, December 2021, pp.1153-1190, DOI: <https://doi.org/10.1007/s10817-021-09594-z>
<https://doi.org/10.1007/s10817-021-09594-z>
- [SG24] Flavio Del Santo and Nicolas Gisin. 2024. *Creative and geometric times in physics, mathematics, logic, and philosophy*. Preprint. arXiv:2404.06566
<https://arxiv.org/pdf/2404.06566.pdf>
- [Sha06] Oron Shagrir. *Why we view the brain as a computer*. In *Synthese*, December 2006, Volume 153, Issue 3, pp.393-416.
<https://link.springer.com/article/10.1007/s11229-006-9099-8>
- [Sh67] Joseph R. Shoenfield. 1967. *Mathematical Logic*. Reprinted 2001. A. K. Peters Ltd., Massachusetts.
- [She91] Saharon Shelah. 1991. *The Future of Set Theory*. Proceedings of the Bar Ilan Winter School (January 1991), Israel Mathematical Conference, vol 6. Distributed by the AMS.
<https://arxiv.org/pdf/math/0211397.pdf>

- [Sh+11] Sheldon Goldstein et al. 2011. *Bell's Theorem*, Scholarpedia, 6(10):8378.
<http://dx.doi.org/10.4249/scholarpedia.8378>.
- [Shr13] Gila Sher. 2013. *The Foundational Problem of Logic*. In *The Bulletin of Symbolic Logic*, Vol. 19, No. 2 (JUNE 2013), pp. 145-198. DOI:10.2178/bsl.1902010.
<http://www.jstor.org/stable/41955403>
- [Shr18] ... 2018. *On The Explanatory Power of Truth in Logic*. In *Philosophical Issues*, 28, Philosophy of Logic and Inferential Reasoning, 2018, Wiley Periodicals, Inc. doi: 10.1111/phils.12129
[http://philosophyfaculty.ucsd.edu/faculty/gsher/On the Explanatory Role of Truth in Logic.pdf](http://philosophyfaculty.ucsd.edu/faculty/gsher/On%20the%20Explanatory%20Role%20of%20Truth%20in%20Logic.pdf)
- [Shr23] ... 2023. *Is Logic Exceptional?* In *Universitas: Monthly Review of Philosophy and Culture*, January 2023, Fu Jen Catholic University, New Taipei City, Taiwan.
<https://www.academia.edu/120236460/>
- [Si97] Wilfried Sieg. 1997. *Step by recursive step: Church's analysis of effective calculability*. In *Bulletin of Symbolic Logic*, Volume 3, Number 2.
- [Si12] ... 2012. *Hilbert's Programs and Beyond*. 2013. Oxford University Press, New York, NY.
- [Sim88] Stephen G. Simpson. 1988. *Partial Realisation of Hilbert's Program*. In *Journal of Symbolic Logic*. Volume 53, Issue 2, June 1988, pp.349-363.
<https://doi.org/10.1017/S0022481200028309>
- [Sim06] ... 2006. *Subsystems of Second Order Arithmetic*. Preprint, 2006, Second Edition. Published in 2009 for the Association of Symbolic Logic by Cambridge University Press, USA.
<http://www.personal.psu.edu/t20/sosoa/chapter1.pdf>
- [Sk22] Thoralf Skolem. 1922. *Some remarks on axiomatized set theory*. Text of an address delivered in Helsinki before the Fifth Congress of Scandinavian Mathematicians, 4-7 August 1922. In Jean van Heijenoort. 1967. Ed. *From Frege to Gödel: A source book in Mathematical Logic, 1878 - 1931*. Harvard University Press, Cambridge, Massachusetts.
- [Sk28] ... 1928. *On Mathematical Logic*. Text of a lecture delivered on 22nd October 1928 before the Norwegian Mathematical Association. In Jean van Heijenoort. 1967. Ed. *From Frege to Gödel: A source book in Mathematical Logic, 1878 - 1931*. Harvard University Press, Cambridge, Massachusetts.
- [Sk34] ... 1934. *Über die Nicht-charakterisierbarkeit der Zahlenreihe mittels endlich oder abzählbar unendlich vieler Aussagen mit ausschliesslich Zahlenvariablen*. *Fundamenta Mathematicae*, 23, 150-161. English version: *Peano's axioms and models of arithmetic*. In *Mathematical interpretations of formal systems*, 1955, pp.1-14, North Holland, Amsterdam, Holland.
- [Sm92] Raymond M. Smullyan. 1992. *Gödel's Incompleteness Theorems*. Oxford University Press, Inc., New York.
- [Smi13] Peter Smith. 2013. *An Introduction to Gödel's Theorems*. Cambridge Introductions to Philosophy, Second Edition, Cambridge University Press, Cambridge, United Kingdom.
- [Smn05] Jakob G. Simonsen. 2005. *Specker sequences revisited*. In *Mathematical Logic Quarterly*, Volume 51, Issue 5, September 2005, pp.532-540. WILEY-VCH Verlag GmbH & Co., KGaA, Weinheim, Germany.
<http://hjemmesider.diku.dk/~simonsen/papers/j2.pdf>
- [Sms04] Peter Simons. 2004. *Against Set theory*. In Johannes Marek and Maria Reicher, eds., *Experience and Analysis. Proceedings of the 2004 Wittgenstein Symposium*. Vienna: öbv&hpt, 2005, 143-152.
<https://ontology.buffalo.edu/04/AgainstSetTheory.pdf>
- [Smy77] Craig Smoryński. 1977. *The Incompleteness Theorems*. In Jon Barwise (ed.), *Handbook of Mathematical Logic*, 1977, pp.821-865, North-Holland, Amsterdam, Holland.
- [Smy81] ... 1981. *Fifty Years of Self-Reference in Arithmetic*. In *Notre Dame Journal of Formal Logic*, Volume 22, No 4, pp.357-374 (October 1981), Duke University Press, Durham, North Carolina, USA. DOI: 10.1305/ndjfl/1093883515
<https://projecteuclid.org/journals/notre-dame-journal-of-formal-logic/volume-22/issue-4/Fifty-years-of-self-reference-in-arithmetic/10.1305/ndjfl/1093883515.full>

- [SN01] Matthias Schirn and Karl-Georg Niebergall. 2001. *Extensions of the Finitist Point of View*. In *History and Philosophy of Logic*, Volume 22, 2001 - Issue 3, pp.135-161. Taylor and Francis. DOI: 10.1080/01445340210154295.
<https://doi.org/10.1080/01445340210154295>
- [Sng97] Simon Singh. 1997. *Fermat's Last Theorem*. Harper Perennial, 2005, Harper Collins, London, UK.
- [SP10] Andrea Scarantino and Gualtiero Piccinini. 2010. *Information Without Truth*. In *Metaphilosophy*, Vol.41, No. 3, April 2010. Included in *Putting Information First: Luciano Floridi and the Philosophy of Information*. Editor(s): Patrick Allo. Published by Blackwell Publishing Ltd, 9600 Garsington Road, Oxford OX4 2DQ, UK, and 350 Main Street, Malden, MA 02148, USA.
<https://doi/book/10.1002/9781444396836>
- [Spk02] Timothy Sipka. 2002. *Alfred Bray Kempe's "Proof" of the Four Colour Theorem*. In *Math Horizons*, November 2002, Mathematical Association of America, Washington DC, USA.
<https://mathweb.ucsd.edu/ssam/old/19W-154/kempe.pdf>
- [Sra05] M. D. Srinivas. 2005. *Proofs in Indian Mathematics*. In Gérard G. Emch, R. Sridharan, M. D. Srinivas (eds) *Contributions to the History of Indian Mathematics. Culture and History of Mathematics*, vol 3, pp.209-248. Hindustan Book Agency, Gurugram, India. https://doi.org/10.1007/978-93-86279-25-5_9
<https://iks.iitgn.ac.in/wp-content/uploads/2016/02/Proofs-in-Indian-Mathematics-MD-Srinivas-2005.pdf>
- [Sri08] Shashi Mohan Srivastava. 2008. *A Course on Mathematical Logic*. Universitext. Springer, New York, NY, USA.
<https://doi.org/10.1007/978-0-387-76277-7>
- [Srn11] György Serény. 2011. *How do We Know that the Gödel Sentence of a Consistent Theory Is True?* In *Philosophia Mathematica*, Volume 19, Issue 1, February 2011, Pages 47–73. Oxford University Press, UK.
<https://doi.org/10.1093/philmat/nkq028>
- [Srt23] Lorenzo Sartori. 2023. *Putting the 'Experiment' back into the 'Thought Experiment'*. In *Synthese* **201**, Article number: 34 (2023). <https://doi.org/10.1007/s11229-022-04011-3>
<https://doi.org/10.1007/s11229-022-04011-3>
- [Srv19] Rikka Sorvo, Tuire Koponen, Helena Viholainen, Eija Räikkönen, Pilvi Peura, Asko Tolvanen and Mikko Aro. 2019. *Development of math anxiety and its longitudinal relationships with arithmetic achievement among primary school children*. In *Learning and Individual Differences*, Volume 69, January 2019, Pages 173-181, Elsevier.
<https://doi.org/10.1016/j.lindif.2018.12.005>
- [SS17] Saeed Salehi and Payam Seraji. 2017. *Gödel-Rosser's Incompleteness Theorem, generalized and optimized for definable theories*. In *Journal of Logic and Computation*, Volume 27, Issue 5, July 2017, pp.1391-1397. Oxford University Press, UK.
<https://doi.org/10.1093/logcom/exw025>
- [SS18] ... 2018. *On constructivity and the Rosser property: a closer look at some Gödelean proofs*. In *Annals of Pure and Applied Logic*, Volume 169, pp.971-980. ScienceDirect, Elsevier B. V.
<https://doi.org/10.1016/j.apal.2018.04.009>
- [Ste02] Jörn Steuding. 2002. *Probabilistic Number Theory*. The Pennsylvania State University CiteSeerX Archives, doi=10.1.1.118.4755.
<http://citeseerx.ist.psu.edu/viewdoc/summary?doi=10.1.1.118.4755>
- [St81] Ian Nicholas Stewart. 1981. *Concept's of Modern Mathematics*. 1981 ed. (paperback), Penguin Books, England.
- [Stc22] Ovidiu Cristinel Stoica. 2022. *Quantum mechanics requires "conspiracy"*. arXiv Preprint.
<https://arxiv.org/abs/2209.13275v1>
- [Stk12] Michael R Starks. 2019. *What Do Paraconsistent, Undecidable, Random, Computable and Incomplete mean? A review of Gödel's Way: Exploits into an undecidable world by Gregory Chaitin, Francisco A Doria, and Newton C.A. da Costa*. In Michael Starks, *Philosophy, Human Nature and the Collapse of Civilization*, Articles and Reviews 2006-2017, 3rd Ed (2017).
<https://www.academia.edu/11431496/>

- [Su60] Patrick Suppes. 1960. *Axiomatic Set Theory*. Van Norstrand, Princeton.
- [Sw80] E. R. Swart. 1980. *The Philosophical Implications of the Four-Color Problem*. *The American Mathematical Monthly*, Vol. 87, No. 9 (Nov., 1980), pp. 697-707.
https://www.maa.org/sites/default/files/pdf/upload_library/22/Ford/Swart697-707.pdf
- [SW17] Wilfried Sieg and Patrick Walsh. 2017. *Natural Formalization: Deriving the Cantor-Bernstein Theorem in ZF*. Article uploaded by Wilfried Sieg on ResearchGate on 30/11/2017.
<https://pfwalsh.com/wp-content/uploads/CBT-Paper.pdf>
- [SW19] ... 2019. *Natural Formalization: Deriving the Cantor-Bernstein Theorem in ZF*. In *The Review of Symbolic Logic*, Volume 14, Issue 1, March 2021, pp.250-284, DOI: <https://doi.org/10.1017/S175502031900056X>
<https://doi.org/10.1017/S175502031900056X>
- [Sza02] Andrzej Szalas. 2002. *Logic for Computer Science. Lecture Notes*.
https://www.academia.edu/25072711/Logic_for_Computer_Science_Lecture_Notes?email_work_card=title
- [Ta35] Alfred Tarski. 1935. *Der Wahrheitsbegriff in den formalisierten Sprachen*. *Studia Philos.*, Vol. 1, pp.261-405. Expanded English translation, *The concept of truth in formalized languages*. In *Logic, Semantics, Metamathematics*, papers from 1923 to 1938 (p152-278). ed. John Corcoran. 1983. Hackett Publishing Company, Indianapolis.
https://www.academia.edu/39721673/Alfred_Tarski_and_the_Concept_of_Truth_in_Formalized_Languages
- [Ta39] ... 1939. *Some Current Problems in Metamathematics*. Edited version of a lecture given at Harvard University during 1939/40. Editors: Jan Tarski and Jan Wolenski. In *History and Philosophy of Logic*, Volume 16, 1995 - Issue 2, pp.159-168. Taylor and Francis.
<https://doi.org/10.1080/01445349508837247>
- [Tang19] Ewin Tang. 2019. arXiv:1807.04271 [cs.IR].
<https://arxiv.org/pdf/1807.04271.pdf>
- [Tang22] ... 2022. *Dequantizing algorithms to understand quantum advantage in machine learning*. In *Nature Reviews Physics*, 4, 692–693 (2022). <https://doi.org/10.1038/s42254-022-00511-w>
<https://www.nature.com/articles/s42254-022-00511-w#citeas>
- [Tao07] Terence Tao. 2007. *There's more to mathematics than rigour and proofs*. In *What's New*, Weblog 6 May, 2007, at Wordpress.com.
<https://terrytao.wordpress.com/career-advice/theres-more-to-mathematics-than-rigour-and-proofs/>
- [Tao24] ... 2024. *Machine assisted proofs*. Presentation at *2024 Joint Mathematics Meetings, (JMM 2024)*, Jan 3, 2024, Moscone North/South, Moscone Center, San Francisco, CA USA.
<https://terrytao.files.wordpress.com/2024/03/machine-jan-3.pdf>
- [Ti51] E. C. Titchmarsh. 1951. *The Theory of the Riemann Zeta-Function*. Clarendon Press, Oxford.
- [Th94] William P. Thurston. 1994. *On Proof and Progress in Mathematics*. In *Bulletin of the American Mathematical Society*, Volume 30, Number 2, April 1994, pp.161-177.
<https://arxiv.org/pdf/math/9404236.pdf>
- [Th19] Babu Thaliath. 2019. *Language and reference*. In *Sophia: Collection of Philosophy of Education*, No. 27 (2019): (July-December 2019): Ontology of Language in Education. DOI: <https://doi.org/10.17163/soph.n27.2019.04>
<https://doi.org/10.17163/soph.n27.2019.04>
- [Thm98] Robin Thomas. 1998. *An Update On The Four-Color Theorem*. *Notices of The American Mathematical Society*, Volume 45 (1998), no. 7, pp.848–859.
<http://www.ams.org/notices/199807/thomas.pdf>
- [Tng10] Evans Ayagikwaga Tungosiamu. 2014. *Examining Mathematics Anxiety Among Pre-Service Teachers in Some Selected Colleges of Education in Ghana*. M. Phil. Dissertation, Principal Supervisor Charles K. Assuah, University of Education, Winneba, Ghana.
<https://independent.academia.edu/EVANSTUNGOSIAMU>

- [Tu36] Alan Turing. 1936. *On computable numbers, with an application to the Entscheidungsproblem*. In M. Davis (ed.). 1965. *The Undecidable*. Raven Press, New York. Reprinted from the *Proceedings of the London Mathematical Society*, ser. 2. vol. 42 (1936-7), pp.230-265; corrections, *Ibid*, vol 43 (1937) pp. 544-546.
- [Tu39] ... 1939. *Systems of logic based on ordinals*. In M. Davis (ed.). 1965. *The Undecidable*. Raven Press, New York. Reprinted from the *Proceedings of the London Mathematical Society*, ser. 2. vol. 45 (1939), pp.161-228.
- [Tu50] ... 1950. *Computing Machinery and Intelligence*. In *Mind*, Volume LIX, Issue 236, 1 October 1950, Pages 433-460.
<https://doi.org/10.1093/mind/LIX.236.433>
- [Ty107] R. Gregory Taylor. *Church's Thesis after 70 Years*, edited by A. Olszewski et al. Review in *The Review of Modern Logic*, Volume 11, Issue 1-2, (2007), pp.195-204. Open access in *Project Euclid*.
<https://projecteuclid.org/euclid.rml/1317305594>
- [Tym79] Thomas Tymoczko. 1979. *The Four-Color Problem and Its Philosophical Significance*. *The Journal of Philosophy*, Vol. 76, No. 2. (Feb., 1979), pp. 57-83.
- [UN04] Liisa Uusimaki and Rod Nason. 2004. *Causes Underlying Pre-Service Teachers' Negative Beliefs and Anxieties About Mathematics*. In *Proceedings of the 28th Conference of the International Group for the Psychology of Mathematics Education*, 2004, Vol 4, pp.369-376.
http://emis.matem.unam.mx/proceedings/PME28/RR/RR141_Uusimaki.pdf
- [Vck22] Peter Vickers. 2022. *How to identify a scientific fact*. OUPblog, November 30th 2022, Oxford University Press, Oxford, UK.
<https://blog.oup.com/2022/11/how-to-identify-a-scientific-fact/>
- [Vi11] M. Villata. 2011. *CPT symmetry and antimatter gravity in general relativity*. In *EPL (Europhysics Letters)*, Volume 94, Number 2, March 2011.
<https://doi.org/10.1209/0295-5075/94/20001>
- [Vid06] Joseph Vidal-Rosset. 2006. *Does Gödel's Incompleteness Theorem Prove That Truth Transcends Proof?* In J. van Benthem, G. Heinzmann, M. Rebuschi and H. Visser (eds.), *The Age of Alternative Logics: Assessing Philosophy of Logic and Mathematics Today*, pp.51–73, 2006, Springer.
https://www.academia.edu/2678622/The_logic_of_complementarity?email_work_card=title
- [VL17] Steven Vigdor and Tim Londergan. 2017. *The War Against Facts*. In *Debunking Denial*, Blogpost, June 27, 2017, WordPress.com.
<https://debunkingdenial.com/>
- [Vln22] Mario Bacelar Valente. 2022. *The Faithfulness Problem*. In *Principia: An International Journal of Epistemology*, 26 (3):429-447 (2022). DOI: 10.5007/1808-1711.2022.e84395.
<https://philpapers.org/rec/VALTFP-2>
- [Vo10] Vladimir Voevodsky. 2010. *What If Current Foundations of Mathematics Are Inconsistent?* Lecture to the Schools of Mathematics and Natural Sciences, Institute for Advanced Study, Princeton during celebration of its eightieth anniversary.
<https://www.ias.edu/ideas/2012/voevodsky-foundations-of-mathematics>
- [Vss20] Albert Visser. 2020. *Meeting on Neutral Ground. A Reflection on Man-Machine Contests*. In *Studia Semiotyczne (Semiotic Studies)*, t. XXXIV, nr 1(2020), s.243–266, Polskie Towarzystwo Semiotyczne, Warsaw, Poland. DOI: 10.26333/sts.xxxiv1.11
<http://studiasemiotyczne.pts.edu.pl/index.php/Studiasemiotyczne/article/view/210/204>
- [Wa63] Hao Wang. 1963. *A survey of Mathematical Logic*. North Holland Publishing Company, Amsterdam.
- [WBF22] Lucie White, Philippe van Basshuysen, and Mathias Frisch. 2022. *When Is Lockdown Justified?* In *Philosophy of Medicine*, Volume 3, Issue 1, pp.1–22. Pitt Open Library Publishing, University of Pittsburgh, Pittsburgh, USA. DOI 10.5195/pom.2022.85.
<http://philsci-archive.pitt.edu/21209/1/White%2Bet%2Bal-Final.pdf>

- [Wck23] Markus Weckström. 2023. *Natural Law, the Modeling Relation, and Two Roots of Perspectivism*. Preprint. Version: 13 Feb 2023 14:24. *PhilSci Archive*, University of Pittsburgh, Philadelphia, USA. <http://philsci-archive.pitt.edu/21750/>
- [We10] Hermann Weyl. 1910. *Definitions of Fundamental Mathematical Concepts*. English translation by Stephen Pollard of Weyl's habilitation lecture *Über die Definitionen der mathematischen Grundbegriffe*. In *Mathematisch-naturwissenschaftliche Blätter*, 7 (1910):93-95, 109-113. https://www.academia.edu/36559178/Definitions_of_Fundamental_Mathematical_Concepts
- [We27] ... 1927. *Comments on Hilbert's second lecture on the foundations of mathematics*. In Jean van Heijenoort. 1967. Ed. *From Frege to Gödel: A source book in Mathematical Logic, 1878 - 1931*. Harvard University Press, Cambridge, Massachusetts.
- [Wgn08] Roy Wagner. 2008. *Post-Structural Readings of a Logico-Mathematical Text*. In *Perspectives on Science*, Volume 16, Issue 2, Summer 2008, pp.196–230, MIT Press, Massachusetts, USA. doi: <https://doi.org/10.1162/posc.2008.16.2.196> <https://direct.mit.edu/posc/article/16/2/196/15222/Post-Structural-Readings-of-a-Logico-Mathematical>
- [Wgn09] ... 2009. *S(z_p, z_p): Post-Structural Readings of Gödel's Proof*. Polimetrica S.a.s., Milano, Italy. <https://www.academia.edu/1490181/>
- [Wgn19] ... 2019. *Does Mathematics Need Foundations?* In: Centrone, S., Kant, D., Sarikaya, D. (eds) *Reflections on the Foundations of Mathematics*, Synthese Library, vol 407. Springer, Cham. https://doi.org/10.1007/978-3-030-15655-8_17 <https://www.research-collection.ethz.ch/bitstream/handle/20.500.11850/387094/foundationswagner.pdf>
- [Wgr60] Eugene P. Wigner. 1960. *The unreasonable effectiveness of mathematics in the natural sciences*. Richard Courant lecture in mathematical sciences delivered at New York University, May 11, 1959. In *Communications on Pure and Applied Mathematics*, 13: 1–14. doi:10.1002/cpa.3160130102. <http://www.hep.upenn.edu/~johnda/Papers/wignerUnreasonableEffectiveness.pdf>
- [WG03] Peter Wegner and Dina Goldin. 2003. *Computation Beyond Turing Machines*. Communications of the ACM, 46 (4) 2003.
- [Wi22] Ludwig Wittgenstein. 1933. *Tractatus Logico-Philosophicus*. Introduction by Bertrand Russell, with a parallel translation from the original German by C. K. Ogden. 1922, Kegan Paul, Trench, Trubner & Co., Ltd., London, U.K. http://www.gutenberg.org/files/5740/5740-pdf.pdf?session_id=5c488ead342e685b59b88011cb84d52d0789a9c5
- [Wi74] ... 1933. *Philosophical Grammar*. Edited by Rush Rhees, translated from the original 1969 German edition titled *Philosophische Grammatik* by Anthony Kenny. 1974 ed., University of California Press, Berkeley and Los Angeles.
- [Wi78] ... 1937. *Remarks on the Foundations of Mathematics*. 1978 ed., MIT Press, Cambridge, Massachusetts.
- [Wl03] Frank Waaldijk. 2003. *On the Foundations of Constructive Mathematics—Especially in Relation to the Theory of Continuous Functions*. In *Foundations of Science*, Volume 10, Issue 3, September 2005, pp. 249-324, Springer Verlag. DOI: 10.1007/s10699-004-3065-z <https://link.springer.com/article/10.1007/s10699-004-3065-z>
- [Wlb99] Norman Wildberger. 1999. *Real fish, real numbers, real jobs*. In *The Mathematical Intelligencer*, 21, 4-7 (1999). DOI: 10.1007/BF03024838 https://www.researchgate.net/publication/225795896_Real_fish_real_numbers_real_jobs
- [Wln13] Robin Wilson. 2013. *Four Colors Suffice*. Revised 2014 edition. Princeton University Press, Oxfordshire, United Kingdom.
- [Wls95] Andrew Wiles. 1995. *Modular Elliptic Curves and Fermat's Last Theorem*. In *Annals of Mathematics*, Second Series, Volume 141, No. 3 (May, 1995), pp.443-551 (109 pages), Princeton University, Princeton, New Jersey, USA. doi:10.2307/2118559 <https://www.jstor.org/stable/2118559>

- [Wo09] Krzysztof Wójtowicz. 2009. *Theory of Quantum Computation and Philosophy of Mathematics. Part I*. In *Logic and Logical Philosophy*, Volume 18 (2009), pp.313-332. Scientific Publisher of the Mikoła Kopernik University, Toruń, Poland. DOI: 10.12775/LLP.2009.016
<http://dx.doi.org/10.12775/LLP.2009.016>
- [Wo19] ... 2019. *Theory of Quantum Computation and Philosophy of Mathematics. Part II*. In *Logic and Logical Philosophy*, Volume 28, No. 1, March (2019), pp.173-193. Scientific Publisher of the Mikoła Kopernik University, Toruń, Poland. DOI: 10.12775/LLP.2018.006
<http://dx.doi.org/10.12775/LLP.2018.006>
- [WR10] Alfred North Whitehead and Bertrand Russell. 2010. *Principia Mathematica to *56*. 1962. Paperback edition. Cambridge University Press, London, U.K.
- [Ya93] Stephen Yablo. 1993. *Paradox without self-reference*. *Analysis*, 53(4), pp. 251-252.
<http://www.mit.edu/~yablo/pwsr.pdf>
- [YBM04] B. Yushua, M. A. Bokhari, A. Mji, and D. C. J. Wessels. 2004. *Mathematics: Conceptions, Learning and Teaching*. Technical Report Series, TR 322, December 2004, Department of Mathematical Sciences, King Fahd University of Petroleum & Minerals, Dahrhan, Saudi Arabia.
https://www.academia.edu/2724631/Mathematics_conceptions_learning_and_teaching
- [Zac07] Richard Zach. 2007. *Hilbert's Program Then and Now*. In Dale Jacquette, ed., *Philosophy of Logic*. Handbook of the Philosophy of Science, Volume 5, September 2007, pp.411-447, Elsevier, Amsterdam.
<https://people.ucalgary.ca/~rzach/static/hptn.pdf>
- [ZZK19] Jing Zhang, Nan Jhao and Qi Ping Kong. 2019. *The Relationship Between Math Anxiety and Math Performance: A Meta-Analytic Investigation*. In *Frontiers in Psychology*, Systematic Review Article, 07 August 2019.
<https://doi.org/10.3389/fpsyg.2019.01613>

Index

- ω -consistency
 - Gödel, 3, 18, 31, 152, 178, 184, 185, 187, 194, 235, 236, 241, 243, 244, 247, 249, 307, 308, 310, 365, 369, 411, 442, 443, 455, 457, 467, 478, 482, 484, 853, 984
- ε -calculus
 - Hilbert, 3, 18, 19, 166, 178, 181, 182, 184, 247, 262, 263, 276, 281, 984
- ε -function
 - Hilbert, 427
- Ásgeir Berg
 - Matthíasson
 - Mat13, 306–308
- Émile
 - Borel, 214
- Évariste
 - Galois, 52
- Łełyk
 - Mateusz
 - LW23, 186, 445
- Èrdi
 - Peter, 875
- Ḍṛggaṇīta*, 41
- śruti*, 41
- āgama*, 41
- matī*, 41
- paurāṇikaśruti*, 41
- smṛti*, 41
- svamatināvā*, 41
- upapatti*, 41
- verifiability*
 - algorithmic, 129, 984
- yukti*, 41
- Štěpán
 - Holub
 - Hlb20, 540
- 4CT
 - Four Colour Theorem, 79–85
- Bueno
 - Otávio, 391
- Simonsen
 - Jakob G.
 - Smn05, 201, 212, 514
- a posteriori
 - knowledge, 327
- a priori
 - knowledge, 327
- A.
 - Mji
 - YBM04, 832
- A. H.
 - Lightstone
 - Li64, 186
- AAB19
- Adam
 - Zalcman, 163, 164, 569, 725, 726, 739–741, 750, 751
- Alan
 - Ho, 163, 164, 569, 725, 726, 739–741, 750, 751
- Alexander
 - Korotkov, 163, 164, 569, 725, 726, 739–741, 750, 751
- Amit
 - Vainsencher, 163, 164, 569, 725, 726, 739–741, 750, 751
- Andre
 - Petukhov, 163, 164, 569, 725, 726, 739–741, 750, 751
- Andrew
 - Dunsworth, 163, 164, 569, 725, 726, 739–741, 750, 751
- Anthony
 - Megrant, 163, 164, 569, 725, 726, 739–741, 750, 751
- Austin
 - Fowler, 163, 164, 569, 725, 726, 739–741, 750, 751
- Ben
 - Chiaro, 163, 164, 569, 725, 726, 739–741, 750, 751
- Benjamin
 - Villalonga, 163, 164, 569, 725, 726, 739–741, 750, 751
- Brian
 - Burkett, 163, 164, 569, 725, 726, 739–741, 750, 751
- Brooks
 - Foxen, 163, 164, 569, 725, 726, 739–741, 750, 751
- Charles
 - Neill, 163, 164, 569, 725, 726, 739–741, 750, 751
- Chris
 - Quintana, 163, 164, 569, 725, 726, 739–741, 750, 751
- Craig
 - Gidney, 163, 164, 569, 725, 726, 739–741, 750, 751
- Daniel
 - Sank, 163, 164, 569, 725, 726, 739–741, 750, 751
- Dave
 - Bacon, 163, 164, 569, 725, 726, 739–741, 750, 751
- David
 - Landhuis, 163, 164, 569, 725, 726, 739–741, 750, 751

- David A.
Buell, 163, 164, 569, 725, 726, 739–741, 750, 751
- Dmitry
Lyakh, 163, 164, 569, 725, 726, 739–741, 750, 751
- Dvir
Kafri, 163, 164, 569, 725, 726, 739–741, 750, 751
- Edward
Farhi, 163, 164, 569, 725, 726, 739–741, 750, 751
- Eleanor G.
Rieffel, 163, 164, 569, 725, 726, 739–741, 750, 751
- Eric
Ostby, 163, 164, 569, 725, 726, 739–741, 750, 751
- Erik
Lucero, 163, 164, 569, 725, 726, 739–741, 750, 751
- Evan
Jeffrey, 163, 164, 569, 725, 726, 739–741, 750, 751
- Fedor
Kostritsa, 163, 164, 569, 725, 726, 739–741, 750, 751
- Fernando G. S. L.
Brandao, 163, 164, 569, 725, 726, 739–741, 750, 751
- Frank
Arute, 163, 164, 569, 725, 726, 739–741, 750, 751
- Hartmut
Neven, 163, 164, 569, 725, 726, 739–741, 750, 751
- Jarrold R.
McClellan, 163, 164, 569, 725, 726, 739–741, 750, 751
- John
Martinis, 163, 164, 569, 725, 726, 739–741, 750, 751
- John C.
Platt, 163, 164, 569, 725, 726, 739–741, 750, 751
- John M.
Martinis, 163, 164, 569, 725, 726, 739–741, 750, 751
- Joseph C.
Bardin, 163, 164, 569, 725, 726, 739–741, 750, 751
- Josh
Mutus, 163, 164, 569, 725, 726, 739–741, 750, 751
- Julian
Kelly, 163, 164, 569, 725, 726, 739–741, 750, 751
- Keith
Guerin, 163, 164, 569, 725, 726, 739–741, 750, 751
- Kevin J.
Satzinger, 163, 164, 569, 725, 726, 739–741, 750, 751
- Sung, 163, 164, 569, 725, 726, 739–741, 750, 751
- Kostyantyn
Kechedzhi, 163, 164, 569, 725, 726, 739–741, 750, 751
- Kristel
Michielsen, 163, 164, 569, 725, 726, 739–741, 750, 751
- Kunal
Arya, 163, 164, 569, 725, 726, 739–741, 750, 751
- Marissa
Giustina, 163, 164, 569, 725, 726, 739–741, 750, 751
- Markus
Hoffmann, 163, 164, 569, 725, 726, 739–741, 750, 751
- Masoud
Mohseni, 163, 164, 569, 725, 726, 739–741, 750, 751
- Mathew
McEwen, 163, 164, 569, 725, 726, 739–741, 750, 751
- Neeley, 163, 164, 569, 725, 726, 739–741, 750, 751
- Mathew D.
Trevithick, 163, 164, 569, 725, 726, 739–741, 750, 751
- Mathew P.
Harrigan, 163, 164, 569, 725, 726, 739–741, 750, 751
- Michael J.
Hartmann, 163, 164, 569, 725, 726, 739–741, 750, 751
- Mike
Lindmark, 163, 164, 569, 725, 726, 739–741, 750, 751
- Murphy Yuezhen
Niu, 163, 164, 569, 725, 726, 739–741, 750, 751
- Nicholas C.
Rubin, 163, 164, 569, 725, 726, 739–741, 750, 751
- Ofer
Naaman, 163, 164, 569, 725, 726, 739–741, 750, 751
- Paul V.
Klimov, 163, 164, 569, 725, 726, 739–741, 750, 751
- Pedram
Roushan, 163, 164, 569, 725, 726, 739–741, 750, 751
- Ping
Yeh, 163, 164, 569, 725, 726, 739–741, 750, 751
- Rami
Barends, 163, 164, 569, 725, 726, 739–741, 750, 751

- Rob
Graff, 163, 164, 569, 725, 726, 739–741, 750, 751
- Roberto
Collins, 163, 164, 569, 725, 726, 739–741, 750, 751
- Rupak
Biswas, 163, 164, 569, 725, 726, 739–741, 750, 751
- Ryan
Babbush, 163, 164, 569, 725, 726, 739–741, 750, 751
- Salvatore
Mandrà, 163, 164, 569, 725, 726, 739–741, 750, 751
- Sergei V.
Isakov, 163, 164, 569, 725, 726, 739–741, 750, 751
- Sergey
Knysh, 163, 164, 569, 725, 726, 739–741, 750, 751
- Sergio
Boixo, 163, 164, 569, 725, 726, 739–741, 750, 751
- Steve
Habegger, 163, 164, 569, 725, 726, 739–741, 750, 751
- Theodore
White, 163, 164, 569, 725, 726, 739–741, 750, 751
- Travis S.
Humble, 163, 164, 569, 725, 726, 739–741, 750, 751
- Trent
Huang, 163, 164, 569, 725, 726, 739–741, 750, 751
- Vadim
Smelyanskiy, 163, 164, 569, 725, 726, 739–741, 750, 751
- William
Courtney, 163, 164, 569, 725, 726, 739–741, 750, 751
- Xiao
Mi, 163, 164, 569, 725, 726, 739–741, 750, 751
- Yu
Chen, 163, 164, 569, 725, 726, 739–741, 750, 751
- Z. Jamie
Yao, 163, 164, 569, 725, 726, 739–741, 750, 751
- Zhang
Jiang, 163, 164, 569, 725, 726, 739–741, 750, 751
- Zijun
Chen, 163, 164, 569, 725, 726, 739–741, 750, 751
- Abel-Luis
Peralta
Pel18, 419
Pel19, 419
- Aberdein
Andrew
Abr19, 32
AC24, 336–339
- Abr19
Andrew
Aberdein, 32
- Abraham
Fraenkel, 343
- Abraham A.
Fraenkel
BF58, 186, 506
- abstract
knowledge, 838
- AC24
Andrew
Aberdein, 336–339
- Dan
Cohen, 336–339
- Ackermann
Wilhelm
HA28, 186
- Adam
Frank, 789
FGW22, 599–602, 788
- Olszewski
OWJ06, 206
- Zalcman
AAB19, 163, 164, 569, 725, 726, 739–741, 750, 751
- AdB14
Diederik
Aerts, 671, 676, 677, 731
- Massimiliano Sassoli
de Bianchi, 671, 676, 677, 731
- Adg19
David J.
Adger, 354
- Adger
David J.
Adg19, 354
- Adnan
Mazlini
AZ10, 836
- Adrien-Marie
Legendre, 627
- Ae82
Diederik
Aerts, 668, 670, 671
- Aerts
Diederik, 669, 678
AdB14, 671, 676, 677
Ae14, 731
Ae82, 668, 670, 671
Aetal, 679
- Aetal
Diederik

- Aerts, 679
 Massimiliano Sassoli
 de Bianchi, 679
 Sandro
 Sozzo, 679
 Tomas
 Veloz, 679
- Agrawal
 Manindra
 AKS04, 603, 614
- AH18
 Khabirul
 Alam, 836
 Ujjwal Kumar
 Halder, 836
- AH77
 Kenneth
 Appel, 79–81, 89–91, 95, 110, 123, 124, 760
 Wolfgang
 Haken, 79–81, 89–91, 95, 110, 123, 124, 760
- AHK77
 John
 Koch, 79–81, 89–91, 95, 110, 123, 124, 760
 Kenneth
 Appel, 79–81, 89–91, 95, 110, 123, 124, 760
 Wolfgang
 Haken, 79–81, 89–91, 95, 110, 123, 124, 760
- Ahl53
 Lars V.
 Ahlfors, 129
- Ahlfors
 Lars V.
 Ahl53, 129
- Akiyoshi
 Ryota
 Aky24, 242
- Akman
 Varol
 SCA00, 558
- AKS04
 Manindra
 Agrawal, 603, 614
 Neeraj
 Kayal, 603, 614
 Nitin
 Saxena, 603, 614
- Aky24
 Ryota
 Akiyoshi, 242
- Alain
 Aspect, 658
 Connes, 72
- Alam
 Khabirul
 AH18, 836
- Alan
 David
 Sokal, 70–72
 Foster
 Byd14, 836
 Ho
 AAB19, 163, 164, 569, 725, 726, 739–741, 750,
 751
 Turing, 129, 139, 178, 179, 196, 202, 207, 265, 315,
 410, 415, 418, 422, 458, 546, 547, 551, 557,
 558, 560, 561, 565–567, 590, 640, 680, 761
 Test, 477
 Thesis, 129
 Tu36, 154, 156, 158, 161, 200, 203, 204, 230, 239,
 254, 261, 505, 506, 548, 557, 561, 562, 686,
 791
 Tu39, 505, 506
 Tu50, 548, 557
- Albert
 Einstein, 179, 374, 458, 681, 689
 Ei36, 662
 Ei36a, 662
 Ei50, 715, 716
 EPR35, 375, 650, 653, 659, 661, 664, 691
 Visser
 Vss20, 540
- Alemañ-Berenguer
 Rafael-Andrés
 Brg23, 522, 523
- Alexander
 Korotkov
 AAB19, 163, 164, 569, 725, 726, 739–741, 750,
 751
 Niederklapfer
 Ndr24, 344
 Yessenin-Volpin
 He04, 152, 237
- Alexander C.
 Paseau
 PG21, 384–386, 388–390
- Alexander S.
 Kechris
 BKPS, 39, 204, 205
- Alf van der
 Poorten, 52
- Alfred
 Tarski, 7, 18, 31, 128, 130, 132, 135, 167, 185, 214,
 244, 254, 255, 264, 271–274, 284, 285, 315,
 316, 358, 360, 382, 438, 453, 490, 513, 544,
 549, 551, 552, 554, 607, 660, 684, 853, 854
 Ta35, 161, 184, 286, 311, 506, 813
 Ta39, 508
- Alfred Bray
 Kempe
 Kmp79, 53, 81, 86, 89–96, 98, 99
- Alfred North
 Whitehead, 257

- WR10, 186, 325
 Alfredo Roque
 Freire
 Fri19, 495, 496, 500
 algorithm
 Deutsch, 746
 algorithmic
 computability, 3, 7, 18, 31, 40, 129, 131, 134, 159, 161, 177, 178, 184, 187–189, 192–194, 197, 198, 206, 209, 226, 227, 229, 231, 233, 235, 243, 247, 272, 310–313, 315, 316, 328, 341, 343, 362, 363, 374, 375, 410, 411, 429–432, 439, 440, 442, 445, 446, 450, 453, 456, 459, 461, 467, 475–477, 490, 514, 524, 547, 551, 552, 554–556, 559, 566–568, 573, 578, 580, 581, 583, 585–587, 589, 590, 593, 603, 607, 608, 615, 620, 639, 640, 642, 644, 652, 654–663, 668–671, 676, 678, 680–683, 686–690, 698, 723, 725, 727, 730, 731, 733, 736, 743, 747–749, 753, 758, 760, 761, 763, 764, 786, 791, 828, 875, 984
 decidability, 567, 568
 predictability, 689, 726
 proof, 309, 451, 452, 547, 758
 uncomputability, 341, 464, 645, 686
 undecidability, 581
 unprovability, 309
 unverifiability, 562
 verifiability, 3, 7, 18, 31, 32, 40, 129, 131, 132, 178, 187, 272, 310, 312, 313, 315–319, 328, 341, 362, 363, 368, 374, 375, 377, 410, 411, 430, 431, 439, 440, 442, 450, 453, 456, 459, 461, 467–469, 475–477, 486, 490, 491, 506, 514, 524, 547, 551–556, 559, 566–568, 573, 578, 581, 583, 585–587, 589, 590, 593, 603, 607, 608, 615, 620, 640, 642, 644, 645, 654, 656, 658, 660–662, 668, 670, 671, 676, 678, 681–683, 686–690, 698, 723, 725–727, 731, 736, 743, 747, 761, 875, 984
 Alia
 Martin
 PBC20, 171
 Alisdair
 Urquhart
 CU93, 186
 All17
 Patrick
 Allo, 79, 110
 Allo
 Patrick
 All17, 79, 110
 Allori
 Valia
 Alr24, 658, 659
 Allzén
 Simon
 Alz22, 172
 Alonzo
 Church, 148, 203, 295, 315, 590
 Ch36, 791
 Thesis, 129
 Alr24
 Valia
 Allori, 658, 659
 alternaive facts, 7
 alternative facts, 705
 Alz22
 Simon
 Allzén, 172
 Amir
 Shpilka
 Dvd19, 186
 Yehudayoff
 Dvd19, 186
 Amit
 Vainsencher
 AAB19, 163, 164, 569, 725, 726, 739–741, 750, 751
 Amitabha
 Gupta
 Gpt18, 713–715
 Amy
 Devine
 Rli16, 841
 An04
 Bhupinder Singh
 Anand, 127, 284, 395
 An07a
 Bhupinder Singh
 Anand, 311, 372, 546, 547
 An07b
 Bhupinder Singh
 Anand, 29, 143, 226, 311, 372, 411, 434, 546, 547, 552
 An07c
 Bhupinder Singh
 Anand, 29, 143, 204, 226, 311, 372, 411, 434, 546, 547, 552
 An12
 Bhupinder Singh
 Anand, 127, 141, 505, 690, 875
 An13
 Bhupinder Singh
 Anand, 152, 875
 An13a
 Bhupinder Singh
 Anand, 160, 244, 875
 An13b
 Bhupinder Singh
 Anand, 875
 An13p
 Bhupinder Singh

- Anand, 875
- An15
 Bhupinder Singh
 Anand, 152, 200, 341, 374, 514, 554, 683, 875
- An15a
 Bhupinder Singh
 Anand, 262, 552, 875
- An15b
 Bhupinder Singh
 Anand, 262, 875
- An15p
 Bhupinder Singh
 Anand, 683, 875
- An16
 Bhupinder Singh
 Anand, 18, 54, 65, 103, 105, 120, 123, 127–130, 132, 134, 141, 146, 148, 150, 152, 159–162, 164, 166, 175, 177, 196, 200, 205, 207, 209, 231, 233, 234, 252, 253, 272, 276, 283, 311, 312, 315–317, 383, 386, 389, 390, 395, 400, 402, 417, 424, 434, 435, 439, 440, 442, 443, 453, 459, 467, 476, 477, 490, 495, 531, 545, 547, 551, 554, 556, 653, 661, 690, 731, 758, 800, 812, 835, 875
- An21a
 Bhupinder Singh
 Anand, 47
- An21b
 Bhupinder Singh
 Anand, 47
- An22d
 Bhupinder Singh
 Anand, 86
- An22e
 Bhupinder Singh
 Anand, 47, 86
- An23
 Bhupinder Singh
 Anand, 123
- Anand
 Bhupinder Singh
 An04, 127, 284, 395
 An07a, 311, 372, 546, 547
 An07b, 29, 143, 226, 311, 372, 411, 434, 546, 547, 552
 An07c, 29, 143, 204, 226, 311, 372, 411, 434, 546, 547, 552
 An12, 127, 141, 505, 690, 875
 An13, 152, 875
 An13a, 160, 244, 875
 An13b, 875
 An13p, 875
 An15, 152, 200, 341, 374, 514, 554, 683, 875
 An15a, 262, 552, 875
 An15b, 262, 875
 An15p, 683, 875
- An16, 18, 54, 65, 103, 105, 120, 123, 127–130, 132, 134, 141, 146, 148, 150, 152, 159–162, 164, 166, 175, 177, 196, 200, 205, 207, 209, 231, 233, 234, 252, 253, 272, 276, 283, 311, 312, 315–317, 383, 386, 389, 390, 395, 400, 402, 417, 424, 434, 435, 439, 440, 442, 443, 453, 459, 467, 476, 477, 490, 495, 531, 545, 547, 551, 554, 556, 653, 661, 690, 731, 758, 800, 812, 835, 875
- An21a, 47
- An21b, 47
- An22d, 86
- An22e, 47, 86
- An23, 123
- Dharini, 875
- Pillay
 BKPS, 39, 204, 205
- Anandi
 Hattiangadi
 BH24, 298
 Htt23, 299, 300
- And72
 Philip W.
 Anderson, 377, 378
- Anderson
 Philip W.
 And72, 377, 378
- André
 Weil, 52
- Andrés Eduardo
 Caicedo
 Cai07, 492
- Andre
 Petukhov
 AAB19, 163, 164, 569, 725, 726, 739–741, 750, 751
- Andrea
 Scarantino
 SP10, 372
- Andreea S.
 Calude
 Cl01, 80
 Cld11, 824–831
- Andrei Nikolaevich
 Kolmogorov, 129, 177, 195, 197, 297
 Ko25, 275
 Ko56, 616
- Andrej
 Bauer
 Ba16, 23, 177, 187, 189, 194–196, 213, 214, 276, 294, 372, 400
- Andres F.
 Salazar-Gomez
 GDGGR, 558
- Andrew
 Aberdeen

- Abr19, 32
 AC24, 336–339
 Dunsworth
 AAB19, 163, 164, 569, 725, 726, 739–741, 750, 751
 Granville
 Grn22, 23, 102, 111–115, 124, 125, 148–150, 186, 258, 386, 560
 Grn95, 627
 Wiles, 52, 54
 Wls95, 52–54, 66, 67, 69–72, 119
 Andrew Peter
 Arana
 Arn10, 404
 Andrey Andreevich
 Markov
 Mrk54, 791
 Andrey I.
 Bovykin
 Bov00, 485
 Andrzej
 Mostowski
 Wo52, 186, 401
 Szałas
 Sza02, 27, 28, 186
 Anne Marie
 Helmenstine
 Hlm19, 848
 Annemarie
 Fritz
 OHF19, 841
 Anthony
 Beavers, 875
 Megrant
 AAB19, 163, 164, 569, 725, 726, 739–741, 750, 751
 Anton
 Zeilinger, 658
 Appel
 Kenneth
 AH77, 79–81, 89–91, 95, 110, 123, 124, 760
 AHK77, 79–81, 89–91, 95, 110, 123, 124, 760
 AR02b
 Erich H.
 Reck, 186, 271
 Steve
 Awodey, 186, 271
 Ar09
 Boaz
 Barak, 509
 Sanjeev
 Arora, 509
 Arana
 Andrew Peter
 Arn10, 404
 Ardeshir
 Mohammad
 ArRm09, 189
 Arend
 Heyting, 129, 177, 195, 197, 297
 Hyt59, 279
 Arenhart
 Jonas R. B.
 KA19, 38
 Aricebo, 790
 Aristotle, 41
 Arn10
 Andrew Peter
 Arana, 404
 Arnon
 Avron
 Avr20, 540
 Keren
 Krn22, 336
 Aro
 Mikko
 Srv19, 836
 Arora
 Sanjeev
 Ar09, 509
 ArRm09
 Mohammad
 Ardeshir, 189
 Rasoul
 Ramezani, 189
 Art07
 Sergei
 Artemov, 18
 Artemov
 Sergei
 Art07, 18
 Arthur
 Cayley
 Cay79, 80
 Jaffe, 70
 Arthur M.
 Collings
 KC19, 743, 746
 Arute
 Frank
 AAB19, 163, 164, 569, 725, 726, 739–741, 750, 751
 Arya
 Kunal
 AAB19, 163, 164, 569, 725, 726, 739–741, 750, 751
 Aryabhata, 41
 Aschieri
 Federico
 AsZ12, 186
 Ashok
 Chaddha, 877

- Asko
Tolvanen
Srv19, 836
- Aspect
Alain, 658
- AsZ12
Federico
Aschieri, 186
Margherita
Zorzi, 186
- AT03
Mark
van Atten, 288
Robert
Tragesser, 288
- At17
Mark
van Atten, 279, 280
- At18
Mark
van Atten, 226
- At23
Mark
van Atten, 275
- Atiyah
Michael, 70
- Atle
Selberg, 627
- Augustin-Louis
Cauchy, 65
- Austin
Fowler
AAB19, 163, 164, 569, 725, 726, 739–741, 750, 751
- Avg21
Jeremy
Avigad, 73, 74
- Avg23
Jeremy
Avigad, 349–351
- Avigad
Jeremy
Avg21, 73, 74
Avg23, 349–351
- Avr20
Arnon
Avron, 540
- Avron
Arnon
Avr20, 540
- Aw18
Jon
Awbrey, 519
- AWB20
Cathy
Williams, 831
- Jo
Boaler, 831
- Megan
Selbach-Allen, 831
- Awbrey
Jon
Aw18, 519
- Awodey
Steve
AR02b, 186, 271
- Ayse
Pinar
SCA00, 558
- AZ10
Effandi
Zakaria, 836
Mazlini
Adnan, 836
- B.
Yushua
YBM04, 832
- Bārzdīņš
Jānis
BFS08, 438, 439
- Ba16
Andrej
Bauer, 23, 177, 187, 189, 194–196, 213, 214, 276, 294, 372, 400
- Babbush
Ryan
AAB19, 163, 164, 569, 725, 726, 739–741, 750, 751
- Babu
Thaliath
Thl19, 33
- Bacon
Dave
AAB19, 163, 164, 569, 725, 726, 739–741, 750, 751
- BaG23
Isaac
Goldbring, 707–709
Jeffrey Alan
Barrett, 707–709
- Bailly
Francis
BLo08, 33
- Banach-Tarski
paradox, 191
Theorem, 513
- Bar-On
Kati Kish
Bro22, 214, 278, 339, 343
Bro22a, 282
- Bar88
Michael

- Barnsley, 509, 513, 791
- Barak
Boaz
Ar09, 509
- Bardin
Joseph C.
AAB19, 163, 164, 569, 725, 726, 739–741, 750, 751
- Barendregt
Henk
Brd13, 23, 298, 335
BW05, 53, 54, 146, 298
- Barends
Rami
AAB19, 163, 164, 569, 725, 726, 739–741, 750, 751
- Barnsley
Michael
Bar88, 509, 513, 791
BPS88, 791
- Barrett
Jeffrey Alan
BaG23, 707–709
Brr08, 375–377
Jonathan
PBR12, 727
- Barry
Mazur, 74
- Barry A.
Cipra
Cip88, 63
- Bars
Itzhak
BCST, 531
- Bartlett
Jonathan
Brt18, 642–644
- Bartosz
Wcisłó
LW23, 186, 445
- Barwell
Richard
Bwl, 845, 846
- Bauer
Andrej
Ba16, 23, 177, 187, 189, 194–196, 213, 214, 276, 294, 372, 400
- BBJ03
George S.
Boolos, 18, 186, 202, 204, 209, 478, 485, 487, 508, 561, 849
John P.
Burgess, 18, 186, 202, 204, 209, 478, 485, 487, 508, 561, 849
Richard C.
Jeffrey, 18, 186, 202, 204, 209, 478, 485, 487, 508, 561, 849
- BC05
Elena
Castellani, 60, 61
Katherine
Brading, 60, 61
- BCST
Itzhak
Bars, 531
Neil
Turok, 531
Paul J.
Steinhardt, 531
Shih-Hung
Chen, 531
- Be59
Evert W.
Beth, 186, 478, 480
- Beavers
Anthony, 875
- Bekdemir
Mehmet
Bkd10, 836
- Bel61
E. T.
Bell, 53
- Belbase
Shashidhar
Blb10, 836, 837, 841
- Bell
E. T.
Bel61, 53
John L.
Bl107, 440, 441
John Stewart
Bl64, 573, 637, 656, 657, 660, 662, 679, 727, 731
- Ben
Chiaro
AAB19, 163, 164, 569, 725, 726, 739–741, 750, 751
- Ben-David
Shai
Dvd19, 186
- Benacerraf
Paul
BPu64, 18
- Benjamin
Villalonga
AAB19, 163, 164, 569, 725, 726, 739–741, 750, 751
- Benoit B.
Mandelbrot
BPS88, 791
Mn77, 791
- BenzmüllerChristoph
BP14, 187, 355

- Berghofer
 Philipp
 Bgh23, 174
- Bernays
 Paul, 251, 259–261, 412
 BF58, 186, 506
- Bernd
 Buldt
 Bld16, 151, 447–449
- Bertrand
 Russell, 256, 257, 305, 306, 333, 351, 380, 503, 814, 815, 817, 818, 820, 822
 Rus08, 192, 264
 Rus17, 349, 821, 835
 Rus37, 512, 688
 WR10, 186, 325
- Besson
 Corine
 BH24, 298
- Beth
 Evert W.
 Be59, 186, 478, 480
- Beziau
 Jean-Yves, 875
- BF58
 Abraham A.
 Fraenkel, 186, 506
 Paul
 Bernays, 186, 506
- BFS08
 Carl H.
 Smith, 438, 439
 Jānis
 Bārzdīņš, 438, 439
 Rūsiņš
 Freivalds, 438, 439
- BG11
 Naveen Sundar
 Govindarajalu, 206
 Selmer
 Bringsjord, 206
- BG11a
 Naveen Sundar
 Govindarajalu, 206
 Selmer
 Bringsjord, 206
- Bgh23
 Philipp
 Berghofer, 174
- BH24
 Anandi
 Hattiangadi, 298
 Corine
 Besson, 298
- Bha19
 Manjul
 Bhargava, 605
- Bhargava, 605
- Bhargava
 Manjul
 Bha19, 605
- Bhaskar II, 41
- Bhupinder Singh
 Anand
 An04, 127, 284, 395
 An07a, 311, 372, 546, 547
 An07b, 29, 143, 226, 311, 372, 411, 434, 546, 547, 552
 An07c, 29, 143, 204, 226, 311, 372, 411, 434, 546, 547, 552
 An12, 127, 141, 505, 690, 875
 An13, 152, 875
 An13a, 160, 244, 875
 An13b, 875
 An13p, 875
 An15, 152, 200, 341, 374, 514, 554, 683, 875
 An15a, 262, 552, 875
 An15b, 262, 875
 An15p, 683, 875
 An16, 18, 54, 65, 103, 105, 120, 123, 127–130, 132, 134, 141, 146, 148, 150, 152, 159–162, 164, 166, 175, 177, 196, 200, 205, 207, 209, 231, 233, 234, 252, 253, 272, 276, 283, 311, 312, 315–317, 383, 386, 389, 390, 395, 400, 402, 417, 424, 434, 435, 439, 440, 442, 443, 453, 459, 467, 476, 477, 490, 495, 531, 545, 547, 551, 554, 556, 653, 661, 690, 731, 758, 800, 812, 835, 875
 An21a, 47
 An21b, 47
 An22d, 86
 An22e, 47, 86
 An23, 123
- Bi18
 Errett
 Bishop, 23, 193, 278
- Bi66
 Errett
 Bishop, 359
- Bia18
 Massimiliano Sassoli
 de Bianchi, 668–670
- Bia19
 Massimiliano Sassoli
 de Bianchi, 668–670
- Bishop
 Errett
 Bi18, 23, 193, 278
 Bi66, 359
- Biswas
 Rupak
 AAB19, 163, 164, 569, 725, 726, 739–741, 750, 751

- Björn
Lundgren
Lun17, 502, 801, 802
- Bkd10
Mehmet
Bekdemir, 836
- BKPS
Alexander S.
Kechris, 39, 204, 205
Anand
Pillay, 39, 204, 205
Richard A.
Shore, 39, 204, 205
Samuel R.
Buss, 39, 204, 205
- Bl64
John Stewart
Bell, 573, 637, 656, 657, 660, 662, 679, 727, 731
- Blaise
Pascal, 52
- Blazer
Christie
Blz11, 836
- Blb10
Shashidhar
Belbase, 836, 837, 841
- Bld16
Bernd
Buldt, 151, 447–449
- Bll07
John L.
Bell, 440, 441
- BLo08
Francis
Bailly, 33
Giuseppe
Longo, 33
- Bloor
David, 70
- Blz11
Christie
Blazer, 836
- Bn08
David
Brin, 786
- Bo52
David
Bohm, 653
- Boaler
Jo
AWB20, 831
- Boaz
Barak
Ar09, 509
- Bob
Coecke, 673, 674
- Boh49
Niels
Bohr, 652, 662
- Bohdan
Hejna
Hi30, 419
- Bohm
David, 653, 660
Bo52, 653
de Broglie, 655
double-slit, 654, 655
- Bohr
Niels, 179, 374, 458, 650, 657, 663, 680, 681, 731
Boh49, 652, 662
- Boixo
Sergio
AAB19, 163, 164, 569, 725, 726, 739–741, 750, 751
- Boolos
George S.
BBJ03, 18, 186, 202, 204, 209, 478, 485, 487, 508, 561, 849
- Borel
Émile, 214
- Boris Yakovlevich
Podolsky
EPR35, 375, 650, 653, 659, 661, 664, 691
- Boubaki
Nicolas, 295
- Bov00
Andrey I.
Bovykin, 485
- Bovykin
Andrey I.
Bov00, 485
- Boyd
Wendy
Byd14, 836
William Edgar
Byd14, 836
- BP14
Bruno Woltzenlogel
Paleo, 187, 355
Christoph
Benzmüller, 187, 355
- BPS88
Benoit B.
Mandelbrot, 791
Dietmar
Saupe, 791
Hans-Otto
Peitgen, 791
Michael
Barnsley, 791
McGuire, 791
Richard F.

- Voss, 791
- Robert L.
Devaney, 791
- Yuval
Fisher, 791
- BPu64
Hilary
Putnam, 18
- Paul
Benacerraf, 18
- Br08
L. E. J.
Brouwer, 7, 131, 152, 233, 237, 243, 263, 276, 437, 505, 855
- Br13
L. E. J.
Brouwer, 136, 373
- Br23
L. E. J.
Brouwer, 271, 274, 275
- Br27
L. E. J.
Brouwer, 233
- Brading
Katherine
BC05, 60, 61
- Brandao
Fernando G. S. L.
AAB19, 163, 164, 569, 725, 726, 739–741, 750, 751
- Brd13
Henk
Barendregt, 23, 298, 335
- Bremer
Manuel
Brm07, 152, 237
- Brendan D.
McKay
McK12, 80
- Brent
Richard P.
Brn00, 614
- Brg23
Rafael-Andrés
Alemañ-Berenguer, 522, 523
- Bri93
Selmer
Bringsjord, 591
- Brian
Burkett
AAB19, 163, 164, 569, 725, 726, 739–741, 750, 751
- Conrad, 74
- Gallagher
Gal18, 373
- Rotman
Rot88, 333, 381
- Bricmont
Jean, 70, 71
- Brin
David
Bn08, 786
- Bringsjord
Selmer
BG11, 206
BG11a, 206
Bri93, 591
- Brm07
Manuel
Bremer, 152, 237
- Brn00
Richard P.
Brent, 614
- Bro22
Kati Kish
Bar-On, 214, 278, 339, 343
- Bro22a
Kati Kish
Bar-On, 282
- Brooks
Foxen
AAB19, 163, 164, 569, 725, 726, 739–741, 750, 751
- Brouwer, 343
L. E. J., 18, 129, 177, 195, 197, 226, 256, 257, 262, 263, 271, 273, 278, 283, 297, 343, 358, 359, 365, 374, 505, 516, 517, 554, 578, 672, 686, 824, 875
Br08, 7, 131, 152, 233, 237, 243, 263, 276, 437, 505, 855
Br13, 136, 373
Br23, 271, 274, 275
Br27, 233
- Brown
Julian R.
DB93, 658
- Brr08
Jeffrey Alan
Barrett, 375–377
- Brt18
Jonathan
Bartlett, 642–644
- Bru02
Yuriy
Brun, 80, 92
- Bruce Raymond
Long
Lon14, 373
- Brun
Yuriy
Bru02, 80, 92
- Bruno Woltzenlogel

- Paleo
BP14, 187, 355
- Bs97
Samuel R.
Buss, 231, 233, 234
- Bs98
Samuel R.
Buss, 433, 440, 441
- Bu10
Jeff
Buechner, 143
- Bu20
Jeff
Buechner, 540
- Buckwalter
Wesley
PBC20, 171
- Buechner
Jeff
Bu10, 143
Bu20, 540
- Buell
David A.
AAB19, 163, 164, 569, 725, 726, 739–741, 750, 751
- Bukhari
M. A.
YBM04, 832
- Buldt
Bernd
Bld16, 151, 447–449
- Bur10
John
Burgess, 540, 545
- Burgess
John
Bur10, 540, 545
John P.
BBJ03, 18, 186, 202, 204, 209, 478, 485, 487, 508, 561, 849
- Burkett
Brian
AAB19, 163, 164, 569, 725, 726, 739–741, 750, 751
- Buss
Samuel R.
BKPS, 39, 204, 205
Bs97, 231, 233, 234
Bs98, 433, 440, 441
- Buzzard
Kevin, 73
- BW05
Freek
Wiedijk, 53, 54, 146, 298
Henk
Barendregt, 53, 54, 146, 298
- Bwl
Richard
Barwell, 845, 846
- Byd14
Alan
Foster, 836
Jubilee
Smith, 836
Wendy
Boyd, 836
William Edgar
Boyd, 836
- Byrnes
John
SB99, 147, 553, 554
- C. B.
Nix-James, 876
- Ca37
Rudolf
Carnap, 186
- Ca62
Rudolf
Carnap, 246, 247, 371
- Ca62a
Rudolf
Carnap, 36, 117, 118, 120, 123, 259, 286, 295, 323, 336, 341, 342, 668, 799, 811, 813
- Cai
Tianxin
CCZ15, 53
- Cai07
Andrés Eduardo
Caicedo, 492
- Caicedo
Andrés Eduardo
Cai07, 492
- Calude
Andreea S.
CI01, 80
Cld11, 824–831
Christian S.
CCS01, 139, 145
Cristian S.
CD19, 610
Elena
CCS01, 139, 145
- Camille
Jordan, 516
- Cantor
Georg, 7, 157, 179, 274, 437, 458, 472, 505, 686, 816, 817, 821, 823
theorem, 578
- Caret
Colin R,
Crt23, 298, 299
- Carl

- Pomerance
LP11, 603, 614
- Sagan
Sa85, 792
- Carl Friedrich
Gauss, 627
- Carl H.
Smith
BFS08, 438, 439
- Carl J.
Posy
Pos13, 237, 245, 257, 258, 274, 300
- Carlo
Cellucci
Cll19, 123
- Carnap
explicandum, 36, 259, 286, 295, 323, 336, 341–343, 668, 799, 811, 813
explicatum, 36, 259, 286, 295, 323, 336, 341–343, 668, 799, 811, 813
Rudolf, 38, 192, 227–230, 428, 543, 544, 801
Ca37, 186
Ca62, 246, 247, 371
Ca62a, 36, 117, 118, 120, 123, 259, 286, 295, 323, 336, 341, 342, 668, 799, 811, 813
- Carnielli
Walter A.
EC89, 186, 433, 478
- Carolina
Maldonado-Carreñoénez-Leal
Rli16, 841
- Castellani
Elena
BC05, 60, 61
- Castelvecchi
Davide
Cst18, 736
- cat paradox
Erwin
Schrödinger, 610, 646
- Cat07
Paola
Cattabriga, 419
- Catarina Dutilh
Novaes
Nvs09, 104, 105
Nvs19, 146, 485, 495
- categorical
theory, 668
- Cathedral and John Connon
School, 876
- Catherine
Christer-Hennix, 424
He04, 152, 237
- Cathy
Williams
AWB20, 831
- Cattabriga
Paola
Cat07, 419
- Cauchy
Augustin-Louis, 65
- Cay79
Arthur
Cayley, 80
- Cayley
Arthur
Cay79, 80
- CCS01
Christian S.
Calude, 139, 145
Elena
Calude, 139, 145
Solomon
Marcus, 139, 145
- CCZ15
Deyi
Chen, 53
Tianxin
Cai, 53
Yong
Zhang, 53
- CD19
Cristian S.
Calude, 610
Monica
Dumitrescu, 610
- Cellucci
Carlo
Cll19, 123
- CG15
Valentin
Goranko, 81, 92
Willem
Conradie, 81, 92
- Ch36
Alonzo
Church, 791
- Cha05
Oswaldo
Chateaubriand, 167, 170, 373
- Chaddha
Ashok, 877
- Chaitanya
Mehta, 56
- Chaitin
Gregory, 70
Ct82, 687
Gregory J., 573
Ct75, 201, 204
Ct82, 201
- Halting

- Probability, 201, 204
 Changeaux
 Jean-Pierre, 72
 Chardin
 G.
 Chr97, 531
 Charles
 Neill
 AAB19, 163, 164, 569, 725, 726, 739–741, 750, 751
 Parsons
 Pas95, 505
 Charles Jean
 de la Vallée Poussin, 627
 Charles M.
 Grinstead
 GS97, 612
 Chateaubriand
 Oswaldo
 Cha05, 167, 170, 373
 Che42
 Lord
 Cherwell, 609
 Chebyshev
 Pafnuty Lvovich, 627
 Chen
 Deyi
 CCZ15, 53
 Shih-Hung
 BCST, 531
 Yu
 AAB19, 163, 164, 569, 725, 726, 739–741, 750, 751
 Zijun
 AAB19, 163, 164, 569, 725, 726, 739–741, 750, 751
 Cheng
 Yong
 Chg20, 540
 Cherwell
 Lord
 Che42, 609
 Chetan
 Mehta, 875
 Fermat, 56
 Murthy
 Mu91, 35, 74, 103, 127, 130, 131, 134, 135, 148, 162, 186, 230, 239, 254, 389, 421, 490, 505, 678, 853
 Chg20
 Yong
 Cheng, 540
 Chiaro
 Ben
 AAB19, 163, 164, 569, 725, 726, 739–741, 750, 751
 Chimpanzee
 Third, 786
 Chinn
 Steve
 Chn18, 836
 Chn18
 Steve
 Chinn, 836
 Cho18
 Timothy Y.
 Chow, 186, 241, 247, 252, 485
 Chow
 Timothy Y.
 Cho18, 186, 241, 247, 252, 485
 Chr97
 G.
 Chardin, 531
 Chris
 Quintana
 AAB19, 163, 164, 569, 725, 726, 739–741, 750, 751
 Christer-Hennix
 Catherine, 424
 He04, 152, 237
 Christian
 Joy
 Chs24, 660
 Retoré, 875
 Christian S.
 Calude
 CCS01, 139, 145
 Christie
 Blazer
 Blz11, 836
 Christoph
 Benzmüller
 BP14, 187, 355
 Christopher
 Moore
 Mor12, 158
 Chs24
 Joy
 Christian, 660
 Church
 Alonz
 Thesis, 129
 Alonzo, 148, 203, 295, 315, 590
 Ch36, 791
 Thesis, 144, 202, 203, 206, 266, 267, 470, 561, 590, 591, 593, 690
 Church-Turing
 principle, 206, 725, 736
 Thesis, 3, 19, 129, 139, 141, 144, 164, 178, 179, 202, 204–206, 265–268, 270, 315, 458, 551, 561, 590, 594, 725, 726, 736, 743
 Church-Turing Thesis

- CT, 202
- Cicekli
Ilyas
SCA00, 558
- Cip88
Barry A.
Cipra, 63
- Cipra
Barry A.
Cip88, 63
- Cl01
Andreea S.
Calude, 80
- Clauser
John F., 658
- Cld11
Andreea S.
Calude, 824–831
- Cll19
Carlo
Cellucci, 123
- closed
string, 76
- Co05
Paul J.
Cohen, 186, 319, 367–369
- Co63
Paul J.
Cohen, 370, 371
- Co64
Paul J.
Cohen, 370, 371
- Co66
Paul J.
Cohen, 370–372, 459
- Coates
John, 74
- Coecke
Bob, 673, 674
- cognitive
science, 668
- Coh05
Paul R.
Cohen, 558
- Cohen
Dan
AC24, 336–339
Paul J.
Co05, 186, 319, 367–369
Co63, 370, 371
Co64, 370, 371
Co66, 370–372, 459
Paul R.
Coh05, 558
- Colbeck
Roger
- CR12, 727
- Coleman
Robert
F., 71
- Colin J.
Rittberg
Rit15, 359, 403
- Colin R.
Caret
Crt23, 298, 299
- Collatz
conjecture, 569, 570, 579–581
- Collings
Arthur M.
KC19, 743, 746
- Collins
Roberto
AAB19, 163, 164, 569, 725, 726, 739–741, 750, 751
- Complementarity
Thesis, 20, 23, 26, 29, 31, 33, 36, 40–42, 47, 66, 71, 105, 122, 123, 159, 172, 184, 190, 192, 221, 224, 226, 229, 259, 273, 276, 281, 295, 297, 298, 302, 324, 328, 331, 333, 358, 361, 365, 367, 368, 373, 435, 437, 439, 465, 539, 544, 589, 605, 637, 684, 686, 727, 747, 754, 808, 811, 813, 824, 825, 828, 830, 831, 834, 843, 846, 861
- complementarity, 177, 411, 554, 651, 652, 754, 828
- computability
algorithmic, 3, 7, 18, 31, 40, 129, 131, 134, 159, 161, 177, 178, 184, 187–189, 192–194, 197, 198, 206, 209, 226, 227, 229, 231, 233, 235, 243, 247, 272, 310–313, 315, 316, 328, 341, 343, 362, 363, 374, 375, 410, 411, 429–432, 439, 440, 442, 445, 446, 450, 453, 456, 459, 461, 467, 475–477, 490, 514, 524, 547, 551, 552, 554–556, 559, 566–568, 573, 578, 580, 581, 583, 585–587, 589, 590, 593, 603, 607, 608, 615, 620, 639, 640, 642, 644, 652, 654–663, 668–671, 676, 678, 680–683, 686–690, 698, 723, 725, 727, 730, 731, 733, 736, 743, 747–749, 753, 758, 760, 761, 763, 764, 786, 791, 828, 875, 984
- strong, 192
weak, 192
- Conjecture
Goldbach's, 636
- conjecture
Collatz, 569, 570, 579–581
Taniyama-Shimura, 52
- Connes
Alain, 72
- Conrad
Brian, 74
- Conradie

- Willem
 CG15, 81, 92
 Continuum
 Hypothesis, 823
 Cook
 Stephen, 156–159, 614
 CU93, 186
 Cop04
 Jack
 Copeland, 725
 Copeland
 Jack
 Cop04, 725
 Cor73
 John
 Corcoran, 295, 296
 Corey J.
 Maley
 Mly22, 140, 141
 Corine
 Besson
 BH24, 298
 Corry
 Leo
 Cry10, 47
 Cry17, 24, 25
 Cry22, 19
 Courtney
 William
 AAB19, 163, 164, 569, 725, 726, 739–741, 750, 751
 Cr05
 John N.
 Crossley, 186
 CR12
 Renato
 Renner, 727
 Roger
 Colbeck, 727
 Craig
 Gidney
 AAB19, 163, 164, 569, 725, 726, 739–741, 750, 751
 Smoryński
 Smy77, 186
 Smy81, 440
 Crilly
 Tony
 Crl05, 80
 Crispin
 Wright, 412, 413
 Cristian S.
 Calude
 CD19, 610
 Crl05
 Tony
 Crilly, 80
 Crossley
 John N.
 Cr05, 186
 Crt23
 Colin R.
 Caret, 298, 299
 Cry10
 Leo
 Corry, 47
 Cry17
 Leo
 Corry, 24, 25
 Cry22
 Leo
 Corry, 19
 Csatári
 Ferenc
 Csr19, 712
 Csr24, 23, 186, 245, 292
 Csr19
 Ferenc
 Csatári, 712
 Csr24
 Ferenc
 Csatári, 23, 186, 245, 292
 Cst18
 Davide
 Castelvecchi, 736
 CT
 Church-Turing Thesis, 19, 202, 561
 Ct75
 Gregory J.
 Chaitin, 201, 204
 Ct82
 Gregory
 Chaitin, 687
 Gregory J.
 Chaitin, 201
 CU93
 Alisdair
 Urquhart, 186
 Stephen
 Cook, 186
 Curie
 Pierre, 60, 61
 Curie's
 principle, 60, 61
 Curtis
 Franks
 Fr09, 24, 259, 273, 274, 852
 Cushman
 Fiery
 PBC20, 171
 D. C. J.
 Wessels

- YBM04, 832
- Décio
Krause
KA19, 38
Krs22, 265, 390–393, 820
- Dénes
Szücs
Rli16, 841
- da Costa
Newton C. A., 391
- Da Silva
Ricardo J
Das14, 186, 405
- Da64
Martin
Davis, 18
- Da82
Martin
Davis, 152, 186, 244, 411, 433
- Da95
Martin
Davis, 142, 143, 407, 551
- Dan
Cohen
AC24, 336–339
- Daniel
Isaacson, 435, 437
Isc11, 150, 250
Sanders
RSSp, 80, 86, 90, 123, 125
RSST, 80, 86, 90, 123, 125
Sank
AAB19, 163, 164, 569, 725, 726, 739–741, 750, 751
- Daniel C.
Dennett
De17, 812
- Daniela
Frauchiger
FrRe18, 705, 736
Rus
GDGGR, 558
- Daniele
Molinini
FM15, 186, 379, 380, 833, 876
- Danielle
Macbeth
Mcb14, 25, 26, 187, 340, 501, 502
- Danko D.
Georgiev, 875
- Dardashti
Radin
DDT19, 534
- Darmon
Henri, 74
DDR95, 52
- DaS14
Ricardo J
Da Silva, 186, 405
- Dav05
E. B.
Davies, 192
- Dav05a
E. B.
Davies, 702, 703
- Dave
Bacon
AAB19, 163, 164, 569, 725, 726, 739–741, 750, 751
- David
Bloor, 70
Bohm, 653, 660
Bo52, 653
Brin
Bn08, 786
Deutsch, 743
Deu85, 163, 206, 569, 582, 585, 586, 588, 725, 728, 730, 731, 738, 739
DJ85, 736
DJ92, 731, 733, 734, 736, 737, 740, 741, 762, 763
Gamez
Gam18, 259, 286, 335, 336
Grinspoon
FGW22, 599–602, 788
Hilbert, 18, 33, 170, 177, 182, 187, 190, 230, 236–239, 243, 246–248, 251, 252, 254–257, 259–261, 263, 271, 273, 274, 276, 283, 286, 330, 332, 334, 335, 358, 374, 402, 410, 412, 479, 505, 506, 516, 517, 551, 554, 662, 672, 684, 685, 824, 875
Dogma, 170
HA28, 186
Hi00, 179, 223, 235, 240, 363, 852
Hi25, 186
Hi27, 7, 131, 136, 181, 262, 275, 373, 437, 505
Hi30, 235
Kashtan
Ksh20, 540
Landhuis
AAB19, 163, 164, 569, 725, 726, 739–741, 750, 751
Owens
Own06, 172, 173
Papineau
Ppn19, 175–177
Pengelley
LbP10, 53
Pereplyotchik
Per17, 816, 817
- David A.
Buell
AAB19, 163, 164, 569, 725, 726, 739–741, 750,

- 751
- David J.
Adger
Adg19, 354
- Davide
Castelvecchi
Cst18, 736
- Davies
E. B.
Dav05, 192
Dav05a, 702, 703
Paul C. W.
DB93, 658
- Davis
Martin
Da64, 18
Da82, 152, 186, 244, 411, 433
Da95, 142, 143, 407, 551
- Daw15
Ryan
Dawson, 327–332
- Dawid
Richard
DDT19, 534
- Dawson
Ryan
Daw15, 327–332
- DB93
Julian R.
Brown, 658
Paul C. W.
Davies, 658
- Dck20
Leonard Eugene
Dickson, 53
- DDR95
Fred
Diamond, 52
Henri
Darmon, 52
Richard
Taylor, 52
- DDT19
Karim
Thebault, 534
Radin
Dardashti, 534
Richard
Dawid, 534
- de Bianchi
Massimiliano Sassoli
AdB14, 671, 676, 677, 731
Aetal, 679
Bia18, 668–670
Bia19, 668–670
- de Broglie
Bohm, 655
double-slit, 654, 655
- de Grefte
Job
Grf21, 100, 167, 168, 170
- de la Vallée Poussin
Charles Jean, 627
- de Saussure
Ferdinand, 399
- De17
Daniel C.
Dennett, 812
- decidability
algorithmic, 567, 568
- Dedekind
Richard, 72, 358
- Del Santo
Flavio
SG24, 210–212, 645
- Deligne
Pierre, 74
- DelPreto
Joseph
GDGGR, 558
- Dennett
Daniel C.
De17, 812
- Denning
Kathryn, 795, 796
Dng10, 786, 787
- Dennis
Dieks
Dks17, 640–642
- Derakhshan
Farzaneh
SD21, 147, 148
- Derrida
Jacques, 396, 399
- Dershowitz
Nachum
DG08, 266–268
- Descartes
René, 876
- Detlefsen
Michael, 413
- Detlovs
Vilnis
DP17, 186
- Deu85
David
Deutsch, 163, 206, 569, 582, 585, 586, 588, 725,
728, 730, 731, 738, 739
- Deutsch
algorithm, 746
David, 743

- Deu85, 163, 206, 569, 582, 585, 586, 588, 725, 728, 730, 731, 738, 739
- DJ85, 736
- DJ92, 731, 733, 734, 736, 737, 740, 741, 762, 763
- Dev94
- Keith
- Devlin, 53
- Devaney
- Robert L.
- BPS88, 791
- Devine
- Amy
- Rli16, 841
- Devlin
- Keith
- Dev94, 53
- Deyi
- Chen
- CCZ15, 53
- DG08
- Nachum
- Dershowitz, 266–268
- Yuri
- Gurevich, 266–268
- Dharini
- Anand, 875
- Di70
- Jean
- Dieudonné, 294
- diagonal lemma
- Wikipedia, 442
- diagonalization lemma
- fixed point theorem, 441
- Diamond
- Fred, 74
- DDR95, 52
- Jared, 786
- Dic52
- Leonard Eugene
- Dickson, 627, 628, 636
- Dickson
- Leonard Eugene
- Dck20, 53
- Dic52, 627, 628, 636
- Diederik
- Aerts, 669, 678
- AdB14, 671, 676, 677, 731
- Ae82, 668, 670, 671
- Aetal, 679
- Dieks
- Dennis
- Dks17, 640–642
- Dietmar
- Saupe
- BPS88, 791
- Dieudonné
- Jean, 70
- Di70, 294
- Dina
- Goldin
- WG03, 139, 141, 142
- Dirichlet
- Peter Gustav Lejeune, 627
- disembodied
- proof
- FLT, 48–51
- Divakaran
- P. P.
- Dvk18, 40, 41
- DJ85
- David
- Deutsch, 736
- DJ92
- David
- Deutsch, 731, 733, 734, 736, 737, 740, 741, 762, 763
- Richard
- Jozsa, 731, 733, 734, 736, 737, 740, 762, 763
- Dks17
- Dennis
- Dieks, 640–642
- Dmitry
- Lyakh
- AAB19, 163, 164, 569, 725, 726, 739–741, 750, 751
- Dmt22
- Spiridon
- Dumitru, 703, 704
- Dng10
- Kathryn
- Denning, 786, 787
- Dogma
- Brouwer
- L. E. J., 170
- David
- Hilbert, 166
- Hilbert
- David, 170
- Kurt
- Gödel, 170
- L. E. J.
- Brouwer, 166
- double-slit, 655
- Bohm-de Broglie, 654, 655
- Douglas
- Vakoch, 788
- Doukas
- Kapantaïs
- Kap16, 267–270
- Downwards
- Löwenheim-Skolem
- Theorem, 220

- DP17
 Karlis
 Podnieks, 186
 Vilnis
 Detlovs, 186
- Drāghici
 Virgil
 Drg23, 249
- Drāghici
 Virgil
 Drg18, 501
 Drg23, 186, 315, 418, 419, 433, 446, 501
- Drake
 Frank, 787, 795
- Drg18
 Virgil
 Drāghici, 501
- Drg23
 Virgil
 Drāghici, 249
 Drāghici, 186, 315, 418, 419, 433, 446, 501
- Du13
 Marie
 Duží, 266
- Duží
 Marie
 Du13, 266
- Dumitrescu
 Monica
 CD19, 610
- Dumitru
 Spiridon
 Dmt22, 703, 704
- Dummett, 190, 343
 Michael, 412, 413
- Dunsworth
 Andrew
 AAB19, 163, 164, 569, 725, 726, 739–741, 750, 751
- Dustin
 Lazarovici
 Lzr23, 347, 348
- Dvd19
 Amir
 Shpilka, 186
 Yehudayoff, 186
 Pavel
 Hrubeš, 186
 Shai
 Ben-David, 186
 Shay
 Moran, 186
- Dvir
 Kafri
 AAB19, 163, 164, 569, 725, 726, 739–741, 750, 751
- Dvk18
 P. P.
 Divakaran, 40, 41
- E. B.
 Davies
 Dav05, 192
 Dav05a, 702, 703
- E. C.
 Titchmarsh
 Ti51, 627
- E. M.
 Wright
 HW60, 612, 614, 615, 620, 623, 626, 627, 636
- E. R.
 Swart
 Sw80, 80
- E. T.
 Bell
 Bel61, 53
- Eberl
 Matthias
 Ebr20, 190–192
- Ebr20
 Matthias
 Eberl, 190–192
- EC89
 Richard L.
 Epstein, 186, 433, 478
 Walter A.
 Carnielli, 186, 433, 478
- Edmund
 Landau
 La29, 127, 400, 681, 684
- Edward
 Farhi
 AAB19, 163, 164, 569, 725, 726, 739–741, 750, 751
 Fredkin, 71
- Effandi
 Zakaria
 AZ10, 836
- Ei36
 Albert
 Einstein, 662
- Ei36a
 Albert
 Einstein, 662
- Ei50
 Albert
 Einstein, 715, 716
 Erwin
 Schrödinger, 715, 716
- Eija
 Rääkkönen
 Srv19, 836
- Einstein, 343

- Albert, 179, 374, 458, 681, 689
 Ei36, 662
 Ei36a, 662
 Ei50, 715, 716
 EPR35, 375, 650, 653, 659, 661, 664, 691
- Eisenstein
 Gotthold, 74
- Eleanor G.
 Rieffel
 AAB19, 163, 164, 569, 725, 726, 739–741, 750, 751
- Elena
 Calude
 CCS01, 139, 145
 Castellani
 BC05, 60, 61
- Elliott
 Mendelson
 Me15, 118, 248, 440–445, 481, 849, 854
 Me64, 18, 118, 128, 130–132, 134–136, 146, 152–154, 184–186, 201, 202, 240, 244, 248, 249, 276, 311, 312, 352, 382, 417, 423, 426, 433, 440, 443, 444, 460, 479, 481, 483, 486–488, 490, 506, 508, 551, 554, 561, 562, 565, 849–855
 Me90, 117, 142
- Elon
 Musk, 788
- empirical
 oracle, 762
- EPR35
 Albert
 Einstein, 375, 650, 653, 659, 661, 664, 691
 Boris Yakovlevich
 Podolsky, 375, 650, 653, 659, 661, 664, 691
 Nathan
 Rosen, 375, 650, 653, 659, 661, 664, 691
- Epstein
 Richard L.
 EC89, 186, 433, 478
- Er06
 Paul
 Ernest, 834
- Er12
 Paul
 Ernest, 824, 833
- Eratosthenes sieve, 287
- Erdős
 Paul, 627
- Eric
 Ostby
 AAB19, 163, 164, 569, 725, 726, 739–741, 750, 751
- Erich H.
 Reck
 AR02b, 186, 271
- Erik
 Lucero
 AAB19, 163, 164, 569, 725, 726, 739–741, 750, 751
- Erin
 Maloney
 RSM18, 836
- Ernest
 Paul
 Er06, 834
 Er12, 824, 833
- Ernst
 Specker, 201, 212, 514
 Zermelo, 817
- Errett
 Bishop
 Bi18, 23, 193, 278
 Bi66, 359
- Erwin
 Schrödinger, 179, 458, 662, 680, 723, 743
 cat paradox, 610, 646
 Ei50, 715, 716
 Sc35, 375, 648
 Schrödinger, 741
- Esenin-Volpin, *see* Yessenin-Volpin
- Euclid, 41
- Eugene
 Wigner, 736
- Eugene C.
 Luschei
 Lus62, 186
- Eugene P.
 Wigner
 Wgr60, 29, 347, 348, 808
- Evan
 Jeffrey
 AAB19, 163, 164, 569, 725, 726, 739–741, 750, 751
- Evans Ayagikwaga
 Tungosiamu
 Tng10, 836
- Evert W.
 Beth
 Be59, 186, 478, 480
- evidence-based
 quantification, 3, 187, 206, 363
- Ewin
 Tang
 Tang19, 741
 Tang22, 741, 742
- Excluded Middle
 Law
 LEM, 3, 18, 19, 166, 178, 184, 193, 194, 196–199, 227, 238, 243, 245, 256, 263, 271, 274–277, 281, 288, 359, 360, 362, 364, 379, 399, 473, 474, 476, 477, 490, 505, 799, 853, 984
 Principle, 166, 178, 181, 182, 262, 263

- existential
 quantification, 177, 183, 192, 247, 255, 263, 276, 277, 427, 455, 456, 479, 480
- explicandum
 Carnap, 36, 259, 286, 295, 323, 336, 341–343, 668, 799, 811, 813
- explication, 36, 238, 261, 289, 336, 518, 544, 843, 844
- explicatum
 Carnap, 36, 259, 286, 295, 323, 336, 341–343, 668, 799, 811, 813
- Fabrice
 Pataut
 Ptt98, 408
- factually grounded belief
 knowledge
 Piccinini, 7, 20, 29, 40, 55, 103, 122, 167, 169–172, 319, 354, 361, 372, 413, 437, 472
- faith-based
 quantification, 186
- Fano
 Vincenzo
 FG12, 540
- Farhi
 Edward
 AAB19, 163, 164, 569, 725, 726, 739–741, 750, 751
- Farzaneh
 Derakhshan
 SD21, 147, 148
- Fe00
 Solomon
 Feferman, 360, 361, 363–366
- Fe02
 Solomon
 Feferman, 192, 264, 315, 505, 682
- Fe06
 Solomon
 Feferman, 127, 409, 592
- Fe06a
 Solomon
 Feferman, 395, 408, 410
- Fe08
 Solomon
 Feferman, 127
- Fe60
 Solomon
 Feferman, 427
- Fe92
 Solomon
 Feferman, 487, 490
- Fe97
 Solomon
 Feferman, 366, 494, 495
- Fe98
 Solomon
 Feferman, 515, 517, 518, 844
- Fe99
 Solomon
 Feferman, 335
- Federico
 Aschieri
 AsZ12, 186
- Fedor
 Kostritsa
 AAB19, 163, 164, 569, 725, 726, 739–741, 750, 751
- Feferman
 Solomon
 Fe00, 360, 361, 363–366
 Fe02, 192, 264, 315, 505, 682
 Fe06, 127, 409, 592
 Fe06a, 395, 408, 410
 Fe08, 127
 Fe60, 427
 Fe92, 487, 490
 Fe97, 366, 494, 495
 Fe98, 515, 517, 518, 844
 Fe99, 335
 FFMS, 507
- Ferdinand
 de Saussure, 399
- Ferenc
 Csatári
 Csr19, 712
 Csr24, 23, 186, 245, 292
- Fermat
 Chetan
 Mehta, 56
 Infinite descent, 82, 83, 97, 100
 Last Theorem, 54, 56, 66, 428
 FLT, 47–54, 58, 64–67, 75–78
 Lost Proof, 47–54, 56, 58, 64–67, 428
 Pierre de, 47–54, 56, 58, 64–67, 75–78, 428
 Unrecorded Proof
 FUP, 47–54, 58, 64–67, 75, 76, 78
- Fernando G. S. L.
 Brandao
 AAB19, 163, 164, 569, 725, 726, 739–741, 750, 751
- Feynman
 Richard P., 52, 75
- FF98
 Gerda
 Fritsch, 94
 Rudolf
 Fritsch, 94
- FFMS
 Harvey M.
 Friedman, 507
 John R.
 Steel, 507
 Penelope

- Maddy, 507
 Solomon
 Feferman, 507
- FG12
 Pierluigi
 Graziani, 540
 Vincenzo
 Fano, 540
- FGW22
 Adam
 Frank, 599–602, 788
 David
 Grinspoon, 599–602, 788
 Sara
 Walker, 599–602, 788
- Fi19
 Michael Stephen
 Fiske, 163, 563, 569, 570, 572, 574–576, 578–580, 725
- Fiery
 Cushman
 PBC20, 171
- first-order
 logic
 FOL, 23, 128, 131, 166, 179, 182, 186, 243, 245, 247, 264, 271, 273–275, 277, 283, 284, 358, 359, 451, 477, 486, 490, 852, 855
 Peano Arithmetic
 PA, 18, 23, 31, 32, 40, 127, 128, 131–134, 136, 140, 146, 152, 154, 156, 159, 161, 162, 166, 177, 179, 185, 188, 193, 199, 201, 203, 205, 206, 213, 216, 219, 222, 224, 225, 229, 231, 233–237, 239–241, 243–245, 247, 251, 254–256, 260, 261, 264, 265, 270–272, 279, 284, 286, 287, 294, 296, 297, 302, 307, 308, 310–312, 315, 317–319, 321, 322, 325, 329, 330, 333, 347, 352–355, 358, 359, 362–366, 368, 369, 372, 374, 375, 382, 395, 400, 402, 408, 410, 411, 415, 418, 421, 422, 424, 432, 443, 444, 449–451, 453, 454, 458–462, 465, 467–469, 472, 476–478, 485–489, 491, 494, 495, 506, 509, 518, 545–547, 551, 552, 554–556, 558, 565, 566, 573, 578, 580, 590, 659, 662, 681, 682, 684, 686, 690, 724, 725, 727, 741, 753, 754, 758–762, 786, 789, 791–794, 802, 811, 812, 824, 827, 828, 830, 849, 855
 Set Theory
 ZF, 32, 140, 145, 146, 166, 247, 315, 325, 329, 353, 355, 362, 364–366, 370–372, 401–403, 415–417, 459, 462, 464, 465, 469, 472, 485, 487, 494, 505–509, 533, 760, 802, 827, 830
 ZFC, 403, 506, 508
- Fisher
 Yuval
 BPS88, 791
- Fiske
 Michael Stephen
 Fi19, 163, 563, 569, 570, 572, 574–576, 578–580, 725
 fixed point theorem
 diagonalization lemma, 441
 reflection theorem, 439
- Fl20
 Juliet
 Floyd, 464–472, 475–477
- Flach
 Matheus, 52
- Flavio
 Del Santo
 SG24, 210–212, 645
- Flo19
 Vera
 Flocke, 227–230, 428
- Flocke
 Vera
 Flo19, 227–230, 428
- Florencia
 Reali
 Rli16, 841
- Floyd
 Juliet, 332
 Fl20, 464–472, 475–477
 FP00, 302, 305, 307, 351, 404, 414
- FLT
 disembodied
 proof, 48–51
 Fermat
 Last Theorem, 47–54, 58, 64–67, 75–78
- FM15
 Daniele
 Molinini, 186, 379, 380, 833, 876
 Michèle
 Friend, 186, 379, 380, 833, 876
- FOL
 logic
 first-order, 23, 128, 131, 166, 179, 182, 186, 243, 245, 247, 264, 271, 273–275, 277, 283, 284, 358, 359, 451, 477, 486, 490, 852, 855
- For10
 Giambattista
 Formica, 334
- Forced
 Halting Theorem, 565, 567, 568, 761
- formal
 oracle, 762
- Formica
 Giambattista
 For10, 334
- Fortnow
 Lance
 Frt03, 141
 Frt09, 158, 160, 322

- Foster
 Alan
 Byd14, 836
- Four Colour Theorem
 4CT, 79–85
- Fowler
 Austin
 AAB19, 163, 164, 569, 725, 726, 739–741, 750, 751
- Foxen
 Brooks
 AAB19, 163, 164, 569, 725, 726, 739–741, 750, 751
- FP00
 Hilary
 Putnam, 302, 305, 307, 351, 404, 414
 Juliet
 Floyd, 302, 305, 307, 351, 404, 414
- Fr09
 Curtis
 Franks, 24, 259, 273, 274, 852
- Fra94
 Pasquale
 Frasca, 36, 283, 284, 325, 327
- Fraenkel
 Abraham, 343
 Abraham A.
 BF58, 186, 506
- Francis
 Bailly
 BLo08, 33
- Frank
 Adam, 789
 FGW22, 599–602, 788
 Arute
 AAB19, 163, 164, 569, 725, 726, 739–741, 750, 751
 Drake, 787, 795
 Quinn, 70
 Waaldijk
 Wl03, 285, 689, 690
- Frank H.
 Guenther
 GDGGR, 558
- Franks
 Curtis
 Fr09, 24, 259, 273, 274, 852
- Frascolla
 Pasquale
 Fra94, 36, 283, 284, 325, 327
- Fraser
 James Duncan
 FV22, 374
- Frauchiger
 Daniela
 FrRe18, 705, 736
- Frd01
 Michael
 Friedman, 214, 278, 339, 343
- Fre18
 Rodrigo A.
 Freire, 127
- Fred
 Diamond, 74
 DDR95, 52
 Richman
 Rch83, 154–156
- Fredkin
 Edward, 71
- Freek
 Wiedijk
 BW05, 53, 54, 146, 298
- Frege
 Gottlob, 273, 820
- Freire
 Alfredo Roque
 Fri19, 495, 496, 500
 Rodrigo A.
 Fre18, 127
- Freivalds
 Rūsiņš
 BFS08, 438, 439
- French
 Robert M.
 Frn00, 558
- Fri19
 Alfredo Roque
 Freire, 495, 496, 500
- Friedman
 Harvey M.
 FFMS, 507
 Michael
 Frd01, 214, 278, 339, 343
 Ori
 PBC20, 171
- Friend
 Michèle
 FM15, 186, 379, 380, 833, 876
- Frisch
 Mathias
 WBF22, 47, 48
- Fritsch
 Gerda
 FF98, 94
 Rudolf
 FF98, 94
- Fritz
 Annemarie
 OHF19, 841
- Frn00
 Robert M.
 French, 558

- FrRe18
 Daniela
 Frauchiger, 705, 736
 Renato
 Renner, 705, 736
- Frt03
 Lance
 Fortnow, 141
- Frt09
 Lance
 Fortnow, 158, 160, 322
- Fu42
 W. H.
 Furry, 609
- FUP
 Fermat
 Unrecorded Proof, 47–54, 58, 64–67, 75, 76, 78
- Furry
 W. H.
 Ga15, 609
- FV22
 James Duncan
 Fraser, 374
 Peter
 Vickers, 374
- G.
 Chardin
 Chr97, 531
- G. H.
 Hardy, 295
 Har40, 419
 Har41, 470
 HL23, 608
 HW60, 612, 614, 615, 620, 623, 626, 627, 636
- G. T.
 Kneebone
 Kn63, 186
- Gödel
 ω -consistency, 3, 18, 31, 152, 178, 184, 185, 187, 194, 235, 236, 241, 243, 244, 247, 249, 307, 308, 310, 365, 369, 411, 442, 443, 455, 457, 467, 478, 482, 484, 853, 984
 Kurt, 18, 69, 203, 295, 402, 458, 516, 517, 551, 743, 824
 Go31, 7, 31, 33, 35, 132, 135, 151, 152, 154, 156, 158, 160, 161, 164, 166, 179, 184, 185, 199, 201, 213, 219, 225, 229, 236, 241, 245, 247, 249, 258, 260, 276, 279, 306, 308, 316, 319, 330, 331, 353, 367, 368, 372, 383, 384, 389, 394–396, 399, 400, 402, 403, 407, 409–411, 415–417, 419, 422, 423, 425, 427, 429–435, 437, 439, 440, 442, 450–454, 456, 457, 466, 467, 478, 480, 481, 503, 505, 506, 509, 540, 543–545, 547, 552, 554, 558, 560, 567, 584, 607, 686, 690, 791, 793, 812, 857
 Go33, 252, 277
 Go40, 459
 Go51, 203, 373
 Go64, 549, 550
- Gödelian
 Thesis, 7, 18, 152, 196, 215, 270, 284, 287, 540, 546, 548, 553, 554, 556
- Gödelian Thesis
 Lucas, 196, 215, 270, 284, 287, 540, 545–547, 554
 Penrose, 540, 545, 548, 551, 554
- Ga15
 Yvon
 Gauthier, 656
- Gabriel
 Lamé, 65
- Gaf04
 Haim
 Gaifman, 220–222, 224, 225, 312, 440, 485
- Gaf06
 Haim
 Gaifman, 439
- Gaifman
 Haim
 Gaf04, 220–222, 224, 225, 312, 440, 485
 Gaf06, 439
- Gaisi
 Takeuti, 242
- Gal18
 Brian
 Gallagher, 373
- Gallagher
 Brian
 Gal18, 373
- Galois
 Évariste, 52
- Gam18
 David
 Gamez, 259, 286, 335, 336
- Gamez
 David
 Gam18, 259, 286, 335, 336
- Ganea
 Mihai
 Gna14, 207–209
- Gao
 Shan
 Gao23, 709, 710
- Gao23
 Shan
 Gao, 709, 710
- Gardner
 Robert
 Grd21, 81, 92
- Gauss
 Carl Friedrich, 627
- Gauthier
 Yvon

- Ga15, 656
- Gd44
R. L.
Goodstein, 73, 220, 294, 362, 435–437, 492–494, 496–499
- GDDGP, *see* GDDGR
- GDGGR
Andres F.
Salazar-Gomez, 558
Daniela
Rus, 558
Frank H.
Guenther, 558
Joseph
DelPreto, 558
Stephanie
Gil, 558
- Geiser
James, 423
genetically inherited
knowledge, 805
- Gentzen
Gerhard, 134, 136, 145, 178, 237, 238, 240–242, 252–254, 256, 261, 360, 363–366, 435, 507
- Georg
Cantor, 7, 157, 179, 274, 437, 458, 472, 505, 686, 816, 817, 821, 823
- Georg Wilhelm Friedrich
Hegel, 399
- George
Lakoff
LR00, 32, 33, 36, 72, 117, 118, 120, 128, 141, 146, 177, 259, 284, 286, 290, 293, 295, 298, 323, 335, 340, 341, 353, 358, 373, 374, 386, 507, 510, 514, 550, 590, 642, 661, 663, 668, 686, 797–803, 805, 806, 808–811, 813, 816, 829
Pólya
Pol59, 609
- George S.
Boolos
BBJ03, 18, 186, 202, 204, 209, 478, 485, 487, 508, 561, 849
- Georges
Gonthier
Gnt08, 80
Gon08, 123
- Georgiev
Danko D., 875
- Gerardo
Ramirez
RSM18, 836
- Gerda
Fritsch
FF98, 94
- Gerhard
Gentzen, 134, 136, 145, 178, 237, 238, 240–242, 252–254, 256, 261, 360, 363–366, 435, 507
- Gi19
Nicolas
Gisin, 217, 519, 644, 645, 688
- Gi20
Nicolas
Gisin, 217, 519, 644, 688
- Gia97
Giovanni
lorio Giannoli, 42–44, 47, 405, 406, 557
- Giambattista
Formica
For10, 334
- Gidney
Craig
AAB19, 163, 164, 569, 725, 726, 739–741, 750, 751
- Gil
Kalai
Kli19, 737–739
Kli22, 739, 740
Stephanie
GDGGR, 558
- Gila
Hanna, 32
Sher
Shr13, 298, 299, 358, 813
Shr18, 23, 36, 359, 360
Shr23, 299
- Giovanni
lorio Giannoli
Gia97, 42–44, 47, 405, 406, 557
Sambin
MS05, 274
- Gisin
Nicolas
Gi19, 217, 519, 644, 645, 688
Gi20, 217, 519, 644, 688
SG24, 210–212, 645
- Giuseppe
Longo
BLo08, 33
Peano, 358, 516
- Giustina
Marissa
AAB19, 163, 164, 569, 725, 726, 739–741, 750, 751
- Glimm
James, 70
- Gna14
Mihai
Ganea, 207–209
- Gnt08
Georges
Gonthier, 80
- Go31

- Kurt
 Gödel, 7, 31, 33, 35, 132, 135, 151, 152, 154, 156, 158, 160, 161, 164, 166, 179, 184, 185, 199, 201, 213, 219, 225, 229, 236, 241, 245, 247, 249, 258, 260, 276, 279, 306, 308, 316, 319, 330, 331, 353, 367, 368, 372, 383, 384, 389, 394–396, 399, 400, 402, 403, 407, 409–411, 415–417, 419, 422, 423, 425, 427, 429–435, 437, 439, 440, 442, 450–454, 456, 457, 466, 467, 478, 480, 481, 503, 505, 506, 509, 540, 543–545, 547, 552, 554, 558, 560, 567, 584, 607, 686, 690, 791, 793, 812, 857
- Go33
 Kurt
 Gödel, 252, 277
- Go40
 Kurt
 Gödel, 459
- Go51
 Kurt
 Gödel, 203, 373
- Go64
 Kurt
 Gödel, 549, 550
- Godziszewski
 Michał Tomasz
 GoU19, 388, 446, 447, 503, 504
- Goldbach's
 Conjecture, 636
- Goldbring
 Isaac
 BaG23, 707–709
- Goldin
 Dina
 WG03, 139, 141, 142
- Goldman
 T.
 NG91, 531
- Goldstein
 Sheldon
 Sh+11, 648, 650, 655
- Gon08
 Georges
 Gonthier, 123
- Gonthier
 Georges
 Gnt08, 80
 Gon08, 123
- Goodstein
 R. L., 179, 458, 469, 758
 Gd44, 73, 220, 294, 362, 435–437, 492–494, 496–499
- Goodstein's
 Theorem, 66
- Gorō
 Shimura, 52
- Goranko
 Valentin
 CG15, 81, 92
- Goro
 Shimura, 74
- Gottfried
 Wilhelm
 Leibniz, 818, 820
- Gotthold
 Eisenstein, 74
- Gottlob
 Frege, 273, 820
- GoU19
 Michał Tomasz
 Godziszewski, 388, 446, 447, 503, 504
 Rafał
 Urbaniak, 388, 446, 447, 503, 504
- Govindarajalu
 Naveen Sundar
 BG11, 206
 BG11a, 206
- Gow02
 Timothy
 Gowers, 504
- Gowers
 Timothy
 Gow02, 504
- Goyal
 Philip
 Gyl22, 646, 648
- Gpt18
 Amitabha
 Gupta, 713–715
- Gr17
 N.
 Gurappa, 638
 Roderich
 Groß, 558
- Graff
 Rob
 AAB19, 163, 164, 569, 725, 726, 739–741, 750, 751
- Graham
 Priest, 399
- Granville
 Andrew
 Grn22, 23, 102, 111–115, 124, 125, 148–150, 186, 258, 386, 560
 Grn95, 627
- Graziani
 Pierluigi
 FG12, 540
- Grd21
 Robert
 Gardner, 81, 92
- Gregory

- Chaitin, 70
 Ct82, 687
- Gregory J.
 Chaitin, 573
 Ct75, 201, 204
 Ct82, 201
- Greig
 Ian
 Grg02a, 691–698
- Grg02a
 Ian
 Greig, 691–698
- Griffiths
 Owen
 PG21, 384–386, 388–390
- Grinspoon
 David
 FGW22, 599–602, 788
- Grinstead
 Charles M.
 GS97, 612
- Grl21
 Jesús Eduardo Granados
 Gurrola, 502
- Grn22
 Andrew
 Granville, 23, 102, 111–115, 124, 125, 148–150, 186, 258, 386, 560
- Grn95
 Andrew
 Granville, 627
- Groß
 Roderich
 Gr17, 558
- Grp17
 N.
 Gurappa, 637, 638
- Grp18
 N.
 Gurappa, 638, 639
- Grp22
 N.
 Gurappa, 655
- GS97
 Charles M.
 Grinstead, 612
 J. Laurie
 Snell, 612
- Gu19
 Yuri
 Gurevich, 266
- Gualtiero
 Piccinini, 7, 437
 Pic03, 540, 558
 Pic11, 206
 Pic15, 593
- Pic19, 20, 21, 29, 35, 40, 44, 45, 55, 74, 100, 103, 167–172, 174, 175, 274, 319, 353, 354, 361, 372, 472
 SP10, 372
- Guenther
 Frank H.
 GDGGR, 558
- Guerin
 Keith
 AAB19, 163, 164, 569, 725, 726, 739–741, 750, 751
- Gupta
 Amitabha
 Gpt18, 713–715
- Gurappa
 N.
 Grp17, 637, 638
 Grp18, 638, 639
 Grp22, 655
- Gurevich
 Yuri
 DG08, 266–268
 Gu19, 266
- Gurrola
 Jesús Eduardo Granados
 Grl21, 502
- György
 Serény
 Srn11, 411–414
- Gyl22
 Philip
 Goyal, 646, 648
- H. W.
 Lenstra Jr.
 LP11, 603, 614
- Hájek
 Petr
 HP98, 485
- HA28
 David
 Hilbert, 186
 Wilhelm
 Ackermann, 186
- Haan
 Stefan
 RJHH, 125, 126
- Habegger
 Steve
 AAB19, 163, 164, 569, 725, 726, 739–741, 750, 751
- Hadamard
 Jacques, 627
- Hahn
 Hans, 516
- Haim
 Gaifman

- Gaf04, 220–222, 224, 225, 312, 440, 485
 Gaf06, 439
- Haken
 Wolfgang
 AH77, 79–81, 89–91, 95, 110, 123, 124, 760
 AHK77, 79–81, 89–91, 95, 110, 123, 124, 760
- Halder
 Ujjwal Kumar
 AH18, 836
- Hallett, 191
- Halting
 decidability, 154
 function, 686
 oracle, 196, 197
 output, 576, 577
 point, 568, 572, 574
 Probability
 Chaitin, 201, 204
 problem, 179, 198
 Turing, 198, 200
 problem for T , 197
 state, 568, 570–572, 574, 576, 578, 579
 syntax, 576
 Theorem
 Turing, 580
 value, 579
- Halting Argument
 Turing, 474
- Halting problem, 561
 Turing, 561, 569, 570
- Halting Theorem
 Forced, 565, 567, 568, 761
 Turing, 418, 562, 567–569, 582, 761
- Halting-decidability Problem for T , 569
- Halting-decidability problem for T , 565
- Halting-decidability Theorem for T , 567, 569, 581, 761, 762
- Hamkins
 Joel David
 HN24, 563–565
- Hamming
 Richard W.
 Hmg79, 349
- Han06
 Robert Alan
 Hanna, 298
- Hanna
 Gila, 32
 Robert Alan
 Han06, 298
- Hannes
 Leitgeb
 Lei09, 409, 410
 Lei10, 541
- Hanovar
 Vasant, 875
- Hans
 Hahn, 516
 Radder
 Rdd22, 342, 597, 598
- Hans-Otto
 Peitgen
 BPS88, 791
 PR86, 791
- Hao
 Wang, 452
 Wa63, 186, 246, 478, 479
- Har40
 G. H.
 Hardy, 419
- Har41
 G. H.
 Hardy, 470
- Hardy
 G. H., 295
 Har40, 419
 Har41, 470
 HL23, 608
 HW60, 612, 614, 615, 620, 623, 626, 627, 636
- Harrigan
 Mathew P.
 AAB19, 163, 164, 569, 725, 726, 739–741, 750, 751
- Harrington
 Leo, 38, 39
 Paris
 Theorem, 435
- Harris
 Michael
 Hrs01, 71, 72
 Hrs19, 53–55, 58, 67, 69, 70, 74, 119
 Roy, 825, 827
- Hartley
 Rogers
 Rg87, 18, 186, 479, 565, 849
- Hartmann
 Michael J.
 AAB19, 163, 164, 569, 725, 726, 739–741, 750, 751
- Hartmut
 Neven
 AAB19, 163, 164, 569, 725, 726, 739–741, 750, 751
- Harvey M.
 Friedman
 FFMS, 507
- Hattiangadi
 Anandi
 BH24, 298
 Htt23, 299, 300
- Hawking
 Stephen, 215, 592, 788

- Hd06
Shawn
Hedman, 186, 433, 499, 500
- He04
Alexander
Yessenin-Volpin, 152, 237
Catherine
Christer-Hennix, 152, 237
- Heawood
Percy J., 96
- Hedman
Shawn
Hd06, 186, 433, 499, 500
- Hegel
Georg Wilhelm Friedrich, 399
- Hei76
Jean
van Heijenoort, 18
- Hej18
Bohdan
Hejna, 419
- Hejna
Bohdan
Hi30, 419
- Helena
Viholainen
Srv19, 836
- Helge
Kragh
Kra19, 534, 536, 538
- Helmenstine
Anne Marie
Hlm19, 848
- Helmholtz, 343
- Henk
Barendregt
Brd13, 23, 298, 335
BW05, 53, 54, 146, 298
- Hennix, *see* Christer-Hennix
- Henri
Darmon, 74
DDR95, 52
Poincaré, 136, 374, 516, 517, 662, 672, 682, 686
- Her83
William
Hermanns, 689
- Hermann
Weyl, 278, 332, 343, 682
We10, 341, 803, 804, 811
We27, 136, 146
- Hermanns
William
Her83, 689
- Hersh
Reuben
Hr97, 294
- Herzog
Moritz
OHF19, 841
- Heyting, 279
Arend, 129, 177, 195, 197, 297
Hyt59, 279
- Hi00
David
Hilbert, 179, 223, 235, 240, 363, 852
- Hi25
David
Hilbert, 186
- Hi27
David
Hilbert, 7, 131, 136, 181, 262, 275, 373, 437, 505
- Hi30
David
Hilbert, 235
- Hiebler
Moritz
RJHH, 125, 126
- Hilary
Putnam, 306, 466, 467, 518, 546, 833
BPu64, 18
FP00, 302, 305, 307, 351, 404, 414
Pu71, 263
- Hilbert
 ε -calculus, 3, 18, 19, 166, 178, 181, 182, 184, 247, 262, 263, 276, 281, 984
 ε -function, 427
David, 18, 33, 170, 177, 182, 187, 190, 230, 236–239, 243, 246–248, 251, 252, 254–257, 259–261, 263, 271, 273, 274, 276, 283, 286, 330, 332, 334, 335, 358, 374, 402, 410, 412, 479, 505, 506, 516, 517, 551, 554, 662, 672, 684, 685, 824, 875
Dogma, 166
HA28, 186
Hi00, 179, 223, 235, 240, 363, 852
Hi25, 186
Hi27, 7, 131, 136, 181, 262, 275, 373, 437, 505
Hi30, 235
Program, 286
Thesis, 144, 206
- Hilbert's
Program, 187, 252, 254, 255, 257
- Hilbert's Program, 285
- HL23
G. H.
Hardy, 608
J. E.
Littlewood, 608
- Hlb20
Štěpán
Holub, 540
- Hlm19

- Anne Marie
Helmenstine, 848
- Hmg79
Richard W.
Hamming, 349
- HN24
Joel David
Hamkins, 563–565
Theodor
Nenu, 563–565
- Ho
Alan
AAB19, 163, 164, 569, 725, 726, 739–741, 750, 751
- Hoffmann
Markus
AAB19, 163, 164, 569, 725, 726, 739–741, 750, 751
- Holub
Štěpán
Hlb20, 540
- Hooke
Robert, 876
- Hos18
Sabine
Hossenfelder, 533
- Hos18a
Sabine
Hossenfelder, 260, 378, 379, 530–532, 702, 704, 706
- Hos19
Sabine
Hossenfelder, 534, 539
- Hossenfelder
Sabine
Hos18, 533
Hos18a, 530–532, 702, 704, 706
Hos19, 534, 539
Hos1a, 260, 378, 379
- HP98
Pavel
Pudlák, 485
Petr
Hájek, 485
- Hr97
Reuben
Hersh, 294
- Hrs01
Michael
Harris, 71, 72
- Hrs19
Michael
Harris, 53–55, 58, 67, 69, 70, 74, 119
- Hrubeš
Pavel
Dvd19, 186
- Htt23
Anandi
Hattiangadi, 299, 300
- Huang
Trent
AAB19, 163, 164, 569, 725, 726, 739–741, 750, 751
- human
knowledge, 217, 645
- Humberto
Maturana
LMMP, 595, 596
- Humble
Travis S.
AAB19, 163, 164, 569, 725, 726, 739–741, 750, 751
- Huw
Price
PW23, 720, 721
- Huzurbazar
Manohar S., 186, 373, 876, 877
- HW60
E. M.
Wright, 612, 614, 615, 620, 623, 626, 627, 636
G. H.
Hardy, 612, 614, 615, 620, 623, 626, 627, 636
- Hypothesis
Continuum, 823
- Hyt59
Arend
Heyting, 279
- Ian
Greig
Grg02a, 691–698
- Ian Nicholas
Stewart
St81, 80
- Iemhoff, 343
- Igor
Pak, 117
- illusion
knowledge, 381
- Ilyas
Cicekli
SCA00, 558
- Immanuel
Kant, 273, 518
- immediate
knowledge, 549
- impredicativity
paradox, 154
- Infinite descent
Fermat, 82, 83, 97, 100
- insight, 54, 55, 65, 142, 143, 168, 169, 306, 313, 322, 327, 373, 407, 410, 543, 551, 678, 746, 760, 845

- Institute of Science
Mumbai, 876
- intuitive
knowledge, 517, 797
- Isaac
Goldbring
BaG23, 707–709
Newton, 876
- Isaacson
Daniel, 435, 437
Isc11, 150, 250
Thesis, 434–436
- Isakov
Sergei V.
AAB19, 163, 164, 569, 725, 726, 739–741, 750, 751
- Isc11
Daniel
Isaacson, 150, 250
- Itzhak
Bars
BCST, 531
- J. Barkley
Rosser, 179, 458, 551
Ro36, 29, 247, 249, 434, 467, 478, 480, 481
Ro53, 29–31, 186, 247–249, 434, 442–444
- J. E.
Littlewood
HL23, 608
- J. Laurie
Snell
GS97, 612
- Jörn
Steuding
Ste02, 608–610
Steuding
Ste02, 628
- Jānis
Bārzdīņš
BFS08, 438, 439
- Jack
Copeland
Cop04, 725
- Jacques
Derrida, 396, 399
Hadamard, 627
- Jaffe
Arthur, 70
- Jakob G.
Simonsen
Smn05, 201, 212, 514
- Jakob Grue
Simonsen
Smn05, 189
- Jakobitsch
Max-Julian
RJHH, 125, 126
- James
Geiser, 423
Glimm, 70
- James Duncan
Fraser
FV22, 374
- James H.
Schmerl
KS06, 485
- James J.
Madden
Md01, 141, 800
- Jan
Mycielski
MM01, 144, 508
Mycl, 358
Woleński
OWJ06, 206
- Janusz
Robert
OWJ06, 206
- Jared
Diamond, 786
- Jarrold R.
McClean
AAB19, 163, 164, 569, 725, 726, 739–741, 750, 751
- Jason
Megill
Meg, 546
- Jayant V
Narlikar, 876
- Jean
Bricmont, 70, 71
Dieudonné, 70
Di70, 294
van Heijenoort
Hei76, 18
- Jean-Marc
Lévy-
Leblond, 70, 72
- Jean-Pierre
Changeaux, 72
- Jean-Yves
Beziau, 875
- Jeff
Buechner
Bu10, 143
Bu20, 540
Paris
KP82, 493, 494, 500
- Jeffrey
Evan
AAB19, 163, 164, 569, 725, 726, 739–741, 750, 751

- Ketland, 413
- Richard C.
BBJ03, 18, 186, 202, 204, 209, 478, 485, 487,
508, 561, 849
- Jeffrey Alan
Barrett
BaG23, 707–709
Brr08, 375–377
- Jeremy
Avigad
Avg21, 73, 74
Avg23, 349–351
- Jerome
Lettvin
LMMP, 595, 596
- Jesús Eduardo Granados
Gurrola
Gr121, 502
- Jessica
Oddan
Odn24, 721–723
- Jhao
Nan
ZZK19, 841
- Jiang
Zhang
AAB19, 163, 164, 569, 725, 726, 739–741, 750,
751
- Jiménez-Leal
William
Rli16, 841
- Jing
Zhang
ZZK19, 841
- Jo
Boaler
AWB20, 831
- Jo17
Steven
Johnson, 787, 788, 795, 796
- Job
de Grefte
Grf21, 100, 167, 168, 170
- Joel David
Hamkins
HN24, 563–565
- Johann Heinrich
Pestalozzi
Principle of Anschauung, 105, 123
- John
Burgess
Bur10, 540, 545
Byrnes
SB99, 147, 553, 554
Coates, 74
Corcoran
Cor73, 295, 296
- Koch
AHK77, 79–81, 89–91, 95, 110, 123, 124, 760
- Martinis
AAB19, 163, 164, 569, 725, 726, 739–741, 750,
751
- Turri
PBC20, 171
- Wallis, 52
- John von
Neumann, 334
- John C.
Platt
AAB19, 163, 164, 569, 725, 726, 739–741, 750,
751
- John F.
Clauser, 658
- John L.
Bell
Bl107, 440, 441
- John M.
Martinis
AAB19, 163, 164, 569, 725, 726, 739–741, 750,
751
- John N.
Crossley
Cr05, 186
- John P.
Burgess
BBJ03, 18, 186, 202, 204, 209, 478, 485, 487,
508, 561, 849
- John R.
Steel
FFMS, 507
- John Randolph
Lucas, 29, 179, 215, 226, 411, 458, 540, 541, 544,
548, 551, 554, 559
Lu61, 143, 284, 311, 545
Lu96, 284, 311, 545, 546, 560
- John Stewart
Bell
Bl64, 573, 637, 656, 657, 660, 662, 679, 727, 731
- John von
Neumann, 334, 335
- Johnson
Steven
Jo17, 787, 788, 795, 796
- Jon
Awbrey
Aw18, 519
- Jonas R. B.
Arenhart
KA19, 38
- Jonathan
Barrett
PBR12, 727

- Bartlett
 BRT18, 642–644
 Phillips
 PBC20, 171
 Swift, 6
- Jordan
 Camille, 516
- Joseph
 DelPreto
 GDGGR, 558
 Shoenfield
 Sh67, 186, 433, 479, 495
 Vidal-Rosset
 Vid06, 406
- Joseph C.
 Bardin
 AAB19, 163, 164, 569, 725, 726, 739–741, 750, 751
- Josh
 Mutus
 AAB19, 163, 164, 569, 725, 726, 739–741, 750, 751
- Joshua
 Knobe
 PBC20, 171
- Joy
 Christian
 Chs24, 660
- Jozsa
 Richard
 DJ92, 731, 733, 734, 736, 737, 740, 762, 763
- Jubilee
 Smith
 Byd14, 836
- Julian
 Kelly
 AAB19, 163, 164, 569, 725, 726, 739–741, 750, 751
- Julian R.
 Brown
 DB93, 658
- Juliet
 Floyd, 332
 Fl20, 464–472, 475–477
 FP00, 302, 305, 307, 351, 404, 414
- Juliette
 Kennedy
 Knd13, 23, 33–36, 258
 Knd17, 203
- justified true belief
 knowledge
 Plato, 7, 20, 29, 40, 55, 103, 122, 167, 169–172, 319, 354, 361, 372, 413, 437, 472
- Ka11
 Richard
 Kaye, 400, 466, 485
- KA19
 Décio
 Krause, 38
 Jonas R. B.
 Arenhart, 38
- Ka91
 Richard
 Kaye, 400, 433, 434, 458, 466, 485, 488, 490
- Kafri
 Dvir
 AAB19, 163, 164, 569, 725, 726, 739–741, 750, 751
- Kalai
 Gil
 Kli19, 737–739
 Kli22, 739, 740
- Kalmár
 László
 Km59, 206, 590, 591
- Kant
 Immanuel, 273, 518
- Kap16
 Doukas
 Kapantais, 267–270
- Kapantais
 Doukas
 Kap16, 267–270
- Karim
 Thebault
 DDT19, 534
- Karl-Georg
 Niebergall
 SN01, 235–240, 251, 259–261
- Karlis
 Podnieks
 DP17, 186
 Pdn15, 20, 28–31
 Pdn92, 186
- Kashtan
 David
 Ksh20, 540
- Kasper
 Müller, 636
- Katherine
 Brading
 BC05, 60, 61
- Kathryn
 Denning, 795, 796
 Dng10, 786, 787
- Kati Kish
 Bar-On
 Bro22, 214, 278, 339, 343
 Bro22a, 282
- Kau87
 Louis H.
 Kauffman, 502, 743, 746

- Kauffman
 Louis H.
 Kau87, 502, 743, 746
 KC19, 743, 746
- Kayal
 Neeraj
 AKS04, 603, 614
- Kaye
 Richard
 Ka11, 400, 466, 485
 Ka91, 400, 433, 434, 458, 466, 485, 488, 490
- KC19
 Arthur M.
 Collings, 743, 746
 Louis H.
 Kauffman, 743, 746
- Kechedzhi
 Kostyantyn
 AAB19, 163, 164, 569, 725, 726, 739–741, 750, 751
- Kechris
 Alexander S.
 BKPS, 39, 204, 205
- Keith
 Devlin
 Dev94, 53
 Guerin
 AAB19, 163, 164, 569, 725, 726, 739–741, 750, 751
- Kelly
 Julian
 AAB19, 163, 164, 569, 725, 726, 739–741, 750, 751
- Kempe
 Alfred Bray
 Kmp79, 53, 81, 86, 89–96, 98, 99
- Ken
 Wharton
 PW23, 720, 721
- Kennedy
 Juliette
 Knd13, 23, 33–36, 258
 Knd17, 203
- Kenneth
 Appel
 AH77, 79–81, 89–91, 95, 110, 123, 124, 760
 AHK77, 79–81, 89–91, 95, 110, 123, 124, 760
- Kenneth W.
 Regan
 Re16, 609
- Keren
 Arnon
 Krn22, 336
- Ketland
 Jeffrey, 413
- Kevin
 Buzzard, 73
 Kevin J.
 Satzinger
 AAB19, 163, 164, 569, 725, 726, 739–741, 750, 751
 Sung
 AAB19, 163, 164, 569, 725, 726, 739–741, 750, 751
- Khabirul
 Alam
 AH18, 836
- Khosla
 Rajiv, 875
- Kirby
 Laurie
 KP82, 493, 494, 500
- Kitcher
 Philip, 70
- Kl36
 Stephen Cole
 Kleene, 590
- Kl52
 Stephen Cole
 Kleene, 23, 129, 186, 189, 199, 249, 274, 275, 412, 479, 481, 483
- Kleene
 Stephen Cole, 266
 Kl36, 590
 Kl52, 23, 129, 186, 189, 199, 249, 274, 275, 412, 479, 481, 483
- Kli19
 Gil
 Kalai, 737–739
- Kli22
 Gil
 Kalai, 739, 740
- Klimov
 Paul V.
 AAB19, 163, 164, 569, 725, 726, 739–741, 750, 751
- Km59
 László
 Kalmár, 206, 590, 591
- Kma08
 Vojtěch
 Kolman, 136–139, 386–388, 472, 473
- Kma18
 Vojtěch
 Kolman, 105, 107–110
- Kmp79
 Alfred Bray
 Kempe, 53, 81, 86, 89–96, 98, 99
- Kn63
 G. T.
 Kneebone, 186
- Knd13

- Juliette
 Kennedy, 23, 33–36, 258
- Knd17
 Juliette
 Kennedy, 203
- Kneebone
 G. T.
 Kn63, 186
- Knobe
 Joshua
 PBC20, 171
- knowledge, 21, 32, 36, 40, 41, 166–171, 189, 215, 217, 274, 284, 291, 294, 298, 299, 319, 320, 354, 364, 365, 375, 377, 381, 438, 472, 502, 533, 536, 551, 582, 588, 591, 592, 645, 649, 650, 672, 676, 685, 727, 728, 737, 748, 749, 754–756, 759, 790, 826, 832–834, 837, 838, 842
- a posteriori, 327
- a priori, 327
- abstract, 838
- base, 848
- factually grounded belief, 437
 Piccinini, 7, 20, 29, 40, 55, 103, 122, 167, 169–172, 319, 354, 361, 372, 413, 437, 472
- genetically inherited, 805
- human, 217, 645
- illusion, 381
- immediate, 549
- intuitive, 517, 797
- justified true belief, 437
 Plato, 7, 20, 29, 40, 55, 103, 122, 167, 169–172, 319, 354, 361, 372, 413, 437, 472
- lack of, 672, 673, 675, 676
- limits, 645
- logical, 759
- mathematical, 224, 287, 321, 464, 606, 607, 749, 751, 752, 754, 755, 807, 832, 837, 838, 841, 842
- of a state, 764
- oracle, 749, 764
- predicate, 383
- prior, 736, 837
- pure, 838
- scientific, 361, 796
- shared, 827
- tacit, 817
- transfer, 379
- verifier, 743
- Knysh
 Sergey
 AAB19, 163, 164, 569, 725, 726, 739–741, 750, 751
- Ko25
 Andrei Nikolaevich
 Kolmogorov, 275
- Ko56
- Andrei Nikolaevich
 Kolmogorov, 616
- Koch
 John
 AHK77, 79–81, 89–91, 95, 110, 123, 124, 760
- Kolman
 Vojtěch
 Kma08, 136–139, 386–388, 472, 473
 Kma18, 105, 107–110
- Kolmogorov
 Andrei Nikolaevich, 129, 177, 195, 197, 297
 Ko25, 275
 Ko56, 616
- Kolyvagin
 Victor, 52
- Kong
 Qi Ping
 ZZK19, 841
- Konrad
 Zdanowski
 QZ07, 225, 226
- Koponen
 Tuire
 Srv19, 836
- Korotkov
 Alexander
 AAB19, 163, 164, 569, 725, 726, 739–741, 750, 751
- Kossak
 Roman
 KS06, 485
- Kostritsa
 Fedor
 AAB19, 163, 164, 569, 725, 726, 739–741, 750, 751
- Kostyantyn
 Kechedzhi
 AAB19, 163, 164, 569, 725, 726, 739–741, 750, 751
- Kov18
 Marko
 Kovic, 790
 Kvic, 790
- Kovic
 Marko
 Kov18, 790
- KP82
 Jeff
 Paris, 493, 494, 500
- Laurie
 Kirby, 493, 494, 500
- Kr14
 Stanislaw
 Krajewski, 266
- Kr16
 Stanislaw

- Krajewski, 177, 273, 276, 287–290, 292–294, 358, 400, 514, 515, 806
- Kr19
Stanislaw
Krajewski, 187
- Kr20
Stanislaw
Krajewski, 407, 540, 543, 544
- Kra19
Helge
Kragh, 534, 536, 538
- Kragh
Helge
Kra19, 534, 536, 538
- Krajewski
Stanislaw
Kr14, 266
Kr16, 177, 273, 276, 287–290, 292–294, 358, 400, 514, 515, 806
Kr19, 187
Kr20, 407, 540, 543, 544
- Krause
Décio
KA19, 38
Krs22, 265, 390–393, 820
- Kripke
Saul A.
Krp13, 144, 145, 206
- Kritel
Michielsen
AAB19, 163, 164, 569, 725, 726, 739–741, 750, 751
- Krn22
Arnon
Keren, 336
- Krp13
Saul A.
Kripke, 144, 145, 206
- Krs22
Décio
Krause, 265, 390–393, 820
- Krzysztof
Wójtowicz
Wo09, 740, 741, 743–748, 750–752
Wo19, 743, 751–762
- KS06
James H.
Schmerl, 485
Roman
Kossak, 485
- Ksh20
David
Kashtan, 540
- Kunal
Arya
- AAB19, 163, 164, 569, 725, 726, 739–741, 750, 751
- Kurt
Gödel, 18, 69, 203, 295, 402, 458, 516, 517, 551, 743, 824
Dogma, 170
Go31, 7, 31, 33, 35, 132, 135, 151, 152, 154, 156, 158, 160, 161, 164, 166, 179, 184, 185, 199, 201, 213, 219, 225, 229, 236, 241, 245, 247, 249, 258, 260, 276, 279, 306, 308, 316, 319, 330, 331, 353, 367, 368, 372, 383, 384, 389, 394–396, 399, 400, 402, 403, 407, 409–411, 415–417, 419, 422, 423, 425, 427, 429–435, 437, 439, 440, 442, 450–454, 456, 457, 466, 467, 478, 480, 481, 503, 505, 506, 509, 540, 543–545, 547, 552, 554, 558, 560, 567, 584, 607, 686, 690, 791, 793, 812, 857
Go33, 252, 277
Go40, 459
Go51, 203, 373
Go64, 549, 550
- L. E. J.
Brouwer, 18, 129, 177, 195, 197, 226, 256, 257, 262, 263, 271, 273, 278, 283, 297, 343, 358, 359, 365, 374, 505, 516, 517, 554, 578, 672, 686, 824, 875
Br08, 7, 131, 152, 233, 237, 243, 263, 276, 437, 505, 855
Br13, 136, 373
Br23, 271, 274, 275
Br27, 233
Dogma, 166, 170
- Löb
Martin
Lob59, 230
Martin H.
Lob59, 103, 127, 130, 134, 135, 162, 239, 254, 389, 490, 678, 802
- Löwenheim
Leopold
Lo15, 220–222, 328, 367, 368, 370, 462
- Löwenheim-Skolem
Downwards
Theorem, 220
- László
Kalmár
Km59, 206, 590, 591
- Lévy-Leblond
Jean-Marc, 70, 72
- La29
Edmund
Landau, 127, 400, 681, 684
- Labh
Sunny Kumar
Lbh23, 715
- lack of

- knowledge, 672, 673, 675, 676
 Lakoff
 George
 LR00, 32, 33, 36, 72, 117, 118, 120, 128, 141, 146, 177, 259, 284, 286, 290, 293, 295, 298, 323, 335, 340, 341, 353, 358, 373, 374, 386, 507, 510, 514, 550, 590, 642, 661, 663, 668, 686, 797–803, 805, 806, 808–811, 813, 816, 829
 Lam17
 Timm
 Lampert, 219, 306, 307, 309, 310, 547
 Lam19
 Timm
 Lampert, 332, 333, 450–453
 Lamé
 Gabriel, 65
 Lampert
 Timm
 Lam17, 219, 306, 307, 309, 310, 547
 Lam19, 332, 333, 450–453
 Lance
 Fortnow
 Frt03, 141
 Frt09, 158, 160, 322
 Landau
 Edmund
 La29, 127, 400, 681, 684
 Landhuis
 David
 AAB19, 163, 164, 569, 725, 726, 739–741, 750, 751
 Langlands
 Robert, 74
 Lars
 Orbach
 OHF19, 841
 Lars V.
 Ahlfors
 Ahl53, 129
 Last Theorem
 Fermat
 FLT, 47–54, 58, 64–67, 75–78
 Laubenbacher
 Reinhard
 LbP10, 53
 Laureano
 Luna
 Ln08, 488
 Laurie
 Kirby
 KP82, 493, 494, 500
 Santos
 PBC20, 171
 Law
 Excluded Middle
 LEM, 3, 18, 19, 166, 178, 184, 193, 194, 196–199, 227, 238, 243, 245, 256, 263, 271, 274–277, 281, 288, 359, 360, 362, 364, 379, 399, 473, 474, 476, 477, 490, 505, 799, 853, 984
 Laxman
 Luitel
 Lui19, 115, 116, 320
 Lazarovici
 Dustin
 Lzr23, 347, 348
 Lbh23
 Sunny Kumar
 Labh, 715
 LbP10
 David
 Pengelley, 53
 Reinhard
 Laubenbacher, 53
 lecture
 Zilsel, 252
 Legendre
 Adrien-Marie, 627
 Lei09
 Hannes
 Leitgeb, 409, 410
 Lei10
 Hannes
 Leitgeb, 541
 Leibniz
 Gottfried
 Wilhelm, 818, 820
 Leitgeb
 Hannes
 Lei09, 409, 410
 Lei10, 541
 LEM
 Law
 Excluded Middle, 3, 18, 19, 166, 178, 184, 193, 194, 196–199, 227, 238, 243, 245, 256, 263, 271, 274–277, 281, 288, 359, 360, 362, 364, 379, 399, 473, 474, 476, 477, 490, 505, 799, 853, 984
 Lenstra Jr.
 H. W.
 LP11, 603, 614
 Leo
 Corry
 Cry10, 47
 Cry17, 24, 25
 Cry22, 19
 Harrington, 38, 39
 Leonard Eugene
 Dickson
 Dck20, 53
 Dic52, 627, 628, 636
 Leopold
 Löwenheim

- Lo15, 220–222, 328, 367, 368, 370, 462
- Lettvin
Jerome
LMMP, 595, 596
- Li
Yu
Liy22, 400, 401, 406, 433
- Li64
A. H.
Lightstone, 186
- Lightstone
A. H.
Li64, 186
- Liisa
Uusimaki
UN04, 836
- Limiting Thesis
PA, 355, 830
ZF, 355, 830
- limits
knowledge, 645
- Lindmark
Mike
AAB19, 163, 164, 569, 725, 726, 739–741, 750, 751
- linguistic
relativity, 341
- Littlewood
J. E.
HL23, 608
- Liv09
Paul M.
Livingston, 396, 399
- Liv10
Paul M.
Livingston, 383, 414, 415, 462–464
- Liv12
Paul M.
Livingston, 384
- Livadas
Stathis
Lvd16, 182–184, 344–346, 454–456
- Livingston
Paul M.
Liv09, 396, 399
Liv10, 383, 414, 415, 462–464
Liv12, 384
- Liy22
Yu
Li, 400, 401, 406, 433
- LMMP
Humberto
Maturana, 595, 596
Jerome
Lettvin, 595, 596
Walter
Pitts, 595, 596
Warren
McCulloch, 595, 596
- Ln08
Laureano
Luna, 488
- Lo15
Leopold
Löwenheim, 220–222, 328, 367, 368, 370, 462
- Lob59
Martin
Löb, 230
Martin H.
Löb, 103, 127, 130, 134, 135, 162, 239, 254, 389, 490, 678, 802
- logic
first-order
FOL, 23, 128, 131, 166, 179, 182, 186, 243, 245, 247, 264, 271, 273–275, 277, 283, 284, 358, 359, 451, 477, 486, 490, 852, 855
- logical
knowledge, 759
- Lon14
Bruce Raymond
Long, 373
- Londergan
Tim
VL17, 380
- Long
Bruce Raymond
Lon14, 373
- Longo
Bailly
BLo08, 33
- Lord
Cherwell
Che42, 609
- Lorenzo
Sartori
Srt23, 515
- lorio Giannoli
Giovanni
Gia97, 42–44, 47, 405, 406, 557
- Louis
J.
Mordell, 71
- Louis H.
Kauffman
Kau87, 502, 743, 746
KC19, 743, 746
- LP11
Carl
Pomerance, 603, 614
H. W.
Lenstra Jr., 603, 614
- LR00

- George
Lakoff, 32, 33, 36, 72, 117, 118, 120, 128, 141, 146, 177, 259, 284, 286, 290, 293, 295, 298, 323, 335, 340, 341, 353, 358, 373, 374, 386, 507, 510, 514, 550, 590, 642, 661, 663, 668, 686, 797–803, 805, 806, 808–811, 813, 816, 829
- Rafael
Núñez, 117, 118, 120
- Rafael E.
Núñez, 32, 33, 36, 72, 128, 141, 146, 177, 259, 284, 286, 290, 293, 295, 298, 323, 335, 340, 341, 353, 358, 373, 374, 386, 507, 510, 514, 550, 590, 642, 661, 663, 668, 686, 797–803, 805, 806, 808–811, 813, 816, 829
- Lu61
John Randolph
Lucas, 143, 284, 311, 545
- Lu96
John Randolph
Lucas, 284, 311, 545, 546, 560
- Lucas
Gödelian Thesis, 196, 215, 270, 284, 287, 540, 545–547, 554
John Randolph, 29, 179, 215, 226, 411, 458, 540, 541, 544, 548, 551, 554, 559
Lu61, 143, 284, 311, 545
Lu96, 284, 311, 545, 546, 560
- Lucero
Erik
AAB19, 163, 164, 569, 725, 726, 739–741, 750, 751
- Lucie
White
WBF22, 47, 48
- Ludwig
Wittgenstein, 19, 21, 24, 29, 36, 178, 226, 283, 297, 306, 308–310, 315–317, 325, 327–333, 351, 383, 404, 411, 414, 415, 430, 450–452, 462–465, 467–472, 475–477, 547, 552, 754
Wi22, 7, 355
Wi74, 430
Wi78, 143, 152, 153, 219–221, 237, 302–305, 307, 309–311, 325, 381, 382, 453, 547, 686
- Lui19
Laxman
Luitel, 115, 116, 320
- Luitel
Laxman
Lui19, 115, 116, 320
- Lun17
Björn
Lundgren, 502, 801, 802
- Luna
Laureano
Ln08, 488
- Lundgren
Björn
Lun17, 502, 801, 802
- Lus62
Eugene C.
Luschei, 186
- Luschei
Eugene C.
Lus62, 186
- Lvd16
Stathis
Livadas, 182–184, 344–346, 454–456
- LW23
Bartosz
Wcislo, 186, 445
Mateusz
Łełyk, 186, 445
- Lyakh
Dmitry
AAB19, 163, 164, 569, 725, 726, 739–741, 750, 751
- Lzr23
Dustin
Lazarovici, 347, 348
- M.
Villata
Vi11, 531
- M. A.
Bukhari
YBM04, 832
- M. D.
Srinivas
Sra05, 41, 42, 45, 46
- Müller
Kasper, 636
- Ma08
Penelope
Maddy, 335
- Ma18
Penelope
Maddy, 23, 359, 449, 507, 799, 812
- Ma18a
Penelope
Maddy, 23, 359, 507, 812
- Maby Winton
Newson
Nw02, 852
- Macbeth
Danielle
Mcb14, 25, 26, 187, 340, 501, 502
- Madden
James J.
Md01, 141, 800
- Maddy
Penelope
FFMS, 507
Ma08, 335

- Ma18, 23, 359, 449, 507, 799, 812
 Ma18a, 23, 359, 507, 812
- Mahodayapuram, 41
- Maietti
 Maria Emilia
 MS05, 274
 Mt09, 274
- Maldonado-Carreño
 Carolina
 Rli16, 841
- Maley
 Corey J.
 Mly22, 140, 141
- Mallarmé
 Stéphane, 399
- Maloney
 Erin
 RSM18, 836
- Mandelbrot
 Benoit B.
 BPS88, 791
 Mn77, 791
- Mandrà
 Salvatore
 AAB19, 163, 164, 569, 725, 726, 739–741, 750, 751
- Manin
 Yuri
 Ivanovich, 71
- Manindra
 Agrawal
 AKS04, 603, 614
- Manjul
 Bhargava
 Bha19, 605
- Manohar S.
 Huzurbazar, 186, 373, 876, 877
- Manuel
 Bremer
 Brm07, 152, 237
- Marcin
 Miłkowski
 Mil14, 558, 559, 593, 595
- Marcus
 Solomon
 CCS01, 139, 145
- Marek
 V. Wictor
 MM01, 144, 508
- Margherita
 Zorzi
 AsZ12, 186
- Maria Emilia
 Maietti
 MS05, 274
 Mt09, 274
- Marie
 Duží
 Du13, 266
- Marin
 Mersenne, 52
- Mario Bacelar
 Valente
 Vln22, 103
- Marissa
 Giustina
 AAB19, 163, 164, 569, 725, 726, 739–741, 750, 751
- Mark
 van Atten
 At23, 275
 van Atten
 AT03, 288
 At17, 279, 280
 At18, 226
- Marko
 Kovic
 Kov18, 790
- Markov
 Andrey Andreevich
 Mrk54, 791
- Markus
 Hoffmann
 AAB19, 163, 164, 569, 725, 726, 739–741, 750, 751
- Pansart
 Pan09, 225
- Pantsar, 875
 Pan09, 7, 20, 21, 26–29, 31, 33, 34, 36, 45, 46, 54, 55, 67, 100, 103, 110, 118–121, 123, 164, 176, 259, 282, 285, 286, 295, 319–323, 336, 341, 349, 350, 356, 390, 407, 438, 440, 513, 544, 605, 607, 799, 811, 813, 824
 Pan19, 164, 165
- Weckström
 Wck23, 716–718
- Martin
 Alia
 PBC20, 171
- Davis
 Da64, 18
 Da82, 152, 186, 244, 411, 433
 Da95, 142, 143, 407, 551
- Löb
 Lob59, 230
- Ryle, 788
- Martin H.
 Löb
 Lob59, 103, 127, 130, 134, 135, 162, 239, 254, 389, 490, 678, 802
- Martin-Löf
 Per, 591, 592

- Mlf08, 313, 314
 Mlf87, 103, 121–123, 323, 324
- Martinis
 John
 AAB19, 163, 164, 569, 725, 726, 739–741, 750, 751
 John M.
 AAB19, 163, 164, 569, 725, 726, 739–741, 750, 751
- Masoud
 Mohseni
 AAB19, 163, 164, 569, 725, 726, 739–741, 750, 751
- Massimiliano Sassoli
 de Bianchi
 AdB14, 671, 676, 677, 731
 Aetal, 679
 Bia18, 668–670
 Bia19, 668–670
- Mat13
 Ásgeir Berg
 Matthíasson, 306–308
- Mateusz
 Łełyk
 LW23, 186, 445
- Mathematical
 Intuition, 843
 Monsters, 843
- mathematical
 knowledge, 224, 287, 321, 464, 606, 607, 749, 751, 752, 754, 755, 807, 832, 837, 838, 841, 842
 structure, 668
- Mathematics
 Thesis, 325, 824, 825, 830
- Matheus
 Flach, 52
- Mathew
 McEwen
 AAB19, 163, 164, 569, 725, 726, 739–741, 750, 751
 Neeley
 AAB19, 163, 164, 569, 725, 726, 739–741, 750, 751
- Mathew D.
 Trevithick
 AAB19, 163, 164, 569, 725, 726, 739–741, 750, 751
- Mathew P.
 Harrigan
 AAB19, 163, 164, 569, 725, 726, 739–741, 750, 751
- Mathias
 Frisch
 WBF22, 47, 48
- Matthíasson
 Ásgeir Berg
 Mat13, 306–308
- Matthew F.
 Pusey
 PBR12, 727
- Matthias
 Eberl
 Ebr20, 190–192
 Schirn
 SN01, 235–240, 251, 259–261
- Maturana
 Humberto
 LMMP, 595, 596
- Max-Julian
 Jakobitsch
 RJHH, 125, 126
- Mazlini
 Adnan
 AZ10, 836
- Mazur
 Barry, 74
- Mcb14
 Danielle
 Macbeth, 25, 26, 187, 340, 501, 502
- McClean
 Jarrod R.
 AAB19, 163, 164, 569, 725, 726, 739–741, 750, 751
- McCulloch
 Warren
 LMMP, 595, 596
- McEwen
 Mathew
 AAB19, 163, 164, 569, 725, 726, 739–741, 750, 751
- McGuire
 Michael
 BPS88, 791
- McK12
 Brendan D.
 McKay, 80
- McKay
 Brendan D.
 McK12, 80
- Md01
 James J.
 Madden, 141, 800
- Me15
 Elliott
 Mendelson, 118, 248, 440–445, 481, 849, 854
- Me64
 Elliott
 Mendelson, 18, 118, 128, 130–132, 134–136, 146, 152–154, 184–186, 201, 202, 240, 244, 248, 249, 276, 311, 312, 352, 382, 417, 423, 426, 433, 440, 443, 444, 460, 479, 481, 483, 486–488, 490, 506, 508, 551, 554, 561, 562, 565,

- 849–855
- Me90
Elliott
Mendelson, 117, 142
- Mechanist
Thesis, 541
- Meg
Jason
Megill, 546
- Megan
Selbach-Allen
AWB20, 831
- Megill
Jason
Meg, 546
- Migrant
Anthony
AAB19, 163, 164, 569, 725, 726, 739–741, 750, 751
- Mehmet
Bekdemir
Bkd10, 836
- Mehta
Chaitanya, 56
Chetan, 875
Fermat, 56
- Melvyn B.
Nathanson
Na08, 53, 117, 290, 373, 502
- Mendelson
Elliott
Me15, 118, 248, 440–445, 481, 849, 854
Me64, 18, 118, 128, 130–132, 134–136, 146, 152–154, 184–186, 201, 202, 240, 244, 248, 249, 276, 311, 312, 352, 382, 417, 423, 426, 433, 440, 443, 444, 460, 479, 481, 483, 486–488, 490, 506, 508, 551, 554, 561, 562, 565, 849–855
Me90, 117, 142
- Mersenne
Marin, 52
- Mhr23
Mihir
Singh, 664, 666, 668
- Mi
Xiao
AAB19, 163, 164, 569, 725, 726, 739–741, 750, 751
- Miłkowski
Marcin
Mil14, 558, 559, 593, 595
- Michèle
Friend
FM15, 186, 379, 380, 833, 876
- Michael
Atiyah, 70
Barnsley
Bar88, 509, 513, 791
BPS88, 791
Detlefsen, 413
Dummett, 412, 413
Friedman
Frd01, 214, 278, 339, 343
Harris
Hrs01, 71, 72
Hrs19, 53–55, 58, 67, 69, 70, 74, 119
McGuire
BPS88, 791
Rathjen
RS17, 358
- Michael J.
Hartmann
AAB19, 163, 164, 569, 725, 726, 739–741, 750, 751
- Michael Martin
Nieto
NG91, 531
- Michael R.
Starks
Stk12, 219
- Michael Stephen
Fiske
Fi19, 163, 563, 569, 570, 572, 574–576, 578–580, 725
- Michał
Tomasz Godziszewski
GoU19, 388, 446, 447, 503, 504
- Michielsen
Kristel
AAB19, 163, 164, 569, 725, 726, 739–741, 750, 751
- Mihai
Ganea
Gna14, 207–209
- Mihir
Singh
Mhr23, 664, 666, 668
- Mike
Lindmark
AAB19, 163, 164, 569, 725, 726, 739–741, 750, 751
- Mikko
Aro
Srv19, 836
- Mil14
Marcin
Miłkowski, 558, 559, 593, 595
- Mji
A.
YBM04, 832
- Mlf08
Per
Martin-Löf, 313, 314

- Mlf87
Per
Martin-Löf, 103, 121–123, 323, 324
- Mly22
Corey J.
Maley, 140, 141
- MM01
Jan
Mycielski, 144, 508
V. Wictor
Marek, 144, 508
- Mn77
Benoit B.
Mandelbrot, 791
- Mohammad
Ardeshir
ArRm09, 189
- Mohseni
Masoud
AAB19, 163, 164, 569, 725, 726, 739–741, 750, 751
- molecular
phenomena, 76
- molecule
water, 76
- Molinini
Daniele
FM15, 186, 379, 380, 833, 876
- Mon17
Stella
Moon, 433–435
- Monica
Dumitrescu
CD19, 610
- Moon
Stella
Mon17, 433–435
- Moore
Christopher
Mor12, 158
- Mor12
Christopher
Moore, 158
- Mordell
Louis
J., 71
- Moritz
Herzog
OHF19, 841
Hiebler
RJHH, 125, 126
- Mostowski
Andrzej
Wo52, 186, 401
- Mrk54
Andrey Andreevich
Markov, 791
- MS05
Giovanni
Sambin, 274
Maria Emilia
Maietti, 274
- Mt09
Maria Emilia
Maietti, 274
- Mu91
Chetan
Murthy, 35, 74, 103, 127, 130, 131, 134, 135, 148, 162, 186, 230, 239, 254, 389, 421, 490, 505, 678, 853
- Mumbai
Institute of Science, 876
- Mur06
Roman
Murawski, 298, 311–313
- Mur20
Roman
Murawski, 55, 56, 544
- Murawski
Roman
Mur06, 298, 311–313
Mur20, 55, 56, 544
- Murphy Yuezhen
Niu
AAB19, 163, 164, 569, 725, 726, 739–741, 750, 751
- Murthy
Chetan
Mu91, 35, 74, 103, 127, 130, 131, 134, 135, 148, 162, 186, 230, 239, 254, 389, 490, 505, 678, 853
- Musk
Elon, 788
- Mutus
Josh
AAB19, 163, 164, 569, 725, 726, 739–741, 750, 751
- Mycielski
Jan
MM01, 144, 508
Mycl, 358
- Mycl
Jan
Mycielski, 358
- N.
Gurappa
Grp17, 637, 638
Grp18, 638, 639
Grp22, 655
- Núñez
Rafael
LR00, 117, 118, 120

- Rafael E.
LR00, 32, 33, 36, 72, 128, 141, 146, 177, 259, 284, 286, 290, 293, 295, 298, 323, 335, 340, 341, 353, 358, 373, 374, 386, 507, 510, 514, 550, 590, 642, 661, 663, 668, 686, 797–803, 805, 806, 808–811, 813, 816, 829
- Na08
Melvyn B.
Nathanson, 53, 117, 290, 373, 502
- Naaman
Ofer
AAB19, 163, 164, 569, 725, 726, 739–741, 750, 751
- Nachum
Dershowitz
DG08, 266–268
- Nan
Jhao
ZZK19, 841
- Nanjwenge
Sean Evans
Nnj18, 81
- Narasimha, 41
- Narlikar
Jayant V, 876
- Nason
Rod
UN04, 836
- Nathan
Rosen
EPR35, 375, 650, 653, 659, 661, 664, 691
- Nathanson
Melvyn B.
Na08, 53, 117, 290, 373, 502
- Naveen Sundar
Govindarajalu
BG11, 206
BG11a, 206
- Ndr24
Alexander
Niederklapfer, 344
- Neeley
Mathew
AAB19, 163, 164, 569, 725, 726, 739–741, 750, 751
- Neeraj
Kayal
AKS04, 603, 614
- Neil
Robertson
RSSp, 80, 86, 90, 123, 125
RSST, 80, 86, 90, 123, 125
Tennant, 412, 413
Turok
BCST, 531
- Neill
Charles
AAB19, 163, 164, 569, 725, 726, 739–741, 750, 751
- Nenu
Theodor
HN24, 563–565
- Neumann
John von, 334, 335
- Neven
Hartmut
AAB19, 163, 164, 569, 725, 726, 739–741, 750, 751
- Newson
Maby Winton
Nw02, 852
- Newton
Isaac, 876
- Newton C. A.
da Costa, 391
- NG91
Michael Martin
Nieto, 531
T.
Goldman, 531
- Nicholas C.
Rubin
AAB19, 163, 164, 569, 725, 726, 739–741, 750, 751
- Nicolas
Boubaki, 295
Gisin
Gi19, 217, 519, 644, 645, 688
Gi20, 217, 519, 644, 688
SG24, 210–212, 645
- Niebergall, 192
Karl-George
SN01, 235–240, 251, 259–261
- Niederklapfer
Alexander
Ndr24, 344
- Niels
Bohr, 179, 374, 458, 650, 657, 663, 680, 681, 731
Boh49, 652, 662
- Nieto
Michael Martin
NG91, 531
- Nilakantha, 41
- Nitin
Saxena
AKS04, 603, 614
- Niu
Murphy Yuezhen
AAB19, 163, 164, 569, 725, 726, 739–741, 750, 751
- Nix-James
C. B., 876

- Nnj18
 Sean Evans
 Nanjwenge, 81
- Norman
 Wildberger
 Wlb99, 117
- Novaes
 Catarina Dutilh
 Nvs09, 104, 105
 Nvs19, 146, 485, 495
- Novikov
 P. S.
 Nv64, 186
- Nv64
 P. S.
 Novikov, 186
- Nvs09
 Catarina Dutilh
 Novaes, 104, 105
- Nvs19
 Catarina Dutilh
 Novaes, 146, 485, 495
- Nw02
 Maby Winton
 Newson, 852
- Ockham's Razor, 315
- Oddan
 Jessica
 Odn24, 721–723
- Odn24
 Jessica
 Oddan, 721–723
- Ofer
 Naaman
 AAB19, 163, 164, 569, 725, 726, 739–741, 750, 751
- OHF19
 Annemarie
 Fritz, 841
 Lars
 Orbach, 841
 Moritz
 Herzog, 841
- Ola
 Paul
 Ola23, 356, 357
- Ola23
 Paul
 Ola, 356, 357
- Olszewski
 Adam
 OWJ06, 206
- open
 string, 76
- oracle, 266, 570, 572, 576, 731–737, 740, 741, 749, 755, 764
- empirical, 762
 formal, 762
 Halting, 196, 197
 machine, 567
 proof, 755
 quantum, 762, 763
- Orbach
 Lars
 OHF19, 841
- Ori
 Friedman
 PBC20, 171
- Oron
 Shagrir
 Sha06, 592
- Ostby
 Eric
 AAB19, 163, 164, 569, 725, 726, 739–741, 750, 751
- Oswald
 Veblen, 517
- Oswaldo
 Chateaubriand
 Cha05, 167, 170, 373
- Otávio
 Bueno, 391
- Ovidiu Cristinel
 Stoica
 Stc22, 699, 711, 712
- Owen
 Griffiths
 PG21, 384–386, 388–390
- Owens
 David
 Own06, 172, 173
- OWJ06
 Adam
 Olszewski, 206
 Jan
 Woleński, 206
 Robert
 Janusz, 206
- Own06
 David
 Owens, 172, 173
- PvNP, 144, 156–160, 163, 232, 322, 608, 614, 615, 751, 754
- P. P.
 Divakaran
 Dvk18, 40, 41
- P. S.
 Novikov
 Nv64, 186
- Pólya
 George
 Pol59, 609

- PA
 Limiting Thesis, 355, 830
 Peano Arithmetic
 first-order, 18, 23, 31, 32, 40, 127, 128, 131–134, 136, 140, 146, 152, 154, 156, 159, 161, 162, 166, 177, 179, 185, 188, 193, 199, 201, 203, 205, 206, 213, 216, 219, 222, 224, 225, 229, 231, 233–237, 239–241, 243–245, 247, 251, 254–256, 260, 261, 264, 265, 270–272, 279, 284, 286, 287, 294, 296, 297, 302, 307, 308, 310–312, 315, 317–319, 321, 322, 325, 329, 330, 333, 347, 352–355, 358, 359, 362–366, 368, 369, 372, 374, 375, 382, 395, 400, 402, 408, 410, 411, 415, 418, 421, 422, 424, 432, 443, 444, 449–451, 453, 454, 458–462, 465, 467–469, 472, 476–478, 485–489, 491, 494, 495, 506, 509, 518, 545–547, 551, 552, 554–556, 558, 565, 566, 573, 578, 580, 590, 659, 662, 681, 682, 684, 686, 690, 724, 725, 727, 741, 753, 754, 758–762, 786, 789, 791–794, 802, 811, 812, 824, 827, 828, 830, 849, 855
 standard interpretation
 weak, 132
- Pa71
 Rohit
 Parikh, 136, 204, 231, 739
- Padmanabhan
 Panu
 Pd17, 520, 521
 Pd17a, 521
- Pafnuty Lvovich
 Chebyshev, 627
- Pak
 Igor, 117
- Paleo
 Bruno Woltzenlogel
 BP14, 187, 355
- Pan09
 Markus
 Pansart, 225
 Pantsar, 7, 20, 21, 26–29, 31, 33, 34, 36, 45, 46, 54, 55, 67, 100, 103, 110, 118–121, 123, 164, 176, 259, 282, 285, 286, 295, 319–323, 336, 341, 349, 350, 356, 390, 407, 438, 440, 513, 544, 605, 607, 799, 811, 813, 824
- Pan19
 Markus
 Pantsar, 164, 165
- Pansart
 Markus
 Pan09, 225
- Pantsar
 Markus, 875
 Pan09, 7, 20, 21, 26–29, 31, 33, 34, 36, 45, 46, 54, 55, 67, 100, 103, 110, 118–121, 123, 164, 176, 259, 282, 285, 286, 295, 319–323, 336, 341, 349, 350, 356, 390, 407, 438, 440, 513, 605, 607, 799, 811, 813, 824
- Pan19, 164, 165
 Pan20, 544
- Panu
 Padmanabhan
 Pd17, 520, 521
 Pd17a, 521
 Raatikainen
 Raa04, 281, 282
 Raa05, 408, 410
 Raa20, 540
- Paola
 Cattabriga
 Cat07, 419
- Papineau
 David
 Ppn19, 175–177
- Paradox
 Skolem's, 220
- paradox
 impredicativity, 154
 Zeno's, 686
- Parikh
 Rohit
 Pa71, 136, 204, 231, 739
- Paris
 Harrington
 Theorem, 435
 Jeff
 KP82, 493, 494, 500
- Parmeshvara, 41
- Parsons
 Charles
 Pas95, 505
- particle
 point, 75, 76
- Pas95
 Charles
 Parsons, 505
- Pascal
 Blaise, 52
- Paseau
 Alexander C.
 PG21, 384–386, 388–390
- Pasquale
 Frascolla
 Fra94, 36, 283, 284, 325, 327
- Pataut
 Fabrice
 Ptt98, 408
- Patrick
 Allo
 All17, 79, 110
 Suppes
 Su60, 186

- Walsh
 SW17, 145, 146, 507–509
 SW19, 145, 146
- Patrizia
 Piredda
 Prd21, 637, 640, 699, 700, 719, 720
 Prd23, 37, 637, 640, 699, 719
- Paul
 Benacerraf
 BPu64, 18
 Bernays, 251, 259–261, 412
 BF58, 186, 506
 Erdős, 627
 Ernest
 Er06, 834
 Er12, 824, 833
 Ola
 Ola23, 356, 357
 Seymour
 RSSp, 80, 86, 90, 123, 125
 RSST, 80, 86, 90, 123, 125
- Paul C. W.
 Davies
 DB93, 658
- Paul J.
 Cohen
 Co05, 186, 319, 367–369
 Co63, 370, 371
 Co64, 370, 371
 Co66, 370–372, 459
 Steinhardt
 BCST, 531
- Paul M.
 Livingston
 Liv09, 396, 399
 Liv10, 383, 414, 415, 462–464
 Liv12, 384
- Paul R.
 Cohen
 Coh05, 558
- Paul V.
 Klimov
 AAB19, 163, 164, 569, 725, 726, 739–741, 750, 751
- Paula
 Quinon
 Qun19, 202, 203
 Qun20, 407, 543, 544
 QZ07, 225, 226
- Pavel
 Hruběš
 Dvd19, 186
 Pudlák
 HP98, 485
- Payam
 Seraji
 SS17, 249, 478
 SS18, 404
- PBC20
 Alia
 Martin, 171
 Fiery
 Cushman, 171
 John
 Turri, 171
 Jonathan
 Phillips, 171
 Joshua
 Knoke, 171
 Laurie
 Santos, 171
 Ori
 Friedman, 171
 Wesley
 Buckwalter, 171
- PBR12
 Jonathan
 Barrett, 727
 Matthew F.
 Pusey, 727
 Terry
 Rudolph, 727
- Pd17
 Panu
 Padmanabhan, 520, 521
- Pd17a
 Panu
 Padmanabhan, 521
- Pdn15
 Karlis
 Podnieks, 20, 28–31
- Pdn92
 Karlis
 Podnieks, 186
- Pe90
 Roger
 Penrose, 311, 406, 548
- Pe94
 Roger
 Penrose, 311, 406, 548
- Peano
 Giuseppe, 358, 516
- Peano Arithmetic
 first-order
 PA, 18, 23, 31, 32, 40, 127, 128, 131–134, 136, 140, 146, 152, 154, 156, 159, 161, 162, 166, 177, 179, 185, 188, 193, 199, 201, 203, 205, 206, 213, 216, 219, 222, 224, 225, 229, 231, 233–237, 239–241, 243–245, 247, 251, 254–256, 260, 261, 264, 265, 270–272, 279, 284, 286, 287, 294, 296, 297, 302, 307, 308, 310–312, 315, 317–319, 321, 322, 325, 329, 330, 333,

- 347, 352–355, 358, 359, 362–366, 368, 369, 372, 374, 375, 382, 395, 400, 402, 408, 410, 411, 415, 418, 421, 422, 424, 432, 443, 444, 449–451, 453, 454, 458–462, 465, 467–469, 472, 476–478, 485–489, 491, 494, 495, 506, 509, 518, 545–547, 551, 552, 554–556, 558, 565, 566, 573, 578, 580, 590, 659, 662, 681, 682, 684, 686, 690, 724, 725, 727, 741, 753, 754, 758–762, 786, 789, 791–794, 802, 811, 812, 824, 827, 828, 830, 849, 855
- Pedram
Roushan
AAB19, 163, 164, 569, 725, 726, 739–741, 750, 751
- Peitgen
Hans-Otto
BPS88, 791
PR86, 791
- Pel18
Abel-Luis
Peralta, 419
- Pel19
Abel-Luis
Peralta, 419
- Peluce
V. Alexis
Plc20, 591, 592
- Penchev
Vasil
Pnc20, 164
- Penelope
Maddy
FFMS, 507
Ma08, 335
Ma18, 23, 359, 449, 507, 799, 812
Ma18a, 23, 359, 507, 812
- Pengelly
David
LbP10, 53
- Penrose
Gödelian Thesis, 540, 545, 548, 551, 554
Roger, 29, 72, 179, 226, 395, 411, 458, 540, 541, 544, 548, 550, 551, 554
Pe90, 311, 406, 548
Pe94, 311, 406, 548
- Per
Martin-Löf, 591, 592
Mlf08, 313, 314
Mlf87, 103, 121–123, 323, 324
- Per17
David
Pereplyotchik, 816, 817
- Peralta
Abel-Luis
Pel18, 419
Pel19, 419
- Percy J.
Heawood, 96
- Pereplyotchik
David
Per17, 816, 817
- Pestalozzi
Johann Heinrich
Principle of Anschauung, 105, 123
- Peter
Èrdi, 875
Simons
Sms04, 354
Smith, 451
Smi13, 186, 409, 433, 435–437, 444, 445
Vickers
FV22, 374
Vck22, 167
Wegner
WG03, 139, 141, 142
- Peter Gustav Lejeune
Dirichlet, 627
- Peter H.
Richter
PR86, 791
- Petr
Hájek
HP98, 485
- Petukhov
Andre
AAB19, 163, 164, 569, 725, 726, 739–741, 750, 751
- Peura
Pilvi
Srv19, 836
- PG21
Alexander C.
Paseau, 384–386, 388–390
Owen
Griffiths, 384–386, 388–390
- phenomena
molecular, 76
- Philip
Goyal
Gyl22, 646, 648
Kitcher, 70
- Philip W.
Anderson
And72, 377, 378
- Philipp Berghofer
Bgh23, 174
- Philippe
van Basshuysen
WBF22, 47, 48
- Phillips
Jonathan
PBC20, 171

- Pic03
 Gualtiero
 Piccinini, 540, 558
- Pic11
 Gualtiero
 Piccinini, 206
- Pic15
 Gualtiero
 Piccinini, 593
- Pic19
 Gualtiero
 Piccinini, 20, 21, 29, 35, 40, 44, 45, 55, 74, 100, 103, 167–172, 174, 175, 274, 319, 353, 354, 361, 372, 472
- Piccinini
 Gualtiero, 7, 437
 Pic03, 540, 558
 Pic11, 206
 Pic15, 593
 Pic19, 20, 21, 29, 35, 40, 44, 45, 55, 74, 100, 103, 167–172, 174, 175, 274, 319, 353, 354, 361, 372, 472
 SP10, 372
 knowledge
 factually grounded belief, 7, 20, 29, 40, 55, 103, 122, 167, 169–172, 319, 354, 361, 372, 413, 437, 472
- Pierluigi
 Graziani
 FG12, 540
- Pierre
 Curie, 60, 61
 Deligne, 74
- Pierre de
 Fermat, 47–54, 56, 58, 64–67, 75–78, 428
- Pillay
 Anand
 BKPS, 39, 204, 205
- Pilvi
 Peura
 Srv19, 836
- Pinar
 Ayse
 SCA00, 558
- Ping
 Yeh
 AAB19, 163, 164, 569, 725, 726, 739–741, 750, 751
- Piredda
 Patrizia
 Prd21, 637, 640, 699, 700, 719, 720
 Prd23, 37, 637, 640, 699, 719
- Pitts
 Walter
 LMMP, 595, 596
- Plato, 41, 437
 knowledge
 justified true belief, 7, 20, 29, 40, 55, 103, 122, 167, 169–172, 319, 354, 361, 372, 413, 437, 472
- Platonism, 72
- Platt
 John C.
 AAB19, 163, 164, 569, 725, 726, 739–741, 750, 751
- Plc20
 V. Alexis
 Peluce, 591, 592
- Pnc20
 Vasil
 Penchev, 164
- Podnieks
 Karlis
 DP17, 186
 Pdn15, 20, 28–31
 Pdn92, 186
- Podolsky
 Boris Yakovlevich
 EPR35, 375, 650, 653, 659, 661, 664, 691
- Poincaré, 343
 Henri, 136, 374, 516, 517, 662, 672, 682, 686
- point
 particle, 75, 76
- Pol59
 George
 Pólya, 609
- Pomrance
 Carl
 LP11, 603, 614
- Poorten
 Alf van der, 52
- Pos13
 Carl J.
 Posy, 237, 245, 257, 258, 274, 300
- Posy
 Carl J.
 Pos13, 237, 245, 257, 258, 274, 300
- Ppn19
 David
 Papineau, 175–177
- PR86
 Hans-Otto
 Peitgen, 791
 Peter H.
 Richter, 791
- Prd21
 Patrizia
 Piredda, 637, 640, 699, 700, 719, 720
- Prd23
 Patrizia
 Piredda, 37, 637, 640, 699, 719
- predictability

- algorithmic, 689, 726
- Price
 - Huw
 - PW23, 720, 721
- Priest
 - Graham, 399
- Principle
 - Exclude Middle, 182
 - Excluded Middle, 166, 178, 181, 182, 262, 263
- principle
 - Church-Turing, 206, 725, 736
 - Curie's, 60, 61
- Principle of Anschauung
 - Johann Heinrich
 - Pestalozzi, 105, 123
- prior
 - knowledge, 736, 837
- Probability
 - Halting
 - Chaitin, 201, 204
- Program
 - Hilbert, 286
 - Hilbert's, 187, 252, 254, 255, 257
- proof
 - algorithmic, 309, 451, 452, 547, 758
 - oracle, 755
- provable formula
 - true
 - interpretation, 23
- Ptt98
 - Fabrice
 - Pataut, 408
- Pu71
 - Hilary
 - Putnam, 263
- Pudlák
 - Pavel
 - HP98, 485
- Puranas, 41
- pure
 - knowledge, 838
- Pusey
 - Matthew F.
 - PBR12, 727
- Putnam
 - Hilary, 306, 466, 467, 518, 546, 833
 - BPu64, 18
 - FP00, 302, 305, 307, 351, 404, 414
 - Pu71, 263
- PW23
 - Huw
 - Price, 720, 721
 - Ken
 - Wharton, 720, 721
- Qi Ping
 - Kong
 - ZZK19, 841
- Qu53
 - Willard Van Orman
 - Quine, 816, 822
- Qu63
 - Willard Van Orman
 - Quine, 186
- quantification, 3, 18–21, 31, 38, 132, 135, 166, 177, 178, 181, 186, 188, 189, 192, 193, 227, 228, 230, 237–239, 243, 254, 261–264, 273, 274, 279, 284, 362, 374, 453, 454, 501, 503, 505, 552, 554, 555, 672, 683, 799
 - evidence-based, 3, 187, 206, 363
 - existential, 177, 183, 192, 247, 255, 263, 276, 277, 427, 455, 456, 479, 480
 - faith-based, 186
 - strong, 188, 508
 - unbounded, 184, 240
 - universal, 183, 238, 254, 255, 263, 454–456
 - weak, 188, 508
- quantum
 - oracle, 762, 763
 - verifier, 743
- Quine
 - Willard Van Orman, 263, 518
 - Qu53, 816, 822
 - Qu63, 186
- Quinn
 - Frank, 70
- Quinon
 - Paula
 - Qun19, 202, 203
 - Qun20, 407, 543, 544
 - QZ07, 225, 226
- Quintana
 - Chris
 - AAB19, 163, 164, 569, 725, 726, 739–741, 750, 751
- Qun19
 - Paula
 - Quinon, 202, 203
- Qun20
 - Paula
 - Quinon, 407, 543, 544
- QZ07
 - Konrad
 - Zdanowski, 225, 226
 - Paula
 - Quinon, 225, 226
- R. Gregory
 - Taylor
 - Tyl07, 206
- R. L.
 - Goodstein, 179, 458, 469, 758
 - Gd44, 73, 220, 294, 362, 435–437, 492–494, 496–499

- Räikkönen
Eija
Srv19, 836
- Rūsiņš
Freivalds
BFS08, 438, 439
- Ra02
Ran
Raz, 157
- Raa04
Panu
Raatikainen, 281, 282
- Raa05
Panu
Raatikainen, 408, 410
- Raa20
Panu
Raatikainen, 540
- Raatikainen
Panu
Raa04, 281, 282
Raa05, 408, 410
Raa20, 540
- Radder
Hans
Rdd22, 342, 597, 598
- Radin
Dardashti
DDT19, 534
- Rafael
Núñez
LR00, 117, 118, 120
- Rafael E.
Núñez
LR00, 32, 33, 36, 72, 128, 141, 146, 177, 259, 284, 286, 290, 293, 295, 298, 323, 335, 340, 341, 353, 358, 373, 374, 386, 507, 510, 514, 550, 590, 642, 661, 663, 668, 686, 797–803, 805, 806, 808–811, 813, 816, 829
- Rafael-Andrés
Alemañ-Berenguer
Brg23, 522, 523
- Rafal
Urbaniak
GoU19, 388, 446, 447, 503, 504
- Rajiv
Khosla, 875
- Ramezani
Rasoul
ArRm09, 189
- Rami
Barends
AAB19, 163, 164, 569, 725, 726, 739–741, 750, 751
- Ramirez
Gerardo
RSM18, 836
- Ran
Raz
Ra02, 157
- Rasoul
Ramezani
ArRm09, 189
- Rass
Stefan
Rass, 125, 126
- Rathjen
Michael
RS17, 358
- Raymond
Smullyan
Sm92, 186, 433, 479
- Raz
Ran
Ra02, 157
- Rch83
Fred
Richman, 154–156
- Rdd22
Hans
Radder, 342, 597, 598
- Re16
Kenneth W.
Regan, 609
- Reali
Florence
Rli16, 841
- Reck
Erich H.
AR02b, 186, 271
- reflection theorem
fixed point theorem, 439
- Reinhard
Laubenbacher
LbP10, 53
- relativity
linguistic, 341
- René
Descartes, 876
Thom, 518
- Renato
Renner
CR12, 727
FrRe18, 705, 736
- Renner
Renato
CR12, 727
FrRe18, 705, 736
- represent
mathematical
structure, 668
- Retoré

- Christian, 875
- Reuben
Hersh
Hr97, 294
- Rg87
Hartley
Rogers, 18, 186, 479, 565, 849
- Ricardo J
Da Silva
Das14, 186, 405
- Richard
Barwell
Bwl, 845, 846
Dawid
DDT19, 534
Dedekind, 72
Dedeknd, 358
Jozsa
DJ92, 731, 733, 734, 736, 737, 740, 762, 763
Kaye
Ka11, 400, 466, 485
Ka91, 400, 433, 434, 458, 466, 485, 488, 490
Taylor, 74
DDR95, 52
Zch
Zac07, 187
- Richard A.
Shore
BKPS, 39, 204, 205
- Richard C.
Jeffrey
BBJ03, 18, 186, 202, 204, 209, 478, 485, 487, 508, 561, 849
- Richard F.
Voss
BPS88, 791
- Richard L.
Epstein
EC89, 186, 433, 478
- Richard P.
Brent
Brn00, 614
Feynman, 52, 75
- Richard W.
Hamming
Hmg79, 349
- Richman
Fred
Rch83, 154–156
- Richter
Peter H.
PR86, 791
- Rieffel
Eleanor G.
AAB19, 163, 164, 569, 725, 726, 739–741, 750, 751
- Rikka
Sorvo
Srv19, 836
- Rit15
Colin J.
Rittberg, 359, 403
- Rittberg
Colin J.
Rit15, 359, 403
- RJHH
Max-Julian
Jakobitsch, 125, 126
Moritz
Hiebler, 125, 126
Stefan
Haan, 125, 126
Rass, 125, 126
- Rli16
Amy
Devine, 841
Carolina
Maldonado-Carreño, 841
Dénes
Szücs, 841
Florencia
Reali, 841
Jiménez-Leal
Reali, 841
- Ro36
J. Barkley
Rosser, 29, 247, 249, 434, 467, 478, 480, 481
- Ro53
J. Barkley
Rosser, 29–31, 186, 247–249, 434, 442–444
- Rob
Graff
AAB19, 163, 164, 569, 725, 726, 739–741, 750, 751
- Robert
F.
Coleman, 71
Gardner
Grd21, 81, 92
Hooke, 876
Janusz
OWJ06, 206
Langlands, 74
Tragesser
AT03, 288
- Robert Alan
Hanna
Han06, 298
- Robert L.
Devaney
BPS88, 791
- Robert M.

- French
Frn00, 558
- Roberto
Collins
AAB19, 163, 164, 569, 725, 726, 739–741, 750, 751
- Robertson
Neil
RSSp, 80, 86, 90, 123, 125
RSST, 80, 86, 90, 123, 125
- Robin
Thomas
RSSp, 80, 86, 90, 123, 125
RSST, 80, 86, 90, 123, 125
Thm98, 80
- Wilson
Wln13, 86, 90, 93
- Rod
Nason
UN04, 836
- Roderich
Groß
Gr17, 558
- Rodrigo A.
Freire
Fre18, 127
- Roger
Colbeck
CR12, 727
Penrose, 29, 72, 179, 226, 395, 411, 458, 540, 541, 544, 548, 550, 551, 554
Pe90, 311, 406, 548
Pe94, 311, 406, 548
- Rogers
Hartley
Rg87, 18, 186, 479, 565, 849
- Rohit
Parikh
Pa71, 136, 204, 231, 739
- Roman
Kossak
KS06, 485
Murawski
Mur06, 298, 311–313
Mur20, 55, 56, 544
- Rosen
Nathan
EPR35, 375, 650, 653, 659, 661, 664, 691
- Rosser
J. Barkley, 179, 458, 551
Ro36, 29, 247, 249, 434, 467, 478, 480, 481
Ro53, 29–31, 186, 247–249, 434, 442–444
Rule C, 31, 247–249, 427, 434, 442–444
- Rot88
Brian
Rotman, 333, 381
- Roushan
Pedram
AAB19, 163, 164, 569, 725, 726, 739–741, 750, 751
- Roy
Harris, 825, 827
Wagner
Wgn08, 420
Wgn09, 394, 408, 415, 420, 421
Wgn19, 116
- RS17
Michael
Rathjen, 358
Wilfried
Sieg, 358
- RSM18
Erin
Maloney, 836
Gerardo
Ramirez, 836
Stacey T.
Shaw, 836
- RSSp
Daniel
Sanders, 80, 86, 90, 123, 125
Neil
Robertson, 80, 86, 90, 123, 125
Paul
Seymour, 80, 86, 90, 123, 125
Robin
Thomas, 80, 86, 90, 123, 125
- RSST
Daniel
Sanders, 80, 86, 90, 123, 125
Neil
Robertson, 80, 86, 90, 123, 125
Paul
Seymour, 80, 86, 90, 123, 125
Robin
Thomas, 80, 86, 90, 123, 125
- Ru53
Walter
Rudin, 129, 209, 510
- Rubin
Nicholas C.
AAB19, 163, 164, 569, 725, 726, 739–741, 750, 751
- Ruc20
Rudy
Rucker, 540
- Rucker
Rudy
Ruc20, 540

- Rudin
Walter
Ru53, 129, 209, 510
- Rudolf
Carnap, 38, 192, 227–230, 428, 543, 544, 801
Ca37, 186
Ca62, 246, 247, 371
Ca62a, 36, 117, 118, 120, 123, 259, 286, 295, 323, 336, 341, 342, 668, 799, 811, 813
Fritsch
FF98, 94
- Rudolph
Terry
PBR12, 727
- Rudy
Rucker
Ruc20, 540
- Rule C
Rosser, 31, 247–249, 427, 434, 442–444
- Rupak
Biswas
AAB19, 163, 164, 569, 725, 726, 739–741, 750, 751
- Rus
Daniela
GDGGR, 558
- Rus08
Bertrand
Russell, 192, 264
- Rus17
Bertrand
Russell, 349, 821, 835
- Rus37
Bertrand
Russell, 512, 688
- Russell
Bertrand, 256, 257, 305, 306, 333, 351, 380, 503, 814, 815, 817, 818, 820, 822
Rus08, 192, 264
Rus17, 349, 821, 835
Rus37, 512, 688
WR10, 186, 325
- Ryan
Babbush
AAB19, 163, 164, 569, 725, 726, 739–741, 750, 751
Dawson
Daw15, 327–332
- Ryle
Martin, 788
- Ryota
Akiyoshi
Aky24, 242
- Sa85
Carl
Sagan, 792
- Sabine
Hossenfelder
Hos18, 533
Hos18a, 260, 378, 379, 530–532, 702, 704, 706
Hos19, 534, 539
- Saeed
Salehi
SS17, 249, 478
SS18, 404
- Sagan
Carl
Sa85, 792
- Saharon
Shelah
She91, 293, 294, 373, 507
- Salazar-Gomez
Andres F.
GDGGR, 558
- Salehi
Saeed
SS17, 249, 478
SS18, 404
- Salvatore
Mandrà
AAB19, 163, 164, 569, 725, 726, 739–741, 750, 751
- Sambin
Giovanni
MS05, 274
- Samuel R.
Buss
BKPS, 39, 204, 205
Bs97, 231, 233, 234
Bs98, 433, 440, 441
- Sanders
Daniel
RSSp, 80, 86, 90, 123, 125
RSST, 80, 86, 90, 123, 125
- Sandro
Sozzo
Aetal, 679
- Sanjeev
Arora
Ar09, 509
- Sank
Daniel
AAB19, 163, 164, 569, 725, 726, 739–741, 750, 751
- Santos
Laurie
PBC20, 171
- Sapir-Whorf
Hypothesis, 341
- Sara
Walker
FGW22, 599–602, 788

- Sartori
 Lorenzo
 Srt23, 515
- SAT, 158, 754
- Satzinger
 Kevin J.
 AAB19, 163, 164, 569, 725, 726, 739–741, 750, 751
- Saul A.
 Kripke
 Krp13, 144, 145, 206
- Saupe
 Dietmar
 BPS88, 791
- Saxena
 Nitin
 AKS04, 603, 614
- SB99
 John
 Byrnes, 147, 553, 554
 Wilfried
 Sieg, 147, 553, 554
- Sc35
 Erwin
 Schrödinger, 375, 648
- SCA00
 Ayse
 Pinar, 558
 Ilyas
 Cicekli, 558
 Varol
 Akman, 558
- Scarantino
 Andrea
 SP10, 372
- Schirn
 Matthias
 SN01, 235–240, 251, 259–261
- Schmerl
 James H.
 KS06, 485
- School
 Cathedral and John Connon, 876
- Schrödinger
 Erwin, 179, 458, 662, 680, 723, 743
 cat paradox, 610, 646
 Ei50, 715, 716
 Sc35, 375, 648
- Schrödinger
 Erwin, 741
- science
 cognitive, 668
- scientific
 knowledge, 361, 796
- SD21
 Farzaneh
 Derakhshan, 147, 148
 Wilfried
 Sieg, 147, 148
- Sean Evans
 Nanjwenge
 Nnj18, 81
- Selbach-Allen
 Megan
 AWB20, 831
- Selberg
 Atle, 627
- Selmer
 Bringsjord
 BG11, 206
 BG11a, 206
 Bri93, 591
- sequence
 Specker, 189, 201, 212, 514
- Serény
 György
 Srn11, 411–414
- Seraji
 Payam
 SS17, 249, 478
 SS18, 404
- Sergei
 Artemov
 Art07, 18
- Sergei V.
 Isakov
 AAB19, 163, 164, 569, 725, 726, 739–741, 750, 751
- Sergey
 Knysh
 AAB19, 163, 164, 569, 725, 726, 739–741, 750, 751
- Sergio
 Boixo
 AAB19, 163, 164, 569, 725, 726, 739–741, 750, 751
- Set Theory
 first-order
 ZF, 32, 140, 145, 146, 166, 247, 315, 325, 329, 353, 355, 362, 364–366, 370–372, 401–403, 415–417, 459, 462, 464, 465, 469, 472, 485, 487, 494, 505–509, 533, 760, 802, 827, 830
 ZFC, 403, 506, 508
 Zermelo-Fraenkel
 ZF, 32, 140, 247, 308, 353, 355, 402, 506, 508, 518, 830, 843
- Seymour
 Paul
 RSSp, 80, 86, 90, 123, 125
 RSST, 80, 86, 90, 123, 125
- SG24
 Flavio

- Del Santo, 210–212, 645
- Nicolas
Gisin, 210–212, 645
- Sh+11
Sheldon
Goldstein, 648, 650, 655
- Sh67
Joseph
Shoenfield, 186, 433, 479, 495
- Sha06
Oron
Shagrir, 592
- Shagrir
Oron
Sha06, 592
- Shai
Ben-David
Dvd19, 186
- Shan
Gao
Gao23, 709, 710
- Shanker
Sturat G., 327–332
- shared
knowledge, 827
- Shashi Mohan
Srivastava
Sri08, 186, 487, 488
- Shashidhar
Belbase
Blb10, 836, 837, 841
- Shaw
Stacey T.
RSM18, 836
- Shawn
Hedman
Hd06, 186, 433, 499, 500
- Shay
Moran
Dvd19, 186
- She91
Saharon
Shelah, 293, 294, 373, 507
- Shelah
Saharon
She91, 293, 294, 373, 507
- Sheldon
Goldstein
Sh+11, 648, 650, 655
- Sher
Gila
Shr13, 298, 299, 358, 813
Shr18, 23, 36, 359, 360
Shr23, 299
- Shih-Hung
Chen
- BCST, 531
- Shimura
Gorō, 52
Goro, 74
Taniyama
conjecture, 52
- Shoenfield
Joseph
Sh67, 186, 433, 479, 495
- Shore
Richard A.
BKPS, 39, 204, 205
- Shpilka
Amir
Dvd19, 186
- Shr13
Gila
Sher, 298, 299, 358, 813
- Shr18
Gila
Sher, 23, 36, 359, 360
- Shr23
Gila
Sher, 299
- Si12
Wilfried
Sieg, 23, 218, 252, 254, 256
- Sieg
Wilfried
RS17, 358
SB99, 147, 553, 554
SD21, 147, 148
Si12, 23, 218, 252, 254, 256
SW17, 145, 146, 507–509
SW19, 145, 146
- Sierpiński
Wacław, 516
- Sim06
Stephen
Simpson, 495
- Sim88
Stephen
Simpson, 514
- Simon
Allzén
Alz22, 172
- Singh
Sng97, 51–53, 59, 65
- Simons
Peter
Sms04, 354
- Simonsen
Jakob Grue
Smn05, 189
- Simpson
Stephen

- Sim06, 495
 Sim88, 514
- Singh
 Mihir
 Mhr23, 664, 666, 668
 Simon
 Sng97, 51–53, 59, 65
- Sipka
 Timothy
 Spk02, 95, 96, 99
- Sk22
 Thoralf
 Skolem, 215, 219–222, 225, 328, 366–370, 402, 462, 492, 815
- Sk28
 Thoralf
 Skolem, 186
- Sk34
 Thoralf
 Skolem, 489
- Skolem
 Thoralf, 327, 332, 469, 758
 Sk22, 215, 219–222, 225, 328, 366–370, 402, 462, 492, 815
 Sk28, 186
 Sk34, 489
- Skolem's
 Paradox, 220
- Sm92
 Raymond
 Smullyan, 186, 433, 479
- Smelyanskiy
 Vadim
 AAB19, 163, 164, 569, 725, 726, 739–741, 750, 751
- Smi13
 Peter
 Smith, 186, 409, 433, 435–437, 444, 445
- Smith
 Carl H.
 BFS08, 438, 439
 Jubilee
 Byd14, 836
 Peter, 451
 Smi13, 186, 409, 433, 435–437, 444, 445
- Smn05
 Jakob G.
 Simonsen, 201, 212, 514
 Jakob Grue
 Simonsen, 189
- Smoryński
 Craig
 Smy77, 186
 Smy81, 440
- Sms04
 Peter
- Simons, 354
- Smy77
 Craig
 Smoryński, 186
- Smy81
 Craig
 Smoryński, 440
- SN01
 Karl-Georg
 Niebergall, 235–240, 251, 259–261
 Matthias
 Schirn, 235–240, 251, 259–261
 Niebergall
 Karl-George, 235–240, 251, 259–261
 Schirn
 Matthias, 235–240, 251, 259–261
- Snell
 J. Laurie
 GS97, 612
- Sng97
 Simon
 Singh, 51–53, 59, 65
- Sokal
 Alan
 David, 70–72
- Solomon
 Feferman
 Fe00, 360, 361, 363–366
 Fe02, 192, 264, 315, 505, 682
 Fe06, 127, 409, 592
 Fe06a, 395, 408, 410
 Fe08, 127
 Fe60, 427
 Fe92, 487, 490
 Fe97, 366, 494, 495
 Fe98, 515, 517, 518, 844
 Fe99, 335
 FFMS, 507
 Marcus
 CCS01, 139, 145
- Sorvo
 Rikka
 Srv19, 836
- Sozzo
 Sandro
 Aetal, 679
- SP10
 Andrea
 Scarantino, 372
 Gualtierio
 Piccinini, 372
 Piccinini
 Gualtierio, 372
 Scarantino
 Andrea, 372
- Specker

- Ernst, 201, 212, 514
sequence, 189, 201, 212, 514
- Spiridon
Dumitru
Dmt22, 703, 704
- Spk02
Timothy
Sipka, 95, 96, 99
- Sra05
M. D.
Srinivas, 41, 42, 45, 46
- Sri08
Shashi Mohan
Srivastava, 186, 487, 488
Shasi Mohan
Srivastava, 488
- Srinivas
M. D.
Sra05, 41, 42, 45, 46
- Srivastava
Shashi Mohan
Sri08, 186, 487, 488
- Srn11
György
Serény, 411–414
- Srt23
Lorenzo
Sartori, 515
- Srv19
Aro
Mikko, 836
Asko
Tolvanen, 836
Eija
Räikkönen, 836
Helena
Viholainen, 836
Koponen
Tuire, 836
Mikko
Aro, 836
Peura
Pilvi, 836
Pilvi
Peura, 836
Räikkönen
Eija, 836
Rikka
Sorvo, 836
Sorvo
Rikka, 836
Tolvanen
Asko, 836
Tuire
Koponen, 836
Viholainen
Helena, 836
- SS17
Payam
Seraji, 249, 478
Saeed
Salehi, 249, 478
- SS18
Payam
Seraji, 404
Saeed
Salehi, 404
- St81
Ian Nicholas
Stewart, 80
- Stéphane
Mallarmé, 399
- Stacey T.
Shaw
RSM18, 836
- standard interpretation
PA
weak, 132
- Stanford Encyclopedia of Philosophy, 441
- Stanislaw
Krajewski
Kr14, 266
Kr16, 177, 273, 276, 287–290, 292–294, 358, 400,
514, 515, 806
Kr19, 187
Kr20, 407, 540, 543, 544
- Starks
Michael R.
Stk12, 219
- Stathis
Livadas
Lvd16, 182–184, 344–346, 454–456
- Stc22
Ovidiu Cristinel
Stoica, 699, 711, 712
- Ste02
Jörn
Steuding, 608–610, 628
- Steel
John R.
FFMS, 507
- Stefan
Haan
RJHH, 125, 126
Rass
RJHH, 125, 126
- Steinhardt
Paul J.
BCST, 531
- Stella
Moon
Mon17, 433–435

- Stephanie
 Gil
 GDGGR, 558
- Stephen
 Cook, 156–159, 614
 CU93, 186
 Hawking, 215, 592, 788
 Simpson
 Sim06, 495
 Sim88, 514
 Weinberg, 72
 Yablo
 Ya93, 388, 446, 447, 502–504
- Stephen Cole
 Kleene, 266
 Kl36, 590
 Kl52, 23, 129, 186, 189, 199, 249, 274, 275, 412, 479, 481, 483
- Steuding
 Jörn
 Ste02, 608–610, 628
- Steve
 Awodey
 AR02b, 186, 271
 Chinn
 Chn18, 836
 Habegger
 AAB19, 163, 164, 569, 725, 726, 739–741, 750, 751
- Steven
 Johnson
 Jo17, 787, 788, 795, 796
 Vigdor
 VL17, 380
 Weinberg, 530, 702, 704, 706
- Stewart
 Ian Nicholas
 St81, 80
- Stk12
 Michael R.
 Starks, 219
- stochastic, 743
- Stoica
 Ovidiu Cristinel
 Ste22, 699, 711, 712
- string
 closed, 76
 open, 76
 theory, 76
- strong
 algorithmic
 computability, 192
 quantification, 188, 508
- structure
 mathematical, 668
- Stuart G.
 Shanker, 327–332
- Su60
 Patrick
 Suppes, 186
- Sung
 Kevin J.
 AAB19, 163, 164, 569, 725, 726, 739–741, 750, 751
- Sunny Kumar
 Labh
 Lbh23, 715
- Suppes
 Patrick
 Su60, 186
- SW17
 Patrick
 Walsh, 145, 146, 507–509
 Wilfried
 Sieg, 145, 146, 507–509
- SW19
 Patrick
 Walsh, 145, 146
 Wilfried
 Sieg, 145, 146
- Swart
 E. R.
 Sw80, 80
- Swift
 Jonathan, 6
- Szücs
 Dénes
 Rli16, 841
- Sza02
 Andrzej
 Szałas, 27, 28, 186
- Szałas
 Andrzej
 Sza02, 27, 28, 186
- T.
 Goldman
 NG91, 531
- Ta35
 Alfred
 Tarski, 161, 184, 286, 311, 506, 813
- Ta39
 Alfred
 Tarski, 508
- tacit
 knowledge, 817
- Takeuti
 Gaisi, 242
- Tang
 Ewin
 Tang19, 741
 Tang22, 741, 742
- Tang19

- Ewin
Tang, 741
- Tang22
Ewin
Tang, 741, 742
- Taniyama
Shimura
conjecture, 52
Yutaka, 52, 74
- Taniyama-Shimura
conjecture, 52
- Tao
Terence
Tao07, 105, 107
Tao24, 124
- Tao07
Terence
Tao, 105, 107
- Tao24
Terence
Tao, 124
- Tarski
Alfred, 7, 18, 31, 128, 130, 132, 135, 167, 185, 214, 244, 254, 255, 264, 271–274, 284, 285, 315, 316, 358, 360, 382, 438, 453, 490, 513, 544, 549, 551, 552, 554, 607, 660, 684, 853, 854
Ta35, 161, 184, 286, 311, 506, 813
Ta39, 508
- Tarskian
truth
values, 554
- Taylor
R. Gregory
Tyl07, 206
Richard, 74
DDR95, 52
- Tennant
Neil, 412, 413
- Terence
Tao
Tao07, 105, 107
Tao24, 124
- Terry
Rudolph
PBR12, 727
- Th94
William P.
Thurston, 55
- Thaliath
Babu
Thl19, 33
- Thebault
Karim
DDT19, 534
- Theodor
Nenu
HN24, 563–565
- Theodore
White
AAB19, 163, 164, 569, 725, 726, 739–741, 750, 751
- Theorem
Löwenheim-Skolem
Downwards, 220
Wilkie, 434, 435
- theorem
Cantor, 578
- theory
categorical, 668
string, 76
- Thesis
Church, 129, 144, 202, 203, 206, 266, 267, 470, 561, 590, 591, 593, 690
Church-Turing, 3, 19, 129, 139, 141, 144, 164, 178, 179, 202, 204–206, 265–268, 270, 315, 458, 551, 561, 590, 594, 725, 726, 736, 743
Complementarity, 20, 23, 26, 29, 31, 33, 36, 40–42, 47, 66, 71, 105, 122, 123, 159, 172, 184, 190, 192, 221, 224, 226, 229, 259, 273, 276, 281, 295, 297, 298, 302, 324, 328, 331, 333, 358, 361, 365, 367, 368, 373, 435, 437, 439, 465, 539, 544, 589, 605, 637, 684, 686, 727, 747, 754, 808, 811, 813, 824, 825, 828, 830, 831, 834, 843, 846, 861
Gödelian, 7, 18, 152, 196, 215, 270, 284, 287, 540, 546, 548, 553, 554, 556
Hilbert, 144, 206
Isaacson, 434–436
Limiting
PA, 355, 830
ZF, 355, 830
Mathematics, 325, 824, 825, 830
Mechanist, 541
PA
Limiting, 355
Turing, 129, 202–204, 267, 561
Veridicality, 801
ZF
Limiting, 355
- Third
Chimpanzee, 786
- Thl19
Babu
Thaliath, 33
- Thm98
Robin
Thomas, 80
- Thom
René, 518
- Thomas
Robin
RSSp, 80, 86, 90, 123, 125

- RSST, 80, 86, 90, 123, 125
 Thm98, 80
 Tymoczko
 Tym79, 80
 Thoralf
 Skolem, 327, 332, 469, 758
 Sk22, 215, 219–222, 225, 328, 366–370, 402, 462, 492, 815
 Sk28, 186
 Sk34, 489
 Thurston
 William
 P., 71
 William P.
 Th94, 55
 Ti51
 E. C.
 Titchmarsh, 627
 Tianxin
 Cai
 CCZ15, 53
 Tim
 Londergan
 VL17, 380
 Timm
 Lampert
 Lam17, 219, 306, 307, 309, 310, 547
 Lam19, 332, 333
 Timothy
 Gowers
 Gow02, 504
 Sipka
 Spk02, 95, 96, 99
 Timothy Y.
 Chow
 Cho18, 186, 241, 247, 252, 485
 Titchmarsh
 E. C.
 Ti51, 627
 Tng10
 Evans Ayagikwaga
 Tungosiamu, 836
 Tolvanen
 Asko
 Srv19, 836
 Tomas
 Veloz
 Aetal, 679
 Tony
 Crilly
 Crl05, 80
 Tragesser
 Robert
 AT03, 288
 Travelling Salesman Problem
 TSP, 458, 765–781, 783–785
 Travis S.
 Humble
 AAB19, 163, 164, 569, 725, 726, 739–741, 750, 751
 Trent
 Huang
 AAB19, 163, 164, 569, 725, 726, 739–741, 750, 751
 Trevithick
 Mathew D.
 AAB19, 163, 164, 569, 725, 726, 739–741, 750, 751
 Troelstra, 343
 truth
 values
 Tarskian, 554
 TSP
 Travelling Salesman Problem, 458, 765–781, 783–785
 Tu36
 Alan
 Turing, 154, 156, 158, 161, 200, 203, 204, 230, 239, 254, 261, 505, 506, 548, 557, 561, 562, 686, 791
 Tu39
 Alan
 Turing, 505, 506
 Tu50
 Alan
 Turing, 548, 557
 Tuire
 Koponen
 Srv19, 836
 Tungosiamu
 Evans Ayagikwaga
 Tng10, 836
 Turing
 Alan, 129, 139, 178, 179, 196, 202, 207, 265, 315, 410, 415, 418, 422, 458, 546, 547, 551, 557, 558, 560, 561, 565–567, 590, 640, 680, 761
 Test, 477
 Thesis, 129
 Tu36, 154, 156, 158, 161, 200, 203, 204, 230, 239, 254, 261, 505, 506, 548, 557, 561, 562, 686, 791
 Tu39, 505, 506
 Tu50, 548, 557
 Halting
 problem, 198, 200
 Theorem, 580
 Halting Argument, 474
 Halting problem, 561, 569, 570
 Halting Theorem, 418, 562, 567–569, 582, 761
 Thesis, 202–204, 267, 561
 Turing Test, 287
 Turok

- Neil
BCST, 531
- Turri
John
PBC20, 171
- Tyl07
R. Gregory
Taylor, 206
- Tym79
Thomas
Tymoczko, 80
- Tymoczko
Thomas
Tym79, 80
- Ujjwal Kumar
Halder
AH18, 836
- UN04
Liisa
Uusimaki, 836
Rod
Nason, 836
- unbounded
quantification, 184, 240
- uncomputability
algorithmic, 341, 464, 645, 686
- undecidability
algorithmic, 581
- universal
quantification, 183, 238, 254, 255, 263, 454–456
- University
West Virginia, 117
- unprovability
algorithmic, 309
- Unrecorded Proof
Fermat
FUP, 47–54, 58, 64–67, 75, 76, 78
- unverifiability
algorithmic, 562
- Urbaniak
Rafał
GoU19, 388, 446, 447, 503, 504
- Urquhart
Alisdair
CU93, 186
- Uusimaki
Liisa
UN04, 836
- V. Alexis
Peluce
Plc20, 591, 592
- V. Wictor
Marek
MM01, 144, 508
- Vadim
Smelyanskiy
AAB19, 163, 164, 569, 725, 726, 739–741, 750, 751
- Vainsencher
Amit
AAB19, 163, 164, 569, 725, 726, 739–741, 750, 751
- Vakoch
Douglas, 788
- Valente
Mario Bacelar
Vln22, 103
- Valentin
Goranko
CG15, 81, 92
- Valia
Allori
Alr24, 658, 659
- van Atten
Mark
AT03, 288
At17, 279, 280
At18, 226
At23, 275
- van Basshuysen
Philippe
WBF22, 47, 48
- Van Bendegem, 192
- van Dalen, 343
- van Heijenoort
Jean
Hei76, 18
- Varol
Akman
SCA00, 558
- Vasant
Hanovar, 875
- Vasil
Penchev
Pnc20, 164
- Vck22
Peter
Vickers, 167
- Veblen
Oswald, 517
- Veloz
Tomas
Aetal, 679
- Vera
Flocke
Flo19, 227–230, 428
- Veridicality
Thesis, 801
- verifiability
algorithmic, 3, 7, 18, 31, 32, 40, 129, 131, 132, 178, 187, 272, 310, 312, 313, 315–319, 328, 341,

- 362, 363, 368, 374, 375, 377, 410, 411, 430, 431, 439, 440, 442, 450, 453, 456, 459, 461, 467–469, 475–477, 486, 490, 491, 506, 514, 524, 547, 551–556, 559, 566–568, 573, 578, 581, 583, 585–587, 589, 590, 593, 603, 607, 608, 615, 620, 640, 642, 644, 645, 654, 656, 658, 660–662, 668, 670, 671, 676, 678, 681–683, 686–690, 698, 723, 725–727, 731, 736, 743, 747, 761, 875
- verifier
 knowledge, 743
 quantum, 743
- Vi11
 M.
 Villata, 531
- Vickers
 Peter
 FV22, 374
 Vck22, 167
- Victor
 Kolyvagin, 52
- Vid06
 Joseph
 Vidal-Rosset, 406
- Vidal-Rosset
 Joseph
 Vid06, 406
- Vigdor
 Steven
 VL17, 380
- Viholainen
 Helena
 Srv19, 836
- Villalonga
 Benjamin
 AAB19, 163, 164, 569, 725, 726, 739–741, 750, 751
- Villata
 M.
 Vi11, 531
- Vilnis
 Detlovs
 DP17, 186
- Vincenzo
 Fano
 FG12, 540
- Virgil
 Drăghici
 Drg23, 249
 Drăghici
 Drg18, 501
 Drg23, 186, 315, 418, 419, 433, 446, 501
- Visser
 Albert
 Vss20, 540
- VL17
- Steven
 Vigdor, 380
- Tim
 Londergan, 380
- Vladimir
 Voevodsky, 241, 252
 Vo10, 186, 243, 253, 433
- Vln22
 Mario Bacelar
 Valente, 103
- Vo10
 Vladimir
 Voevodsky, 186, 243, 253, 433
- Voevodsky
 Vladimir, 241, 252
 Vo10, 186, 243, 253, 433
- Vojtěch
 Kolman
 Kma08, 136–139, 386–388, 472, 473
 Kma18, 105, 107–110
- Vss20
 Albert
 Visser, 540
- W. H.
 Furry
 Ga15, 609
- Wójtowicz
 Krzysztof
 Wo09, 740, 741, 743–748, 750–752
 Wo19, 743, 751–762
- Wa63
 Hao
 Wang, 186, 246, 478, 479
- Waaldijk
 Frank
 Wl03, 285, 689, 690
- Wacław
 Sierpiński, 516
- Wagner
 Roy
 Wgn08, 420
 Wgn09, 394, 408, 415, 420, 421
 Wgn19, 116
- Walker
 Sara
 FGW22, 599–602, 788
- Wallis
 John, 52
- Walsh
 Patrick
 SW17, 145, 146, 507–509
 SW19, 145, 146
- Walter
 Pitts
 LMMP, 595, 596
 Rudin

- Ru53, 129, 209, 510
- Walter A.
Carnielli
EC89, 186, 433, 478
- Wang
Hao, 452
Wa63, 186, 246, 478, 479
- Warren
McCulloch
LMMP, 595, 596
- water
molecule, 76
- WBF22
Lucie
White, 47, 48
Mathias
Frisch, 47, 48
Philippe
van Basshuysen, 47, 48
- Wcislo
Bartosz
LW23, 186, 445
- Wck23
Markus
Weckström, 716–718
- We10
Hermann
Weyl, 341, 803, 804, 811
- We27
Hermann
Weyl, 136, 146
- weak
algorithmic
computability, 192
quantification, 188, 508
standard interpretation
PA, 132
- Weckström
Markus
Wck23, 716–718
- Wegner
Peter
WG03, 139, 141, 142
- Weil
André, 52
- Weinberg
Stephen, 72
Steven, 530, 702, 704, 706
- Wen
Xiao-Gang, 530
- Wendy
Boyd
Byd14, 836
- Wesley
Buckwalter
PBC20, 171
- Wessels
D. C. J.
YBM04, 832
- West Virginia
University, 117
- Weyl
Hermann, 278, 332, 343, 682
We10, 341, 803, 804, 811
We27, 136, 146
- WG03
Dina
Goldin, 139, 141, 142
Peter
Wegner, 139, 141, 142
- Wgn08
Roy
Wagner, 420
- Wgn09
Roy
Wagner, 394, 408, 415, 420, 421
- Wgn19
Roy
Wagner, 116
- Wgr60
Eugene P.
Wigner, 29, 347, 348, 808
- Wharton
Ken
PW23, 720, 721
- White
Lucie
WBF22, 47, 48
Theodore
AAB19, 163, 164, 569, 725, 726, 739–741, 750, 751
- Whitehead
Alfred North, 257
WR10, 186, 325
- Wi22
Ludwig
Wittgenstein, 7, 355
- Wi74
Ludwig
Wittgenstein, 430
- Wi78
Ludwig
Wittgenstein, 143, 152, 153, 219–221, 237, 302–305, 307, 309–311, 325, 381, 382, 453, 547, 686
- Wiedijk
Freek
BW05, 53, 54, 146, 298
- Wigner
Eugene, 736
Eugene P.
Wgr60, 29, 347, 348, 808

- Wikipedia
 diagonal lemma, 442
- Wildberger
 Norman
 Wlb99, 117
- Wiles
 Andrew, 52, 54
 Wls95, 52–54, 66, 67, 69–72, 119
- Wilfried
 Sieg
 RS17, 358
 SB99, 147, 553, 554
 SD21, 147, 148
 Si12, 23, 218, 252, 254, 256
 SW17, 145, 146, 507–509
 SW19, 145, 146
- Wilhelm
 Ackermann
 HA28, 186
- Wilkie
 Theorem, 434, 435
- Willard Van Orman
 Quine, 263, 518
 Qu53, 816, 822
 Qu63, 186
- Willem
 Conradie
 CG15, 81, 92
- William
 P.
 Thurston, 71
- Courtney
 AAB19, 163, 164, 569, 725, 726, 739–741, 750, 751
- Hermanns
 Her83, 689
- Jiménez-Leal
 Rli16, 841
- William Edgar
 Boyd
 Byd14, 836
- William P.
 Thurston
 Th94, 55
- Williams
 Cathy
 AWB20, 831
- Wilson
 Robin
 Wln13, 86, 90, 93
- Wittgenstein
 Ludwig, 19, 21, 24, 29, 36, 178, 226, 283, 297, 306, 308–310, 315–317, 325, 327–333, 351, 383, 404, 411, 414, 415, 430, 450–452, 462–465, 467–472, 475–477, 547, 552, 754
 Wi22, 7, 355
- Wi74, 430
 Wi78, 143, 152, 153, 219–221, 237, 302–305, 307, 309–311, 325, 381, 382, 453, 547, 686
- Wl03
 Frank
 Waalwijk, 285, 689, 690
- Wlb99
 Norman
 Wildberger, 117
- Wln13
 Robin
 Wilson, 86, 90, 93
- Wls95
 Andrew
 Wiles, 52–54, 66, 67, 69–72, 119
- Wo09
 Krzysztof
 Wójtowicz, 740, 741, 743–748, 750–752
- Wo19
 Krzysztof
 Wójtowicz, 743, 751–762
- Wo52
 Andrzej
 Mostowski, 186, 401
- Woleński
 Jan
 OWJ06, 206
- Wolfgang
 Haken
 AH77, 79–81, 89–91, 95, 110, 123, 124, 760
 AHK77, 79–81, 89–91, 95, 110, 123, 124, 760
- WR10
 Alfred North
 Whitehead, 186, 325
- Bertrand
 Russell, 186, 325
- Wright
 Crispin, 412, 413
- E. M.
 HW60, 612, 614, 615, 620, 623, 626, 627, 636
- Xiao
 Mi
 AAB19, 163, 164, 569, 725, 726, 739–741, 750, 751
- Xiao-Gang
 Wen, 530
- Ya93
 Stephen
 Yablo, 388, 446, 447, 502–504
- Yablo
 Stephen
 Ya93, 388, 446, 447, 502–504
- Yao
 Z. Jamie

- AAB19, 163, 164, 569, 725, 726, 739–741, 750, 751
- YBM04
- A.
- Mji, 832
- B.
- Yushua, 832
- D. C. J.
- Wessels, 832
- M. A.
- Bukhari, 832
- Yeh
- Ping
- AAB19, 163, 164, 569, 725, 726, 739–741, 750, 751
- Yehudayoff
- Amir
- Dvd19, 186
- Yessenin-Volpin
- Alexander
- He04, 152, 237
- Yong
- Cheng
- Chg20, 540
- Zhang
- CCZ15, 53
- Yu
- Chen
- AAB19, 163, 164, 569, 725, 726, 739–741, 750, 751
- Li
- Liy22, 400, 401, 406, 433
- Yuri
- Gurevich
- DG08, 266–268
- Gu19, 266
- Ivanovich
- Manin, 71
- Yuriy
- Brun
- Bru02, 80, 92
- Yushua
- B.
- YBM04, 832
- Yutaka
- Taniyama, 52, 74
- Yuval
- Fisher
- BPS88, 791
- Yvon
- Gauthier
- Ga15, 656
- Z. Jamie
- Yao
- AAB19, 163, 164, 569, 725, 726, 739–741, 750, 751
- Zac07
- Richard
- Zach, 187
- Zach
- Richard
- Zac07, 187
- Zakaria
- Effandi
- AZ10, 836
- Zalcman
- Adam
- AAB19, 163, 164, 569, 725, 726, 739–741, 750, 751
- Zdanowski
- Konrad
- QZ07, 225, 226
- Zeilinger
- Anton, 658
- Zeno's
- paradox, 686
- Zermelo
- Ernst, 817
- Zermelo-Fraenkel
- Set Theory
- ZF, 32, 140, 247, 308, 353, 355, 402, 506, 508, 518, 830, 843
- ZF
- Limiting Thesis, 355, 830
- Set Theory
- first-order, 32, 140, 145, 146, 166, 247, 315, 325, 329, 353, 355, 362, 364–366, 370–372, 401–403, 415–417, 459, 462, 464, 465, 469, 472, 485, 487, 494, 505–509, 533, 760, 802, 827, 830
- Zermelo-Fraenkel, 32, 140, 247, 308, 353, 355, 402, 506, 508, 518, 830, 843
- ZFC
- Set Theory
- first-order, 403, 506, 508
- Zhang
- Jiang
- AAB19, 163, 164, 569, 725, 726, 739–741, 750, 751
- Jing
- ZZK19, 841
- Yong
- CCZ15, 53
- Zijun
- Chen
- AAB19, 163, 164, 569, 725, 726, 739–741, 750, 751
- Zilsel
- lecture, 252
- Zorzi
- Margherita
- AsZ12, 186
- ZZK19

Jing
Zhang, [841](#)
Nan
Jhao, [841](#)
Qi Ping
Kong, [841](#)

We

Bid A

Fond Farewell

to the Gödel

to the Hilbert

to the Brouwer

We Thought We Knew

...

With Remorse For Believing

They Were All We Saw

Not More, Not Less

*The moving finger writes, and having writ, moves on,
Not all thy piety, nor wit, can lure it back to cancel half a line,
Nor all thy tears wash away a word of it.*

... The *Rubáiyát* of Omar Khayyám

ABSTRACT

In this multi-disciplinary investigation, we address the philosophical challenge that arises when an intelligence—whether human or mechanistic—accepts arithmetical propositions as true under an interpretation—either axiomatically or on the basis of *subjective* self-evidence—*without* any specified methodology for *objectively evidencing* such acceptance. We then show how an *evidence-based* perspective of quantification in terms of:

- algorithmic *verifiability*, and
- algorithmic *computability*

admits *evidence-based* definitions of:

- *well-definedness*, and
- *effective computability*,

which yield two unarguably constructive interpretations of the first-order Peano Arithmetic PA—over the structure \mathbb{N} of the natural numbers—that are complementary, not contradictory:

- The first yields the *weak*, standard, interpretation $\mathcal{I}_{PA(\mathbb{N}, SV)}$ of PA over \mathbb{N} , which is *well-defined* with respect to assignments of algorithmically *verifiable* Tarskian truth values to the formulas of PA under $\mathcal{I}_{PA(\mathbb{N}, SV)}$; and thus constitutes a constructively *weak* proof of consistency for PA.
- The second yields a *strong*, finitary, interpretation $\mathcal{I}_{PA(\mathbb{N}, SC)}$ of PA over \mathbb{N} , which is *well-defined* with respect to assignments of algorithmically *computable* Tarskian truth values to the formulas of PA under $\mathcal{I}_{PA(\mathbb{N}, SC)}$; and thus constitutes a constructively *strong* proof of consistency for PA.

We situate our investigation within a broad analysis of quantification vis à vis:

- Hilbert's ε -calculus
- The Law of the Excluded Middle
- An Algorithmic ω -Rule
- Rosser's Rule C
- The Church-Turing Thesis
- Wittgenstein's constructive mathematics
- Gödel's ω -consistency
- Hilbert's ω -Rule
- Gentzen's Rule of Infinite Induction
- Markov's Principle
- Aristotle's particularisation
- *Evidence-based* quantification.

By showing how these are formally inter-related, we highlight the fragility of both:

- the persisting, *theistic*, classical/Platonic interpretation of quantification grounded in Hilbert's ε -calculus;

and

- the persisting, *atheistic*, constructive/Intuitionistic interpretation of quantification rooted in Brouwer's *mistaken* belief that the Law of the Excluded Middle is non-finitary.

We then consider some consequences for mathematics, mathematics education, philosophy, and the natural sciences, of an *agnostic, evidence-based*, finitary interpretation of quantification which challenges classical paradigms in all these disciplines.



The author is an independent researcher reviewing classical interpretations of Cantor's, Gödel's, Tarski's and Turing's reasoning, and addressing some grey areas in the foundations of mathematics, logic, philosophy and computability.