

Homogenous Cosmos Originated from Unique Genesis

Homogenous Cosmos Originated from Unique Genesis $\stackrel{\text{def}}{=} \sum_{m \equiv D}^D \left[\int_{i_0}^X f(m_{i_0 \rightarrow X}) i_0 \right]$

Author: Yang Guosheng Huang Jun

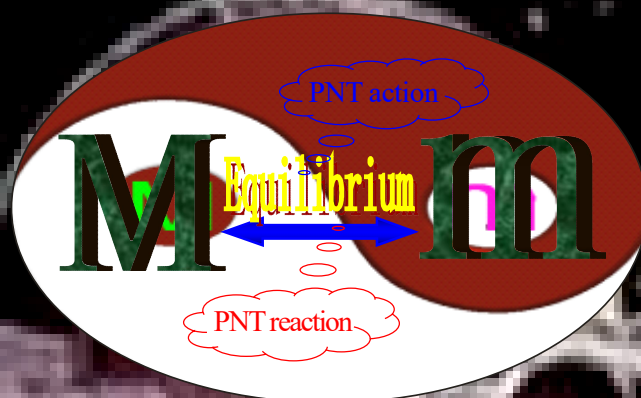

It's innovative **cosmos redefinition** in logic enantiomorph of newly highlighted factuality that **discretionary particles in cosmos** are mutually convertible with consequent PNT dynamics about universal existence & motion in the nature of coherent *natura naturans* throughout cosmic evolution. — **Science rudiment of the new century.**

1991~2023

 “Physical Regularity” is but vivid essence objectification of matter in universal existence & motion, which is consequent inherence in a class by itself originated from unique & invariable authenticity of nature as coherent natura naturans throughout cosmic evolution.

Homogenous Cosmos Originated from Unique Genesis

Accordingly, ultimate consummation of science towards formulation of universal existence & motion of matter in thorough coherence only challenges verification of unique issue — “what matter is in cosmos” as inherence of natura naturans.

$$\text{Homogenous Cosmos Originated from Unique Genesis} \stackrel{\text{def}}{=} \sum_{m \equiv D}^D [\int_{i_0}^x f(m_{i_0 \rightarrow x}) i_0]$$

Logic constitution of PNT Dynamics

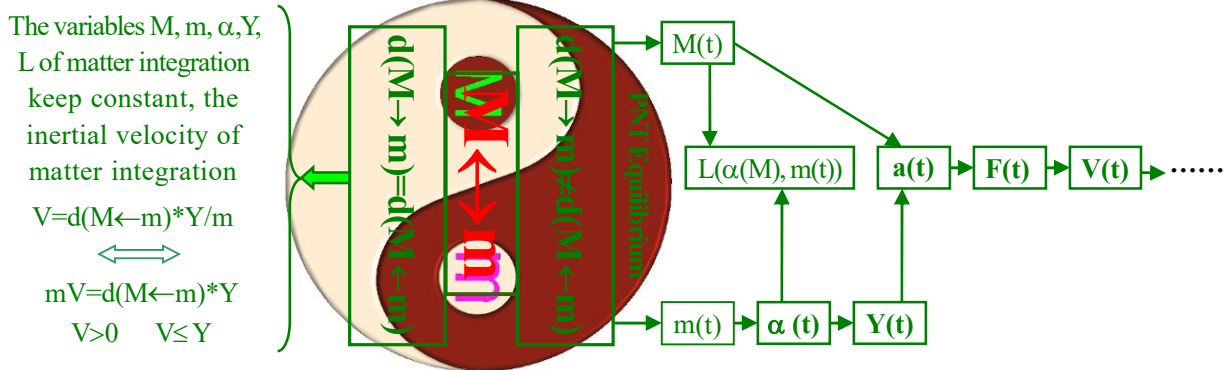

PNT Dynamics Equations

Matter inertial conservation equations:

$$\left\{ \begin{array}{l} M(t)+m(t)=R(t) \\ M(t)/m(t)=K(t) \\ V(t)*m(t)=d(M \leftarrow m)(t)*Y(t) \\ L^3(t)*\alpha(t)=A*m(t) \\ Y(t)=B*\alpha(t) \end{array} \right. \iff \left\{ \begin{array}{l} M(t)=K(t)*R(t)/[1+K(t)] \\ m(t)=R(t)/[1+K(t)] \\ V(t)=d(M \leftarrow m)(t)*Y(t)/m(t) \\ L^3(t)=A*m(t)/\alpha(t) \quad (\otimes) \\ Y(t)=B*\alpha(t) \quad (\otimes) \end{array} \right.$$

(1) The acceleration of matter integration:

$$a(t)=Y(t)*K'(t) \quad \dots \dots \dots \quad \textcircled{1}$$

(2) The force acting on matter integration:

$$\begin{aligned} F(t) &= m(t)*a(t) \\ &= R(t)*Y(t)K'(t)/(1+K(t)) \quad \dots \dots \dots \quad \textcircled{2} \end{aligned}$$

(3) Motion velocity of matter integration:

$$\begin{aligned} V(t) &= V_0 + \Delta V = V_0 + \int a(t) dt \\ &= V_0 + \int Y(t)K'(t) dt \quad \dots \dots \dots \quad \textcircled{3} \end{aligned}$$

Cosmic status quo is but demiurgic aggradation of sequential homologic cosmogony, which exactly exists as well-regulated integration of cosmic homogeneity system making up of out-and-out serial natura naturata in the nature of coherent natura naturans throughout cosmic evolution. It is only possible for concordant cosmos to be demiurgic aggradation of out-and-out serial natura naturata in the nature of coherent natura naturans throughout cosmic evolution; there is no way for demiurgic aggradation in the nature of different natura naturans to be concordant cosmos through and through. If we say cosmos is aesthetically regular, the unique aesthetic regularity of cosmos is but sequential homologic cosmogony in the nature of coherent natura naturans throughout cosmic evolution.

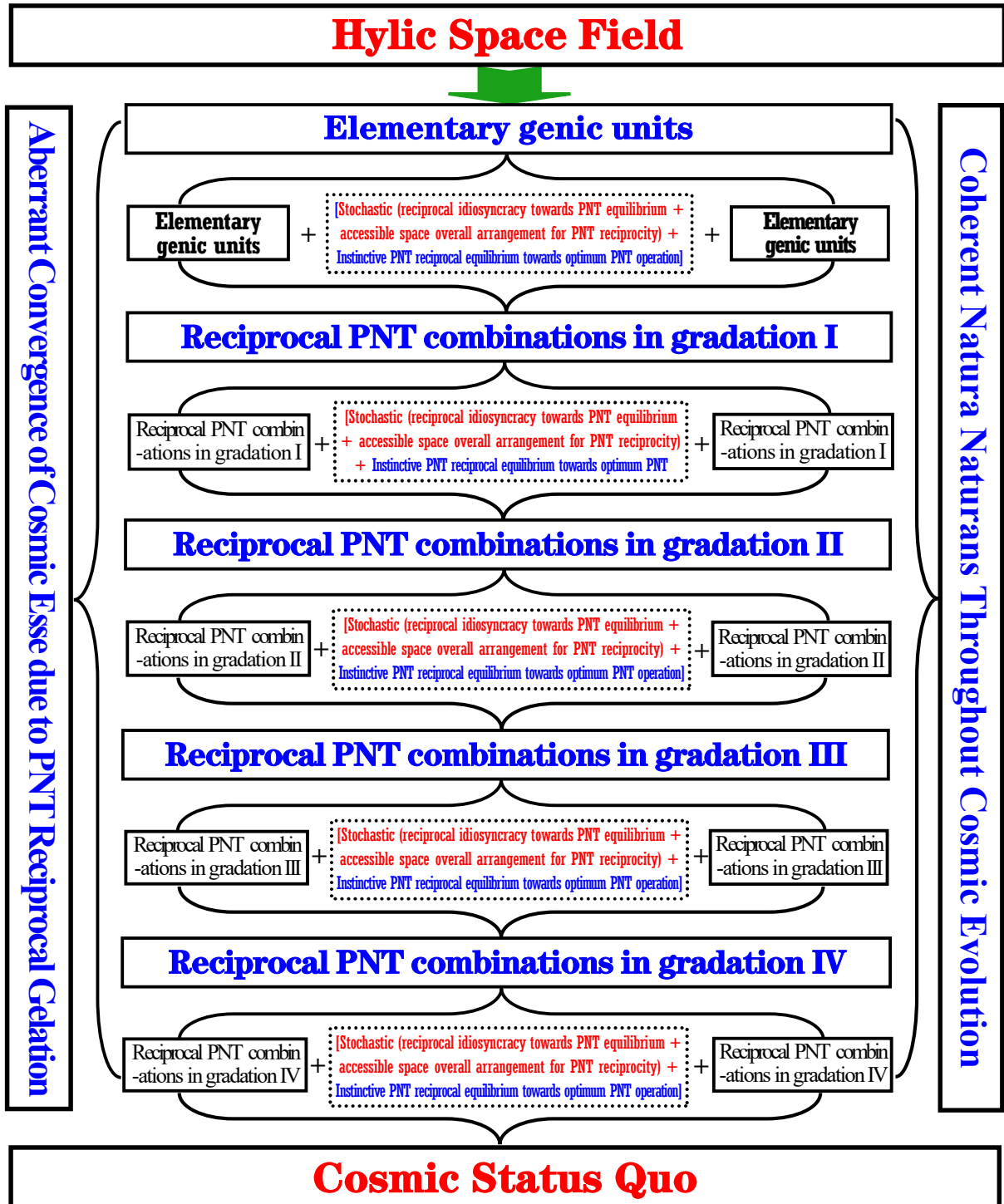

Illustration of Integrative Sequential Homologic Cosmogony

As coherent natura naturans throughout cosmic evolution, instinctive PNT reciprocal equilibrium towards optimum PNT operation is radical potentiality & conditionality for cosmos always ready to orientate itself towards perfection.

Since “ultimate authenticity of nature” can be neither omnifarious authenticity smallwares full of a basket nor authenticity chameleon one piece and only but coherent natura naturans throughout cosmic evolution.

Historical Progress of Science in Inherent Optimum Orientation Towards Perfect Ideological Enantiomorph of Ultimate Authenticity of Nature

As commensurate ideological enantiomorph about authenticity of accessible existence & motion around us, ultimate consummation of science must be unique scientific verity as “Perfect ideological enantiomorph of ultimate authenticity of nature” therefore.

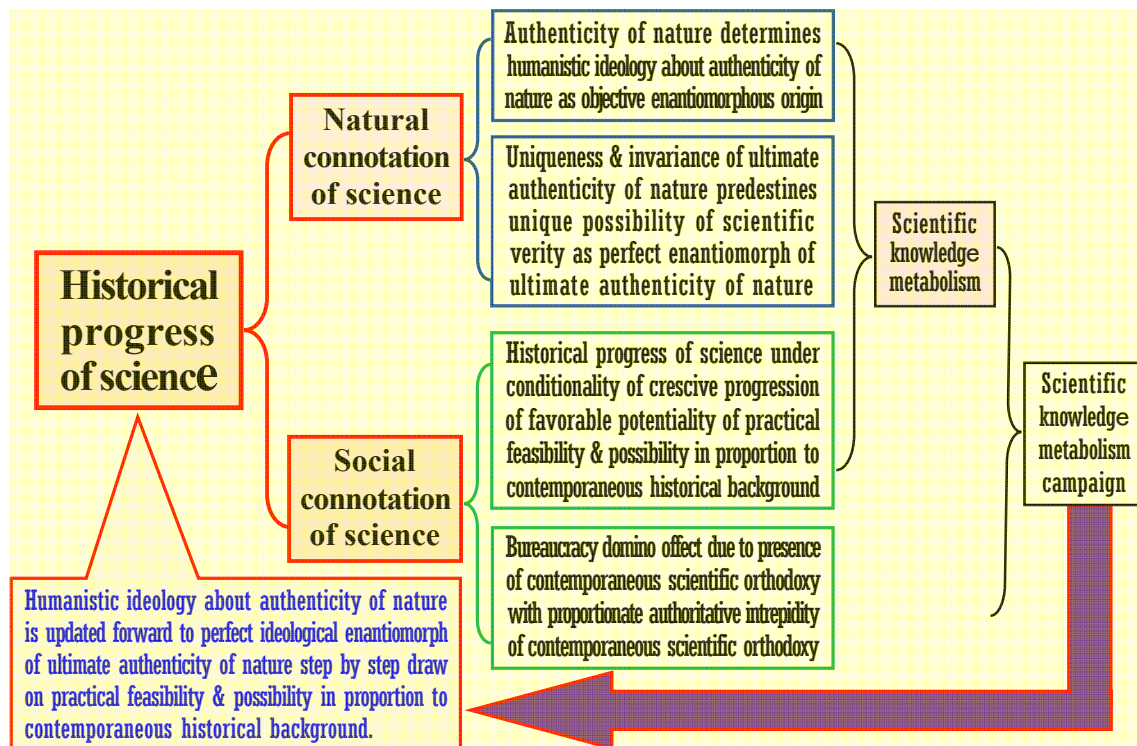

Even as permanent synthesized conditionality of “crevice progression of practical feasibility & possibility in proportion to contemporaneous historical background + the uniqueness & invariance of ultimate authenticity of nature predestines the unique possibility of scientific verity as perfect ideological enantiomorph of ultimate authenticity of nature” through and through, it’s only possible for the major melody of historical progress of science to be a series of epochmaking scientific knowledge metabolism in inherent optimum orientation towards perfect ideological enantiomorph of ultimate authenticity of nature.

Veritable progress of science is not intuitional cumulative achievement of colorful scientific travelogues A, B, C, D, E, F, . . . like omnifarious smallwares full of a basket about rich and colorful existence & motion accessible around us but successive hypostatic endeavor to push humanistic ideology about authenticity of nature forward to perfect ideological enantiomorph of ultimate authenticity of nature step by step draw on practical feasibility & possibility in proportion to contemporaneous historical background.

Historical progress of science in inherent optimum orientation towards perfect ideological enantiomorph of ultimate authenticity of nature generally makes up of N successive crescive cycles $\theta_1, \theta_2, \theta_3, \dots, \theta_{n-1}, \theta_n$, each circle makes up of “gradational quantitative change of original naissance of burgeoning contemporaneous scientific orthodoxy, freewheeling substantiation & perfection of contemporaneous scientific orthodoxy” and “timely qualitative change of epochmaking scientific knowledge metabolism between demodod contemporaneous scientific orthodoxy and coming burgeoning contemporaneous scientific orthodoxy with synchro subrogation of contemporaneous scientific orthodoxies”.

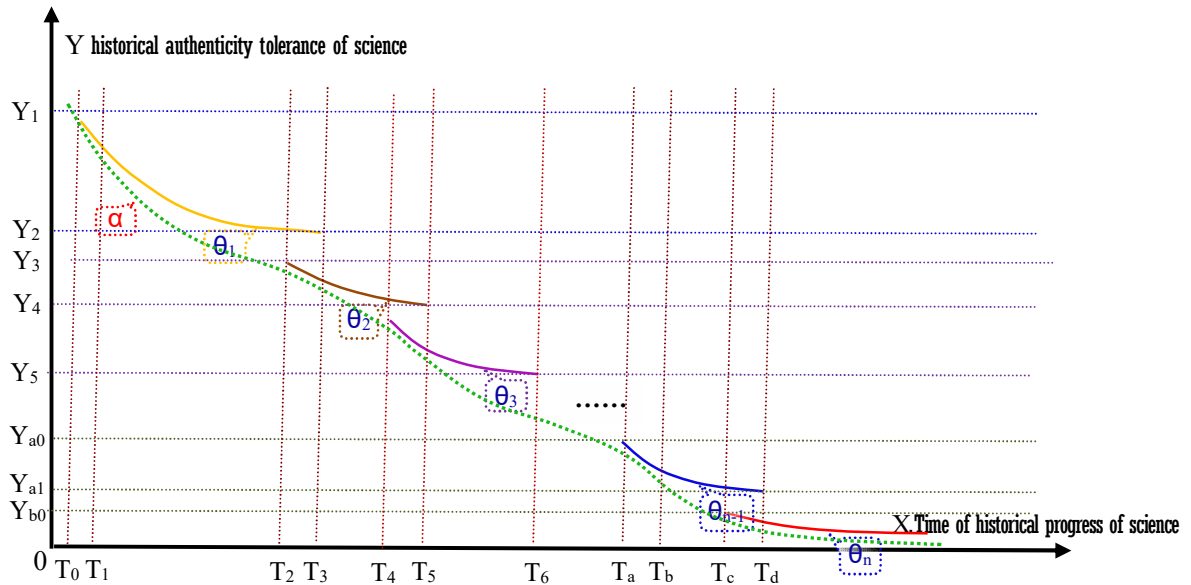

Quantitative change curve of historical progress of science making up of N successive subrogation of contemporaneous scientific Orthodoxies $\theta_1, \theta_2, \theta_3, \dots, \theta_{n-1}, \theta_n$ in inherent optimum orientation towards perfect ideological enantiomorph of ultimate authenticity of nature

Social legitimacy authorization of contemporaneous scientific orthodoxy depends on proportionable contemporaneous scientific authentication. Along historical progress of science in inherent optimum orientation towards perfect ideological enantiomorph of ultimate authenticity of nature, integrative layout of quantitative change of both historical authenticity tolerance of science $\theta_1, \theta_2, \theta_3, \dots, \theta_{n-1}, \theta_n$ of humanistic ideology about authenticity of nature in proportion to contemporaneous historical background and historical authenticity tolerance of science $\beta_1, \beta_2, \beta_3, \dots, \beta_{n-1}, \beta_n$ of synchro contemporaneous scientific authentication can be illustrated as below:

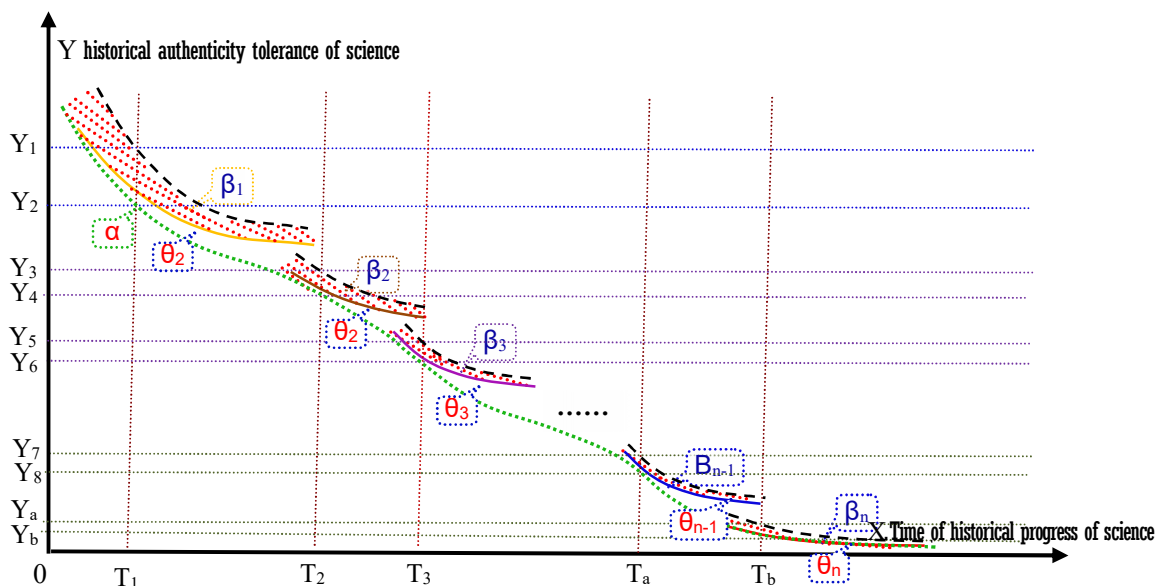

Integrative layout of quantitative change of both “historical authenticity tolerance of science of humanistic ideology about authenticity of nature” and “historical authenticity tolerance of science of commensurate proportionable scientific authentication” throughout historical progress of science

As coherent natura naturans throughout cosmic evolution, instinctive PNT reciprocal equilibrium towards optimum PNT operation is radical potentiality & conditionality for cosmos always ready to orientate itself towards perfection.

Cover Letter

As multiple notion with double significance of “**social connotation**” & “**natural connotation**”, social legitimacy & validity of truths can never exceed cannon range

i). Since **ultimate authenticity of nature** can be neither omnifarious authenticity smallwares



full of a basket nor authenticity chameleon one piece and only, but coherent natura naturans throughout cosmic evolution, cosmos is demiurgic aggradation of sequential homologic cosmogony which exactly exists as well-regulated integration of cosmic homogeneity system making up of out-and-out serial natura naturata in the nature of coherent natura naturans throughout cosmic evolution, as humanistic ideology about authenticity of accessible existence & motion around us, science is always humanistic ideology about authenticity of nature in proportion to contemporaneous historical background, it's only possible for ultimate consummation of science to be **perfect ideological enantiomorph of ultimate authenticity of nature** as unique scientific verity

about universal existence & motion. Even as permanent synthesized conditionality of “**crecive progression of practical feasibility & possibility in proportion to contemporaneous historical background + the uniqueness & invariance of ultimate authenticity of nature predestines the unique possibility of scientific verity as perfect ideological enantiomorph of ultimate authenticity of nature**” through and through, it's only possible for the major melody of historical progress of science to be a series of epochmaking scientific knowledge metabolism in inherent optimum orientation towards **perfect ideological enantiomorph of ultimate authenticity of nature**.

As multiple notion with double significance of “**social connotation**” & “**natural connotation**”, so-called “science” is but humanistic ideology about authenticity of accessible existence & motion derived from timely scientific knowledge proliferation against practical feasibility & possibility in proportion to contemporaneous historical background, commensurate ideological system about authenticity of historically accessible existence & motion in proportion to contemporaneous historical background. Along crecive progression of historical progress of science in inherent optimum orientation towards perfect ideological enantiomorph of ultimate authenticity of nature, different ages with ingenerate practical feasibility & possibility proportionately bring out commensurate ideological system about authenticity of nature in proportion to contemporaneous historical background with commensurate scientific legitimacy qualification of historical authenticity tolerance of science, such integrative progression of quantitative & qualitative change of commensurate ideological system about authenticity of nature along time extension exactly brings out integrative profile of historical progress of science in inherent optimum orientation towards perfect ideological enantiomorph of ultimate authenticity of nature.

Historical progress of science in the recent several centuries seemed like a far-flung exploration of the first itinerary around numerous distinctive landscapes of brand-new landmasses of science with palette & tablet on back, several hundred years' scientific travelogues were compiled thereby.

“Social connotation” of science mostly exists in

A). **Reciprocity in typical bidirectional resonant benign circle** between crecive progression of humanistic practical feasibility & possibility in proportion to contemporaneous historical background and commensurate historical progress of science in inherent optimum orientation towards perfect ideological enantiomorph of ultimate authenticity of nature endows science with “social connotation” as **humanistic ideology about authenticity of historically accessible existence & motion in proportion to contemporaneous historical background**.

If there is no humanistic society & social production in advance, there is neither objective necessity for original naissance & successive development of science nor practical potentiality for original naissance and successive development of science therefore. In another words, hypostatic existence of humanistic society & social production not only makes original naissance and successive development of science objectively necessary but also makes original naissance and successive development of science practically possible.

Throughout historical progress of science, “quantitative & qualitative change of practical feasibility & possibility in proportion to contemporaneous historical background” and “quantitative & qualitative change of humanistic ideology about authenticity of nature in proportion to contemporaneous historical background” are always **innate conditionality couple in reciprocity model of typical bidirectional resonant benign circle**, which not only indicates commensurate practical feasibility & possibility is always hypostatic potentiality for historical progress of science but also indicates commensurate achievement of humanistic ideology about authenticity of nature can proportionably enhance practical feasibility & possibility of the age as well. Once both innate conditionality between “quantitative & qualitative change of commensurate practical feasibility & possibility” and “quantitative & qualitative change of commensurate ideological system about authenticity of nature” in monofier modality bring out integrative progression of historical progress of science in inherent optimum orientation towards perfect ideological enantiomorph of ultimate authenticity of nature, vivid quantitative & qualitative change of historical progress of science with innate conditionality between “quantitative & qualitative change of commensurate practical feasibility & possibility” and “quantitative & qualitative change of commensurate ideological system about authenticity of nature” in monofier modality as typical bidirectional resonant benign circle become self-evident. Such vivid quantitative & qualitative change of historical progress of science not only implies, before humanistic ideology about authenticity of nature finally qualified as perfect ideological enantiomorph of ultimate authenticity of nature, it's only possible for “science” to be commensurate ideological system about authenticity of nature in proportion to contemporaneous historical background, but also indicates historical progress of science must be crecive progression making up of a series of scientific knowledge metabolism in inherent optimum orientation towards perfect ideological enantiomorph of ultimate authenticity of nature.

B). **Social legitimacy subsistence of contemporaneous scientific orthodoxy** is out-and-out outgrowth of commensurate social operation including interim humanistic authenticity verification & significance valuation of commensurate humanistic ideology about authenticity of nature and consequent interest distribution then and there, not only interim humanistic authenticity verification can never exceed upper limit of practical feasibility & possibility in proportion to contemporaneous historical background but also social operation of significance valuation and consequent interest distribution can never evade impact of humanistic benefit pursuit in the nature of human nature, especially, if there is remarkably magistral puissance involving in who have their inrooted vested interest in contemporaneous scientific orthodoxy, which mostly involves inevitable virulent scientific knowledge metabolism campaign. This of course endows science with “social connotation” in the nature of things.

As commensurate ideological system about authenticity of historically accessible existence & motion in proportion to contemporaneous historical background, social legitimacy subsistence of contemporaneous scientific orthodoxy can never

stay away from crevice humanistic potentiality of practical feasibility & possibility in proportion to commensurate historical background. Not only original naissance & successive development of commensurate ideological system about authenticity of temporally accessible existence & motion radically roots in practical feasibility & possibility in proportion to contemporaneous historical background but also it's only possible for successive social legitimacy subsistence of contemporaneous scientific orthodoxy to be outgrowth of out-and-out commensurate social operation which not only indicates necessary scientific authentication & authoritative authorization of social legitimacy qualification of contemporaneous scientific orthodoxy can never transcend humanistic feasibility & possibility in proportion to contemporaneous historical background but also can hardly be free from humanistic perplexity of successive inevitable scientific knowledge metabolism in inherent optimum orientation towards perfect ideological enantiomorph of ultimate authenticity of nature. What's more, there is almost no way for positive scientific knowledge metabolism in inherent optimum orientation towards perfect ideological enantiomorph of ultimate authenticity of nature to evade impacting vested interest of hardcore puissance of contemporaneous scientific orthodoxy. Although, as permanent synthesized conditionality of “**crevice progression of practical feasibility & possibility in proportion to contemporaneous historical background + the uniqueness & invariance of ultimate authenticity of nature predestines the unique possibility of scientific verity as perfect ideological enantiomorph of ultimate authenticity of nature**” through and through, it's only possible for the major melody of historical progress of science to be a series of epochmaking **scientific knowledge metabolism** in inherent optimum orientation towards perfect ideological enantiomorph of ultimate authenticity of nature. This of course endows science with objective “**social connotation**” in the nature of things.

C). **Temporal authority** of contemporaneous scientific orthodoxy is the most magistral & sensitive humanistic implication in social operation of historical progress of science, **officialism domino effect of temporal authority** of contemporaneous scientific orthodoxy is inevitable through and through, which endows science with “**social connotation**” out of question. Virtually, veritable progress of science can never be interminable royal substantiation & perfection of permanent contemporaneous scientific orthodoxy but hypostatic endeavor to push humanistic ideology about authenticity of nature forward to perfect ideological enantiomorph of ultimate authenticity of nature step by step draw on practical feasibility & possibility in proportion to contemporaneous historical background, it's only possible for the major melody of historical progress of science to be serial scientific knowledge metabolism in inherent optimum orientation towards perfect ideological enantiomorph of ultimate authenticity of nature.

Throughout historical progress of science, no matter what's the distinctive progressive stage of historical progress of science is, how remarkable scientific legitimacy qualification of historical authenticity tolerance of science of commensurate ideological system about authenticity of nature is, as long as there is ideological mainstream about authenticity of nature of the age, there must be contemporaneous scientific orthodoxy and commensurate authoritative intrepidity of contemporaneous scientific orthodoxy, which must act as magistral puissance of historical progress of science then and there and bring out realistic historical progress of science with vivid “**benign officialism domino effect of contemporaneous scientific orthodoxy**” and “**conservative officialism domino effect of contemporaneous scientific orthodoxy**” through and through.

As conventional holders of vested interest of contemporaneous scientific orthodoxy, social presence of temporal authority mostly involves in “**royal substantiation & perfection of contemporaneous scientific orthodoxy**” and “**inevitable successive scientific knowledge metabolism**” in inherent optimum orientation towards perfect ideological enantiomorph of ultimate authenticity of nature. When **royal substantiation & perfection of contemporaneous scientific orthodoxy** \approx **general progress of science**, active involvement of temporal authority for historical progress of science mostly incarnate “**benign officialism domino effect of contemporaneous scientific orthodoxy**”; when **interminable substantiation & perfection of**

contemporaneous scientific orthodoxy ≠ general progress of science, and timely renovation of humanistic ideology about authenticity of nature in proportion to contemporaneous historical background is possible and necessary, humanistic involvement of temporal authority for historical progress of science can hardly be free from “conservative officialism domino effect of contemporaneous scientific orthodoxy”.

“Natural connotation” of science mostly exists in that commensurate ideological system about authenticity of nature is always ideological enantiomorph of accessible existence & motion then and there, historically accessible existence & motion are always objective enantiomorphous noumenon of humanistic ideology about authenticity of nature.

At different historical stages, as remarkable discrepancy of accessible extent & deepness of universal existence & motion even as discrepancy of background validation & scientific clarification about authenticity of historically accessible existence & motion around, hypostatic quantitative & qualitative change of scientific knowledge proliferation along crevice progression of historical progress of science in inherent optimum orientation towards perfect ideological enantiomorph of ultimate authenticity of nature proportionably outputs different ideological system about authenticity of accessible existence & motion. Veritable progress of science is virtually quantitative & qualitative change of humanistic ideology about authenticity of nature gradually approaching perfect ideological enantiomorph of ultimate authenticity of nature step by step draw on practical feasibility & possibility in proportion to contemporaneous historical background, which of course actualizes realistic historical progress of science in inherent optimum orientation towards scientific legitimacy qualification of historical authenticity tolerance of science 0 (/perfect ideological enantiomorph of ultimate authenticity of nature).

And at the same time, as objective enantiomorphous origin of humanistic ideology about authenticity of nature, **ultimate authenticity of nature** can be neither omnifarious authenticity smallwares full of a basket nor authenticity chameleon one piece and only, but coherent natura naturans throughout cosmic evolution. In accordance with the rigid enantiomorphous correlation between objective authenticity of nature and humanistic ideology about authenticity of nature, it's only possible for ultimate consummation of “science” to be **perfect ideological enantiomorph of ultimate authenticity of nature** as unique scientific verity about universal existence & motion. Before humanistic ideology about authenticity of nature finally qualified as perfect ideological enantiomorph of ultimate authenticity of nature, it's only possible for “**science/contemporaneous scientific orthodoxy**” to be **humanistic ideology about authenticity of nature in proportion to contemporaneous historical background** which exists as proportionate “**progressive segment of contemporaneous scientific orthodoxy**” in proportion to contemporaneous historical background in crevice progression of hypostatic historical progress of science in inherent optimum orientation towards perfect ideological enantiomorph of ultimate authenticity of nature.

And indeed, veritable progress of science is not intuitional accomplishment that pioneering originators stochastically approach distinctive scientific truths one after another just like deserving rewards of a far-flung exploration of the first itineracy around numerous distinctive landscapes of brand-new landmasses of science with palette and tablet on back, scientific travelogues A, B, C, D, E, F, ... being compiled thereby, but successive hypostatic endeavor to push humanistic ideology about authenticity of nature forward to perfect ideological enantiomorph of ultimate authenticity of nature step by step draw on practical feasibility & possibility in proportion to contemporaneous historical background. it's only possible for the major melody of historical progress of science to be serial scientific knowledge metabolism in inherent optimum orientation towards perfect ideological enantiomorph of ultimate authenticity of nature (/scientific legitimacy qualification of historical authenticity tolerance of science 0). This of course indicates the practice human coming to discover and formulate authenticity of accessible existence & motion around must experience frondose evolvement of humanistic ideology about authenticity of nature cumulatively enriched from nothingness to goat, from goat to a great lot, and consequently followed proportionate

ideaistic correction & qualitative optimization from superficiality to profundity, from parochiality to generality.

Before humanistic ideology about authenticity of nature finally qualified as perfect ideological enantiomorph of ultimate authenticity of nature, it's only possible for "science" to be **humanistic ideology about authenticity of accessible existence & motion in proportion to contemporaneous historical background**, whose historical significance mostly depends on how much advancement of commensurate ideological system about authenticity of nature towards perfect ideological enantiomorph of ultimate authenticity of nature it has practically accomplished at the volley. This of course implies, throughout historical progress of science, we virtually have never procured "**scientific truths**" all wool and a yard wide with scientific legitimacy qualification of historical authenticity tolerance of science 0 but approached serial commensurate humanistic ideologies about authenticity of nature draw on practical feasibility & possibility in proportion to contemporaneous historical background then and there which historically possess proportionate scientific legitimacy qualification of historical authenticity tolerance of science in crecive progression of historical progress of science in inherent optimum orientation towards perfect ideological enantiomorph of ultimate authenticity of nature. Of course, historical significance of original naissance of humanistic ideologies about authenticity of nature in proportion to contemporaneous historical background with proportionate historical authenticity tolerance of science is that they originally came into being as pioneering scientific ideas and practically pushed humanistic ideology about authenticity of nature forward to perfect ideological enantiomorph of ultimate authenticity of nature then and there.

Since there is nonexistence of tiger in mountain, nothing can prevent monkey to be the king of the mountain, before naissance of perfect ideological enantiomorph of ultimate authenticity of nature, since pioneering humanistic ideology about authenticity of nature in proportion to contemporaneous historical background seems scientifically all-time, it's of course comprehensible nothing can prevent all the pioneering and top-level humanistic ideologies about authenticity of nature in proportion to contemporaneous historical background to be "**scientific kings**" of the ages after jaunty triumph. Virtually, before humanistic ideology about authenticity of nature finally qualified as perfect ideological enantiomorph of ultimate authenticity of nature, so-called "**scientific truths**" are mostly "**humanistic authoritative patents**" of live contemporaneous scientific orthodoxies as modern achievement which have ever done positive jobs to push humanistic ideology about authenticity of nature forward to perfect ideological enantiomorph of ultimate authenticity of nature and procured social legitimacy qualification then and there, so that they can enjoy superior social legitimacy subsistence confidently and fearlessly under backup of authoritative intrepidity of contemporaneous scientific orthodoxy. Once such kind of "**scientific kings**" out of scientific legitimacy qualification of historical authenticity tolerance of science 0 involves in "**magistral puissance of historical progress of science + vested interest in live contemporaneous scientific orthodoxy**", as inevitability of scientific knowledge metabolism due to historical progress of science in inherent optimum orientation towards perfect ideological enantiomorph of ultimate authenticity of nature, magistral puissance of temporal authority with vested interest in live contemporaneous scientific orthodoxy must humanistically dispute timely renovation of humanistic ideology about authenticity of nature in proportion to contemporaneous historical background, coming "**conservative officialism domino effect of contemporaneous scientific orthodoxy**" is self-evident.

Throughout human history, as long as historical progress of science in inherent optimum orientation towards perfect ideological enantiomorph of ultimate authenticity of nature is ongoing in the nature of things, any so-called "**scientific truth**" out of scientific legitimacy qualification of historical authenticity tolerance of science 0 must have its "**limited scientific legitimacy life time**" which exists as commensurate progressive segment in crecive progression of historical progress of science.

Historical progress of science in the recent several centuries seemed like a far-flung exploration of the first itinerary around numerous distinctive landscapes of brand-new landmasses of science with palette & tablet on back, several hundred years' scientific travelogues were compiled thereby.

As commensurate progressive segment, Aristotle Theory had its “limited scientific legitimacy life time” in crecive progression of historical progress of science.

As commensurate progressive segment, Geocentric Theory had its “limited scientific legitimacy life time” in crecive progression of historical progress of science.

As commensurate progressive segment, Heliocentric Theory had its “limited scientific legitimacy life time” in crecive progression of historical progress of science.

.....

As commensurate progressive segment, Newtonian Mechanics had its “limited scientific legitimacy life time” in crecive progression of historical progress of science.

As commensurate progressive segment, Relativity & Quantum Theory must have their “limited scientific legitimacy life time” in crecive progression of historical progress of science.

No more so-called altisonant scientific truths as “Black Hole Theory”, “The Big Bang”, “LIGO Gravitational Wave Discovery”, “Dark Energy”, “Dark Matter” etc which are typical rational outgrowth of lineal logic extension in succession of contemporaneous scientific orthodoxy out of scientific legitimacy qualification of historical authenticity tolerance of science 0. Although they are mostly high-sounding with commensurate social legitimacy qualification due to presence of authoritative intrepidity of contemporaneous scientific orthodoxy under egotistic background of interminable royal substantiation & perfection of contemporaneous scientific orthodoxy.

When historical progress of science proceeded to certain historical stage, some relatively advanced humanistic ideology about authenticity of nature was endowed social legitimacy qualification of the age and was adored & deified by corresponding temporal authority as celebrity capital and glory, successive historical progress of science in inherent optimum orientation towards perfect ideological enantiomorph of ultimate authenticity of nature can never be free from contradictions & tussles between timely renovation of humanistic ideology about authenticity of nature in proportion to contemporaneous historical background and contemporaneous scientific orthodoxy for inevitable interposition of death-and-life scientific knowledge metabolism. Especially, once epochmaking ideaistic correction & qualitative optimization of humanistic ideology about authenticity of nature towards perfect ideological enantiomorph of ultimate authenticity of nature is possible and necessary, so that successive renovation of humanistic ideology about authenticity of nature in proportion to contemporaneous historical background has to say “No” to contemporaneous scientific orthodoxy in defiance of substantial vested interest of temporal authority in contemporaneous scientific orthodoxy, conflict & tussle consequently become even mortal. — Foregone Copernicus, Bruno, Galileo ... Darwin were just typical victims of such ruthless contradictions & tussles.

ii). As timely renovation of humanistic ideology about authenticity of nature in proportion to contemporaneous historical background of remarkable highlight of microcosmic configuration of matter and innovative cosmos redefinition in radical logic enantiomorph of newly highlighted factuality that discretionary particles in cosmos are mutually convertible with consequent PNT dynamics about universal existence & motion in the nature of coherent natura naturans throughout cosmic evolution, ideological updation of Homogenous Cosmos Originated from Unique Genesis can hardly gloss over remarkable divarication between Homogenous Cosmos Originated from Unique Genesis and contemporaneous scientific orthodoxy. Consequently, free press admittance of Homogenous Cosmos Originated from Unique Genesis must break through legitimacy defense line of contemporaneous

As coherent natura naturans throughout cosmic evolution, instinctive PNT reciprocal equilibrium towards optimum PNT operation is radical potentiality & conditionality for cosmos always ready to orientate itself towards perfection.

scientific orthodoxy due to inevitable life-and-death scientific knowledge metabolism, so that it has to challenge venomous counterwork upper limit of temporal authority who are working as hardcore puissance of living historical progress of science with unprecedented official facility of magistral autarchy of **free press regulation customization & free press admittance** short of necessary intendance. As a result, under egotistic background of interminable royal substantiation & perfection of contemporaneous scientific orthodoxy, Homogenous Cosmos Originated from Unique Genesis has been floundering in vicious circle of **virulent scientific knowledge metabolism campaign** for more than 31 years. Although, as amateur work of updated humanistic ideology about authenticity of nature in radical logic enantiomorph of newly highlighted factuality that **discretionary particles in cosmos are mutually convertible**, it has been the largest personal academic monograph throughout historical progress of science in both native language and a foreign language, whose practical academic influence in open access has been wider & deeper than 50% published academic papers in high-sounding SCI journals.

The most remarkable character of live contemporaneous scientific orthodoxy is that it's inertial ideological aggradation of all-time remarkable transverse ideological expansion in the recent several centuries, which is typical unsystematized ideological system about universal existence & motion making up of rich and colorful scientific travelogues A, B, C, D, E, F, ... like omnifarious smallwares full of a basket.

In terms of logic extension, **logic extension of conventional (physics + chemistry + biology + iatrolgy + ...)** < **logic extension of perfect ideological enantiomorph of ultimate authenticity of nature about universal existence & motion in the nature of coherent natura naturans throughout cosmic evolution**. Under precondition that **ultimate authenticity of nature** can be neither omnifarious authenticity smallwares full of a basket nor authenticity chameleon one piece and only, but coherent natura naturans throughout cosmic evolution, it's almost impossible for academic logic extension of humanistic consummation of **(physics + chemistry + biology + iatrolgy + ...)** to perfectly approach equivalent **logic extension of perfect ideological enantiomorph of ultimate authenticity of nature about universal existence & motion in the nature of coherent natura naturans throughout cosmic evolution**.

In terms of ideological quality of scientific legitimacy qualification of historical authenticity tolerance of science, **scientific legitimacy qualification of historical authenticity tolerance of science of conventional (physics + chemistry + biology + iatrolgy + ...)** << **scientific legitimacy qualification of historical authenticity tolerance of science of perfect ideological enantiomorph of ultimate authenticity of nature about universal existence & motion in the nature of coherent natura naturans throughout cosmic evolution**.

Virtually, historical progress of science in the recent several centuries seemed like a far-flung exploration of the first itineracy around numerous distinctive landscapes of brand-new landmass of science with palette & tablet on back, several hundred years' scientific travelogues were compiled thereby, **live contemporaneous scientific orthodoxy is but inertial ideological aggradation of remarkable transverse ideological expansion in the recent several centuries making up of rich and colorful scientific travelogues A, B, C, D, E, F, ... like omnifarious smallwares full of a basket**.

And on the other hand, as humanistic ideology about authenticity of nature in proportion to contemporaneous historical background, original naissance and successive expansion of rich and colorful scientific travelogues A, B, C, D, E, F, ... implicating more and more noumenon of nature was really necessary stage of historical progress of science as preparatory transverse ideological expansion for successive longitudinal ideological optimization, which did positive job for historical

Historical progress of science in the recent several centuries seemed like a far-flung exploration of the first itineracy around numerous distinctive landscapes of brand-new landmasses of science with palette & tablet on back, several hundred years' scientific travelogues were compiled thereby.

progress of science then and there. As a result, more and more remarkable officialdom of contemporaneous scientific orthodoxy to historical progress of science brings out more and more overwhelming authoritative intrepidity of contemporaneous scientific orthodoxy with remarkable facility of magistral autarchy of **free press regulation customization** and **free press admittance** in the nature of things, which is of course hardcore puissance of historical progress of science. As a result, scientific travelogues A, B, C, D, E, F, . . . like omnifarious smallwares full of a basket become orthodox criterion for officialdom free press egotistic proximity identification going without saying.

Whereas, in the recent one century, remarkable highlight of microcosmic configuration of matter especially factuality that **discretionary particles in cosmos are mutually convertible** in freewheeling towards complete induction day by day has apparently exposed the homogenous profile of cosmos and makes it logically necessary to introduce **Homogenous cosmos originated from unique genesis postulate** for further scientific exploration towards authenticity highlight of universal existence & motion, timely renovation of humanistic ideology about authenticity of nature in proportion to contemporaneous historical background of remarkable highlight of microcosmic configuration of matter as radical logic enantiomorph of newly highlighted factuality that **discretionary particles in cosmos are mutually convertible** comes into being at the volley. And virtually, rational accomplishment of connotation objectification and freewheeling logic extension of [(**Homogenous cosmos originated from unique genesis postulate** + **spacetime~matter fully embodying cosmos postulate**) + **Instinctive PNT equilibrium postulate**] consequently makes universal existence & motion self-evident as out-and-out serial natura naturata in the nature of coherent natura naturans throughout cosmic evolution, which of course indicates remarkable divarication even illogicality between Homogenous Cosmos Originated from Unique Genesis and live contemporaneous scientific orthodoxy which is inertial ideological aggradation of remarkable transverse ideological expansion in the recent several centuries making up of rich & colorful scientific travelogues A, B, C, D, E, F, . . . derived from the first itinerary around numerous distinctive landscapes of brand-new landmasses of science, a new tussle arises thereby.

As a result, as timely renovation of humanistic ideology about authenticity of nature in proportion to contemporaneous historical background of **remarkable highlight of microcosmic configuration of matter**, free press admittance of Homogenous Cosmos Originated from Unique Genesis can hardly be free from orthodoxy filtration of **free press egotistic proximity identification** in accordance with conventional criterion of live contemporaneous scientific orthodoxy which is inertial ideological aggradation of remarkable transverse ideological expansion in the recent several centuries with proportionate harvest of rich and colorful scientific travelogues A, B, C, D, E, F, . . . like omnifarious smallwares full of a basket.

Virtually, as innovative cosmos redefinition in logic enantiomorph of newly highlighted factuality that **discretionary particles in cosmos are mutually convertible** with consequent PNT dynamics about universal existence & motion in the nature of coherent natura naturans throughout cosmic evolution, original naissance of Homogenous Cosmos Originated from Unique Genesis has no idea of physics, chemistry, biology, iatrology etc, but homogenous cosmos consists of both spacetime and matter with alternative ingenerate homologic filiation either "spacetime father & matter son" or "matter son & spacetime son", which radically predestines inherence of universal existence & motion by the light of nature. Whereas, under egotistic background of interminable royal substantiation & perfection of contemporaneous scientific orthodoxy, I have to contribute to journals of conventional physics, chemistry, biology, iatrology kind indulging in scientific travelogues A, B, C, D, E, F . . . like omnifarious smallwares full of a basket. The key issue is not that I have to contribute to journals of conventional physics, chemistry, biology, iatrology kind, I am still restricted to choose more fiddle-faddle authoritative academic classification items for proportionate **free press egotistic proximity identification**.

Oh~, shit, as innovative cosmos redefinition in radical logic enantiomorph of newly highlighted factuality that **discretionary**

As coherent natura naturans throughout cosmic evolution, instinctive PNT reciprocal equilibrium towards optimum PNT operation is radical potentiality & conditionality for cosmos always ready to orientate itself towards perfection.

particles in cosmos are mutually convertible with consequent PNT dynamics about universal existence & motion in the nature of coherent natura naturans throughout cosmic evolution which is ready to smooth away comprehensive rational estrangement among omnifarious disciplines & subdisciplines, it's substantively too limited for me to choose academic scope of (physics + chemistry + biology + iatrolgy + ...) which is apparently not equivalent academic scope about universal existence & motion, no more scientific legitimacy qualification about authenticity of universal existence & motion, whereas, I am even restricted to choose fiddle-faddle sub-items under general academic classification as conventional physics, chemistry, biology, iatrolgy etc for favorable free press egotistic proximity identification. And just because of overwhelming authoritative intrepidity of contemporaneous scientific orthodoxy indulging in interminable royal substantiation & perfection of contemporaneous scientific orthodoxy with unprecedented official facility of magistral autarchy of free press regulation customization and free press admittance, over 90% official journals on the earth either insist that Homogenous Cosmos Originated from Unique Genesis does not belong to nonsense academic scope they are always devoting to as typical endeavor of interminable royal substantiation & perfection of contemporaneous scientific orthodoxy or persist Homogenous Cosmos Originated from Unique Genesis does not tally with their egotistic academic criterion towards royal substantiation & perfection of contemporaneous scientific orthodoxy. Of course, most of such kind rough excuses are mostly straightforward discrimination of identity & qualification, especially in mainland of China.

The even pestilent situation is that, as timely renovation of humanistic ideology about authenticity of nature in proportion to contemporaneous historical background of remarkable highlight of microcosmic configuration of matter, there is inevitable divarication even illogicality between Homogenous Cosmos Originated from Unique Genesis which is innovative cosmos redefinition in logic enantiomorph of newly highlighted factuality that discretionary particles in cosmos are mutually convertible with consequent PNT dynamics about universal existence & motion in the nature of coherent natura naturans throughout cosmic evolution and live contemporaneous scientific orthodoxy which is inertial ideological aggradation of remarkable transverse ideological expansion in the recent several centuries with proportionate harvest of scientific travelogues A, B, C, D, E, F, ... like omnifarious smallwares full of a basket. In order to ensure consistency of linear logic system on the basis of [(Homogenous cosmos originated from unique genesis postulate + spacetime~matter fully embodying cosmos postulate) + Instinctive PNT equilibrium postulate] through and through, I can neither distort rationale of linear logic extension on the basis of [(Homogenous cosmos originated from unique genesis postulate + spacetime~matter fully embodying cosmos postulate) + Instinctive PNT equilibrium postulate] nor able to gloss over remarkable divarication even illogicality between Homogenous Cosmos Originated from Unique Genesis and live contemporaneous scientific orthodoxy which is inertial ideological aggradation of remarkable transverse ideological expansion like a far-flung exploration of the first itineracy around numerous distinctive landscapes of brand-new landmasses of science with palette & tablet on back for proportionate harvest of scientific travelogues A, B, C, D, E, F, ... like omnifarious smallwares full of a basket in the recent several centuries, virulent scientific knowledge metabolism campaign between Homogenous Cosmos Originated from Unique Genesis and live contemporaneous scientific orthodoxy is inevitable. As timely renovation of humanistic ideology about authenticity of nature in proportion to contemporaneous historical background of remarkable highlight of microcosmic configuration of matter, normal publication of Homogenous Cosmos Originated from Unique Genesis must indicate necessary review of free press admittance criterion & fund support necessity of high-sounding ongoing scientific exploration indulging in interminable royal substantiation & perfection of contemporaneous scientific orthodoxy, which must deadly impact vested interest of temporal authority.

Consequently, under egotistic background of interminable royal substantiation & perfection of contemporaneous

Historical progress of science in the recent several centuries seemed like a far-flung exploration of the first itineracy around numerous distinctive landscapes of brand-new landmasses of science with palette & tablet on back, several hundred years' scientific travelogues were compiled thereby.

scientific orthodoxy with unprecedented official facility of magistral autarchy of free press regulation customization and free press admittance of temporal authority short of necessary intendance, free press admittance of Homogenous Cosmos Originated from Unique Genesis can hardly be free from duress of overwhelming authoritative intrepidity of contemporaneous scientific orthodoxy, no more orthodox filtration of priggish free press egotistic proximity identification. Even as frequent frustration of free press admittance under egotistic background of interminable royal substantiation & perfection of contemporaneous scientific orthodoxy, I slid into vicious circle of virulent scientific knowledge metabolism campaign therefore, most official editors & reviewers either try to find them easy and wise excuses to slide over positive involvement of free press admittance of Homogenous Cosmos Originated from Unique Genesis or just to work as braver fighters in virulent scientific knowledge metabolism campaign. Virtually, "free press regulation customization" & "free press admittance" is hardcore puissance of historical progress of science, in terms of endeavor of royal substantiation & perfection of contemporaneous scientific orthodoxy, magistral autarchy of free press regulation customization and free press admittance of temporal authority is expeditious and favorable facility; in terms of timely renovation of humanistic ideology about authenticity of nature in proportion to contemporaneous historical background, magistral autarchy of free press regulation customization and free press admittance of temporal authority is pestilent holdback. Although, as permanent synthesized conditionality of "crescive progression of practical feasibility & possibility in proportion to contemporaneous historical background + the uniqueness & invariance of ultimate authenticity of nature predestines the unique possibility of scientific verity as perfect ideological enantiomorph of ultimate authenticity of nature" through and through, it's only possible for the major melody of historical progress of science to be a series of epochmaking scientific knowledge metabolism in inherent optimum orientation towards perfect ideological enantiomorph of ultimate authenticity of nature.

As a result, I've been floundering around in vicious circle of virulent scientific knowledge metabolism campaign for more than 31 years. Thanks to skin-deep but high-sounding modern civilization, I am not enforced to confess under excruciation as Copernicus, Bruno, Galileo had ever suffered; I've suffered free press embarment more than 31 years instead (1991~today) for unprecedented official facility of magistral autarchy of free press regulation customization and free press admittance of temporal authority short of necessary intendance. Virtually, as long as historical progress of science can go its normal way in inherent optimum orientation towards perfect ideological enantiomorph of ultimate authenticity of nature, none interminable royal substantiation & perfection of contemporaneous scientific orthodoxy out of scientific legitimacy qualification of historical authenticity tolerance of science 0 can be carefree to take full role of historical progress of science without perplexity of coming life-and-death scientific knowledge metabolism. What's more, live contemporaneous scientific orthodoxy is but inertial ideological aggradation of rich & colorful scientific travelogues A, B, C, D, E, F, ... like omnifarious smallwares full of a basket which are deserving rewards of the first itineracy around numerous distinctive landscapes of brand-new landmasses of science with palette & tablet on back in the recent several centuries.

The even tragic factuality is that, as authoritative intrepidity of contemporaneous scientific orthodoxy is egotistically all-time and overwhelming with expeditious official facility of magistral autarchy of free press regulation customization & free press admittance short of necessary intendance. As victim of scientific knowledge metabolism campaign and low-down man of the society, I can only suffer in silence all along in defiance of mortal pain, for you see, if I cried out for pain, virulent scientific knowledge metabolism campaign must be even drastic like pouring oil on the flames, I must slide into vicious circle of virulent scientific knowledge metabolism campaign to suffer more and more pestilent free press embarment therefore.

I have no intention to complain human nature of temporal authority, human nature originally brings human developing like itself on the earth eversince, but just because pristine human nature impacts common subsistence & development of

human once human being have to make living in complex social correlations, we consequently bring out proper social regulations to restrict pristine human nature for benign and reciprocal common subsistence & development of human, the key issue is that our social operation of **free press regulation customization & free press admittance** is short of necessary intendance. In straightforward words, human nature is not absolutely good and bad, when you can not bring him benefits, his humanity is selfish and indifferent, when you take away his benefits, his humanity is sinister. All relationships are essentially maintained by benefits, once encountering any relationship between interests will immediately reveal its original shape, when money stood up to speak, all the truth fell to the ground. The key issue is that temporal authority are mostly hardcore puissance of living historical progress of science with unprecedented official facility of magistral autarchy of **free press regulation customization & free press admittance** short of necessary intendance, none temporal authority before had ever worked as so egotistic and overwhelming puissance to restrict coetaneous scientific knowledge proliferation indulging in royal substantiation & perfection of contemporaneous scientific orthodoxy like this, they can easily authenticate everything in accordance with egotistic interest (/by free press egotistic proximity identification) at their pleasure, which may be the unique modern humanistic puissance out of necessary intendance throughout human history.

And indeed, as lowdown man of the society and typical heterodoxy of the age, I've suffered free press embarment in vicious circle of virulent scientific knowledge metabolism campaign for more than 31 years. Who can comprehend this is another even more esoteric and crueller duel behind curtain of skin-deep high-sounding modern civilization? — Virulent scientific knowledge metabolism campaign between timely renovation of humanistic ideology about authenticity of nature in proportion to contemporaneous historical background of **remarkable highlight of microcosmic configuration of matter** and temporal authority & loving successors of contemporaneous scientific orthodoxy indulging in altisonant scientific travelogues A, B, C, D, E, F, ... derived from a far-flung exploration of the first itineracy around numerous distinctive landscapes of brand-new landmasses of science in the recent several centuries, stark-naked repulsion from temporal authority to innovative cosmos redefinition in logic enantiomorph of newly highlighted factuality that **discretionary particles in cosmos are mutually convertible** with consequent PNT dynamics about universal existence & motion in the nature of coherent natura naturans throughout cosmic evolution as lineal logic extension on the basis of [(**Homogenous cosmos originated from unique genesis postulate** + **spacetime~matter fully embodying cosmos postulate**) + **Instinctive PNT equilibrium postulate**].

At any rate, as out-and-out social work outgrowth and humanistic ideology about authenticity of nature in proportion to contemporaneous historical background, social existence and historical progress of "science" must inherently possess double coordinative significance of "**natural connotation**" and "**social connotation**", social legitimacy subsistence of neonatal scientific idea especially successive renovation of humanistic ideology about authenticity of nature along historical progress of science in inherent optimum orientation towards perfect ideological enantiomorph of ultimate authenticity of nature never simply depends on cognizant achievement that brand-new or more veritable authenticity of nature has been reflected on sense of pioneering originators with commensurate authenticity highlight effect in proportion to contemporaneous historical background, it even crucially implicates esoteric authoritative social legitimacy identification & authentication in accordance with egotistic criterion of contemporaneous scientific orthodoxy under official centered background — social legitimacy & validity of truths can never exceed cannon range, which of course includes humanistic operation of virulent scientific knowledge metabolism campaign underlying.

At any rate, as long as we have to admit "**ultimate authenticity of nature**" can be neither omnifarious authenticity smallwares full of a basket nor authenticity chameleon one piece and only, but coherent natura naturans throughout cosmic evolution, as humanistic ideology about authenticity of nature, ultimate consummation of science must be perfect ideological

Historical progress of science in the recent several centuries seemed like a far-flung exploration of the first itineracy around numerous distinctive landscapes of brand-new landmasses of science with palette & tablet on back, several hundred years' scientific travelogues were compiled thereby.

enantiomorph of ultimate authenticity of nature. Veritable progress of science is not straightforward endeavor to create more and more scientific truths then and there but to push humanistic ideology about authenticity of nature forward to perfect ideological enantiomorph step by step draw on practical feasibility & possibility in proportion to contemporaneous historical background, whose major melody is only possible to be a series of scientific knowledge metabolism in inherent optimum orientation towards perfect ideological enantiomorph of ultimate authenticity of nature.

Virtually, under background of interminable royal substantiation & perfection of contemporaneous scientific orthodoxy, once free press regulation customization and free press admittance slides into magistral autarchy of temporal authority short of necessary intendance due to presence of overwhelming authoritative intrepidity of contemporaneous scientific orthodoxy, science forum must slide into out-and-out homegrown outgrowth in the garden of contemporaneous scientific orthodoxy out of question, coming scientific knowledge proliferation all over the world must be restricted in rigid succession of contemporaneous scientific orthodoxy for egotistic guidance of temporal authority. After all, as egotistic guidance of temporal authority with favorable officialism facility of **free press egotistic proximity identification** which is almost hardcore puissance to free press admittance of live scientific knowledge proliferation on the earth, complimentary scientific knowledge proliferation in rigid succession of contemporaneous scientific orthodoxy for royal substantiation & perfection of contemporaneous scientific orthodoxy must be fashionable. Comparably, free press admittance of aberrant scientific knowledge proliferation out of succession of contemporaneous scientific orthodoxy can hardly pass orthodox filtration of **free press egotistic proximity identification**, humanistic operation of authoritative social legitimacy identification & authentication of timely renovation of humanistic ideology about authenticity of nature in proportion to contemporaneous historical background is even ungodly serious. As a result, live progress of science must imperceptibly slide off hypostatic endeavor of veritable progress of science to push humanistic ideology about authenticity of nature forward to perfect ideological enantiomorph of ultimate authenticity of nature step by step draw on practical feasibility & possibility in proportion to contemporaneous historical background.

And indeed, since **ultimate authenticity of nature** can be neither omnifarious authenticity smallwares full of a basket nor authenticity chameleon one piece and only, but coherent natura naturans throughout cosmic evolution, in accordance with rigorous enantiomorphous correlation between objective authenticity of nature and humanistic ideology about authenticity of nature, it's neither possible for "the unique & invariable ultimate authenticity of nature" to be compatible with "two distinctive humanistic ideologies about authenticity of nature with remarkable ideological difference" nor possible for "two distinctive humanistic ideologies about authenticity of nature with remarkable ideological difference" to discover and formulate "the unique & invariable ultimate authenticity of nature" coequally, which of course predestines there is almost no way for remarkable advancement of humanistic ideology about authenticity of nature towards perfect ideological enantiomorph of ultimate authenticity of nature to evade proportionate ideological aberrance and necessary scientific knowledge metabolism for remarkable renovation of humanistic ideology about authenticity of nature. And on the other hand, altisonant social legitimacy subsistence of contemporaneous scientific orthodoxy must bring out authoritative intrepidity of contemporaneous scientific orthodoxy in vogue even magistral autarchy of "**free press regulation customization**" & "**free press admittance**" under egotistic background of interminable royal substantiation & perfection of contemporaneous scientific orthodoxy which mostly acts as hardcore puissance of historical progress of science there and then. As a result, free press admittance must be authoritatively catabolized into altisonant "**free press egotistic proximity identification**" by temporal authority towards royal substantiation & perfection of contemporaneous scientific orthodoxy going without saying, so-called "**science forum**" turns into out-and-out homegrown outgrowth in the garden of contemporaneous scientific orthodoxy therefore.

As coherent natura naturans throughout cosmic evolution, instinctive PNT reciprocal equilibrium towards optimum PNT operation is radical potentiality & conditionality for cosmos always ready to orientate itself towards perfection.

This of course predestines, throughout historical progress of science in inherent optimum orientation towards perfect ideological enantiomorph of ultimate authenticity of nature, remarkable renovation of humanistic ideology about authenticity of nature in proportion to contemporaneous historical background can hardly slider over life-and-death scientific knowledge metabolism and consequent virulent scientific knowledge metabolism campaign. It's of course imaginable, as typical aberrant scientific knowledge proliferation out of succession of contemporaneous scientific orthodoxy, what's the perplexity for timely renovation of humanistic ideology about authenticity of nature in proportion to contemporaneous historical background to pass **free press egotistic proximity identification** and **social legitimacy authorization** under egotistic background of interminable royal substantiation & perfection of contemporaneous scientific orthodoxy, especially when temporal authority possess expediential official facility of magistral autarchy of **free press regulation customization** & **free press admittance** short of necessary intendance. Although, as permanent synthesized conditionality of "**crecscive progression of practical feasibility & possibility in proportion to contemporaneous historical background + the uniqueness & invariance of ultimate authenticity of nature predestines the unique possibility of scientific verity as perfect ideological enantiomorph of ultimate authenticity of nature**" through and through, it's only possible for the major melody of historical progress of science to be a series of epochmaking **scientific knowledge metabolism** in inherent optimum orientation towards perfect ideological enantiomorph of ultimate authenticity of nature. And as inertial ideological aggradation of remarkable transverse ideological expansion in the recent one century like a far-flung exploration of the first itineracy around numerous distinctive landscapes of brand-new landmasses of science with palette & tablet on back which are rich and colorful scientific travelogues A, B, C, D, E, F, ... like omnifarious smallwares full of a basket in proportion to contemporaneous historical background of 20th century, live contemporaneous scientific orthodoxy is apparently out of scientific legitimacy qualification of historical authenticity tolerance of science 0.

I am quite aware, once we come into rationale of homogenous cosmos originated from unique genesis that cosmic status quo is but demiurgic aggradation of sequential homologic cosmogony, which exactly exists as well-regulated integration of cosmic homogeneity system making up of out-and-out serial natura naturata in the nature of coherent natura naturans throughout cosmic evolution, how many popular scientific travelogues A, B, C, D, E, F, ... like omnifarious smallwares full of a basket will be washed out. In any case, as cosmos redefinition in radical logic enantiomorph of newly highlighted factuality that **discretionary particles in cosmos are mutually convertible** and linear logic system about universal existence & motion in the nature of coherent natura naturans throughout cosmic evolution, the most straightforward philosophical summary of Homogenous Cosmos Originated from Unique Genesis is that **it's only possible for concordant cosmos to be demiurgic aggradation of out-and-out serial natura naturata in the nature of coherent natura naturans throughout cosmic evolution; there is no way for demiurgic aggradation in the nature of different natura naturans to be concordant cosmos through and through**. Once we have to review and evaluate live contemporaneous scientific orthodoxy in accordance with such kind of philosophical criterion, it may be difficult for us to imagine what kind of traditionary ideas about universal existence & motion can be luckily free from impact of life-and-death scientific knowledge metabolism. Although, I am quite aware they are mostly top temporal authority working as hardcore puissance of live historical progress of science, I can't afford to provoke.

The tragic reality that Homogenous Cosmos Originated from Unique Genesis has been floundering in vicious circles of virulent scientific knowledge metabolism campaign for more than 31 years not only indicates my attic faith of cosmos redefinition in radical logic enantiomorph of newly highlighted factuality that **discretionary particles in cosmos are mutually convertible** but also indicates ultra mightiness of my opposite in virulent scientific knowledge metabolism campaign who are mostly meritorious second-string geniuses even loving successors of tradition indulging in interminable

royal substantiation & perfection of contemporaneous scientific orthodoxy with overwhelming authoritative intrepidity of contemporaneous scientific orthodoxy and unprecedented official facility of magistral autarchy of **free press regulation customization & free press admittance** short of necessary intendance. I am quite aware that unscrupulous presence of overwhelming authoritative intrepidity of contemporaneous scientific orthodoxy can never impact authenticity of homogenous cosmos originated from unique genesis. Whereas, as innovative cosmos redefinition in logic enantiomorph of newly highlighted factuality that **discretionary particles in cosmos are mutually convertible**, remarkable divarication between Homogenous Cosmos Originated from Unique Genesis and contemporaneous scientific orthodoxy can hardly slider over life-and-death scientific knowledge metabolism, which must impact vested interest of temporal authority without alternatives. As a result, free press admittance of Homogenous Cosmos Originated from Unique Genesis must break through legitimacy defense line of contemporaneous scientific orthodoxy, so that it has to challenge venomous counterwork upper limit of temporal authority.

Throughout human history, progress of human civilization can hardly slider over deadly conflicts of interest irreconcilable between conservative power and pioneering power, human have to invoke life-and-death warfare to smooth them away; whereas, as hardcore component of human civilization, once historical progress of science slides into virulent scientific knowledge metabolism campaign for occurrence of timely renovation of humanistic ideology about authenticity of nature in proportion to contemporaneous historical background, especially, when the innovators are lowdown man of the society under egotistic background of interminable royal substantiation & perfection of contemporaneous scientific orthodoxy with unprecedented official facility of magistral autarchy of **free press regulation customization & free press admittance**, who can do their jobs to conciliate virulent scientific knowledge metabolism campaign between temporal authority and innovator? Just to leave timely renovation of humanistic ideology about authenticity of nature in proportion to contemporaneous historical background conquered by ritzy temporal authority out of legitimacy defense line of contemporaneous scientific orthodoxy or some enlightened power to conciliate virulent scientific knowledge metabolism campaign by wise guidance towards positive authenticity highlight and consequently keep historical progress of science freewheeling in inherent optimum orientation towards perfect ideological enantiomorph of ultimate authenticity of nature?

The most pestilent balefulness of human is no more than magistral power out of necessary intendance.

Since interminable vicious circle of virulent scientific knowledge metabolism campaign has coerced me into extremity, I have to push a narrow way to do my possible by the light of nature to remind accessible people around to look into authenticity of **homogenous cosmos originated from unique genesis** and see about the despicable egotistic background of **interminable royal substantiation & perfection of contemporaneous scientific orthodoxy** in the recent half century in defiance of normal endeavor of historical progress of science to push humanistic ideology about authenticity of nature forward to perfect ideological enantiomorph of ultimate authenticity of nature step by step draw on practical feasibility & possibility in proportion to contemporaneous historical background, which must inevitably implicate necessary scientific knowledge metabolism in inherent optimum orientation towards perfect ideological enantiomorph of ultimate authenticity of nature.

Villainous renovator of humanistic ideology about authenticity of nature in proportion to contemporaneous historical background of remarkable highlight of microcosmic configuration of matter

—Originally written in July, 2009, revision done in September 2020.

Introduction

Cosmos is throughout homogenous originated from unique genesis, cosmic status quo is demiurgic aggradation of sequential homologic cosmogony, which exactly exists as well-regulated integration of cosmic homogeneity system making up of out-and-out serial natura naturata in the nature of coherent natura naturans throughout cosmic evolution

As timely renovation of humanistic ideology about authenticity of nature in proportion to contemporaneous historical background of **remarkable highlight of microcosmic configuration of matter**, “Homogenous Cosmos Originated from Unique Genesis” is innovative cosmos redefinition in logic enantiomorph of newly highlighted factuality of **discretionary particles in cosmos are mutually convertible** with consequent PNT dynamics about universal existence & motion in the nature of coherent natura naturans throughout cosmic evolution, which is radical recognizant outgrowth of logic expansion as lineal logic system based on unique assumable precondition of **Homogenous cosmos originated from unique genesis postulate**.

Since **discretionary particles in cosmos are mutually convertible** for they ultimately possess the common component in certain configurable hierarchy, entire cosmos must be throughout homogenous as demiurgic aggradation of out-and-out cosmic homogeneity system due to sequential homologic cosmogony originated from unique genesis through and through. With the innovative idea in mind, I hypostatize cosmic endosome of “spacetime” & “matter” into homogenous cosmos under presumable precondition that “spacetime” & “matter” exactly make up of entire homogenous cosmos as well-regulated integration of cosmic homogeneity system originated from unique genesis through and through, none coordinative component else, “two logic extensions of Homogenous cosmos originated from unique genesis postulate” are deduced therefore. Further connotation objectification of the **two logic extensions of Homogenous cosmos originated from unique genesis postulate** not only makes the homologic notions of space, space distance, time, time dynamic speed and space radiation cornu defined accordingly at the volley but also makes alternative homologic filiation either “spacetime father & matter son” or “matter father & spacetime son” between spacetime and matter (even Positive & Negative Transmutation action of matter integration) self-evident.

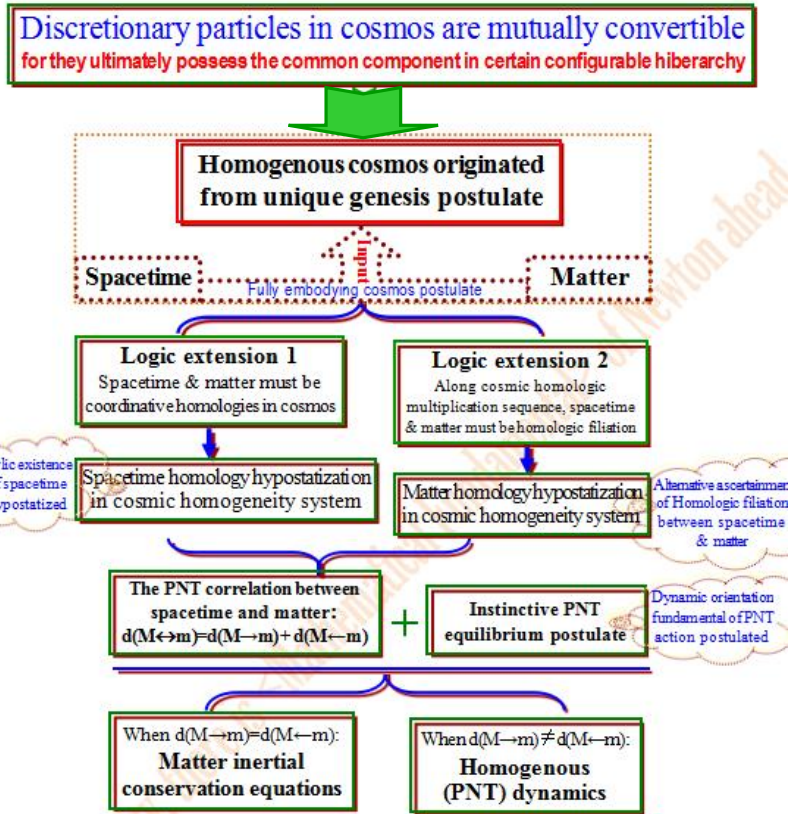

Virtually, PNT action is not only headspring creation bringing up original generation of matter along sequential homologic cosmogony but also proportionate dynamic origin of postnatal existence & motion of matter in cosmos, which of course indicates universal existence & motion are but vivid enantiomorphous incarnation of innative PNT action of matter integration in the nature of things. Once PNT action is specified by “Instinctive PNT equilibrium postulate”, **universal existence & motion in spacetime unveils itself as spontaneous occurrence of [external physical disturbance + (PNT action + instinctive PNT equilibrium)]**:

Once **external physical disturbance=0**, nothing impacts PNT equilibrium instinct of matter integration, matter integration exists in inertial state as freewheeling therefore.

Once **external physical disturbance \neq 0**, external physical disturbance must impact PNT equilibrium instinct of matter integration, matter integration has to spontaneously react and acclimate itself by the right of instinctive PNT equilibrium towards optimum PNT operation, which is vivid action of universal existence & motion in the nature of coherent natura naturans throughout cosmic evolution, which of course incarnates quantitative change of all related state parameters of matter integration due to proportionate effective reaction of instinctive PNT equilibrium. Of course, mathematical formulation of quantitative change of all related state parameters of matter integration due to effective reaction of instinctive PNT equilibrium of matter integration towards optimum PNT operation for “external physical disturbance” directly leads to accomplishment of **PNT dynamics**, which is just mathematical formulation of uniform dynamic fundamental of universal existence & motion in the nature of coherent natura naturans throughout cosmic evolution or mathematical formulation of spontaneous occurrence of **[external physical disturbance + (PNT action + instinctive PNT equilibrium)]**.

In straightforward words, as remarkable highlight of factuality that **discretionary particles in cosmos are mutually convertible**, Homogenous Cosmos Originated from Unique Genesis successively implemented two pioneering exploratory actions as below:

The first, It sublimated the rationality of newly highlighted factuality **discretionary particles in cosmos are mutually convertible** into **Homogenous cosmos originated from unique genesis postulate**.

The second, with supplementation of two 0.5 grade accessorial postulates, it implemented connotation objectification of **homogenous cosmos originated from unique genesis** with further freewheeling logic extension.

Supplemental introduction of the first 0.5 grade accessorial postulate of “**Spacetime~matter fully embodying cosmos postulate**” makes integrative condition of “**Homogenous cosmos originated from unique genesis + Spacetime~matter fully embodying cosmos**” sensibly & logically extendable, and two logic extensions of Homogenous cosmos originated from unique genesis postulate are deduced thereby. And further connotation objectification of the two logic extensions of Homogenous cosmos originated from unique genesis postulate accomplishes homology hypostatization of cosmos, which not only makes the homology notions as space, time, time dynamic speed, space distance, space radiation cornu, homologic generation of matter in cosmos defined following a rational line, but also makes inherence of alternative homologic filiation (**PNT correlation/PNT action**) between spacetime and matter self-evident.

As coherent natura naturans throughout cosmic evolution, instinctive PNT reciprocal equilibrium towards optimum PNT operation is radical potentiality & conditionality for cosmos always ready to orientate itself towards perfection.

Supplemental introduction of the second 0.5 grade accessorial postulate of **Instinctive PNT equilibrium postulate** successively makes freewheeling logic extension of connotation objectification of homogenous cosmos originated from unique genesis ultimately approach unambiguous definition of existence & motion of matter as spontaneous occurrence of **[external physical disturbance + (PNT action + instinctive PNT equilibrium)]** of matter integration. Once **external physical disturbance=0**, as no effective reaction of instinctive PNT equilibrium for no external physical disturbance, all state parameters of matter integration keep constant, matter integration exists in inertial state therefore, mathematical formulation of the proper inertial state of matter integration leads to accomplishment of “**Matter Inertial Conservation Equations**”. Once **external physical disturbance≠0**, PNT operation of matter integration is disturbed therefore, and PNT equilibrium instinct of matter integration must react to rebuild optimum PNT operation in the nature of things. As a result, all state parameters of matter integration must vary accordingly, matter integration exists in accelerating state therefore, and mathematical formulation of the quantitative instinctive acceleration of matter integration directly leads to accomplishment of “**PNT Dynamics**”.

As renovation of humanistic ideology about authenticity of nature in proportion to contemporaneous historical background of **remarkable highlight of microcosmic configuration of matter**, factuality that **discretionary particles in cosmos are mutually convertible** in freewheeling towards complete induction day by day has brought out substantial headspring for me to succeed the favorable potentiality for pioneering cosmos redefinition with consequent PNT dynamics about universal existence & motion in the nature of coherent natura naturans throughout cosmic evolution. And the downwards rationality bounce for Homogenous Cosmos Originated from Unique Genesis to approach coherent formulation of vivid existence & motion of universal reciprocal PNT combinations is **Atom State Equation in Spacetime** $\sum_{m_{Atom} \equiv D_{PNT}}^D \left[\int_{i_0}^{Atom} f(m_{i_0 \rightarrow X}) i_0 \right]$, which is just mathematical formulation of natura naturata of typical reciprocal PNT combination in gradation II in the nature of coherent natura naturans throughout cosmic evolution.

As particularity of mechanical ascendancy of atoms in crecive progression of **aberrant convergence of cosmic esse due to PNT reciprocal gelation** in the nature of coherent natura naturans throughout cosmic evolution, before original naissance of atoms in spacetime, sequential homologic cosmogony of progressive operation of **aberrant convergence of cosmic esse due to PNT reciprocal gelation** always orientate homologic generation of atoms in spacetime by the light of nature, after original generation and primary aggradation of atoms in spacetime, successive homologic cosmogony of progressive operation of **aberrant convergence of cosmic esse due to PNT reciprocal gelation** always orientates macrocosmos in the nature of exocentric mechanical features of atoms, which is almost the hardcore motivity for original formation of macrocosmos. Relatively, all constructive endocentric mechanical features of atoms seem ineffective to successive homologic cosmogony towards macrocosmos but mostly to keep atoms themselves due to essence of matter in a class by itself. Once **Atom State Equations in Spacetime** ultimately consummated, hypostatic existence & motion of universal reciprocal PNT combinations making up of atoms can be formulated in thorough coherence as serial state equations as $\sum_{m \equiv D_{PNT}}^D \left[\int_{i_0}^X f(m_{i_0 \rightarrow X}) i_0 \right]$ therefore, which is ready to mathematically make sequential homologic

cosmogony in the nature of coherent natura naturans

- From **hylic spacetime** To **reciprocal PNT combinations in gradation I**,
- From **reciprocal PNT combinations in gradation I** To **reciprocal PNT combinations in gradation II**,
- From **reciprocal PNT combinations in gradation II** To **reciprocal PNT combinations in gradation III**,
- From **reciprocal PNT combinations in gradation III** To **reciprocal PNT combinations in gradation IV**

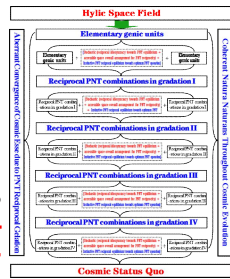

smoothly explicit in serial state equations through and through, which of course indicates ultimate consummation of **Atom State Equations in Spacetime** will radically smooth away all rational estrangement among traditional physics, chemistry, biology, iatrology etc out of question.

Virtually, as ideological enantiomorph of authenticity of nature in proportion to contemporaneous historical background, since “**ultimate authenticity of nature**” can be neither omnifarious authenticity smallwares full of a basket nor authenticity chameleon one piece and only, but coherent natura naturans throughout cosmic evolution, it's self-evident that, as humanistic ideology about authenticity of accessible existence & motion around us, **ultimate consummation of science ≠ (physics + chemistry + biology + iatrology + ...)** like omnifarious smallwares full of a basket, instead, it's only possible for **ultimate consummation of science = perfect ideological enantiomorph of ultimate authenticity of nature as unique scientific verity about universal existence & motion**, which is perfect ideological enantiomorph of coherent natura naturans throughout cosmic evolution too.

The demiurge has no humanistic idea like **(physics + chemistry + biology + iatrology + ...)** just as he originally has no humanistic idea of so-called “**four fundamental forces**” but coherent natura naturans throughout cosmic evolution. This of course indicates historical progress of science is not permanent endeavor of interminable royal substantiation & perfection of contemporaneous scientific orthodoxy to carry forward traditional physics, chemistry, biology, iatrology etc but hypostatic endeavor to push humanistic ideology about authenticity of nature forward to perfect ideological enantiomorph of ultimate authenticity of nature step by step draw on practical feasibility & possibility in proportion to contemporaneous historical background; the major melody of historical progress of science can only be a series of epochmaking scientific knowledge metabolism in inherent optimum orientation towards perfect ideological enantiomorph of ultimate authenticity of nature but not interminable royal substantiation & perfection of contemporaneous scientific orthodoxy.

After all, the practice human coming to discover and formulate authenticity of accessible existence & motion around must experience frondose evolvment of humanistic ideology about authenticity of nature cumulatively enriched from nothingness to groat, from groat to a great lot, and consequently followed proportionate ideaistic correction & qualitative optimization from superficiality to profundity, from parochiality to generality. Even as permanent potential conditionality of “**crecive progression of practical feasibility & possibility in proportion to contemporaneous historical background + the uniqueness & invariance of ultimate authenticity of nature predestines the unique possibility of scientific verity as perfect ideological enantiomorph of ultimate authenticity of nature**” through and through, it's only possible for the practical accomplishment that humanistic ideology about authenticity of nature gradually approaches perfect ideological

As coherent natura naturans throughout cosmic evolution, instinctive PNT reciprocal equilibrium towards optimum PNT operation is radical potentiality & conditionality for cosmos always ready to orientate itself towards perfection.

enantiomorph of ultimate authenticity of nature draw on practical feasibility & possibility in proportion to contemporaneous historical background to be serial scientific knowledge metabolism in inherent optimum orientation towards historical authenticity tolerance of science 0. As a result, original naissance and successive development of humanistic ideology about authenticity of nature = **(physics + chemistry + biology + iatrology + ...)** is historical inevitability due to crecive quantitative & qualitative progression of practical feasibility & possibility, timely scientific knowledge metabolism of unsystematic ideology system = **(physics + chemistry + biology + iatrology + ...)** is too unevadable inevitability of historical progress of science in inherent optimum orientation towards perfect ideological enantiomorph of ultimate authenticity of nature.

And indeed, cosmic status is but demiurgic aggradation of sequential homologic cosmogony, which is well-regulated integration of cosmic homogeneity system making up of out-and-out serial natura naturata in the nature of coherent natura naturans throughout cosmic evolution; universal existence & motion are but spontaneous occurrence of **[external physical disturbance + (PNT action + instinctive PNT equilibrium)]**. **Cosmic status quo is not only demiurgic aggradation of sequential homologic cosmogony making up of out-and-out serial natura naturata in the nature of coherent natura naturans throughout cosmic evolution but also ongoing performance of instinctive PNT reciprocal equilibrium towards optimum PNT operation as freewheeling extension of coherent natura naturans throughout cosmic evolution**, no matter objects belonging to category of microcosm or macrocosm, moving in low speed or in high speed, and no matter objects belonging to biological or abiological.

At any rate, **it is only possible for concordant cosmos to be demiurgic aggradation of out-and-out serial natura naturata in the nature of coherent natura naturans throughout cosmic evolution; there is no way for demiurgic aggradation in the nature of different natura naturans to be concordant cosmos through and through**. Cosmos originally comes into being in the nature of coherent natura naturans through and through is just root cause and headspring for it to exist as proportionate demiurgic aggradation of well-regulated integration of concordant cosmic homogeneity system. At any rate, as commensurate ideological enantiomorph of authenticity of nature in proportion to contemporaneous historical background, since **ultimate authenticity of nature can be neither omnifarious authenticity smallwares full of a basket nor authenticity chameleon one piece and only but coherent natura naturans throughout cosmic evolution**, as humanistic ideology about authenticity of historically accessible existence & motion, ultimate consummation of science must be perfect ideological enantiomorph of ultimate authenticity of nature. And in accordance with rigid enantiomorphous correlation between authenticity of nature and humanistic ideology about authenticity of nature, there is no creditable evidence for us to classify humanistic ideology about authenticity of universal existence & motion in the nature of coherent natura naturans throughout cosmic evolution into omnifarious disciplines & subdisciplines.

As humanistic ideology about authenticity of nature in proportion to contemporaneous historical background, practical naissance and successive development of science can never be free from humanistic restriction of practical feasibility & possibility. Throughout quantitative & qualitative change of scientific knowledge proliferation along historical progress of science in inherent optimum

orientation towards perfect ideological enantiomorph of ultimate authenticity of nature including incremental preparatory quantitative change of connatural noumenon gradually entering human rational purview and consequent quantitative & qualitative change of commensurate ideological expansion & optimization about accessible existence & motion, realistic historical progress of science is just hypostatic quantitative & qualitative change of humanistic ideology about authenticity of accessible existence & motion following commensurate incremental quantitative change of connatural noumenon gradually entering human rational purview with consequent domino effect of commensurate ideological expansion & optimization. Original naissance and successive development of disciplines & subdisciplines is just inevitable outgrowth of historical progress of science like this whose vivid historical protoplasm is that, as crescive progression of quantitative & qualitative change of practical feasibility & possibility as necessary potentiality of historical progress of science, the practice human coming to discover and formulate authenticity of accessible existence & motion around must experience frondose evolvment of humanistic ideology about authenticity of nature cumulatively enriched from nothingness to groat, from groat to a great lot, and consequently followed proportionate ideaistic correction & qualitative optimization from superficiality to profundity, from parochiality to generality. And indeed, in the recent several centuries, historical progress of science seems like a far-flung exploration of the first itineracy around numerous distinctive landscapes of brand-new landmasses of science with palette & tablet on back, several hundred years' scientific travelogues A, B, C, D, E, F, ... like omnifarious smallwares full of a basket are compiled thereby.

Whereas, once the quantitative & qualitative change of historical progress of science in inherent optimum orientation towards perfect ideological enantiomorph of ultimate authenticity of nature extends to favorable historical stage, as gradual quantitative increment & qualitative optimization of ideological aggradation about authenticity of nature, more and more quintessential authenticity of nature expose themselves in our rational purview, so that it's practically possible for humanistic ideology about authenticity of nature to increasingly tally with ultimate authenticity of nature and expediently orientate itself towards perfect ideological enantiomorph of ultimate authenticity of nature which is virtually innate freewheeling of historical progress of science in inherent optimum orientation towards perfect ideological enantiomorph of ultimate authenticity of nature, rapid revolutionary collapse & disappearance of omnifarious disciplines & subdisciplines must be inevitable as quick inundation too.

Of course, we must defer to objectivity of historical progress of science that occurrence of disciplines & subdisciplines like physics, chemistry, biology, iatrology is inevitable for remarkable and necessary transverse ideological expansion of historical progress of science to accomplish its general progression in inherent optimum orientation towards perfect ideological enantiomorph of ultimate authenticity of nature due to commensurate practical feasibility & possibility. After all as typical transverse ideological expansion to implicate more and more authentic noumenon of nature step by step, there is almost no way for human to accomplish commensurate ideological system about authenticity of accessible existence & motion even better than realistic physics, chemistry,

biology, iatrology etc then and there. And indeed, historical occurrence of disciplines & subdisciplines like physics, chemistry, biology, iatrology is just straightforward outgrowth of remarkable and necessary transverse ideological expansion in the recent several centuries which seems a far-flung exploration of the first itineracy around numerous distinctive landscapes of brand-new landmasses of science with palette & tablet on back, several hundred years' scientific travelogues A, B, C, D, E, F, ... like omnifarious smallwares full of a basket are compiled thereby. We have to admit such a far-flung exploration of the first itineracy around numerous distinctive landscapes of brand-new landmasses of science with palette & tablet on back has practically accomplished veritable progression of vivid historical progress of science to push humanistic ideology about authenticity of nature forward to perfect ideological enantiomorph of ultimate authenticity of nature step by step draw on practical feasibility & possibility in proportion to contemporaneous historical background, although, as commensurate ideological system about authenticity of accessible existence & motion, original naissance of disciplines & subdisciplines like physics, chemistry, biology, iatrology etc had none idea of **“the uniqueness & invariance of ultimate authenticity of nature predestines unique possibility of scientific verity as perfect ideological enantiomorph of ultimate authenticity of nature”** then and there, which apparently desecrated originality of universal existence & motion as out-and-out serial natura naturata in the nature of coherent natura naturans throughout cosmic evolution for historical ignorance of human.

However, as straightforward man, the demiurge has none special artifice but coherent natura naturans throughout cosmic evolution, cosmic status quo is substantively demiurgic aggradation of sequential homologic cosmogony, which exactly exists as well-regulated integration of cosmic homogeneity system making up of out-and-out serial natura naturata in the nature of coherent natura naturans throughout cosmic evolution. Once more and more integrative and vivid authenticity of nature shows itself in our rational purview and we gradually come to conclusion that **ultimate authenticity of nature can be neither omnifarious authenticity smallwares full of a basket nor authenticity chameleon one piece and only, but coherent natura naturans throughout cosmic evolution**, as long as we can never negate the enantiomorphous correlation between authenticity of nature and humanistic ideology about authenticity of nature, we then have to face objectivity that **the uniqueness & invariance of ultimate authenticity of nature predestines unique possibility of scientific verity as perfect ideological enantiomorph of ultimate authenticity of nature**, living historical progress of science is not permanent endeavor of royal substantiation & perfection of contemporaneous scientific orthodoxy to carry forward physics, chemistry, biology, iatrology etc, but possible longitudinal ideological optimization to wash out physics, chemistry, biology, iatrology etc.

At any rate, ultimate authenticity of universal existence & motion radically depends on originality of the demiurge, and originality of the demiurge is but coherent natura naturans throughout cosmic evolution. Comparably, as successive humanistic endeavor to push humanistic ideology about authenticity of temporally accessible existence & motion forward to perfect ideological enantiomorph of ultimate authenticity of nature step by step draw on practical feasibility & possibility in proportion to contemporaneous historical background, hypostatic quantitative & qualitative change of historical progress of science must experience frondose evolvment of humanistic ideology about authenticity

of nature cumulatively enriched from nothingness to groat, from groat to a great lot, and consequently followed proportionate ideaistic correction & qualitative optimization from superficiality to profundity, from parochiality to generality due to crescive progression of practical feasibility & possibility in proportion to contemporaneous historical background, till at last, historical progress of science approaches perfect ideological enantiomorph of ultimate authenticity of nature.

In fact, as inertial ideological aggradation of remarkable transverse ideological expansion, hypostatic humanistic ideology about authenticity of nature as live contemporaneous scientific orthodoxy is substantively unsystematized ideological system making up of rich and colorful scientific travelogues A, B, C, D, E, F, ... like omnifarious smallwares full of a basket, which are virtually deserving reward of the first itineracy around numerous distinctive landscapes of brand-new landmasses of science with palette & tablet on back in the recent several centuries. Inertial ideological aggradation of historical progress of science like this is of course not rantankerous joke of the God but step-by-step inevitability of historical progress of science in inherent optimum orientation towards perfect ideological enantiomorph of ultimate authenticity of nature due to crescive progression of necessary potentiality of practical feasibility & possibility in proportion to contemporaneous historical background. In straightforward words, since the gradually accessible noumenon seemed so rich and colorful distinctive landscapes of brand-new landmasses of science in our rational purview then and there, as timely ideological enantiomorph about authenticity of nature, it's only possible for commensurate ideological system about authenticity of nature to be so rich and colorful scientific travelogues A, B, C, D, E, F, ... like omnifarious smallwares full of a basket.

Meanwhile, as remarkable highlight of microcosmic configuration of matter which makes homogenous profile of cosmos more and more explicit in our rational purview, under the favorable background, historical progress of science in inherent optimum orientation towards historical authenticity tolerance of science 0 seems impossible to slide over rational review of entire cosmos as "integrative cosmic homogeneity system originated from unique genesis", remarkable renovation of humanistic ideology about authenticity of nature in proportion to contemporaneous historical background seems inevitable. Whereas, as royal substantiation & perfection of contemporaneous scientific orthodoxy has been the rage near one century in freewheeling, authoritative intrepidity of contemporaneous scientific orthodoxy is all-time and overwhelming in a clear and ordered pattern, even as operability & perceivability of modern scientific experiments have been closer and closer to upper limit of human, which can neither expose a fly in the ointment of contemporaneous scientific orthodoxy nor able to offer solid authentication to timely renovation of humanistic ideology about authenticity of nature forward to perfect ideological enantiomorph of ultimate authenticity of nature, it's almost impossible for historical progress of science to evade virulent scientific knowledge metabolism campaign under pestilent duress of overwhelming authoritative intrepidity of contemporaneous scientific orthodoxy, free press admittance of Homogenous Cosmos Originated from Unique Genesis must break through legitimacy defense line of contemporaneous scientific orthodoxy, so that it has to challenge venomous venomous counterwork upper limit of temporal authority. 31 years' free press

embarrassment of Homogenous Cosmos Originated from Unique Genesis is not only my personal tragedy but also serious social problem of historical progress of science, especially social legitimacy authorization & social legitimacy subsistence of timely renovation of humanistic ideology about authenticity of nature in proportion to contemporaneous historical background against gradational life-and-death scientific knowledge metabolism in inherent optimum orientation towards perfect ideological enantiomorph of ultimate authenticity of nature.

The even morbid situation is that, as timely renovation of humanistic ideology about authenticity of nature in proportion to contemporaneous historical background of **remarkable highlight of microcosmic configuration of matter**, Homogenous Cosmos Originated from Unique Genesis is brand-new topic ready to highlight universal existence & motion as demiurgic aggradation of sequential homologic cosmogony which exists as well-regulated integration of cosmic homogeneity system making up of out-and-out serial natura naturata in the nature of coherent natura naturans throughout cosmic evolution. Whereas, under background of interminable royal substantiation & perfection of contemporaneous scientific orthodoxy with unprecedented official facility of magistral autarchy of **free press regulation customization & free press admittance** of temporal authority short of necessary intendance, as permanent egotistic guidance & restriction in the recent half century, almost 90% so-called official journals on the earth straightforwardly insist that Homogenous Cosmos Originated from Unique Genesis is not favorite topic belonging to academic scope they are professionally devoting to. Oh~, shit, either you are mad or I am; either you are member in cosmos or I am member out of cosmos. As a result, I have to comment modern physics is esoterically floundering in superior riancy devoting to interminable royal substantiation & perfection of contemporaneous scientific orthodoxy short of necessary intendance due to magistral autarchy of **free press regulation customization** and **free press admittance** of temporal authority.

In any case, we must defer to objectivity that realistic historical progress of science can never be free from conditionality of “**crecive progression of practical feasibility & possibility in proportion to contemporaneous historical background + the uniqueness & invariance of ultimate authenticity of nature predestines the unique possibility of scientific verity as perfect ideological enantiomorph of ultimate authenticity of nature**”, hypostatic historical progress of science is just quantitative & qualitative change of humanistic ideology about authenticity of nature under synthesized conditionality of “**crecive progression of practical feasibility & possibility in proportion to contemporaneous historical background + the uniqueness & invariance of ultimate authenticity of nature predestines the unique possibility of scientific verity as perfect ideological enantiomorph of ultimate authenticity of nature**” through and through, and just because of permanent synthesized conditionality of “**crecive progression of practical feasibility & possibility in proportion to contemporaneous historical background + the uniqueness & invariance of ultimate authenticity of nature predestines the unique possibility of scientific verity as perfect ideological enantiomorph of ultimate authenticity of nature**” through and through, it’s only possible for the major melody of historical progress of science to be a series of epochmaking **scientific knowledge metabolism** in inherent optimum orientation towards perfect ideological enantiomorph of ultimate authenticity of nature.

As remarkable transition of scientific practice from macrocosm to microcosms due to historical progress of science in inherent optimum orientation towards perfect ideological enantiomorph of

ultimate authenticity of nature, the nearest epochmaking **scientific knowledge metabolism** occurred in terminal years of 19th century and early years of 20th century. The most remarkable evidence of scientific knowledge metabolism of the age was that **Relativity** and **Quantum Theory** procured social legitimacy qualification of the age and took full role of contemporaneous scientific orthodoxy instead of Newtonian Mechanics ever since.

In subsequent half century, endeavor of substantiation & perfection of contemporaneous scientific orthodoxy almost took full role of historical progress of science in the nature of things. Whereas, half century later (about in 1970), as royal substantiation & perfection of contemporaneous scientific orthodoxy gradually exhausted its inherent potentiality to push humanistic ideology about authenticity of nature forward to perfect ideological enantiomorph of ultimate authenticity of nature draw on practical feasibility & possibility in proportion to contemporaneous historical background, the inefficiency of **demoded royal substantiation & perfection of contemporaneous scientific orthodoxy ≠ general progress of science** became more and more remarkable. And on the other hand, hypostatic historical progress of science has brought out live contemporaneous scientific orthodoxy four typical features of social legitimacy subsistence as below:

①. As live contemporaneous scientific orthodoxy originally coming into being during the course of human practice transition from macrocosmos to microcosmos in early years of 20th century, it had renovated humanistic ideology about authenticity of nature draw on practical feasibility & possibility in proportion to contemporaneous historical background and consequently refurbished scientific legitimacy qualification to possible minimum historical authenticity tolerance of science then and there, which was of course normal segment of historical progress of science in inherent optimum orientation towards perfect ideological enantiomorph of ultimate authenticity of nature and made it rationally backed and superior to enjoy social legitimacy subsistence blithely till today. However, as sportfully indulging in authoritative intrepidity of contemporaneous scientific orthodoxy short of necessary intendance, temporal authority seem unenlightened even foolish that live contemporaneous scientific orthodoxy is but ideological system about authenticity of nature in proportion to contemporaneous historical background of 20th century and a proportionate normal progressive segment of historical progress of science in inherent optimum orientation towards perfect ideological enantiomorph of ultimate authenticity of nature.

Live contemporaneous scientific orthodoxy is not terminus of historical progress of science, no more perfect ideological enantiomorph of ultimate authenticity of nature. In accordance with crevice progression of practical feasibility & possibility for historical progress of science, it's only possible for the major melody of historical progress of science to serial epochmaking scientific knowledge metabolism in inherent optimum orientation towards perfect ideological enantiomorph of ultimate authenticity of nature, veritable progress of science is not endeavor of **interminable royal substantiation & perfection of contemporaneous scientific orthodoxy** but endeavor to push humanistic ideology about authenticity of nature forward to perfect ideological enantiomorph of ultimate authenticity of nature draw on practical feasibility & possibility in proportion to contemporaneous historical background. Since historical progress of science is still in its normal way in inherent optimum orientation towards perfect ideological enantiomorph of ultimate authenticity of nature, we must be intelligibly ready to review and accept timely renovation of humanistic ideology about authenticity of nature in proportion to contemporaneous historical background. In any case, we should be aware that live contemporaneous scientific orthodoxy is but inertial ideological aggradation of remarkable transverse ideological expansion in the recent several centuries making up of rich &

colorful scientific travelogues A, B, C, D, E, F, . . . like omnifarious smallwares full of a basket which are virtually deserving rewards of a far-flung humanistic exploration of the first itinerary around numerous distinctive landscapes of brand-new landmasses of science with palette and tablet on back. As commensurate ideological system about authenticity of nature in proportion to contemporaneous historical background of 20th century, live contemporaneous scientific orthodoxy is obvious unsystematic ideological aggradation far away from perfect ideological enantiomorph of ultimate authenticity of nature.

②. As live contemporaneous scientific orthodoxy originally coming into being during the course of human practice transition from macrocosmos to microcosmos in early years of 20th century, it possesses the largest social loop of temporal authority with superior puissance of overwhelming authoritative intrepidity of contemporaneous scientific orthodoxy throughout historical progress of science, which makes contemporaneous scientific orthodoxy burly and unshakable.

③. As live contemporaneous scientific orthodoxy originally coming into being during the course of human practice transition from macrocosmos to microcosmos in early years of 20th century, it possesses unprecedented official facility of magistral autarchy of **free press regulation customization & free press admittance** short of necessary intendance, which is out-and-out hardcore puissance of historical progress of science. The most straightforward officialism domino effect of magistral autarchy of free press regulation customization and free press admittance is **egotistical customization of historical progress of science** towards substantiation & perfection of contemporaneous scientific orthodoxy at pleasure of temporal authority, so that live scientific knowledge proliferation all over the world has to be in rigid succession of contemporaneous scientific orthodoxy like omnifarious scientific travelogues A, B, C, D, E, F, . . . in defiance of objectivity that cosmos is throughout homogenous originated from unique genesis, cosmic status quo is but demiurgic aggradation of sequential homologic cosmogony, which exactly exists as well-regulated integration of cosmic homogeneity system making up of out-and-out serial natura naturata in the nature of coherent natura naturans throughout cosmic evolution.

And just because of magistral autarchy of free press regulation customization and free press admittance of temporal authority short of necessary intendance, officialism operation of free press admittance turns into **free press egotistic proximity identification** in the nature of things. As a result, free press admittance of any aberrant scientific knowledge proliferation out of succession of contemporaneous scientific orthodoxy can hardly slider over orthodox filtration of free press egotistic proximity identification at pleasure of temporal authority, which is not only root cause and magistral puissance to coronate royal substantiation & perfection of contemporaneous scientific orthodoxy high-sounding keynote of historical progress of science of the age even make so-called “modern science forum” out-and-out homegrown outgrowth in the garden of contemporaneous scientific orthodoxy therefore but also expediential facility for temporal authority to involve in inevitable virulent scientific knowledge metabolism campaign as hardcore puissance of historical progress of science in defiance of objectivity that, as permanent synthesized conditionality of “**crecive progression of practical feasibility & possibility in proportion to contemporaneous historical background + the uniqueness & invariance of ultimate authenticity of nature predestines the unique possibility of scientific verity as perfect ideological enantiomorph of ultimate authenticity of nature**” through and through, it’s only possible for the major melody of historical progress of science to be a series of epochmaking scientific knowledge metabolism in inherent optimum orientation towards perfect ideological enantiomorph of ultimate authenticity of nature, **general progress of science ≠ interminable royal substantiation & perfection of contemporaneous scientific orthodoxy.**

④. Authentication efficiency of modern scientific experiments has been rather close to upper limit of human perception feasibility, so that modern scientific experiments can neither expose a fly in the ointment of contemporaneous scientific

Historical progress of science in the recent several centuries seemed like a far-flung exploration of the first itinerary around numerous distinctive landscapes of brand-new landmasses of science with palette & tablet on back, several hundred years’ scientific travelogues were compiled thereby.

orthodoxy at the volley nor easy to offer credible authentication to successive renovation of humanistic ideology about authenticity of nature in proportion to contemporaneous historical background, which not only makes royal substantiation & perfection of contemporaneous scientific orthodoxy interminably freewheeling without scruple but also makes successive renovation of humanistic ideology about authenticity of nature in proportion to contemporaneous historical background helplessly unbacked. What's more, as typical conservative officialism domino effect of contemporaneous scientific orthodoxy, modern scientific experiments need substantial fund support, fund application & procurement mostly depends on subjective volition of temporal authority, if there is stirring predictable authenticity from contemporaneous scientific orthodoxy, necessary experimental verification or experiment validation is of course cost-efficient at pleasure of temporal authority; if there is significant predictable authenticity from timely renovation of humanistic ideology about authenticity of nature in proportion to contemporaneous historical background needing necessary experimental verification or experiment validation, as archons of the society, obduracy of temporal authority is of course self-evident, which may be as pestilent as free press admittance of timely renovation of humanistic ideology about authenticity of nature in proportion to contemporaneous historical background.

And just because of practical domino effect the four typical features of social legitimacy subsistence of live contemporaneous scientific orthodoxy, as timely renovation of humanistic ideology about authenticity of nature in proportion to contemporaneous historical background of **remarkable highlight of microcosmic configuration of matter** in logic enantiomorph of newly highlighted factuality that **discretionary particles in cosmos are mutually convertible**, social legitimacy subsistence of Homogenous Cosmos Originated from Unique Genesis has really slidden into pestilent deadlock ever since:

i). As freewheeling of magistral autarchy of free press regulation customization & free press admittance short of necessary intendance in the recent half century, it's really easy for temporal authority to lock such a powerless heterodoxy in free press embarment in a walk. Virtually, in mainland of China, as bred-in-the-bone feudality & bureaucracy, official academic operation can hardly stay away from **official rank, money, guanxi**, as poor floater of the society, I have neither official rank nor money nor guanxi for involvement of official academic operation. And on the other hand, as timely renovation of humanistic ideology about authenticity of nature in proportion to contemporaneous historical background of **remarkable highlight of microcosmic configuration of matter** and innovative cosmos redefinition in radical logic enantiomorph of newly highlighted factuality that **discretionary particles in cosmos are mutually convertible** with consequent PNT dynamics about universal existence & motion in the nature of coherent natura naturans throughout cosmic evolution, which I write in both native language and a foreign language. Once I try to contribute my monograph in foreign language to journals out of China, there is almost no way for me to slider over virulent scientific knowledge metabolism campaign, in any case, free press admittance of Homogenous Cosmos Originated from Unique Genesis directly impacts vested interest of temporal authority, there is almost nobody ready to displeas overwhelming temporal authority for it; once I try to contribute my monograph in mainland of China, there is almost no way for me to evade discrimination of identity & qualification, for you see, I am but a poor floater struggling for subsistence in abominable social ambience as mainland of China.

Of course, as self-educated man without respectable identity & qualification, my personal limitation seems inevitable. For instance, English is my foreign language, I can hardly express myself in English without a fly in the ointment, whereas, my literal imperfection is but minor details or small-beer shortages, they can never be deadly excuse to negate my devotional pursuit of authenticity highlight that **cosmos is throughout homogenous originated from unique genesis, cosmic status quo**

is demiurgic aggradation of sequential homologic cosmogony, which exactly exists as well-regulated integration of cosmic homogeneity system making up of out-and-out serial natura naturata in the nature of coherent natura naturans throughout cosmic evolution, unless virulent scientific knowledge metabolism campaign really lack of excuses.

Virtually, if there is no pestilent perplexity of virulent scientific knowledge metabolism campaign ahead, many of such kind of small-beer shortages can be smooth away at the volley, the key issue is that, as typical aberrant scientific knowledge proliferation out of succession of contemporaneous scientific orthodoxy, Homogenous Cosmos Originated from Unique Genesis is obviously incompatible for free press egotistic proximity identification of temporal authority, and most of the superior temporal authority are not willing to spend three more minutes to look into issue whether cosmos is really homogenous originated from unique genesis through and through, cosmic status quo is but demiurgic aggradation of sequential homologic cosmogony, which exactly exists as well-regulated integration of cosmic homogeneity system making up of out-and-out serial natura naturata in the nature of coherent natura naturans throughout cosmic evolution. And just because of esoteric perplexity of virulent scientific knowledge metabolism campaign underlying, it seems none of my small-beer shortages can be my last one for free press admittance. Virtually, as personal limitation, I can hardly leave nothing to be desired through and through, even as all-time magistral autarchy of free press regulation customization & free press admittance of temporal authority short of necessary intendance, no matter coming cosmic authenticity clarification indicates how much vicious free press embarment Homogenous Cosmos Originated from Unique Genesis had ever suffered for virulent scientific knowledge metabolism campaign under egotistic background of royal substantiation & perfection of contemporaneous scientific orthodoxy, nobody of temporal authority is responsible, such situation of course leaves virulent scientific knowledge metabolism campaign unscrupulous without misgiving. As a result, as innovative cosmos redefinition in logic enantiomorph of newly highlighted factuality of **discretionary particles in cosmos are mutually convertible** with consequent PNT dynamics about universal existence & motion in the nature of coherent natura naturans throughout cosmic evolution, free press admittance of Homogenous Cosmos Originated from Unique Genesis has never been considered as nonsense scientific topic anywhere in the recent 31 years. Although, as amateur work, it has been the largest personal monograph throughout historical progress of science written by heterodoxy in both native language and a foreign language with non-ignorable academic influence all over the world in open access. Till today, I am still floundering around in vicious circle of virulent scientific knowledge metabolism campaign under invisible duress of overwhelming authoritative intrepidity of contemporaneous scientific orthodoxy.

ii). Power contrast between the both opposites of scientific knowledge metabolism campaign is so remarkable, as renovator of humanistic ideology about authenticity of nature in proportion to contemporaneous historical background of remarkable highlight of microcosmic configuration of matter and victim of virulent scientific knowledge metabolism campaign under egotistic background of interminable royal substantiation & perfection of contemporaneous scientific orthodoxy with expediential official facility of magistral autarchy of **free press regulation customization & free press admittance** of temporal authority, I am so lowdown & helpless man of the society. Comparably, as orthodox opposite of officialism scientific knowledge metabolism campaign, temporal authority are most overwhelming throughout historical progress of science out of question. As a result, on one hand, as personal limitation, it's really difficult for such a poor helpless floater struggling in mainland of China as me to do more credential about authenticity clarification & verification of Homogenous Cosmos Originated from Unique Genesis so as to make cosmos redefinition in radical logic enantiomorph of newly highlighted factuality that **discretionary particles in cosmos are mutually convertible** more comprehensible and feasible to be demonstrated by social practice; and on the other hand, as long as Homogenous Cosmos Originated from Unique Genesis is locked in free press embarment without release, it's almost impossible for anybody to successfully apply necessary fund support for further verification & authentication of Homogenous Cosmos

Originated from Unique Genesis, even though there are substantial academicians who are ready to carry forward the very idea, they maybe also encounter similar perplexity of free press admittance for inevitable life-and-death scientific knowledge metabolism against overwhelming opposite involvement of authoritative intrepidity of contemporaneous scientific orthodoxy. Although, Homogenous Cosmos Originated from Unique Genesis has been the largest personal academic monograph throughout historical progress of science in both native language and a foreign language with many thousands of cordial readers all over the world who seem ready to do more jobs about authenticity clarification & verification and try to formulate universal existence & motion as out-and-out serial natura naturata in the nature of coherent natura naturans throughout cosmic evolution, although, the author of the monograph is but a poor floater struggling for subsistence in mainland of China.

Although, the undoubted objectivity is that, as permanent synthesized conditionality of “**crecscive progression of practical feasibility & possibility in proportion to contemporaneous historical background + the uniqueness & invariance of ultimate authenticity of nature predestines the unique possibility of scientific verity as perfect ideological enantiomorph of ultimate authenticity of nature**” through and through, it's only possible for the major melody of historical progress of science to be a series of epochmaking **scientific knowledge metabolism** in inherent optimum orientation towards perfect ideological enantiomorph of ultimate authenticity of nature, and as long as historical progress of science can go its normal way in inherent optimum orientation towards perfect ideological enantiomorph of ultimate authenticity of nature, none interminable royal substantiation & perfection of contemporaneous scientific orthodoxy out of scientific legitimacy qualification of historical authenticity tolerance of science 0 can be carefree to take full role of historical progress of science without perplexity of coming life-and-death scientific knowledge metabolism.

Whereas, once there is no way for historical progress of science in inherent optimum orientation towards perfect ideological enantiomorph of ultimate authenticity of nature to shy away scientific legitimacy metabolism and has to sacrifice live authoritative intrepidity of contemporaneous scientific orthodoxy due to necessary scientific knowledge metabolism, the humanistic negative impact of commensurate authoritative intrepidity of contemporaneous scientific orthodoxy to historical progress of science is too self-evident, especially, once magistral autarchy of **free press regulation customization & free press admittance** of temporal authority under background of interminable royal substantiation & perfection of contemporaneous scientific orthodoxy exposes pestilent hostility to timely renovation of humanistic ideology about authenticity of nature in proportion to contemporaneous historical background. And indeed, under egotistic background of interminable royal substantiation & perfection of contemporaneous scientific orthodoxy with expedient facility of magistral autarchy of free press regulation customization and free press admittance, as author of Homogenous Cosmos Originated from Unique Genesis who wrote down cosmos redefinition in logical enantiomorph of newly highlighted factuality of **discretionary particles in cosmos are mutually convertible** with consequent PNT dynamics about universal existence & motion in the nature of coherent natura naturans throughout cosmic evolution, I am but a black bear, the man who dares to publish Homogenous Cosmos Originated from Unique Genesis on the earth is out-and-out hero. We have to take care of the humanistic seriousness of historical progress of science due to inevitable self-contradictory coexistence of overwhelming authoritative intrepidity of contemporaneous scientific orthodoxy and necessary epochmaking scientific knowledge metabolism in inherent optimum orientation towards perfect ideological enantiomorph of ultimate authenticity of nature.

As coherent natura naturans throughout cosmic evolution, instinctive PNT reciprocal equilibrium towards optimum PNT operation is radical potentiality & conditionality for cosmos always ready to orientate itself towards perfection.

Virtually, remarkable highlight of microcosmic configuration of matter especially factuality that **discretionary particles in cosmos are mutually convertible** is always in permanent clarification orientation towards perfect induction has made homogenous profile of cosmos more and more explicit in our rational purview, which is of course remarkable headspring for me to look into homogenous cosmos originated from unique genesis and consequent PNT dynamics about universal existence & motion in the nature of coherent natura naturans throughout cosmic evolution. Whereas, as timely renovation of humanistic ideology about authenticity of nature in proportion to contemporaneous historical background of **remarkable highlight of microcosmic configuration of matter**, free press admittance of Homogenous Cosmos Originated from Unique Genesis has to challenge venomous counterwork upper limit of temporal authority due to overwhelming authoritative intrepidity of contemporaneous scientific orthodoxy with expedient official facility of magistral autarchy of **free press regulation customization** and **free press admittance** of temporal authority. And now, 31 years has gone, Homogenous Cosmos Originated from Unique Genesis is still floundering around in vicious circle of virulent officialism scientific knowledge metabolism campaign without alternatives.

Throughout historical progress of science, social legitimacy subsistence of any contemporaneous scientific orthodoxy out of scientific legitimacy qualification of historical authenticity tolerance of science 0 must consist in machine-made evolvment model of **“historical legitimacy keynote initialization + freewheeling royal substantiation & perfection of contemporaneous scientific orthodoxy + successive social legitimacy metabolism of science”** in historical progression, it’s only possible for the major melody of historical progress of science to be successive epochmaking scientific knowledge metabolism in inherent optimum orientation towards perfect ideological enantiomorph of ultimate authenticity of nature through and through, before humanistic ideology about authenticity of nature finally qualified as **perfect ideological enantiomorph of ultimate authenticity of nature**, none **interminable royal substantiation & perfection of contemporaneous scientific orthodoxy** can be carefree to take full role of historical progress of science and finish all the rest route of historical progress of science in inherent optimum orientation towards perfect ideological enantiomorph of ultimate authenticity of nature like freewheeling nonstop. As necessary segments of historical progress of science, practical significance of royal substantiation & perfection of contemporaneous scientific orthodoxy mostly consists in that, as burgeoning pioneering humanistic ideology about authenticity of nature in proportion to contemporaneous historical background, it’s almost impossible for any burgeoning pioneering humanistic ideology about authenticity of nature to be consummated in a sudden, it needs necessary time for successive substantiation & perfection, and in the early years after original naissance of commensurate pioneering humanistic ideology about authenticity of nature, freewheeling **royal substantiation & perfection of contemporaneous scientific orthodoxy \approx general progress of science** then and there.

Since newly highlighted factuality that **discretionary particles in cosmos are mutually convertible** is always in freewheeling orientation towards complete induction day by day, I never lack of confidence about authenticity of nature that **cosmos is throughout homogenous originated from unique genesis, cosmic status quo is demiurgic aggradation of sequential homologic cosmogony, which exactly exists as well-regulated integration of cosmic homogeneity system making up of out-and-out serial natura naturata in the nature of coherent natura naturans throughout cosmic evolution.** Whereas, as free press admittance of Homogenous Cosmos Originated from Unique

Genesis directly impacts vested interest of temporal authority and consequently has to challenge venomous counterwork upper limit of temporal authority for virulent scientific knowledge metabolism campaign, I am frustrated so much for interminable free press embarment.

Throughout human history, progress of human civilization can hardly slider over deadly conflicts of interest irreconcilable between conservative power and pioneering power, human have to invoke life-and-death warfare to smooth them away. Whereas, as hardcore component of human civilization, once historical progress of science in inherent optimum orientation towards perfect ideological enantiomorph of ultimate authenticity of nature slides into virulent scientific knowledge metabolism campaign due to occurrence of remarkable renovation of humanistic ideology about authenticity of nature in proportion to contemporaneous historical background, what's the enlightened power to conciliate virulent scientific knowledge metabolism campaign between innovators and temporal authority for benign historical progress of science, especially when authoritative intrepidity of contemporaneous scientific orthodoxy is all-time and overwhelming?

Since live contemporaneous scientific orthodoxy is not perfect ideological enantiomorph of ultimate authenticity of nature and it's only possible for the major melody of historical progress of science to be epochmaking scientific knowledge metabolism in inherent optimum orientation towards perfect ideological enantiomorph of ultimate authenticity of nature, why free press admittance of timely renovation of humanistic ideology about authenticity of nature in proportion to contemporaneous historical background of remarkable highlight of microcosmic configuration of matter is so unintelligible under egotistic background of royal substantiation & perfection of contemporaneous scientific orthodoxy? Is it necessary for historical progress of science to spring up life-and-death warfare between timely cosmos redefinition in radical logic enantiomorph of newly highlighted factuality that **discretionary particles in cosmos are mutually convertible** and live contemporaneous scientific orthodoxy to smooth away virulent scientific knowledge metabolism campaign?

Since nothing can stop vicious circle of virulent scientific knowledge metabolism campaign between innovative **cosmos redefinition** in radical logic enantiomorph of newly highlighted factuality that **discretionary particles in cosmos are mutually convertible** and live contemporaneous scientific orthodoxy with all-time officialism backup of overwhelming authoritative intrepidity, it seems only possible for the ultimate come-off to be either Homogenous Cosmos Originated from Unique Genesis dies off in historical billow undisturbedly or Homogenous Cosmos Originated from Unique Genesis ignites a single spark ready to start a prairie fire.

—Originally written in Dec. 2004, revision done at the volley.

Contents

Cover letter	6
Introduction	20
Contents	36
Read Guide	42
(1) Historical progress of science	42
(2) Skeleton of Homogenous Cosmos Originated from Unique Genesis	48
(I). Connotation Objectification of Homogenous Cosmos Originated from Unique Genesis—Homologisation of Spacetime & Matter—Precondition Initialization of PNT Dynamics	
Forward	70
(I-i) Introduction of Homogenous cosmos originated from unique genesis postulate	72
(I-ii) Connotation objectification of two logic extensions of Homogenous cosmos originated from unique genesis postulate —Ingenerate coexistence of “spacetime” & “matter” fully embodies cosmic homogeneity system as lineal coordinative homology	79
(I-ii-1) Connotation objectification of logic extension 1 of Homogenous cosmos originated from unique genesis postulate — homologic objectification of spacetime as coordinator homology in cosmic homogeneity system	79
(I-ii-2) Connotation objectification of logic extension 2 of Homogenous cosmos originated from unique genesis postulate —Homologic generation of matter in homogenous cosmos	87
(I-ii-3) Sum-up of connotation objectification of two logic extensions of Homogenous Cosmos originated from unique genesis postulates	90
(II). Freewheeling Logic Extension of Connotation Objectification of Homogenous Cosmos Originated from Unique Genesis—PNT Dynamics	
(II-i) Original generation of matter in the nature of coherent natura naturans brings out essence of matter in a class by itself; essence of matter in a class by itself predestines thorough coherence of dynamic regularity of universal existence & motion	96
(II-i-1) Matter Inertial Conservation Equations	116
(II-i-2) Positive & Negative Transmutation Dynamics—PNT Dynamics	129
(II-ii) “Space distance” and “space radiation cornu”	142
(III). As Demiurgic Aggradation of Sequential Homologic Cosmogony, Cosmos is Well-regulated Integration of Cosmic Homogeneity System Making Up of Out-and-out Serial Natura Naturata in the Nature of Coherent Natura Naturans Throughout Cosmic Evolution, Universal Existence & Motion Are Spontaneous Occurrence of [External Physical Disturbance + (PNT Action + Instinctive PNT Equilibrium)] —Universal Applicability of PNT Dynamics	

Forward	148
(III-i) “Force Field” and “Force”	151
(III-i-1) Authentic Connotation of Force Due to Homogenous Cosmos Originated from Unique Genesis	155
(III-i-2) “Gravitational Field” and “Gravity”	161
(III-i-3) Homogenous Cosmos Originated from Unique Genesis Encountered LIGO Gravitational Wave Discovery	186
(III-i-4) “Electromagnetic Field” and “Electromagnetic Force”	224
(III-i-5) “Strong Interaction” and “Weak Interaction”	234
(III-ii) “Spacetime” and “Motion”	240
(III-iii) General Existence & Motion Patterns of Matter in Spacetime	251
(IV). Cosmogony of Homogenous Cosmos Originated from Unique Genesis —As Demiurgic Aggradation of Sequential Homologic Cosmogony, Cosmos is Well-regulated Integration of Cosmic Homogeneity System Making up of Out-and-out Serial Natura Naturata in the Nature of Coherent Natura Naturans Throughout Cosmic Evolution	
(IV-i) As demiurgic aggradation of sequential homologic cosmogony, cosmos is well-regulated integration of cosmic homogeneity system making up of out-and-out serial natura naturata in the nature of coherent natura naturans throughout cosmic evolution	273
(IV-ii) Overall arrangement of homogenous cosmos as well-regulated integration of cosmic homogeneity system due to sequential homologic cosmogony in the nature of coherent natura naturans throughout cosmic evolution	299
(IV-iii) Dynamic essence of universal existence & motion and absolute compatibility of systematic substantiality quantification of cosmic homogeneity system making up of out-and-out serial natura naturata in the nature of coherent natura naturans throughout cosmic evolution	339
(IV-iv) “Big Bang” reflected in sense of “Homogenous Cosmos Originated from Unique Genesis”	356
(V). Systematical Unique-genesis Quantization Formulation of Universal Existence & Motion along Sequential Homologic Cosmogony Starting at Field Genic Origin i_0 to Universal Reciprocal PNT Combinations in the Nature of Coherent Natura Naturans Throughout Cosmic Evolution	
(V-i) Mathematical definition of “Homogenous Cosmos Originated from Unique Genesis”	383
(V-ii) “PNT Action” and “PNT Reaction”	393
(V-iii) Spontaneous individuation of dynamic configuration of resultant reciprocal PNT combinations in the nature of coherent natura naturans of instinctive PNT reciprocal equilibrium towards optimum PNT operation throughout cosmic evolution	408
(V-iv) Initial endeavor of systematical unique-genesis quantization formulation of well-regulated	

As coherent natura naturans throughout cosmic evolution, instinctive PNT reciprocal equilibrium towards optimum PNT operation is radical potentiality & conditionality for cosmos always ready to orientate itself towards perfection.

cosmic homogeneity system making up of out-and-out serial natura naturata in the nature of coherent natura naturans throughout cosmic evolution 426

(V-iv-1) Unique-genesis quantization formulation of “dynamic hylc spacetime” 429

(V-iv-2) Systematical unique-genesis quantization formulation of serial natura naturata of “reciprocal PNT combinations in gradation I” in the nature of coherent natura naturans throughout cosmic evolution 452

(V-iv-3) Systematical unique-genesis quantization formulation of serial natura naturata of “reciprocal PNT combinations in gradation II” in the nature of coherent natura naturans throughout cosmic evolution—— Atom State Equations in Spacetime 467

(V-iv-4) Systematical unique-genesis quantization formulation of serial natura naturata of “reciprocal PNT combinations in gradation III” in the nature of coherent natura naturans throughout cosmic evolution 490

(V-iv-5) Systematical unique-genesis quantization formulation of serial natura naturata of “reciprocal PNT combinations in gradation IV” in the nature of coherent natura naturans throughout cosmic evolution 495

(V-iv-6) Words behind systematical unique-genesis quantization formulation of well-regulated cosmic homogeneity system making up of out-and-out serial natura naturata in the nature of coherent natura naturans throughout cosmic evolution 507

(VI). Initial Endeavor of Natura Naturans Personalization Towards Human Necessity Based on Primary Authenticity Clarification of Homogenous Cosmos Originated from Unique Genesis

The highest rational realm of scientific innovation under contemporaneous historical background is but feasible natura naturans personalization towards human necessity of social production and social life; as mathematical formulation of out-and-out serial natura naturata in the nature of coherent natura naturans throughout cosmic evolution, ultimate consummation of “Atom State Equation in Spacetime” indicates ultimate consummation of systematical unique-quantization quantization formulation of universal existence & motion, which must bring out a grand prolific spring for coming technology application 514

Technology i:

(V-i) Introduction of PNT Engine——Engine contriving is even creationary job to facilitate connatural existence & motion in the nature of coherent natura naturans throughout Cosmic evolution artificially adjustable towards “ideal motion” following our inclinations 518

(VI-i-1) Common Engine and Flying Saucer Engine 520

(VI-i-2) Tyre model of PNT engine 534

(VI-i-3) Preliminary Experimental Exploration of PNT Engine 593

(VI-i-4) Question extract from “fund application for preliminary experimental exploration of PNT activation resource of PNT engine in 2011” 598

(VII). As Timely Renovation of Humanistic Ideology about Authenticity of Nature in Proportion to Contemporaneous Historical Background of Remarkable

Highlight of Microcosmic Configuration of Matter and Typical Aberrant Scientific Knowledge Proliferation Out of Succession of Contemporaneous Scientific Orthodoxy, Free Press Admittance of Homogenous Cosmos Originated from Unique Genesis Must Break Through Legitimacy Defense Line of Contemporaneous Scientific Orthodoxy due to Inevitable Life-and-death Scientific Knowledge metabolism, so That It Has to Challenge Venomous Counterwork Upper Limit of Temporal Authority Under Egotistic Background of Interminable Royal Substantiation & Perfection of Contemporaneous Scientific Orthodoxy—Social Legitimacy & Validity of Truths Can Never Exceed Cannon Range.

Forward	606
(VII-i) Along crecive progression of historical progress of science in inherent optimum orientation towards perfect ideological enantiomorph of ultimate authenticity of nature, remarkable contrast of historical concatenation & inherent logic configuration between Homogenous Cosmos Originated from Unique Genesis and live Contemporaneous scientific orthodoxy	612
(VII-ii) Social Legitimacy Subsistence Perplexity of Timely Renovation of Humanistic Ideology about Authenticity of Nature in Proportion to Contemporaneous Historical Background of Remarkable Highlight of Microcosmic Configuration of Matter Under Egotistic Background of Royal Substantiation & Perfection of Contemporaneous Scientific Orthodoxy	634
(VII-iii) An Email from Victim of Scientific Knowledge Metabolism Campaign	663
(VII-iv) Brief Review of Scientific Experiment	676
(VII-v) Humanistic ideology about authenticity of nature in proportion to contemporaneous historical background and proportionate commensurate scientific authentication	684
(VII-vi) Nine serial questions from modern physics reflected on sense of Homogenous Cosmos Originated from Unique Genesis	704
(VIII). Historical Progress of Science in Inherent Optimum Orientation Towards Perfect Ideological Enantiomorph of Ultimate Authenticity of Nature	
Forward	738
(VIII-i) Qualitative summary of historical progress of science	742
(VIII-ii) Evolvement profile of historical progress of science	777
(VIII-iii) Reciprocal coevolution between integrative social circumstances and scientific knowledge proliferation in monofier modality	813
(VIII-iv) Optimum accomplishment of scientific knowledge proliferation in conditionality of integrative social circumstances	856
(IX). Reference Interpretation of Homogenous Cosmos Originated from Unique Genesis and Nowadays “Reference Popularity” Under Egotistic Background of Interminable Royal Substantiation & Perfection of Contemporaneous Scientific Orthodoxy	
Forward	886

As coherent natura naturans throughout cosmic evolution, instinctive PNT reciprocal equilibrium towards optimum PNT operation is radical potentiality & conditionality for cosmos always ready to orientate itself towards perfection.

(IX-i) Reference Interpretation of Homogenous Cosmos Originated from Unique Genesis	888
(IX-ii) Practical significance of reference popularity	892
(IX-iii) Dithyrambic reference popularity under egotistic background of interminable royal substantiation & perfection of contemporaneous scientific orthodoxy	912
(IX-iv) As timely cosmos redefinition in radical logic enantiomorph of newly highlighted factuality that discretionary particles in cosmos are mutually convertible and typical aberrant scientific knowledge proliferation out of succession of contemporaneous scientific orthodoxy, esoteric perplexity of Homogenous Cosmos Originated from Unique Genesis floundering about in high-sounding reference popularity under egotistic background of interminable royal substantiation & perfection of contemporaneous scientific orthodoxy	921
(IX-v) Serial assembly of special nouns & items of Homogenous Cosmos Originated from Unique Genesis and necessary interpretation	930
Final Words	988
Final final words	1014
References	1030



It's only possible for concordant cosmos to be demiurgic aggradation of out-and-out serial natura naturata in the nature of coherent natura naturans throughout cosmic evolution; there is no way for demiurgic aggradation in the nature of different natura naturans to be concordant cosmos through and through.

As coherent natura naturans throughout cosmic evolution, instinctive PNT reciprocal equilibrium towards optimum PNT operation is radical potentiality & conditionality for cosmos always ready to orientate itself towards perfection.

Read Guide

Factuality that **discretionary particles in cosmos are mutually convertible** in freewheeling orientation towards complete induction day by day straightforwardly exposes homogenous profile of cosmos, which makes us more and more confident to introduce “**Homogenous cosmos originated from unique genesis postulate**” for logical operation towards theoretical exploration & clarification of sequential homologic cosmogony and consequent universal existence & motion in the nature of homogenous cosmos originated from unique genesis at the volley.

As timely renovation of humanistic ideology about authenticity of nature in proportion to contemporaneous historical background and innovative cosmos redefinition in radical logic enantiomorph of newly highlighted factuality that **discretionary particles in cosmos are mutually convertible** with consequent PNT dynamics about universal existence & motion in the nature of coherent natura naturans throughout cosmic evolution, I implemented connotation objectification of homogenous cosmos originated from unique genesis on the basis of (**Homogenous cosmos originated from unique genesis postulate** + **spacetime~matter fully embodying cosmos postulate**), which makes alternative homologic filiation between spacetime and matter and essence of matter self-evident; and on the basis of [(**Homogenous cosmos originated from unique genesis postulate** + **spacetime~matter fully embodying cosmos postulate**) + **Instinctive PNT equilibrium postulate**], I accomplished freewheeling logic extension of connotation objectification of homogenous cosmos originated from unique genesis, which makes universal existence & motion in the nature of coherent natura naturans throughout cosmic evolution as spontaneous occurrence of [**External physical disturbance** + (**PNT action** + **Instinctive PNT equilibrium**)] self-evident, which is virtually coherent dynamic fundamental of **instinctive PNT reciprocal equilibrium towards optimum PNT operation** as radical potentiality & conditionality for original sequential homologic cosmogony and consequent universal existence & motion, coherent natura naturans for cosmos always ready to orientate perfection by itself. And mathematical formulation of quantitative performance of **instinctive PNT reciprocal equilibrium towards optimum PNT operation** of matter integration directly approaches **PNT dynamics** in the nature of things.

(1) Historical progress of science

—Modern physics is floundering in riancy

Abstract: *Historical progress of science is generally covariant reciprocal succession of transverse ideological expansion and longitudinal ideological optimization. However, live progress of science seems egregiously extreme for transverse ideological expansion is conventionalized too much and longitudinal ideological optimization is restrained for monstrous predominance of travelogue style transverse ideological expansion on stilts. As a result, historical harvest of sciences in the recent several centuries are substantively aggradation of colorful*

Historical progress of science in the recent several centuries seemed like a far-flung exploration of the first itinerary around numerous distinctive landscapes of brand-new landmasses of science with palette & tablet on back, several hundred years' scientific travelogues were compiled thereby.

*scientific travelogues like omnifarious smallwares full of a basket, which were gained by human as deserving rewards of formidable but devious science exploration journey in the recent several centuries, and it's almost impossible for them to be digested into thorough coherence of grand lineal logic system. Although, **ultimate authenticity of nature can be neither omnifarious authenticity smallwares full of a basket nor authenticity chameleon one piece and only, but coherent natura naturans throughout cosmic evolution; it's only possible for concordant cosmos to be demiurgic aggradation of out-and-out serial natura naturata in the nature of coherent natura naturans throughout cosmic evolution; there is no way for demiurgic aggradation in the nature of different natura naturans to be concordant cosmos through and through.***

Keywords: *transverse ideological expansion; longitudinal ideological optimization.*

Before involving the major thesis of Homogenous Cosmos Originated from Unique Genesis, my intention to mention historical progress of science herein is ready to remind people to review quantitative & qualitative change of historical tenor in inherent optimization progression of scientific knowledge proliferation throughout historical progress of science systematically. Because only when we expressly look into historical progress of science in reference frame of commensurate spacetime constitution and treat it living progression of quantitative & qualitative change of scientific knowledge proliferation in proportion to active law of causation of all relevant historical background complications, we can accessibly find out the intrinsic necessity & inevitability of historical progress of science through and through; so that we can consciously acclimate ourselves to optimize our progressive fettle & orientation opportunely for our intelligence of foreknowledge.

In simple words, so-called “historical progress of science” is but sequential historical process that human come to discover and formulate authenticity of accessible existence & motion around from nothingness to groat, from groat to a great lot, from superficiality to profundity and from parochiality to generality. The historical process that scientific knowledge cumulatively enriched from nothingness to groat, from groat to a great lot is just the transverse ideological expansion; and the historical process that scientific knowledge qualitatively optimized from superficiality to profundity and from parochiality to generality is just the longitudinal ideological optimization. The most remarkable indication of transverse ideological expansion generally incarnates quantitative expansion of recognizant range and consequent knowledge aggradation. Whereas, the most remarkable indication of longitudinal ideological optimization generally incarnates gradual qualitative optimization of ideological system in inherent orientation towards perfect ideological enantiomorph of ultimate authenticity of nature on the basis of commensurate scientific knowledge aggradation of remarkable transverse ideological expansion.

Generally, as aspirant social practice gradually outspreading in depth of rich and colorful existence & motion accessible in the nature, transverse ideological expansion can go its way more feasibly and straightforwardly than longitudinal ideological optimization can usually do. And generally, the transverse ideological expansion is favorable precondition & groundwork for longitudinal ideological optimization, there is almost no way for us to achieve longitudinal ideological optimization short of commensurate backup of favorable groundwork of transverse ideological expansion. Virtually, the longitudinal ideological optimization is just progressive logos optimization and sublimation based on headspring background of favorable background of transverse ideological expansion, which is generally integrative abstract, generalization and systematization of favorable background transverse ideological expansion including the relative sub-longitudinal ideological optimization in prior along crescive progression of historical progress of science in inherent optimum orientation towards perfect ideological

enantiomorph of ultimate authenticity of nature. The more extensive favorable groundwork of transverse ideological expansion for successive longitudinal ideological optimization is, and the more reliable the rational domination to favorable groundwork of transverse ideological aggradation for successive longitudinal ideological optimization is, the superior quality of the logic notion derived from successive longitudinal ideological optimization is therefore. Historical progress of science is just historical progression of reciprocal facilitation of transverse ideological expansion and longitudinal ideological optimization in covariant alternation.

Of course, as limitation of practical feasibility & possibility, human are neither able to accomplish perfect ideological enantiomorph of ultimate authenticity of nature once, nor able to acclimate themselves in optimum progressive fettle towards consummate formulation of ultimate authenticity of nature once, but have to experience historical recognizant development of reciprocal alternation of transverse ideological expansion & longitudinal ideological optimization draw on practical feasibility & possibility in proportion to contemporaneous historical background. We have to admit, during the course of gradual cumulation, correction and optimization of scientific knowledge, successive scientific knowledge proliferation on one hand is rooted in prior historical knowledge aggradation for necessary progenitive vitality towards further progress, which indicates there is almost no possibility for positive progress of science to leap over or break away inherent historical progression ever since. And on the other hand, further progress of sciences is rigorously bewitched and restricted by contemporaneous scientific orthodoxy as well, even engaged and fooled by conventional prejudice, which sternly predestines historical progress of science can not be plain sailing for ever.

As crescive progression of practical feasibility & possibility in proportion to contemporaneous historical background, it's almost impossible for us to call away various negative possibilities for our positive progress in time 100 over 100, there are many causative possibilities for us to conventionally inherit and insist too much of the historical immaturity or localized segments so as to slide into self-fooling behavior unknowingly. We maybe even treat the prisoner cage built up by historical ignorance or unnoticed immature of conventionality as "chirrupy dancing bar", nothing seems sensible for us to break away conventionality for further advancement to push humanistic ideology about authenticity of nature forward to perfect ideological enantiomorph of ultimate authenticity of nature, we obviously wallow in royal substantiation & perfection of contemporaneous scientific orthodoxy too much even ignorantly perpetrate this sort of or that sort of altisonant mistakes till we are bitterly awakened by unexpected factuality or illogicality.

As inevitability of ideological development along crescive progression of historical progress of science, I think, in the recent half century, the most fatal lapsus of progress of science was no more than transverse ideological expansion was too monstrously conventionalized and apotheosized by temporal authority, no more than our "sense myopia" of scientific exploration to enrich our scientific knowledge by cumulative study of omnifarious matter specimens accessible around us. We were too conservative and subconscious to devote ourselves to studying matter as rich and colorful specimens accessible around us one after another, we apparently neglected the demiurgic coherence and proportionate innative essence of matter originated from the proper original generation & formation of matter throughout cosmic evolution. We never studied universal existence & motion as coherent single notion of systematical out-and-out serial natura naturata in the nature of coherent natura naturans throughout cosmic evolution. It apparently seems, in order to study apple, we fetch apples from apple tree one by one and intently twiddle with them on tip of our fingers one after another, but never ready to study overall animate apples in apple tree according to inborn growth of apple. Thus, we unknowingly neglected an invisible logos domain for potential

Historical progress of science in the recent several centuries seemed like a far-flung exploration of the first itineracy around numerous distinctive landscapes of brand-new landmasses of science with palette & tablet on back, several hundred years' scientific travelogues were compiled thereby.

effect of intangible misdirection and bewitchment of conventionality.

Although, it's historical inevitability for crescive transverse expansion and proportionate longitudinal optimization of humanistic ideology about authenticity of nature from nothingness to groat, from groat to a great lot; from superficiality to profundity and from parochiality to generality; although, it had ever been our great historical bloom and pride. In the recent half century, just because the resplendent transverse ideological expansion artery we had ever been proud of was conventionalized and apotheosized too much for remarkable predominance in historical progression of scientific exploration at one time, we unknowingly kept a slack hand with successive necessary longitudinal ideological optimization or just paid insufficient attention to topical longitudinal ideological optimization and persisted to study this object and that object, this particle and that particle one by one conventionally, but never ready to transcend altisonant convention, we consequently neglected an “invisible logos domain — cosmic origin of matter”, Although matter is always our everlasting kernel topic of scientific study, whereas, historical progress of science extending to today, we still have never studied matter as coherent object of matter itself, no more to study universal existence & motion in the nature of coherent natura naturans throughout cosmic evolution, but to unremittingly fetch and study this matter specimen or that matter state, this radiation or that particle accessible around us one after another like twiddling with this red apple and that green apple on tip of our fingers off the cuff.

Virtually, ultimate authenticity of nature can be neither omnifarious authenticity smallwares full of a basket nor authenticity chameleon one piece and only, but coherent natura naturans throughout cosmic evolution. As straightforward man, the demiurge has none special artifice but coherent natura naturans throughout cosmic evolution, and cosmic status quo is but demiurgic aggradation of out-and-out serial natura naturata in the nature of coherent natura naturans throughout cosmic evolution, which of course indicates matter is too outgrowth of out-and-out serial natura naturata in the nature of coherent natura naturans throughout cosmic evolution, innate output in accordance with coherent demiurgic fundamental of identity through and through, a single logic notion in a class by itself. The demiurge never separately enacts this distinctive demiurgic fundamental (**natura naturans**) for this kind of object a little now and enacts that distinctive demiurgic fundamental for that kind of object a little then. As long as we have to admit matter is connatural outgrowth of cosmic evolution in accordance with coherent demiurgic fundamental of identity through and through, we then have to admit, as our study object, universal matter is but single logic notion with coherent existent connotation in a class by itself, as dynamical incarnation of matter with coherent existent connotation in a class by itself, universal existence & motion must be subject to coherent dynamic regularity therefore.

In another words, the quintessential arcanum of cosmos must be originated from original evolvment & development. Our common sense about authenticity of nature tells us that connatural evolvment & development of cosmos must be subject to demiurgic fundamental of identity. the demiurge can never create cosmic contents unconditionally and randomly, —creates this sort of object in this way a little now and creates that sort of object in that way a little then. In a summary word, original generation & formation of matter in cosmos must be subject to coherent demiurgic fundamental through and through. That's why we sparkplug “**it is only possible for concordant cosmos to be demiurgic aggradation of out-and-out serial natura naturata in the nature of coherent natura naturans throughout cosmic evolution; there is no way for demiurgic aggradation in the nature of different natura naturans to be concordant cosmos through and through**”, although universal existence & motion looks so rich and colorful upon our intuitive sense.

As coherent natura naturans throughout cosmic evolution, instinctive PNT reciprocal equilibrium towards optimum PNT operation is radical potentiality & conditionality for cosmos always ready to orientate itself towards perfection.

And undoubtedly, essence of matter can only inherently come into being during the course of their original generation & formation and is congenitally kept with matter existing as idiographic objects under the proper generative and formative preconditions. Consequently, as our study object, what basal groundwork that matter originally generated on, we should analyze and study it therein. Accordingly, in order to study essence of matter and follow a rational line to study universal existence & motion of matter in spacetime, we should study and verify the natural generation and formation of matter in cosmos under the general background of cosmic evolution in prior, which is just inherence of natura naturans. And in accordance with generation determinism, following the rational line of original generation & formation of matter throughout cosmic demiurgic evolution, as subject about universal existence & motion of matter in cosmos, science must proportionably possess rational clew in thorough coherence parallel to sequential causality of cosmic evolution, and the applicable extension of the rational logic of course crowns all cosmic contents therefore.

Since we affirm cosmos is homogenous originated from unique genesis through and through, original generation of matter throughout cosmic evolution must be subject to demiurgic fundamental of identity, in accordance with generation determinism, essence of matter generally comes into being during the course of original generation & formation of matter and is kept with matter existing as idiographic object under the proper generative & formative preconditions, the very “demiurgic fundamental of identity” of original generation and formation of matter must include the most determinant rationale of essence of matter, even coherent dynamic regularity of universal existence & motion of matter in spacetime. Accordingly, following the rational line of cosmic demiurgic evolution, we can expediently arrive at that, under precondition that cosmos is throughout homogenous originated from unique genesis, ultimate consummation of science with proportionate mathematical formulation of universal existence & motion in thorough coherence but depends on radical verification of the two issues as below:

The first; how does matter originally come into being during the course of cosmic demiurgic evolution?

The second; during the course of original generation & formation of matter under the general background of cosmic demiurgic evolution, what’s the essence of matter endued by the light of nature?

On the basis of scientific authentication of the two issues above, as spontaneous occurrence in the nature of essence of matter in a class by itself, **coherent dynamic regularity of universal existence & motion** will be self-evident logic freewheeling along the proper rational line.

Of course, in the recent several centuries, we were always devoting ourselves to studying matter in the nature persistently, whereas, there were really very few of us who had ever taken special care to follow such a rational line to study matter as single coherent notion as the demiurge originally creates it in the nature of coherent natura naturans throughout cosmic evolution. Instead, we generally study existence & motion of matter accessible around us as omnifarious matter specimens, and even fewer of us who had ever taken care to think of the ingenerate cause & effect of matter under general background of cosmic demiurgic evolution, no more the inborn essence of matter and consequent dynamic regularity of universal existence & motion of matter as innative consequence in thorough coherence of the demiurge. Instead, as certain inevitable historical causes, most of us are subconsciously used to observing and studying the eyeable or perceptible matter specimens accessible around us conventionally as studying this red apple or that green apple on tip of our fingers so as to enrich our colorful recognizant harvest as smallwares full of a basket day by day —studying macroscopical objects then

microcosmic ones, studying objects moving in low speed then in high speed, but very little rational care was paid to the coherent and radical causality of universal existence & motion in spacetime, no more thorough coherence of natura naturans throughout cosmic evolution and consequent essence of matter which is ended by cosmic demiurgic evolution.

As remarkable advancement of our transverse exploration in the recent several centuries, our harvests were always exciting for substantial study of omnifarious matter specimens accessible around us, whereas, we have to admit our harvests are remarkably fragmentary like omnifarious smallwares full of a basket. We are apparently aberrant to push humanistic ideology about authenticity of nature forward to perfect ideological enantiomorph of ultimate authenticity of nature draw on practical feasibility & possibility in proportion to contemporaneous historical background, which of course indicates non-involvement of rationale to study matter as out-and-out serial natura naturata in the nature of coherent natura naturans throughout cosmic evolution, so that we are consequently out of rationale to study all animate apples on vivid apple tree following a rational line through and through but to infatuatedly study this isolated red apple or that isolated green apple on tip of our fingers.

I still explicitly remembered I wrote a paper titled “Modern physics is floundering in riancy behind Big Bang” in winter 1995, in which there were such paragraphs as below:

There is a grandiose crystal palace deep in sea, which looks rather magnificent and alluring indeed, men are anxious to possess it very much. Whereas, it's very regret that men are after all human being but not fish, if just to leave it deep in sea naturally, no matter how much men are envious of it, they can only bemoan their inadequacy in the faces.

—Carry it up to the shore?

Yes, of course, but the scale of the crystal palace is so grand, who is able to carry it up wholly to the shore once?

—Collective power is capital to create wonder, just to let us work cooperatively on it and carry it up to shore piece by piece. With this aspiration in mind, many of us dived deep into the sea and carried the compositive crystal pieces of the crystal palace up to shore one after another.

Human power is so great and peerless, in no time, such a grandiose crystal palace had been generally carried up to the shore. Riding the fence of the beautiful flickering crystals on shore, man can hardly help their elation — “Wow, we've succeeded!”. Whereas, some other even thoughtful and level-headed ones began to suspect that our original ambition to dive into the sea was just because we were envious of the magnificent crystal palace, and now, it seems the original crystal palace deep in sea have been reluctantly finished carrying up to shore, however, what a crystal palace we have substantially possessed on shore? —they are all but “fragmentary crystals” over there. And indeed, the original realistic crystal palace of which we are always envious has been disarranged even subverted by us on the contrary!

In the recent several centuries, practical deploitation & achievement of sciences was exactly like this!

Although, it's historical inevitability, we should not keep a slack hand with it any longer!

As expedient transverse ideological expansion, we've harvested rich and colorful scientific travelogues A, B, C, D, E, F, ... like omnifarious smallwares full of a basket about accessible existence & motion around us in the recent several centuries indeed, and we were always anxious to enregister them as treasure knowledge for social legitimacy qualification. As a result, we proportionately established omnifarious disciplines even

subdisciplines. As transverse ideological expansion gradually extending to saturation, fringe disciplines occurred thereby, books in our bookstore become richer and richer. It's of course not occurrence awful; the even worse situation is, although "matter" is our everlasting kernel topic of scientific exploration indeed, we've never studied matter as single coherent logic notion as out-and-out *natura naturata* in the nature of coherent *natura naturans* throughout cosmic evolution eversince, instead, we are always ready to devote ourselves to painting rich and colorful scientific travelogues A, B, C, D, E, F, ... aiming at this special physical specimen or that distinctive physical occurrence, this preternatural particle or that unintelligible radiation off the cuff like esoteric fancy dallying with this red apple and that green apple on tip of our fingers at our pleasure which were historically accessible and entered our rational purview as perceivable object one after another along crescive progression of practical feasibility & possibility as hypostatic potentiality for historical progress of science, no more to study universal existence & motion in the nature of coherent *natura naturans* throughout cosmic evolution.

Since cosmic status quo is but demiurgic aggradation of out-and-out serial *natura naturata* in the nature of coherent *natura naturans* throughout cosmic evolution, matter must have coherent essence and consequential dynamic regularity of existence & motion. As ideological system about universal existence & motion, science must proportionably have uniform and unique subject followed originality of coherent *natura naturans* throughout cosmic evolution. In any case, **it's only possible for concordant cosmos to be demiurgic aggradation of out-and-out serial *natura naturata* in the nature of coherent *natura naturans* throughout cosmic evolution; there is no way for demiurgic aggradation in the nature of different *natura naturans* to be concordant cosmos through and through.** The omnifarious disciplines & subdisciplines we've cumulatively established in the recent centuries are but our incunabular historical experience against barbarism and ignorance under commensurate historical background, our incunabular historical travelogues as deserving rewards of a formidable but devious stochastic exploration journey. And indeed, till today, we are always ready to study omnifarious existence & motion accessible around us as distinctive objects conventionally, but never study them as coherent esse of matter itself. As inevitability of historical ignorance of human, intrinsic historical progression seems always ready to push forward our civilization as well as ready to make use of opportunity to play joke on us; we must be even aware of it for our benign progress therefore.

Today, it should be time for us to study "universal existence & motion of matter" as single logic notion of out-and-out serial *natura naturata* in the nature of coherent *natura naturans* throughout cosmic evolution now!

(2) Ideological Skeleton of Homogenous Cosmos Originated from Unique Genesis

Before humanistic ideology about authenticity of nature finally qualified as perfect ideological enantiomorph of ultimate authenticity of nature, the most pestilent obstacle for historical progress of science is mostly unnoticed thought misdirection & bewitchment derived from authoritative intrepidity of contemporaneous scientific orthodoxy out of scientific legitimacy qualification of historical authenticity tolerance of science 0 to succedent generation, especially, once authoritative intrepidity of contemporaneous scientific orthodoxy is egotistically all-time and overwhelming towards interminable substantiation & perfection of contemporaneous scientific orthodoxy.

— Canguang-Duang

2.1. Remarkable highlight of microcosmic configuration of matter has brought out substantial headspring as downwind potentiality for timely renovation of humanistic ideology about authenticity of nature, which is virtually cosmos redefinition in logic enantiomorph of newly highlighted factuality of **discretionary particles in cosmos are mutually convertible** with consequent PNT dynamics about universal existence & motion in the nature of coherent natura naturans throughout cosmic evolution on the basis of [(Homogenous cosmos originated from unique genesis postulate + spacetime~matter fully embodying cosmos postulate) + Instinctive PNT equilibrium postulate].

Naissance of Homogenous Cosmos Originated from Unique Genesis is not inertial extension of quantitative change of transverse ideological expansion like scientific travelogues A, B, C, D, E, F, ...of tradition, but rational sublimation of remarkable highlight of microcosmic configuration of matter as typical longitudinal ideological optimization, —timely renovation of humanistic ideology about authenticity of nature in proportion to contemporaneous historical background of remarkable highlight of microcosmic configuration of matter.

Remarkable progress of modern particle physics penetrating into microcosmic conformation of matter has virtually thrown more and more light onto factuality day by day that **discretionary particles in cosmos are mutually convertible**. With rational backup of the very fecund knowledge resource, Homogenous Cosmos Originated from Unique Genesis further noticed the root cause any discretionary two particles in cosmos are mutually convertible is but they ultimately possess the common compositive component in certain configurable hiberarchy. Since discretionary particles in cosmos are mutually convertible, it of course implies any discretionary two particles in cosmos possess the common compositive components/component in certain configurable hiberarchy. Inversely, any discretionary two particles in cosmos are ultimately made up of the same compositive components or component. Leastways, any discretionary two particles in cosmos are ultimately made up of common extremity compositive component in their terminal configurable hiberarchy. This of course implies cosmos is throughout homogenous. And furthermore, since the entire cosmic contents are ultimately made up of the “common extremity compositive component” in their terminal hiberarchy leastways, the so-called “common extremity compositive component” must be unique, because there is no possibility for two or more different components to take the role of the “common extremity compositive component”. So we can arrive at our conclusion that cosmos must be throughout homogenous originated from unique genesis.

And indeed, when the idea of Homogenous cosmos originated from unique genesis was primarily gestated in my mind in Nov.1991, it was just question series as following.

- 1) Since any discretionary two particles/objects in cosmos are mutually convertible, what's the root cause for them to be convertible?

The key I found is that **any two particles/objects always possess the common compositive components in some certain structural hiberarchy, which is just the root cause for them to be mutually convertible**, and I even noticed the further extension to microcosmic hiberarchy, the proportionate compositive components of matter/objects in cosmos are more simplex and uniform.

- 2) Since any discretionary two particles are mutually convertible, does it imply all the objects in cosmos have the “common extremity compositive component” in their common terminal microcosmic hiberarchy?
- 3) If yes, on the point of the terminal microcosmic hiberarchy, entire cosmic contents are but the same!?! Is the “common extremity compositive component” on the terminal microcosmic hiberarchy just the “common extremity progenitor” of entire cosmos? Does it mean entire cosmic contents have common extremity progenitor and are all lineage homology originated from the common extremity hylic progenitor?

As coherent natura naturans throughout cosmic evolution, instinctive PNT reciprocal equilibrium towards optimum PNT operation is radical potentiality & conditionality for cosmos always ready to orientate itself towards perfection.

- 4) If cosmos is throughout homogenous originated from unique genesis (**common extremity hylic progenitor**) really, then, what a hypostatic demiurgic aggradation originated from the common extremity progenitor (**unique genesis**) which practically takes the full role of existence of homogenous cosmos can be?

As radical logic enantiomorph of newly highlighted factuality that discretionary particles in cosmos are mutually convertible, Homogenous Cosmos Originated from Unique Genesis was just sent forth from such a question series, which digested the three issues ahead into “**Homogenous cosmos originated from unique genesis postulate**” and left the fourth issue behind as rational pursuit of successive logic extension based on **Homogenous cosmos originated from unique genesis postulate**.

Homogenous cosmos originated from unique genesis postulate is just the full logic precondition and rational origin of the whole treatise. As favorable fecund thought resource, remarkable highlight of factuality that **discretionary particles in cosmos are mutually convertible** has brought out substantial headspring for me to succeed the downwind potentiality for pioneering cosmos redefinition with consequent coherent PNT dynamics about universal existence & motion in the nature of coherent natura naturans throughout cosmic evolution. And virtually, conclusion that **discretionary particles in cosmos are mutually convertible** in freewheeling towards complete induction day by day directly leads to pioneering introduction of **Homogenous cosmos originated from unique genesis postulate**.

If such two particles can be found, it can be fully proved there is absolutely no way for the two particles to be converted each other, then, such evidence either has radically negated authenticity that cosmos is throughout homogenous originated from unique genesis or indicates another cosmos has been practically perceived. Because there must be one of the two particles which has transcended category of homogenous cosmos, and of course, it's only possible for it coming from another inhomogeneous cosmos.

2.2. Rationale model and proportionate content layout of Homogenous Cosmos Originated from Unique Genesis

As freewheeling outgrowth of historical progress of science, “Homogenous Cosmos Originated from Unique Genesis” is innovative cosmos redefinition in logic enantiomorph of newly highlighted factuality of **discretionary particles in cosmos are mutually convertible** \leadsto **for they ultimately possess the common component/components in certain configurable hiberarchy** with coherent PNT dynamics about universal existence & motion in the nature of coherent natura naturans throughout cosmic evolution, which is typical linear logic system about cosmic homologic configuration, alternative homologic filiation between spacetime & matter and universal existence & motion in the nature of coherent natura naturans starting at so-called cosmic genic origin to cosmic status quo through and through based on general presumable precondition of **homogenous cosmos originated from unique genesis**.

As conclusion of factuality that “**discretionary particles in cosmos are mutually convertible**” is in freewheeling towards complete induction day by day, Homogenous Cosmos Originated from Unique Genesis introduced **Homogenous cosmos originated from unique genesis postulate**. Subsequently, it substituted the solid experiential factuality of spacetime~matter fully embodying cosmos into Homogenous cosmos originated from unique genesis postulate so as to actualize connotation objectification of homogenous cosmos originated from unique genesis, so that it's possible to highlight the homologic attribute of spacetime and matter and alternative homologic filiation between spacetime and matter, which made essence of matter /PNT action self-evident at the volley. And subsequently, on the basis of “**essence of matter/PNT action + instinctive PNT equilibrium**”, it logically defines and mathematically formulates existence & motion of matter in cosmos following a rational line.

In summary words, Homogenous Cosmos Originated from Unique Genesis is ready to introduce two issues to people herein.

The first, How Homogenous Cosmos Originated from Unique Genesis originally came into the general presumable precondition of **Homogenous cosmos originated from unique genesis postulate** under favorable background of remarkable highlight of factuality that **discretionary particles in cosmos are mutually convertible**.

The second, Freewheeling logic expansion of **Homogenous cosmos originated from unique genesis postulate** with supplementation of our undeniable intuitional experience of cosmos. —If cosmos is really homogenous originated from unique genesis through and through, once we substitute hypostatic cosmic contents (such as spacetime and matter) into Homogenous cosmos originated from unique genesis postulate (or cosmic homogeneity system) so as to hypostatize idea of homogenous cosmos originated from unique genesis, what kind of integrative homologic configuration of cosmos and consequential universal existence & motion of matter in spacetime can we educe accordingly?

Towards rational clarification of the topic, Homogenous Cosmos Originated from Unique Genesis affirms that cosmos consists of spacetime and matter, no more coordinative components else in advance, and with rational backup of such preparatory affirmation, Homogenous Cosmos Originated from Unique Genesis substituted the cosmic tangible endosome of “**spacetime**” and “**matter**” into “Homogenous cosmos originated from unique genesis postulate” so as to educe the two logic extensions of Homogenous cosmos originated from unique genesis postulate as following:

Logic extension 1: Since cosmos is throughout homogenous originated from unique genesis, as undeniable components of cosmos, **both “spacetime” and “matter” must be homologic coordinators coequally originated from the common cosmic extremity genesis** (/cosmic genic origin) along sequential homologic cosmogony. As a result, as coordinative homology in cosmos, “spacetime” must be coequally physical as matter, unless we have tangible evidence to exclude spacetime out of category of cosmos.

Logic extension 2: If cosmos is object fully embodied by hypostatic coexistence of “spacetime” and “matter”, nothing else, along sequential homologic cosmogony starting at the so-called common cosmic extremity genesis (/cosmic genic origin) to cosmic status quo, **“spacetime” and “matter” must be alternative homologic filiation** either “spacetime father & matter son” or “matter father & spacetime son”.

Homogenous Cosmos Originated from Unique Genesis subsequently hypostatized logic extension 1 of Homogenous cosmos originated from unique genesis postulate with “space field hypothesis”.

Spacetime homology hypostatization introduced “spacetime genic field hypothesis” to hypostatize “spacetime is homologic coordinator equally as physical as matter in cosmos”, and introduced phantasmal field genic unit assumption to complement the dynamic essence of spacetime which is coordinative homology of matter so as to consummate the hylic essentiality of hylic spacetime, so that “time” and “time dynamic speed” (even “space distance” and “space radiation cornu” introduced in section (II-ii)) are defined accordingly.

Homogenous Cosmos Originated from Unique Genesis subsequently hypostatized logic extension 2 of Homogenous cosmos originated from unique genesis postulate with “matter homologic generation hypothesis”.

In accordance with logic extension 2 of Homogenous cosmos originated from unique genesis postulate, matter homologic generation hypothesis goes a further step to exclude the alternative homologic filiation possibility of “matter father & spacetime son” so as to ascertain homologic filiation of “spacetime father & matter son”, so that

homologic generation of matter along sequential homologic cosmogony become self-evident: — *along sequential homologic cosmogony, matter is lineal homologic outgrowth of hylic spacetime when spacetime develops to well-rounded stage, some field genic units in space field congealed into “crystal” format for extra-saturation of space field strength.*

As lineal homologic outgrowth after hylic spacetime along evolutionary sequence of cosmic homologic multiplication, the innate generation of matter in cosmos of course implies factuality that compositive components of hylic spacetime can transit and transmute into elementary components of matter, we call such transmission and transmutation compositive components of hylic spacetime towards elementary components of matter “negative towards positive transmutation” and expediently symbolize it as “ $M \rightarrow m$ ”. Among the symbolization, “ M ” denotes quantification of mass of related compositive components of hylic spacetime (just the related “field genic units”), “ m ” denotes quantification of mass of related compositive components of matter (just the related “elementary genic units”).

And at the same time, matter is lineal coordinative homology of hylic spacetime, since compositive components of hylic spacetime can transit and transmute into elementary components of matter, inversely, the elementary components of matter must be able to transit and transmute into compositive components of hylic spacetime coequally, Otherwise, the evolution of cosmos would trend to extremity, and ultimately, there is either only spacetime alone or matter alone in cosmos. So we call the elementary components of matter transmute into compositive components of hylic spacetime “positive towards negative transmutation” and we expediently symbolize the physical process as “ $M \leftarrow m$ ”, among the symbolization, “ M ” denotes quantification of mass of related compositive components of hylic spacetime, “ m ” denotes quantification of mass of related compositive components of matter.

Of course, it’s even intuitionistic for us to comprehend that “negative towards positive transmutation” and “positive towards negative transmutation” must be innate bi-directional transmutation coordinative twain of matter integration, we call the coexistence of the bi-directional twain of “negative towards positive transmutation” and “positive towards negative transmutation” in matter integration “positive & negative transmutation”, for expedience, we abbreviate it as “PNT”, and expediently call general living performance of positive & negative transmutation of matter integration “PNT action”. Virtually, PNT action is just the ingenerate correlation between spacetime and matter. We are expediential to symbolize PNT action as “ $M \leftrightarrow m$ ”, among the symbolization, “ M ” denotes quantification of mass of the related hylic spacetime (**matter field**) of matter integration, and “ m ” denotes quantification of mass of the positive matter of matter integration.

Apparently, no matter “negative towards positive transmutation”, “positive towards negative transmutation” or “positive & negative transmutation”, they are all substantial quantitative change processes of matter integration in spacetime, and we can of course comprehend that the living existent quantity and existent state of matter integration in spacetime directly depend on the relativistic quantitative change rate of “negative towards positive transmutation” and “positive towards negative transmutation”, for convenience to formulate living existent quantity and existent state of matter integration in spacetime mathematically, we introduce notions of “negative towards positive transmutation rate”, “positive towards negative transmutation rate” and “positive & negative transmutation rate”, and expediently symbolize them as $d(M \rightarrow m)$, $d(M \leftarrow m)$ and $d(M \leftrightarrow m)$.

In terms of any matter integration in spacetime, $d(M \rightarrow m)$, $d(M \leftarrow m)$ and $d(M \leftrightarrow m)$ obviously satisfy

Historical progress of science in the recent several centuries seemed like a far-flung exploration of the first itineracy around numerous distinctive landscapes of brand-new landmasses of science with palette & tablet on back, several hundred years’ scientific travelogues were compiled thereby.

$$d(M \leftrightarrow m) = d(M \rightarrow m) + d(M \leftarrow m).$$

And further, in terms of the dynamic existence of matter integration in spacetime, Homogenous Cosmos Originated from Unique Genesis primarily affirmed that any object in spacetime inherently possesses absolute spacetime momentum:

$$mv = d(M \leftarrow m)Y \quad \longleftrightarrow \quad v = d(M \leftarrow m)Y/m$$

In the equation, “Y” denotes time dynamic speed of matter integration; “v” denotes absolute velocity of matter integration in spacetime.

In terms of any matter integration in spacetime, the both quantitative change processes of negative towards positive transmutation “M→m” and positive towards negative transmutation “M←m” are inherently coexistent with inherence of “PNT instinctive equilibrium”. If $d(M \rightarrow m) = d(M \leftarrow m)$, the magnitude of “M” and “m” of matter integration will of course keep constant and all related state coefficients of matter integration proportionately keep constant therefore. Thus, we can formulate the integrative mathematical correlation of all the related state variables of matter integration in so-called matter inertial conservation equations as below:

$$\left\{ \begin{array}{l} M(t) + m(t) = R(t) \\ M(t)/m(t) = K(t) \\ V(t) * m(t) = d(M \leftarrow m)(t) * Y(t) \\ L^3(t) * \alpha(t) = A * m(t) \\ Y(t) = B * \alpha(t) \end{array} \right. \longleftrightarrow \left\{ \begin{array}{l} M(t) = K(t) * R(t) / [1 + K(t)] \\ m(t) = R(t) / [1 + K(t)] \\ V(t) = d(M \leftarrow m)(t) * Y(t) / m(t) \\ L^3(t) = A * m(t) / \alpha(t) \quad (\otimes) \\ Y(t) = B * \alpha(t) \quad (\otimes) \end{array} \right.$$

In above equations:

$M(t)$ is the function of matter field mass “M” of matter integration varying in time current “t”;

$m(t)$ is the function of mass “m” of positive matter of matter integration varying in time current “t”;

$R(t)$ denotes the total mass of matter integration varying in time current “t”;

$K(t)$ denotes the quotient function of $M(t)$ over $m(t)$ varying in time current “t”;

$Y(t)$ denotes time dynamic speed varying in time current “t”;

$L(t)$ denotes the length of object (positive matter) varying in time current “t”;

$\alpha(t)$ denotes matter field strength varying in time current “t”;

Christcross-row A and B in equations are two constants in direct proportion.

However, as cosmos obviously exists in dynamic circulation, there are substantively few possibility for matter integration in spacetime to keep ideal quantitative change status of $d(M \rightarrow m) = d(M \leftarrow m)$, but mostly exist in quantitative change status of $d(M \rightarrow m) \neq d(M \leftarrow m)$. The key issue is what's the connatural dynamic orientation fundamental of the innate coexistent coordinative bi-transmutation twain, there must be something determinant underlying. I was confused by this issue for rather a long time indeed before I realized the situation that universal existence & motion in cosmos seem always ready to orientate themselves to balance by the light of nature, and I am sure such situation must radically relate PNT operation of matter integration. As a result, Homogenous Cosmos Originated from Unique Genesis was encouraged to introduce another postulate —— **Instinctive PNT equilibrium postulate.**

It is assumed that any matter integration has instinct to keep its PNT dynamic equilibrium {just instinct to keep $d(M \rightarrow m) = d(M \leftarrow m)$ }, once matter integration loses its PNT operational balance, the coexistent covariant bi-transmutation of

As coherent natura naturans throughout cosmic evolution, instinctive PNT reciprocal equilibrium towards optimum PNT operation is radical potentiality & conditionality for cosmos always ready to orientate itself towards perfection.

“ $M \rightarrow m$ ” and “ $M \leftarrow m$ ” will spontaneously equilibrate orientating new PNT balance, till at last matter integration recovers new balance of $d(M \rightarrow m)' = d(M \leftarrow m)'$.

Under precondition of affirmation of ingenerate “PNT action” between lineal coordinative homology of spacetime & matter and introduction of “Instinctive PNT equilibrium postulate”, in the face of occurrence of quantitative change of $d(M \rightarrow m) \neq d(M \leftarrow m)$ of matter integration in spacetime, Homogenous Cosmos Originated from Unique Genesis arrived at PNT dynamics as below:

(1) The motion acceleration of matter integration:

$$a(t) = Y(t) * K'(t) \quad \dots\dots\dots \textcircled{1}$$

(2) The magnitude of force acting on matter integration:

$$\begin{aligned} F(t) &= m(t) * a(t) \\ &= R(t) * Y(t) K'(t) / (1 + K(t)) \quad \dots\dots\dots \textcircled{2} \end{aligned}$$

(3) The motion velocity of matter integration:

$$\begin{aligned} V(t) &= V_0 + \Delta V = V_0 + \int a(t) dt \\ &= V_0 + \int Y(t) K'(t) dt \quad \dots\dots\dots \textcircled{3} \end{aligned}$$

(4) The displacement of matter integration:

$$\begin{aligned} S &= V_0 * t + \int a(t) dt dt \\ &= V_0 * t + \int Y(t) K'(t) dt dt \quad \dots\dots\dots \textcircled{4} \end{aligned}$$

(5) The momentum change of matter integration:

$$\begin{aligned} \Delta P &= m(t) * V - m_0 V_0 \\ &= R(t) * [V_0 + \int Y(t) K'(t) dt] / [1 + K(t)] - m_0 V_0 \quad \dots\dots\dots \textcircled{5} \end{aligned}$$

(6) The energy change of matter integration:

$$\begin{aligned} \Delta E &= 1/2 m(t) V^2 - 1/2 m_0 V_0^2 \\ &= 1/2 R(t) * [V_0 + \int Y(t) K'(t) dt]^2 / [1 + K(t)] - 1/2 m_0 V_0^2 \quad \dots\dots\dots \textcircled{6} \end{aligned}$$

All these equations were originally written down before Chinese New Year of 1995, although, it still need further authentication & verification once we look into systematical unique-genesis quantization formulation of universal existence & motion along sequential homologic cosmogony starting at field genic origin i_0 to universal reciprocal PNT combinations in the nature of coherent natura naturans throughout cosmic evolution.

All in all, as factuality that **discretionary particles in cosmos are mutually convertible** in freewheeling towards complete induction day by day, Homogenous profile of Cosmos become more and more explicit in our rational purview, I successively implemented two pioneering exploratory actions as below:

The first, I sublimated the rationality of newly highlighted factuality **discretionary particles in cosmos are mutually convertible** into **Homogenous cosmos originated from unique genesis postulate**.

The second, with supplementation of two 0.5 grade accessorial postulates, I implemented connotation objectification with further freewheeling logic extension of homogenous cosmos originated from unique genesis, and finally, it mathematically formulated the PNT action of matter integration with instinct of PNT equilibrium.

The integrative logic constitution of PNT dynamics can be generally illustrated as below:

Historical progress of science in the recent several centuries seemed like a far-flung exploration of the first itineracy around numerous distinctive landscapes of brand-new landmasses of science with palette & tablet on back, several hundred years' scientific travelogues were compiled thereby.

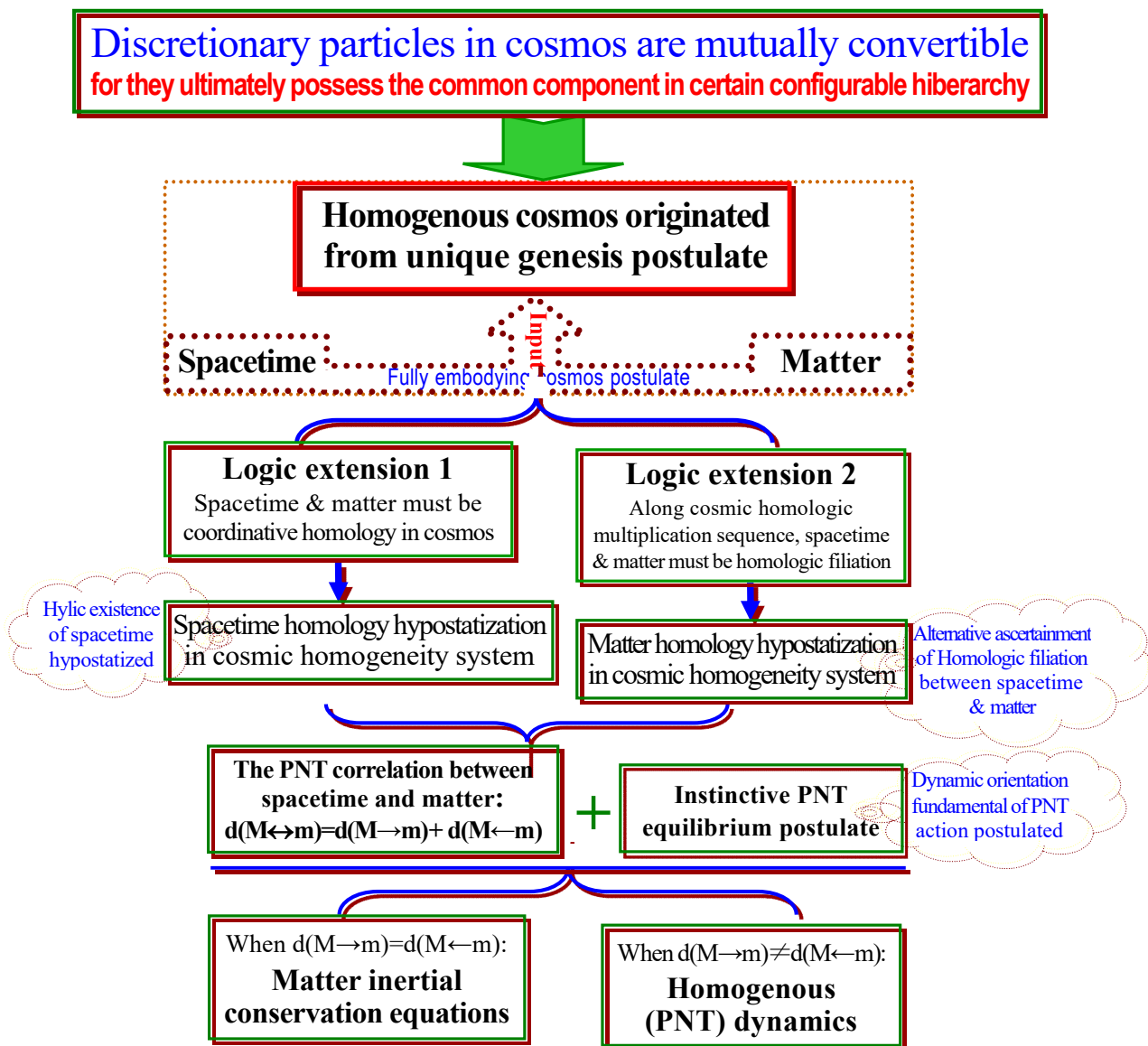

(G-ii-1) Inborn logic constitution of PNT dynamics

This is just the core and distillate of Homogenous Cosmos Originated from Unique Genesis which is virtually made up of **the first part** and **the second part** of the monograph.

The subsequent parts of the monograph are either complementary illumination or further logic extension & hypostatization of the very idea of homogenous cosmos originated from unique genesis, which of course include rational highlight of longitudinal sequential homologic cosmogony from cosmic origin to cosmic status quo in the nature of instinctive PNT reciprocal equilibrium towards optimum PNT operation through and through and rational highlight of transverse postnatal existence & motion all over spacetime in cosmos, whose intention is ready to highlight universal compatibility of coherent dynamic regularity of instinctive reciprocal PNT equilibrium towards optimum PNT operation in original generation and postnatal existence & motion of universal reciprocal PNT combinations in rule of identity.

The third part —As Demiurgic Aggradation of Sequential Homologic Cosmogony, Cosmos is Well-regulated Integration of Cosmic Homogeneity System Making Up of Out-and-out Serial Natura Naturata in the Nature of Coherent Natura Naturans Throughout Cosmic Evolution, Universal Existence & Motion Are Spontaneous Occurrence of **[External**

As coherent natura naturans throughout cosmic evolution, instinctive PNT reciprocal equilibrium towards optimum PNT operation is radical potentiality & conditionality for cosmos always ready to orientate itself towards perfection.

physical disturbance + (PNT action + Instinctive PNT equilibrium)] — Universal Applicability PNT Dynamics

This part is just rational hypostatization of universal applicability of PNT dynamics, which emphatically implicates innovative redefinition and brief analysis of force & motion in cosmos.

As long as we have to admit that ultimate authenticity of nature is neither possible to be omnifarious authenticity smallwares full of a basket nor possible to be authenticity chameleon one piece and only, but coherent natura naturans throughout cosmic evolution, then, we can of course conclude that original generation of universal matter must be subject to demiurgic fundamental of identity as coherent natura naturans throughout cosmic evolution, it's completely impossible for the demiurge to create this object in accordance natura naturans number 1 a little now and create that matter in accordance with natura naturans number 2 a little then.

Original generation of matter in the nature of coherent natura naturans brings out essence of matter in a class by itself; since original generation of universal matter must be subject to demiurgic fundamental of identity as coherent natura naturans throughout cosmic evolution, essence of universal matter must be in a class by itself. **Essence of matter in a class by itself predestines thorough coherence of dynamic regularity of universal existence & motion,** as logic extension of essence of matter in the nature of coherent natura naturans throughout cosmic evolution, universal existence & motion must be coherent as spontaneous occurrence in the nature of essence of matter in a class by itself.

Virtually, the demiurge has none special artifice but freewheeling of coherent natura naturans through and through, and cosmic status quo is but demiurgic aggradation of out-and-out serial natura naturata in the nature of coherent natura naturans throughout cosmic evolution. As spontaneous occurrence in the nature of coherent natura naturans throughout cosmic evolution, it's only possible for dynamic regularity of universal existence & motion to be uniform and coherent through and through, and as physical turning point of variation of existence & motion of matter, there is no potentiality for the demiurge to arrange the so-called "force" into four independent programme as four fundamental forces, which has apparently desecrated the originality of demiurgic fundamental of coherent natura naturans throughout cosmic evolution of the demiurge. Whereas, as crescive progression of practical feasibility & possibility in proportion to contemporaneous historical background, it's only possible for human to implicate limited natural features of brand-new landmasses of science one after another for proportionate distinctive humanistic ideology about authenticity of nature in proportion to contemporaneous historical background then and there, distinctive humanistic ideology about authenticity of nature in proportion to contemporaneous historical background with fine-drawn recognizant features of so-called four fundamental forces as gravity, electromagnetic force, strong interaction and weak interaction must be necessary progressive segment of historical progress of science in inherent optimum orientation towards historical authenticity tolerance of science 0 due to crescive progression of practical feasibility & possibility along historical progress of science. Even as remarkable features of mechanical ascendancy of the four typical forces in the nature, there are substantial reasons for us to call them "four fundamental forces" in the nature out of question.

That's to say, so-called "four fundamental forces" in the nature is not originality of the demiurge, but historical inevitability for progressive succession of distinctive humanistic ideology about authenticity of nature in proportion to contemporaneous historical background due to crescive progression of practical feasibility & possibility in proportion to contemporaneous historical background. And indeed, the original conceptualization for stochastic encounter as remarkable physical features of brand-new landmasses of science then and there and subsequent rational clarification draw on practical feasibility & possibility in proportion to contemporaneous historical background of gravity, electromagnetic force, strong interaction and weak interaction were of course

Historical progress of science in the recent several centuries seemed like a far-flung exploration of the first itinerary around numerous distinctive landscapes of brand-new landmasses of science with palette & tablet on back, several hundred years' scientific travelogues were compiled thereby.

necessary progressive segments along crescive progression of historical progress of science that human come to discover and formulate authenticity of accessible existence & motion around from nothingness to goat, from goat to a great lot, and consequently followed the proportionate ideaistic correction & qualitative optimization from superficiality to profundity, from parochiality to generality draw on practical feasibility & possibility in proportion to contemporaneous historical background.

In accordance with connotation objectification and freewheeling logic extension of homogenous cosmos originated from unique genesis, so-called “force” is spontaneous occurrence of **[External physical disturbance + (PNT action + Instinctive PNT equilibrium)]**, just the instinctive dynamic domino effect once PNT action out of its stationary situation. Among the conditional combination, **(PNT action + instinctive PNT equilibrium)** is inherence of discretionary matter integration in cosmos, and the individual physical feature of idiographic force only depends on the characteristic feature of the so-called “**External physical disturbance**”, which means what kind of physical esse is transferred and transmitted among matter integration and impacts operational equilibrium of PNT action of matter integration thereby. Of course, once the so-called “**External physical disturbance**” occurs in matter integration, PNT equilibrium instinct of matter integration must spontaneously react towards optimum PNT operation. Comparably, as humanistic ideology about authenticity of nature in proportion to foregoing historical background, what is gravity, electromagnetic force, strong interaction and weak interaction?

WaSe~, how abstruse humanistic ideology about authenticity of nature in proportion to contemporaneous historical background is, even the demiurge has to be subdued by distinctive historical progress of human science due to crescive progression of practical feasibility & possibility in proportion to contemporaneous historical background, who is originally astonished by the behavioral occult of human but can hardly help laughing finally for intelligent comprehension of it. After all, the demiurge himself always keeps creating cosmos in accordance with coherent natura naturans throughout cosmic evolution, and as a result, cosmic status quo is but demiurgic aggradation of out-and-out serial natura naturata in the nature of coherent natura naturans throughout cosmic evolution. He even can hardly imagine it by dreaming that, once human come to look into authenticity of nature draw on practical feasibility & possibility in proportion to contemporaneous historical background, as historically credible conclusions must be drawn off the cuff in defiance of historical limitation, people consequently produced so many colorful abstruse humanistic ideology in proportion to contemporaneous historical background with fine-drawn recognizant features of so-called four fundamental forces as gravity, electromagnetic force, strong interaction and weak interaction then and there, even though cosmic status quo is but demiurgic aggradation making up of out-and-out serial natura naturata in the nature of coherent natura naturans throughout cosmic evolution.

And as people have been used to stepping the ready-made rational footprints towards verification of the very issue, Homogenous Cosmos Originated from Unique Genesis has to highlight compatibility of spontaneous occurrence of **[external physical disturbance + (PNT action + instinctive PNT equilibrium)]** of matter integration to classic physical connotation of “gravity”, “electromagnetic force”, “strong interaction” & “weak interaction”, and offer necessary logic complementarity & correction passingly according to connotation objectification and freewheeling logic extension of homogenous cosmos originated from unique genesis.

Under precondition of homogenous cosmos originated from unique genesis, universal existence & motion of matter is but spontaneous occurrence of **[external physical disturbance + (PNT action + instinctive PNT equilibrium)]** in the nature of **instinctive PNT reciprocal equilibrium towards optimum PNT operation**, which of course indicates discretionary accomplishment of demiurgic combination of any matter in cosmos is but spontaneous outcome of “**reciprocal**

As coherent natura naturans throughout cosmic evolution, instinctive PNT reciprocal equilibrium towards optimum PNT operation is radical potentiality & conditionality for cosmos always ready to orientate itself towards perfection.

idiosyncrasy towards PNT equilibrium + accessible space overall arrangement for PNT reciprocity” among available compositive matter integration with successive unconditional implementation of **instinctive PNT reciprocal equilibrium towards optimum PNT operation**. This of course implies there is no feasibility & possibility for connatural generation of so-called “Black Hole” in cosmos.

After all, original generation of matter in the nature of coherent natura naturans brings out essence of matter in a class by itself; essence of matter predestines dynamic regularity of universal existence & motion, universal existence & motion are but spontaneous occurrence in the nature of essence of matter in a class by itself, which is virtually dynamic enantiomorph of PNT action of matter integration with instinct of PNT equilibrium. There is completely no possibility for spontaneous occurrence of **[external physical disturbance + (PNT action + instinctive PNT equilibrium)]** in the nature of **instinctive PNT reciprocal equilibrium towards optimum PNT operation** to change matter in homogenous cosmos as celestial bodies into heterogenous object or immateriality as “Black Hole”.

In straightforward words, spontaneous occurrence of **[external physical disturbance + (PNT action + instinctive PNT equilibrium)]** in the nature of **instinctive PNT reciprocal equilibrium towards optimum PNT operation** can only make matter acclimate themselves in spacetime accordingly, it’s not enigmatical magic to change matter into heterogenous object or immateriality as Black Hole kind, hypostatic existence & motion in the nature of instinctive PNT reciprocal equilibrium towards optimum PNT operation in cosmos can never be enigmatical action or realistic way for original generation of heterogenous object or immateriality as Black Holes. However, LIGO suddenly announced that they even had found mechanical collision & combination of binary Black Hole in cosmos, and they even had discovered gravitational wave for occurrence of mechanical collision & combination of the two Black Holes. I was astonished so much, so that I could hardly help exclaiming, WaSe~, how wonderfully the dinosaur in Jack’s house dances!

The fourth part — Cosmogony of Homogenous Cosmos Originated from Unique Genesis—As Demiurgic Aggradation of Sequential Homologic Cosmogony, Cosmos is Well-regulated Integration of Homogeneity System Making up of Out-and-out Serial Natura Naturata in the Nature of Coherent Natura Naturans Throughout Cosmic Evolution

Under precondition that cosmos is throughout homogenous originated from unique genesis as an integrative homogeneity system, this part briefly highlighted thorough homologic configuration, overall arrangement and intrinsic universal dynamic regularity of homogenous cosmos as consequence that cosmos comes into being along sequential homologic cosmogony starting from unique genesis to cosmic status quo in the nature of coherent natura naturans throughout cosmic evolution, which is virtually instinctive PNT reciprocal equilibrium towards optimum PNT operation.

The fifth part —Systematical Unique-genesis Quantization Formulation of Universal Existence & Motion along Sequential Homologic cosmogony Starting at Field Genic Origin i_0 to Universal Reciprocal PNT Combinations in the Nature of Coherent Natura Naturans Throughout Cosmic Evolution

Under precondition that mathematical definition of Homogenous cosmos originated from unique genesis was primarily offered and PNT action & PNT reaction were generally illuminated, it tried to hypostatize the essence of homogenous cosmos originated from unique genesis and the proportionate coherent dynamic regularity into discretionary existence & motion as distinctive objects in cosmos, and ultimately, it methodologically tried to focus and sublimate the essentiality of homogenous cosmos originated from unique genesis and the proportionate coherent dynamic regularity into Atom State Equation in Spacetime.

Virtually, throughout demiurgic evolution of cosmos, before naissance of atoms in spacetime, all positive

Historical progress of science in the recent several centuries seemed like a far-flung exploration of the first itineracy around numerous distinctive landscapes of brand-new landmasses of science with palette & tablet on back, several hundred years’ scientific travelogues were compiled thereby.

evolution is effective resource for generation of atoms in spacetime ([reciprocal PNT combinations in gradation II](#)), and after generation of atoms in spacetime, the dynamic connotation incarnated in atomic endosome is all radical dominant dynamic rationale for original generation even postnatal existence & motion of universal [reciprocal PNT combinations in gradation III](#) in spacetime, the dominant effect of dynamic rationale of atoms even extends to original generation and postnatal existence & motion of celestial bodies, galaxies ([reciprocal PNT combinations in gradation IV](#)) in spacetime. This of course indicates practical significance of Atom State Equation in Spacetime.

The sixth part —Initial Endeavor of Natura Naturans Personalization Towards Human Necessity Based on Primary Authenticity Clarification of Homogenous Cosmos Originated from Unique Genesis

Ultimate consummation of “atom state equation in spacetime” is ready to bring out coming technology application a grand prolific spring, and virtually, current technology proliferation of Homogenous Cosmos Originated from Unique Genesis is mostly limited for imperfection of Atom State Equation in Spacetime.

As technologic practice towards drive of object, engine contriving is straightforward creationary endeavor to facilitate PNT operation of matter integration artificially adjustable towards “ideal motion” following our inclinations, which is dynamic noumenon of connatural existence & motion in the nature of coherent natura naturans throughout cosmic evolution. In accordance with authenticity of nature that existence & motion of matter is virtually dynamic mirror of PNT operation of matter integration in spacetime and practical necessity of “PNT continuous controllability”, our design blue print and key technologic challenge of PNT engine are of course self-evident. Since existence & motion in cosmos are so rich and colorful, which are radically rooted in PNT operation of matter integration, connatural PNT operation of matter integration must be proportionately prolific, we design PNT engine is but practical endeavor to make PNT operation of matter integration under artificial control, so that we can manage ideal PNT operation for proportionate ideal existence & motion of matter integration. Whereas, before ultimate consummation of Atom State Equation in Spacetime, it's really difficult for us to ascertain the appropriate PNT activation source and PNT activation & rectification signal, no more to focus tangible operational characters of ideal PNT reaction between appropriate PNT activation source and PNT activation & rectification signal to define necessary functional parameters and proper PNT control mechanism of PNT engine in accordance with PNT continuous controllability.

The seventh part —As Timely Renovation of humanistic ideology about Authenticity of Nature in proportion to contemporaneous historical background of Remarkable Highlight of Microcosmic Configuration of Matter and Typical Aberrant Scientific Knowledge Proliferation out of Succession of Contemporaneous Scientific Orthodoxy, Free Press Admittance of Homogenous Cosmos Originated from Unique Genesis Must Break Through Legitimacy Defense Line of Contemporaneous Scientific Orthodoxy due to Inevitable Life-and-death scientific Knowledge Metabolism, so That It Has to Challenge Venomous Counterwork Upper Limit of Temporal Authority Under Egotistic Background of Interminable Royal Substantiation & Perfection of Contemporaneous Scientific Orthodoxy—Social Legitimacy & Validity of Truths Can Never Exceed Cannon Range.

In this part, I emphatically highlighted the consequent discrepancy of historical background and inherent logic Constitution between Homogenous Cosmos Originated from Unique Genesis and live contemporaneous scientific orthodoxy and consequent perplexity & helplessness as typical aberrant scientific knowledge proliferation out of succession of contemporaneous scientific orthodoxy under background of high-sounding royal substantiation & perfection of contemporaneous scientific orthodoxy.

As coherent natura naturans throughout cosmic evolution, instinctive PNT reciprocal equilibrium towards optimum PNT operation is radical potentiality & conditionality for cosmos always ready to orientate itself towards perfection.

As typical aberrant scientific knowledge proliferation out of succession of contemporaneous scientific orthodoxy rooted in favorable groundwork of remarkable highlight of microcosmic configuration of matter, Homogenous Cosmos Originated from Unique Genesis is innovative cosmos redefinition in radical logic enantiomorph of newly highlighted factuality of **discretionary particles in cosmos are mutually convertible** with consequent PNT dynamics about universal existence & motion in the nature of coherent natura naturans throughout cosmic evolution, which is lineal logic system about sequential homologous cosmogony and proportionate universal existence & motion on the basis of unique assumable precondition of **Homogenous cosmos originated from unique genesis postulate**. Comparably, as humanistic ideology about authenticity of nature in proportion to contemporaneous historical background, live contemporaneous scientific orthodoxy is but inertial ideological aggradation of rich and colorful scientific travelogue A, B, C, D, E, F, ... like omnifarious smallwares full of a basket about historically accessible existence & motion around us in the recent several centuries. However, under background of interminable royal substantiation & perfection of contemporaneous scientific orthodoxy with expediential official facility of magistral autarchy of “**free press regulation customization**” & “**free press admittance**” of temporal authority short of necessary intendance, science forum is out-and-out homegrown outgrowth in the garden of live contemporaneous scientific orthodoxy, free press admittance of any aberrant scientific knowledge proliferation out of succession of contemporaneous scientific orthodoxy can hardly be free from duress of authoritative intrepidity of contemporaneous scientific orthodoxy, we have to admit none magistral humanistic puissance short of necessary intendance can always do its positive jobs on the earth, humanistic puissance of free press admittance can never be exception. As a result, as inevitable scientific knowledge metabolism of historical progress of science in inherent optimum orientation towards perfect ideological enantiomorph of ultimate authenticity of nature, free press admittance of Homogenous Cosmos Originated from unique Genesis must break through legitimacy defense line of contemporaneous scientific orthodoxy, so that it has to challenge venomous counterwork upper limit of temporal authority in defiance of objectivity that it's only possible for the major melody of historical progress of science to be serial epochmaking scientific knowledge metabolism in inherent optimum orientation towards scientific legitimacy qualification of historical authenticity tolerance of science 0, I even slid into vicious circle due to inevitable scientific knowledge metabolism campaign at daggers drawn.

The eighth part — Historical Progress of Science in Inherent Optimum Orientation Towards Perfect Ideological Enantiomorph of Ultimate Authenticity of Nature

Before humanistic ideology about authenticity of nature finally qualified as perfect ideological enantiomorph of ultimate authenticity of nature, it's only possible for so-called “science” to be **ideological system about authenticity of nature in proportion to contemporaneous historical background** or recognizant representation of historically accessible existence & motion in the nature reflected on human sense then and there, which of course includes historical limitation of practical feasibility & possibility for human to look into authenticity of nature and consequent proportionate logic constitution of formulation of authenticity of nature in proportion to contemporaneous historical background. “Scientific knowledge proliferation” is but gradual quantitative increase & qualitative optimization of recognizant representation of historically accessible existence & motion in the nature reflected on human sense along crescive progression of historical progress of science in inherent optimum orientation towards historical authenticity tolerance of science 0. This of course indicates successive scientific knowledge proliferation throughout human history not only relates to historically accessible existence & motion around us but also relates to practical feasibility & possibility in proportion to contemporaneous historical background. And virtually, historical progress of science is generally succession of quantitative & qualitative change of scientific knowledge proliferation under

Historical progress of science in the recent several centuries seemed like a far-flung exploration of the first itinerary around numerous distinctive landscapes of brand-new landmasses of science with palette & tablet on back, several hundred years' scientific travelogues were compiled thereby.

permanent synthesized conditionality of “**crecive progression of practical feasibility & possibility in proportion to contemporaneous historical background + the uniqueness & invariance of ultimate authenticity of nature predestines the unique possibility of scientific verity as perfect ideological enantiomorph of ultimate authenticity of nature**” through and through.

For expedience of rational highlight of the very issue, it firstly introduced **Qualitative summary of historical progress of science** and **Evolvement profile of historical progress of science**, which introduced the normal quantitative & qualitative change of scientific knowledge proliferation throughout historical progress of science under potential conditionality of “**crecive progression of practical feasibility & possibility in proportion to contemporaneous historical background + the uniqueness & invariance of ultimate authenticity of nature predestines the unique possibility of scientific verity as perfect ideological enantiomorph of ultimate authenticity of nature**” with dramatic humanity accompaniment of scientific knowledge metabolism & consequent scientific knowledge metabolism campaign, which emphasizes, as it's only possible for ultimate authenticity of nature to be unique & invariable throughout cosmic evolution, ultimate consummation of science (**humanistic ideology about authenticity of nature**) must be **perfect ideological enantiomorph of ultimate authenticity of nature**, and as crecive progression of practical feasibility & possibility in proportion to contemporaneous historical background, it's only possible for the major melody of quantitative & qualitative change of humanistic ideology about authenticity of nature in proportion to contemporaneous historical background to be serial epochmaking scientific knowledge metabolism in inherent optimum orientation towards perfect ideological enantiomorph of ultimate authenticity of nature.

Then, it introduced “**Reciprocal coevolution of scientific knowledge proliferation and integrative social circumstances in monofier modality**” and “**optimum consequent implementation of scientific knowledge proliferation under proper integrative social circumstances**”, which generally analyze the inherent reciprocity & causality between scientific knowledge proliferation and integrative social circumstances.

Just similar as coexistence of **natural connotation & social connotation** is just the both surface of the science coin, the potential conditionality of the uniqueness & invariance of ultimate authenticity of nature predestines the unique possibility of scientific verity as perfect ideological enantiomorph of ultimate authenticity of nature and syntonc reciprocity of integrative social circumstances and scientific knowledge proliferation is always coexistent throughout historical progress of science too. The relative disparity is only that, as different historical stage with different historical limitation along crecive progression of practical feasibility & possibility in proportion to contemporaneous historical background, there is proportionate disparity of practical effect that the uniqueness & invariance of ultimate authenticity of nature predestines the unique possibility of scientific verity even bi-directional reciprocal effect between integrative social circumstances and commensurate scientific knowledge proliferation, which of course implies general regularity of quantitative & qualitative change of scientific knowledge proliferation throughout historical progress of science.

The ninth part — Reference Interpretation of Homogenous Cosmos Originated from Unique Genesis and Nowaday “Reference Popularity” Under Egotistic Background of Interminable Royal Substantiation & Perfection of Contemporaneous Scientific Orthodoxy

As typical longitudinal rational sublimation and timely renovation of humanistic ideology about authenticity of nature in proportion to contemporaneous historical background of **remarkable highlight of microcosmic configuration of matter**, Homogenous Cosmos Originated from Unique Genesis is typical cosmos redefinition in logic enantiomorph of newly highlighted factuality that **discretionary particles in cosmos are mutually convertible** with consequent PNT dynamics about universal existence & motion in the nature of coherent natura naturans throughout cosmic evolution. Favorable groundwork of **remarkable highlight of microcosmic configuration of matter** especially the factuality that **discretionary particles**

As coherent natura naturans throughout cosmic evolution, instinctive PNT reciprocal equilibrium towards optimum PNT operation is radical potentiality & conditionality for cosmos always ready to orientate itself towards perfection.

in cosmos are mutually convertible in freewheeling towards complete induction day by day has brought out substantial headspring for me to succeed the downwind potentiality for pioneering cosmos redefinition and proportionate PNT dynamics about universal existence & motion as spontaneous occurrence in the nature of coherent natura naturans throughout cosmic evolution, which is not only all necessary references but also overall logic fulcrum of Homogenous Cosmos Originated from Unique Genesis.

As innovative ideological system about universal existence & motion in radical logic enantiomorph of newly highlighted factuality that **discretionary particles in cosmos are mutually convertible**, connotation objectification & successive freewheeling logic extension of “**Homogenous cosmos originated from unique genesis postulate**” with supplementation of two 0.5 grade accessorial postulates needs no references out of the independent ideological system, no more the rational highlight of applicability of PNT dynamics throughout homogenous cosmos. Virtually, as timely renovation of humanistic ideology about authenticity of nature in proportion to contemporaneous historical background of **remarkable highlight of microcosmic configuration of matter**, Homogenous Cosmos Originated from Unique Genesis is typical outgrowth of aberrant scientific knowledge proliferation out of succession of contemporaneous scientific orthodoxy, which never succeeds the rich and colorful scientific travelogues A, B, C, D, E, F, ...like omnifarious smallwares full of a basket for further highlight of authenticity of nature but does its job for cosmos redefinition in logic enantiomorph of newly highlighted factuality that **discretionary particles in cosmos are mutually convertible** with consequent PNT dynamics about universal existence & motion in the nature of coherent natura naturans throughout cosmic evolution, which is typical longitudinal ideological optimization as linear logic system based on presumable precondition of **Homogenous cosmos originated from unique genesis postulate**.

As fecund thought resource of certain historical stage for successive scientific knowledge proliferation, as long as references themselves are still not absolute scientific verity in social legitimacy qualification of historical authenticity tolerance of science 0, reference popularity must synchronously bring out both nonzero “**positive significance**” & “**negative significance**” of reference popularity. The more remarkable the historical authenticity tolerance of science of the living references is, there is relatively less inherent potentiality for reference popularity to accomplish its positive significance to push humanistic ideology about authenticity of nature forward to perfect ideological enantiomorph of ultimate authenticity of nature, and inversely, there is more probability to expose negative significance of reference popularity.

The most straightforward practical significance of reference popularity is that interminable implementation of reference popularity under egotistic guidance of temporal authority must bring out invisible egotistic restriction towards substantiation & perfection of contemporaneous scientific orthodoxy, which must grimly coerce that coming scientific knowledge proliferation all over the world must be in rigid succession of contemporaneous scientific orthodoxy, and none aberrant scientific knowledge proliferation out of succession of contemporaneous scientific orthodoxy can be qualified and acceptable for free press admittance. Whereas, the deadly factuality is that, before humanistic ideology about authenticity of nature finally qualified as perfect ideological enantiomorph of ultimate authenticity of nature, none interminable royal substantiation & perfection of contemporaneous scientific orthodoxy out of scientific legitimacy qualification of historical authenticity tolerance of science 0 can be carefree to take full role of historical progress of science like freewheeling nonstop towards perfect ideological enantiomorph of ultimate authenticity of nature without life-and-death impact of epoch-making scientific knowledge metabolism.

The integrative logic constitution and content distribution of Homogenous Cosmos Originated from Unique Genesis can be illustrated by another diagram as below:

Historical progress of science in the recent several centuries seemed like a far-flung exploration of the first itinerary around numerous distinctive landscapes of brand-new landmasses of science with palette & tablet on back, several hundred years' scientific travelogues were compiled thereby.

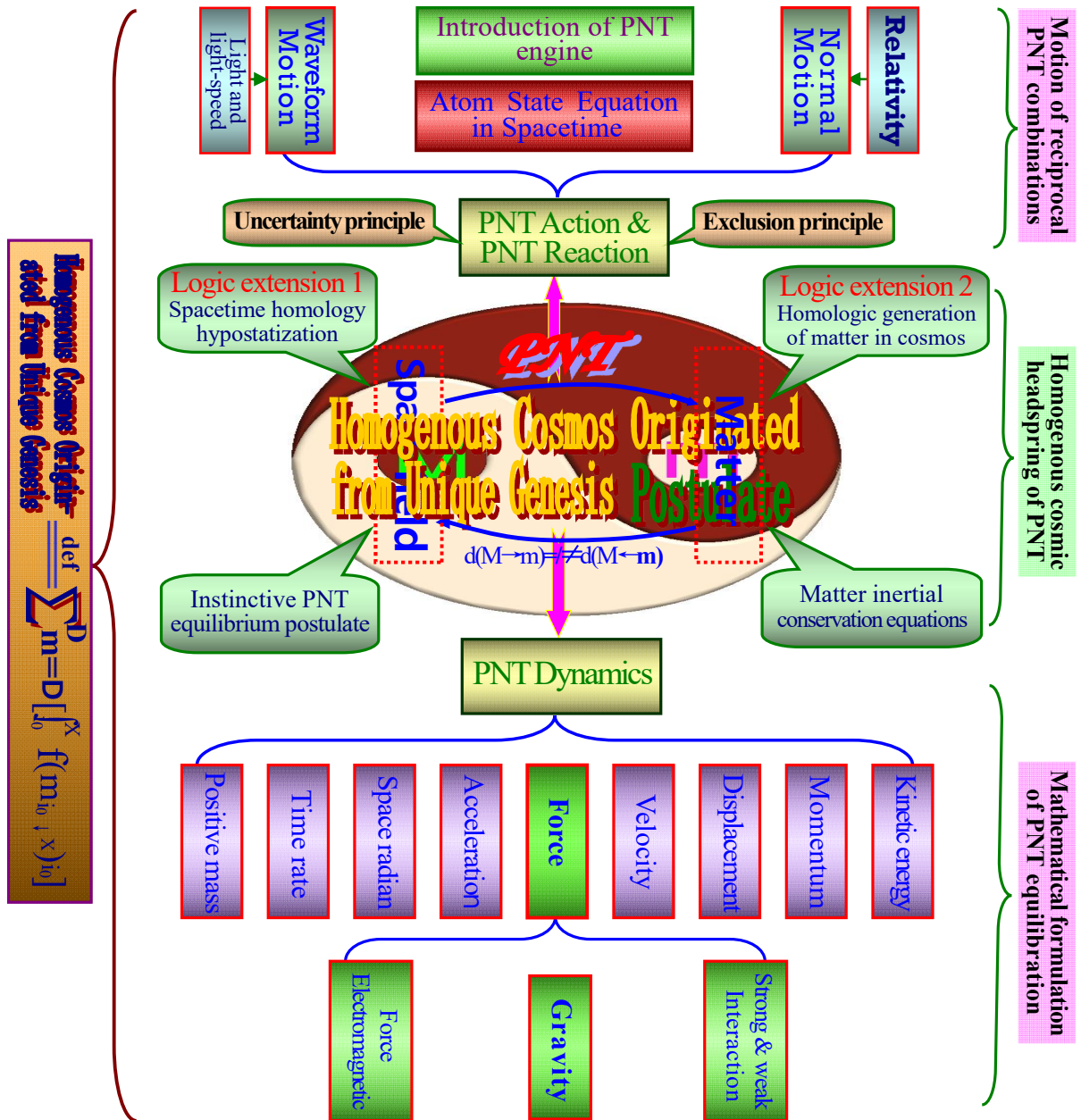

(G-ii-2) Integrative logic constitution of Homogenous Cosmos Originated from Unique Genesis

The centric ellipse pattern of the illustration is just the prolate Taiji diagram or PNT dynamic equilibrium icon, which is prolonged a little for expedient layout of the integrative illustration.

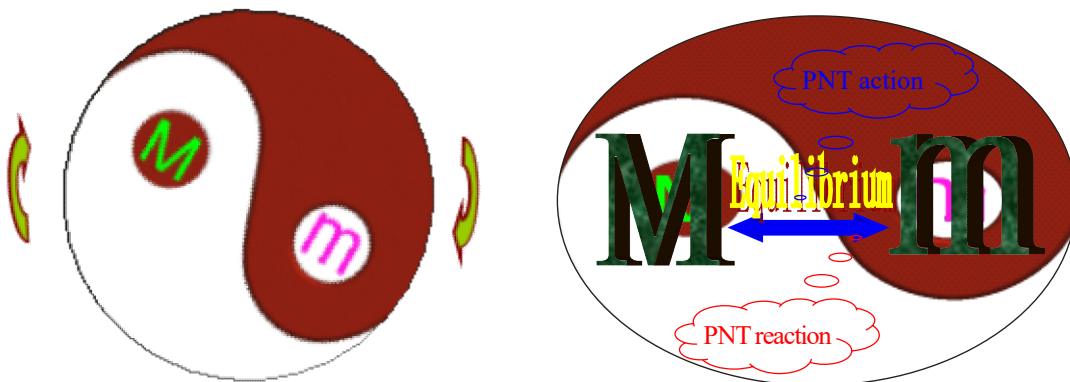

(G-ii-3) Instinctive PNT equilibrium icon

As coherent natura naturans throughout cosmic evolution, instinctive PNT reciprocal equilibrium towards optimum PNT operation is radical potentiality & conditionality for cosmos always ready to orientate itself towards perfection.

The background headspring the PNT equilibrium icon implicated is just the homogenous cosmic origin of PNT correlation of spacetime and matter, which generally includes the “Space field hypothesis”, “Matter homologic generation hypothesis”, “Instinctive PNT equilibrium postulate”, “Matter Inertial Conservation Equations” under the precondition that cosmos is throughout homogenous originated from unique genesis. The cause the Taiji diagram (or PNT equilibrium illustration) is worthy of taking the kernel position of the integrative illustration is just because the Taiji diagram (or PNT equilibrium icon) can be regarded as incarnation icon or emblem of the so-called “unique coherent fundamental” of cosmos, universal existence & motion even original sequential homologic cosmogony are all embodiment of instinctive PNT reciprocal equilibrium towards optimum PNT operation, and PNT dynamics is but mathematical formulation of instinctive dynamic PNT equilibrium of matter integration. And at the same time, as universal existence & motion of matter in cosmos have PNT equilibrium instinct inherently, the PNT dynamic equilibrium icon can be directly regarded as the emblem of PNT action.

The upward arrow in the integrative illustration extending from Taiji diagram indicates the accessorial clew of the whole treatise; it is mainly ready to illustrate the universal existence & motion of daedal reciprocal PNT combinations in spacetime including separate elementary genic units. It generally contains the content of “PNT Action and PNT Reaction”, “Spacetime and Motion”, “Connatural Motion Patterns of Matter”, “Introduction of Atom State Equation in Spacetime”, “Common Engine and Flying Saucer Engine”. The downward arrow in the integrative illustration extending from Taiji diagram indicates the logic system of general mathematical formulation of PNT equilibrium of matter integration; it generally contains the content of “Matter Inertial Conservation Equations”, “PNT Dynamics” and “Force Field and Force”.

Virtually, the rationale of PNT dynamics impenetrate mathematical analysis of universal existence & motion through and through, no matter original sequential homologic cosmogony which hypostatize generation of universal reciprocal PNT combinations in cosmos or postnatal existence & motion of reciprocal PNT combinations in cosmos including normal motion, wave-form motion in spacetime, even relativity, light and light-speed, Atom State Equation in Spacetime, common engine and flying saucer engine etc. My intention to juxtapose PNT dynamics below the Taiji diagram equally and symmetrically to PNT Action and PNT Reaction is that I can not neglect the substantial significance of PNT dynamics and I have to care the expedience to unfurl the inherence and lay out the integrative logic constitution of the related details mentioned in the monograph.

2.3. Universal Applicability of PNT Dynamics

It's only possible for essence of matter to be inherently come into being during the course of its original generation and congenitally kept with matter existing as idiographic objects under the proper generative and formative preconditions. The logic origin for Homogenous Cosmos Originated from Unique Genesis to define “existence & motion of matter” is “essence of matter”, in a straightforward word, existence & motion of matter is but spontaneous occurrence in the nature of coherent natura naturans throughout cosmic evolution. However, “essence of matter” radically originated from homologic generation of matter as lineal homology of space field. As long as we can confirm the demiurge can only create matter in the nature of coherent natura naturans throughout cosmic evolution, but not create matter A in this way a little now and create matter B in that way a little then, original generation of matter in the nature of coherent natura naturans brings out essence of matter in a class by itself, essence of matter in a class by itself predestines thorough coherence of dynamic regularity of universal existence & motion — spontaneous occurrence in the nature of coherent natura naturans throughout cosmic evolution as [External physical disturbance + (PNT action + Instinctive PNT equilibrium)].

Historical progress of science in the recent several centuries seemed like a far-flung exploration of the first itinerary around numerous distinctive landscapes of brand-new landmasses of science with palette & tablet on back, several hundred years' scientific travelogues were compiled thereby.

And indeed, as remarkable progress of modern particle physics, more and more light has been thrown onto factuality that **discretionary particles in cosmos are mutually convertible**, and living progress of modern particle physics even makes the factuality orient complete induction day by day, which of course indicates that cosmos is homogenous originated from unique genesis through and through. As a result, Homogenous Cosmos Originated from Unique Genesis radically introduced “Homogenous cosmos originated from unique genesis postulate”. Thus, as long as we can confirm that entire cosmos is made up of spacetime and matter, none coordinative component else, spacetime and matter must be coordinative homology in filiation in cosmos. Living presence of homologic filiation between spacetime and matter of course implies presence of PNT correlation or PNT action between spacetime and matter. Virtually, PNT action is not only headspring creation of original generation of matter along sequential homologic cosmogony but also proportionate dynamic origin of postnatal existence & motion of matter in cosmos, which of course indicates existence & motion of matter radically depend on PNT operation of matter integration by the light of nature. Once PNT action is regularized by “Instinctive PNT equilibrium postulate”, existence & motion of matter become vivid spontaneous occurrence as dynamic mirror of **[external physical disturbance + (PNT action + instinctive PNT equilibrium)]** of matter integration. Of course, spontaneous occurrence as dynamic mirror of **[external physical disturbance + (PNT action + instinctive PNT equilibrium)]** of matter integration is inherently subject to fundamental of **instinctive PNT reciprocal equilibrium towards optimum PNT operation**.

Once external physical disturbance=0, mathematical formulation of spontaneous occurrence of **[external physical disturbance + (PNT action + instinctive PNT equilibrium)]** directly leads to accomplishment of “matter inertial conservation equations”. Once external physical disturbance \neq 0, mathematical formulation of spontaneous occurrence of **[external physical disturbance + (PNT action + instinctive PNT equilibrium)]** directly leads to accomplishment of “PNT dynamics”.

This of course indicates application of PNT dynamics is universal existence & motion of matter in cosmos. Any object in cosmos, as long as it belongs to category of matter and exists in spacetime, existence & motion of the object must be subject to either **matter inertial conservation equations** or **PNT dynamics**. This is nobbut lineal logic extension of homogenous cosmos originated from unique genesis in rules of identity.

All in all, under general precondition of homogenous cosmos originated from unique genesis, as long as we can confirm the thorough natura naturans coherence of sequential homologic cosmogony from so-called cosmic genic origin to cosmic status quo, as single subject ready to discover and formulate universal existence & motion in the nature of coherent natura naturans throughout cosmic evolution, ultimate consummation of science must be perfect ideological enantiomorph of ultimate authenticity of nature, throughout the very humanistic ideology about authenticity of nature as perfect ideological enantiomorph of ultimate authenticity of nature, there is only unique initial quantization constant which is just the quantification of so-called “cosmic genic origin i_0 ”.

On one hand, since original generation and subsequent accumulation of elementary genic units in spacetime, all original generation and postnatal existence & motion of subatomic units (**reciprocal PNT combinations in gradation I**), elementary atoms (**reciprocal PNT combinations in gradation II**), molecules, molecule system (**gas, liquid and solid, no matter biological objects or abiological objects, which are just rich and colorful reciprocal PNT combinations in gradation III**), celestial bodies and galaxies (**reciprocal PNT combinations in gradation IV**) are completely sequential freewheeling of spontaneous occurrence of “PNT action + instinctive PNT equilibrium” based on stochastic accomplishment of “**reciprocal idiosyncrasy towards PNT equilibrium + accessible space overall arrangement for PNT reciprocity**” among compositive components in the nature of instinctive PNT reciprocal equilibrium towards optimum PNT operation of matter integration.

As coherent natura naturans throughout cosmic evolution, instinctive PNT reciprocal equilibrium towards optimum PNT operation is radical potentiality & conditionality for cosmos always ready to orientate itself towards perfection.

And on the other hand, along sequential homologic cosmogony in the nature of coherent natura naturans throughout cosmic evolution, as remarkable particularity of sequential linkage of elementary atoms (just reciprocal PNT combinations in gradation II), the ideographic mathematical logic system will be sublimated and refined into a magic mathematical model of an equation or equation group ——Atom State Equation in Spacetime $\sum_{m \equiv D}^D \int_{i_0}^{\text{Atom}} f(m_{i_0 \rightarrow \text{Atom}}) i_0$, which is unique-genesis quantization equation focused dynamic composing of atom in spacetime containing all demiurgic aggradation of cosmic evolution before generation of elementary atoms including convergent integral aggradation of compositive homologic genic units and the corresponding layered PNT reciprocity mechanism within atom in the nature of instinctive PNT reciprocal equilibrium towards optimum PNT operation.

After all, convergence of cosmic esse due to PNT reciprocal relation throughout sequential homologic cosmogony is a strict linear process of matter convergence in distinctive structure. As reciprocal PNT combinations in gradation II, elementary atoms not only contain all distinctive matter essence of elementary genic units and reciprocal PNT combinations in gradation I, but also their hypostatic dynamic composing as inner formative reciprocity are too the dynamic origin or dynamic causes for idiographic generation and formation of reciprocal PNT combinations in gradation III, they are even the radical mechanical causes for distinctive existence & motion of resultant reciprocal PNT combinations in gradation III in spacetime. Throughout sequential homologic cosmogony, aberrant convergence of cosmic esse due to PNT reciprocal gelation (宇质 PNT 惠合聚敛静化分流) totally accomplishes natural elementary structure sublimation of matter twice, and the second natural elementary structure sublimation of matter ultimately covers the first natural elementary structure sublimation of matter 100 over 100.

The first natural elementary structure sublimation of matter during the course of aberrant convergence of cosmic esse due to PNT reciprocal gelation is **original generation of elementary genic units** in spacetime. Once generated in spacetime, all elementary genic units unconditionally take roles of fecund materials by stochastic accomplishment of “reciprocal idiosyncrasy towards PNT equilibrium + accessible space overall arrangement for PNT reciprocity” each other for successive homologic multiplication of reciprocal PNT combinations in gradation I ——subatomic units. Original generation of resultant reciprocal PNT combinations in gradation I are but spontaneous convergent outgrowth in the nature of instinctive reciprocal PNT equilibrium towards optimum PNT operation on the basis of stochastic accomplishment of “reciprocal idiosyncrasy towards PNT equilibrium + accessible space overall arrangement for PNT reciprocity” among available compositive elementary genic units. Both original generation and idiographic existence & motion of resultant subatomic unit radically depends on intrinsic dynamic composes of the proper compositive elementary genic units.

The second natural elementary structure sublimation of matter during the course of aberrant convergence of cosmic esse due to PNT reciprocal gelation is **original generation of elementary atoms** in spacetime, (Just reciprocal PNT combinations in gradation II). Once generated in spacetime, all elementary atoms unconditionally take role of fecund materials by stochastic accomplishment of “reciprocal idiosyncrasy towards PNT equilibrium + accessible space overall arrangement for PNT reciprocity” among compositive atoms or molecules with spontaneous demiurgic occurrence of instinctive PNT reciprocal equilibrium towards optimum PNT operation for successive homologic multiplication of reciprocal PNT combinations in gradation III——molecules, molecule system, subsequent original generation of reciprocal PNT combinations in gradation III is but spontaneous demiurgic occurrence in the nature of instinctive reciprocal PNT equilibrium towards optimum PNT operation on the basis of stochastic accomplishment of “reciprocal idiosyncrasy towards PNT equilibrium + accessible space overall arrangement for PNT reciprocity” among available

elementary atoms, elementary atoms and sub reciprocal PNT combinations in gradation III, sub reciprocal PNT combinations in gradation III and sub reciprocal PNT combinations in gradation III. Both original generation and idiographic existence & motion of resultant molecules, molecule system (reciprocal PNT combinations in gradation III) radically depends on intrinsic dynamic composes of the proper compositive atoms, no matter the objects belong to biological category or abiological category.

2.4. Perplexity of social legitimacy subsistence of Homogenous Cosmos Originated from Unique Genesis as timely renovation of humanistic ideology about authenticity of nature in proportion to contemporaneous historical background of remarkable highlight of microcosmic configuration of matter under egotistic background of royal substantiation & perfection of contemporaneous scientific orthodoxy.

As long as development of science is always human endeavor to discover and formulate universal existence & motion as authentic, comprehensive and systematical as possible draw on practical feasibility & possibility in proportion to contemporaneous historical background all along, historical progress of science must be in inherent optimum orientation towards historical authenticity tolerance of science 0 in the nature of things. And before humanistic ideology about authenticity of nature finally qualified as perfect ideological enantiomorph of ultimate authenticity of nature, it's only possible for "science" to be commensurate **ideological system about authenticity of nature in proportion to contemporaneous historical background** in crevice progression of historical progress of science in inherent optimum orientation towards perfect ideological enantiomorph of ultimate authenticity of nature.

At any historical stage, if long-time preponderance of authoritative intrepidity of contemporaneous scientific orthodoxy transcends limit of contemporaneous scientific orthodoxy in proportion to contemporaneous historical background, magisterial interposition of authoritative intrepidity of contemporaneous scientific orthodoxy to hypostatic progress of science must divaricate high-sounding royal substantiation & perfection of contemporaneous scientific orthodoxy from veritable progress of science to push humanistic ideology about authenticity of nature forward to perfect ideological enantiomorph of ultimate authenticity of nature step by step draw on practical feasibility & possibility in proportion to contemporaneous historical background. After all, so-called contemporaneous scientific orthodoxy out of scientific legitimacy qualification of historical authenticity tolerance of science 0 is but top level output of ideology about authenticity of nature in proportion to contemporaneous historical background, as permanent quantitative change of scientific knowledge proliferation in the nature of things, scientific knowledge aggradation can never be constant along historical progress of science, which mostly exists as live historical background and synchronously affects and conditions successive scientific knowledge proliferation as well. As a result, it's almost impossible for **demoded substantiation & perfection of contemporaneous scientific orthodoxy \approx historical progress of science** in practical effect.

Live contemporaneous scientific orthodoxy originally came into being during the course of ideological transition from macrophysics to microphysics in proportion to contemporaneous historical background of remarkable implication dilation of scientific practice from macrocosm to microcosmos in terminal years of 19th century and early years of 20th century, as interposition of substantial unexpected microcosmic factuality apparently negated validity of our intuitionistic experience in macrocosm time after time, people had to review universal existence & motion to accomodate remarkable deregulation of unexpected microcosmic factuality, rational renovation of humanistic ideology about authenticity of nature in proportion to contemporaneous historical background of remarkable implication dilation of scientific practice from macrocosm to microcosmos in terminal years of 19th century and early years of 20th century became inevitable. And now, high-sounding royal substantiation

As coherent natura naturans throughout cosmic evolution, instinctive PNT reciprocal equilibrium towards optimum PNT operation is radical potentiality & conditionality for cosmos always ready to orientate itself towards perfection.

& perfection of contemporaneous scientific orthodoxy has been boffo for more than one century.

As primary implication in microcosmos as travel in brand-new landmasses step by step, ideological aggradation of contemporaneous scientific orthodoxy still seems rich and colorful scientific travelogues like omnifarious smallwares full of a basket, who generally study universal existence & motion as independent disciplines as physics, chemistry, biology, iatrolgy, ..., even intersectant subjects as chemical physics, biophysics etc. Even as magistral autarchy of **free press regulation customization & free press admittance** of temporal authority, live scientific knowledge proliferation is almost restricted in rigid succession of contemporaneous scientific orthodoxy. After all, there is completely no way for any aberrant scientific knowledge proliferation out of succession of contemporaneous scientific orthodoxy to pass free press egotistic proximity identification from temporal authority. Since World War II, there was none top-ranking genius came forth in scientific research on the earth, whereas, under egotistic background of high-sounding royal substantiation & perfection of contemporaneous scientific orthodoxy, so-called second-sting geniuses even so-called loving successors of contemporaneous scientific orthodoxy are really authoritative and overwhelming unprecedentedly. Although, it's only possible for veritable progress of science to be hypostatic endeavor to push humanistic ideology about authenticity of nature forward to perfect ideological enantiomorph of ultimate authenticity of nature step by step draw on practical feasibility & possibility in proportion to contemporaneous historical background instead of interminable royal substantiation & perfection of contemporaneous scientific orthodoxy under egotistic guidance of temporal authority.

As timely renovation of humanistic ideology about authenticity of nature in proportion to contemporaneous historical background of remarkable highlight of microcosmic configuration of matter, factuality that discretionary particles in cosmos are mutually convertible in freewheeling towards complete induction day by day has brought out substantial headspring for me to succeed downwind potentiality for pioneering cosmos redefinition in logic enantiomorph of newly highlighted factuality of **discretionary particles in cosmos are mutually convertible** with consequent PNT dynamics about universal existence & motion in the nature of coherent natura naturans throughout cosmic evolution. Whereas, as typical outgrowth of aberrant scientific knowledge proliferation out of succession of contemporaneous scientific orthodoxy, original naissance of Homogenous Cosmos Originated from Unique Genesis had no idea of physics, chemistry, biology, iatrolgy etc but endeavor of logic extension on the basis of **[(Homogenous cosmos originated from unique genesis postulate + spacetime~matter fully embodying cosmos postulate) + Instinctive PNT equilibrium postulate]**, as outgrowth of logic extension, universal existence & motion is but spontaneous occurrence of **[External physical disturbance + (PNT action + Instinctive PNT equilibrium)]**, which is typical linear logic system as outgrowth of longitudinal ideological optimization under background of remarkable highlight of microcosmic configuration of matter and crowns all scientific travelogue style physics, chemistry, biology, iatrolgy ... as real subclass at the volley, although, as logic expansion based on unique precondition, spontaneous occurrence of **[External physical disturbance + (PNT action + Instinctive PNT equilibrium)]** seems so different from travelogue style tradition of **[physics + chemistry + biology + iatrolgy + ...]**.

I am quite sure, since the ultimate authenticity of nature can be neither omnifarious authenticity smallwares full of a basket nor authenticity chameleon one piece and only, it's only possible for the demiurge to create cosmos in accordance with coherent natura naturans throughout cosmic evolution, there is no rational originality of so-called physics, chemistry, biology, iatrolgy of the demiurge, but humanistic endeavor to push humanistic ideology about authenticity of accessible existence & motion forward to perfect ideological enantiomorph of ultimate authenticity of nature step by step draw on practical feasibility & possibility in proportion to contemporaneous

historical background brings them out in the nature of things, which is of course hypostatic historical progress of science in inherent optimum orientation towards perfect ideological enantiomorph of ultimate authenticity of nature, although, as gradational quantitative & qualitative change of practical feasibility & possibility in proportion to contemporaneous historical background, it apparently desecrates originality of coherent natura naturans throughout cosmic evolution of the demiurge. And as a result, I became typical heterodoxy of the age, there is almost no way for me to pass free press egotistic proximity identification from temporal authority.

What's more, as personal limitation, it's really difficult for me to be unquestionable in accordance with egotistic criterion of contemporaneous scientific orthodoxy.

What's more, under background of high-sounding royal substantiation & perfection of contemporaneous scientific orthodoxy, **free press regulation customization** and **free press admittance** is completely under magistral autarchy of temporal authority short of necessary intendance, no magistral humanistic puissance short of necessary intendance can always do its positive jobs on the earth, as a result, science forum can hardly be free from egotistic restriction of authoritative intrepidity of contemporaneous scientific orthodoxy. And towards free press admittance, there is almost no way for me to slider over perplexity of virulent scientific knowledge metabolism campaign.

What's more, historical progress of science extends to today, as practical accessibility of science has been relatively near to upper limit of human perception, scientific experiments are not only difficult for human to detect and uncover a fly in the ointment of live contemporaneous scientific orthodoxy but also difficult to offer creditable demonstration for coming renovation of humanistic ideology about authenticity of nature in proportion to contemporaneous historical background, which is apparently different from the ideological transition of humanistic ideology about authenticity of nature from macrophysics to microphysics in terminal years of 19th century and early years of 20th century for interposition of startling deregulation of microcosmic factuality against our intuitional experience, necessary renovation of humanistic ideology about authenticity of nature in proportion to contemporaneous historical background of successive implication dilation of scientific practice from macrocosm to microcosmos was self-evident.

Firstly written in Dec. 2004, literal revision was done in Dec. 2007

——Zhenzhu town, Wugang city, Hunan province

The First Part

Connotation Objectification of Homogenous Cosmos Originated from Unique Genesis Homologisation of Spacetime & Matter — Precondition Initialization of PNT Dynamics

Forward

As timely renovation of humanistic ideology about authenticity of nature in proportion to contemporaneous historical background of **Remarkable highlight of microcosmic configuration of matter**, the first step of Homogenous Cosmos Originated from Unique Genesis towards cosmos redefinition in logic enantiomorph of newly highlighted factuality of **discretionary particles in cosmos are mutually convertible** with consequent PNT dynamics about universal existence & motion in the nature of coherent natura naturans throughout cosmic evolution are **“connotation objectification of homogenous cosmos originated from unique genesis”**, whose modus operandi is generally as following:

1) Remarkable highlight of microcosmic configuration of matter especially remarkable highlight of factuality that **discretionary particles in cosmos are mutually convertible** made the homogenous profile of cosmos more and more explicit day by day.

Whereas, whether cosmos is really homogenous through and through? If yes, what a hypostatic homogenous cosmos is it? Towards the pioneering exploration, it introduces **“Homogenous cosmos originated from unique genesis postulate”**.

2) As the ideographic function of Homogenous cosmos originated from unique genesis postulate is similar to a couple cosmic mould cavities for cosmic profile, we primarily come to implement mould injection to cosmic mould cavities of **“Homogenous cosmos originated from unique genesis postulate”**, —— substituting the solid experiential factuality of **“spacetime~matter fully embodying cosmos”** into Homogenous cosmos originated from unique genesis postulate so as to make integrative precondition of **“Homogenous cosmos originated from unique genesis + spacetime~matter fully embodying cosmos”** logically extendable, and two logic extensions of Homogenous cosmos originated from unique genesis postulate are deduced thereby.

Historical progress of science in the recent several centuries seemed like a far-flung exploration of the first itineracy around numerous distinctive landscapes of brand-new landmasses of science with palette & tablet on back, several hundred years' scientific travelogues were compiled thereby.

—On the basis of integrative precondition of “**homogenous cosmos originated from unique genesis + spacetime & matter coequally belong to category of cosmos**”, it logically arrives at “logic extension 1 of Homogenous cosmos originated from unique genesis postulate” —**spacetime and matter are coequally physical for homologisation.**

—On the basis of integrative precondition of “**homogenous cosmos originated from unique genesis + spacetime & matter fully embodying cosmos**”, it logically arrives at “logic extension 2 of Homogenous cosmos originated from unique genesis postulate” —**spacetime and matter must be alternative homologic filiation** either “spacetime father & matter son” or “matter son & spacetime son” for absence of third coordinator in cosmos.

And subsequently, it introduces “connotation objectification of the two logic extensions of Homogenous cosmos originated from unique genesis postulate” to accomplish homology objectification of entire cosmos so as to highlight intrinsic homologic attribute of spacetime and matter, homologic filiation between spacetime and matter, even essence of matter, which are of course necessary rational groundwork for further logic extension towards qualitative redefinition and mathematical formulation of existence & motion of matter in homogenous cosmos.

(I-i) Introduction of Homogenous cosmos originated from unique genesis postulate

Homogenous cosmos originated from unique genesis postulate is just enantiomorphous reflection of newly highlighted factuality that **discretionary particles in cosmos are mutually convertible**

Abstract: As remarkable highlight of microcosmic configuration of matter, especially the factuality that **discretionary particles in cosmos are mutually convertible** is always in live orientation towards complete induction day by day, more and more lights have been thrown onto authenticity of homogenous profile of cosmos, in our rational purview, homogenous profile of cosmos has been more and more explicit.

Whereas, is cosmos really homogenous originated from unique genesis through and through?

If yes, what integrative cosmic homologic configuration and proportionate universal homologic existence & motion should be accordingly?

After all, if cosmos is really homogenous originated from unique genesis through and through, rationale of humanistic ideology about authenticity of universal existence & motion will be remarkably renovated accordingly, which of course implies timely renovation of humanistic ideology about authenticity of nature in proportion to contemporaneous historical background underlying, we have to review universal existence & motion therefore.

What's more, the factuality that **discretionary particles in cosmos are mutually convertible** is always in live orientation towards complete induction indeed, although, it has not approached complete induction till today, it has substantively brought substantial potentiality as favorable headspring for us to look into **the both issues** above, we can of course succeed favorable headspring of remarkable highlight of microcosmic configuration of matter for possible authenticity highlight. Since the newly highlighted factuality of **discretionary particles in cosmos are mutually convertible** always in live orientation towards complete induction indicates cosmos is throughout homogenous originated from unique genesis, as pioneering endeavor towards authenticity highlight of cosmos, we can of course succeed the favorable headspring as radical rationale of **Homogenous cosmos originated from unique genesis postulate**, so that we can expediently look into proportionate cosmos redefinition even consequent universal existence & motion following a rational line of it.

This is of course pioneering endeavor toward timely renovation of humanistic ideology about authenticity of nature in proportion to contemporaneous historical background of **remarkable highlight of microcosmic configuration of matter**.

Keywords: Homogenous cosmos originated from unique genesis postulate, logic extension 1 of Homogenous cosmos originated from unique genesis postulate, logic extension 2 of Homogenous cosmos originated from unique genesis postulate.

(I-i-a) Remarkable highlight of factuality "**discretionary particles in cosmos are mutually convertible**" causes naissance of scientific idea of **Homogenous cosmos originated from unique genesis**.

Before humanistic ideology about authenticity of nature finally qualified as perfect ideological enantiomorph of ultimate authenticity of nature, as commensurate ideological enantiomorph of accessible existence & motion around us, science is always commensurate ideological system about authenticity of accessible existence & motion in proportion to contemporaneous historical background in rigid progression of historical progress of science in inherent optimum orientation towards perfect ideological enantiomorph of ultimate authenticity of nature.

In terminal years of 19th century and early years of 20th century, as remarkable implication dilation of

Historical progress of science in the recent several centuries seemed like a far-flung exploration of the first itineracy around numerous distinctive landscapes of brand-new landmasses of science with palette & tablet on back, several hundred years' scientific travelogues were compiled thereby.

scientific practice from macrocosm to microcosmos, interposition of unexpected microcosmic factuality apparently negated validity of Newtonian Mechanics one after another. People had to review universal existence & motion again for interposition of startling deregulation in microcosmos, proportionate ideological transition of science from macrophysics to microphysics became inevitable, necessary renovation of humanistic ideology about authenticity of nature in proportion to contemporaneous historical background of successive implication dilation of scientific practice from macrocosm to microcosmos was possibly self-evident. As a result, Relativity & Quantum Theory came into being accordingly.

And now, as hypostatic potentiality for historical progress of science, quantitative & qualitative change of practical feasibility & possibility has lasted another century, quantitative change of scientific knowledge proliferation along intrinsic progression of historical progress of science has remarkably renovated our live scientific knowledge aggradation and rational purview of cosmic profile, especially **remarkable highlight of microcosmic configuration of matter**, which has apparently highlighted homogenous profile of cosmos and seems substantial potentiality and headspring for timely renovation of humanistic ideology about authenticity of nature in proportion to live historical background.

As remarkable progress of modern particles physics in the recent 100 years, we've found more and more colorful particles in cosmos, we see any discretionary 2 particles selected from particle/object aggregation of $\{A_1, A_2, A_3, \dots, A_n (n \in \mathbb{N})\}$ are mutually convertible. (Which means any discretionary C_n^2 option of the particle aggregation is mutually convertible). The cause is that the discretionary 2 particles/objects selected from the particle/object aggregation always possess the common compositive components in certain configurable hiberarchy.

Such factuality can lead us to approach such deduction, if the magnitude of $n (n \in \mathbb{N})$ is big enough so that object aggregation of $\{A_1, A_2, A_3, \dots, A_n (n \in \mathbb{N})\}$ can represent the entire cosmic contents, and any discretionary 2 objects selected from the object aggregation are still mutually convertible, then the entire cosmic contents must possess the common extremity component in terminal configurable hiberarchy, —the cosmos is throughout homogenous made up of the common extremity component in terminal configurable hiberarchy.

And at the same time, since the entire cosmic contents possess the so-called “common extremity component” in their common terminal configurable hiberarchy, the so-called “common extremity component” in cosmos must be unique, because there is no possibility for two or more different components to take the role of “common extremity component”. This of course implies the entire cosmic contents originated from the “common and unique extremity hylc progenitor/component”, any cosmic content is either he unique extremity hylc progenitor (or genic origin) itself or homologous compound radically originated from the common unique extremity hylc progenitor (or genic origin). It of course implies the entire cosmos is not only throughout homogenous but also absolute homology aggregation systematically originated from unique genesis.

However, we have to admit the conclusion any discretionary 2 particles/objects in cosmos are mutually convertible is still our experiential summary based on millions of but still inadequate positive facts that history has already offered. The rational situation is rather similar as a mathematical induction. In human history, we have procured substantial facts which support, when $n=1, 2, 3, \dots, k$, all situations satisfy conclusion that any discretionary 2 objects in the particle/object aggregation $\{A_1, A_2, A_3, \dots, A_k (k \in \mathbb{N})\}$ are mutually convertible, and as history continuously extending, we found more and more new particles in cosmos, the magnitude of k is

proportionally increasing, all situations still satisfy the conclusion. Whereas, once we suppose the magnitude of n is big enough so that the particle/object aggregation $\{A_1, A_2, A_3 \dots A_n (n \in N)\}$ can be exactly equal to cosmic contents, whether all situations still satisfy the conclusion?

Confronting challenge of the very issue, we have to admit that the conclusion “**discretionary particles in cosmos are mutually convertible**” is still a conclusion of incomplete induction. Although it has been remarkably highlighted by K experimental facts which have been perceived in the recent one century, it is still imperfect for there are still $n - k (n \in N, n > k)$ facts out of demonstration, ——a conclusion with substantial positive evidence but still out of complete induction.

Whereas, is it possible for cosmos to be really homogenous originated from unique genesis through and through? Since we still lack of credible backup for our positive conclusion, confronting challenge of the very issue, should we flinch or not?

No! No~No~No, leastways, as temporal limitation of human practice, the conclusion **discretionary particles in cosmos are mutually convertible** with substantial evidence is still out of complete induction does not directly indicate potential flimflam that there must be some certain two potential particles in cosmos not mutually convertible undoubtedly. At any rate, we have to admit it’s almost impossible for human practice to be always consummate & satisfying for theoretical necessity of scientific exploration then and there, temporal limitation of human practice for further scientific exploration is something inevitable. And on the other hand, something all-important is that it’s still necessary for us to consider whether the conclusion of factuality **discretionary particles in cosmos are mutually convertible** is still in living orientation towards complete induction as proceeding of human practice, and something even all-important is that it’s still necessary for us to consider whether introduction of the presumable conclusion really significant for further theoretical exploration of science, which virtually indicates revolutionary renovation of humanistic ideology about authenticity of nature in proportion to contemporaneous historical background. Otherwise, we are substantively recreant in scientific exploration.

Virtually, no matter on stand of active practice or rational necessity of scientific exploration, we should not flinch for the great potential conclusion still out of complete induction. After all, the positive conclusion of the very issue is really all-important for us to look into the grand cosmological authenticity. in any case, all the particles we perceived in the recent one century are mutually convertible, none is exceptive, and as time going itself, we perceived more and more positive facts supporting the conclusion of the factuality, this of course indicates the conclusion of the very factuality in living orientation towards complete induction. And confronting challenge of the very issue whether cosmos is throughout homogenous originated from unique genesis or not, if we say “Yes”, we of course have substantial positive evidence; inversely, if we say “No”, nothing seems favorable for rational support.

If cosmos is really homogenous originated from unique genesis through and through, then, the thorough paced configuration of cosmos will be remarkably illuminated, ——intrinsic attribute and ingenerate correlation of spacetime & matter, consequential existence & motion of matter in spacetime due to the proper intrinsic attribute and ingenerate correlation of spacetime & matter will immediately be self-evident followed a rational line of sequential homologic cosmogony starting at the so-called unique extremity progenitor component to cosmic status quo. In any case, essence of matter generally come into being during the course of their original generation & formation which is inherently kept with matter as idiographic objects under the proper generative

conditions. The magic significance of exploration endeavor towards the very issue is rather similar as that we are looking for a very long string in terrible darkness, as our eyeshot is too dark, we are almost confused unknowing where to go and what to do, However, as an innovative and enterprising attempt (such as pioneering introduction of **Homogenous cosmos originated from unique genesis postulate**), one terminal of the long string in terrible darkness has suddenly been caught hold of by us, the rest job is but to pull the string and approach all the necessary with the string in hands, and terrible darkness virtually means nothing to us ever since.

Considering the logic significance of the very issue for further scientific exploration, in order not to leave the positive scientific pursuit of intrinsic attribute & inherent correlation of spacetime & matter even universal existence & motion of matter in spacetime along the very rational clew impotent, it seems wise for us to ascertain the potential conclusion with living orientation towards complete induction as presumable precondition so as to release hypostatic endeavor of scientific pursuit from our temporal limitation. We consequently introduce a presumable precondition of "**Homogenous cosmos originated from unique genesis postulate**" herein. At any rate, on exploration journey of science, preferential introduction of intelligent postulate is usually ready to release pioneering endeavor from temporal practice limitation towards expedient scientific pursuit, whose practical significance mostly indwells, as intelligent and timely introduction of the proper postulate, how much of our goal rational purview has been swiftly illuminated and widely open thereby.

(I-i-b) Homogenous cosmos originated from unique genesis postulate

It is assumed that **cosmos is throughout homogenous originated from unique genesis**. In detailed words, entire cosmic contents are all congenitally coherent homology consisting in an absolute homogeneity system which originally originated from unique genesis along sequential homologic cosmogony starting at so-called "unique genesis" to cosmic status quo through and through. Cosmic contents are either the so-called "unique genesis (cosmic extremity genic component/cosmic genic origin)" itself or idiographic homologous compounds with distinctive homologic configurations in cosmic homogeneity system.

The introduction of Homogenous cosmos originated from unique genesis postulate radically roots in conclusion of potential factuality that discretionary particles in cosmos are mutually convertible. Upon our strict sense, the reason that **Homogenous cosmos originated from unique genesis postulate** can only be qualified as "postulate" of the age is but because conclusion that **discretionary particles in cosmos are mutually convertible** is still experiential conclusion in live clarification orientation towards complete induction but still out of complete induction. Whereas, the introduction of Homogenous cosmos originated from unique genesis postulate is substantively like a powerful thunderbolt in darkness of our rational purview towards remarkable highlight of sequential homologic cosmogony and universal existence & motion in the nature of coherent natura naturans throughout cosmic evolution, which flashes thorough configuration of cosmos in a sudden that cosmos is throughout homogenous originated from unique genesis, so that, we can expediently look into homologic attribute of spacetime & matter, homologic correlation between spacetime and matter and universal existence & motion in homogenous cosmos following a rational line of sequential homologic cosmogony towards cosmic status quo.

Of course, Homogenous cosmos originated from unique genesis postulate is logic origin and general precondition of the whole subject, it's also the basal logic fulcrum of the subject and rational reference that live contemporaneous scientific orthodoxy (especially modern particle physics) has gradually highlighted for Homogenous Cosmos Originated from Unique Genesis by stochastic recognizant cumulation of serial microcosmic configuration

of matter in the recent 100 years. The kernel of the basal logic fulcrum is that **discretionary particles in cosmos are mutually convertible**, in a straightforward word, as innovative cosmos redefinition with consequent PNT dynamics about universal existence & motion in the nature of coherent natura naturans throughout cosmic evolution, Homogenous Cosmos Originated from Unique Genesis is typical longitudinal ideological optimization as radical logic enantiomorph of newly highlighted factuality that **discretionary particles in cosmos are mutually convertible**. Inversely, if somebody are able to find such two objects (or two particles) in cosmos, which can be fully proved there is absolutely no way for them to be converted each other, then, he either has radically negated the factuality cosmos is throughout homogenous originated from unique genesis or he has practically found tangible cosmos II already .

(I-i-c) Logic extension of “Homogenous cosmos originated from unique genesis + spacetime~matter fully embodying cosmos”.

What a homogenous cosmos is it on earth?

If we only think of the Homogenous cosmos originated from unique genesis postulate only, we can hardly perceive something hypostatic about cosmos. after all, Homogenous cosmos originated from unique genesis postulate is but a nonrepresentational generalization about cosmic profile, whose ideographic efficacy is substantively like something offered by a couple cosmic mould cavities. Although a couple cosmic mould cavities really offers profile of cosmos, it’s empty, it is not expedient for us to perceive the tangible profile of hypostatic cosmos. Since you insist that cosmos is homogenous originated from unique genesis through and through and the entire cosmos is completely an integrative cosmic homogeneity system, you should show us what are the hypostatic homologic components in cosmos which are congenitally correlated into coherent homologic integration as vivid cosmic homogeneity system all wool and a yard wide.

Towards the necessity of theoretical pursuit, we substitute the solid intuitional factuality that cosmos consists of spacetime and matter, none coordinative component else into Homogenous cosmos originated from unique genesis postulate so as to hypostatize the realistic homologic profile of cosmos with hypostatic cosmic endosome, so that we can expediently look into intrinsic homologic attribute of spacetime and matter, ingenerate homologic filiation between spacetime and matter and consequential existence & motion of matter in spacetime at the volley.

Upon our solid intuition, spacetime and matter are of course hypostatic contents of cosmos out of question, since we confirm cosmos is throughout homogenous originated from unique genesis, all cosmic contents must be homology in cosmic homogeneity system with either direct pedigree correlation or indirect pedigree correlation.

Note : Since discretionary particles in cosmos are mutually convertible in homogenous cosmos, if we can procure such two particles which are impossible for them to be converted each other, the consequential conclusion may be generally as below:

- 1) If the both particles belong to category of cosmos, such factuality radically negates argument that cosmos is homogenous originated from from unique genesis.
- 2) If one of the two particles is object out of category of cosmos, it of course means we have practically perceived an object of another cosmos of so-called “cosmos II”.
- 3) If the both particles are objects out of category of cosmos, and we can confirm the cosmos II is throughout homogenous originated from unique genesis too, then, it of course means we have practically perceived an object of a third cosmos of so-called “cosmos III”.

Historical progress of science in the recent several centuries seemed like a far-flung exploration of the first itinerary around numerous distinctive landscapes of brand-new landmasses of science with palette & tablet on back, several hundred years’ scientific travelogues were compiled thereby.

This of course means, as long as we have no tangible evidence to exclude spacetime and matter out of category of cosmos, both spacetime and matter must coequally belong to category of cosmic homogeneity system as homologic coordinators.

Thus, on the basis of integrative precondition of “homogenous cosmos originated from unique genesis + spacetime & matter coequally belonging to category of cosmos”, we can arrive at deduction as below:

Logic extension 1: Since cosmos is throughout homogenous originated from unique genesis, as undeniable components of cosmos, both “spacetime” and “matter” must be homologic coordinators coequally originated from the common cosmic extremity genesis (/cosmic genic origin) along sequential homologic cosmogony. And of course, as coordinative homology in cosmos, “spacetime” must be coequally physical as matter, unless we have tangible evidence to exclude spacetime out of category of cosmos.

Moreover, upon our solid intuition, besides spacetime and matter, there seems nothing else coordinative in cosmos. However, is it really true that cosmos completely consists of spacetime and matter, none else?

In the face of challenge of the very issue, it seems, upon our solid intuition, we should be confident to draw our sensible conclusion that cosmos straightforwardly consists of spacetime and matter. Leastways, besides spacetime and matter, nothing else we’ve found in cosmos indeed, it even seems impossible for us to find a third coordinative component in cosmos. However, we are substantively difficult to prove the sensible conclusion fully upon our strict sense. If we reluctantly introduce the sensible conclusion as “truth” for further logic extension, we are substantively flimsy and bashful for we’ve bet too much of our intuition, which apparently seems rational perplexity as mute englutis lotus but unable to speak out his live taste.

In order to release pioneering scientific pursuit from pestilent rational perplexity for historical limitation in practice for the moment, we introduce an auxiliary postulate——**spacetime~matter fully embodying cosmos postulate**, which postulates that **cosmos is object fully and exactly embodied by hypostatic coexistence of coordinative spacetime and matter, nothing else.**

Apparently, in terms of theoretical function, “spacetime~matter fully embodying cosmos postulate” and “Homogenous cosmos originated from unique genesis postulate” coequally outline profile of cosmos besides disparity of significance. If we think the ideographic significance of cosmic profile of Homogenous cosmos originated from unique genesis postulate a couple of mould cavities of cosmos, then, the ideographic significance of cosmic profile of spacetime~matter fully embodying cosmos postulate is similar as an accessorial slide of the couple of mould cavities of Homogenous cosmos originated from unique genesis postulate. And just because of the necessity, we introduce spacetime~matter fully embodying cosmos postulate as a coordinative auxiliary postulate of Homogenous cosmos originated from unique genesis.

Thus, on the basis of integrative precondition of “Homogenous cosmos originated from unique genesis + spacetime~matter fully embodying cosmos”, we can arrive at further logic extension as below:

Logic extension 2: If cosmos is object fully embodied by hypostatic coexistence of spacetime and matter, none homologic coordinator else, along original sequential homologic cosmogony starting at the common cosmic extremity genesis (/cosmic genic origin) to cosmic status quo, “spacetime” and “matter” must be alternative homologic filiation either “spacetime father & matter son” or “matter father & spacetime son”.

This is just the primary two logic extensions of Homogenous cosmos originated from unique genesis postulate once we objectify spacetime and matter into Homogenous cosmos originated from unique genesis

postulate. —on the basis of integrative precondition of “Homogenous cosmos originated from unique genesis + spacetime & matter coequally belonging to cosmos”, it educes “logic extension 1 of Homogenous cosmos originated from unique genesis postulate” — spacetime and matter are coequally physical as coordinative homology; on the basis of integrative precondition of “Homogenous cosmos originated from unique genesis + spacetime~matter fully embodying cosmos”, it educes “logic extension 2 of Homogenous cosmos originated from unique genesis postulate” — spacetime and matter must be alternative homologic filiation either “spacetime father & matter son” or “matter father & spacetime son”.

The integrative logic constitution of introduction of Homogenous cosmos originated from unique genesis postulate and primary education of two logic extensions of the very postulate with sensible supplementation of “spacetime~matter fully embodying cosmos postulate” can be illuminated as below:

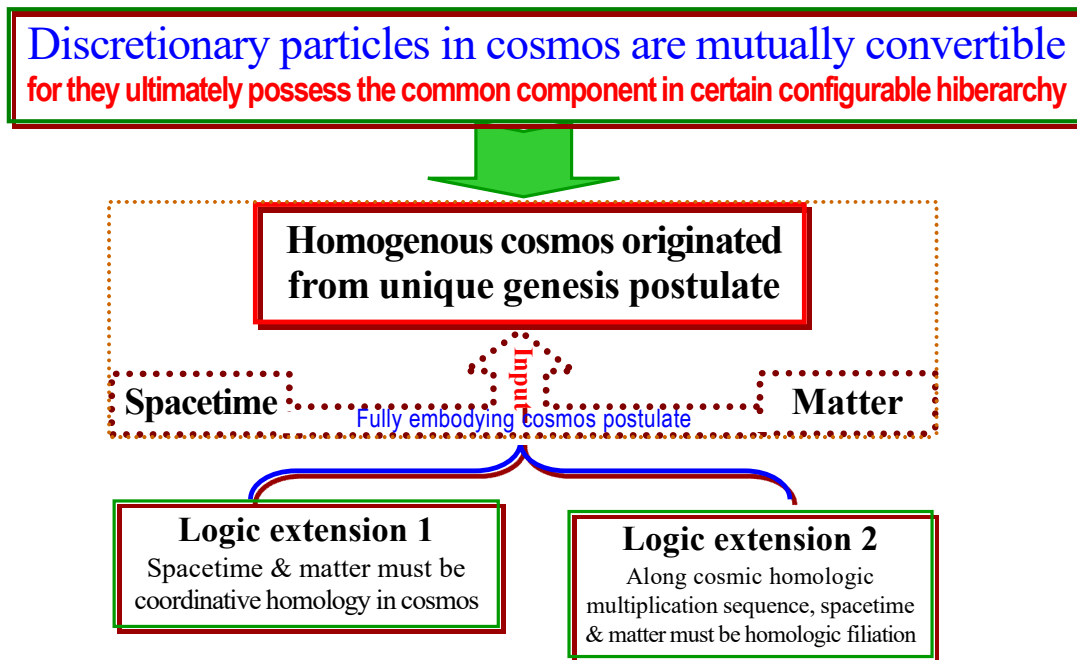

Throughout Homogenous Cosmos Originated from unique Genesis, introduction of **Homogenous cosmos originated from unique genesis postulate** is the most significant and pioneering action, which indicates start of timely renovation of humanistic ideology about authenticity of nature in proportion to contemporaneous historical background of **remarkable highlight of microcosmic configuration of matter**. Virtually, **Homogenous cosmos originated from unique genesis postulate** is just enantiomorphous reflection of newly highlighted factuality that **discretionary particles in cosmos are mutually convertible**.

—Firstly written in Dec. 1992, literal revision was done in Jan. 2009.

(I-ii) Connotation objectification of two logic extensions of Homogenous cosmos originated from unique genesis postulate

Ingenerate coexistence of “spacetime” & “matter” fully embodies cosmic homogeneity system as lineal Coordinative homology

Connotation objectification of two logic extensions of Homogenous cosmos originated from unique genesis postulate is but attempt to objectify the proper logic connotation of the two logic extensions of Homogenous cosmos originated from unique genesis postulate into proportionate cosmic actualities, which is endeavor similar as changing “money” into “goods”, the so-called “money” is just logic connotation of logic extension 1 and logic extension 2 of Homogenous cosmos originated from unique genesis postulate; the so-called “goods” are of course the “spacetime homology hypostatization as lineal coordinator of matter in cosmic homogeneity system” and “homologic generation of matter in homogenous cosmos”.

Theoretical introduction of “spacetime homology hypostatization as lineal coordinator of matter in cosmic homogeneity system” is ready to objectify spacetime and matter are coequally physical; theoretical introduction of “homologic generation of matter in homogenous cosmos” is ready to ascertain the alternative homologic filiation by excluding homologic filiation possibility of matter father & spacetime son, so as to make alternative homologic filiation between spacetime and matter self-evident even make homologic attribute of spacetime & matter in successive freewheeling at the volley.

(I-ii-1) Connotation objectification of logic extension 1 of Homogenous cosmos originated from unique genesis postulate

Homologic hypostatization of spacetime as coordinator homology in cosmic homogeneity system

Abstract: *Spacetime homology hypostatization in cosmic homogeneity system as coordinative homology of matter is just objectification and supplemental extension of logic extension 1 of Homogenous cosmos originated from unique genesis postulate— “spacetime and matter are coequally physical”, which introduces “spacetime genic field hypothesis” to hypostatize spacetime and matter are coequally physical and introduces “phantasmal field genic unit hypothesis” to complement the dynamic essence of hylic spacetime so as to consummate physical connotation of spacetime. And consequently, time and time dynamic speed (even the “space distance”, “space radiation cornu” introduced in section (II-ii)) can be defined accordingly.*

Keywords: *genic unit, space field, negative matter(dark matter), positive matter (baryonic matter), time, time dynamic speed, standard time unit, standard equivalent time and standard equivalent time coefficient.*

(I-ii-1-a) Objectification of homologic spacetime in cosmic homogeneity system

① Spacetime genic field hypothesis

In accordance with logic extension 1 of Homogenous cosmos originated from unique genesis postulate, since it has been confirmed as sensible postulate that cosmos is throughout homogenous originated from unique

genesis, as hypostatic components in cosmos, “spacetime” and “matter” must be coordinative homology originated from the common cosmic extremity genesis along sequential homologic cosmogony, and “spacetime” must be coequally physical as matter in cosmos, unless we have tangible evidence to exclude spacetime out of category of cosmos. Here, for the necessity and expedience of further analysis, we hypostatize the “hylic essence” of homologic spacetime into substantial aggregation of compositive element of homologous genic unit series coexisting as field, (and as the hylic existence of homologic spacetime consisting of the proper compositive genic units is very similar as field, we call spacetime “space field” too.) and we just call it “**spacetime genic field hypothesis**”, which can be described as below;

It is hypothesized that **space field consists of n+1 sorts of elementary genic components/units essentially originated from cosmic extremity genic origin along sequential homologic cosmogony**. We just call these elementary genic components/units in space field “field genic units ①”, and separately symbolize them as $i_0, i_1, i_2, \dots, i_n$ ($n \in \mathbb{N}$). And at the same time, we denote the relativistic configuration ratio ② of each genic unit in space field as a, b, c, \dots, x , so that we can primarily denote the integrative component configuration of field genic units in space field as $a*i_0, b*i_1, c*i_2, \dots, x*i_n$. ($n \in \mathbb{N}$)

②: Phantasmal field genic unit hypothesis

Upon our common experience and solid intuition, any matter innately exists in dynamic and variable state, but never exists in stationary state; it even seems there is none reasonable ways for any matter to exist in ideal stationary and invariable state. According as the homologic essence of hylic spacetime in cosmic homogeneity system, it seems necessary for us to complement the dynamic essentiality of hylic spacetime as logic freewheeling so as to consummate the physical existence of material space field. So we introduce **Phantasmal field genic unit hypothesis** to complement the dynamic essence of hylic spacetime as below:

Once we introduce spacetime-matter fully embodying cosmos, on the basis of [homogenous cosmos originated from unique genesis + spacetime-matter fully embodying cosmos], we can of course arrive at lineal homologic correlation between spacetime and matter, which indicates alternative of “spacetime father and matter son” or “matter father and spacetime son”. Once we exclude the possibility of “matter father and spacetime son”, we directly arrive at “spacetime father and matter son” thereby, which of course implies that **all field genic units in space field exist in state of everlasting mutual transmutation and transition in transnormal speed, so that it's completely impossible for us to ascertain and perceive any definite presence of any separate field genic unit in space field, but only possible for us to perceive the holistic effect of their dynamic coexistence**.

According as logic extension 1 of Homogenous cosmos originated from unique genesis postulate, homology hypostatization of spacetime in cosmic homogeneity system as coordinative homology of matter not only introduced

Note ①: The Chinese name of “cosmic genic unit” is a little different from the English name. The Chinese name of cosmic genic unit is “jizhi (极子)” which is originally named for the field genic origin i_0 derived from the word “infinitesimal extremity” (极限) and just the Chinese abbreviation of “extremity quantum” (极限量子); it straightforwardly means the hylic objectification of the infinitesimal material unit in cosmos.

Note ②: Of course, the n+1 sorts of field genic units were not coming into being in a magic flash, there must be a substantial evolutionary process for them to come into being one after another, and at the same time, their coexisting configuration ratio in space field is proportionately variable in accordance with the proper prolific ambient conditions of space field. Yet, as historical limitation, it's almost impossible for me to offer definite configuration ratio of various field genic units in space field. And indeed, as space genic field hypothesis, the indefinite number series indicating the indefinite configuration ratio of the field genic unit series in space field has been enough for further outspread of logic extension of Homogenous cosmos originated from unique genesis postulate already.

Historical progress of science in the recent several centuries seemed like a far-flung exploration of the first itinerary around numerous distinctive landscapes of brand-new landmasses of science with palette & tablet on back, several hundred years' scientific travelogues were compiled thereby.

“spacetime genic field hypothesis” to hypostatize the physical esse of hyllic spacetime but also introduced “phantasmal field genic unit hypothesis” to complement the dynamic essence of hyllic spacetime so as to consummate physical existence of homologic spacetime in cosmic homogeneity system.

And as introduction of innovative idea of homogenous cosmos originated from unique genesis, objectification of logic extension 1 of Homogenous cosmos originated from unique genesis postulate has virtually hypostatized spacetime as coordinative homology of matter in cosmic homogeneity system. In order to differentiate the hyllic coordinative existence of homologic spacetime and matter in cosmic homogeneity system, we just call the material components of homologic spacetime “negative matter/dark matter” and call the material components of matter we usually refer to “positive matter/baryonic matter”.

(I-ii-1-b) “Time” and “Time Dynamic Speed”

We now come to define “time” and “time dynamic speed” in accordance with the two hypotheses above.

According to space field genic hypothesis and Phantasmal field genic unit hypothesis above, it is very easy for us to know that the most hypostatic physical endosome of space field are but the hyllic esse embodied by genic component configuration of certain homologic field genic unit series originated from the “cosmic common extremity genic origin” and the dynamic essence of transnormal dynamic transmutation & transition among all field genic units.

So called “time” is just dynamic esse of hyllic space field, —the dynamic integration of mutual transmutation & transition among all field genic units in space field. Time rate directly depends on rapidness and intensity of dynamic transmutation & transition among all field genic units in space field. In different space fields, as difference of space field strength, the intensity and rapidness of dynamic transmutation & transition among field genic units is proportionably different. Generally, the bigger the magnitude of space field strength is, the more intense and rapid the covariant transmutation & transition among field genic units is, and the faster time goes therefore.

As integrated activity aggregation of dynamic transmutation and transition of field genic units in space field, time itself is virtually a special speed, —the integrative rate of dynamic mutual transmutation and transition of all field genic units in space field. For convenience, we just call the integrative rate of dynamic mutual transmutation and transition of all field genic units in space field “time dynamic speed”, and symbolize it with general character “Y”. Time dynamic speed is just the symbolic logic style of the integrative intensity and rapidness of dynamic transmutation and transition of field genic units in space field. It adopts proper numerical value to denote the dynamic transmutation intensity and rapidness of field genic units according to physical significance & necessity, which is a little similar as we adopt centigrade value to denote the intensity degree of thermic motion of molecules.

Then, how should we define “time dynamic speed” exactly?

It's well known, when we are ready to theoretically scale thermal degree of any objects, we propaedeutically adopt precondition definition of boiling water under standard atmosphere as 100°C as thermal quantification standard to scale and quantify thermal intensity of any objects. Whereas, once we come to scale the rate of time, (Just to define or quantify the rate of integrative dynamic intensity or rapidness of transmutation & transition of field genic units in space field mathematically) the similar way is apparently not ideal.

Let's suppose, if our study object just limits in one sole object, for instance, it's just the water, under standard atmosphere press and 20°C, we define the cumulative length of linear thermal motion route of any water molecule in free water in one standard time unit "water thermal speed", (Note: here "free water" means water molecule never collides on any impurity molecules during the course of thermal motion.) Then, compared with centigrade value, water thermal speed not only has remarkable superiority of accuracy to indicate thermal degree, but also has remarkable superiority to incarnate the thermal hypostasis of molecule motion integration. Time dynamic speed can be defined by the similar way.

Thus, for definition expedience of time dynamic speed, it's necessary for us to introduce two related special items in advance.

①. "Phoney motion"

Any water molecule is perceivable and relatively steady material object which we can track and ascertain at any moment; as a result, there must be tangible motion route during the course of thermal motion of molecule. Whereas, normal existence of any field genic unit is absolutely inconstant, so that it is completely impossible for us to ascertain and perceive their definite presence as explicit behavioral esse in time current, as a result, when they are coexisting and mutually transmuting in their innate state, there is none tangible motion route or orbit of any field genic unit. However, the transmutation and transition among field genic units can substantively lead to transposition among different field genic units. For instance, there are field genic units A and B in certain space field, when field genic units A and B transmute each other, genic unit A turns into genic unit B, and almost at the same time, genic unit B turns into genic unit A, thus, the consequence of the transmutation between field genic unit A and field genic unit B is just equivalent to transposition between genic unit A and field genic unit B. We just call the very transposition caused by mutual transmutation among field genic units in the space field "phoney motion".

As long as the sorts of field genic units in space field are definite, as long as any two field genic units in the space field can convertibly transmute each other, the dynamic transmutation and transition among field genic units must lead to "phoney motion". And as the transposition among field genic units has no definite direction, but equivalent to any direction in ratio, the "phoney motion" has no direction, which of course indicates that the word "phoney" of phoney motion has double meanings, firstly, it indicates actualization of their transposition depends on mutual conversion, field genic units never transfer mechanically as independent esse, but as mutual conversion makes their behavioral effect equivalent to transference; secondly, the transposition never goes along certain direction. It's substantively a "phoney motion".

②. "Standard time unit"

When we are ready to measure or quantify geometrical magnitude of any object, it's always necessary for us to choose a proper standard measure unit in prior. For instance, we choose "meter" as the standard length unit to measure discretionary length of any object or distance between any two points. But now, let's suppose the material of the ruler is rather sensitive at thermic intumescence, so that once we measure with this ruler under different ambient conditions of temperature, just because of discrepancy of thermic intumescence of the ruler in different temperature conditions, even though, the measure results we get might be just the same numeric magnitude, the practical length of objects we measured may be remarkably different. When we come to consider the measurement of time rate, as disparity among different space fields, similar domino effect is even remarkable.

As distinction of space field strength, the rate of time in different space field can never be the same.

As time rate determines comprehensive motion rate of the matter existing in the proper space field including the rate of any clocks (It's easy to be comprehended according to definition of absolute spacetime momentum $mV=d(M\leftarrow m)Y$ of any object in spacetime and the relevant PNT dynamics equations, such as acceleration formula $a(t)=Y(t)*K'(t)$, velocity formula $V=V_0+\Delta V=V_0+\int a(t)dt$ etc), this of course indicates even just the same clock existing in different space field, as hypostatic distinction of space field strength, the connatural motion speed of the clock is impossible to be the same.

Let's suppose there are two aircrafts, they are just the same and each is fixed with a clock exactly the same too. And let's suppose just at the same moment the both aircrafts start at space field A and separately fly into the space field B and space field C at the same initial speed. Standing in the space field A, we observe the both aircrafts, we find the both aircrafts separately fly into space field B and space field C at the same moment and at the same initial speed, then we begin to record time in the space field A. 11 seconds later, we come to observe the both clocks on the two aircrafts, the results may be that the clock in space field B has gone 10 seconds, and the clock in the space field C has gone 12 seconds. And synchronously, standing in space field A, we come to measure the distance that the both aircrafts separately flown through in the "same interval", the results may be that the aircraft in the space field B has flown through 100 kilometers, and the aircraft in the space field C has flown through 120 kilometers. Although considered by the observer in space field A, the speed of the aircraft in space field C is 1.2 times of the speed of the aircraft in space field B, if the cosmonauts can communicate with each other, then the flying speed of their own aircraft they mutually communicated themselves is just the same. (Just as 100 kilometers/10 seconds = 120 kilometers/12 seconds). Even the both aircrafts transpose the space fields they fly in, as the change rate of aircraft flying speed and the change rate of the clock on the aircraft are exactly synchronous and equivalent, the cosmonaut in the aircraft has no way to find out the change of the flying speed of his aircraft, he still think his aircraft keeping in initial motion state constantly.

Just because of the very synchronous and equivalent domino effect time works on universal motion rate of matter in spacetime, when we come to measure the cosmic time in different space fields, it seems necessary for us to define a proper "standard time unit" for coherent quantification of time, but not to behave as ignorant belief in measurement in accordance with the ruler itself in defiance of the thermic intumescence in different temperature conditions.

Then, what a "standard time unit" we should choose according to practical feasibility & necessity?

In accordance with practical feasibility and necessity, we confirm that **under presumable precondition that the space field status of which the earth exists in is constant**; the interval of 1 second on the earth is just one standard time unit. Apparently, as introduction of the "presumable precondition", we can not ensure the so-called "standard time unit" is absolute constant without question, it seems nothing is even more accessible for us to pursue.

Now, we come to define time dynamic speed. So called "time dynamic speed" is just mathematical quantification of phoney displacement cumulation of field genic units materialized by their mutual dynamic transmutation & transition in one standard time unit. The magnitude of time dynamic speed not only directly indicates the time rate, but also implicates the integrative rate/capability of universal existence & motion of matter in cosmos.

If we still adopt "meter" as the unit of phoney displacement and adopt "second" as the time unit, then, the unit of time dynamic speed is "meter/second" too. However, as the genic phoney displacement has no definite

direction, time dynamic speed is a pure scalar quantity, it but quantitatively scales dynamic intensity & rapidness of phantasmal transmutation & transition among field genic units in space field; it's a numerical indication of dynamic intensity of connatural genic transmutation & transition in space field.

The root cause time dynamic speed is but scalar quantity is that mutual phantasmal transmutation and transition of field genic units makes the existence of field genic units in spacetime absolutely inconstant, once any field genic unit performed any transmutation and transition, it immediately became "non-self", so that it's impossible for us to ascertain any definite reference to define orientation in space field, as a result, there is none definite orientation of genic transmutation and transition indeed. As a result, time dynamic speed can only be a scalar quantity indicating dynamic intensity or rapidness of phantasmal transmutation and transition of field genic units in space field. This of course indicates, as a very special speed reflecting intensity and rapidness of mutual transmutation and transition among field genic units in space field, time dynamic speed is substantively different from our conventional logos of speed.

③. "Standard equivalent time" and "Standard equivalent time coefficient"

In time current, the comprehensive cosmic matter existing in everlasting motion state, the physical significance of time is just to keep universal matter in connatural motion rates, no matter they are physical motion, chemical motion, biological motion etc in the nature, and on the contrary, the comprehensive connatural motion rate directly indicates the rate of time. (Of course, it includes the motion rate of any clock, the equation of the matter inertial conservation equations $mV=d(M \leftarrow m)Y \iff V=d(M \leftarrow m)Y/m$ and the dynamics formulas $a(t)=Y(t)*K'(t), V=V_0 + \Delta V=V_0 + \int a(t)dt$ have obviously indicated it)

Time dynamic speed is the most convenient physical token for us to indicate rate of time, whereas, as different space field has different time dynamic speed, and indeed, space fields all over cosmos are not even, it is still not convenient for us to denote the mathematical interval uniformly in cosmic wide space fields. For instance, we can of course denote an interval of 1 second on the surface of the earth, however, just in the same interval, in another special space field whose spacetime idiosyncrasy is different from the spacetime idiosyncrasy of the space field around surface of earth, then the hypostatic physical time passed is not exact 1 second in this special space field. If we still reluctantly regard the interval in this different space field as 1 second, the quantitative physical significance or physical effect of time connatural objectification of the both 'interval' with the same numeric magnitude of "1 second" is substantively different, because they separately contain different connatural physical motion quantity according to the dynamics comparison of the both equations $m_E V=d(M \leftarrow m)*Y_E$ and $m_D V=d(M \leftarrow m)*Y_D$, $Y_E \neq Y_D$. (In the equations, m_E denotes the mass of any object on the Earth, Y_E denotes the time dynamic speed on the surface of the earth; whereas, m_D denotes the mass of any object in the discretionary special space field, Y_D denotes the time dynamic speed of discretionary special space field). Resultingly, in order to calculate the natural time uniformly, it is very necessary for us to introduce another notion of "standard equivalent time".

The most substantial physical significance of cosmic interval is that how much connatural motion or physical effect of matter is proportionately performed or caused in certain interval, the proper quantification of connatural motion or physical effect of matter is the unique fundamental standard to scale the practical significance of natural interval. In a simple word, so called "standard equivalent time" just means that different numeric interval magnitude denotation with the same materialization physical effect. Say materially, record a numeric interval T_A in the space field A, and then record another numeric interval T_B in space field B, as long as T_A and T_B have

the same natural physical effect in spacetime, we then can say T_A is just the standard equivalent interval of T_B . The most ideal physical variable to denote the physical effect of interval is the “Time-motion”. For expedience, we just denote it with the general character ‘S’. So called “Time-motion” is just the product of interval magnitude T in this space field and the proper time dynamic speed Y , just as below:

$$S = Y * T \quad \dots\dots\dots (I -i -1)$$

According to the principium of equivalent time effect, if we just denote the time dynamic speed of space field A as Y_A , and the time dynamic speed in space field B as Y_B , then we can arrive at the standard equivalent time definition equation as below:

$$Y_A * T_A = Y_B * T_B \quad \dots\dots\dots (I -i -2)$$

(In the equation above, T_A and T_B separately denote the interval recorded with the same clock in space field A and space field B.)

Generally, for some certain convenience, we usually choose the time dynamic speed in the space field near the earth surface Y_E to take the place of Y_A and just to choose standard time T to take the place of T_B , and thus T_B is just the standard equivalent time, we denote it as ‘ T_s ’, consequently, the equation above changes into:

$$Y_E * T_s = Y * T \quad \dots\dots\dots (I -i -3)$$

(In the equation “ Y ” denotes the time dynamic speed of the discretionary space field we study)

For some certain expedience, the equation above can be changed into style as below:

$$\lambda = T_s / T = Y_E / Y \quad \dots\dots\dots (I -i -4)$$

In the equation above, the symbol λ denotes “standard time equivalent coefficient”

As the change of the space field strength is generally consecutive, the magnitude of time rate is too consecutive thereby. As a result, the proper value range of λ is too consecutive, When we come to study the motion of matter in spacetime, as the change of the space field strength which matter depends on existing in is rather limited, the proper value range of λ is relatively narrow thereby.

——Firstly written in Dec. 1992, literal revision was done in Dec.1995

Supplemental note ③: “time” is just the integrative incarnation of dynamic transition and transmutation of field genic units in space field, and the essential physical quantity which directly represent the dynamic intensity and swiftness of mutual transition & transmutation of field genic units in space field is “time dynamic speed Y ”. And at the same time, the homologic filiation of spacetime and matter has predestined that PNT action is innative essence of matter, virtually, PNT action is not only original generation creation ($m = \int_0^1 [d(M \rightarrow m) - d(M \leftarrow m)] dt > 0$) but also dynamic origin of universal postnatal existence & motion of matter in spacetime, any matter integration inherently has absolute spacetime momentum as $mV = d(M \leftarrow m) * Y$, (among the equation, $d(M \leftarrow m)$ is the positive towards negative transmutation ratio, and “ Y ” is just the time dynamic speed of matter integration). This of course indicates that any matter integration with ingenerate absolute spacetime momentum $mV = d(M \leftarrow m) * Y$ can straightforwardly reflect the dynamic intensity and swiftness of mutual transition

As coherent natura naturans throughout cosmic evolution, instinctive PNT reciprocal equilibrium towards optimum PNT operation is radical potentiality & conditionality for cosmos always ready to orientate itself towards perfection.

& transmutation of field genic units in space field—swiftness of time. And virtually, when we practically come to define “time” of nature, we are usually expedient to adopt some certain ideal motion exemplar and define “time unit” according to the typical regular motion character especially the relatively steady periodic regular motion character.

However, throughout cosmic evolution, spacetime is in everlasting evolutionary proceeding in inconstant state through and through, which of course means dynamic intensity and swiftness of mutual transition & transmutation of field genic units in space field has no constant state throughout cosmic evolution—time dynamic speed (/swiftness of time) has no constant ever since, there is no standard time unit throughout cosmic evolution therefore.

In accordance with definition equation of absolute spacetime momentum $mV = d(M \leftarrow m) * Y$, since it’s impossible for time dynamic speed Y to be constant, it of course implies there is no possibility for absolute spacetime momentum of any matter integration to be constant, after all, both time dynamic speed Y and positive towards negative transmutation ratio are impossible to be constant. And as a result, there is no everlasting inertial motion in cosmos. In any case, if time dynamic speed of spacetime can be constant, under precondition there is no reciprocity among matter integration, the $d(M \leftarrow m)$, $d(M \rightarrow m)$, m of matter integration must be constant, as a result, “ $d(M \leftarrow m) * Y$ ” is constant, as $d(M \leftarrow m) * Y = mV$, absolute spacetime momentum of matter integration “ mV ” must be constant, even as “ m ” of matter integration is constant, “ V ” of matter integration must be constant, matter integration exists in constant inertial state. That’s to say, if time dynamic speed Y (/swiftness of time) of matter integration can be constant, there is “absolute standard time” and “absolute standard time unit” therefore, as long as there are no reciprocity among matter integration, all the free matter integration must exist in absolute inertial state.

All in all, cosmos is always in its ingenerate evolution, throughout which it’s impossible for time dynamic speed to be constant, as a result, there is no “standard time” and “standard time unit” in cosmos, there is no matter integration in everlasting inertial state in cosmos. Whereas, once human come to study idiographic existence & motion of matter in spacetime, for expedience of quantification of related physical quantity of proper physical process, we have to expediently introduce presumable notion of inertial reference frame, standard time and standard time unit.

And virtually, the so-called “standard time” in living application of human is defined according to connatural revolution of earth around sun and connatural rotation of earth itself under precondition we suppose the ambient spacetime of the earth is always constant, no matter whether there is tiny change of connatural revolution and connatural rotation of earth or not when the earth reaches different position in large-scale spacetime, we always confirm the time the earth finishes revolving a circle around the sun is “one year”, and we always confirm the time the earth finish rotating a circle itself is “one day”, which of course implicates $1 \text{ day} / 24 = 1 \text{ hour}$, $1 \text{ day} / (24 \times 60) = 1 \text{ minute}$, $1 \text{ day} / (24 \times 60 \times 60) = 1 \text{ second}$ in logic. Whereas, whether there is tiny change of connatural revolution and connatural rotation of earth or not when the earth reaches different position in large-scale spacetime practically complicates the “non-standard connotation” of standard time.

Of course, we can define “standard time” and “standard time unit” in accordance with any ideal motion of characteristic moving objects, such as connatural periodic libration of distinctive atoms under certain spacetime ambience, connatural vibration of single vibrator on surface of earth. As absolute spacetime momentum of any matter integration is subject to $mV = d(M \leftarrow m) * Y$ in rule of identity, the non-standard connotation of “standard time” & “standard time unit” is always equivalent.

(For expedience of explanation, the note introduced “absolute spacetime momentum” ahead of the text in general logic sequence of the monograph, if you are difficult to understand, please refer to more explanation of the related issues later.)

(I-ii-2) Connotation objectification of logic extension 2 of Homogenous cosmos originated from unique genesis postulate

Ultimate ascertainment of alternative homologic filiation between spacetime and matter leads to undeniable homologic generation of matter in homogenous cosmos

Abstract: *In accordance with logic extension 2 of Homogenous cosmos originated from unique genesis postulate—spacetime and matter are homologic filiation, matter homologic generation hypothesis goes a further step to exclude the filiation alternative possibility of “matter father” and “spacetime son” so as to lead to the positive homologic filiation between spacetime and matter, which straightforwardly means, along sequential homologic cosmogony, matter is homologic multiplication outgrowth in lineal succession of hylic spacetime when spacetime develops to well-rounded stage, —some space field genic units congealed into “crystal” format for extra-saturation of space field strength.*

Keywords: *matter homologic generation hypothesis, positive matter, elementary genic unit.*

(I-ii-2-a) Homologic generation of matter in homogenous cosmos

In accordance with logic extension 2 of Homogenous cosmos originated from unique genesis postulate, if cosmos is object fully embodied by hypostatic coexistence of spacetime and matter, nothing else, along sequential homologic cosmogony starting at the so-called common cosmic extremity genesis to cosmic status quo, “spacetime” and “matter” must be alternative homologic filiation either “**spacetime father & matter son**” or “**matter father & spacetime son**”.

Of course, It's easy for us to comprehend that homologic filiation between spacetime and matter apparently implies filiation alternative of “spacetime father, matter son” and “spacetime son, matter father”. However, cosmic authenticity can only be unique. What's the definite homologic filiation between spacetime and matter on earth? — “spacetime father and matter son” or “matter father and spacetime son”?

In accordance with logic extension 2 of Homogenous cosmos originated from unique genesis postulate, if cosmos is object fully and exactly embodied by hypostatic existence of both spacetime and matter, nothing else, along original sequential homologic cosmogony starting at the so-called common cosmic extremity genesis to cosmic status quo, “spacetime” and “matter” must be lineal homologic filiation. However, what's the definite homologic filiation between spacetime and matter on earth? Are the spacetime father and the matter son or are the matter father and the spacetime son?

Considering the solid authenticity of nature that matter exists in spacetime, we exclude the alternative possibility of homologic filiation of matter father and spacetime son. Because if the matter is father and spacetime is son really, before birth of the “son”, where can the “father” exist and how to motion without spacetime? It's obviously incompatible against the actuality that matter exists and motions in spacetime. Whereas, if spacetime is father and matter is the son (sequential homologic cosmogony outgrowth of spacetime), it obviously seems compatible to the actuality that matter exists and motions in spacetime according to general behavioral logic sequence. Resultingly, we can affirm matter homologic generation as Matter homologic generation hypothesis as below according to alternative clarification of homologic filiation between spacetime and matter:

It's hypothesized that, **along sequential homologic cosmogony, matter is lineal homology behind hylic**

As coherent natura naturans throughout cosmic evolution, instinctive PNT reciprocal equilibrium towards optimum PNT operation is radical potentiality & conditionality for cosmos always ready to orientate itself towards perfection.

spacetime when spacetime develops to well-rounded stage, — some space field genic units congealed into “crystal” formation for extra-saturation of space field.

This of course implies, on the basis of integrative precondition of “homogenous cosmos originated from unique genesis + spacetime-matter fully embodying cosmos”, matter homologic generation hypothesis is further logic outcome of alternative clarification of homologic filiation between spacetime and matter by excluding alternative possibility of homologic filiation of matter father and spacetime son.

Till now, the logic proliferation of Homogenous Cosmos Originated from Unique Genesis is as below:

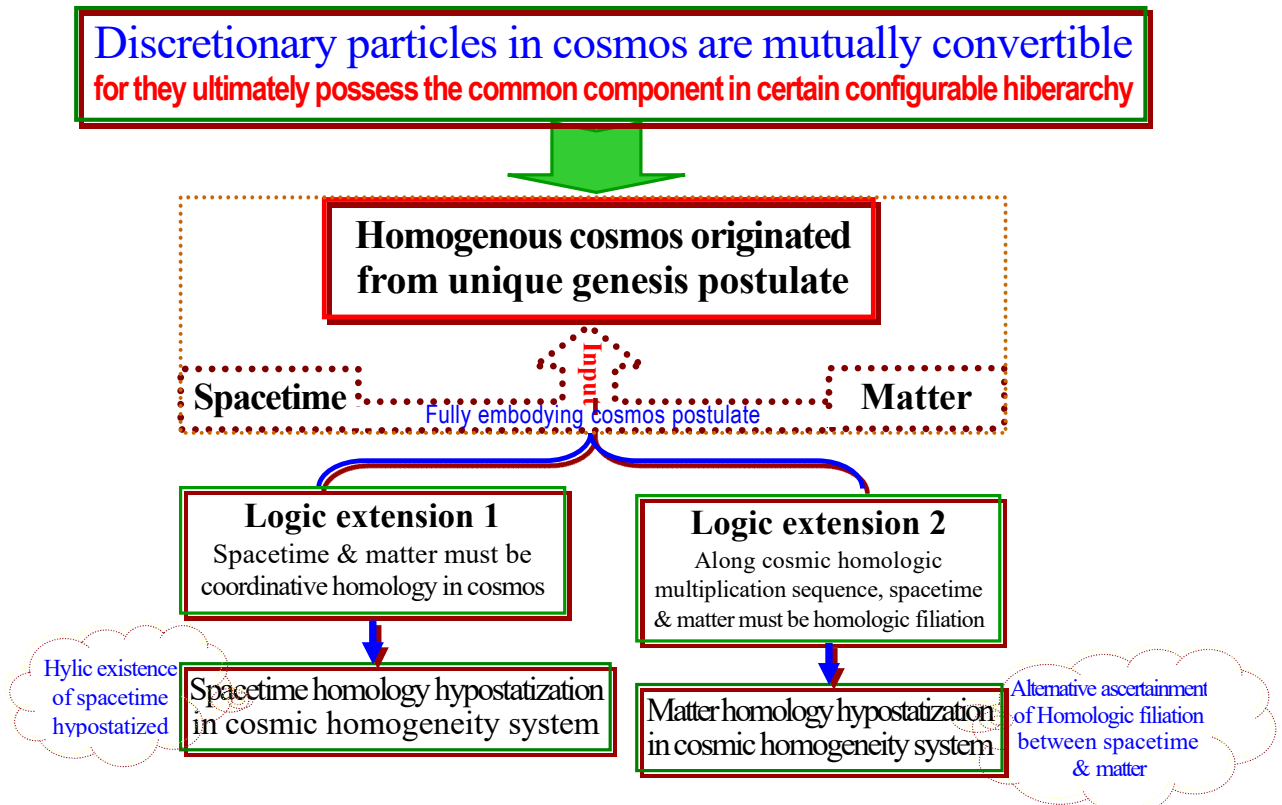

—Firstly written in Dec. 1992, literal revision was done in Jan. 2009.

Appendix:

Acknowledgement about introduction of two special nouns of “dark matter” and “baryonic matter” to Homogenous Cosmos Originated from Unique Genesis

This morning (a.m. 8:00, 2009-10-28), when I watched CCTV morning news, I knew the modern physics exploration pursuit is demonstration of “dark matter”. Of course, dark matter research had nothing to do with me, it's unnecessary for me to be spoffish. However, once I heard the proper description about dark matter the announcer offered, my sensibility was almost impacted by a lightning in a sudden, I was astonished that the so-called “dark matter” was too familiar to me, as if the announcer announced something of mine.

No, it's impossible! But what's the magic trouble?

I immediately turned to research the related information on Baidu web site with word “dark matter” and procured some related information about dark matter immediately. I found the so-called “dark matter” the authors mentioned in their papers was very similar to the “negative matter” I mentioned in Homogenous Cosmos Originated from Unique Genesis. The dark matter embracers think cosmos consists of “dark matter” and “baryonic matter”, whereas Homogenous Cosmos Originated from Unique Genesis persists in that cosmos consists of “negative matter” and “positive matter”. Although the wording and thought origin between dark matter, baryonic matter and negative matter, positive matter are obviously different, their practical connotations of the both are so similar. The remarkable discrepancy is only that Homogenous Cosmos Originated from Unique Genesis confirms negative matter and positive matter making up of integrative cosmic homogeneity system, and as negative matter (spacetime) and positive matter fully embodying homogenous cosmos, both negative matter & positive matter are coordinative homology in homologic filiation that positive matter are progressional outgrowth of negative matter. And inherently, positive matter keeps positive & negative transmutation relation (PNT action) with negative matter for their innate lineal homology. Subsequently, Homogenous Cosmos Originated from Unique Genesis introduces “Instinctive PNT equilibrium postulate” and analyzes & formulates existence & motion of matter in spacetime based on “PNT action + instinctive PNT equilibrium” of matter integration, so that it accomplishes PNT dynamics accordingly.

And virtually, the practical demonstration of hylic existence of space field I mentioned in the section of “Further verification & demonstration of Homogenous Cosmos Originated from Unique Genesis” (which was originally written in 2004) was really similar as experimental exploration of dark matter.

As unexpected duplicate, I immediately operated my manuscript of Homogenous Cosmos Originated from Unique Genesis as following:

1) I took out the “search and replacement” dialog, in the search content bar, I input “negative matter”, and in replacement bar, I input “negative matter/dark matter”, then choose “all replaced”.

2) I took out the “search and replacement” dialog, in the search content bar, I input “positive matter”, and in replacement bar, I input “positive matter/baryonic matter”, then choose “all replaced”.

I hope intelligent attention can be paid to the duplicate between Homogenous Cosmos Originated from Unique Genesis and dark matter theory.

2009-10-28, a.m. 10, Guangdong, chaoan, tiepu

Reference coming from

<http://bolide.lamost.org/articles/article18.htm> 《暗物质研究的曙光/Dawn of dark matter exploration》

<http://bolide.lamost.org/articles/article7.htm> 《寻找暗物质/Dark matter exploration》

<http://bolide.lamost.org/articles/article133.htm> 《暗物质粒子发现在即/Dark matter particle will be found soon》

As coherent natura naturans throughout cosmic evolution, instinctive PNT reciprocal equilibrium towards optimum PNT operation is radical potentiality & conditionality for cosmos always ready to orientate itself towards perfection.

(I-ii-3) Sum-up of connotation objectification of two logic extensions of Homogenous cosmos originated from unique genesis postulate

Abstract: *The throughout logic extension of Homogeneous Cosmos Originated from Unique Genesis is but logic expansion of Homogenous cosmos originated from unique genesis postulate with supplementation of two 0.5 grade auxiliary postulates of “spacetime~matter fully embodying cosmos postulate” and “Instinctive PNT equilibrium postulate”. Although, ostensibly, connotation objectification of the two logic extensions of Homogenous cosmos originated from unique genesis postulate brings out three more postulates of “space genic field hypothesis”, “Phantasmal field genic unit hypothesis” and “matter homologic generation hypothesis”, virtually, “space genic field hypothesis”, “Phantasmal field genic unit hypothesis” and “matter homologic generation hypothesis” are but exchange output from two logic extensions of Homogenous cosmos originated from unique genesis postulate as exchange from money to material goods. In a straightforward word, the two logic extensions of Homogenous cosmos originated from unique genesis postulate is but money derived from “cosmos is throughout homogenous + spacetime~matter fully embodies cosmos”, and connotation objectification of two logic extensions of Homogenous cosmos originated from unique genesis postulate is just manner to change the money into goods, so that it’s more applicable and expedient for us to study more.*

(I-ii-3-a) Logic outspread constitution of “Homogenous cosmos originated from unique genesis + spacetime~matter fully embodying cosmos”.

As broken down representation of connotation objectification of logic extensions of “Homogenous cosmos originated from unique genesis + spacetime~matter fully embodying cosmos”, “space genic field hypothesis”, “phantasmal genic unit hypothesis” and “matter homologic generation hypothesis” have to maintain their “hypothesis” identities. Above all, Homogenous cosmos originated from unique genesis postulate derived from newly highlighted factuality of discretionary particles in cosmos are mutually convertible, although the conclusion of the very factuality is apparently in permanent clarification orientation towards complete induction but still out of complete induction at present. As a result, Homogenous cosmos originated from unique genesis postulate can only be introduced as a sensible postulate with pioneering intrepidity. And what’s more, “space genic field hypothesis”, “phantasmal genic unit hypothesis” and “matter homologic generation hypothesis” are but broken down representation of connotation objectification of Homogenous cosmos originated from unique genesis postulate with supplementation of spacetime~matter fully embodying cosmos postulate, the broken down situation is rather similar as we can break down human body as “human body = head + the body + purtenance + extremities”. Of course, we can also introduce similar equation to represent the broken down “connotation objectification of Homogenous cosmos originated from unique genesis postulate with supplementation of spacetime-matter fully embodying cosmos postulate” as below:

$$\begin{aligned} & \text{Homogenous cosmos originated from unique genesis postulate} + \text{Spacetime-matter fully embodying cosmos postulate} \\ & \approx \text{Logic extension 1 of Homogenous cosmos originated from unique genesis postulate} + \text{Logic extension 2 of} \\ & \quad \text{Homogenous cosmos originated from unique genesis postulate} \\ & \approx (\text{space genic field hypothesis} + \text{Phantasmal field genic unit hypothesis}) + \text{matter homologic generation hypothesis} \end{aligned}$$

In terms of logic outspread constitution of “Homogenous cosmos originated from unique genesis + spacetime~matter fully embodying cosmos”, something I have emphasize herein is that the precondition of

logic extension 1 of Homogenous cosmos originated from unique genesis is “cosmos is homogenous originated from unique genesis + spacetime & matter are all belonging to cosmos”, however, I only mention “spacetime~matter fully embodying cosmos” in above equation, but do not mention “spacetime & matter are coequally belonging to cosmos”, because, in logic connotation, “spacetime & matter are all belonging to cosmos” covers the logic connotation of “spacetime & matter are all belonging to cosmos” 100 over 100. And just because of this, many occasions, I only mention “spacetime~matter fully embodying cosmos” without “spacetime & matter are all belonging to cosmos”.

Upon strict sense, throughout radical objectification & highlight of homologic attribute of spacetime & matter, homologic filiation between spacetime & matter and existence & motion of matter in cosmos, Homogenous Cosmos Originated from Unique Genesis totally introduced “**(1.0 + 0.5)+ 0.5**” postulates. In another words, in order to illuminate cosmic homologic profile and consequential universal existence & motion in cosmos, Homogenous Cosmos Originated from Unique Genesis introduced a couple cosmic mould cavities of Homogenous cosmos originated from unique genesis postulate, an accessorial slide of spacetime~matter fully embodying cosmos postulate and a dynamic soul of Instinctive PNT equilibrium postulate.

The so-called “**1**” postulate is just the prime precondition of **Homogenous cosmos originated from unique genesis postulate**, which is just the couple cosmic mould cavities and the logic origin of the whole subject. In a straightforward word, all contents about homologic existence & motion of matter in cosmos introduced in the monograph are but logic extension of the very postulate with supplementation of two “0.5” grade postulates.

The first “**0.5**” grade auxiliary postulate is just the “**Spacetime~matter fully embodying cosmos postulate**”, it's a coordinative supplemental postulate like an accessorial slide of the couple mould cavities of Homogenous cosmos originated from unique genesis postulate, which hypothesizes spacetime and matter fully embody the entire cosmos, besides spacetime and matter, nothing else coordinative is existent in cosmos. The supplemental introduction of “Spacetime~matter fully embodying cosmos postulate” directly make integrative precondition of “homogenous cosmos originated from unique genesis + spacetime~matter fully embodying cosmos” logically extendable, and two logic extensions of Homogenous cosmos originated from unique genesis postulate are deduced thereby.

The second “**0.5**” grade accessorial postulate is “**Instinctive PNT equilibrium postulate**”——dynamic soul of cosmos. The reason I call it the second “**0.5**” grade accessorial postulate is but because it's a supplemental postulate for consummate linkage & transition from logic extension and connotation objectification of “homogenous cosmos originated from unique genesis + spacetime~matter fully embodying cosmos” to definite “existence & motion of matter” in cosmos.

Once logic extension and proper connotation objectification of “homogenous cosmos originated from unique genesis + spacetime~matter fully embodying cosmos” approaches ascertainment of alternative homologic filiation between spacetime and matter, as long as we can exclude possibility of “**matter father & spacetime son**”, “**spacetime father & matter son**” is unique possibility, homologic generation of matter in cosmos is self-evident. And homologic filiation between spacetime and matter directly indicates presence of PNT action, PNT action is not only headspring creation of original generation of matter along sequential homologic cosmogony but also dynamic origin of postnatal existence & motion of matter in spacetime, which apparently indicates existence & motion of matter undeniably root in PNT action of matter integration.

However, what magic action is PNT action on earth?

In any case, it's absolutely impossible for PNT action to be blackguardly action of the demiurge. Since PNT action radically determines existence & motion of matter, there must be some definite dynamic fundamental of PNT action underlying which indicates sense of the demiurge, otherwise, there is no way for cosmos to be so well-regulated. Whereas, to my despair, it's almost impossible for me to ascertain the definite dynamic fundamental of PNT action underlying off the cuff, but to suppose it may be generally "instinctive PNT equilibrium" according to remarkable experiential factuality around after confusion for a long time.

Virtually, only the supplemental introduction of "Instinctive PNT equilibrium postulate" can consummate the rational transition from logic extension and proper connotation objectification of "**Homogenous cosmos originated from unique genesis + Spacetime~matter fully embodying cosmos**" to definite "existence & motion of matter" in cosmos, —spontaneous optimization of PNT action of matter integration in the nature of instinctive PNT reciprocal equilibrium towards optimum PNT operation.

The integrative logic constitution of logic extension in logic model of "**(1.0 + 0.5) + 0.5**" is generally as below:

(Homogenous cosmos originated from unique genesis postulate + spacetime~matter fully embodying cosmos postulate)
+ Instinctive PNT equilibrium postulate
 \approx **(Logic extension 1 of Homogenous cosmos originated from unique genesis postulate + Logic extension 2 of Homogenous cosmos originated from unique genesis postulate) + Instinctive PNT equilibrium postulate**
 \approx **[(spacetime genic field hypothesis + Phantasmal field genic unit hypothesis) + Matter homologic generation hypothesis] + Instinctive PNT equilibrium postulate**
 \approx **Spontaneous occurrence as dynamic mirror of "PNT action + Instinctive PNT equilibrium" of matter integration under integrative background of homogenous cosmos originated from unique genesis**
= Vivid existence & motion of matter in cosmos under integrative background of homogenous cosmos originated from unique genesis.

(I-ii-3-b) Elementary genic components and their distinctive existence & motion in spacetime

Just the same as physical existence of hylic spacetime, physical existence of positive matter must have its connatural elementary genic components too, and since positive matter is progressional outgrowth of homologic multiplication along cosmic demiurgic evolution behind of hylic spacetime, the elementary genic components of matter must be successive genic unit series of space field genic units $i_0, i_1, i_2, \dots, i_n (n \in \mathbb{N})$. So we can expediently denote the elementary genic units of positive matter as successive extension of space field genic unit series $i_0, i_1, i_2, \dots, i_n (n \in \mathbb{N})$, which can be expressed as $i_{n+1}, i_{n+2}, i_{n+3}, \dots, i_{n+p}, (n, p \in \mathbb{N})$, and we just call them elementary genic units, so-called "elementary genic units" are just the elementary components of positive matter.

Cosmos consists of spacetime and matter, the space field genic units $i_0, i_1, i_2, \dots, I_n (n \in \mathbb{N})$ and elementary genic units $i_{n+1}, i_{n+2}, i_{n+3}, \dots, i_{n+p}, (n, p \in \mathbb{N})$ form integrative sequential homologic genic unit series $i_0, i_1, i_2, \dots, i_n, i_{n+1}, i_{n+2}, i_{n+3}, \dots, i_{n+p}, (n, p \in \mathbb{N})$. This not only implies cosmos is throughout homogenous originated from unique genesis, but also indicates the homologic lineage of spacetime and matter, so the integrative sequential genic unit series of $i_0, i_1, i_2, \dots, i_n, i_{n+1}, i_{n+2}, i_{n+3}, \dots, i_{n+p}, (n, p \in \mathbb{N})$ can even be regarded as the symbolic denotation of homogenous cosmos originated from unique genesis.

The initial generation of elementary genic units in spacetime is similar as crystal congealed from the proper extra-saturated solution. Once the space field strength gradually strengthen, space field genic units in

space field will transit and transmute towards elementary genic units faster than elementary genic units transit and transmute towards space field genic units, some of the field genic units will transit and transmute into elementary genic units, and more mass residue of positive matter occurred thereby. And subsequently, coexistent elementary genic units will gradually converge in the nature of instinctive PNT reciprocal equilibrium towards optimum PNT operation by the light of nature (by reciprocity of strong interaction, weak interaction, electromagnetic force, gravity) so as to form rich and colorful reciprocal PNT combinations and exist as macroscopic objects with idiographic physical embodiment but not like space field genic units existing in phantasmal state and weak in idiographic physical embodiment of themselves.

And at the same time, the relatively independent physical esse of positive matter in spacetime still implies further strengthening of space field won't remarkably impact the mechanism of spacetime any longer, but more sensitively impacts mass residue and related existent status of matter in spacetime. This of course implies, after matter comes into being in spacetime, the development of spacetime has approached its terminal.

Of course, if the space field strength arises weakening tendency, transition & transmutation of elementary genic units towards space field genic units will sensitively be more expedient than transition & transmutation of space field genic units towards elementary genic units so as to retard the weakening tendency of space field strength, and mass residue of positive matter will proportionally decrease thereby. That's to say, the generation of matter in spacetime is reversible, since matter can generate under proper spacetime conditions, once the proper spacetime conditions are gradually tenuated or degenerated, mass residue of positive matter will proportionally decrease till at last it exhausts in spacetime completely.

——Firstly written in Dec. 1992, literal revision was done in Dec. 1995

The Second Part

Freewheeling Logic Extension of Connotation Objectification of Homogenous Cosmos Originated from Unique Genesis —PNT Dynamics

Introduction: As primary clarification of homologic essence of spacetime and matter especially homologic filiation between spacetime and matter, we come to highlight dynamic regularity of existence & motion of matter in spacetime. Following the logic extension as illustration below:

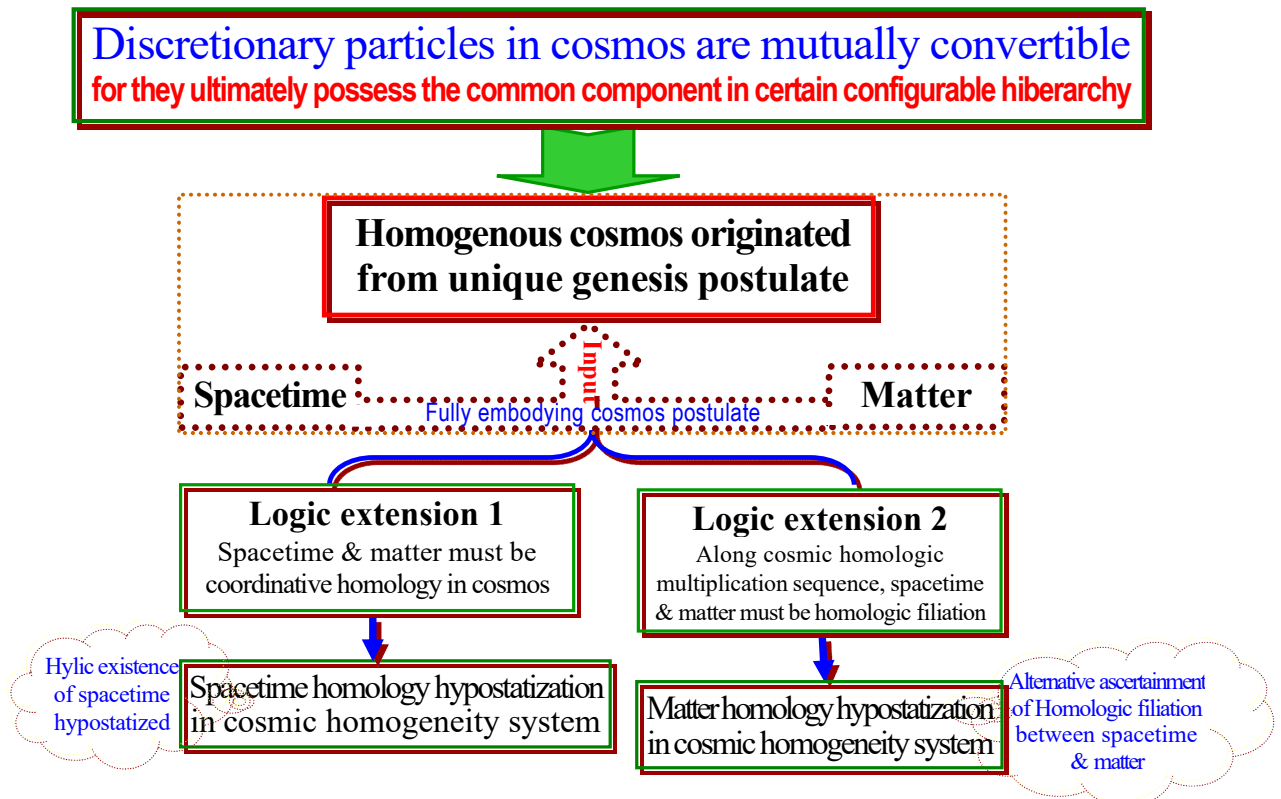

Historical progress of science in the recent several centuries seemed like a far-flung exploration of the first itinerary around numerous distinctive landscapes of brand-new landmasses of science with palette & tablet on back, several hundred years' scientific travelogues were compiled thereby.

Homogenous Cosmos Originated from Unique Genesis emphatically focus the lineal homologic filiation between spacetime and matter——PNT action with inherent instinctive PNT equilibrium to analyze and formulate existence & motion of matter in spacetime so as to expand logic extension of “Homogenous cosmos originated from unique genesis postulate” as below:

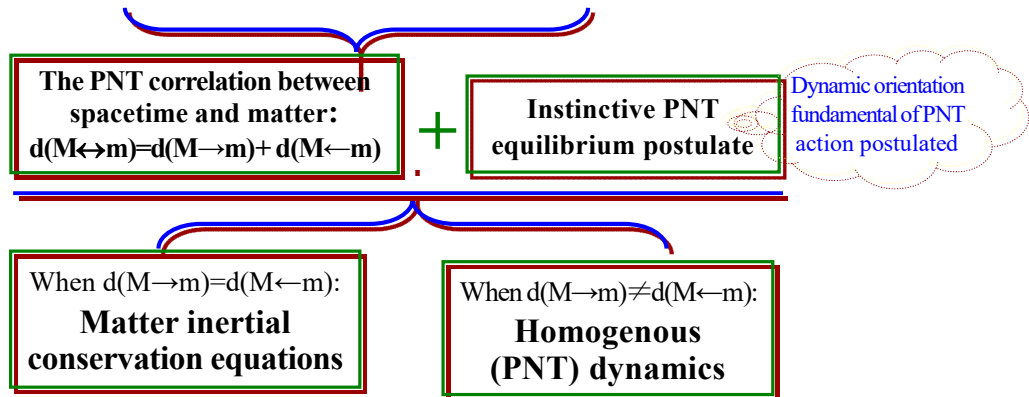

Throughout evolution of homogenous cosmos, PNT action is not only headspring demiurgic action of original generation of matter along sequential homologic cosmogony but also dynamic origin of postnatal existence & motion of matter in spacetime, which of course indicates existence & motion is but vivid dynamic enantiomorphous incarnation of PNT action with equilibrium instinct of matter integration in spacetime.

For analytic expedience, Homogenous Cosmos Originated from Unique Genesis classifies PNT performance into two typical cases of $d(M\rightarrow m)=d(M\leftarrow m)$ and $d(M\rightarrow m)\neq d(M\leftarrow m)$ and analyzes & formulates the proportionate existence & motion of matter in spacetime accordingly. As a result, in accordance with PNT performance case of $d(M\rightarrow m)=d(M\leftarrow m)$, “Matter Inertial Conservation Equations” are formulated therein; in accordance with PNT performance case of $d(M\rightarrow m)\neq d(M\leftarrow m)$, PNT Dynamics is formulated thereby. And finally, it introduced “space distance and space radiation cornu” as successive complement of space field hypothesis at the volley.

(II-i) Original generation of matter in the nature of coherent natura naturans brings out essence of matter in a class by itself; essence of matter in a class by itself predestines thorough coherence of dynamic regularity of universal existence & motion

Abstract: *When logic extension and proper connotation objectification of “homogenous cosmos originated from unique genesis + spacetime~matter fully embodying cosmos” approaches ascertainment of alternative homologic filiation between spacetime and matter, as long as we can exclude alternative possibility of matter father and spacetime son, homologic generation of matter in cosmos is self-evident. Homologic generation of matter in the nature of constant demiurgic fundamental in cosmos congenitally brings out essence of matter in a class by itself—PNT action of matter integration, and essence of matter in a class by itself radically predestines thorough coherence of dynamic regularity of universal existence & motion, —existence & motion is but spontaneous occurrence in the nature of essence of matter in a class by itself. At any rate, PNT action is not only headspring creation of original generation of matter along sequential homologic cosmogony but also dynamic origin of postnatal existence & motion of matter in spacetime, which of course indicates existence & motion is but vivid enantiomorphous incarnation of PNT action of matter integration. And once PNT action is endued dynamic fundamental of “instinctive PNT equilibrium”, so-called “matter motion” is but spontaneous optimization of PNT action of matter integration in the nature of instinctive PNT reciprocal equilibrium towards optimum PNT operation —spontaneous occurrence in the nature of essence of matter in a class by itself as dynamic enantiomorph of PNT action of matter integration, universal existence & motion are consequently endued soul.*

All in all, considered by Homogenous Cosmos Originated from Unique Genesis, mathematical formulation of existence & motion of matter in cosmos is but mathematical formulation of spontaneous occurrence of “PNT action + instinctive PNT equilibrium” of matter integration. Towards the very scientific highlight, we are ready to accomplish mathematical formulation of spontaneous occurrence of “PNT action + instinctive PNT equilibrium” step by step as following:

I) *Introduce mathematical symbols of mass of “positive matter & matter field” of matter integration, —we denote mass of positive matter “m” and denote mass of matter field “M”. Subsequently, we introduce symbolic representation of quantitative PNT action (quantitative positive & negative transmutation) of matter integration as below:*

i-1) *We introduce symbolic representation of negative towards positive transmutation “M→m”.*

And we denote the negative towards positive transmutation rate “d(M→m)”.

i-2) *We introduce symbolic representation of positive towards negative transmutation “M←m”.*

And we denote the positive towards negative transmutation rate “d(M←m)”.

i-3) *We introduce symbolic representation of bidirectional positive & negative transmutation of matter integration “M↔m”.*

And we denote the bidirectional positive & negative transmutation rate of matter integration “d(M↔m)”.

Of course, d(M↔m), d(M→m), d(M←m) satisfy equation d(M↔m)=d(M→m)+d(M←m).

II) *Homogenous Cosmos Originated from unique Genesis primarily confirms any matter integration innately has absolute spacetime momentum “mV=d(M←m)*Y”, then, it analyzes the ingenerate correlation between PNT action and existence & motion of matter and primarily offers physical definitions of “matter existence” and “matter motion”.*

Keywords: *matter integration, matter field, matter field strength, positive & negative transmutation, negative towards positive transmutation rate, positive towards negative transmutation rate, positive & negative transmutation rate, Instinctive PNT equilibrium postulate, motion, absolute spacetime momentum, utmost speed of matter motion in spacetime, existence of matter, motion of matter.*

1. Homologic essence of matter and primary quantification of homologic essence of matter

“Physical Regularity” is but vivid essence objectification of matter in universal existence & motion, which is of course subject to law of identity throughout cosmos, after all, it's only possible for essence of matter to be universal inherence in a class by itself. At any rate, original generation of matter in the nature of coherent natura naturans brings out essence of matter in a class by itself, original generation of matter as lineal homology of spacetime in homogenous cosmos must be subject to rule of identity beyond all doubt.

When logic extension and proper connotation objectification of “homogenous cosmos originated from unique genesis + spacetime~matter fully embodying cosmos” approaches ascertainment of alternative homologic filiation between spacetime and matter, once we exclude possibility of “matter father & spacetime son”, homologic generation of matter in cosmos is self-evident. In detailed words, in accordance with logic extension 1 of Homogenous cosmos originated from unique genesis postulate, space field hypothesis hypostatize both hylic & dynamic essence of spacetime as coordinative homology of matter; and in accordance with logic extension 2 of Homogenous cosmos originated from unique genesis postulate, matter homologic generation hypothesis hypostatize the homologic filiation between spacetime and matter after excluding the alternative possibility of matter father & spacetime son, so that matter generation is self-evident, even consequent PNT action between spacetime and matter become successive freewheeling.

In accordance with inherence of homologic filiation between spacetime and matter, we call the integrative combination making up of related spacetime and proper positive matter in living relation of PNT action “**matter integration**”. And we call the proper related local spacetime “matter field” and denote mass of it “M”, we call the related local positive matter “matter” and denote mass of it “m” .

Matter as progressional homologic outgrowth of hylic spacetime, homologic generation of matter in homogenous cosmos of course implies that field genic units in extra-saturated space field can transit and transmute into elementary genic units, this of course means mass of matter field “M” are able to transit and transmute into mass of positive matter “m”, for expression expedience, we just call the dynamic process mass of matter field M transit and transmute into mass of positive matter of matter integration “negative towards positive transmutation” , and we symbolize negative towards positive transmutation “ $M \rightarrow m$ ” .

And at the same time, since “spacetime” and “matter” coexist in cosmos as lineal homologic coordinators equally, mass M of matter field can transit and transmute into mass of positive matter m, we can of course draw our positive conclusion that mass m of positive matter must be able to transit and transmute into mass M of space field too, otherwise, cosmic evolution must lead to extremity—as more and more mass M of space field transit and transmute into mass m of positive matter, hylic spacetime will be less and less day by day as long as the cosmos is limited, til at last, there are only positive matter in cosmos but no spacetime any longer. We call the mass m of positive matter transit and transmute into mass M of matter field “positive towards negative transmutation”, and we symbolize positive towards negative transmutation “ $M \leftarrow m$ ”.

As coherent natura naturans throughout cosmic evolution, instinctive PNT reciprocal equilibrium towards optimum PNT operation is radical potentiality & conditionality for cosmos always ready to orientate itself towards perfection.

Since “spacetime” and “matter” can coequally coexist in cosmos and make cosmos in relatively steady status, negative towards positive transmutation and positive towards negative transmutation must be coexisting bidirectional transmutation of matter integration. For expressional expedience, we just call the bidirectional coexistence of negative towards positive transmutation and positive towards negative transmutation “positive & negative transmutation”, and we symbolize positive & negative transmutation as “ $M \leftrightarrow m$ ”.

Of course, no matter it is negative towards positive transmutation or positive towards negative transmutation or positive & negative transmutation, since they are living dynamic processes, there must be dynamic intensity or speed disparity of their dynamic status. In order to formulate the dynamic intensity or speed of negative towards positive transmutation, positive towards negative transmutation and positive & negative transmutation, we introduce notion of “negative towards positive transmutation rate” to represent the rate of negative towards positive transmutation and symbolize it as “ $d(M \rightarrow m)$ ”; we introduce notion of “positive towards negative transmutation rate” to represent the rate of positive towards negative transmutation and symbolize it as “ $d(M \leftarrow m)$ ”; we introduce notion of “positive & negative transmutation rate” to represent the rate of positive & negative transmutation and symbolize it as “ $d(M \leftrightarrow m)$ ”.

Apparently, as “positive & negative transmutation $M \leftrightarrow m$ ” just consists of “negative towards positive transmutation $M \rightarrow m$ ” and “positive towards negative transmutation $M \leftarrow m$ ”, proportionably, “positive & negative transmutation rate $d(M \leftrightarrow m)$ ” of course consists of “negative towards positive transmutation rate $d(M \rightarrow m)$ ” and “positive towards negative transmutation rate $d(M \leftarrow m)$ ” too, which of course implies $d(M \leftrightarrow m)$, $d(M \rightarrow m)$ and $d(M \leftarrow m)$ satisfy equation as below:

$$d(M \leftrightarrow m) = d(M \rightarrow m) + d(M \leftarrow m) \quad \dots \dots \dots \quad (\text{II-i-1})$$

2. Existence & motion is spontaneous occurrence in the nature of “instinctive PNT reciprocal equilibrium towards optimum PNT operation”, which is virtually dynamic mirror of “PNT action + instinctive PNT equilibrium” of matter integration.

2.1. Distinctive existence & motion of positive matter in spacetime relative to space field genic units.

Radically, existence of positive matter in spacetime can embody distinctive steady existent selfhood radically depends on relative progression situation of transition & transmutation of the compositive elementary genic units of positive matter in spacetime.

In terms of existence of field genic unit in spacetime, before involvement of transition and transmutation, any field genic unit is physical esse of selfhood, once the field genic units involve transition & transmutation in space field, they immediately change into different field genic units and lose selfhood consequently, which is just dynamic hypostatization of time. This of course implies normal existence of any field genic in spacetime is absolutely erratic, nothing is effective for field genic unit to embody perceivable idiographic existent selfhood in time current, so that it’s completely impossible for us to ascertain any definite existent selfhood of certain field genic unit in spacetime.

Relative to field genic units in space field, mass of elementary genic units is remarkably massive, once they involve positive & negative transmutation in space field, elementary genic units can always maintain relatively steady selfhood of physical esse of relatively steady mass residue, definite motion orientation, PNT operational configuration and geometrical profile. In essence, positive matter made up of elementary genic units can embody distinctive selfhood of physical esse in spacetime depends on situation that mutual transmutation & transition

between compositive elementary genic units of positive matter and accessible space field genic units in space field are much more retarded than spontaneous transmutation & transition among field genic units in spacetime.

That's to say, once transition & transmutation between elementary genic units and field genic units is spontaneously implemented, it above all implies coexistence of bidirectional transition & transmutation of negative towards positive transmutation from field genic units to elementary genic units and positive towards negative transmutation from elementary genic units to field genic units, then the coexistence of bidirectional transition & transmutation satisfies cumulation of negative towards positive transmutation from field genic units to elementary genic units $\int_0^t d(M \rightarrow m) dt$ - cumulation of positive towards negative transmutation from elementary genic units to field genic units $\int_0^t d(M \leftarrow m) dt = \text{mass residue of elementary genic units } m \geq 0$, which just means the throughout quantitative change of PNT action satisfies:

$$\int_0^t d(M \rightarrow m) dt - \int_0^t d(M \leftarrow m) dt = m \geq 0$$

(Note: in above equation, we introduce "m ≥ 0" instead of "m > 0" only means we still can not exclude the possibility there may be a tiny alternation throughout the quantitative change process the quantity of mass is 0)

Virtually, this is just original generation of matter in cosmos——original generation of elementary genic units based on extra-saturated space field in cosmos.

And normal existence of elementary genic units in spacetime means, in terms of certain certain matter integration, the integrative existent situation of cumulation of negative towards positive transmutation from field genic units to elementary genic units $\int_0^t d(M \rightarrow m) dt$ - cumulation of positive towards negative transmutation from elementary genic units to field genic units $\int_0^t d(M \leftarrow m) dt = \text{mass residue of elementary genic units } m \geq 0$ is maintained as idiographic physical process, so that existence of the proper elementary genic units in spacetime can embody definite selfhood of existent features of mass scale, motion orientation, PNT operational configuration and geometrical profile.

Initial generation of elementary genic units of course indicates naissance of positive matter in spacetime, whereas, well-rounded generation and formation of positive matter is not only limited in initial generation of elementary genic units in spacetime, it even involves serial reciprocal convergent combination among mutually available elementary genic units, elementary genic units and the primary convergent combinations of elementary genic units, even idiographic primary convergent combinations of elementary genic units and idiographic primary convergent combinations of elementary genic units towards rich and colorful reciprocal PNT combinations. We emphasize the characteristic existent features of positive matter relative to field genic units generally implicates the relatively steady distinctive features of positive matter of definite mass scale, motion orientation, PNT operational configuration and geometrical profile and so on.

In time current, distinctive existence & motion of independent elementary genic units are just distinctive substantiation the proper scale PNT action satisfies integral cumulation of negative towards positive transmutation from field genic units to elementary genic units $\int_0^t d(M \rightarrow m) dt$ - integral cumulation of positive towards negative transmutation from elementary genic units to field genic units $\int_0^t d(M \leftarrow m) dt = \text{physical selfhood esse of elementary genic units (total mass residue } m \geq 0)$ is maintained in relatively steady idiographic succession ever since.

... ..

In time current, distinctive existence & motion of molecule, neutron, proton, electron, ..., quark are just

distinctive substantiation the proper scale PNT action satisfies integral cumulation of negative towards positive transmutation from field genic units to elementary genic units $\int_0^t d(M \rightarrow m) dt$ - integral cumulation of positive towards negative transmutation from elementary genic units to field genic units $\int_0^t d(M \leftarrow m) dt$ = physical selfhood esse of molecule, neutron, proton, electron, ..., quark (total mass residue $m > 0$) is maintained in relatively steady idiographic succession ever since.

... ..

In time current, distinctive existence & motion of earth is just distinctive substantiation the earth scale PNT action satisfies integral cumulation of negative towards positive transmutation from field genic units to elementary genic units $\int_0^t d(M \rightarrow m) dt$ - integral cumulation of positive towards negative transmutation from elementary genic units to field genic units $\int_0^t d(M \leftarrow m) dt$ = physical selfhood esse of earth (total mass residue $m > 0$) is maintained in relatively steady idiographic succession ever since.

... ..

In time current, distinctive existence & motion of Milk Way is just distinctive substantiation the Milk Way scale PNT action satisfies integral cumulation of negative towards positive transmutation from field genic units to elementary genic units $\int_0^t d(M \rightarrow m) dt$ - integral cumulation of positive towards negative transmutation from elementary genic units to field genic units $\int_0^t d(M \leftarrow m) dt$ = physical selfhood esse of Milk Way (total mass residue $m > 0$) is maintained in relatively steady idiographic succession ever since.

... ..

In time current, distinctive existence & motion of Cosmic status quo is just distinctive substantiation the cosmic scale PNT action satisfies integral cumulation of negative towards positive transmutation from field genic units to elementary genic units $\int_0^t d(M \rightarrow m) dt$ - integral cumulation of positive towards negative transmutation from elementary genic units to field genic units $\int_0^t d(M \leftarrow m) dt$ = physical selfhood esse of Cosmic status quo (total mass residue $m > 0$) is maintained in relatively steady idiographic succession ever since.

Thus, it's easy for us to see idiographic existence of matter is but connatural substantiation as physical esse of cosmos in time current ever since,; integrative existence of Milk Way is but connatural substantiation as physical esse of Milk Way in time current ever since;; integrative existence of earth is but connatural substantiation as physical esse of earth in time current ever since;; distinctive existence of any particle is but connatural substantiation as physical esse of particle in time current ever since; Even in terms of single independent elementary genic unit in spacetime, although the existence of single independent elementary genic unit in spacetime is usually inconstant in waveform motion, even at some certain tiny interval of the proper wave period, its mass residue may be zero, whereas, throughout the wave period, the round existence as physical esse of a single independent elementary genic unit in spacetime is still relatively constant, as long as the external spacetime condition is relatively constant. In another word, as long as the external spacetime is relatively constant, The PNT action of independent elementary genic unit satisfying integral cumulation of negative towards positive transmutation from field genic units to elementary genic units $\int_0^t d(M \rightarrow m) dt$ - integral cumulation of positive towards negative transmutation from elementary genic units to field genic units $\int_0^t d(M \leftarrow m) dt$ = physical selfhood esse of elementary genic unit (total mass residue $m \geq 0$) is still maintained in relatively steady succession ever since.

The more massive the mass of object is, the steadier and more substantial the physical esse of object in spacetime is.

Historical progress of science in the recent several centuries seemed like a far-flung exploration of the first itinerary around numerous distinctive landscapes of brand-new landmasses of science with palette & tablet on back, several hundred years' scientific travelogues were compiled thereby.

2.2. Absolute spacetime momentum of matter integration in cosmos

As dynamic essence of time and PNT action of matter integration, Homogenous Cosmos Originated from Unique Genesis primarily affirms that any object in cosmos innately has absolute spacetime momentum P_A as below:

$$P_A = mV_A = d(M \leftarrow m) * Y \quad \dots \dots \dots \quad (\text{II-i-2})$$

(In the equation, m denotes the mass of positive matter of matter integration, V_A denotes the absolute motion speed of matter integration in spacetime, $d(M \leftarrow m)$ is just the positive towards negative transmutation rate and Y is just the time dynamic speed of matter integration.)

The formula of absolute spacetime momentum of matter integration affirms the active role of time in existence & motion of matter in spacetime, —the dynamic essence (time dynamic speed Y) of time is just the dynamic origin of existence & motion of matter, and the “ $d(M \leftarrow m)$ ” in equation of $P_A = mV_A = d(M \leftarrow m) * Y$ is just the tangible witness that time dynamic essence is kinetic origin of existence & motion of matter, which implicates matter integration revivifies some of its mass which have originally been congealed from physical spacetime and hypostatized dynamic esse of spacetime by “positive towards negative transmutation ($M \leftarrow m$)” and embodies the revived dynamic esse of spacetime on matter integration as spacetime momentum (please refer to the section of “PNT action and PNT reaction” —“revivification reaction of space field potential vallum”). Of course, notion introduction of “positive towards negative transmutation rate $d(M \leftarrow m)$ ” even makes the dynamic revivification of positive towards negative transmutation quantified in scale of time.

The equation $mV_A = d(M \leftarrow m) * Y$ implicates two conclusions:

The first: motion is ingenerate attribute of matter in spacetime.

The reason is as below:

$$\begin{aligned} \text{As } \begin{cases} mV_A = d(M \leftarrow m) * Y & \iff & V_A = d(M \leftarrow m) * Y / m \\ d(M \leftarrow m) > 0 & Y > 0 & m > 0 \end{cases} \\ \text{so that } d(M \leftarrow m) * Y / m > 0 \iff V_A > 0 \end{aligned}$$

The absolute moving speed of matter integration is defined referring to presumable absolute stationary reference. As motion is ingenerate attribute of matter in spacetime, any object in cosmos is innately moving; it's completely impossible for us to find an absolute stationary reference in cosmos, such ideal absolute stationary reference can only be presumable in rational notion but can never be found.

The second, time dynamic speed is just the utmost speed of matter motion in spacetime.

The reason is as below:

$$\text{Because } \begin{cases} mV_A = d(M \leftarrow m) * Y & \iff & V_A / Y = d(M \leftarrow m) / m \\ d(M \leftarrow m) / m \leq 1 & V_A > 0 & Y > 0 \end{cases}$$

($d(M \leftarrow m) / m \leq 1$ just means $d(M \leftarrow m) \leq m$, that's to say, in any short time interval, the magnitude of positive towards negative transmutation rate can never be even bigger than the total mass margin of positive matter of matter integration in spacetime)

$$\text{So } V_A / Y \leq 1 \iff V_A \leq Y$$

In time current, existence & motion of matter in spacetime is always in so monotony regularity.

As coherent natura naturans throughout cosmic evolution, instinctive PNT reciprocal equilibrium towards optimum PNT operation is radical potentiality & conditionality for cosmos always ready to orientate itself towards perfection.

If m in equation denotes the total mass of positive matter in cosmos, proportionably, the “ V ”= $d(M \leftarrow m) * Y/m$ just denotes the integrative motion speed of positive matter in cosmos;

If m in equation denotes the mass of the Milk Way, proportionably, the “ V ”= $d(M \leftarrow m) * Y/m$ denotes the integrative motion speed of the Milk Way;

If m in equation denotes the mass of earth, proportionably, the “ V ”= $d(M \leftarrow m) * Y/m$ denotes the connatural motion speed of the earth;

If m in equation denotes the mass of your body, proportionably, the “ V ”= $d(M \leftarrow m) * Y/m$ denotes the connatural motion speed of your body in spacetime;

... ..

If m in equation denotes the mass of Oxygen atom, proportionably, the “ V ”= $d(M \leftarrow m) * Y/m$ denotes the motion speed of oxygen atom in spacetime;

If m in equation denotes the mass of Hydrogen atom, proportionately, the “ V ”= $d(M \leftarrow m) * Y/m$ denotes the motion speed of Hydrogen atom in spacetime;

If m in equation denotes the mass of neutron (/proton/electron), proportionably, the “ V ”= $d(M \leftarrow m) * Y/m$ denotes the motion speed of neutron (/proton/electron) in spacetime;

If m in equation denotes the mass of Quark or neutrino proportionably, the “ V ”= $d(M \leftarrow m) * Y/m$ denotes the motion speed of Quark or neutrino in spacetime;

If m in equation denotes the mass of photon or neutrino ①, proportionately, the “ V ”= $d(M \leftarrow m) * Y/m$ denotes the motion speed of photon or neutrino in spacetime—— light speed or transmission speed of neutrino.

In accordance with definition formula of absolute spacetime momentum $P_A = mV_A = d(M \leftarrow m) * Y$, existence & motion of matter inherently relates to mass m , positive towards negative transmutation rate $d(M \leftarrow m)$ and time dynamic speed Y of matter integration.

Note ①: The physics Nobel prize of 2015 was awarded to Japanese scientist Takaki Hajita and Canadian scientist Arthur B. McDonald, to commend them having found that neutrino has mass. Considered by Homogenous Cosmos Originated from Unique Genesis, neutrino has mass is but something self-evident in the nature of things, I would be even shy to speak out such kind of conclusion for palpable weak intelligence that, neutrino even has its ingenerate mass as typical particle in cosmos.

In accordance with the motion formulation $mV = d(M \leftarrow m)Y \iff V = d(M \leftarrow m)Y/m$ of Homogenous Cosmos originated from Unique Genesis, no matter time dynamic speed Y is constant or not, the factuality we can confirm is that $d(M \leftarrow m)/m \leq 1$. Once $d(M \leftarrow m)/m = 1$, the object we studying has transcend category of positive matter but negative genic units in space field, whose idiographic existence & motion is just physical objectification of time dynamic speed Y , and the dynamic integration of existence & motion of negative genic units in space field is just substantiality of spacetime. At any rate, once the hypostatic existence & motion of object satisfies $d(M \leftarrow m)/m = 1 \iff d(M \leftarrow m) = m$, the mass of object exists in transmutation & transition situation entirely in time current so that we can never perceive any palpable mass presence of object through and through. Only when $d(M \leftarrow m)/m$ of matter integration satisfies $d(M \leftarrow m)/m < 1$, there is possibility for us to perceive mass presence of the object in time current. Any existence & motion in cosmos, as long as the $d(M \leftarrow m)/m$ of matter integration satisfies $d(M \leftarrow m)/m < 1$, it must be existence & motion of positive matter, and there must be positive presence of mass of object in time current, no matter it’s photon or neutrino.

As freewheeling of royal substantiation & perfection of demoded contemporaneous scientific orthodoxy, modern physics is always floundering in riancy, physics Nobel Prize is too unexpectedly innocent thereby.

Historical progress of science in the recent several centuries seemed like a far-flung exploration of the first itinerary around numerous distinctive landscapes of brand-new landmasses of science with palette & tablet on back, several hundred years’ scientific travelogues were compiled thereby.

If there is no physical disturbance to matter integration, so that the both positive towards negative transmutation rate $d(M \leftarrow m)$ and time dynamic speed Y of matter integration are constants, then, absolute spacetime momentum $P_A = mV_A = d(M \leftarrow m) * Y$ of matter integration is constant. And as presence of instinctive PNT equilibrium of matter integration, once positive towards negative transmutation rate $d(M \leftarrow m)$ is constant, negative towards positive transmutation rate $d(M \rightarrow m)$ must be constant and $d(M \leftarrow m) d(M \rightarrow m)$ must satisfy $d(M \leftarrow m) = d(M \rightarrow m)$, then, the mass m of matter integration must be constant and $V_A = d(M \leftarrow m) * Y / m$ must be constant, which indicates matter integration is in inertial moving state satisfying Newtonian law of inertia.

In terms of PNT action of macroscopic object in spacetime, as both quantities of $d(M \rightarrow m)$ and $d(M \leftarrow m)$ of PNT operation of matter integration are relatively big, and the mutual equilibrium covariance is relatively compact and not easy to expose their quantity disparity, as a result, the existence & motion of macroscopic object in spacetime is unromantic, there is almost no possibility for us to perceive mass change during the course of existence & motion of macroscopic object.

Whereas, in terms of PNT action of microscopic object in spacetime, as both quantities of $d(M \rightarrow m)$ and $d(M \leftarrow m)$ of PNT operation of matter integration are tiny and with poor margin for covariant PNT equilibrium, so the both $d(M \rightarrow m)$ and $d(M \leftarrow m)$ of PNT operation of microcosmic object are not easy to gloss over their object is not steady at all, but big a little now and small a little then in indefinite existent appearance, once big, it may be selfhood in a flash; once small, it's non-selfhood in a flash, so we find the lifespan of typical particles is very instantaneously short. In terms of existence & motion pattern of microcosmic object, the more microcosmic object it is, the more remarkable waveform motion it appears, such as serial succession of particle wave, light wave, Cosmic Microwave Background.

Any object in cosmos, the more tiny mass m of object is, the magnitude of $d(M \leftarrow m)$ of PNT action is relatively more closer to mass m of positive matter of matter integration, the quotient of $V/Y = d(M \leftarrow m)/m$ is more closer to 1, the absolute speed of the proper object is more closer to time dynamic speed therefore. As a result, in terms of characteristic existence of particle in time current, the more tiny the mass of particle is, the higher innate speed of particle is. On point of the very view, time dynamic speed is just the special speed of object with mass cumulation $m=0$, which is just the extremity speed of cosmos. And at the same time, the more closer the magnitude of $d(M \leftarrow m)$ to mass m is, the more intensively PNT action impacts the existent selfhood of object, so the microscopic particles are always moving in higher speed and more instantaneously chop and change by the light of nature.

“Mass”, “momentum” and “energy” of particle are three different serial characteristic homologic esse originated from the same homologic origin with distinctive existent profile in homogenous cosmos. In another words, “mass”, “momentum” and “energy” are but three serial distinctive homologic hypostatization as idiographic esse originated from the common homologic origin, whereas, at any moment in time current, it's only possible for it to be found as one definite existent esse with distinctive existent profile originated from the common homologic origin. As a result, in terms of any definite particle in spacetime, it's absolutely impossible for us to define the precise quantities of “mass”, “momentum” and “energy” of one particle just at the same moment, which indicates, once we define the quantity of “mass” of a particle, there is completely no way for us to ascertain the definite quantities of “momentum” and/or “energy” of the particle any more for it's completely impossible for the common homologic origin to be hypostatized as two or two more different existent esse at the same moment; once we

define the quantity of “momentum”, there is completely no way for us to ascertain definite quantity of “mass” and/or “energy” of the particle any more for it’s completely impossible for the common homologic origin to be hypostatized as two or two more different existent esse at the same moment. —Sun-wukong is so magic a spirit with 72 distinctive anamorphosis totally. However, in any case, it’s only possible for Sun-wukong to be ascertained as one definite anamorphosis at any moment. Once Sun-wukong has turned into coordinative anamorphosis of “Bai-gujin”, there is no possibility for us to find any other actual existent as “Sun-wukong” any more; once Sun-wukong has turned into coordinative anamorphosis of “Liu-muwang”, there is no possibility for us to find any other actual existent as “Sun-wukong” or “Bai-gujin” any more. This is just something about the so-called “uncertainty principle” mentioned in Quantum Theory.

Just because of magic homologic existent authenticity like this, as physical scientist with remarkable contribution in Quantum Theory, Feynman had ever commented like this: **We have to emphasize the significant discrepancy between Newtonian mechanics and Quantum mechanics, we are always talking about approach probability of electrons under certain conditions, even with aid of the best experimental support, we are still difficult to predict the precise occurrence but approach probability of electrons. If this is true, it indicates physics has given up its original ambition to predict positive occurrence in the nature. And now, we think it’s impossible to predict positive occurrence in the nature but to predict approach probability. Although, this apparently falls short of our early intention to know the nature, which even seems setback of us, nobody can change the situation. we can only talk about approach probability at present; even though it seems present, there are substantial possibilities for situation to be like this for ever, the nature may be just like this most probably.** (Extracted from page 328 of Atom Physics —Yang-hujia)

And almost just the same time I was born, Dirac commented like this: **In my opinion, it’s apparent we did not approach any fundamental of Quantum Mechanics yet, and the laws we now introduced in Quantum Mechanics apparently need further revision; only thus, there is potentiality for us to approach theory as Relativity kind in this field. Most probably, from current Quantum Mechanics to future Quantum mechanics like Relativity kind, the revision may be as remarkable as revision from Bohr’s orbit theory to current Quantum Theory. Once we’ve done remarkable revision to it, of course, the idea we introduce statistical account for demonstrative explanation may be changed drastically.** (Extracted from page 328 of Atom Physics —Yang-hujia)

In my opinion, Feynman was but one of a group of laborious ants who were ready to push forward the grand science train towards authenticity of existence & motion of particles, just because they had tried their best thereby and gotten touch with the solid object, they perceived some substantiality of the hypostatic existence & motion of particles indeed, and since history proceeded in this way, Feynman of course commented accordingly. Whereas, Dirac’s words but betrayed the stimulative confidence and nonconfidence of Quantum Theory of their age.

Considered by Homogenous Cosmos Originated from Unique Genesis, spacetime and matter are lineal homology exactly like water and ice, matter existing in spacetime is just situation as ice floating in water. Of course, microscopic particles existing in spacetime is but situation as tiny ice floating in water, (relatively, macroscopic objects existing in spacetime is situation as floeberg floating in ocean.). As the total mass m of particle is really very tiny, once the particle performs positive & negative transmutation in spacetime by the light of nature, as the magnitudes of $d(M \leftarrow m)$ and mass m of matter integration are too close, the performance of positive towards negative transmutation “ $M \leftarrow m$ ” of matter integration impacts the value of mass m of the particle remarkably, so that the value of mass m of particle is remarkably erratic, which even makes the existence

of particle seem gleaming in spacetime. This is exactly similar situation as tiny ice floating in water, for frequent variation of ambient temperature, the tiny ice in water is water a little now and is ice a little then going round and round. Can the demiurge shake the elbows really? It is but because we can only see the ice but can never see the water throughout, as a result, we can only find the probabilistic existence of particles in spacetime.

Whereas, it of course does not mean there is no definite regularity of existence & motion of particles, since the PNT action of particles directly relates to their genic configuration and the physical conditions of the space field around for them to perform PNT, it of course implies the regularity must be underlying herein. The issue but depends on clarification of the covariant linkage mechanism between particles and space field including connatural genic configuration of particles, PNT operational linkage configuration of particles, genic configuration of space field and PNT operational linkage character of space field when it is ready to involve PNT operation with particles, once all of these hypostatize on parameters of $d(M \rightarrow m)$, $d(M \leftarrow m)$, m , Y etc, all regularity must be incarnated by themselves. Leastways, we can draw our conclusion that ingenerate probabilistic existence & motion of particles in spacetime and the related ingredients of connatural genic configuration of particles, PNT operational linkage character of particles, genic configuration of space field and PNT operational linkage character of space field must satisfy general determinism.

The essence of matter has predestined that particles in spacetime must have absolute spacetime momentum $P_A = mV_A = d(M \leftarrow m) * Y$, whereas, as mass m of particles is very tiny, both mass m and absolute speed (or rate of time dynamic domino effect) " $V = d(M \leftarrow m) * Y / m$ " of matter integration are substantively sensitive due to change of $d(M \leftarrow m)$. As a result, existence & motion of particles is inherently fast and erratic, particles in cosmos are of course ingenerate flash chameleon.

Something I'd like to emphasize herein is that we are always wild about experimental observation of objects that we study, whereas, once our study objects gradually turn to microscopic particles whose existence & motion is obviously fast and erratic, the so-called superposition of existence & motion of microscopic object consequently occurred.

What's superposition of existence & motion of matter?

There is even something magic as Schrodinger's cat underlying.

Haw, once in the face of the issues, I am almost confused whether to cry or to laugh, I would like to cry, and I would like to laugh as well. After equanimity, since there is no way for me to cry and laugh at the same time, I have to cry after laughing, and laugh after crying.

Do you think my manner OK?

Of course, I have to ask you to witness my cry and my laugh, ——let's suppose the effective time for you to perceive my cry or my laugh upon your vision is 0.5 second.

I cry in the morning and laugh in the afternoon. Consequently, you find I cry in the morning and laugh in the afternoon definitely. This is of course all right, after all, you need only two "0.5 second" for definite apperception of my cry and my laugh.

That's OK! Whereas, I would rather to challenge your vision utmost.

I increase exchange frequency of my cry and my laugh, I cry now and laugh one minute later. Consequently, you find me crazy, cry then laugh, and laugh then cry. This is of course all right, after all, you need only two "0.5 second" for definite apperception of my cry and my laugh.

That's OK! Whereas, I would rather to challenge your vision utmost.

I increase exchange frequency of my cry and my laugh, I cry once and laugh once just in one second. Consequently, you find it funny, once I finish crying then laughing immediately, and once I finish laughing then crying immediately. This is of course all right, after all, you need only two "0.5 second" for definite apperception of my cry and my laugh.

That's OK! Whereas, I would rather to challenge your vision utmost.

I increase exchange frequency of my cry and my laugh, I cry 10 times and laugh 10 times just in one second. Consequently, you are astonished to find, Oh, what's the unintelligible magic? I am entirely crying and laughing synchronously, my behavior of both cry and laugh is completely superposed as Schrodinger's cat is living and dead at the same time.

... ..

Once we try to perceive distinctive existence & motion of some certain microscopic object (such as an electron) by experiments, we mostly neglect one thing that the very physical implementation of experimental apperception is still a substantial physical process which need consume some time. If the consumed time is relatively longer, the physical implementation of experimental apperception is proportionately more retarded and the apperception effect is proportionably rougher, which can generally cause divarication as below:

Let's suppose there is a particle moving between A point and B point round and round, the particle finishes moving one round between A point and B point needs 0.0001 second, that's to say, the particle moves between A point and B point round and round in frequency of 10000 HZ. We introduce a special "physical process" to observe the existent status of the particle moving round and round between A point and B point in frequency of 10000 HZ. Let's support the instrument implements an effective observation needs time of 0.0001 second, this of course indicates, in one second, the instrument can only implement 1000 times of effective observation. If we do not observe the very particle, we are of course aware that the particle moves between A point and B point round and round in frequency of 10000 HZ, whereas, once we introduce the very instrument to observe existent status of the particle moving round and round between A point and B point in frequency of 10000 HZ, we can of course find the particle exists at both A point and B point.

After all, once the instrument finishes effective observation once in 0.0001 second, the particle has coequally stayed in both A point and B point 10 times already, once we believe the observation instrument, we have to believe existent superposition of the particle at both A point and B point. And no matter the observation result is true or not, "rational regularity" are always like this.

That's to say, any effective physical observation action must be a hypostatic physical process which must exhausts a solid interval. Once we observe an periodic moving object, only when the necessary interval of the effective physical observation action is less than one periods of the periodic moving object, our observation action has effective time precondition for definite perception of the proper moving object. If the necessary interval of the effective physical observation action is bigger than one periods of the periodic moving object, the very observation action can hardly perceive the definite moving status of the periodic moving object in time, or it can only perceive the rough profile upon its intrinsic capability and relative "vision dullness" occurred therefore, the physical observation action is not capable to approach precise observation. Generally, the bigger the necessary interval of the effective physical observation action is than one periods of the periodic moving

object, then, the observation instrument is relatively more stupid and the so-called “vision dullness” is more remarkable.

The most typical instance of “vision dullness” around us is that, in cosmos, any hypostatic atom is not a solid sphere, but a loose globe coop made up of a tiny nucleus in centre and several even more tiny electrons moving around the tiny nucleus, whose loose form can even make you sure to impregnate pailful water into. Whereas, upon our bare vision capability, it's almost impossible for us to perceive any atom is but a loose globe coop made up of a tiny nucleus in centre and several even more tiny electrons moving around the tiny nucleus, no matter the solid or liquid around us.

At any rate, upon my bare vision capability, I can never see any atom is loose globe coop made up of a tiny nucleus in centre and several even more tiny electrons moving around the tiny nucleus, whether you are the same as me or not, I am not convenient to show my snobbishness before you. If there was not α -particle scattering experiment of Rutherford in prior, you come to tell me that any atom is but a loose globe coop made up of a tiny nucleus in centre and several even more tiny electrons moving around the tiny nucleus, I must suspect you going without saying even deprecate you therefore. All in all, nothing seems reasonable for man to believe in you by the right of normal intelligence of human being, no matter it's virtually barbaric or crude, “rational regularity” is always something like this.

In another word, in microscopic hiberarchy electrons moving around nucleus, normal human vision is completely dull. Since there is typical vision dullness of human being, there is substantial possibility for experimental observation instrument to involve in similar vision dullness, especially once we introduce instrument to observe microscopic object moving in high speed.

Generally, we study existence & motion of matter in spacetime is to study the variation of mass of positive matter “m”, mass of matter field “M”, velocity of matter integration “V”, geometrical length of object “L”, field strength of matter field “ α ”, time dynamic speed “Y” and all the related parameters as acceleration “a”, force “F”, displacement “S”, velocity change “ ΔV ”, momentum change “ ΔP ”, energy change “ ΔE ” etc. However, what's the radical causative variation of matter integration which radically determines variation of all state parameters of matter integration? And what's the general dynamic orientation of matter integration due to the radical causative variation and how does the causative variation occur and do its job?

Of course, observation effect still implicates domino effect of relativity. In detail word, in terms of the same object as our observing target, if the moving speed of the observer relative to the target object is different, the observing result is proportionate different. For instance, upon our normal intuition, an atom H^1_1 is generally a similar globe made up of a high speed electron running around a proton, whose volume is far more than volume sum of a proton and an electron. Whereas, if we run after the electron and observe the geometrical profile of the H^1_1 atom, it's easy for us to imagine the closer the moving speed of the observer to the moving speed of the electron, the globe profile of H^1_1 atom is looser and more empty, till at last, once the moving speed of the observer is equivalent to the moving speed of the electron around the proton, the globe profile of H^1_1 atom completely disappeared, but only one isolated proton and one electron relatively stationary on two points with some certain distance between them (such relativity will be introduced in coming section of “spacetime” and “motion”).

2.3. Radical correlation between “PNT action” and “existence & motion of matter” and supplemental introduction of “Instinctive PNT equilibrium postulate”

As coherent natura naturans throughout cosmic evolution, instinctive PNT reciprocal equilibrium towards optimum PNT operation is radical potentiality & conditionality for cosmos always ready to orientate itself towards perfection.

Once logic extension and proper connotation objectification of “homogenous cosmos originated from unique genesis + spacetime~matter fully embodying cosmos” approaches ascertainment of alternative homologic filiation between spacetime and matter, as long as we can exclude possibility of “matter father & spacetime son”, homologic generation of matter in cosmos is self-evident. And **homologic filiation between spacetime and matter directly indicates presence of PNT action, PNT action is not only headspring creation of original generation of matter along sequential homologic cosmogony but also dynamic origin of postnatal existence & motion of matter in spacetime, which apparently indicates that universal existence & motion of matter radically root in PNT action of matter integration.**

Whereas, what's the magic action of PNT action? If we know the dynamic fundamental of PNT action, we then know the dynamic fundamental of universal existence & motion of matter in cosmos.

When we come to study existence & motion of matter in spacetime, We usually emphatically study the mass m of positive matter, mass M of matter field, velocity V of matter integration, geometrical length L of positive matter, field strength α of matter field, time dynamic speed of matter field, even the the related variables as acceleration a , force F , displacement s , velocity change ΔV , momentum change ΔP , energy change ΔE and so on.

The positive & negative transmutation ($M \leftrightarrow m$) of matter integration is the most essential correlation between hyllic spacetime and positive matter, in accordance with definition of positive & negative transmutation ($M \leftrightarrow m$), it's easy for us to comprehend that PNT performance of matter integration directly determines the magnitude of both matter field mass “ M ” and positive matter mass “ m ”. However, the variation of matter field mass “ M ” and positive matter mass “ m ” also relates all the other parameters of matter integration for their ingenerate homologic pertinence, for instance, the variation of matter field mass “ M ” will directly impact the matter field strength, time dynamic speed in the field, magnitude of space radiation cornu of the very field even geometrical profile of objects in the matter field (please refer to the coming section of space distance and space radiation cornu) etc; the variation of positive matter mass “ m ” will directly impact the volume even inner structure of positive matter etc. What's more, the variation of positive & negative transmutation ($M \leftrightarrow m$) directly implicates the variation of $d(M \leftrightarrow m)$ and $d(M \leftarrow m)$, this of course means variation of absolute spacetime momentum $mV_A = d(M \leftarrow m) * Y$, because it is impossible for operational variation of positive & negative transmutation to avoid variation of positive towards negative transmutation rate $d(M \leftarrow m)$ and time dynamic speed Y , this of course means the presence of force, acceleration, momentum change and kinetic energy change of matter integration.

This of course implies PNT action radically predestines the existence & motion of matter in spacetime; it can be considered that existence & motion of matter in spacetime are but existent objectification of PNT action of matter integration. Existence & motion of matter in spacetime radically depends on PNT performance of matter integration. In another word, variation of existence & motion of matter integration in spacetime are but consequence of instinctive PNT equilibrium towards optimum PNT operation.

In terms of PNT operation of matter integration under certain conditions, if $d(M \rightarrow m) > d(M \leftarrow m)$, then the mass of positive matter will consequently increase, proportionately, the mass of matter field will decrease, and all the state parameters of matter integration related to the mass of positive matter and mass of matter field will vary accordingly, such as moving speed of positive matter, geometrical profile of positive matter, time rate or time dynamic speed of matter integration etc; if $d(M \rightarrow m) < d(M \leftarrow m)$, then the mass of positive matter will consequently decrease, proportionately, the mass of matter field will increase, and all the state parameters of matter integration related to the mass of positive matter and mass of matter field will vary

Historical progress of science in the recent several centuries seemed like a far-flung exploration of the first itinerary around numerous distinctive landscapes of brand-new landmasses of science with palette & tablet on back, several hundred years' scientific travelogues were compiled thereby.

accordingly; if $d(M \rightarrow m) = d(M \leftarrow m)$, both mass of positive matter and mass of matter field will keep constant, and all other state parameters of matter integration related to mass of positive matter and mass of matter field will keep constant accordingly too.

Whereas, the variation of PNT action of matter integration is eventually actualized by covariant coordination of negative towards positive transmutation rate $d(M \rightarrow m)$ and positive towards negative transmutation rate $d(M \leftarrow m)$. No matter what's the idiographic manner for negative towards positive transmutation rate $d(M \rightarrow m)$ and positive towards negative transmutation rate $d(M \leftarrow m)$ to coordinate, it won't impact we classify the covariant coordination between negative towards positive transmutation rate $d(M \rightarrow m)$ and positive towards negative transmutation rate $d(M \leftarrow m)$ into "constant covariant coordination" and "inconstant covariant coordination" as below:

The first, $d(M \rightarrow m) = d(M \leftarrow m)$, and $d(M \rightarrow m)$ & $d(M \leftarrow m)$ keep constant

This is just the so-called constant covariant coordination between negative towards positive transmutation rate $d(M \rightarrow m)$ and positive towards negative transmutation rate $d(M \leftarrow m)$. Apparently, as $d(M \rightarrow m) = d(M \leftarrow m)$, mass of matter field "M" and mass of positive matter "m" keep constant, matter field strength of any point in matter field keeps constant, time dynamic speed of any point in matter field keeps constant, geometrical profile or length of object in the matter field keeps constant, and according to equation $V = d(M \leftarrow m) * Y/m$, as all $d(M \leftarrow m)$, Y, m keep constant, matter moving velocity V keeps constant, no matter we refer to absolutely stationary reference or any discretionary inertial reference, matter integration keeps in inertial existence, —bearing force 0, acceleration 0, neither momentum change nor kinetic energy change.

Note: as law of causation and innate couple covariant variables coming into being during the course of matter generation in spacetime, it's impossible for $d(M \rightarrow m)$ and $d(M \leftarrow m)$ to vary synchronously in situation of $d(M \rightarrow m) = d(M \leftarrow m)$ in time current.

The second, the inconstant reciprocal equilibrium of positive & negative transmutation ——— $d(M \rightarrow m) \neq d(M \leftarrow m)$

This is just the so-called inconstant covariant coordination between negative towards positive transmutation rate $d(M \rightarrow m)$ and positive towards negative transmutation rate $d(M \leftarrow m)$. in order to study and formulate existence & motion of matter in spacetime due to inconstant covariant coordination between negative towards positive transmutation rate $d(M \rightarrow m)$ and positive towards negative transmutation rate $d(M \leftarrow m)$, it's apparently necessary for us to clarify the covariant coordination dynamic orientation between $d(M \rightarrow m)$ and $d(M \leftarrow m)$.

It's easy for us to comprehend that as innate couple coexisting inverse variables of "positive & negative transmutation" of matter integration, the negative towards positive transmutation rate $d(M \rightarrow m)$ and positive towards negative transmutation rate $d(M \leftarrow m)$ can never be mutually disrelated, there must be some certain covariant correlation between them, —the variation of negative towards positive transmutation rate must be causative condition to stimulate reaction variation of positive towards negative transmutation rate; the variation of positive towards negative transmutation rate must be causative condition to stimulate reaction variation of negative towards positive transmutation rate as well, so that the both form innate couple covariant variables. The issue is but what the dynamic orientation principle of the innate couple covariant variables? In another word, why negative towards positive transmutation rate $d(M \leftarrow m)$ and positive towards negative transmutation rate $d(M \leftarrow m)$ must coordinate spontaneously? And what's the state pursuit of their spontaneous covariant coordination?

In accordance with various evidences that comprehensive existence in cosmos are always ready to orient

balance and stabilization, it seems wise for us to affirm the innate couple covariant variables are always ready to orient positive & negative transmutation balance (PNT balance). So Homogenous Cosmos Originated from Unique Genesis introduces another fundamental postulate — **Instinctive PNT equilibrium postulate** herein.

—It is assumed that **any matter integration has instinct to maintain its PNT dynamic equilibrium** (just instinct to keep $d(M \rightarrow m) = d(M \leftarrow m)$), **once matter integration loses its original PNT operational state** (even operational balance), **the coexistent bi-directional covariant transmutation of “M→m” and “M←m” must spontaneously equilibrate/counterbalance towards new PNT balance till at last matter integration recovers new balance of $d(M \rightarrow m)' = d(M \leftarrow m)'$.**

That's to say, negative towards positive transmutation rate $d(M \rightarrow m)$ and positive towards negative transmutation rate $d(M \leftarrow m)$ of matter integration are innate bi-directional covariant couple towards PNT equilibrium as law of causation. The everlasting dynamic orientation of their mutual coordination is positive & negative transmutation counterbalance of matter integration, variation of any one must immediately stimulate the opposite to react spontaneously towards new PNT balance. For instance, conditional increase/decrease of negative towards positive transmutation rate $d(M \rightarrow m)$ must spontaneously stimulate counterbalance reaction of decrease/increase of positive towards negative transmutation rate $d(M \leftarrow m)$; inversely, conditional increase/decrease of positive towards negative transmutation rate $d(M \leftarrow m)$ must spontaneously stimulate counterbalance reaction of decrease/increase of negative towards positive transmutation rate $d(M \rightarrow m)$; till at last, brand-new PNT balance is accomplished.

At the stage, the three reasons Homogenous Cosmos Originated from Unique Genesis consulted for introduction of “Instinctive PNT equilibrium postulate” are as following:

- A) Under precondition that cosmos is throughout homogenous originated from unique genesis and cosmos exactly consists of spacetime and matter, none coordinative components else, as active lineal homologic filiation between spacetime and matter, PNT action must be the determinant and radical motivation of existence & motion of matter in spacetime.
- B) Usually, variation of existence & motion of matter is not irregularly aimless and endless, there is always default goal orientation, and variation of existence & motion always keeps on going without letup by the light of nature before ultimately approaching ideal goal existent fettle.
- C) Upon experience intuition, no matter in the nature or in our society, it seems all existence & motion indistinctly behaves default but immanent instinctive equilibrium.

Introduction of Instinctive PNT equilibrium postulate affirms intrinsic dynamic orientation of PNT action.

Both “**Instinctive PNT equilibrium postulate**” and “**spacetime~matter fully embodying cosmos postulate**” are equally supplemental postulates of **Homogenous cosmos originated from unique genesis postulate** in 0.5 grade, whereas, their distinctive supplemental function is different. If we define the significance of Homogenous cosmos originated from unique genesis postulate is just something as upper & nether cavities of cosmic mould, then, significance of “spacetime~matter fully embodying cosmos postulate” is just a supplemental slide of cosmic mould, which virtually consummates the cosmic mould as a supplemental slide of upper & nether cavities of cosmic mould of Homogenous cosmos originated from unique genesis postulate. However, introduction of “Instinctive PNT equilibrium postulate” endows dynamic soul of cosmos by the light of nature. After all, introduction

of “Instinctive PNT equilibrium postulate” has confirmed the dynamic equilibrium fundamental of PNT action, and virtually, PNT action is not only headspring creation of original generation of matter along sequential homologic cosmogony but also dynamic origin of postnatal existence & motion of matter in spacetime, which of course indicates existence & motion is but vivid enantiomorphous incarnation of PNT action of matter integration. And once PNT action is endowed dynamic fundamental of instinctive PNT equilibrium, so-called “matter motion” is but spontaneous optimization of PNT action of matter integration in the nature of instinctive PNT reciprocal equilibrium towards optimum PNT operation ——spontaneous occurrence in the nature of coherent natura naturans throughout cosmic evolution like dynamic enantiomorphous image of PNT action of matter integration, cosmos is consequently endowed soul.

After all, cosmos is substantively an aggregation of dynamic matter, and the dynamic endosome of cosmos is so well-regulated, this of course indicates that it's impossible for the dynamic endosome to be blackguardly behavior of the demiurge. Instead, it should be civilized behavior indicating intelligence of the demiurge. And in homogenous cosmos, PNT action is not only headspring creation of original generation of matter along sequential homologic cosmogony but also dynamic origin of postnatal existence & motion of matter in spacetime, which apparently indicates that existence & motion of matter radically root in PNT action of matter integration. This of course indicates that PNT action is dynamic fundamental of identity throughout cosmos. Cosmos is always ready to orientate itself towards perfection, after all, once cosmos originally comes into being, the demiurge has finished his natura naturans job to endow his intelligence as dynamic fundamental as essence of matter in spacetime already.

2.4. “Existence & motion of matter” in homogenous cosmos

As presence of “ $d(M \rightarrow m) \neq d(M \leftarrow m)$ ” and “instinctive PNT equilibrium” of matter integration, the magnitude of mass of matter field “M” and mass of positive matter “m” and all the related state parameters must vary according to spontaneous performance of instinctive PNT equilibrium between $d(M \rightarrow m)$ and $d(M \leftarrow m)$. During the course of instinctive PNT equilibrium between $d(M \rightarrow m)$ and $d(M \leftarrow m)$, if $d(M \rightarrow m) > d(M \leftarrow m)$, then, mass of positive matter “m” consequently increase, and mass of matter field proportionally decrease, as variation of mass of positive matter and matter field, matter field strength α , time dynamic speed Y vary accordingly, and there is nonzero force, acceleration, velocity change, momentum change, kinetic energy change etc; if $d(M \rightarrow m) < d(M \leftarrow m)$, then, mass of positive matter “m” consequently decreases, and mass of matter field proportionally increases, as variation of mass of positive matter and matter field, matter field strength α , time dynamic speed Y vary accordingly, and there is natural occurrence of nonzero force, acceleration, velocity change, momentum change, kinetic energy change etc.

So-called “matter existence” is that, when matter integration performs PNT action under proper spacetime condition by the light of nature, integrative situation that integral cumulation of negative towards positive transmutation from field genic units to elementary genic units $\int_0^t d(M \rightarrow m) dt$ - integral cumulation of positive towards negative transmutation from elementary genic units to field genic units $\int_0^t d(M \leftarrow m) dt$ = selfhood physical esse of positive matter with mass residue $m > 0$ (which indicates $\int_0^t [d(M \rightarrow m) - d(M \leftarrow m)] dt = m > 0$ in time current) is maintained in relatively steady idiographic succession with absolute spacetime momentum $mV = d(M \leftarrow m) * Y$ ever since.

As a result, matter existence can be mathematically formulated as below:

$$\begin{cases} \int_0^t [d(M \rightarrow m) - d(M \leftarrow m)] dt = m > 0 \\ mV = d(M \leftarrow m) * Y \end{cases}$$

In a simple word, so-called “matter existence” is spontaneous occurrence due to PNT action with instinctive PNT equilibrium of matter integration once integral accumulation of living positive & negative transmutation of matter integration satisfies $\int_0^t [d(M \rightarrow m) - d(M \leftarrow m)] dt = m > 0$, which usually implicates magnitude of mass, configuration and energetic status of matter integration.

So-called “matter motion” is that, when matter integration performs PNT action under proper spacetime condition by the light of nature, as external dissonance to PNT performance of matter integration, integrative situation that integral cumulation of negative towards positive transmutation from field genic units to elementary genic units $\int_0^t d(M \rightarrow m) dt$ - integral cumulation of positive towards negative transmutation from elementary genic units to field genic units $\int_0^t d(M \leftarrow m) dt$ = selfhood physical esse of positive matter with mass residue $m > 0$ (which indicates $\int_0^t [d(M \rightarrow m) - d(M \leftarrow m)] dt = m > 0$ in time current) and absolute spacetime momentum $mV = d(M \leftarrow m) * Y$ is consequently disturbed. The radical indication integrative situation that integral cumulation of negative towards positive transmutation from field genic units to elementary genic units $\int_0^t d(M \rightarrow m) dt$ - integral cumulation of positive towards negative transmutation from elementary genic units to field genic units $\int_0^t d(M \leftarrow m) dt$ = selfhood physical esse of positive matter with mass residue $m > 0$ and absolute spacetime momentum $mV = d(M \leftarrow m) * Y$ is disturbed is $d(M \rightarrow m) \neq d(M \leftarrow m)$. Of course, once “ $d(M \rightarrow m) \neq d(M \leftarrow m)$ ” of matter integration occurred, spontaneous occurrence of PNT action with instinctive PNT equilibrium must be subject to fundamental of instinctive PNT reciprocal equilibrium towards optimum PNT operation, and instinctive PNT equilibrium in operation must accomplish quantitative change from $d(M \rightarrow m) \neq d(M \leftarrow m)$ towards $d(M \rightarrow m)' = d(M \leftarrow m)'$ as expediently as possible, $d(M \rightarrow m) \neq d(M \rightarrow m)'$; $d(M \leftarrow m) \neq d(M \leftarrow m)'$.

As a result, matter motion can be mathematically formulated as below:

$$\begin{cases} \int_0^t [d(M \rightarrow m) - d(M \leftarrow m)] dt = m > 0 \\ mV = d(M \leftarrow m) * Y \\ d(M \rightarrow m) \neq d(M \leftarrow m) \quad \rightarrow \quad d(M \rightarrow m)' = d(M \leftarrow m)' \end{cases}$$

In a simple word, so-called “matter motion” is but, under precondition that matter integration satisfies mass integral accumulation $\int_0^t [d(M \rightarrow m) - d(M \leftarrow m)] dt = m > 0$ in time current, PNT action has to rebuild the perfect operation of PNT action of matter integration by the right of instinctive PNT reciprocal equilibrium towards optimum PNT operation once some certain external disturbance occurs to PNT operation of matter integration so as to cause occurrence of $d(M \rightarrow m) \neq d(M \leftarrow m)$, — spontaneous occurrence in the nature of instinctive PNT reciprocal equilibrium towards optimum PNT operation proportionate to external disturbance, which usually implicates magnitude of mass, configuration and energetic status of matter integration. In above equations, the symbolic mark “” indicates spontaneous dynamic orientation of matter integration from initial state $d(M \rightarrow m) \neq d(M \leftarrow m)$ to target state $d(M \rightarrow m)' = d(M \leftarrow m)'$ due to instinctive PNT reciprocal equilibrium towards optimum PNT operation.

All in all, no matter it is PNT performance case of $d(M \rightarrow m) = d(M \leftarrow m)$ or $d(M \rightarrow m) \neq d(M \leftarrow m)$, the integrative logic constitution of all the related state variables of matter integration can be illustrated as below:

Historical progress of science in the recent several centuries seemed like a far-flung exploration of the first itinerary around numerous distinctive landscapes of brand-new landmasses of science with palette & tablet on back, several hundred years' scientific travelogues were compiled thereby.

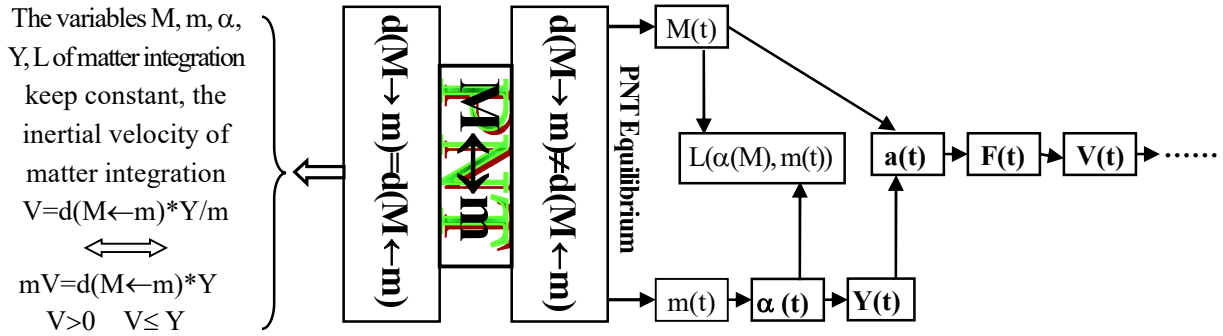

(II-i-1) logic constitution of PNT dynamics

This is just the illustration of so-called “PNT dynamics logic constitution”.

The integrative logic constitution of the whole argument is as below:

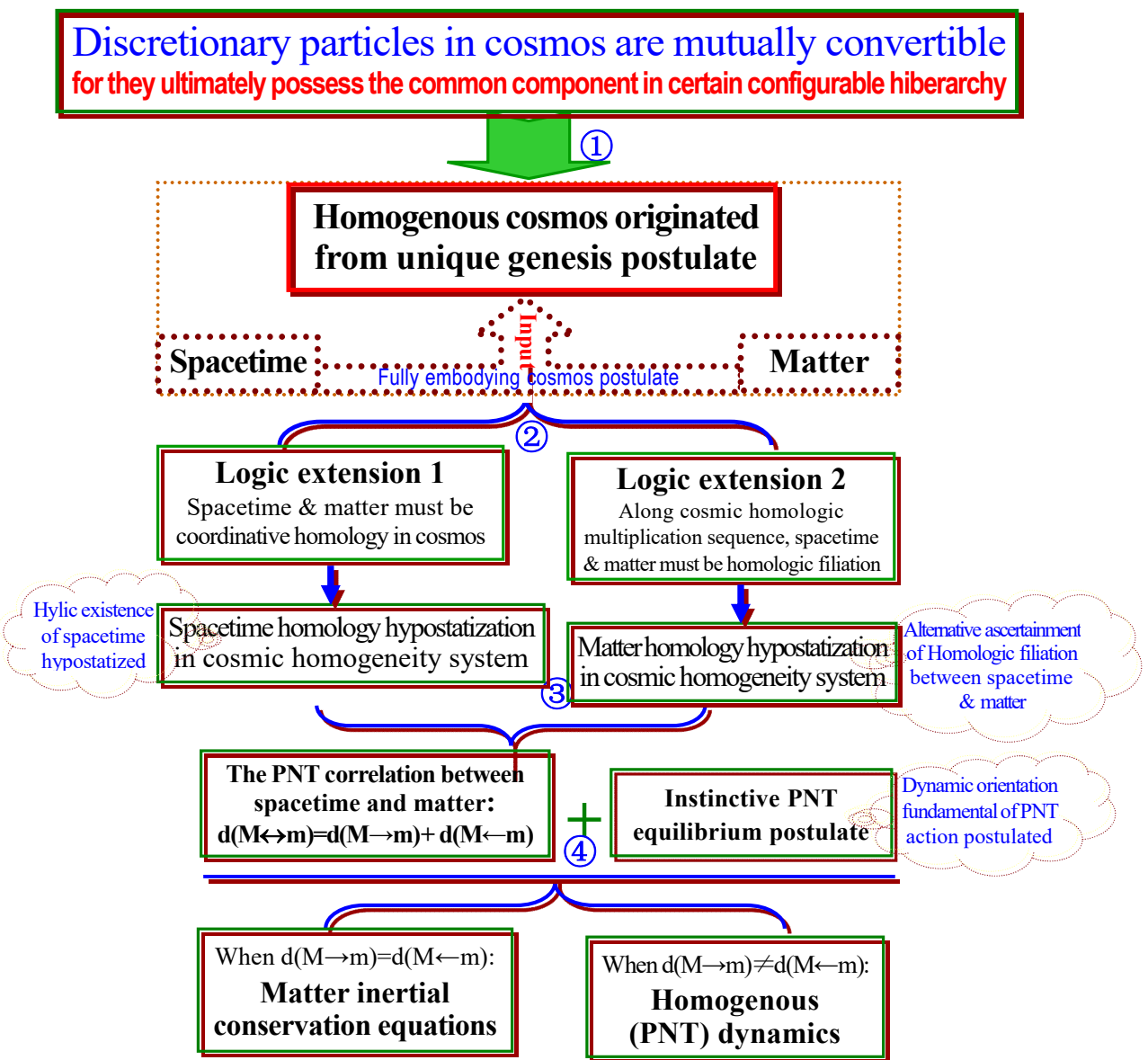

(II-i-2) Inborn logic constitution of PNT dynamics

The inborn logic constitution of PNT dynamics consists of four chain-reacting logic linkages:

As coherent natura naturans throughout cosmic evolution, instinctive PNT reciprocal equilibrium towards optimum PNT operation is radical potentiality & conditionality for cosmos always ready to orientate itself towards perfection.

The ① logic linkage: Rational approach from factuality “**discretionary particles in cosmos are mutually convertible** \sim **for they ultimately possess the common component in some certain configurable hierarchy**” to “Homogenous cosmos originated from unique genesis postulate”.

The ② logic linkage: It substitutes cosmic hypostatic components of **spacetime** and **matter** into **Homogenous cosmos originated from unique genesis postulate** under auxiliary presumable precondition that cosmos just consists of **spacetime** and **matter**, none coordinative component else, so that two logic extensions of Homogenous cosmos originated from unique genesis postulate are deduced thereby.

The ③ logic linkage: objectification of the two logic extensions of **Homogenous cosmos originated from unique genesis postulate**. It introduces “**space field hypothesis**” to objectify logic extensions 1 of Homogenous cosmos originated from unique genesis postulate —“as coordinative homology, spacetime and matter are coequally physical in cosmos”, and it introduces “**matter homologic generation hypothesis**” to objectify logic extensions 2 of Homogenous cosmos originated from unique genesis postulate —“spacetime and matter are homologic filiation”, so that it goes a further step to highlight intrinsic attribute of spacetime and matter as coordinative homology, homologic correlation between spacetime and matter as PNT action.

The ④ logic linkage: PNT action is not only headspring creation of original generation of matter along sequential homologic cosmogony but also dynamic origin of postnatal existence & motion of matter in spacetime, which apparently indicates that existence & motion of matter radically root in PNT action of matter integration. In order to confirm the dynamic fundamental of universal existence & motion, Homogenous Cosmos Originated from Unique Genesis introduces “**Instinctive PNT equilibrium postulate**”, so that matter motion consequently reveals itself racy as spontaneous optimization of PNT action of matter integration, —spontaneous occurrence of “**PNT action + instinctive PNT equilibrium**” in the nature of instinctive PNT reciprocal equilibrium towards optimum PNT operation of matter integration. The next job to illuminate existence & motion of matter in cosmos is but what kind of mathematical logic we should introduce to formulate the PNT action with PNT equilibrium instinct which is just hypostatic existence & motion of matter in spacetime. With the issue in mind, Homogenous Cosmos Originated from Unique Genesis introduced “matter inertial conservation equations” and “PNT dynamics” accordingly.

The integrative logic constitution can be simplified as below:

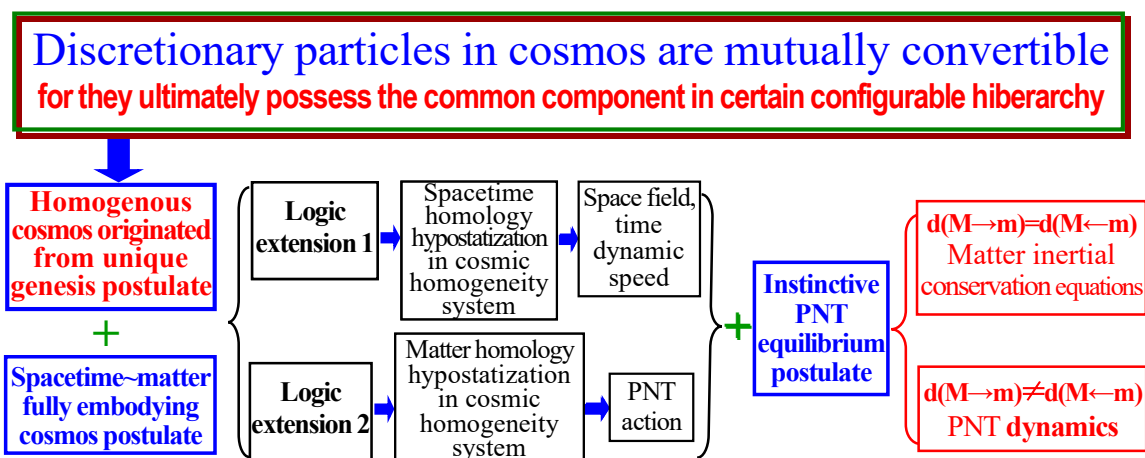

(II-i-3) Simplified logic constitution of Homogenous Cosmos Originated from Unique Genesis

All in all, the integrative logic proliferation of Homogenous Cosmos Originated from Unique Genesis is generally like imagery as following:

Historical progress of science in the recent several centuries seemed like a far-flung exploration of the first itinerary around numerous distinctive landscapes of brand-new landmasses of science with palette & tablet on back, several hundred years' scientific travelogues were compiled thereby.

As remarkable highlight of factuality that discretionary particles in cosmos are mutually convertible, I see the formative framework of cosmos——cosmos is throughout homogenous originated from unique genesis. As conclusion of the factuality **discretionary particles in cosmos are mutually convertible** is still out of complete induction but in permanent clarification orientation towards complete induction with substantial potentiality, I have to introduce the idea of **homogenous cosmos originated from unique genesis** as presumable precondition of Homogenous cosmos originated from unique genesis postulate. Of course, on the basis of bare presence of cosmic formative framework, we can not see the fleshy profile of cosmos, it's still necessary for us to add appropriate flesh onto cosmic formative sculpt according to our experiential factuality that cosmos generally consists of spacetime and matter, none coordinative component else so as to make the integrative precondition of **"homogenous cosmos originated from unique genesis + spacetime~matter fully embodying cosmos"** logically extendable, and two logic extensions of Homogenous cosmos originated from unique genesis postulate are deduced therefore. Rational significance of two logic extensions of **Homogenous cosmos originated from unique genesis postulate** are like money, connotation objectification of the two logic extensions of Homogenous cosmos originated from unique genesis postulate is attempt to change money to goods so as to highlight the homologic attribute of spacetime & matter even ascertain the alternative homologic filiation between spacetime and matter. And virtually, ascertainment of homologic filiation alternative between spacetime and matter not only implies homologic generation of matter in homogenous cosmos but also indicates presence of PNT action of matter integration. PNT action is not only headspring creation of original generation of matter along sequential homologic cosmogony throughout cosmic evolution but also consequential dynamic origin of universal existence & motion of matter in cosmos, which of course indicates that existence & motion radically roots in PNT action of matter integration. Once PNT action is regularized by "Instinctive PNT equilibrium postulate", existence & motion of matter in spacetime unveils itself racyly, and mathematical formulation of PNT action with equilibrium instinct of matter integration directly leads to formation of PNT dynamics.

In the succedent two sections, we'll analyze and formulate existence & motion of matter in spacetime further according to operational quantitative classification of $d(M \rightarrow m) = d(M \leftarrow m)$ and $d(M \rightarrow m) \neq d(M \leftarrow m)$ of PNT performance. The section of "Matter Inertial Conservation Equations" derives from analysis and formulation of PNT performance case of $d(M \rightarrow m) = d(M \leftarrow m)$; the section of "Positive & Negative Transmutation Dynamics ——PNT dynamics" derives from analysis and formulation of PNT performance case of $d(M \rightarrow m) \neq d(M \leftarrow m)$.

——Firstly written in Dec. 1995, literal revision was done in Dec.2004

(II-i-1) Matter Inertial Conservation Equations

Abstract: In homogenous cosmos, PNT action is not only demiurgic action of original generation of matter in spacetime but also dynamic origin of existence & motion of matter in cosmos. Since we have supposed that PNT action is always action with instinct to maintain equilibrium of PNT performance of matter integration, once we come to mathematically analyze existence & motion of matter in the nature of instinctive PNT reciprocal equilibrium towards optimum PNT operation, we then have to consider to manage an integrative rationale origin for mathematical analysis of existence & motion of matter in spacetime, which include general logic correlations of all state variables related to PNT operation of matter integration. Once we consummate formulation of such an integrative rationale origin including general logic correlations of all state variables related to PNT operation of matter integration, we consequently arrive at “Matter Inertial Conservation Equations”. So-called “Matter Inertial Conservation Equations” is just formulation of rationale origin in mathematical format towards mathematical formulation of existence & motion, which include general logic correlation of all state variables related to PNT operation of matter integration.

In detail words, when $d(M \rightarrow m) = d(M \leftarrow m) = Q = \text{some certain constant} > 0$, the mass m of positive matter of matter integration is constant, the mass M of matter field of matter integration is constant, so that the total mass of matter integration “ $m + M = R$ ” is constant and the mass quotient of mass M of matter field over mass m of positive matter of matter integration “ $M/m = K$ ” is constant, the letter R denotes the total mass of matter integration, the letter K denotes mass quotient of mass M of matter field over mass m of positive matter of matter integration. And the absolute spacetime momentum of matter integration “ $mV = d(M \leftarrow m)Y$ ” is of course constant. In order to consummate the rationale origin for further mathematical formulation of existence & motion including comprehensive logic correlation among all state variables related to PNT operation of matter integration, we primarily suppose the logic correlation among length of matter L , proportionate space field strength $\alpha(M)$ and mass of positive matter of matter integration satisfying $L^3 \alpha(M) = A * m$, among the equation, letter A denotes constant of direct proportion; and we suppose the logic correlation between time dynamic speed Y and the proportionate space field strength at position with distance r from the center of positive matter $\alpha(M, r)$ satisfying $Y = B * \alpha(M, r)$, among the equation, letter B denotes constant of direct proportion. As a result, we arrive at Matter Inertial Conservation Equations as following:

$$\left\{ \begin{array}{l} M + m = R \\ M/m = K \\ mV = d(M \leftarrow m)Y \\ L^3 * \alpha(M) = A * m \\ Y = B * \alpha(M, r) \end{array} \right. \longleftrightarrow \left\{ \begin{array}{l} M = KR / (1 + K) \\ m = R / (1 + K) \\ V = d(M \leftarrow m)Y / m \\ L^3 * = A * m / \alpha(M) \quad (\otimes) \\ Y = B * \alpha(M, r) \quad (\otimes) \end{array} \right.$$

Key words: matter inertial conservation equations.

So-called “matter existence” is that, when matter integration performs PNT action under proper spacetime condition by the light of nature, integrative situation that integral cumulation of negative towards positive transmutation from field genic units to elementary genic units $\int_0^t d(M \rightarrow m)dt$ - integral cumulation of positive towards negative transmutation from elementary genic units to field genic units $\int_0^t d(M \leftarrow m)dt = \text{selfhood physical esse of positive matter with mass residue } m > 0$ (which indicates $\int_0^t [d(M \rightarrow m) - d(M \leftarrow m)]dt = m > 0$ in time current)

is maintained in relatively steady idiographic succession with absolute spacetime momentum $mV=d(M\leftarrow m)*Y$ ever since.

As a result, matter existence can be mathematically formulated as below:

$$\begin{cases} \int_0^t [d(M\rightarrow m)-d(M\leftarrow m)]dt=m>0 \\ mV=d(M\leftarrow m)*Y \end{cases}$$

Against the downwind backup of the primary definition of “matter existence”, in order to formulate “existence & motion” mathematically in general dynamic equations, we come to focus on the integrative logic correlation of all state variables related to PNT operation of matter integration in prior, which of course implicates the mass m of positive matter of matter integration, mass M of matter field of matter integration, positive towards negative transmutation rate $d(M\leftarrow m)$, moving speed of matter integration V , the length L of positive matter of matter integration, time dynamic speed Y of matter field of matter integration, and space field strength of matter field of matter integration $\alpha(M)$.

For the necessity of highlight of integrative logic correlation of matter integration, we now come to look into what's matter integration first.

1. Introduction of matter integration

Original generation of matter in the nature of coherent natura naturans brings out essence of matter in a class by itself; essence of matter in a class by itself predestines thorough coherence of dynamic regularity of universal existence & motion. Consequently, in order to make essence of matter self-evident, we have to clarify original generation of matter in cosmos above all; and in order to mathematically formulate existence & motion of matter in cosmos, we have to manage appropriate quantification of essence of matter.

In point of homogenous cosmos originated from unique genesis, matter is conditional outcome as lineal homology of spacetime when spacetime develops to some certain procreant stage, ——convergent crystal of extra-saturated spacetime. Such factuality of course indicates self-evident issues below:

A) Since both matter and spacetime can coexist steadily as lineal homology in cosmos, spacetime and matter must keep relatively steady PNT correlation ever since.

B) Since we confirm matter is outcome as lineal homology of spacetime when spacetime develops to some certain stage, this of course means the proper procreant spacetime must be ambient condition for existence & motion of matter in spacetime, and the proper procreant spacetime and the proportionate existence & motion of matter in spacetime must be strict law of causation as initial generation determinism. If the proper procreant spacetime arises aggrandizement, the existence & motion of matter in spacetime must proportionably arises aggrandizement; if the procreant spacetime arises retrogression, the existence & motion of matter in spacetime must arises retrogression proportionately.

We just call the proper procreant spacetime “matter field” which keeps PNT correlation with the corresponding matter inherently. As matter field inherently keeps PNT correlation with positive matter, matter field is virtually innate yokemate field of positive matter, once the positive matter comes to increase for convergent cumulation of mass, the matter field must increase and strengthen proportionably. We just call the integrative esse made up of positive matter and the innate yokemate field of positive matter “matter integration” which are inherently correlated by PNT action.

In straightforward words, so-called matter integration is just the integrative esse made up of positive matter and the innate yokemate field of positive matter which are inherently correlated by PNT action. If we denote the mass of matter field of matter integration M , and we denote mass of positive matter of matter integration m , then the symbolization of “ $M \leftrightarrow m$ ” can be not only the symbol of positive & negative transmutation but also the ideographic symbol of matter integration. The configuration and overall arrangement of matter integration can be illustrated as below:

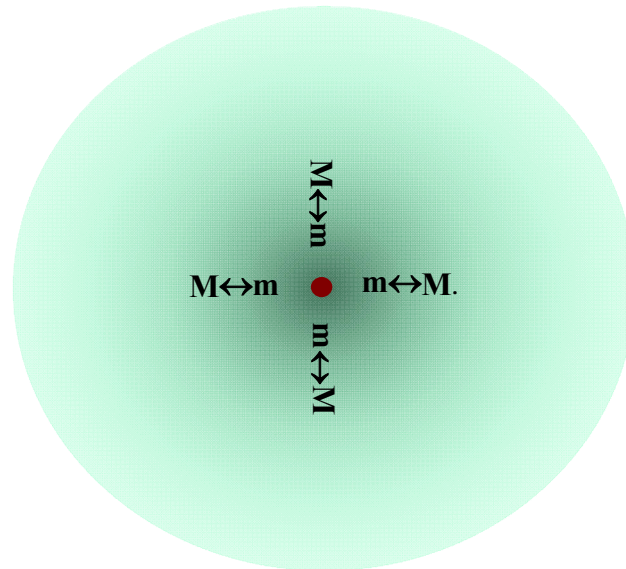

(II-i-1-a) Configuration and overall arrangement of matter integration

The french grey globe extent in above illustration denotes matter field of matter integration, the small solid red globe in centre of the illustration denotes the positive matter of matter integration. The four symbolization of “ $M \leftrightarrow m$ ” around the central solid red globe means that positive matter and matter field of matter integration inherently keep PNT action omnidirectional, and it is just such innative PNT action of matter integration which radically determines idiographic existence & motion of matter in spacetime.

As introduction of idea of homogenous cosmos originated from unique genesis and subsequent confirmation of homologic filiation of spacetime and matter, when Homogenous Cosmos Originated from Unique Genesis comes to study existence & motion of matter in spacetime, the study object is not isolated positive matter any longer but matter in integrative esse of matter integration, it radically studies vivid existence & motion of matter in spacetime by highlighting PNT performance of matter integration.

2. Formulation of inertial existence & motion of matter integration in spacetime in PNT performance case of $d(M \rightarrow m) = d(M \leftarrow m) = Q > 0$, — Matter Inertial Conservation Equations

Existence & motion of matter in spacetime radically depends on PNT action of matter integration, idiographic existence & motion of matter in spacetime is but dynamic mode straightforward mirrored PNT action of matter integration. In a simple word, existence & motion of matter is just the vivid incarnation of ongoing PNT action of matter integration.

PNT performance of matter integration can be generally classified into two cases of $d(M \rightarrow m) = d(M \leftarrow m) = Q$ (Q is a constant) and $d(M \rightarrow m) \neq d(M \leftarrow m)$. And now, we emphatically come to analyze the inertial existence & motion case of $d(M \rightarrow m) = d(M \leftarrow m)$ and try to formulate the proper state in simple equations.

Let's suppose there is a matter integration, for expedience of mathematical formulation, we denote the mass of matter field of matter integration M and denote the mass of positive matter of matter integration m . As PNT performance of matter integration satisfies $d(M \rightarrow m) = d(M \leftarrow m) = Q$ (Q is a constant), we can consequently arrive at our conclusions as following:

- (1) As both magnitude of M and m keep constant, M added to m equals certain constant value R thereby, just as below:

$$M+m=R \quad \dots \dots \quad \textcircled{1}$$

- (2) As both magnitude of M and m keeps constant, the quotient K of M over m keeps constant thereby, just as below:

$$M/m=K \quad \dots \dots \dots \quad \textcircled{2}$$

In equation ① above, the quantity “ R ” denotes the total mass of matter integration, we just call the parameter R “total mass scale” of both negative mass and positive mass of matter integration. In equation ② above, the quantity “ K ” denotes the quotient of matter field mass M over positive matter mass m , we call the parameter K “equilibrium quotient negative mass over positive mass” of matter integration. If none physical disturbance to matter integration, PNT operation of matter integration must satisfy $d(M \rightarrow m) = d(M \leftarrow m) = Q > 0$, so that mass of matter field M keeps constant, mass of positive matter m keeps constant, and as a result, “ $M+m=R$ ” and “ $M/m=K$ ” keep constant therefore, which of course indicates mass conservation of matter integration in cosmos, so we just call the both equation ① and equation ② inertial conservation equations.

What is necessary for supplemental interpretation is that, in terms of discretionary matter integration in inertial conservation state in spacetime, as idiographic disparity of quantities of M , m , $d(M \rightarrow m) = d(M \leftarrow m) =$ some certain constant, the quantities of R and K are proportionately different; in terms of equation “ $M/m=K$ ”, M and m must satisfy $M > 0$, $m > 0$, once $m=0$, it indicates the matter integration is nonexistent. Of course, even the different matter integration are all in inertial state, as idiographic disparity of M , m and $d(M \rightarrow m) = d(M \leftarrow m) =$ distinctive constant, the quantities of R and K are consequently different. Comparably, disparity of R indicates more of disparity of mass scale of matter integration; disparity of K indicates more equilibrium state of matter integration, which relates more of the active degree of PNT operation of matter integration, and consequently, it relates more of moving speed, existent stability and changeability of matter integration. so we just call the parameter R “mass scale value of matter integration”, and we call the parameter K “equilibrium quotient negative mass over positive mass” of matter integration.

Ostensibly, it seems the quantitative range of “mass scale value of matter integration R ” may be $(0, +\infty)$, whereas, as long as we have to admit the limit of cosmos, as cosmic content, we then have to admit it's almost impossible for the quantity of “mass scale value of matter integration R ” to be $+\infty$. And what's more, the “mass scale value of matter integration R ” is consequence of demiurgic evolution of cosmos, demiurgic evolution of cosmos must be subject to coherent natura naturans throughout cosmic evolution in the nature of instinctive PNT reciprocal equilibrium towards optimum PNT operation. The root cause matter has to readjust its existence & motion spontaneously is but because matter has not acclimated itself the proper surrounding in the nature of instinctive PNT reciprocal equilibrium towards optimum PNT operation. This of course indicates existence & motion of matter in spacetime must be subject to dynamic fundamental of instinctive PNT reciprocal equilibrium towards optimum PNT operation, if increase of total mass R of matter integration is incompatible

to dynamic fundamental of instinctive PNT reciprocal equilibrium towards optimum PNT operation, there is no realistic possibility to accomplish increase of total mass R of matter integration. However, as personal limitation, I am still difficult to offer the definite quantitative range of total mass R of matter integration (0, +W) due to conditionality of instinctive PNT reciprocal equilibrium towards optimum PNT operation.

Historical progress of science is always hypostatic endeavor to push humanistic ideology about authenticity of nature forward to perfect ideological enantiomorph of ultimate authenticity of nature draw on practical feasibility & possibility in proportion to contemporaneous historical background. Throughout historical progress of science, although, there were substantively many great scientists one after another, any great scientist could only do his eximious job aiming at historically accessible existence & motion around then and there draw on practical feasibility & possibility in proportion to contemporaneous historical background and consequently output commensurate humanistic ideology about authenticity of nature in proportion to contemporaneous historical background. Before humanistic ideology about authenticity of nature finally qualified as perfect ideological enantiomorph of ultimate authenticity of nature, achievement of great scientists is mostly limited in endeavor to push humanistic ideology about authenticity of nature forward to perfect ideological enantiomorph of ultimate authenticity of nature draw on practical feasibility & possibility in proportion to contemporaneous historical background, it's almost impossible for them to achieve perfect ideological enantiomorph of ultimate authenticity of nature once, and all resultant historical scientific truths are but compositive achievement belonging to commensurate humanistic ideology about authenticity of nature in proportion to contemporaneous historical background out of question.

The authentic factuality is that, veritable progress of science is always endeavor to push humanistic ideology about authenticity of nature forward to perfect ideological enantiomorph of ultimate authenticity of nature step by step draw on practical feasibility & possibility in proportion to contemporaneous historical background, before commensurate humanistic ideology about authenticity of nature finally qualified as perfect ideological enantiomorph of ultimate authenticity of nature, so-called “science” is always humanistic ideology about authenticity of nature in proportion to contemporaneous historical background, which of course include the so-called travelogue style popular physics, chemistry, biology, iatrology, etc we have accomplished like a far-flung exploration of the first itineracy around numerous distinctive landscapes of brand-new landmasses of science with palette & tablet on back in the recent several centuries, although, historical progress of science is always in inherent optimum orientation towards perfect ideological enantiomorph of ultimate authenticity of nature.

As introduction of scientific idea of homogenous cosmos originated from unique genesis, practical rational implementation of connotation objectification and freewheeling logic extension of homogenous cosmos originated from unique genesis has imited more rationale vitality to coming scientific knowledge proliferation. And just because of in-depth rational highlight of homogenous cosmos originated from unique genesis in lineal logic extension model of **{(homogenous cosmos originated from unique genesis + spacetime matter fully embodying cosmos) + instinctive PNT equilibrium}**, we arrived at conclusion that universal existence & motion must be subject to coherent dynamic fundamental of **instinctive PNT reciprocal equilibrium towards optimum PNT operation**, existence & motion of celestial bodies under conditionality of gravity can never be exceptive, which must be distinctive existence & motion in the nature of instinctive PNT reciprocal equilibrium towards optimum PNT operation, so that occurrence of gravitational interaction among celestial bodies must be subject to fundamental of “mass disparity accessible to positive gravity” and “mass approximation accessible to negative gravity”, so that there is no hypostatic way for original generation of so-called “Black Hole” in cosmos.

Historical progress of science in the recent several centuries seemed like a far-flung exploration of the first itineracy around numerous distinctive landscapes of brand-new landmasses of science with palette & tablet on back, several hundred years' scientific travelogues were compiled thereby.

As universal existence & motion in homogenous cosmos must be subject to coherent dynamic fundamental of instinctive PNT reciprocal equilibrium towards optimum PNT operation, the possible quantitative change range of parameter of “equilibrium quotient negative mass over positive mass K” must be a rather limited range (α , β). Whereas, something is necessary for me to emphasize herein is that, as existence & motion in cosmos are so rich and colorful, in terms of any hypostatic existence & motion, its “equilibrium quotient negative mass over positive mass” K must belong to range of (α , β), however, it's not discretionary value belonging to (α , β) is applicable to discretionary matter integration in spacetime. At any rate, original generation and postnatal existence & motion of discretionary object in cosmos must be subject to coherent dynamic fundamental of instinctive PNT reciprocal equilibrium towards optimum PNT operation; once it's impossible to be compatible with instinctive PNT reciprocal equilibrium towards optimum PNT operation, there is no possibility for it to be generated and existed as idiographic object in cosmos. As minimum of the range of (α , β), α is the value indicating the best existent situation of object in spacetime, once object exists in such situation, its reciprocal structure is most ideal and its existent state is the most steady in spacetime. α is the value indicating the worst existent situation of object in spacetime, once object exists in such situation, its reciprocal structure is most peripheral and its existent state is the most flimsy in spacetime, once the “equilibrium quotient negative mass over positive mass” K of matter integration approaching the value β , it indicates the existent state of the object has approached the critical value to death.

During the course of aberrant convergence of cosmic esse due to PNT reciprocal gelation, when the elementary genic units firstly come into being in spacetime, the existent situation of elementary genic units in spacetime is of course very flimsy, the matter fields of elementary genic units are of course very flimsy proportionately. In such existent situation, the value of “equilibrium quotient negative mass over positive mass” K of isolated elementary genic units is of course very near to β value, after a series of stochastic reciprocity in the nature of instinctive PNT reciprocal equilibrium towards optimum PNT operation, the elementary genic units gradually turn into reciprocal PNT combinations in gradation I, reciprocal PNT combinations in gradation II, reciprocal PNT combinations in gradation III, reciprocal PNT combinations in gradation IV, the existent state of elementary genic units in spacetime is optimized step by step with value of “equilibrium quotient negative mass over positive mass” K of matter integration closing to value of α in proportion.

However, reciprocity of aberrant convergence of cosmic esse due to PNT reciprocal gelation does not stop when the “equilibrium quotient negative mass over positive mass” K of matter integration approaches α . virtually, realistic universal existence & motion are not optimum existence and motion in cosmos, but stochastic original demiurgic generation and postnatal existence & motion in the nature of instinctive PNT reciprocal equilibrium towards optimum PNT operation, once “**reciprocal idiosyncrasy towards PNT equilibrium + accessible space overall arrangement for PNT reciprocity**” among compositive components stochastically accomplished, there must be consequent spontaneous occurrence of original generation of brand-new reciprocal PNT combinations in the nature of instinctive PNT reciprocal equilibrium towards optimum PNT operation, if no stochastic accomplishment of “**reciprocal idiosyncrasy towards PNT equilibrium + accessible space overall arrangement for PNT reciprocity**” among compositive components, there is no consequent spontaneous occurrence of original generation of brand-new reciprocal PNT combinations in the nature of instinctive PNT reciprocal equilibrium towards optimum PNT operation. As a result, the natural distributing of “equilibrium quotient negative mass over positive mass K” is almost continuous in range of (α , β) for stochastic accomplishment of “**reciprocal idiosyncrasy towards PNT equilibrium + accessible space overall arrangement for PNT reciprocity**” among compositive components.

As coherent natura naturans throughout cosmic evolution, instinctive PNT reciprocal equilibrium towards optimum PNT operation is radical potentiality & conditionality for cosmos always ready to orientate itself towards perfection.

In principle, there is more compatible reciprocity among the proper compositive components in accordance with dynamic fundamental of instinctive PNT reciprocal equilibrium towards optimum PNT operation, there is more potential probability for original generation of reciprocal PNT combinations on the basis of the proper compositive components, and the existent state of the resultant reciprocal PNT combinations is more steady. In terms of atoms (**reciprocal PNT combinations in gradation II**) in cosmos, why the total quantity of all kinds of atoms in cosmos is so remarkably different? And why there are only more than 110 sorts of atoms in cosmos, not 800 sorts or 1000 sorts?

Because there is only possibility for the demiurge to implement coherent natura naturans throughout cosmic evolution, which is dynamic fundamental of instinctive PNT reciprocal equilibrium towards optimum PNT operation. The demiurge actualizes the compatible possibility due to instinctive PNT reciprocal equilibrium towards optimum PNT operation into reality and leaves the incompatible impossibility due to instinctive PNT reciprocal equilibrium towards optimum PNT operation into nothingness by the light of nature.

In terms of the atoms in cosmos, if the inborn reciprocal connotation of atoms is more compatible to demiurgic fundamental of instinctive PNT reciprocal equilibrium towards optimum PNT operation, there is more potential probability for original generation of the atoms, and the postnatal atoms are relatively more steady to exist in spacetime, as a result, there are relatively more of the very sort of atoms in cosmos ever since. Comparably, if the inborn reciprocal connotation of atoms is more incompatible to demiurgic fundamental of instinctive PNT reciprocal equilibrium towards optimum PNT operation, there is less potential probability for original generation of the atoms, and the postnatal atoms are relatively more unstable to exist in spacetime, as a result, there are relatively less of the very sort of atoms in cosmos ever since. Usually, there are less nucleons of atomic nucleus, there is more potential probability for original generation of the corresponding atoms, and the corresponding atoms are relatively more steady to exist in spacetime, and as a result, there are more of the very sort of atoms in cosmos. There are more nucleons of atomic nucleus, there is less potential probability for perfect original generation of the corresponding atoms, and the corresponding atoms are relatively more unstable to exist in spacetime, and as a result, there are less of the very sort of atoms in cosmos. Heavy metals are mostly rare metals in cosmos, and the atoms of heavy metals are mostly unstable for natural radiation even fission.

In terms of quantitative change of reciprocal aggregation of reciprocal PNT combinations in gradation IV in the nature of instinctive PNT reciprocal equilibrium towards optimum PNT operation, which is spontaneous occurrence under guidance of so-called “gravitational interaction” among celestial bodies, in a relatively small-scale quantitative range of mass of celestial bodies, the increase of mass of celestial bodies is rather compatible to the dynamic fundamental of instinctive PNT reciprocal equilibrium towards optimum PNT operation. Whereas, the quantitative change of convergent accumulation of mass of celestial bodies is not unlimited through and through, once convergent accumulation of mass of celestial bodies extends to some certain mass scale, as massive accumulation of mass must cause too serious condensation of mass of celestial body in limited space, it must impact the expedience of smooth PNT operation of matter integration in limited space, which is of course incompatible to dynamic fundamental of instinctive PNT reciprocal equilibrium towards optimum PNT operation. As a result, the demiurgic evolution of reciprocal PNT combinations in gradation IV in the nature of instinctive PNT reciprocal equilibrium towards optimum PNT operation has to hypostatize regularity of “mass disparity accessible to positive gravity” and “mass approximation accessible to negative gravity” accordingly. In terms of any celestial body in massive mass scale, in order to to ensure smooth PNT operation of matter integration, the massive celestial

bodies are usually not easy to reject tender increase of mass for stochastic intervention of small celestial bodies, but instinctively reject remarkable increase of mass for stochastic intervention of massive celestial bodies (please refer to the coming section of “force field” and “force” in the third part). And even as the stochastic intervention of massive celestial bodies is too inudant, the even massive consequent celestial body has to crack itself beyond endurance, such as fixed stars explode themselves by the light of nature.

As remarkable discrepancy in mechanical structure among elementary genic units, among reciprocal PNT combinations in gradation I, among reciprocal PNT combinations in gradation II, among reciprocal PNT combinations in gradation III, and among reciprocal PNT combinations in gradation IV, there is substantial cause for distribution of “equilibrium quotient negative mass over positive mass” K of elementary genic units, reciprocal PNT combinations in gradation I, reciprocal PNT combinations in gradation II, reciprocal PNT combinations in gradation III, reciprocal PNT combinations in gradation IV to be independent system along sequential homologic cosmogony. In accordance with our general experience about universal existence & motion, the distribution of “equilibrium quotient negative mass over positive mass” K of matter integration of elementary genic units, reciprocal PNT combinations in gradation I, reciprocal PNT combinations in gradation II, reciprocal PNT combinations in gradation III, reciprocal PNT combinations in gradation IV may be similar as a part of parabola. As a result, the distribution of “equilibrium quotient negative mass over positive mass” K of matter integration of elementary genic units, reciprocal PNT combinations in gradation I, reciprocal PNT combinations in gradation II, reciprocal PNT combinations in gradation III, reciprocal PNT combinations in gradation IV can be generally illustrated as following:

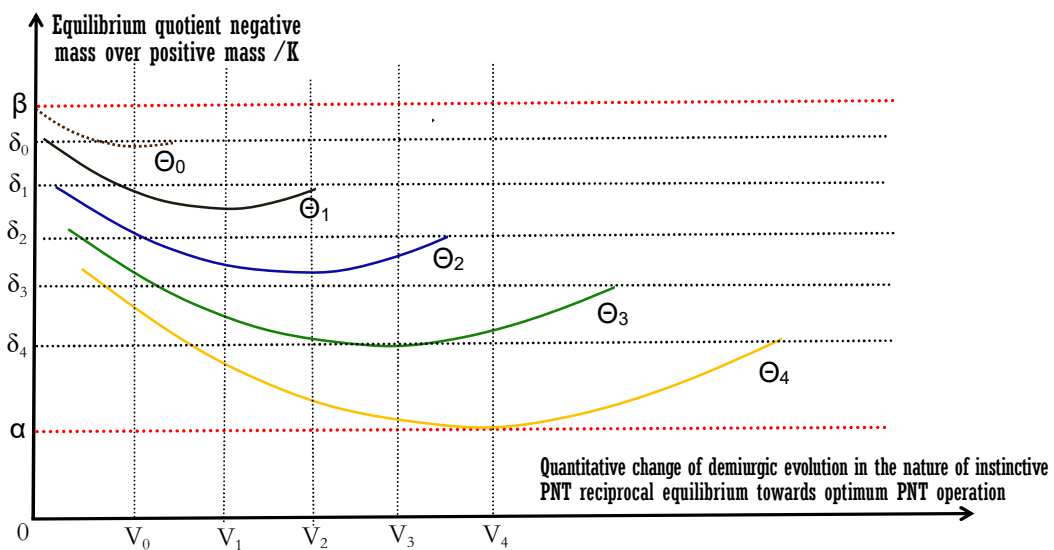

(II-i-1-b) Distribution of “equilibrium quotient negative mass over positive mass” K of matter integration along quantitative change of demiurgic evolution in the nature of instinctive PNT reciprocal equilibrium towards optimum PNT operation

In illustration above, the y-axis indicates value of equilibrium quotient negative mass over positive mass K , x-axis indicates quantitative change of demiurgic evolution in the nature of instinctive PNT reciprocal equilibrium towards optimum PNT operation.

In illustration above, the α red line is the lower limit line of equilibrium quotient negative mass over positive mass K , which indicates the situation of best existence & motion of matter integration in the nature of instinctive PNT reciprocal equilibrium towards optimum PNT operation, any object in cosmos whose equilibrium quotient negative mass over positive mass is close to value α must be relatively steady-going in spacetime.

As coherent natura naturans throughout cosmic evolution, instinctive PNT reciprocal equilibrium towards optimum PNT operation is radical potentiality & conditionality for cosmos always ready to orientate itself towards perfection.

In illustration above, the β red line is the upper limit line of equilibrium quotient negative mass over positive mass K, which indicates the situation of worst existence & motion of matter integration in the nature of instinctive PNT reciprocal equilibrium towards optimum PNT operation, any object in cosmos whose equilibrium quotient negative mass over positive mass is close to value β must be relatively flimsy in spacetime.

In illustration above, the broken curve Θ_0 indicates distribution of equilibrium quotient negative mass over positive mass K of matter integration of elementary genic units in spacetime. As the sorts of elementary genic units in cosmos are rather limited, I readjust the curve into broken line to indicate dot distribution of equilibrium quotient negative mass over positive mass K of limited elementary genic units along the curve. Vertical broken line V_0 indicates lower limit of equilibrium quotient negative mass over positive mass K of matter integration of elementary genic units in spacetime; broken line δ_0 indicates upper limit of equilibrium quotient negative mass over positive mass K of the last sort of elementary genic unit along cosmic demiurgic evolution, there is none potentiality for generation of any other elementary genic unit in spacetime along evolutionary extension of cosmos, whose equilibrium quotient negative mass over positive mass K of matter integration is even bigger than δ_0 .

In illustration above, the broken curve Θ_1 indicates distribution of equilibrium quotient negative mass over positive mass K of matter integration of reciprocal PNT combinations in gradation I. Vertical broken line V_1 indicates lower limit of equilibrium quotient negative mass over positive mass K of matter integration of reciprocal PNT combinations in gradation I in spacetime; broken line δ_1 is upper limit of equilibrium quotient negative mass over positive mass K of reciprocal PNT combinations in gradation I along quantitative change of demiurgic evolution in the nature of instinctive PNT reciprocal equilibrium towards optimum PNT operation, which indicates there is none reciprocal potentiality for original generation of reciprocal PNT combinations in gradation I in spacetime along evolutionary extension of cosmos, whose equilibrium quotient negative mass over positive mass K of matter integration is even bigger than δ_1 .

In illustration above, the broken curve Θ_2 indicates distribution of equilibrium quotient negative mass over positive mass K of matter integration of reciprocal PNT combinations in gradation II. Vertical broken line V_2 indicates lower limit of equilibrium quotient negative mass over positive mass K of matter integration of reciprocal PNT combinations in gradation II in spacetime; broken line δ_2 is upper limit of equilibrium quotient negative mass over positive mass K of reciprocal PNT combinations in gradation II along quantitative change of demiurgic evolution in the nature of instinctive PNT reciprocal equilibrium towards optimum PNT operation, which indicates there is none reciprocal potentiality for original generation of reciprocal PNT combinations in gradation II in spacetime along evolutionary extension of cosmos, whose equilibrium quotient negative mass over positive mass K of matter integration is even bigger than δ_2 .

In illustration above, the broken curve Θ_3 indicates distribution of equilibrium quotient negative mass over positive mass K of matter integration of reciprocal PNT combinations in gradation III. Vertical broken line V_3 indicates lower limit of equilibrium quotient negative mass over positive mass K of matter integration of reciprocal PNT combinations in gradation III in spacetime; broken line δ_3 is upper limit of equilibrium quotient negative mass over positive mass K of reciprocal PNT combinations in gradation III along quantitative change of demiurgic evolution in the nature of instinctive PNT reciprocal equilibrium towards optimum PNT operation, which indicates there is none reciprocal potentiality for original generation of reciprocal PNT combinations in gradation III in spacetime along evolutionary extension of cosmos, whose equilibrium quotient negative mass over positive mass K of matter integration is even bigger than δ_3 .

In illustration above, the broken curve Θ_4 indicates distribution of equilibrium quotient negative mass over positive mass K of matter integration of reciprocal PNT combinations in gradation IV. Vertical broken line V_4 indicates lower limit of equilibrium quotient negative mass over positive mass K of matter integration of reciprocal PNT combinations in gradation IV in spacetime; broken line δ_4 is upper limit of equilibrium quotient negative mass over positive mass K of reciprocal PNT combinations in gradation IV along quantitative change of demiurgic evolution in the nature of instinctive PNT reciprocal equilibrium towards optimum PNT operation, which indicates there is none reciprocal potentiality for original generation of reciprocal PNT combinations in gradation IV in spacetime along evolutionary extension of cosmos, whose equilibrium quotient negative mass over positive mass K of matter integration is even bigger than δ_4 .

- (3) The negative transmutation rate $d(M \leftarrow m)$ and time dynamic speed Y of matter integration keep constant, so that the absolute spacetime momentum of matter integration in spacetime must be constant, just as the equation below:

$$m * V = d(M \leftarrow m) * Y \quad \dots \dots \dots \quad \textcircled{3}$$

- (4) The length of matter must be certain constant, and now we primarily assume that the cube of the length L of positive matter (/baryonic matter) is proportional to the positive mass m of matter integration and inverse proportional to the matter field strength α . We now denote the functional correlation between α and M as $\alpha(M)$, as both M and m are constants, consequently, the length L of matter must be constant too, just as the equation below:

$$L^3 * \alpha(M) = A * m \quad \dots \dots \dots \quad \textcircled{4} \quad (\otimes)$$

(In the equation, A is the proportionality constant, and all marks “ \otimes ” in this treatise indicate primary presumable equation)

- (5) The time rate of matter integration keeps constant, and the best variable indicating the time rate is time dynamic speed Y. Now we primarily assume that time dynamic speed Y of any point in matter field with distance r to the mass center of object is proportional to the strength of matter field at the very point $\alpha(M, r)$. Under the precondition that matter integration keeps constant, M is a constant, and $\alpha(M, r)$ is a constant too, so that Y is consequently a constant too, just as the equation below:

$$Y = B * \alpha(M, r) \quad \dots \dots \dots \quad \textcircled{5} \quad (\otimes)$$

(Among the above equation B is the proportionality constant)

Generally, when we practically come to study the existence & motion of matter integration in spacetime, we just choose matter field strength and time dynamic speed on the surface of object. And as primary presumable equations, equation $\textcircled{4}$ and equation $\textcircled{5}$ still need further credible demonstration, it may be even necessary for further revision once we look into more details.

Now, we can arrange the five equations above into Matter Inertial Conservation Equations $\textcircled{1}$ as following:

$$\left\{ \begin{array}{l} M+m=R \\ M/m=K \\ mV=d(M \leftarrow m)Y \\ L^3 * \alpha(M) = A * m \quad (\otimes) \\ Y = B * \alpha(M, r) \quad (\otimes) \end{array} \right. \quad \longleftrightarrow \quad \left\{ \begin{array}{l} M=KR/(1+K) \\ m=R/(1+K) \\ V=d(M \leftarrow m)Y/m \\ L^3 = A * m / \alpha(M) \quad (\otimes) \\ Y = B * \alpha(M, r) \quad (\otimes) \end{array} \right.$$

As coherent natura naturans throughout cosmic evolution, instinctive PNT reciprocal equilibrium towards optimum PNT operation is radical potentiality & conditionality for cosmos always ready to orientate itself towards perfection.

In the above equations, R denotes the total mass of matter integration; K denotes the quotient of negative mass over positive mass. Something is necessary to add interpretation is that, when we come to analyze the quantitative change of idiographic existence & motion in the nature, the mass quantity of m can be negative quantity in some cases. Whereas, in Matter Inertial Conservation Equations, both quantities of M and m can only be positive quantities. Once $m \leq 0$ occurred, the matter integration is virtually nonexistent any longer. And in natural demiurgic sequence of sequential homologic cosmogony through and through, matter field is consequent proportionate outcome of $m > 0$, once there is remarkable decrease of mass of m, especially the quantitative change of m remarkably orients 0, relatively, the mass of the proportionate matter field M must be more sensitive to orient 0. As a result, there will not be unnatural occurrence of $M > 0$, $m = 0$ for ever.

Along lineal logic extension of connotation objectification & freewheeling logic extension of homogenous cosmos originated from unique genesis, establishment of Matter Inertial Conservation Equations is substantively significant and pivotal towards formulation of universal existence & motion under unique presumable precondition of Homogenous cosmos originated from unique genesis postulate, it's virtually formulation of **general logic correlations of all state variables of matter integration related to PNT action**, which makes it qualified to take role of rationale origin for further formulation of universal existence & motion in homogenous cosmos. If we define universal existence & motion is but spontaneous occurrence of **[external physical disturbance + (PNT action + Instinctive PNT equilibrium)]**, then, Matter Inertial Conservation Equations is mathematical formulation of constant **(PNT action + Instinctive PNT equilibrium)**, PNT dynamics is mathematical formulation of logic extension of "rationale of **[Matter Inertial Conservation Equation + $d(M \rightarrow m) \neq d(M \leftarrow m)$]** due to instinctive PNT reciprocal equilibrium towards optimum PNT operation in condition of **external physical disturbance $\neq 0$** . Although, till today, I am still not sure how much of the equations is still necessary to be revised accordingly.

——Firstly written in Dec. 1995, literal revision was done in Dec.2004

Note ①: "Matter Inertial Conservation Equations" and "PNT Dynamics" of Homogenous Cosmos Originated from Unique Genesis almost came into being at the same day in winter of 1995. Along lineal logic extension of connotation objectification & freewheeling logic extension of homogenous cosmos originated from unique genesis, introduction of Matter Inertial Conservation Equations is of course the most important step in linear logic expansion of Homogenous Cosmos Originated from Unique Genesis. At any rate, the Matter Inertial Conservation Equations have almost contained general logic correlations of all existent parameters of matter integration related to PNT action, further mathematical analysis and formulation of universal existence & motion in the nature of instinctive PNT reciprocal equilibrium towards optimum PNT operation must focus on the rationale of the Matter Inertial Conservation Equations accordingly, although the equations seem so simple ostensibly. And in rather a long time, my teacher and good friend professor Huang jun (jun.huang@carleton.ca / steedhuang@ujs.edu.cn) always persisted that Matter Inertial Conservation Equations seemed too simple in proportion to its significance towards formulation of universal existence & motion.

Professor Huang: You always insist Matter Inertial Conservation Equations are very important throughout logic expansion of Homogenous Cosmos Originated from Unique Genesis, which are not only logic basis of PNT Dynamics, but also rationale of general state equations about universal existence & motion of reciprocal PNT combinations. Whereas, the Matter Inertial Conservation Equations seem so simple, is it possible for radical rationale of nature to be so simple?

Mark Yang: I was astonished for the comment from my teacher Huang for rather a moment of course. I admit that Matter Inertial Conservation Equations are simple indeed, whereas, the simpleness never impacts the significance for Matter Inertial Conservation Equations to take the role of radical rationale for formulation of universal existence & motion.

Since we confirm [Homogenous cosmos originated from unique genesis + spacetime~matter fully embodying cosmos], there is no way for us to shy away ingenerate homologic filiation correlation between “spacetime” and “matter”, which is generally hypostatized as “PNT action” of matter integration and predestines physical existence & motion of matter in spacetime as radical dynamic origin. Since we further suppose that PNT action is always instinctive action towards PNT equilibrium, once we are ready to analyze and formulate universal existence & motion in cosmos mathematically, we then have to consider introducing proper state equations as original rationale which contains general logic correlations of all state variables of matter integration related to PNT action for expedience of mathematical formulation of universal existence & motion, Matter Inertial Conservation Equations are of course the very thing for the job. Although, there is none ideal “PNT action in absolute equilibrium state (just the same as there is no motion in absolute inertial state in cosmos)”, we have to suppose one ideal model of PNT operation in equilibrium state for expedience of rational clarification & formulation of general correlations of all existent parameters of matter integration, which is of course pioneering attempt similar as there are none absolute inertial references in cosmos, whereas, in order to formulate the motion speed of matter in cosmos, we have to introduce “inertial reference” for expedience.

Professor Huang: I see, I see, I have no reasons to doubt the expedience & necessity of introduction of Matter Inertial Conservation Equations as radical rationale for mathematical formulation of universal existence & motion, once [(Homogenous cosmos originated from unique genesis + spacetime~matter fully embodying cosmos) + instinctive PNT equilibrium] has been introduced, the key issue is that, the simpleness of the equations can not eliminate my suspicion whether so simple Matter Inertial Conservation Equations are adequate & credible enough for mathematical formulation of universal existence & motion as basic rationale or not.

Mark Yang: in the face of suspicion of professor Huang, as helplessness without alternatives indeed, I had to keep silent for a moment, in any case, upon my mathematical knowledge, it's really difficult for me to demonstrate the scientific credibility of Matter Inertial Conservation Equations with supplementation of typical instance of hypostatic existence & motion accessible around at present. Although, I am quite sure simpleness is not something incompatible to coherent natura naturans throughout cosmic evolution, development of science is not endeavor to make humanistic ideology about authenticity of nature more and more complex & luxuriant for vogue, but hypostatic endeavor to push humanistic ideology about authenticity of nature forward to perfect ideological enantiomorph of ultimate authenticity of nature draw on practical feasibility & possibility in proportion to contemporaneous historical background. Instead, complexity can only make the demiurge difficult to accomplish so rich and colorful outgrowth of cosmos in accordance with coherent natura naturans throughout cosmic evolution. And indeed, when I primarily dealt with the Matter Inertial Conservation Equations, I but had idea in mind to consummate general logic correlations of all state variables of matter integration related to PNT action for expedience of mathematical formulation of universal existence & motion in the nature of instinctive PNT reciprocal equilibrium towards optimum PNT operation, none else. And now, you see, it seems doing its job well without nonfeasance, although it's so simple.

As coherent natura naturans throughout cosmic evolution, instinctive PNT reciprocal equilibrium towards optimum PNT operation is radical potentiality & conditionality for cosmos always ready to orientate itself towards perfection.

Several days later, professor Huang offered me two pair of equations and suggested me to introduce them. I thought them over for rather a long time, I still persisted my original equations as “ $M+m=R$, $M/m=K$, $mV=d(M \leftarrow m)Y$ ” are relatively better to take the role of radical rationale of PNT dynamics. Professor Huang perceived my hesitation, he even showed me his alarm, your equation $M/m=K$ maybe bring you into trouble once the negative increase of mass m orients 0, for instance, collision of positive electron and negative electron results in 0 mass of matter integration.

Mark Yang: that’s no problem, along sequential homologic cosmogony in the nature of coherent natura naturans throughout cosmic evolution, matter field is consequent outgrowth of $m>0$ of matter integration, once there is negative increase of mass m towards 0, the mass of matter field M must be more sensitive and preferential to orient 0, there is ingenerate potential precedence for matter field mass M to approach 0 in prior instead of unnatural occurrence of $M>0$, $m=0$.

All in all, I still lack credible evidence to ensure the perfect qualification of Matter Inertial Conservation Equations to take the role of radical rationale for further mathematical formulation of universal existence & motion till today, whereas, I have not found better equations to take place of it yet, although, it originally came into being in a sudden for my afflatus then and there. I now mentioned the negotiation about the issue between professor Huang and me is but ready to remind readers to pay more attention to Matter Inertial Conservation Equations. After all, once we introduced scientific idea of homogenous cosmos originated from unique genesis, along the lineal logic extension of connotation objectification & freewheeling logic extension of homogenous cosmos originated from unique genesis, establishment of Matter Inertial Conservation Equations is substantively significant and pivotal towards formulation of universal existence & motion on the basis of [\[\(Homogenous cosmos originated from unique genesis + spacetime~matter fully embodying cosmos\) + instinctive PNT equilibrium\]](#). Otherwise, once you turn to the next page for PNT dynamics, you will find the factuality immediately.

(II-i-2) Positive & Negative Transmutation Dynamics—PNT Dynamics

Abstract: *If we define universal existence & motion is but spontaneous occurrence of [external physical disturbance + (PNT action + Instinctive PNT equilibrium)], then, Matter Inertial Conservation Equations is mathematical formulation of constant (PNT action + Instinctive PNT equilibrium), PNT dynamics is mathematical formulation of logic extension of “rationale of [Matter Inertial Conservation Equation + $d(M \rightarrow m) \neq d(M \leftarrow m)$] due to instinctive PNT reciprocal equilibrium towards optimum PNT operation in condition of external physical disturbance $\neq 0$. The direct cause for matter integration to lose PNT balance is occurrence of $d(M \rightarrow m) \neq d(M \leftarrow m)$ of PNT action of matter integration. Once matter integration loses its PNT balance, instinctive PNT equilibrium must react for perfection of PNT operation of matter integration in the nature of instinctive PNT reciprocal equilibrium towards optimum PNT operation, and as a result, all state variables of matter integration will consequently change according as following:*

$$\begin{array}{l}
 \left. \begin{array}{l}
 \text{The matter field of matter} \\
 \text{integration is impacted}
 \end{array} \right\} \begin{array}{l}
 \Delta M \text{ is positive } (\Delta M > 0) \\
 \Delta M \text{ is negative } (\Delta M < 0)
 \end{array} \\
 \\
 \left. \begin{array}{l}
 \text{The matter of matter} \\
 \text{integration is impacted}
 \end{array} \right\} \begin{array}{l}
 \text{Matter integration doesn't work} \\
 \text{outside.} \\
 \text{Matter integration works outside.}
 \end{array}
 \end{array} \left. \vphantom{\begin{array}{l} \Delta M \text{ is positive} \\ \Delta M \text{ is negative} \end{array}} \right\} \begin{array}{l}
 \text{Unbalanced matter inertial conservation} \\
 \text{equations (I), (II), (III), (IV)}
 \end{array}$$

We arrive at the uniform format of discretionary unbalanced matter inertial conservation equations

$$(V) \left\{ \begin{array}{l}
 M(t)+m(t)=R(t) \\
 M(t)/m(t)=K(t) \\
 V(t)*m(t)=d(M \leftarrow m)(t)*Y(t) \\
 L^3(t)*\alpha(t)=A*m(t) \\
 Y(t)=B*\alpha(t)
 \end{array} \right\} \longleftrightarrow \left\{ \begin{array}{l}
 M(t)=K(t)*R(t)/[1+K(t)] \\
 m(t)=R(t)/[1+K(t)] \\
 V(t)=d(M \leftarrow m)(t)*Y(t)/m(t) \\
 L^3(t)=A*m(t)/\alpha(t) \\
 Y(t)=B*\alpha(t)
 \end{array} \right.$$

We arrive at presumable acceleration equation: $a(t)=Y(t)*K'(t)$, and with supplemental reference of traditionary dynamics definition equations and $m(t)=R(t)/(1+K(t))$, we consequently deduce the proportionate equations of PNT dynamics as following:

$$\left\{ \begin{array}{l}
 \text{Force equation :} \\
 \text{Velocity equation:} \\
 \text{Displacement equation:} \\
 \text{Momentum change equation:} \\
 \text{Energy change equation:}
 \end{array} \right. \begin{array}{l}
 F(t)=m(t)*Y(t)*K'(t) \\
 V=V_0+\int Y(t)*K'(t)dt \\
 S=V_0*t+\int Y(t)*K'(t)dtdt \\
 \Delta P=m(t)*V-m_0*V_0 \\
 \Delta E=1/2m(t)*V^2-1/2m_0V_0^2
 \end{array}$$

Key words: unbalanced matter inertial conservation equations.

So-called “matter motion” is that, when matter integration performs PNT action under proper spacetime condition by the light of nature, as external dissonance to PNT performance of matter integration, integrative situation that integral cumulation of negative towards positive transmutation from field genic units to elementary genic units $\int_0^t d(M \rightarrow m)dt$ - integral cumulation of positive towards negative transmutation from elementary genic units to field genic units $\int_0^t d(M \leftarrow m)dt$ =selfhood physical esse of positive matter with mass residue $m > 0$ (which indicates $\int_0^t [d(M \rightarrow m)-d(M \leftarrow m)]dt=m > 0$ in time current) and absolute spacetime momentum $mV=d(M \leftarrow m)*Y$

As coherent natura naturans throughout cosmic evolution, instinctive PNT reciprocal equilibrium towards optimum PNT operation is radical potentiality & conditionality for cosmos always ready to orientate itself towards perfection.

is consequently disturbed. The radical indication integrative situation that integral cumulation of negative towards positive transmutation from field genic units to elementary genic units $\int_0^t d(M \rightarrow m) dt$ - integral cumulation of positive towards negative transmutation from elementary genic units to field genic units $\int_0^t d(M \leftarrow m) dt = \text{selfhood}$ physical esse of positive matter with mass residue $m > 0$ and absolute spacetime momentum $mV = d(M \leftarrow m) * Y$ is disturbed is $d(M \rightarrow m) \neq d(M \leftarrow m)$. Of course, once “ $d(M \rightarrow m) \neq d(M \leftarrow m)$ ” of matter integration occurred, spontaneous occurrence of PNT action with instinctive PNT equilibrium must be subject to fundamental of instinctive PNT reciprocal equilibrium towards optimum PNT operation, and instinctive PNT equilibrium in operation must accomplish quantitative change from $d(M \rightarrow m) \neq d(M \leftarrow m)$ towards $d(M \rightarrow m)' = d(M \leftarrow m)'$ as expediently as possible, $d(M \rightarrow m) \neq d(M \rightarrow m)'$; $d(M \leftarrow m) \neq d(M \leftarrow m)'$.

As a result, matter motion can be mathematically formulated as below:

$$\begin{cases} \int_0^t [d(M \rightarrow m) - d(M \leftarrow m)] dt = m > 0 \\ mV = d(M \leftarrow m) * Y \\ d(M \rightarrow m) \neq d(M \leftarrow m) \quad \xrightarrow{\text{PNT}} \quad d(M \rightarrow m)' = d(M \leftarrow m)' \end{cases}$$

And now, we come to formulate “matter motion” in general dynamics.

1. Formulation of existence & motion in the nature of instinctive PNT reciprocal equilibrium towards optimum PNT operation once PNT performance of matter integration satisfies $d(M \rightarrow m) \neq d(M \leftarrow m)$ — PNT Dynamics.

In homogenous cosmos, “PNT action with instinct of PNT equilibrium” is essence of matter, which inherently predestines dynamic regularity of existence & motion of matter. Virtually, “existence & motion of matter in cosmos is just spontaneous occurrence of “external physical disturbance + (PNT action + instinctive PNT equilibrium)”, —dynamic embodiment straightforward mirrored PNT action with instinct of PNT equilibrium of matter integration. We go in for dynamics formulation of universal existence & motion of matter is but attempt to mathematically formulate physical process of “external physical disturbance + (PNT action + instinctive PNT equilibrium)” once “external physical disturbance $\neq 0$ ”, so that PNT operation of matter integration slides into $d(M \rightarrow m) \neq d(M \leftarrow m)$, and instinctive PNT equilibrium has to perform its vocation to rebuild optimum PNT operation of matter integration by the light of nature, which of course implicates proportionate variation of state parameters of $m, K'(t), Y(t), a(t), V(t) \dots$ of matter integration for instinctive equilibrium between $d(M \rightarrow m)$ and $d(M \leftarrow m)$.

We now come to analyze the unbalanced PNT operation as condition $d(M \rightarrow m) \neq d(M \leftarrow m)$ of matter integration on the basis of matter inertial conservation equations, —just to emphatically analyze how all state parameters of matter integration vary accordingly during the course of the covariant equilibrium between $d(M \rightarrow m)$ and $d(M \leftarrow m)$ once matter integration loses its PNT operational balance.

Obviously, as PNT performance characteristics of matter integration, there are only two ways for matter integration to lose its balance or break its original state. The first is to impact the matter field of matter integration, so as to cause matter field mass M a change ΔM , and so as to make the matter integration lose its PNT equilibrium or break its original state. The second is to impact the positive matter (or baryonic matter) of mater system, to make the negative transmutation dominant to positive transmutation, so as to make the positive mass m of matter integration arises a decrease $-\Delta m$, so as to make the matter integration lose its PNT equilibrium or break its original state.

As the presence of PNT equilibrium instinct, once matter integration loses its PNT equilibrium or its original PNT state is broken, the inverse covariant $d(M \rightarrow m)$ and $d(M \leftarrow m)$ of matter integration will immediately equilibrate towards new PNT equilibrium spontaneously. And just because of the performance of the instinctive covariant equilibrium between $d(M \rightarrow m)$ and $d(M \leftarrow m)$, all the state variables of matter integration vary accordingly. And indeed, we here introduce PNT dynamics is ready to illuminate the corresponding quantitative change of the related state variables of matter integration varying due to domino effect of instinctive PNT reciprocal equilibrium towards optimum PNT operation.

1.1. In accordance with the first condition, there is an increase ΔM of the negative mass of matter field, as the value ΔM can be either positive or negative, the condition can be classified into two sub conditions.

1.1.1. The value of ΔM is positive ($\Delta M > 0$), —the outside inputs negative mass to the matter field of matter integration, the negative mass of matter field is proportionably increased so as to make the matter integration lose its PNT equilibrium or break its original PNT state.

Let's suppose, before the mass of matter field increased, the $d(M \rightarrow m)$ and $d(M \leftarrow m)$ of matter integration just existing in equilibrium condition $d(M \rightarrow m) = d(M \leftarrow m)$, and of course the matter integration exists in inertial situation. As the occurrence of the ΔM mass increase of matter field, the magnitude of positive transmutation rate $d(M \rightarrow m)$ will increase consequentially, as a result, the matter integration will arise $d(M \rightarrow m) > d(M \leftarrow m)$, the positive transmutation arises predominance, then as presence of equilibrium instinct of matter integration, the positive mass of matter integration will arise proportionable increase Δm , $\Delta m > 0$, which satisfies $d(\Delta m) = d(M \rightarrow m) - d(M \leftarrow m)$, it indicates the change rate of Δm just equals positive transmutation rate reduced negative transmutation rate and $\Delta m = \int [d(M \rightarrow m) - d(M \leftarrow m)] dt$. And at the same time, as the occurrence of the positive transmutation rate predominance, the negative transmutation rate will spontaneously arise increase trend subsequently, so as to weaken and retard the increase trend of positive transmutation rate, so as to tend to new PNT equilibrium of matter integration.

During the course of the covariant equilibrium between $d(M \rightarrow m)$ and $d(M \leftarrow m)$, the state variables of R , K , Y , α , L , $d(M \leftarrow m)$, V , ... of course vary accordingly. For expedience, we just denote them in function format with variable t ("t" denotes time), just as $R(t)$, $K(t)$, $Y(t)$, $\alpha(t)$, $L(t)$, $d(M \leftarrow m)(t)$, $V(t)$. As PNT action of matter integration loses its equilibrium or breaks its original state, the matter inertial conservation equations changes into:

$$I) \begin{cases} (M + \Delta M) + (m + \Delta m) = R(t) \\ (M + \Delta M) / (m + \Delta m) = K(t) \\ V(t) * (m + \Delta m) = d(M \leftarrow m)(t) * Y(t) \\ L^3(t) * \alpha(t) = A * (m + \Delta m) \quad (\otimes) \\ Y(t) = B * \alpha(t) \quad (\otimes) \end{cases} \iff \begin{cases} M + \Delta M = K(t) * R(t) / [1 + K(t)] \\ m + \Delta m = R(t) / [1 + K(t)] \\ V(t) = d(M \leftarrow m)(t) * Y(t) / (m + \Delta m) \\ L^3(t) = A * (m + \Delta m) / \alpha(t) \quad (\otimes) \\ Y(t) = B * \alpha(t) \quad (\otimes) \end{cases}$$

All PNT equilibrium instances caused by outside working to matter integration or transferring energy to matter integration belong to this category.

1.1.2. ΔM is negative ($\Delta M < 0$), the matter integration works to outside or transfers energy to outside.

For expedient comprehension, we just denote the negative value ΔM in format " $-\Delta M$ ". As the occurrence of " $-\Delta M$ " will absolutely cause $d(M \rightarrow m) < d(M \leftarrow m)$, so it is easy for us to know that the positive mass of matter

integration will consequentially arises a negative value $-\Delta m$ too, and thus, the covariant equilibrium towards new equilibrium makes the matter inertial conservation equations change into:

$$(II) \quad \left\{ \begin{array}{l} (M-\Delta M)+(m-\Delta m)=R(t) \\ (M-\Delta M)/(m-\Delta m)=K(t) \\ V(t)*(m-\Delta m)=d(M \leftarrow m)(t)*Y(t) \\ L^3(t)*\alpha(t)=A*(m-\Delta m) \\ Y(t)=B*\alpha(t) \end{array} \right. \iff \left\{ \begin{array}{l} M-\Delta M=K(t)*R(t)/[1+K(t)] \\ m-\Delta m=R(t)/[1+K(t)] \\ V(t)=d(M \leftarrow m)(t)*Y(t)/(m-\Delta m) \\ L^3(t)=A*(m-\Delta m)/\alpha(t) \\ Y(t)=B*\alpha(t) \end{array} \right.$$

All PNT equilibrium instances matter integration working to outside or transferring energy to outside belong to this category.

In accordance with the second condition, the positive mass arises a decrease $-\Delta m$ dissolving into its matter field, as at the same time, when the “ $-\Delta m$ ” dissolving into the matter field, it may work to object outside or consume energy to object outside (/not to work to object outside or transfer energy to object outside), as a result, when we come to analyze this condition, there are two sub-conditions we have to deal with separately.

1.2. Matter integration does not work to outside or consume energy to outside.

In this condition, the dissolved mass of positive matter/baryonic matter is completely inputted into the matter field of the local matter integration, and just to make the negative mass of matter field arises an equivalent increase ΔM , which satisfies $\Delta M-\Delta m=0$. Thus the matter inertial conservation equations change into:

$$(III) \quad \left\{ \begin{array}{l} (M+\Delta M)+(m-\Delta m)=R(t) \\ (M+\Delta M)/(m-\Delta m)=K(t) \\ V(t)*(m-\Delta m)=d(M \leftarrow m)(t)*Y(t) \\ L^3(t)*\alpha(t)=A*(m-\Delta m) \\ Y(t)=B*\alpha(t) \end{array} \right. \iff \left\{ \begin{array}{l} M+\Delta M=K(t)*R(t)/[1+K(t)] \\ m-\Delta m=R(t)/[1+K(t)] \\ V(t)=d(M \leftarrow m)(t)*Y(t)/(m-\Delta m) \\ L^3(t)=A*(m-\Delta m)/\alpha(t) \\ Y(t)=B*\alpha(t) \end{array} \right.$$

Generally, in such cases, the value of $-\Delta m$ is very small, if the value of $-\Delta m$ is relatively rather big, and the matter integration does not work to outside or consume energy to outside, or works very little or consume very little energy to outside, the reaction due to the increase of the matter field strength will consequently be very remarkable, and generally, the positive matter/baryonic matter will be accessible to consume or emit energy in radiation or heat format, even maybe intensively blast itself as common bomb or A-bomb.

1.3. Matter integration works to outside or consumes energy to outside.

It implies that on one hand, the dissolved $-\Delta m$ makes the matter field arises an increase ΔM , and on the other hand, at the same time consumes some of it to outside. For expedience, we just denote the mass consumed to outside “ $-\Delta W$ ”, $\Delta M, -\Delta W, -\Delta m$ satisfy $\Delta M=\Delta m-\Delta W \neq 0$, and thus, the matter inertial conservation equations change into:

$$(IV) \quad \left\{ \begin{array}{l} (M+\Delta M-\Delta W)+(m-\Delta m)=R(t) \\ (M+\Delta M-\Delta W)/(m-\Delta m)=K(t) \\ V(t)*(m-\Delta m)=d(M \leftarrow m)(t)*Y(t) \\ L^3(t)*\alpha(t)=A*(m-\Delta m) \\ Y(t)=B*\alpha(t) \end{array} \right. \iff \left\{ \begin{array}{l} M+\Delta M-\Delta W=K(t)*R(t)/[1+K(t)] \\ m-\Delta m=R(t)/[1+K(t)] \\ V(t)=d(M \leftarrow m)(t)*Y(t)/(m-\Delta m) \\ L^3(t)=A*(m-\Delta m)/\alpha(t) \\ Y(t)=B*\alpha(t) \end{array} \right.$$

Fuel gets burning and emitting light, fuel engine works to outside, nuclear energy produces electrical power all belong to this category.

In the four above cases that mater system loses its equilibrium, besides (III) can arise independently, all the rest arise in couple, for instance, (I) and (II) coexist interacting, system (II) works to system (I), in another word, system (II) is the energy supply system or driving system, system (I) is the system being driven by system (II). If system (I) and (IV) coexist interacting, the system (IV) dissolves itself as to release energy and transfers energy to system (I).

In accordance with the above analysis of the four typical cases that matter integration loses its PNT balance, we find out once matter integration loses its PNT balance, no matter what kind of unbalanced condition it is, as the occurrence of covariant equilibrium between $d(M \rightarrow m)$ and $d(M \leftarrow m)$, both of the mass of positive matter (/baryonic matter) and matter field will counterbalance accordingly. For expedience, we just denote the counterbalance varying M and m with variable t in uniform function format $M(t)$, $m(t)$ ("t" denotes time). Thus, whichever unbalanced condition it is, we can express the unbalanced matter inertial conservation equations in the uniform format as following:

$$(V) \begin{cases} M(t)+m(t)=R(t) \\ M(t)/m(t)=K(t) \\ V(t)*m(t)=d(M \leftarrow m)(t)*Y(t) \\ L^3(t)*\alpha(t)=A*m(t) \quad (\otimes) \\ Y(t)=B*\alpha(t) \quad (\otimes) \end{cases} \iff \begin{cases} M(t)=K(t)*R(t)/[1+K(t)] \\ m(t)=R(t)/[1+K(t)] \\ V(t)=d(M \leftarrow m)(t)*Y(t)/m(t) \\ L^3(t)=A*m(t)/\alpha(t) \quad (\otimes) \\ Y(t)=B*\alpha(t) \quad (\otimes) \end{cases}$$

We all know, acceleration is just a physical quantification indicates the rate of motion status changed, whereas, the motion status change just arise when matter integration loses its PNT balance. Generally, the more the matter integration loses its PNT balance, the more intensively and remarkably the motion status change thereby, and then the magnitude of the acceleration of matter integration will be bigger according to our general sense. However, in the unbalanced matter inertial conservation equations, the variable which can indicate the unbalanced degree of matter integration is just the change rate $K'(t)$ of function $K(t)$, the bigger the value $K'(t)$ occur, the more the matter integration loses its balance, then the motion state of matter integration changes more intensively and faster. Contrarily, motion state of matter integration changes more faintly towards inertial motion.

PNT dynamics primarily confirms that the acceleration "a" of matter integration is proportional to change rate $K'(t)$ of negative and positive mass quotient function $K(t)$, and the proportionality constant is just the time dynamic speed Y of matter integration, just as the equation below:

$$a=Y*K'(t)$$

Virtually, during the course of covariant equilibrium between $d(M \rightarrow m)$ and $d(M \leftarrow m)$, the time dynamic speed is not a constant, but a variable due to the change of matter field strength α . We just denote the mathematical correlation in function format as $Y(t)=B*\alpha(t)$. And at the same time, "a" is a variable too in time current t , in order to be precise, we also denote it in function format as $a(t)$, then the equation above changes into:

$$a(t)=Y(t)*K'(t) \quad \dots \dots \quad (II-i-2-1) (\otimes)$$

This is just the acceleration definition equation of PNT dynamics.

In accordance with our general sense, force is the root cause of motion estate change. In hypostasis, to any separate matter integration, it's but the innate consequence of matter integration losing its PNT balance. To any mater system with certain total positive mass, the magnitude of force is but the quantification indication of intensity of matter integration losing its PNT balance. And in accordance with our general experience, different force works on the objects with the same mass, the magnitude of force is proportional to the consequent motion variation effect; and the same magnitude force works to different objects with different mass, the impact effect derived from the force is inversely proportional to the magnitude of the mass of objects. In PNT dynamics, the definition equation of force $F=m*a$ in traditional physics still keeps its original meaning, but instead, the mass of matter changed to $m(t)=R(t)/(1+K(t))$; and further, integrated the acceleration definition equation of PNT dynamics $a(t)=Y(t)*K'(t)$, we can arrive at the force definition equation of PNT dynamics as below:

$$\begin{aligned}
 F &= m(t) * a(t) \\
 &= R(t) * Y(t) * K'(t) / [1 + K(t)] \quad \dots\dots\dots \quad \text{(II-i-2-2)}
 \end{aligned}$$

Velocity change is but the cumulation of acceleration along time, according to the acceleration definition equation: $a(t)=Y(t)*K'(t)$, we can arrive at the velocity definition equation of PNT dynamics as below:

$$\begin{aligned}
 V &= V_0 + \Delta V \\
 &= V_0 + \int a(t) dt \\
 &= V_0 + \int Y(t) * K'(t) dt \quad \dots\dots\dots \quad \text{(II-i-2-3)}
 \end{aligned}$$

(In the equation above, V_0 denotes the initial speed of matter integration; ΔV denotes the velocity change in certain interval)

Displacement is just cumulation of velocity along time, as $V=V_0+\int a(t)dt$, we can expediently arrive at the displacement definition equation of PNT dynamics as below:

$$\begin{aligned}
 S &= V_0 * t + \int a(t) dt dt \\
 &= V_0 * t + \int Y(t) * K'(t) dt dt \quad \dots\dots\dots \quad \text{(II-i-2-4)}
 \end{aligned}$$

In accordance with original definition equation of momentum change $\Delta P=mV-mV_0$ and integrating the mass definition equation $m(t)=R(t)/(1+K(t))$ and the velocity definition equation $V=V_0+\int a(t)dt$ of PNT dynamics, we can expediently arrive at the definition equation of momentum change of PNT dynamics as below:

$$\begin{aligned}
 \Delta P &= m(t) * V - m_0 V_0 \\
 &= R(t) * [V_0 + \int Y(t) * K'(t) dt] / [1 + K(t)] - m_0 V_0 \quad \dots\dots\dots \quad \text{(II-i-2-5)}
 \end{aligned}$$

This equation can also be simplified into:

$$\begin{aligned}
 \Delta P &= m(t) * V - m_0 V_0 \\
 &= m(t) * (V_0 + V - V_0) - m_0 V_0 \\
 &= [m(t) - m_0] V_0 + m(t) * (V - V_0) \\
 &= \Delta m * V_0 + m(t) * \Delta V
 \end{aligned}$$

(In the equation above, Δm and ΔV separately denote the mass change and velocity change in the interval that the motion state of object changes)

According to conventional definition equation of kinetic energy change $\Delta E=1/2mV^2-1/2mV_0^2$, and integrating the mass definition equation $m(t)=R(t)/(1+K(t))$ and velocity definition equation $V=V_0+\int a(t)dt$ of PNT dynamics, we can expediently arrive at the kinetic energy change definition equation of PNT dynamics as below:

$$\begin{aligned} \Delta E &= 1/2m(t)V^2 - 1/2m_0V_0^2 \\ &= 1/2R(t) * [V_0 + \int Y(t) * K'(t) dt]^2 / [1 + K(t)] - 1/2m_0V_0^2 \quad \dots\dots\dots \text{(II-i-2-6)} \end{aligned}$$

2. Universal applicability of PNT Dynamics

As remarkable highlight of factuality that any “**discretionary particles in cosmos are mutually convertible**”, I introduced **Homogenous cosmos originated from unique genesis postulate**. Subsequent logic extension and connotation objectification of [homogenous cosmos originated from unique genesis + spacetime~matter fully embodying cosmos] not only makes alternative homologic filiation between spacetime and matter either “**spacetime father & matter son**” or “**matter father & spacetime son**” self-evident but also make homologic generation of matter in spacetime and homologic attribute of spacetime & matter in successive logic freewheeling once we exclude alternative possibility of homologic filiation of “**matter father & spacetime son**”.

Homologic generation of matter in homogenous cosmos of course brings out essence of matter which is just “PNT action” of matter integration. Virtually, PNT action is not only headspring creation of original generation of matter along sequential homologic cosmogony but also dynamic origin of postnatal existence & motion of matter in spacetime, which apparently indicates that existence & motion of matter radically root in PNT action of matter integration. In a straightforward word, existence & motion of matter is but dynamic embodiment mirrored PNT action of matter integration. Once PNT action is specified by “Instinctive PNT equilibrium postulate”, existence & motion of matter in spacetime become even true to nature that matter motion is but spontaneous optimization of PNT action of matter integration due to instinctive PNT reciprocal equilibrium towards optimum PNT operation once PNT operation of matter integration is out of balance. And mathematical formulation of spontaneous optimization of PNT action of matter integration due to instinctive PNT reciprocal equilibrium towards optimum PNT operation directly lead to formation of PNT dynamics about universal existence & motion of matter.

At any rate, **original generation of matter in the nature of coherent natura naturans brings out essence of matter in a class by itself; essence of matter in a class by itself predestines thorough coherence of dynamic regularity of universal existence & motion**. Essence of matter generally comes into being during the course of original generation of matter and is kept with matter existing as idiographic object under the proper generative & formative preconditions. As it's only possible for original generation of all matter in cosmos to be subject to coherent natura naturans throughout cosmic evolution, essence of universal matter can only be thoroughly coherent in a class by itself. And accordingly, as dynamic enantiomorph of PNT action of matter integration, it's only possible for universal existence & motion of matter to be subject to coherent dynamic regularity as spontaneous occurrence in the nature of essence of matter in a class by itself, — **instinctive PNT reciprocal equilibrium towards optimum PNT operation** of matter integration.

At any rate, “PNT action” is not only demiurgic action of original generation of matter in cosmos, but also dynamic nascence of postnatal existence & motion of elementary genic units universal reciprocal PNT combinations in cosmos. As mathematical formulation of PNT action of matter integration in the nature of instinctive PNT reciprocal equilibrium towards optimum PNT operation, PNT dynamics is not only applicable to original generation of elementary genic units and universal reciprocal PNT combinations, which is just **aberrant convergence of cosmic esse due to PNT reciprocal gelation** throughout cosmic evolution including original generation of elementary genic units and reciprocal PNT combinations in gradation I, reciprocal PNT combinations in gradation II,

As coherent natura naturans throughout cosmic evolution, instinctive PNT reciprocal equilibrium towards optimum PNT operation is radical potentiality & conditionality for cosmos always ready to orientate itself towards perfection.

reciprocal PNT combinations in gradation III, reciprocal PNT combinations in gradation IV, but also applicable to postnatal existence & motion of universal objects in spacetime.

In a straightforward word, as coherent natura naturans throughout cosmic evolution, it's only possible for essence of universal matter to be thorough coherent in a class by itself. And accordingly, as dynamic mirror against essence of matter, universal existence & motion of matter in cosmos must be subject to uniform dynamic regularity due to coherent essence of matter in a class by itself. Virtually, **it is only possible for concordant cosmos to be demiurgic aggradation of out-and-out serial natura naturata in the nature of coherent natura naturans throughout cosmic evolution; there is no way for demiurgic aggradation in the nature of different natura naturans to be concordant cosmos through and through.**

As mathematical formulation of the very rationality, application of PNT dynamics is of course universal existence & motion of matter in cosmos, no matter microcosmic objects or macroscopic objects, and no matter objects moving in high speed or in low speed. Virtually, the uniqueness & coherence of dynamic regularity of universal existence & motion are but rational approach of lineal logic extension radically derived from homogenous cosmos originated from unique genesis, which is made up of lineal logic extension as original generation of matter in the nature of coherent natura naturans brings out essence of matter in a class by itself, essence of matter in a class by itself predestines thorough coherence of dynamic regularity of universal existence & motion. After all, universal existence & motion are but vivid essence objectification of matter in cosmos, essence of matter radically derives from original generation of matter, and original generation of matter must be out-and-out serial natura naturata in the nature of coherent natura naturans throughout cosmic evolution.

All in all, Homogenous Cosmos Originated from Unique Genesis is innovative cosmos redefinition in logic enantiomorph of newly highlighted factuality of **discretionary particles in cosmos are mutually convertible**. As remarkable distinction of thought origin & hypostatic logic proliferation derived from contemporaneous historical background, discrepancy even divarication between Homogenous Cosmos Originated from Unique Genesis and Newtonian Mechanics, Relativity, Quantum Mechanics are of course self-evident. For you see, since **ultimate authenticity of nature** can be neither omnifarious authenticity smallwares full of a basket nor authenticity chameleon one piece and only but coherent natura naturans throughout cosmic evolution, as ideological enantiomorph of authenticity of nature, it's only possible for ultimate consummation of science to be perfect ideological enantiomorph of ultimate authenticity of nature about universal existence & motion. And at the same time, Homogenous Cosmos Originated from Unique Genesis has no reasons to admit distinction among gravity, electromagnetic force, strong interaction and weak interaction, no more distinction between microcosmic objects and macroscopic objects and distinction between object moving in high speed and object moving in low speed.

Of course, when we practically come to study the macroscopical objects moving in low speed, as the change of $m(t)$ is substantively very tiny during the course of spontaneous optimization of PNT action of matter integration, so that we can directly adopt m_0 instead of $m(t)$ neglecting the relatively tiny change of mass of positive matter.

Thus, the force definition equation of PNT dynamics $F=m(t)*a(t)$ can be consequently simplified into:

$$F=m*a(t)$$

The momentum change definition equation of PNT dynamics $\Delta P=(m(t)-m_0)V_0+m(t)*(V-V_0)$ can consequently be simplified into:

$$\begin{aligned} \Delta P &=(m_0-m_0)V_0+m_0*(V-V_0) \\ &=m_0V-m_0V_0 \end{aligned}$$

The kinetic energy change definition equation of PNT dynamics $\Delta E = 1/2m(t)V^2 - 1/2m_0V_0^2$ can be simplified into:

$$\Delta E = 1/2m_0V^2 - 1/2m_0V_0^2$$

It indicates, under the precondition of admission of PNT dynamics, when we practically come to study macroscopical objects moving in low speed, in order to avoid unnecessary complexity, we can expediently adopt Newtonian mechanics as accessible approximation.

Final words: The most anguished adversity all my life was unexpected encounter of scientific idea of Homogenous cosmos originated from unique genesis and consequently slid into endless vicious circle of virulent scientific knowledge metabolism campaign eversince.

Realistic progress of science can never be free from permanent synthesized conditionality of “**crecive progression of practical feasibility & possibility in proportion to contemporaneous historical background + the uniqueness & invariance of ultimate authenticity of nature predestines the unique possibility of scientific verity as perfect ideological enantiomorph of ultimate authenticity of nature**”, and just because of permanent synthesized conditionality of “**crecive progression of practical feasibility & possibility in proportion to contemporaneous historical background + the uniqueness & invariance of ultimate authenticity of nature predestines the unique possibility of scientific verity as perfect ideological enantiomorph of ultimate authenticity of nature**” through and through, it's only possible for the major melody of historical progress of science to be a series of epochmaking scientific knowledge metabolism in inherent optimum orientation towards historical authenticity tolerance of science 0, till at last, humanistic ideology about authenticity of nature finally tallies with ultimate authenticity of nature 100% as perfect ideological enantiomorph of coherent natura naturans throughout cosmic evolution.

In any case, as long as we have to admit **ultimate authenticity of nature** can be neither omnifarious authenticity smallwares full of a basket nor authenticity chameleon one piece and only, but coherent natura naturans throughout cosmic evolution, we then have to admit, as commensurate ideological enantiomorph of accessible existence & motion around us, ultimate consummation of science must be perfect ideological enantiomorph of ultimate authenticity of nature. After all, in accordance with rigid enantiomorphous correlation between “authenticity of nature” and “humanistic ideology about authenticity of nature”, it's neither possible for “the unique & invariable ultimate authenticity of nature” to tally with “two distinctive humanistic ideologies about authenticity of nature with remarkable ideological difference” nor possible for “two distinctive humanistic ideologies about authenticity of nature with remarkable ideological difference” to discover and formulate “the unique & invariable ultimate authenticity of nature” coequally. This of course indicates any revolutionary renovation of humanistic ideology about authenticity of nature in proportion to contemporaneous historical background can hardly slider over scientific knowledge metabolism campaign even has to challenge venomous counterwork upper limit of temporal authority for social legitimacy subsistence without alternatives.

Remarkable highlight of microcosmic configuration of matter has thrown more and more lights onto cosmic configuration, homogenous profile of cosmos becomes more and more explicit in our rational purview, which is of course substantial headspring of Homogenous Cosmos Originated from Unique Genesis. Is cosmos really homogenous originated from unique genesis through and through? If yes, what integrative cosmic homologic configuration and proportionate universal homologic existence & motion should be accordingly? As factuality that **discretionary particles in cosmos are mutually convertible** is always in freewheeling orientation towards perfect induction day by day, introduction of **Homogenous cosmos originated from unique genesis postulate** became imminently necessary. And as pioneering connotation objectification and freewheeling logic extension of homogenous cosmos originated from

As coherent natura naturans throughout cosmic evolution, instinctive PNT reciprocal equilibrium towards optimum PNT operation is radical potentiality & conditionality for cosmos always ready to orientate itself towards perfection.

unique genesis on the basis of [(Homogenous cosmos originated from unique genesis + spacetime~matter fully embodying cosmos postulate) + instinctive PNT equilibrium] as linear logic extension has renovated humanistic ideology about authenticity of nature so much in proportion to contemporaneous historical background of remarkable highlight of microcosmic configuration of matter, consequent proportionate PNT dynamics is so different from all traditional dynamics, which of course indicates inevitability of scientific knowledge metabolism and virulent scientific knowledge metabolism campaign.

I have to comment herein, as straightforward man, I originally have no intention to violate altisonant social legitimacy of contemporaneous scientific orthodoxy indeed, whereas, as stochastic attention to homogenous profile of cosmos under favorable background of remarkable highlight of microcosmic configuration of matter, I approached brand-new presumable rationale of Homogenous cosmos originated from unique genesis postulate, and with supplementation of two 0.5 grade accessorial postulates, I expanded the logic connotation of Homogenous cosmos originated from unique genesis postulate on the basis of [(Homogenous cosmos originated from unique genesis + spacetime~matter fully embodying cosmos postulate) + instinctive PNT equilibrium] as linear logic extension. All in all, as factuality that discretionary particles in cosmos are mutually convertible is always in freewheeling orientation towards perfect induction day by day, homogenous profile of cosmos has been more and more explicit in our rational purview, I have no reasons to slight introduction of Homogenous cosmos originated from unique genesis postulate and successive freewheeling logical operation towards potential authenticity highlight on the basis of [(Homogenous cosmos originated from unique genesis + spacetime~matter fully embodying cosmos postulate) + instinctive PNT equilibrium].

However, as timely renovation of humanistic ideology about authenticity of nature in proportion to contemporaneous historical background of remarkable highlight of microcosmic configuration of matter, virulent scientific knowledge metabolism campaign is waiting for me ahead in the nature of things, I slide into endless perplexity of free press admittance and social legitimacy subsistence of Homogenous Cosmos Originated from Unique Genesis, I can hardly slider over serious factuality:

The deadly factuality is that, as typical aberrant scientific knowledge proliferation out of succession of contemporaneous scientific orthodoxy even personal limitation, it's almost impossible for Homogenous Cosmos Originated from Unique Genesis to find compatible free press egotistic proximity identification from temporal authority who mostly possess magistral autarchy of free press regulation customization and free press admittance short of necessary intendance, what's more, my poor identification & qualification is only enough to strive for about 10 seconds rational attention of temporal authority, once sliding into virulent scientific knowledge metabolism campaign or/and identification & qualification discrimination, nothing is necessary to go on one second later.

The impersonal factuality is that, as out-and-out social work outgrowth and humanistic ideology about authenticity of nature in proportion to contemporaneous historical background, social existence and historical progress of "science" must inherently possess double coordinative significance of "natural connotation" and "social connotation", social legitimacy subsistence of neonatal scientific idea especially successive renovation of humanistic ideology about authenticity of nature along crecive progression of historical progress of science in inherent optimum orientation towards perfect ideological enantiomorph of ultimate authenticity of nature never simply depends on cognizant achievement that brand-new or more veritable authenticity of nature has been reflected on sense of pioneering originators with commensurate authenticity highlight effect in proportion to contemporaneous historical background, it even crucially implicates esoteric authoritative social legitimacy identification & authentication in accordance with egotistic criterion of contemporaneous scientific orthodoxy under official centered background——social legitimacy & validity of truths can never exceed cannon range, which of course includes humanistic operation of virulent scientific knowledge metabolism campaign underlying.

Historical progress of science in the recent several centuries seemed like a far-flung exploration of the first itinerary around numerous distinctive landscapes of brand-new landmasses of science with palette & tablet on back, several hundred years' scientific travelogues were compiled thereby.

Especially, under background of high-sounding royal substantiation & perfection of contemporaneous scientific orthodoxy, once **free press regulation customization & free press admittance** is under magistral autarchy of temporal authority short of necessary intendance, and default social legitimacy of contemporaneous scientific orthodoxy is sovereign out of question, as inevitable interposition of humanistic self-preservation, it's almost impossible for esoteric authoritative social legitimacy identification & authentication of coming renovation of humanistic ideology about authenticity of nature in proportion to contemporaneous historical background to evade occurrence of tragedy, unless substantial factuality has negated the scientific credibility of contemporaneous scientific orthodoxy in prior. For instance, before naissance of Relativity & Quantum Theory in early years of last century, as gradual interposition of various microcosmic factuality, more and more microcosmic factuality negated Newtonian Mechanics time after another, as a result, timely naissance and successive development of Relativity & Quantum Theory met less intrepid counterwork from temporal authority or loving successors of Newtonian Mechanics then and there.

In any case, before humanistic ideology about authenticity of nature finally qualified as perfect ideological enantiomorph of ultimate authenticity of nature, it's only possible for science to be humanistic ideology about authenticity of nature in proportion to contemporaneous historical background in crescive progression of historical progress of science in inherent optimum orientation towards perfect ideological enantiomorph of ultimate authenticity of nature, and veritable progress of science is not intuitional cumulative achievement of colorful scientific travelogues A, B, C, D, E, F, ... as deserving reward of the first itineracy around preternatural landscapes of brand-new landmasses of science like omnifarious smallwares full of a basket but successive hypostatic endeavor to push humanistic ideology about authenticity of nature forward to perfect ideological enantiomorph of ultimate authenticity of nature step by step draw on practical feasibility & possibility in proportion to contemporaneous historical background.

Whereas, under background of royal substantiation & perfection of contemporaneous scientific orthodoxy, as authoritative intrepidity of contemporaneous scientific orthodoxy is all-time and overwhelming, especially magistral autarchy of free press regulation customization and free press admittance of temporal authority short of necessary intendance, science forum even live historical progress of science has been egotistically customized so much towards interminable royal substantiation & perfection of contemporaneous scientific orthodoxy going without saying, there is obvious aberrancy of live scientific knowledge proliferation towards royal substantiation & perfection of contemporaneous scientific orthodoxy instead of hypostatic endeavor to push humanistic ideology about authenticity of nature forward to perfect ideological enantiomorph of ultimate authenticity of nature draw on practical feasibility & possibility in proportion to contemporaneous historical background. Floundering around in vicious circle of virulent scientific knowledge metabolism campaign, the factuality I have to face is that if I stop fighting today, I must die tomorrow, if I persist struggling in virulent scientific knowledge metabolism campaign, my counterwork opposite must be even furious tomorrow. The even pestilent factuality is that, as personal limitation, it's almost impossible for Homogenous Cosmos Originated from Unique Genesis to be impeccably perfect, whereas, since it's almost impossible for me to shy away virulent scientific knowledge metabolism campaign under duress of overwhelming authoritative intrepidity of contemporaneous scientific orthodoxy, any insignificant defect of it must be my pestilent defect. I can hardly slider over factuality that free press admittance of Homogenous Cosmos Originated from Unique Genesis must break through legitimacy defense line of contemporaneous scientific orthodoxy, so that it has to challenge venomous counterwork upper limit of temporal authority. Virtually, PNT

dynamics originally came into being in 1995, in successive quarter century, I contributed more than 400 times, there was almost no way for Homogenous Cosmos Originated from Unique Genesis to approach formal review as nonsense scientific topic on the earth.

Even though, I seem slightly lucky than Copernicus, Bruno, Galileo, after all, I've struggled in virulent scientific knowledge metabolism campaign for 30 years, I am still alive till today. Whereas, I have to comment herein it's but because I am floundering around in social ambience of 21st century that foregone analogous undeserved suffering of Copernicus Bruno Galileo etc had been well-known all over the world, so that temporal authority are not convenient to openly implement forcible subjection to heterodoxy for maintenance of social legitimacy subsistence of contemporaneous scientific orthodoxy, whereas, as magistral autarchy of free press regulation customization and free press admittance short of necessary intendance, they are relatively more convenient to accomplish free press monopolization and free press filtration control by **free press egotistic proximity identification** draw on official facility of magistral autarchy of free press regulation customization & free press admittance short of necessary intendance, which of course implicates esoteric authoritative operation of free press admittance of aberrant scientific knowledge proliferation out of succession of contemporaneous scientific orthodoxy even timely renovation of humanistic ideology about authenticity of nature in proportion to contemporaneous historical background. Otherwise, once life-and-death scientific knowledge metabolism impact their social legitimacy subsistence unexpectedly, I must die even abjectly than Bruno. After all, under background of royal substantiation & perfection of contemporaneous scientific orthodoxy, authoritative intrepidity of contemporaneous scientific orthodoxy is all-time and overwhelming out of question, no matter group scale of temporal authority or powerful implication extent & intensity to live scientific knowledge proliferation.

And indeed, eversince naissance of human civilization on the earth, none magistral autarchy of free press regulation customization and free press admittance had ever done so powerful jobs to egotistically customize live scientific knowledge proliferation in rigid succession of contemporaneous scientific orthodoxy and control social legitimacy subsistence of commensurate humanistic ideology about authenticity of nature as what live temporal authority have done in the recent half century and are doing today, which of course include powerful restriction even snobbish repulsion to timely renovation of humanistic ideology about authenticity of nature in proportion to contemporaneous historical background.

After all, as magisterial freewheeling of royal substantiation & perfection of contemporaneous scientific orthodoxy going without saying in the recent half century, modern science forum has become out-and-out homegrown outgrowth in the garden of contemporaneous scientific orthodoxy beyond all doubt, there is obvious endeavor aberrancy of historical progress of science in inherent optimum orientation towards perfect ideological enantiomorph of ultimate authenticity of nature, which apparently seems endeavor for substantiation & perfection of contemporaneous scientific orthodoxy instead of endeavor to push humanistic ideology about authenticity of nature forward to perfect ideological enantiomorph of ultimate authenticity of nature step by step draw on practical feasibility & possibility in proportion to contemporaneous historical background.

As a result, overbearing temporal authority with vested interest in contemporaneous scientific orthodoxy & magistral puissance to historical progress of science never seem sane enough that, as permanent synthesized conditionality of **“crescive progression of practical feasibility & possibility in proportion to contemporaneous historical background + the uniqueness & invariance of ultimate authenticity of nature predestines the unique possibility of scientific verity as perfect ideological enantiomorph of ultimate authenticity of nature”** through and through, it's only possible for the major melody

Historical progress of science in the recent several centuries seemed like a far-flung exploration of the first itinerary around numerous distinctive landscapes of brand-new landmasses of science with palette & tablet on back, several hundred years' scientific travelogues were compiled thereby.

of historical progress of science to be a series of epochmaking scientific knowledge metabolism in inherent optimum orientation towards perfect ideological enantiomorph of ultimate authenticity of nature (/historical authenticity tolerance of science 0), till at last, humanistic ideology about authenticity of nature finally tallies with ultimate authenticity of nature 100% and is consequently qualified as perfect ideological enantiomorph of coherent natura naturans throughout cosmic evolution. Veritable progress of science is neither historical process pioneering originators stochastically approach distinctive scientific truths one after another nor interminable freewheeling of royal substantiation & perfection of contemporaneous scientific orthodoxy but hypostatic endeavor to push humanistic ideology about authenticity of nature forward to perfect ideological enantiomorph of ultimate authenticity of nature step by step draw on practical feasibility & possibility in proportion to contemporaneous historical background.

As inertial ideological aggradation of remarkable transverse ideological expansion in the recent one century which are rich and colorful scientific travelogues A, B, C, D, E, F, ... like omnifarious smallwares full of a basket in proportion to contemporaneous historical background of 20th century, live contemporaneous scientific orthodoxy is apparently out of scientific legitimacy qualification of historical authenticity tolerance of science 0. As long as historical progress of science is still in its normal way in inherent optimum orientation towards perfect ideological enantiomorph of ultimate authenticity of nature, the realistic progressive quantitative & qualitative change of commensurate ideological system about authenticity of nature under conditionality of “**crecive progression of practical feasibility & possibility in proportion to contemporaneous historical background + the uniqueness & invariance of ultimate authenticity of nature predestines the unique possibility of scientific verity as perfect ideological enantiomorph of ultimate authenticity of nature**” through and through can never shy away necessary scientific knowledge metabolism in inherent optimum orientation towards perfect ideological enantiomorph of ultimate authenticity of nature, the unique possible fate of live contemporaneous scientific orthodoxy is to be washed out by necessary scientific knowledge metabolism once further progressive renovation of humanistic ideology about authenticity of nature occurs along crecive progression of historical progress of science in inherent optimum orientation towards perfect ideological enantiomorph of ultimate authenticity of nature. And indeed, throughout historical progress of science, all epoch-making progress of humanistic ideology about authenticity of nature were outcome of life-and-death scientific knowledge metabolism, none could be exceptive throughout historical progress of science.

——Firstly written in Dec. 1995, literal revision was done in Dec.2004

(II-ii) “Space distance” and “Space radiation cornu”

Abstract: *In terms of any space field, the most physical endosome of it is but some homogenous field genic unit series with certain compositive configuration and the dynamic esse of transmutation & transition among all the homogenous field genic units. So-called “space distance” is just the physical dypass filled and linked by dynamic continuation of transmutation & transition of all adjacent field genic units in space field, just physical objectification of time or physical objectification of dynamic continuation activity of transmutation & transition among field genic units in space field. As dynamic transmutation & transition of field genic units has relative domino effect for dynamic assimilation, space distance has relative domino effect thereby. So-called “space radiation cornu” is just the relative perceivable domino effect of dynamic spacetime geometric profile, which depends on discretional radiation intensity caused by genic transition & transmutation and influenced by relative motion speed of observer in the spacetime for spacetime dynamic assimilation. Both space distance and space radiation cornu are not only directly related to the dynamic intensity of transmutation & transition among field genic units but also related to the dynamic assimilation effect of the observer in spacetime.*

Keywords: *Space distance, royal dypass, genic discretional radiation, genic discretional radiation intensity, Space radiation cornu.*

So called “spacetime” is but the coherent integrity title of space and time, we have primary description about spacetime in “Space field hypothesis” of the first part. So-called “time” is but the activity aggregation of transition & transmutation among field genic units in space field. Considered from some certain point, time is too a special speed indicating the activity intensity of the transition & transmutation among the field genic units in space field. For expedience of further quantitative analysis, we just call it “time dynamic speed”, and just denote it as “Y”. So-called “time dynamic speed” is just the linear cumulation of phoney displacement of field genic units in one standard time unit. As phoney displacement has no direction or has no certain explicit orientation, time dynamic speed is but a scalar quantity, which is virtually a numeric representation of intensity and swiftness of transition & transmutation among field genic units in space field. It can represent the time rate in the proper space field exactly.

Now, we come to highlight & clarify physical connotation of “space” further following the space field hypothesis as freewheeling logic extension, which is generally ready to illuminate two issues:

The first is “**space-distance**”.

The second is “**space radiation cornu**”.

1. Space distance

In accordance with basal postulates of space field hypothesis, we can know that the most physical endosome of any space field are but “some certain material genic unit series in certain quantitative compositive configuration” and “the dynamic transition & transmutation among field genic units”. Since “time” is just the activity aggregation of transition & transmutation among field genic units in space field; what is “space distance”?

1.1. Definition of space distance

Virtually, “time” and “space distance” are coherent logos, which can never be separated as the both sides of

a piece of cent; of course, the so-called “cent” is just the dynamic esse of transition & transmutation among field genic units in space field. So-called “space distance” is just physical noumenon of dynamic succession materialized by dynamic transmutation & transition among all mutually accessible field genic units in space field, tangible physical domino effect of time or substantiality objectification of dynamic succession of transmutation & transition among accessible field genic units in space field. If there is no dynamic succession of transmutation & transition among available field genic units so as to accomplish physical correlation among discretional points in space field, there is no tangible physical noumenon of so-called space distance in space field but unrelated points without any physical correlation, there is none possibility for physical existence & motion starting at discretional point to extend to another point, there are only points absolutely inaccessible, nothing can be invoked to define the “estrangement/interval” between this point and that point. (Of course, without conditional presence of space distance, there is no possibility to achieve motion in space field therefore.)

1.2. Cosmic connotation of space distance in cosmic homogeneity system

In the face of grand cosmic existence, we above all define the entire cosmos is a material aggregation, considering that any two discretional objects in cosmos are mutually convertible, we then confirm the cosmic material aggregation must be throughout homogenous; the so-called cosmic material aggregation must be a coherent homogeneity system in full universal scale. In the very cosmic coherent homogeneity system, any physical content included in are either the so-called “cosmic genic origin” itself or compound radically originated from the cosmic genic origin. The “extremity sameness” of the radical cosmic genic origin is the root cause for cosmos to be universally correlated; only the individual configuration discrepancies are the causes for the cosmos to be so rich and colorful. And general existence & motion in cosmic coherent homogeneity system are but transmutation & transition among different physical configurations which radically root in cosmic genic origin, whereas, any transmutation & transition can never change the “cosmic genic origin” itself but the compound physical configurations radically rooted in cosmic genic origin.

In terms of dynamic transmutation & transition among field genic units in space field, dynamic transmutation & transition of field genic units in any space field can never go beyond category of cosmic coherent homogeneity system; so the space distance can only exist within category and range of coherent cosmic homogeneity system. For instance, there are two points, one is in cosmos, the other is out of cosmos, as transmutation & transition of cosmic field genic units can only extend within cosmic coherent homogeneity system but can never extend to and approach objects out of category or range of cosmic coherent homogeneity system, there is no possibility for space distance to extend to and approach any “point” out of cosmos. As a result, there is none coherent “space distance notion” between any two points one is in cosmos and the other is out of cosmos. So we have none accessible physical resorts to judge how far it is from cosmos to non-cosmos or any point out of cosmos, because we can not introduce notion of “space distance” with cosmic connotation only to formulate the spacing between cosmos and non-cosmos, which is even similar as we can not formulate the “distance” between the earth and the sun with kilogram^①, Newton etc. This of course indicates there is virtually no way for any physical existence & motion starting at cosmos to extend to non-cosmos.

(Note^①: Of course, as two compositive elements in cosmic homogeneity system, , the discrepancies between “mass” and “space distance” are of course difference in physical configurations originated from extremity sameness of cosmic extremity genic origin. As the cosmos is throughout homogenous, any two objects in cosmos, as they are all undoubtedly originated from the extremity sameness of cosmic extremity genic origin, they must be convertible, and it's of course

impossible for the two connotation elements as “mass” and “space distance” to be exception. If we can find such two objects in cosmos, we can find tangible proof that there is no way for them to be converted, we then can draw our positive conclusion, either we’ve procured tangible proof to negate that cosmos is throughout homogenous originated from unique genesis or we’ve practically found the cosmos II.)

Of course, the cosmic connotation of space distance in cosmic homogeneity system (**just the limitation of physical existence of space distance within category of cosmic homogeneity system**) also implies, considered by us in cosmos, the holistic cosmos must be an out-and-out “close field” in category, after all, universal existence & motion are all limited in a purely homologous category of cosmic homogeneity system. Cosmos is universally correlated for its purely homologous contents, whereas, as non-cosmos are not in the same physical category as cosmic homogeneity system kind, there is no way for cosmos and non-cosmos to be correlated as cosmic contents usually mutually do. In another word, the discrepancies between this object and that object in cosmos are only limited in difference of physical configurations radically originated from extremity sameness of cosmic extremity genic origin, all difference of physical configurations radically originated from extremity sameness of cosmic extremity genic origin are mutually convertible within the coherent cosmic homogeneity system and usually with their congenital evolutionary venation correlations livingly maintained in time current, so the cosmos is universally and livingly correlated thereby; whereas, the discrepancy between cosmos and non-cosmos has transcended essential hylic category as cosmic homogeneity system kind, the distinction and correlation between them can not be formulated by “interactions or correlations” logos with cosmic meaning only. As a result, considered by us in cosmos, it’s only possible for us to find cosmos is a close field. In terms of the issue whether cosmos is really correlated with non-cosmos or not, there is substantively no way for us to perceive, for you see; only interactions with cosmic meaning can do physical jobs to our perception.

1.3. “Royal dypass optimization” of space distance

As the transition & transmutation among field genic units are discretionary and erratic, the physical dypass filled and linked by transmutation & transition of field genic units starting at one point to another point are usually numerous, they are all out-and-out physical space distance indeed.

However, the quantitative space distance we usually mention is just the shortest distance between any two ascertained points in spacetime, it virtually means the most expedient dypass filled and linked by transmutation & transition of field genic units extending from one point to another point—the “royal dypass”. In fact, to any inconstant space field, royal dypass is variable according to change of space field strength. It of course implies, in inconstant space field, the space distance between any two ascertained points is not constant, if the space field strength orientates to strengthen, the dynamic transmutation & transition among field genic units consequently become more and more expedient and swift, as a result, there are more and more possibilities for any two points to accomplish physical correlations as space distance. Synchronously with the possibility increase to accomplish physical correlation between any two points in space field, and the proper royal dypass linked by continuous genic transition & transmutation are more and more feasibly and remarkably optimized, the space distance between any two points in spacetime seems more and more expedient and shorter & shorter thereby. (Of course, at the same time, it implies increase of radiation cornu, and all the objectives exist in the space field will seem more active as indicated in equation “ $mV=d(M \leftarrow m)*Y$ ”).

At the same time, upon our general sense, the shortest distance between any two points is always straight,

Historical progress of science in the recent several centuries seemed like a far-flung exploration of the first itinerary around numerous distinctive landscapes of brand-new landmasses of science with palette & tablet on back, several hundred years’ scientific travelogues were compiled thereby.

while in variable strength space field, throughout the course of space field strength varying, the shortest distance between any two points is not always straight relatively, as the space field strength orientates to strengthen, the royal dyppass is optimized consequently, some certain “royal dyppass” that we think it is straight under certain conditional background of space field strength, once the space field strength orientates to strengthen, another even more expedient “royal dyppass” occur thereby, then the original “royal dyppass” immediately seemed curved compared with the updated “royal dyppass”. As a result, and “straight line” is always relative, there are none absolute straight lines or short line in cosmos, long line turns to shorter, straight line becomes curve are just individual objectification of spacetime variation.

1.4. Space distance and time

Space distance and time are two innate coexisting consort notions in cosmos, in any space field, there is presence of time notion, there must be presence of space distance notion, and no time, no space distance. In fact, the correlations between the two notions are even more than this. For instance, we mention the space distance between two points is S , virtually, the space distance S was defined under the default precondition that the space distance was confirmed in an interval t satisfied “ $t > S/Y$ ”, (here “ Y ” is just the time dynamic speed) When we come to limit the quantity of the interval t , and observe the space distance S , if “ $t < S/Y$ ”, then the space distance S has none cosmic meaning at all, it's impossible for us to perceive the space distance in spacetime within such an interval, and indeed, there is none physical possibility for such “space distance” to occur in such an interval t ; if “ $t = S/Y$ ”, we then can only find the space distance S along the royal dyppass linear extension, no more else. Because in the interval limitation t , the space distance S can only be accomplished along the royal dyppass way by genic transmutation & transition, only t satisfies “ $t = S/Y$ ”, the proper space distance can come to occur as physical space distance, and only under the default precondition that “ $t > S/Y$ ”, the proper space distance S has its full cosmic meaning, and this is why time dynamic speed is the utmost speed of cosmos.

For instance, we say a railway has a length of L , critically, the railway length L is defined under the default precondition that the whole railway exists in an interval t , which satisfies “ $t \geq L/Y$ ”; if we just come to consider the railway length within an interval t , which satisfies $t < L/Y$, then the railway length L has none cosmic meaning, we can never imagine what the length L means. The distance from the sun to the nearest star in Milky Way galaxy is about 4 light-year, if we just study the existence of the distance 4 light-year in an interval t (t satisfies $t < 4\text{light-year}/Y$), then, such study has none cosmic significance. Further, let's suppose your desk standing before you with a length L' , if your eyesight pass through your desk within an interval t , which satisfies “ $t \leq L'/Y$ ”, then, there is virtually inadequate spacetime condition for you to perceive substantial cosmic existence of your desk at all.

If there is none presence of time in space field, there must be none space distance in the so-called “space field”, even there is consequently none “point” notion with physical significance. Even though, we can reluctantly suppose there are some special “points” in such kind of space field, virtually, as there is none physical correlations between any two points, none physical endosome can be invoked to define what space distance is between any two points like this.

2. Space radiation cornu

Before offering explicit definition of “space radiation cornu”, it is necessary for us to illuminate a related notion of “discretional radiation” in advance.

2.1. Discretional radiation

Any genic transition and transmutation is not orientated definitely and constantly, but performs randomly according to spontaneous possibility range (Of course, under certain space field conditions, transition & transmutation extension among field genic units in spacetime are usually equivalent in all so-called “directions”). We just call the discretional equivalent genic transition & transmutation extension in all directions “discretional radiation”, and we just call the spontaneous discretional radiation intensity as “genic discretional radiation intensity”.

2.2. Definition of space radiation cornu

So-called “Space radiation cornu” is just relative perceivable dynamic spacetime geometric domino effect, which radically depends on discretional radiation intensity caused by discretional transition & transmutation among field genic units and inevitably influenced by relative motion speed of observer in spacetime for spacetime dynamic assimilation. Generally, the bigger the discretional radiation intensity is, the bigger the space radiation cornu is. The reason I described it as “relative perceivable dynamic geometric spacetime domino effect” is but ready to emphasize the inevitable relativity of spacetime dynamic assimilation domino effect; the magnitude of space radiation cornu is always relatively proportional to the moving speed of observer. In accordance with general dynamic assimilation of spacetime, the bigger the moving speed of the observer is, the more remarkable dynamic assimilation domino effect of spacetime will consequently occur, the smaller the radiation cornu the observer will find thereby. Contrarily, the observer will find the space radiation cornu bigger.

No time, no space distance, no more space radiation cornu.

3. Cosmic connotation of “ π ”

Generally, the space radiation cornu of the space field we live in is “ π ”, considered by Homogenous Cosmos Originated from Unique Genesis, “ π ” is not an “irrational number” as traditionary mathematics mentioned. Considered on pure physical view, “ π ” is but an “inconstant number” which may be directly related to time dynamic speed. And on the contrary, it is the most meaningful number in the nature, in any case, “ π ” is an innate number implicates all spacetime features including time rate, object mass, object geometrical profile and volume, none-zero division range of any space vector etc, whose natural connotation is self-evident. Ultimate comprehension of cosmic connotation of “ π ” will consequently throw luminous light onto authenticity of mathematical spacetime, and it may be just the key logic link between physics and mathematics. In another word, it may be just the closest and most connatural ligament and turning point between mathematics and physics.

Standing on the earth, if we demand the value of “ π ” to be a constant, we need two necessary preconditions as below:

- ①. The space field strength of large-scale spacetime around the solar system must be steady through and through.
- ②. We have to ensure the earth moving in absolutely inertial state in spacetime.

Precondition ① can ensure the original space radiation cornu around us is steady, precondition ② can ensure the steady relativity domino effect of space radiation cornu, after all, once we come to perceive space radiation cornu, perceivable space radiation cornu has its inherent relativity domino effect related to our moving speed in spacetime. Virtually, it's neither possible for space field strength of large-scale spacetime around the solar system to be constant nor possible for the earth to move in absolutely inertial state through and through. Virtually, the energetic state change of the earth such as “volcano”, “earthquake” Phenomena on the earth mostly relates the external change of space field around the earth, which will be introduced in section of (V-iii).

In any case, Homogenous Cosmos Originated from Unique Genesis may affirm without hesitation the value of π must be directly related to time dynamic speed, (I still can not be sure whether time dynamic speed is just $\pi \times 10^8 \text{m/s}$). For expedience, we can just denote time dynamic speed in function format with variable π as $Y(\pi)$, then introduce the function into PNT dynamics. For instance, we can express the acceleration definition equation as $a(t)=Y(\pi)*K'(t)$; express velocity definition equation as $V=V_0+\int Y(\pi)*K'(t)dt$; express displacement definition equation as $S=V_0*t+\int Y(\pi)*K'(t)dt$... Of course, at the same time, the PNT dynamics inversely implicates the motion orientation and geometrical profile of our study object. Thus, following up the logic clue, it is obviously imaginable that we can ultimately turn mathematics, space geometry and physics into thorough coherence of logic integration.

The reason that the value of “ π ” is inconstant is mainly because the ambient spacetime of the earth is always not constant, and the earth never motions in absolutely inertial state in spacetime therefore, what's more, cosmos exists in everlasting tiny varying state for connatural evolution eversince (which will be introduced in section (IV-ii) as diagram (IV-ii-5)). As a result, any circumference divided by its corresponding diameter equals an inconstant value “ π ”. And it is just the inconstant value of “ π ” which indicates the cosmos exists in everlasting motion and transformation.

— Firstly written in Dec. 1995, literal revision was done in Dec.2004

The Third Part

As Demiurgic Aggradation of Sequential Homologic Cosmogony, Cosmos is well-regulated integration of Cosmic Homogeneity System Making up of Out-and-out Serial Natura Naturata in the Nature of Coherent Natura Naturans Throughout Cosmic Evolution, Universal Existence & Motion Are Spontaneous Occurrence of [External Physical Disturbance + (PNT Action + Instinctive PNT Equilibrium)] — Universal Applicability of PNT Dynamics

Forward

It is only possible for concordant cosmos to be demiurgic aggradation of out-and-out serial natura naturata in the nature of coherent natura naturans throughout cosmic evolution; there is no way for demiurgic aggradation in the nature of different natura naturans to be concordant cosmos through and through.

“Physical Regularity” is but vivid essence objectification of matter in universal existence & motion, which is consequent inherence in a class by itself originated from unique & invariable authenticity of nature as coherent natura naturans throughout cosmic evolution. Accordingly, ultimate consummation of science towards formulation of universal existence & motion of matter in thorough coherence only challenges verification of unique issue — “what matter is in cosmos” as inherence of natura naturans.

The most remarkable character of live contemporaneous scientific orthodoxy is that it's inertial ideological aggradation of all-time remarkable transverse ideological expansion in the recent several centuries, which is typical unsystematized ideological system about universal existence & motion making up of rich and colorful scientific travelogues A, B, C, D, E, F, ... like omnifarious smallwares full of a basket. Virtually, historical progress of science in the recent several centuries seemed like a far-flung exploration of the first itineracy around numerous distinctive landscapes of brand-new landmass of science with palette & tablet on back, several hundred years' scientific travelogues were compiled thereby.

Historical progress of science in the recent several centuries seemed like a far-flung exploration of the first itineracy around numerous distinctive landscapes of brand-new landmasses of science with palette & tablet on back, several hundred years' scientific travelogues were compiled thereby.

As innovative cosmos redefinition in radical logic enantiomorph of newly highlighted factuality that **discretionary particles in cosmos are mutually convertible** with consequent PNT dynamics about universal existence & motion in the nature of coherent natura naturans throughout cosmic evolution, if it were not because historical progress of science had ever experienced hypostatic itineracy around numerous distinctive landscapes of the brand-new landmasses of science with so rich and colorful exploration harvest of scientific travelogues A, B, C, D, E, F, ... like omnifarious smallwares full of a basket, there were no reasons for me to think of so-called "gravity", "electromagnetic force", "strong interaction" & "weak interaction". In any case, scientific ideas as "gravity", "electromagnetic force", "strong interaction" & "weak interaction" are completely out of succession of logic extension of connotation objectification & freewheeling logic extension of homogenous cosmos originated from unique genesis.

And virtually, once "spacetime" and "matter" are introduced into cosmic homogeneity system as coexistent coordinative homology without any third homologic coordinator, and we can exclude the possibility of alternative homologic filiation of "matter father & spacetime son" between spacetime and matter, the ingenerate PNT action between spacetime and matter become self-evident, once PNT action is specified by "**Instinctive PNT equilibrium postulate**", universal existence & motion in spacetime unveils itself as spontaneous occurrence of **[external physical disturbance + (PNT action + instinctive PNT equilibrium)]**. Once "**external physical disturbance=0**", matter integration exists in inertial state as freewheeling; once "**external physical disturbance \neq 0**", matter integration has to spontaneously acclimate itself by the right of instinctive PNT equilibrium towards optimum PNT operation, and mathematical formulation of instinctive acclimation of matter integration against proportionable "**external physical disturbance**" towards optimum PNT operation directly leads to accomplishment of **PNT dynamics**, which is mathematical formulation of coherent natura naturans throughout cosmic evolution as essence of matter in a class by itself.

Original generation of matter in the nature of coherent natura naturans brings out essence of matter in a class by itself the demiurge is always straightforward without any special artifice but coherent natura naturans throughout cosmic evolution, cosmic status quo is but demiurgic aggradation of sequential homologic cosmogony which exists as well-regulated integrative cosmic homogeneity system of out-and-out serial natura naturata in the nature of coherent natura naturans throughout cosmic evolution. As out-and-out serial natura naturata, since it's only possible for original generation of matter in cosmos to be subject to coherent natura naturans throughout cosmic evolution, the essence of matter in cosmos must be proportionably coherent in a class by itself beyond all doubt.

Essence of matter in a class by itself predestines thorough coherence of dynamic regularity of universal existence & motion: Original generation of matter in the nature of coherent natura naturans must bring out inherence of existence & motion of matter in spacetime, there must be inherent causality between essence originated from original generation of matter and dynamic regularity of universal existence & motion in the nature of things. Since cosmic status quo is well-regulated homogeneity system making up of out-and-out serial natura naturata in the nature of coherent natura naturans throughout cosmic evolution, essence of matter in cosmos must be proportionately coherent in a class by itself. And as consequent postnatal occurrence of matter, universal existence & motion must be spontaneous occurrence subject to coherent natura naturans throughout cosmic evolution of the demiurge too, which is virtually coherent dynamic regularity in homogenous cosmos in the nature of instinctive PNT reciprocal equilibrium towards optimum PNT operation. In straightforward words, universal existence & motion in homogenous cosmos are but spontaneous occurrence in the nature of instinctive PNT reciprocal equilibrium towards optimum PNT operation.

Virtually, the coherence of dynamic regularity about universal existence & motion is but lineal logic extension of homogenous cosmos originated from unique genesis, which is direct logic extension from original generation of matter in law of identity along sequential homologic cosmogony in the nature of coherent natura naturans throughout cosmic evolution to proportionate consequence of essence of matter in a class by itself, from essence of matter in a class by itself to coherent dynamic regularity of universal

existence & motion as spontaneous occurrence in the nature of instinctive PNT reciprocal equilibrium towards optimum PNT operation. If there are not rich and colorful ready-made scientific travelogues accessible like this, nothing I can invoke to think of so-called “gravity”, “electromagnetic force”, “strong interaction” & “weak interaction”, at any rate, so-called “gravity”, “electromagnetic force”, “strong interaction” & “weak interaction” are completely out of linear logic extension of **[(Homogenous cosmos originated from unique genesis postulate + spacetime~matter fully embodying cosmos postulate) + Instinctive PNT equilibrium postulate]**, although, upon our intuitional experience, universal existence & motion are so rich and colorful.

How does the coherent dynamic fundamental of PNT dynamics do its magic to make cosmos so well-regulated integration of cosmic homogeneity system through and through?

Towards hypostatic rational highlight of the very issue, we come to emphatically objectify the applicable rationality of PNT dynamics as primary mathematical formulation of coherent natura naturans throughout cosmic evolution, which makes universal existence & motion well-regulated in integrative cosmic homogeneity system in the nature of instinctive PNT reciprocal equilibrium towards optimum PNT operation.

(III-i) “Force Field” and “Force”

Preface: Cosmic evolution is generally sequential homologic cosmogony including original generation and successive evolvement of spacetime and original generation and postnatal existence & motion of matter in spacetime, which of course include the cause & effect of universal existence & motion. Once we are ready to clarify the original cause & effect of mechanical phenomena in cosmos, we have to clarify how mechanical phenomena comes into being throughout cosmic evolution.

Throughout cosmic evolution, does matter come into being first or mechanical phenomena come into being first?

What the ingenerate homologic relationship between “matter” and “mechanical phenomena”?

Substantial experience had told us that mechanical phenomena is always something leeching on to matter, there is none mechanical phenomena isolated from matter. And throughout cosmic evolution, there is original generation of matter first, then mechanical phenomena occur as ingenerate attribute of matter. In straightforward words, mechanical phenomena is but spontaneous occurrence of [external physical disturbance + (PNT action + instinctive PNT equilibrium)] of matter integration. Original generation of matter in the nature of coherent natura naturans brings out essence of matter in a class by itself; essence of matter in a class by itself predestines thorough coherence of dynamic regularity of universal existence & motion.

And on the other hand, throughout historical progress of science human coming to know ultimate authenticity of nature from nothingness to goat, from goat to a great lot and consequently followed the proportionate ideaistic correction & qualitative optimization from superficiality to profundity, from parochiality to generality, human came to know mechanical phenomena in the nature generally experienced a parallel recognizant progression from superficiality to profundity, from macrocosms to microcosms. Throughout which human perceived and clarified gravity, electromagnetic force, strong interaction and weak interaction one after another.

No matter inchoative perception or successive mature comprehension of gravity, electromagnetic force, strong interaction and weak interaction, they were all hypostatic progression of historical progress of science in proportion to contemporaneous historical background. And at the same time, when human came to know hypostatic applicability of gravity, electromagnetic force, strong interaction and weak interaction more and more extensively in the nature, human began to realize that universal existence & motion in the nature are generally dominated by the four type of mechanical phenomena of gravity, electromagnetic force, strong interaction and weak interaction. As a result, the temporal authorities apparently had substantial confidence to declare going without saying that the four type of mechanical phenomena were just the so-called “four fundamental forces” in the nature.

As crescive progression of practical feasibility & possibility in proportion to contemporaneous historical background, there is only practical feasibility & possibility for realistic scientific knowledge proliferation to accomplish proportionate advancement in proportion to contemporaneous historical background, there is almost no practical feasibility & possibility for hypostatic scientific knowledge proliferation in inherent orientation towards absolute scientific verity as perfect ideological enantiomorph of ultimate authenticity of nature to do its normal jobs in defiance of realistic limitation of contemporaneous historical background, which is compatible with ultimate authenticity of nature 100 over 100.

This was of course earlier freewheeling of historical progress of science in inherent optimum orientation towards perfect ideological enantiomorph of ultimate authenticity of nature.

As humanistic ideology about authenticity of nature in proportion to contemporaneous historical background, temporal science is idiographic ideological system like this is not only related to impersonal authenticity of accessible existence & motion around us but also related to our idiographic scientific practice along crescive progression of historical progress of science. In any case, humanistic ideology about authenticity of nature in proportion to contemporaneous historical background is not only live ideological

system about authenticity of accessible existence & motion around us but also ideological aggradation about authenticity of accessible existence & motion under contemporaneous historical background, historical ideological occurrence and successive ideaistic clarification of the so-called “four fundamental forces” was straightforward progressional increase of scientific knowledge even proportionate ideological evolvement along crecive progression of historical progress of science.

Whereas, we have to admit that humanistic partition & definition of so-called “four fundamental forces” due to crecive progression of practical feasibility & possibility in proportion to contemporaneous historical background apparently contradicts cosmic demiurgic fundamental of coherent natura naturans throughout cosmic evolution but obviously reflects historical progression of historical progress of science in inherent optimum orientation towards historical authenticity tolerance of science 0 draw on practical feasibility & possibility in proportion to contemporaneous historical background. As long as we have to admit that, as straightforward man, the demiurge has none special artifice besides coherent natura naturans throughout cosmic evolution, and as a result, cosmic status quo is but outgrowth of out-and-out serial natura naturata in the nature of coherent natura naturans throughout cosmic evolution, we then have admit humanistic ideology about authenticity of nature with typical ideological features of “four fundamental forces” must have desecrated originality of coherent natura naturans throughout cosmic evolution of the demiurge.

At any rate, it's only possible for people of different ages to devote themselves to scientific exploration then and there, and consequently accomplish humanistic ideology about authenticity of nature in proportion to contemporaneous historical background in crecive progression of historical progress of science in inherent optimum orientation towards perfect ideological enantiomorph of ultimate authenticity of nature. When gravity, electromagnetic force, strong interaction and weak interaction initially came into being as initial ideological notion of human one after another, as historical limitation of reproducible thought resource and practical feasibility & accessibility, it seemed only possible for us to perceive and study this kind of mechanical phenomena and that kind of mechanical phenomena one by one off the cuff like toying with this red apple or that green apple on tip of our fingers. As a result, we were of course more feasible and sensitive to perceive their perceivable “thumbprint” more and more but short of practical feasibility & possibility to perceive their coherent essence originated from their common homologic origin, although multiformity of universal existence & motion are but serial natura naturata in the nature of coherent natura naturans throughout cosmic evolution which makes up of well-regulated integration of cosmic homogeneity system.

What's more, as practical feasibility & possibility in proportion to commensurate background, no matter how limited our background of favorable ideological resource was and how insensitive our perception was to the brand-new object, we could only do our best then and there; no matter how unshaped our recognizant harvest was, we also had no reasons to mishandle our practical accessibility & feasibility towards possible approach then and there. As a result, we just separately partitioned and defined them YY interaction, ZZ interaction ... in accordance with the historically perceivable thumbprint of the very mechanical phenomena. At any rate, we should be sane to our fixed lot knowing our distance and should not overlook even maltreat our possible approach draw on practical accessibility & feasibility in proportion to commensurate background. After all, there were only worthy possibilities for men in different ages to draw their possible conclusions with backup of commensurate background; succedent generation can only come to review on their own historical stage but can never hypostatize their wisdom in prior.

At any rate, historical occurrence and successive rational perfection of the so-called “four fundamental forces” tallies with intrinsic inevitability human coming to know ultimate authenticity of nature from superficiality to profundity, from macrocosm to microcosmos, from parochiality to generality. And just because of crecive progression of historical progress of science due to practical feasibility & possibility in proportion to contemporaneous historical background, whether historical occurrence and successive rational perfection of the so-called “four fundamental forces” really tallies with ultimate authenticity of nature or not, and how much historical occurrence and successive rational perfection of the so-called “four fundamental forces” has practically

reflected ultimate authenticity of nature is still necessary for us to review.

Casting back history, a gifted conclusion of Aristotle that heavier objects always fall faster to the ground than the lighter ones was believed and adored by succedent generations for near two thousand years. In early 19 century, many optimistical people believed that Newton had found the universal laws in the nature, further development of sciences in the future was but to make the related experiments more detailed and convictive. In terminal of 19 century and beginning of 20 century, human found electron, proton and neutron one after another, the related proud authorities were so confident that they had found the elementary particles of cosmos already; No matter whether historical partition and definition of so-called four fundamental forces in cosmos were in this queue or not, leastways, we can fully conclude the historical derivation model of the historical partition and definition of the so-called four fundamental forces in cosmos is just the same as the instances listed above, —— triumphant songs or enthusiastic whoopee of historical progress of science off the cuff as well as substantial annotation of historical ignorance. Since there is nonexistence of tiger in mountain, nothing can prevent monkey to be the king of the mountain, before naissance of perfect ideological enantiomorph of ultimate authenticity of nature, since pioneering humanistic ideology about authenticity of nature in proportion to contemporaneous historical background seems scientifically all-time, it's of course comprehensible that all the pioneering and top-level humanistic ideology about authenticity of nature in proportion to contemporaneous historical background are always ready to be scientific king of the age after jaunty triumph.

Whereas, scientific aggradation till today, as remarkable highlight of microcosmic configuration of matter, especially remarkable highlight of factuality that any discretionary particles in cosmos are mutually convertible, the homogenous profile of cosmos has been more and more explicit. Consequent connotation objectification with freewheeling logic extension of homogenous cosmos originated from unique genesis remarkably refurbish our rational purview of “matter” and “universal existence & motion”. Virtually, on standpoint of homogenous cosmos originated from unique genesis, universal existence & motion are but spontaneous occurrence in the nature of essence of matter in a class by itself, as a result, dynamic regularity of universal existence & motion must be subject to law of identity due to essence of matter in a class by itself. “Force” is but dynamic domino effect in the nature of **instinctive PNT reciprocal equilibrium towards optimum PNT operation** for external physical disturbance of matter integration which is related to PNT operation, so-called “four fundamental forces” are but four typical instances of dynamic effect in the nature of instinctive PNT reciprocal equilibrium towards optimum PNT operation due to four distinctive external physical disturbance of matter integration which is related to PNT operation. Force phenomenon in cosmos can never be exception out of spontaneous occurrence of **[External physical disturbance + (PNT action + Instinctive PNT equilibrium)]** of matter integration.

If scientific notions of so-called “four fundamental forces” of tradition as typical humanistic ideology about authenticity of nature in proportion to contemporaneous historical background were not so well-known around, there is no way for me to think of so grotesque notions as “gravity”, “electromagnetic force”, “strong interaction” and “weak interaction”. In any case, scientific notions as “gravity”, “electromagnetic force”, “strong interaction”, “weak interaction” of tradition are completely out of logic extension of Homogenous Cosmos Originated from Unique Genesis as radical logic enantiomorph of newly highlighted factuality that discretionary particles in cosmos are mutually convertible. It was but because, after I finished connotation objectification and freewheeling logic extension of homogenous cosmos originated from unique genesis, I suddenly remembered there were still related notions as **four fundamental forces** in tradition. I see they are but four distinctive instances of dynamic domino effect in the nature of instinctive PNT reciprocal equilibrium towards optimum PNT operation due to distinctive external physical disturbance of matter integration, whose homologic coherence and individual distinction seem four melons on one bine.

All in all, as typical longitudinal ideological optimization, Homogenous Cosmos Originated from Unique Genesis is rational sublimation of remarkable highlight of microcosmic configuration of matter, which is lineal logic system about universal existence

& motion as spontaneous occurrence in the nature of coherent natura naturans throughout cosmic evolution on the basis of [(Homogenous cosmos originated from unique genesis + spacetime~matter fully embodying cosmos) + instinctive PNT equilibrium]. As discrepancy of inherent logic constitution, once it's turn for Homogenous Cosmos Originated from Unique Genesis to analyze and formulate the so-called "force" in cosmos, there are no reasons for me to think of the traditionary notions as "gravity", "electromagnetic force", "strong interaction" and "weak interaction" which were fine-drawn ideological features belonging to humanistic ideology about authenticity of nature in proportion to foregoing distinctive historical background as typical scientific travelogues A, B, C, D, E, F, ... like omnifarious smallwares full of a basket, although, cosmic status quo is but demiurgic aggradation of out-and-out serial natura naturata in the nature of coherent natura naturans throughout cosmic evolution beyond all doubt. In straightforward words, since the gradually accessible noumenon seemed so rich and colorful distinctive landscapes of brand-new landmasses of science in our rational purview then and there, as timely ideological enantiomorph about authenticity of nature, it's only possible for commensurate ideological system about authenticity of nature to be so rich and colorful scientific travelogues A, B, C, D, E, F, ... like omnifarious smallwares full of a basket.

Riding the fence of such rational purview, we get down to contrast the original coherence of sequential homologic cosmogony in the nature of coherent natura naturans throughout cosmic evolution and hypostatic scientific exploration along historical progress of science in inherent optimum orientation towards perfect ideological enantiomorph of ultimate authenticity of nature, Oh~, my God, the contrast disparity between the both is so marvelous, it's stark legpull the God played on us!?

——In terms of objectivity of cosmos: cosmos is throughout homogenous originated from unique genesis, cosmic status quo is demiurgic aggradation of sequential homologic cosmogony, which exactly exists as well-regulated integration of cosmic homogeneity system making up of out-and-out serial natura naturata in the nature of coherent natura naturans throughout cosmic evolution, and the so-called "coherent natura naturans throughout cosmic evolution" is just connatural demiurgic fundamental of instinctive PNT reciprocal equilibrium towards optimum PNT operation through and through.

——As crecive progression of practical feasibility & possibility in proportion to contemporaneous historical background: live humanistic ideology about authenticity of nature is but inertial ideological aggradation of remarkable transverse ideological expansion making up of rich and colorful scientific travelogues A, B, C, D, E, F, ... like omnifarious smallwares full of a basket, which are virtually formidable harvest of a far-flung exploration of the first itineracy around numerous distinctive landscapes of brand-new landmasses of science with palette & tablet on back in the recent several centuries. Although, cosmic status quo is but demiurgic aggradation of sequential homologic cosmogony, which exactly exists as well-regulated integration of cosmic homogeneity system making up of out-and-out serial natura naturata in the nature of coherent natura naturans throughout cosmic evolution.

In order to show off his humorous gift, is the God always ready to play joke on us!?

(III-i-1) Authentic Connotation of Force Due to Homogenous Cosmos Originated from Unique Genesis

Abstract: *Along sequential homologic cosmogony, there is matter first then occurrence of “mechanical phenomenon” which is spontaneous outgrowth of essence of matter in a class by itself due to stochastic conditionality. In straightforward words, original generation of matter in the nature of coherent natura naturans brings out essence of matter in a class by itself; essence of matter in a class by itself predestines thorough coherence of dynamic regularity of universal existence & motion.*

As freewheeling logic extension of [(Homogenous cosmos originated from unique genesis postulate + spacetime~matter fully embodying cosmos postulate) + Instinctive PNT equilibrium postulate], so-called “force” is but dynamic domino effect due to instinctive PNT reciprocal equilibrium towards optimum PNT operation for occurrence of external physical disturbance of matter integration related to PNT operation, —spontaneous occurrence of [external physical disturbance + (PNT action + Instinctive PNT equilibrium)] of matter integration, which is virtually physical process matter integration spontaneously rebuilding optimum PNT operation against external disturbance related to PNT operation by the right of congenital attribute of PNT equilibrium instinct. Among the spontaneous reaction mechanism, constituent of “external physical disturbance” is just the external cause for occurrence of force, constituent of (PNT action + Instinctive PNT equilibrium) is just the root cause or original motility for spontaneous implementation of force.

The uniform mathematical expression of force is

$$F=m*K'(t)*Y(t)$$

All n all, force is but physical domino effect of spontaneous occurrence of [external physical disturbance + (PNT action + Instinctive PNT equilibrium)].

As particularity of homologic configuration of matter due to coherent natura naturans throughout cosmic evolution, the so-called “external physical disturbance” has individual instances as “physical disturbance of matter field superposition”, “physical disturbance of matter field superposition with congeneric or complemental genic preponderance or genic insufficiency”, “PNT complemental linkage optimization among unsaturated particles in available space range”, so that the physical domino effect of spontaneous occurrence of [external physical disturbance + (PNT action + Instinctive PNT equilibrium)] is consequently individualized into:

- ①. *Physical domino effect of spontaneous occurrence of [physical disturbance of matter field superposition + (PNT action + Instinctive PNT equilibrium)], which is just so-called “gravity”.*
- ②. *Physical domino effect of spontaneous occurrence of [physical disturbance of matter field superposition with congeneric or complemental genic preponderance or genic insufficiency + (PNT action + Instinctive PNT equilibrium)], which is just so-called “electromagnetic force”.*
- ③. *Physical domino effect of spontaneous occurrence of [PNT complemental linkage optimization among unsaturated particles in available space range + (PNT action + Instinctive PNT equilibrium)], which is just so-called “strong interaction”.*

Since primal introduction of **Homogenous cosmos originated from unique genesis postulate** for connotation objectification with freewheeling logic extension of homogenous cosmos originated from unique genesis, Homogenous Cosmos Originated from Unique Genesis implemented logical operation as below:

- 1) As remarkable highlight of factuality that discretionary particles in cosmos are mutually convertible,

As coherent natura naturans throughout cosmic evolution, instinctive PNT reciprocal equilibrium towards optimum PNT operation is radical potentiality & conditionality for cosmos always ready to orientate itself towards perfection.

which is even in living orientation towards complete induction, Homogenous Cosmos Originated from Unique Genesis introduces “Homogenous cosmos originated from unique genesis postulate”.

2) Substitute the solid intuitional experience that cosmos consists of spacetime and matter, none coordinative component else as supplemental assumption of “spacetime~matter fully embodying cosmos postulate” into cosmic model cavity of “**Homogenous cosmos originated from unique genesis postulate**” so as to manage logic extension of [Homogenous cosmos originated from unique genesis + spacetime~matter fully embodying cosmos] and so as to accomplish connotation objectification of homogenous cosmos originated from unique genesis successively.

3) The logic extension of “Homogenous cosmos originated from unique genesis + spacetime~matter fully embodying cosmos” directly indicates alternative homologic filiation between spacetime and matter either “**spacetime father & matter son**” or “**matter father & spacetime son**”, whereas, once we exclude the alternative possibility of “**matter father & spacetime son**”, the alternative homologic filiation between spacetime and matter become self-evident therefore.

4) The physical noumenon of homologic filiation between spacetime and matter of course implies inherent “PNT correlation” or “PNT action” of matter integration in freewheeling logic extension. Virtually, PNT action is not only the headspring creation of original generation of matter but also proportionate dynamic origin of postnatal existence & motion of matter in spacetime, which of course indicates that existence & motion of matter radically depends on PNT action of the proper matter integration. In a straightforward word, idiographic existent state of matter is just dynamic enantiomorph of PNT action of the proper matter integration, and once the PNT action is regularized by “instinctive PNT equilibrium postulate”, existence & motion of matter in spacetime immediately turns out itself as spontaneous occurrence of “PNT action + instinctive PNT equilibrium”. PNT dynamics is just mathematical formulation of physical process of “PNT action + instinctive PNT equilibrium”.

Of course, “force” is one of the most elementary notions of PNT dynamics, so-called “force” is but dynamic domino effect due to instinctive PNT reciprocal equilibrium towards optimum PNT operation for external physical disturbance of matter integration related to PNT operation, ——spontaneous occurrence of matter integration due to [**external physical disturbance + (PNT action + Instinctive PNT equilibrium)**].

In the spontaneous mechanism of force definition above, “**external physical disturbance**” directly means the state parameters of matter integration related to PNT operation are disturbed and consequently arises non-zero quantitative change, so that the PNT operation of matter integration has to react due to instinctive PNT reciprocal equilibrium towards optimum PNT operation therefore, which of course means that “**external physical disturbance**” is just external cause for occurrence of force. “**PNT action**” is virtually the living lineal homologic correlation between spacetime and positive matter and ingenerate attribute of matter integration, which is radically derived from Homogenous cosmos originated from unique genesis postulate with supplementation of one 0.5 grade auxiliary hypothesis of spacetime~matter fully embodying cosmos postulate. “**instinctive PNT equilibrium**” is a kind of instinctive directional motility to rebuild optimum PNT operation (/to recover PNT equilibrium of matter integration) once the PNT operation of matter integration is disturbed by external physical disturbance. Virtually, PNT dynamics is just mathematical formulation that PNT equilibrium instinct direct rebuilding optimum PNT operation of matter integration once PNT operation is disturbed by external physical disturbance, which of course involves in variation of all state parameters as m , $K'(t)$, $Y(t)$, $a(t)$, $V(t)$ etc of matter integration. (**PNT action + Instinctive PNT equilibrium**) is ingenerate attribute of matter integration, the distinction of characteristic forces are generally derived from distinctive “**external physical disturbance**”.

Virtually, we can even define “existence & motion” is but spontaneous occurrence of [external physical disturbance + (PNT action + Instinctive PNT equilibrium)] of matter integration. Usually, when we come to emphasize “force” of matter integration, we mostly focus on “external physical disturbance $\neq 0$ ”, —focus on the resultant dynamic domino effect of spontaneous reaction of unbalanced PNT operation of matter integration with instinct of PNT equilibrium, whereas, once we take care of general connotation of “existence & motion of matter”, we then have no quantitative limitation of external physical disturbance, which of course includes special instance of “external physical disturbance=0”, outside force of matter integration is 0 and matter integration exists in inertial state accordingly.

The unitive lingual equation expression of force is as below:

Force=mass of object \times PNT unbalance rate of matter integration \times time dynamic speed

And the symbolic formulation of force is as below:

$$F=m \cdot K'(t) \cdot Y(t)$$

Force definition of Homogenous Cosmos Originated from Unique Genesis is purely logic extension of connotation objectification of homogenous cosmos originated from unique genesis. As a result, applicability of force definition of Homogenous Cosmos Originated from Unique Genesis is matter throughout homogenous cosmos without any supplemental condition. That's to say, in homogenous cosmos, there is none essence distinction between this kind of idiographic force and that kind of idiographic force, any force in cosmos is but dynamic domino effect due to instinctive PNT reciprocal equilibrium towards optimum PNT operation for occurrence of external physical disturbance of matter integration, —spontaneous occurrence of matter integration due to [external physical disturbance + (PNT action + Instinctive PNT equilibrium)]. Distinctive difference of hypostatic forces can only be derived from what kind of cosmic esse and what kind of manner involved to hypostatize external physical disturbance to matter integration so as to cause dynamic domino effect due to instinctive PNT reciprocal equilibrium towards optimum PNT operation and consequently hypostatize variation of all related state parameters as $m, K'(t), Y(t), a(t), V(t)$ etc by the light of nature. The everlasting PNT operational orientation of dynamic effect due to instinctive PNT equilibrium towards optimum PNT operation is “PNT operational equilibrium”, and the stochastic force direction of dynamic effect due to instinctive PNT equilibrium towards optimum PNT operation is but spontaneous optimum alternative towards optimum PNT operation.

The physical implementation of dynamic effect due to instinctive PNT equilibrium towards optimum PNT operation is radically derived from ingenerate living mechanism of matter integration. So-called “matter integration” is just integration of both positive matter and matter field which are inherently correlated by PNT action. Physical implementation of force must depend on operation of PNT action with equilibrium instinct of matter integration, and PNT action inherently performs between positive matter and matter field, this of course indicates, in terms of assimilation of external physical disturbance to PNT operation of matter integration, physical implementation of force has to depend on physical intermedium of matter field for performance of instinctive PNT reciprocal equilibrium towards optimum PNT operation so as to assimilate the external physical disturbance thereby.

If we just call the physical intermedium which involves in for reciprocal PNT equilibrium covariance towards optimum PNT operation of matter integration “force field”. It apparently seems force field can never be out of matter field, otherwise, there is no possibility for physical implementation of force to be hypostatized by reciprocal PNT equilibrium covariance. Just because of this, we can draw our conclusion that force field must firstly be derived from matter field. And if the positive matter of matter integration has some certain

As coherent natura naturans throughout cosmic evolution, instinctive PNT reciprocal equilibrium towards optimum PNT operation is radical potentiality & conditionality for cosmos always ready to orientate itself towards perfection.

special genic configuration, as positive matter and the proper matter field are inherently correlated by PNT action, the so-called “special genic configuration” of positive matter of matter integration must be transferred to matter field by PNT action as much as possible, so that the matter field of matter integration consequently has proportionate special genic configuration for ingenerate osmotic infection of PNT action, distinctive force field is just such infected matter field with genic preponderance or insufficiency derived from special genic configuration of positive matter for ingenerate osmotic infection of PNT action between positive matter and matter field. Usually, different force fields depend on distinctive genic preponderance or insufficiency of matter field derived from special genic configuration of positive matter, in a straightforward word, distinctive genic preponderance or insufficiency of matter fields directly indicates presence of different force fields.

If the positive matter of matter integration has some certain special compositive genic configuration, the reciprocity of PNT action between positive matter and matter field of matter integration must transmit and transmute some of the special compositive genic configuration from positive matter to matter field, so that the proper matter field has the proportional special compositive genic configuration too, the proper matter field is affected therefore. And characteristic force fields are just such matter fields with special compositive genic configuration for they have been affected by the positive matter by PNT action. Difference of among different force fields is only limited in difference of compositive genic configuration, different compositive genic configuration of matter fields bring out different force fields. In a straightforward word, ZZ force field is but matter field with ZZ characteristic compositive genic configuration. Of course, different force fields with distinctive compositive genic configuration inherently have different ways to materialize physical implementation of force.

All in all, so-called “force” is but spontaneous occurrence of [**external physical disturbance + (PNT action + Instinctive PNT equilibrium)**], individuality of different forces only derives from distinction of “external physical disturbance” which causes unbalance of PNT action of matter integration. The traditional idea of so-called “gravity”, “electromagnetic force”, “strong interaction”, “weak interaction” are but four typical instances of distinctive external physical disturbance causing unbalance of PNT action of matter integration. And subsequently, we introduce “gravity”, “electromagnetic force”, “strong interaction” & “weak interaction” herein is generally ready to highlight the distinctive connotation of [**external physical disturbance + (PNT action + Instinctive PNT equilibrium)**] with distinctive “**external physical disturbance**” which indicating causality of “gravity”, “electromagnetic force”, “strong interaction” and “weak interaction”, we especially focus on analysis of the distinctive “external physical disturbance” and the consequent quantitative change of all state variables of matter integration due to instinctive PNT reciprocal equilibrium towards optimum PNT operation. Of course, the best alternative for instinctive PNT reciprocal equilibrium towards optimum PNT operation determines the orientation of force.

Cosmos is always ready to orientate itself towards perfection by the right of nature, as coherent natura naturans throughout cosmic evolution, instinctive PNT reciprocal equilibrium towards optimum PNT operation is radical potentiality & conditionality for cosmos always ready to orientate itself towards perfection. As spontaneous occurrence of [**external physical disturbance + (PNT action + Instinctive PNT equilibrium)**], characteristic feature of force is just the most veritable incarnation that cosmos is always ready to orientate itself towards perfection by the right of nature. If we are philosophical to speak out that cosmos is so grandly esthetic itself, at any rate, it’s always ready to orientate itself towards perfection by the light of nature, it’s even wiser for us to say that cosmos is so grandly esthetic itself, after all, universal existence & motion are but spontaneous occurrence of coherent natura naturans

in the nature of instinctive PNT reciprocal equilibrium towards optimum PNT operation of matter integration through and through.

All in all, force is but physical domino effect of spontaneous occurrence of [external physical disturbance + (PNT action + Instinctive PNT equilibrium)].

As particularity of homologic configuration of matter due to coherent natura naturans throughout cosmic evolution, the so-called “external physical disturbance” has individual instances as “physical disturbance of matter field superposition”, “physical disturbance of matter field superposition with congeneric or complemental genic preponderance or genic insufficiency”, “PNT complemental linkage optimization among unsaturated particles in available space range”, so that the physical domino effect of spontaneous occurrence of [external physical disturbance + (PNT action + Instinctive PNT equilibrium)] is consequently individualized into:

- ①. Physical domino effect of spontaneous occurrence of [physical disturbance of matter field superposition + (PNT action + Instinctive PNT equilibrium)], which is just so-called “gravity”.
- ②. Physical domino effect of spontaneous occurrence of [physical disturbance of matter field superposition with congeneric or complemental genic preponderance or genic insufficiency + (PNT action + Instinctive PNT equilibrium)], which is just so-called “electromagnetic force”.
- ③. Physical domino effect of spontaneous occurrence of [PNT complemental linkage optimization among unsaturated particles in available space range + (PNT action + Instinctive PNT equilibrium)], which is just so-called “strong interaction”.

The logical constitution of above individualization of force can be illustrated as below:

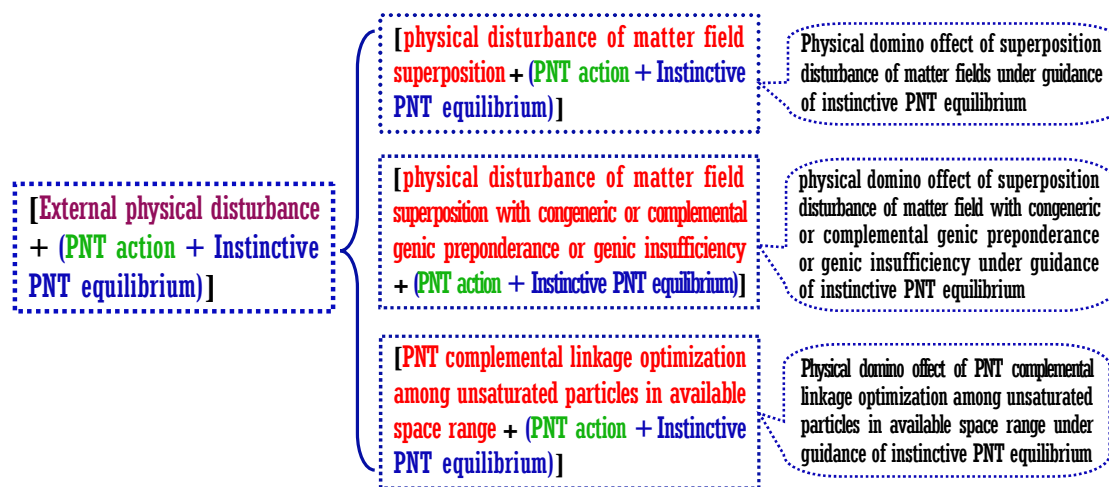

(III-i-1) Logic constitution of individuality classification of force

Virtually, as straightforward man, the demiurge has never created so-called “four fundamental forces” like gravity, electromagnetic force, strong interaction & weak interaction, he may be confused very much to meet so unintelligible humanistic ideas like these. In any case, the demiurge can never play special artifice but coherent natura naturans throughout cosmic evolution = freewheeling of [(stochastic accomplishment of “reciprocal idiosyncrasy towards PNT equilibrium + accessible space overall arrangement for PNT reciprocity” among compositive components) + consequent convergence of compositive components in the nature of instinctive PNT reciprocal equilibrium towards optimum PNT operation] through and through, which is not only inherent programme of sequential homologic cosmogony towards original generation of universal reciprocal PNT combinations but also vivid programme of postnatal existence & motion of universal reciprocal PNT combinations eversince. As author of Homogenous Cosmos Originated from Unique Genesis, in rather a long time, I was really uncomfortable to meet people to

As coherent natura naturans throughout cosmic evolution, instinctive PNT reciprocal equilibrium towards optimum PNT operation is radical potentiality & conditionality for cosmos always ready to orientate itself towards perfection.

show off travelogue style physical knowledge about conventional gravity, electromagnetic force, strong interaction & weak interaction like superior learned man or even like big man before me.

In any case, as distinctive humanistic ideology about authenticity of nature in proportion to contemporaneous historical background, so-called **“four fundamental forces”** are not something realistic belonging to the nature, but mostly because we have experienced distinctive historical progress of science like a far-flung exploration of the first itinerary around numerous distinctive landscapes of brand-new landmasses of science with palette & tablet on back. As long as we have to admit that **cosmos is throughout homogenous originated from unique genesis, cosmic status quo is but demiurgic aggradation of sequential homologic cosmogony, which exactly exists as well-regulated integration of cosmic homogeneity system making up of out-and-out serial natura naturata in the nature of coherent natura naturans throughout cosmic evolution.** Theoretically, **coherent natura naturans throughout cosmic evolution** must crown all connotation of cosmic mechanical phenomenon through and through, whereas, as connotation of **“coherent natura naturans throughout cosmic evolution”**, it’s impossible for cosmic mechanical phenomenon to be made up of so-called **“four fundamental forces”**. In straightforward words, since it’s **“coherent natura naturans throughout cosmic evolution”** crowning all cosmic mechanical phenomenon through and through, it’s impossible for cosmic mechanical phenomenon to be made up of **“four fundamental forces”**, there is no way for **“four fundamental forces”** to make up of **“coherent natura naturans throughout cosmic evolution”**.

We can of course imagine that there were many many dramatic contemporaneous scientific orthodoxies like Aristotle Theory, Geocentric Theory, Heliocentric Theory, ... before live contemporaneous scientific orthodoxy, whereas, as temporal authority and loving successors of contemporaneous scientific orthodoxy indulging in altisonant social legitimacy subsistence of contemporaneous scientific orthodoxy, once similar dramatic situation of contemporaneous scientific orthodoxy out of scientific legitimacy qualification of historical authenticity tolerance of science 0 suddenly exposed its inherent historical limitation for successive occurrence of timely renovation of humanistic ideology about authenticity of nature in proportion to contemporaneous historical background, we are unexpectedly discomfortable even difficult to accept so cool reality in the nature of things. As a result, magistral autarchy of **free press regulation customization & free press admittance** of temporal authority short of necessary intendance must be invoked as expedient official facility in virulent scientific knowledge metabolism campaign.

Original generation of all non-living objects besides elementary genic units is just previous output of freewheeling coherent natura naturans eversince, postnatal existence & motion of non-living things besides elementary genic units is too ongoing performance of freewheeling coherent natura naturans throughout cosmic evolution. Original generation of all organisms is just previous output of freewheeling coherent natura naturans eversince, and postnatal existence & motion of organisms is too ongoing performance of freewheeling coherent natura naturans throughout cosmic evolution.

For further highlight of hypostatic rationality of PNT dynamics, we subsequently introduce typical force fields and forces which is straightforwardly related to coherent natura naturans throughout cosmic evolution under precondition of homogenous cosmos originated from unique genesis.

—Firstly written in Dec. 1995, literal revision was done in Dec.2004
Further revision was done in February & March 2016

(III-i-2) Gravitational Field and Gravity

Abstract: *As freewheeling logic extension of [(Homogenous cosmos originated from unique genesis postulate + spacetime~matter fully embodying cosmos postulate) + Instinctive PNT equilibrium postulate], so-called “force” is but dynamic domino effect due to instinctive PNT reciprocal equilibrium towards optimum PNT operation for occurrence of external physical disturbance of matter integration related to PNT operation, —spontaneous occurrence of [external physical disturbance + (PNT action + Instinctive PNT equilibrium)] of matter integration, which is virtually physical process matter integration spontaneously rebuilding optimum PNT operation against external disturbance related to PNT operation by the right of congenital attribute of PNT equilibrium instinct. Among the spontaneous reaction mechanism, constituent of “external physical disturbance” is just the external cause for occurrence of force, constituent of (PNT action + Instinctive PNT equilibrium) is just the root cause or original motility for spontaneous implementation of force.*

In straightforward words, so-called “gravity” is but physical domino effect of spontaneous occurrence of [physical disturbance of matter field superposition + (PNT action + Instinctive PNT equilibrium)] of matter integration, whose radical motivity is (PNT action + Instinctive PNT equilibrium) of matter integration out of question, just because physical disturbance of matter field superposition is direct quantitative cause to bring PNT operation of matter integration out of stationary state, the consequent reaction of instinctive PNT equilibrium proportionably objectifies mechanical feature of so-called “gravity” thereby.

“Gravitational field” is just the archetype of matter field. As matter field inherently come into being during the course of original generation of matter and proportionably grow up following convergent accumulation of positive matter of matter integration. And of course, the original generation of positive matter is not unconditional, it has initial spacetime condition for original generation of positive matter as lineal homology of material spacetime, the so-called “initial spacetime conditions for original generation of positive matter” is just the critical boundary and lower limit of matter field or gravitational field in field strength, which of course implies matter field or gravitational field is limited and the critical boundary and lower limit of matter field or gravitational field is just the initial spacetime condition for original generation of matter as lineal homology of physical spacetime.

AS “PNT action + instinctive PNT equilibrium” is of course inherence of matter integration, “gravity” is dynamic domino effect of gravitational field superposition disturbance which causes PNT operation of matter integration losing its original stationary status so that PNT equilibrium instinct has to rebuild operational perfection of PNT action of mater integration. As matter field superposition conditions directly affect the feasibility for implementation of instinctive PNT reciprocal equilibrium towards optimum PNT operation of matter integration, and as disparity of gravitational field superposition, there are different expedient alternative for implementation of instinctive PNT reciprocal equilibrium towards optimum PNT operation, as a result, spontaneous occurrence of expedient alternative for implementation of instinctive PNT reciprocal equilibrium towards optimum PNT operation hypostatize different mechanical orientation of universal gravitation. When field superposition of gravitational fields is still relatively superficial, it's even more expedient for matter integration to reject further superposition of gravitational fields for implementation of instinctive PNT reciprocal equilibrium towards optimum PNT operation, as a result, the gravitational reciprocity materializes “repulsion” as feasible expedience. When field superposition of gravitational fields has been relatively sufficient, it's even

more expedient for matter integration to assimilate further superposition of gravitational fields for implementation of instinctive PNT reciprocal equilibrium towards optimum PNT operation, as a result, the gravitational reciprocity materializes “attraction” as feasible expedience.

As different superposition of gravitational fields bring out different feasibility for implementation of instinctive PNT reciprocal equilibrium towards optimum PNT operation of matter integration, in accordance with idiographic superposition of gravitational fields, expedient implementation of instinctive PNT reciprocal equilibrium towards optimum PNT operation hypostatize gravitational reciprocity fundamental of “mass disparity accessible for attraction” and “mass equivalence accessible for repulsion”.

Keywords: force field, gravitational field, gravity, matter field superposition, inexpedient assimilable inadequate field superposition, peripheral inexpedient assimilable globose field lamella, negative gravity, expediently assimilable adequate field superposition, central expediently assimilable globose field extent, positive gravity, mass disparity accessible to positive gravity, mass approximation accessible to negative gravity.

As typical humanistic ideology about authenticity of nature in proportion to contemporaneous historical background, so-called “**four fundamental forces**” is but historical outgrowth as out-and-out scientific travelogues derived from the first itineracy around numerous distinctive landscapes of brand-new landmasses of science with palette & tablet on back, which not only has no idea that **ultimate authenticity of nature** can be neither omnifarious authenticity smallwares full of a basket nor authenticity chameleon one piece and only, but coherent natura naturans throughout cosmic evolution but also has desecrated rigid enantiomorphous correlation between humanistic ideology and authenticity of nature that **the uniqueness & invariance of ultimate authenticity of nature determines the unique possibility of scientific verity as perfect ideological enantiomorph of ultimate authenticity of nature.**

Homogenous cosmos is but demiurgic aggradation of sequential homologous cosmogony, which exactly exists as well-regulated integration of cosmic homogeneity system making up of out-and-out serial natura naturata in the nature of coherent natura naturans throughout cosmic evolution. And indeed, as straightforward man, the demiurge only has unique artifice through and through, which is **coherent natura naturans throughout cosmic evolution.** Original naissance of distinctive existence & motion with relatively steady characters in cosmos are but consequent outgrowth as physical domino effect of **coherent natura naturans throughout cosmic evolution**, universal existence & motion with vivid physical variation are but stochastic performance of **coherent natura naturans throughout cosmic evolution** out of question. The demiurge brings out universal existence & motion as serial natura naturata in the nature of coherent natura naturans throughout cosmic evolution, he never has idea of “force or mechanical phenomena in the nature”, no more so-called “**four fundamental forces**” in the nature.

In straightforward words:

Original generation of matter in the nature of coherent natura naturans brings out essence of matter in a class by itself;
Essence of matter in a class by itself predestines thorough coherence of dynamic regularity of universal existence & motion.

Force phenomena in the nature is not straightforward outgrowth of **coherent natura naturans throughout cosmic evolution** of the demiurge, but because matter are brought out as **serial natura naturata** in the nature of **coherent natura naturans throughout cosmic evolution** with resultant definite inherence in the nature of things, force phenomena in the nature are brought out as stochastic spontaneous occurrence due to **[resultant definite inherence of matter integration +**

Historical progress of science in the recent several centuries seemed like a far-flung exploration of the first itineracy around numerous distinctive landscapes of brand-new landmasses of science with palette & tablet on back, several hundred years’ scientific travelogues were compiled thereby.

external physical disturbance], the resultant definite inherence of matter integration is generally (**PNT action + instinctive PNT equilibrium**) of matter integration. In straightforward words, the demiurge never creates “force” in cosmos, he even has no idea of “force” at all, instead, he only creates matter by the right of **coherent natura naturans throughout cosmic evolution**, which brings out consequent serial natura naturata in the nature of **coherent natura naturans throughout cosmic evolution**. After accomplishing creation of serial natura naturata in the nature of **coherent natura naturans throughout cosmic evolution**, nothing else seems necessary for the demiurge to do for cosmogony but to leave matter stochastically exist and motion itself in accordance with **resultant definite inherence of matter integration**. In terms of universal existence & motion, they are straightforward stochastic spontaneous occurrence against resultant definite inherence of matter under proper environmental conditions. Since matter is inherently created in the nature of **coherent natura naturans throughout cosmic evolution** with resultant definite inherence in the nature of things, it postnaturally has unique script of resultant definite inherence to perform stochastic existence & motion as spontaneous occurrence due to external physical disturbance, distinctive existence & motion of objects are but stochastic spontaneous occurrence of matter under corresponding environmental conditions against resultant definite inherence of matter, which of course indicates all physical connotation of force phenomenon in cosmos are included through and through in spontaneous occurrence of matter against resultant definite inherence of matter integration.

Under precondition that homogenous cosmos is but demiurgic aggradation of sequential homologous cosmogony, which exactly exists as well-regulated integration of cosmic homogeneity system making up of out-and-out serial natura naturata in the nature of **coherent natura naturans throughout cosmic evolution**, So-called “force” is but spontaneous occurrence of [**external physical disturbance + (PNT action + Instinctive PNT equilibrium)**] of matter integration, force phenomenon in cosmos can never be exception out of spontaneous occurrence of [**external physical disturbance + (PNT action + Instinctive PNT equilibrium)**] of matter integration. And “**instinctive PNT reciprocal equilibrium towards optimum PNT operation**” is the universal dynamic fundamental and **coherent natura naturans** to accomplish demiurgic evolution and all related mechanical effect throughout cosmic evolution. Force individuality in cosmos mostly depends on distinctive physical feature of so-called “**external physical disturbance**”, force direction is straightforward consequence of most expedient alternative of spontaneous PNT reaction against distinctive physical feature of idiographic external physical disturbance due to instinctive PNT reciprocal equilibrium towards optimum PNT operation of matter integration.

After necessary highlight of natural configuration of matter field, we analyze “gravity” herein is ready to formulate how the matter field superposition interference among celestial bodies brings out distinctive “**external physical disturbance**” as “inexpedient assimilable inadequate field superposition” and “expediently assimilable adequate field superposition” of matter integration of celestial bodies. And as occurrence of the distinctive external physical disturbance disarranges the natural configuration of matter field, PNT action with PNT equilibrium instinct of matter integration of celestial bodies has to react towards optimum PNT operation in most expedient alternative by the light of nature and consequently hypostatize the fundamental of gravitational reciprocity accordingly.

1. Gravitational field

Homogenous Cosmos Originated from Unique Genesis confirms that gravitational field is just the archetype of matter field itself, which is congenital connubial field of positive matter and inherently coordinates existence & motion of positive matter in spacetime.

As coherent natura naturans throughout cosmic evolution, instinctive PNT reciprocal equilibrium towards optimum PNT operation is radical potentiality & conditionality for cosmos always ready to orientate itself towards perfection.

In accordance with distributive characteristics of conventional gravity in Newtonian mechanics, Homogenous Cosmos Originated from Unique Genesis primarily affirms, in term of any celestial body with mass m , the matter field strength α of discretionary point in matter field with distance R to the center of mass m of celestial body satisfies equation as below:

$$\alpha = \varepsilon * m / R^2 \quad \dots\dots\dots \quad (\text{III-i -1}) \quad (\otimes)$$

Among the equation, ε is just the gravitational constant, m denotes the mass of celestial body.

The equation above indicates the matter field strength α of any point in matter field is proportional to the positive mass m of celestial body (/matter integration), and is inversely proportional to the square of the distance R from the very point to the mass center of celestial body (/matter integration).

As archetype of matter field, gravitational field originally comes into being during the course of initial generation and formation of matter, apparently, just at the exact conditional interphase matter coming into being in spacetime, there must be an initialization condition of space field strength α_0 indicating demiurgic possibility of initial generation of matter in spacetime, which of course means space field strength α_0 is the low limit of spacetime condition for original generation of matter in spacetime. As subsequent convergent combination of positive matter in spacetime, field extent and strength of matter field increase proportionably.

Firstly, matter field (/gravitational field) is just congenital connubial field of positive matter, which comes into being, expand & strengthen following original generation and subsequent convergent combination of positive matter, the bigger the mass of positive matter is, the larger scale and more solid the matter field (/gravitational field) is therefore.

Secondly, no matter how large the scale of matter field (/gravitational field) is, the matter field (/gravitational field) extent is always limited, there must be low limit of strength α_0 around the periphery spherical surface of matter field (/gravitational field)

That's to say, no matter what a huge extent scale of matter field (/gravitational field) is, matter field is always limited with low limit of periphery field strength α_0 , which means once the periphery field strength of matter field extends to α_0 , the extent of matter field does not extend any longer. The distance from the barycenter of positive matter to the periphery spherical surface with field strength α_0 is just the radius of matter field (/gravitational field), for expression expedience, we just denote the radius of matter field R_{max} . In accordance with field strength formulation $\alpha = \varepsilon * m / R^2$, we can arrive mathematical correlation between low limit of field strength of matter field α_0 and radius of matter field R_{max} as below:

$$\alpha_0 = \varepsilon * m / R_{\text{max}}^2 \quad \longleftrightarrow \quad R_{\text{max}}^2 = \varepsilon * m / \alpha_0 \quad \dots\dots\dots \quad (\text{III-i -2})$$

According to equation above, we can see that, to any matter field, radius square R_{max}^2 is proportional to the mass m of positive matter (or celestial body), and positive matter (or celestial body) with different mass scale proportionately have different maximum radius of matter field, the bigger the mass m is, the larger the maximum radius of matter field R_{max} proportionably is. And at the same time, it indicates, along matter field strength weakening orientation, once the matter field strength decreases to low limit of field strength α_0 , the matter field doesn't extend any longer.

The overall arrangement & integrated profile of positive matter and matter field is generally as below:

Historical progress of science in the recent several centuries seemed like a far-flung exploration of the first itinerary around numerous distinctive landscapes of brand-new landmasses of science with palette & tablet on back, several hundred years' scientific travelogues were compiled thereby.

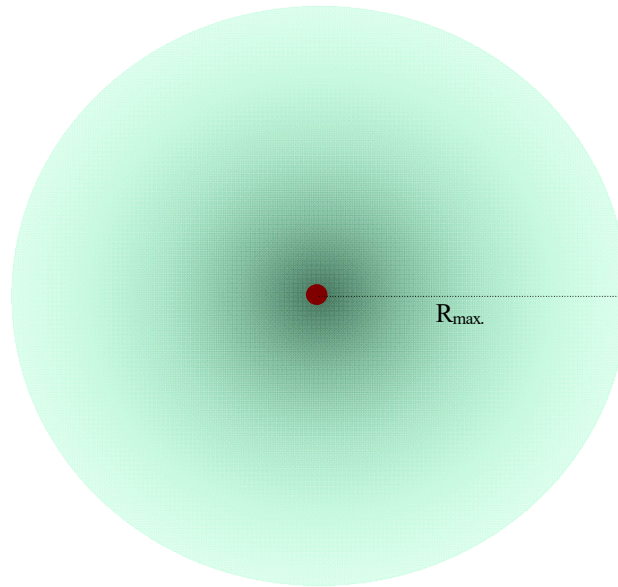

(III-i-2-a) Overall arrangement & integrated profile of positive matter and matter field

In above diagram, the french grey globe extent indicates matter field (/gravitational field) of matter integration, the center red core indicates positive matter of matter integration.

In traditionary physics, to any object in cosmos, as long as it has non-zero mass, the matter field extent of the proper matter integration (in which the object is centered as positive matter) is all equally boundless, no matter the so-called object is actually a single electron, proton, neutron, atom, ..., the earth, the solar system, Milk Way galaxy etc, as if all matter fields in cosmos are exactly equivalent to full scale of cosmic extent. Whereas, considered by Homogenous Cosmos Originated from Unique Genesis, matter is not object existing in cosmos ever since initial birth of cosmos, but evolutionary outgrowth when sequential homologic cosmogony extend to some certain stage. Virtually, initial generation of matter in spacetime not only follows demiurgic evolution of sequential homologic multiplication but also involves in necessary background physical state parameters. As congenital connubial field of positive matter, “matter field” comes into being exactly following initial generation of matter in spacetime and synchronously grows up and strengthens following convergent combination enrichment of mass of positive matter.

Original generation of positive matter in spacetime needs proper initial spacetime conditions, so-called “initial spacetime condition” is usually the low limit of spacetime conditions towards initial generation of positive matter in spacetime. Any object with solid mass in cosmos must have its original generation as positive matter and subsequent mass enrichment towards substantial object, the physical process of original generation and subsequent mass enrichment of object is too the synchronous process matter field of the very object coming into being and proportionably growing up. As a result, matter field of any object in cosmos proportionately has its low limit of initial spacetime strength which is usually field strength of the periphery spherical surface of matter field. This of course indicates that any matter field is not boundless but limited with low limit of field strength α_0 of the periphery spherical surface of matter field.

As field strength α of any point in matter field satisfies $\alpha = \varepsilon * m / R^2 \iff R^2 = \varepsilon * m / \alpha$, in accordance with law of identity of the very logic, radius of matter field R_{max} must satisfy $R_{max}^2 = \varepsilon * m / \alpha_0$ too. (among the equation, ε denotes the gravitational constant, α_0 denotes the low limit of field strength of matter field, m denotes

As coherent natura naturans throughout cosmic evolution, instinctive PNT reciprocal equilibrium towards optimum PNT operation is radical potentiality & conditionality for cosmos always ready to orientate itself towards perfection.

mass of positive matter of matter integration)

2. Gravity

2.1. Variation model of PNT operation of gravity due to instinctive PNT reciprocal equilibrium towards optimum PNT operation for mutual disturbance of matter field superposition and the proper mathematical analysis

Throughout historical progress of science, “gravity” has never been precisely proved to be absolute “attraction” among objects, but limited intuitionistic experience in our accessible range makes us believe in that gravity is always attraction among objects. Whereas, once we come to define universal existence & motion in the nature of coherent natura naturans throughout cosmic evolution, “gravity” can never be exception out of physical domino effect of spontaneous occurrence of **[physical disturbance of matter field superposition + (PNT action + Instinctive PNT equilibrium)]** of matter integration.

In straightforward words, so-called “gravity” is but physical domino effect of spontaneous occurrence of **[physical disturbance of matter field superposition + (PNT action + Instinctive PNT equilibrium)]** of matter integration.

On point of cosmic content is homogenous originated from unique genesis through and through, gravity can never be some certain independent force in the nature, it’s too dynamic domino effect due to instinctive PNT reciprocal equilibrium towards optimum PNT operation for external physical disturbance of matter integration related to PNT operation, —spontaneous occurrence of **[external physical disturbance + (PNT action + Instinctive PNT equilibrium)]** of matter integration, the general distinction of idiographic forces mostly depend on distinctive physical character of “**external physical disturbance**”.

Man drag trailer is but physical process of oxidation catabolism of some organic material in human body and offer energy (just physical process PNT operational opposite $d(M \leftarrow m)$) of matter integration is relatively preponderant to opposite $d(M \rightarrow m)$ —PNT performance situation of $d(M \rightarrow m) < d(M \leftarrow m)$) to the trailer matter integration, so that PNT operation of trailer matter integration is disturbed and instinctive PNT reciprocal equilibrium towards optimum PNT operation performs by the light of nature, physical implementation of force is hypostatized thereby. Internal-combustion engine starts and works on load is but physical process some fuel material is burnt and offer energy to the load matter integration, so that PNT operation of load matter integration is disturbed and instinctive PNT reciprocal equilibrium towards optimum PNT operation performs by the light of nature, physical implementation of force is hypostatized thereby, ………

Comparably, gravity is another kind of force whose spontaneous performance of instinctive PNT reciprocal equilibrium towards optimum PNT operation is caused by distinctive “external physical disturbance” of matter fields superposition, so that PNT operation of both matter integration with matter field superposition is disturbed and instinctive PNT reciprocal equilibrium towards optimum PNT operation performs by the light of nature, physical implementation of gravity is hypostatized thereby. That’s to say, the distinctive characteristics of gravity is that external cause of “external physical disturbance” is hypostatized by “matter field superposition”. In a straightforward word, gravity is spontaneous occurrence of **[external physical disturbance + (PNT action + Instinctive PNT equilibrium)]** of matter integration.

Let’s suppose there are celestial body A and celestial body B, the radius of matter field of celestial body A is $R_{1\max}$, the radius of matter field of celestial body B is $R_{2\max}$, the distance between celestial body A and

celestial body B is S. If S and R_{1max}, R_{2max} . satisfy $S \geq R_{1max} + R_{2max}$, there is no possibility for occurrence of matter field superposition between celestial body A and celestial body B, and as a result, there is no possibility for occurrence of gravity between celestial body A and celestial body B. Only when S and R_{1max}, R_{2max} . satisfy $S < R_{1max} + R_{2max}$, there is possibility for occurrence of matter field superposition between celestial body A and celestial body B. And as a result, there is possibility for spontaneous occurrence of gravitational reciprocity between celestial body A and celestial body B. The physical model of gravitational reciprocity is generally as below:

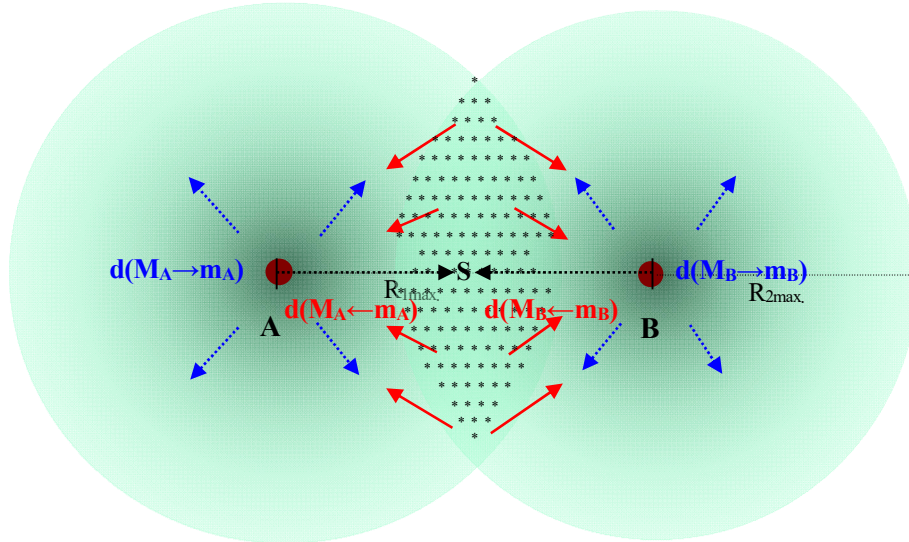

(III-i-2-b) Reciprocity model of gravity due to [matter field superposition disturbance + (PNT action + Instinctive PNT equilibrium)]

The area marked “*” is just the matter field superposition area of celestial body A and celestial body B.

In terms of celestial body A, as presence of the matter field superposition as illustration above, there must be a mass increase ΔM ($\Delta M > 0$) of matter field of celestial body A, and presence of mass increase ΔM ($\Delta M > 0$) of matter field of celestial body A must proportionately strengthen negative towards positive transmutation “ $M_A \rightarrow m_A$ ”, (which is indicated by red arrows in illustration above), so that $d(M_A \rightarrow m_A)$ increases thereby. And at the same time, as presence of ΔM ($\Delta M > 0$), the total mass of matter integration of celestial body A increases and time dynamic speed of matter integration of celestial body A consequently increases too.

In accordance with definition formulation of absolute spacetime momentum $m_A V = d(M_A \rightarrow m_A) Y$, as both time dynamic speed “Y” and negative towards positive transmutation ratio $d(M_A \rightarrow m_A)$ increase, absolute spacetime momentum $m_A V$ of celestial body A must increase accordingly. And virtually, the increase of absolute spacetime momentum of celestial body A is just outcome of impulse of gravity working on celestial body A which can be mathematically formulated as below:

$$\Delta(m_A V) = F * t$$

Among the equation, $\Delta(m_A V)$ denotes the increase of absolute spacetime momentum of celestial body A, F denote the living gravity celestial body A bearing, t denotes the time living gravity working on celestial body A. (of course throughout the dynamic process $d(M_A \rightarrow m_A) \neq d(M_A \leftarrow m_A)$, quantity m_A is too a variable)

Now, we come to formulate gravity mathematically according to PNT dynamics.

We just treat celestial body A as our study object, we denote matter field mass of celestial body A M,

As coherent natura naturans throughout cosmic evolution, instinctive PNT reciprocal equilibrium towards optimum PNT operation is radical potentiality & conditionality for cosmos always ready to orientate itself towards perfection.

denote mass of celestial body A m, and denote the mass increase ΔM of celestial body A in function format $\Delta M(S, t)$ with variables distance S and time t. Of course, once ΔM ($\Delta M > 0$) occurs in matter integration, matter integration of celestial body A must lose its PNT balance, and as a result, the matter inertial conservation equations must break into

$$\left\{ \begin{array}{l} M + [\Delta M(S, t) - \Delta m(S, t)] + m + \Delta m(S, t) = R + \Delta M(S, t) \\ [M + (\Delta M(S, t) - \Delta m(S, t))] / [m + \Delta m(S, t)] = K(t) \\ V(t) * (m + \Delta m(S, t)) = d(M \leftarrow m)(t) * Y(t) \\ L^3(t) * \alpha(t) = A * [m + \Delta m(S, t)] \\ Y(t) = B * \alpha(t) \end{array} \right. \iff \left\{ \begin{array}{l} M + [\Delta M(S, t) - \Delta m(S, t)] = K(t) [R + \Delta M(S, t)] / [1 + K(t)] \\ m + \Delta m(S, t) = [R + \Delta M(S, t)] / [1 + K(t)] \\ V(t) = d(M \leftarrow m)(t) * Y(t) / [m + \Delta m(S, t)] \\ L^3(t) = A * [m + \Delta m(S, t)] / \alpha(t) \\ Y(t) = B * \alpha(t) \end{array} \right.$$

In accordance with PNT dynamics, we can firstly arrive at acceleration formulation of celestial body A as below:

$$\begin{aligned} a(t) &= Y(t) * K'(t) \\ &= B * \alpha(t) * \{ [M + \Delta M(S, t) - \Delta m(S, t)] / [m + \Delta m(S, t)] \}' \end{aligned} \quad \dots \dots \dots \quad \text{(III-i -3)}$$

In accordance with force definition equation $F = m * a$, we can arrive at formulation of gravity as below:

$$\begin{aligned} F(t) &= (m + \Delta m(S, t)) * Y(t) * K'(t) \\ &= [m + \Delta m(S, t)] * B * \alpha(t) * \{ [M + \Delta M(S, t) - \Delta m(S, t)] / [m + \Delta m(S, t)] \}' \end{aligned} \quad \dots \dots \dots \quad \text{(III-i -4)}$$

Of course, even if we treat celestial body B as our study object, the formulation must tally with the same mathematical logic.

2.2. Expediential implementation alternative of instinctive PNT reciprocal equilibrium towards optimum PNT operation of matter integration due to occurrence of matter field superposition actualizes dynamic orientation of gravity.

Gravity is but spontaneous occurrence of “disturbance of matter field superposition + (PNT action + instinctive PNT equilibrium)”, the dynamic orientation of gravity is but outcome of most expediential implementation alternative of (PNT action + instinctive PNT equilibrium) due to instinctive PNT reciprocal equilibrium towards optimum PNT operation under precondition of occurrence of matter field superposition.

Whereas, what’s the most expediential implementation alternative for (PNT action + instinctive PNT equilibrium) to actualize dynamic orientation of gravity once disturbance of matter field superposition among matter integration occurs?

We’ve introduced ahead that any matter integration in cosmos has instinct to keep its PNT equilibrium, (which is just instinct of matter integration to maintain $d(M \rightarrow m)$ and $d(M \leftarrow m)$ equivalent $d(M \rightarrow m) = d(M \leftarrow m)$). As both genic configuration and overall arrangement of matter field directly relate to PNT operation of matter integration, disturbance of overall arrangement of matter field will of course impact PNT operation, and consequently, instinctive PNT equilibrium of matter integration will unconditionally react to rebuild PNT operation of matter integration once overall arrangement of matter field is disturbed. Thus, the instinctive PNT equilibrium of matter integration extends to maintain perfection of overall arrangement of matter field, once overall arrangement of matter field is disturbed by external conditions such as matter field superposition, the matter integration will spontaneously react to rebuild its PNT operation by the right of instinctive PNT reciprocal

equilibrium towards optimum PNT operation. Otherwise, instinctive PNT equilibrium of matter integration will be invalid. Gravity is just such dynamic domino effect once perfection of overall arrangement of matter field of matter integration is disturbed by matter field superposition and matter integration has to spontaneously react to rebuild its PNT operation by the right of instinctive PNT reciprocal equilibrium towards optimum PNT operation.

In terms of any matter integration in cosmos, the overall arrangement of field strength of matter field is generally as equation $\alpha=\varepsilon*m/R^2$ formulated, which forms the perfection of overall arrangement of matter field, and the overall arrangement of matter field directly implicates PNT operation of matter integration by the light of nature. Once disturbance of matter field superposition occurs, PNT operation of matter integration must be impacted, and instinct of PNT equilibrium of matter integration must spontaneously react to rebuild PNT operation due to instinctive PNT reciprocal equilibrium towards optimum PNT operation by the most expedient implementation.

On one hand, the matter integration is instinctively ready to reject matter field superposition so as to avoid disturbance of normal/optimum PNT operation. And at the same time, once disturbance occurs, matter integration is always ready to rebuild its PNT operation by the most expedient implementation due to instinctive PNT reciprocal equilibrium towards optimum PNT operation. This of course implicates the most expedient implementation alternative of spontaneous reaction to rebuild PNT operation by the right of instinctive PNT reciprocal equilibrium towards optimum PNT operation, which is just expedient alternative of dynamic orientation of gravity due to instinctive PNT reciprocal equilibrium towards optimum PNT operation, the most expedient implementation alternative of instinctive PNT reciprocal equilibrium towards optimum PNT operation to maintain perfection of overall arrangement of matter field, either instinctively reject external disturbance of further matter field superposition towards perfection of overall arrangement of matter field or expediently assimilate the superposed matter field towards perfection of overall arrangement of matter field.

Let's suppose there is a matter integration A in spacetime, whose matter field radius is R_{1max} , and there is another matter integration B in spacetime, whose matter field radius is R_{2max} . Matter integration B keeps moving towards matter integration A, till at last there is hypostatic matter field superposition between matter integration A and matter integration B (of course, at the initial moment, the matter field superposition is still not inadequate). Of course the matter field superposition between matter integration A and matter integration B is typical anamorphic field superposition lump of both matter integration A and matter integration B, which obviously impact perfection of overall arrangement of matter field. As a result, both matter integration A and matter integration B will spontaneously react to rebuild perfection of overall arrangement of their matter field due to instinctive PNT reciprocal equilibrium towards optimum PNT operation by the light of nature.

However, as matter field of matter integration B initially superposes into matter integration A, the field superposition between matter integration A and matter integration B is almost impossible to be inadequate, so that both matter integration A and matter integration B are still not expedient to assimilate the anamorphic field superposition lump of their matter field. Comparably, it's even more expedient for them to reject disturbance of further field superposition of the opposite matter integration so as to maintain overall arrangement of their matter field perfection. As a result, the spontaneous reaction of both matter integration A and matter integration B materializes repulsion of disturbance of further matter field superposition, and the gravitational reciprocity

between matter integration A and matter integration B actualizes as instinctive repulsion against disturbance of inadequate field superposition therefore. For convenience of distinction, we just call the gravitational repulsion between matter integration A and matter integration B against disturbance of inadequate matter field superposition “negative gravity”.

Of course, the interaction model of negative gravity can be illustrated as below:

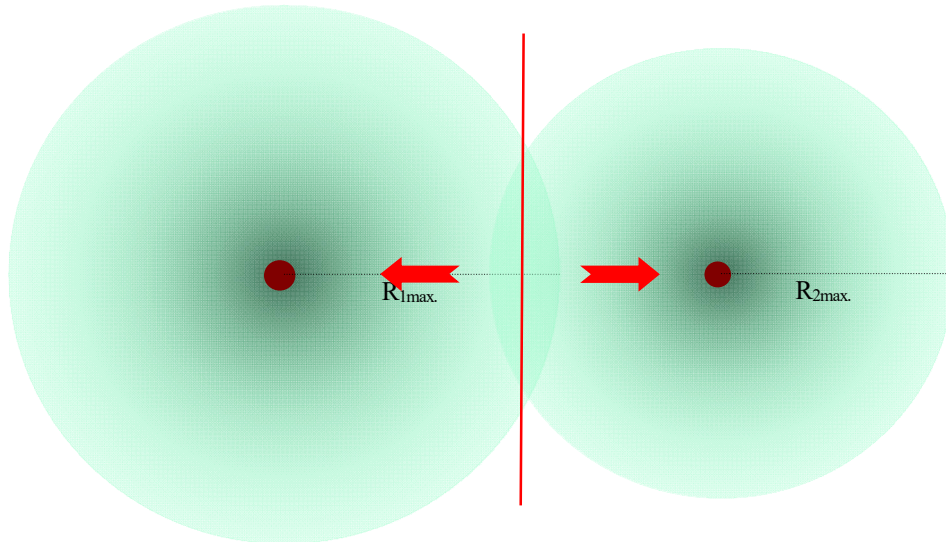

(III-i-2-c) Negative gravity due to inexpedient assimilable inadequate field superposition

Taking reference of matter integration A, if the impulse derived from negative gravity between matter integration A and matter integration B does not completely counteract the original momentum of matter integration B towards matter integration A, or the negative gravity between matter integration A and matter integration B does not change motion orientation of matter integration B enough, so that matter integration B does not slide out of matter field of matter integration A. Thus, matter integration B will go closer and closer to matter integration A and there is more and more matter field superposition between matter integration A and matter integration B therefore. Once the matter field superposition between matter integration A and matter integration B is adequate enough so that it is not easy for matter integration to reject disturbance of field superposition any longer but more expedient for both matter integration A and matter integration B to assimilate the “anamorphic field superposition lump” towards perfect overall arrangement of their matter fields than rejecting further superposition of matter fields, thus, the both consequently change their instinctive reciprocity manner to assimilate the “anamorphic field superposition lump” of their matter field immediately. As a result, the mechanical domino effect of competitive indrawn assimilation of the “anamorphic field superposition lump” of their matter fields is attraction between matter integration A and matter integration B, and the so-called mutual attraction derived from competitive indrawn assimilation of the “anamorphic field superposition lump” between matter integration A and matter integration B is just the gravitational reciprocity we usually mentioned in tradition.

For convenience of distinction, we just call the gravitational reciprocity derived from competitive indrawn assimilation of anamorphic field superposition lump “positive gravity”, which embodies attraction among celestial bodies. The mechanical pattern of gravitational reciprocity of positive gravity can be illuminated as below:

Historical progress of science in the recent several centuries seemed like a far-flung exploration of the first itinerary around numerous distinctive landscapes of brand-new landmasses of science with palette & tablet on back, several hundred years’ scientific travelogues were compiled thereby.

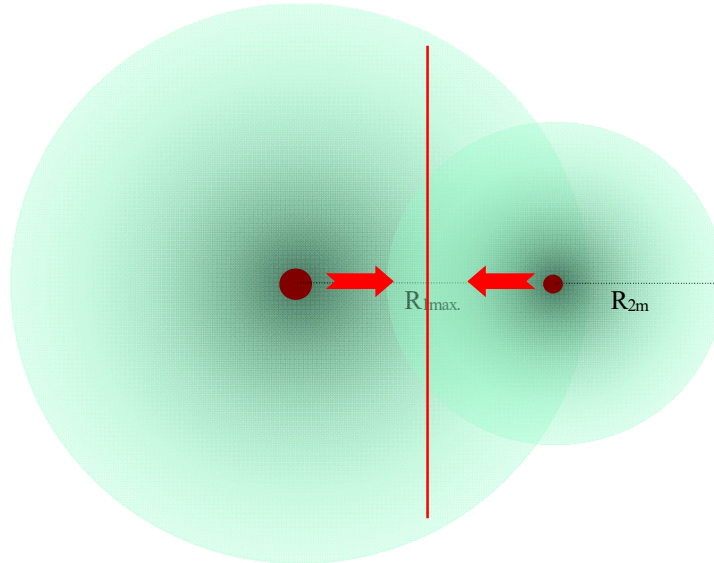

(III-i-2-d) Positive gravity due to expediential indrawn assimilation of adequate field superposition

However, once there is field superposition between matter integration A and matter integration B, what's the quantitative terminus of field superposition for spontaneous occurrence of negative gravity and positive gravity? In detail words, in terms of two matter integration in spacetime with field superposition, what's the quantitative range of field superposition for spontaneous occurrence of negative gravity? And what's the quantitative range of field superposition for spontaneous occurrence of positive gravity?

As no experience in this field in prior, we apparently lack necessary evidence for positive conclusion of the issue at present, Whereas, it seems not convenient for us to accomplish further highlight of the very thesis without a presumable conclusion of the issue for expedient logic succession.

Homogenous Cosmos Originated from Unique Genesis primarily assumes, in terms of discretionary two celestial bodies or galaxies in large-scale spacetime with matter field radius R_{1max} , R_{2max} , during the course of the both stochastically moving in large-scale spacetime:

①. If we denote distance between the two celestial bodies/galaxies L , and L satisfies: $L > R_{1max} + R_{2max}$, then, the both celestial bodies/galaxies have no matter field superposition at all, nothing is accessible to accomplish “interaction” between the two celestial bodies/galaxies as spontaneous occurrence of [external physical disturbance + (PNT action + Instinctive PNT equilibrium)].

②. If the distance L between the two celestial bodies/galaxies satisfies : $R_{1max} - R_{2max} < L < R_{1max} + R_{2max}$, ($R_{1max} > R_{2max}$), then, there is matter field superposition between the both celestial bodies/galaxies, and interaction between the two celestial bodies/galaxies as spontaneous occurrence of [external physical disturbance + (PNT action + Instinctive PNT equilibrium)] must occur. Whereas, as the matter field superposition between the two celestial bodies /galaxies is still relatively inadequate, in order to maintain their inherent esthetical configuration of matter field for optimum PNT operation, PNT equilibrium instinct of the both celestial bodies/galaxies is relatively more accessible and feasible to reject the superposition of matter field for optimum PNT operation, as a result, the interaction of so-called gravitational reciprocity consequently incarnates “negative gravity”.

③. If the distance L between the two celestial bodies/galaxies satisfies : $0 < L < R_{1max} - R_{2max}$, ($R_{1max} > R_{2max}$), then, there is substantial matter field superposition between the both celestial bodies/galaxies, and interaction between the two celestial bodies/galaxies as spontaneous occurrence of [external physical disturbance + (PNT action

As coherent natura naturans throughout cosmic evolution, instinctive PNT reciprocal equilibrium towards optimum PNT operation is radical potentiality & conditionality for cosmos always ready to orientate itself towards perfection.

+ Instinctive PNT equilibrium)] must occur. And as the matter field superposition between the two celestial bodies /galaxies has been relatively adequate, in order to maintain even optimize their inherent esthetical configuration of matter field for optimum PNT operation, PNT equilibrium instinct of the both celestial bodies/galaxies is relatively more accessible and feasible to assimilate the superposition of matter field for optimum PNT operation, as a result, the interaction of so-called gravitational reciprocity consequently incarnates “positive gravity”.

Towards the necessity, we treat a massive matter integration O in spacetime as our stationary reference, and we suppose there is a relatively small matter integration A going towards matter integration O. We differentiate the occurrence of negative gravity and positive gravity according to quantitative change of field superposition between matter integration O and matter integration A during the course of matter integration A gradually closing to matter integration O. We primarily authenticate upon our intuitional experience, during the course of matter integration A gradually closing to matter integration O, before a half of the matter field of matter integration A superposed into matter field of matter integration O, the mechanical occurrence between matter integration O and matter integration A is “negative gravity” for instinctive rejection of incompatible anamorphic field superposition lump for inadequate field superposition, once more than a half matter field of matter integration A has superposed into matter field of matter integration O, the mechanical occurrence between matter integration O and matter integration A consequently turns into positive gravity for expedient indrawn assimilation of adequate field superposition.

As the uniform configuration of matter field of matter integration in cosmos, if we treat a massive matter integration in spacetime stationary reference, and a relatively small matter integration goes close to the massive matter integration, then, the peripheral inexpedient assimilable globose field lamella towards perfection of overall arrangement of matter field against occurrence of incompatible anamorphic matter field lump for inadequate superposition of matter field between the massive matter integration and small matter integration is thinner, and the displacement the small matter integration has to implement to pass through the peripheral inexpedient assimilable globose field lamella towards perfection of overall arrangement of matter field against occurrence of incompatible anamorphic matter field lump for inadequate superposition of matter field is less, and less momentum of the small matter integration will be exhausted to pass through the peripheral inexpedient assimilable globose field lamella working against the negative gravity. Comparably, the central expediently assimilable globose field extent towards perfection of overall arrangement of matter field for adequate matter field superposition is bigger. This of course indicates, it’s more accessible for a small matter integration and a larger matter integration with remarkable mass disparity to accomplish positive gravity instead of negative gravity.

If two matter integration with approximative mass scale are going close each other with substantial field superposition, the peripheral inexpedient assimilable globose field lamella towards perfection of overall arrangement of matter field against occurrence of incompatible anamorphic matter field lump for inadequate superposition of matter field is thicker, and the displacement one of the both matter integration has to implement to pass through the peripheral inexpedient assimilable globose field lamella towards perfection of overall arrangement of matter field against occurrence of incompatible anamorphic matter field lump for inadequate superposition of matter field is bigger, and more momentum of any one of the both matter integration will be exhausted to pass through the peripheral inexpedient assimilable globose field lamella working against the negative gravity. Relatively, the central expediently assimilable globose field extent towards perfection of overall arrangement of matter field for adequate matter field superposition is thinner. This of course indicates, it’s more

accessible for two matter integration with approximative mass scale to materialize remarkable negative gravity instead of positive gravity.

The general layout of “peripheral inexpedient assimilable globose field lamella towards perfection of overall arrangement of matter field against occurrence of incompatible anamorphic matter field lump for inadequate superposition of matter field” (/relative repulsion field lamella for inexpedient assimilable disturbance of inadequate matter field superposition) and “central expediently assimilable globose field extent towards perfection of overall arrangement of matter field for adequate matter field superposition” (/relative expediently assimilable field superposition extent for adequate matter field superposition) of gravitational reciprocity can be illustrated as below:

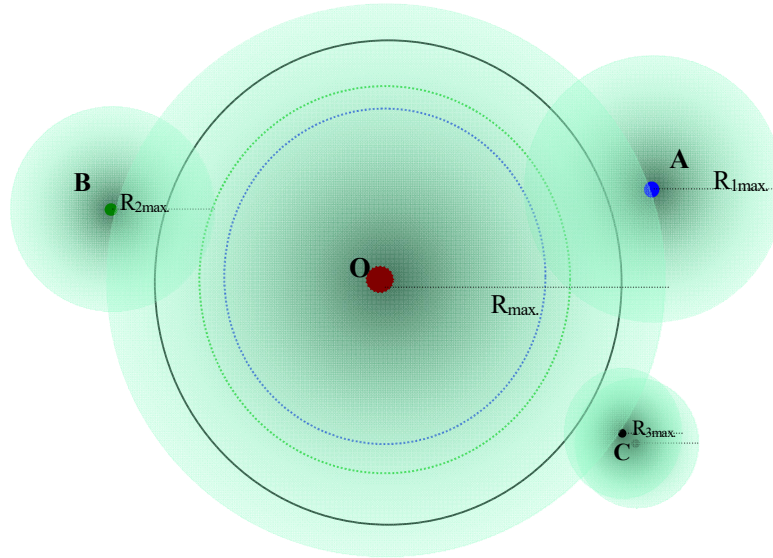

(III-i-2-e) General relative layout of “peripheral inexpedient assimilable globose field lamella” and “central expediently assimilable globose field extent” for gravitational reciprocity

In above diagram, there are four celestial bodies O, A, B, C in above illustration, their mass m_O, m_A, m_B, m_C satisfy $m_O > m_A > m_B > m_C$, and the corresponding matter field radius $R_{max}, R_{1max}, R_{2max}, R_{3max}$ satisfy $R_{max} > R_{1max} > R_{2max} > R_{3max}$. We treat celestial body O as stationary reference and consider relative layout of “peripheral inexpedient assimilable globose field lamella towards perfection of overall arrangement of matter field against occurrence of incompatible anamorphic matter field lump for inadequate superposition of matter field” and “central expediently assimilable globose field extent towards perfection of overall arrangement of matter field for adequate matter field superposition” of gravitational reciprocity accordingly.

As mass of celestial bodies A, B, C satisfy $m_A > m_B > m_C$, and proportionately the matter field radius $R_{1max}, R_{2max}, R_{3max}$ satisfy $R_{1max} > R_{2max} > R_{3max}$.

①. In terms of celestial body A, in order to superpose half of its matter field into matter field of celestial body O, so that celestial body A can approach the central expediently assimilable globose field extent for gravitational attraction between celestial body O and celestial body A, celestial body A must break through the peripheral inexpedient assimilable globose field lamella which is just the spherical lamella out of the blue spherical surface in matter field of celestial body O.

②. In terms of celestial body B, in order to superpose half of its matter field into matter field of celestial body O, so that celestial body B can approach the central expediently assimilable globose field extent for gravitational attraction for adequate matter field superposition between celestial body O and celestial body B,

As coherent natura naturans throughout cosmic evolution, instinctive PNT reciprocal equilibrium towards optimum PNT operation is radical potentiality & conditionality for cosmos always ready to orientate itself towards perfection.

celestial body B must break through the peripheral inexpedient assimilable globose field lamella which is just the spherical lamella out of the green spherical surface in matter field of celestial body O.

③. In terms of celestial body C, in order to superpose half of its matter field into matter field of celestial body O, so that celestial body C can approach the central expediently assimilable globose field extent for gravitational attraction between celestial body O and celestial body C, celestial body C must break through the peripheral inexpedient assimilable globose field lamella which is just the spherical lamella out of the black spherical surface in matter field of celestial body O.

Apparently, the peripheral inexpedient assimilable globose field lamella towards perfection of overall arrangement of matter field against occurrence of incompatible anamorphic matter field lump for inadequate superposition of matter field between celestial body A and celestial body O is the thickest ring, whereas, the centric relative expediently assimilable matter field extent for gravitational attraction between celestial body A and celestial body O is the thinnest extent. The peripheral inexpedient assimilable globose field lamella towards perfection of overall arrangement of matter field against occurrence of incompatible anamorphic matter field lump for inadequate superposition of matter field between celestial body B and celestial body O is the thicker lamella, whereas, the central expediently assimilable globose field extent towards perfection of overall arrangement of matter field for adequate matter field superposition between celestial body B and celestial body O is thinner extent too. The peripheral inexpedient assimilable globose field lamella towards perfection of overall arrangement of matter field against occurrence of incompatible anamorphic matter field lump for inadequate superposition of matter field between celestial body C and celestial body O is the thinnest lamella, whereas, the central expediently assimilable globose field extent towards perfection of overall arrangement of matter field for adequate matter field superposition between celestial body C and celestial body O is the thickest extent.

Such factuality indicates, in terms of any two celestial bodies with remarkable mass disparity, their peripheral inexpedient assimilable globose field lamella towards perfection of overall arrangement of matter field against occurrence of incompatible anamorphic matter field lump for inadequate superposition of matter field is always relatively thinner, whereas, their central expediently assimilable globose field extent towards perfection of overall arrangement of matter field for adequate matter field superposition is always relatively thicker, they are relatively easier to break through peripheral inexpedient assimilable globose field lamella and approach central expediently assimilable globose field extent for gravitational attraction, we just call such fundamental of gravitational reciprocity “mass disparity accessible to positive gravity”.

In terms of any two celestial bodies with relatively equivalent mass, their peripheral inexpedient assimilable globose field lamella towards perfection of overall arrangement of matter field against occurrence of incompatible anamorphic matter field lump for inadequate superposition of matter field is always relatively thicker, whereas, their central expediently assimilable globose field extent towards perfection of overall arrangement of matter field for adequate matter field superposition is always relatively thinner, they are relatively difficult to break through peripheral inexpedient assimilable globose field lamella and approach central expediently assimilable globose field extent for gravitational attraction, we just call such fundamental of gravitational reciprocity “mass approximation accessible to negative gravity”.

That’s to say, considered by Homogenous Cosmos Originated from Unique Genesis, so-called “gravity” is not purely “gravitational attraction” as what tradition insists, but spontaneous occurrence of “PNT action +

instinctive PNT equilibrium” as chain-reacting due to occurrence of “matter field superposition” in the nature of instinctive PNT reciprocal equilibrium towards optimum PNT operation. The magnitude of matter field superposition determines the magnitude of so-called “gravity”, and the most expedient implementation alternative of instinctive PNT reciprocal equilibrium towards optimum PNT operation actualize the dynamic orientation of so-called gravity.

In terms of the celestial body A and celestial body B in above diagram, before half matter field of celestial body B sliding into matter field of celestial body A, the so-called gravitational reciprocity between celestial body A and celestial body B is virtually dynamic domino effect of gravitational repulsion against disturbance of field inadequate superposition for the most accessible implementation of instinctive PNT reciprocal equilibrium towards optimum PNT operation of matter integration. Only once more than a half matter field of celestial body B has slidden into matter field of celestial body A, the so-called gravitational reciprocity between celestial body A and celestial body B is dynamic domino effect of relative expedient indrawn assimilation due to adequate matter field superposition in the nature of instinctive PNT reciprocal equilibrium towards optimum PNT operation, which virtually embodies the gravitational attraction.

Compared to traditionary physics, the gravity definition of Homogenous Cosmos Originated from Unique Genesis not only implicates the limitation of gravitational field of idiographic matter integration and gravitational reciprocity precondition of mutual field disturbance of matter field superposition, but also implicates mechanical features of expedient reciprocity alternative of “dynamic domino effect of instinctive disturbance repulsion due to inadequate field superposition” and “dynamic domino effect of expedient indrawn assimilation due to adequate field superposition”, this of course implies remarkable mechanical discrepancy as below:

1) let's suppose there are celestial body E and celestial body F, the mass of celestial body E is far more than mass of celestial body F. We treat celestial body E as stationary reference, and celestial body F has an initial velocity V whose orientation is tangent on the critical spherical surface of matter field of celestial body E, just as illustration below:

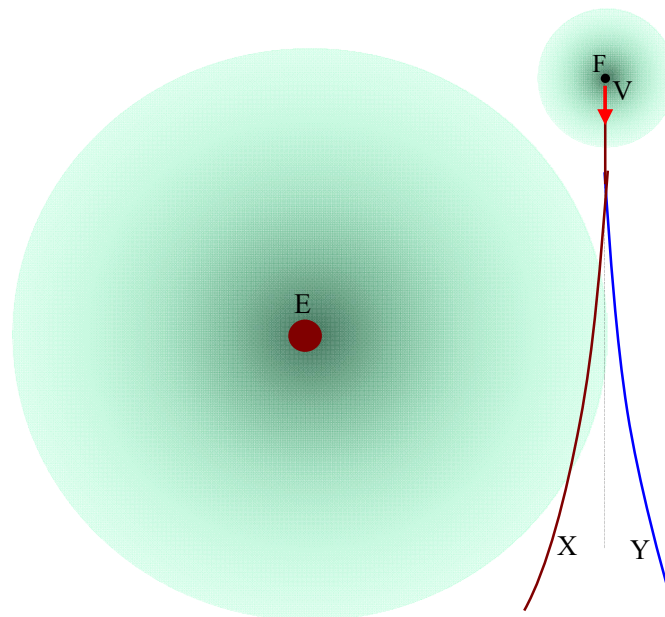

(III-i-2-f) Gravitational motion track contrast of moving object with initial tangent velocity in accordance with gravitational reciprocity of Homogenous Cosmos Originated from Unique Genesis and in accordance with gravitational reciprocity of tradition

As coherent natura naturans throughout cosmic evolution, instinctive PNT reciprocal equilibrium towards optimum PNT operation is radical potentiality & conditionality for cosmos always ready to orientate itself towards perfection.

In accordance with gravitational theory of tradition, during the course celestial body F moves closing to celestial body E upon its initial momentum, there is of course gravitational reciprocity between celestial body E and celestial body F, and the very gravitational reciprocity is absolute attraction, as a result, the proper motion track of celestial body F should be track X with slight deflexion to left as illustration above. Whereas, considered by Homogenous Cosmos Originated from Unique Genesis, when celestial body F moves upon its initial momentum before there is field superposition between celestial body E and celestial body F, there is no gravitational reciprocity between celestial body E and celestial body F, only when there is occurrence of field superposition between celestial body E and celestial body F, there is gravitational reciprocity between celestial body E and celestial body F, and as the field superposition is less than a half matter field of celestial body F, the gravitational reciprocity between celestial body E and celestial body F is negative gravity, as a result, the proper motion track of celestial body F should be track Y with slight deflexion to right as illustration above.

2) Even though celestial body F has an initial velocity V towards celestial body E whose orientation is not exactly tangent on the critical surface of matter field of celestial body E. Instead, there is a sharp angle θ between orientation of velocity V of celestial body F and the connecting line between barycenter of celestial body E and barycenter of celestial body F. Let's suppose the initial momentum of celestial body F is enough for it to break through the peripheral inexpedient assimilable globose field lamella in matter field of celestial body E, which can be illustrated as below:

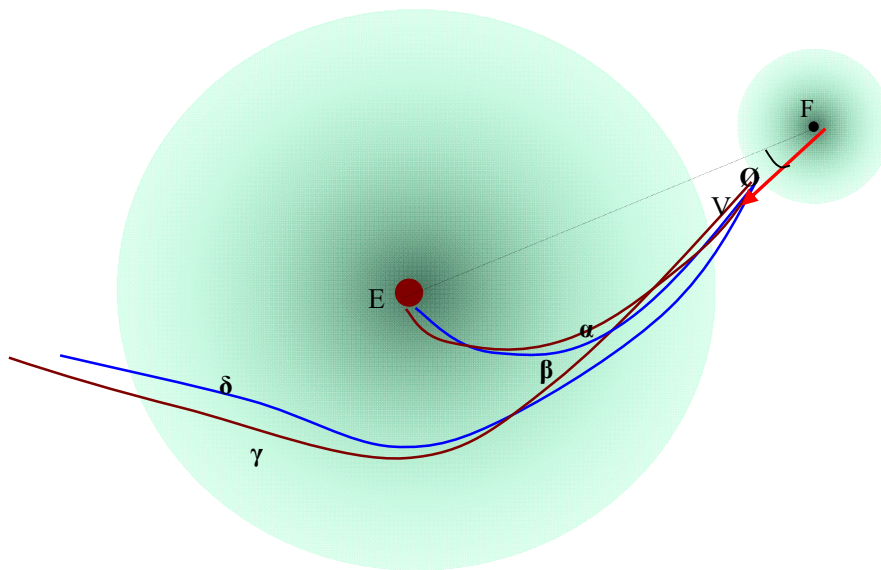

(III-i-2-g) Gravitational motion track contrast of object moving in accordance with gravitational reciprocity of Homogenous Cosmos Originated from Unique Genesis and in accordance with gravitational reciprocity of tradition, whose initial momentum is enough to break through the peripheral inexpedient assimilable globose field lamella

2-a). Once celestial body F slides into matter field of celestial body E, if the initial spacetime momentum of celestial body F is enough to break through the relative peripheral opposing gravitational field ring against disturbance of inadequate superposition of matter field, but not enough to escape the whole matter field of celestial body E and ultimately to be adsorbed by celestial body E.

In accordance with gravity definition of tradition, the gravitational reciprocity between celestial body E and celestial body F is “pure gravitational attraction” through and through, as a result, the gravitational motion

track of celestial body F is curve α . However, in accordance with gravity definition of Homogenous Cosmos Originated from Unique Genesis, at the right of celestial body E, once the matter field of celestial body F primarily slides into matter field of celestial body E, and before half matter field of celestial body F sliding into matter field of celestial body E, celestial body F must bear opposing gravitational action against disturbance of inadequate superposition of matter field, as a result, the gravitational motion track of celestial body F is curve β .

2-b) If the initial spacetime momentum of celestial body F is not only large enough to break through the relative peripheral opposing gravitational field ring against disturbance of inadequate superposition of matter field but also large enough to escape control of gravitational attraction of matter field of celestial body E.

In accordance with gravity definition of tradition, the gravitational reciprocity between celestial body E and celestial body F is “pure gravitational attraction” through and through, as a result, the gravitational motion track of celestial body F is curve γ . However, In accordance with gravity definition of Homogenous Cosmos Originated from Unique Genesis, at the right of celestial body E, once the matter field of celestial body F primarily slides into matter field of celestial body E, and before half matter field of celestial body F sliding into matter field of celestial body E, celestial body F must bear opposing gravitational action against disturbance of inadequate superposition of matter field, and on the left of celestial body E, as celestial body F gradually goes away from the celestial body E, once half of the matter field of celestial body F has slidden out of matter field of celestial body E, the celestial body F must bear opposing gravitational action against disturbance of inadequate superposition of matter field too, as a result, the gravitational motion track of celestial body F is curve δ .

3) Of course, if the initial spacetime momentum of celestial body F (or celestial bodies F_1, F_2, F_3) is exactly appropriated, so that celestial body F (or celestial bodies F_1, F_2, F_3) can pass through the relative peripheral opposing gravitational field ring against disturbance of inadequate superposition of matter field, and at the same time, the celestial body F (or celestial bodies F_1, F_2, F_3) can neither be absorbed and nor be able to ultimately escape the attraction control of matter field of celestial body E, thus, under gravitational control of celestial body E, celestial body F (or celestial bodies F_1, F_2, F_3) will of course be one planet or secondary planet of celestial body E, which can be illustrated as below:

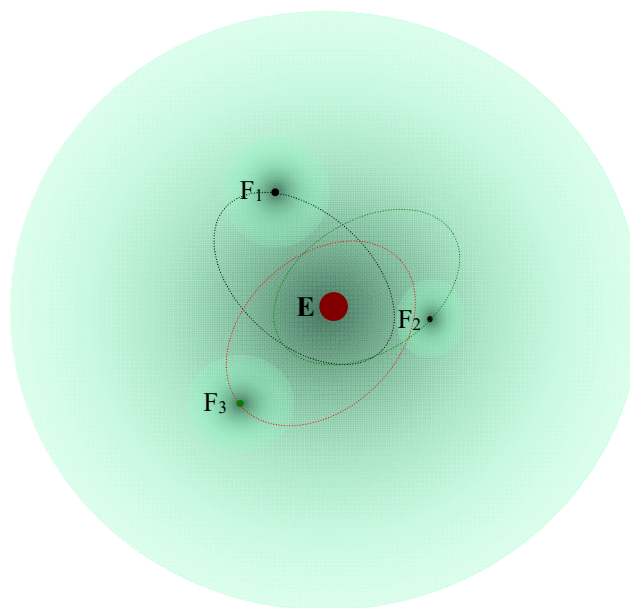

(III-i-2-h) Small celestial bodies go around big celestial body as planets for proper gravitational reciprocity.

As coherent natura naturans throughout cosmic evolution, instinctive PNT reciprocal equilibrium towards optimum PNT operation is radical potentiality & conditionality for cosmos always ready to orientate itself towards perfection.

No matter in accordance with traditional definition of gravity or in accordance with newly definition of gravity of Homogenous Cosmos originated from Unique Genesis, the dynamic situation of small celestial bodies going around large celestial body as planets is general the same. The unimportant discrepancy is only limited in initial speed of the small celestial body when it originally enters matter field of large celestial body and ultimately goes around the large celestial body as planet. During the course of interaction towards formation from two independent celestial bodies to revolution system, Homogenous Cosmos Originated from Unique Genesis thinks there is a small part of negative gravity when the matter field of the small celestial body initially slides into matter field of the large celestial body, whereas, in accordance with traditional gravity theory, there is no interaction of negative gravity but positive gravity through and through. And just because Homogenous Cosmos Originated from Unique Genesis introduces a small part of interaction of negative gravity, in terms of the same revolution system, if we treat the large celestial body stationary reference, on the point of Homogenous Cosmos Originated from Unique Genesis, the initial speed of the small celestial body should be a little higher for it has to working against negative gravity to break through relative peripheral inexpedient assimilable globose field lamella first before entering its normal revolution orbit.

Original generation of universal reciprocal PNT combinations is all outgrowth of out-and-out serial natura naturata in the nature of coherent natura naturans throughout cosmic evolution, no matter reciprocal PNT combinations in gradation I, reciprocal PNT combinations in gradation II, reciprocal PNT combinations in gradation III, or reciprocal PNT combinations in gradation IV. the demiurge is virtually so simple & straightforward, in any case, he is only able to perform unique programme of **coherent natura naturans throughout cosmic evolution = stochastic accomplishment of [(“reciprocal idiosyncrasy towards PNT equilibrium + accessible space overall arrangement for PNT reciprocity” among compositive components) + consequent convergence of compositive components in the nature of instinctive PNT reciprocal equilibrium towards optimum PNT operation]** through and through.

Original naissance of elementary genic units are the start of aberrant convergence of cosmic esse due to PNT reciprocal gelation.

As freewheeling of **aberrant convergence of cosmic esse due to PNT reciprocal gelation/sequential homologous cosmogony** in the nature of coherent natura naturans throughout cosmic evolution, going with gradual enrichment of elementary genic units in spacetime, original generation, postnatal existence & motion of reciprocal PNT combinations in gradation I are successive easy outgrowth behind stochastic occurrence of **[(reciprocal idiosyncrasy towards PNT equilibrium + accessible space overall arrangement for PNT reciprocity) among elementary genic units in spacetime + Instinctive PNT reciprocal equilibrium towards optimum PNT operation]**. Not only elementary genic units in spacetime are direct materials of reciprocal PNT combinations in gradation I, but also external mechanical features of compositive elementary genic units are radical causes of original generation, postnatal existence & motion of reciprocal PNT combinations in gradation I.

As freewheeling of **aberrant convergence of cosmic esse due to PNT reciprocal gelation/sequential homologous cosmogony** in the nature of coherent natura naturans throughout cosmic evolution, going with gradual enrichment of reciprocal PNT combinations in gradation I in spacetime, original naissance, postnatal existence & motion of reciprocal PNT combinations in gradation II are successive easy outgrowth behind stochastic occurrence of **[(reciprocal idiosyncrasy towards PNT equilibrium + accessible space overall arrangement for PNT reciprocity) among reciprocal PNT combinations in gradation I in spacetime + Instinctive PNT reciprocal equilibrium towards optimum PNT operation]**. Not only reciprocal PNT combinations in gradation I in spacetime are direct materials of reciprocal PNT combinations in gradation II, but also external

mechanical features of compositive reciprocal PNT combinations in gradation I are radical causes of original generation, postnatal existence & motion of reciprocal PNT combinations in gradation II.

As freewheeling of aberrant convergence of cosmic esse due to PNT reciprocal gelation/sequential homologic cosmogony in the nature of coherent natura naturans throughout cosmic evolution, going with gradual enrichment of reciprocal PNT combinations in gradation II in spacetime, original naissance, postnatal existence & motion of reciprocal PNT combinations in gradation III are successive easy outgrowth behind stochastic occurrence of [(reciprocal idiosyncrasy towards PNT equilibrium + accessible space overall arrangement for PNT reciprocity) among reciprocal PNT combinations in gradation II even sub reciprocal PNT combinations in gradation III in spacetime + Instinctive PNT reciprocal equilibrium towards optimum PNT operation]. Not only reciprocal PNT combinations in gradation II in spacetime are direct materials of reciprocal PNT combinations in gradation III, but also external mechanical features of compositive reciprocal PNT combinations in gradation II even sub reciprocal PNT combinations in gradation III are radical causes of original generation, postnatal existence & motion of reciprocal PNT combinations in gradation III.

As freewheeling of aberrant convergence of cosmic esse due to PNT reciprocal gelation/sequential homologic cosmogony in the nature of coherent natura naturans throughout cosmic evolution, going with gradual enrichment of reciprocal PNT combinations in gradation III even sub-reciprocal PNT combinations in gradations IV in spacetime, original naissance, postnatal existence & motion of reciprocal PNT combinations in gradation IV are successive easy outgrowth behind stochastic occurrence of [(reciprocal idiosyncrasy towards PNT equilibrium + accessible space overall arrangement for PNT reciprocity) among reciprocal PNT combinations in gradation III even sub-reciprocal PNT combinations in gradations IV in spacetime + Instinctive PNT reciprocal equilibrium towards optimum PNT operation]. Not only reciprocal PNT combinations in gradation III even sub reciprocal PNT combinations in gradation IV in spacetime are direct materials of reciprocal PNT combinations in gradation IV, but also external mechanical features of compositive reciprocal PNT combinations in gradation III even sub reciprocal PNT combinations in gradation IV are radical causes of original generation, postnatal existence & motion of reciprocal PNT combinations in gradation IV.

1.2.3. Gravitational reciprocity fundamental of “mass disparity accessible to positive gravity” & “mass approximation accessible to negative gravity” conditions well-regulated overall arrangement of celestial bodies & galaxies in cosmos coequally.

As spontaneous occurrence of [external physical disturbance + (PNT action + instinctive PNT equilibrium)], gravitational reciprocity fundamental of “mass disparity accessible to positive gravity” and “mass approximation accessible to negative gravity” tallies with the well-regulated overall arrangement of celestial bodies in cosmos very well, the overall arrangement of mass of celestial bodies in cosmos are neither too scattered nor too concentrated, instead, galaxies in cosmos are well-regulated in cosmos with proper compositive mass scale as themselves.

Homologic generation and formation of matter in cosmos is a successive process of homologic multiplication from microcosm to macrocosm, which will be introduced later as aberrant convergence of cosmic esse due to PNT reciprocal gelation for successive outgrowth as out-and-out serial natura naturata of reciprocal PNT combinations in gradation I, reciprocal PNT combinations in gradation II, reciprocal PNT combinations in gradation III and reciprocal PNT combinations in gradation IV subject to coherent natura naturans throughout cosmic evolution. Positive matter firstly generates in spacetime as the minimum particles of elementary genic units, then, as freewheeling stochastic accomplishment of “reciprocal idiosyncrasy towards PNT equilibrium + accessible space overall arrangement for PNT reciprocity” among compositive components with successive spontaneous accomplishment of

instinctive PNT reciprocal equilibrium towards optimum PNT operation, it stochastically and gradually forms reciprocal PNT combinations from simpleness to complexity like electron, neutron, proton, nucleon, atoms, molecule, ..., gas, liquid, solid little by little, and ultimately form celestial bodies, galaxies even super galaxies.

Firstly, gravitational reciprocity fundamental of “mass disparity accessible to positive gravity” is propitious to massive celestial bodies to capture small celestial bodies around so as to make the overall arrangement of mass of positive matter in spacetime relatively concentrated, forming idiographic celestial bodies even galaxies with considerable compositive scale of mass.

The objects (or particles) with less mass mostly possess of higher speed in spacetime, and at the same time, objects with less mass proportionably have smaller matter field, once they go close to massive celestial bodies, the relative peripheral inexpedient assimilable globose field lamella is of course thinner. This of course means small celestial bodies are not only mostly active in spacetime having more opportunities to run into matter fields of massive celestial bodies but also very easy to break through the relative peripheral inexpedient assimilable globose field lamella and enter central expediently assimilable globose field extent for gravitational attraction, what’s more, celestial bodies with less mass have less inertia, whose motion state are easier to be changed accordingly. All these physical characters are propitious for small celestial bodies to be captured by relative massive celestial bodies by gravitational reciprocity towards original mass cumulation of massive celestial bodies or galaxies, so that mass distribute in cosmos is not too dispersive.

Secondly, gravitational reciprocity fundamental of “mass approximation accessible to negative gravity” is propitious for coexistence of massive celestial bodies with equivalent mass scale, which almost makes it impossible for the mass scale of massive celestial bodies to be too enormous and ultimately conditions the rich and colorful overall arrangement of celestial bodies and galaxies in cosmos.

In terms of celestial body with massive mass scale, the more massive the celestial body is, the relatively lower speed it has in spacetime, matter field of it is proportionably strong with bigger matter field radius. If the massive celestial bodies go close to another massive celestial body with equivalent mass scale, the relative peripheral inexpedient assimilable globose field lamella is of course thicker, instead, the relative central expediently assimilable field extent for gravitational attraction is thinner. If small celestial bodies go close to it, the relative peripheral inexpedient assimilable globose field lamella is of course thinner, instead, the relative central expediently assimilable field extent for gravitational attraction is thicker.

This of course indicates, although the massive celestial bodies in spacetime seem tardy, it can capture small celestial bodies passing by upon its strong matter field at the volley. However, as gravitational reciprocity fundamental of “mass disparity accessible to positive gravity” and “mass approximation accessible to negative gravity” coequally do their jobs, during the course of mass cumulation of massive celestial bodies, the massive celestial bodies are always prone to capture small celestial bodies around but very difficult to seize equivalent massive celestial bodies around, there is improbabilities for massive celestial body to seize another equivalent massive celestial body around by gravitational reciprocity. Virtually, in large-scale spacetime, we neither find occurrence of collision between star and star nor find one star going around another star.

For expedience to highlight the very issue, let’s suppose there are two massive celestial bodies A and B, whose mass scale is almost equivalent and whose matter fields are superposed a little as illustration as below

(we can even suppose they are just two adjacent stars in spacetime) :

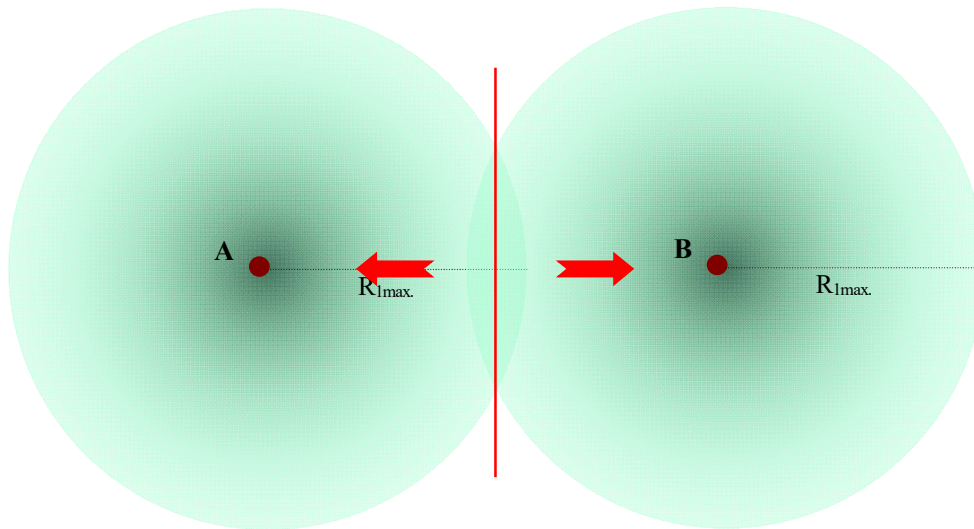

(III-i-2-i) The opposing gravitation reciprocity between two celestial bodies in equivalent mass scale

In accordance with gravity theory of tradition, there is only gravitational attraction between any two celestial bodies. Whereas, in accordance with gravity redefinition of Homogenous Cosmos Originated from Unique Genesis, gravity is but spontaneous occurrence of [matter field superposition disturbance + (PNT action + instinctive PNT equilibrium)]. Before occurrence of matter field superposition, the configuration of matter field of any celestial body is of course originality of the demiurge, and any matter integration inherently has instinct to maintain the ingenerate esthetic formation of matter field. Once there is occurrence of slight matter field superposition between the both celestial bodies, the instinct of matter integration to maintain the inherent esthetic formation of matter field must repulse further quantitative change of matter field superposition, after all, occurrence of matter field superposition has wrecked the inherent esthetic formation of matter field. What's more, the mass scale of the both celestial bodies is rather remarkable, as a result, the relative peripheral inexpedient assimilable globose field lamella is rather thick, even though the celestial body A has some a little initial momentum towards celestial body B, there is few possibility for celestial body A to break through the relative peripheral inexpedient assimilable globose field lamella and consequently enter the relative central expediently assimilable globose field extent for gravitational attraction, and finally, celestial body A and celestial body B either collide and form a new celestial body even large, or celestial body A and celestial body B form binary stars.

That's to say, in terms of two massive celestial bodies such as two stars in cosmos, as the mass of the both stars is equivalently massive, one star is very difficult to assimilate the matter field of the other star towards ingenerate esthetic formation of matter field. And virtually, in large-scale spacetime, there are few probabilities for one star to collide another star, no more one star going around another star like binary stars. Just because both "mass disparity accessible to positive gravity" and "mass approximation accessible to negative gravity" do their jobs by the light of nature in cosmos, overall arrangement of celestial bodies even galaxies in cosmos is so well-regulated.

All in all, gravitation reciprocity is but spontaneous occurrence of [matter field superposition disturbance + (PNT action + instinctive PNT equilibrium)], just the spontaneous occurrence of instinctive PNT reciprocal equilibrium towards optimum PNT operation of (PNT action + instinctive PNT equilibrium) under external condition of "matter

As coherent natura naturans throughout cosmic evolution, instinctive PNT reciprocal equilibrium towards optimum PNT operation is radical potentiality & conditionality for cosmos always ready to orientate itself towards perfection.

field superposition disturbance”. And the dynamic orientation of gravity is just the most expedient implementation alternative for (PNT action + instinctive PNT equilibrium) to actualize instinctive PNT reciprocal equilibrium towards optimum PNT operation under external condition of matter field superposition between the interacted celestial bodies. As disparity of field superposition degree, there are different expedient implementation alternatives of “inexpedient assimilable inadequate matter field superposition towards negative gravity” and “expediently assimilable adequate matter field superposition towards positive gravity”.

And such expedient implementation alternative for quantitative disparity of matter field superposition in the nature of instinctive PNT reciprocal equilibrium towards optimum PNT operation straightforwardly hypostatize fundamental of gravitational reciprocity of “mass disparity accessible to positive gravity” and “mass approximation accessible to negative gravity”, which tally with status quo of overall arrangement of celestial bodies in cosmos very well. In detail words, gravitational reciprocity fundamental of “mass disparity accessible to positive gravity” is remarkably propitious to massive celestial bodies absorbing small celestial bodies available around, so that overall arrangement of mass of positive matter (/celestial bodies) in cosmos is not too scattered. Gravitational reciprocity fundamental of “mass approximation accessible to negative gravity” is remarkably propitious to coexistence of massive celestial bodies (such as stars) in galaxies, so that the overall arrangement of mass of positive matter (/celestial bodies) in cosmos is not too concentrated. In terms of mass cumulation scale of single celestial body in cosmos, “mass approximation accessible to negative gravity” does good job to prevent the mass cumulation scale of celestial body to be too enormous.

In fact, any two adjacent stars in cosmos can coexist with relatively steady distance as relatively independent realms, there is few probabilities for any two adjacent stars to collide each other. Virtually, the general diversification we can perceive in cosmos are mostly inner variety in celestial bodies system centred a massive star as big fish eats small fish, and small fish eats shrimps. mass approximation accessible to negative gravity does remarkable job to limit the compositive scale of mass of stars in cosmos, so that there is almost improbabilities for compositive mass scale of stars (celestial bodies) to be too enormous. Gravitational reciprocity fundamental of “mass approximation accessible to negative gravity” apparently impacts the formative probability of so-called “Black Hole”, whose compositive scale of mass is rather enormous so that the gravity on the surface of the celestial body is even strong enough to astrict lights on the surface of it, no more occurrence of further collision & combination of Black Holes.

In even straightforward words, there is perfect existence of matter in prior, then consequent mechanical phenomena among matter accordingly. mechanical phenomena in the nature is but postnatal feature of existence & motion as spontaneous occurrence of [external physical disturbance + (PNT action + instinctive PNT equilibrium)] of matter integration once external physical disturbance $\neq 0$, which is virtually not demiurgic originality of the demiurge but necessary ideological notion of human in proportion to contemporaneous historical background due to expedience of ideological enantiomorph of accessible existence & motion then and there. In any case, once the demiurge creates the cosmos by coherent natura naturans throughout cosmic evolution, he only create “matter” and leave matter existing by themselves, he has no idea of “force”, but just because when human come to know the authenticity of nature, as humanistic ideology about authenticity of nature in proportion to contemporaneous historical background, there were notions as this kind of force and that kind of force even fundamental forces then and there. temporal authority agreeably spout so much about this kind of force and that kind of force, even four fundamental forces was mostly because, during the course of the first itinerary around the brand-new landmasses of

science, they really met distinctive landscapes like this and that indeed, which was the direct causes of proportionate ideological introduction of distinctive force A, distinctive force B even distinctive force C off the cuff; and on the other hand, as magistral autarchy of free press regulation customization and free press admittance of temporal authority under egotistic historical background of royal substantiation & perfection of contemporaneous scientific orthodoxy short of necessary intendance, all endeavor of substantiation & perfection of contemporaneous scientific orthodoxy is of course popular at their pleasure. Whereas, free press admittance of all aberrant scientific knowledge proliferation out of succession of contemporaneous scientific orthodoxy especially timely renovation of humanistic ideology about authenticity of nature in proportion to contemporaneous historical background has to challenge venomous counterwork upper limit of temporal authority.

Virtually, **original generation of matter in the nature of coherent natura naturans brings out essence of matter in a class by itself; essence of matter in a class by itself predestines thorough coherence of dynamic regularity of universal existence & motion.** universal existence & motion in cosmos are spontaneous occurrence of [**external physical disturbance + (PNT action + Instinctive PNT equilibrium)**] of matter integration, when **external physical disturbance=0**, matter integration exists in inertial state, when **external physical disturbance≠0**, matter integration exists in accelerating state. As coherent spontaneous occurrence in the nature of essence of matter in a class by itself, it is only possible for universal existence & motion to incarnate essence of matter as much as possible so as to make hypostatic existence & motion of matter as connatural & out-and-out as possible in the nature of things. As postnatal spontaneous occurrence in the nature of essence of matter in a class by itself, there is completely no ways for any hypostatic existence & motion to be even able to change or recreate physical connotation of essence of matter, so that, no matter how remarkable mechanical domino effect occurred on matter, essence of matter can never be changed, matter is always matter itself, there is no objective possibility for any remarkable mechanical domino effect to change matter into unintelligible immateriality, which of course includes, as spontaneous occurrence of [**physical disturbance of matter field superposition + (PNT action + Instinctive PNT equilibrium)**] among celestial bodies, there is no objective possibility for any real-life “gravitational interaction” to change normal celestial bodies into immateriality as so-called “Black Hole”.

In straightforward words, if universal existence & motion are just domino effect of objectivity as causality A, then, it's only possible for hypostatic existence & motion to incarnate domino effect of objectivity as causality A as much as possible, there is no way for any hypostatic existence & motion to recreate or revise objectivity as causality A at all, no matter what magic hypostatic existence & motion matter has experienced, matter must keep in everlasting situation as matter itself, none hypostatic existence & motion can be radical cause or motivity to change “matter” into “immateriality”. In another words, **hypostatic existence & motion** is but **spontaneous occurrence in the nature of essence of matter in a class by itself**, the reason that matter has to arise non-zero quantitative existence & motion is that, there is external physical disturbance to PNT operation of matter integration, so that, as presence of PNT equilibrium instinct, matter integration has to proportionably readjust PNT operation towards optimum equilibrium by itself. Virtually, **hypostatic existence & motion** is just proportionable physical objectification as spontaneous occurrence in the nature of essence of matter in a class by itself due to homologic input of external physical disturbance on idiographic matter integration. Whereas, in homogenous cosmos, none **hypostatic existence & motion** can be radical cause or motivity to change “matter” into “immateriality”.

All in all, as two independent objectivity in cosmos,

As coherent natura naturans throughout cosmic evolution, instinctive PNT reciprocal equilibrium towards optimum PNT operation is radical potentiality & conditionality for cosmos always ready to orientate itself towards perfection.

①. “Hypostatic existence & motion” is but spontaneous occurrence in the nature of essence of matter in a class by itself / coherent natura naturans throughout cosmic evolution.

②. “Hypostatic existence & motion” can even recreate or revise essence of matter, so that “hypostatic existence & motion” can be radical cause or motivity to change “matter” into “immateriality”, for instance, so-called “gravitational reciprocity” can even bring “normal celestial bodies” into so-called “Black Holes” as coherent natura naturans doing its job itself.

The items ① & ② above are apparently self-contradictory.

If “hypostatic existence & motion” can recreate or revise essence of matter/coherent natura naturans throughout cosmic evolution, so that “hypostatic existence & motion” can be radical cause or motivity to change “matter” into “immateriality”, And at the same time, once “matter” has been changed into “immateriality” as Black Hole, is it possible for “hypostatic existence & motion” of so-called Black Hole to maintain its original format as spontaneous occurrence in the nature of coherent natura naturans throughout cosmic evolution, so that so-called “gravitational reciprocity” is still applicable on Black Hole?

Virtually, as straightforward man, the demiurge can never play special artifice but coherent natura naturans throughout cosmic evolution = freewheeling of [(stochastic accomplishment of “**reciprocal idiosyncrasy towards PNT equilibrium + accessible space overall arrangement for PNT reciprocity**” among compositive components) + consequent convergence of compositive components in the nature of **instinctive PNT reciprocal equilibrium towards optimum PNT operation**] through and through, which is not only permanent programme of sequential homologic cosmogony of original generation of universal reciprocal PNT combinations through and through but also vivid programme of postnatal existence & motion of universal reciprocal PNT combinations eversince. Whereas, so-called “Black Hole” is apparently unintelligible imagination in rational mode of lineal logic extension in succession of contemporaneous scientific orthodoxy out of scientific legitimacy qualification of historical authenticity tolerance of science 0 without necessary credible demonstration, which is apparently out of outgrowth of out-and-out serial natura naturata in the nature of coherent natura naturans throughout cosmic evolution = freewheeling of [(stochastic accomplishment of “**reciprocal idiosyncrasy towards PNT equilibrium + accessible space overall arrangement for PNT reciprocity**” among compositive components) + consequent convergence of compositive components in the nature of **instinctive PNT reciprocal equilibrium towards optimum PNT operation**] and violates dynamic fundamental of universal existence & motion even originality of coherent natura naturans throughout cosmic evolution of the demiurge.

And indeed, original naissance of scientific idea of so-called “Black Hole” was originally recognizant output of Laplace in 1798 who implemented lineal logical extension in succession of contemporaneous scientific orthodoxy of the law of gravitation $F=G(Mm)/R^2$ which of course satisfies logic model if ready-made scientific regularity $F=G(Mm)/R^2$ of contemporaneous scientific orthodoxy is all right beyond all doubt, then, the quantity of **F** must increase in proportion to increment of quantity of **M** in the equation, once increment of **M** is bigger enough, so that **F** is proportionably enough to astrict photo, Black Hole comes into being therefore, which is of course opinionated conclusion in defiance of neither whether ready-made scientific regularity $F=G(Mm)/R^2$ of contemporaneous scientific orthodoxy satisfies legitimacy qualification of historical authenticity tolerance of science 0 nor whether there is objective possibility for quantity of **M** to be bigger enough to offer proportionable gravity to astrict photo” for inflexible belief of contemporaneous scientific orthodoxy off the cuff. What’s more, we still lack necessary credible evidence of “**objective existence of Black Hole in cosmos**” besides authoritative implementation of linear logic extension in succession of contemporaneous scientific orthodoxy out of scientific legitimacy qualification of historical authenticity tolerance of science 0 eversince.

Historical progress of science in the recent several centuries seemed like a far-flung exploration of the first itinerary around numerous distinctive landscapes of brand-new landmasses of science with palette & tablet on back, several hundred years’ scientific travelogues were compiled thereby.

However, under egotistic background of royal substantiation & perfection of contemporaneous scientific orthodoxy, the even pestilent factuality is that, as authoritative intrepidity of contemporaneous scientific orthodoxy is all-time with unprecedented official facility of magistral autarchy of **free press regulation customization & free press admittance** short of necessary intendance, modish Black Hole Theories as typical linear logic extension in succession of contemporaneous scientific orthodoxy have been apparently inundant without necessary scientific authentication all along. In any case, as magistral autarchy of **free press regulation customization & free press admittance** of temporal authority short of necessary intendance, nowadays science forum has been out-and-out homegrown outgrowth in the garden of contemporaneous scientific orthodoxy beyond all doubt, endeavor for royal substantiation & perfection of contemporaneous scientific orthodoxy is always expedient to share free press at pleasure of temporal authority. Comparably, timely renovation of humanistic ideology about authenticity of nature in proportion to contemporaneous historical background has to challenge venomous counterwork upper limit of temporal authority for customary free press egotistic proximity identification, especially, when timely renovation of humanistic ideology about authenticity of nature comes into being as typical aberrant scientific knowledge proliferation out of succession of contemporaneous scientific orthodoxy.

You can of course imagine the necessary legitimacy metabolism and proportionate orthodoxy subrogation in terminal years of 19th century and early years in 20th century for remarkable practice implication dilatation from macrocosm to microcosm with proportionate ideological transition from macrophysics to microphysics, whereas, can you imagine whether it's possible for interminable royal substantiation & perfection of live contemporaneous scientific orthodoxy which originally came into being in early years of 20th century for remarkable practice implication dilatation from macrocosm to microcosm with proportionate ideological transition from macrophysics to microphysics to be nonstop towards perfect ideological enantiomorph of ultimate authenticity of nature?

—Firstly written in Dec. 1995, literal revision was done in Dec.2004
Further revision was done in February & March 2016

(III-i-3) Homogenous Cosmos Originated from Unique Genesis Encountered LIGO Gravitational Wave Discovery

Abstract: *In accordance with rationality of logic succession & integration, LIGO alleging mechanical collision & combination of binary Black Hole for discovery of so-called “gravitational wave” must possess solid logic precondition of **scientific authentication of credible existence and mechanical collision possibility of Black Holes in cosmos.***

*Whereas, till today, in terms of the issue whether there are really “**Black Holes**” in cosmos or not, there is only theoretical prediction in rational mode of lineal logic extension in succession of contemporaneous scientific orthodoxy out of scientific legitimacy qualification of historical authenticity tolerance of science 0 without necessary credible scientific authentication, no more possibility of mechanical collision of so-called Black Holes in cosmos.*

*However, LIGO suddenly stood out for high-sounding declaration that they even had perceived mechanical collision & combination of binary Black Hole far away in spacetime and consequently perceived the proper “gravitational waves” derived from the mechanical collision & combination, although we’ve only heard of Black Holes from so-called “authority” but never perceived authentic ones in cosmos eversince. The very situation is really similar as nobody knows whether there is a dinosaur in Jack’s house or not, whereas, one day, Bob suddenly cried out, **Oh ~, my God, how wonderfully the dinosaur in Jack’s house dances!***

—Oh ~, shit, what’s the grotesque hoax! Is there really a dinosaur in Jack’s house?

Before verification of the very situation, what’s the precipitate and unintelligible wonder that even a dinosaur dances wonderfully in Jack’s house!?

In any case, draw on authoritative impavidity of second-string geniuses or loving successor of Relativity under background of high-sounding royal substantiation & perfection of contemporaneous scientific orthodoxy, LIGO not only unreasonably considered the theoretical mode of gravitational wave in accordance with General Relativity is just the authentic gravitational wave mode in the nature which can be directly qualified as authentication reference of gravitational wave in the nature without any necessary demonstration, but also unreasonably considered that endeavor to substitute the “XX wave” perceived by laser interferometer into logical operation pipelining of contemporaneous scientific orthodoxy as initial parameters for theoretical deduction of mechanical collision & combination of binary Black Hole is just equivalent to reality that mechanical collision & combination of binary Black Hole has been perceived.

Virtually, upon our dispassionate sense, we have to admit that “Black Hole” is transitory ideological flower derived from authoritative exertion off the cuff, but not ideological fruitage originated from credible scientific authentication, it’s straightforward lineal logic extension of contemporaneous scientific orthodoxy out of scientific legitimacy qualification of historical authenticity tolerance of science 0 without necessary credible scientific authentication. Whereas, under favorable background of high-sounding royal substantiation & perfection of contemporaneous scientific orthodoxy, LIGO seemed always ready to sell their bandit rationality draw on authoritative impavidity of second-string geniuses as loving successors of Relativity!!

Keywords: *Gravitational wave, Black Hole, theoretical mode of gravitational wave, historical authenticity tolerance of science, successive freewheeling substantiation & perfection of contemporaneous scientific orthodoxy,*

historical authenticity tolerance of science, top-ranking geniuses, second-string geniuses, third-rate talents.

1. In terms of issue **whether there are really Black Holes in cosmos or not**, there is only theoretical prediction in rational mode of lineal logic extension in succession of **contemporaneous scientific orthodoxy out of scientific legitimacy qualification of historical authenticity tolerance of science 0** without necessary credible scientific authentication eversince. However, LIGO suddenly stood out for high-sounding declaration that they even had perceived mechanical collision & combination of two “Black Holes” faraway in spacetime invoking factuality they had perceived “**so-called gravitational wave**” by laser interferometer which was theoretically authenticated in accordance with General Relativity, although we’ve only heard of Black Holes but never perceived any authentic one in cosmos eversince. Such occurrence under background of interminable royal substantiation & perfection of contemporaneous scientific orthodoxy was really startling and unintelligible for it substantively seemed endeavor to produce more fog in haziness or build more floors on air castle indeed. Does it indicate pioneering advancement of royal substantiation & perfection of contemporaneous scientific orthodoxy or overwhelming authoritative intrepidity of contemporaneous scientific orthodoxy??

Scientific idea of “Black Hole” originally came into being in 1798, when Laplace theoretically predicted according to commensurate orthodoxy of gravitational theory that a celestial body whose density is almost the same as the sun while radius is 250 times of the sun must bring enormous gravitational field, so that even lights can hardly escape from the surface of it.

In the subsequent 200 years, there were substantial people who devoted themselves to study of so-called “Black Holes” , whereas, is there really natural potentiality along demiurgic extension of coherent natura naturans for original generation of a celestial body whose density is almost the same as the sun while radius is 250 times of the sun in cosmos? ——— **are there really Black Holes in cosmos? Is the law of gravity still the same with Black Holes, and Black Holes can even collide each other for further demiurgic convergence by gravitational reciprocity?**

Looking back 200 years of history, there are really none credible demonstration about the issue whether there are really Black Holes in cosmos, **none credible evidence for demonstration of authentic existence of so-called “Black Holes” in cosmos really eversince, otherwise, can you show me one??**

However, just one month ago, LIGO suddenly came out for high-sounding declaration that they even had perceived “gravitational wave” derived from mechanical collision & combination of binary Black Hole faraway in cosmos.

Oh~, my God, what’s the terrible unintelligibility? Since we can hardly offer a credible demonstration about the issue whether there are really Black Holes in cosmos till today, what’s the inconceivable magic that LIGO even have perceived mechanical collision & combination of binary Black Hole in cosmos?

It’s unintelligible indeed!

Homogenous Cosmos Originated from Unique Genesis never suspect existence of gravitational wave in cosmos. Once the gravitational field (/matter field) is impacted intensively, so that PNT equilibrium instinct of matter integration can hardly acclimate itself and assimilate the external physical disturbance into connatural configuration of matter integration in time, some of the physical esse of matter field may be consequently swung

into dynamic mode as wave and ultimately swing out of matter integration, the physical esse originally belonging to matter field but being swung into dynamic mode as wave and ultimately swinging out of matter integration is of course gravitational wave in spacetime.

Cosmos is always ready to orientate itself towards perfection by the right of nature, gravitational wave is stochastic speciality of cosmos as occasional joke of the demiurge, as a result, it usually lacks proportionate ambience for normal steady existence, which of course implies physical esse of gravitational wave must be flimsy in open spacetime. Once transmitted in open spacetime, gravitational wave must be worn down stochastically for variation of physical ambience. We call such stochastic ullage of gravitational wave “stochastic journey ullage of gravitational wave”.

There are usually stochastic journey ullage of gravitational wave as below:

i) Negative oriented ullage of gravitational waves in relative weaker space field: —As evolutionary disparity of large-scale spacetime, it’s almost impossible for strength of space field of large scale spacetime to be absolutely even, once the gravitational waves swing out of original matter integration and subsequently slide into relatively weaker space field during the course of their journey, then negative oriented ullage of gravitational waves must consequently occur as river flows into sand, energy ullage of gravitational wave is of course inevitable.

ii) Positive oriented ullage of gravitational waves for PNT assimilation of heavy celestial bodies: —If gravitational waves passing through heavy celestial bodies or galaxies, the gravitational waves must be assimilated by PNT action of the heavy celestial bodies or galaxies, the ullage of gravitational waves is usually assimilated as energy or mass of the celestial bodies or galaxies. And consequently, the gravitational waves will be proportionably exhausted for PNT assimilation ullage, the gravitational waves even may be completely exhausted ultimately.

The heavier the celestial bodies or galaxies gravitational waves passing through, the more physical esse of the gravitational waves will be assimilated by PNT action of the celestial bodies or galaxies. For instance, if a small celestial body unexpectedly slides into central expediently assimilable globose field extent of matter field of the earth and finally knocks at the earth badly, some gravitational waves must be activized therefore, and there is substantial possibility for the gravitational waves to swing out of the matter integration of the earth. And of course, once the gravitational waves have swung out of matter integration of the earth after proportionate positive oriented ullage for PNT assimilation of the earth, it’s still in matter integration of the solar system, the rest of the gravitational waves must go on being assimilated by PNT action of integrative solar system, it may be a problem whether it’s still possible for the gravitational waves to be able to swing out of matter integration of integrative solar system.

For another instance, if gravitational waves have to pass through so-called “Black Hole” (let’s suppose there are really Black Holes in cosmos, and let’ suppose essence of so-called “Black Hole” still keep the same as common matter/(such as celestial bodies) in cosmos so that dynamic regularity of existence & motion of so-called “Black Hole” is the same as normal matter of identity in cosmos), then, there must be none gravitational waves on the shadow side of gravitational waves against the Black Hole, which of course indicates once the gravitational waves pass through the Black Hole, all physical esse of gravitational waves must be completely assimilated by the Black Hole.

It’s of course imaginable, if binary Black Hole mutually collide and ultimately turn into a neonatal bigger

Historical progress of science in the recent several centuries seemed like a far-flung exploration of the first itinerary around numerous distinctive landscapes of brand-new landmasses of science with palette & tablet on back, several hundred years’ scientific travelogues were compiled thereby.

one, we denote the amount of gravitational waves activated by mechanical collision of the both Black Holes W , and we denote the amount of gravitational waves ultimately swing out of the gravitation field of the neonatal Black Hole derived from mechanical collision of the both Black Holes Q , then, quantities of W and Q must satisfy $W > Q$, even $W > 2Q$, which of course implies, before ultimately swinging out of gravitational field of the neonatal Black Hole derived from mechanical collision & combination of the both initial Black Holes, some of the gravitational waves activated by mechanical collision of the both Black Holes must be assimilated by the neonatal Black Hole immediately, even there may be more than a half of the gravitational waves will be assimilated by the neonatal Black Hole, —just because there are too many gravitational waves activated in a sudden, the neonatal Black Hole can hardly assimilate all the activated gravitational waves in time, some of the activated gravitational waves ultimately escape out of gravitational field of the neonatal Black Hole and become free gravitational waves in large-scale spacetime therefore.

And just because of this, it's apparently doubtful that mechanical collision & combination of one Black Hole 36 times of sun mass and another Black Hole 29 times of sun mass directly leads to naissance of a neonatal Black Hole 62 times of sun mass and consequently causes gravitational waves with equivalent energy of 3 times of sun mass for mechanical collision & combination of the both initial Black Holes which ultimately escape out of gravitational field of the neonatal Black Hole.

I knew very little of the relevant research instruments and proper measure conditions of gravitational wave of LIGO organization, no more knowing whether they had considered stochastic journey ullage of gravitational waves or not. Whereas, throughout the operation of LIGO gravitational wave discovery, existence of Black Hole is obvious acquiesce going without saying, even though, human can only predict existence of so-called Black Hole in cosmos in rational mode of typical lineal logic extension in rigid succession of contemporaneous scientific orthodoxy without scientific authentication before this. However, LIGO blindly stood out and cried out, —Oh~, my God, binary Black Hole collided and combined together over there, and substantial gravitational waves were swung out thereby! The very situation is really similar as that nobody knows whether there is really a dinosaur in Jack's house or not, whereas, one day, Bob suddenly cries out, Oh~, my God, how wonderfully the dinosaur in Jack's house dances!

—Oh~, shit, what's the grotesque hoax! is there really a dinosaur in Jack's house? Before verification of the very situation, what's the precipitate and unintelligible wonder that even a dinosaur dances wonderfully in Jack's house!?

Are there really "Black Holes" in cosmos?

And what's the demiurgic magic for the demiurge to create Black Holes in cosmos? Is the demiurgic magic of so-called Black Hole of the demiurge compatible with the linear demiurgic extension of coherent natura naturans throughout cosmic evolution?

Even if there are really Black Holes in cosmos, whether is there still potentiality for any two adjacent Black Holes to collide and combine for so-called "gravitational reciprocity among Black Holes"?

And how much probability is there for any two adjacent Black Holes to collide and combine due to so-called "gravitational reciprocity among Black Holes"?

Comparably, why we have never found mechanical collision & combination of any two adjacent stars, although, there are so many stars around us?

"Gravitational reciprocity" is of course typical spontaneous occurrence in the nature of essence of matter in a class by itself, once

normal matter turns into so-called “Black Hole” (let’s suppose there is possible demiurgic way for normal matter in cosmos to turn into so-called “Black Hole” first), is it possible for existence of so-called “Black Hole” to hypostatize the same inherence of normal matter in cosmos, so that existence & motion of so-called “Black Hole” is subject to the same dynamic regularity as normal matter (such as normal celestial bodies around us) in rule of identity? For example, once the normal matter turns into so-called “Black Hole”, for enormous increase of mass, is it possible for the dynamic regularity of “gravitational reciprocity” among Black Holes to keep in the same dynamic regularity of “gravitational reciprocity” among normal celestial bodies in cosmos?

Even if there is really possibility for any two adjacent Black Holes to collide and combine, what kind of dynamic regularity that Black Hole collision must be subject to?

Is it possible for collision of Black Holes to be subject to mass conservation, momentum & energy conservation in rule of identity?

At any rate, before practical clarification of the issue, we have no reasons to subjectively persist that physical fundamental in homogenous cosmos is even applicable to heterogenous existence out of category of homogenous cosmos going without saying.

Against rationale of contemporaneous scientific orthodoxy out of scientific legitimacy qualification of historical authenticity tolerance of science 0, Lapelase, Aubenharmou, Slide, S.W. Hawking etc implemented lineal logic extension in rigid succession of contemporaneous scientific orthodoxy, so that they predicted existence of Black Holes in cosmos even theoretically predicted some of the physical attributes of Black Holes in accordance with related fundamental of contemporaneous scientific orthodoxy off the cuff. The scientific creditability of such prediction generally depends on logic backup of so-called “contemporaneous scientific orthodoxy”, after all, they are all outcome of lineal logic extension in rigid succession of contemporaneous scientific orthodoxy. Although, the so-called “contemporaneous scientific orthodoxy” which takes role of logic backup for lineal logic extension is apparently out of scientific legitimacy qualification of **historical authenticity tolerance of science** ① 0, the scientific creditability of lineal logic extension of the proper contemporaneous scientific orthodoxy is still

Supplemental note ①: Taking reference of **ultimate authenticity of nature**, we call the authentic discrepancy between historical legitimacy of science and ultimate authenticity of nature “**historical authenticity tolerance of science**”. After all, ultimate consummation of science is but perfect ideological enantiomorph of ultimate authenticity of nature. As crevice progression of practical feasibility & possibility, the practice human coming to discover and formulate authenticity of accessible existence & motion around us must experience frondose evolvement of humanistic ideology about authenticity of nature cumulatively enriched from nothingness to goat, from goat to a great lot, and consequently followed proportionate ideaistic correction & qualitative optimization from superficiality to profundity, from parochiality to generality, the earlier age of historical progress of science is, the more remarkable authentic discrepancy between historical legitimacy of science and ultimate authenticity of nature is, the proportional value of “historical authenticity tolerance of science” is relatively more remarkable, scientific knowledge proliferation derived from lineal logic extension in rigid succession of contemporaneous scientific orthodoxy is relatively more narrow and flimsy, and authentic reliability of the corresponding scientific knowledge proliferation is relatively poorer therefore.

Virtually, historical progress of science is always in inherent optimum orientation towards historical authenticity tolerance of science 0, which of course indicates the later age of historical progress of science is, the less authentic discrepancy between historical legitimacy of science and ultimate authenticity of nature is, the value of “historical authenticity tolerance of science” is relatively more tiny and closer to 0, scientific knowledge proliferation derived from lineal logic extension in rigid succession of contemporaneous scientific orthodoxy is relatively more general and credible, and authentic reliability of the very scientific knowledge proliferation is relatively higher therefore. Successive quantitative & qualitative change of scientific knowledge proliferation of human just brings out hypostatic historical progress of science in inherent optimum orientation towards historical authenticity tolerance of science 0 by the light of nature.

Historical progress of science in the recent several centuries seemed like a far-flung exploration of the first itinerary around numerous distinctive landscapes of brand-new landmasses of science with palette & tablet on back, several hundred years’ scientific travelogues were compiled thereby.

historically worthy of further verification, the key issue is that we still lack necessary credible scientific authentication of it till today.

Of course, the dubiety of the prediction is because they are but outcome of lineal logic extension in rigid succession of contemporaneous scientific orthodoxy out of scientific legitimacy qualification of historical authenticity tolerance of science 0 then and there. After all, the commensurate lineal logic extension in rigid succession of contemporaneous scientific orthodoxy mostly walks on air of beautiful ignorance that we are always ready to invoke the contemporaneous scientific orthodoxy as absolute scientific verity without authentication whether so-called commensurate humanistic ideology about authenticity of nature has been ultimately qualified as perfect ideological enantiomorph of ultimate authenticity of nature with scientific legitimacy qualification of historical authenticity tolerance of science 0. As a result, once the so-called scientific truth of contemporaneous scientific orthodoxy was invoked for rational precondition for lineal logic extension, there are substantial possibilities for the so-called scientific truths to be used as “logic aberrance audion” for implementation of lineal logic extension in rigid succession of contemporaneous scientific orthodoxy!

What's more, the positive conclusion that gravitational reciprocity is purely “attractive interaction” among objects is still out-and-out acquiescence derived from authoritative impavidity of temporal authority with flimsy authentication due to practical feasibility & possible in proportion to contemporaneous historical background, even as social presence of authoritative intrepidity of contemporaneous scientific orthodoxy, nobody seems innovative to challenge the flimsy authentication of authenticity of gravitational reciprocity!

Considered by Homogenous Cosmos Originated from Unique Genesis, original generation of matter in the nature of coherent natura naturans brings out essence of matter in a class by itself; essence of matter in a class by itself predestines thorough coherence of dynamic regularity of universal existence & motion, universal existence & motion is but spontaneous occurrence of essence of matter in a class by itself. This of course implies, as spontaneous occurrence of essence of matter in a class by itself, hypostatic existence & motion can never be radical cause to change or recreate the so-called ingenerate essence of matter in a class by itself, which of course indicates, as distinctive existence & motion in cosmos, so-called “gravitational reciprocity” can never be something supernatural out of spontaneous occurrence of essence of matter in a class by itself which is virtually spontaneous occurrence of [external physical disturbance + (PNT action + instinctive PNT equilibrium)], no more radical cause or original motivity to change or recreate essence of matter in a class by itself.

Virtually, spontaneous occurrence of is [external physical disturbance + (PNT action + instinctive PNT equilibrium)] just hypostatic incarnation of of coherent natura naturans throughout cosmic evolution, original generation and postnatal vivid existence & motion are but out-and-out serial natura naturata in the nature of coherent natura naturans throughout cosmic evolution. Whereas, as distinctive interaction of spontaneous occurrence of essence of matter in a class by itself, is it possible for so-called “gravitational reciprocity” to be original motivity to lead normal celestial bodies to change into so-called “Black Hole” which seems immateriality in cosmos? Even though, we suppose it's possible for so-called “gravitational reciprocity” to be original motivity to lead normal celestial bodies to change into so-called “Black Hole”, once normal celestial bodies have turned into “Black Hole”, is it possible for essence of matter as hypostatic celestial bodies to keep its original physical connotation? Can the so-called “gravitational reciprocity” among normal celestial bodies still keep its original physical reciprocal connotation among “Black Holes” or between “Black Holes” and “normal celestial bodies”?

This is of course intrepid conclusion of temporal authority without necessary authentication under backup of all-time authoritative intrepidity of contemporaneous scientific orthodoxy going without saying!

We must be aware of the factuality, as crescive progression of practical feasibility & possibility in proportion to contemporaneous historical background, the practice human coming to discover and formulate authenticity of accessible existence & motion around us must experience frondose evolvement of humanistic ideology about authenticity of nature cumulatively enriched from nothingness to groat, from groat to a great lot, and consequently followed proportionate ideaistic correction & qualitative optimization from superficiality to profundity, from parochiality to generality. At any distinctive stage throughout historical progress of science, no matter how poor quality of commensurate humanistic ideology about authenticity of nature is or how remarkable the historical authenticity tolerance of science of commensurate humanistic ideology about authenticity of nature is, as long as there is scientific mainstream of the age, there must be so-called “contemporaneous scientific orthodoxy” beyond all doubt, and authoritative intrepidity of contemporaneous scientific orthodoxy is of course something inherent of so-called “contemporaneous scientific orthodoxy”.

And at the same time, before humanistic ideology about authenticity of nature finally qualified as perfect ideological enantiomorph of ultimate authenticity of nature, the reason that commensurate humanistic ideology about authenticity of nature can be qualified as “social legitimacy” as so-called contemporaneous scientific orthodoxy of the age is that, historical naissance of the commensurate ideology about authenticity of nature has done substantial job to push humanistic ideology about authenticity of nature forward to perfect ideological enantiomorph of ultimate authenticity of nature then and there, whose ideological quality is relatively top level as timely renovation of humanistic ideology about authenticity of nature in proportion to contemporaneous historical background. Whereas, it does not imply we have practically approached perfect ideological enantiomorph of ultimate authenticity of nature, as historical limitation, the commensurate ideology about authenticity of nature is but relatively top scientific level due to practical feasibility & possibility in proportion to contemporaneous historical background, whose social legitimacy qualification of the age of course relies on proportionate backup of contemporaneous historical background.

After all, since ultimate authenticity of nature can be neither omnifarious authenticity smallwares full of a basket nor authenticity chameleon one piece and only, but coherent natura naturans throughout cosmic evolution, in accordance with the rigid enantiomorphous correlation between humanistic ideology about authenticity of nature and ultimate authenticity of nature, it's neither possible for “the unique & invariable ultimate authenticity of nature” to be compatible with “two distinctive humanistic ideologies about authenticity of nature with remarkable ideological difference” nor possible for “two distinctive humanistic ideologies about authenticity of nature with remarkable ideological difference” to discover and formulate “the unique & invariable ultimate authenticity of nature” coequally, —the uniqueness & invariance of ultimate authenticity of nature predestines unique possibility of scientific verity. Veritable progress is but hypostatic endeavor to push humanistic ideology about authenticity of nature forward to perfect ideological enantiomorph of ultimate authenticity of nature step by step draw on practical feasibility & possibility in proportion to contemporaneous historical background, which is virtually hypostatic process that commensurate humanistic ideology about authenticity of nature become more and more updated towards perfect ideological enantiomorph of ultimate authenticity of nature. In another words, historical progress of science is virtually process humanistic ideology about authenticity of nature is gradually

updated forward to perfect ideological enantiomorph of ultimate authenticity of nature, historical consummate degree of science radically depends on corresponding value of historical authenticity tolerance of science of commensurate humanistic ideology about authenticity of nature.

This of course indicates, throughout historical progress of science:

On one hand, as crecive progression of practical feasibility & possibility for historical progress of science, the proportionate quantitative & qualitative change of humanistic ideology about authenticity of nature in proportion to contemporaneous historical background must lead commensurate ideological system about authenticity of nature update in inherent optimum orientation towards perfect ideological enantiomorph of ultimate authenticity of nature, which makes scientific truths more and general in less and less historical authenticity tolerance of science. Veritable progress of science is not intuitional cumulative achievement of colorful scientific travelogues A, B, C, D, E, F, ...as deserving reward of the first itineracy around preternatural landscapes of brand-new landmasses of science like omnifarious smallwares full of a basket but successive hypostatic endeavor to push humanistic ideology about authenticity of nature forward to perfect ideological enantiomorph of ultimate authenticity of nature step by step draw on practical feasibility & possibility in proportion to contemporaneous historical background.

Before humanistic ideology about authenticity of nature finally qualified as perfect ideological enantiomorph of ultimate authenticity of nature, it's only possible for so-called "science" to be commensurate ideological system about authenticity of nature in proportion to contemporaneous historical background with proportionate scientific legitimacy qualification of historical authenticity tolerance of science. In terms of any "contemporaneous scientific orthodoxy" out of scientific legitimacy qualification of historical authenticity tolerance of science 0, as long as historical progress of science is still on its normal way inherent optimum orientation towards perfect ideological enantiomorph of ultimate authenticity of nature, once remarkable advancement of humanistic ideology about authenticity of nature forward to perfect ideological enantiomorph of ultimate authenticity of nature occurred, there must be remarkable renovation of humanistic ideology about authenticity of nature in proportion to contemporaneous historical background. In any case, as **the uniqueness & invariance of ultimate authenticity of nature predestines the unique possibility of scientific verity as perfect ideological enantiomorph of ultimate authenticity of nature**, the timely renovation of humanistic ideology about authenticity of nature must be remarkably different from live contemporaneous scientific orthodoxy, as social legitimacy qualification of humanistic ideology about authenticity of nature can only be unique in the same age, there must be life-and-death scientific knowledge metabolism campaign between timely renovation of humanistic ideology about authenticity of nature and live contemporaneous scientific orthodoxy. As long as timely renovation of humanistic ideology about authenticity of nature has done positive job to push humanistic ideology about authenticity of nature forward to perfect ideological enantiomorph of ultimate authenticity of nature, the live contemporaneous scientific orthodoxy must be ultimately washed out without alternatives.

And on the other hand, as ideological enantiomorph of authenticity of nature, the unique enantiomorphous correlation between humanistic ideology about authenticity of nature and authenticity of nature directly implies the uniqueness and invariance of ultimate authenticity of nature must predestine the unique possibility of scientific verity as perfect ideological enantiomorph of ultimate authenticity of nature, the gradual quantitative & qualitative change of humanistic ideology about authenticity of nature in proportion to contemporaneous historical background must make coming innovative humanistic ideology about authenticity of nature blackball even negate conservative

ready-made humanistic ideology about authenticity of nature which mostly exists as live contemporaneous scientific orthodoxy then and there. In another words, development of science must indicate update or renovation of humanistic ideology about authenticity of nature, and update or renovation of humanistic ideology about authenticity of nature towards perfect ideological enantiomorph of ultimate authenticity of nature must blackball even negate live contemporaneous scientific orthodoxy without alternatives. In terms of any contemporaneous scientific orthodoxy out of scientific legitimacy qualification of historical authenticity tolerance of science 0, as long as historical progress of science still on its normal way to push humanistic ideology about authenticity of nature forward to perfect ideological enantiomorph of ultimate authenticity of nature step by step draw on practical feasibility & possibility in proportion to contemporaneous historical background, hypostatic accomplishment of advancement of historical authenticity tolerance of science towards 0 must wash out contemporaneous scientific orthodoxy without alternatives. In even precise words, historical progress of science is virtually incremental quantitative & qualitative change that humanistic ideology about authenticity of nature is gradually updated forward to perfect ideological enantiomorph of ultimate authenticity of nature step by step draw on practical feasibility & possibility in proportion to contemporaneous historical background. In another words, veritable progress of science is not skin-deep cumulative achievement of colorful scientific travelogues A, B, C, D, E, F, ... as deserving reward of the first itineracy around preternatural landscapes of brand-new landmasses of science like omnifarious smallwares full of a basket but hypostatic endeavor to push humanistic ideology about authenticity of nature forward to perfect ideological enantiomorph of ultimate authenticity of nature step by step draw on practical feasibility & possibility in proportion to contemporaneous historical background.

Throughout historical progress of science or before humanistic ideology about authenticity of nature finally qualified as perfect ideological enantiomorph of ultimate authenticity of nature, it seems we have no reasons to insist some certain scientific truths is absolute scientific verity out of question, we but have reasons to think, along crecive progression of historical progress of science, original naissance and successive development of the very scientific truths has ever taken positive roles of historical progress of science in inherent optimum orientation towards perfect ideological enantiomorph of ultimate authenticity of nature. In any case, **the uniqueness & invariance of ultimate authenticity of nature predestines the unique possibility of scientific verity as perfect ideological enantiomorph of ultimate authenticity of nature**, and as **crecive progression of practical feasibility & possibility in proportion to contemporaneous historical background**, the practice human coming to discover and formulate authenticity of accessible existence & motion around us must experience frondose evolvment of humanistic ideology about authenticity of nature cumulatively enriched from nothingness to groat, from groat to a great lot, and consequently followed proportionate ideaistic correction & qualitative optimization from superficiality to profundity, from parochiality to generality.

This is just straightforward historical factuality, as permanent potential conditionality of **“crecive progression of practical feasibility & possibility in proportion to contemporaneous historical background + the uniqueness & invariance of ultimate authenticity of nature predestines the unique possibility of scientific verity as perfect ideological enantiomorph of ultimate authenticity of nature”** through and through, it’s only possible for practical accomplishment that humanistic ideology about authenticity of nature gradually approaches perfect ideological enantiomorph of ultimate authenticity of nature draw on practical feasibility & possibility in proportion to contemporaneous historical background to be serial scientific knowledge metabolism in inherent optimum orientation towards scientific legitimacy qualification of

Historical progress of science in the recent several centuries seemed like a far-flung exploration of the first itineracy around numerous distinctive landscapes of brand-new landmasses of science with palette & tablet on back, several hundred years’ scientific travelogues were compiled thereby.

historical authenticity tolerance of science 0. Before humanistic ideology about authenticity of nature finally qualified as perfect ideological enantiomorph of ultimate authenticity of nature, it's only possible for so-called "science" to be commensurate ideological system about authenticity of nature in proportion to contemporaneous historical background with proportionate scientific legitimacy qualification of historical authenticity tolerance of science.

Whereas, as pioneering humanistic ideology about authenticity of nature in proportion to contemporaneous historical background and contemporaneous scientific orthodoxy, as long as the temporal authority are confident enough to contemporaneous scientific orthodoxy, facing the brand-new implication of unknown objects or potentiality, they can of course go through the brand-new implication of unknown objects or potentiality by implementation of linear logic extension in rigid succession of contemporaneous scientific orthodoxy going without saying, but never to suspect the scientific reliability of contemporaneous scientific orthodoxy to be treated as logic basis for implementation of linear logic extension in succession of contemporaneous scientific orthodoxy.

By right of confidence of contemporaneous scientific orthodoxy, Ptolemy could implement his distinctive lineal logic extension in rigid succession of contemporaneous scientific orthodoxy of his age without misgiving.

By right of confidence of contemporaneous scientific orthodoxy, Copernicus could implement his distinctive lineal logic extension in rigid succession of contemporaneous scientific orthodoxy of his age without misgiving.

By right of confidence of contemporaneous scientific orthodoxy, Newton could implement his distinctive lineal logic extension in rigid succession of contemporaneous scientific orthodoxy of his age without misgiving too.

... ..

By right of confidence of contemporaneous scientific orthodoxy, nowadays science aristocrats are wild about distinctive lineal logic extension in rigid succession of contemporaneous scientific orthodoxy of today without misgiving too.

Virtually, so-called "**lineal logic extension in succession of contemporaneous scientific orthodoxy**" is a kind of logic model for scientific knowledge proliferation when historical progress of science in inherent optimum orientation towards historical authenticity tolerance of science 0 proceeds to some certain progressive stage, some certain relatively mature scientific knowledge in proportion to contemporaneous historical background has been promoted social legitimacy qualification of the age, the corresponding orthodox authority (/temporal authority) consequently carry forward eulogistic scientific knowledge proliferation in rigid succession of contemporaneous scientific orthodoxy by subconscious implementation of lineal logic extension of their celebrated legitimacy so as to crown all accessible existence & motion in their rational purview, which usually treats contemporaneous scientific orthodoxy as absolute scientific verity straightway even treat it as undoubted "logic basis/rationale" off the cuff in defiance of whether contemporaneous scientific orthodoxy has been qualified as perfect ideological enantiomorph of ultimate authenticity of nature with scientific legitimacy qualification of historical authenticity tolerance of science 0 or not, no more how remarkable "historical authenticity tolerance of science" of contemporaneous scientific orthodoxy is.

Under background of royal substantiation & perfection of contemporaneous scientific orthodoxy, once unexpected unknown occurrence in cosmos enters human rational purview, as historical limitation, as we are difficult to know or demonstrate it on the spot, we are mostly sensitive to deduce or predict the potential objectivity of the unexpected unknown existence in accordance with contemporaneous scientific orthodoxy so as to make

As coherent natura naturans throughout cosmic evolution, instinctive PNT reciprocal equilibrium towards optimum PNT operation is radical potentiality & conditionality for cosmos always ready to orientate itself towards perfection.

contemporaneous scientific orthodoxy omnipotent.

And indeed, before humanistic ideology about authenticity of nature finally qualified as perfect ideological enantiomorph of ultimate authenticity of nature in legitimacy qualification of historical authenticity tolerance of science 0, lineal logic extension in succession of contemporaneous scientific orthodoxy has different credibility due to proportionate historical authenticity tolerance of science of contemporaneous scientific orthodoxy which is logic basis for implementation of lineal logic extension in succession of contemporaneous scientific orthodoxy.

Scientific credibility of lineal logic extension in succession of contemporaneous scientific orthodoxy implemented by Ptolemy was of course in proportion to historical authenticity tolerance of science of commensurate contemporaneous scientific orthodoxy of Ptolemy's age.

Scientific credibility of lineal logic extension in succession of contemporaneous scientific orthodoxy implemented by Copernicus is of course in proportion to historical authenticity tolerance of science of commensurate contemporaneous scientific orthodoxy of Copernicus' age.

Scientific credibility of lineal logic extension in succession of contemporaneous scientific orthodoxy implemented by Newton is of course in proportion to historical authenticity tolerance of science of commensurate contemporaneous scientific orthodoxy of Newtonian age.

... ..

Scientific credibility of lineal logic extension in succession of contemporaneous scientific orthodoxy implemented by Einstein is of course in proportion to historical authenticity tolerance of science of commensurate contemporaneous scientific orthodoxy of Einstein's age.

In terms of Black Hole theory, original naissance of idea of Black Hole derived from lineal logic extension of classic gravity formulation of $F=G(Mm)/R^2$, whose lineal logic extension process is generally as below:

- (1). If magnitude of mass M of celestial body can increase unlimitedly, and magnitude of R increases proportionally to mass M under precondition that the density of the celestial body is relatively steady (M increases itself, whereas, R is a constant all along), then, the larger the mass M of celestial body is, the more strengthen of the matter field on surface of celestial body is. Once the mass M increases enough, so that the matter field on surface of the celestial body is proportionably strengthen enough to astrict lights on surface of celestial body, Black Hole occurs therefore.
- (2). If magnitude of mass M of celestial body is constant, whereas, the radius of celestial body can decrease unlimitedly (which means the physical structure of matter can collapse unlimitedly). So that the smaller the radius of celestial body is, the more strengthened matter field on surface of the celestial body is, once the matter field strength is strengthening enough so that any light can never get rid of full restriction of gravity on surface of celestial body, then, Black Hole occurs.

As historical limitation of practical feasibility and accessibility as hypostatic potentiality in proportion to contemporaneous historical background for historical progress of science, it's of course practically possible and acceptable for us to implement lineal logic extension in rigid succession of contemporaneous scientific orthodoxy of gravity formulation $F=G(Mm)/R^2$ upon freewheeling of historical progress of science. Whereas, in accordance with cosmological fundamental, in terms of any celestial body with constant density in cosmos, if the radius R of celestial body keeps constant or the radius R keeps varying proportionably to M , whether it's

Historical progress of science in the recent several centuries seemed like a far-flung exploration of the first itinerary around numerous distinctive landscapes of brand-new landmasses of science with palette & tablet on back, several hundred years' scientific travelogues were compiled thereby.



possible for mass M of celestial body to increase enough so that the gravity on surface of celestial body is strong enough to astrict lights on surface of the celestial body?

Or in terms of a celestial body with constant mass M, whether it's possible for the radius of the celestial body to decrease unlimitedly so that the gravity on surface of the celestial body is enough to astrict lights on surface of the celestial body?

We apparently lack rational capital of necessary scientific authentication, it's but madcap confidence of lineal logic extension in rigid succession of contemporaneous scientific orthodoxy in defiance of scientific legitimacy qualification of historical authenticity tolerance of science 0.

On pure view of philosophy and logic, as long as we admit cosmos is throughout homologic and limited, we then have to admit that any physical process extension of quantitative change in cosmos can never extend everlastingly without conditional limitation. In another word, as long as cosmic content is homologically limited, any everlasting continuation of physical quantitative change towards certain characteristic object must ultimately exhaust and individualize complete cosmic content into the single characteristic object, so that the single characteristic object ultimately represents existence of the whole cosmos out and out.

If there is only positive towards negative transmutation "M→m" in cosmos, and the quantitative change of positive towards negative transmutation "M→m" can last everlastingly without conditional limitation, as long as cosmos is throughout homogenous and limited, everlasting continuation of quantitative change of positive towards negative transmutation "M→m" must ultimately exhaust and individualize cosmic content through and through. And finally, there are only positive matter but none negative matter (/space field) in cosmos, which of course indicates that positive matter represents characteristic existence of the whole cosmos out and out.

If physical process of original generation of neutron (/proton) in cosmos can last everlastingly without conditional limitation, as long as cosmos is throughout homogenous and limited, everlasting continuation of original generation of neutron (/proton) must ultimately exhaust and individualize cosmic content through and through. And finally, there are only massive neutron (/proton) in cosmos, nothing else (no space, no time, no any other particles), which of course indicates entire cosmos is a pure aggregation of neutron (/proton).

If physical process of original generation of oxygen atoms can everlastingly last without conditional limitation, as long as cosmos is throughout homogenous and limited, everlasting continuation of original generation of oxygen atoms must ultimately exhaust and individualize cosmic content into oxygen atoms through and through. And finally, there are only massive oxygen atoms in cosmos, nothing else (no space, no time, no particles, no any other atoms), which of course indicates entire cosmos is but a pure aggregation of oxygen atoms.

If physical process of original generation of copper atoms can last everlastingly without conditional limitation, as long as cosmos is throughout homogenous and limited, everlasting continuation of original generation of copper atoms must ultimately exhaust and individualize cosmic content into copper atoms through and through. And finally, there are only massive copper atoms in cosmos, nothing else (no space, no time, no particles, no any other atoms), which of course indicates entire cosmos is but a pure aggregation of copper atoms.

... ..

If physical process of quantitative increase of mass of some certain celestial body can last everlastingly without conditional limitation, as long as cosmos is throughout homogenous and limited, everlasting continuation

of quantitative increase of mass of the celestial body must ultimately exhaust and gather cosmic content through and through. And finally, there is only the celestial body in cosmos, nothing else (no space, no time, no particles, no any other celestial bodies), which of course indicates the unique celestial body represents characteristic existence of the whole cosmos, no matter the celestial body is bright or dark.

... ..

However, this is impossible. At any rate, **cosmos is always ready to orientate itself towards perfection by the right of nature.**

Original generation of matter in the nature of constant demiurgic fundamental brings out essence of matter in a class by itself; essence of matter in a class by itself predestines thorough coherence of dynamic regularity of universal existence & motion. As **spontaneous occurrence in the nature of essence of matter in a class by itself** —vivid dynamic objectification of instinctive PNT reciprocal equilibrium towards optimum PNT operation, existence & motion of matter is postnatal characteristic action derived from original generation of matter by the light of nature, as a result, action of idiographic existence & motion of matter can only embody the inherence of matter itself as adequate as possible. Whereas, it's impossible for idiographic existence & motion of matter in homogenous cosmos to reforge or rebuild inherence of matter, which of course implies there is no possibility for any idiographic existence & motion in homogenous cosmos to unintelligibly change some certain object (**positive matter**) into something miraculous as heterogenous object or immateriality, no matter what's the magic consequence of existence & motion of certain celestial body under gravitational reciprocity, as straightforward acclimatisable reaction in the nature of instinctive PNT reciprocal equilibrium towards optimum PNT operation, it's almost impossible for intelligible existence & motion of celestial body derived from gravitational reciprocity to change "matter" into "immateriality" as so-called "Black Hole".

Virtually, in terms of ingenerate homologic correlation between "positive matter" and "matter field", matter field (/gravitational field) is just the accessorial output of original generation and successive existence of positive matter. On one hand, the quantitative change of gravitational field is always consequence of proportional quantitative change of mass of celestial body, throughout the quantitative change process, quantitative change of mass of celestial body is always the magistral quantitative change. And on the other hand, innative PNT action of matter integration between positive matter and matter field inherently assort the positive matter with the proper matter field all the way, —as constant quantitative increase of mass of celestial body, the mass scale of the corresponding matter field increase proportionably, as a result, the impact that matter field (/gravitational field) acts on positive matter (/celestial body) is stronger and stronger, the quantity of $d(M \rightarrow m)$ of matter integration is bigger and bigger. Then, the positive matter of matter integration will inherently increase quantity of $d(M \leftarrow m)$ upon PNT equilibrium instinct so as to balance the predominance of $d(M \rightarrow m)$ of matter integration and ultimately materialize the existent harmony between positive matter (/celestial body) and matter field (/gravitational field).

If quantitative increase of $d(M \leftarrow m)$ is still not enough to balance the predominance of $d(M \rightarrow m)$ of matter integration, then, the positive matter (/celestial body) will consequently radiate. Once radiation resource derives from a celestial body as typical physical feature of it, the celestial body is of course a star in cosmos. And of course, radiation intensity of celestial body (/star) is mostly depends on mass scale of the celestial body (/star). Usually, the mass scale of celestial body (/star) is bigger, the radiation intensity of the celestial body (/star) is higher.

Historical progress of science in the recent several centuries seemed like a far-flung exploration of the first itinerary around numerous distinctive landscapes of brand-new landmasses of science with palette & tablet on back, several hundred years' scientific travelogues were compiled thereby.

If quantitative increase of radiation intensity of celestial body (/star) is still difficult to balance the predominance of quantitative increase of mass of the celestial body (for the star to reject increase of mass), there is formidable alternative for the celestial body (/star) to blast itself into pieces, but there is almost no way for the atomic conformation of all compositive atoms of the celestial body (/star) to collapse and consequently turn into so-called "Black Hole". Virtually, in human perceivable eyeshot in cosmos, we have perceived substantial occurrence of blast of immense stars, but never perceived peculiar occurrence of atomic collapsing of all compositive atoms of any celestial body towards original generation of so-called "Black Hole".

All in all, it's impossible for physical process of quantitative increase of mass of celestial bodies to continue everlastingly without conditional limitation, whether it's possible for connatural quantitative increase of mass of celestial body in cosmos to extend to mass scale of so-called "Black Hole" or not even whether it's possible for Black Holes in cosmos to increase their mass by mechanical collision of equivalent Black Holes or not are still serious issues needing further demonstration. However, LIGO suddenly stood out for high-sounding declaration in spite of the very issues insanely that they even perceived mechanical collision of binary Black Hole faraway in cosmos, even there is gravitational wave derives from the mechanical collision of the binary Black Hole. Such situation is apparently declaring all over the world, as loving successors of contemporaneous scientific orthodoxy, even as magistral autarchy of free press regulation customization and free press admittance of temporal authority short of necessary intendance, temporal authority are always ready to enjoy themselves in high-sounding freewheeling of royal substantiation & perfection of contemporaneous scientific orthodoxy draw on cock-a-hoop self-appreciation in homegrown science forum in the garden of contemporaneous scientific orthodoxy, any lineal logic extension in rigid succession of contemporaneous scientific orthodoxy seems agreeably acceptable without further scientific authentication, as loving successors of contemporaneous scientific orthodoxy, social legitimacy authorization of theoretical predication in rational mode of lineal logic extension of contemporaneous scientific orthodoxy only needs several popular references from several respectable foregone sages out of question in defiance of whether social legitimacy qualification of so-called contemporaneous scientific orthodoxy satisfies historical authenticity tolerance of science 0 or there is necessary demonstration. Social legitimacy authorization of theoretical prediction of existence of so-called Black Hole in cosmos is typical instance like this, which is of course typical theoretical prediction in accordance with contemporaneous scientific orthodoxy of classic gravitational theory out of scientific legitimacy qualification of historical authenticity tolerance of science 0 in rational mode of lineal logic extension of contemporaneous scientific orthodoxy, even though it seems no feasible & credible methodology and no accessible & credible criterion for us to authenticate legitimacy qualification of historical authenticity tolerance of science 0 of contemporaneous scientific orthodoxy at present.

And at the same time, the solution that we judge existence of Black Hole therein by so-called integrative motion orientation of observable celestial bodies in large-scale spacetime virtually tolerate acquiesce that **integrative motion orientation change of a large number of celestial bodies in large-scale spacetime is but effect of gravity**, and presence of gravitational effect of course implies existence of solid convergent mass therein, whereas, we virtually perceived nothing over there upon our vision, so that we have to arrive at prediction of existence of heavy Black Hole (or dark matter) thereby and predict the solid convergent mass of so-called "Black Hole (or dark matter)" referring to the proper integrative motion orientation change of observable celestial bodies in accordance with traditionary regularity of gravity.

However, is it true that **integrative motion orientation change of a large number of celestial bodies in large-scale spacetime is really gravitational effect?**

Under temporal background, it's but our madcap confidence of lineal logic extension in rigid succession of contemporaneous scientific orthodoxy without solid demonstration, even though we can not ensure historical authenticity tolerance of science of contemporaneous scientific orthodoxy 0.

The presumptive “acquiesce” apparently lacks necessary scientific authentication too!

Even though we authorize Ptolemy or Copernicus to bring into play off the cuff under the very background, as long as Ptolemy and Copernicus were confident of their contemporaneous scientific orthodoxy, similar lineal logic extension in rigid succession of contemporaneous scientific orthodoxy in Ptolemy's access or Copernicus' access would be justly confident as well. And as modern intellectual, we of course have substantial reasons to suspect the reliability of lineal logic extension in rigid succession of contemporaneous scientific orthodoxy in Ptolemy's access or Copernicus' access, whereas, once ourselves involved in lineal logic extension in rigid succession of contemporaneous scientific orthodoxy, it is not so sensitive for us to find the fallibility off the cuff, for we are on stand of the top of historical progress of science all-time with superiority complex, we lack valid reference which can make us inferior by comparison then and there. The key issue is that, as long as we are not able to ensure the historical authenticity tolerance of science of contemporaneous scientific orthodoxy 0, reliability of successive knowledge multiplication by lineal logic extension in rigid succession of contemporaneous scientific orthodoxy must depend on further scientific authentication.

This of course indicates, in accordance with cosmogony fundamental that **it's only possible for concordant cosmos to be demiurgic aggradation of out-and-out serial natura naturata in the nature of coherent natura naturans throughout cosmic evolution; there is no way for demiurgic aggradation in the nature of different natura naturans to be concordant cosmos through and through**, there is apparently no absolute verity in live contemporaneous scientific orthodoxy, not only the gravity theory is worthy of further review, but also the linear logic extension in succession of classic gravity theory is even worthy of our review. As recognizant outcome of lineal logic extension in succession of classic gravity theory, the legitimacy of theoretical introduction of “Dark Matter” and “Black Hole” mostly depends on our religiosity to traditionary gravity theory. And just because of our religiosity to traditionary gravity theory, we implemented pean knowledge proliferation in succession of contemporaneous scientific orthodoxy, this is of course a bet on our religiosity to traditionary gravity theory.

Of course, it's not culpable for implementation of lineal logic extension in rigid succession of contemporaneous scientific orthodoxy, the key issue is that it still need necessary scientific authentication whether the outcome of lineal logic extension in rigid succession of contemporaneous scientific orthodoxy is true or not.

And indeed, till today, among 7 billions of live people on earth besides the several geniuses of SW Hawking kind, nobody has ever perceived a Black Hole in cosmos factually but people who have ever heard of Black Hole. That's to say, about the authenticity whether there are really Black Holes in cosmos, we have none credible scientific authentication but theoretical prediction in rational model of lineal logic extension in rigid succession of contemporaneous scientific orthodoxy of classic gravitational theory. No matter the original idea of “Black Hole” coming into being in 1798 A.D or in 1798 B.C., and no matter there were successively M pieces of scientific big men or N pieces of scientific majesties who had ever devoted to study of so-called “Black Hole

Theory” famously, there was none realistic interposition whether there are really Black Holes in cosmos for none credible scientific authentication having been ever offered eversince. These respectable references taking on airs which are related to issue of “Black Holes” are but nice-looking masks for the second-string geniuses to play off the cuff.

The key issue is that, since the so-called “Black Hole Theory” can only be expedient temporal prediction in rational mode of lineal logic extension of contemporaneous scientific orthodoxy out of scientific legitimacy qualification of historical authenticity tolerance of science 0, without necessary credible scientific authentication, such kind of expedient prediction is of course not qualified to enjoy scientific legitimacy qualification going without saying. The key issue is that, till today, we still lack credible scientific authentication about whether there are really Black Holes in cosmos, none credible scientific authentication accessible for it indeed, otherwise, can you show me one?

Along the normal quantitative change of scientific knowledge proliferation in coming days, there are only two possible outcomes for progress of science:

Either get the lineal logic extension in rigid succession of contemporaneous scientific orthodoxy (1) & (2) demonstrated true.

Or get the lineal logic extension in rigid succession of contemporaneous scientific orthodoxy (1) & (2) demonstrated wrong.

Whereas, LIGO gravitational wave discovery neither demonstrated the lineal logic extension in rigid succession of contemporaneous scientific orthodoxy (1) & (2) true nor demonstrated the lineal logic extension in rigid succession of contemporaneous scientific orthodoxy (1) & (2) wrong, but to facilitate more on top of temporal obscurity as if building more floors on top of air castle, —just based on temporal obscurity and disregarded whether there are really Black Holes in cosmos or not draw on unparalleled authoritative intrepidity of contemporaneous scientific orthodoxy, LIGO suddenly stood out and resoundingly cried out they even had perceived mechanical collision & combination of binary Black Hole in cosmos, and just because of the percept of mechanical collision & combination of binary Black Hole, they even declared that they had discovered gravitational wave derived from mechanical collision & combination of binary Black Hole. And the even valiant and unintelligible conclusion is that, their so-called “percept” of mechanical collision & combination of binary Black Hole has demonstrated authentic existence of gravitational wave as well.

Oh, shit! What’s the flimflam logic!?

Is the object LIGO perceived gravitational wave really?

Can the so-called “gravitational wave” theoretically judged by contemporaneous scientific orthodoxy predict existence of Black Hole even mechanical collision & combination of binary Black Hole? And inversely, existence even mechanical collision & combination occurrence of Black Holes can demonstrate existence of gravitational wave as well? —mother gives birth of daughter; and inversely, daughter can give birth of mother as well?

—S.W. Hawking said he had seen “ghost”, whereas, all 7 billions of live people on the earth besides S.W. Hawking himself only heard of ghost, none of them had ever seen a ghost! However, in defiance of authentic existence or nonexistence of ghost, LIGO gracefully stood out and magnanimously declared they even had seen ghosts fighting together and touching off gravitational wave therefore!

—Ghost tale of nowadays science!! even if it's not remarkably preposterous, it must be uncanny leastways!!

On 16 June 2016, LIGO declared that they found gravitational waves derived from mechanical collision & combination of a Black Hole 14 times of sun mass and another Black Hole 8 times of sun mass again, I considered the declaration the next day. However, I found the declaration from LIGO this time was almost just the same as the last time, they seemed having done nothing to consolidate their credibility, —neither authentic existence of Black Hole highlighted in cosmos, nor mechanical collision & combination possibility of Black Holes demonstrated as necessary precondition in prior, but theoretically emphasized the similar situation relying on Relativity for a second time towards highlight of their intelligent accomplishment as loving successors of General Relativity, which can never beautify their behavioral attribute of scientific exploration as endeavor to build more floors on top of air castle.

Even though we assume there are really Black Holes in cosmos, the distribution density of stars in cosmos must be much denser than distribution density of so-called Black Holes, since there are so few chances for us to find mechanical collision & combination of any two stars in cosmos, what's the credible reason for us to find mechanical collision & combination of Black Holes so frequently? Towards resounding cosmological discovery, we carried forward Big Bang Theory according to evidence of so-called "red shift" that all galaxies in cosmos are expanding outwards. Whereas, towards discovery of gravitational wave today, we frequently found mechanical collision & combination of massive Black Holes in cosmos easily.

Such scientific necromancy is substantively magic!

Is it to say, if there are really Black Holes in cosmos, Black Holes never expand outwards as all galaxies in cosmos usually do in-phase; instead, Black Holes mostly go inverse way against expansion of all galaxies towards centric convergence for ultimate collision & combination step by step? Or all the galaxies exist in cosmos I which is expanding outwards the cosmic center; whereas, all Black Holes exist in cosmos II which is shrinking towards the cosmic center?

If some days later, further development of science demonstrates there is substantively nonexistence of so-called "Black Hole" in cosmos, it's of course imaginable how funny the resounding accomplishment of LIGO gravitational wave discovery would be.

In any case, considered by Homogenous Cosmos Originated from Unique Genesis, as connatural domino effect of "mass approximation accessible to negative gravity" of gravitational reciprocity, there is almost no possibility for quantitative change of original convergent accumulation of mass of any celestial body in cosmos to extend to mass scale of so-called "Black Hole". Even though there are two Black Holes generated accidentally for nonsense of the demiurge, as connatural domino effect of "mass approximation accessible to negative gravity" of gravitational reciprocity, there is almost no possibility for the two Black Holes to collide for spontaneous occurrence of gravitational reciprocity.

2. Upon our dispassionate sense, we have to admit the practical operation of LIGO gravitational wave discovery was really scientific trick of second-string geniuses as loving successors of General Relativity, which apparently made it incredible scientific discovery. After all, whether the theoretical mode of gravitational waves theoretically deduced in accordance with General Relativity are really authentic mode of gravitational waves in the nature still needs further scientific authentication. Before accomplishment of necessary scientific

authentication, we have inadequate reasons to conclude that the theoretical mode of gravitational waves theoretically deduced in accordance with General Relativity are just the authentic mode of gravitational waves in the nature. What's more, substituting "XX wave" into logical operation of contemporaneous scientific orthodoxy for theoretical prediction of mechanical collision & combination of binary Black Hole faraway in spacetime is not credible manner of discovery of mechanical collision & combination of binary Black Hole in spacetime. As a result, we have to suspect that LIGO are trying to sell their bandit logic draw on their authoritative impavidity as devotional loving successors of General Relativity.

The practical operation of LIGO gravitational wave discovery is generally as below:

The first, envisage "theoretical modes of gravitational waves" in accordance with General Relativity.

The second, try to search waves similar as "theoretical mode of gravitational waves" theoretically deduced in accordance with General Relativity with so-called "laser interferometer".

The third, perceived the target waves of "XX waves", which is really similar as "theoretical mode of gravitational waves" theoretically deduced in accordance with General Relativity. Subsequently, substituted "XX waves" into logical operation of contemporaneous scientific orthodoxy for theoretical deduction, so that mechanical collision & combination of massive binary Black Hole faraway in large-scale spacetime was deduced accordingly.

The fourth, declare all over the world that LIGO has found mechanical collision & combination of massive binary Black Hole faraway in large-scale spacetime, and the mechanical collision & combination of the binary Black Hole triggered off gravitational wave as the "XX wave" LIGO perceived herein.

My comment about the practical operation of LIGO gravitational wave discovery is generally as below:

The first, envisage "theoretical modes of gravitational waves" in accordance with General Relativity.

First of all, I'd like to emphatically clarify the authenticity dependability of theoretical modes of gravitational wave of LIGO, which are deduced from and tally with General Relativity, even though we firstly throw the issue aside whether there are really Black Holes in cosmos.

It is only possible for concordant cosmos to be demiurgic aggradation of out-and-out serial natura naturata in the nature of coherent natura naturans throughout cosmic evolution; there is no way for demiurgic aggradation in the nature of different natura naturans to be concordant cosmos through and through. After successive freewheeling substantiation & perfection for more than one century, since it's still impossible for "General Relativity + Quantum Theory" to highlight universal existence & motion in thorough coherence through and through, and living endeavor for development of science is still in its conventionality to accomplish colorful travelogues like daily goods stochastically, there is of course no tangible evidence for us to be convinced that General Relativity is absolute scientific verity.

And before naissance of absolute scientific verity, any contemporaneous scientific orthodoxy of science without demonstration of historical authenticity tolerance of science 0 is not qualified to be credible "logic basis/rationale" for lineal logic extension in rigid succession of contemporaneous scientific orthodoxy without misgivings. Although, before naissance of absolute scientific verity, there is no possibility for contemporaneous scientific orthodoxy to satisfy historical authenticity tolerance of science 0. And virtually, as historical feasibility & possibility, we usually do not blackball lineal logic extension in rigid succession of contemporaneous scientific orthodoxy for expedient progress of science before naissance of absolute scientific verity, and mostly, such kind of lineal logic extension in rigid succession of contemporaneous scientific orthodoxy can offer us intelligent

prediction towards authenticity of the unknown more or less, which can lead our sense to authenticity of nature draw on practical feasibility & possibility step by step. Whereas, any theoretical prediction towards authenticity of the unknown derived from such lineal logic extension in rigid succession of contemporaneous scientific orthodoxy ultimately needs support of substantial scientific authentication.

As theoretical modes of gravitational waves in accordance with General Relativity, since we do not have tangible evidence to ensure historical authenticity tolerance of science of General Relativity 0, LIGO have no evidence to ensure the theoretical modes of gravitational waves in accordance with General Relativity must be authentic modes of gravitational waves in cosmos, the authenticity of “theoretical modes of gravitational waves in accordance with General Relativity” still need support of further tangible demonstration. Even though, we have a lot reasons to believe in General Relativity according to our experience, we can never draw our positive conclusion upon our limited experience.

That’s to say, although theoretical mode of gravitational wave in accordance with General Relativity is primary rational judgement towards authentic mode of gravitational wave in the nature too, whereas, such primary rational judgement still need further tangible demonstration. Before accomplishment of tangible demonstration of authenticity of theoretical modes of gravitational waves in accordance with General Relativity, no matter how many “XX waves” similar as theoretical modes of gravitational waves in accordance with General Relativity practically perceived by LIGO, no matter how frequently LIGO perceived “XX waves” similar as theoretical modes of gravitational waves in accordance with General Relativity, and no matter how approximate the “XX waves” perceived by LIGO are relative to the theoretical modes of gravitational waves in accordance with General Relativity, LIGO has no full evidence to conclude the “XX waves” which they practically perceived are just “authentic gravitational waves” in the nature.

All in all, as long as we have no tangible evidence to ensure historical authenticity tolerance of General Relativity 0, General Relativity is not qualified to be undoubted “logic basis/rationale” for lineal logic extension without necessary tangible demonstration. As a result, before accomplishment of necessary tangible demonstration, we still lack evidence to ensure the theoretic gravitational waves tallying with contemporaneous scientific orthodoxy of General Relativity is just the authentic gravitational waves in the nature.

The second, try to search waves similar as “theoretical mode of gravitational waves” theoretically deduced in accordance with General Relativity with so-called “laser interferometer”.

First of all, since LIGO does not have full evidence to ensure their theoretical modes of gravitational waves in accordance with General Relativity are all wool and a yard wide format of gravitational waves in the nature, LIGO has no reason to conclude the “XX waves” they practically perceived around which are very similar as their theoretical modes of gravitational waves are just “gravitational waves” all wool and a yard wide in the nature.

Secondly, even though we do not suspect the XX waves LIGO perceived around are just the authentic gravitational waves in the nature, LIGO still can not offer full evidence to show people that the “XX waves” they practically perceived by so-called laser interferometer are just the “original format” of gravitational waves in the nature.

Because one determinant precondition for us to ensure the XX waves we perceived by laser interferometer are really original format of gravitational waves in the nature is that we must nail down the interaction fundamental

and interaction effect between gravitational waves and laser interferometer. However, as we know nothing about gravitational waves but able to predict existence of it theoretically at present, and it seems there is almost no way for LIGO to know interaction fundamental and interaction effect between gravitational waves and laser interferometer. Virtually, upon our nowadays wits, there is even no way for us to know the proper transmission conditions and proper transmission speed of gravitational waves, even though we do not suspect authentic existence of gravitational waves in the nature.

In fact, the physical connotation of the manner we introduce laser interferometer to search and identify “gravitational wave” in the nature is similar as the mathematical connotation of “x”, “y” and “f” in function $f(x, y)$.

The independent variable “x” in the function $f(x, y)$ is similar as the authentic wave-form of gravitational waves in the nature.

The resultant variable “y” in the function $f(x, y)$ is similar as the physical signal of the gravitational waves reflected on the laser interferometer.

The mathematical correlation “f” between the independent variable “x” and resultant variable “y” in the function $f(x, y)$ is similar as the interaction fundamental and interaction effect between gravitational wave and laser interferometer.

The key issue is that the so-called “gravitational wave signal” which is just the “XX wave” we perceived by laser interferometer is virtually the interaction image between so-called “gravitational wave” (virtually we have no evidence to ensure whether it's authentic gravitational wave or not) and “laser interferometer”, it maybe image from planar mirror or image from distorting mirror. Whereas, we know nothing about gravitational wave till today, no more the interaction fundamental and proper interaction effect between gravitational wave and laser interferometer. And virtually, in order to know the authentic wave-form of gravitational wave, we not only must know the perfect gravitational wave signal which is just the interaction image between gravitational wave and laser interferometer but also we must be aware of the interaction fundamental and proper interaction effect which is similar as the mapping correlation between variable independent variable X and output variable Y of function.

However, till today, we know nothing about “gravitational wave”, we even do not know the proper transmission conditions and transmission speed of gravitational wave in spacetime, no more the interactional fundamental even interaction effect between gravitational wave and laser interferometer. As a result, even though we are confident that the “XX wave” we perceived is just “interaction image” of authentic gravitational wave in the nature, we still lack full evidence to ensure the very “interaction image” of authentic gravitational wave which projects on laser interferometer is just the “original wave-form” of gravitational wave in the nature.

The third, perceived the target waves of “XX waves”, which is really similar as “theoretical mode of gravitational waves” theoretically deduced in accordance with General Relativity. Subsequently, substituted “XX waves” into logical operation of contemporaneous scientific orthodoxy for theoretical deduction, so that mechanical collision & combination of massive binary Black Holes faraway in large-scale spacetime was deduced accordingly.

The issue standing in the breach of the operation of LIGO gravitational wave discovery is still that LIGO have no full reasons to ensure the theoretical mode of gravitational wave in accordance with General Relativity is just the authentic mode of gravitational wave in the nature all along, as a result, no matter how many “XX waves” similar as theoretical mode of gravitational wave in accordance with General Relativity they practically perceived, they have no full reasons to conclude the “XX wave” is just authentic gravitational wave in the nature.

Secondly, LIGO did never practically find mechanical collision & combination of two massive Black Holes in spacetime, but substituted “XX wave” into logic operation of contemporaneous scientific orthodoxy for theoretical deduction of it, no more whether the “XX wave” is really gravitational wave in the nature or not, no more whether the “XX wave” is really in original wave-form of authentic gravitational wave in the nature or not.

So-called “theoretical deduction” of mechanical collision & combination of binary Black Hole in spacetime is but theoretical attempt that it substitute “XX wave” into logic operation of contemporaneous scientific orthodoxy for logic output which is mostly in rational mode of lineal logic extension in rigid succession of contemporaneous scientific orthodoxy. Even though we have no reasons to argue against LIGO showing conviction to contemporaneous scientific orthodoxy, whereas, in the face of the factuality whether there is authentic occurrence of mechanical collision & combination of binary Black Hole in spacetime as the corresponding theoretical deduction of LIGO or not, LIGO can only show the world they have substantial confidence to stake the authenticity of the theoretical deduction of mechanical collision & combination of binary Black Hole in spacetime at the most. At any rate, LIGO have no reasons to draw their positive conclusion upon their conviction to contemporaneous scientific orthodoxy. Otherwise, none struggle for progress of science is necessary any more, as long as we are confident enough of contemporaneous scientific orthodoxy, just upon the very trick, it seems none scientific issues are unsolvable.

The fourth, declare all over the world that LIGO has found mechanical collision & combination of massive binary Black Hole faraway in large-scale spacetime, and the mechanical collision & combination of the binary Black Holes triggered off gravitational wave as the “XX wave” LIGO perceived herein.

It’s of course not something accidental that “LIGO gravitational wave discovery” is so resounding all over the world. And indeed, the most remarkable feature of royal substantiation & perfection of contemporaneous scientific orthodoxy is that the meritorious successors of temporal social legitimacy are always ready to devote to high-sounding substantiation & perfection of contemporaneous scientific orthodoxy respectably instead of ready for highlight of vivid authenticity of accessible existence & motion in the nature. Even as complete “scientific free press customization”, “scientific free press admittance” and “social legitimacy authorization” are completely under autarchy of the meritorious successors of contemporaneous scientific orthodoxy who are mostly popular second-string geniuses of the very age, all coming academicians have to resignedly slide into eulogistic scientific knowledge proliferation in rigid succession of contemporaneous scientific orthodoxy for instinctive acclimation of magisterial volition of “free press regulation customization”, “free press admittance” even “social legitimacy authorization”. Thus, in the age of royal substantiation & perfection of contemporaneous scientific orthodoxy, so-called “historical progress of science” become full-time job to carry forward contemporaneous scientific orthodoxy without questions, as long as all coming academicians are subconsciously ready to devote themselves to carrying forward contemporaneous scientific orthodoxy, the perfect situation for historical progress of science has been ongoing, nothing else is necessary, even though all coming academicians are resignedly chorusing “the new clothing of the king is really beautiful”. Comparably, any aberrant scientific knowledge proliferation out of succession of contemporaneous scientific orthodoxy which is about vivid existence & motion of matter in cosmos indeed is of course something desolate. In any case, you have to admit nowadays reference popularity apparently gives out full-bodied taste like this.

If your scientific endeavor seems to make the scientific tree of contemporaneous scientific orthodoxy more branchy with flourishing leaves, or you offered eulogistic substantiation to contemporaneous scientific

orthodoxy like LIGO gravitational wave discovery that you have demonstrated some certain viewpoint of contemporaneous scientific orthodoxy is right, —great congratulations, you've entered popular highway of successive freewheeling substantiation & perfection of contemporaneous scientific orthodoxy, and royal Vanity Fair waiting for you over there very near. If your scientific endeavor seems nothing to do with royal substantiation & perfection of contemporaneous scientific orthodoxy like bigotry of aberrant scientific knowledge proliferation out of succession of contemporaneous scientific orthodoxy, or you even insist that some certain viewpoint of contemporaneous scientific orthodoxy is wrong, —sorry, since you are so ramstam to slide over popular highway of successive freewheeling of royal substantiation & perfection of contemporaneous scientific orthodoxy towards altisonant Vanity Fair, we have no reason to serve your perversion, state aside as vagabond heterodoxy stewing in your own grease, please.

The even serious inherence is that, as it's only possible for authenticity of nature to be unique and invariable, —authenticity of nature can be neither omnifarious authenticity smallwares full of a basket nor authenticity chameleon one piece and only, but coherent natura naturans throughout cosmic evolution, in accordance with the exact enantiomorphous correlation between objective authenticity of nature and humanistic ideology about authenticity of nature, it's neither possible for “the unique & invariable ultimate authenticity of nature” to be compatible with “two distinctive humanistic ideologies about authenticity of nature with remarkable ideological difference” nor possible for “two distinctive humanistic ideologies about authenticity of nature with remarkable ideological difference” to highlight and formulate “the unique & invariable ultimate authenticity of nature” coequally, —**the uniqueness & invariance of ultimate authenticity of nature predestines unique possibility of scientific verity**. This of course indicates ultimate consummation of science must be perfect ideological enantiomorph of ultimate authenticity of nature, as long as contemporaneous scientific orthodoxy has not been qualified as perfect ideological enantiomorph of ultimate authenticity of nature, successive pioneering achievement of historical progress of science in inherent optimum orientation towards perfect ideological enantiomorph of ultimate authenticity of nature must be different from contemporaneous scientific orthodoxy, and once successive pioneering achievement is authenticated relatively closer to perfect ideological enantiomorph of ultimate authenticity of nature, successive pioneering achievement of historical progress of science must wash out contemporaneous scientific orthodoxy without alternatives. Virtually, as permanent synthesized conditionality of “**crescive progression of practical feasibility & possibility in proportion to contemporaneous historical background + the uniqueness & invariance of ultimate authenticity of nature predestines the unique possibility of scientific verity as perfect ideological enantiomorph of ultimate authenticity of nature**” through and through, it's only possible for the major melody of historical progress of science to be a series of epochmaking scientific knowledge metabolism in inherent optimum orientation towards perfect ideological enantiomorph of ultimate authenticity of nature.

As two mainstays of modern physics, original naissance and successive development of Relativity and Quantum Theory were virtually proportionate ideological shift from macrophysics to microphysics when human rational purview gradually transferred from macrocosm to microcosmos. Whereas, in rational modality, Relativity and Quantum Theory are obviously two independent theories with remarkable distinction as twins brother and sister, which are impossible to be compatible. As a result, Relativity and Quantum Theory can never be perfect ideological enantiomorph of ultimate authenticity of nature, in any case, it's only possible for perfect ideological enantiomorph of ultimate authenticity of nature to be unique scientific verity one piece and only but never scientific verities this one and that one.

And indeed, in accordance with pure philosophic criterion that **it's only possible for concordant cosmos to be demiurgic aggradation of out-and-out serial natura naturata in the nature of coherent natura naturans throughout cosmic evolution; there is no way for demiurgic aggradation in the nature of different natura naturans to be concordant cosmos through and through**, there is no absolute scientific verity in live contemporaneous scientific orthodoxy. What's more, upon our thorough historical experience, it's almost impossible for inertial extension of successive freewheeling substantiation & perfection of contemporaneous scientific orthodoxy to approach epochmaking scientific innovation without special shift, which of course implies, if we do not break through the conventionality of freewheeling royal substantiation & perfection of contemporaneous scientific orthodoxy so as to release the living scientific knowledge proliferation bewitchment from inrooted conventionality of temporal legitimacy, it's almost impossible for coming scientific knowledge proliferation to approach historical authenticity tolerance of science 0 along inertial extension of royal substantiation & perfection of contemporaneous scientific orthodoxy of "General Relativity + Quantum Theory" straightway.

And just because of this, I have to comment two related issues as below:

A) **Realistic progress of science can never be free from restriction & conditionality of "crescive progression of practical feasibility & possibility in proportion to contemporaneous historical background + the uniqueness & invariance of ultimate authenticity of nature predestines the unique possibility of scientific verity as perfect ideological enantiomorph of ultimate authenticity of nature"**, and as permanent potential conditionality of **"crescive progression of practical feasibility & possibility in proportion to contemporaneous historical background + the uniqueness & invariance of ultimate authenticity of nature predestines the unique possibility of scientific verity as perfect ideological enantiomorph of ultimate authenticity of nature"** through and through, it's only possible for the practical accomplishment that humanistic ideology about authenticity of nature gradually approaches perfect ideological enantiomorph of ultimate authenticity of nature draw on practical feasibility & possibility in proportion to contemporaneous historical background to be serial scientific knowledge metabolism in inherent optimum orientation towards perfect ideological enantiomorph of ultimate authenticity of nature.

As long as we have to admit that ultimate authenticity of nature can neither be omnifarious authenticity smallwares full of a basket nor authenticity chameleon one piece and only, but coherent natura naturans throughout cosmic evolution, in accordance with historical inevitability of potential conditionality of **"crescive progression of practical feasibility & possibility in proportion to contemporaneous historical background + the uniqueness & invariance of ultimate authenticity of nature predestines the unique possibility of scientific verity as perfect ideological enantiomorph of ultimate authenticity of nature"**, if we suppose there are totally $T_1, T_2, T_3, T_4, \dots, T_{N-1}, T_N$ timely renovation of humanistic ideology about authenticity of nature in proportion to contemporaneous historical background throughout historical progress of science, whose historical authenticity tolerance of science are proportionately $T_{1\#}, T_{2\#}, T_{3\#}, T_{4\#}, \dots, T_{(N-1)\#}$. Among the N times of renovation of humanistic ideology about authenticity of nature in proportion to contemporaneous historical background, only the N^{th} rational renovation of humanistic ideology about authenticity of nature satisfies " $T_{N\#}=0$ ", which of course indicates the N^{th} rational renovation of humanistic ideology about authenticity of nature tallies with ultimate authenticity of nature 100 over 100 as perfect ideological enantiomorph of coherent natura naturans throughout cosmic evolution.

In accordance with the developmental fundamental of historical progress of science that incremental quantitative & qualitative change of historical progress of science must be in inherent optimum orientation towards historical authenticity tolerance of science 0, the quantitative change of historical authenticity tolerance

of science of the N times of renovation of humanistic ideology about authenticity of nature in proportion to contemporaneous historical background must be as following:

$$T_{1\#} > T_{2\#} > T_{3\#} > T_{4\#} > \dots > T_{(N-1)\#} > T_{N\#} = 0$$

The original generation orders of the N times of renovation of humanistic ideology about authenticity of nature in proportion to contemporaneous historical background along historical progress of science must be $T_1 \sim T_2 \sim T_3 \sim T_4 \sim \dots \sim T_{N-1} \sim T_N$.

And at the same time, throughout historical progress of science, any occurrence of renovation of humanistic ideology about authenticity of nature in proportion to contemporaneous historical background with relative advantage of historical authenticity tolerance of science close to 0 must wash out the live contemporaneous scientific orthodoxy whose historical authenticity tolerance of science is relatively bigger than the brand-new renovation of humanistic ideology about authenticity of nature in proportion to contemporaneous historical background, till at last, humanistic ideology about authenticity of nature tallies with ultimate authenticity of nature 100 over 100 as perfect ideological enantiomorph of ultimate authenticity of nature.

This of course indicates the scientific knowledge metabolism order of the N-1 scientific truths along historical progress of science is $T_1 \sim T_2 \sim T_3 \sim T_4 \sim \dots \sim T_{N-1}$ too, and finally, there is only the Nth renovation of humanistic ideology about authenticity of nature in proportion to contemporaneous historical background coexisting with human society ever since, which is in social legitimacy qualification of historical authenticity tolerance of science 0 as perfect ideological enantiomorph of ultimate authenticity of nature.

Virtually, it's just the rigid succession of scientific knowledge metabolism throughout historical progress of science hypostatize realistic historical progress of science in inherent optimum orientation towards historical authenticity tolerance of science 0. After all, as it's only possible for ultimate authenticity of nature to be unique and invariable, it's neither possible for "the unique & invariable ultimate authenticity of nature" to be compatible with "two distinctive humanistic ideologies about authenticity of nature with remarkable ideological difference" nor possible for "two distinctive humanistic ideologies about authenticity of nature with remarkable ideological difference" to discover and formulate "the unique & invariable ultimate authenticity of nature" coequally. And as crevice progression of practical feasibility & possibility in proportion to contemporaneous historical background, it's completely impossible for human to bring universal existence & motion into rational purview once and radically clarify universal existence & motion once, but only possible to accomplish commensurate humanistic ideology about authenticity of nature draw on practical feasibility & possibility in proportion to contemporaneous historical background then and there, it's only possible for the major melody of historical progress of science to be serial epochmaking scientific knowledge metabolism in inherent optimum orientation towards scientific legitimacy qualification of historical authenticity tolerance of science 0.

Throughout historical progress of science, in terms of any contemporaneous scientific orthodoxy out of scientific legitimacy qualification of historical authenticity tolerance of science 0, as long as permanent endeavor of development of science is to discover and formulate universal existence & motion as authentic, comprehensive and systematical as possible draw on practical feasibility & possibility in proportion to contemporaneous historical background, as long as historical progress of science is still on its normal way in inherent optimum orientation towards historical authenticity tolerance of science 0, it must be washed out by coming positive renovation of

humanistic ideology about authenticity of nature towards perfect ideological enantiomorph of ultimate authenticity of nature sooner or later, it's only possible for any contemporaneous scientific orthodoxy out of scientific legitimacy qualification of historical authenticity tolerance of science 0 to exist as idiographic progressive segment in proportion to contemporaneous historical background in crescive progression of historical progress of science.

After all, in accordance with rigorous enantiomorphous correlation between objective authenticity of nature and humanistic ideology about authenticity of nature, it's neither possible for "the unique & invariable ultimate authenticity of nature" to be compatible with "two distinctive humanistic ideologies about authenticity of nature with remarkable ideological difference" nor possible for "two distinctive humanistic ideologies about authenticity of nature with remarkable ideological difference" to discover and formulate "the unique & invariable ultimate authenticity of nature" coequally. Relativity & Quantum Theory can never be exceptive.

Virtually, as timely renovation of humanistic ideology about authenticity of nature in proportion to contemporaneous historical background of successive implication dilation of scientific practice from macrocosm to microcosmos in terminal years of 19th century and early years of 20th century, original naissance and successive royal substantiation & perfection of Relativity & Quantum Theory had not only perfectly accomplished ideological transition from macrophysics to microphysics but also had taken role of commensurate leading puissance of historical progress of science draw on freewheeling of practical feasibility & possibility in proportion to contemporaneous historical background.

However, we have to admit the historical limitation of Relativity & Quantum Theory, after freewheeling royal substantiation & perfection of contemporaneous scientific orthodoxy for half a century, it seemed it had exhausted its inherent potentiality to push humanistic ideology about authenticity of nature forward to perfect ideological enantiomorph of ultimate authenticity of nature, there were substantial evidence indicating modern physics has slidden into esoteric situation floundering around in riancy. Apparently, permanent endeavor of substantiation & perfection of Relativity & Quantum Theory can not accomplish historical progress of science as nonstop towards perfect ideological enantiomorph of ultimate authenticity of nature through and through. Original naissance and successive development of Relativity & Quantum Theory can only exist as idiographic progressive segment in proportion to contemporaneous historical background of 20th century in crescive progression of historical progress of science.

B) Royal substantiation & perfection of "Relativity + Quantum Theory" has been apparently impotent for historical progress of science to do its normal jobs to push humanistic ideology about authenticity nature forward to perfect ideological enantiomorph of ultimate authenticity of nature. Whereas, authoritative intrepidity of contemporaneous scientific orthodoxy is all-time and overwhelming, especially as magistral autarchy of "free press regulation customization" and "free press admittance" of temporal authority short of necessary intendance, free press admittance of successive renovation of humanistic ideology about authenticity of nature in proportion to contemporaneous historical background can hardly be free from duress of authoritative intrepidity of contemporaneous scientific orthodoxy once life-and-death scientific knowledge metabolism is inevitable, such situation must indubitably bring all potential top-ranking geniuses pestilent resistance in virulent scientific knowledge metabolism campaign.

Veritable progress of science is not intuitional cumulative achievement of colorful scientific travelogues A, B, C, D, E, F, ... as deserving reward of the first itineracy around preternatural landscapes of brand-new landmasses of science like omnifarious smallwares full of a basket but successive hypostatic endeavor to push humanistic ideology about authenticity of nature forward to perfect ideological enantiomorph of ultimate authenticity

of nature step by step draw on practical feasibility & possibility in proportion to contemporaneous historical background, which radically hypostatize general progress of science in inherent optimum orientation towards historical authenticity tolerance of science 0 through and through. Whereas, we have to admit, in the recent one century, progress of science is mostly royal substantiation & perfection of “Relativity + Quantum Theory”. And indeed, since the world war II, there is none top-ranking genius occurred in scientific exploration on the earth.

And on the other hand, nowadays science forum seems like VIP beadhouse of meritorious second-string geniuses who have ever carried forward contemporaneous scientific orthodoxy. Scientific free press is apparently under monopolization of temporal authority, science forum is homegrown outgrowth in the garden of contemporaneous scientific orthodoxy beyond all doubt, and the shopkeepers of living science forum are mostly the senior successors of “Relativity + Quantum Theory”, who are meritorious second-string geniuses for having offered substantiation of contemporaneous scientific orthodoxy or having carried forward contemporaneous scientific orthodoxy. The contributors are mostly the fresh successors of contemporaneous scientific orthodoxy who have ever turned over in traditional dye vat for a while and are anxious to stand out to show a distinctive attitude with some color on their bodies, and the men who monopolize free press regulation customization and free press admittance of science are of course the qualified successors of contemporaneous scientific orthodoxy. Science forum is superior entertainment of temporal authority. Such superior entertainment is of course favorable advantage for lineal logic extension in rigid succession of contemporaneous scientific orthodoxy of cordial successors of contemporaneous scientific orthodoxy.

Such scientific trick of LIGO gravitational wave discovery like producing more fog in haziness or building more floors on air castle can be so popular in homegrown science forum even so resounding all over the world directly depends on independent management & legitimacy authorization of scientific free press of temporal authority under general background of high-sounding royal substantiation & perfection of contemporaneous scientific orthodoxy. If I were editor or reviewer of physical review letters, I of course had no reasons to let LIGO gravitational wave discovery share the free press of the journal, because it's remarkable scientific trick like producing more fog in haziness or building more floors on air castle, no more rewarded it Nobel Prize.

This is just remarkable disparity between “**endeavor of substantiation & perfection of contemporaneous scientific orthodoxy**” and “**endeavor to push humanistic ideology about authenticity of nature forward to perfect ideological enantiomorph of ultimate authenticity of nature draw on practical feasibility & possibility in proportion to contemporaneous historical background**”. And just because modern science forum is out-and-out homegrown outgrowth in the garden of contemporaneous scientific orthodoxy for magistral autarchy of “**free press regulation customization**” & “**free press admittance**” of temporal authority short of necessary intendance, authoritative intrepidity of contemporaneous scientific orthodoxy is all-time even overwhelming, as timely renovation of ideology about authenticity of nature in proportion to contemporaneous historical background of remarkable highlight of microcosmic configuration of matter out of succession of contemporaneous scientific orthodoxy, Homogenous Cosmos Originated from Unique Genesis slid into the negative opposite of the social factuality inevitably.

And just because authoritative intrepidity of contemporaneous scientific orthodoxy is all-time and overwhelming, especially magistral autarchy of free press regulation customization and free press admittance of temporal authority short of necessary intendance, science forum is homegrown outgrowth in the garden of contemporaneous scientific orthodoxy beyond all doubt, no matter what kind of theory it is, as long as the authors are VIP like meritorious

second-string geniuses or loving successors of contemporaneous scientific orthodoxy who are always ready for royal substantiation & perfection of contemporaneous scientific orthodoxy, their theories must be arranged high-soundly without questions in defiance of necessary scientific authentication, although live contemporaneous scientific orthodoxy is still so far away from legitimacy qualification of historical authenticity tolerance of science 0. As a result, many hazy and flirtatious lineal logic extension in rigid succession of contemporaneous scientific orthodoxy entered rational purview of human in a walk for superior self-sportful of temporal authority, many subjective prejudice of temporal authority was adulterated in human rational purview.

For instance, **whether there are really “Black Holes” in cosmos?**

Till today, **besides theoretical prediction in rational model of linear logic extension in succession of so-called contemporaneous scientific orthodoxy out of scientific legitimacy qualification of historical authenticity tolerance of science 0, we have no credible evidence about authentic existence of so-called “Black Hole” in cosmos indeed, modern popularity of Black Hole Theory is but superiority of second-string geniuses stepping in the air against living social legitimacy qualification of contemporaneous scientific orthodoxy of the age. You can of course comprehend, before humanistic ideology about authenticity of nature finally qualified as perfect ideological enantiomorph of ultimate authenticity of nature, so-called “scientific truths” are mostly “authoritative patents” under backup of authoritative intrepidity of contemporaneous scientific orthodoxy then and there.**

Whereas, we have to admit nowadays science forum is out-and-out homegrown outgrowth in the garden of contemporaneous scientific orthodoxy due to magistral autarchy of free press regulation customization and free press admittance of temporal authority short of necessary intendance towards substantiation & perfection of contemporaneous scientific orthodoxy. As long as your scientific idea about Black Holes in your imagination tallies with the popular leitmotiv of royal substantiation & perfection of contemporaneous scientific orthodoxy, you can of course pass free press egotistic proximity identification smoothly. If you are even able to list substantial respectable references behind your paper, your free press admittance even legitimacy authorization can be expediently smooth in the nature of things, you can even gain Nobel Prize as **LIGO Gravitational Wave Discovery** at the volley. However, once you come to suspect authentic existence of Black Holes in cosmos, you must slid into virulent scientific knowledge metabolism campaign under pestilent duress of overwhelming authoritative intrepidity of contemporaneous orthodoxy, your free press admittance has to challenge venomous counterwork upper limit of temporal authority beyond all doubt, although, till today, nobody can offer credible evidence whether there is really Black Holes in cosmos or not.

Virtually, in any historical stage of historical progress of science, as long as development of science is always endeavor to discover and formulate accessible existence & motion around us as authentic, comprehensive and systematical as possible draw on practical feasibility & possibility in proportion to contemporaneous historical background, it's impossible for realistic historical progress of science in inherent optimum orientation towards perfect ideological enantiomorph of ultimate authenticity of nature in legitimacy qualification of historical authenticity tolerance of science 0 to be completely limited in interminable royal substantiation & perfection of contemporaneous scientific orthodoxy. Especially, when practical progress of science apparently betrays that **interminable royal substantiation & perfection of contemporaneous scientific orthodoxy \neq general progress to push humanistic ideology about authenticity of nature forward to perfect ideological enantiomorph of ultimate authenticity of nature draw on practical feasibility & possibility in proportion to contemporaneous historical background,** coming renovation of humanistic ideology about

Historical progress of science in the recent several centuries seemed like a far-flung exploration of the first itinerary around numerous distinctive landscapes of brand-new landmasses of science with palette & tablet on back, several hundred years' scientific travelogues were compiled thereby.

authenticity of nature in proportion to contemporaneous historical background must be more and more necessary, no matter whether there is necessary & adequate humanistic potentiality of practical feasibility & possibility as favorable headspring ready for it. The even pestilent factuality is that, as magistral autarchy of free press regulation customization and free press admittance of temporal authority short of necessary intendance, free press admittance of your aberrant scientific knowledge proliferation can hardly be free from duress of authoritative intrepidity of contemporaneous scientific orthodoxy, unless you silently keep your idea in your own pocket all along instead of attempt for normal free press admittance, which is of course typical conservative officialism domino effect of contemporaneous scientific orthodoxy.

And indeed, high-sounding LIGO gravitational wave discovery all over the world is not something accidental, instead, it's just the typical instance in proportion to the factuality that substantiation & perfection of "Relativity + Quantum Theory" has been impotent, whereas, authoritative intrepidity of contemporaneous scientific orthodoxy is still all-time. And virtually, there are substantial similar occurrence in nowadays scientific study, especially in the fields deep into microcosm or faraway in the space where you can never perceive yourself but the words from temporal authorities are always something undoubted, such as The Big Bang, Black Holes in cosmos, Dark matter, Dark energy, ... Higgs particle etc. Why are they so popular in the world?

The key issue is that, on one hand, historical progress of science extends to today, as scientific truths has been relatively superior, we are not only difficult to find a fly in the ointment of live contemporaneous scientific orthodoxy, but also even difficult to demonstrate a brand-new theory which is even superior, and virtually, the demonstration reliability & capability of some certain experiment to target physical factuality becomes more and more esoteric. And on the other hand, authoritative intrepidity of contemporaneous scientific orthodoxy is all-time and overwhelming, especially, free press regulation customization and free press admittance is under magistral autarchy of temporal science aristocracy short of necessary intendance, so that, once people come to evaluate the social worthiness of some brand-new humanistic ideology about authenticity of nature, the most determinant thing is of course not how near is the brand-new humanistic ideology about authenticity of nature close to perfect ideological enantiomorph of ultimate authenticity of nature, but whether the brand-new humanistic ideology about authenticity of nature has passed esoteric authoritative social legitimacy identification & authentication from temporal authority. Of course, endeavor of substantiation & perfection of temporal has inherent advantage to pass esoteric authoritative social legitimacy identification & authentication from temporal authority, whereas, if your humanistic ideology about authenticity of nature is outcome of typical aberrant scientific knowledge proliferation out of succession of contemporaneous scientific orthodoxy, no matter how near your humanistic ideology about authenticity of nature is close to perfect ideological enantiomorph of ultimate authenticity of nature, as long as temporal authority are able to wisely slide over social authentication or jesuitically keep silent aside, your renovation of humanistic ideology about authenticity of nature will be something nonexistent in the world therefore.

The even pestilent factuality is that, as temporal authority mostly implement free press egotistic proximity identification straightway, endeavor of substantiation & perfection of contemporaneous scientific orthodoxy is always easy to pass free press egotistic proximity identification. Whereas, aberrant scientific knowledge proliferation has to challenge authoritative intrepidity of contemporaneous scientific orthodoxy. Such factuality will of course bring out great resistance to coming necessary scientific knowledge metabolism. Since "free press regulation customization" and "free press admittance" is under magistral autarchy of temporal authority short of necessary

intendance, nothing can prevent self-preservation of human to be adulterated into puissance implementation of “free press regulation customization” and “free press admittance” itself, which may be even implemented as con-ignorable determinant in social legitimacy authorization of brand-new humanistic ideology about authenticity of nature in proportion to contemporaneous historical background.

Although, high-sounding royal substantiation & perfection of contemporaneous scientific orthodoxy has been impotent, authoritative intrepidity of contemporaneous scientific orthodoxy is always all-time and overwhelming, so that, on one hand, modern physics is floundering in riancy, and on the other hand, aberrant scientific knowledge proliferation can hardly get rid of free press embarment. LIGO gravitational wave discovery was so high-sounding all over the world even was rewarded physical Nobel prize 2017 was substantively not something accidental, it’s typical mirror of superior self-sportful of authoritative second-string geniuses under background of royal substantiation & perfection of contemporaneous scientific orthodoxy. Such authoritative intrepidity of so-called second-string geniuses under royal substantiation & perfection of contemporaneous scientific orthodoxy can not only bring out blackhearted ascendancy in coming inevitable scientific knowledge metabolism campaign but also misdirect coming progress of science.

And indeed, the scientific incredibility and authoritative impavidity of LIGO gravitational wave discovery have proportionably exposed the sense weakness and the authoritative impavidity of loving successors of “Relativity + Quantum Theory” even popular second-string geniuses of the age. We may even suspect, as popular second-string geniuses and loving successors of contemporaneous scientific orthodoxy under the well-off background of royal substantiation & perfection of “Relativity + quantum theory”, in order to take a bow to substantial fund support, LIGO might have had a card up their sleeves before the laser interferometer having been built up. At any rate, endeavor to contribute a beautiful flower on head of the tzar is always something expedient and easy; comparably, endeavor to drag the tzar down from his horse is really great challenge. And indeed, “Black Hole” is really magic expedience for authoritative exertion for nobody is able to see about it but only able to image it according to canonical comment of the loving successors of contemporaneous scientific orthodoxy as theoretical prediction of lineal logic extension of contemporaneous scientific orthodoxy out of scientific legitimacy qualification of historical authenticity tolerance of science 0. We have to admit it’s really wise for LIGO to invoke mechanical collision & combination of binary Black Hole in spacetime to take care of “gravitational wave discovery”.

Virtually, the rational operation of LIGO gravitational wave discovery can only support conclusion, **if we assume the theoretical mode of gravitational wave in accordance with General Relativity is really the authentic mode of gravitational wave in the nature, we can exclude adulterant of non-gravitational-waves around 100 over 100, which are very similar as gravitational waves, and we’ve practically perceived the “XX wave” which is substantively similar as theoretical mode of gravitational waves theoretically deduced in accordance with General Relativity, LIGO can reluctantly conclude that the “XX wave” may be “gravitational wave”.** However, LIGO still lack full reasons to conclude the “XX wave” they perceived is just the original wave-form of authentic gravitational wave in the nature, no more the freebooting that substituting “XX wave” into logical operation of contemporaneous scientific orthodoxy as initial parameters for theoretical deduction of mechanical collision & combination of binary Black Holes in spacetime is equivalent to reality that mechanical collision & combination of binary Black Holes in spacetime has been perceived.

The practical operation of LIGO gravitational wave discovery is substantively similar as romantic modus

Historical progress of science in the recent several centuries seemed like a far-flung exploration of the first itinerary around numerous distinctive landscapes of brand-new landmasses of science with palette & tablet on back, several hundred years’ scientific travelogues were compiled thereby.

operandi a father who has never seen his son to find his son as below.

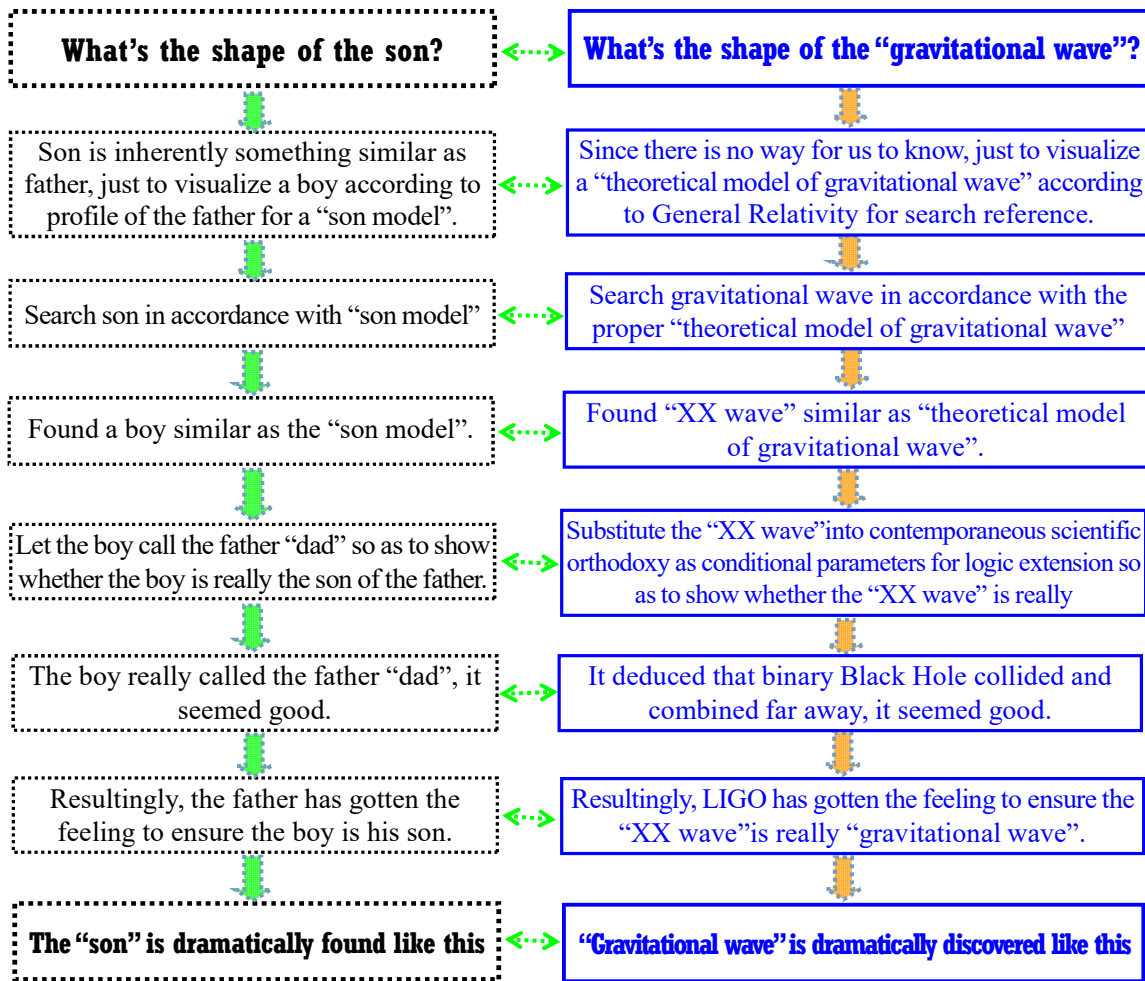

(III-i-3-a) practical operation of "LIGO gravitational wave discovery" is similar as a father who has never seen his son to seek his son.

The most straightforward officialism domino effect of magistral autarchy of free press regulation customization & free press admittance is that live scientific knowledge proliferation all over the world must be rigid succession of contemporaneous scientific orthodoxy like omnifarious scientific travelogues A, B, C, D, E, F, ... in defiance of authenticity that cosmos is but demiurgic aggradation of out-and-out serial natura naturata in the nature of coherent natura naturans throughout cosmic evolution and free press admittance of any aberrant scientific knowledge proliferation out of succession of contemporaneous scientific orthodoxy must challenge venomous counterwork upper limit of temporal authority, which is not only root cause to make endeavor of royal substantiation & perfection of contemporaneous scientific orthodoxy popular keynote of historical progress of science of the age and make so-called modern science forum out-and-out homegrown outgrowth in the garden of contemporaneous scientific orthodoxy but also expediential officialism facility for temporal authority to involve in inevitable life-and-death scientific knowledge metabolism campaign in the nature of human self-preservation due to inevitability of historical progress of science in inherent optimum orientation towards perfect ideological enantiomorph of ultimate authenticity of nature in conditionality of crescive progression of practical feasibility & possibility in proportion to contemporaneous historical background.

Under egotistic background of interminable royal substantiation & perfection of contemporaneous scientific

As coherent natura naturans throughout cosmic evolution, instinctive PNT reciprocal equilibrium towards optimum PNT operation is radical potentiality & conditionality for cosmos always ready to orientate itself towards perfection.

orthodoxy, as expedient official facility of magistral autarchy of **free press regulation customization & free press admittance** of temporal authority like lavish hierarchies waiting for devotional loving successors, entrance ticket is of course free press egotistic proximity identification, all endeavor for high-sounding royal substantiation & perfection of contemporaneous scientific orthodoxy always seems expedient shortcut like complaisant dedication of a beautiful flower on head of magnate in Vanity Fair, especially the loving successors of contemporaneous scientific orthodoxy with respectable coronet on head, whose complaisant coquetry apparently slide over necessary scientific authentication. What's more, under egotistic background of interminable royal substantiation & perfection of contemporaneous scientific orthodoxy, in terms of modern scientific project on the earth, it casts more fund of human, we mostly expect more of the consequence for scientific development, whereas, consequence may not always be as expected, the altisonant responsible undertakers are always ready to proportionably procure more high-sounding hype all over the world to balance the cost in defiance of practical consequence of the scientific exploration. The pestilent hazard of the occurrence is not we are unable to pay so high-sounding hype, but too high-sounding hype of insignificant consequence of expensive scientific exploration must directly misdirect historical progress of science somehow, it maybe even build up colossal puissance obstacle before social subsistence of coming renovation of humanistic ideology about authenticity of nature, especially to poor innovators. Relatively, **LIGO gravitational wave discovery** is still a small case, you must remember the high-sounding "**Big Bang**" of the age.

All in all, under egotistic background of interminable royal substantiation & perfection of contemporaneous scientific orthodoxy, we have to pay close attention to esoteric occurrence that some expensive but inferior scientific theories are excessively authorized even high-soundly hyped by freewheeling authoritative intrepidity of contemporaneous scientific orthodoxy. In any case, veritable progress of science is always endeavor to push humanistic ideology about authenticity of nature forward to perfect ideological enantiomorph of ultimate authenticity of nature step by step draw on practical feasibility & possibility in proportion to contemporaneous historical background but not interminable royal substantiation & perfection of contemporaneous scientific orthodoxy.

Are there really "Black Holes" in cosmos?

There was even buzz on website on April 10 2019 that the first "**Black Hole photo**" promulgated all over the world. In the photo, the saffron yellow Black Hole looks like an eye watching the cosmos, the Black Hole locates in ShiNv constellation/室女座 which is 55 million light-years away from us. In order to take the photo, more than 100 academicians spent 10 years.

Oh~, my God, such scientific trick to show off "**Black Hole photo**" is even more redoubtable than LIGO having perceived "mechanical collision & combination of binary Black Hole" far away in spacetime!

Who can demonstrate the so-called "saffron yellow shadow area" is just realistic existence of "Black Hole"??

What's the objectivity in the photo for us to draw positive conclusion the photo is none else but "Black Hole"??

And it substantively indicates that, under favorable background of high-sounding royal substantiation & perfection of contemporaneous scientific orthodoxy, "endeavor of substantiation & perfection of contemporaneous scientific orthodoxy" is expediently accessible operation/shortcut for loving successors of contemporaneous scientific orthodoxy to approach "fame & gain". And indeed, under background of high-sounding royal substantiation & perfection of contemporaneous scientific orthodoxy with favorable backup of magistral autarchy of free press regulation customization and free press admittance of temporal authority short of necessary intendance, endeavor of substantiation & perfect of contemporaneous scientific orthodoxy is so downwind easy to approach authoritative

Historical progress of science in the recent several centuries seemed like a far-flung exploration of the first itinerary around numerous distinctive landscapes of brand-new landmasses of science with palette & tablet on back, several hundred years' scientific travelogues were compiled thereby.

identification and legitimacy authorization without credible scientific authentication, if some **respectable references** can be added for supplementation, it must be nice job out of question. In any case, credible scientific evidence about “Black Hole” is inaccessible, taking a complimentary role behind temporal authority is really good way to show off their respectable officialism as loving successors of contemporaneous scientific orthodoxy all wool and a yard wide, which can of course make them optimistically popular and worthy in royal substantiation & perfection of contemporaneous scientific orthodoxy.

What's “**royal substantiation & perfection of contemporaneous scientific orthodoxy**” on earth?

As lacking of necessary foreknowledge of status quo of sciences and historical progress of science, as science hierarchy of the age, once timely renovation of humanistic ideology about authenticity of nature in proportion to contemporaneous historical background procured social legitimacy qualification and consequently became contemporaneous scientific orthodoxy of the age, temporal authority mostly had no sense of historical limitation of the burgeoning contemporaneous scientific orthodoxy even ignorant of the inherence of historical progress of science that, as permanent synthesized conditionality of “**crescive progression of practical feasibility & possibility in proportion to contemporaneous historical background + the uniqueness & invariance of ultimate authenticity of nature predestines the unique possibility of scientific verity as perfect ideological enantiomorph of ultimate authenticity of nature**” through and through, it's only possible for the major melody of historical progress of science to be a series of epochmaking scientific knowledge metabolism in inherent optimum orientation towards perfect ideological enantiomorph of ultimate authenticity of nature, and veritable progress of science is not intuitional cumulative achievement of colorful scientific travelogues A, B, C, D, E, F, ... like omnifarious smallwares full of a basket, but successive hypostatic endeavor to push humanistic ideology about authenticity of nature forward to perfect ideological enantiomorph of ultimate authenticity of nature step by step draw on practical feasibility & possibility in proportion to contemporaneous historical background.

As a result, temporal authority mostly overrate legitimacy qualification of live contemporaneous scientific orthodoxy for cock-a-hoop self-appreciation and consequently insist scientific truths of contemporaneous scientific orthodoxy are all absolute scientific verities beyond all doubt, so that they seem confident that all the rest jobs for historical progress of science are but interminable royal substantiation & perfection of contemporaneous scientific orthodoxy going without saying. And as authoritative intrepidity of contemporaneous scientific orthodoxy is all-time and overwhelming, they even insist that all coming scientific knowledge proliferation all over the earth must be in rigid succession of contemporaneous scientific orthodoxy ever since, otherwise, there is no way for free press admittance.

Virtually, historical progress of science is always endeavor to push humanistic ideology about authenticity of nature forward to perfect ideological enantiomorph of ultimate authenticity of nature step by step draw on practical feasibility & possibility in proportion to contemporaneous historical background, it's almost impossible for **royal substantiation & perfection of contemporaneous scientific orthodoxy = general progress of science** all under egotistic restriction of authoritative intrepidity of contemporaneous scientific orthodoxy must lack of alignment of original endeavor of historical progress of science to push humanistic ideology about authenticity of nature forward to perfect ideological enantiomorph of ultimate authenticity of nature step by step draw on practical feasibility & possibility in proportion to contemporaneous historical background.

And indeed, as permanent synthesized conditionality of “**crescive progression of practical feasibility & possibility in proportion to contemporaneous historical background + the uniqueness & invariance of ultimate authenticity of nature predestines the**

unique possibility of scientific verity as perfect ideological enantiomorph of ultimate authenticity of nature” through and through, it’s only possible for the major melody of historical progress of science to be a series of epochmaking scientific knowledge metabolism in inherent optimum orientation towards perfect ideological enantiomorph of ultimate authenticity of nature.

And indeed, live contemporaneous scientific orthodoxy originally came into being during the course of ideological transition of human from macrophysics to microphysics, as historical interposition of various credible microcosmic factuality obviously broke through conventionality of ready-made macrophysics, human had to review universal existence & motion systematically again, and of course, the updated ideological system about authenticity of universal existence & motion must be compatible to the microcosmic factuality newly highlighted. As a result, Relativity and Quantum Theory came into being under contemporaneous historical background therefore. We should admit this was hypostatic possible advancement of historical progress of science in early years of 20th century in proportion to commensurate practical feasibility & possibility then and there. And at the same time, we should also admit, as practical feasibility & possibility in proportion to contemporaneous historical background, Relativity and Quantum Theory are still far away from perfect ideological enantiomorph of ultimate authenticity of nature. As a result, coming historical progress of science can never be nonstop of substantiation & perfection of contemporaneous scientific orthodoxy for ever, especially, coming scientific knowledge proliferation all over the world should not be restricted in rigid succession of contemporaneous scientific orthodoxy under egotistic guidance of temporal authority, no more scientific knowledge metabolism campaign under powerful duress of overwhelming authoritative intrepidity of contemporaneous scientific orthodoxy. What’s more, we have to admit so-called modern science forum is homegrown outgrowth in the garden of contemporaneous scientific orthodoxy beyond all doubt; what’s more, nowadays free press regulation customization & free press admittance is completely under magistral autarchy of temporal authority short of necessary intendance.

And indeed, the most remarkable feature of royal substantiation & perfection of contemporaneous scientific orthodoxy is that, under precondition that live contemporaneous scientific orthodoxy is still out of scientific legitimacy qualification of historical authenticity tolerance of science 0, high-sounding royal substantiation & perfection of contemporaneous scientific orthodoxy seems ready to monopolize comprehensive social resource for general progress of science draw on authoritative intrepidity of contemporaneous scientific orthodoxy which is mostly derived from intrepid superiority of the living second-string geniuses of the age, although, it’s self-evident that royal substantiation & perfection of contemporaneous scientific orthodoxy \neq original endeavor of historical progress of science to push humanistic ideology about authenticity of nature forward to perfect ideological enantiomorph of ultimate authenticity of nature draw on practical feasibility & possibility in proportion to contemporaneous historical background. And just because of permanent domino effect of authoritative intrepidity of contemporaneous scientific orthodoxy, living scientific knowledge proliferation all over the world must be in rigid succession of contemporaneous scientific orthodoxy, otherwise, there is no way for free press egotistic proximity identification.

The scientific idea of Black Hole originally came into being in 1798, Laplace invoked the gravity formulation of $F=G(Mm)/R^2$ for lineal logic extension in succession of contemporaneous scientific orthodoxy in 18th century then and there, if there is a celestial body whose density is similar as the sun and radius is 250 times of the sun, the celestial body will produce enormous gravity on its surface, even lights can hardly escape from the surface of the celestial body.

Historical progress of science in the recent several centuries seemed like a far-flung exploration of the first itinerary around numerous distinctive landscapes of brand-new landmasses of science with palette & tablet on back, several hundred years’ scientific travelogues were compiled thereby.

However, **are there really Black Holes in cosmos?**

At any rate, we have none credible scientific authentication ever since!

However, draw on implementation of **linear logic extension in succession of contemporaneous scientific orthodoxy** off the cuff against authoritative intrepidity of contemporaneous scientific orthodoxy out of scientific legitimacy qualification of historical authenticity tolerance of science 0, temporal authority predicted existence of Black Holes in cosmos, and under precondition of magistral autarchy of “free press regulation customization” and “free press admittance” of temporal science aristocracy short of necessary intendance, science forum is homegrown outgrowth in the garden of contemporaneous scientific orthodoxy beyond all doubt, any scientific paper about Black Holes in cosmos, no matter whether it has credible scientific authentication or not, as long as it tallies with leitmotiv & popularity of high-sounding royal substantiation & perfection of contemporaneous scientific orthodoxy, it must be easy to pass free press admittance and authoritative legitimacy authorization, it's even possible to win Nobel Prize as LIGO gravitational wave discovery. On the contrary, if your scientific idea does not tally with leitmotiv of royal substantiation & perfection of contemporaneous scientific orthodoxy, you have to challenge authoritative intrepidity of contemporaneous scientific orthodoxy as scientific heterodoxy without alternatives, there may be no way for you to break through free press embarment.

This is of course typical anachronism of **interminable substantiation & perfection of contemporaneous scientific orthodoxy** instead of normal endeavor of historical progress of science to push humanistic ideology about authenticity of nature forward to perfect ideological enantiomorph of ultimate authenticity of nature step by step draw on practical feasibility & possibility in proportion to contemporaneous historical background.

However, upon our dispassionate sense, we have to admit, as humanistic ideology about authenticity of nature in proportion to contemporaneous historical background, so-called “Black Hole” is but delicate and transitory flower on head of so-called scientists for exertion of lineal logic extension in succession of contemporaneous scientific orthodoxy in defiance of whether legitimacy qualification of contemporaneous scientific orthodoxy historical authenticity tolerance of science 0, but never consequence derived from credible scientific authentication.

Are there really “**Black Holes**” in cosmos? The issue is still serious & challenging till today.

Whereas, LIGO suddenly rushed out that they had found mechanical collision of binary Black Holes, and gravitational wave was produced by the very mechanical collision of binary Black Holes, because they had perceived some a little “XX wave” very similar as the theoretical model of gravitational wave which was deduced in accordance with Relativity.

Since human grown up on the earth, when have we found “mechanical collision & combination of discretionary two stars” in cosmos?

Whereas, in order to make gravitational wave discovery vivid ghost story of science, LIGO found mechanical collision & combination of binary Black Holes so frequently as they met their wives & sons at home. Objects visible as stars around us never collide and combine, objects invisible as Black Holes collide and combine so often.

Don't you think such factuality esoteric and unintelligible?

However, under background of interminable royal substantiation & perfection of contemporaneous scientific orthodoxy, as magistral autarchy of free press regulation customization and free press admittance of temporal authority short of necessary intendance, vivid ghost story of science like gravitational wave discovery is just the very thing for expedient free press admittance and scientific legitimacy authorization towards royal substantiation

& perfection of contemporaneous scientific orthodoxy, it even could be rewarded physical Nobel Prize going without saying.

As innovative cosmos redefinition in radical logic enantiomorph of newly highlighted factuality that **discretionary two particles in cosmos are mutually convertible** with consequent PNT dynamics about universal existence & motion in the nature of coherent natura naturans throughout cosmic evolution, Homogenous Cosmos Originated from Unique Genesis radically persists that universal existence & motion are but spontaneous occurrence of **[External physical disturbance + (PNT action + Instinctive PNT equilibrium)]**. Any hypostatic existence & motion in cosmos can only incarnate spontaneous occurrence of **[External physical disturbance + (PNT action + Instinctive PNT equilibrium)]** as much as possible, none supernatural existence & motion can exceed category of spontaneous occurrence of **[External physical disturbance + (PNT action + Instinctive PNT equilibrium)]**, which is virtually objectivity as spontaneous occurrence due to essence of matter in a class by itself. As spontaneous occurrence due to essence of matter in a class by itself, any hypostatic existence & motion in cosmos can never impact essence of matter in a class by itself but to incarnate essence of matter in a class by itself as much as possible. In straightforward words, none hypostatic existence & motion in cosmos can change normal matter in cosmos into larruping “immateriality”, which of course include there is none hypostatic existence & motion in cosmos able to change normal celestial bodies into so-called “Black Hole”. Virtually, so-called spontaneous occurrence of **[External physical disturbance + (PNT action + Instinctive PNT equilibrium)]** is just coherent natura naturans throughout cosmic evolution, none hypostatic existence & motion in cosmos can change normal celestial bodies into so-called “Black Hole” directly indicates “Black Hole” is out of outgrowth range of coherent natura naturans throughout cosmic evolution.

Whereas, as low-down man of the society and typical heterodoxy of the age, free press admittance of Homogenous Cosmos Originated from Unique Genesis can never be free from pestilent duress of overwhelming authoritative intrepidity of contemporaneous scientific orthodoxy, and just because free press admittance of Homogenous Cosmos Originated from Unique Genesis directly impacts vested interest of temporal authority, there is almost nobody ready to displease overwhelming temporal authority for free press admittance of Homogenous Cosmos Originated from Unique Genesis, what’s more, under interminable royal substantiation & perfection of contemporaneous scientific orthodoxy, free press regulation and free press admittance is completely under magistral autarchy of temporal authority short of necessary intendance. As a result, there is almost no way for Homogenous Cosmos Originated from Unique Genesis to pass free press admittance on the earth, till today, I am still floundering around in vicious circle of virulent scientific knowledge metabolism campaign. This of course indicates humanistic operation quality of so-called modern science forum.

All in all, against the faint background whether there are really “Black Holes” in cosmos, LIGO gravitational wave discovery was obvious endeavor to produce more fog in haziness or was intention to build more floors on air castle indeed. Are there credible reasons for us to affirm that LIGO gravitational wave discovery is but incredible scientific discovery —unintelligible scientific trick, vivid ghost story of science?

The practical operation of LIGO gravitational wave discovery really seemed like a scientific sacrifice before grave of Einstein with fete-pean of General Relativity. On one hand, whether theoretical mode of gravitational wave in accordance with General Relativity is really authentic gravitational wave mode in the nature still needs necessary “scientific authentication”. Since we lack adequate evidence to be sure of historical authenticity tolerance of science 0 of contemporaneous scientific orthodoxy, nothing can support us to believe in lineal logic extension

Historical progress of science in the recent several centuries seemed like a far-flung exploration of the first itinerary around numerous distinctive landscapes of brand-new landmasses of science with palette & tablet on back, several hundred years’ scientific travelogues were compiled thereby.

in succession of contemporaneous scientific orthodoxy without necessary scientific authentication, before approaching credible scientific authentication, no matter how many “XX waves” similar as theoretical mode of gravitational wave in accordance with General Relativity have been practically perceived by LIGO, LIGO have no adequate reasons to draw positive conclusion that the “XX wave” similar as theoretical mode of gravitational wave in accordance with General Relativity is just “authentic gravitational wave” in the nature.

And on the other hand, endeavor to substitute XX wave as initial parameters into logical operation of contemporaneous scientific orthodoxy for theoretical deduction of mechanical collision & combination of binary Black Hole in spacetime can never be equivalent to realistic mechanical collision & combination of binary Black Hole in spacetime having been perceived, it's but thinkable imagination against rationale of contemporaneous scientific orthodoxy. **logical operation in accordance with contemporaneous scientific orthodoxy out of scientific legitimacy qualification of historical authenticity tolerance of science 0 for theoretical deduction of mechanical collision & combination of binary Black Holes in spacetime \equiv objectivity that we have perceived mechanical collision & combination of binary Black Holes in spacetime** is typical bandit logic with backup of authoritative intrepidity of contemporaneous scientific orthodoxy, unless we are able to prove that live contemporaneous scientific orthodoxy has satisfied scientific legitimacy qualification of historical authenticity tolerance of science 0 indeed.

What's more, till today, whether there are really Black Holes in cosmos or not, there are only theoretical predictions in rational mode of lineal logic extension of contemporaneous scientific orthodoxy out of scientific legitimacy qualification of historical authenticity tolerance of science 0 without any credible scientific authentication, no more practical possibility of mechanical collision of any binary Black Hole in spacetime.

Wo~Se~, how wonderfully the dinosaur in Jack's house dances!

—Written in Feb. 2016, revision was done in June.2016
Further revision was done in Oct 2017

Supplemental note ②: Historical progress of human civilization is of course syntonic reciprocity of “humanistic ideology about authenticity of nature” and “proportionate social practice” draw on practical feasibility & possibility in proportion to contemporaneous historical background, which directly incarnates immanent orientation of historical progress of human civilization. In accordance with general feature of quantitative & qualitative change of humanistic ideology & proportionate social practice along intrinsic progression of historical progress of human civilization, geniuses of human society related to historical progress of human civilization can be generally classified into three ranks.

1. **Top-ranking geniuses:** Throughout historical progress of human civilization, top-ranking geniuses are just the pioneering creators who contribute the epochmaking foreknowledge at pioneering foreland of knowledge multiplication so as to lead remarkable tideway towards historical progress of human civilization then and there. In human history, Vinci, Copernicus, Galileo, Beethoven, Newton, Darwin ... Einstein, Bohr ... Michael-Jackson etc were typical top-ranking geniuses.

As coherent natura naturans throughout cosmic evolution, instinctive PNT reciprocal equilibrium towards optimum PNT operation is radical potentiality & conditionality for cosmos always ready to orientate itself towards perfection.

However, as crescive progression of practical feasibility & possibility in proportion to contemporaneous historical background and the uniqueness & invariance of ultimate authenticity of nature proportionably predestines the unique humanistic possibility of scientific verity, for you see, there is completely no possibility for two distinctive scientific truths with remarkable ideological difference to formulate the unique and invariable ultimate authenticity of nature coequally, the major melody of historical progress of science must be serial epochmaking scientific knowledge metabolism in inherent optimum orientation towards perfect ideological enantiomorph of ultimate authenticity of nature. Throughout historical progress of science, as pioneering renovator of humanistic ideology about authenticity of nature forward to perfect ideological enantiomorph of ultimate authenticity of nature draw on practical feasibility & possibility in proportion to contemporaneous historical background, hypostatic endeavor of top-ranking geniuses inevitably break through conventionality of live contemporaneous scientific orthodoxy and consequently accomplish scientific keynote of coming age, which is of course remarkable innovation for historical progress of science. As a result, there was substantial probability for top-ranking geniuses to slide into virulent scientific knowledge metabolism campaign, especially in early years of historical progress of science. After all, as it's only possible for ultimate authenticity of nature to be unique and invariable, absolute scientific verity about universal existence & motion can only be perfect ideological enantiomorph of ultimate authenticity of nature. in accordance with rigorous enantiomorphous correlation between objective authenticity of nature and humanistic ideology about authenticity of nature, it's neither possible for "the unique & invariable ultimate authenticity of nature" to be compatible with "two distinctive humanistic ideologies about authenticity of nature with remarkable ideological difference" nor possible for "two distinctive humanistic ideologies about authenticity of nature with remarkable ideological difference" to discover and formulate "the unique & invariable ultimate authenticity of nature" coequally.

And indeed, there were substantial tragedies of top-ranking geniuses for scientific knowledge metabolism campaign in the early years of historical progress of science. Even today, as human nature as self-preservation still remains aboriginality subliminally, and the more superior humanistic ideology about authenticity of nature towards perfect ideological enantiomorph of ultimate authenticity of nature become more and more difficult to be demonstrated by tangible experiments, even as magistral autarchy of free press regulation customization & free press admittance of temporal authority short of necessary intendance——science forum can hardly be free from duress of authoritative intrepidity of contemporaneous scientific orthodoxy, there is almost no fair play for necessary scientific knowledge metabolism towards authenticity highlight of nature, so-called social authoritative operation of legitimacy authorization of coming renovation of humanistic ideology about authenticity of nature in proportion to contemporaneous historical background become more and more unintelligible, it's still difficult for coming potential top-ranking geniuses to slide over tragedy for deadly impact of scientific knowledge metabolism campaign.

2. **Second-string geniuses:** The second-string geniuses are the favored people who have acclimatized themselves in historical vogue and substantiated & carried forward the mainstream of living civilization of the very age. whose typical business feature is of course to bring out positive substantiation & perfection of contemporaneous scientific orthodoxy of the age when **royal substantiation & perfection of flourishing contemporaneous scientific orthodoxy \approx historical progress of science in proportion to contemporaneous historical background.** The reason the second-string geniuses are outstanding talents worthy of the name is mostly because they have substantiated and carried forward the costate civilization of the age, and just because of having acclimatized themselves in historical vogue then and there, the second-string geniuses are mostly fashionable talents of the age with favorable award and quick promotion.

We have to admit that temporal authority is an esoteric class of human society. Under background of high-sounding royal substantiation & perfection of contemporaneous scientific orthodoxy, once "free press regulation customization"

Historical progress of science in the recent several centuries seemed like a far-flung exploration of the first itinerary around numerous distinctive landscapes of brand-new landmasses of science with palette & tablet on back, several hundred years' scientific travelogues were compiled thereby.

& “free press admittance” is completely under magistral autarchy of temporal authority short of necessary intendance, science forum must slide into egotistic monopolization under duress of authoritative intrepidity of contemporaneous scientific orthodoxy beyond all doubt, coming scientific knowledge proliferation must be restricted in rigid succession of contemporaneous scientific orthodoxy. Such situation apparently violates historical inevitability that, under permanent synthesized conditionality of “**crecive progression of practical feasibility & possibility in proportion to contemporaneous historical background + the uniqueness & invariance of ultimate authenticity of nature predestines the unique possibility of scientific verity as perfect ideological enantiomorph of ultimate authenticity of nature**” through and through, it's only possible for the major melody of historical progress of science to be a series of epochmaking scientific knowledge metabolism in inherent optimum orientation towards perfect ideological enantiomorph of ultimate authenticity of nature. In another words, as self-preservation of human nature, humanistic operation of magistral autarchy of free press regulation customization and free press admittance of temporal authority short of necessary intendance must bring out deadly obstacle of social legitimacy authorization of successive renovation of humanistic ideology about authenticity of nature in proportion to contemporaneous historical background towards perfect ideological enantiomorph of ultimate authenticity of nature.

3. **Third-rate talents:** The people who are rewarded with creditable diploma & degree for their acquirement of ready-made knowledge of contemporaneous scientific orthodoxy in vogue, the ideological successors or carriers of costate civilization of the age, who are mostly culturati for having learned substantial ready-made knowledge of contemporaneous scientific orthodoxy in vogue but having done very little to push progress of human civilization forward. In straightforward words, the reason for third-rate talents to be geniuses worthy of the name is mostly because they have learned substantial ready-made knowledge of contemporaneous scientific orthodoxy in vogue without contribution to historical progress of human civilization. The most remarkable character of third-rate talents is of course diploma & degree. As historical progress of human civilization is always in crecive progression, third-rate talents are mostly the preliminary talents of the second-string geniuses even the top-ranking geniuses.

(III-i-4) Electromagnetic Field and Electromagnetic Force

Abstract: *As freewheeling logic extension of [(Homogenous cosmos originated from unique genesis postulate + spacetime~matter fully embodying cosmos postulate) + Instinctive PNT equilibrium postulate], so-called “force” is but dynamic domino effect due to instinctive PNT reciprocal equilibrium towards optimum PNT operation for occurrence of external physical disturbance of matter integration related to PNT operation, —spontaneous occurrence of [external physical disturbance + (PNT action + Instinctive PNT equilibrium)] of matter integration, which is virtually physical process matter integration spontaneously rebuilding optimum PNT operation against external disturbance related to PNT operation by the right of congenital attribute of PNT equilibrium instinct. Among the spontaneous reaction mechanism, constituent of “external physical disturbance” is just the external cause for occurrence of force, constituent of (PNT action + Instinctive PNT equilibrium) is just the root cause or original motility for spontaneous implementation of force.*

In straightforward words, so-called “electromagnetic force” is but physical domino effect of spontaneous occurrence of [physical disturbance of matter field superposition with congeneric or complemental genic preponderance or genic insufficiency + (PNT action + Instinctive PNT equilibrium)] of matter integration, whose radical motivity is Instinctive PNT equilibrium of matter integration out of question, just because physical disturbance of matter field superposition with congeneric or complemental genic preponderance or genic insufficiency is direct quantitative cause to bring PNT operation of matter integration out of stationary state, the consequent reaction of instinctive PNT equilibrium proportionably objectifies mechanical feature of so-called “electromagnetic force” thereby.

The genic configuration of positive matter of course impacts the genic configuration of PNT action and ultimately impacts the genic configuration of matter field of matter integration therefore. If there is remarkable genic preponderance in genic configuration of positive matter, the genic preponderance in genic configuration of positive matter must impact the genic configuration of PNT action and ultimately impacts the genic configuration of matter field of matter integration therefore, so that it makes the genic configuration of matter field have proportional genic preponderance too. If there is remarkable genic insufficiency in genic configuration of positive matter, the genic insufficiency in genic configuration of positive matter must impact the genic configuration of PNT action and ultimately impacts the genic configuration of matter field of matter integration therefore, so that it makes the genic configuration of matter field have proportional genic insufficiency too.

So-called “electromagnetic field” is just the matter field with abnormal genic configuration for it is affected by special genic configuration of positive matter by PNT action. And just because of the distinction of genic preponderance or genic insufficiency in genic configuration of matter field, electromagnetic fields can be classified into “positive electrical field” and “negative electrical field”. Electromagnetic reciprocity is just the dynamic domino effect for superposition disturbance of matter fields with abnormal genic configuration. Mechanical orientation of electromagnetic reciprocity is of course consequence of most expedient alternative of implementation for instinctive PNT reciprocal equilibrium towards optimum PNT operation. The proper mechanical orientation of electromagnetic reciprocity is generally as below:

$$[(\text{PNT action} + \text{PNT equilibrium instinct}) + \text{genic insufficiency}] + [\text{genic preponderance} + (\text{PNT action} + \text{PNT equilibrium instinct})] \\ = \text{Electromagnetic abstraction between different charges}$$

Historical progress of science in the recent several centuries seemed like a far-flung exploration of the first itinerary around numerous distinctive landscapes of brand-new landmasses of science with palette & tablet on back, several hundred years’ scientific travelogues were compiled thereby.

$[(\text{PNT action} + \text{PNT equilibrium instinct}) + \text{genic insufficiency}] + [\text{genic insufficiency} + (\text{PNT action} + \text{PNT equilibrium instinct})]$
=Electromagnetic repulsion between positive charges

$[(\text{PNT action} + \text{PNT equilibrium instinct}) + \text{genic preponderance}] + [\text{genic preponderance} + (\text{PNT action} + \text{PNT equilibrium instinct})]$
=Electromagnetic repulsion between negative charges

*The quantitative change of physical implementation of electromagnetic force is of course subject to uniform force definition equation of PNT dynamics $F=m*K'(t)*Y(t)$, the distinctive individuality of electromagnetic force is that the PNT unbalance is caused by superposition of matter field with abnormal genic-configuration, and just for the difference of abnormal genic-configuration of matter field, the distinctive individuality especially mechanical orientation of the proper electromagnetic forces are materialized accordingly.*

Keywords: *genic preponderance, genic insufficiency, electromagnetic force.*

As typical humanistic ideology about authenticity of nature in proportion to contemporaneous historical background, so-called “**four fundamental forces**” is but historical outgrowth as out-and-out scientific travelogues derived from the first itineracy around numerous distinctive landscapes of brand-new landmasses of science with palette & tablet on back, which not only has no idea that **ultimate authenticity of nature** can be neither omnifarious authenticity smallwares full of a basket nor authenticity chameleon one piece and only, but coherent natura naturans throughout cosmic evolution but also has desecrated rigid enantiomorphous correlation between humanistic ideology and authenticity of nature that **the uniqueness & invariance of ultimate authenticity of nature determines the unique possibility of scientific verity as perfect ideological enantiomorph of ultimate authenticity of nature.**

Homogenous cosmos is but demiurgic aggradation of sequential homologous cosmogony, which exactly exists as well-regulated integration of cosmic homogeneity system making up of out-and-out serial natura naturata in the nature of coherent natura naturans throughout cosmic evolution. And indeed, as straightforward man, the demiurge only has unique artifice through and through, which is **coherent natura naturans throughout cosmic evolution.** Original naissance of distinctive existence & motion with relatively steady characters in cosmos are but consequent outgrowth as physical domino effect of **coherent natura naturans throughout cosmic evolution**, universal existence & motion with vivid physical variation are but stochastic performance of **coherent natura naturans throughout cosmic evolution** out of question. The demiurge brings out universal existence & motion as serial natura naturata in the nature of coherent natura naturans throughout cosmic evolution, he never has idea of “force or mechanical phenomena in the nature”, no more so-called “**four fundamental forces**” in the nature.

In straightforward words:

**Original generation of matter in the nature of coherent natura naturans brings out essence of matter in a class by itself;
Essence of matter in a class by itself predestines thorough coherence of dynamic regularity of universal existence & motion.**

Force phenomena in the nature is not straightforward outgrowth of **coherent natura naturans throughout cosmic evolution** of the demiurge, but because matter are brought out as **serial natura naturata** in the nature of **coherent natura naturans throughout cosmic evolution** with resultant definite inherence in the nature of things, force phenomena in the nature are brought out as stochastic spontaneous occurrence due to **[resultant definite inherence of matter integration + external physical disturbance]**, the resultant definite inherence of matter integration is generally **(PNT action + instinctive PNT equilibrium)** of matter integration. In straightforward words, the demiurge never creates “force” in cosmos, he

As coherent natura naturans throughout cosmic evolution, instinctive PNT reciprocal equilibrium towards optimum PNT operation is radical potentiality & conditionality for cosmos always ready to orientate itself towards perfection.

even has no idea of “force” at all, instead, he only creates matter by the right of **coherent natura naturans throughout cosmic evolution**, which brings out consequent serial natura naturata in the nature of **coherent natura naturans throughout cosmic evolution**. After accomplishing creation of serial natura naturata in the nature of **coherent natura naturans throughout cosmic evolution**, nothing else seems necessary for the demiurge to do for cosmogony but to leave matter stochastically exist and motion itself in accordance with **resultant definite inherence of matter integration**. In terms of universal existence & motion, they are straightforward stochastic spontaneous occurrence against resultant definite inherence of matter under proper environmental conditions. Since matter is inherently created in the nature of coherent natura naturans throughout cosmic evolution with resultant definite inherence in the nature of things, it postnatally has unique script of resultant definite inherence to perform stochastic existence & motion as spontaneous occurrence due to external physical disturbance, distinctive existence & motion of objects are but stochastic spontaneous occurrence of matter under corresponding environmental conditions against resultant definite inherence of matter, which of course indicates all physical connotation of force phenomenon in cosmos are included through and through in spontaneous occurrence of matter against resultant definite inherence of matter integration.

Under precondition that homogenous cosmos is but demiurgic aggradation of sequential homologic cosmogony, which exactly exists as well-regulated integration of cosmic homogeneity system making up of out-and-out serial natura naturata in the nature of coherent natura naturans throughout cosmic evolution, So-called “force” is but spontaneous occurrence of **[external physical disturbance + (PNT action + Instinctive PNT equilibrium)]** of matter integration, force phenomenon in cosmos can never be exception out of spontaneous occurrence of **[external physical disturbance + (PNT action + Instinctive PNT equilibrium)]** of matter integration. And “**instinctive PNT reciprocal equilibrium towards optimum PNT operation**” is the universal dynamic fundamental and coherent natura naturans to accomplish demiurgic evolution and all related mechanical effect throughout cosmic evolution. Force individuality in cosmos mostly depends on distinctive physical feature of so-called “**external physical disturbance**”, force direction is straightforward consequence of most expedient alternative of spontaneous PNT reaction against distinctive physical feature of idiographic external physical disturbance due to instinctive PNT reciprocal equilibrium towards optimum PNT operation of matter integration.

We analyze “electromagnetic force” herein is ready to formulate how the field superposition interference among electromagnetic fields with genic preponderance or genic insufficiency brings out distinctive “**external physical disturbance**” as

$$\begin{aligned} & [(PNT \text{ action} + PNT \text{ equilibrium instinct}) + \text{genic insufficiency}] + [\text{genic preponderance} + (PNT \text{ action} + PNT \text{ equilibrium instinct})], \\ & [(PNT \text{ action} + PNT \text{ equilibrium instinct}) + \text{genic insufficiency}] + [\text{genic insufficiency} + (PNT \text{ action} + PNT \text{ equilibrium instinct})], \\ & [(PNT \text{ action} + PNT \text{ equilibrium instinct}) + \text{genic preponderance}] + [\text{genic preponderance} + (PNT \text{ action} + PNT \text{ equilibrium instinct})] \end{aligned}$$

of matter integration. And as occurrence of the distinctive external physical disturbance, PNT action with PNT equilibrium instinct of matter integration has to react towards optimum PNT operation in most expedient alternative by the light of nature and consequently hypostatize the fundamental of electromagnetic reciprocity accordingly.

1. Electromagnetic field

The lineal homologic correlation between spacetime and matter must predestine ingenerate bidirectional positive & negative transmutation “ $M \leftrightarrow m$ ” between matter field and the proper positive matter. As some certain special genic configuration or special internal existence & motion of positive matter, genic configuration of positive matter exhibit obvious non-saturation or genic compositive deviation. In another words, the genic

configuration of positive matter exhibits “genic preponderance” or “genic insufficiency”. As there is ingenerate positive & negative transmutation “ $M \leftrightarrow m$ ” between matter field and positive matter, once there is genic preponderance or genic insufficiency in genic configuration of positive matter, the positive matter will either seize more complementary genic units from matter field so as to offset some of genic insufficiency of positive matter or release more extra-saturated genic units to matter field so as to lower genic preponderance of positive matter as possible as it can. As a result, there are genic preponderance or genic insufficiency in matter field therefore. —As performance of positive & negative transmutation “ $M \leftrightarrow m$ ” between positive matter and matter field, the genic preponderance or genic insufficiency of positive matter are transferred to matter integration. Electric field is just such affected matter field with special genic preponderance or genic insufficiency, and because of the distinction of genic preponderance or genic insufficiency in matter field, electric fields can be classified into “positive electric field” and “negative electric field”.

Homogenous Cosmos Originated from Unique Genesis primarily confirms that “positive electric field” is just matter field with genic insufficiency, which can be illustrated as below:

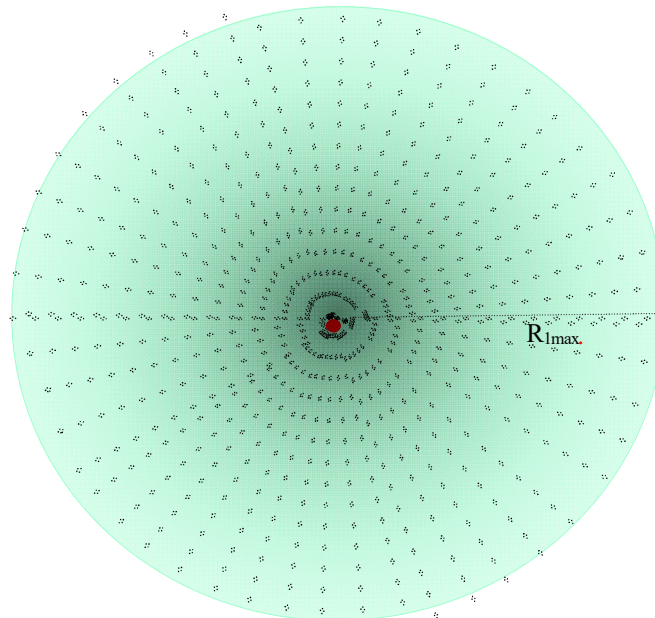

(III-i-4-a) Positive electric field with genic insufficiency

The tiny black rings in french grey globe extent indicate existence of genic insufficiency in matter field. Negative electric field is just matter field with genic preponderance, which can be illustrated as below:

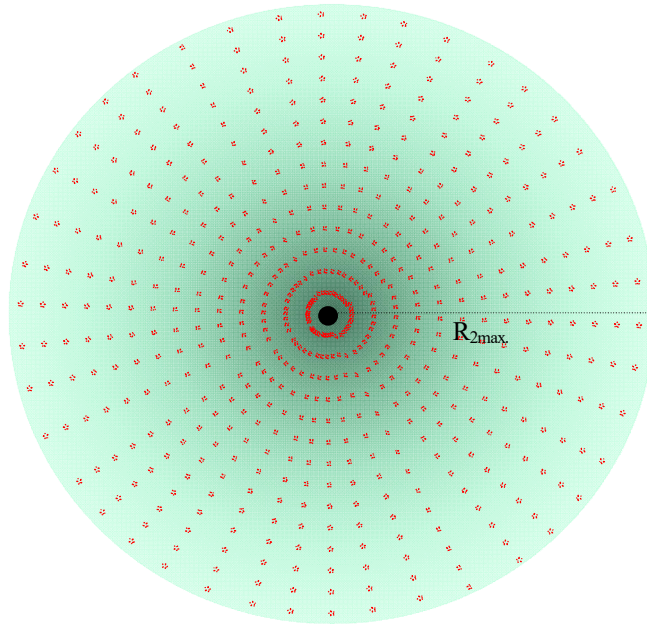

(III-i-4-b) Negative electric field with genic preponderance

The red “*” in french grey globe extent indicates existence of genic preponderance in matter field.

As affected matter field with special genic preponderance or genic insufficiency, field extent of electric fields is too limited within matter field, extent of any electric field can never transcend extent of original matter field, which of course means it’s impossible for electric field extends to space field where space field strength is even below α_0 . Of course, extent of electric fields can be less than extent of matter field.

In terms of electric field around point charge, distribution of the electric field strength is generally similar as matter field (/gravitational field). If we denote the charge of a point charge Q, centered the point charge, and we denote the electric field strength of any point in electric field with distance R to the point charge β , then, β , Q, R satisfy equation as below:

$$\beta = \omega * Q / R^2 \quad \dots\dots\dots \quad \text{(III-i -5) } (\otimes)$$

(Among the equation above, ω denotes the constant of direct proportion)

Variation of electric field must cause magnetic field, so we can arrive at our conclusion that magnetic field is but a varying medium state of electric field.

2. Electromagnetic force

Just as precondition of occurrence of gravity, precondition of occurrence of electromagnetic force is superposition disturbance of electric fields, electromagnetic force is but spontaneous occurrence of **[physical disturbance of matter field superposition with congeneric or complemental genic preponderance or genic insufficiency + (PNT action + Instinctive PNT equilibrium)]** of matter integration, and electromagnetic force orientation is but expediential choice in the nature of **(PNT action + Instinctive PNT equilibrium)** under precondition of electric field superposition disturbance.

Distinction of genic preponderance or genic insufficiency in electric field of course makes the reciprocity between distinctive electric fields different therefore. Taking reference of genic configuration perfection of matter field, if the genic preponderance or genic insufficiency in electric fields of the both interacted matter integration

are mutually complementary, then, instinct of matter integration which is always ready to orient genic configuration perfection of matter field will spontaneously make the both matter integration (/electric fields) close each other as possible as they are virtually able to, which exactly embodies the reciprocity between the both electric fields electromagnetic attraction, —reciprocity between an electric field with genic preponderance and another electric field with genic insufficiency is always electromagnetic attraction as:

$$[(\text{PNT action} + \text{PNT equilibrium instinct}) + \text{genic insufficiency}] + [\text{genic preponderance} + (\text{PNT action} + \text{PNT equilibrium instinct})] = \text{Electromagnetic abstraction between different charges}$$

which can be illustrated as below:

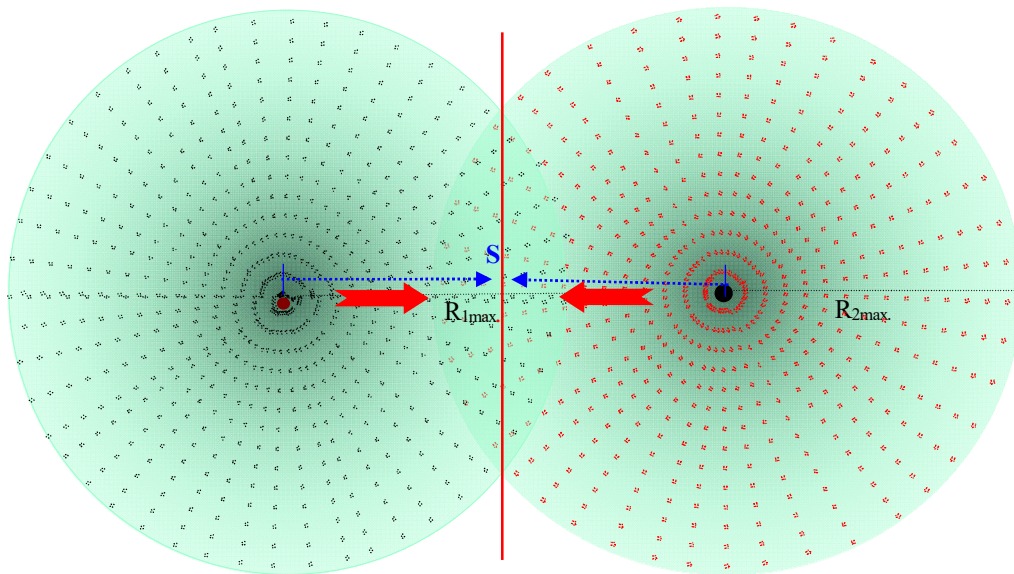

(III-i-4-c) Electromagnetic attraction between positive electric field and negative electric field

The direction of the both red arrows in above illustration means the attraction direction between positive charge and negative charge.

Taking reference of normal genic configuration of matter field, if two electric fields with the same genic preponderance (or the same genic insufficiency) are closing each other toward deeper electric field superposition, the density of genic preponderance (or genic insufficiency) in electric field will be higher and higher so that the genic configuration of electric field is deviated from normal genic configuration of matter field more and more. This of course impacts the instinct of matter integration which is always ready to maintain and orient genic configuration perfection of matter field. As a result, once two electric fields with the same genic preponderance (or the same genic insufficiency) close each other towards deeper electric field superposition, the instinct of matter integration orientating genic configuration perfection of matter field will spontaneously reject them to close each other, and electromagnetic repulsion occurs therefore. The reciprocity between electric fields with the same genic preponderance (or the same genic insufficiency) always embodies electromagnetic repulsion as:

$$[(\text{PNT action} + \text{PNT equilibrium instinct}) + \text{genic insufficiency}] + [\text{genic insufficiency} + (\text{PNT action} + \text{PNT equilibrium instinct})] = \text{Electromagnetic repulsion between positive charges}$$

which can be illustrated as below:

As coherent natura naturans throughout cosmic evolution, instinctive PNT reciprocal equilibrium towards optimum PNT operation is radical potentiality & conditionality for cosmos always ready to orientate itself towards perfection.

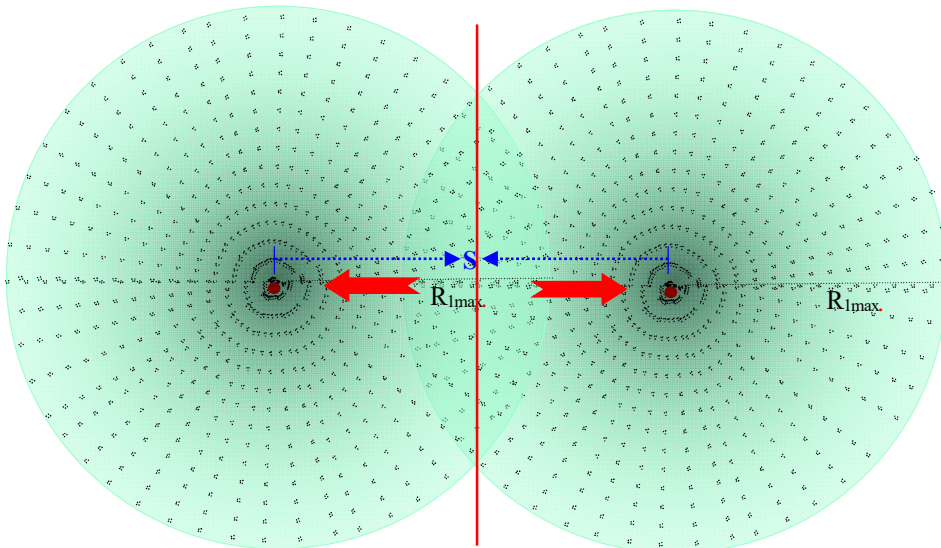

(III-i-4-d) Electromagnetic repulsion between positive electric field and positive electric field

The direction of the both red arrows in above illustration means the repulsion direction between positive electric field and positive electric field.

Or [(PNT action + PNT equilibrium instinct) + genic preponderance] + [genic preponderance + (PNT action + PNT equilibrium instinct)]
 =Electromagnetic repulsion between negative charges

which can be illustrated as below:

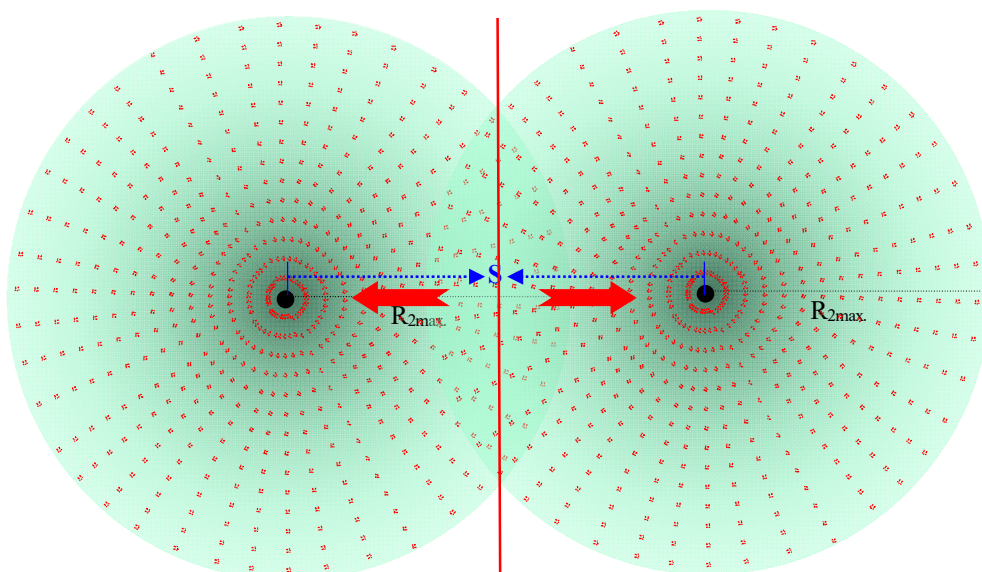

(III-i-4-e) Electromagnetic repulsion between negative electric field and negative electric field

The direction of the both red arrows in above illustration means the repulsion direction between negative electric field and negative electric field.

We now come to analyze the mathematical expression of electromagnetic force in accordance with PNT dynamics.

Let's suppose there are point charge A and point charge B, we denote the mass of point charge A "m₁", mass of point charge B "m₂", electric field mass of point charge A "M₁" and electric field mass of point charge B "M₂", we denote extent radius of electric field of point charge A "R_{1max}", extent radius of electric field of

Historical progress of science in the recent several centuries seemed like a far-flung exploration of the first itinerary around numerous distinctive landscapes of brand-new landmasses of science with palette & tablet on back, several hundred years' scientific travelogues were compiled thereby.

point charge B “R_{2max}” and the distance between point charge A and point charge B “S”, S, R_{1max}, R_{2max} satisfy S < R_{1max} + R_{2max}. Thus, there must be electric field superposition between point charge A and point charge B, there must be electromagnetic reciprocity between the both point charges. let's suppose point charge A is our study object, during the course of physical implementation of electromagnetic reciprocity, we denote the point charge B overlaps its electric field mass into the electric field of point charge A “ΔM”, and denote the function correlation of ΔM varying with distance S and time t ΔM(S, t). And at the same time, we denote the consequent mass change of positive matter of charge A “Δm”, and denote the mathematical correlation of Δm varying with variables of distance S between the both charges and time t Δm(S, t), then during the course of physical implementation of electromagnet reciprocity between the two point charges, the unbalanced matter inertial conservation equations of charge A proportionably changes into:

$$\left\{ \begin{array}{l} M + [\Delta M(S, t) - \Delta m(S, t)] + m + \Delta m(S, t) = R + \Delta M(S, t) \\ \{ [M + [\Delta M(S, t) - \Delta m(S, t)]] / [m + \Delta m(S, t)] = K(t) \\ V(t) * [m + \Delta m(S, t)] = d(M \leftarrow m)(t) * Y(t) \\ L^3(t) * \alpha(t) = A * [m + \Delta m(S, t)] \\ Y(t) = B * \alpha(t) \end{array} \right. \iff \left\{ \begin{array}{l} M + [\Delta M(S, t) - \Delta m(S, t)] = K(t) [R + \Delta M(S, t)] / [1 + K(t)] \\ m + \Delta m(S, t) = [R + \Delta M(S, t)] / [1 + K(t)] \\ V(t) = d(M \leftarrow m)(t) * Y(t) / [m + \Delta m(S, t)] \\ L^3(t) = A * [m + \Delta m(S, t)] / \alpha(t) \\ Y(t) = B * \alpha(t) \end{array} \right.$$

Then we can deduce, the acceleration of the point charge A is as below:

$$\begin{aligned} a(t) &= Y(t) * K'(t) \\ &= B * \alpha(t) * \{ [M + \Delta M(S, t) - \Delta m(S, t)] / [m + \Delta m(S, t)] \}' \end{aligned} \quad \dots \dots \dots \quad \text{(III-i -6)}$$

In accordance with conventional force definition equation F = m * a, we can arrive at the electromagnetic force acting on point charge A as below:

$$\begin{aligned} F(t) &= (m + \Delta m(S, t)) * Y(t) * K'(t) \\ &= (m + \Delta m(S, t)) * B * \alpha(t) * \{ [M + \Delta M(S, t) - \Delta m(S, t)] / [m + \Delta m(S, t)] \}' \end{aligned} \quad \dots \dots \quad \text{(III-i -7)}$$

The motion velocity of point charge A is as below:

$$\begin{aligned} V &= V_0 + \Delta V = V_0 + \int a(t) dt \\ &= V_0 + \int B * \alpha(t) * \{ [M + \Delta M(S, t) - \Delta m(S, t)] / [m + \Delta m(S, t)] \}' dt \end{aligned} \quad \dots \dots \dots \quad \text{(III-i -8)}$$

If the point charge does not move in electric field, but in a conductor, and let's suppose the total charges of the very point charge is q, the length of the conductor is L, and there are totally N units of such point charges in the conductor. Then we can know the current I(t) in conductor as below:

$$\begin{aligned} I(t) &= NqV/L \\ &= Nq \{ V_0 + \int B * \alpha(t) * \{ [M + \Delta M(S, t) - \Delta m(S, t)] / [m + \Delta m(S, t)] \}' dt \} / L \end{aligned} \quad \dots \dots \dots \quad \text{(III-i -9)}$$

Conductor possess attribute of resistance but implies during the course of the point charge moving in conductor, point charge has to spend some of its kinetic energy to atoms of conductor so as to overcome resistance of conductor. Presence of resistance of conductor never impacts the dynamic regularity that point charge must be subjected to.

This of course means electromagnet force is not independent force in the nature; it is too dynamic domino effect in the nature of instinctive PNT reciprocal equilibrium towards optimum PNT operation for occurrence of

external physical disturbance of matter integration related to PNT operation, —spontaneous occurrence of [external physical disturbance + (PNT action + Instinctive PNT equilibrium)] of matter integration, the only distinction or individuality of electromagnetic force is that the external cause for occurrence of force is characteristic “electric field superposition disturbance” which is a typical sort of “external physical disturbance”.

—Firstly written in Dec. 1995, literal revision was done in Dec.2004
Further revision was done in February & March 2016

(III-i-5) Strong Interaction & Weak Interaction

Abstract: *As freewheeling logic extension of [(Homogenous cosmos originated from unique genesis postulate + spacetime~matter fully embodying cosmos postulate) + Instinctive PNT equilibrium postulate], so-called “force” is but dynamic domino effect due to instinctive PNT reciprocal equilibrium towards optimum PNT operation for occurrence of external physical disturbance of matter integration related to PNT operation, —spontaneous occurrence of [external physical disturbance + (PNT action + Instinctive PNT equilibrium)] of matter integration, which is virtually physical process matter integration spontaneously rebuilding optimum PNT operation against external disturbance related to PNT operation by the right of congenital attribute of PNT equilibrium instinct. Among the spontaneous reaction mechanism, constituent of “external physical disturbance” is just the external cause for occurrence of force, constituent of (PNT action + Instinctive PNT equilibrium) is just the root cause or original motility for spontaneous implementation of force.*

In straightforward words, so-called “strong interaction” is but physical domino effect of spontaneous occurrence of [PNT complementary linkage optimization among unsaturated particles in available space range + (PNT action + Instinctive PNT equilibrium)] of matter integration, whose radical motivity is Instinctive PNT equilibrium of matter integration out of question, just because PNT complementary linkage optimization among unsaturated particles in available space range is direct quantitative cause to bring PNT operation of matter integration out of stationary state, the consequent reaction of instinctive PNT equilibrium proportionably objectifies mechanical feature of so-called “strong interaction” thereby.

As genic cumulation of tiny particles is substantively very limited, it's almost impossible for operational genic-linkage of PNT action of particles to be inherently perfect. Whereas, if distinctive operational genic-linkages of PNT action of two different particles are reciprocal and the both particles are close enough, the both distinctive operational genic-linkages of PNT action of the both particles must be unconditionally linked up in the nature of instinctive PNT reciprocal equilibrium towards optimum PNT operation, this is just spontaneous “implementation or action” of so-called “strong interaction”.

As personal limitation, I have very poor knowledge about so-called “weak interaction”, as a result, I am not convenient to highlight the cosmic connotation of spontaneous occurrence of “external physical disturbance + (PNT action + instinctive PNT equilibrium)” of weak interaction.

Keywords: *strong interaction, weak interaction.*

As typical humanistic ideology about authenticity of nature in proportion to contemporaneous historical background, so-called “four fundamental forces” is but historical outgrowth as out-and-out scientific travelogues derived from the first itineracy around numerous distinctive landscapes of brand-new landmasses of science with palette & tablet on back, which not only has no idea that ultimate authenticity of nature can be neither omnifarious authenticity smallwares full of a basket nor authenticity chameleon one piece and only, but coherent natura naturans throughout cosmic evolution but also has desecrated rigid enantiomorphous correlation between humanistic ideology and authenticity of nature that the uniqueness & invariance of ultimate authenticity of nature determines the unique possibility of scientific verity as perfect ideological enantiomorph of ultimate authenticity of nature.

As coherent natura naturans throughout cosmic evolution, instinctive PNT reciprocal equilibrium towards optimum PNT operation is radical potentiality & conditionality for cosmos always ready to orientate itself towards perfection.

Homogenous cosmos is but demiurgic aggradation of sequential homologic cosmogony, which exactly exists as well-regulated integration of cosmic homogeneity system making up of out-and-out serial natura naturata in the nature of coherent natura naturans throughout cosmic evolution. And indeed, as straightforward man, the demiurge only has unique artifice through and through, which is **coherent natura naturans throughout cosmic evolution**. Original naissance of distinctive existence & motion with relatively steady characters in cosmos are but consequent outgrowth as physical domino effect of **coherent natura naturans throughout cosmic evolution**, universal existence & motion with vivid physical variation are but stochastic performance of **coherent natura naturans throughout cosmic evolution** out of question. The demiurge brings out universal existence & motion as serial natura naturata in the nature of coherent natura naturans throughout cosmic evolution, he never has idea of “force or mechanical phenomena in the nature”, no more so-called “**four fundamental forces**” in the nature.

In straightforward words:

Original generation of matter in the nature of coherent natura naturans brings out essence of matter in a class by itself;
Essence of matter in a class by itself predestines thorough coherence of dynamic regularity of universal existence & motion.

Force phenomena in the nature is not straightforward outgrowth of **coherent natura naturans throughout cosmic evolution** of the demiurge, but because matter are brought out as **serial natura naturata** in the nature of **coherent natura naturans throughout cosmic evolution** with resultant definite inherence in the nature of things, force phenomena in the nature are brought out as stochastic spontaneous occurrence due to [**resultant definite inherence of matter integration + external physical disturbance**], the resultant definite inherence of matter integration is generally (**PNT action + instinctive PNT equilibrium**) of matter integration. In straightforward words, the demiurge never creates “force” in cosmos, he even has no idea of “force” at all, instead, he only creates matter by the right of **coherent natura naturans throughout cosmic evolution**, which brings out consequent serial natura naturata in the nature of **coherent natura naturans throughout cosmic evolution**. After accomplishing creation of serial natura naturata in the nature of **coherent natura naturans throughout cosmic evolution**, nothing else seems necessary for the demiurge to do for cosmogony but to leave matter stochastically exist and motion itself in accordance with **resultant definite inherence of matter integration**. In terms of universal existence & motion, they are straightforward stochastic spontaneous occurrence against resultant definite inherence of matter under proper environmental conditions. Since matter is inherently created in the nature of **coherent natura naturans throughout cosmic evolution** with resultant definite inherence in the nature of things, it postnationally has unique script of resultant definite inherence to perform stochastic existence & motion as spontaneous occurrence due to external physical disturbance, distinctive existence & motion of objects are but stochastic spontaneous occurrence of matter under corresponding environmental conditions against resultant definite inherence of matter, which of course indicates all physical connotation of force phenomenon in cosmos are included through and through in spontaneous occurrence of matter against resultant definite inherence of matter integration.

Under precondition that homogenous cosmos is but demiurgic aggradation of sequential homologic cosmogony, which exactly exists as well-regulated integration of cosmic homogeneity system making up of out-and-out serial natura naturata in the nature of coherent natura naturans throughout cosmic evolution, So-called “force” is but spontaneous occurrence of [**external physical disturbance + (PNT action + Instinctive PNT equilibrium)**] of matter integration, force phenomenon in cosmos can never be exception out of spontaneous occurrence of [**external physical disturbance + (PNT action + Instinctive PNT equilibrium)**] of matter integration. And “**instinctive PNT reciprocal equilibrium towards**

optimum PNT operation” is the universal dynamic fundamental and coherent natura naturans to accomplish demiurgic evolution and all related mechanical effect throughout cosmic evolution. Force individuality in cosmos mostly depends on distinctive physical feature of so-called “**external physical disturbance**”, force direction is straightforward consequence of most expedient alternative of spontaneous PNT reaction against distinctive physical feature of idiographic external physical disturbance due to instinctive PNT reciprocal equilibrium towards optimum PNT operation of matter integration.

We analyze “strong interaction” & “weak interaction” herein is ready to formulate how the close quarters interference of characteristic PNT action among particles brings out distinctive “**external physical disturbance**” of matter integration, and as occurrence of distinctive external physical disturbance, PNT action with PNT equilibrium instinct has to react towards optimum PNT operation in the most expedient alternative by the light of nature and consequently hypostatize the physical reciprocity of “strong interaction” & “weak interaction” accordingly.

1. Strong interaction

“Strong interaction” is but physical domino effect of spontaneous occurrence of [**PNT complementary linkage optimization among unsaturated particles in available space range + (PNT action + Instinctive PNT equilibrium)**] of matter integration. In terms of any particle with tiny mass, the PNT operation of matter integration is generally not as regular as the macroscopical ones, performance of the couple opposites of “ $M \rightarrow m$ ” and “ $M \leftarrow m$ ” of PNT operation are usually not strictly even. For example, there is a single elementary genic unit in space field, when it implements PNT operation, it's apparently impossible for it to perform negative transmutation and positive transmutation synchronously, but to perform negative transmutation first, then to perform positive transmutation successively. Thus, the PNT operation of the single elementary genic unit is completely separated into two sequential process of positive towards negative transmutation “ $M \leftarrow m$ ” & negative towards positive transmutation “ $M \rightarrow m$ ”, the two inverse physical implementation periodically go round and round. To any matter integration whose mass is a little bigger than a single elementary genic unit, although their PNT operation is not separated as clearly as single elementary genic unit, but as their mass is still very limited, the couple operational PNT opposites are still very difficult to keep equivalent and even in time current. As a result, their PNT operation usually exhibits similar waveform periodic variation, ——positive transmutation is regnant a little now and negative transmutation is regnant a little then, and the both regnant transmutation rhythms go round and round, whose dynamic modality is very similar as the natural motion of pendulum.

To any two particles whose inverse PNT operational couple of negative transmutation and positive transmutation are not exactly even but in dynamic modality similar as the natural motion of pendulum, once the one is performing negative transmutation (or performance of negative transmutation is relatively regnant), at the same time, the other is just performing positive transmutation (or performance of positive transmutation is relatively regnant), as the both transmutation opposites seem mutually complementary resource, once such two particles with inversely regnant transmutation are closed enough, the two particles with mutually complementary resource will spontaneously link up and combine into an integrated reciprocal PNT link. We can expediently call such reciprocal PNT combination between two particles with mutually complementary resource “reciprocal positive & negative transmutation link”, single pendulum style dynamic pattern of PNT combination performance. Reciprocal positive & negative transmutation links among particles joint particles firmly, and the reciprocal PNT combination

performance in pendulum dynamic pattern among available particles is just the dynamic modality of strong interaction.

As presence of dynamic reciprocity of reciprocal positive & negative transmutation link among available particles in single pendulum modality, strong interaction never exhibits itself as constant force in time current, but periodically exhibits variable force in similar mechanical modality as single pendulum including periodic variation of force magnitude and direction. And indeed, if we unchain the reciprocated PNT link among particles and let the separate particles exist independently in spacetime, we can find their separate motion exhibits waveform characteristics. Of course, reciprocated PNT link can exist between two particles with phase disparity of the couple PNT opposites, even exist among several more particles with phase disparity of the couple PNT opposites too, as long as their phase disparities are mutually complementary and reciprocal towards their common PNT operational consummation.

Now we come to analyze strong interaction according to PNT dynamics.

Let's suppose there is reciprocated PNT link between particle A and particle B. For expedience, we just choose the particle A as our study object. We denote the matter field mass of particle A "M", and denote the positive mass of particle A "m". During the course of performance of PNT reciprocity between particle A and particle B, we denote the mathematical correlation of mass transferred between particle A and Particle B with functor t as $\Delta m(t)$, t denotes time. Then, we can know, during the course of performance of PNT reciprocity (strong interaction), the unbalanced matter inertial conservation equations of particle A can be expressed as following:

$$\left\{ \begin{array}{l} M + \Delta M(t) + m + \Delta m(t) = R + \Delta M(t) \\ [M + \Delta M(t)] / [m + \Delta m(t)] = K(t) \\ V(t) * [m + \Delta m(t)] = d(M \leftarrow m)(t) * Y(t) \\ L^3(t) * \alpha(t) = A * [m + \Delta m(t)] \\ Y(t) = B * \alpha(t) \end{array} \right. \iff \left\{ \begin{array}{l} M + \Delta M(t) = K(t) [R + \Delta M(t)] / [1 + K(t)] \\ m + \Delta m(t) = [R + \Delta M(t)] / [1 + K(t)] \\ V(t) = d(M \leftarrow m)(t) * Y(t) / [m + \Delta m(t)] \\ L^3(t) = A * [m + \Delta m(t)] / \alpha(t) \\ Y(t) = B * \alpha(t) \end{array} \right.$$

Then we can arrive at the acceleration equation of particle A in time current as below:

$$\begin{aligned} a(t) &= Y(t) * K'(t) \\ &= B * \alpha(t) * \{ [M + \Delta M(t)] / [m + \Delta m(t)] \}' \end{aligned} \quad \dots \dots \dots \quad \text{(III-i -10)}$$

The strong force working on particle A in time current is:

$$\begin{aligned} F(t) &= [m + \Delta m(t)] * Y(t) * K'(t) \\ &= [m + \Delta m(t)] * B * \alpha(t) * \{ [M + \Delta M(t)] / [m + \Delta m(t)] \}' \end{aligned} \quad \dots \dots \dots \quad \text{(III-i -11)}$$

The force orientation of strong interaction depends on the negative or positive value of $\Delta M(t)$ and $\Delta m(t)$, the periodic variation of strong interaction is synchronous with periodic waveform variation of value of $\Delta M(t)$ and $\Delta m(t)$.

2. Weak Interaction

As poor knowledge about authentic detail of weak interaction, I am still not convenient to analyze and clarify weak interaction further now. Whereas, considered by Homogenous Cosmos Originated from Unique Genesis, "force" is but dynamic domino effect in the nature of instinctive PNT reciprocal equilibrium towards optimum PNT operation for occurrence of external physical disturbance of matter integration related to PNT

operation, —spontaneous occurrence of [external physical disturbance + (PNT action + Instinctive PNT equilibrium)] of matter integration, perceivable distinction among different forces in the nature is but idiographic physical objectification derived from distinctive “external physical disturbance” and the consequent occurrence that PNT equilibrium instinct comes to rebuild PNT operational perfection by the light of nature, which is just physical action of so-called “force” in the nature, weak interaction can never be exceptive.

All in all, since we confirm that entire cosmic content is homogenous originated from unique genesis through and through, and “matter” is but a single notion which is originally created by the demiurge in accordance with demiurgic law of identity, once we coming to clarify authenticity of existence & motion of matter in the nature, there is no excuses for us to involve in perplexity to clarify existence & motion of this kind of matter and that kind of matter, matter in this kind of existent state and in that kind of existent state or matter moving in low speed and in high speed. Of course, there is no radical distinction of this kind of force and that kind of force. Since entire cosmic content is homogenous originated from unique genesis through and through, matter in cosmos can only be a single notion with coherent logic connotation, and consequently, existence & motion of matter in the nature must be throughout coherent for invariable essentiality of matter, which of course indicates force can only be coherent through and through ever since matter is originally generated in cosmos, there is no root cause for the demiurge to waywardly arrange this kind of force and that kind of force in the nature in defiance of thorough coherence of matter essence in a class by itself. **It's only possible for concordant cosmos to be demiurgic aggradation of out-and-out serial natura naturata in the nature of coherent natura naturans throughout cosmic evolution; there is no way for demiurgic aggradation in the nature of different natura naturans to be concordant cosmos through and through,** this is logic sublimation of homogenous cosmos originated from unique genesis.

Of course, connotation objectification of homogenous cosmos originated from unique genesis on the basis of “homogenous cosmos originated from unique genesis + spacetime~matter fully embodying cosmos” and successive freewheeling logic extension of connotation objectification of homogenous cosmos originated from unique genesis on the basis of “PNT action + instinctive PNT equilibrium” can only educe unique coherent force definition in cosmos logically, which is spontaneous occurrence of matter integration as “external physical disturbance + (PNT action + instinctive PNT equilibrium)”, there is completely no way for the logic extension of Homogenous Cosmos Originated from Unique Genesis to approach notions as “gravity”, “electromagnetic force”, “strong interaction”, “weak interaction”, which even seems grotesque to reality of connotation objectification with freewheeling logic extension of homogenous cosmos originated from unique genesis.

However, as foregone sages had stepped out so remarkable footprints along crescive progression of historical progress of science in prior, and all living people have been used to stepping the ready-made footprints for rational verification of the very issue of nature, as freewheeling of rational sublimation against favorable background of remarkable highlight of microcosmic configuration of matter, there is almost no way for Homogenous Cosmos Originated from Unique Genesis to shy away such ready-made factuality in historical progression and has to defer to it. Virtually, Homogenous Cosmos Originated from Unique Genesis refers to “gravity”, “electromagnetic force”, “strong interaction”, “weak interaction” herein is mainly ready to highlight the compatibility as spontaneous occurrence of [external physical disturbance + (PNT action + Instinctive PNT equilibrium)] of matter integration to classic physical connotation of “gravity”, “electromagnetic force”, “strong interaction” & “weak interaction”, and offer necessary logic complementarity & correction offhand according to connotation objectification with freewheeling

logic extension of homogenous cosmos originated from unique genesis. My clarification endeavor herein is apparently different from attempt of classic grand unification of the so-called four fundamental forces.

And indeed, in terms of original occurrence of existence & motion of matter throughout cosmic evolution, if the demiurge is contributive, the upmost contribution of the demiurge is but it has appointed homologic filiation of “spacetime further” & “matter son” between spacetime and matter and accomplished original generation of elementary genic units (/the rudimentary matter) as lineal homologic outgrowth of extra-saturated space field upon freewheeling of sequential homologic cosmogony at the volley. Original generation of elementary genic units (elementary genic units are just the rudimentary matter, and virtually, the so-called original generation of matter throughout cosmic evolution just means the initial generation of elementary genic units on the basis of extra-saturated space field.) of course inherently predestines essence of matter. Subsequent generation and formation of universal reciprocal PNT combinations in gradation I, reciprocal PNT combinations in gradation II, reciprocal PNT combinations in gradation III and reciprocal PNT combinations in gradation IV are but freewheeling outgrowth in the nature of instinctive PNT reciprocal equilibrium towards optimum PNT operation of matter integration as freewheeling cosmic demiurgic evolution without letup.

In another words, if the demiurge is contributive to demiurgic evolution of homogenous cosmos, the upmost contribution of the demiurge is but it has appointed homologic filiation of spacetime further & matter son between spacetime and matter and accomplished original generation of elementary genic units (/the rudimentary matter) as lineal homologic outgrowth of extra-saturated space field along freewheeling of homologic cosmogony at the volley. Eversince the original generation of elementary genic units in cosmos, the demiurge has been free from his cosmic demiurgic job but bring “essence of matter” into play all the way, the subsequent generation and postnatal existence & motion of universal reciprocal PNT combinations are but freewheeling outgrowth in the nature of instinctive PNT reciprocal equilibrium towards optimum PNT operation based on stochastic accomplishment of {reciprocal idiosyncrasy towards PNT equilibrium + accessible space overall arrangement for PNT reciprocity} among compositive sub-matter-integration. The so-called “gravity”, “electromagnetic force”, “strong interaction” and “weak interaction” are not original demiurgic objects of the demiurge at all, they are but cognizant outcome of human under the proper historical background during the course of historical progress of science once we historically came to face this or that postnatal characteristic existent features of matter one after another. The historical occurrence of the ideological notions of “gravity”, “electromagnetic force”, “strong interaction” and “weak interaction” as humanistic ideology about authenticity of nature for scientific knowledge proliferation along crecive progression of historical progress of science in inherent optimum orientation towards historical authenticity tolerance of science 0 maybe even cause boggle even perplexity of the demiurge.

At any rate, as recognizant representation of historically accessible existence & motion around on human sense, science is but temporal humanistic ideology about the temporally accessible existence & motion of matter in the nature. Nowaday science is just something like this is not only inherently related to external accessible existence & motion around us but also inevitably related to the historical scientific exploration experience even scientific manner of human.

It's of course imaginable if there are two earths just the same as “earth A” and “earth B” in cosmos, towards rational comprehension of authenticity of nature, although universal existence & motion human on earth A and human on earth B have to involve in is just the same beyond all doubt for it's just the same demiurgic



It's only possible for concordant cosmos to be demiurgic aggradation of out-and-out serial natura naturata in the nature of coherent natura naturans throughout cosmic evolution; there is no way for demiurgic aggradation in the nature of different natura naturans to be concordant cosmos through and through.

aggradation of sequential homologous cosmogony which exactly exists as well-regulated integration of homogeneity system making up of out-and-out serial natura naturata in the nature of coherent natura naturans throughout cosmic evolution. As long as there is hypostatic discrepancy in practice of historical progress of science between human on earth A and human on earth B, the humanistic ideology about authenticity of nature of human on earth A must be different from the humanistic ideology about authenticity of nature of human on earth B, even though commensurate ideological system about authenticity of nature on earth A and commensurate ideological system about authenticity of nature on earth B are almost in the same progressional tenor towards perfect ideological enantiomorph of ultimate authenticity of nature with equivalent historical authenticity tolerance of science.

—Firstly written in Dec. 1995, literal revision was done in Dec.2004

Further revision was done in February & March 2016

As coherent natura naturans throughout cosmic evolution, instinctive PNT reciprocal equilibrium towards optimum PNT operation is radical potentiality & conditionality for cosmos always ready to orientate itself towards perfection.

(III-ii) Spacetime and Motion

Abstract: *“Spacetime” is but the simplification title of both “space” and “time”. As ingenerate attribute of matter, “motion” is activity inheritance in disguised form from dynamic spacetime to matter for matter is just lineal homologic multiplication outcome of hylic spacetime, such activity inheritance is virtually materialized by PNT performance between spacetime and matter, so that, in a simple word, motion is but straightforward dynamic enantiomorph of PNT action in spacetime; so that absolute spacetime momentum of matter integration can be expressed as “ $mV=d(M \leftarrow m)Y \iff V=d(M \leftarrow m)Y/m$ ”. At the same time, motion of matter integration in spacetime can cause “spacetime dynamic assimilation”, So-called “spacetime dynamic assimilation” is just relative domino effect that as increase of moving speed of observer, the dynamic esse of spacetime is proportionably weakened or decreased, —the higher speed of observer is, the more spacetime dynamic esse will be tenuated, resultingly, the same spacetime dynamic esse judged by different observers moving at different speeds, as the disparities of their moving speeds, the corresponding physical quantities of the common spacetime dynamic esse are different. Generally, their judged physical quantities of spacetime dynamic esse are subject to common definition as below:*

Relative state quantity = Normal state quantity \times Dynamic assimilation function

Keywords: *Spacetime dynamic assimilation, relativity, normal state quantity, relative state quantity, Spacetime dynamic assimilation function, relative effective reciprocity radian range*

So-called “spacetime” is but the simplification title of both “space” and “time”. We’ve primarily introduced space and time in sections ahead, we now come to illuminate why the congenital correlation between spacetime and matter derived from lineal homologic filiation along sequential homologic cosmogony dominates existence & motion of matter in spacetime further, and as motion of observers with certain moving speed in spacetime can cause idiographic dynamic assimilation, why spacetime dynamic assimilation happens and how spacetime dynamic assimilation impact relative state quantities of observers moving in different speeds in spacetime——homogenous relativity.

1. Homologic connotation of motion in cosmos

The cosmic unique-genesis connotation of motion essentially derived from cosmic unique-genesis homogenous evolvement and development.

We affirm that entire cosmos essentially originated from unique genesis and completely exist as a grand homogeneity system; both coordinative spacetime and matter belong to category of cosmos and exactly make up of the complete cosmic homogeneity system. Along sequential homologic cosmogony, spacetime and matter must be in alternative homologic filiation either “spacetime father & matter son” or “matter father & spacetime son”, after excluded the alternative possibility of matter father & spacetime son, we arrive at conclusion that matter is lineal homologic multiplication outgrowth of hylic spacetime along sequential homologic cosmogony. This of course implies congenital correlation between spacetime and matter——positive & negative transmutation between spacetime and matter——PNT action, the so-called “PNT action” is just the ingenerate and essential attribute of matter in spacetime, which radically predestines existence & motion of matter in spacetime.

As ingenerate attribute of matter, “motion” is activity inheritance in disguised form from dynamic spacetime to matter for matter is just lineal homologic multiplication outgrowth of hyllic spacetime, such activity inheritance is virtually materialized by PNT performance between spacetime and matter, so that, in a simple word, motion is but straightforward dynamic enantiomorph of PNT action in spacetime; so that absolute spacetime momentum of matter integration can be expressed as

$${}^{\leftarrow}mV=d(M\leftarrow m)Y \quad \longleftrightarrow \quad V=d(M\leftarrow m)Y/m.$$

Of course, matter inertial conservation equations and PNT dynamics hypostatize the very essentiality as well.

In detail words, as ingenerate attribute of matter, the essentiality of motion can be generalized as following:

1.1. Matter motion is activity heritage of dynamic spacetime

Matter is lineal homologic outgrowth of hyllic spacetime along sequential homologic cosmogony in the nature of coherent natura naturans throughout cosmic evolution, as cosmic demiurgic homologic cosmogony must be throughout sequential and reversible, spacetime and matter must keep their congenital lineal homologic correlation——PNT correlation or PNT action, it's just the physical PNT action between matter and spacetime inherently makes the activity heritage from dynamic spacetime to matter materialized, so that motion is ingenerate attribute of matter and any matter exists in spacetime must possess absolute spacetime momentum as below:

$$mV=d(M\leftarrow m)Y \quad \longleftrightarrow \quad V=d(M\leftarrow m)Y/m$$

No matter what motion state matter exists in spacetime, and no matter what motion process matter experiences, as long as it belongs to the category of cosmic substance and exists in spacetime, it must possess absolute spacetime momentum as $mV=d(M\leftarrow m)Y$, (Of course I have to comment here, as time dynamic speed is a scalar, the absolute spacetime momentum is a scalar quantity, but not a vector.). And this of course implies any matter exists in cosmos moving in accordance with law of identity. This is just something about the “nature”, and it is just because of such ingenerate coherence of matter, existence & motion of matter in cosmos are so concordant and well-regulated.

And in accordance with absolute spacetime momentum, $mV=d(M\leftarrow m)Y \quad \longleftrightarrow \quad V=d(M\leftarrow m)Y/m$, as $d(M\leftarrow m)>0$, $Y>0$, $m>0$, resultingly, V satisfies $V>0$ absolutely. This of course implies that motion is ingenerate attribute of matter; there is none absolute static objects in the cosmos. Any objects existing in cosmos, if it belongs to category of negative matter/dark matter, it must exist in dynamic genic transition and transmutation; if it belongs to category of positive matter/baryonic matter, it must keep PNT action with dynamic spacetime and consequentially possess absolute motion speed $V=d(M\leftarrow m)Y/m$. No matter dynamic genic transition and transmutation or PNT performance between spacetime and matter, they all imply “variation”, so the cosmos is completely an organic homogeneity system in living dynamic process, and in time current, we can never find the “same object”.

And indeed, existence & motion of matter in spacetime is radically determined by PNT performance of matter integration, so-called “motion” is but enantiomorphous embodiment of PNT performance of matter integration in spacetime or the most straightforward representation format of PNT performance of matter integration.

1.2. Motion utmost speed is just time dynamic speed

As matter is lineal homologic proliferation outgrowth of dynamic spacetime along sequential homologic cosmogony, matter motion is consequent activity heritage from dynamic spacetime, which is inherently materialized

As coherent natura naturans throughout cosmic evolution, instinctive PNT reciprocal equilibrium towards optimum PNT operation is radical potentiality & conditionality for cosmos always ready to orientate itself towards perfection.

by PNT performance between spacetime and matter, resultingly, any object in cosmos possesses absolute spacetime momentum ① $mV = d(M \leftarrow m)Y \iff V/Y = d(M \leftarrow m)/m$. In the equation, as positive towards negative transmutation rate $d(M \leftarrow m)$ just denotes the variation rate of total positive mass of matter integration m , there is absolutely no way for value of $d(M \leftarrow m)$ to be even bigger than m , and as $d(M \leftarrow m) > 0, m > 0$, so $V/Y = d(M \leftarrow m)/m \leq 1 \iff V \leq Y$, which apparently implies there is no possibility for speed of matter motion to exceed time dynamic speed, time dynamic speed is the utmost speed of matter motion in homogenous cosmos.

At the same time, as the cosmic contents are exactly limited in unique-genesis homogeneity system, the motion utmost speed of the cosmic unique-genesis homogeneity system is just time dynamic speed Y . Virtually, as comprehensive cosmic motion including genic transition & transmutation in cosmic homogeneity system are but limited in transference and transmutation in hyllic configurations, it of course implies there is nonexistence in cosmos whose motion speed may even exceed time dynamic speed. Once the motion speed of object exceeds time dynamic speed, it then must have transcended the category of cosmos, and it's impossible for it to have anything to do with cosmic contents originated from unique genesis any longer.

For instance, there are two cars moving on an ideal linear road, one ahead and the other behind. According to our conventional experience, if the car behind runs faster than the one ahead, the behind one will consequentially collide on the car ahead. Whereas, if before the behind one colliding on the ahead one, the run speed of the behind car has approached or even exceeded time dynamic speed Y , then the behind one can never collide on the one ahead any longer. Because before the behind one colliding on the ahead one, as the speed of the behind one has approached or even exceeded time dynamic speed, the behind car has completely transcended category of cosmos already, it can never find any cosmic existence any longer. Even if the behind car is originally a bullet, once its moving speed approaches or even exceeds time dynamic speed, then the bullet can never injure anything else in cosmos.

For another instance, let's suppose there is a large iron house obturated 100 over 100, and in the center of the obturated iron house, there is an aircraft. According to our conventional experience, once the aircraft starts up and collides on the iron wall, it would be crashed at once. But if before reaching the iron wall, the flying speed of the aircraft can approach or even exceed time dynamic speed, then the aircraft can never collide on the iron wall any longer, and once the flying speed of the aircraft approaches or even exceeds time dynamic speed, then the aircraft is neither in the iron house and nor out of the iron house, but out of cosmos.

For another instance, if you reach out your hand to push your desk, if the speed of your hand trying to reach your desk can approach or exceed time dynamic speed, then you can never reach and touch your desk.

Note ①: I have to comment herein, absolute spacetime momentum is a scalar quantity but not a vector, because it is originally defined under default absolutely static reference frame which is nonexistence in cosmos, and what's more, the absolute spacetime momentum of object in cosmos is usually a cumulative value of various configurable PNT performance on all proper hiberarchy of idiographic reciprocal PNT combination, for instance, the absolute spacetime momentum of any atom in spacetime of course includes the absolute spacetime momentum of ultimate structural hiberarchy of atom and all absolute spacetime momentum of all the compositive components within atom which make up of the atom as relatively independent components with idiographic PNT performance. Please come to know more about this topic referring to the coming section of "spacetime momentum micromodelization and macromodelization in hiberarchy of reciprocal PNT combination".

And virtually, if you can reach out your hand so quickly, once you reach out your hand at this speed, you've then immediately poked throughout the cosmos already, which indicates you've already reached your hand out of cosmos. Thus, you can of course imagine how wide ② the cosmos virtually is.

1.3. Motion is but dynamic enantiomorph of PNT action of matter integration in spacetime

The dominance of matter integration PNT action to matter motion is generally implemented by instinctive covariant equilibrium between $d(M \leftarrow m)$ and $d(M \rightarrow m)$ towards new balance. If $d(M \rightarrow m) = d(M \leftarrow m)$, then matter integration exists in inertial state, and the proper inertial velocity is $V = d(M \leftarrow m)Y/m$, $d(M \leftarrow m)$, Y , m and all related state variables of matter integration keep constant; If $d(M \rightarrow m) \neq d(M \leftarrow m)$, then matter integration will spontaneously arise PNT equilibrium towards optimum PNT operation, and all the state variables of matter integration will vary accordingly. Throughout the course of PNT equilibrium, there is a change rate dm of mass m which satisfies $d(M \rightarrow m) - d(M \leftarrow m) = dm$, $dm \neq 0$; and $V = d(M \leftarrow m)(t)Y(t)/m(t)$, $F(t) = d(p)/d(t)$, among the equations, t denotes time, $d(p)$ denotes the momentum change of matter integration.

However, for some certain inconvenience, Homogenous Cosmos Originated from Unique Genesis did not analyze the dynamic principium directly on the basis of covariant equilibrium between $d(M \rightarrow m)$ and $d(M \leftarrow m)$, I must comment here that any motion varying process of matter integration in spacetime is just the process that $d(M \rightarrow m)$ and $d(M \leftarrow m)$ instinctively equilibrium towards new PNT equilibrium.

Of course, throughout the process of the covariant equilibrium between $d(M \rightarrow m)$ and $d(M \leftarrow m)$, not only the mass of matter and velocity of matter integration change, but also momentum & energy of matter integration, matter field strength, time dynamic speed, even space radiation cornu and geometrical profile of objects varies accordingly.

For instance, we define the corner of carriage of a train stopping on the railway a standard right-angle reference frame, then, once the train starts; the right-angle reference frame can not be standard any longer.

For another instance, if we define the basket ball in the arm of a boy standing by the road a standard "sphere", once the boy gets on the bus and moves with the bus with the ball in his arm, then, the ball in boy's arm can never be a standard sphere any longer.

2. Spacetime Dynamic Assimilation

When we primarily come to analyze the cosmic unique-genesis connotation of motion, we just study the relatively independent matter integration moving in default initial reference frame, the intention for us to do it like this is to illuminate the congenital covariant mechanism between spacetime and matter in the natural and simple way according to the background logos of cosmic original demiurgic multiplication of matter. This is of course the major clew for us to study and comprehend motion of matter in the nature. Whereas, it does not signify the full cosmic connotation of motion; motion still has its relativity meaning, just as we observe the

Note ②: as the cosmic contents and non-cosmic contents do not belong to the same homogeneity system, in accordance with cosmic connotation of reciprocity, there is no possibility for cosmic contents and non-cosmic contents to approach any physical reciprocity, and as a result, the "estrangement" between cosmos and non-cosmos can never be measured by cosmic notion of "distance", and virtually, the cosmic existence of distance can never extend out of cosmos. And at the same time, there is absolutely no way for non-cosmic contents to perceive existence of cosmic endosome of distance, the confusion is similar as, upon our intuitive sense, we can not conclude how many kilograms the distance from the earth to the sun is.

As coherent natura naturans throughout cosmic evolution, instinctive PNT reciprocal equilibrium towards optimum PNT operation is radical potentiality & conditionality for cosmos always ready to orientate itself towards perfection.

same mountain in different angle of view; we may consequently find different observation profiles of the same mountain. And now, let's suppose our observation objective is just the earth, we separately stand in an aircraft moving at 2 times of supersonic speed and in a flying saucer moving at speed of 0.8C, and we just observe the earth from the same orientation, then, may the motion status, geometrical profile and mass of the earth be the same? If not, what would be the differences between the two different relative situations?

For this, it's necessary for us to know something about "spacetime dynamic assimilation" in advance.

It is well known; hydrogen atom H^1_1 just consists of one single proton and one single electron running around the proton. As the electron outside of nucleus circumscribes around the nucleus in rather high speed, we generally find that the hydrogen atom a similar-sphere in size of hydrogen atom, which is obviously far larger than the total volume of one proton and one electron.

But now, let's suppose that we are just running around the hydrogen atom exactly followed the very electron around the hydrogen nucleus, and at the same time, we observe the geometrical profile of hydrogen atom. It is very easy for us to comprehend that the wider gap our running speed is lower than the electron's, we then would consequently find the geometrical profile of the hydrogen atom more substantial and veritable; and on the other hand, the closer our running speed is to the electron circumscription speed, we then would find out the geometrical profile of the original similar-sphere of hydrogen atom seem thinner and more inveracious. Once our running speed equals the circumscription speed of the electron, then the similar-sphere profile of hydrogen atom would completely disappeared, we ultimately find that hydrogen atom is but a proton and an electron exist relatively static with some certain distance. (Of course, as observer in cosmos, if our motion speed is even bigger than the speed of electron out of hydrogen nucleus, just because of "relativity domino effect" in spacetime, in our physical purview, the existent probability of hydrogen nucleus & the electron out of hydrogen nucleus proportionably become less and less in time current, which is the same physical effect as the mass of hydrogen nucleus and the electron out of the hydrogen become less and less in time current, till at last, once our motion speed equals time dynamic speed Y, the hydrogen nucleus and the electron out of hydrogen nucleus completely disappear in our physical purview. Virtually, as observer in cosmos, once our motion speed equals time dynamic speed Y, we completely lose physical purview in cosmos or our physical purview is consequently limited in one ideal line, universal existence & motion consequently become "nonexistence/0 existence" in our physical purview.)

The motion status of genic transition and transmutation in space field is rather similar to the situation of electrons running around nucleus, the geometrical profile of space field is not only related to the intensity of the stochastic radiation originated from genic transition and transmutation, but also related to the relativistic speed of the observer. As the genic transition and transmutation has no orientation, the relativistic speed of observer has no orientation limitation due to relative domino effect too. If we just neglect the tiny influence to the space field caused by the motion variation of matter integration, the lower the motion speed of observer is, then judged by the observer, the more intensive genic transition and transmutation is, and the more saturated and substantial the geometrical profile of spacetime will be looked like. Inversely, the higher the speed of the observer is, then judged by the observer, the more retardant the genic transition and transmutation in space field is, and the geometrical profile of the space field will then be looked more unsaturated and inveracious. Till at last, the motion speed of observe approaches time dynamic speed, then judged by the observer, the space field is completely nonexistent. We just call the dynamic esse tenuation tendency of space field following speed increase of observer "Spacetime dynamic assimilation".

So-called "spacetime dynamic assimilation" is just relative domino effect that as increase of moving speed

Historical progress of science in the recent several centuries seemed like a far-flung exploration of the first itinerary around numerous distinctive landscapes of brand-new landmasses of science with palette & tablet on back, several hundred years' scientific travelogues were compiled thereby.

of observer, the dynamic esse of spacetime proportionably tenuate, —the higher speed of observer is, the more spacetime dynamic esse will be tenuated, resultingly, the same spacetime dynamic esse judged by different observers moving at different speeds, as the disparities of their idiographic moving speeds, the corresponding physical quantities of the common hypostatic cosmic endosome are different.

Space dynamic assimilation makes the space field exhibit relative weakening tendency with the increase of motion speed of observer. The weakening physical connotation generally includes; 1, the space field intensity exhibits weakening tendency. 2, the space radiation cornu arises narrowing tendency. 3, the geometrical length will consequently vary, in its relative motion direction its length will be longer, and its volume will then be less. 4, the mass of objective arises decreasing tendency. And the relative weakening tendency will at last continue to motion speed of observer equals to time dynamic speed, space radiation cornu changes to zero; length of objective in its motion orientation becomes infinitely long, but its volume is zero; its totally mass of objective is zero, relative speed is absolute zero, time rate is zero, and it completely has nothing to do with all outside.

3. Relativity of Homogenous Cosmos Originated from Unique Genesis

The PNT dynamics is established by studying relative moving object referred to the default frame reference. Once default frame reference is affirmed, the motion of the object relative to the default frame reference is critically subject to PNT dynamics. For some certain convenience, we just call the motion under default frame reference as “normal motion”, for instance, we find car moving on the road, rocket started up from the ground and so on. Whereas, it's not the full connotation of motion in spacetime, it's still necessary for us to introduce homogenous relativity for presence of spacetime dynamic assimilation.

We study relativity is just to study the motion status of the object A relative to another motion object B referred to the default reference frame O. It implies that both objects A and B are moving relative to default frame reference O. let's suppose, the object B is just the observer; it observes how object A moves. For this, we primarily suppose the velocities of the objects A and B relative to default frame reference O are V_A and V_B (of course $V_B \neq 0$, if $V_B = 0$, then observation result is just the same as the default frame reference) we come to analyze the motion status of object A observed by moving observer B. For example, when we come to study high energy physics, we have to judge whether a high speed moving particle can collide on another high-speed moving one; in high-speed state, whether a head off missilery can exactly attack at the aggressive one. ..., they all involve relativity.

According as “space dynamic assimilation” introduced ahead, we know that the bigger the motion speed of observer is, the more remarkable the spacetime dynamic assimilation domino effect is. We study relativity is just to study the relative status of one object relative to another moving object, as the disparity of spacetime dynamic assimilation domino effect between objects moving in different speeds, they have different spacetime quantification standard. As a result, the observers moving in different speeds find different motion status, different physical quantities, and different relative reciprocity effect & reciprocity possibility. Homogenous Cosmos Originated from Unique Genesis studies relativity is just to illustrate the difference of the observing domino effect and reciprocity effect derived from disparities of spacetime dynamic assimilation due to different observers moving in different speeds.

For this, Homogenous Cosmos Originated from Unique Genesis primarily affirms that any relative state quantity of matter integration equals the product of normal motion state quantity and the proper spacetime dynamic assimilation function.

Relative state quantity = Normal state quantity \times Dynamic assimilation function

Now, we come to analyze the relative state quantities of various state parameters of matter integration.

First: Relative mass of object A observed by observer B

If we just denote the spacetime dynamic assimilation function of mass as $H_1(V)$, and denote the normal state quantification of mass as $m(t) = R(t)/(1+K(t))$, and denote the relative quantity of mass of objective A observed by B as m_r , in accordance with the definition equation of relative state quantity of mass, we arrive at:

$$\begin{aligned} m_r &= m(t) * H(V) \\ &= R(t) / [1 + K(t)] * H_1(V) \end{aligned} \quad \dots\dots\dots \quad (\text{III-ii-1})$$

In the equation, the letter V denotes the velocity of A relative to B referred to the inertial frame reference O. Of course, if A keeps static to inertial frame reference O, then the normal state quantity of mass of A can be taken place by m_0 in stead of $m(t) = R(t)/(1+K(t))$, m_0 is some certain constant.

If we primarily assume the spacetime dynamic assimilation function of mass as $H_1(V) = (1 - V^2/Y^2)^{1/2}$, (Y is the time dynamic speed of default inertial frame reference O), then the relative state quantity of mass changes into:

$$\begin{aligned} m_r &= m(t) * H(V) \\ &= R(t) (1 - V^2/Y^2)^{1/2} / [1 + K(t)] \end{aligned} \quad \dots\dots\dots \quad (\text{III-ii-2})$$

Thus, it can be seen that any discretionary object observed by different observers in different moving speed, the magnitude of observed mass are different accordingly, once the motion speed of the observer approaches time dynamic speed, then no matter how large the original mass is, judged by the observer, the mass of object is absolutely zero, and as a result, he can not find physical existence of the object any longer.

Second: Relative velocity of object A observed by observer B

For the same reason, if we denote the spacetime dynamic assimilation function of velocity $H_2(V)$, denote the velocity state function of norm motion as $V = V_0 + \int a(t) dt$, and denote the relative velocity of object A observed by observer B as V_r , then the relative velocity state quantity definition equation can be expressed as:

$$V_r = [V_0 + \int a(t) dt] * H_2(V) \quad \dots\dots\dots \quad (\text{III-ii-3})$$

But, we should notice that the V_r here denotes the velocity of object A referred to inertial frame reference O and judged by observer B, and V denotes the velocity of object B relative to object A referred to the inertial frame reference O. Of course, if object A keeps inertial motion relative to inertial frame reference O, then, $\int a(t) dt = 0$; if object A keeps stationary referred to inertial frame reference O, then, $V_0 + \int a(t) dt = 0$. And at the moment, if object A existing in variable motion state relative to object B, then judged by B, object A moving in variable norm motion situation. In another word, the state quantity of object B, which is regarded as normal quantity is virtually a variable quantity, all the relativistic state quantities of object A varying in accordance with the changing normal state quantity of object B. If the norm state quantity of object B arises increasing tendency, then correspondingly, the relative mass of object A must arises decreasing tendency; the norm state quantity of space radiation cornu exhibits increasing tendency, then correspondingly, relative state quantity of space radiation cornu of object A must exhibit decreasing tendency;

If we just denote the norm motion velocity $V = d(M \leftarrow m)(t) Y(t) / m(t)$, and denote the relative velocity of object A observed by observer B as V_r , then, the relative velocity can be formulated as below:

Historical progress of science in the recent several centuries seemed like a far-flung exploration of the first itinerary around numerous distinctive landscapes of brand-new landmasses of science with palette & tablet on back, several hundred years' scientific travelogues were compiled thereby.

$$V_r = d(M \leftarrow m)(t) Y(t) * H_2(V) / m(t) \quad \dots\dots \quad (III-ii-4)$$

If we primarily assume that the parameter function of spacetime dynamic assimilation of velocity is $H_2(V) = (1 - V^2/Y^2)^{1/2}$, (Y denotes the time dynamic speed of inertial frame reference O), then, the proper relativity motion state equation changes into:

$$V_r = [V_0 + \int a(t) dt] * (1 - V^2/Y^2)^{1/2} \quad \dots\dots\dots \quad (III-ii-5)$$

$$\text{Or: } V_r = d(M \leftarrow m)(t) Y(t) * (1 - V^2/Y^2)^{1/2} / m(t) \quad \dots\dots \quad (III-ii-6)$$

Thus, it can be seen that a certain moving object observed by different observers moving in different speed, its velocity referring to the same frame reference is different accordingly, the bigger the relative motion speed of observer is, judged by the observer, the lower the relative speed of the observed object is, and once the motion speed of observer approaches time dynamic speed, no matter how high the original speed of the object is, its relative speed is zero, so that there is no way for the time dynamic speed moving observer to find the existence of any object in cosmos. Of course, for the same reason, even the observed object is just a clock; the matter is also the same naturally. In another word, the faster the observer runs relative to the clock, then judged by the observer, the slower the clock runs, once the running speed of the observer approaches time dynamic speed, then it can only find the clock absolutely static, which virtually implies it can not find any motion existence or process existence in cosmos any longer.

Third: Relative geometrical profile of object A observed by observer B

The relative geometrical profile of object involves both the relative length of object and the relative space radiation cornu (just the relative space radian cornu).

Here, we study the length of object first.

If we just denote the reference function of length of matter as $H_3(V)$, we also denote the normal motion state quantity of length of matter as $L^3(t) = A * m(t) / \alpha(t)$; and denote the relative length state quantity of object A to observer B as L_R . (Of course, here L_R denotes the length on the moving direction of object B relative to object A) then, the relative length of object A observed by observer B can be formulated as below:

$$L^3_R = A * m(t) H_3(V) / \alpha(t) \quad \dots\dots\dots \quad (III-ii-7)$$

If we assume that the parameter function of spacetime dynamic assimilation of length is $H_3(V) = (1 - V^2/Y^2)^{-1/2}$, (Y denotes the time dynamic speed of inertial frame reference O), then the length of relative state quantity definition equation changes into:

$$L^3_R = A * m(t) (1 - V^2/Y^2)^{-1/2} / \alpha(t) \quad \dots\dots\dots \quad (III-ii-8)$$

Referring to the equation above, we can see the higher the motion speed of observer is, then the length of object in its motion orientation is longer, and once the motion speed of observer approaches time dynamic speed, then considered by the observer, the length of object in its motion orientation is infinite long, no matter how short its original length is.

Subsequently, we come to analyze the “relative state quantity of space radiation”.

Before we practically analyze the relative state quantity of space radiation, we primarily assume that under normal motion conditions, the cube of space radiation U is proportional to the time dynamic speed Y(t), just as below:

As coherent natura naturans throughout cosmic evolution, instinctive PNT reciprocal equilibrium towards optimum PNT operation is radical potentiality & conditionality for cosmos always ready to orientate itself towards perfection.

$$U^3 = N * Y(t) \quad \dots\dots\dots \quad (\text{III-ii-9}) \quad (\otimes)$$

(In the equation above, N is just the proportionality coefficient)

And because: $Y(t) = B * \alpha(t)$

as a result; $U^3 = N * B * \alpha(t) \iff U = [N * B * \alpha(t)]^{-3} \quad \dots\dots\dots \quad (\text{III-ii-10})$

If we just denote the relative reference function of space radiation as $H_4(V)$, and denote the relative state quantity of space radiation as U_R , we then can arrive at relative state definition equation of space radiation as below:

$$U_R = [N * B * \alpha(t)]^{-3} * H_4(V) \quad \dots\dots\dots \quad (\text{III-ii-11})$$

If we primarily assume the proper spacetime dynamic assimilation function of space radiation cornu as $H_4(V) = (1 - V^2/Y^2)^{1/2}$, then:

$$U_R = [N * B * \alpha(t)]^{-3} * (1 - V^2/Y^2)^{1/2} \quad \dots\dots\dots \quad (\text{III-ii-12})$$

As space radiation directly predestines geometrical profile of any object existing in the spacetime, besides the natural tiny influence caused by general cosmic connatural tiny variation, as presence of spacetime dynamic assimilation, the moving speed of observer directly impacts the physical coefficients and relative geometrical profile of the observed object too.

Standing by the railway, we define a corner of the train-case a “standard right-angle reference frame” model, then observed by a driver on a moving car, the “standard right-angle reference frame” can never be standard any longer.

Standing side by side with a boy who just stands by the road with a “basket ball” in his army, if we just define the basket ball in his army a standard “sphere”, then, once the boy climbs up the bus with the basket ball and the bus runs subsequently, then the basket ball can not be found as a “sphere” by us any longer.

The bigger the moving speeds of observer are, the smaller the space radiation cornu he can find, and proportionably, the less physic existence he can find in cosmos. Once the moving speed of observer approaches time dynamic speed, then in his opinion, the space radiation cornu is zero and entire cosmos but limit existing in an ideal line; once his motion speed exceeds time dynamic speed, he can never find any cosmic existence any longer, he has completely gone beyond the cosmos.

Of course, if object observed is just the earth or any other objects stationary to the earth, then the $[N * B * \alpha(t)]^{-3}$ in equation (III-ii-12) can be taken place by “ π ”, just as equation below:

$$U_R = \pi * (1 - V^2/Y^2)^{1/2} \quad \dots\dots\dots \quad (\text{III-ii-13})$$

Of course, even it is just the earth, and observed by an observer moving at a certain speed relative to the earth, as increase of the relative speed, in the observer’s opinion, the mass of the earth will become less and less, and its geometrical profile will become longer and longer in its moving orientation, till at last its mass tend to zero and its volume exists in an ideal line.

Fourth: Relative effective interaction space radian range between object A and object B.

The relative effective interaction space radian range depends on the relative effective space radian between the observer and object. That’s to say, in physical qualification, the relative effective interaction space radian range and the relative effective space radian are congruent. It implies that the relative effective interaction space

radian range satisfies the same mathematical equation as relative space radiation cornu too, just as below:

$$U_R = [N*B*\alpha(t)]^{-3}(1-V^2/Y^2)^{1/2}$$

The only discrepancy is that the U_R in the above equation denotes the relative effective interaction space radian range, that's to say, only in the space radian range of U_R , there is physical possibility for object A and object B to arises interaction. For instance, in general situation, any vector on the earth has non-zero heft in space radian range $(0, \pi)$, it can work outside or transfer energy to transeunt objects by "collision" or "radiation" in such space radian range. If there is a vector on object A, considered by object B, the vector only has a non-zero heft in relative effective space radian range $(0, U_R)$. Of course, only within the space radian range $(0, U_R)$, there is physical possibility for objects A to arises motion orientation and for object A and object B to arises interaction, even object B find object A is moving in a circle orbit, considered by object B, the circle perimeter must be $2U_R$, (r denotes the radius of the circle.), but not $2\pi r$, the same as the situation on the earth in general condition, and if the larger the magnitude of the relative speed between object A and object B is, the narrower the relative effective interaction space radian range will consequently be, once the relative speed approaches time dynamic speed, considered by object B, object A only exists in an ideal line, **(In fact, considered by object B, the complete cosmos exists in an ideal line)**, there is only possibility for objects A and object B to arises interaction in such a line. And once the relative speed exceeds time dynamic speed, the both objects have nothing to do with each other. Then judged by object A, object B has completely transcended the cosmos, it has nothing to do with any object in cosmos.

For an instance, relative to a flying assault missile, an interceptor missile flies towards the assault missile at speed of V , then, relative to the flying assault missile, the interceptor missile only has effective assault space radian range $(0, U_R)$, if their relative positions exceed the effective assault space radian range, it is impossible for the interceptor missile to roquet the assault missile, unless the interceptor readjust its velocity. That's to say, to any proper relative speed, it proportionably has a corresponding applicable relative interaction space radian range, the larger the relative speed is, the narrower the effective relative interaction space radian range is. Of course, it also implies the less cosmic contents the observer can physically perceive as well.

For another instance, the larger the relative speed between the rocket and the bottom whiff is, the weaker the mutual interaction effect between the rocket and the bottom whiff is; as a result, the rocket is more difficult to accelerate continuously. And once their relative speed approaches time dynamic speed, then there is none physical possibility to materialize cosmic interaction between the rocket and ejection of burning fuel any longer, and the rocket has nothing to accelerate any longer **③**.

We here introduce homogenous relativity is mainly to elucidate relative disparity of moving matter integration derived from spacetime dynamic assimilation disparity due to moving observers in different moving speeds. Virtually, on point of general normal motion, such relative disparity is but disparity among different cases moving in different speeds in accordance with the uniform PNT dynamics, at any rate, no matter they

Note **③**: Of course, in accordance with PNT dynamics, once the velocity of rocket approaches time-dynamic-speed little by little, the mass of rocket will proportionably approach infinity, perhaps it is still not enough even all cosmic mass gathers to the one body of the rocket. Of course, it's virtually impossible, and at the same time, it positively indicates that time dynamic speed is just the utmost speed in cosmos.

As coherent natura naturans throughout cosmic evolution, instinctive PNT reciprocal equilibrium towards optimum PNT operation is radical potentiality & conditionality for cosmos always ready to orientate itself towards perfection.

are normal motion or relative motion, the dynamic principium they must be subject to is coherent, the key issue is but disparity of spacetime dynamic assimilation due to moving matter integration in different speeds, which we introduced as references. All in all, observing in different moving speeds, as disparity of spacetime dynamic assimilation, the observers moving in different speed have different quantification standards, as a result, they have different relative state quantities observed themselves. That's to say, different observers with different spacetime dynamic assimilation domino effect for their disparity of moving speeds proportionably possess different cosmic existence, for instance, the cosmic existence observed by an observer standing on Mars must be different from cosmic existence observed by an observer standing on earth.

For example, we stand on the earth and observe a rocket flying away from the earth, during the course of the rocket accelerating, we will find the mass of the rocket bigger and bigger, and the matter field strength on the surface of the rocket will be larger and larger, time become faster and faster, once the velocity of rocket approaches the time dynamic speed, we then find that the mass of the rocket is infinity, the matter field strength on the surface of the rocket is infinity, time rate approaches the extremity. And inversely, if we just stand on the rocket and observe the existent state of the earth, during the course of the rocket accelerating, we will find out the mass of the earth less and less, the space field strength on the surface of the earth is weaker and weaker, time on the surface of the earth is slower and slower, and once the velocity of the rocket approaches time dynamic speed, we will then find out that the mass of the earth is zero, the space radian is zero, the earth (Even the entire cosmos) just exists in an ideal line, time rate is zero. And virtually, at the moment, the rocket can never find the existence of the earth (can never find any existence in the cosmos too), even it knocks into the earth time after time, it has none feeling of any collision, after all, once velocity of rocket approaches time dynamic speed, it can only work to the earth in one ideal line theoretically.

Of course, I introduced the relativity transform of “ $(1-V^2/Y^2)^{1/2}$ ” in prior is but for expedience to illuminate the general mathematical orientation of various relativity parameters of matter integration. In accordance with the cosmic unique-genesis homology logos, when we come to study relativity, all relative parameter functions $H_n(V)$ should be originally deduced from the PNT dynamics equations, but in order to incarnate and highlight the relative effect, it is better for us to express the relative parameter functions in the format with variable of V . And just because of my current limit of mathematical knowledge and primary verification and demonstration of PNT dynamics, it seems no expedient ways for me to accomplish the job accordingly just now.

——Firstly written in Dec. 1995, literal revision was done in Dec.2004

(III-iii) General existence & motion patterns of matter in spacetime

Abstract: *Universal existence & motion are but spontaneous occurrence in the nature of essence of matter in a class by itself, motion status and variation of all state variables of matter integration radically depend on PNT performance of instinctive covariant equilibrium between $d(M \rightarrow m)$ and $d(M \leftarrow m)$.*

*If $d(M \rightarrow m) = d(M \leftarrow m) = \text{certain constant}$, absolute spacetime momentum " $m * V = d(M \leftarrow m) * Y$ " of matter integration keeps constant and matter integration keeps inertial motion state.*

*If $d(M \rightarrow m) \neq d(M \leftarrow m)$, as presence of PNT equilibrium instinct of matter integration, $d(M \rightarrow m)$ and $d(M \leftarrow m)$ of matter integration will spontaneously equilibrate toward new balance of $d(M \rightarrow m) = d(M \leftarrow m) = \text{new constant}$. And as instinctive covariant equilibrium variation of $d(M \leftarrow m)$, m and Y , absolute spacetime momentum " $m * V = d(M \leftarrow m) * Y$ " \iff " $V = d(M \leftarrow m) * Y / m$ " of matter integration change accordingly, matter integration arises acceleration in accordance with instinctive equilibrium between $d(M \rightarrow m)$ and $d(M \leftarrow m)$. If PNT performance of mater system arises continuous periodic circulation of $d(M \rightarrow m) > d(M \leftarrow m)$ and $d(M \rightarrow m) < d(M \leftarrow m)$, then, matter integration motions in waveform state thereby.*

*Light-wave is typical waveform motion " $m * C = d(M \leftarrow m) * Y$ " \iff " $C = d(M \leftarrow m) * Y / m$ " in cosmos. As the related state variables of $d(M \leftarrow m)$, m and Y usually are not constants in universal spacetime, it's impossible for light-speed C to be constant in so-called "vacuum".*

Keywords: *Waveform motion, light-speed*

1. Motion is dynamic enantiomorph of PNT action of matter integration

Cosmos is throughout homogenous originated from unique genesis and matter is lineal homologic multiplication outcome of spacetime along sequential homologic cosmogony have determined the inherent presence of PNT correlation between spacetime and matter. Any cosmic matter, as long as it has its positive mass and exists in spacetime, it must keep PNT (" $M \leftrightarrow m$ ") correction with its consort matter field, which practically materializes the activity heritage from dynamic spacetime to matter. As a result, any cosmic matter must possess absolute spacetime momentum: $P = m * V = d(M \leftarrow m) * Y$, so that "motion" is ingenerate attribute of matter, matter motion radically depends on PNT performance of matter integration, in a simple word, matter motion is just dynamic embodiment in enantiomorphous representation format of PNT action of matter integration in spacetime.

If $d(M \rightarrow m)$ and $d(M \leftarrow m)$ of PNT performance keep constant and satisfy $d(M \rightarrow m) = d(M \leftarrow m)$, then the absolute spacetime momentum of matter integration " $m * V = d(M \leftarrow m) * Y$ " keeps constant, matter integration exists in inertial state. If the couple covariant opposites $d(M \rightarrow m)$ and $d(M \leftarrow m)$ of PNT performance keep unequal as $d(M \rightarrow m) \neq d(M \leftarrow m)$, as congenital presence of PNT equilibrium instinct of matter integration, $d(M \rightarrow m)$ and $d(M \leftarrow m)$ will spontaneously equilibrate towards new balance, the absolute spacetime momentum of matter integration " $m * V = d(M \leftarrow m) * Y$ " is inconstant, matter integration exists in accelerating state thereby, all state variables of matter integration vary followed performance of covariant equilibrium between $d(M \rightarrow m)$ and $d(M \leftarrow m)$, and quantitative change of all state variables of matter integration are subject to PNT dynamics. We here try to illuminate general existence & motion patterns of matter is of course mainly to introduce the typical and connatural covariant equilibrium instances between $d(M \rightarrow m)$ and $d(M \leftarrow m)$.

As coherent natura naturans throughout cosmic evolution, instinctive PNT reciprocal equilibrium towards optimum PNT operation is radical potentiality & conditionality for cosmos always ready to orientate itself towards perfection.

In terms of macroscopical object, as the magnitudes of $d(M \rightarrow m)$ and $d(M \leftarrow m)$ of matter integration are rather substantial, as a result, their adjustable variation range is rather abundant therein, and it is very easy for matter integration to keep PNT equilibrium for its abundant adjustable variation range. As a result, the existence & motion state of macroscopical objects seems very mechanical and inertial. However, in terms of microcosmic objects, the condition is much different, as very limited mass cumulation of genic units, PNT performance of microcosmic objects is consequently very special. As dynamic enantiomorph of PNT action of matter integration, hypostatic existence & motion of microcosmic objects are proportionably distinctive accordingly. I've introduced rather a lot about inertial motion and general motion of macroscopical objects in spacetime in ahead sections, in order to consummate the topic of connatural existence & motion patterns of matter herein, we now emphatically introduce the motion status of microcosmic objects as a supplemental item —— waveform motion in spacetime.

2. Waveform motion in the nature

2.1. Waveform motion derived from periodic PNT action rhythm

Original generation of matter in cosmos began with separate elementary genic units, in the beginning; there are only disseminative elementary genic units in spacetime, then, as instinctive PNT reciprocal equilibrium towards optimum PNT operation, rich and colorful reciprocal PNT combinations coming into being, ——genic couple, particles, ... atom, molecule ... gas, liquid, solid, ... celestial bodies, galaxy etc. Throughout cosmic demiurgic evolution from single elementary genic units to macroscopical objects, celestial bodies, galaxy, even galaxy combinations, existence & motion of matter were always changing accordingly.

In terms of single separate elementary genic unit in spacetime, apparently, once it performs PNT in space field, as single elementary genic unit, it's completely impossible for it to perform both negative towards positive transmutation and positive towards negative transmutation synchronously and evenly, but to perform negative towards positive transmutation (or positive towards negative transmutation) first, then to perform positive towards negative transmutation (or negative towards positive transmutation), and just always goes its PNT performance like this round and round.

That's to say, as single elementary genic unit, its PNT performance has been clearly separated into two sequential transmutation opposites of negative towards positive transmutation " $M \leftarrow m$ " and positive towards negative transmutation " $M \rightarrow m$ ". And on the other hand, no matter it's negative towards positive transmutation on-going or positive towards negative transmutation on-going, the single elementary genic unit exists in two different acceleration states, such two sequential acceleration processes perform on elementary genic unit in spacetime round and round, it forms typical waveform motion. The displacement the elementary genic unit passed during the course of finishing performance a couple PNT operational cycle of " $M \rightarrow m$ " and " $M \leftarrow m$ " is just the wavelength λ , the interval the elementary genic unit experienced a couple PNT operational cycle of " $M \rightarrow m$ " and " $M \leftarrow m$ " is just the wave period T.

In terms of matter integration consisting of two, three, or several more elementary genic units, as its preliminary genic cumulation scale, its PNT performance is not the same as the single elementary genic unit ——PNT performance is completely dissociated into two PNT opposites of " $M \rightarrow m$ " and " $M \leftarrow m$ ", whereas, as its genic cumulation scale is still very limited, the covariant PNT opposites of " $M \rightarrow m$ " and " $M \leftarrow m$ " are still very difficult to keep even or equivalent synchronously; instead, the performance of the both PNT opposites always arise $d(M \rightarrow m) > d(M \leftarrow m)$ a little now, and arises $d(M \rightarrow m) < d(M \leftarrow m)$ a little then without remarkable

intermission, and the both processes continuously perform on the matter integration round and round. And on the other hand, as the both processes of $d(M \rightarrow m) > d(M \leftarrow m)$ and $d(M \rightarrow m) < d(M \leftarrow m)$ imply two different acceleration processes of matter integration, once the two acceleration processes of $d(M \rightarrow m) > d(M \leftarrow m)$ and $d(M \rightarrow m) < d(M \leftarrow m)$ perform on the matter integration round and round continuously, it forms typical waveform motion too. Compared with motion pattern of single elementary genic unit, their dynamic configurations are almost the same.

Under precondition that cosmos is throughout homogenous originated from unique genesis, the connatural feature of wave-particle duality of microcosmic particles and matter wave feature of relatively massive particles in spacetime is self-evident.

Generally, the less elementary genic units the matter integration contains, the more accessible for the matter integration to exhibit its uneven PNT performance, it's easier for matter integration to expose its PNT rhythm intensity disparity between $d(M \rightarrow m)$ and $d(M \leftarrow m)$. And at the same time, as the mass of the matter integration is relatively tiny, the matter integration is very convenient and sensitive to embody the PNT rhythm intensity disparity between $d(M \rightarrow m)$ and $d(M \leftarrow m)$ upon its motion status. As a result, it is more sensitive to embody waveform feature, but not heavy to maintain its particle feature.

Instead, the more elementary genic units the matter integration contains, the easier for the matter integration to eliminate and gloss over the PNT rhythm intensity disparity between $d(M \rightarrow m)$ and $d(M \leftarrow m)$, it's more difficult for the matter integration to exhibit or expose its uneven PNT performance. And as the mass of the matter integration is relatively massive, the matter integration is relatively inertial and not sensitive to embody the PNT rhythm intensity disparity between $d(M \rightarrow m)$ and $d(M \leftarrow m)$ upon its motion status. As a result, it is not sensitive to embody waveform feature, but more sensitive to embody particle feature on the contrary. As gradual increase of positive mass of matter integration to macrocosm, the waveform feature of matter integration become more and more typical proportionately.

All in all, along quantitative change from macrocosm to microcosmos, the waveform feature of matter integration is gradually consolidated, while particle feature of matter integration is gradually weakened. Inversely, along quantitative change from microcosmos to macrocosm, waveform feature of matter integration is gradually weakened, till at last, waveform feature of matter integration disappeared; while particle feature is gradually consolidated. Generally, electromagnetic wave are just limited in the waveform motion of matter integration made up of few elementary genic units, we usually call the waveform motion of matter integration with substantial convergent cumulation of elementary genic units "matter wave".

2.2. Mathematical analysis of waveform motion

Now, we come to analyze and formulate waveform motion according to PNT dynamics.

As PNT performance of wave origin arises sequential and periodic acceleration cycle of $d(M \rightarrow m) > d(M \leftarrow m)$ and $d(M \rightarrow m) < d(M \leftarrow m)$, for expedience, we come to analyze and formulate the both acceleration processes of the sequential PNT performance cycle of $d(M \rightarrow m) > d(M \leftarrow m)$ and $d(M \rightarrow m) < d(M \leftarrow m)$ separately as following:

First, the accelerating process of $d(M \rightarrow m) > d(M \leftarrow m)$

Let's suppose the accelerating process of $d(M \rightarrow m) > d(M \leftarrow m)$ lasts time t_1 , and at any moment τ within interval t_1 , we denote the function correlation of variation of matter field mass M as $\Delta M(\tau)$, and at the same time, we denote the variation of positive mass m as $\Delta m(\tau)$, then the proper unbalanced matter inertial conservation

equations change into:

$$\left\{ \begin{array}{l} [M-\Delta M(\tau)] + [m+\Delta m(\tau)] = R(\tau) \\ [M-\Delta M(\tau)]/[m+\Delta m(\tau)] = K(\tau) \\ V(\tau) * [m+\Delta m(\tau)] = d(M \leftarrow m)(\tau) * Y(\tau) \\ L^3(\tau) * \alpha(\tau) = A * [m+\Delta m(\tau)] \\ Y(\tau) = B * \alpha(\tau) \end{array} \right. \iff \left\{ \begin{array}{l} M-\Delta M(\tau) = K(\tau) * R(\tau) / [1+K(\tau)] \\ m+\Delta m(\tau) = R(\tau) / [1+K(\tau)] \\ V(\tau) = d(M \leftarrow m)(\tau) * Y(\tau) / [m+\Delta m(\tau)] \\ L^3(\tau) = A * [m+\Delta m(\tau)] / \alpha(\tau) \\ Y(\tau) = B * \alpha(\tau) \end{array} \right.$$

According to PNT dynamics, we can arrive at the acceleration equation of any moment τ of matter integration as below:

$$\begin{aligned} a(\tau) &= Y(\tau) * K'(\tau) \\ &= B * \alpha(\tau) * \{ [M-\Delta M(\tau)] / [m+\Delta m(\tau)] \}' \end{aligned} \quad \dots\dots\dots \text{(III-iii -1)}$$

The force that matter integration stands at any moment τ is as below:

$$\begin{aligned} F(\tau) &= (m+\Delta m(\tau)) * a(\tau) \\ &= [m+\Delta m(\tau)] * B * \alpha(\tau) * \{ [M-\Delta M(\tau)] / [m+\Delta m(\tau)] \}' \end{aligned} \quad \dots\dots\dots \text{(III-iii -2)}$$

The motion velocity of matter integration at terminal moment of t_1 is as below:

$$\begin{aligned} V &= V_0 + \int_0^{t_1} a(\tau) d\tau \\ &= V_0 + \int_0^{t_1} B * \alpha(\tau) * \{ [M-\Delta M(\tau)] / [m+\Delta m(\tau)] \}' d\tau \end{aligned} \quad \dots\dots\dots \text{(III-iii -3)}$$

The displacement of matter integration in interval t_1 is as below:

$$\begin{aligned} S_1 &= V_0 * t_1 + \int_0^{t_1} a(\tau) d\tau \\ &= V_0 * t_1 + \int_0^{t_1} B * \alpha(\tau) * \{ [M-\Delta M(\tau)] / [m+\Delta m(\tau)] \}' d\tau \end{aligned} \quad \dots\dots\dots \text{(III-iii -4)}$$

Second: the accelerating process of $d(M \rightarrow m) < d(M \leftarrow m)$.

Let's suppose the whole acceleration process of $d(M \rightarrow m) < d(M \leftarrow m)$ lasts time t_2 , at any moment τ within interval t_2 , we denote the variation of matter field mass M as $\Delta M(\tau)$, and denote the variation of matter mass m as $\Delta m(\tau)$. Then the proper unbalanced matter inertial conservation equations change into:

$$\left\{ \begin{array}{l} [M+\Delta M(\tau)] + [m-\Delta m(\tau)] = R(\tau) \\ [M+\Delta M(\tau)]/[m-\Delta m(\tau)] = K(\tau) \\ V(\tau) * [m-\Delta m(\tau)] = d(M \leftarrow m)(\tau) * Y(\tau) \\ L^3(\tau) * \alpha(\tau) = A * [m-\Delta m(\tau)] \\ Y(\tau) = B * \alpha(\tau) \end{array} \right. \iff \left\{ \begin{array}{l} M+\Delta M(\tau) = K(\tau) * R(\tau) / [1+K(\tau)] \\ m-\Delta m(\tau) = R(\tau) / [1+K(\tau)] \\ V(\tau) = d(M \leftarrow m)(\tau) * Y(\tau) / [m-\Delta m(\tau)] \\ L^3(\tau) = A * [m-\Delta m(\tau)] / \alpha(\tau) \\ Y(\tau) = B * \alpha(\tau) \end{array} \right.$$

According to PNT dynamics, we can arrive at the acceleration equation of matter integration at any moment τ as below:

$$\begin{aligned} a(\tau) &= Y(\tau) * K'(\tau) \\ &= B * \alpha(\tau) * \{ [M+\Delta M(\tau)] / [m-\Delta m(\tau)] \}' \end{aligned} \quad \dots\dots\dots \text{(III-iii-5)}$$

The force that matter integration bears at any moment τ is as below:

$$\begin{aligned} F(\tau) &= [m-\Delta m(\tau)] * a(\tau) \\ &= [m-\Delta m(\tau)] * B * \alpha(\tau) * \{ [M+\Delta M(\tau)] / [m-\Delta m(\tau)] \}' \end{aligned} \quad \dots\dots\dots \text{(III-iii-6)}$$

The motion speed of matter integration at the terminal interval t_2 is as below:

$$V = V_0 + \int_0^{t_2} a(\tau) d\tau$$

$$=V_0 + \int_0^{t_2} B^* \alpha(\tau) * \{ [M + \Delta M(\tau)] / [m - \Delta m(\tau)] \}' d\tau \quad \dots\dots\dots \text{(III-iii-7)}$$

The displacement of the matter integration in the interval t_2 is as below:

$$S_2 = V_0 * t_2 + \int_0^{t_2} a(\tau) d\tau d\tau$$

$$= V_0 * t_2 + \int_0^{t_2} B^* \alpha(\tau) * \{ [M + \Delta M(\tau)] / [m - \Delta m(\tau)] \}' d\tau d\tau \quad \dots\dots\dots \text{(III-iii-8)}$$

Integrated the first and second sequential acceleration phases above, we can arrive at the wave period as below:

$$T = t_1 + t_2$$

If it is regular waveform motion, then $t_1 = t_2$.

The proper wavelength of matter integration is:

$$\lambda = (S_1 + S_2) \cos \theta \quad \dots\dots\dots \text{(III-iii-9)}$$

(In the equation above, θ denotes the angle between the vibration direction and the transference direction of the wave, if the wave is a rather regular one, then $S_1 = S_2$)

The transmission speed of the wave is:

$$V = \lambda / T = (S_1 + S_2) \cos \theta / (t_1 + t_2) \quad \dots\dots\dots \text{(III-iii-10)}$$

According to the analysis of waveform motion above, we can find that the most typical distinctive character of waveform motion is that PNT performance of matter integration arises sequential periodic rhythm intensity disparity between $d(M \rightarrow m)$ and $d(M \leftarrow m)$, and the integrative PNT performance of matter integration consists of couple sequential processes of $d(M \rightarrow m) > d(M \leftarrow m)$ and $d(M \rightarrow m) < d(M \leftarrow m)$ round and round, and the performance of sequential PNT opposites imply two different sequential acceleration process round and round. Not only light, electromagnetic wave, matter wave are like this, but also mechanical waves are the same too. In another word, from the electromagnetic waves to matter waves, to mechanic waves, as their dynamic configurations are very similar, their natural motion situations are rather similar therein, and indeed, their representative dynamic equations are almost in the same format.

3. About "Light" and "Light-Speed"

One basal postulate of Relativity is "light-speed is constant in vacuum", whereas, Homogenous Cosmos Originated from Unique Genesis thinks there is non-existence of so-called "vacuum" in cosmic homogeneity system but hyllic space field with specific field strength which is virtually lineal coordinative homology ahead of matter, and it's impossible for light-speed to be a constant in so-called "vacuum". Towards the proper clarification, I'd like to highlight three issues in prior as below:

3.1. Since cosmos is throughout homogenous originated from unique genesis, vacuum can only be variable hyllic space field as lineal coordinative homology ahead of matter, and It's completely Impossible for light-speed to be constant in so-called "vacuum"

The reason Homogenous Cosmos Originated from Unique Genesis can introduce general presumable precondition of Homogenous cosmos originated from unique genesis boldly and resolutely is that more and more cases are favorably illuminating the factuality day by day that **discretionary particles in cosmos are mutually convertible** \curvearrowright **for they ultimately possess the common component in certain configurable hiberarchy.** And under precondition of Homogenous cosmos originated from unique genesis, as long as we have no tangible evidence to exclude spacetime out of category of homogenous cosmos, we have to admit "spacetime" must

As coherent natura naturans throughout cosmic evolution, instinctive PNT reciprocal equilibrium towards optimum PNT operation is radical potentiality & conditionality for cosmos always ready to orientate itself towards perfection.

be coordinative homology of matter and as physical as matter; and if cosmos just consists of “spacetime” and “matter”, none coordinative component else, along sequential homologic cosmogony, spacetime and matter must be in alternative filiation either “spacetime father & matter son” or “matter father & spacetime son”. Under general presumable precondition of Homogenous cosmos originated from unique genesis, since spacetime and matter are coordinative homology with lineal filiation, this of course implies remarkable divarication between Relativity and Homogenous Cosmos Originated from Unique Genesis.

In the face of presence of so deadly divarication, Homogenous Cosmos Originated from Unique Genesis can only frankly declare herein, as long as **cosmos is throughout homogenous originated from unique genesis through and through, and we have no tangible evidence to exclude spacetime out of category of homogenous cosmos**, vacuum can never be vacuum itself but hyllic space field as coordinative homology of matter with specific field strength, and it’s completely impossible for light-speed in so-called “vacuum” to be constant therefore. Whereas, in terms of so-called “Relativity”, if Relativity is still ready to persist in itself, I am afraid, Relativity has to stand out to offer negative evidence to issues, —either cosmos is not homogenous originated from unique genesis or even if cosmos is throughout homogenous originated from unique genesis, whereas, spacetime is something out of category of homogenous cosmos; otherwise, so-called vacuum must be variable hyllic space field as coordinative homology of matter with specific field strength, and it’s completely impossible for light-speed in so-called “vacuum” to be constant therefore. Oh, respectable Relativity, if you can not say “No” to the both challenge issues justly, you’d better deny yourself a little of your cock-a-hoop official emotion first, keep silent aside!

Because, if we have no tangible evidence to negate the general presumable precondition of Homogenous cosmos originated from unique genesis, under precondition that cosmos is completely homogenous originated from unique genesis, entire cosmic contents is but a cosmic-scale well-regulated homogeneity system through and through, any substantiality belong to category of cosmos is either cosmic genic origin i_0 itself or radically originated from cosmic genic origin i_0 along sequential homologic cosmogony. In terms of any substantiality in cosmos with a view to cosmic original demiurgic evolution of sequential homologic multiplication, as long as it’s possible to be generated originally along sequential homologic cosmogony, it of course implies, all related active segments or process along cosmic original demiurgic sequence of homologic multiplication towards generation of universal substantiality must be sequentially variable so as to form the successivity of progenitive causality towards original generation of the very substantiality, otherwise there is no way for sequential homologic cosmogony to approach original generation of the very substantiality, —there is none physical possibility of original generation of the very substantiality at all.

And at the same time, any substantiality radically originated from cosmic genic origin i_0 still must be sequentially variable along cosmic original demiurgic sequence of homologic multiplication as well, otherwise, once sequential homologic cosmogony approaches proliferation of the very substantiality, there is no way for sequential homologic cosmogony to extend further, and the very substantiality consequently becomes the deadly obstacle of cosmic homologic multiplication and normal integrative circulative operation. If so, there are only possibility, either the substantiality end up sequential homologic cosmogony, or the substantiality is completely washed out of integrated demiurgic proliferation & circulative operation of cosmic homogeneity system for its incomplicant invariability, whose existent effect relative to cosmos is completely equivalent as object out of cosmos. On the point of correlation between motion and variation, motion must inherently imply variation, any invariable

object can never motion in its connatural way; there are non-existence without ingenerate motion as well as there are non-existence invariable in cosmos.

This is apparently not normal way of cosmic evolution who is always ready to orientate itself towards perfection by the light of nature, and it of course implies it's neither possible for nature to proliferate any invariable substantiality along sequential homologic cosmogony in the nature of coherent natura naturans throughout cosmic evolution nor possible for cosmos to adulterate any invariable substantiality in its normal prolific & existent circle operation. As cosmic homologic substantiality, vacuum, light-speed in so-called vacuum can never be exceptive, —neither so-called “vacuum” as meaningless and monotone as Relativity defaulted in silence nor constant light-speed in vacuum as Relativity introduced as postulate in its theory.

3.2. Light-speed definition in Relativity is virtually value of “ m_c/m_p ”

In accordance with definition of absolute spacetime momentum $mV=d(M\leftarrow m)Y$, when the “m” in equation denotes the mass of a photon, the “V” in equation just denotes the light-speed. That's to say, in accordance with definition of absolute spacetime momentum $mV=d(M\leftarrow m)Y$, light-speed C can still be expressed as below:

$$m \cdot C = d(M\leftarrow m)Y \quad \longleftrightarrow \quad C = d(M\leftarrow m)Y/m$$

We can see, even if at any waveform phase, the value of $d(M\leftarrow m)/m$ can keep some certain constant, (In fact, it's impossible), however, in wide open spacetime, the magnitude of Y is usually variable, it at least implies, in different space fields with physical discrepancy, as the variation of time dynamic speed Y, light-speed can never keep constant.

For convenience to clarify our suspicion further, let's suppose there are a photon and a clock in the same space field. We define the motion situation of the clock as below:

$$m_c V_c = d(M\leftarrow m)Y \quad \longleftrightarrow \quad V_c = d(M\leftarrow m)Y/m_c$$

(In the equation m_c denotes the mass of the clock; V_c denotes the velocity of the clock)

And we define the motion situation of the photon as below:

$$m_p \cdot C = d(M\leftarrow m)Y \quad \longleftrightarrow \quad C = d(M\leftarrow m)Y / m_p$$

(In the equation m_p denotes the mass of the photon; C denotes the velocity of the photon)

Of course, the displacement the photon transmitted in certain natural interval T is as below:

$$C \cdot T = d(M\leftarrow m)Y \cdot T / m_p$$

And the “time” the clock practically recorded in certain natural interval T in spacetime is virtually just the displacement the clock performed by its connatural motion too, so that we can express the recorded time quantity as below:

$$V_c \cdot T = d(M\leftarrow m)Y \cdot T / m_c$$

According to our conventional definition of light-speed $C_T = S/t$, apparently, in this equation, S is the displacement the photon transmitted in the certain interval T, and ‘t’ is the displacement the clock performed in the same interval T too, just as below:

$$S = C \cdot T = d(M\leftarrow m)Y \cdot T / m_p \quad t = V_c \cdot T = d(M\leftarrow m)Y \cdot T / m_c$$

Substitute the two equations above into conventional definition equation $C_T = S/t$, we them arrive at:

As coherent natura naturans throughout cosmic evolution, instinctive PNT reciprocal equilibrium towards optimum PNT operation is radical potentiality & conditionality for cosmos always ready to orientate itself towards perfection.

$$\begin{aligned}
 C_T &= C * T / V_c * T = C / V_c \\
 &= [d(M \leftarrow m) Y / m_p] / [d(M \leftarrow m) Y / m_c] \\
 &= m_c / m_p
 \end{aligned}$$

This of course indicate, during the course of our practical measure, if magnitude of m_c/m_p is variable, we will find light-speed variable, if not, we will find light-speed is constant.

However, if we just keep the both clock and photon motioning as themselves in generally similar spacetime condition, the magnitude of both m_c and m_p will strictly vary in accordance with law of identity due to common essentiality of matter in spacetime. As a result, the quotient of m_c/m_p always keep constant, we are straightforwardly led to conclusion that light-speed in vacuum is constant therefore. Even if there is tiny discrepancy in external spacetime conditions of clock and photon, as their uniform essentiality of matter which radically predestines the common dynamic regularity of existence & motion, it's still accessible for us to be fucked that light-speed is constant in so-called vacuum.

Oh, my God, what's the confounded magic?

When Einstein came to define light-speed, he introduced a clock in his pocket, and the resultant measure is just the relativity domino effect of existence & motion of photon in reference of existence & motion of clock subject to the same dynamic regularity of law of identity under the similar external condition of spacetime, —Introducing existence & motion of clock under spacetime condition A as quantification scale to judge existence & motion of photon under similar external condition as spacetime condition A, as both existence & motion of clock and photon under generally similar spacetime condition A are subject to the same dynamic regularity of law of identity, the result is of course self-evident that we find the relativity domino effect of existence & motion of photon referred to existence & motion of clock under the similar spacetime condition A is constant, —light-speed in vacuum is constant. The situation is similar as, a hen and a cock standing still in the same moving carriage, no matter what offbeat existence & motion of both hen and cock implemented with the moving carriage observed by man on the ground, if we regard the existence & motion of the hen as quantification benchmark to scale the existence & motion of the cock, our conclusion can only be that the speed of cock is constant.

It seems there's default sense behind historical conclusion light-speed is constant in so-called vacuum

- 1) The existence & motion of photon in vacuum is absolutely unconditional, as a result, light-speed in vacuum is unconditionally constant. What's more, our practical measure of relativity domino effect of existence & motion of photon in reference of existence & motion of clock subject to the same dynamic fundamental of law of identity in the similar spacetime complimented the default sense indeed.
- 2) "Clock" is purely clock but not belonging to category of general existence & motion of matter in cosmos, as a result, no matter what kind of dynamic fundamental existence & motion of matter in cosmos must be subject to, it has nothing to do with operation of clock for clock is unimaginable substantiality out of category of universal existence & motion in cosmic homogeneity system.

However, considered by Homogenous Cosmos Originated from Unique Genesis

- A) Connatural operation of clock is but special instance belonging to category of universal existence & motion in cosmic homogeneity system—**standard motion sample for reference of universal existence**

& **motion**, the root cause clock can be regarded as “clock” by us is just because it’s special substantiality with distinctive existence & motion which substantiated the most connatural and general existence & motion in the nature. In another word, “clock” is but special substantiality of existence & motion which is regarded as “benchmark” of existence & motion to scale comprehensive existence & motion speed in the nature, the root cause we regard it as benchmark existence & motion specimen to scale comprehensive existence & motion speed in the nature is that the distinctive esse of existence & motion of clock can substantiate the most virginal and general existence & motion straightforwardly steadily (**which indicates there is not substantial possibility for it to be intervened**). In the nature, the substantiality that can steadily substantiate the most virginal and general existence & motion in the nature best usually possesses of the most substantial authentic qualification to take role of clock.

B) As “benchmark” of existence & motion to scale comprehensive existence & motion speed in the nature, the existence & motion of clock must be subject to the general dynamic regularity in the nature as well, which of course implies the connatural existence & motion of clock is subject to the definition equation of absolute spacetime momentum too:

$$m_c V_c = d(M \leftarrow m)Y \quad \longleftrightarrow \quad V_c = d(M \leftarrow m)Y / m_c$$

But comparably, as substantiality of absolute spacetime momentum, dynamic substantiation of clock is the most straightforward, steady and virgin one, this is just the most substantial qualification of clock to take role of “benchmark existence & motion specimen” to scale comprehensive existence & motion speed of matter in the nature.

C) In a straightforward word, existence & motion of matter is but optimum acclimation of matter system in proper physical ambiance in the nature of instinctive PNT reciprocal equilibrium towards optimum PNT operation. Hypostatic existence & motion of lights is just optimum acclimation of photons in proper physical ambiance due to dynamic fundamental of instinctive PNT reciprocal equilibrium towards optimum PNT operation, once vacuum, air, water and glass exist as physical ambiance for idiographic existence & motion of photons, as distinction of physical characters of vacuum, air, water and glass, transmission speed of lights in vacuum, air, water and glass is different therefore.

Of course, existence & motion of photon in so-called vacuum is subject to definition equation of absolute spacetime momentum too:

$$m_p * C = d(M \leftarrow m)Y \quad \longleftrightarrow \quad C = d(M \leftarrow m)Y / m_p$$

Since there is none constant vacuum, it of course implies time dynamic speed Y of so-called inconstant vacuum is proportionably variable, as a result, light-speed $C = d(M \leftarrow m)Y / m_p$ must be inconstant. That’s to say, the existence & motion of photon in so-called vacuum is not unconditional, if the related active external conditions vary, light-speed must vary accordingly. And virtually, time dynamic speed of spacetime is one of the active external conditions of existence & motion of photon in spacetime, since time dynamic speed of so-called vacuum is not constant, it’s of course impossible for light-speed in so-called vacuum to be constant.

Whereas, the existence & motion of photon in so-called vacuum is almost the same type of clock, which is the most straightforward, steady and virgin dynamic substantiation of general existence & motion in

the nature, as a result, the relativity domino effect of existence & motion of photon in reference of existence & motion of clock is substantively similar as that a hen and a cock standing still in the same moving carriage, no matter what offbeat existence & motion of both hen and cock implemented with the moving carriage observed by man on the ground, if we regard the existence & motion of the hen as quantification benchmark to scale the existence & motion of the cock, our conclusion can only be that the speed of cock is constant.

All in all, considered by Homogenous Cosmos Originated from Unique Genesis, there is no possibility for sequential homologic cosmogony to proliferate any invariable substantiality through and through, it's completely impossible for cosmos to adulterate any incompliant invariable substantiality throughout sequential homologic cosmogony and circulative operation, otherwise, sequential homologic cosmogony can never be smooth and successive through and through. As out-and-out substantiality in homogenous cosmos, there is no way for vacuum and light-speed to be exceptive.

The comparable variation situation of light-speed and time dynamic speed can be generally illustrated as below:

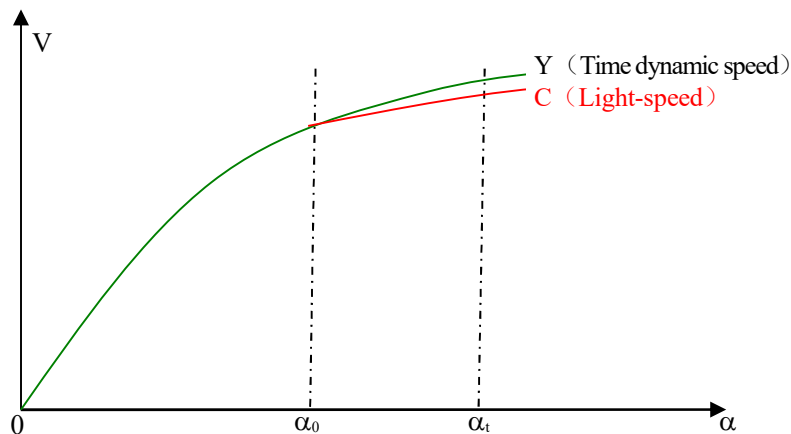

(Illustration-1) Comparable variation situation of light-speed and time dynamic speed

In the illustration above, α denotes the space field strength, V denotes the magnitude of speed, Y denotes time dynamic speed, C denotes light-speed, α_0 denotes the critical space field strength when space field strength is adequate to generate elementary genic units in space field, —before generation of elementary genic units in spacetime, the positive evolution of space field is always ready to consummate space field itself. Resultingly, the progressive change of time dynamic speed of space field is always remarkable, α_t denotes space field strength of cosmic “today”, —eversince there is positive matter in space field, the successive progressive evolution of space field impacts more of mass quantity of positive matter and physical existence & motion of positive matter in spacetime. Whereas, it does not mean it will do nothing for itself any longer, there is still tiny change of time dynamic speed for cushion due to strengthening orientation of space field. In terms of light-speed $C = d(M \leftarrow m_p)Y / m_p$, as long as there is change of time dynamic speed, light-speed must change accordingly. The reason that light-speed can not equal to time dynamic speed is but it's impossible for $d(M \leftarrow m_p) / m_p = 1$, if $d(M \leftarrow m_p) / m_p = 1$, then, $d(M \leftarrow m_p) = m_p$, which of course indicates photon has no mass in time current and whose hypostatic existence & motion is exactly the same as ingenerate dynamic existence of negative genic units in space field.

Of course, light-speed is not the utmost speed in cosmos too.

3.3. As two typical renovation of humanistic ideology about authenticity of nature in proportion to contemporaneous historical background, historical naissance of Relativity & Quantum Theory was timely renovation of humanistic ideology about authenticity of nature in proportion to contemporaneous historical background of successive implication dilation of scientific practice from macrocosm to microcosmos in terminal years of 19th century and early years of 20th century; and historical naissance of Homogenous Cosmos Originated from Unique Genesis was timely renovation of humanistic ideology about authenticity of nature in proportion to contemporaneous historical background of remarkable highlight of microcosmic configuration of matter in terminal years of 20th century and early years in 21th century. Remarkable discrepancy between Relativity, Quantum Theory and Homogenous Cosmos Originated from Unique Genesis is not only historical inevitability of crescive progression of scientific knowledge proliferation along historical progress of science in inherent optimum orientation towards perfect ideological enantiomorph of ultimate authenticity of nature but also logic objectivity between gradual increment of cosmic noumenon in our rational purview and commensurate scientific knowledge proliferation then and there.

Throughout historical progress of science, naissance of top-rank geniuses usually indicates epochmaking innovation of science, whereas, it's necessary for us to emphasize herein is that naissance of top-rank geniuses can never be unprovoked, it must root in proper historical background, and the hypostatic feature of commensurate historical background mostly determines the proportionate potentiality & accessibility for epochmaking innovation of the proper top-rank geniuses so as to make naissance of top-rank geniuses possible in crescive progression of historical progress of science. In another word, historical naissance of top-rank geniuses can never be isolated from commensurate background as proper causality & conditionality in crescive progression of historical progress of science, idiographic feature of commensurate background not only indicates hypostatic potentiality of timely renovation of humanistic ideology about authenticity of nature in proportion to contemporaneous historical background but also determines proportionate accessibility & limitation for timely renovation of humanistic ideology about authenticity of nature in proportion to contemporaneous historical background which radically determines crescive progression of historical progress of science in inherent optimum orientation towards perfect ideological enantiomorph of ultimate authenticity of nature. At any rate, there is no way for a beautiful dinner to be ready without necessary eatable, even though you are the best cook.

Favorable historical background of Galileo age not only indicated the proper potentiality of Galileo's scientific innovation but also determined the proportionate accessibility & limit of Galileo's scientific innovation towards consummate formulation of unique and invariable ultimate authenticity of nature, and consequently made historical gift altitude of Galileo self-evident in crescive progression of historical progress of science. Even though Galileo was more intelligent than Newton, it's almost impossible for Galileo to build classic mechanics as Newtonian Mechanics. In any case, there is no way for a beautiful dinner to be ready without necessary eatable, even though you are the best cook, for instance, if only potato is available, can you bring out nice rice?

Favorable historical background of Newton age not only indicated commensurate potentiality for Newton's scientific innovation but also radically determined the proportionate accessibility & limit of Newton's scientific innovation towards perfect ideological enantiomorph of ultimate authenticity of nature, which made historical gift altitude of Newton self-evident in crescive progression of historical progress of science in inherent optimum orientation towards perfect ideological enantiomorph of ultimate authenticity of nature. Even though Newton was

more intelligent than Einstein or Bohr, it's completely impossible for Newton to build Relativity or Quantum Theory. In any case, there is no way for a beautiful dinner to be ready without necessary eatable, even though you are the best cook, for instance, if potato is only available, there is no way for you to bring out nice rice?

As timely renovation of humanistic ideology about authenticity of nature in proportion to contemporaneous historical background of successive implication dilation of scientific practice from macrocosm to microcosmos in terminal years of 19th century and early years of 20th century, favorable historical background of Einstein & Bohr age not only indicated the downwind potentiality towards Einstein & Bohr's scientific innovation but also determined the proportionate accessibility limitation of Einstein & Bohr's scientific innovation towards perfect ideological enantiomorph of ultimate authenticity of nature, which made historical gift altitude of Einstein & Bohr self-evident along crescive progression of historical progress of science in inherent optimum orientation towards perfect ideological enantiomorph of ultimate authenticity of nature. No matter how intelligent Einstein & Bohr were, it's completely impossible for their scientific innovation to transcend the historical accessibility limitation for ideological transition of science from macrophysics to microphysics in proportion to successive implication dilation of scientific practice from macrocosm to microcosmos in terminal years of 19th century and early years of 20th century.

In another words, as successive intervention of unexpected microcosmic factuality remarkably negated validity of Newtonian mechanics time after time, people had to review universal existence & motion to accomodate the unexpected deregulation of microcosmic factuality by the right of historical accessibility and consequently accomplish proportionate ideological transition of science from macrophysics to microphysics accordingly. In any case, any top-ranking genius can only do their best jobs upon historical feasibility and possibility in proportion to contemporaneous historical background then and there, there is no way for a beautiful dinner to be ready without necessary eatable, even though you are the best cook in the world.

If there were none favorable background of remarkable highlight of microcosmic configuration of matter in the recent one century, especially remarkable highlight of factuality that **discretionary particles in cosmos are mutually convertible**, it's substantively difficult to imagine what's the practical accessibility for me to approach the sixty-four-dollar questions:

Whether cosmos is really homogenous originated from unique genesis through and through?

If yes, what integrative homologic configuration of cosmos and proportionate universal existence & motion should be accordingly?

In any case, there is no way for a beautiful dinner to be ready without necessary eatable, even though you are the best cook in the world.

Since historical intervention of unexpected microcosmic factuality had remarkably broke through validity of Newtonian Mechanics one after another, live humanistic ideology about authenticity of nature must accomodate the newly deregulation of unexpected microcosmic factuality by the right of historical accessibility without alternative. And virtually, Relativity & Quantum Theory were just historical outgrowth due to necessary ideological transition of science from macrophysics to microphysics in proportion to successive implication dilation of scientific practice from macrocosm to microcosmos and intervention of unexpected microcosmic factuality apparently broke through conventionality of tradition in terminal years of 19th century and early years of 20th century. And indeed, naissance of Relativity & Quantum Theory were remarkable indication that humanistic ideology about authenticity of nature had primarily accommodated historical deregulation of unexpected

microcosmic factuality upon historical accessibility then and there.

As timely renovation of humanistic ideology about authenticity of nature in proportion to contemporaneous historical background of remarkable highlight of microcosmic configuration of matter, Homogenous Cosmos Originated from Unique Genesis is innovative cosmos redefinition in radical logic enantiomorph of newly highlighted factuality that **any discretionary particles in cosmos are mutually convertible** with consequent PNT dynamics about universal existence & motion in the nature of coherent natura naturans throughout cosmic evolution. Although, remarkable highlight of microcosmic configuration of matter in the recent one century did not remarkably disaccustom Relativity & Quantum Theory, the factuality that **discretionary particles in cosmos are mutually convertible** in freewheeling towards complete induction day by day has brought more and more lights onto authenticity of homogenous cosmos originated from unique genesis.

Since history has brought out so substantial headspring towards rational highlight of authenticity of nature, we have to face issues at the volley:

Since discretionary particles in cosmos are convertible, is cosmos really homogenous originated from unique genesis through and through? If yes, what integrative homologic configuration of cosmos and proportionate universal existence & motion should be accordingly?

Virtually, it's just the both sixty-four-dollar questions which educed Homogenous Cosmos originated from Unique Genesis through and through.

As remarkable discrepancy of thought origin due to historical accessibility and rational logic proliferation, remarkable divarication even logic conflict between Relativity and Homogenous Cosmos Originated from Unique Genesis is involuntarily inevitable for freewheeling scientific knowledge proliferation along crescive progression of historical progress of science. If Einstein were still alive, once he encountered my idea of Homogenous Cosmos Originated from Unique Genesis, he must madly rap the table and stand up from his chair with huffish astonishment, "ahoy, stupid fellow, what's your nonsense!?! Vacuum is material space field with specific strength? It's even impossible for light-speed in vacuum to be constant!?"

I would like to respond his astonishment with cap in hand: "Monseigneur, it's not my desire & eisegesis. Virtually, when the scientific idea of Homogenous cosmos originated from unique genesis firstly came to me, I was but a cherubic senior high school student, I substantively had no intention to attack or negate any ready-made scientific idea, I but bone-deeply perceived the potential homogenous profile of cosmos behind the factuality that **discretionary particles in cosmos are mutually convertible**, —if discretionary particles in cosmos are mutually convertible indeed, there is substantial possibility for entire cosmic contents to be out-and-out cosmic homogeneity system originated from unique genesis through and through. And once we take the scientific idea of Homogenous cosmos originated from unique genesis onto our table or introduce it as innovative postulate.

(A) As long as we have inadequate reasons to exclude "spacetime" out of category of cosmos, "spacetime" must be typical homologic component of cosmic homogeneity system, and it of course indicates spacetime must be coordinative homology of matter, so that spacetime must be as physical as matter in cosmos.

(B) if cosmos just consists of "spacetime" and "matter", besides "spacetime" and "matter", none coordinative component is existent in cosmos, then, along sequential homologic cosmogony, "spacetime" and "matter" must be in alternative homologic filiation, either "spacetime father & matter son" or "matter father & spacetime son" which inevitably indicates ingenerate PNT correlation or PNT action between spacetime and matter in successive freewheeling logic extension. And once we exclude the alternative possibility of "matter father & spacetime son", successive homologic generation of matter along sequential homologic cosmogony and consequent homologic

As coherent natura naturans throughout cosmic evolution, instinctive PNT reciprocal equilibrium towards optimum PNT operation is radical potentiality & conditionality for cosmos always ready to orientate itself towards perfection.

attribute of spacetime and matter is self-evident.

This is just the connotation objectification of homogenous cosmos originated from unique genesis.

Virtually, PNT action is not only headspring creation of original generation of matter along sequential homologic cosmogony but also dynamic origin of postnatal existence & motion of matter in cosmos, which of course indicates existence & motion of matter in spacetime is but mirror of innative PNT action of matter integration. Once PNT action is specified by “Instinctive PNT equilibrium postulate”, existence & motion of matter in spacetime unveils itself as spontaneous occurrence of [external physical disturbance + (PNT action + instinctive PNT equilibrium)]. Once “external physical disturbance=0”, mathematical formulation of existence & motion of matter integration leads to accomplishment of “Matter Inertial Conservation Equations”; once “external physical disturbance≠0”, mathematical formulation of instinctive acclimation of matter integration against the proper “external physical disturbance” towards optimum PNT operation directly leads to accomplishment of PNT Dynamics.

This is just the freewheeling logic extension of connotation objectification of homogenous cosmos originated from unique genesis.

However, I was unexpectedly astonished to find the pestilent illogicality between idea of homogenous cosmos originated from unique genesis and your famous postulate that light-speed is constant in vacuum. Considered by Homogenous Cosmos Originated from Unique Genesis, there are neither so-called “vacuum” but “material space field” as coherent homology in cosmic homogeneity system coequally originated from unique genesis nor “invariable objects” but variable objects in living cosmic integrative homogenous circulative operation, nothing can be exceptive in cosmos indeed. After all, under precondition that cosmos is homogenous originated from unique genesis through and through, there is no possibility for any invariable substantiality to be originally generated throughout sequential homologic cosmogony as coordinative homology in cosmic homogeneity system, since it exists as substantiality in cosmic homogeneity system, it must be compatible throughout succession of cosmic demiurgic evolution of sequential homologic cosmogony leastways, which of course implies its convertibility for compatibility in cosmic homogeneity system. And virtually, there is no way for any invariable substantiality to be compatibly adulterated in cosmic integrative dynamic circulation which virtually form living comprehensive correlation throughout homogenous cosmos, for any invariable substantiality in homogenous cosmos must form deadlock of living integrative dynamic circulation of cosmos.

As hypostatic substantiality in cosmos, both vacuum and light-speed undoubtedly belong to category of cosmic homogeneity system, any substantiality in cosmic homogeneity system must be throughout compatible and variable along succession of sequential homologic cosmogony leastways. And in time current, sequential homologic cosmogony always keeps living, this of course indicates any substantiality throughout succession of sequential homologic cosmogony must be convertible, which is virtually inherence of living comprehensive correlation throughout homogenous cosmos.

And indeed, when I primarily encountered the issue of Homogenous cosmos originated from unique genesis, I was but a unsophisticated senior high school student, I knew nothing about your Relativity. And virtually, original naissance of idea of homogenous cosmos originated from unique genesis had nothing to do with your Relativity, no more successive connotation objectification & freewheeling logic extension of Homogenous cosmos originated from unique genesis with supplementation of two accessorial postulates in 0.5 grade. However, as the descriptive object of both Relativity and Homogenous Cosmos Originated from Unique Genesis is just the same “authenticity of nature”, as long as we have to admit the uniqueness and invariance of authenticity of nature, there is no way for the unique & invariable authenticity of nature to be coequally formulated by two different

scientific theories; and inversely, two different scientific theories can never coequally formulate the unique & invariable authenticity of nature. This of course indicates there must be social legitimacy metabolism between Relativity and Homogenous Cosmos Originated from Unique Genesis without alternative.

In any case, as uniqueness & invariance of ultimate authenticity of nature determines the unique possibility of scientific verity as perfect ideological enantiomorph of ultimate authenticity of nature, veritable progress of science is not historical process human stochastically approach distinctive scientific truths one after another but hypostatic endeavor to push humanistic ideology about authenticity of nature forward to perfect ideological enantiomorph of ultimate authenticity of nature step by step draw on practical feasibility & possibility in proportion to contemporaneous historical background so as to accomplish historical progress of science in inherent optimum orientation towards historical authenticity tolerance of science 0. Virtually, veritable progress of science is substantial process historical authenticity tolerance of science in inherent optimum orientation towards 0 indeed. As remarkable different scientific theories to reflect the common authenticity of nature, it's of course impossible for Homogenous Cosmos Originated from Unique Genesis and Relativity to synchronously share coequal social legitimacy in succession of historical progress of science. Instead, there must be social legitimacy metabolism between Relativity and Homogenous Cosmos Originated from Unique Genesis going without saying, whose historical authenticity tolerance of science is relatively bigger, who is necessary to be out, whose historical authenticity tolerance of science is relatively closer to 0, who is the winner of social legitimacy metabolism. This is everlasting regulation of social legitimacy metabolism throughout historical progress of science.

And indeed, the kernel issue of Homogenous Cosmos Originated from Unique Genesis is not whether vacuum is really something unintelligible without any definite physical connotation, whether light-speed is really constant in so-called vacuum, it's but **whether cosmos is really homogenous originated from unique genesis through and through? If yes, what integrative cosmic homologic configuration and proportionate universal homologic existence & motion should be accordingly?** As cosmic endosome all wool and a yard wide, vacuum is material space field with specific strength and time dynamic speed, light-speed is impossible to be constant in so-called vacuum are really straightforward logic extension of connotation objectification & freewheeling logic extension of homogenous cosmos originated from unique genesis.

Otherwise, would you please try to think whether there are still possibilities for cosmos to be compound originated from multiple genesis or unintelligible originated from none-genesis? Or even if cosmos is really homogenous originated from unique genesis through and through, are there still some possibilities to educe different conclusions, even your accordant conclusions?

Of course, at any rate, we all should admit, under historical background of early years of 20th century, Relativity could break loose of temporal conventionality and unify energy and mass into coherence was really pioneering work and remarkable milestone of science progress of 20th century. No matter how far away it still is from perfect ideological enantiomorph of ultimate authenticity of nature, and no matter how remarkable its historical authenticity tolerance of science still is, as timely renovation of humanistic ideology about authenticity of nature in proportion to contemporaneous historical background of successive implication dilation of scientific practice from macrocosm to microcosmos in terminal years of 19th century and early years of 20th century, naissance of Relativity indicated live humanistic ideology about authenticity of nature had primarily accomodated the new deregulation of unexpected microcosmic factuality and hypostatized historical progress of human science

in inherent optimum orientation towards perfect ideological enantiomorph of ultimate authenticity of nature (/historical authenticity tolerance of science 0) indeed, it's really a progressive step towards perfect ideological enantiomorph of ultimate authenticity of nature and built up a milestone of historical progress of science then and there.

Do you insist:

You never think you've virtually accomplished necessary renovation of humanistic ideology about authenticity of nature in proportion to contemporaneous historical background of successive implication dilation of scientific practice from macrocosm to microcosmos in terminal years of 19th century and early years of 20th century?

Do you insist your job is ultimate milestone of historical progress of science or ultimate consummation of science?

It's even impossible for any further progress of science to overstep your ready-made prediction? Or do you think General Relativity is just perfect ideological enantiomorph of ultimate authenticity of nature? And there is none necessity for any successive renovation of humanistic ideology about authenticity of nature in proportion to contemporaneous historical background to say "no" to general relativity any longer, such as renovation of humanistic ideology about authenticity of nature in proportion to contemporaneous historical background of remarkable highlight of microcosmic configuration of matter in 21st century?

In fact, as long as we have to admit it's only possible for authenticity of nature to be unique & invariable, —Authenticity of nature can be neither omnifarious authenticity smallwares full of a basket nor authenticity chameleon one and only, it's only possible for it to be coherent natura naturans throughout cosmic evolution, which of course indicates two different scientific theories are impossible to discover & formulate the unique & invariable authenticity of nature coequally, and inversely, the unique & invariable authenticity of nature is impossible to be discovered and formulated coequally by two different scientific theories as well. Such factuality even indicates that veritable progress of science is not intuitional cumulative achievement of colorful scientific travelogues A, B, C, D, E, F, ... like omnifarious smallwares full of a basket about rich and colorful existence & motion accessible around us, but successive hypostatic endeavor to push humanistic ideology about authenticity of nature forward to perfect ideological enantiomorph of ultimate authenticity of nature as coherent theory about universal existence & motion step by step draw on practical feasibility & possibility in proportion to contemporaneous historical background.

As long as there is no way for us to prove that Relativity is just perfect ideological enantiomorph of ultimate authenticity of nature or coherent natura naturans throughout cosmic evolution, and we have to admit the uniqueness & invariance of ultimate authenticity of nature, which radically predestines unique possibility of scientific verity about universal existence & motion as perfect ideological enantiomorph of ultimate authenticity of nature, we then have to admit coming historical progress of science in inherent optimum orientation towards historical authenticity tolerance of science 0 must accomplish further and further advancement of historical authenticity tolerance of science towards 0 draw on practical feasibility & possibility in proportion to contemporaneous historical background, which must be successive rational renovation of humanistic ideology about authenticity of nature towards perfect ideological enantiomorph of ultimate authenticity of nature in proportion to idiographic contemporaneous historical background one after another, which must be apparently different from Relativity.

Since it's completely impossible for two different scientific theories with distinctive ideological connotation to formulate the unique & invariable ultimate authenticity of nature coequally, along historical progress of science towards perfect ideological enantiomorph of ultimate authenticity of nature, none coming rational renovation

of humanistic ideology about authenticity of nature with remarkable advantage of historical authenticity tolerance of science close to 0 is able to shy away divarication from Relativity. In another word, as long as living scientific knowledge proliferation is still in its inherent orientation towards historical authenticity tolerance of science 0, the unique possible end-result of Relativity is to be washed out by coming rational renovation of humanistic ideology about authenticity of nature in proportion to contemporaneous historical background towards perfect ideological enantiomorph of ultimate authenticity of nature without alternatives, no matter whether the actual rational renovation of humanistic ideology about authenticity of nature is the one in proportion to contemporaneous historical background of remarkable highlight of microcosmic configuration of matter in terminal years of 20th century as Homogenous Cosmos Originated from Unique Genesis or not.

Not only divarication and contradiction between Relativity and Homogenous Cosmos Originated from Unique Genesis is like this, all divarication and contradiction between traditionary physics and Homogenous Cosmos Originated from Unique Genesis is just the same. In fact, as both low-down man & typical heterodoxy, I was so frangible to counterwork against so altisonant science aristocrat with full jurisdiction of science free press admittance in hand. In order to avoid the agony caused by mortal contradiction between authoritative loving successors of contemporaneous scientific orthodoxy and Joe Blow nonconformist, I was always ready to shy away this mortal way. Whereas, I was so sad that the impersonal logic of connotation objectification & freewheeling logic extension of homogenous cosmos originated from unique genesis completely made it no way for me to, so that I am still struggling bitterly under esoteric control  of temporal authority till today.

In fact, as long as we admit the “uniqueness & invariance of authenticity of nature”, which indicates authenticity of nature is neither omnifarious authenticity smallwares full a basket nor authenticity chameleon one piece and only, but coherent natura naturans throughout cosmic evolution, in accordance with rigorous enantiomorphous correlation between objective authenticity of nature and humanistic ideology about authenticity of nature, the absolute scientific verity about universal existence & motion must be perfect ideological enantiomorph of coherent natura naturans throughout cosmic evolution in legitimacy qualification of historical authenticity tolerance of science 0. In any case. And veritable progress of science is not historical process human stochastically approach distinctive scientific truths one after another but hypostatic endeavor to push humanistic ideology about authenticity of nature forward to perfect ideological enantiomorph of ultimate authenticity of nature step by step draw on practical feasibility & possibility in proportion to contemporaneous historical background.

Since we have to admit the factuality **the uniqueness & invariance of ultimate authenticity of nature predestines the unique possibility of scientific verity as perfect ideological enantiomorph of ultimate authenticity of nature** and Relativity is not perfect ideological enantiomorph of coherent natura naturans throughout cosmic evolution, as long as the practical leitmotiv that development of science is always endeavor to discover and formulate universal existence & motion as authentic, comprehensive and systematical as possible draw on practical feasibility & possibility in proportion to contemporaneous historical background is permanent eversince, and historical progress of science in inherent optimum orientation towards historical authenticity tolerance of science 0 is still on its normal way, Relativity out of scientific legitimacy qualification of historical authenticity tolerance of science 0 must be washed by coming renovation of humanistic ideology about authenticity of nature in proportion to contemporaneous historical background once further advancement of historical authenticity tolerance of science towards 0 accomplished, no matter whether the coming scientific innovation is Homogenous Cosmos Originated from Unique Genesis or not. At any rate,

it's neither possible for “the unique & invariable ultimate authenticity of nature” to be compatible with “two distinctive humanistic ideologies about authenticity of nature with remarkable ideological difference” nor possible for “two distinctive humanistic ideologies about authenticity of nature with remarkable ideological difference” to discover and formulate “the unique & invariable ultimate authenticity of nature” coequally.

Legitimacy metabolism fair play between Homogenous Cosmos Originated from Unique Genesis and Relativity of Einstein is something like this, and social legitimacy metabolism fair play between Homogenous Cosmos Originated from Unique Genesis and discretionary divarication is always something like this. In fact, as lowdown man of the society without official rank, without money, without esoteric guanxi with placeman, before altisonant science aristocrat, I am so faint and helpless, in order to shy away counterwork of temporal authority, I really had tired to keep silent in defiance of the life-and-death divarication. Whereas, straightforward connotation objectification & freewheeling logic extension of homogenous cosmos originated from unique genesis made me no way to be free from life-and-death scientific knowledge metabolism, even today, I am still floundering in free press embarment due to magistral autarchy of free press regulation customization & free press admittance of temporal authority short of necessary intendance.

Although, as necessary renovation of humanistic ideology about authenticity of nature for ideological transition of science from macrophysics to microphysics, naissance of Relativity & Quantum Theory in early years of 20th century had practically accomplished remarkable advancement towards historical authenticity tolerance of science 0 then and there, Relativity and Quantum Theory are two incompatible theories, such factuality is of course incompatible to the factuality that ultimate authenticity of nature can be neither omnifarious authenticity smallwares full a basket nor authenticity chameleon one piece and only, but coherent natura naturans throughout cosmic evolution.

Since Relativity and Quantum Theory are two incompatible theories, and they both are necessary to coexist for validity of live contemporaneous scientific orthodoxy, none of them can be perfect ideological enantiomorph of coherent natura naturans throughout cosmic evolution about universal existence & motion. Original naissance and successive freewheeling royal substantiation & perfection of Relativity and Quantum Theory was only solid jobs and effective steps to have pushed humanistic ideology about authenticity of nature forward to perfect ideological enantiomorph of ultimate authenticity of nature draw on practical feasibility & possibility in proportion to contemporaneous historical background of remarkable implication dilation of scientific practice from macrocosm to microcosmos in terminal years of 19th century and early years of 20th century. All in all,

- ①. As long as we have to admit ultimate authenticity of nature can be neither omnifarious authenticity smallwares full of a basket nor authenticity chameleon one piece and only but coherent natura naturans throughout cosmic evolution. And accordingly, historical progress of science is but humanistic endeavor to push humanistic ideology about authenticity of nature forward to perfect ideological enantiomorph of ultimate authenticity of nature step by step draw on practical feasibility & possibility in proportion to contemporaneous historical background.
- ②. As long as we have to admit that both Relativity & quantum Theory are not perfect ideological enantiomorph of ultimate authenticity of nature with scientific legitimacy qualification of historical authenticity tolerance of science 0.
- ③. Historical progress of science is still in its inherent optimum orientation towards perfect ideological enantiomorph of ultimate authenticity of nature (/historical authenticity tolerance of science 0).

Then, there is no way for Relativity & Quantum Theory to shy away destiny to be washed out by further renovation of humanistic ideology about authenticity of nature in proportion to contemporaneous historical background towards perfect ideological enantiomorph of

ultimate authenticity of nature, no matter whether it's renovation of humanistic ideology about authenticity of nature in proportion to contemporaneous historical background of remarkable highlight of microcosmic configuration of matter or not.

All in all, since **ultimate authenticity of nature** can be neither omnifarious authenticity smallwares full of a basket nor authenticity chameleon one piece and only, but coherent natura naturans throughout cosmic evolution, as commensurate ideological enantiomorph of accessible existence & motion around us, ultimate consummation of science must be perfect ideological enantiomorph of ultimate authenticity of nature, veritable progress of science is not intuitional cumulative achievement of colorful scientific travelogues A, B, C, D, E, F, ... like omnifarious smallwares full of a basket about rich and colorful existence & motion accessible around us but successive hypostatic endeavor to push humanistic ideology about authenticity of nature forward to perfect ideological enantiomorph of ultimate authenticity of nature draw on practical feasibility & possibility in proportion to contemporaneous historical background, which is of course hypostatic historical progress of science in inherent optimum orientation towards historical authenticity tolerance of science 0.

Virtually, as permanent synthesized conditionality of **“crescive progression of practical feasibility & possibility in proportion to contemporaneous historical background + the uniqueness & invariance of ultimate authenticity of nature predestines the unique possibility of scientific verity as perfect ideological enantiomorph of ultimate authenticity of nature”** through and through, it's only possible for the major melody of historical progress of science to be a series of epochmaking scientific knowledge metabolism in inherent optimum orientation towards historical authenticity tolerance of science 0. Before humanistic ideology about authenticity of nature finally qualified as perfect ideological enantiomorph of ultimate authenticity of nature, interminable royal substantiation & perfection of contemporaneous scientific orthodoxy out of scientific legitimacy qualification of historical authenticity tolerance of science 0 can never be nonstop towards perfect ideological enantiomorph of ultimate authenticity of nature.

And virtually, historical naissance of Relativity & Quantum Theory were but timely outgrowth of ideological transition from macrophysics to microphysics in proportion to successive implication dilation of scientific practice from macrocosm to microcosmos in terminal years of 19th century and early years of 20th century. As commensurate ideological system about authenticity of nature in proportion to contemporaneous historical background, nothing can be objective potentiality for interminable royal substantiation & perfection of Relativity & Quantum Theory to take full role of general progress of science all along (**demoted substantiation & perfection of contemporaneous scientific orthodoxy ≠ general progress of science to push humanistic ideology about authenticity of nature forward to perfect ideological enantiomorph of ultimate authenticity of nature step by step draw on practical feasibility & possibility in proportion to contemporaneous historical background**). Instead, as long as historical progress of science is still in its normal way in inherent optimum orientation towards perfect ideological enantiomorph of ultimate authenticity of nature, any humanistic ideology about authenticity of nature out of scientific legitimacy qualification of historical authenticity tolerance of science 0 must be washed out by coming superior humanistic ideology about authenticity of nature. In any case, as the **ultimate authenticity of nature** can be neither omnifarious authenticity smallwares full of a basket nor authenticity chameleon one piece and only, it's only possible for it to be coherent natura naturans throughout cosmic evolution, in accordance with rigorous enantiomorphous correlation between objective authenticity of nature and humanistic ideology about authenticity of nature, it's neither possible for “the unique & invariable ultimate authenticity of nature” to be compatible with “two distinctive humanistic ideologies about authenticity of nature with remarkable ideological difference” nor possible for “two distinctive humanistic ideologies about authenticity of nature with remarkable ideological difference” to discover and formulate “the unique & invariable ultimate authenticity of nature” coequally.

If we are subjectively ready to reject coming renovation of humanistic ideology about authenticity of nature in proportion to contemporaneous historical background to say “No” to Relativity or Quantum Theory in defiance of historical objectivity of general progress of science in inherent optimum orientation towards perfect ideological enantiomorph of ultimate authenticity of nature, it only indicates, as temporal authority of contemporaneous scientific orthodoxy, we would rather persist working as loving successors of contemporaneous scientific orthodoxy for interminable substantiation & perfection of contemporaneous scientific orthodoxy instead of working as cordial exploiters for general progress of science to push humanistic ideology about authenticity of nature forward to perfect ideological enantiomorph of ultimate authenticity of nature draw on practical feasibility & possibility in proportion to contemporaneous historical background as possible as we can usually do, there is substantial probability for us to slide into esoteric perplexity of interminable royal substantiation & perfection of contemporaneous scientific orthodoxy and pestilent aberrancy of general progress of science to push humanistic ideology about authenticity of nature forward to perfect ideological enantiomorph of ultimate authenticity of nature draw on practical feasibility & possibility in proportion to contemporaneous historical background.

—Firstly written in Dec. 1995, literal revision was done in Dec.2004

Supplemental note ②: Under untimely background of high-sounding freewheeling royal substantiation & perfection of contemporaneous scientific orthodoxy, the pestilent cause Homogenous Cosmos Originated from Unique Genesis can hardly get rid of perplexity of free press embarment is that temporal authority have never studied and are not used to studying universal existence & motion under general background of cosmogony under predictable affirmation of holistic cosmic configuration, but are always intoxicated in greeting and entertaining stochastic scientific travelogues A, B, C, D, E, F, ...like omnifarious smallwares full of a basket, —studying colorful material specimens as “solid”, “liquid”, “gas”, ... “molecule”, “atom”, “particle”, “radiation”... one after another for PACC, PACS orders like dallying with this green apple or that red apple on tip of our fingers.

They are never ready to devote themselves to verifying whether cosmos is really homogenous originated from unique genesis or compound originated from multiple genesis or unintelligible originated from none-genesis, no more to earnestly confront rational challenge of connotation objectification of homogenous cosmos originated from unique genesis on the basis of “Homogenous cosmos originated from unique genesis + spacetime & matter fully embodying cosmos” and freewheeling logic extension of connotation objectification of homogenous cosmos originated from unique genesis on the basis of “PNT action + instinctive PNT equilibrium”, which crown all homologous evolution of cosmos and consequential universal existence & motion of matter in cosmos in thorough coherence as linear logic system. After all, the rational pursuit of verification whether cosmos is really homogenous originated from unique genesis through and through, even if cosmos is throughout homogenous originated from unique genesis indeed, what the homogenous cosmos even universal existence & motion of matter should be has apparently fallen away from ebullience of high-sounding freewheeling royal substantiation & perfection of contemporaneous scientific orthodoxy.

Royal substantiation & perfection of contemporaneous scientific orthodoxy is always so altisonant and popular

Historical progress of science in the recent several centuries seemed like a far-flung exploration of the first itinerary around numerous distinctive landscapes of brand-new landmasses of science with palette & tablet on back, several hundred years' scientific travelogues were compiled thereby.

in the recent one century, as devoting to substantiation & perfection of contemporaneous scientific orthodoxy for fame and gain, nothing seems necessary for temporal authority to take care of whether cosmos is really homogenous originated from unique genesis through and through, no more to take care of my endeavor of connotation objectification of homogenous cosmos originated from unique genesis on the basis of “homogenous cosmos originated from unique genesis + spacetime~matter fully embodying cosmos” and freewheeling logic extension of connotation objectification of homogenous cosmos originated from unique genesis on the basis of “essence of matter/PNT action + instinctive PNT equilibrium”. After all, the endeavor to verify whether cosmos is really homogenous originated from unique genesis through and through, if yes, what integrative homologic configuration of cosmos and proportionate universal homologic existence & motion should be accordingly has apparently deviated royal successive freewheeling substantiation & perfection of contemporaneous scientific orthodoxy. And indeed, the connotation of **“it's only possible for concordant cosmos to be demiurgic aggradation of out-and-out serial natura naturata in the nature of coherent natura naturans throughout cosmic evolution; there is no way for demiurgic aggradation in the nature of different natura naturans to be concordant cosmos through and through”** has been broadest negation of live contemporaneous scientific orthodoxy.

Of course, remarkable discrepancy between Homogenous Cosmos Originated from Unique Genesis and live contemporaneous scientific orthodoxy in thought origin and proportionate logic proliferation has predestined their inevitable divarication, illogicality and consequent scientific knowledge metabolism & scientific knowledge metabolism campaign. The even dad-blamed factuality is that, as civilization outgrowth of human society, naissance & livability of coming innovative scientific knowledge is not only occurrence limited in authenticity of nature reflected on sense of pioneering originator and the proper effect of authenticity demonstration off the cuff, livability of coming innovative scientific knowledge must pass esoteric authoritative social legitimacy identification & authentication in accordance with ideological constitution of contemporaneous scientific orthodoxy. Whereas, the pestilent imbroglio is that authoritative legitimacy identification is mostly under autarchy of temporal authority in defiance of historical limitation of contemporaneous scientific orthodoxy short of necessary intendance. As a result, it's completely impossible for living scientific knowledge metabolism & scientific knowledge metabolism campaign to be sensible fair play between contemporaneous scientific orthodoxy and coming renovation of humanistic ideology about authenticity of nature in proportion to contemporaneous historical background but invisible and interminable sitzkrieg between “lordliness” and “heterodoxy” without alternative, situation is mostly inevitable buskin. (for instance, theatrical coexistence of pestilent free press embarment of Homogenous Cosmos Originated from Unique Genesis for more than 30 years and elation of The Big Bang in social legitimacy enjoyment, theatrical coexistence of pestilent free press embarment of Homogenous Cosmos Originated from Unique Genesis for more than 30 years and elation of The Large-scale Structure of Spacetime in social legitimacy enjoyment, theatrical coexistence of pestilent free press embarment of Homogenous Cosmos Originated from Unique Genesis for more than 30 years and elation of LIGO Gravitational Wave Discovery in social legitimacy enjoyment)

In the face of all-time authoritative intrepidity of contemporaneous scientific orthodoxy short of necessary intendance, successive renovation of humanistic ideology about authenticity of nature in proportion to contemporaneous historical background is always frail!

Along crescive progression of historical progress of science, tragic experience of Copernicus, Galileo, Bruno had demonstrated such factuality one after another; and today, the same factuality has been demonstrated by tragic experience of Homogenous Cosmos Originated from Unique Genesis once more that **social legitimacy & validity of truths can never exceed cannon range, especially once timely renovation of humanistic ideology about authenticity of nature in proportion to contemporaneous historical background slid into virulent scientific knowledge metabolism campaign for it fatefully conflicted vested interest of temporal authority.**

The Fourth Part

—As Demiurgic Aggradation of Sequential Homologic Cosmogony, Cosmos is Well-regulated Integration of Cosmic Homogeneity System Making up of Out-and-out Serial Natura Naturata in the Nature of Coherent Natura Naturans Throughout Cosmic Evolution

“Physical Regularity” is but vivid essence objectification of matter in universal existence & motion, which is consequent inherence in a class by itself as coherent natura naturans throughout cosmic evolution. Accordingly, ultimate consummation of science towards formulation of universal existence & motion of matter in thorough coherence only challenges verification of unique issue —“what matter is in cosmos” as inherence of natura naturans.

In accordance with rigorous enantiomorphous correlation between objective authenticity of nature and humanistic ideology about authenticity of nature, we have to admit the **uniqueness & invariance of ultimate authenticity of nature**, we must admit it's only possible for development of science to orientate “**unique scientific verity about universal existence & motion**” as perfect ideological enantiomorph of ultimate authenticity of nature by itself.

In any case, it's not only impossible for “the unique & invariable ultimate authenticity of nature” to be compatible with “two distinctive humanistic ideologies about authenticity of nature with remarkable ideological difference”, but also impossible for “two distinctive humanistic ideologies about authenticity of nature with remarkable ideological difference” to discover and formulate “the unique & invariable ultimate authenticity of nature” coequally.

(IV-i) As demiurgic aggradation of sequential homologic cosmogony, cosmos is well-regulated integration of cosmic homogeneity system making up of out-and-out serial natura naturata in the nature of coherent natura naturans throughout cosmic evolution

Abstract: The generation and formation of homogenous cosmos is firstly generation of sequential genic unit series of $i_0, i_1, i_2, \dots, i_n, i_{n+1}, i_{n+2}, i_{n+3}, \dots, i_{n+p}$, ($n, p \in N$), subsequently, as gradual enrichment of elementary genic units $i_{n+1}, i_{n+2}, i_{n+3}, \dots, i_{n+p}$, ($n, p \in N$) in spacetime, “reciprocal idiosyncrasy towards PNT equilibrium + accessible space overall arrangement for PNT reciprocity” come true stage by stage, consequently, reciprocal PNT combinations in gradation I, reciprocal PNT combinations in gradation II, reciprocal PNT combinations in gradation III, reciprocal PNT combinations in gradation IV come into being one after another and enrich in spacetime. Gradual generation and enrichment of reciprocal PNT combinations in gradation I, reciprocal PNT combinations in gradation II, reciprocal PNT combinations in gradation III and reciprocal PNT combinations in gradation IV generally keep to quantitative change regularity of expansion increase model of parallel cone.

All in all, the demiurge has none special artifice but coherent natura naturans throughout cosmic evolution, as a result, cosmic status quo is but coherent outgrowth of out-and-out serial natura naturata in the nature of coherent dynamic fundamental of instinctive PNT equilibrium towards optimum PNT operation followed stochastic extension of accomplishment of “reciprocal idiosyncrasy towards PNT equilibrium + accessible space overall arrangement for PNT reciprocity” all along.

Keywords: homogenous cosmos originated from unique genesis, cosmic homogeneity system, reciprocal PNT combination, reciprocal PNT combinations in gradation I, reciprocal PNT combinations in gradation II, reciprocal PNT combinations in gradation III, reciprocal PNT combinations in gradation IV

1. Homogenous Cosmos Originated from Unique Genesis is innovative cosmos redefinition in logic enantiomorph of newly highlighted factuality that “discretionary particles in cosmos are mutually convertible” with consequent PNT dynamics about universal existence & motion in the nature of coherent natura naturans throughout cosmic evolution.

As pioneering endeavor of historical progress of science in inherent optimum orientation towards perfect ideological enantiomorph of ultimate authenticity of nature based on newly highlighted factuality that **discretionary particles in cosmos are mutually convertible**, Homogenous Cosmos Originated from Unique Genesis successively implemented two pioneering exploratory actions:

The first, it sublimated the rationality of newly highlighted factuality **discretionary particles in cosmos are mutually convertible** into Homogenous cosmos originated from unique genesis postulate.

The second, with supplementation of two 0.5 grade auxiliary postulates, it outspreaded and hypostatized the logic connotation of Homogenous cosmos originated from unique genesis.

Supplemental introduction of the first 0.5 grade accessorial postulate of “**Spacetime~matter fully embodying cosmos postulate**” makes condition of “**Homogenous cosmos originated from unique genesis + Spacetime~matter fully embodying cosmos**” feasibly and logically extendable, so that two logic extensions of Homogenous cosmos originated from unique genesis postulate are deduced thereby. And further objectification of the two logic extensions of Homogenous

As coherent natura naturans throughout cosmic evolution, instinctive PNT reciprocal equilibrium towards optimum PNT operation is radical potentiality & conditionality for cosmos always ready to orientate itself towards perfection.

cosmos originated from unique genesis postulate accomplishes homology hypostatization of cosmic endosome, which not only makes the homology notions as space, time, time dynamic speed, space distance, space radiation cornu, homologic generation of matter along sequential homologic cosmogony self-evident but also makes homologic attribute of spacetime and matter, **PNT correlation or PNT action** between spacetime and matter in successive freewheeling of logic extension.

Supplemental introduction of the second 0.5 grade auxiliary postulate of **Instinctive PNT equilibrium postulate** makes condition of “**PNT action + instinctive PNT equilibrium**” of matter integration feasibly & logically extendable, which swimmingly accomplishes freewheeling logic extension of homology hypostatization of cosmic endosome and straightforwardly leads to PNT dynamics. At any rate, homologic generation of matter in homogenous cosmos has predestined PNT action is ingenerate attribute of matter, and existence & motion of matter in spacetime radically depends on performance of innative PNT action of matter integration, in another word, existence & motion of matter in spacetime is but dynamic enantiomorph of PNT action of matter integration. Once PNT action of matter integration specified by “Instinctive PNT equilibrium postulate”, existence & motion of matter in spacetime unveils itself racyly. And mathematical formulation of PNT action with equilibrium instinct of matter integration directly leads to formulation accomplishment of PNT dynamics, cosmos redefinition becomes well-rounded therefore.

So-called “**cosmos**” is just an organic hylc aggregation made up of coordinative homology of “spacetime” and “matter” with original causality of sequential homologic cosmogony hypostatized through and through, especially homologic essentiality of spacetime & matter, homologic filiation of spacetime and matter inherently hypostatized as “PNT action” between spacetime and matter.

So-called “**cosmos originated from unique genesis**” just means entire cosmos is an out-and-out homogeneity system originated from unique genesis with original causality of sequential homologic cosmogony hypostatized through and through, any object in cosmos is either the so-called “unique genesis” itself, or homologic compound or combination radically originated from the so-called “unique genesis” with idiographic homologic configuration indicating individuality of itself.

So-called “**homogenous**” cosmos is mainly to emphasize the absoluteness of purely homologic configuration throughout cosmic category, which not only implies comprehensive cosmic endosome are entirely made up of cosmic homogeneity system, but also implies it is only possible for cosmos to be limited in the homogeneity system derived from coherent demiurgic evolution of sequential homologic cosmogony starting at the so-called cosmic genic origin to cosmic status quo through and through. And indeed, the absolutely exclusive PNT dynamics has radically predestined there is no possibility for cosmos to adulterate any non-unique-genesis object out of category of cosmic homogeneity system.

So-called homogeneity “**system**” is mainly to emphasize the successivity of inherent lineage connotation as solid causality derived from sequential homologic cosmogony in the nature of coherent natura naturans throughout cosmic evolution, which makes cosmos well-regulated in silhouette and well-rounded in compatibility as grand homogeneity system through and through.

2. Cosmos is demiurgic aggradation of sequential homologic cosmogony, which exactly exists as well-regulated integration of cosmic homogeneity system making up of out-and-out serial natura naturata in the nature

Historical progress of science in the recent several centuries seemed like a far-flung exploration of the first itinerary around numerous distinctive landscapes of brand-new landmasses of science with palette & tablet on back, several hundred years' scientific travelogues were compiled thereby.

of coherent natura naturans throughout cosmic evolution.

2.1. Spacetime~matter fully embodies cosmic homogeneity system

“Discretionary particles in cosmos are mutually convertible \sim for they ultimately possess the common component in certain configurable hiberarchy” directly implies, in the ultimate configurable hiberarchy, all cosmic objects have the common component, entire cosmos possess the common ultimate component. Inversely, cosmos is throughout homogenous originated from unique genesis and entire cosmic endosome are all wool and a yard wide homology in a cosmic scale homogeneity system.

And as long as we are confident to confirm that cosmos consists of “spacetime” and “matter”, none hylic coordinator any more, such factuality will make logic extensions of Homogenous cosmos originated from unique genesis postulate self-evident as below:

The first, both “spacetime” and “matter” are originated from the common “unique genesis” as coordinative homology, and as a result, spacetime must be equally physical as matter.

The second, along sequential homologic cosmogony, “spacetime” and “matter” must be in alternative homologic filiation either “spacetime father & matter son” or “matter father & spacetime son”.

This of course means “Spacetime homology hypostatization as coordinative homologue of matter in cosmic homogeneity system” and “Homologic generation of matter in cosmos” introduced in the first part of the monograph.

Considered by Homogenous Cosmos Originated from Unique Genesis, spacetime is but physical embodiment of dynamic coexistence of genic homology $i_0, i_1, i_2, \dots i_n (n \in \mathbb{N})$, as the integrated dynamic coexistence of the genic homology is rather similar as “field”, spacetime is called “space field” therefore. The homologic attribute of space field radically depends on all the compositive genic components. $i_1, i_2, \dots i_n (n \in \mathbb{N})$ are all coordinative homology originated from the so-called “cosmic genic origin i_0 ”.

The general characteristic parameters of space field are “time (time dynamic speed)”, “space distance”, and “space radiation cornu”.

So called “time” is just dynamic esse of hylic space field, —the dynamic integration of mutual transmutation & transition among all field genic units in space field. Time rate directly depends on rapidness and intensity of dynamic transmutation & transition among all field genic units in space field. The mathematical quantification of time rate is just the so-called “time dynamic speed (Y)”.

So called “time dynamic speed” is just mathematical quantification of phoney displacement cumulation of field genic units materialized by their mutual dynamic transmuting & transiting in one standard time unit. The magnitude of time dynamic speed not only directly means the time rate, but also means the integrative rate or capability of universal existence & motion of matter in cosmos.

So-called “space distance” is just dynamic succession materialized by dynamic transmutation & transition among all accessible field genic units in space field, just physical objectification of time or physical objectification of the dynamic continuation of transmutation & transition among accessible field genic units in space field.

So-called “Space radiation cornu” is just relative geometric domino effect of perceivable dynamic spacetime, which radically depends on discretional radiation intensity caused by discretional transition & transmutation among field genic units and inevitably influenced by relative motion speed of observer in spacetime for spacetime

As coherent natura naturans throughout cosmic evolution, instinctive PNT reciprocal equilibrium towards optimum PNT operation is radical potentiality & conditionality for cosmos always ready to orientate itself towards perfection.

dynamic assimilation.

Time (time dynamic speed), space distance and space radiation cornu are three coordinative homologic parameters with inherent homologic relation, which jointly incarnate the spacetime as itself. As mathematical quantification of dynamic attribute of genic field, any definite time dynamic speed means the proportionate characteristic value of time rate, space distance and space radiation cornu, and the variation of time dynamic speed of course means the proportional consequential variation of time rate, space distance and space radiation cornu as well.

So-called “matter” is successive homologic multiplication outgrowth of spacetime along cosmic evolution of sequential multiplication when space field develops to well-rounded progenitive stage, —some space field genic units congealed into “crystal” format for extra-saturation of space field. Homologic generation of matter in cosmos predestines PNT action of matter integration is something ingenerate, PNT action of matter integration inherently determines the existence & motion of matter in spacetime.

So-called “matter existence” is that, when matter integration performs PNT action under proper spacetime condition by the light of nature, integrative situation that integral cumulation of negative towards positive transmutation from field genic units to elementary genic units $\int_0^t d(M \rightarrow m) dt$ - integral cumulation of positive towards negative transmutation from elementary genic units to field genic units $\int_0^t d(M \leftarrow m) dt$ = selfhood physical esse of positive matter with mass residue $m > 0$ (which indicates $\int_0^t [d(M \rightarrow m) - d(M \leftarrow m)] dt = m > 0$ in time current) is maintained in relatively steady idiographic succession with absolute spacetime momentum $mV = d(M \leftarrow m) * Y$ ever since.

As a result, matter existence can be mathematically formulated as below:

$$\begin{cases} \int_0^t [d(M \rightarrow m) - d(M \leftarrow m)] dt = m > 0 \\ mV = d(M \leftarrow m) * Y \end{cases}$$

In a simple word, so-called “matter existence” is spontaneous physical occurrence due to PNT action with instinctive PNT equilibrium of matter integration once integral accumulation of living positive & negative transmutation of matter integration satisfies $\int_0^t [d(M \rightarrow m) - d(M \leftarrow m)] dt = m > 0$, which usually implicates magnitude of mass, configuration and energetic status of matter integration.

So-called “matter motion” is that, when matter integration performs PNT action under proper spacetime condition by the light of nature, as external dissonance to PNT performance of matter integration, integrative situation that integral cumulation of negative towards positive transmutation from field genic units to elementary genic units $\int_0^t d(M \rightarrow m) dt$ - integral cumulation of positive towards negative transmutation from elementary genic units to field genic units $\int_0^t d(M \leftarrow m) dt$ = selfhood physical esse of positive matter with mass residue $m > 0$ (which indicates $\int_0^t [d(M \rightarrow m) - d(M \leftarrow m)] dt = m > 0$ in time current) and absolute spacetime momentum $mV = d(M \leftarrow m) * Y$ is consequently disturbed. The radical indication integrative situation that integral cumulation of negative towards positive transmutation from field genic units to elementary genic units $\int_0^t d(M \rightarrow m) dt$ - integral cumulation of positive towards negative transmutation from elementary genic units to field genic units $\int_0^t d(M \leftarrow m) dt$ = selfhood physical esse of positive matter with mass residue $m > 0$ and absolute spacetime momentum $mV = d(M \leftarrow m) * Y$ is disturbed is $d(M \rightarrow m) \neq d(M \leftarrow m)$. Of course, once “ $d(M \rightarrow m) \neq d(M \leftarrow m)$ ” of matter integration occurred, spontaneous occurrence of PNT action with instinctive PNT equilibrium must be subject to fundamental of instinctive PNT

reciprocal equilibrium towards optimum PNT operation, and instinctive PNT equilibrium in operation must accomplish quantitative change from $d(M \rightarrow m) \neq d(M \leftarrow m)$ towards $d(M \rightarrow m)' = d(M \leftarrow m)'$ as expediently as possible, $d(M \rightarrow m) \neq d(M \rightarrow m)'$; $d(M \leftarrow m) \neq d(M \leftarrow m)'$.

As a result, matter motion can be mathematically formulated as below:

$$\begin{cases} \int_0^t [d(M \rightarrow m) - d(M \leftarrow m)] dt = m > 0 \\ mV = d(M \leftarrow m) * Y \\ d(M \rightarrow m) \neq d(M \leftarrow m) \quad \xrightarrow{\text{PNT}} \quad d(M \rightarrow m)' = d(M \leftarrow m)' \end{cases}$$

In a simple word, so-called “matter motion” is but, under precondition that matter integration satisfies mass integral accumulation $\int_0^t [d(M \rightarrow m) - d(M \leftarrow m)] dt = m > 0$ in time current, PNT action has to rebuild the perfect operation of PNT action of matter integration by the right of instinctive PNT reciprocal equilibrium towards optimum PNT operation once some certain external disturbance occurs to PNT operation of matter integration so as to cause occurrence of $d(M \rightarrow m) \neq d(M \leftarrow m)$, —spontaneous occurrence in the nature of instinctive PNT reciprocal equilibrium towards optimum PNT operation proportionate to external disturbance, which usually implicates magnitude of mass, configuration and energetic status of matter integration. In above equations, the symbolic mark “” indicates spontaneous dynamic orientation of matter integration from initial state $d(M \rightarrow m) \neq d(M \leftarrow m)$ to target state $d(M \rightarrow m)' = d(M \leftarrow m)'$ due to instinctive PNT reciprocal equilibrium towards optimum PNT operation.

2.2. Homologic demiurgic idiosyncrasy of cosmogony

2.2.1 Absolute succession of sequential homologic cosmogony originated from unique genesis

Absolute succession of cosmic homologic multiplication originated from unique genesis means the thorough demiurgic multiplication of cosmic evolution radically originated from common extremity genesis and is exactly limited in prolific extension of sequential homologic cosmogony rooted in the unique genesis. And virtually, both spacetime and matter are coordinative homology originated from the common unique genesis coming down in one continuous line and consequently make up of the cosmic homogeneity system through and through. Cosmic evolution can never procreate any new essential “genesis”, but to multiply more and more complex compound of homology rooted in the unique cosmic genic origin i_0 . The magnificence of the cosmos is not because the nature has originally procreated rich and colorful essential hylc genic origins, but has proliferated rich and colorful homology in idiographic homologic configurations rooted in the same cosmic genic origin i_0 throughout sequential homologic cosmogony. The distinction between any two cosmic objects is but limited in homologic disparity of hylc cumulative scale and compositive configuration rooted in the common cosmic genic origin.

2.2.2 Absolute “successivity & reversibility” of sequential homologic cosmogony

Absolute “successivity & reversibility” of sequential homologic cosmogony means no matter the throughout cosmic evolution or any segment of the sequential cosmic evolution are absolutely continuous and reversible. In another word, cosmic evolution is just a serial process consisting of sequential and reversible opposites or segments as ingenerate causes and effects along evolutionary sequence coming down in one continuous line through and through. Any object in cosmos, since it can be generated under certain positive preconditions, resultingly,

As coherent natura naturans throughout cosmic evolution, instinctive PNT reciprocal equilibrium towards optimum PNT operation is radical potentiality & conditionality for cosmos always ready to orientate itself towards perfection.

it must be degenerated under the symmetrical opposite conditions.

And virtually, the couple inverse processes generally coexist on any object in cosmos, and the relative progressional degree of the coexisting couple opposites directly determines the existent quantity and state of the object. If such inverse processes do not coexist on any object, the cosmic evolvment and development would inevitably tend to extremity or absolute isolation thereby. And in fact, only such coexistence of such couple covariant opposites can make up of cosmic “perfect dynamic process” and “perfect existence” —such as transmutation and transition between genic units, PNT of matter integration, dissolution equilibrium, chemical reaction equilibrium, ..., metabolism balance, natality and decease ratio etc. Just as foregoing philosophy said: “Perfect nature but derives from consummate equilibrium among integrative contradictions”.

2.2.3 Spontaneous equilibrium coexistence of evolvment & retrogression is motivity of perfection orientation of cosmic evolution

In time current, any dynamic cosmic esse is always consequence of coexistent coordinative evolvment and retrogression, and such coexistent couple of coordinative evolvment and retrogression always depends on their ingenerate ambient conditions, if their inherent ambient conditions relatively keep steady, such coexistent couple of coordinative evolvment and retrogression unconditionally keep stationary equilibrium; if their inherent ambient conditions vary, the coexistent couple of coordinative evolvment and retrogression will spontaneously readjust orientating new equilibrium, which seems always ready to imply us the coexistent couple of coordinative evolvment and retrogression has inherent instinct to maintain equilibrium so as to make the nature perfect itself.

In terms of discretionary cosmic esse such as a particle, a star or discretionary galaxy in cosmos, the idiographic existence including existent quantity and existent state is always determined by inherent potential backup of relative tenor of coexistent couple of coordinative evolvment and retrogression. If the relative tenor of coexistent couple of coordinative evolvment and retrogression keeps dynamic balance all square, the idiographic existence of the physical esse will remain in its inertial status; if the relative tenor of coexistent couple of coordinative evolvment and retrogression loses counterbalance, the idiographic existence of the physical esse will consequently acclimatize accordingly, if the ingenerate evolvment tenor is relatively preponderant to the ingenerate retrogression tenor, both idiographic existent quantity and existent state of the physical esse will proportionably consolidate themselves towards new positive counterbalance; if ingenerate retrogression tenor is relatively preponderant to ingenerate evolvment tenor, both idiographic existent quantity and existent state of the physical esse will proportionably attenuate themselves towards new negative counterbalance.

All in all, cosmic status quo is neither outcome of pure evolvment nor outcome of pure retrogression, but outcome of coexistent coordinative evolvment and retrogression. Any idiographic existence of discretionary cosmic esse is undoubtedly outcome of coexistent coordinative evolvment and retrogression. And the most significant thing is that coexistent coordinative evolvment and retrogression always possess inherent idiosyncrasy of instinctive equilibrium. Cosmic status quo is of course outcome of perfect cosmic evolution; perfect cosmic evolution is but performance the coexistent coordinative evolvment and retrogression always ready to orient consummate equilibrium by the light of nature. Progressional tenor of cosmic evolution depends on the relative tenor of the coexistent coordinative evolvment and retrogression.

2.3. Sequential homologic cosmogony of homogenous cosmos

The essentiality of matter can only inherently come into being during the course of their original generation

Historical progress of science in the recent several centuries seemed like a far-flung exploration of the first itinerary around numerous distinctive landscapes of brand-new landmasses of science with palette & tablet on back, several hundred years' scientific travelogues were compiled thereby.

and formation and is kept with matter existing as idiographic objects under the proper generative and formative preconditions. Resultingly, as our study object, what basal groundwork matter originally generated on, we should analyze and study it in the nature of things from. The essentiality of discretionary cosmic endosome of course originally come into being during the course of sequential homologic cosmogony and is kept with it existing as idiographic object under the proper generative and formative preconditions. Resultingly, as our study object, in order to clarify the essentiality of the proper cosmic endosome, we should clarify the proper background generation and formation of the very cosmic endosome along sequential homologic cosmogony in prior.

The major evolutionary proliferation project of cosmic evolution is the progression of sequential generation and successive enrichment of field genic units $i_0, i_1, i_2, \dots, i_n$ ($n \in \mathbb{N}$) and elementary genic units $i_{n+1}, i_{n+2}, i_{n+3}, \dots, i_{n+p}$, ($n, p \in \mathbb{N}$) above all. At first, it's homologic multiplication of space field, field genic units i_1, i_2, \dots, i_n ($n \in \mathbb{N}$) are gradually generated one by one and successively enriched in, till at last, space field tends to saturation. Subsequently, elementary genic units $i_{n+1}, i_{n+2}, i_{n+3}, \dots, i_{n+p}$, ($n, p \in \mathbb{N}$) are gradually generated in crystal format one by one and successive enriched in space field with remarkable existent idiosyncrasy.

As special generation of elementary genic units under proper space field background, attribute below of elementary genic units is ingenerate:

The first, the presence of elementary genic units in space field can embody idiographic existent individuality of physical esse of elementary genic units themselves. Throughout the process elementary genic units transmute and transit with accessible field genic units around in space field, there are always idiographic mass margin, explicit motion orientation and geometrical modality of proper elementary genic units, which are just the indicative characteristics of elementary genic units themselves as definite objects in cosmos.

The second, "PNT action" of elementary genic units is ingenerate, ——since there is external positive possibility for elementary genic units to generate by the light of nature, there must be equally external negative possibility for elementary genic units to degenerate as well, and such external positive possibility and negative possibility must be covariant couple of coexistent coordinative evolvement and retrogression as inherent attribute of elementary genic units, which is virtually just the innative PNT action of elementary genic units. In straightforward words, PNT action is inherent attribute of elementary genic units existing in spacetime which of course radically determines the characteristic existence & motion of elementary genic units in spacetime.

The third, as the local limitation of generative ambient conditions of elementary genic units, it's almost impossible for the PNT operational linkage of PNT action of elementary genic units to be well-rounded and perfect once initially generated in space field.

The fourth, instinctive PNT reciprocal equilibrium towards optimum PNT operation must be ingenerate attribute of elementary genic units. ——as long as there is substantial accessibility of "**reciprocal idiosyncrasy towards PNT equilibrium + accessible space overall arrangement for PNT reciprocity**" between any discretionary two elementary genic units (/between any discretionary two matter integration), PNT reciprocal equilibrium towards optimum PNT operation must be implemented unconditionally. Virtually, PNT reciprocal equilibrium towards optimum PNT operation is instinctive self-acclimation of matter integration in spacetime, inherence of matter taking role of natura naturans for cosmos always ready to orientate itself towards perfection by the light of nature; elementary

genic units can never be exceptive.

As inherent attribute of elementary genic units, once there is substantial accessibility of **“reciprocal idiosyncrasy towards PNT equilibrium + accessible space overall arrangement for PNT reciprocity”** among elementary genic units, PNT reciprocal equilibrium towards optimum PNT operation must be implemented unconditionally so as to turn originally free elementary genic units in spacetime into combination (/combinations) for PNT reciprocal equilibrium towards optimum PNT operation has virtually been materialized into solid interaction among accessible elementary genic units which makes all the interacted elementary genic units seem convergent compound as independent esse in spacetime. We just call such combination **“reciprocal PNT combination”**. As long as there are substantial accessibility of **“reciprocal idiosyncrasy towards PNT equilibrium + accessible space overall arrangement for PNT reciprocity”**, elementary genic units in spacetime must unconditionally turn into rich and colorful reciprocal PNT combinations step by step.

As PNT action and instinct of PNT equilibrium are purely something inherent of elementary genic units, both initial generation and further proliferation of rich and colorful reciprocal PNT combinations in spacetime are but freewheeling evolution of cosmos or freewheeling modulization project of cosmos, ——inevitability predestined by homologous filiation between spacetime and matter (PNT action) and instinct of PNT equilibrium. Since the first moment elementary genic units initially generated in space field, the innative PNT action and instinct of PNT equilibrium have congenitally predestined the intrinsic orientation of universal existence & motion of positive matter in cosmos, it has radically predestined cosmic status quo must be like this going without saying and future cosmos must undoubtedly go on developing along the freewheeling tendency for ever. This is unique decree of the demiurge, ——the unique fundamental of both cosmic demiurgic evolution and postnatal existence & motion of universal matter.

So-called **“reciprocal PNT combination”** is just convergent mechanical compound made up of compositive sub-mechanical-units originally coming into being for spontaneous occurrence of instinctive PNT reciprocal equilibrium towards optimum PNT operation due to favorable presence of **“reciprocal idiosyncrasy towards PNT equilibrium + accessible space overall arrangement for PNT reciprocity”** among the very sub-mechanical-units. In another words, so-called **“reciprocal PNT combination”** is just convergent esse in spacetime with relatively steady & reciprocal PNT operation among compositive sub-mechanical-units in accordance with demiurgic fundamental of instinctive PNT reciprocal equilibrium towards optimum PNT operation, ——evolutional outgrowth of spontaneous occurrence of instinctive PNT reciprocal equilibrium towards optimum PNT operation. The more adequate and consummate the PNT reciprocity among compositive sub-mechanical-units is, the steadier the resultant reciprocal PNT combination in spacetime is.

Apparently, original generation of reciprocal PNT combination depends on two favorable conditions below:

The first: there must be favorable **“reciprocal idiosyncrasy towards PNT equilibrium”** of all compositive sub-mechanical-units, and this is just the internal condition for spontaneous occurrence of instinctive PNT reciprocal equilibrium towards optimum PNT operation which is just physical action causing reciprocal PNT combination coming into being.

The second: there must be favorable **“accessible space overall arrangement for PNT reciprocity”** among all compositive sub-mechanical-units, and this is just the external condition for spontaneous occurrence of instinctive PNT reciprocal equilibrium towards optimum PNT operation which is just physical action making

Historical progress of science in the recent several centuries seemed like a far-flung exploration of the first itinerary around numerous distinctive landscapes of brand-new landmasses of science with palette & tablet on back, several hundred years' scientific travelogues were compiled thereby.

reciprocal PNT combinations come into being.

The generation and further multiplication of reciprocal PNT combinations in cosmos must experience a substantial process from microcosm to macrocosm, from simpleness to complexity, in accordance with idiographic distinction of dominant compositive sub-mechanical-units from microcosm to macrocosm, from simpleness to complexity, we classify the reciprocal PNT combinations in cosmos into four typical categories and call them reciprocal PNT combinations in gradation I, reciprocal PNT combinations in gradation II, reciprocal PNT combinations in gradation III and reciprocal PNT combinations in gradation IV.

So-called “reciprocal PNT combinations in gradation I” is convergent mechanical compound category of subatomic kind, which originally coming into being for spontaneous occurrence of instinctive PNT reciprocal equilibrium towards optimum PNT operation due to well-rounded presence of **“reciprocal idiosyncrasy towards PNT equilibrium + accessible space overall arrangement for PNT reciprocity”** among the original compositive elementary genic units gradually enriched in spacetime (but not excluding the possible presence of succedent relatively simple subatomic units or particles), such as quark, \dots , electron, neutron, proton, α particles and so on.

The dominant sub-mechanical-units of reciprocal PNT combinations in gradation I is “elementary genic units” (but not excluding the possible presence of succedent relatively simple subatomic units or particles); the PNT reciprocity of reciprocal PNT combinations in gradation I is mainly the so-called “strong interaction” among the compositive sub-mechanical-units (but not excluding the possible presence of so-called “weak interaction”).

So-called “reciprocal PNT combinations in gradation II” is convergent mechanical compound category of atom kind, which originally coming into being for spontaneous occurrence of instinctive PNT reciprocal equilibrium towards optimum PNT operation due to well-rounded presence of **“reciprocal idiosyncrasy towards PNT equilibrium + accessible space overall arrangement for PNT reciprocity”** among compositive subatomic units gradually enriched in spacetime (but not excluding possible presence of elementary genic units), such as hydrogen atom, carbon atom \dots , oxygen atom, \dots uranium atom and so on.

The dominant sub-mechanical-units of reciprocal PNT combinations in gradation II are “subatomic units” (but not excluding possible presence of elementary genic units); the PNT reciprocity of reciprocal PNT combinations in gradation II is mainly the so-called “electromagnetic force” among the compositive subatomic units (but not excluding possible presence of elementary genic units)

So-called “reciprocal PNT combinations in gradation III” is convergent mechanical compound category as molecule, molecule system, organism and so on, which originally coming into being for spontaneous occurrence of instinctive PNT reciprocal equilibrium towards optimum PNT operation due to well-rounded presence of **“reciprocal idiosyncrasy towards PNT equilibrium + accessible space overall arrangement for PNT reciprocity”** among compositive atoms gradually enriched in spacetime (but not excluding presence of succedent relatively simple molecule, molecule system), such as hydrogen molecule, oxygen molecule, \dots carbon dioxide, crystal, stone, DNA, organism and so on.

The dominant sub-mechanical-units of reciprocal PNT combinations in gradation III are atoms (but not excluding presence of succedent relatively simple molecule, molecule system etc.); the PNT reciprocity of reciprocal PNT combinations in gradation III is mainly the so-called “electromagnetic force” among the compositive atoms (but not excluding presence of succedent relatively simple molecule, molecule system etc).

As coherent natura naturans throughout cosmic evolution, instinctive PNT reciprocal equilibrium towards optimum PNT operation is radical potentiality & conditionality for cosmos always ready to orientate itself towards perfection.

So-called “reciprocal PNT combinations in gradation IV” is convergent mechanical compound category as celestial bodies, galaxy kind in cosmos (but not excluding presence of any objects with mutual disturbance of substantial matter field superposition), which originally coming into being for spontaneous occurrence of instinctive PNT reciprocal equilibrium towards optimum PNT operation due to well-rounded presence of “**reciprocal idiosyncrasy towards PNT equilibrium + accessible space overall arrangement for PNT reciprocity**” among compositive celestial bodies or galaxies gradually enriched in spacetime (but not excluding presence of any objects with mutual disturbance of substantial matter field superposition), such as earth, moon, sun, solar system, Milky Way galaxy and so on.

The dominant sub-mechanical-units of reciprocal PNT combinations in gradation IV are macroscopical objects, celestial bodies and galaxies, (but not excluding presence of any objects with mutual disturbance of substantial matter field superposition); the PNT reciprocity of reciprocal PNT combinations in gradation IV is mainly the so-called “gravity” and “anti-gravity” among the compositive macroscopical objects, celestial bodies and galaxies (but not excluding presence of any objects with mutual disturbance of substantial matter field superposition).

Practical multiplication of all the four gradations of reciprocal PNT combinations along sequential homologic cosmogony is a throughout succession. Spontaneous occurrence of instinctive PNT reciprocal equilibrium towards optimum PNT operation due to well-rounded presence of “**reciprocal idiosyncrasy towards PNT equilibrium + accessible space overall arrangement for PNT reciprocity**” among compositive elementary genic units gradually enriched in spacetime make reciprocal PNT combinations in gradation I coming into being, as a result, reciprocal PNT combinations in gradation I crown all elementary genic units.

As demiurgic natura naturans along cosmic evolution, spontaneous occurrence of instinctive PNT reciprocal equilibrium towards optimum PNT operation for well-rounded stochastic accomplishment of “**reciprocal idiosyncrasy towards PNT equilibrium + accessible space overall arrangement for PNT reciprocity**” among compositive subunits of reciprocal PNT combinations in gradation I kind (not excluding possible presence of elementary genic units) gradually enriched in spacetime make reciprocal PNT combinations in gradation II come into being at the volley. As a result, reciprocal PNT combinations in gradation II crown all reciprocal PNT combinations in gradation I and all elementary genic units.

As demiurgic natura naturans along cosmic evolution, spontaneous occurrence of instinctive PNT reciprocal equilibrium towards optimum PNT operation for well-rounded stochastic accomplishment of “**reciprocal idiosyncrasy towards PNT equilibrium + accessible space overall arrangement for PNT reciprocity**” among compositive subunits of reciprocal PNT combinations in gradation II kind (not excluding possible presence of reciprocal PNT combinations in gradation I and elementary genic units) gradually enriched in spacetime make reciprocal PNT combinations in gradation III come into being at the volley. As a result, reciprocal PNT combinations in gradation III crown all reciprocal PNT combinations in gradation II, reciprocal PNT combinations in gradation I and all elementary genic units.

As demiurgic natura naturans along cosmic evolution, spontaneous occurrence of instinctive PNT reciprocal equilibrium towards optimum PNT operation for well-rounded stochastic accomplishment of “**reciprocal idiosyncrasy towards PNT equilibrium + accessible space overall arrangement for PNT reciprocity**” among compositive subunits of reciprocal PNT combinations in gradation III kind (not excluding possible presence of reciprocal PNT combinations in gradation II, reciprocal PNT combinations in gradation I and elementary genic units) gradually enriched in spacetime make reciprocal PNT combinations in gradation IV come into being at the volley. As a result, reciprocal PNT combinations in gradation IV crown all reciprocal PNT combinations in gradation III, reciprocal PNT combinations in gradation II, reciprocal PNT

Historical progress of science in the recent several centuries seemed like a far-flung exploration of the first itinerary around numerous distinctive landscapes of brand-new landmasses of science with palette & tablet on back, several hundred years' scientific travelogues were compiled thereby.

combinations in gradation I and all elementary genic units.

Original generation of universal reciprocal PNT combinations can be illustrated as below:



(IV-i-1) Illustration of original generation of reciprocal PNT combinations in homogenous cosmos

As straightforward man, the demiurge has none special artifice but \coherent natura naturans throughout cosmic evolution, it's his freewheeling of instinctive PNT reciprocal equilibrium towards optimum PNT operation on the basis of stochastic accomplishment of “reciprocal idiosyncrasy towards PNT equilibrium + accessible space overall arrangement for PNT reciprocity” throughout cosmic evolution without any exception, which is not only permanent programme of sequential homologic cosmogony of original generation of universal reciprocal PNT combinations through and through but also vivid programme of postnatal existence & motion of universal reciprocal PNT combinations.

All in all, universal reciprocal PNT combination in cosmos are but outgrowth of instinctive PNT reciprocal equilibrium towards optimum PNT operation for well-rounded presence of “reciprocal idiosyncrasy towards PNT equilibrium + accessible space overall arrangement for PNT reciprocity” among compositive subunits, they are optimum mechanical units in the nature of instinctive PNT reciprocal equilibrium towards optimum PNT operation. In a simple word, original generation of universal reciprocal PNT combinations is but connatural outgrowth due to “reciprocal idiosyncrasy towards PNT equilibrium + accessible space overall arrangement for PNT reciprocity” in the nature of instinctive PNT reciprocal equilibrium towards optimum PNT operation. It can be said that idiographic existence of discretionary reciprocal PNT combination in spacetime is but a relatively optimum concentration of compositive subunits in the nature of instinctive PNT reciprocal equilibrium towards optimum PNT operation. The better the

As coherent natura naturans throughout cosmic evolution, instinctive PNT reciprocal equilibrium towards optimum PNT operation is radical potentiality & conditionality for cosmos always ready to orientate itself towards perfection.

reciprocal idiosyncrasy towards PNT equilibrium among the compositive subunits is, the more intensive the PNT reciprocity towards condensation action among the corresponding compositive subunits is, the consequent condensed combination is relatively more solid and steady (such as nucleus); the more adequate the reciprocal idiosyncrasy towards PNT equilibrium among the compositive subunits is reciprocated, the consequent reciprocal PNT combination is inertial and more steady (such as inert gases).

Thus it can be seen the throughout cosmic evolution can be generally differentiated into three sequential stages:

The first stage: evolution of space field till saturation of space field.

The second stage: generation and succedent enrichment of elementary genic units in spacetime.

The third stage: as continuous generation and enrichment of elementary genic units in spacetime, spontaneous occurrence of instinctive PNT reciprocal equilibrium towards optimum PNT operation due to well-rounded presence of “reciprocal idiosyncrasy towards PNT equilibrium + accessible space overall arrangement for PNT reciprocity” among sub-mechanical units bring about substantial multiplication of rich and colorful reciprocal PNT combinations in cosmos day by day.

Of course, the demiurgic process of successive generation & multiplication of reciprocal PNT combinations from microcosm to macrocosm, from simpleness to complexity can be differentiated into four sequential phases.

The first phase: original generation, successive enrichment & multiplication, overall aggradation of reciprocal PNT combination I along sequential homologic cosmogony.

As freewheeling of aberrant convergence of cosmic esse due to PNT reciprocal gelation in the nature of coherent natura naturans throughout cosmic evolution, going with gradual enrichment of elementary genic units in spacetime, original generation, postnatal existence & motion of reciprocal PNT combinations in gradation I are successive easy outgrowth behind stochastic occurrence of [(reciprocal idiosyncrasy towards PNT equilibrium + accessible space overall arrangement for PNT reciprocity) among elementary genic units in spacetime + Instinctive PNT reciprocal equilibrium towards optimum PNT operation]. Not only elementary genic units in spacetime are direct materials of reciprocal PNT combinations in gradation I, but also external mechanical features of compositive elementary genic units are radical causes of original generation, postnatal existence & motion of reciprocal PNT combinations in gradation I.

The second phase: original generation, successive enrichment & multiplication, overall aggradation of reciprocal PNT combination II along sequential homologic cosmogony.

As freewheeling of aberrant convergence of cosmic esse due to PNT reciprocal gelation/sequential homologic cosmogony in the nature of coherent natura naturans throughout cosmic evolution, going with gradual enrichment of reciprocal PNT combinations in gradation I in spacetime, original naissance, postnatal existence & motion of reciprocal PNT combinations in gradation II are successive easy outgrowth behind stochastic occurrence of [(reciprocal idiosyncrasy towards PNT equilibrium + accessible space overall arrangement for PNT reciprocity) among reciprocal PNT combinations in gradation I in spacetime + Instinctive PNT reciprocal equilibrium towards optimum PNT operation]. Not only reciprocal PNT combinations in gradation I in spacetime are direct materials of reciprocal PNT combinations in gradation II, but also external mechanical features of compositive reciprocal PNT combinations in gradation I are radical causes of original generation, postnatal existence & motion of reciprocal PNT combinations in gradation II.

The third phase: original generation, successive enrichment & multiplication, overall aggradation of reciprocal PNT combination III along sequential homologic cosmogony.

As freewheeling of aberrant convergence of cosmic esse due to PNT reciprocal gelation/sequential homologic cosmogony in the nature of coherent natura naturans throughout cosmic evolution, going with gradual enrichment of reciprocal

Historical progress of science in the recent several centuries seemed like a far-flung exploration of the first itinerary around numerous distinctive landscapes of brand-new landmasses of science with palette & tablet on back, several hundred years' scientific travelogues were compiled thereby.

PNT combinations in gradation II in spacetime, original naissance, postnatal existence & motion of reciprocal PNT combinations in gradation III are successive easy outgrowth behind stochastic occurrence of [(reciprocal idiosyncrasy towards PNT equilibrium + accessible space overall arrangement for PNT reciprocity) among reciprocal PNT combinations in gradation II even sub reciprocal PNT combinations in gradation III in spacetime + Instinctive PNT reciprocal equilibrium towards optimum PNT operation]. Not only reciprocal PNT combinations in gradation II in spacetime are direct materials of reciprocal PNT combinations in gradation III, but also external mechanical features of compositive reciprocal PNT combinations in gradation II even sub reciprocal PNT combinations in gradation III are radical causes of original generation, postnatal existence & motion of reciprocal PNT combinations in gradation III.

The fourth phase: original generation, successive enrichment & multiplication, overall aggradation of reciprocal PNT combination IV along sequential homologic cosmogony.

As freewheeling of aberrant convergence of cosmic esse due to PNT reciprocal gelation/sequential homologic cosmogony in the nature of coherent natura naturans throughout cosmic evolution, going with gradual enrichment of reciprocal PNT combinations in gradation III even sub-reciprocal PNT combinations in gradations IV in spacetime, original naissance, postnatal existence & motion of reciprocal PNT combinations in gradation IV are successive easy outgrowth behind stochastic occurrence of [(reciprocal idiosyncrasy towards PNT equilibrium + accessible space overall arrangement for PNT reciprocity) among reciprocal PNT combinations in gradation III even sub-reciprocal PNT combinations in gradations IV in spacetime + Instinctive PNT reciprocal equilibrium towards optimum PNT operation]. Not only reciprocal PNT combinations in gradation III even sub reciprocal PNT combinations in gradation IV in spacetime are direct materials of reciprocal PNT combinations in gradation IV, but also external mechanical features of compositive reciprocal PNT combinations in gradation III even sub reciprocal PNT combinations in gradation IV are radical causes of original generation, postnatal existence & motion of reciprocal PNT combinations in gradation IV.

In any case, the veritable cosmic evolution but brings about sequential generation of $i_1, i_2, i_3, \dots, i_n, i_{n+1}, i_{n+2}, i_{n+3}, \dots, i_{n+p}$, ($n, p \in \mathbb{N}$) basing on cosmic genic origin i_0 . original demiurgic evolution of macrocosm is but succedent spontaneous occurrence of instinctive PNT reciprocal equilibrium towards optimum PNT operation due to well-rounded presence of “reciprocal idiosyncrasy towards PNT equilibrium + accessible space overall arrangement for PNT reciprocity” among compositive sub-mechanical units of elementary genic units, among compositive sub-mechanical units of reciprocal PNT combinations in gradation I, among compositive sub-mechanical units of reciprocal PNT combinations in gradation I and elementary genic units, among compositive sub-mechanical units of reciprocal PNT combinations in gradation II, among compositive sub-mechanical units of reciprocal PNT combinations in gradation I and reciprocal PNT combinations in gradation II, , among compositive sub-mechanical units of reciprocal PNT combinations in gradation III and reciprocal PNT combinations in gradation III, it's but the essentiality of matter which practically brings on freewheeling extension of cosmic evolution to make matter modulization project implemented by the light of nature.

All in all, Cosmic status quo is but demiurgic aggradation of sequential homologic cosmogony, which exactly exists as well-regulated integration of cosmic homogeneity system making up of out-and-out serial natura naturata in the nature of coherent natura naturans throughout cosmic evolution. Cosmos is always ready to orientate itself towards perfection, instinctive PNT reciprocal equilibrium towards optimum PNT operation is just the everlasting motivity for cosmos always ready to orientate itself towards perfection, which is connatural outgrowth of [Stochastic (reciprocal idiosyncrasy towards PNT equilibrium + accessible space overall arrangement for PNT reciprocity) + Instinctive PNT reciprocal

As coherent natura naturans throughout cosmic evolution, instinctive PNT reciprocal equilibrium towards optimum PNT operation is radical potentiality & conditionality for cosmos always ready to orientate itself towards perfection.

equilibrium towards optimum PNT operation].

It is only possible for concordant cosmos to be demiurgic aggradation of out-and-out serial natura naturata in the nature of coherent natura naturans throughout cosmic evolution; there is no way for demiurgic aggradation in the nature of different natura naturans to be concordant cosmos through and through. If we say cosmos is aesthetically regular, the unique aesthetic regularity of cosmos is but **sequential homologic cosmogony in the nature of coherent natura naturans throughout cosmic evolution**. Integrative sequential homologic cosmogony in the nature of coherent natura naturans throughout cosmic evolution can be illustrated as below:

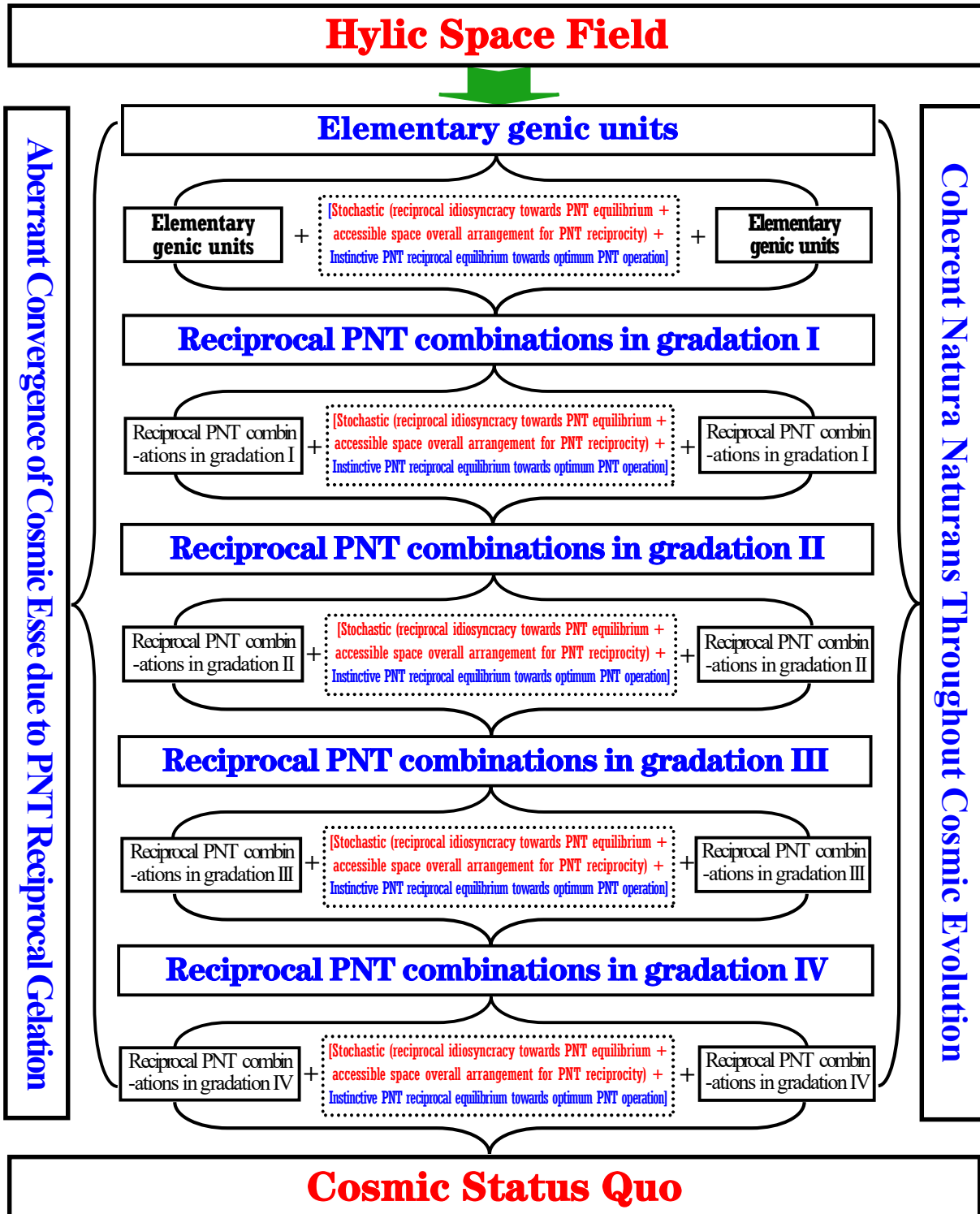

(IV-i-2) Illustration of integrative sequential homologic cosmogony

Historical progress of science in the recent several centuries seemed like a far-flung exploration of the first itinerary around numerous distinctive landscapes of brand-new landmasses of science with palette & tablet on back, several hundred years' scientific travelogues were compiled thereby.

As universal existence & motion are generally made up of elementary genic units, reciprocal PNT combinations in gradation I, reciprocal PNT combinations in gradation II, reciprocal PNT combinations in gradation III, reciprocal PNT combinations in gradation IV, and as remarkable discrepancy of mechanical structure among elementary genic units, reciprocal PNT combinations in gradation I, reciprocal PNT combinations in gradation II, reciprocal PNT combinations in gradation III, reciprocal PNT combinations in gradation IV, the distribution of “equilibrium quotient negative mass over positive mass” K of universal existence & motion can be generally illustrated as following:

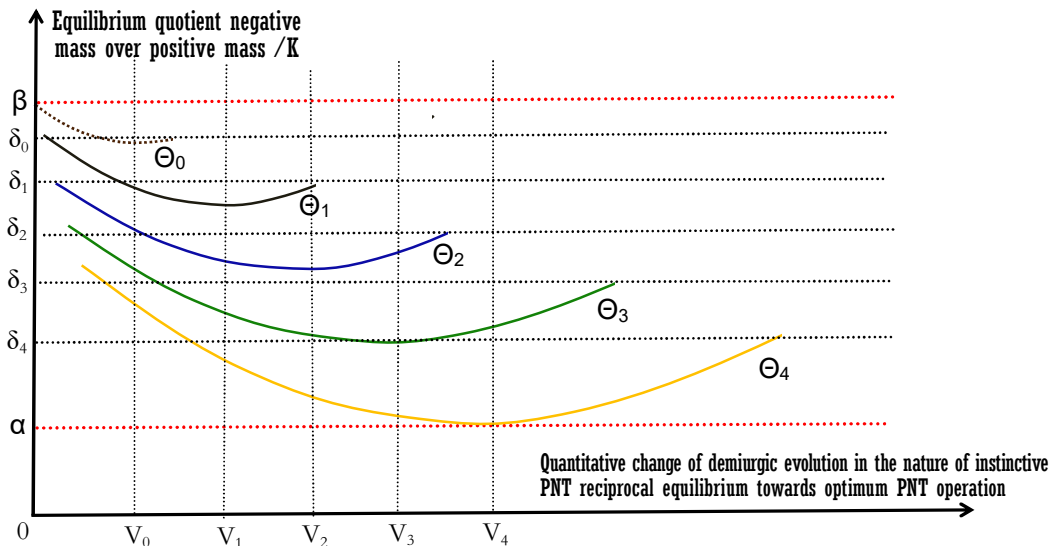

(IV-i-3) Distribution of “equilibrium quotient negative mass over positive mass” K of matter integration along quantitative change of demiurgic evolution in the nature of instinctive PNT reciprocal equilibrium towards optimum PNT operation

In illustration above, the y-axis indicates value of equilibrium quotient negative mass over positive mass K , x-axis indicates quantitative change of demiurgic evolution in the nature of instinctive PNT reciprocal equilibrium towards optimum PNT operation.

In illustration above, the α red line is the lower limit line of equilibrium quotient negative mass over positive mass K , which indicates the situation of best existence & motion of matter integration in the nature of instinctive PNT reciprocal equilibrium towards optimum PNT operation, any object in cosmos whose equilibrium quotient negative mass over positive mass is close to value α must be relatively steady-going in spacetime.

In illustration above, the β red line is the upper limit line of equilibrium quotient negative mass over positive mass K , which indicates the situation of worst existence & motion of matter integration in the nature of instinctive PNT reciprocal equilibrium towards optimum PNT operation, any object in cosmos whose equilibrium quotient negative mass over positive mass is close to value β must be relatively flimsy in spacetime.

In illustration above, the broken curve Θ_0 indicates distribution of equilibrium quotient negative mass over positive mass K of matter integration of elementary genic units in spacetime. As the sorts of elementary genic units in cosmos are rather limited, I readjust the curve into broken line to indicate dot distribution of equilibrium quotient negative mass over positive mass K of limited elementary genic units along the curve. Vertical broken line V_0 indicates lower limit of equilibrium quotient negative mass over positive mass K of matter integration of elementary genic units in spacetime; broken line δ_0 indicates upper limit of equilibrium quotient negative mass over positive mass K of the last sort of elementary genic unit along cosmic demiurgic evolution,

As coherent natura naturans throughout cosmic evolution, instinctive PNT reciprocal equilibrium towards optimum PNT operation is radical potentiality & conditionality for cosmos always ready to orientate itself towards perfection.

there is none potentiality for generation of any other elementary genic unit in spacetime along evolutionary extension of cosmos, whose equilibrium quotient negative mass over positive mass K of matter integration is even bigger than δ_0 .

In illustration above, the broken curve Θ_1 indicates distribution of equilibrium quotient negative mass over positive mass K of matter integration of reciprocal PNT combinations in gradation I. Vertical broken line V_1 indicates lower limit of equilibrium quotient negative mass over positive mass K of matter integration of reciprocal PNT combinations in gradation I in spacetime; broken line δ_1 is upper limit of equilibrium quotient negative mass over positive mass K of reciprocal PNT combinations in gradation I along quantitative change of demiurgic evolution in the nature of instinctive PNT reciprocal equilibrium towards optimum PNT operation, which indicates there is none reciprocal potentiality for original generation of reciprocal PNT combinations in gradation I in spacetime along sequential homologic cosmogony, whose equilibrium quotient negative mass over positive mass K of matter integration is even bigger than δ_1 .

In illustration above, the broken curve Θ_2 indicates distribution of equilibrium quotient negative mass over positive mass K of matter integration of reciprocal PNT combinations in gradation II. Vertical broken line V_2 indicates lower limit of equilibrium quotient negative mass over positive mass K of matter integration of reciprocal PNT combinations in gradation II in spacetime; broken line δ_2 is upper limit of equilibrium quotient negative mass over positive mass K of reciprocal PNT combinations in gradation II along quantitative change of demiurgic evolution in the nature of instinctive PNT reciprocal equilibrium towards optimum PNT operation, which indicates there is none reciprocal potentiality for original generation of reciprocal PNT combinations in gradation II in spacetime along sequential homologic cosmogony, whose equilibrium quotient negative mass over positive mass K of matter integration is even bigger than δ_2 .

In illustration above, the broken curve Θ_3 indicates distribution of equilibrium quotient negative mass over positive mass K of matter integration of reciprocal PNT combinations in gradation III. Vertical broken line V_3 indicates lower limit of equilibrium quotient negative mass over positive mass K of matter integration of reciprocal PNT combinations in gradation III in spacetime; broken line δ_3 is upper limit of equilibrium quotient negative mass over positive mass K of reciprocal PNT combinations in gradation III along quantitative change of demiurgic evolution in the nature of instinctive PNT reciprocal equilibrium towards optimum PNT operation, which indicates there is none reciprocal potentiality for original generation of reciprocal PNT combinations in gradation III in spacetime along sequential homologic cosmogony, whose equilibrium quotient negative mass over positive mass K of matter integration is even bigger than δ_3 .

In illustration above, the broken curve Θ_4 indicates distribution of equilibrium quotient negative mass over positive mass K of matter integration of reciprocal PNT combinations in gradation IV. Vertical broken line V_4 indicates lower limit of equilibrium quotient negative mass over positive mass K of matter integration of reciprocal PNT combinations in gradation IV in spacetime; broken line δ_4 is upper limit of equilibrium quotient negative mass over positive mass K of reciprocal PNT combinations in gradation IV along quantitative change of demiurgic evolution in the nature of instinctive PNT reciprocal equilibrium towards optimum PNT operation, which indicates there is none reciprocal potentiality for original generation of reciprocal PNT combinations in gradation IV in spacetime along sequential homologic cosmogony, whose equilibrium quotient negative mass over positive mass K of matter integration is even bigger than δ_4 .

Historical progress of science in the recent several centuries seemed like a far-flung exploration of the first itinerary around numerous distinctive landscapes of brand-new landmasses of science with palette & tablet on back, several hundred years' scientific travelogues were compiled thereby.

All in all, all reciprocal PNT combinations in spacetime are but outgrowth of instinctive PNT reciprocal equilibrium towards optimum PNT operation, some kinds of relatively steady characteristic PNT operational patterns resulting in spontaneous occurrence of instinctive PNT reciprocal equilibrium towards optimum PNT operation. In simple words, generation of reciprocal PNT combinations is but instinctive optimum materialization of PNT action among compositive sub-mechanical-units in spacetime, it may be convenient for us to call such instinctive optimum materialization of PNT action among compositive sub-mechanical-units towards convergent mechanical system as “resultant optimum PNT equilibrium status quo”. It of course can be said that any distinctive existence of discretionary reciprocal PNT combination is but living existence of idiographic “resultant optimum PNT equilibrium status quo” embodied in proper components. The more adequate and consummate the PNT reciprocity of the so-called “resultant optimum PNT equilibrium status quo” is, the corresponding reciprocal PNT combination is more solid and steady in spacetime.

Radically, cosmos but possess unique genesis throughout demiurgic evolution, ——no matter how cosmos proceeds its magic evolution, and no matter cosmic evolution has proceeded to what kind of peculiar stage, cosmic demiurgic evolution can never create any new genesis out of normal extension of sequential homologic cosmogony rooted in unique genesis of the so-called cosmic genic origin i_0 but only bring out serial homology rooted in cosmic genic origin i_0 , entire cosmic endosome can only be a grand coherent homology aggregation ——cosmic homogeneity system.

2.4. Quantitative demiurgic evolution of cosmic homogeneity system throughout sequential homologic cosmogony

We study quantitative multiplication extension of cosmic homogeneity system throughout cosmic evolution is mainly ready to clarify and demonstrate how the cosmic homogeneity system quantitatively comes into being along sequential homologic cosmogony aiming at the major three sequential stages of cosmic evolution even the so-called four serial sub phases of matter modulization project.

Of course, the major three sequential stages are compatible quantitative change succession of cosmic evolution. Throughout the compatible quantitative change succession, the progressive quantitative change of the first stage is always ready for new start and further quantitative change of the second stage; the progressive quantitative change of both the first stage and the second stage is always ready for new start and further quantitative change of the third stage.

Almost just the same as quantitative change extension of the sequential three major stages of cosmic evolution, the quantitative change extension of the four sub serial phases of the third stage of cosmic evolution are a similar compatible quantitative change succession of matter freewheeling modulization in accordance with essentiality of matter too. The progressive quantitative change of generation and enrichment of elementary genic units in spacetime is always ready for successive generation and enrichment of reciprocal PNT combinations in gradation I; the progressive quantitative change of generation and enrichment of elementary genic units and reciprocal PNT combinations in gradation I in spacetime is always ready for successive generation and enrichment of reciprocal PNT combinations in gradation II, the progressive quantitative change of generation and enrichment of elementary genic units, reciprocal PNT combinations in gradation I and reciprocal PNT combinations in gradation II in spacetime is always ready for successive generation and enrichment of reciprocal PNT combinations in gradation III; the progressive quantitative change of generation and enrichment of elementary genic units,

As coherent natura naturans throughout cosmic evolution, instinctive PNT reciprocal equilibrium towards optimum PNT operation is radical potentiality & conditionality for cosmos always ready to orientate itself towards perfection.

reciprocal PNT combinations in gradation I, reciprocal PNT combinations in gradation II and reciprocal PNT combinations in gradation III in spacetime is always ready for successive generation and enrichment of reciprocal PNT combinations in gradation IV. Such quantitative change extension make up of the quantitative multiplication of cosmic demiurgic evolution through and through, whose mathematical logic is very similar as quantitative expansion increase of parallel cone, which can be illustrated as below:

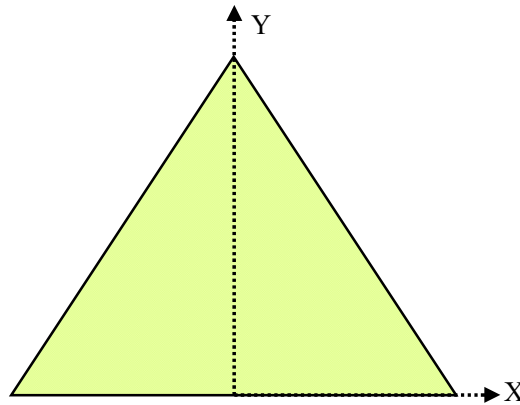

(IV-i-4) Quantitative change of cosmic evolutionary multiplication in expansion increase model of parallel core

In above diagram, X axis is the quantification axis of semidiameter of underside of the cone introduced to scale semidiameter increase of the expanding parallel cone throughout quantitative change of sequential homologic cosmogony; Y axis is just the quantification axis of height of the parallel cone. Of course the volume expansion of the cone indicates the overall cumulation of cosmic demiurgic multiplication.

Throughout the first stage of sequential homologic cosmogony, space field gradually develops till at last it turns to saturation, and the proportionate quantitative change extension is just as a small cone expand from volume 0 to proportionate volume scale which indicates eigenvalue of saturated space field.

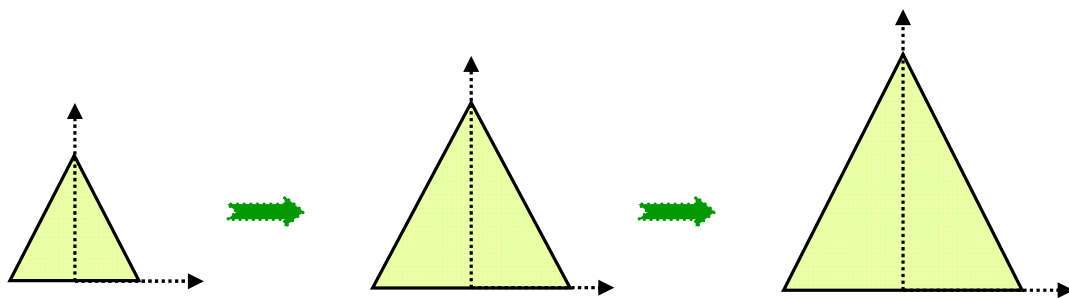

(IV-i-5) Quantitative change of space field development in expansion increase model of parallel cone

During the course of the second stage of cosmic evolution, elementary genic units begins to come into being and gradually enrich in spacetime, as a result, on top of the cone, another small cone (in yellow) comes out indicating occurrence of new objects of elementary genic units and successively to enrich followed the cosmic evolution goes deep into. Although, during the course of the second stage of cosmic evolution, the original cone model has changed into a compound cone with a big one on base indicating successive expansion increase of space field and a small one on top indicating successive expansion increase of continuous generation and enrichment of elementary genic units in space field. Of course, both the big cone on base and the small cone on top will synchronously expand in generally parallel profile as the original single cone besides the volume become

Historical progress of science in the recent several centuries seemed like a far-flung exploration of the first itinerary around numerous distinctive landscapes of brand-new landmasses of science with palette & tablet on back, several hundred years' scientific travelogues were compiled thereby.

bigger and bigger, whereas, the relative volume quotient of the big cone on base and small cone on top is of course always varying accordingly for change of the proper physical conditions of cosmos. The material quantitative change extension can be illustrated as below:

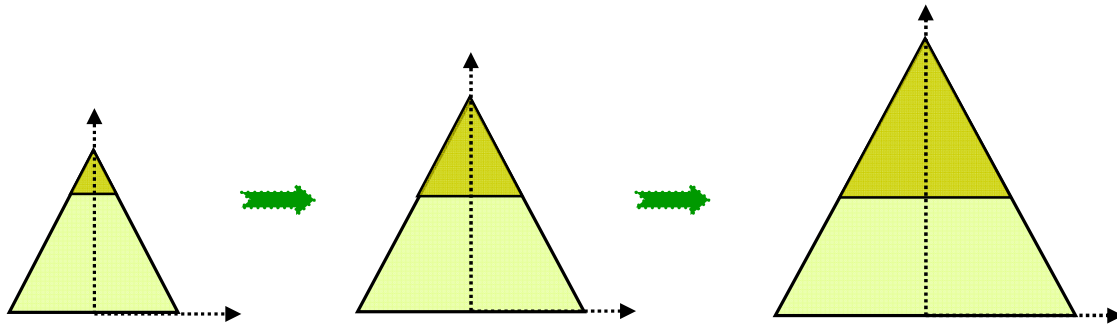

(IV-i-6) Quantitative change of the second stage of cosmic evolution in expansion increase model of parallel cone

During the course of the third stage of cosmic evolution, as continuous generation and gradual enrichment of elementary genic units in spacetime, there are more and more substantial possibilities for elementary genic units even the succedent colorful reciprocal PNT combinations to accomplish “reciprocal idiosyncrasy towards PNT equilibrium + accessible space overall arrangement for PNT reciprocity”, spontaneous occurrence of instinctive PNT reciprocal equilibrium towards optimum PNT operation due to well-rounded presence of “reciprocal idiosyncrasy towards PNT equilibrium + accessible space overall arrangement for PNT reciprocity” among compositive sub-mechanical units will occur widely, there are consequently more and reciprocal PNT combinations in space field. As a result, a third small cone in blue comes out on top of the second cone in yellow.

Of course, as cosmic evolution goes further, volume of the three cones will expand synchronously generally in the parallel profile as the original single cone, whereas, the relative volume quotient is always varying accordingly as change of integrative physical conditions of cosmos for continuation of cosmic evolution. The material quantitative change extension can be illustrated as below:

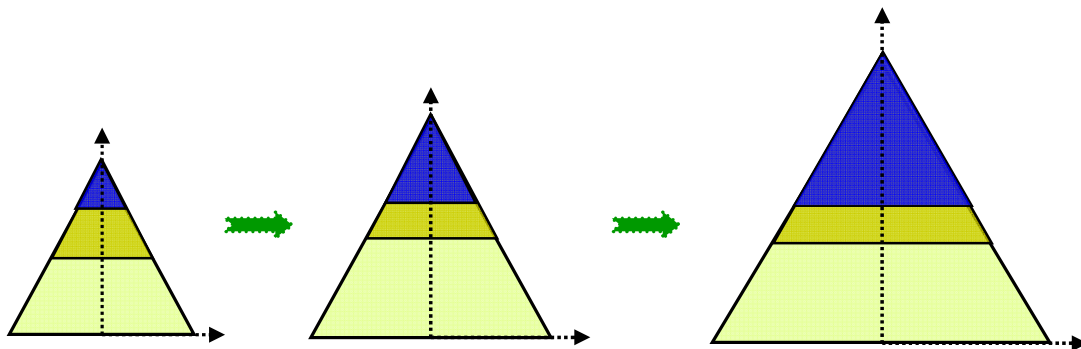

(IV-i-7) Quantitative change of the third stage of cosmic evolution in expansion increase model of parallel cone

In the diagram above, middle yellow cone means the elementary genic units still remain in their original existent state in spacetime, although there are substantial possibilities for them to turn into reciprocal PNT combinations.

Of course, the quantitative change extension of the successive generation and succedent enrichment of the four sequential gradations of reciprocal PNT combinations is almost the same as the quantitative change extension of the three major sequential stages of cosmic evolution besides the process continuity of the four sequential sub phases is even relatively compact than the three sequential major stages, which can be generally illustrated as below:

As coherent natura naturans throughout cosmic evolution, instinctive PNT reciprocal equilibrium towards optimum PNT operation is radical potentiality & conditionality for cosmos always ready to orientate itself towards perfection.

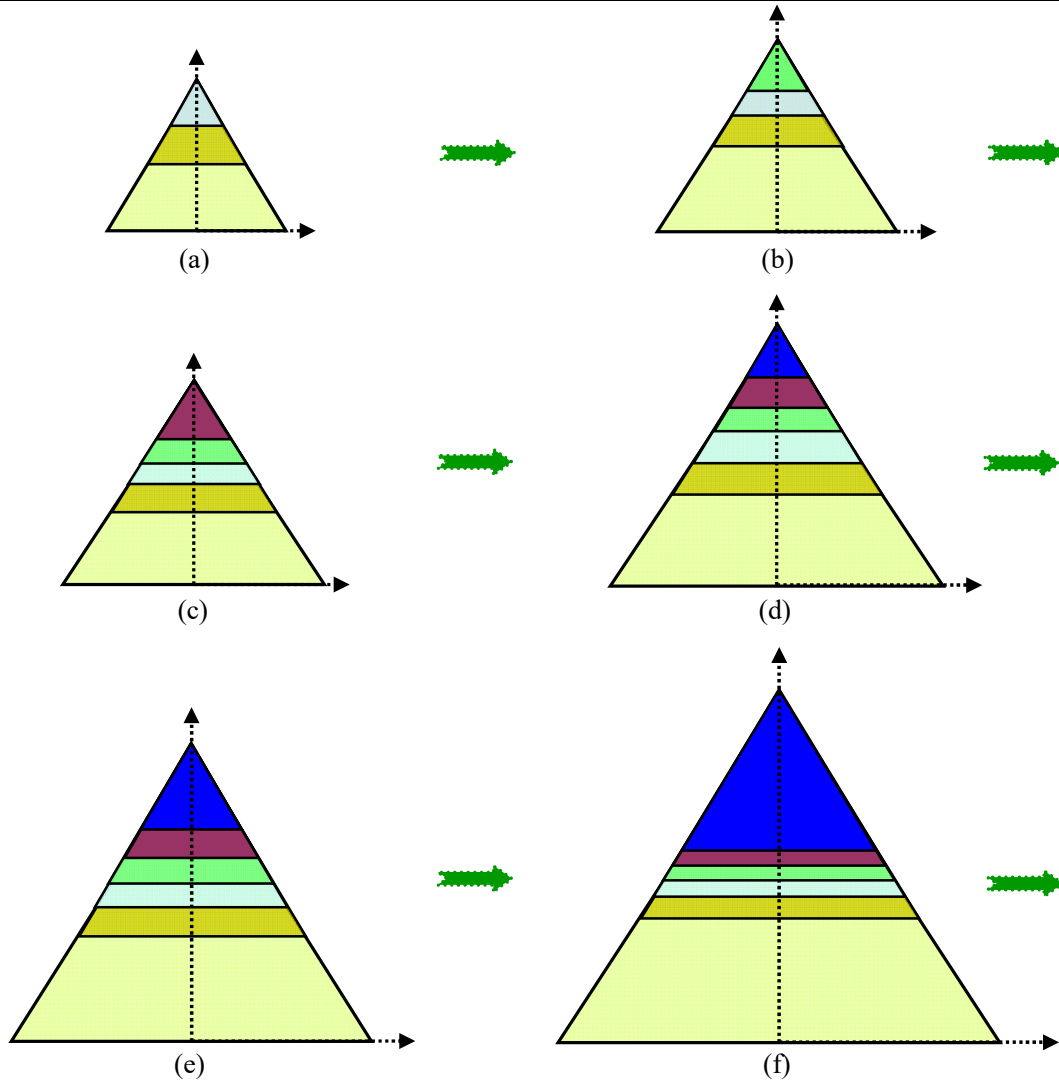

(IV-i-8) Quantitative change of the four sub phases of the third stage of cosmic evolution in expansion increase model of parallel cone



Diagram (a) indicates as continuous generation and gradual enrichment of elementary genic units in spacetime, once elementary genic units in spacetime accomplish sufficient condition of “reciprocal idiosyncrasy towards PNT equilibrium + accessible space overall arrangement for PNT reciprocity”, spontaneous occurrence of instinctive PNT reciprocal equilibrium towards optimum PNT operation due to well-rounded presence of “reciprocal idiosyncrasy towards PNT equilibrium + accessible space overall arrangement for PNT reciprocity” among compositive elementary genic units will occur, reciprocal PNT combinations in gradation I comes into being, cosmic endosome includes field genic units (just the bottom,  of the cone), elementary genic units (just the second layer  of the cone) and reciprocal PNT combinations in gradation I (just the top layer  of the cone) therefore. And relative quotient of field genic units, elementary genic units and reciprocal PNT combinations in gradation I go on readjusting for further continuation of cosmic evolution by the light of nature.

Diagram (b) indicates as continuous generation and gradual enrichment of reciprocal PNT combinations in gradation I in spacetime, once reciprocal PNT combinations in gradation I and ambient available matter integration accomplish sufficient condition of “reciprocal idiosyncrasy towards PNT equilibrium + accessible space overall arrangement for PNT reciprocity”, spontaneous occurrence of instinctive PNT reciprocal equilibrium towards optimum

Historical progress of science in the recent several centuries seemed like a far-flung exploration of the first itinerary around numerous distinctive landscapes of brand-new landmasses of science with palette & tablet on back, several hundred years' scientific travelogues were compiled thereby.





PNT operation due to well-rounded presence of “reciprocal idiosyncrasy towards PNT equilibrium + accessible space overall arrangement for PNT reciprocity” among compositive reciprocal PNT combinations in gradation I and other ambient available matter integration will occur, reciprocal PNT combinations in gradation II comes into being, cosmic endosome includes field genic units (the bottom  of the cone), elementary genic units (the second layer  of the cone), reciprocal PNT combinations in gradation I (the third layer  of the cone) and reciprocal PNT combinations in gradation II (the top layer  of the cone) therefore. And relative quotient of field genic units, elementary genic units, reciprocal PNT combinations in gradation I and reciprocal PNT combinations in gradation II go on readjusting for further continuation of cosmic evolution by the light of nature.





Diagram (c) indicates as continuous generation and gradual enrichment of reciprocal PNT combinations in gradation II in spacetime, once reciprocal PNT combinations in gradation II and ambient available matter integration accomplish sufficient condition of “reciprocal idiosyncrasy towards PNT equilibrium + accessible space overall arrangement for PNT reciprocity”, spontaneous occurrence of instinctive PNT reciprocal equilibrium towards optimum PNT operation due to well-rounded presence of “reciprocal idiosyncrasy towards PNT equilibrium + accessible space overall arrangement for PNT reciprocity” among compositive reciprocal PNT combinations in gradation II and other ambient available matter integration will occur, reciprocal PNT combinations in gradation III comes into being, cosmic endosome includes field genic units (the bottom  of the cone), elementary genic units (the second layer  of the cone), reciprocal PNT combinations in gradation I (the third layer  of the cone), reciprocal PNT combinations in gradation II (the fourth layer  of the cone) and reciprocal PNT combinations in gradation III (the top layer  of the cone) therefore. And relative quotient of field genic units, elementary genic units, reciprocal PNT combinations in gradation I, reciprocal PNT combinations in gradation II and reciprocal PNT combinations in gradation III go on readjusting for further continuation of cosmic evolution by the light of nature.







Diagram (d) indicates as continuous generation and gradual enrichment of reciprocal PNT combinations in gradation III in spacetime, once reciprocal PNT combinations in gradation III and ambient available matter integration accomplish sufficient condition of “reciprocal idiosyncrasy towards PNT equilibrium + accessible space overall arrangement for PNT reciprocity”, spontaneous occurrence of instinctive PNT reciprocal equilibrium towards optimum PNT operation due to well-rounded presence of “reciprocal idiosyncrasy towards PNT equilibrium + accessible space overall arrangement for PNT reciprocity” among compositive reciprocal PNT combinations in gradation III and other ambient available matter integration will occur, reciprocal PNT combinations in gradation IV comes into being, cosmic endosome includes field genic units (the bottom  of the cone), elementary genic units (the second layer  of the cone), reciprocal PNT combinations in gradation I (the third layer  of the cone), reciprocal PNT combinations in gradation II (the fourth layer  of the cone), reciprocal PNT combinations in gradation III (the fifth layer  of the cone) and reciprocal PNT combinations in gradation IV (the top layer  of the cone) therefore. And relative quotient of field genic units, elementary genic units, reciprocal PNT combinations in gradation I, reciprocal PNT combinations in gradation II, reciprocal PNT combinations in gradation III and reciprocal PNT combinations in gradation IV go on readjusting followed further continuation of cosmic evolution by the light of nature.

Diagram (e), diagram (f) indicate, although the cosmic endosome in species still remains the same as what diagram (d) indicates, as cosmic evolution still continuing, the relative quotient of all compositive field genic

As coherent natura naturans throughout cosmic evolution, instinctive PNT reciprocal equilibrium towards optimum PNT operation is radical potentiality & conditionality for cosmos always ready to orientate itself towards perfection.

units, elementary genic units, reciprocal PNT combinations in gradation I, reciprocal PNT combinations in gradation II, reciprocal PNT combinations in gradation III and reciprocal PNT combinations in gradation IV are still in spontaneous acclimation and readjustment towards optimum and tranquilization.

Although, the quantitative change of cosmic evolutionary multiplication in expansion increase model of parallel cone can straightforwardly incarnate the succession sequence and relative quotient of quantitative change throughout cosmic evolutionary multiplication, it is still short of representation of idiographic quantitative change continuation of integrative cosmic evolution. In order to represent the integrated quantitative change continuation of cosmic evolution, we introduce another diagram of “integrated quantitative change rate curve of cosmic evolutionary multiplication” as below:

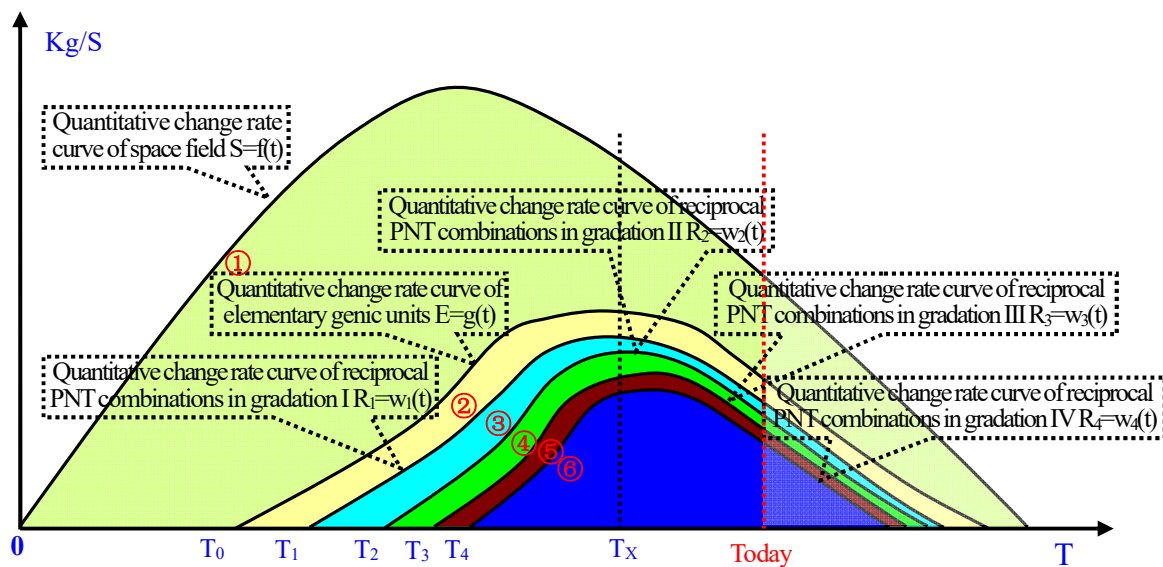

(IV-i-9) Integrated quantitative change rate curve of sequential homologous cosmogony through and through

The horizontal axis of the coordinate indicates time, unit: second (S), the vertical axis of the coordinate indicates quantitative change rate of multiplication cosmic evolution, unit: kilogram/second (Kg/S).

T₀ on horizontal axis represents the moment elementary genic units primarily generate and enrich in spacetime;

T₁ on horizontal axis represents the moment reciprocal PNT combinations in gradation I primarily generate and enrich in spacetime.

T₂ on horizontal axis represents the moment reciprocal PNT combinations in gradation II primarily generate and enrich in spacetime.

T₃ on horizontal axis represents the moment reciprocal PNT combinations in gradation III primarily generate and enrich in spacetime.

T₄ on horizontal axis represents the moment reciprocal PNT combinations in gradation IV primarily generate and enrich in spacetime.

T_x on horizontal axis represents any discretionary moment between T₄ and today.

Today on horizontal axis represents the moment of cosmic today.

The curve ① represents quantitative change rate of evolutionary multiplication of space field throughout cosmic evolution from time 0 to today, and we denote it with function $S=f(t)$.

The curve ② represents quantitative change rate of evolutionary multiplication of elementary genic units

Historical progress of science in the recent several centuries seemed like a far-flung exploration of the first itinerary around numerous distinctive landscapes of brand-new landmasses of science with palette & tablet on back, several hundred years' scientific travelogues were compiled thereby.

throughout cosmic evolution from time T_0 to today, and we denote it with function $E=g(t)$.

The curve ③ represents quantitative change rate of evolutionary multiplication of reciprocal PNT combinations in gradation I throughout cosmic evolution from time T_1 to today, and we denote it with function $R_1=w_1(t)$.

The curve ④ represents quantitative change rate of evolutionary multiplication of reciprocal PNT combinations in gradation II throughout cosmic evolution from time T_2 to today, and we denote it with function $R_2=w_2(t)$.

The curve ⑤ represents quantitative change rate of evolutionary multiplication of reciprocal PNT combinations in gradation III throughout cosmic evolution from time T_3 to today, and we denote it with function $R_3=w_3(t)$.

The curve ⑥ represents quantitative change rate of evolutionary multiplication of reciprocal PNT combinations in gradation IIV throughout cosmic evolution from time T_4 to today, and denote it with function $R_4=w_4(t)$.

However, there is a issue I have to comment herein, we introduce “second/s” as unit of the time on level axis, and we introduce Kilogram/second (Kg/S) as unit of quantitative change rate of cosmic evolution multiplication. Upon strict sense, when we come to study the quantitative change throughout cosmic evolution, nothing is reasonable for us to introduce “second” as all-purpose unit to define and quantify time continuation or time lapse throughout cosmic evolution.

This issue above all relates original introduction of notion of time and what's the physical esse of time in the nature. Traditionary notion of time was introduced as “**standard motion sample for reference of comprehensive motion**” upon subconscious sense for expedience to differentiate and study comprehensive motion rate and relative motion materialization effect around us, for example, standard motion of crystal lattice oscillation of quartz of quartz clock, pendulum of pendulum clock swings under effect of gravity, moon running around the earth, the earth running around the sun etc. Whereas, any existence & motion in the nature directly relates to time dynamic speed of the spacetime, and usually, time dynamic speed is not constant in the nature, as “standard motion sample for comprehensive motion reference”, the characteristic motion of physical esse of time can never be exceptive.

Standard time unit of “second” is defined by human in accordance with the current spacetime status around the earth even with unnoticed default that the spacetime condition around the earth is everlasting constant. This of course indicates standard time unit of second is not specific esse of nature but specific default of human. As it's almost impossible for time dynamic speed of spacetime around the earth to be everlastingly constant, we randomly snatch two separate second in time current, we can not ensure the both separate second have the same or equivalent physical connotation of nature. In straightforward words, time unit of second is but a default standard time unit of human own wishful thinking, it's not connatural standard time unit of nature.

And virtually, throughout cosmic evolution, there is substantial evolutionary course for time to evolve from time dynamic speed 0 to temporal time dynamic speed of cosmos, which of course means, at different cosmic evolutionary stages, cosmos possess different time dynamic speeds of spacetime; this of course means remarkable disparity of physical connotation of time performance at different cosmic evolutionary stages, and we can never to introduce any default “standard time unit” to quantify and formulate physical connotation of practical time continuation & lapse, which is generally similar as we can never resort an elastic scale calibrated on earth to quantify mass on moon, on Jupiter, on Mars according to its original scale going without saying. Leastways, in order to scale practical time domino effect or physical connotation of different cosmic evolutionary stages with different time dynamic speed performing time continuation, we should introduce proper time conversion to

As coherent natura naturans throughout cosmic evolution, instinctive PNT reciprocal equilibrium towards optimum PNT operation is radical potentiality & conditionality for cosmos always ready to orientate itself towards perfection.

ensure scaling time continuation or lapse in coherent physical connotation.

Throughout the course of cosmic evolution that time dynamic speed evolves from time dynamic speed 0 to temporal time dynamic speed of cosmos, the substantial time continuation in coherent physical connotation may be like this: if we define 1mm near the position of “today” on the horizontal axis of the coordinate matches 3.15×10^{14} seconds, then, at relatively ahead part of the level axis, 10 mm may be enough to match 3.15×10^{14} seconds, then 8 mm matches 3.15×10^{14} seconds, 6 mm matches 3.15×10^{14} seconds, …, 1.5 mm matches 3.15×10^{14} seconds, till at last it approaches scale of today position where 1 mm matches 3.15×10^{14} seconds.

As we adopt “second” as time unit throughout level axis, compared with the real quantitative change rate curve, the slope of the curves on show is of course larger than they originally should be. And the farer ahead of today position, the higher it deviates to, virtually, these curves should be more flat in coordinate.

Apparently, from cosmic evolutionary time 0 to cosmic Today, the total multiplication of space field can be formulated as below:

$$Q = \int_0^{\text{today}} f(t) dt$$

From cosmic evolutionary time 0 to cosmic evolutionary time T_0 , cosmic evolutionary multiplication is all multiplication of space field, which can be formulated as below:

$$Q_0 = \int_0^{T_0} f(t) dt$$

Once cosmic evolution proceeds to cosmic evolutionary time T_0 , elementary genic units begin to generate and enrich in spacetime, from cosmic evolutionary time T_0 to cosmic evolutionary time Today, the total multiplication of elementary genic units can be formulated as below:

$$Q_1 = \int_{T_0}^{\text{today}} g(t) dt$$

Once cosmic evolution proceeds to cosmic evolutionary time T_1 , reciprocal PNT combinations begin to generate and enrich in spacetime, from cosmic evolutionary time T_1 to cosmic evolutionary time Today, the total multiplication of reciprocal PNT combinations can be formulated as below:

$$Q_2 = \int_{T_1}^{\text{today}} w(t) dt$$

This value is just the quantity indicated by the blue cone on top of diagram (IV-i-4).

Since cosmic evolutionary time T_0 , there are elementary genic units generated and enriched in spacetime, the generation of elementary genic units is virtually qualitative change of space field genic units. As a result, from cosmic evolutionary time 0 to cosmic today, the final hoarding of space field genic units in spacetime is not equal to practical multiplication total of space field genic units throughout cosmic evolution, but equals to balance of multiplication total of space field genic units and multiplication total of elementary genic units, which is just the integral calculus \mathcal{C}_0 indicated by the buff surface enclosed by curve $S=f(t)$ and curve $E=g(t)$ in diagram (IV-i-6).

$$\mathcal{C}_0 = \int_0^{\text{today}} f(t) dt - \int_{T_0}^{\text{today}} g(t) dt$$

From cosmic evolutionary time 0 to cosmic today, the integral is always a variable. And this integral is also the quantity indicated by the bottom buff cone in diagram (IV-i-5) (e), (f).

Since cosmic evolutionary time T_1 , there are reciprocal PNT combinations in gradation I generated and enriched

Historical progress of science in the recent several centuries seemed like a far-flung exploration of the first itinerary around numerous distinctive landscapes of brand-new landmasses of science with palette & tablet on back, several hundred years' scientific travelogues were compiled thereby.

in spacetime, the generation of reciprocal PNT combinations in gradation I is virtually qualitative change of convergent coalescent of elementary genic units. As a result, from cosmic evolutionary time T_0 to cosmic today, the final hoarding of elementary genic units in spacetime is not equal to practical multiplication total of elementary genic units throughout cosmic evolution, but equals to balance of multiplication total of elementary genic units and multiplication total of reciprocal PNT combinations in gradation I, which is just the integral calculus \mathcal{C}_1 indicated by the yellow surface enclosed by curve $E=g(t)$ and curve $R_1=w_1(t)$ in illustration (IV-i-6).

$$\mathcal{C}_1 = \int_{T_0}^{\text{today}} g(t)dt - \int_{T_1}^{\text{today}} w_1(t)dt$$

From cosmic evolutionary time T_1 to cosmic today, the integral \mathcal{C}_1 is always a variable. And this integral is also the quantity indicated by the second yellow cone in (diagram IV-i-5) (e), (f), if number from bottom to top. .

Since cosmic evolutionary time T_2 , there are reciprocal PNT combinations in gradation II generated and enriched in spacetime, the generation of reciprocal PNT combinations in gradation II is virtually qualitative change of convergent coalescent of reciprocal PNT combinations in gradation I and elementary genic units. As a result, from cosmic evolutionary time T_1 to cosmic today, the final hoarding of reciprocal PNT combinations in gradation I in spacetime is not equal to practical multiplication total of reciprocal PNT combinations in gradation I throughout cosmic evolution, but equals to balance of multiplication total of reciprocal PNT combinations in gradation I and multiplication total of reciprocal PNT combinations in gradation II, which is just the integral calculus \mathcal{C}_2 indicated by the grey surface enclosed by curve $R_1=w_1(t)$ and curve $R_2=w_2(t)$ in illustration (IV-i-6).

$$\mathcal{C}_2 = \int_{T_1}^{\text{today}} w_1(t)dt - \int_{T_2}^{\text{today}} w_2(t)dt$$

From cosmic evolutionary time T_1 to cosmic today, the integral calculus \mathcal{C}_2 is always a variable. And this integral is also the quantity indicated by the third grey cone in (diagram IV-i-5) (e), (f), if number from bottom to top. .

Since cosmic evolutionary time T_3 , there are reciprocal PNT combinations in gradation III generated and enriched in spacetime, the generation of reciprocal PNT combinations in gradation III is of course qualitative change of convergent coalescent of reciprocal PNT combinations in gradation II, reciprocal PNT combinations in gradation I and elementary genic units. As a result, from cosmic evolutionary time T_2 to cosmic today, the final hoarding of reciprocal PNT combinations in gradation II in spacetime is not equal to practical multiplication total of reciprocal PNT combinations in gradation II throughout cosmic evolution, but equals to balance of multiplication total of reciprocal PNT combinations in gradation II and multiplication total of reciprocal PNT combinations in gradation III, which is just the integral calculus \mathcal{C}_3 indicated by the green surface enclosed by curve $R_2=w_2(t)$ and curve $R_3=w_3(t)$ in illustration (IV-i-6).

$$\mathcal{C}_3 = \int_{T_2}^{\text{today}} w_2(t)dt - \int_{T_3}^{\text{today}} w_3(t)dt$$

From cosmic evolutionary time T_2 to cosmic today, the integral calculus \mathcal{C}_3 is always a variable. And this integral calculus is also the multiplication quantity indicated by the fourth green cone in illustration (IV-i-5) (e), (f), if number from bottom to top.

Since cosmic evolutionary time T_4 , there are reciprocal PNT combinations in gradation IV generated and enriched in spacetime, the generation of reciprocal PNT combinations in gradation IV is of course qualitative change of convergent coalescent of reciprocal PNT combinations in gradation III, reciprocal PNT combinations in gradation II, reciprocal PNT combinations in gradation I and elementary genic units. As a result, from cosmic

evolutional time T_3 to cosmic today, the final hoarding of reciprocal PNT combinations in gradation III in spacetime is not equal to practical multiplication total of reciprocal PNT combinations in gradation III throughout cosmic evolution, but equals to balance of multiplication total of reciprocal PNT combinations in gradation III and multiplication total of reciprocal PNT combinations in gradation IV, which is just the integral calculus \mathcal{C}_4 which is indicated by the red surface enclosed by curve $R_3=w_3(t)$ and curve $R_4=w_4(t)$ in illustration (IV-i-6).

$$\mathcal{C}_4 = \int_{T_3}^{\text{today}} w_3(t) dt - \int_{T_4}^{\text{today}} w_4(t) dt$$

From cosmic evolutionary time T_3 to cosmic today, the integral \mathcal{C}_4 is always a variable. And this integral is also the multiplication quantity indicated by the fifth red cone in illustration (IV-i-5) (e), (f), if number from bottom to top.

The integral calculus of $\mathcal{C}_5 = \int_{T_4}^{\text{today}} w_4(t) dt$ is just the multiplication total of celestial bodies and galaxies in cosmos, which is also the multiplication quantity indicated by the top blue cone in illustration (IV-i-5) (e), (f).

—Firstly written in Dec. 2004, Hunan, Wugang, Zhenzhu
Revision was done in Oct. 2013, Dongguan, Shatian, Nanxing

(IV-ii) Overall arrangement of homogenous cosmos as well-regulated integration of cosmic homogeneity system due to sequential homologic cosmogony in the nature of coherent natura naturans throughout cosmic evolution

Abstract: *Evolution and formation of homogenous cosmos is not only grand succession of sequential homologic multiplication in coherent causality, but also, along evolutionary extension, prior evolutionary aggradation is always favorable procreant groundwork and physical precondition for further homologic multiplication and the primary evolutionary outcome usually envelops the subsequent evolutionary outgrowth 100 over 100. This of course implies the resultant existence of conditional lamellas of homogenous cosmos one by one proportional to sequential homologic cosmogony in coherent cause & effect succession, which ultimately brings out purely homogenous configuration and integrative overall arrangement of cosmos. The most remarkable conditional lamellas in coherent cause & effect succession hypostatized by sequential homologic cosmogony are “cosmic white extent/lamella” around the “cosmic yolk extent”. I introduce thesis of “Overall arrangement of homogenous cosmos as demiurgic aggradation of sequential homologic cosmogony in the nature of coherent natura naturans throughout cosmic evolution” herein is mostly ready to highlight the homologic coevolution of cosmic white extent and cosmic yolk extent, especially the naissance and subsequent durative evolution of cosmic yolk extent centered in cosmic white extent, which mainly involves coevolution of extent expansion of cosmic yolk extent and aberrant convergence of cosmic esse due to PNT reciprocal gelation in coherent causality towards cosmic status quo.*

Keywords: *negative substance suffusion extent, positive substance floating extent, cosmic white extent, cosmic yolk extent, light-exhaustion medium lamella, white towards yolk transmutable pervasion, yolk towards white transmutable pervasion, aberrant convergence of cosmic esse due to PNT reciprocal gelation, quantitative change regularity of white towards yolk transmutable pervasion, quantitative change function of yolk towards white transmutable pervasion, quantitative change regularity function of cosmic yolk evolution, instinctive filter confinement of cosmic yolk extent, relative weak space field interlayer among galaxies, instinctive weak space field interlayer confinement of galaxy.*

1. Egg model configuration & overall arrangement of “Negative substance suffusion extent” and “Positive substance floating extent” of homogenous cosmos.

Cosmic demiurgic evolution is thorough succession of sequential homologic cosmogony in coherent causality, the prior evolutionary aggradation is always favorable procreant groundwork and physical precondition for further homologic multiplication. Cosmic evolution is firstly gradual development of space field towards saturation consummation, continuation of extra-saturation of space field lead to generation of elementary genic units in spacetime. As gradual enrichment of elementary genic units in space field, the density of elementary genic units in spacetime is higher and higher, there is more and more probability for elementary genic units to accomplish favorable condition of “reciprocal idiosyncrasy towards PNT equilibrium + accessible space overall arrangement for PNT reciprocity”, which of course lead to chain-reacting of spontaneous occurrence of instinctive PNT reciprocal equilibrium towards optimum PNT operation ever since and consequently multiply rich and colorful reciprocal PNT combinations

As coherent natura naturans throughout cosmic evolution, instinctive PNT reciprocal equilibrium towards optimum PNT operation is radical potentiality & conditionality for cosmos always ready to orientate itself towards perfection.

in spacetime towards cosmic status quo.

Throughout cosmic evolutional succession, evolutional aggradation of gradual development of space field towards saturation consummation must form full envelop situation to continuous generation & gradual enrichment of elementary genic units and succedent multiplication of reciprocal PNT combinations as chain-reacting ever since. Otherwise, any absence of the proper necessity of conditional saturated space field envelop must form “local condition leak” for continuous generation & enrichment of elementary genic units no more succedent chain-reacting multiplication of reciprocal PNT combinations, which even may be found as “Black Hole”. Such full “condition envelop” situation must accomplish the proper sequential envelop lamella overall arrangement of cosmos proportional to sequential homologic cosmogony in the nature of coherent natura naturans throughout cosmic evolution. Among the sequential envelop lamella arrangement, the most remarkable sequential envelop lamellas are just the ambient conditional envelop lamella made up of saturated space field for continuous generation & gradual enrichment of elementary genic units even successive multiplication of rich and colorful reciprocal PNT combinations as chain-reacting ever since, —as existence & motion of matter radically depends on physical maintenance of proper saturated space field, in overall arrangement of integrative well-regulated cosmic homogeneity system, the proper saturated space field must envelop the existence & motion of matter 100 over 100 as full ambient lamella, this of course forms cosmic layered structure of envelop lamella arrangement of homogenous cosmos.

As the ambient conditional envelop lamella for generation & formation of matter is pure hyllic aggregation of negative matter (/field genic units), so I just call the ambient conditional envelop lamella “negative substance suffusion extent” of cosmos. As the idiographic existence & motion of matter (including original generation of elementary genic units and the consequential multiplication of rich and colorful reciprocal PNT combinations in spacetime) in spacetime is somewhat like objects floating on saturated space field, so it seems expedient for us to call the district matter existing in “positive substance floating extent” of cosmos.

In accordance with sequential homologic cosmogony in the nature of coherent natura naturans throughout cosmic evolution, negative substance suffusion extent must envelop positive substance floating extent 100 over 100 as ambient conditional lamella, as such overall arrangement between negative substance suffusion extent and positive substance floating extent is very similar as configuration of egg made up of egg white and yolk, it’s apparently expedient for us to call the negative substance suffusion extent of cosmos “cosmic white extent” and call positive substance floating extent of cosmos “cosmic yolk extent”.

Of course, as it’s only possible for cosmic demiurgic evolution to be sequential homologic cosmogony in the nature of coherent natura naturans throughout cosmic evolution, this of course implies there must be cause and effect transition lamella between lamella of cosmic white extent and inner cone of cosmic yolk extent, which link up both generation of elementary genic units in space field close to the inner cone district of cosmic yolk extent —“negative towards positive transmutation” and degeneration of elementary genic units in spacetime close to ambient lamella of cosmic white extent—“positive towards negative transmutation”. As the original generation and existence of elementary genic units in spacetime directly embodies idiographic existence & motion of rays or radiations and degeneration of elementary genic units in spacetime directly embodies disappearance of rays or radiations in spacetime on the contrary, no matter whether there is substantial positive generation of rays and

Historical progress of science in the recent several centuries seemed like a far-flung exploration of the first itinerary around numerous distinctive landscapes of brand-new landmasses of science with palette & tablet on back, several hundred years’ scientific travelogues were compiled thereby.

radiations in transition lamella close to inner cone district of cosmic yolk extent or not, as there is absolute degeneration of rays and radiations in transition lamella close to cosmic white extent, any ray or radiation entered the transition lamella must die off, so the transition lamella between cosmic white extent and cosmic yolk extent seems like a slaughterhouse of rays and radiations, and resultingly, I just call it “light-exhaustion medium lamella”.

So-called “light-exhaustion medium lamella” is just the medium lamella between cosmic white extent and cosmic yolk extent, along cosmic evolutionary sequence, whose inner surface touch cosmic yolk extent linking up generation of elementary genic units——negative towards positive transmutation; outer surface touch cosmic white extent linking up degeneration of elementary genic units——positive towards negative transmutation, and whose space field strength is reluctant to support normal existence & motion of rays and radiations. Of course, it's connatural circumscription between cosmic yolk extent and cosmic white extent. As all photons even particles must exhaust in light-exhaustion medium lamella, looking through light-exhaustion medium lamella, the cosmic white extent is of course out-and-out “Black Hole”.

Now, we can illustrate the overall arrangement of homogenous cosmos as below:

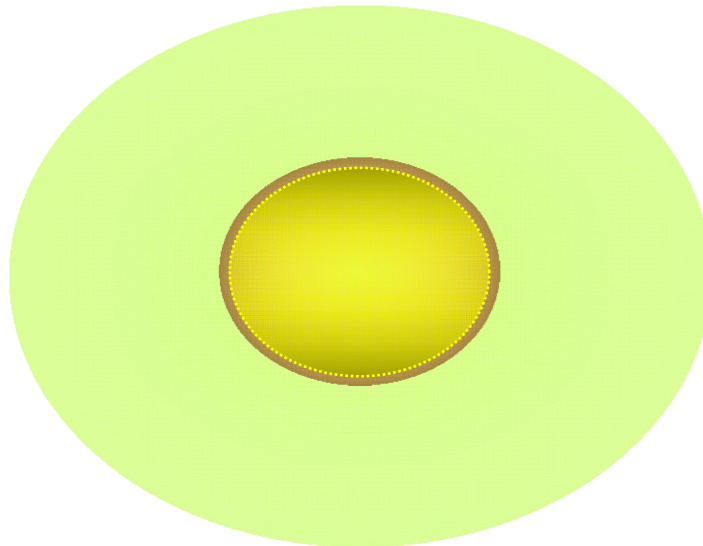

(IV-ii-1) Egg model configuration & overall arrangement of homogenous cosmos

In diagram above, the outer lamella in buff denotes cosmic white extent, the inner cone district in bright yellow denotes cosmic yolk extent, the medium lamella between cosmic white extent and cosmic yolk extent in light brown is just the light-exhaustion medium lamella.

In logic rationality, the cosmic egg model overall arrangement is only restricted by condition that cosmic white extent must envelop cosmic yolk extent 100 over 100 as ambient conditional lamella, this of course does not exclude possibility of double-yolk overall arrangement even multi-yolk overall arrangement of homogenous cosmos as blow.

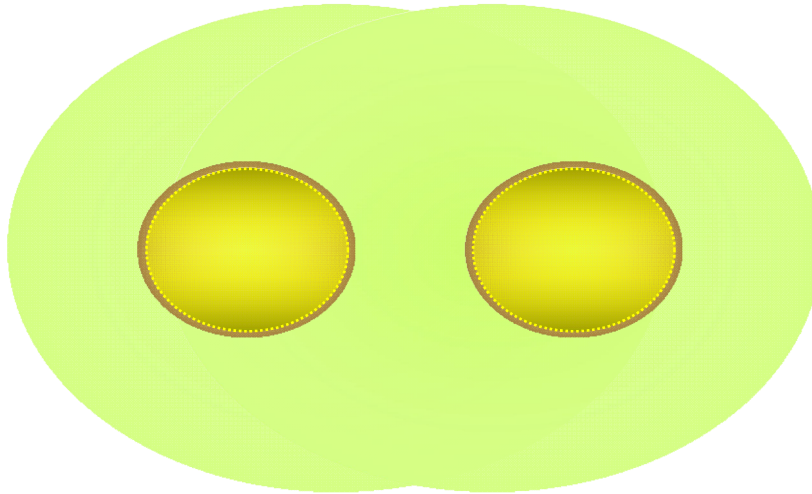

(IV-ii-2) Double-yolk egg model configuration & overall arrangement of homogenous cosmos

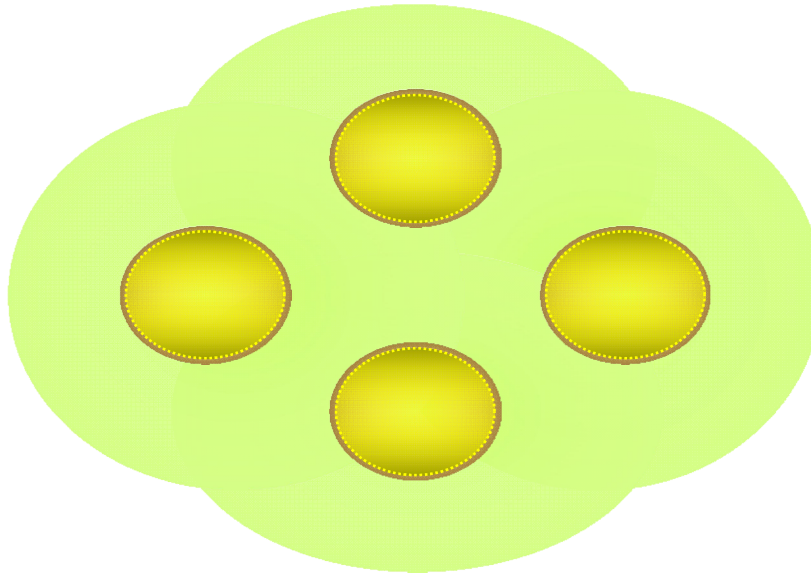

(IV-ii-3) Multi-yolk egg model configuration & overall arrangement of homogenous cosmos

As continuity of gradual quantitative change of cosmic evolution, the space field strength layout of both cosmic white extent and cosmic yolk extent is usually continuous but not even. And usually, the space field strength of cosmic yolk extent varies in accordance with enrichment scale and convergent density of positive matter, the grander enrichment scale and the more convergent density are, the space field strength around is relatively bigger, the closer to the enrichment & density centre, the proper space field strength is relatively bigger. However, in terms of space field strength distribution of cosmic white extent, as continuity of gradual quantitative change of cosmic evolution, the space field strength is inversely tenuate by distance from the cosmic yolk extent centre, —the farer away from the cosmic yolk extent center, the weaker the space field strength is. This of course even means remarkable physical disparity of time dynamic speed, space distance, space radiation cornu and so on.

2. Evolutional potential towards cosmic yolk extent and substantial evolutional accumulation of cosmic yolk extent

Evolution of cosmic yolk extent is of course a segment of cosmic evolution.

Historical progress of science in the recent several centuries seemed like a far-flung exploration of the first itinerary around numerous distinctive landscapes of brand-new landmasses of science with palette & tablet on back, several hundred years' scientific travelogues were compiled thereby.

The strength increase of space field is not unlimited, once the strength of space field increases to some certain value (Just means once the magnitude of time dynamic speed increases to some certain value) so that the field genic units are very difficult to manage their normal existence of dynamic transmutation & transmission to acclimate themselves in space field any longer, things will develop in the opposite direction when they become extreme, some field genic units have to converge into special configuration and separate themselves from space field like salt out from extra-saturated salt solution so as to embody idiographic existence & motion of so-called elementary genic units in spacetime, which is remarkably different from their original existence & motion of field genic units in space field. And subsequently, as gradual enrichment of elementary genic units in space field, substantial coexistence of elementary genic units in space field will accomplish “**reciprocal idiosyncrasy towards PNT equilibrium + accessible space overall arrangement for PNT reciprocity**” by the light of nature. And as presence of instinctive PNT equilibrium towards optimum PNT operation, the elementary genic units gradually converge and combine into rich and colorful reciprocal PNT combinations stage by stage.

We define progressive situation below “cosmic potential towards cosmic yolk extent”:

- a) As space field gradually strengthening towards saturation, once there is evidence of extra-saturation of space field, there is original generation of elementary genic units in space field. And as there is substantial potential for extra-saturation of space field, there is successive enrichment of elementary genic units in space field, so that there is inevitable occurrence of “**reciprocal idiosyncrasy towards PNT equilibrium + accessible space overall arrangement for PNT reciprocity**” among objects.
- b) As presence of instinctive PNT equilibrium towards optimum PNT operation, “**reciprocal idiosyncrasy towards PNT equilibrium + accessible space overall arrangement for PNT reciprocity**” must lead to multiplication of reciprocal PNT combinations stage by stage towards cosmic status quo.

In a straightforward word, so-called cosmic potential towards cosmic yolk extent is progressive evolution succession, as space field strength gradually strengthening towards saturation, once there is evidence of extra-saturation of space field, elementary genic units generate in space field thereby, and as gradual enrichment of elementary genic units in space field accomplishing “**reciprocal idiosyncrasy towards PNT equilibrium + accessible space overall arrangement for PNT reciprocity**” by the light of nature, reciprocal PNT combinations occur and even go further multiplication stage by stage.

2.1. Mutual transmutable pervasion between cosmic white extent and cosmic yolk extent

The sequential homologous cosmogony of course implies bidirectional pervasion between any two lineal homology, this of course includes bidirectional pervasion between cosmic white extent and cosmic yolk extent, —positive transmutable pervasion from cosmic white extent to cosmic yolk extent and negative transmutable pervasion from cosmic yolk extent to cosmic white extent. We call the positive transmutable pervasion from cosmic white extent to cosmic yolk extent “white towards yolk transmutable pervasion” and symbolize it ($M_{\text{white} \rightarrow \text{yolk}}$), for expedience of mathematical analysis, we further introduce $d(M_{\text{white} \rightarrow \text{yolk}})$ to denote “white towards yolk transmutable pervasion speed”; we call negative transmutable pervasion from cosmic yolk extent to cosmic white extent “yolk towards white transmutable pervasion” and symbolize it ($M_{\text{yolk} \leftarrow \text{white}}$), for expedience of mathematical analysis, we further introduce $d(M_{\text{yolk} \leftarrow \text{white}})$ to denote “yolk towards white transmutable pervasion rate”.

As coherent natura naturans throughout cosmic evolution, instinctive PNT reciprocal equilibrium towards optimum PNT operation is radical potentiality & conditionality for cosmos always ready to orientate itself towards perfection.

Apparently, physical occurrence of $d(M_{\text{white} \rightarrow m_{\text{yolk}}}) > d(M_{\text{white} \leftarrow m_{\text{yolk}}})$ is just accrescent springhead of cosmic yolk extent —more and more elementary genic units come into being and more and more reciprocal PNT combinations come into being successively. Cosmos becomes more and more well-rounded towards cosmic status quo. Physical occurrence of $d(M_{\text{white} \rightarrow m_{\text{yolk}}}) < d(M_{\text{white} \leftarrow m_{\text{yolk}}})$ is just the tenuation springhead of cosmic yolk extent —more and more reciprocal PNT combinations have to be disjointed and more and more elementary genic units degenerate into field genic units and slide into space field disappeared. If $d(M_{\text{white} \rightarrow m_{\text{yolk}}}) = d(M_{\text{white} \leftarrow m_{\text{yolk}}})$, it indicates cosmic white extent and cosmic yolk extent achieve mutually transmutable pervasion balance, large-scale structure of cosmos is relative steady.

2.1. Quantitative change of cosmic progressive orientation towards cosmic yolk extent

The evolution of cosmic yolk extent is outgrowth of coexistence of white toward yolk transmutation of cosmic esse and yolk towards white pervasion of cosmic esse. Under precondition of coexistence of white towards yolk pervasion and yolk towards white pervasion of cosmic esse, if $d(M_{\text{white} \rightarrow m_{\text{yolk}}}) > d(M_{\text{white} \leftarrow m_{\text{yolk}}})$, it means pullulation of cosmic yolk extent; if $d(M_{\text{white} \rightarrow m_{\text{yolk}}}) = d(M_{\text{white} \leftarrow m_{\text{yolk}}})$, it means evolutionary stationary state of cosmic yolk extent; if $d(M_{\text{white} \rightarrow m_{\text{yolk}}}) < d(M_{\text{white} \leftarrow m_{\text{yolk}}})$, it means atrophy or degeneration of cosmic yolk extent.

Once white towards yolk pervasion is relatively preponderant to yolk towards white pervasion just as $d(M_{\text{white} \rightarrow m_{\text{yolk}}}) > d(M_{\text{white} \leftarrow m_{\text{yolk}}})$, cosmic yolk extent appears pullulation, which concretely embodies as below:

1) once the bidirectional pervasion of cosmic esse between cosmic yolk extent and cosmic white extent satisfies $d(M_{\text{white} \rightarrow m_{\text{yolk}}}) > d(M_{\text{white} \leftarrow m_{\text{yolk}}})$, there is consequent quantitative change of extent expansion of cosmic yolk extent.

2) Once the bidirectional pervasion of cosmic esse between cosmic yolk extent and cosmic white extent satisfies $d(M_{\text{white} \rightarrow m_{\text{yolk}}}) > d(M_{\text{white} \leftarrow m_{\text{yolk}}})$, there is consequent quantitative change of acclimatization cushion of time dynamic speed.

3) Once the bidirectional pervasion of cosmic esse between cosmic yolk extent and cosmic white extent satisfies $d(M_{\text{white} \rightarrow m_{\text{yolk}}}) > d(M_{\text{white} \leftarrow m_{\text{yolk}}})$, there is consequent generation of elementary genic units in space field, and as enrichment of elementary genic units in space field, there is inevitable occurrence of “**reciprocal idiosyncrasy towards PNT equilibrium + accessible space overall arrangement for PNT reciprocity**”, and as presence of instinctive reciprocal PNT equilibrium towards optimum PNT operation, rich and colorful reciprocal PNT combinations occur thereby, —**aberrant convergence of cosmic esse due to PNT reciprocal gelation** hypostatized therein.

In another word, once the bidirectional pervasion of cosmic esse between cosmic white extent and cosmic yolk extent satisfies $[d(M_{\text{white} \rightarrow m_{\text{yolk}}}) - d(M_{\text{white} \leftarrow m_{\text{yolk}}})] > 0$, the progressive input for cosmic evolution is generally assimilated on three constructive items as below:

The first, some of the progressive resource for cosmic evolution is assimilated in extent expansion of cosmic yolk extent so as to make the qualified space field for generation and existence maintenance of elementary genic units larger and larger.

The second, some of the progressive resource for cosmic evolution is assimilated in acclimatization cushion of time dynamic speed, which means, during the course of evolution of cosmic yolk extent, there is

Historical progress of science in the recent several centuries seemed like a far-flung exploration of the first itinerary around numerous distinctive landscapes of brand-new landmasses of science with palette & tablet on back, several hundred years' scientific travelogues were compiled thereby.

still acclimatization cushion of time dynamic speed of cosmic yolk extent, the proper quantitative change of acclimatization cushion of time dynamic speed will of course assimilate some of the potential resource for cosmic evolution $[d(M_{\text{white} \rightarrow \text{myolk}}) - d(M_{\text{white} \leftarrow \text{myolk}})] > 0$.

The third, some of the progressive resource for cosmic evolution is assimilated in generation of elementary genic units in space field and even the deep multiplication of reciprocal PNT combinations in spacetime, which is just the so-called “**aberrant convergence of cosmic esse due to PNT reciprocal gelation**”.

There are usually two working procedures for **aberrant convergence of cosmic esse due to PNT reciprocal gelation**, initial generation of elementary genic units is the first working procedure of **aberrant convergence of cosmic esse due to PNT reciprocal gelation**, which is called working procedure of crystal pervasion of field genic units, succedent generation and formation of reciprocal PNT combinations in gradation I, reciprocal PNT combinations in gradation II, reciprocal PNT combinations in gradation III, reciprocal PNT combinations in gradation IV is just the second working procedure of aberrant convergence of cosmic esse due to PNT reciprocal gelation. Generally, the more adequate working procedures the elementary genic units experienced in the nature of instinctive reciprocal PNT equilibrium towards optimum PNT operation, the ultimate outcome of reciprocal PNT combinations are relatively more branchy and the existent shape of the resultant objects seems more omnifarious and heavy.

Crystal pervasion working procedure of field genic units from space field: —Once the space field evolves to some certain stage, as the space field strength has been relatively adequate, so that the field genic units are difficult for acclimate themselves in space field by increasing speed of mutual transmutation and transition in their normal way against further strengthening tendency of space field, resultingly, some of the field genic units in space field spontaneously converge in crystal format, —elementary genic units generated therefore. As existence & motion of elementary genic units exhibit remarkable inertia of transmutation and transition in space field, so that the generation of elementary genic units from space field is equivalent to some field genic units are subsided from space field in crystal format so as to transfer some of the active resource for space field strength and so as to retard strengthening of space field.

As convergent formation of universal reciprocal PNT combinations in the nature of instinctive reciprocal PNT equilibrium towards optimum PNT operation on the basis of stochastic accomplishment of “**reciprocal idiosyncrasy towards PNT equilibrium + accessible space overall arrangement for PNT reciprocity**” among elementary genic units, among elementary genic units and compositive reciprocal PNT combinations even among discretionary reciprocal PNT combinations, there are more and more rich and colorful reciprocal PNT combinations in gradation I, reciprocal PNT combinations in gradation II, reciprocal PNT combinations in gradation III and reciprocal PNT combinations in gradation IV. Further multiplication of reciprocal PNT combinations makes existence and motion of macrocosmos more and more retarded and heavier.

The reason convergent formation of universal reciprocal PNT combinations is too called “**aberrant convergence of cosmic esse due to PNT reciprocal gelation**” is mainly because once the field genic units transmute into elementary genic units, they won't transmute and transmit as fast as before in space field, and resultingly embody their idiographic mass and distinctive existence & motion in spacetime, especially, once the elementary genic units

gradually converge into rich and colorful reciprocal PNT combinations in the nature of instinctive reciprocal PNT equilibrium towards optimum PNT operation for stochastic occurrence of “**reciprocal idiosyncrasy towards PNT equilibrium + accessible space overall arrangement for PNT reciprocity**” among elementary genic units, among elementary genic units and primary reciprocal PNT combinations, among discretionary reciprocal PNT combinations, the convergent effect of cosmic esse due to PNT reciprocal gelation is even remarkable.

Even if on stand of mathematical definition of motion of Homogenous Cosmos originated from Unique Genesis $mV=d(M \leftarrow m)Y \iff V=Y*d(M \leftarrow m)/m$, the existence and motion of field genic units in space field is out and out devotion as mutual transmutation and transition among field genic units, so that, in time current, there is no way for us to find idiographic mass no more distinctive existence and motion of any field genic unit in space field, even if we suppose there is mass m of discretionary field genic unit, during the course of mutual transmutation and transition of field genic units in space field all along, as m and $d(M \leftarrow m)$ satisfy $d(M \leftarrow m)/m=1$ all along, the dynamic transmutation and transition of all field genic units in space field directly hypostatize existence of time, there is no way for us to find idiographic mass no more distinctive existence and motion of any field genic unit in space field. However, in terms of existence and motion of elementary genic units in spacetime, situation is obviously different, although it’s impossible for any elementary genic unit to put an end of correlation to space field, instead, any elementary genic unit keeps PNT correlation with space field inherently, nobbut the performance of PNT correlation does not devote as drastically as field genic units in space field, which means the inherent mass m of elementary genic unit is still bigger than $d(M \leftarrow m)$ through and through, so that $d(M \leftarrow m) < m \iff d(M \leftarrow m)/m < 1$, so that we can find idiographic mass even distinctive existence and motion of elementary genic units in spacetime. This is just something about the so-called existence & motion of matter in spacetime in accordance with our traditionary ration.

In terms of reciprocal PNT combinations in spacetime, as the feature $d(M \leftarrow m) < m \iff d(M \leftarrow m)/m < 1$ of reciprocal PNT combinations are even typical, as a result, the idiographic existence & motion of reciprocal PNT combination is more vivid and remarkable.

Both assimilation of extent expansion of cosmic yolk extent and acclimatization cushion of time dynamic speed are assimilation of space field evolution of cosmic yolk extent, only the generation of elementary genic units and further multiplication of reciprocal PNT combinations stage by stage embody **aberrant convergence of cosmic esse due to PNT reciprocal gelation**, so that we can generally sum up assimilation configuration of progressive resource for cosmic evolution $[d(M_{\text{white}} \rightarrow m_{\text{yolk}}) - d(M_{\text{white}} \leftarrow m_{\text{yolk}})] > 0$ as below:

$$[d(M_{\text{white}} \rightarrow m_{\text{yolk}}) - d(M_{\text{white}} \leftarrow m_{\text{yolk}})] = \text{assimilation of space field evolution of cosmic yolk extent} + \text{anti-dynamic convergence of cosmic esse}$$

$$= (\text{assimilation of extent expansion of cosmic yolk extent} + \text{assimilation of acclimatization cushion of time dynamic speed}) + (\text{assimilation of initial generation of elementary genic units} + \text{assimilation of further generation of reciprocal PNT combinations})$$

We call the coexistent assimilative quantitative change of extent expansion of cosmic yolk extent, acclimatization cushion of time dynamic speed, aberrant convergence of cosmic esse due to PNT reciprocal gelation under precondition of cosmic esse bidirectional pervasion between cosmic white extent and cosmic yolk extent

$[d(M_{\text{white}} \rightarrow m_{\text{yolk}}) - d(M_{\text{white}} \leftarrow m_{\text{yolk}})] > 0$ quantitative assimilation for growth of cosmic yolk extent.

2.2. Quantitative change regularity of cosmic yolk extent

The quantitative change of white towards yolk pervasion of cosmos not only satisfies equation as “ $[d(M_{\text{white}} \rightarrow m_{\text{yolk}}) - d(M_{\text{white}} \leftarrow m_{\text{yolk}})] = \text{assimilation of space field evolution of cosmic yolk extent} + \text{dynamic-gelation convergence of cosmic esse} = (\text{assimilation of extent expansion of cosmic yolk extent} + \text{assimilation of acclimatization cushion of time dynamic speed}) + (\text{assimilation of initial generation of elementary genic units} + \text{assimilation of further generation of reciprocal PNT combinations})$ ”, throughout the process of cosmic evolution with condition of $[d(M_{\text{white}} \rightarrow m_{\text{yolk}}) - d(M_{\text{white}} \leftarrow m_{\text{yolk}})] > 0$, the quantitative change of field evolution of cosmic yolk extent and aberrant convergence of cosmic esse due to PNT reciprocal gelation still condition each other even mutually hold in play.

The mutual diversion between field evolution of cosmic yolk extent and **aberrant convergence of cosmic esse due to PNT reciprocal gelation** mainly embodies as below:

On one hand, the field evolution of cosmic yolk extent (includes extent expansion of cosmic yolk extent and acclimatization cushion of time dynamic speed) can create favorable condition for **aberrant convergence of cosmic esse due to PNT reciprocal gelation**, of course, it holds down aberrant convergence of cosmic esse due to PNT reciprocal gelation in resource assimilation at the same time. And on the other hand, followed the field evolution of cosmic yolk extent, the conditions for dynamic-gelation convergence of cosmic esse is better and better, so that performance of aberrant convergence of cosmic esse due to PNT reciprocal gelation becomes better and better, this of course means aberrant convergence of cosmic esse due to PNT reciprocal gelation consequently assimilates more and more progressive resource of $[d(M_{\text{white}} \rightarrow m_{\text{yolk}}) - d(M_{\text{white}} \leftarrow m_{\text{yolk}})] > 0$, and inversely, it holds down field evolution of cosmic yolk extent in resource assimilation as well.

We call the hypostatic mutual conditioning and holding in play between field evolution of cosmic yolk extent and aberrant convergence of cosmic esse due to PNT reciprocal gelation under precondition of bidirectional homologic pervasion $d(M_{\text{white}} \rightarrow m_{\text{yolk}}) - d(M_{\text{white}} \leftarrow m_{\text{yolk}})] > 0$ “quantitative change regularity of dominant white towards yolk pervasion”.

The pullulation of cosmic yolk extent is just the quantitative change process of field evolution of cosmic yolk extent and **aberrant convergence of cosmic esse due to PNT reciprocal gelation** conditioning each other under precondition of bidirectional homologic pervasion $d(M_{\text{white}} \rightarrow m_{\text{yolk}}) - d(M_{\text{white}} \leftarrow m_{\text{yolk}})] > 0$. following the quantitative change of bidirectional homologic pervasion $d(M_{\text{white}} \rightarrow m_{\text{yolk}}) - d(M_{\text{white}} \leftarrow m_{\text{yolk}})] > 0$, at discretionary time t , if we denote the quantitative change of resource assimilation of extent expansion of cosmic yolk extent in function $V_1 = \delta(t)$, denote the quantitative change of resource assimilation of acclimatization cushion of time dynamic speed in function $V_2 = \varepsilon(t)$ and denote the quantitative change of resource assimilation of aberrant convergence of cosmic esse due to PNT reciprocal gelation in function $V_3 = \zeta(t)$, then, the quantitative change regularity of bidirectional homologic pervasion with white towards yolk pervasion predominance which generally indicates quantitative change extension of mutual conditioning between field evolution of cosmic yolk extent and **aberrant convergence of cosmic esse due to PNT reciprocal gelation** can be primarily formulated as $\mu(\delta(t), \varepsilon(t), \zeta(t))$, this is just the function of quantitative change regularity of bidirectional homologic pervasion with white towards yolk pervasion predominance.

As coherent natura naturans throughout cosmic evolution, instinctive PNT reciprocal equilibrium towards optimum PNT operation is radical potentiality & conditionality for cosmos always ready to orientate itself towards perfection.

As various limitation, it is still difficult for us to approach consummation of mathematical function of quantitative change regularity of bidirectional homologic pervasion with white towards yolk pervasion predominance $\mu(\delta(t), \varepsilon(t), \zeta(t))$, whereas, under precondition to offer the presumable quantitative change pattern of bidirectional homologic pervasion margin $[d(M_{\text{white} \rightarrow m_{\text{yolk}}}) - d(M_{\text{white} \leftarrow m_{\text{yolk}}})]$, and in accordance with the mutual conditioning correlation between field evolution of cosmic yolk extent and **aberrant convergence of cosmic esse due to PNT reciprocal gelation** even the experience we get from cosmic status quo, we can approximately study out the functional curve of resource assimilation rate of extent expansion of cosmic yolk extent $V_1 = \delta(t)$, functional curve of resource assimilation rate of acclimatization cushion of time dynamic speed $V_2 = \varepsilon(t)$ and functional curve of resource assimilation rate of aberrant convergence of cosmic esse due to PNT reciprocal gelation $V_3 = \zeta(t)$, so that it's expedient for us to know the relative quantitative change situation of bidirectional homologic pervasion margin $[d(M_{\text{white} \rightarrow m_{\text{yolk}}}) - d(M_{\text{white} \leftarrow m_{\text{yolk}}})]$, resource assimilation rate of extent expansion of cosmic yolk extent $V_1 = \delta(t)$ and resource assimilation rate of aberrant convergence of cosmic esse due to PNT reciprocal gelation $V_3 = \zeta(t)$. The proper functional curves are generally as below:

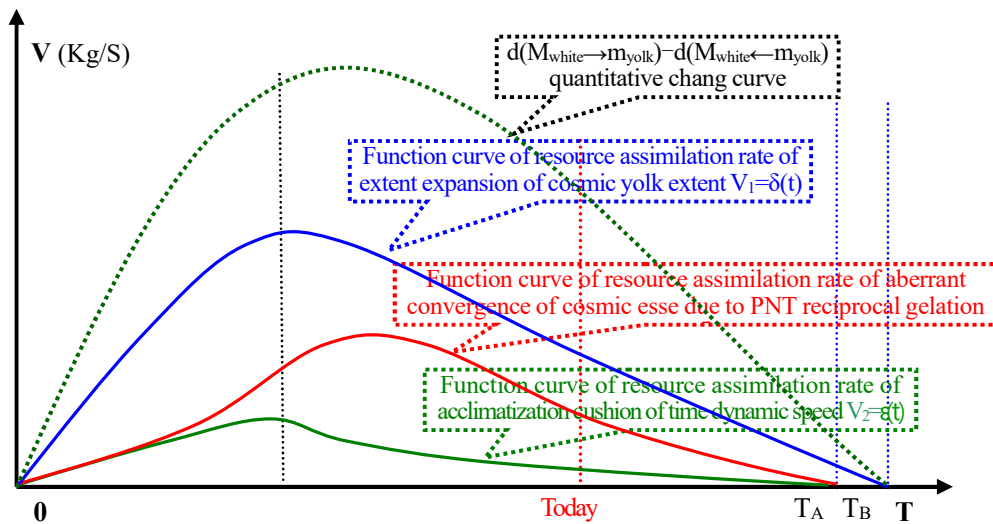

(IV-ii-4) Contrast illustration of function curve of resource assimilation rate of extent expansion of cosmic yolk extent, function curve of resource assimilation rate of acclimatization cushion of time dynamic speed and function curve of resource assimilation rate of aberrant convergence of cosmic esse due to PNT reciprocal gelation.

The horizontal axes denote time T, vertical axes denote speed V, the bottle green broken line in above illustration denotes quantitative change curve of $d(M_{\text{white} \rightarrow m_{\text{yolk}}}) - d(M_{\text{white} \leftarrow m_{\text{yolk}}})$, which is introduced as presumable precondition for expedient analysis of resource assimilation of extent expansion of cosmic yolk extent, resource assimilation of acclimatization cushion of time dynamic speed and resource assimilation of aberrant convergence of cosmic esse due to PNT reciprocal gelation through and through. In illustration above, point T_A indicates the end time of aberrant convergence of cosmic esse due to PNT reciprocal gelation once $[d(M_{\text{white} \rightarrow m_{\text{yolk}}}) - d(M_{\text{white} \leftarrow m_{\text{yolk}}})]$ gradually runs to 0, point T_B indicates the end time of extent expansion of cosmic yolk extent and acclimatization cushion of time dynamic speed, once $[d(M_{\text{white} \rightarrow m_{\text{yolk}}}) - d(M_{\text{white} \leftarrow m_{\text{yolk}}})]$ gradually runs to 0.

Relative to quantitative change curve of resource assimilation rate of extent expansion of cosmic yolk extent $V_1 = \delta(t)$ and quantitative change curve of resource assimilation rate of acclimatization cushion of time

dynamic speed $V_2=\varepsilon(t)$, the peak of quantitative change curve of resource assimilation rate of dynamic-gelation convergence of cosmic esse is remarkably behind, because the favorable condition of **aberrant convergence of cosmic esse due to PNT reciprocal gelation** is gradually consummated following quantitative change of expansion of cosmic yolk extent. Only when the cosmic yolk extent has expanded adequately, there is possibility for neonatal elementary genic units to exist in cosmic yolk extent for substantial time, there is solid possibility for elementary genic units to enrich in cosmic yolk extent and accomplish “**reciprocal idiosyncrasy towards PNT equilibrium + accessible space overall arrangement for PNT reciprocity**”, and ultimately, as presence of instinctive reciprocal equilibrium towards optimum PNT operation, rich and colorful reciprocal PNT combinations occur therefore. And at the same time, as extent expansion of cosmic yolk extent and further generation & multiplication of reciprocal PNT combinations can directly result in density decrease of elementary genic units in space time, this of course leads to temperature decrease of cosmos, which is favorable to initial generation of elementary genic units in space field so as to be propitious to aberrant convergence of cosmic esse due to PNT reciprocal gelation.

In time current, if we denote the quantitative change function of white towards yolk pervasion of cosmic esse $f(M_{\text{white}} \rightarrow m_{\text{yolk}})$, and we denote the quantitative change function of yolk towards white pervasion of cosmic esse $j(M_{\text{white}} \leftarrow m_{\text{yolk}})$, then the total quantity η of resource assimilation of evolution of cosmic yolk extent at discretionary time t can be formulated as following:

$$\eta = \int_0^t f(M_{\text{white}} \rightarrow m_{\text{yolk}}) dt - \int_0^t j(M_{\text{white}} \leftarrow m_{\text{yolk}}) dt$$

Till today, the total quantity η_{today} of evolutionary resource assimilation of cosmic yolk extent is as following:

$$\eta_{\text{today}} = \int_0^{\text{today}} f(M_{\text{white}} \rightarrow m_{\text{yolk}}) dt - \int_0^{\text{today}} j(M_{\text{white}} \leftarrow m_{\text{yolk}}) dt$$

The total quantity \hbar of evolutionary resource assimilation of extent expansion of cosmic yolk extent at discretionary time t is as following:

$$\hbar = \int_0^t \delta(t) dt$$

Till today, the total quantity \hbar_{today} of resource assimilation of extent expansion of cosmic yolk extent is as following:

$$\hbar_{\text{today}} = \int_0^{\text{today}} \delta(t) dt$$

The total quantity \mathcal{K} of resource assimilation of acclimatization cushion of time dynamic speed of cosmic yolk extent is as following:

$$\mathcal{K} = \int_0^t \varepsilon(t) dt$$

Till today, the total quantity $\mathcal{K}_{\text{today}}$ of resource assimilation of acclimatization cushion of time dynamic speed of cosmic yolk extent is as following:

$$\mathcal{K}_{\text{today}} = \int_0^{\text{today}} \varepsilon(t) dt$$

The total quantity \mathfrak{h} of resource assimilation of **aberrant convergence of cosmic esse due to PNT reciprocal gelation** of cosmic yolk extent at discretionary time t is as following:

$$\mathfrak{h} = \int_0^t \zeta(t) dt$$

Till today, the total quantity $\mathfrak{h}_{\text{today}}$ of resource assimilation of **aberrant convergence of cosmic esse due to PNT**

As coherent natura naturans throughout cosmic evolution, instinctive PNT reciprocal equilibrium towards optimum PNT operation is radical potentiality & conditionality for cosmos always ready to orientate itself towards perfection.

reciprocal gelation is as following:

$$\hbar_{\text{today}} = \int_0^{\text{today}} \zeta(t) dt$$

The total quantity of resource assimilation of aberrant convergence of cosmic esse due to PNT reciprocal gelation \hbar_{today} is virtually just the total quantity of positive matter in cosmic yolk extent (/cosmos). Under cosmic status quo, the total positive matter coexist in cosmic yolk extent (/cosmos) as separate elementary genic units, reciprocal PNT combinations in gradation I, reciprocal PNT combinations in gradation II, reciprocal PNT combinations in gradation III, reciprocal PNT combinations in gradation IV.

Of course, at discretionary moment t , $\eta = \hbar + \mathcal{K} + \hbar$; and at cosmic today, $\eta_{\text{today}} = \hbar_{\text{today}} + \mathcal{K}_{\text{today}} + \hbar_{\text{today}}$.

During the course of evolution of cosmic yolk extent with live input of potential resource of bidirectional lineage homologic pervasion with white towards yolk pervasion dominance $[d(M_{\text{white} \rightarrow m_{\text{yolk}}}) - d(M_{\text{white} \leftarrow m_{\text{yolk}}})] > 0$, as resource assimilation of field evolution of cosmic yolk extent is more straightforward and facile than **aberrant convergence of cosmic esse due to PNT reciprocal gelation**, cosmic potential resource of bidirectional lineage homologic pervasion with white towards yolk pervasion dominance $[d(M_{\text{white} \rightarrow m_{\text{yolk}}}) - d(M_{\text{white} \leftarrow m_{\text{yolk}}})] > 0$ is always preferential to be assimilated in field evolution of cosmic yolk extent, only when the field evolution has created adequate external conditions for aberrant convergence of cosmic esse due to PNT reciprocal gelation, performance of aberrant convergence of cosmic esse due to PNT reciprocal gelation can go its normal way. In accordance with primary estimate, more than 75% cosmic potential resource is assimilated in field evolution, cosmic potential resource assimilated in aberrant convergence of cosmic esse due to PNT reciprocal gelation may be less than 25%.

Virtually, throughout evolution of cosmic yolk extent, resource assimilation rate of extent expansion of cosmic yolk extent $V_1 = \delta(t)$, resource assimilation rate of acclimatization cushion of time dynamic speed $V_2 = \varepsilon(t)$ and resource assimilation rate of aberrant convergence of cosmic esse due to PNT reciprocal gelation $V_3 = \zeta(t)$ are just the three variables of quantitative change regularity function of cosmic yolk evolution $\lambda(\delta(t), \varepsilon(t), \zeta(t))$. The quantitative change regularity function of cosmic yolk evolution not only indicates quantitative conditional correlation of resource assimilation rate of extent expansion of cosmic yolk extent $V_1 = \delta(t)$, resource assimilation rate of acclimatization cushion of time dynamic speed $V_2 = \varepsilon(t)$ and resource assimilation rate of aberrant convergence of cosmic esse due to PNT reciprocal gelation $V_3 = \zeta(t)$ at discretionary time t , but also indicates resource assimilation quantity of extent expansion of cosmic yolk extent, resource assimilation quantity of acclimatization cushion of time dynamic speed of cosmic yolk extent and resource assimilation quantity of aberrant convergence of cosmic esse due to PNT reciprocal gelation at discretionary time t , even indicates the ongoing evolution of cosmic yolk extent at any time t .

In accordance with original definition of quantitative change regularity function of cosmic yolk evolution, there are equations as below:

$$\int_0^t \lambda(\delta(t), \varepsilon(t), \zeta(t)) dt = \int_0^t f(M_{\text{white} \rightarrow m_{\text{yolk}}}) dt - \int_0^t j(M_{\text{white} \leftarrow m_{\text{yolk}}}) dt$$

$$\int_0^{\text{today}} \lambda(\delta(t), \varepsilon(t), \zeta(t)) dt = \int_0^{\text{today}} f(M_{\text{white} \rightarrow m_{\text{yolk}}}) dt - \int_0^{\text{today}} j(M_{\text{white} \leftarrow m_{\text{yolk}}}) dt$$

The quantitative change regularity function of cosmic yolk evolution is one of the core functions of in

cosmology, as both personal and external limitation, Homogenous Cosmos originated from Unique Genesis is still difficult to define the function exactly at present. Whereas, in order to highlight the quantitative change regularity function of cosmic yolk evolution as much as possible, under the same presumable precondition of lineal bidirectional homologic pervasion $[d(M_{white} \rightarrow m_{yolk}) - d(M_{white} \leftarrow m_{yolk})] > 0$, we here introduce evolutionary quantitative change curve of time dynamic speed Y instead of quantitative change curve of resource assimilation rate of acclimatization cushion of time dynamic speed $V_2 = \epsilon(t)$, introduce extent expansion rate curve of cosmic yolk extent instead of quantitative change curve of resource assimilation rate of extent expansion of cosmic yolk extent $V_1 = \delta(t)$ and introduce generation rate curves of elementary genic units and multiplication rate of 4 typical reciprocal PNT combinations of gradation I, gradation II, gradation III & gradation IV instead of quantitative change curve of resource assimilation rate of aberrant convergence of cosmic esse due to PNT reciprocal gelation $V_3 = \zeta(t)$ as below:

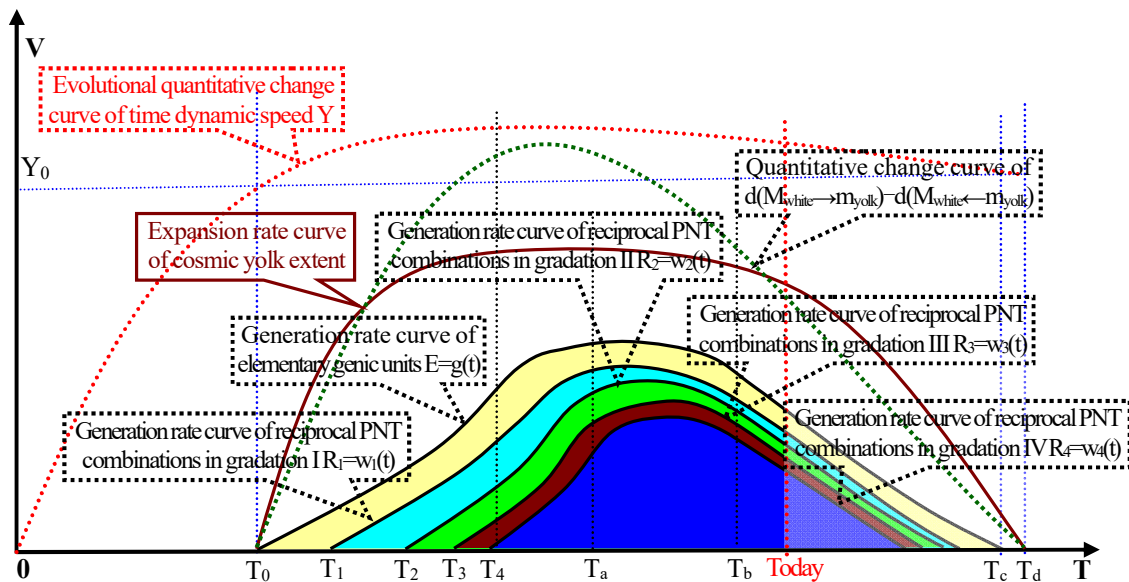

(IV-ii-5) Quantitative change rate curve of extent expansion of cosmic yolk extent, quantitative change curve of acclimatization cushion of time dynamic speed of cosmic yolk extent, quantitative change rate curve of aberrant convergence of cosmic esse due to PNT reciprocal gelation under cosmic live input of $d(M_{white} \rightarrow m_{yolk}) > d(M_{white} \leftarrow m_{yolk})$

The horizontal axes of the illustration above denotes time T , vertical axes denotes speed V , the red broken line denotes evolutionary quantitative change curve of time dynamic speed Y , the brown real line denotes expansion rate curve of cosmic yolk extent, **Today** on horizontal axes means status quo of cosmos.

In accordance with illustration above, we analyze evolutionary process of extent expansion of cosmic yolk extent, acclimatization cushion of time dynamic speed of cosmic yolk extent and aberrant convergence of cosmic esse due to PNT reciprocal gelation as following:

2.2.1. Extent expansion of cosmic yolk extent

Although the extent expansion rate of cosmic yolk extent and resource assimilation rate of extent expansion of cosmic yolk extent are directly correlated, their mathematical significance is obviously different. We define extent expansion rate of cosmic yolk extent is just the radius change of cosmic yolk extent in unit time. If we denote radius of cosmic yolk extent R and denote time t , then extent expansion rate of cosmic yolk extent can

As coherent natura naturans throughout cosmic evolution, instinctive PNT reciprocal equilibrium towards optimum PNT operation is radical potentiality & conditionality for cosmos always ready to orientate itself towards perfection.

be mathematically expressed as dR/dt . If we neglect the tiny change of time dynamic speed for acclimatization cushion of time dynamic speed (Virtually, the magnitude of time dynamic speed is proportionate to density if space field, the bigger the magnitude of time dynamic speed is, the density of space field is), as quantity of resource assimilation of extent expansion of cosmic yolk extent is proportional to the expanded volume of cosmic yolk extent, we can of course arrive at:

$$4\pi R^3/3 \propto V_{1t} \quad \longleftrightarrow \quad R^3 \propto 3V_{1t}/4\pi$$

That's to say, under equivalent cosmic evolutionary potential of bidirectional lineal homologic pervasion with white towards yolk dominance $d(M_{\text{white} \rightarrow \text{myolk}}) - d(M_{\text{white} \leftarrow \text{myolk}}) > 0$, the bigger the radius of cosmic yolk extent is, the effect cosmic evolutionary potential done to extent expansion rate of cosmic yolk extent is relatively unobtrusive. And what's more, the resource assimilation of extent expansion of cosmic yolk extent is still directly held down by coordinative resource assimilation of **aberrant convergence of cosmic esse due to PNT reciprocal gelation**, the more adequate extent expansion of cosmic yolk extent is, the proper conditions of convergent effect of cosmic esse due to PNT reciprocal gelation are relatively better, the spontaneous performance of convergent combination of cosmic esse is relatively more tripping, and resultingly, the coordinative diversion of resource assimilation **aberrant convergence of cosmic esse due to PNT reciprocal gelation** done to extent expansion of cosmic yolk extent is relatively more remarkable.

Evolutional stage from T_0 to T_1 , —rapid extent expansion of cosmic yolk extent: This is initial evolutionary stage of cosmic yolk extent, as extent of cosmic yolk extent is initially narrow, once elementary genic units generated in cosmic yolk extent, it will immediately slide into light-exhaustion medium lamella and disappeared into space field for destructive yolk towards white transmutation, so that existence of elementary genic units in cosmic yolk extent seem like twinkling generated and disappeared in a flash, so that it's almost impossible for elementary genic units in cosmic yolk extent to accomplish "**reciprocal idiosyncrasy towards PNT equilibrium + accessible space overall arrangement for PNT reciprocity**" among elementary genic units, no more generation of reciprocal PNT combinations. This of course indicates action rudiment of **aberrant convergence of cosmic esse due to PNT reciprocal gelation** has occurred, whereas, it still difficult to result in solid outcome, the live input of bidirectional lineal homologic transmutable pervasion with white towards yolk dominance $d(M_{\text{white} \rightarrow \text{myolk}}) - d(M_{\text{white} \leftarrow \text{myolk}}) > 0$ is mostly assimilated into space field of cosmic yolk extent besides some of them proceed in elementary genic units format in a flash. And on the other hand, at the initial evolutionary stage of cosmic yolk extent, the radius of cosmic yolk extent is apparently narrow, so that live input of bidirectional lineal homologic transmutable pervasion with white towards yolk dominance $d(M_{\text{white} \rightarrow \text{myolk}}) - d(M_{\text{white} \leftarrow \text{myolk}}) > 0$ impact the extent expansion remarkably, as a result, the extent expansion rate of this evolutionary stage is remarkable.

Throughout the evolutionary stage, $(M_{\text{white} \rightarrow \text{myolk}})$ mostly means some of the field genic units transmute into elementary genic units for occurrence of extra-saturation of space field; $(M_{\text{white} \leftarrow \text{myolk}})$ mostly means the elementary genic units slide into light-exhaustion medium lamella and degenerate into space field. in a flash If discretionary elementary genic unit in cosmic yolk extent twinkles across cosmic yolk extent in an interval T , the general quantity of elementary genic units in cosmic yolk extent can be formulated as below:

$$U = \int_0^T d(M_{\text{white} \rightarrow \text{myolk}}) dt - \int_0^T d(M_{\text{white} \leftarrow \text{myolk}}) dt$$

As cosmic yolk extent is relatively narrow and the magnitude of T is small, no matter how big magnitude of $d(M_{\text{white}} \rightarrow m_{\text{yolk}})$ and $d(M_{\text{white}} \leftarrow m_{\text{yolk}})$ is, as long as magnitude of $d(M_{\text{white}} \rightarrow m_{\text{yolk}}) - d(M_{\text{white}} \leftarrow m_{\text{yolk}})$ is relatively small, the amount of elementary genic units U in space field is relatively small no more amount of reciprocal PNT combinations in spacetime. The potential resource of bidirectional lineal homologic transmutable pervasion with white towards yolk transmutable dominance $d(M_{\text{white}} \rightarrow m_{\text{yolk}}) - d(M_{\text{white}} \leftarrow m_{\text{yolk}}) > 0$ is mostly assimilated into field evolution of cosmic yolk extent. Whereas, performance of aberrant convergence of cosmic esse due to PNT reciprocal gelation only unfolds its rudiment, there are almost none solid outcome of aberrant convergence of cosmic esse due to PNT reciprocal gelation. Such factuality of course implies hearty extent expansion of cosmic yolk extent at the stage.

Evolutional stage from T₁ to T₄, —extent expansion acceleration starts to be retarded: On one hand, the radius of cosmic yolk extent has been rather capacious, resource assimilation for extent expansion of cosmic yolk extent is more and more substantial, and on the other hand, as remarkable extent expansion of cosmic yolk extent, the external condition of aberrant convergence of cosmic esse due to PNT reciprocal gelation has been well-rounded, performance of **aberrant convergence of cosmic esse due to PNT reciprocal gelation** has been relatively fluent, there is slight curtailment of $d(M_{\text{white}} \leftarrow m_{\text{yolk}})$ of bidirectional homologic lineal transmutable pervasion, whereas, the white towards yolk transmutable pervasion $M_{\text{white}} \leftarrow m_{\text{yolk}}$ and yolk towards white transmutable pervasion are inherent equilibrium couple of bidirectional lineal homologic transmutable pervasion, the curtailment of $d(M_{\text{white}} \leftarrow m_{\text{yolk}})$ of bidirectional homologic lineal transmutable pervasion must stimulate proper increase of $d(M_{\text{white}} \rightarrow m_{\text{yolk}})$ for equilibrium of bidirectional lineal homologic transmutable pervasion so as to drive proceeding of aberrant convergence of cosmic esse due to PNT reciprocal gelation. And thus, performance of aberrant convergence of cosmic esse due to PNT reciprocal gelation begins to hold down field evolution of cosmic yolk extent by substantial resource assimilation. As a result, at the evolutionary stage, field evolution of cosmic yolk extent begins to be retarded, which of course includes retardance of extent expansion of cosmic yolk extent.

Evolutional stage from T₄ to T_a, —slight extent expansion speed increase: As further extent expansion, the radius of cosmic yolk extent becomes bigger and bigger, under precondition of equivalent live input of bidirectional lineal homologic transmutable pervasion with white towards yolk dominance $d(M_{\text{white}} \rightarrow m_{\text{yolk}}) - d(M_{\text{white}} \leftarrow m_{\text{yolk}}) > 0$, the increase of radius of cosmic yolk extent becomes slower and slower, and what's more, as extent expansion has more and more adequate, the external conditions for **aberrant convergence of cosmic esse due to PNT reciprocal gelation** have been better and better and performance of aberrant convergence of cosmic esse due to PNT reciprocal gelation has been more and more facile and fluent, the shrinking of $d(M_{\text{white}} \leftarrow m_{\text{yolk}})$ is even remarkable, dynamic-gelation convergence holds down field evolution of cosmic yolk extent more and more by solid resource assimilation. As a result, at the evolutionary stage, the extent expansion of cosmic yolk extent has been even retarded therefore —there is only slight extent expansion speed increase of cosmic yolk extent.

Evolutional stage from T_a to T_b, —extent expansion arise slowing tendency, Although the live input of bidirectional lineal homologic transmutable pervasion with white towards yolk dominance $d(M_{\text{white}} \rightarrow m_{\text{yolk}}) - d(M_{\text{white}} \leftarrow m_{\text{yolk}}) > 0$ is as solid as before, the radius of cosmic yolk extent is bigger and bigger, which of course makes extent expansion of cosmic yolk extent need more and more resource assimilation. And at the same time, as further extent expansion of cosmic yolk extent, the conditions of aberrant convergence of cosmic esse due to

As coherent natura naturans throughout cosmic evolution, instinctive PNT reciprocal equilibrium towards optimum PNT operation is radical potentiality & conditionality for cosmos always ready to orientate itself towards perfection.

PNT reciprocal gelation becomes better and better towards the optimum status, performance of aberrant convergence of cosmic esse due to PNT reciprocal gelation hold down more and more of field evolution of cosmic yolk extent by by assimilating more and more of the live input of bidirectional lineal homologic transmutable pervasion with white towards yolk dominance $d(M_{\text{white} \rightarrow m_{\text{yolk}}}) - d(M_{\text{white} \leftarrow m_{\text{yolk}}}) > 0$. As a result, extent expansion rate of cosmic yolk extent begins to slow.

Evolutional stage from T_b to T_d , — extent expansion of cosmic yolk extent arises deep slowing till at last extent expansion speed of cosmic yolk extent slows to 0. The radius of cosmic yolk extent is bigger and bigger as proceeding of extent expansion, and further extent expansion need assimilate more and more live input of bidirectional lineal homologic transmutable pervasion with white towards yolk dominance $d(M_{\text{white} \rightarrow m_{\text{yolk}}}) - d(M_{\text{white} \leftarrow m_{\text{yolk}}}) > 0$, whereas, , the live input of bidirectional lineal homologic transmutable pervasion with white towards yolk dominance $d(M_{\text{white} \rightarrow m_{\text{yolk}}}) - d(M_{\text{white} \leftarrow m_{\text{yolk}}}) > 0$ has turned to a spent bullet stage by stage, this of course implies:

- a) As springhead of field evolution of cosmic yolk extent has been more and more exhausted, the field evolution of cosmic yolk extent consequently turn to a spent bullet including acclimatization cushion shrinking of time dynamic speed and extent expansion speed-down of cosmic yolk extent.
- b) There are less and less elementary genic units generated in cosmic yolk extent, and on the other hand, the radius of cosmic yolk extent has been biggest ever since, so that density of elementary genic units in space field of cosmic yolk extent become smaller and smaller, this of course impact the accomplishment ratio of “**reciprocal idiosyncrasy towards PNT equilibrium + accessible space overall arrangement for PNT reciprocity**” among elementary genic units and consequently weaken performance of aberrant convergence of cosmic esse due to PNT reciprocal gelation in cosmos.

However, under equivalent weakening of live input of bidirectional lineal homologic transmutable pervasion with white towards yolk dominance $d(M_{\text{white} \rightarrow m_{\text{yolk}}}) - d(M_{\text{white} \leftarrow m_{\text{yolk}}}) > 0$, the proper retardance of field evolution of cosmic yolk extent is more straightforward and sensitive than the proper retardance of dynamic-gelation convergence of cosmic esse due to weakening of live input of bidirectional lineal homologic transmutable pervasion with white towards yolk dominance $d(M_{\text{white} \rightarrow m_{\text{yolk}}}) - d(M_{\text{white} \leftarrow m_{\text{yolk}}}) > 0$, as a result, weakening of live input of bidirectional lineal homologic transmutable pervasion with white towards yolk dominance $d(M_{\text{white} \rightarrow m_{\text{yolk}}}) - d(M_{\text{white} \leftarrow m_{\text{yolk}}}) > 0$ does its job more remarkably to extent expansion slowing of cosmic yolk extent and acclimatization cushion shrinking of time dynamic speed, till last $d(M_{\text{white} \rightarrow m_{\text{yolk}}}) - d(M_{\text{white} \leftarrow m_{\text{yolk}}}) = 0$, extent expansion speed slows to 0.

The integrative extent expansion of cosmic yolk extent can be illustrated as following:

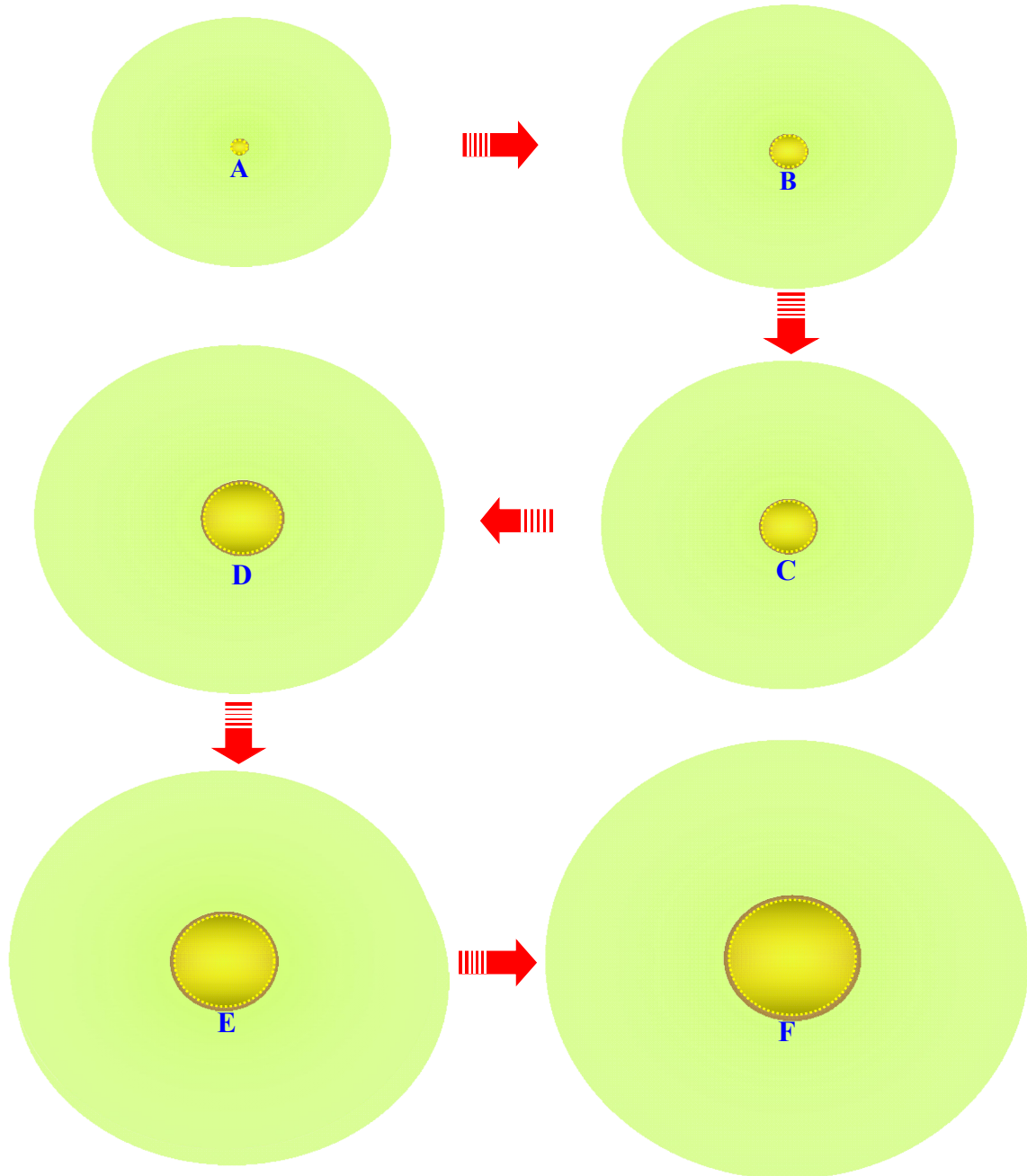

(IV-ii-6) integrative extent expansion of cosmic yolk extent following quantitative change of bidirectional lineal homologic pervasion of $d(M_{white \rightarrow m_{yolk}}) > d(M_{white \leftarrow m_{yolk}})$

2.2.2. Acclimatization cushion of time dynamic speed throughout evolution of cosmic yolk extent

Field evolution of cosmic yolk extent includes extent expansion of cosmic yolk extent and acclimatization cushion of time dynamic speed, once field evolution arises bloom, extent expansion of cosmic yolk extent arises acceleration and acclimatization cushion of time dynamic speed arise increase therefore; once field evolution of cosmic yolk extent arises retrogression, extent expansion of cosmic yolk extent arises deceleration and acclimatization cushion of time dynamic speed arise decrease therefore. Whereas, whether field evolution of cosmic yolk extent arises bloom or retrogression firstly depends on value of evolutionary live input of bidirectional lineal homologic transmutable pervasion with white towards yolk dominance $d(M_{white \rightarrow m_{yolk}}) -$

As coherent natura naturans throughout cosmic evolution, instinctive PNT reciprocal equilibrium towards optimum PNT operation is radical potentiality & conditionality for cosmos always ready to orientate itself towards perfection.

$d(M_{\text{white} \leftarrow m_{\text{yolk}}}) > 0$ and secondly depends on the resource assimilation diversion of **aberrant convergence of cosmic esse due to PNT reciprocal gelation**. Generally, the bigger the value of evolutionary live input of bidirectional lineal homologic transmutable pervasion with white towards yolk dominance $d(M_{\text{white} \rightarrow m_{\text{yolk}}}) - d(M_{\text{white} \leftarrow m_{\text{yolk}}}) > 0$ is, the field evolution is more energetic, extent expansion of cosmic yolk extent and acclimatization cushion of time dynamic speed are more ascending; and at the same time, there is more preponderance of **aberrant convergence of cosmic esse due to PNT reciprocal gelation**, there is more resource assimilation diversion of evolutionary live input of bidirectional lineal homologic transmutable pervasion with white towards yolk dominance $d(M_{\text{white} \rightarrow m_{\text{yolk}}}) - d(M_{\text{white} \leftarrow m_{\text{yolk}}}) > 0$, field evolution of cosmic yolk extent seems more languid, and acclimatization cushion of time dynamic speed seems retarded even arises acclimatization cushion shrinking effect.

Apparently, during the evolutionary stage from time 0 to time T_0 , all the evolutionary live input is completely ready for field evolution/strengthening of cosmos, this of course means proper increase of time dynamic speed. Once cosmic evolution proceeds to time T_0 , it means time dynamic speed has increased to Y_0 , we define time dynamic speed Y_0 is just the critical time dynamic speed of cosmic yolk extent, which means the critical condition of initial generation of elementary genic units in space field.

Once demiurgic evolution of sequential homologic cosmogony gets across time T_0 , there are elementary genic units initially generated in space field, which indicates naissance of cosmic yolk extent, and presence of live input of bidirectional lineal homologic transmutable pervasion with white towards yolk dominance $d(M_{\text{white} \rightarrow m_{\text{yolk}}}) - d(M_{\text{white} \leftarrow m_{\text{yolk}}}) > 0$ means pullulation of cosmic yolk extent. Of course, as field evolution of cosmic yolk extent and aberrant convergence of cosmic esse due to PNT reciprocal gelation are inherently involved so much, quantitative change of acclimatization cushion of time dynamic speed is too involved in through and through.

Generally, if there is only one peak value of quantitative change of $d(M_{\text{white} \rightarrow m_{\text{yolk}}}) - d(M_{\text{white} \leftarrow m_{\text{yolk}}})$ throughout cosmic evolution, it's only possible for consequent quantitative change of acclimatization cushion of time dynamic speed to arises one peak value, and the so-called peak value of acclimatization cushion of time dynamic speed generally locates at a position very near to T_4 as illustration above. The evolutionary stage from T_0 to T_4 is just the stage of **acclimatization cushion speedup of time dynamic speed**, and the evolutionary stage from T_4 to T_d is just the stage of **acclimatization cushion slowdown of time dynamic speed**.

Evolutional stage of acclimatization cushion speedup of time dynamic speed: —in above illustration, evolutionary stage from T_0 to T_4 is just the stage of acclimatization cushion speedup of time dynamic speed. Throughout the evolutionary stage, although there is substantial generation and successive enrichment of reciprocal PNT combinations in space field of cosmic yolk extent, the field evolution of cosmic yolk extent is still inadequate, so that the reciprocal convergent combining rate of elementary genic units is still less than generation rate of elementary genic units in space field, so that elementary genic units enriched in space field still seem extra-saturated and temperature of cosmic yolk extent still seems too high for successive generation of elementary genic units, such situation must cause acclimatization cushion speedup of time dynamic speed.

Evolutional stage of acclimatization cushion slowdown of time dynamic speed: —in above illustration, evolutionary stage from T_0 to T_4 is just the stage of acclimatization cushion slowdown of time dynamic speed. Ever since cosmic evolution gets across time T_4 , extent expansion of cosmic yolk extent has been relatively

Historical progress of science in the recent several centuries seemed like a far-flung exploration of the first itinerary around numerous distinctive landscapes of brand-new landmasses of science with palette & tablet on back, several hundred years' scientific travelogues were compiled thereby.

adequate, and conditions for performance of aberrant convergence of cosmic esse due to PNT reciprocal gelation has been rather perfect therefore, so that reciprocal convergent combining rate of elementary genic units gradually seems preponderant to initial generation rate of elementary genic units in space field, so that density of elementary genic units in space field becomes thinner and thinner, temperature of cosmic yolk extent become lower and lower. Such situation is undoubtedly favorable to initial generation of elementary genic units in space field, more and more elementary genic units are generated facily so as to efficaciously release the acclimatization cushion speedup of time dynamic speed, so that time dynamic speed of cosmic yolk extent arise acclimatization cushion slowdown, till at last, value of $d(M_{\text{white}} \rightarrow m_{\text{yolk}}) - d(M_{\text{white}} \leftarrow m_{\text{yolk}})$ turn to 0, time dynamic speed turns to critical value of time dynamic speed of cosmic yolk extent.

2.2.3. Aberrant convergence of cosmic esse due to PNT reciprocal gelation in cosmic yolk extent, —initial generation of elementary genic units and successive multiplication of reciprocal PNT combinations in the nature of instinctive reciprocal PNT equilibrium towards optimum PNT operation.

Aberrant convergence of cosmic esse due to PNT reciprocal gelation is generally implemented by two successive working procedures, the first working procedure is crystal convergence & pervasion of field genic units; the second working procedure is convergent combination in the nature of instinctive reciprocal PNT equilibrium towards optimum PNT operation. proportionably, the first operational condition for **aberrant convergence of cosmic esse due to PNT reciprocal gelation** is ambient conditions for crystal convergence & pervasion of field genic units (just the ambient conditions for initial generation of elementary genic units), the second operational condition for **aberrant convergence of cosmic esse due to PNT reciprocal gelation** is ambient conditions for feasible convergent combination due to instinctive reciprocal PNT equilibrium towards optimum PNT operation.

Ambient conditions for crystal convergence & pervasion of field genic units (ambient conditions for initial generation of elementary genic units): Firstly, initial generation of elementary genic units in cosmos must condition that time dynamic speed of the procreative background space field must exceed critical value of time dynamic speed of cosmic yolk extent Y_0 , the more the hypostatic time dynamic speed of the very background space field exceed critical value of time dynamic speed of cosmic yolk extent, there are more probability for field genic units in the background space field to astringently transmute into elementary genic units and there is more potential for substantial initial generation of elementary genic units.

Secondly, crystal convergence & pervasion of field genic units need favorable background temperature. If there are substantial elementary genic units ceaselessly generated in cosmic yolk extent, and at the same time, the elementary genic units in cosmic yolk extent can not be astringently combined into reciprocal PNT combinations for ambient limitation of operational feasibility, there will be more and more elementary genic units enriched in space field, density of elementary genic units in space field must increases quickly, and temperature of cosmic yolk extent will be higher and higher as the river rises the boat goes up too. Too high temperature of cosmic yolk extent must restrain successive initial generation of elementary genic units, which consequently makes the crystal convergence & pervasion of field genic units retarded (of course, this is too cause for acclimatization cushion speedup of time dynamic speed). If successive convergent combination rate of elementary genic units is equivalent to or even higher than initial generation rate of elementary genic units in the very background space field, so that there is no possibility for temperature of cosmic yolk extent to be too high, crystal convergence & pervasion of field genic units (/initial generation of elementary genic units) in procreative space

As coherent natura naturans throughout cosmic evolution, instinctive PNT reciprocal equilibrium towards optimum PNT operation is radical potentiality & conditionality for cosmos always ready to orientate itself towards perfection.

field will go its normal way in proportion of potential margin of the hypostatic time dynamic speed of the very background space field relative to critical value of time dynamic speed of cosmic yolk extent.

Ambient conditions for feasible convergent combination in the nature of instinctive reciprocal PNT equilibrium towards optimum PNT operation: All-important condition for convergent combination due to instinctive reciprocal PNT equilibrium towards optimum PNT operation is that there must be necessary elementary genic units in cosmic yolk extent, secondly, there must be proper ambient conditions for elementary genic units in cosmic yolk extent to accomplish “reciprocal idiosyncrasy towards PNT equilibrium + accessible space overall arrangement for PNT reciprocity”.

Accomplishment of “reciprocal idiosyncrasy towards PNT equilibrium + accessible space overall arrangement for PNT reciprocity” among elementary genic units is the adequate & necessary precondition of initial generation of reciprocal PNT combinations in gradation I. “reciprocal idiosyncrasy towards PNT equilibrium” is inherent distinctive idiosyncrasy of elementary genic units, it of course means different elementary genic units have distinctive idiosyncrasy and different elementary genic units need different supplementary PNT reciprocity for expedient convergent combination, the mutual supplementary PNT reciprocity among elementary genic units is more remarkable, there is more inherent potential for convergent combination among elementary genic units, and the performance of convergent combination of elementary genic units depends on less of “accessible space overall arrangement for PNT reciprocity” in accomplishment probability. Inversely, the mutual supplementary PNT reciprocity among elementary genic units is more inconspicuous, there is less potential for convergent combination among the elementary genic units, and the performance of convergent combination of elementary genic units depends on more of “accessible space overall arrangement for PNT reciprocity” in accomplishment probability. In terms of accomplishment of valid “accessible space overall arrangement for PNT reciprocity”, the density of elementary genic units in space field is higher, there is more probability for elementary genic units to accomplish valid “accessible space overall arrangement for PNT reciprocity”; otherwise, there is less probability for elementary genic units to accomplish valid “accessible space overall arrangement for PNT reciprocity”.

In order to accomplish “reciprocal idiosyncrasy towards PNT equilibrium + accessible space overall arrangement for PNT reciprocity” among elementary genic units after initial generation, it is necessary to ensure that the neonatal elementary genic units must be able to remain in cosmic yolk extent for enough time, so that there is enough probability for them to accomplish “reciprocal idiosyncrasy towards PNT equilibrium + accessible space overall arrangement for PNT reciprocity”. After all, any elementary genic unit exists in spacetime as ray or radiation, if the cosmic yolk extent is too narrow, all elementary genic units can run through cosmic yolk extent soon and degenerate in so-called light-exhaustion medium lamella, and there is poor probability for elementary genic units to accomplish “reciprocal idiosyncrasy towards PNT equilibrium + accessible space overall arrangement for PNT reciprocity”. And at the same time, even if the cosmic yolk extent is big enough, whereas, the density of elementary genic units in space field of cosmic yolk extent is very low, such situation is too difficult for neonatal elementary genic units to accomplish “accessible space overall arrangement for PNT reciprocity”. All in all, expedient accomplishment of “reciprocal idiosyncrasy towards PNT equilibrium + accessible space overall arrangement for PNT reciprocity” not only depends on extent of cosmic yolk extent but also depends on density of elementary genic units in cosmic yolk extent as well.

Initial generation and further multiplication of rich and colorful reciprocal PNT combinations is consequential outcome of convergent combination in the nature of instinctive PNT reciprocal equilibrium towards optimum

PNT operation. The ideal performance of **aberrant convergence of cosmic esse due to PNT reciprocal gelation** is that time dynamic speed of the background space field is bigger than the critical value of time dynamic speed of cosmic yolk extent, so that there is substantial generation of elementary genic units, and the generation rate of elementary genic units \leq convergent combination rate of elementary genic units in the nature of instinctive reciprocal PNT equilibrium towards optimum PNT operation.

We now come to analyze evolutionary performance of aberrant convergence of cosmic esse due to PNT reciprocal gelation as illustration (IV-ii-5).

A) Performance of aberrant convergence of cosmic esse due to PNT reciprocal gelation at evolutionary stage from T_0 to T_4

Evolutional stage from T_0 to T_4 is initial stage of aberrant convergence of cosmic esse due to PNT reciprocal gelation with remarkable preponderance of field evolution of cosmic yolk extent.

Evolutional stage from T_0 to T_1 : the remarkable physical characteristic of the evolutionary stage is as below:

The first: time dynamic speed is over critical value of time dynamic speed of cosmic yolk extent.

The second: the extent of cosmic yolk extent is initially narrow.

The both characteristics have radically determined the existent shape of cosmic yolk extent of the very evolutionary stage.

On one hand, as time dynamic speed is bigger than critical value of time dynamic speed of cosmic yolk extent, there are ceaseless generation of elementary genic units in space field, existence & motion of elementary genic units in spacetime directly embodies existence & motion of ray or radiations. And on the other hand, as extent of cosmic yolk extent is still narrow, the elementary genic units slide into light-exhaustion medium lamella and disappeared in it soon after initial generation like a flash in cosmic yolk extent.

Succession of the both physical features makes cosmic yolk extent like bright spot of space field.

As initial stage of aberrant convergence of cosmic esse due to PNT reciprocal gelation in mature spacetime, the idiographic performance of dynamic-gelation convergence of cosmic esse of evolutionary stage from T_0 to T_1 does not embody the integrative action linkages of aberrant convergence of cosmic esse due to PNT reciprocal gelation, but mainly shows the first working procedure of crystal convergence & pervasion of field genic units. As absence of the second working procedure of convergent combination in the nature of instinctive reciprocal PNT equilibrium towards optimum PNT operation, hypostatic performance of aberrant convergence of cosmic esse due to PNT reciprocal gelation of the very evolutionary stage does accomplish common effect of aberrant convergence of cosmic esse due to PNT reciprocal gelation, the ephemeral existence of elementary genic units in cosmic yolk extent but means another more process tache has been created into bidirectional lineal homologic transmutable pervasion and indicates existence of positive matter in spacetime.

Throughout the evolutionary stage, ($M_{\text{white}} \rightarrow m_{\text{yolk}}$) mostly means some of the field genic units transmute into elementary genic units for occurrence of extra-saturation of space field; ($M_{\text{white}} \leftarrow m_{\text{yolk}}$) mostly means the elementary genic units slide into light-exhaustion medium lamella and degenerate into space field. in a flash If discretionary elementary genic unit in cosmic yolk extent twinkles across cosmic yolk extent in an interval T , the general quantity of elementary genic units in cosmic yolk extent can be formulated as below:

As coherent natura naturans throughout cosmic evolution, instinctive PNT reciprocal equilibrium towards optimum PNT operation is radical potentiality & conditionality for cosmos always ready to orientate itself towards perfection.

$$U = \int_0^T d(M_{\text{white} \rightarrow m_{\text{yolk}}}) dt - \int_0^T d(M_{\text{white} \leftarrow m_{\text{yolk}}}) dt$$

As the field evolution of cosmic yolk extent is apparently inadequate, although, **aberrant convergence of cosmic esse due to PNT reciprocal gelation** has appeared its rudiment, most of the live input of potential resource of bidirectional lineage homologic pervasion with white towards yolk pervasion dominance $[d(M_{\text{white} \rightarrow m_{\text{yolk}}}) - d(M_{\text{white} \leftarrow m_{\text{yolk}}})] > 0$ for aberrant convergence of cosmic esse due to PNT reciprocal gelation is ultimately exhausted in field evolution of cosmic yolk extent, so that the cosmic yolk extent become wider and stronger day by day, which is of course favorable condition for **aberrant convergence of cosmic esse due to PNT reciprocal gelation**.

Evolutional stage from T₁ to T₂: remarkable characteristics of the evolutional stage are as following:

The first: extent of cosmic yolk extent has got primary expansion.

The second, as performance of aberrant convergence of cosmic esse due to PNT reciprocal gelation is still faint, time dynamic speed remarkably arises acclimatization cushion speedup.

As cosmic yolk extent has experienced solid expansion primarily, the living time of elementary genic units in cosmic yolk extent has been prolonged in proportion, so that elementary genic units in cosmic yolk extent have more probability to accomplish “**reciprocal idiosyncrasy towards PNT equilibrium + accessible space overall arrangement for PNT reciprocity**”, so that there has been reciprocal PNT combinations of gradation I, reciprocal PNT combinations in gradation II, and temperature & brightness of cosmic yolk extent are proportionably debased, performance of aberrant convergence of cosmic esse due to PNT reciprocal gelation has been relatively better. Whereas, as field evolution of cosmic yolk extent is still not adequate, performance of **aberrant convergence of cosmic esse due to PNT reciprocal gelation** is till not ideal, and resultingly, most of the live input of potential resource of bidirectional lineage homologic pervasion with white towards yolk pervasion dominance $[d(M_{\text{white} \rightarrow m_{\text{yolk}}}) - d(M_{\text{white} \leftarrow m_{\text{yolk}}})] > 0$ is still assimilated into field evolution of cosmic yolk extent, which of course implies acclimatization cushion speedup of time dynamic speed.

Evolutional stage from T₂ to T₃: remarkable characteristics of the evolutional stage are as following:

The first: extent of cosmic yolk extent has got more expansion.

The second, performance of **aberrant convergence of cosmic esse due to PNT reciprocal gelation** has been relatively better, whereas, there still remarkable preponderance of resource assimilation of field evolution of cosmic yolk extent, time dynamic speed still keeps acclimatization cushion speedup but not as rapid .as before

As cosmic yolk extent has experienced solid expansion further, the living time of elementary genic units in cosmic yolk extent has been prolonged in proportion, so that elementary genic units in cosmic yolk extent have even more probability to accomplish “**reciprocal idiosyncrasy towards PNT equilibrium + accessible space overall arrangement for PNT reciprocity**”, so that there has been reciprocal PNT combinations of gradation I, reciprocal PNT combinations in gradation II, reciprocal PNT combinations in gradation III, temperature & brightness of cosmic yolk extent are proportionably debased, performance of aberrant convergence of cosmic esse due to PNT reciprocal gelation has been better and better, which has primarily put up resource assimilation diversion of live input of potential resource of bidirectional lineage homologic pervasion with white towards yolk pervasion dominance $[d(M_{\text{white} \rightarrow m_{\text{yolk}}}) - d(M_{\text{white} \leftarrow m_{\text{yolk}}})] > 0$ against competitive resource assimilation of field evolution of cosmic yolk extent. Whereas, as performance of resource assimilation of field evolution of cosmic yolk extent is inherently more straightforward than resource assimilation of aberrant convergence of cosmic esse due to PNT reciprocal

gelation, most of the live input of potential resource of bidirectional lineage homologic pervasion with white towards yolk pervasion dominance $[d(M_{\text{white} \rightarrow \text{yolk}}) - d(M_{\text{white} \leftarrow \text{yolk}})] > 0$ is still assimilated into field evolution of cosmic yolk extent, which of course implies slight acclimatization cushion speedup of time dynamic speed.

Evolutional stage from T₃ to T₄: remarkable characteristics of the evolutional stage are as following:

The first: accelerating extent expansion of cosmic yolk extent is till ongoing.

The second, performance of **aberrant convergence of cosmic esse due to PNT reciprocal gelation** has been relatively better and better, and the resource assimilation diversion derived from performance of aberrant convergence of cosmic esse due to PNT reciprocal gelation against resource assimilation of field evolution of cosmic yolk extent has more and more remarkable, so that there is only slight acclimatization cushion speedup of time dynamic speed.

As cosmic yolk extent has experienced solid expansion further and further, the living time of elementary genic units in cosmic yolk extent has been prolonged in proportion, so that elementary genic units in cosmic yolk extent have even more probability to accomplish “**reciprocal idiosyncrasy towards PNT equilibrium + accessible space overall arrangement for PNT reciprocity**”, so that there has been reciprocal PNT combinations of gradation I, reciprocal PNT combinations in gradation II, reciprocal PNT combinations in gradation III even begin to form reciprocal PNT combinations of gradation IV as kindergarten celestial bodies and galaxies, temperature & brightness of cosmic yolk extent are proportionably debased, performance of **aberrant convergence of cosmic esse due to PNT reciprocal gelation** has been better and better, which has put up remarkable resource assimilation diversion of live input of potential resource of bidirectional lineage homologic pervasion with white towards yolk pervasion dominance $[d(M_{\text{white} \rightarrow \text{yolk}}) - d(M_{\text{white} \leftarrow \text{yolk}})] > 0$ against competitive resource assimilation of field evolution of cosmic yolk extent. Whereas, as performance of resource assimilation of field evolution of cosmic yolk extent is inherently more straightforward than resource assimilation of aberrant convergence of cosmic esse due to PNT reciprocal gelation, the more of the live input of potential resource of bidirectional lineage homologic pervasion with white towards yolk pervasion dominance $[d(M_{\text{white} \rightarrow \text{yolk}}) - d(M_{\text{white} \leftarrow \text{yolk}})] > 0$ is still assimilated into field evolution of cosmic yolk extent, which of course implies even slight acclimatization cushion speedup of time dynamic speed.

If we denote quantitative change function of white towards yolk transmutable pervasion at evolutional stage from T₀ to T₄ $f_1(M_{\text{white} \rightarrow \text{yolk}})$, and denote quantitative change function of yolk towards white transmutable pervasion at evolutional stage from T₀ to T₄ $j_1(M_{\text{white} \leftarrow \text{yolk}})$, then the total quantity of live input of potential resource assimilated throughout evolutional stage from T₀ to T₄ can be mathematically formulated as below:

$$\xi_1 = \int_{T_0}^{T_4} f_1(M_{\text{white} \rightarrow \text{yolk}}) dt - \int_{T_0}^{T_4} j_1(M_{\text{white} \leftarrow \text{yolk}}) dt$$

If we denote the quantity of resource assimilation of both extent expansion and acclimatization cushion of time dynamic speed ω_1 throughout evolutional stage from T₀ to T₄, and denote quantity of resource assimilation of aberrant convergence of cosmic esse due to PNT reciprocal gelation \mathcal{L}_1 throughout evolutional stage from T₀ to T₄, then $\xi_1, \omega_1, \mathcal{L}_1$ must satisfy equation as below:

$$\xi_1 = \omega_1 + \mathcal{L}_1$$

If we denote the dynamic-gelation convergence rate of cosmic esse \hat{E}_1 throughout evolutional stage from

As coherent natura naturans throughout cosmic evolution, instinctive PNT reciprocal equilibrium towards optimum PNT operation is radical potentiality & conditionality for cosmos always ready to orientate itself towards perfection.

T_0 to T_4 , then \hat{E}_1 can be mathematically defined as below:

$$\begin{aligned} \hat{E}_1 &= \mathcal{E}_1 / \xi_1 \\ &= \mathcal{E}_1 / [\int_{T_0}^{T_4} f_1(M_{\text{white} \rightarrow m_{\text{yolk}}}) dt - \int_{T_0}^{T_4} j_1(M_{\text{white} \leftarrow m_{\text{yolk}}}) dt] \end{aligned}$$

Throughout evolutionary stage from T_0 to T_4 , as the extent expansion of cosmic yolk extent and acclimatization cushion of time dynamic speed are remarkable, and relatively, condition of aberrant convergence of cosmic esse due to PNT reciprocal gelation is till primary, the dynamic-gelation convergence rate of cosmic esse throughout the stage is still relatively lower.

B) aberrant convergence of cosmic esse due to PNT reciprocal gelation at evolutionary stage from T_4 to T_a

Once evolution of cosmic yolk extent enters stage from T_4 to T_a , extent of cosmic yolk extent has been substantially capacious, so that natural life of elementary genic units in cosmic yolk extent has been prolonged in proportion, and there is more probability for elementary genic units and sub reciprocal PNT combinations to accomplish “reciprocal idiosyncrasy towards PNT equilibrium + accessible space overall arrangement for PNT reciprocity”, performance aberrant convergence of cosmic esse due to PNT reciprocal gelation has been more and more facile. As a result, the existence & motion of positive matter in cosmic yolk extent is rich and colorful, —there are substantial elementary genic units, reciprocal PNT combinations in gradation I, reciprocal PNT combinations in gradation II, reciprocal PNT combinations in gradation III and even reciprocal PNT combinations in gradation IV in spacetime of cosmic yolk extent. And as condition for aberrant convergence of cosmic esse due to PNT reciprocal gelation has been rather optimum, the elementary genic units and sub reciprocal PNT combinations continuously develop orientating relatively high-grade reciprocal PNT combinations, distribution of positive matter in cosmic yolk extent gradually develop from original dispersed pattern to well-rounded concentrated pattern, —celestial bodies in cosmic yolk extent become bigger and bigger and gradually turn into galaxies. And at the same time, as performance of aberrant convergence of cosmic esse due to PNT reciprocal gelation becomes rather optimum, the competitive diversion of resource assimilation of aberrant convergence of cosmic esse due to PNT reciprocal gelation against resource assimilation of field evolution of cosmic yolk extent become more and more remarkable, so that extent expansion acceleration of cosmic yolk extent is nearly zero, and acclimatization cushion of time dynamic speed even arises slight speed-down.

If we denote quantitative change function of white towards yolk transmutable pervasion at evolutionary stage from T_4 to T_a $f_2(M_{\text{white} \rightarrow m_{\text{yolk}}})$, and denote quantitative change function of yolk towards white transmutable pervasion at evolutionary stage from T_4 to T_a $j_2(M_{\text{white} \leftarrow m_{\text{yolk}}})$, then the total quantity of live input of potential resource assimilated throughout evolutionary stage from T_4 to T_a can be mathematically formulated as below:

$$\xi_2 = \int_{T_4}^{T_a} f_2(M_{\text{white} \rightarrow m_{\text{yolk}}}) dt - \int_{T_4}^{T_a} j_2(M_{\text{white} \leftarrow m_{\text{yolk}}}) dt$$

If we denote the quantity of resource assimilation of both extent expansion and acclimatization cushion of time dynamic speed ω_2 throughout evolutionary stage from T_4 to T_a , and denote quantity of resource assimilation of aberrant convergence of cosmic esse due to PNT reciprocal gelation \mathcal{E}_2 throughout evolutionary stage from T_4 to T_a , then ξ_2 , ω_2 , \mathcal{E}_2 must satisfy equation as below:

$$\xi_2 = \omega_2 + \mathcal{E}_2$$

If we denote the dynamic-gelation convergence rate of cosmic esse \hat{E}_2 throughout evolutionary stage from T_4 to T_a , then \hat{E}_2 can be mathematically defined as below:

Historical progress of science in the recent several centuries seemed like a far-flung exploration of the first itinerary around numerous distinctive landscapes of brand-new landmasses of science with palette & tablet on back, several hundred years’ scientific travelogues were compiled thereby.

$$\begin{aligned} \hat{E}_2 &= \xi_2 / \xi_1 \\ &= \xi_2 / \left[\int_{T_4}^{T_a} \xi_2(M_{\text{white}} \rightarrow m_{\text{yolk}}) dt - \int_{T_4}^{T_a} \xi_1(M_{\text{white}} \leftarrow m_{\text{yolk}}) dt \right] \end{aligned}$$

Compared with evolution of cosmic yolk extent of stage from T_0 to T_4 , the extent expansion of cosmic yolk extent at evolutionary stage from T_4 to T_a is relatively slower, whereas, performance of aberrant convergence of cosmic esse due to PNT reciprocal gelation is apparently better. As a result, anti-dynamic convergence rate of cosmic esse \hat{E}_2 of evolutionary stage from T_4 to T_a is of course bigger than anti-dynamic convergence rate of cosmic esse \hat{E}_1 of evolutionary stage from T_0 to T_4 , just as $\hat{E}_2 > \hat{E}_1$.

C) Evolutional stage of aberrant convergence of cosmic esse due to PNT reciprocal gelation from T_a to T_b

Evolutional stage of aberrant convergence of cosmic esse due to PNT reciprocal gelation from T_a to T_b is the optimum stage of aberrant convergence of cosmic esse due to PNT reciprocal gelation; the conditions for performance of aberrant convergence of cosmic esse due to PNT reciprocal gelation of the stage are the best ones.

On one hand, as time dynamic speed is remarkably bigger than critical value of time dynamic speed of cosmic yolk extent, there are substantial initial generation of elementary genic units, and as extent expansion of cosmic yolk extent has been rather adequate and further expansion is still ongoing, there are more and more time for elementary genic units to exist in cosmic yolk extent, there is more and more probability for elementary genic units to accomplish “reciprocal idiosyncrasy towards PNT equilibrium + accessible space overall arrangement for PNT reciprocity”, conditions for aberrant convergence of cosmic esse due to PNT reciprocal gelation is even better, as a result, there are even more reciprocal PNT combinations rich and colorful in cosmic yolk extent.

And what's more, as presence of optimum conditions for performance of aberrant convergence of cosmic esse due to PNT reciprocal gelation materializes “reciprocal idiosyncrasy towards PNT equilibrium + accessible space overall arrangement for PNT reciprocity” among elementary genic units and sub reciprocal PNT combinations expediently, there are more and more reciprocal PNT combinations in high gradation, the celestial bodies in cosmos become heavier and heavier, most of the stars and grand galaxies come into being during the course of evolutionary stage from T_a to T_b . In another word, during the course of evolutionary stage from T_a to T_b , performance of aberrant convergence of cosmic esse due to PNT reciprocal gelation directly lead dispersive existence & motion of positive matter in cosmic yolk extent to well-rounded existence & motion of galaxies. And at the same time, as substantial naissance of fixed stars in cosmic yolk extent, brightness and temperature of cosmic yolk extent slightly returns.

Of course, as optimum performance of aberrant convergence of cosmic esse due to PNT reciprocal gelation, resource assimilation of field evolution of cosmic yolk extent is inevitably held down by resource assimilation of aberrant convergence of cosmic esse due to PNT reciprocal gelation most.

Finally, something still necessary to emphasize herein is that the initial generation of idiographic reciprocal PNT combinations directly relates to the proper conditions of aberrant convergence of cosmic esse due to PNT reciprocal gelation, different conditions for aberrant convergence of cosmic esse due to PNT reciprocal gelation usually means proportionate generation of distinctive reciprocal PNT combinations, usually, the more complex reciprocal PNT combinations need relative better conditions for aberrant convergence of cosmic esse due to PNT reciprocal gelation, in another word, the better conditions for aberrant convergence of cosmic esse due to PNT reciprocal gelation, the more complex reciprocal PNT combinations can generate by the light of nature.

As coherent natura naturans throughout cosmic evolution, instinctive PNT reciprocal equilibrium towards optimum PNT operation is radical potentiality & conditionality for cosmos always ready to orientate itself towards perfection.

In terms of initial generation of reciprocal PNT combinations in gradation II, there is initial generation of reciprocal PNT combinations in gradation II throughout evolutionary stage from T_1 to T_b , whereas, under more primary conditions for aberrant convergence of cosmic esse due to PNT reciprocal gelation, there is more probability for initial generation of atoms with relatively poorer mass of nucleon; the more advanced conditions for aberrant convergence of cosmic esse due to PNT reciprocal gelation are, there is more probability for initial generation of atoms with relatively heavier mass of nucleon. Most of the atoms with relatively heavier mass of nucleon are generated during the course of evolutionary stage from T_4 to T_b . Of course, initial generation of atoms with relatively heavier mass of nucleon does not exclude initial generation of atoms with relatively poorer mass of nucleon; inversely, initial generation of atoms with relatively heavier mass of nucleon demands relatively more advanced conditions for aberrant convergence of cosmic esse due to PNT reciprocal gelation, since there is more probability for more advanced condition to accomplish initial generation of atoms with relatively heavier mass of nucleon, there is of course even more probability to accomplish initial generation of atoms with relatively poorer mass of nucleon. As a result, there are apparently more atoms with relatively poorer mass of nucleon than atoms with relatively heavier mass of nucleon; the heavy metals are generally the exiguous metals in cosmos.

What is worthy of emphasis herein is that, as original generation of atoms of heavy metal mostly depends on more rigorous spacetime conditions, once the spacetime conditions slightly weaken, disintegration for inartificial radiation of atoms of heavy metal will sensitively occur therefore. The more time the spacetime weakening of cosmic yolk extent lasts, the weaker the integrative spacetime conditions of cosmic yolk extent will ultimately be, and consequently, more kinds of heavy metal atoms will exhibit disintegration for inartificial radiation. And usually, the heavier the mass of nucleon is, the more remarkable disintegration for inartificial radiation is. Today, many of the heavy metal atoms around us exhibit disintegration for inartificial radiation, this maybe indicate cosmic yolk extent is slightly weakening and time dynamic speed of cosmic yolk extent is proportionably decelerating. Of course, integrative space field weakening of cosmic yolk extent (/slight deceleration of time dynamic speed of cosmic yolk extent) directly indicates Einstein shift of lights in large-scale spacetime as well.

Cosmic today locates a time position about 100 million years behind T_b .

If we denote quantitative change function of white towards yolk transmutable pervasion at evolutionary stage from T_a to T_b $f_3(M_{\text{white}} \rightarrow m_{\text{yolk}})$, and denote quantitative change function of yolk towards white transmutable pervasion at evolutionary stage from T_a to T_b $j_3(M_{\text{white}} \leftarrow m_{\text{yolk}})$, then the total quantity of live input of potential resource assimilated throughout evolutionary stage from T_a to T_b can be mathematically formulated as below:

$$\xi_3 = \int_{T_a}^{T_b} f_3(M_{\text{white}} \rightarrow m_{\text{yolk}}) dt - \int_{T_a}^{T_b} j_3(M_{\text{white}} \leftarrow m_{\text{yolk}}) dt$$

If we denote the quantity of resource assimilation of both extent expansion and acclimatization cushion of time dynamic speed ω_3 throughout evolutionary stage from T_a to T_b , and denote quantity of resource assimilation of aberrant convergence of cosmic esse due to PNT reciprocal gelation \mathcal{L}_3 throughout evolutionary stage from T_a to T_b , then ξ_3 , ω_3 , \mathcal{L}_3 must satisfy equation as below:

$$\xi_3 = \omega_3 + \mathcal{L}_3$$

If we denote the dynamic-gelation convergence rate of cosmic esse \hat{E}_3 throughout evolutionary stage from

Historical progress of science in the recent several centuries seemed like a far-flung exploration of the first itinerary around numerous distinctive landscapes of brand-new landmasses of science with palette & tablet on back, several hundred years' scientific travelogues were compiled thereby.

T_a to T_b , then \hat{E}_3 can be mathematically defined as below:

$$\begin{aligned}\hat{E}_3 &= \int_{T_a}^{T_b} f_3(M_{\text{white} \rightarrow \text{myolk}}) dt - \int_{T_a}^{T_b} f_3(M_{\text{white} \leftarrow \text{myolk}}) dt \\ &= \int_{T_a}^{T_b} [f_3(M_{\text{white} \rightarrow \text{myolk}}) - f_3(M_{\text{white} \leftarrow \text{myolk}})] dt\end{aligned}$$

Compared with evolution of cosmic yolk extent of stage from T_4 to T_a , the extent expansion of cosmic yolk extent at evolutionary stage from T_a to T_b is relatively slower, whereas, performance of **aberrant convergence of cosmic esse due to PNT reciprocal gelation** is apparently better. As a result, anti-dynamic convergence rate of cosmic esse \hat{E}_3 of evolutionary stage from T_a to T_b is of course bigger than anti-dynamic convergence rate of cosmic esse \hat{E}_2 of evolutionary stage from T_4 to T_a , just as $\hat{E}_3 > \hat{E}_2$.

D) aberrant convergence of cosmic esse due to PNT reciprocal gelation at evolutionary stage from T_b to T_d

Evolutional stage from T_b to T_d is just the terminative engineering of **aberrant convergence of cosmic esse due to PNT reciprocal gelation**, although live input of potential resource of bidirectional lineage homologous transmutable pervasion still satisfy $d(M_{\text{white} \rightarrow \text{myolk}}) - d(M_{\text{white} \leftarrow \text{myolk}}) > 0$, the magnitude of $d(M_{\text{white} \rightarrow \text{myolk}}) - d(M_{\text{white} \leftarrow \text{myolk}})$ gradually runs to 0, both field evolution of cosmic yolk extent and performance of **aberrant convergence of cosmic esse due to PNT reciprocal gelation** consequently attenuate in proportion (evolutional attenuation of field of cosmic yolk extent of course means attenuation of both extent expansion of cosmic yolk extent and acclimatization cushion of time dynamic speed), till at last $d(M_{\text{white} \rightarrow \text{myolk}}) - d(M_{\text{white} \leftarrow \text{myolk}}) = 0$, dynamic-gelation convergence rate of cosmic esse turns to 0, acclimatization cushion of time dynamic speed turns to 0 and extent expansion of cosmic yolk extent turns to 0.

But throughout the process $d(M_{\text{white} \rightarrow \text{myolk}}) - d(M_{\text{white} \leftarrow \text{myolk}})$ gradually decrease to 0, quantitative change of field evolution of cosmic yolk extent is impacted by decrease of $d(M_{\text{white} \rightarrow \text{myolk}}) - d(M_{\text{white} \leftarrow \text{myolk}})$ more straightforward, so that the consequent attenuation of field evolution seems more sensitive due to decrease of $d(M_{\text{white} \rightarrow \text{myolk}}) - d(M_{\text{white} \leftarrow \text{myolk}})$. And on the other hand, the conditions for aberrant convergence of cosmic esse due to PNT reciprocal gelation is more rigorous than conditions for field evolution of cosmic yolk extent, as a result, although the consequent effect of aberrant convergence of cosmic esse due to PNT reciprocal gelation due to decrease of $d(M_{\text{white} \rightarrow \text{myolk}}) - d(M_{\text{white} \leftarrow \text{myolk}})$ is still not as straightforward as consequent effect of field evolution of cosmic yolk extent due to decrease of $d(M_{\text{white} \rightarrow \text{myolk}}) - d(M_{\text{white} \leftarrow \text{myolk}})$, in time current, the final approach of 0 of dynamic-gelation convergence rate of cosmic esse is till a little earlier than final approach of 0 of field evolution of cosmic yolk extent.

That's to say, during the course of $d(M_{\text{white} \rightarrow \text{myolk}}) - d(M_{\text{white} \leftarrow \text{myolk}})$ gradually decreases to 0, although evolutional attenuation of field of cosmic yolk extent is more sensitive and straightforward due to decrease of $d(M_{\text{white} \rightarrow \text{myolk}}) - d(M_{\text{white} \leftarrow \text{myolk}})$ than evolutional attenuation of aberrant convergence of cosmic esse due to PNT reciprocal gelation due to decrease of $d(M_{\text{white} \rightarrow \text{myolk}}) - d(M_{\text{white} \leftarrow \text{myolk}})$, as conditions for aberrant convergence of cosmic esse due to PNT reciprocal gelation is relatively more rigorous than field evolution of cosmic yolk extent, it's even earlier for dynamic-gelation convergence rate of cosmic esse to approach 0 than field evolution of cosmic yolk extent to approach 0, — just as illustration (IV-ii-5) above, during the course of $d(M_{\text{white} \rightarrow \text{myolk}}) - d(M_{\text{white} \leftarrow \text{myolk}})$ gradually runs to 0, dynamic-gelation convergence rate of cosmic esse runs to 0 at time position T_c , whereas, field evolution of cosmic yolk extent approach 0 at a time position of T_d which is of course a little far behind T_c .

As coherent natura naturans throughout cosmic evolution, instinctive PNT reciprocal equilibrium towards optimum PNT operation is radical potentiality & conditionality for cosmos always ready to orientate itself towards perfection.

If we denote quantitative change function of white towards yolk transmutable pervasion at evolutionary stage from T_b to T_d $f_4(M_{\text{white} \rightarrow m_{\text{yolk}}})$, and denote quantitative change function of yolk towards white transmutable pervasion at evolutionary stage from T_b to T_d $j_4(M_{\text{white} \leftarrow m_{\text{yolk}}})$, then the total quantity of live input of potential resource assimilated throughout evolutionary stage from T_b to T_d can be mathematically formulated as below:

$$\xi_4 = \int_{T_b}^{T_d} f_4(M_{\text{white} \rightarrow m_{\text{yolk}}}) dt - \int_{T_b}^{T_d} j_4(M_{\text{white} \leftarrow m_{\text{yolk}}}) dt$$

If we denote the quantity of resource assimilation of both extent expansion and acclimatization cushion of time dynamic speed ω_4 throughout evolutionary stage from T_b to T_d , and denote quantity of resource assimilation of aberrant convergence of cosmic esse due to PNT reciprocal gelation \mathcal{E}_4 throughout evolutionary stage from T_b to T_d , then ξ_4 , ω_4 , \mathcal{E}_4 must satisfy equation as below:

$$\xi_4 = \omega_4 + \mathcal{E}_4$$

If we denote the dynamic-gelation convergence rate of cosmic esse \hat{E}_4 throughout evolutionary stage from T_b to T_d , then \hat{E}_4 can be mathematically defined as below:

$$\begin{aligned} \hat{E}_4 &= \mathcal{E}_4 / \xi_4 \\ &= \mathcal{E}_4 / [\int_{T_b}^{T_d} f_4(M_{\text{white} \rightarrow m_{\text{yolk}}}) dt - \int_{T_b}^{T_d} j_4(M_{\text{white} \leftarrow m_{\text{yolk}}}) dt] \end{aligned}$$

Compared with evolution of cosmic yolk extent of stage from T_a to T_b , as live input of potential resource of bidirectional lineage homologic pervasion with white towards yolk pervasion dominance [$d(M_{\text{white} \rightarrow m_{\text{yolk}}}) - (M_{\text{white} \leftarrow m_{\text{yolk}}})$] become less and less, both field evolution of cosmic yolk extent and aberrant convergence of cosmic esse due to PNT reciprocal gelation consequently turn to situation as a spent bullet. In terms of aberrant convergence of cosmic esse due to PNT reciprocal gelation, on one hand, as time dynamic speed of cosmic yolk extent gradually close up critical value of time dynamic speed of cosmic yolk extent, there are originally less and less elementary genic units generated in cosmic yolk extent, and on the other hand, as extent expansion is still ongoing but with proper deceleration, the extent of cosmic yolk extent is still more and more capacious day by day, resultingly, the density of elementary genic units in cosmic yolk extent become even thinner and thinner. This is of course solid cause to negatively impact the accomplishment probability of “accessible space overall arrangement for PNT reciprocity”, and consequently impact the performance efficiency of aberrant convergence of cosmic esse due to PNT reciprocal gelation. As a result, anti-dynamic convergence rate of cosmic esse \hat{E}_4 of evolutionary stage from T_b to T_d is of course less than anti-dynamic convergence rate of cosmic esse \hat{E}_3 of evolutionary stage from T_a to T_b , just as $\hat{E}_4 < \hat{E}_3$.

Once $d(M_{\text{white} \rightarrow m_{\text{yolk}}}) - d(M_{\text{white} \leftarrow m_{\text{yolk}}}) < 0 \iff d(M_{\text{white} \rightarrow m_{\text{yolk}}}) < d(M_{\text{white} \leftarrow m_{\text{yolk}}})$, it means cosmic yolk extent begins to degenerate, —as time dynamic speed helplessly orientates to critical value of time dynamic speed of cosmic yolk extent, more and more reciprocal PNT combinations begin to disassemble, more and more elementary genic units begin to degenerate and disappear into space field, till at last, all positive matter in cosmic yolk extent degenerated and cosmic yolk extent disappeared. In quantitative change progression profile, the evolutionary quantitative change progression profile and degenerative quantitative change progression profile are generally symmetrical inversely.

Virtually, all hypostatic quantitative change about extent expansion of cosmic yolk extent, acclimatization cushion of time dynamic speed and aberrant convergence of cosmic esse due to PNT reciprocal gelation are but mathematical

connotation of quantitative change regularity function of white towards yolk transmutable pervasion of cosmic yolk extent. As long as we ultimately consummate the spacetime unique-genesis quantization function of quantitative change regularity of white towards yolk transmutable pervasion of cosmic yolk extent, all the quantitative change about extent expansion of cosmic yolk extent, acclimatization cushion of time dynamic speed and aberrant convergence of cosmic esse due to PNT reciprocal gelation will be hypostatized in quantitative change regularity function of white towards yolk transmutable pervasion of cosmic yolk extent. And virtually, the quantitative change regularity function of white towards yolk transmutable pervasion of cosmic yolk extent and the atom state equation in spacetime are connotation in coherent mathematical logic series, in logic extension sequence, quantitative change regularity function of white towards yolk transmutable pervasion of cosmic yolk extent is headspring of atom state equation in spacetime.

2.5.3. Instinctive filter confinement of matter in cosmic yolk extent

The further proliferation of reciprocal PNT combinations is just the process cosmic yolk extent turn to be mature and convergent, once the elementary genic units astringently combined into massive reciprocal PNT combinations, it won't be easy for them to slide into weak space field of cosmic white extent and degenerate into field genic units.

On one hand, any object in cosmos inherently has instinct of PNT equilibrium, once there is slight trend sliding towards weak space field and incurring destructive yolk towards white pervasion, (which is virtually just situation positive towards negative transmutation is relatively preponderant to negative towards positive transmutation of the matter integration), the matter integration will spontaneously PNT react to equilibrate the PNT operation and evade destructive yolk towards white pervasion impact and save itself by the light of nature.

And on the other hand, reciprocal PNT combinations usually possess relatively massive convergent mass, even though it maybe unexpectedly slide towards cosmic white extent and incur destructive yolk towards white pervasion damage, the massive convergent mass of matter integration has made it possess substantial mass stockpile to cope with destructive yolk towards white pervasion damage, so that there is substantial leeway to evade destructive damage by the right of PNT equilibrium instinct. Usually, the more massive and convergent the matter integration is, there is more substantial leeway for matter integration to evade destructive damage by the light of nature, and of course there is less probability for it to slide into cosmic white extent.

Thus, all massive objects in cosmic yolk extent are not easy to slide into cosmic white extent to die off for destructive yolk towards white pervasion exhaustion. Such naturalness makes the clear-cut circumscription between cosmic white extent and cosmic yolk extent appear itself. I call such connatural circumscription restriction derived from PNT equilibrium instinct of matter integration even related to relatively massive mass stockpile for substantial leeway to cope with and evade destructive yolk towards white pervasion between cosmic yolk extent and cosmic white extent "instinctive confinement of of matter in cosmic yolk extent".

However, in terms of the photons and particles similar as photons in cosmic yolk extent, as their mass is too tiny, there is substantively poor leeway for them to cope with and evade destructive yolk towards white pervasion exhaustion by the right of their inherent instinct of PNT equilibrium, once they slide towards cosmic white extent, before their instinct of PNT equilibrium accomplish the job to evade destructive yolk towards white pervasion and save itself in time, the photons and particles similar as photons have exhausted themselves

in cosmic white extent already. What's more, the inherent motion speed of photons and particles similar as photons is relatively higher, it's substantively a great challenge for PNT equilibrium instinct of matter integration to accomplish job to draw them back from destructive yolk towards white pervasion before their exhaustion in cosmic white extent. As a result, instinctive confinement of cosmic yolk extent can hardly confine photons and tiny particles similar as photons but to confine relatively macroscopical objects in cosmic yolk extent like a filter, so I just call it "instinctive filter confinement of matter in cosmic yolk extent".

Black Hole is but phenomena that lights and other particles even macroscopical objects slide into weak space field (it may be just the cosmic white extent) and incur destructive yolk towards white pervasion so as to be ultimately exhausted themselves into weak space field (or cosmic white extent). As presence of "light-exhaustion medium lamella" between cosmic yolk extent and cosmic white extent, and as complete exhaustion of all photons, particles in light-exhaustion medium lamella,, once we look through light-exhaustion medium lamella towards cosmic white extent, cosmic white extent is of course out-and-out Black Hole (However, there are usually no ways for us to perceive existence of cosmic white extent unless there are some massive reciprocal PNT combinations orientating the cosmic white extent and consequently exhibiting physical evidence of collapsing themselves helplessly in inverse way of aberrant convergence of cosmic esse due to PNT reciprocal gelation).

Any lights or radiations in cosmic yolk extent, as long as they are not absorbed by objects in cosmic yolk extent, must ultimately slide into light-exhaustion medium lamella and die off therein. The exhaustion of lights & radiations is virtually one part of yolk towards white transmutable pervasion ($M_{\text{white} \leftarrow m_{\text{yolk}}}$). Virtually, cosmic brightness is one of the idiographic state parameters of cosmic dynamic hylic circulation, under precondition there are stars in cosmic yolk extent, as long as the white towards yolk transmutable pervasion rate $d(M_{\text{white} \rightarrow m_{\text{yolk}}})$ and yolk towards white transmutable pervasion rate $d(M_{\text{white} \leftarrow m_{\text{yolk}}})$ satisfy $d(M_{\text{white} \rightarrow m_{\text{yolk}}}) = d(M_{\text{white} \leftarrow m_{\text{yolk}}})$, the large-scale structure of cosmos will keep relatively steady, if $d(M_{\text{white} \rightarrow m_{\text{yolk}}}) > d(M_{\text{white} \leftarrow m_{\text{yolk}}})$, cosmic yolk extent will be more and more well-rounded, and cosmic brightness will be higher day by day; if $d(M_{\text{white} \rightarrow m_{\text{yolk}}}) < d(M_{\text{white} \leftarrow m_{\text{yolk}}})$, cosmic yolk extent will consequently tenuous and cosmic brightness will be lower day by day.

Cosmos is always ready to orientate itself towards perfection in the nature of instinctive PNT reciprocal equilibrium towards optimum PNT operation.

Any reciprocal PNT combination in cosmos, no matter it's just a single star or galaxy, they all originally come into being in accordance with unique perfection-orientated fundamental of instinctive PNT reciprocal equilibrium towards optimum PNT operation due to stochastic occurrence of "reciprocal idiosyncrasy towards PNT equilibrium + accessible space overall arrangement for PNT reciprocity", universal living existence & motion are all virtually ongoing performance of Instinctive PNT reciprocal equilibrium towards optimum PNT operation and will go on developing in accordance with the unique perfection-orientated fundamental for ever. There are none logic possibilities for stars to exhaust their nuclear energy as individual stockpile themselves and ultimately collapse into so-called "Black Hole". In a straightforward word, so-called "star collapse" is apparently out of connatural occurrence of instinctive PNT reciprocal equilibrium towards optimum PNT operation kind which makes cosmos always ready to orientate itself towards perfection by the light of nature, it may be naive imagination out of nature and completely impossible.

—Firstly, it's impossible for the unique perfection-orientated fundamental of instinctive PNT reciprocal

Historical progress of science in the recent several centuries seemed like a far-flung exploration of the first itinerary around numerous distinctive landscapes of brand-new landmasses of science with palette & tablet on back, several hundred years' scientific travelogues were compiled thereby.

equilibrium towards optimum PNT operation to lead to occurrence of celestial bodies with remarkable heavy mass convergence in magic density so that the gravity on surface of the celestial bodies is strong enough to restrict all lights or radiations from the surface of the celestial bodies. Because, during the course of original increasing mass convergence of celestial bodies, the absolute speed of the celestial bodies in spacetime will be less and less, this of course means there is less and less airspace for the effective gravitational fields of celestial bodies to skim through, this of course means there is less and less probability for the effective gravitational fields of celestial bodies to assimilate small celestial bodies available around. And at the same time, as mass approximation accessible to negative gravity, not only the remarkably heavy celestial bodies are mutually sensitive for negative gravity by the light of nature, but also, as relatively preponderant gravitational fields of them, they are usually independent competitors to absorb the relative smaller celestial bodies around. This of course even holds down probability for mass of celestial bodies in spacetime to increase unreasonably.

—Secondly, the radiant state of fixed stars or galaxies mostly depends on and hypostatize energetic state of large-scale background spacetime. As long as energetic state of large-scale background spacetime keeps relatively steady, the radiant state of fixed stars or galaxies will keep relatively steady thereby. In another word, as long as energetic state of large-scale background spacetime keeps relatively steady, the integrative luminance of cosmos will be relatively steady therefore, there is no possibility for fixed stars to collapse for ultimate exhaustion of nuclear energy as individual stockpile towards naissance of so-called “Black Hole” (For instance, the radiant state of sun is just vivid objectification of ongoing occurrence of instinctive PNT reciprocal equilibrium towards optimum PNT operation between characteristic sun with idiographic material configuration, mass scale, density and proper external large-scale background spacetime, as long as the external large-scale background spacetime keeps relatively steady, the radiant state even material configuration, mass scale, density of sun will keep relatively steady therefore, there is no possibility for the sun to lead to mechanical collapse for ultimate exhaustion of nuclear energy as individual stockpile, whether the radiant state of sun can be continued and how long the radiant state of sun can be lasted radically depends on the status of the external large-scale background spacetime of the sun). After all, cosmic status quo is conditional state derived from succession of cosmic demiurgic evolution but not isolated stockpile favored by the demiurge, as long as the background evolutionary conditions keep relatively steady, the consequent existent state of cosmos will be proportionably steady.

Even if the external large-scale background spacetime of fixed stars is strengthening, so that the luminance of the fixed stars consequently become higher and higher and the mass of the fixed stars become bigger and bigger, there are still more opportunities for the fixed stars to explode before the mass and density of the fixed stars increasing to magic scale against connatural perfection-orientated fundamental of instinctive PNT reciprocal equilibrium towards optimum PNT operation so that the gravity on the surface of the fixed stars is strong enough to restrict the radiations from surface of the fixed stars.

If the large-scale background spacetime of fixed stars is weakening, the luminance of the fixed stars will become slighter and slighter, even the mass of the fixed stars will become less and less following the weakening extension of large-scale background spacetime, till at last the whole mass of the fixed stars disappears into weakening large-scale background spacetime, even the spacetime strength of the weakening large-scale background spacetime may be ultimately weaker than the so-called light-exhaustion medium lamella, so that the whole large-scale background spacetime turns into out-and-out Black Hole, but there is no possibility for fixed stars

to turn into so-called conventional Black Hole for mechanical collapse.

Are there so-called “Black Holes” in cosmos really?

Contemporaneous scientific orthodoxy predicted existence of so-called “Black Holes” by lineal logic extension in rigid succession of contemporaneous scientific orthodoxy, however, before demonstration of historical authenticity tolerance of science 0 of contemporaneous scientific orthodoxy, the so-called prediction derived from lineal logic extension in rigid succession of contemporaneous scientific orthodoxy can only be qualified to be “theoretical prediction” under certain historical background, the authenticity of the so-called “theoretical prediction” still need necessary scientific authentication. No matter how famous SW. Hawking had ever been for his Black Hole theory, no matter how many mysterious stories were there behind the factuality that LIGO even procured physical Nobel prize of 2017 for their unintelligible discovery of so-called “gravitational waves” derived from mechanical collision of binary Black Hole far away in spacetime. Thus, you can of course imagine what’s the unintelligible situation of “science forum” even “Nobel Prize”.

All in all, till today, there are none credible scientific authentication about authentic existence of so-called “Black Hole” in cosmos.

Are there really so-called “Black Holes” in cosmos?

As one of the greatest scientists in the world for remarkable contribution of Black Hole theory, SW. Hawking mentioned two famous predictions about cosmos in his famous monograph of <The large-scale structure of spacetime> as below:

The first: the final fate of massive stars is to collapse behind an event horizon to form a “Black Hole”, which will contain a singularity.

The second: there is a singularity in our past which constitutes, in some sense, a beginning to the universe.

There is apparent acquiescence of the first famous prediction about cosmos of SW. Hawking as below

A). “stars” in cosmos are always something like oil lamps, which will of course be extinguished for exhaustion of oil in it.

B). The quantitative change of original convergent accumulation of mass of celestial bodies can always last unlimitedly, so that the gravity of the proper celestial bodies can of course increase enough to restrict all the lights on the surface of the celestial bodies.

The second famous prediction about cosmos of SW. Hawking is virtually just the prior acquiescence of the so-called “Big Bang”.

The both predictions about cosmos of SW. Hawking are not only apparently washy and lack scientific authentication, the even washy factuality is that the wise contribution of SW. Hawking was not he practically demonstrated the both predictions but developed the both predictions as building more houses on top of air castle.

Of course, SW. Hawking is still alive in the world, if you are interesting in the issue, you can of course turn to SW. Hawking himself for question, —**Are there really so-called “Black Holes” in cosmos?** Of course, as the gainers of the physical Nobel prize of 2017, there are still many of them alive in the world, if you are interesting in the issue, you can of course turn to them for question, —**Are there really so-called “Black Holes” in cosmos?**

Historical progress of science in the recent several centuries seemed like a far-flung exploration of the first itinerary around numerous distinctive landscapes of brand-new landmasses of science with palette & tablet on back, several hundred years’ scientific travelogues were compiled thereby.

Several days ago, I chatted with a group of young men in QQ loop, once I mentioned that there might be none Black Holes in cosmos at all, several learned people were really angry and insisted there were substantial Black Holes everywhere in cosmos, I was almost shocked by their confident persistence, in any case, they had substantial reasons to draw such kind of conclusion in accordance with contemporaneous scientific orthodoxy, which seemed to make them rather acquainted. In terms of opinion of Homogenous Cosmos Originated from Unique Genesis that so-called "Black Hole" is completely out of demiurgic range of sequential homologic cosmogony in the nature of coherent natura naturans throughout cosmic evolution, they had no idea about this, and they were not interested in it.

After one minute, I had to speak out unconcernedly, —there are three Black Holes in washroom of my house, can you believe it?

"Nonsense, we can of course go to the washroom of your house to have a look on the spot!" One young man immediately rushed out with the comment.

To have a look on the spot? I replied with slight smile, there are so many Black Holes in cosmos, you can see none of them in any case, what's the reason for you to be so sure to see the three Black Holes in the washroom of my house, which may be even smaller than single atoms like so-called singularities in absolutely dark situation!

The limitation of cosmos is firstly because entire cosmic endosome are but aggregation of out-and-out homology limited in a grand homogeneity system, anything out of the homogeneity system must be object out of cosmos. The cosmic size we usually mentioned may be just the size of cosmic yolk extent, cosmic yolk extent is of course a limited extent whose size can be scaled in light-year ^①.

However, as presence of instinctive filter confinement of cosmic yolk extent, no matter how hard we try our best to control matter motion in cosmos, it's completely impossible for us, existing as macroscopical object in cosmic yolk extent, to go beyond cosmic yolk extent and perceive the substantial limitation of cosmos. After

Note ^①: There are two potential prejudices in traditional notion of light-year:

The first, light-speed is constant in so-called vacuum, whereas, in homogenous cosmos, since spacetime momentum of discretionary object in homogenous cosmos is subject to mathematical definition $mV=d(M \leftarrow m)*Y$, and time dynamic speed Y is not constant, how can light-speed be constant?

The second, in live contemporaneous scientific orthodoxy, the notion of "time" is virtually standard motion reference, the time of "years" is virtually defined as the regular process the earth runs around the sun for a circle, the default precondition of the definition of year is that, no matter whether existence & motion ambience of the earth change or not following the solar system moving in large-scale spacetime in cosmos, the existence & motion status of the earth around the sun is everlasting constant, so that the definition of time of year is a definite constant. Virtually, once solar system moving in large-scale spacetime in cosmos, nothing can ensure the external ambience for normal existence & motion of the earth around the sun to be invariable, once external ambience changes following position shift of the solar system in large-scale spacetime in cosmos, hypostatic existence & motion of the earth around the sun must change accordingly, which of course indicates the circle the earth running around the sun is not everlasting constant. And just because all existence & motion of objects in solar system are equally subject to $mV=d(M \leftarrow m)*Y$, there is nothing can take role of reference for us to perceive the stochastic change of hypostatic existence & motion of the earth around the sun once there is proportionate change of external ambience of solar system for position shift in large-scale spacetime in cosmos, even clock in our pocket. At any rate, as long as we have to admit that sequential homologic cosmogony is successive variation, universal existence & motion is not integrative everlasting constant, nothing we can invoke to insist that time of "year" is everlasting constant. It only positively indicates the definite physical process the earth finish a circle around the sun, whereas, nothing can ensure the hypostatic motion of the earth around the sun is absolute constant.

As coherent natura naturans throughout cosmic evolution, instinctive PNT reciprocal equilibrium towards optimum PNT operation is radical potentiality & conditionality for cosmos always ready to orientate itself towards perfection.

all, once we try to approach circumscription of cosmic yolk extent, PNT equilibrium instinct must spontaneously acclimate our motion status so as to evade destructive yolk towards white pervasion. Otherwise, we must exhaust ourselves for destructive yolk towards white pervasion before we approach real circumscription of cosmic yolk extent, no more to go through the light-exhaustion medium lamella. That's to say, as macroscopical object in cosmic yolk extent, we can only exist & motion as matter itself, but no way for us to approach real circumscription of cosmic yolk extent as to perceive limitation of cosmos, where there is nothing to support normal existence & motion of matter.

This is just dynamic objectification of essence of matter all wool and a yard wide.

4. Relative weak space field interlayer among galaxies

The galaxies in cosmos are so rich and colorful, radical cause for the colorful galaxies with distinctive profile to be independent ones like themselves is mostly because there are so-called “**relative weak space field interlayer among galaxies**” around them which shape the profile of distinctive galaxies like light-exhaustion medium lamella shape the profile of cosmic yolk extent. Although, **relative weak space field interlayer among galaxies** exist in cosmic yolk extent, as their space field strength is slightly weaker than space field strength within galaxy, once celestial bodies in galaxy slide into **relative weak space field interlayer among galaxies**, there must be sensitive damage of yolk towards white transmutable pervasion of celeriac bodies, so that the celeriac bodies have to immediately react by PNT equilibrium instinct towards optimum PNT operation of matter integration and consequently evade damage of yolk towards white transmutable pervasion as straightforward self-preservation. As a result, the so-called “**relative weak space field interlayer among galaxies**” seems like an invisible bounding wall around the galaxy, which demarcates and confines all celestial bodies in galaxy like light-exhaustion medium lamella demarcating and confining all positive matter in cosmic yolk extent.

For convenience of rational comprehension and lingual expression, we call the instinctive confinement of all celestial bodies in galaxy due to [**envelopment of relative weak space field interlayer among galaxies + instinctive PNT equilibrium against damage of yolk towards white transmutable pervasion of celestial bodies in galaxies**] **instinctive weak space field interlayer confinement of galaxy**. In straightforward words, so-called **relative weak space field interlayer confinement of galaxy** is just physical confinement domino effect of all celestial bodies in galaxy due to [**envelopment of relative weak space field interlayer among galaxies + instinctive PNT equilibrium against damage of yolk towards white transmutable pervasion of celestial bodies in galaxies**].

Relative weak space field interlayer among galaxies restricts almost all celestial bodies in galaxies and demarcate distinctive profile of rich and colorful galaxies in cosmos, which makes universal galaxies independent and distinctive. The physical domino effect of galaxy confinement of relative weak space field interlayer among galaxies and cosmic yolk extent confinement of light-exhaustion medium lamella is just the same as spontaneous occurrence of [**envelopment of relative weak space field interlayer among galaxies + instinctive PNT equilibrium against damage of yolk towards white transmutable pervasion of celestial bodies in galaxies**]. The quantitative disparity between galaxy confinement of relative weak space field interlayer among galaxies and cosmic yolk extent confinement of light-exhaustion medium lamella is only limited in, the space field weakening range of relative weak space field interlayer among galaxies is rather narrow, so that the confinement strength of relative weak space field interlayer among galaxies is relatively weak. Comparably, the space field weakening range of light-exhaustion medium lamella is rather wide,

so that the confinement strength of light-exhaustion medium lamella is relatively strong, even lights can hardly pass through light-exhaustion medium lamella and consequently escape cosmic yolk extent.

The physical confinement domino effect of **relative weak space field interlayer confinement of galaxy** mostly depends on attribute of relative weak space field interlayer among galaxies and mass scale and moving speed of celestial bodies in galaxies.

In terms of relative weak space field interlayer among galaxies, the wider the relative weak space field interlayer among galaxies is, and the space field strength weakening range of relative weak space field interlayer among galaxies is relatively wider, the confinement potentiality of relative weak space field interlayer among galaxies is proportionably more substantial. Celestial bodies in galaxy are more difficult to pass through the relative weak space field interlayer among galaxies and escape the galaxy.

In terms of massive celestial bodies in galaxy:

Mass scale of celestial bodies in galaxy not only indicates proportionable potentiality for anti-damage of yolk towards white transmutable pervasion but also indicates proportionate PNT equilibrium instinct of matter integration, the more massive celestial bodies proportionably have more substantial potentiality for anti-damage of yolk towards white transmutable pervasion and inherently possess solid PNT equilibrium instinct in proportion to their mass scale. Once celestial bodies slide into relative weak space field interlayer among galaxies by chance, one side of matter field of matter integration of celestial body must firstly slide into relative weak space field interlayer among galaxies and incur proportionate damage of yolk towards white transmutable pervasion therefore. As inherent presence of instinctive PNT equilibrium of matter integration, celestial body must sensitively react to evade damage of yolk towards white transmutable pervasion as out-and-out self-preservation immediately, which seems instinctive rebound action from the relative weak space field interlayer among galaxies too, confinement function of relative weak space field interlayer among galaxies is accomplished thereby. As a result, celestial bodies in galaxy are not easy to escape from galaxy^②.

Supplemental note^②: it was found by some certain academicians ten more years ago that the necessary gravitational restriction of galaxy is far more than the hypostatic gravitational interaction among all the celestial bodies in galaxy, so that they had to suspect there may be more objects invisible around which offer the additional gravitational restriction of the galaxy. As we could not find the objects around then and there by optical observation, we had to called them "Dark matter", this is just the theoretical originality of "Dark Matter".

Of course, the theoretical originality of "Dark Matter" is of course outgrowth of typical "Lineal logic extension in succession of contemporaneous scientific orthodoxy", which includes two inherent logic conjuries as following:

Logic conjury I: there is obvious default precondition behind outgrowth of typical "Lineal logic extension in succession of contemporaneous scientific orthodoxy" that so-called "gravitational interaction" among celestial bodies is the unique possible cause for general existence & motion of all celestial bodies in galaxy like distinctive galaxy itself, none else, no matter how far away the so-called gravitational theory in live contemporaneous scientific orthodoxy is from perfect ideological enantiomorph of ultimate authenticity with proportionate historical authenticity tolerance of science far away from 0.

Logic conjury II: as outgrowth of typical "lineal logic extension in succession of contemporaneous scientific orthodoxy", it insist that traditionary gravity theory is uniform and almighty theory to any object in cosmos as long as there is so-called "mass" of it, no matter there is really dark matter or not, no matter how remarkable discrepancy between matter and dark matter, is as additional part of ideological system about authenticity in proportion to contemporaneous historical background, since gravity theory is applicable to matter in cosmos, it must

As coherent natura naturans throughout cosmic evolution, instinctive PNT reciprocal equilibrium towards optimum PNT operation is radical potentiality & conditionality for cosmos always ready to orientate itself towards perfection.

be applicable to dark matter, even the gravitational reciprocity/interaction between dark matter and matter is just the same going without saying, so that the gravitational reciprocity between dark matter and celestial bodies in galaxy can complement the deficiency of gravitational reciprocity among celestial bodies in galaxy out of question.

Finally, what I have to comment herein is that, as magistral autarchy of “free press regulation customization” and “free press admittance” of temporal authority short of necessary intendance in the recent half century, historical progress of science was injected too much egotistic ambition & motivity of temporal authority, so that, relative to general endeavor of historical progress of science to push humanistic ideology about authenticity of nature forward to perfect ideological enantiomorph of ultimate authenticity of nature step by step draw on practical feasibility & possibility in proportion to contemporaneous historical background, the most remarkable deformed character of royal substantiation & perfection of contemporaneous scientific orthodoxy seems endeavor to manage possible development of science even possible substantiation & perfection of contemporaneous scientific orthodoxy under default that contemporaneous scientific orthodoxy are all absolute scientific truths out of question, which almost takes full role of live historical progress of science, this is of course the major reason I have to comment that modern physics is floundering around in riancy.

Virtually, since we had perceived factuality that, in accordance with authentic overall arrangement of all celestial bodies in galaxy, the hypostatic gravitational reciprocity/interaction among all celestial bodies in galaxy is apparently less than theoretically necessary gravitational reciprocity/interaction among all the celestial bodies in galaxy, we had substantial reasons to suspect reliability of traditionary sciences as “gravity theory” as well. Whereas, under background of royal substantiation & perfection of contemporaneous scientific orthodoxy, we suspected nothing about reliability of traditionary sciences as gravity theory kind, instead, we were always ready to expand and solid compatibility of traditionary sciences by implementing lineal logic extension in succession of contemporaneous scientific orthodoxy once factuality out of theoretical prediction of contemporaneous scientific orthodoxy occurred. Do you think it's healthy endeavor for historical progress of science?

The authenticity related to mass scale of celestial bodies is that, generally, the more massive celestial bodies relatively have lower moving speed in spacetime, once the massive celestial bodies slide into relative weak space field interlayer among galaxies and consequently incur damage of yolk towards white transmutable pervasion, matter integration of massive celestial bodies possess substantial time to disentangle themselves from damage of yolk towards white transmutable pervasion by PNT equilibrium instinct, which instinctively induce celestial bodies to quit relative weak space field interlayer among galaxies by the light of nature and stay in galaxy as themselves instead of escaping from the galaxy.

In straightforward words, as presence of relative weak space field interlayer among galaxies, the celestial bodies in galaxy are not easy to escape from galaxy, the more massive celestial bodies in galaxy, their existence in galaxy is more steady, they are more difficult to escape from the galaxy.

In terms of tiny celestial bodies in galaxy:

Mass scale of celestial bodies in galaxy not only indicates proportionable potentiality for anti-damage of yolk towards white transmutable pervasion but also indicates proportionate PNT equilibrium instinct of matter integration, the more tiny celestial bodies proportionably have less potentiality for anti-damage of yolk towards white transmutable pervasion and inherently possess small-scale PNT equilibrium instinct in proportion to their mass scale. Once celestial bodies slide into relative weak space field interlayer among galaxies by chance, one side of matter field of matter integration of celestial body must firstly slide into relative weak space field interlayer among galaxies and incur damage of yolk towards white transmutable pervasion therefore. As inherent presence of instinctive PNT equilibrium of matter integration, celestial body must sensitively react to evade damage of yolk towards white transmutable pervasion as out-and-out self-preservation immediately, which seems instinctive rebound action from the relative weak space field interlayer among galaxies too, confinement function of relative weak

Historical progress of science in the recent several centuries seemed like a far-flung exploration of the first itinerary around numerous distinctive landscapes of brand-new landmasses of science with palette & tablet on back, several hundred years' scientific travelogues were compiled thereby.

space field interlayer among galaxies is accomplished thereby. As a result, celestial bodies in galaxy are not easy to escape from galaxy.

The authenticity related to mass scale of celestial bodies is that, generally, the more tiny celestial bodies relatively have higher moving speed in spacetime, once the tiny celestial bodies slide into relative weak space field interlayer among galaxies and consequently incur damage of yolk towards white transmutable pervasion, matter integration of tiny celestial bodies possess less time to disentangle themselves from damage of yolk towards white transmutable pervasion by PNT equilibrium instinct, the reaction of PNT equilibrium instinct as self-preservation is more festinate, there are more opportunities for tiny celestial bodies to run through the relative weak space field interlayer among galaxies and escape from the galaxy, although, matter integration has inherent PNT equilibrium instinct in proportion to its mass scale to react to evade damage of yolk towards white transmutable pervasion.

In straightforward words, as presence of relative weak space field interlayer among galaxies, the celestial bodies in galaxy are not easy to escape from galaxy. Whereas, relatively, tiny celestial bodies in galaxy mostly move in higher speed, they have more sufficient dynamic potentiality to run through the relative weak space field interlayer among galaxies and possess more probability to escape from the galaxy therefore.

Mass scale of photon is very tiny, whereas, moving speed of photon is rather high. Generally, the confinement strength of relative weak space field interlayer among galaxies in cosmic yolk extent is relatively weak, it's almost impossible for relative weak space field interlayer among galaxies to confine lights from stars in galaxies like light-exhaustion medium lamella confining lights in cosmic yolk extent. Whereas, once lights run through relative weak space field interlayer among galaxies, proportionable red shift of lights from galaxies must occur in the nature of things, which is just medium field weakening domino effect of lights. In terms of lights from galaxies faraway, the more relative weak space field interlayer among galaxies they have run through, the wider weakening range of the relative weak space field interlayer among galaxies is, the more remarkable red shift of lights from galaxies must occur accordingly. This of course indicates the physical effect of red shift of lights from galaxies the observer can perceive depends on how many relative weak space field interlayer among galaxies the lights from the target galaxies to the observer have to run through and what's the idiographic weakening range of each relative weak space field interlayer among galaxies, it has nothing to do with the position of the observer.

This of course indicates, **galaxies going away from us** is not the unique possible cause for red shift of lights from galaxies, **lights from faraway galaxies having run through substantial relative weak space field interlayer among galaxies** is solid cause for red shift of lights from galaxies too. Whereas, once we insist **galaxies going away from us** is unique possible cause of red shift of lights from galaxies, and the variation range of red shift of lights from galaxies is mostly proportionable to the speed galaxies going away from us, the variation range of red shift is more remarkable, the faster the galaxies going away from us, then, the self-evident conclusion is that all galaxies in cosmos are going away from us, what's more, there are even solid observation data which indicates the more faraway galaxies we observed, the variation range of red shift of lights from the galaxies are more remarkable, we add such factuality into rationality of the variation range of red shift of lights from galaxies is mostly proportionable to the speed galaxies going away from us, we can even straightforwardly reach conclusion that the galaxies more faraway from us usually go away from us faster. And the even magic factuality is that red shift of lights from galaxies is almost universal factuality, wherever you stand in cosmos and observe galaxies around, red shift of

lights from galaxies like this seems invariable authenticity of nature.

This is just academic art temporal authority resort to produce **The Big Bang** on the basis of [Observation data of red shift of lights from galaxies + “red shift of lights” proportionably resulting from “galaxies flying away”].

As remarkable discrepancy between academic art of [Observation data of red shift of lights from galaxies + “red shift of lights” proportionably resulting from “galaxies flying away”]=The Big Bang and medium field weakening domino effect of lights under rational background of homogenous cosmos originated from unique genesis that lights from galaxies running through relative weak space field interlayer among galaxies must proportionably result in physical domino effect of red shift, remarkable issues worthy of emphasis herein are as below:

Let’s suppose cosmos originally coming into being by a magic Big Bang of so-called singularity, of course, the so-called singularity must be both the start point and center point of cosmos. For convenience of lingual expression, we denote the start point and center point of cosmos “O”. in accordance with our general experience about universal existence & motion, we can suppose, after the instantaneous Big Bang, the situation mass outgrowth from the so-called singularity with ingenerate acceleration must be equivalent in all direction. Naturally, after instantaneous occurrence of the Big Bang, the hypostatic cosmic view must be as below:

Since we suppose the singularity of the Big Bang is point “O”, after the Big Bang, point “O” must be the global center of cosmos. And centralized point “O”, all radical output of mass with inherent acceleration may be generally equivalent in all direction. If we denote the absolute value of acceleration of the mass in all direction “a”, of course, it’s impossible for acceleration a to be constant, but serial values of acceleration of rich and colorful objects moving outwards, we can of course suppose $a \in (\alpha, \beta)$. Then, T seconds after the Big Bang of so-called singularity, we can perceive the radius of cosmos $R=0.5\beta T^2$. Since the cosmos is outgrowth of the Big Bang, the absolute value of acceleration of any mass originally derived from the Big Bang must be bigger than 0 ($\alpha > 0$), if the absolute value of acceleration of idiographic mass derived from the Big Bang of so-called singularity is just 0, nothing can support the idiographic mass to be out-and-out outgrowth of the Big Bang for there is no way for the mass to come out of the so-called singularity and become a part of cosmos. All in all, “a” must be acceleration value bigger than 0, ($\alpha > 0$).

“ $\alpha > 0$ ” of course indicates, as outgrowth of the Big Bang, there must be an empty globe in the center of cosmos, T seconds after the Big Bang, the radius of center empty globe is $r=0.5\alpha T^2$. It’s still a serious question whether it’s possible for lights to exist in the center empty globe. This of course indicates, as outgrowth of the Big Bang, it’s only possible for hypostatic integrative profile of cosmos to be an enormous global lamella, T seconds after the Big Bang, outside radius of the enormous global lamella is $R=0.5\beta T^2$, the radius of center empty globe is $r=0.5\alpha T^2$.

Once we confirm that cosmos is outgrowth of a Big Bang of so-called singularity, the cosmic center point O must be definite and unique as original location of the so-called singularity. T seconds after the Big Bang, the cosmic view is of course definite, and it’s only possible for us to perceive the original view of the Big Bang of cosmos when we observe cosmic view of the Big Bang standing at the cosmic center point O, once we leave off the cosmic center point O, there is no way for us to perceive the original view of the Big bang of cosmos, there must be proportionate tolerance of our observation view of the Big Bang of cosmos once we observe cosmic view of the Big Bang out of observation position of cosmic center point O.

Historical progress of science in the recent several centuries seemed like a far-flung exploration of the first itinerary around numerous distinctive landscapes of brand-new landmasses of science with palette & tablet on back, several hundred years’ scientific travelogues were compiled thereby.

For instance, we observe cosmic view of the Big Bang standing at idiographic points A, B, C, D, E, F, G, ..., the resultant observation view of the Big Bang of cosmos must be different with proportionate tolerance for observation position shift, which can be illustrated as below:

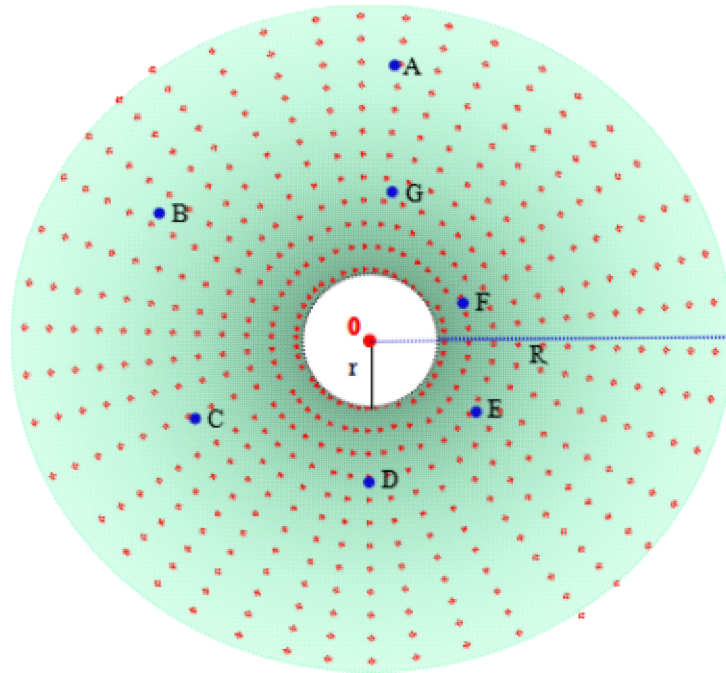

(IV-ii-7) Analytic illustration of observation view discrepancy of the Big Bang of cosmos in different observation position

For instance, in illustration above, there are “point D” and “point G” which are almost symmetrical against cosmic center point **O**.

If we observe the Big Bang view standing at cosmic center point **O**, we must find both galaxies or celestial bodies at point D and galaxies or celestial bodies at point G flying away from the cosmic center point **O** in inverse orientation with almost the same absolute speed & acceleration.

If we observe the Big Bang view standing at point A, we must find that galaxies or celestial bodies at point G flying away from point A in relatively low speed and acceleration (After all, in accordance with Big Bang dynamic fundamental, referred to point **O**, the speed and acceleration of galaxies or celestial bodies at point A flying away from cosmic center point **O** must be higher than the speed and acceleration of galaxies or celestial bodies at point G flying away from cosmic center point **O**, as a result, once we observe existence & motion of galaxies or celestial bodies at point G standing at point A, we must find galaxies or celestial bodies at point G flying away in relative low speed and acceleration) and galaxies or celestial bodies at point D flying away from point A in relatively high speed and acceleration.

The resultant observation distinction for observation position shift is of course self-evident.

Virtually, our observation position is relatively closer to the cosmic center point **O**, our observation view of the Big Bang of cosmos is more similar as the original view of the Big Bang of cosmos with proportionate tiny tolerance. Inversely, if our observation position is relatively more faraway from the cosmic center point **O**, relative to the original view of the Big Bang of cosmos, tolerance of our observation view of the Big Bang of cosmos must be more remarkable. Only when we turn back to the cosmic center point **O**, we can observe the original view of the Big Bang of cosmos all wool and a yard wide.

Considered by Homogenous Cosmos Originated from Unique Genesis:

As coherent natura naturans throughout cosmic evolution, instinctive PNT reciprocal equilibrium towards optimum PNT operation is radical potentiality & conditionality for cosmos always ready to orientate itself towards perfection.

①. Lights coming from faraway galaxies to the observer must run through relative weak space field interlayer among galaxies between target galaxies and observer, any light run through relative weak space field interlayer among galaxies must occur proportionable physical domino effect of **red shift**, which is just conditional field weakening domino effect of lights.

②. Once reaching us, the lights from galaxies more faraway from the earth must have run through more relative weak space field interlayer among galaxies, the physical domino effect of red shift of them must be more remarkable therefore.

③. No matter where we stand to observe galaxies in cosmos, the physical domino effect of red shift of lights from galaxies mostly depends on how many relative weak space field interlayer among galaxies the lights have run through and what's the idiographic weakening range of the relative weak space field interlayer among galaxies which the lights have run through.

The general overall arrangement of galaxies in cosmos is, the more faraway galaxies from us, there are proportionable more relative weak space field interlayer among galaxies between the target galaxies and us. Since the physical red shift domino effect of lights from galaxies is because the lights have passed through proportionable relative weak space field interlayer among galaxies between target galaxies and us, the lights from more faraway galaxies must have run through more relative weak space field interlayer among galaxies once they reach us, as a result, physical domino effect of red shift of the lights must be more remarkable.

In the face of remarkable divarication between **The Big Bang** and **Homogenous Cosmos Originated from Unique Genesis**, we can hardly stop our question—what's the radical cause of physical domino effect of red shift of lights from faraway galaxies?

Is it straightforward physical domino effect of **galaxies flying away from us**?

Is it straightforward medium field weakening domino effect of lights that, **before ultimately reach us, the lights from faraway galaxies have passed through substantial relative weak space field interlayer among galaxies**?

This is still serious issues need further clarification & authentication, although, the Big Bang theory had been self-dramatically carried up to social legitimacy throne by temporal authority early. Whereas, as coetaneous renovation of humanistic ideology about authenticity of nature in proportion to contemporaneous historical background of remarkable highlight of microcosmic configuration of matter, free press admittance of Homogenous Cosmos Originated from Unique Genesis can hardly evade pestilent duress of overwhelming authoritative intrepidity of contemporaneous scientific orthodoxy through and through, it even seems free press admittance of Homogenous Cosmos Originated from Unique Genesis must break through legitimacy defense line of contemporaneous scientific orthodoxy, so that it has to challenge venomous counterwork upper limit of temporal authority without alternatives.

2.5.5. Relativity domino effect of cosmic profile

As object in spacetime, idiographic existence & motion of us will inevitably bring out spacetime dynamic assimilation. Relative to time dynamic speed, the bigger our motion speed is, the more remarkable effect of dynamic assimilation of relative spacetime is, we can perceive less and less cosmic endosome thereby. Once our motion speed approaches time dynamic speed, we can only find the entire cosmos limited in a line, beside with ourselves in mind, nothing else we can physically perceive in cosmos, and as none reference accessible, there is no way for us to perceive whether we are moving or stationary.

—Firstly written in Oct. 2013, Dongguan, Shatian, Nanxing
Revision was done in Oct. 2015, Dongguan, Shatian, Nanxing

(IV-iii) Dynamic essence of universal existence & motion and absolute compatibility of systematic substantiality quantification of cosmic homogeneity system making up out-and-out serial natura naturata in the nature of coherent natura naturans throughout cosmic evolution

Abstract: *Essentiality of matter radically comes into being during the course of original generation & formation of matter and is kept with matter existing as idiographic object under the proper generative & formative preconditions. The dynamic regularity of universal existence & motion in homogenous cosmos radically roots in homologic generation of matter, —sequential generation of homologic genic unit series of $i_0, i_1, i_2, \dots, i_n, i_{n+1}, i_{n+2}, i_{n+3}, \dots, i_{n+p}$, ($n, p \in \mathbb{N}$) and gradual enrichment of elementary genic units $i_{n+1}, i_{n+2}, i_{n+3}, \dots, i_{n+p}$, ($n, p \in \mathbb{N}$) in spacetime stochastically accomplish “reciprocal idiosyncrasy towards PNT equilibrium + accessible space overall arrangement for PNT reciprocity” step by step. Resultingly, reciprocal PNT combinations in gradation I, reciprocal PNT combinations in gradation II, reciprocal PNT combinations in gradation III, reciprocal PNT combinations in gradation IV come into being in the nature of instinctive PNT reciprocal equilibrium towards optimum PNT operation one after another and enrich in spacetime. Matter generated as lineal homologic outgrowth of hylic space field predestines the PNT action is ingenerate attribute of matter, which radically determines existence & motion of matter in spacetime. Of course, such factuality even predestines the “absolutely free quantification conversion accessibility” throughout cosmic homogeneity system and homologic mathematical illation logic rooted in essentiality of homogenous cosmos originated from unique genesis.*

Keywords: *homologic objects originated from cosmic genic origin, non-homologic objects originated from cosmic genic origin, unique-genesis homogenous quantification and unique-genesis homogenous symbolic logic.*

1. Homologic existence & motion of matter in homogenous cosmos

1.1. Universal existence & motion are just essence objectification of matter in cosmos, —spontaneous occurrence of [External physical disturbance + (PNT action + Instinctive PNT equilibrium)] in the nature of instinctive PNT reciprocal equilibrium towards optimum PNT operation.

General existence & motion of matter in cosmos of course includes the transnormal mutual transmutation & transition among accessible field genic units and common existence & motion of positive matter including elementary genic units and reciprocal PNT combinations in spacetime. We highlight something about existence & motion herein is mainly aiming at common existence & motion of positive matter including elementary genic units and reciprocal PNT combinations in spacetime. In straightforward words, existence & motion is but idiographic embodiment of essentiality of matter in spacetime, —homologic generation of matter in homogenous cosmos has inherently predestined the PNT action of matter integration, and PNT action of matter integration radically determines idiographic existence & motion of matter in spacetime.

So-called “matter existence” is that, when matter integration performs PNT action under proper spacetime condition by the light of nature, integrative situation that integral cumulation of negative towards positive transmutation from field genic units to elementary genic units $\int_0^t d(M \rightarrow m) dt$ - integral cumulation of positive towards negative transmutation from elementary genic units to field genic units $\int_0^t d(M \leftarrow m) dt$ = selfhood physical

As coherent natura naturans throughout cosmic evolution, instinctive PNT reciprocal equilibrium towards optimum PNT operation is radical potentiality & conditionality for cosmos always ready to orientate itself towards perfection.

esse of positive matter with mass residue $m > 0$ (which indicates $\int_0^t [d(M \rightarrow m) - d(M \leftarrow m)] dt = m > 0$ in time current) is maintained in relatively steady idiographic succession with absolute spacetime momentum $mV = d(M \leftarrow m) * Y$ ever since.

As a result, matter existence can be mathematically formulated as below:

$$\begin{cases} \int_0^t [d(M \rightarrow m) - d(M \leftarrow m)] dt = m > 0 \\ mV = d(M \leftarrow m) * Y \end{cases}$$

In a simple word, so-called “matter existence” is spontaneous physical occurrence due to PNT action with instinctive PNT equilibrium of matter integration once integral accumulation of living positive & negative transmutation of matter integration satisfies $\int_0^t [d(M \rightarrow m) - d(M \leftarrow m)] dt = m > 0$, which usually implicates magnitude of mass, configuration and energetic status of matter integration.

So-called “matter motion” is that, when matter integration performs PNT action under proper spacetime condition by the light of nature, as external dissonance to PNT performance of matter integration, integrative situation that integral cumulation of negative towards positive transmutation from field genic units to elementary genic units $\int_0^t d(M \rightarrow m) dt$ - integral cumulation of positive towards negative transmutation from elementary genic units to field genic units $\int_0^t d(M \leftarrow m) dt =$ selfhood physical esse of positive matter with mass residue $m > 0$ (which indicates $\int_0^t [d(M \rightarrow m) - d(M \leftarrow m)] dt = m > 0$ in time current) and absolute spacetime momentum $mV = d(M \leftarrow m) * Y$ is consequently disturbed. The radical indication integrative situation that integral cumulation of negative towards positive transmutation from field genic units to elementary genic units $\int_0^t d(M \rightarrow m) dt$ - integral cumulation of positive towards negative transmutation from elementary genic units to field genic units $\int_0^t d(M \leftarrow m) dt =$ selfhood physical esse of positive matter with mass residue $m > 0$ and absolute spacetime momentum $mV = d(M \leftarrow m) * Y$ is disturbed is $d(M \rightarrow m) \neq d(M \leftarrow m)$. Of course, once “ $d(M \rightarrow m) \neq d(M \leftarrow m)$ ” of matter integration occurred, spontaneous occurrence of PNT action with instinctive PNT equilibrium must be subject to fundamental of instinctive PNT reciprocal equilibrium towards optimum PNT operation, and instinctive PNT equilibrium in operation must accomplish quantitative change from $d(M \rightarrow m) \neq d(M \leftarrow m)$ towards $d(M \rightarrow m)' = d(M \leftarrow m)'$ as expediently as possible, $d(M \rightarrow m) \neq d(M \rightarrow m)'$; $d(M \leftarrow m) \neq d(M \leftarrow m)'$.

As a result, matter motion can be mathematically formulated as below:

$$\begin{cases} \int_0^t [d(M \rightarrow m) - d(M \leftarrow m)] dt = m > 0 \\ mV = d(M \leftarrow m) * Y \\ d(M \rightarrow m) \neq d(M \leftarrow m) \quad \xrightarrow{\text{PNT}} \quad d(M \rightarrow m)' = d(M \leftarrow m)' \end{cases}$$

In a simple word, so-called “matter motion” is but, under precondition that matter integration satisfies mass integral accumulation $\int_0^t [d(M \rightarrow m) - d(M \leftarrow m)] dt = m > 0$ in time current, PNT action has to rebuild the perfect operation of PNT action of matter integration by the right of instinctive PNT reciprocal equilibrium towards optimum PNT operation once some certain external disturbance occurs to PNT operation of matter integration so as to cause occurrence of $d(M \rightarrow m) \neq d(M \leftarrow m)$, —spontaneous occurrence in the nature of instinctive PNT reciprocal equilibrium towards optimum PNT operation proportionate to external disturbance, which usually implicates magnitude of mass, configuration and energetic status of matter integration. In above equations, the symbolic mark “” indicates spontaneous dynamic orientation of matter integration from initial state $d(M \rightarrow m) \neq d(M \leftarrow m)$ to target state $d(M \rightarrow m)' = d(M \leftarrow m)'$ in the nature of instinctive PNT reciprocal equilibrium

towards optimum PNT operation.

1.2. "PNT dynamics" is freewheeling approach of logic extension of "cosmic homology hypostatization + Instinctive PNT equilibrium postulate"

The hypostatic connotation that PNT dynamics is freewheeling logic extension of homology hypostatization of cosmic endosome is generally as following:

The confirmation of Homogenous cosmos originated from unique genesis postulate with supplementation of the first 0.5 grade auxiliary hypothesis of "Spacetime-matter fully embodying cosmos postulate" makes the two logic extensions of Homogenous cosmos originated from unique genesis postulate self-evident, succedent hypostatization ① of the two logic extensions of Homogenous cosmos originated from unique genesis postulate materialized homology hypostatization of cosmic endosome, which logically lead to rational extension as below:

A) Rationale objectification of logic extension 1 of Homogenous cosmos originated from unique genesis postulate directly leads out logos of "space field" and "time dynamic speed".

Under intense rational illumination of logic extension 1 of Homogenous cosmos originated from unique genesis postulate, as long as we have no reason to exclude spacetime out of category of cosmos, we have to confirm that spacetime must be coordinative homology of matter and must be as physical as matter. Thus, even though homologic notion of space field is always naughtily ready to slide over us, there is openly no way for it to. At any rate, nothing seems so powerful to indulge us validating, as coordinative homology of matter, spacetime is another block of material cake as twinborn sister of matter; even though homologic notion of time dynamic speed is always naughtily ready to slide over us, there is openly no way for it to. In any case, nothing seems so powerful to indulge us validating, as coordinative homology of matter, hylic spacetime is but absolutely stationary esse. The key issue is how to identify and define the dynamic connotation of space field accordingly.

As coherent homology correlations throughout cosmic endosome, especially deduction of alternative homologic filiation of spacetime & matter even ultimate confirmation of **spacetime father & matter son**, it apparently indicates inherence of PNT action between spacetime and matter even succession of dynamic connotation of spacetime to connatural existence & motion of matter in spacetime by performance of PNT action.

And indeed, time dynamic speed is comprehensive dynamic origin of universal existence & motion even including motivity of cosmic evolution; if no time dynamic speed, cosmos is but cosmic genic origin itself without any physical connotation, no time, no space, no existence & motion, no process, no more dynamics. Virtually, the absolute spacetime momentum of matter in spacetime directly originate from time dynamic speed Y, which is accordingly defined as $mV=d(M\leftarrow m)Y$, force, acceleration, velocity, displacement, momentum change and energy change of matter integration, none of them can be defined without involvement of time dynamic speed.

Note ①: virtually, introduction of Homogenous cosmos originated from unique genesis postulate and emergence of the 2 logic extensions of Homogenous cosmos originated from unique genesis postulate have shaped the general configuration and conformation of cosmos, succedent introduction of spacetime homology hypostatization in cosmic homogeneity system in accordance with logic extension 1 and Homologic generation of matter in cosmos in accordance with logic extension 2 is but job to make the logos of 2 logic extensions of Homogenous cosmos originated from unique genesis postulate more hypostatic and well-rounded accreted onto tangible cosmic endosome for further illumination of cosmos just as job to have "rice" cooked with necessary water in for nice "meal".

As coherent natura naturans throughout cosmic evolution, instinctive PNT reciprocal equilibrium towards optimum PNT operation is radical potentiality & conditionality for cosmos always ready to orientate itself towards perfection.

B) Objectification of logic extension 2 of Homogenous cosmos originated from unique genesis postulate directly leads to alternative homologic filiation even PNT action between spacetime and matter, it even consequently approach PNT dynamics once PNT action is specified by “Instinctive PNT equilibrium postulate”.

In homogenous cosmos originated from unique genesis, filiation confirmation of “spacetime father & matter son” not only directly leads to homologic generation of matter along sequential homologic cosmogony, but also indirectly indicates inherence of PNT correlation (/PNT action) between spacetime and matter, and PNT action inherently involves universal existence & motion of matter in spacetime, which not only directly causes original generation of matter, but also is congenitally kept as essentiality of matter and radically determines general existence & motion of matter as well. Resultingly, in order to study existence & motion of matter in spacetime, we should above all clarify and master the innative PNT action of matter integration. After all, in homogenous cosmos, study existence & motion of matter is but job to illuminate how PNT action radically dominates idiographic existence & motion of matter under certain ambient in the nature of instinctive PNT reciprocal equilibrium towards optimum PNT operation.

As a result, in the face of such rational purview, we can easily see, so-called “matter existence” is but spontaneous occurrence due to PNT action with instinctive PNT equilibrium of matter integration once integral accumulation of the positive matter of matter integration satisfies $\int_0^t [d(M \rightarrow m) - d(M \leftarrow m)] dt = m > 0$. As a result, in the face of such rational purview, we can easily see, so-called “matter motion” is under precondition that matter integration satisfies mass integral accumulation $\int_0^t [d(M \rightarrow m) - d(M \leftarrow m)] dt = m > 0$ in time current, PNT action has to rebuild the perfect operation of PNT action of matter integration upon instinctive PNT reciprocal equilibrium towards optimum PNT operation once some certain external disturbance impact PNT operation of matter integration so as to make occurrence of $d(M \rightarrow m) \neq d(M \leftarrow m)$, —spontaneous occurrence in the nature of instinctive PNT reciprocal equilibrium towards optimum PNT operation due to proportionate external disturbance.

Although, logic extension and proper connotation objectification of “homogenous cosmos originated from unique genesis + spacetime~matter fully embodying cosmos” has virtually illuminated that PNT action is essence of matter and PNT action is not only headspring creation of original generation of matter along sequential homologic cosmogony but also dynamic origin of postnatal existence & motion of matter in spacetime, which apparently indicates that existence & motion of matter radically roots in PNT action of matter integration, such illumination is still not enough to strictly define existence & motion of matter in cosmos, it’s still blurry notion for further formulation of existence & motion. For instance, it can not show us why matter have to motion, how to motion, what’s the goal orientation of motion and what’s the connatural approach for matter to orientate to existent goal? The key issue is there must be certain dynamic fundamental of PNT action underlying which indicates sense of the demiurge.

Towards accomplishment of the very issues, Homogenous Cosmos originated from Unique Genesis has to introduce the second 0.5 grade auxiliary postulate of Instinctive PNT equilibrium postulate. The introduction of Instinctive PNT equilibrium postulate presumably affirms universal existence & motion are congenitally equilibrium orientated, cosmos is always ready to orientate itself towards perfection by the right of nature, cosmic status is but demiurgic aggradation of serial spontaneous occurrence of instinctive PNT reciprocal equilibrium towards optimum PNT operation ever since, and cosmos will go on its innate freewheeling of instinctive PNT reciprocal equilibrium towards optimum PNT operation towards integrative perfection for ever. PNT dynamics is just the mathematical formula of matter spontaneously acclimating themselves towards PNT equilibrium perfection.

Historical progress of science in the recent several centuries seemed like a far-flung exploration of the first itinerary around numerous distinctive landscapes of brand-new landmasses of science with palette & tablet on back, several hundred years’ scientific travelogues were compiled thereby.

The introduction of Instinctive PNT equilibrium postulate ultimately accomplished freewheeling logic extension from homology hypostatization of entire cosmic endosome to PNT dynamics, and cosmos redefinition comes into being therefore.

Further, once mentioning the PNT dynamics principium, I always think of the so-called “Tanji-8-Gua pattern”. I think the “Taiji-bagua pattern” can visually reflect and racily incarnate the thought quintessence of Homogenous Cosmos Originated from Unique Genesis, especially the instinctive PNT equilibrium of PNT dynamics as below.



(Diagram IV-iii-10) Taiji-bagua—PNT equilibrium

In the pattern above, the white vacant fish profile district represents the space field, (Just the “spacetime” or matter field) and the red fish profile represents “matter”; the white vacant fish profile district and the red fish profile district coexist in and cram the TaiJi-8-gua circle implies that the cosmos consists of “spacetime” and “matter” (The Chinese word “TaiJi” herein maybe mean “cosmos” ten to one for whose Chinese literal meaning is just upmost limit of large scale, nothing can be even grander than it). The “fish eye” in the red fish profile district represents “positive (m)”, and the “fish eye” in the white vacant fish profile district represents “negative (M)”. The covariant circumgyration of the fish profile curve between the white vacant fish profile district and the red fish profile district represents the connatural infiltration correlation between spacetime and matter —just the positive & negative transmutation (PNT) between spacetime and matter; and the everlasting dynamic symmetry of the white empty fish profile district and the red fish profile district represents the instinctive PNT equilibrium of matter integration, it implies that no matter how the fish profile curve circumgyrates and no matter what the circumgyration process is, the white vacant fish profile district and the red fish profile district are always ready to keep symmetrical or equilibrium. (Readers may refer to the matter inertial conservation equations and PNT dynamics.)

It's evidently comprehensible that **it's only possible for concordant cosmos to be demiurgic aggradation of out-and-out serial natura naturata in the nature of coherent natura naturans throughout cosmic evolution; there is no way for demiurgic aggradation in the nature of different natura naturans to be concordant cosmos through and through.** Considered by Homogenous Cosmos Originated from Unique genesis, the “unique coherent demiurgic fundamental” of cosmos mentioned herein is just the PNT dynamic equilibrium incarnated in “Taiji-8-gua pattern”. Universal existence & motion are performing and will going on performing in accordance with instinctive PNT reciprocal equilibrium towards optimum PNT operation and PNT dynamics is but mathematical formulation of instinctive PNT reciprocal equilibrium towards optimum PNT operation.

In terms of the “8-Gua” around the “TaiJi circle”, whether the so-called “8-Gua” directly means there are totally 8 elementary genic units in cosmos originated from three field genic units in spacetime?

As coherent natura naturans throughout cosmic evolution, instinctive PNT reciprocal equilibrium towards optimum PNT operation is radical potentiality & conditionality for cosmos always ready to orientate itself towards perfection.

One rational guess maybe like this: the number “8” of the noun “8-Gua” means that there are totally 3 sorts of field genic units, and consequently, the number “8” of the so-called “8-Gua” indicates there are totally 8 sorts of stochastic transmutation and dissipation cases of existence of elementary genic units in spacetime.

The first case is that an elementary genic unit has upmost probability to be converged by 3 field genic units in different sorts in space field totally, however, during certain existent interval throughout PNT performance, none of the 3 field genic units in different sorts stochastically converged— $C_3^0=1$, which means there are totally 1 probabilistic existent case for the elementary genic unit to shape its configuration in spacetime.

The second case is that an elementary genic unit has upmost probability to be converged by 3 field genic units in different sorts in space field totally, however, during certain existent interval throughout PNT performance, only 1 of the 3 field genic units in different sorts stochastically converged— $C_3^1=3$, which means there are totally 3 probabilistic existent cases for the elementary genic unit to shape its configurations in spacetime.

The third case is that an elementary genic unit has upmost probability to be converged by 3 field genic units in different sorts in space field totally, however, during certain existent interval throughout PNT performance, only 2 of the 3 field genic units in different sorts stochastically converged— $C_3^2=3$, which means there are totally 3 probabilistic existent cases for the elementary genic unit to shape its configurations in spacetime.

The fourth case is that an elementary genic unit has upmost probability to be converged by 3 field genic units in different sorts in space field totally, however, during certain existent interval throughout PNT performance, 3 of the 3 field genic units in different sorts stochastically converged— $C_3^3=1$, which means there are totally 1 probabilistic existent case for the elementary genic unit to shape its configuration in spacetime.

And as a result, $C_3^0 + C_3^1 + C_3^2 + C_3^3 = 1 + 3 + 3 + 1 = 8$, which means, as elementary genic units converged by three field genic units in different sorts have to exist in everlasting PNT operation, there are only 8 probabilistic existent cases for elementary genic units to shape their configurations totally. Of course, this is still primary guess.

I wonder where the 8-Gua pattern originally came from; its profile is really occult. In our hometown, many tablets with beautiful godlike taiji-8-Gua pattern on both sides can be found before howffs, why our progenitors venerated the TaiJi-8-Gua pattern so much?



And virtually, when the “Matter inertial conservation equations” were primarily set up, I had no idea of introduction of the so-called “Taiji-8-Gua pattern” as physical aesthetic ideographic icon of dynamic equilibrium indeed, just because some days, I frequently passed the ways aside the houses, in front of which tablet with such godlike and aesthetic pattern on stood quietly.

I suddenly perceived the pattern had wonderful ideographic profile of “dynamic equilibrium”, if just to introduce it as ideographic icon to represent the “dynamic equilibrium”

of matter integration, nothing can be even better than it, I then introduced it. I even had to suspect that the TaiJi-8-Guar pattern was exactly originality for vivid representation of spontaneous dynamic equilibrium of matter in the nature, otherwise, why our forebears called it “YiJing(易经)”, which literally means “transition & transmutation fundamental between positive objects and negative objects”, does it just mean “fundamental of positive & negative transmutation (PNT)” between positive matter and the proper matter field?

We may also comprehend the integrative connotation of the “Taiji pattern” compared to the logic constitution of PNT dynamics.

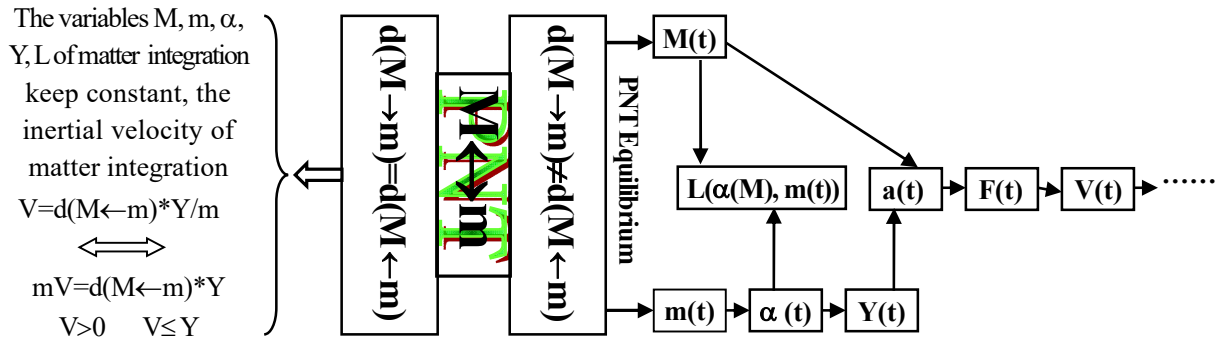

(Diagram IV-iii-11) logic constitution of PNT dynamics

1.3. Homologic interaction in homogenous cosmos

Variation of existence & motion is usually materialized by “interaction”, so-called “interaction” is but physical process matter integration spontaneously arises instinctive PNT reciprocal equilibrium towards optimum PNT operation against external PNT operational disturbance of matter integration.

As spontaneous occurrence of instinctive PNT reciprocal equilibrium towards optimum PNT operation due to presence of PNT operational disturbance among matter integration, all state parameters of matter integration vary accordingly, matter inertial conservation equations turn into:

$$\left\{ \begin{array}{l} M(t)+m(t)= R(t) \\ M(t)/m(t) = K(t) \\ V(t)*m(t)= d(M\leftarrow m)(t)* Y(t) \\ L^3(t)*\alpha(t)=A*m(t) \\ Y(t)=B*\alpha(t) \end{array} \right. \iff \left\{ \begin{array}{l} M(t)=K(t)*R(t)/[1+K(t)] \\ m(t)=R(t)/[1+K(t)] \\ V(t)= d(M\leftarrow m)(t)*Y(t)/ m(t) \\ L^3(t)= A*m(t)/ \alpha(t) \quad (\otimes) \\ Y(t)=B*\alpha(t) \quad (\otimes) \end{array} \right.$$

Matter integration arises acceleration:

$$a(t)=Y(t)*K'(t)$$

Matter integration arises force:

$$\begin{aligned} F &= m(t)*a(t) \\ &= R(t)*Y(t)*K'(t)/[1+K(t)] \end{aligned}$$

Matter integration arises velocity change:

$$\begin{aligned} V &= V_0 + \Delta V = V_0 + \int a(t)dt \\ &= V_0 + \int Y(t)*K'(t)dt \end{aligned}$$

Matter integration arises displacement:

As coherent natura naturans throughout cosmic evolution, instinctive PNT reciprocal equilibrium towards optimum PNT operation is radical potentiality & conditionality for cosmos always ready to orientate itself towards perfection.

$$S = V_0 * t + \int a(t) dt dt$$

$$= V_0 * t + \int Y(t) * K'(t) dt dt$$

Matter integration arises momentum change:

$$\Delta P = m(t) * V - m_0 V_0$$

$$= R(t) * [V_0 + \int Y(t) * K'(t) dt] / [1 + K(t)] - m_0 V_0$$

Matter integration arises energy change:

$$\Delta E = 1/2 m(t) V^2 - 1/2 m_0 V_0^2$$

$$= 1/2 R(t) * [V_0 + \int Y(t) * K'(t) dt]^2 / [1 + K(t)] - 1/2 m_0 V_0^2$$

Interaction in homogenous cosmos is physical reciprocity materialized by compatible transition & transmutation between interactional objects, Actualization of interaction must satisfy conditions of “**coherent homology for compatible accessibility**” and “**mutual PNT operational interference**”.

A) **Coherent homology for compatible accessibility**: —the interactional objects must be radical homology, so that it’s possible for them to approach material transition and transmutation to materialize physical reciprocity. Otherwise, they are completely inaccessible for reciprocity.

That’s to say, as physical reciprocity must be physically materialized by substantial material transition & transmutation between interactional objects, it of course demands the both interactional objects must be homology, because only homology have hypostatic lineage venation to radically approach mutual transition & transmutation.

If the neutron is object belonging to category of cosmic homogeneity system, whereas, proton is heterogenous object out of category of cosmic homogeneity system, as the both are absolutely inconvertible for they belong to alien homogeneity system, nothing mutually compatible between “neutron” and “proton” can be resorted to materialize physical reciprocity, there is absolutely no way for neutron and proton to combine into nucleus.

If the nucleus is object belonging to category of cosmic homogeneity system, whereas, electron is heterogenous object out of category of cosmic homogeneity system, as the both are absolutely inconvertible for they belong to alien homogeneity system, nothing mutually compatible between “nucleus” and “electron” can be resorted to materialize physical reciprocity, there is absolutely no way for nucleus and electron to combine into atom.

If the oxygen atom is object belonging to category of cosmic homogeneity system, whereas, hydrogen atom is heterogenous object out of category of cosmic homogeneity system, as the both are absolutely inconvertible for they belong to alien homogeneity system, nothing mutually compatible between “oxygen atom” and “hydrogen atom” can be resorted to materialize physical reciprocity, there is absolutely no way for oxygen atom and hydrogen atom to combine into H₂O.

.....

If coalball is object belonging to category of cosmic homogeneity system, whereas, oxygen is heterogenous object out of category of cosmic homogeneity system. As the both are absolutely inconvertible for they belong to alien homogeneity system, nothing mutually compatible as hypostatic conversion medium between “coalball” and “oxygen” can be resorted to materialize physical reciprocity, there is absolutely no way for coalball to burn in oxygen.

If burning coalball in stove is object belonging to category of cosmic homogeneity system, whereas, food

in our boiler is heterogenous object out of category of cosmic homogeneity system. As the both are absolutely inconvertible for they belong to alien homogeneity system, nothing mutually compatible between “burning coalball” and “food” can be resorted to materialize physical reciprocity, there is absolutely no way for the burning coalball to cook the food in boiler.

.....

If there is a car, the four wheels of it are (or bodywork is) made of materials belonging to category of cosmic homogeneity system, whereas, the bodywork (or four wheels are) is made of heterogenous materials out of category of cosmic homogeneity system. As the four wheels and bodywork are absolutely inconvertible for they belong to alien homogeneity system, nothing mutually compatible as hypostatic conversion medium between “the four wheels” and “the bodywork” can be resorted to materialize physical reciprocity, no matter how hard the four wheels run madly, it is impossible for the four wheels to materialize any physical “drive” to the bodywork and push the car forward.

If a bus is made of materials belonging to category of cosmic homogeneity system, whereas, a group of citizens are made up of heterogenous materials out of category of homogenous cosmos, for the same reason, there is absolutely no way for these citizens to take this bus. Even if it is possible for these citizens to go on this bus, virtually, it is completely impossible for the bus to take these citizens from one place to another place.

If there is perdue-aircraft made of heterogenous materials out of category of homogenous cosmos, then, it is easy for us to image the perdue-aircraft is absolutely perdue to any material existence in homogenous cosmos, no more physical attack to the perdue-aircraft. Of course, there is absolutely no way for the perdue-aircraft to implement any physical attack to object in homogenous cosmos as well, no more carrying missiles made of materials in homogenous cosmos. Even if the perdue-aircraft directly knock into the earth, both the perdue-aircraft and the earth will be as safe as nothing happened.

.....

Virtually, as the homogenous characters of spacetime, to any object belonging to category of non-cosmic homogeneity system, “spacetime” originated from cosmic unique genesis is completely “non-existence”, heterogenous object out of homogenous cosmos can never find the presence of “space” & “time” originated from cosmic unique genesis, no more exist & motion in spacetime or interact with object in homogenous cosmos. Such factuality implies that entire cosmic endosome can only be limited in absolute cosmic homogeneity system originated from unique genesis, and there is no way for any heterogenous object to be adulterated in cosmic homogeneity system. And all physical transition & transmutation in cosmos can only be limited in compatible variation within category of cosmic homogeneity system, there is no way for physical transition & transmutation in cosmos to go beyond category of cosmic homogeneity system.

And indeed, in cosmic homogeneity system, any discretionary two objects are mutually convertible; as a result, any discretionary two objects in cosmos can approach physical reciprocity by compatible transition and transmutation, cosmos is throughout integrative.

B) Mutual PNT operational interference, —it means, in order to approach interactional effect, there must be possibility for PNT operation of all interactional objects to be interrelated, which mainly means PNT operational involvement extension of any object in cosmos is not infinite, in order to approach interaction between

objects, the PNT operational involvement extension of both interactional objects must be interrelated in spacetime overall arrangement.

Any gravitational field extension is not infinite; any two celestial bodies are ready to approach gravitational reciprocity, there must be possibility for their gravitational field extension to be interrelated, otherwise, there is no way for them to approach gravitational reciprocity.

Any electrical field extension is not infinite; any two electrified objects are ready to approach electromagnetic interaction, there must be possibility for their electrical field extension to be interrelated, otherwise, there is no way for them to approach electromagnetic interaction.

Any PNT operational linkage extension is not infinite; any two particles are ready to approach strong interaction, there must be possibility for their PNT operational linkage extension to be interrelated, otherwise, there is no way for them to approach strong interaction.

The PNT operational interference of mechanical interaction as extrusion, draught, collision around us is of course self-evident.

Of course, besides “coherent homology for compatible accessibility” and “mutual PNT operational interference”, whether two objects are able to approach interaction is still susceptible to relativity effect; which we’ve introduced in section of “Spacetime and Motion” ahead, so it’s needless to repeat it any more.

2. Absolute compatibility of systematic substantiality quantification of cosmic homogeneity system making up of out-and-out serial natura naturata in the nature of coherent natura naturans throughout cosmic evolution

2.1. “Absolute free quantification conversion accessibility” throughout cosmic homogeneity system.

The logic origin of absolutely free quantification conversion accessibility throughout cosmic homogeneity system is just any discretionary two objects in homogenous cosmos are absolutely convertible. If we say, any discretionary two objects in homogenous cosmos are mutually convertible is qualitative description of attribute of throughout convertible accessibility of homogenous cosmos, absolutely free quantification conversion accessibility throughout cosmic homogeneity system is just the proportionate quantitative description of the same factuality. —Homogenous cosmos originated from unique genesis straightforward means entire cosmic endosome exist in a cosmic-scale homogeneity system originated from unique genesis with sequential lineage correlation of original homologic multiplication in coherent causality, which makes the entire homologic aggregation an integrative homogeneity system through and through.

Since on qualitative opinion, any discretionary two objects in cosmos are mutually convertible, proportionably, on quantitative opinion, any discretionary two physical quantities of objects in cosmos must have mutual quantification conversion accessibility or medium. In another word, on quantitative opinion, all physical quantities in cosmos are convertible too; there is substantial quantification conversion accessibility or medium between any two physical quantities in cosmos.

Consequently, in accordance with general symbolic logic, any two congeneric quantities can be directly added or reduced, as the cosmos is just an absolute cosmic homogeneity system, comprehensive cosmic endosome of course can be regarded as a general congeneric aggregation. Basing on the so-called cosmic genic origin i_0 , any discretionary two objects are mutually convertible by breaking through estrangement in homologic configuration, proportionably, on mathematical opinion; any discretionary two physical quantities can approach

proportionate mathematical conversion by breaking through quantification estrangement parallel to estrangement in homologic configuration. For example:

$$1 \text{ kilogram} \pm 1 \text{ kilometer} = \text{some certain value}$$

In order to calculate this equation, we can convert the quantity in unit of kilogram into quantity in unit of kilometer, then add or reduce them.

For another example;

$$' \pi ' \text{ radian} \pm 1 \text{ second} = \text{some certain value} \quad \text{Or:} \quad 1 \text{ kilogram} \pm 1 \text{ joule} = \text{some certain value}$$

.....

In order to calculate such equations, we may first convert unit “radian” into “second” or convert “second” into “radian”; or convert “kilogram” into “joule” or convert “joule” into “kilogram”, then add or reduce them in the same quantification unit.

.....

For the same reason, any two quantification in the cosmos can be multiplied or divided, for examples:

$$1 \text{ second} \times 1 \text{ light-year} = \text{some certain value} \quad \text{or} \quad 1 \text{ second} \div 1 \text{ light-year} = \text{some certain value}$$

$$' \pi ' \text{ radian} \times 1 \text{ joule} = \text{some certain value} \quad \text{or} \quad ' \pi ' \text{ radian} \div 1 \text{ joule} = \text{some certain value}$$

In order to calculate such equations, we may first convert unit “second” into unit “light-year” or convert unit “light-year” into unit “second”; or convert unit “radian” into unit “joule” or convert unit “joule” into unit “radian”, then multiply or divide them.

That's to say, as entire cosmic endosome consist in cosmic homogeneity system, any two discretionary quantification in cosmos have their substantial conversion relation and can perform mathematical operation in the same equation, none is exceptive. And on the other hand, such factuality inversely indicates that entire cosmic endosome substantively consist in cosmic homogeneity system. If somebody can find such two sorts of quantification in cosmos, and he is able to find tangible proof to demonstrate there is none quantification conversion accessibility between the two sorts of quantification or the two sorts of quantification can not perform mathematical operation in the same equation, then, he either has procured tangible proof to negate the factuality that cosmos is throughout homogenous originated from unique genesis, or he has practically found the “cosmos II”.

And indeed, as all material transition & transmutation in cosmos are just limited in “cosmic homogeneity system”, then, any discretionary quantification in cosmos can only be converted into any other sort of quantification in “cosmic homogeneity system” or can only perform mathematical operation with any other sort of quantification in “cosmic homogeneity system” in the same equation. For instance, a quantity “Q” in cosmic homogeneity system and a quantity out of cosmic homogeneity system “@”, as the both quantities do not belong to the congeneric category of homogeneity system, there is absolutely no way for quantity “Q” and “@” to be converted each other, if we reduce or add them or multiply or divide them in the same equation, we will consequently be confused by it indeed as unintelligible equations as below:

$$Q \pm @ = ???$$

$$\text{Or} \quad Q \times @ = ??? \quad \text{and} \quad Q \div @ = ???$$

In the equations, symbol ??? denotes unintelligibility.

This is of course indicates it's impossible for any cosmic existence has its non-cosmic connotation as well, as cosmic endosome, once we try to perceive existence & motion of all homologic objects around us, the cosmos is so substantially rich and colorful; whereas, as non-cosmic endosome, if we just stand out of cosmos and try to perceive existent profile of cosmos, what's our physical perception?

For instance, upon our intuitional experience and conventional ration, we can of course confirm the earth is but a small globe with scale diameter of certain numeric kilometers; cosmos is consequentially a grand globe with scale diameter of Y light-years. Virtually, this is but our subjective perception of geometrical profile of accessible objects around and inertial extension of our conventional subjective experience under default logos reference of spacetime; as non-cosmic object, if we stand out of cosmos without default logos reference of spacetime, all geometrical connotation of any object in cosmos will completely be non-existent thereby.

What's "globe"? What's "volume"?

What's "line"? What's "plane"?

What's "big"? What's "small"?

Is earth bigger or cosmos bigger?

What's space distance? What's time?

There is obviously no way for these to be defined accordingly.

What's "existence" and what's "nonexistence"?

Towards the substantial rational receipt, you'd better suppose, as non-cosmic object, you stand out of cosmos and try to perceive existence in cosmos.

2.2. Absolute compatibility of systematic substantiality quantification of cosmic homogeneity system making up of out-and-out serial natura naturata in the nature of coherent natura naturans throughout cosmic evolution has negated rationale of basic dimensions as distance/meter, time/second, mass/kilogram of tradition.

Traditionary physics persists distance/meter, time/second, mass/kilogram are always three independent basic dimensions. Whereas, once we introduce Homogenous cosmos originated from unique genesis postulate and finish proper connotation objectification of homogenous cosmos originated from unique genesis and further freewheeling logic extension of connotation objectification, theoretical situation is completely different. As introduction of Homogenous cosmos originated from unique genesis postulate, comprehensive cosmic contents consequently turn into well-regulated integration of cosmic homogeneity system making up of out-and-out serial natura naturata in the nature of coherent natura naturans throughout cosmic evolution. And as a result, as mathematical quantification of comprehensive homology of cosmic homogeneity system with compatible conversion accessibility through and through, all substantiality quantification in cosmic homogeneity system are absolute compatible. We can never find two incompatible or independent substantiality quantification in cosmic homogeneity system for it's virtually aggradation of absolute homology making up of out-and-out serial natura naturata in the nature of coherent natura naturans throughout cosmic evolution, which of course include absolute compatibility of substantiality quantification of so-called basic dimensions as distance/meter, time/second, mass/kilogram.

Meanwhile, in the recent several days, my teacher and good friend professor Huang complained time after time in QQ loop that the matter inertial conservation equation $V(t)*m(t)= d(M \leftarrow m)(t)*Y(t)$ does not tally with basic dimension regulation at all. I was confounded indeed, I would like to keep silent but could hardly bear the depression. Oh, shit, I emphasized so many times, cosmic status quo is but demiurgic aggradation of sequential

homologic cosmogony which exactly exists as well-regulated integration of cosmic homogeneity system making up of out-and-out serial natura naturata in the nature of coherent natura naturans throughout cosmic evolution, cosmos is perfect demiurgic aggradation of homology originated from unique genesis all wool and a yard wide, nothing can be found as non-homology out of category of cosmic homogeneity system. Since discretionary particles in cosmos are mutually convertible, any two objects in cosmos are mutually convertible coequally. If somebody can find such two objects that it can be authenticated there is no way for them to be convertible, there must be one of the two objects which does not belong to category of cosmic homogeneity system leastways, and discovery of the absolute incompatible/inconvertible object in cosmic homogeneity system indicates discovery of “cosmos No. 2”.

In mathematical view, the same objectivity is that, since cosmos is but demiurgic aggradation of sequential homologic cosmogony which exactly exists as well-regulated integration of cosmic homogeneity system making up of out-and-out serial natura naturata in the nature of coherent natura naturans throughout cosmic evolution, cosmos is perfect demiurgic aggradation of absolute homology originated from unique genesis all wool and a yard wide, nothing can be found as non-homology in cosmic homogeneity system, as a result, discretionary objects in cosmos are mutually convertible just as well as discretionary particles in cosmos are mutually convertible. As enantiomorphous mathematical quantification, all substantiality quantification in cosmos must be compatible through and through. If somebody can find such two substantiality quantification that they can never be compatible any way, there must be one of the two substantiality quantification which does not belong to category of cosmic homogeneity system leastways, and discovery of the absolute incompatible/inconvertible substantiality quantification in cosmic homogeneity system indicates discovery of “cosmos No. II”. This of course includes absolute compatibility and mutual conversion among so-called basic dimensions as **distance/meter, time/second, mass/kilogram**.

However, there is even people turning to me for complaint that matter inertial conservation equation $V(t)*m(t)=d(M\leftarrow m)(t)*Y(t)$ does not tally with basic dimension regulation at all.

Shit, either you are mad or I am.

There are substantively no “Basic Dimensions” besides quantization of “field genic origin i_0 ” once we’ve finished implementation of connotation objectification of homogenous cosmos originated from unique genesis with further freewheeling logic extension based on **Homogenous cosmos originated from unique genesis postulate**. It may be not wise to demand all coming pioneering scientific idea tallying with conventionality, on the contrary, there is substantial probability for coming pioneering scientific idea to wash out conventionality. The demiurge does not accomplish so-called “basic dimensions” in prior then brings out cosmos accordingly, instead, when humanistic ideology about authenticity of nature proceeded to some certain historical stage, ideological idea of basic dimension came into being as expediential humanist notion under commensurate historical background. Whereas, once turning back to self-possession, I have to review such perplexity that professor Huang is my teacher and good friend, he has no counterwork animus absolutely, the issue may be sensitive to many of my cordial readers too, it may be necessary for me to offer proper interpretation about traditionary rationale of basic dimensions as **distance/meter, time/second, mass/kilogram** against innovative cosmos redefinition in radical logic enantiomorph of newly highlighted factuality that **discretionary particles in cosmos are mutually convertible** herein.

A) Interpretation of basic dimension of time/second against against brand-new cosmos redefinition in radical logic enantiomorph of newly highlighted factuality that discretionary particles in cosmos are mutually convertible.

The basic dimension of “time/second” in tradition is virtually available “standard motion reference” around

us, no matter the acquiescent “standard motion reference” is pendulette on surface of the earth, connatural rotation of the earth, revolution of the earth around the sun or connatural vibration of atomic crystal lattice in spacetime condition near the earth, Whereas, in accordance with rationale of Homogenous Cosmos Originated from Unique Genesis, all natural existence & motion as pendulette on surface of the earth, connatural rotation of the earth, revolution of the earth around the sun or connatural vibration of atomic crystal lattice in spacetime condition near the earth, are but typical instances of common existence & motion in cosmos, whose dynamic connotation can be uniformly formulated as $V(t)*m(t)= d(M \leftarrow m)(t)*Y(t)$. This of course indicates traditionary notion of time/second is just intuitional acquiescence of the integrative domino effect of $V(t)*m(t)= d(M \leftarrow m)(t)*Y(t)$, which is virtually acquiescent “standard motion reference” around us.

Whereas, I have to emphasize herein, once we introduce acquiescent “standard motion references” like pendulette on surface of the earth, connatural rotation of the earth, revolution of the earth around the sun or connatural vibration of atomic crystal lattice in spacetime condition near the earth, ... as time to scale speed of universal existence & motion, which are virtually integrative connotation of equation $V(t)*m(t)= d(M \leftarrow m)(t)*Y(t)$, we consequently neglect hypostatic physical connotation of active elements of $d(M \leftarrow m)(t)$ and $Y(t)$ in equation $V(t)*m(t)=d(M \leftarrow m)(t)*Y(t)$ which are of course stochastic variables. This of course implies the acquiescent “standard motion reference” is virtually not absolute constant but stochastically variable for possible stochastic variation of $d(M \leftarrow m)(t)$ and $Y(t)$ in equation. In straightforward words, authentic time current in the nature is not ingenerate even, but radically depends on time dynamic speed $Y(t)$ of space field, time dynamic speed $Y(t)$ is bigger, time rate is proportionably higher, comprehensive existence & motion in space field going in their ingenerate way in accordance with $V(t)*m(t)=d(M \leftarrow m)(t)*Y(t)$ in law of identity are of course more active therefore. If time dynamic speed $Y(t)$ is less, time rate is proportionably lower, comprehensive existence & motion in space field going in their ingenerate way in accordance with $V(t)*m(t)=d(M \leftarrow m)(t)*Y(t)$ in law of identity are proportionably retarded.

However, once we intuitionally introduce acquiescent “standard motion reference” like pendulette on surface of the earth, connatural rotation of the earth, revolution of the earth around the sun or connatural vibration of atomic crystal lattice in spacetime condition near the earth, ... as time to scale speed of universal existence & motion, our rationale of time consequently slide into ignorant acquiescence that time is ingenerate constant quantification throughout cosmos, which not only negates the longitudinal step-by-step evolutive variation & disparity of time rate (/time dynamic speed) throughout cosmic evolution but also neglects the transverse disparity of time rate (/time dynamic speed) in different space fields, as if time is “innate constant” going in constant rate unconditionally and everlastingly with nothing to do with step-by-step longitudinal quantitative & qualitative evolution of cosmogony.

Virtually, as long as we have to admit cosmogony can only be evolutionary aggregation making up of ongoing successive quantitative & qualitative change of demiurgic evolution, we have to admit it’s impossible for cosmogony to adulterate any “constant” through and through, throughout cosmic evolution, any “constant” in cosmos must be washed out by metabolic evolution of cosmos in the nature of coherent natura naturans throughout cosmic evolution and slidden out of category of homogenous cosmos thereby, time/second in cosmos can never be exception. Traditionary physics acquiescence in accessible “standard motion reference” as time, which is of course expedient for us to differentiate and formulate universal existence & motion around us, whereas, acquiescent “standard motion reference” is not authentic time itself in cosmos, which

neglects deep-seated authenticity of time dynamic speed $Y(t)$ of space field. Time/second is not basic dimension in cosmos but out-and-out commensurate expedient humanistic notion due to practical feasibility & possibility in proportion to contemporaneous historical background.

B) Interpretation of basic dimension of distance/meter against against brand-new cosmos redefinition in radical logic enantiomorph of newly highlighted factuality that discretionary particles in cosmos are mutually convertible.

On the basis of connotation objectification of homogenous cosmos originated from unique genesis, so-called "space distance" is just physical noumenon of dynamic succession materialized by dynamic transmutation & transition among all mutually accessible field genic units in space field, tangible physical domino effect of time or substantiality objectification of dynamic succession of transmutation & transition among accessible field genic units in space field. If there is no dynamic succession of transmutation & transition among available field genic units so as to accomplish physical correlation among discretionary points in space field, there is no tangible physical noumenon of so-called space distance in space field but unrelated points without any physical correlation, there is none possibility for physical existence & motion starting at discretionary point to extend to another point, there are only points absolutely inaccessible, nothing can be invoked to define the "estrangement/interval" between this point and that point.

Presence of physical noumenon of distance directly relates to dynamic transmutation & transition among accessible field genic units in space field, the quality of physical noumenon of distance inherently depends on expedience and rate of transmutation & transition among accessible field genic units in space field. The more expedient and faster transmutation & transition among accessible field genic units in space field is, the Physical noumenon of distance is proportionably more solid and perfect. As quantitative rate of transmutation & transition among accessible field genic units in space field is just time dynamic speed $Y(t)$, which is just dynamic origin for dynamic correlation among discretionary points in space field, once we come to review physical perfection of distance, we have to consider the ingenerate dependence of distance to time dynamic speed $Y(t)$.

For instance, in terms of the length of railway from Guangzhou to Beijing, if we come to consider and manage objectivity of the length in interval " $t \geq L/Y$ ", our consideration & management endeavor is still considerable in accordance with ingenerate limitation of cosmic feasibility & possibility, once we come to consider objectivity of the length in interval " $t < L/Y$ ", our consideration & management endeavor completely transcends ingenerate limitation of cosmic feasibility & possibility, it's completely insignificant and impossible.

And just because quality perfection of distance is consequence of hypostatic transmutation & transition among accessible field genic units in space field, quality perfection of Physical noumenon of distance inherently possesses dynamic relativity domino effect. The higher speed of observer is, spacetime dynamic assimilation effect is more remarkable, Physical noumenon of distance is in relatively poorer quality. For instance, in stationary state, we measured the length of a table is 2 meters, once we ask a moving observer to measure the same table, during the course the moving speed of the observer gradually approach time dynamic speed, the measurement of the observer must be more and more anamorphic relative to stationary length of the table. Once you demand the observer to measure the length of the table in interval " $t < 2\text{meters}/Y$ ", it's almost impossible for the observer to find perfect geometrical profile of the table in his physical purview, no more to measure the table; once moving speed of the observer equals time dynamic speed, it's only possible for physical

As coherent natura naturans throughout cosmic evolution, instinctive PNT reciprocal equilibrium towards optimum PNT operation is radical potentiality & conditionality for cosmos always ready to orientate itself towards perfection.

purview of the observer to be limited in one ideal line, he can perceive nothing in cosmos beside himself.

This of course indicates distance/meter is not basic dimension in cosmos.

C) Interpretation of **basic dimension of mass/kilogram** against against brand-new cosmos redefinition in radical logic enantiomorph of newly highlighted factuality that **discretionary particles in cosmos are mutually convertible**.

The precondition for presence of mass m in spacetime is $\int_0^t [d(M \rightarrow m) - d(M \leftarrow m)] dt = m > 0$ with ingenerate absolute spacetime momentum of $mV = d(M \leftarrow m) * Y$, which not only indicates any mass must exist in ongoing metabolic status in spacetime but also indicates physical presence of mass in spacetime inherently relates to time dynamic speed Y . This of course indicates mass is not basic dimension in cosmos, it's but stochastic metabolic consequence of $\int_0^t [d(M \rightarrow m) - d(M \leftarrow m)] dt = m > 0$, which not only directly relates to time dynamic speed Y but also relates to relative speed of observer in cosmos.

①. **Ingenerate homologic existence of mass in spacetime:** The bigger time dynamic speed of the space field in which mass existing is, the quantity of $d(M \rightarrow m)$ & $d(M \leftarrow m)$ are proportionably bigger, the ongoing metabolic status of $m = \int_0^t [d(M \rightarrow m) - d(M \leftarrow m)] dt > 0$ is relatively more active. If the time dynamic speed of the space field varies, quantities of $d(M \rightarrow m)$ and $d(M \leftarrow m)$ must vary accordingly, mass $m = \int_0^t [d(M \rightarrow m) - d(M \leftarrow m)] dt > 0$ must vary accordingly.

②. **Dynamic relativity domino effect of mass of object in spacetime:** in spacetime, presence of mass has ingenerate dynamic relativity domino effect, the higher speed the observer is, the less mass he can perceive in cosmos, once moving speed of observer equals time dynamic speed, he can only perceive 0 mass in cosmos, no matter how massive the original object observed is. In fact, once moving speed of observer equals time dynamic speed, it's only possible for physical purview of the observer to be limited in "one ideal line", he can perceive nothing besides himself in cosmos.

All in all, mass/kilogram is not basic dimension in cosmos, virtually, in time current, there is no constant mass aggradation in cosmos but ingenerate metabolic mass $\int_0^t [d(M \rightarrow m) - d(M \leftarrow m)] dt = m > 0$ ongoing eversince.

I see my interpretation above may be not smartly explicit for you to understand, and at the same time, as personal limitation, I am still difficult to verify definite mutual conversion equations among distance, time, and mass in cosmos in accordance with coherent natura naturans of the demiurge. The virulent issue is that, under egotistic background of interminable royal substantiation & perfection of contemporaneous scientific orthodoxy, as unprecedented magistral autarchy of free press regulation customization and free press admittance of temporal authority short of necessary intendance, modern science forum completely side into homegrown outgrowth in the garden of live contemporaneous scientific orthodoxy for royal substantiation & perfection of contemporaneous scientific orthodoxy, there must be a lot temporal authority who have similar counterwork suspicion as professor Huang, the issue may be serious for virulent scientific knowledge metabolism campaign. What's more, as free press directly impacts vested interest of overwhelming temporal authority, there are substantively few people who are willing to displease overwhelming temporal authority for free press admittance of Homogenous Cosmos Originated from Unique Genesis, we are genuinely sorry that social legitimacy & validity of truths can never exceed cannon range.

3. Homologic mathematical illation logic in the nature of Homogenous cosmos originated from unique genesis

On opinion of cosmic evolution, homologic mathematical illation logic rooted in essentiality of Homogenous cosmos originated from unique genesis is but general designation of intrinsic quantitative correlation of mathematical

Historical progress of science in the recent several centuries seemed like a far-flung exploration of the first itinerary around numerous distinctive landscapes of brand-new landmasses of science with palette & tablet on back, several hundred years' scientific travelogues were compiled thereby.

formulation of throughout quantitative change of sequential homologic cosmogony start at so-called cosmic genic origin to cosmic status quo, ——mathematical idiosyncrasy of mathematical formulation of throughout cosmic evolution. recognizant target of homologic mathematical illation logic is generally ready to make clear all mathematical correlation of quantitative change of throughout cosmic evolution.

Of course, the mathematical correlation of quantitative change of throughout cosmic evolution of course includes PNT dynamics, in another word, simply on opinion of homologic mathematical illation logic, PNT dynamics is but a compositive segment of it. Both absolutely free quantification conversion accessibility throughout cosmic homogeneity system and homologic mathematical illation logic coordinately derived from quantitative change succession of sequential homologic cosmogony starting at cosmic genic origin to cosmic status quo, integrative mathematical formulation of cosmic evolution not incarnates homologic mathematical illation logic with PNT dynamics implicated in but also crown all absolutely free quantification conversion accessibility throughout cosmic homogeneity system.

All in all, the sameness of cosmic genic origin is the root cause of universal correlations of cosmos, only the disparities in homologic configuration are the causes for the nature to be so rich and colorful. And it is just sequential homologic cosmogony which makes the entire cosmic endosome turn into integrative well-regulated cosmic homogeneity system therefore, and inherently makes PNT dynamics and homogenous mathematical illation logic worthy their names. Of course, homogenous mathematical illation logic with PNT dynamics implicated in also incarnate the very situation that cosmos is throughout homogenous originated from unique genesis as well.

If somebody can find such two objects in cosmos, which can be proved there is absolutely no way for them to be converted each other by breaking through estrangement of configurable disparity between them, or if somebody can find such two cosmic quantification, which can be proved there is absolutely no convertible medium for them to be converted each other or no accessibility for them to perform mathematical operation in the same equation, then he either has found tangible proof to negate the idea of homogenous cosmos originated from unique genesis or he has discovered even seized the “cosmos No. II”.

——Firstly written in Dec. 2004, Hunan, Wugang, Zhenzhu
Revision was done in Oct. 2013, Dongguan, Shatian, Nanxing

(IV-iv) “Big Bang” reflected in sense of Homogenous Cosmos Originated from Unique Genesis

Abstract: *In accordance with enantiomorphous correlation between objective authenticity of nature and humanistic ideology about authenticity of nature, it's impossible for definite authenticity of one cosmos to be compatible with two different cosmologies. And as humanistic ideology about authenticity of nature in proportion to contemporaneous historical background, the scientificity & credibility of “Homogenous Cosmos Originated from Unique Genesis” and “Big Bang” mostly depends on the preciseness and credibility of their idiographic thought origin and proportionate logic proliferation along crescive progression of historical progress of science.*

1) In terms of Homogenous Cosmos Originated from Unique Genesis, the substantiality of the issue is

1-a) *Whether cosmos is really homogenous originated from unique genesis through and through?*

In detail words, is it true that discretionary particles in cosmos are mutually convertible? And is it true that the root cause that discretionary particles in cosmos are mutually convertible is the two objects in cosmos possessing the same compositive components in some certain configurable hierarchy, which makes it possible for the two objects to be compatible and convertible?

1-b) *Even if we suppose the cosmos is throughout homogenous originated from unique genesis in accordance with the factuality that discretionary particles in cosmos are mutually convertible, the original sequential homologic cosmogony starting at the so-called “unique genesis” to cosmic status quo are just as Homogenous Cosmos Originated from Unique Genesis described as connotation objectification & freewheeling logic extension of homogenous cosmos originated from unique genesis and consequent PNT dynamics about universal existence & motion in the nature of coherent natura naturans throughout cosmic evolution, which are spontaneous occurrence in the nature of essence of matter in a class by itself?*

2) In terms of “Big Bang”, the substantiality of the issue is:

2-a) *Even if the red shift evidence in human accessible purview draw on advantage of astronomical telescope is true, whereas, is “red shift” of celestial bodies the unique physical domino effect that celestial bodies are flying away from us? What's the reason for us to ensure there are absolutely none possible physical causes in cosmos for equivalent domino effect of “red shift”?*

What's the reason for us to ensure “the local evidence of red shift in human accessible purview draw on advantage of astronomical telescope \equiv cosmos expansion”?

2-b) *Even if “the local evidence of red shift in human accessible purview upon advantage of astronomical telescope \equiv cosmos expansion”, what's the credible evidence we can resort to conclude that “cosmos expansion” is just inherent and permanent occurrence ever since initial birth of cosmos? Before we practically demonstrate “cosmos expansion” is just cosmic inherent & permanent occurrence ever since initial birth of cosmos, what are the credible reasons for us to resort time-inverse deduction of so-called “cosmos expansion” to deduce original evolution of cosmos through and through?*

“Big Bang” reflected in sense of “Homogenous Cosmos Originated from Unique Genesis” is just substantiation of the issues above.

Finally, I have to comment herein, as brand-new cosmology, if it involves none redefinition of cosmos and consequent universal existence & motion, it must be redundant cosmology. Big Bang seems nothing to do with

cosmos redefinition whose naissance involves neither redefinition of spacetime, matter nor universal existence & motion. Relatively, as timely renovation of humanistic ideology about authenticity of nature in proportion to contemporaneous historical background of remarkable highlight of microcosmic configuration of matter, Homogenous Cosmos Originated from Unique Genesis is typical cosmos redefinition in radical logic enantiomorph of newly highlighted factuality that discretionary two particles in cosmos are mutually convertible and consequent PNT dynamics about universal existence & motion in the nature of coherent natura naturans throughout cosmic evolution.

Keywords: intuitionistic vision-cosmology, logic conjury, cosmos expansion hypothesis, short-trousers cosmology, experience notion derived from available cosmic status quo, the first cosmos, the second cosmos, blue shift, congruent condition linkage, status approximating to condition lower limit of matter coming into being along “initial cosmic radiations→particles→atoms, molecules→macroscopical, objects→celestial bodies, galaxies”, dormant state of process extension of matter coming into being along “initial cosmic radiations→particles→atoms, molecules→macroscopical, objects→celestial bodies, galaxies”.

(i) Thought origin & logic proliferation discrepancy between “Homogenous Cosmos Originated from Unique Genesis” and “Big Bang”.

“Homogenous Cosmos Originated from Unique Genesis” and “Big Bang” are different cosmologies derived from different evidences highlighted under the common historical background. Homogenous Cosmos Originated from Unique Genesis is renovation of humanistic ideology about authenticity of nature in proportion to commensurate background of remarkable highlight of microcosmic configuration of matter, whereas, Big Bang is brand-new humanistic ideology about authenticity of nature in proportion to commensurate background of discovery of red shift in human perceivable purview in cosmos. The distinction between “Homogenous Cosmos Originated from Unique Genesis” and “Big Bang” radically derived from the difference of their distinctive thought kindling and logic proliferation.

In terms of Homogenous Cosmos Originated from Unique Genesis, as remarkable highlight of microcosmic configuration of matter in the recent one century, original idea of homogenous cosmos originated from unique genesis firstly came into being in Nov. 1991, it's cosmos redefinition in radical logic enantiomorph of newly highlighted factuality that “discretionary particles in cosmos are mutually convertible” with consequent PNT dynamics about universal existence & motion in the nature of coherent natura naturans throughout cosmic evolution. In logic modality, Homogenous Cosmos Originated from Unique Genesis is typical linear logic system on the basis of [(Homogenous cosmos originated from unique genesis postulate + spacetime~matter fully embodying cosmos postulate) + Instinctive PNT equilibrium postulate] about universal existence & motion as spontaneous occurrence of [External physical disturbance + (PNT action + Instinctive PNT equilibrium)], whose mathematical definition is as below:

$$\text{Homogenous cosmos originated from unique genesis} \stackrel{\text{def}}{=} \sum_{m \in D} D_{[j_0}^X f(m_{i_0 \rightarrow X})_{i_0}]$$

Comparably, “Big Bang” is another cosmology resurged from graves of Hubble, Lemaitre, Gamow etc in later half of last century, a cosmology straightforwardly extended from intuitionistic vision of red shift evidence in human temporal accessible purview draw on advantage of astronomic telescope, whose direct thought kindling is of course the so-called “red shift”, but potential logic drive is willful cosmic-scale aggrandizement of local & segmental red shift evidence, —in space scale, it willfully aggrandized the local red shift evidence in human temporal accessible purview range into full cosmic-scale evidence as “cosmos expansion”; and in time scale, it

As coherent natura naturans throughout cosmic evolution, instinctive PNT reciprocal equilibrium towards optimum PNT operation is radical potentiality & conditionality for cosmos always ready to orientate itself towards perfection.

willfully aggrandized the segmental evidence of red shift in human temporal accessible purview range into inherent and persistent evidence ever since initial birth of cosmos. Although, Big Bang involved cosmic evolution through and through including original generation & formation of spacetime & matter in the nature of things, it seemed having nothing to do with systematical redefinition of spacetime, matter and universal existence & motion of matter in spacetime for systematical highlight and clarification along cosmic evolution.

Of course, no matter “Homogenous Cosmos Originated from Unique Genesis” or “Big Bang”, the scientificity and authenticity of them radically depend on the preciseness & rationality of their idiographic thought kindling and logic proliferation. Now, we come to anatomize the thought kindling and logic proliferation of both “Homogenous Cosmos Originated from Unique Genesis” and “Big Bang”.

(i-A) Thought kindling & logic proliferation of “Homogenous Cosmos Originated from Unique Genesis”

As pioneering endeavor of historical progress of science in inherent optimum orientation towards perfect ideological enantiomorph of ultimate authenticity of nature under favorable background of remarkable highlight of microcosmic configuration of matter, “Homogenous Cosmos Originated from Unique Genesis” is innovative cosmos redefinition in logic enantiomorph of newly highlighted factuality that **discretionary particles in cosmos are mutually convertible** ~ **for they ultimately possess the common component in certain configurable hiberarchy** with consequent PNT dynamics about universal existence & motion in the nature of coherent natura naturans throughout cosmic evolution, which apparently implies compositive components of universal matter regularly orient extremity sameness along micromodelization tendency, — typical linear logic system about integrative cosmic homologic configuration, lineal homologic filiation of spacetime & matter and existence & motion of matter in thorough coherence followed a rational line of sequential homologic cosmogony starting at so-called cosmic genic origin to cosmic status quo all along based on general presumable precondition of Homogenous cosmos originated from unique genesis postulate.

Since discretionary particles in cosmos are mutually convertible, and the root cause discretionary particles in cosmos are mutually convertible is that, in some certain configurable hiberarchy, the both particles possess the common compositive components, the complete cosmic contents must be a well-regulated coherent homogeneity system originated from the common extremity cosmic genic origin through and through, — cosmos is entirely homogenous originated from unique genesis. With the innovative idea in mind, it substituted hypostatic cosmic endosome of “spacetime” and “matter” into cosmic homogeneity system under presumable precondition that cosmos entirely consists of spacetime and matter, none coordinative component else, it deduced two logic extensions of “Homogenous cosmos originated from unique genesis postulate” therefore. And successively, it hypostatized the two logic extensions with “space field hypothesis” and “matter homologic generation hypothesis” as to approach illumination and redefinition of spacetime, matter and universal existence & motion of matter in spacetime followed a rational line of sequential homologic cosmogony as hypostatic cosmic evolution thereby.

(i-A-1) As timely renovation of humanistic ideology about authenticity of nature in proportion to contemporaneous historical background of **remarkable highlight of microcosmic configuration of matter**, factuality that **discretionary particles in cosmos are mutually convertible** in freewheeling towards complete induction day by day has brought out substantial headspring for me to succeed the downwind potentiality for pioneering cosmos redefinition with consequent PNT dynamics about universal existence & motion in the nature of coherent natura naturans throughout cosmic evolution.

As remarkable progress of particle physics, more and more colorful particles in cosmos were found, and all our experimental practice support that discretionary particles in cosmos are mutually convertible, none is exceptive. This of course implies all these particles have common compositive components in some certain configurable hiberarchy. At any rate, the root cause discretionary particles in cosmos are mutually convertible is that the two objects ultimately possess the same compositive components in some certain configurable hiberarchy. If discretionary particles in cosmos are mutually convertible, it must imply all the objects in cosmos ultimately possess the common extremity component in the terminal configurable hiberarchy, —cosmos is throughout homogenous radically originated from common extremity of so-called “cosmic genic origin”, all objects in cosmos are but homology originated from the common cosmic genic origin in different homologic configuration which originally comes into being along sequential homologic cosmogony in the nature of coherent natura naturans throughout cosmic evolution.

Idea of Homogenous cosmos originated from unique genesis was just burnt out from the very kindling.

However, in strict logos, we still do not have adequate proof to conclude that all particles human have found have been fully equal to actual cosmic endosome of particles, although the factuality human have found has greatly highlighted our positive conclusion, at any rate, it's still inadequate to demonstrate discretionary particles in cosmos are mutually convertible. the troublesome issue is very similar as a mathematical induction demonstration, human practice ever since have demonstrated when $n=1, 2, 3, \dots, K$ ($K \in \mathbb{N}$), any discretionary two particles among the available object aggregation consisting of the k sorts of objects in cosmos are mutually convertible, and followed human practice going deep all along, the magnitude of K increase day by day, the proposition is still positive, however, once we suppose “ K =entire cosmic endosome”, whether the proposition is still positive? We have no credible proof to draw our positive conclusion.

As a result, in the face of such issue challenge whether cosmos is really homogenous originated from unique genesis through and through under such favorable but perplexed historical background, wise and active modus operandi is of course to introduce it as presumable postulate in prior, —on one hand, upon rational sense, we keep ready to demonstrate it further any time, and on the other hand, on point of necessity of pioneering and timely exploration & study, it's really necessary for us to release our pioneering endeavor from our temporal practice limitation on the basis of favorable groundwork, so that our pioneering exploration can push its way deep into the unbeknown quickly and even make further exploration rational with a definite object in view.

This is just logic proliferation of Homogenous Cosmos Originated from Unique Genesis extended from factuality of “discretionary particles in cosmos are mutually convertible” to “Homogenous cosmos originated from unique genesis postulate”, and it is also the first pioneering step Homogenous Cosmos Originated from Unique Genesis resorted for innovative study of universal existence & motion of matter based on favorable harvest of modern particle physics, issue time was in Nov. 1991.

Arrived at this stage, the next subject followed one by one is that since cosmos is entirely homogenous originated from unique genesis, what a homogenous existence & motion aggregation the entire cosmos should be?

(i-A-2) logic proliferation extended from “Homogenous cosmos originated from unique genesis postulate” to “PNT dynamics”

Throughout the logic extension from “Homogenous cosmos originated from unique genesis postulate” to “PNT dynamics”, the first preparation action Homogenous Cosmos Originated from Unique Genesis did was

As coherent natura naturans throughout cosmic evolution, instinctive PNT reciprocal equilibrium towards optimum PNT operation is radical potentiality & conditionality for cosmos always ready to orientate itself towards perfection.

to introduce a potential presumable precondition that cosmos entirely consists of spacetime and matter, none coordinative component any more. The second action for logic proliferation is to substitute cosmic physical endosome of spacetime and matter into Homogenous cosmos originated from unique genesis postulate, —since cosmos completely consists of physical spacetime and matter and cosmos is completely homogenous originated from unique genesis, then, in the grand cosmic homogeneity system, spacetime and matter must satisfy regulations as below:

Logic extension 1: Since cosmos is throughout homogenous originated from unique genesis, as undeniable components of cosmos, both “spacetime” and “matter” must be homologic coordinators coequally originated from the common cosmic extremity genesis (/cosmic genic origin) along original sequential homologic cosmogony, And of course, as coordinative homology in cosmos, “spacetime” must be coequally physical as matter, unless we have tangible evidence to exclude spacetime out of category of cosmos.

Logic extension 2: If cosmos is object fully embodied by hypostatic coexistence of spacetime and matter, nothing else, along original sequential homologic cosmogony starting at the common cosmic extremity genesis (/cosmic genic origin) to cosmic status quo, “spacetime” and “matter” must be in alternative homologic filiation either “spacetime father & matter son” or “matter father & spacetime son”.

This is just the two logic extensions of “Homogenous cosmos originated from unique genesis postulate”.

The third step of logic proliferation of Homogenous Cosmos Originated from Unique Genesis is objectification of the two logic extensions of Homogenous cosmos originated from unique genesis postulate, —introduction of “space field hypothesis” and “matter homologic generation hypothesis”. The objectification of the two logic extensions of Homogenous cosmos originated from unique genesis postulate not only made the notions of time, time dynamic speed, space distance, space radiation corner defined accordingly, but also arrived at PNT correlation /action between spacetime and matter by the light of nature. With presence of PNT action between spacetime and matter in mind, Homogenous Cosmos Originated from Unique Genesis affirmed that there must be regular action fundamental of PNT action between spacetime and matter, considering all objects around us are always ready to orient balance, Homogenous Cosmos Originated from Unique Genesis introduced “Instinctive PNT equilibrium postulate”.

Along the cosmic demiurgic evolution of homologic multiplication sequence, matter is lineal outgrowth of spacetime when spacetime develops to some certain mature phase; the existence & motion of matter in spacetime radically depend on the performance of PNT action between spacetime and matter. As approach of presence of PNT action between spacetime and matter and introduction of Instinctive PNT equilibrium postulate, dynamic figure of existence & motion of matter in spacetime unveils itself thereby. The subsequent challenge is but what kind of mathematical language we should introduce to formulate the PNT action with PNT equilibrium instinct appropriately, so that existence & motion of matter in spacetime can be substantially formulated. Towards the very objective, Homogenous Cosmos Originated from Unique Genesis introduced “matter inertial conservation equations” and “PNT dynamics”.

This is just logic proliferation of Homogenous Cosmos Originated from Unique Genesis extended from Homogenous cosmos originated from unique genesis postulate to PNT dynamics, and it is also the second step Homogenous Cosmos Originated from Unique Genesis resorted to study universal existence & motion of matter in cosmos on the basis of Homogenous cosmos originated from unique genesis postulate, issue time is from spring of 1992 to winter of 1995.

All in all, in accordance with the authenticity that compositive components of universal matter orientate to extremity sameness along micromodelization tendency, Homogenous Cosmos Originated from Unique Genesis innovatively introduced Homogenous cosmos originated from unique genesis postulate, successively, it substituted spacetime and matter into Homogenous cosmos originated from unique genesis under presumable precondition that cosmos entirely consists of coordinative spacetime and matter so as to arrive at the two logic extensions of Homogenous cosmos originated from unique genesis postulate. The objectification of the two logic extensions educed the PNT correlation (or PNT action) between spacetime and matter, and further introduction of Instinctive PNT equilibrium postulate even made existence & motion of matter in spacetime unveil itself. Throughout the logic clew, there are still five issues need further demonstrations.

- ① Whether cosmos is throughout homogenous originated from unique genesis really.
- ② Whether cosmos entirely consists of spacetime and matter without any other coordinative component.
- ③ Along sequential homologic cosmogony in the nature of coherent natura naturans throughout cosmic evolution, whether the lineal homologic filiation is true that spacetime is father and matter is son.
- ④ Whether introduction of Instinctive PNT equilibrium postulate is correct.
- ⑤ Whether the formulas of matter inertial conservation equations and PNT dynamics can authentically formulate the PNT action with PNT equilibrium instinct of matter integration in spacetime.

(i-B) Thought kindling & logic proliferation of “Big Bang”

As typical intuitionistic vision-cosmology, Big Bang directly originated from evidence of so-called red shift in temporal human accessible purview draw on advantage of astronomical telescope, whose most magic and efficacious enchantment is that it willfully aggrandized the local evidence of so-called “red shift” in temporal human accessible purview into full-scale cosmic evidence, ——with logic conjury of “local crowning all”, it willfully aggrandized the local “red shift evidence in temporal human accessible purview by the right of advantage of astronomic telescope” into “full-scale cosmic expansion/cosmos expansion”, and went a further step doing one thing under cover of another, processed the so-called “cosmos expansion” derived from logic conjury of local crowning all with a secondary logic conjury of “segment crowning all along”, mooching argument unknowingly that the so-called “cosmos expansion” is inherent and persistent occurrence ever since initial birth of cosmos. Then, it resorted time-inverse deduction modus operandi to reverse the inherent and persistent occurrence of so-called “cosmos expansion” derived from the double logic conjury above throughout so as to approach its conclusion that the cosmos is always shrinking all long inversely from today to initial birth of cosmos, till at last it shrinks into a “singularity”. As a result, Big Bang ultimately concluded cosmos radically comes into being from a “singularity” by a “Big Bang” with persistent full-scale expansion ever since.

As cosmology, Big Bang apparently adulterated two “logic conjury”.

The first, bravado, ——it played logic conjury of “local crown all over” on local “red shift evidence in human temporal accessible purview by the right of advantage of astronomic telescope”, ——willfully adding equal sign between “red shift evidence in human temporal accessible purview by the right of advantage of astronomic telescope” and “full-scale cosmic expansion”.

The second, doing one thing under cover of another, ——it played secondary logic conjury of “segment crown all along” to so-called “cosmos expansion” which firstly derived from logic conjury of local crown all

over, mooching argument that the so-called “cosmos expansion” is inherent and persistent occurrence ever since initial birth of cosmos.

As two logic conjury involved in, the so-called time-inverse deduction modus operandi derived from red shift evidence is of course necromancy based on logic conjury.

(i-B-1) Prolific logic extension of so-called “cosmos expansion/full-scale cosmic expansion” derives from local evidence of red shift in temporal human accessible purview against advantage of astronomical telescope——whether evidence of red shift in temporal human accessible purview against advantage of astronomical telescope is really radical cause for cosmos expansion or not?

As typical intuitionistic vision cosmology, the thought kindling of Big Bang is “red shift” evidence in temporal human accessible purview by the right of advantage of astronomical telescope, which was perceived by gathering information of light (including various radiations) from remote galaxies.

Whereas, have human looked through cosmos by the right of advantage of astronomical telescope?

No! human but dimly perceived some of the galaxies around us by the right of advantage of astronomical telescope. In an even exact word, by the right of advantage of several idiographic astronomical telescopes, we but perceived some of the optic existence of cosmos, which not only means we still have not perceived complete optic existence of cosmos yet, but also means “cosmic existence” are not limited in optic perceivable existence.

How many cosmic existence & evolution can be contained and transported as information by light (or radiation)?

At first, in space scale, cosmos is not throughout space extension equally with sufficient conditions for existence of lights and radiations, in some part of cosmos, lights and radiations can be initially generated and exist in by the light of nature. Whereas, in some special part of cosmos, there are not sufficient conditions for initial generation & existence of lights and radiations at all, and even lights and radiations can never pass through the special part of cosmos. For instance, in “Black Hole” range, neither lights & radiations can be initially generated in, nor lights & radiations can pass through, lights and radiations are completely absent in Black Hole. This of course implies it is not all cosmic existence & motion which can be perceived by medium of lights or radiations. In another word, lights and radiations are not omnipotent medium we can resort to outguess cosmos, after all, **entire cosmic existence & motion>what human can perceive in cosmos upon vision.**

The second, in time scale, lights or radiations may not be inherent objects of cosmos——none tangible evidence support that natural life of lights or radiations certainly equals to natural life of cosmos.. At the beginning, cosmos comes into being; there may be no possibility for initial generation and existence of lights or radiations at once, unless we can practically prove that lights or radiations are really inherent objects of cosmos. This of course implies we have none adequate reasons to resort lights & radiations to outguess cosmos through and through before we can practically demonstrate lights and radiations are really inherent objects of cosmos.

And on the point of possibility characteristic cosmic lights can pass by earth, compared with cosmos, the earth is so tiny, even if lights are really inherent objects of cosmos, in relatively short interval, how many possibilities are there that astronomic telescope on surface of earth can receive enough idiographic light information from cosmos which is substantial to indicate integrative cosmic existence & motion even cosmic evolution through and through? What’s more, cosmos is not a 100% range lights or radiations can pass through, and we can not ensure lights or radiation are really inherent objects of cosmos; what’s more, the real presence of cosmic lights and radiations

usually exist in inconstant processes involved in release, absorption, pollution, interference etc.

No matter on point of space scale or time scale, the red shift evidence in temporal human accessible purview by the right of advantage of astronomic telescope is but a local segmental evidence of cosmos, although such local segmental evidence can really indicates that all galaxies in our temporal accessible purview are going away from us, it substantively inadequate to support “full-scale cosmic expansion”, unless we can demonstrate:

(A) Within whole cosmic range, human accessible purview has covered entire existence & motion, and all status are really the same as what we had practically perceived as red shift exactly.

Or we can demonstrate:

(B) The physical existence & motion in human temporal accessible purview have been adequate to penetrate into authenticity of universal existence & motion, compared with cosmic range out of human temporal accessible purview, there are none exceptive existence & motion any more, so that we can conclude confidently, —there is no possibilities for cosmic range out of human temporal accessible purview (non-human-purview in cosmos) not to expand, which of course inversely means, if there are still some special physical existence & motion in non-human-purview range different from temporal human accessible purview range, we then we cannot exclude possibilities that non-human-purview range of cosmos do not expand at all, or even shrink or atrophy.

Otherwise, it can only be bandit logic to willfully add **equal sign** between “red shift evidence in human temporal accessible purview by the right of advantage of astronomic telescope” and “full-scale cosmic expansion”. Virtually, the evidence of red shift in human current accessible purview is only adequate to demonstrate that there is some a little local expansion in human accessible purview in cosmos in accordance with comprehension that galaxies flying away from us is the unique possible cause for “red shift of galaxies”. Whereas, is “galaxies flying away from us” really the unique possible cause for “**red shift of galaxies**” in cosmos? We apparently lack evidence that there may be some other unexpected physical potentiality related to existence & motion of lights in spacetime, whose variation maybe cause “**red shift**” of lights equally. And what’s more, even though we presume “red shift of galaxies” in cosmos is just unique potential domino effect of “galaxies flying away from us”, the local expansion in human temporal accessible purview in cosmos is still inadequate to be equivalent to “full-scale cosmic expansion”. The situation is rather similar as, on the earth, any train running north always shows itself evidence running towards North Pole of the earth, however, it’s virtually not all trains with evidence running towards North Pole of the earth are just trains virtually running to North Pole of the earth indeed.

Of course, on the point of active exploration, for some significant necessity, even under situation neither of the two demonstrations can be practically accomplished off the cuff, we too have no respectable excuses to reject hypothesizing “cosmos expansion” in prior according to favorable but inadequate evidence of red shift in human temporal accessible purview. Whereas, before accomplishment of either of the two demonstrations above, the preferential introduction of idea of “cosmos expansion” derived from logic conjury as local crowning all for necessity of further exploration can only be “cosmos expansion hypothesis”, and it virtually can only be reluctantly qualified as “cosmos expansion hypothesis”. However, this is apparently not intelligent modus operandi for Big Bang.

—On practical exploration journey of science, preferential introduction of intelligent postulate is

As coherent natura naturans throughout cosmic evolution, instinctive PNT reciprocal equilibrium towards optimum PNT operation is radical potentiality & conditionality for cosmos always ready to orientate itself towards perfection.

usually ready to release pioneering endeavor from temporal practice limitation towards expedient scientific pursuit, whose practical significance mostly indwells, as intelligent and timely introduction of the proper postulate, how much of our goal rational purview has been swiftly illuminated and widely open thereby.

I can hardly image Big Bang was so magical, even just to play a logic conjury of “local crown all over”, willfully added an equal sign between “local evidence of red shift in human temporal accessible purview by the right of advantage of astronomic telescope” and “cosmos expansion”, puffing a hubble-bubble at will, it even could conciliate so much pristine applause.

This was just the first logic conjury Big Bang performed to the world, local crown all over ——— bravado.

(i-B-2) The logic proliferation rooted in “cosmos expansion” to “Big Bang” had virtually played a secondary logic conjury of “segment crowning all along” on so-called “cosmos expansion” which firstly derived from logic conjury of “local crowning all”, it further mooched argument that the so-called “cosmos expansion” is inherent and persistent occurrence of cosmos ever since initial naissance.

Big Bang in theory of “Big Bang” is outgrowth of time-inverse deduction of “cosmos expansion” virtually derived from red shift by logic conjury of local crowning all and consequently made it show itself all along normal way of time. I am afraid it’s needless for me to prattle whether evidence of red shift in human temporal accessible purview by the right of advantage of astronomic telescope can really match “cosmos expansion” or not herein any more. However, if we are ready to deduce cosmic original evolution by time-inverse deduction of “cosmos expansion”, we must prove a precondition in prior, that’s whether the so-called “cosmos expansion” is inherent occurrence of cosmos and keep with & dominate cosmic evolution all along. Otherwise, there is no reason for us to resort time-inverse deduction of so-called cosmos expansion to deduce original naissance and successive evolution of cosmos through and through. Because, if we are not able to demonstrate whether the so-called “cosmos expansion” is inherent occurrence of cosmos and keep with & dominate cosmic evolution all along, we have nothing to ensure whether “cosmos expansion” and “cosmic naissance & original evolution” accord to necessary condition of “coordinative time equivalence”, so that we can not ensure whether the time-inverse deduction of cosmos expansion can substantially extend with virtual cosmic naissance & evolution in parallel way all along, otherwise, there may be deviation of time parallel synchronization out of joint of coordinative inverse extension of cosmos expansion & integrative cosmic evolution.

What’s more, as typical intuitionistic vision-cosmology, Big Bang was always used to relying on astronomic telescope to gather light information from remote galaxies as to perceive some certain existence and evolution in time current. If Big Bang are ready to resort light information from out space to perceive cosmic existence and evolution in time current, he must prove lights are inherent objects of cosmos in prior, if lights are cosmic outgrowth only when cosmos develops to some certain stage, it maybe a great problem for lights to reflect any existence & evolution in cosmos before original naissance/generation of themselves. As a result, gathering light information from out space is not all-purpose access for us to outguess cosmos through and through. Such modus operandi mooching argument by doing one thing under cover of another upon unnoticed intuitionistic experience is substantively deadly logic conjury and pseudoscience; nothing else can be even top.

And indeed, Big Bang never envisaged such factuality before they drew their extravagant conclusions, no more engaged in demonstrations of the very issues, but to play magic of doing one thing under cover of another

like performance on stage, resorting local evidence of red shift in human temporal accessible purview by the right of advantage of astronomic telescope as camouflage, gesturing a feigned action of time-inverse deduction of cosmos expansion with his left hand, then, with his right hand, fishing out a lively “Big Bang” about cosmic evolution. Virtually, in defiance of whether it’s really rational and creditable to draw conclusion of “cosmos expansion” by modus operandi of “local crowning all”, before we can practically demonstrate that cosmos expansion is cosmic inherent & persistent occurrence indeed, we have no adequate reasons to resort time-inverse deduction of the so-called “cosmos expansion” to deduce throughout cosmic original evolution, after all, before this, we still have nothing creditable to confirm whether the so-called “cosmos expansion” and “cosmic original evolution” satisfy the necessary precondition of time parallel synchronization congruency, such magic time-inverse deduction of so-called cosmos expansion can only be haw-haw phoney doing one thing under cover of another.

This is just the second logic conjury Big Bang performed to the world, —segment crowning all along, doing one thing under cover of another.

All at all, the logic proliferation of Big Bang rooted in evidence of red shift in human temporal accessible purview against advantage of astronomic telescope to cosmos expansion is not smooth and straightforward at all, we can generalize the throughout logic proliferation with three words: “bravado —doing one thing under cover of another—perpetrating a gigantic fraud”, and of course, the ultimate consequence is undoubted air castle therefore. The whole logic proliferation can be illustrated as below:

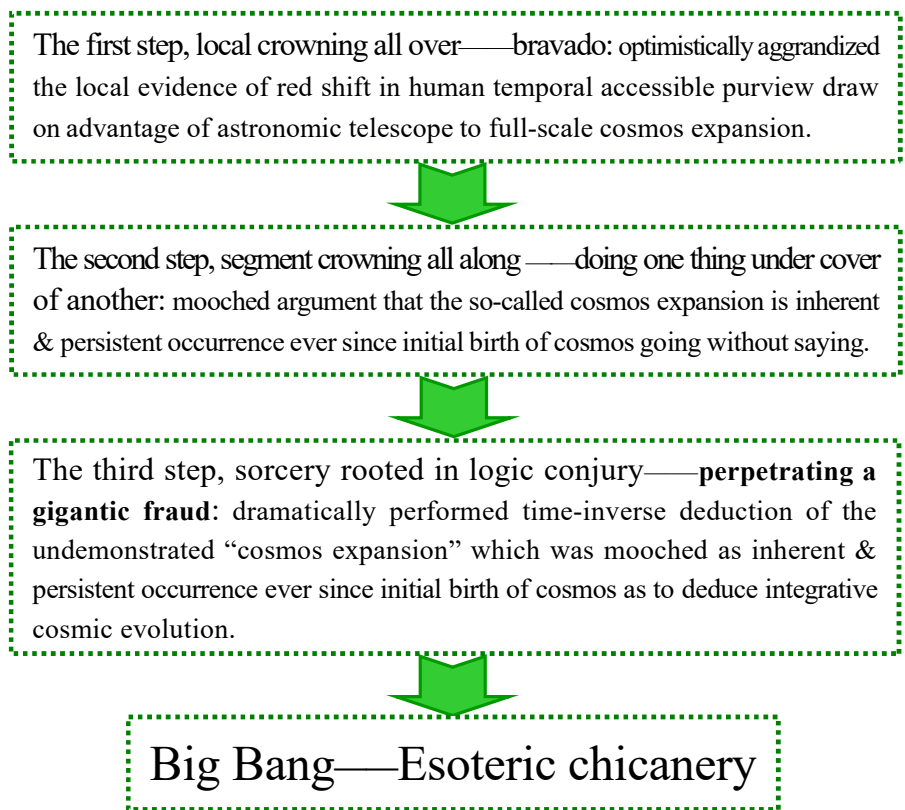

(III-ii-1) Logic extension constitution of Big Bang

Even we suppose that cosmos really comes into being by a “Big Bang”, whereas, in accordance with normal mechanical characters of so-called “Big Bang”, it’s only possible for the cosmogony in Big Bang logic model to be as below:

As coherent natura naturans throughout cosmic evolution, instinctive PNT reciprocal equilibrium towards optimum PNT operation is radical potentiality & conditionality for cosmos always ready to orientate itself towards perfection.

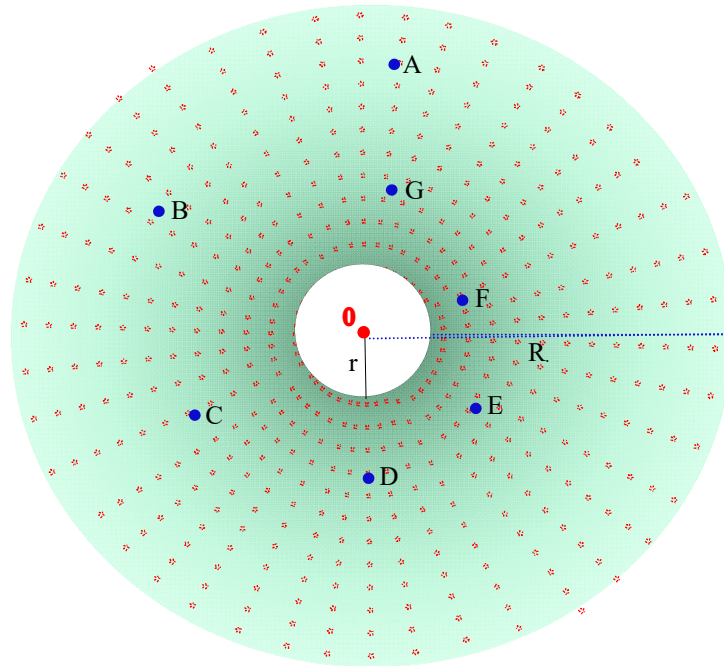

(IV-iv-2) Illustration of cosmogony in Big Bang logic model

It indicates if cosmos really derives from a Big Bang, it's only possible for the consequent cosmos to be a huge "hollow spherical shell". no matter whether occurrence of so-called "Big Bang" needs time or not, no matter how short time it is for the accomplishment of the Big Bang, as long as the time for occurrence of the so-called Big Bang is limited, then, the consequent cosmos derives from so-called Big Bang must be "hollow spherical shell", unless the cosmos originally comes into being in durable fountain model, in straightforward words, cosmogony is but a process like durable fountain. And after the Big Bang, the center hollow globe and the hollow spherical shell of cosmos must synchronously expand eversince. However, the so-called Big Bang Theory never mentioned this eversince, no more presence of the center hollow globe.

Once we refer to "Big Bang" theory during the course I chatted with several men in Wechat loop, I had to badinage the fellows like this, who seemed very proud of "Big Bang" theory, — "Big Bang" theory is but a song the retardee sang for foolish ones, as the retardee sang it in real earnest and the foolish ones listened to it staid as well, the self-evident sequel is of course the retardee's earnest won cheer of the foolish ones.

As cosmology, although Big Bang involved in throughout cosmic original evolution, it never involved in systematical redefinition of spacetime, matter, existence & motion of matter in spacetime thereby, no more resultant innovative dynamics, it even had none remarkable divarication relative to live contemporaneous scientific orthodoxy for its preponderant systematical clarification of cosmic evolution.

This is not something normal for it apparently does not tally with objective regularity of historical progress of science with inevitable scientific knowledge metabolism in inherent optimum orientation towards perfect ideological enantiomorph of ultimate authenticity of nature that, as permanent synthesized conditionality of "crescive progression of practical feasibility & possibility in proportion to contemporaneous historical background + the uniqueness & invariance of ultimate authenticity of nature predestines the unique possibility of scientific verity as perfect ideological enantiomorph of ultimate authenticity of nature" through and through, it's only possible for the major melody of historical progress of science to be a series of epochmaking scientific knowledge metabolism in inherent optimum orientation towards

perfect ideological enantiomorph of ultimate authenticity of nature.

On one hand, as humanistic ideology about authenticity of nature, live contemporaneous scientific orthodoxy is not integrative rationale as coherent logic system originated from unique ideological origin, no more coherent ideology followed a rational line throughout cosmic evolution, but aggradation of omnifarious scientific travelogues like smallwares full of a basket which are gained as deserving rewards of formidable but devious stochastic exploration journey in the recent several centuries. Singly on the point of holistic style, they are widely divergent, once we come to review universal existence & motion of matter in cosmos on point of cosmology with backup of clarification of cosmic evolution, our major idea is of course **“it's only possible for concordant cosmos to be demiurgic aggradation of out-and-out serial natura naturata in the nature of coherent natura naturans throughout cosmic evolution; there is no way for demiurgic aggradation in the nature of different natura naturans to be concordant cosmos through and through”**.

Whereas, on point of traditionary travelogue style, abandoned in numerous omnifarious matter specimens and aiming at any separate study object, we are always trying our best to find their separate inherent property but never ready to mind the even general connotation of the object under grand cosmic background, and this is just modus operandi to add omnifarious scientific travelogues like smallwares into a basket. As a result, as distinction of idiographic study modus operandi, it's almost impossible for them to be congruently uniform. (However, it's so regret that the full jurisdiction of science free press admittance of the age is under ironhanded control of temporal authority as accessible resort for egotistic proximity identification for their respectable science community, who seem meritorious for having ever contributed some spot travelogues like omnifarious smallwares full of a basket, so full science free press admittance arbitrament must be officiated in accordance with esoteric travelogue style criterion. And indeed, scientific free press is always ready for appreciation of temporal authorities, but never ready for inevitable knowledge metabolism followed quantitative & qualitative change of scientific knowledge proliferation; this is the most miserable reality of our age we have to admit)

And on the other hand, spacetime, matter, existence & motion of matter in spacetime as three basic elements of cosmos, if it's impossible for a relatively mature cosmology about existence & motion in cosmos to involve in systematical definitions of spacetime, matter, existence & motion of matter in spacetime, such cosmology can never avoid suspicions of shortage as clothes unable to cover body, —short-trousers cosmology. If it even seems unnecessary to redefine spacetime, matter, existence & motion of matter in spacetime systematically, it of course implies it's needless for it to come into being any more.

(i-B-3) There are too many methodology suspicions as painting snake referring to rabbit in Big Bang

I say there are too many defects as painting snake referring to rabbit in Big Bang mainly means that Big Bang unknowingly introduced too many ready-made experience notions derived from available cosmic status quo for description of abnormal status of cosmos, so that it made some certain description of abnormal cosmos incomprehensible even magic. The very situation is rather similar as painting snake referring to rabbit, —Wow, rabbit, we are so familiar with it, it has four legs; apropos of snake, although we've never seen it, it most probably has two legs at least.

For instance, Big Bang often mentioned “singularity explosion”, “cosmos expansion”. Upon our normal experience notion derived from cosmic status quo, explosion and expansion are typical mechanics domino effect, whereas, what kind of domino effect may singularity explosion and cosmos expansion be? Is it mechanics domino effect or non-mechanics domino effect? If they are mechanics domino effect too, what's the force works in? If it's non-mechanics domino effect, what's the supernatural domino effect of the so-called non-mechanics domino

effect? Can it be defined or formulated? How to define and formulate it? Big Bang had none related annotation about such issues but walking through without words or prevaricating upon intuitionistic experience derived from available cosmic status quo. And at the same time, in accordance with our normal experience notions derived from available cosmic status quo. The realization of explosion and expansion still need necessary outside space for accommodation, whereas, whether “singularity explosion” and “cosmos expansion” need outside space for accommodation too? If yes, what’s the so-called “outside space accommodation” for singularity explosion & cosmos expansion? If none so-called outside space is necessary for accommodation, then how can we define such supernatural explosion & expansion without accommodation support of outside space? Big Bang walked through without any words too.

Secondly, Big Bang confirmed the cosmos initially came into being 1500 million years ago by a big bang starting at a singularity in about atomic size with wondrous density and wondrous temperature even exceeded several hundred million centigrade, and successively expanding, temperature proportionably dropped till at last approached cosmic status quo. When I read such description about initial cosmic status, I was so puzzled.

I can hardly image how they calculated the life of cosmos 1500 million years. For you see, the time notion of “year” is substantively typical experience notion derived from available cosmic status quo, before cosmos evolved into status quo and operate in accordance with temporal conditions, the quantitative notion of “year” not finalize in temporal status yet, what’s the modus operandi for Big Bang to resort a notion of year which directly derived from available cosmic status quo as standard scale to quantify time flows before normal notion of “year” ultimately finalized. Did it just mean Big Bang had found even more essential physical elements in the nature, which are even more substantial to quantitatively indicate time flow or Big Bang had practically found all time mathematical conversion regularity among different cosmic evolution stages with different physical spacetime configurations along sequential cosmic evolution? At any rate, in different evolutionary phases, as physical configuration distinctions of cosmos, time proportionably flows in different conditions, it must be different.

For convenience to illuminate the very issue, let suppose we can copy the solar system another repetition, and thus, we just call the original solar system “solar system origin” (abbreviation: solar system O), and call solar system repetition “solar system copy” (abbreviation: solar system C) . And let suppose, there are two different space fields, one is “space field i”, the other is “space field ii”, and the time dynamic speed of space field i is Y_1 , time dynamic speed of space field ii is Y_2 , $Y_1=Y_2(1+1\%)$. We lay solar system O in space field i and lay solar system C in space field ii, so that general existence & motion of all objects in solar system O are regularly subject to dynamic fundamental of $mv=d(M \leftarrow m)Y_1$, and all general existence & motion of all objects in solar system C are regularly subject to dynamic fundamental of $mv=d(M \leftarrow m)Y_2$.

As both existence & motion of objects in solar system O and existence & motion of objects in solar system C are coordinative subject to their idiographic uniform dynamic regularity, no matter the people on the earth of solar system O or the people on earth of solar system C, they can equally find their own solar system are all regular and unisonous as normal, once the earth of solar system O finishes rotation of a full circle, the people on earth of solar system O will synchronously find the watches in their hands have proportionally finished running 24 hours; once the earth of solar system C finishes rotation of a full circle, the people on earth of solar system C will synchronously find the watches in their hands have proportionally finished running 24 hours; once the earth

of solar system O finishes revolution of a full circle around the sun, the earth of solar system O has proportionally finished rotation of about 365 circles too, once the earth of solar system C finishes revolution of a full circle around the sun, the earth of solar system C has proportionally finished rotation of about 365 circles too. So in normal sense, both the people on earth of solar system O and the people on earth of solar system C will have the common idea, one day is 24 hours, and one year is about 365 days, and in their separate observation, their own solar systems are always orderly in normal way for universal existence & motion of all objects in their own solar system are always subject to the uniform dynamic fundamental of $mv=d(M\leftarrow m)Y_1$ or $mv=d(M\leftarrow m)Y_2$.

However, if the people on earth of solar system O can directly communicate with the people on earth of solar system C, as discrepancy of $Y_1=Y_2(1+1\%)$, once the people on earth of solar system O find the watches in their hands have finished 24 hours exactly, whereas, the people on earth of solar system C will be astonished to find the watches in their hands have just finished 23 hours and 45.6 minutes; once the people on earth of solar system O find it has been their new year festival day, whereas, the people on earth of solar system C will be astonished to find there are still 3.65 days to their new year festival day.

Next, when Big Bang came to describe the so-called “singularity” in their mind, they introduced some notion directly related to normal space notion as “atomy size”, “wondrous density and wondrous heat”. If there is no presence of space notion before initial birth of cosmos, where can we procure notion of “atomy size”? As you know, “atomy size” is a substantial notion of volume; volume is just stand-in of space. If there is no presence of space notion before initial birth of cosmos, where can we procure notion of “density”? As you know, density is originally defined by mass/volume, and volume is just stand-in of space. If there is no presence of space notion before initial birth of cosmos, where can we procure notion of “heat”? As you know, heat directly involves in notion of motion, if no spacetime in prior, what can we resort to make “motion” defined? Is that means, before initial birth of cosmos, there is space (even time) in prior? And indeed, the practical description of so-called “singularity” in Big Bang has substantially indicated that there is space before cosmos, hasn't it?

In a even straightforward words, the theory of Big Bang seems always ready to give man such kind of view of cosmic evolution that the cosmic status quo is just the second cosmos originally came into being by a big bang of so-called singularity in the first cosmos. Comparably, the first cosmos has rather similar spacetime with the second cosmos, but all mass is congregated in a so-called singularity, however, in the second cosmos; all mass has been exploded out. The situation is even similar as a firecracker lying on the ground, if we do not ignite it, there is the first cosmos, once we ignite it and the firecracker consequently exploded, there is the second cosmos. And no matter we time resorting clock in the first cosmos or clock in the second cosmos, the time lasts from moment the firecracker exploded to all fragmentary paper and smoke flying into air is generally the same.

Does Big Bang really mean cosmic status quo is just the second cosmos originally came into being by a big bang derived from a so-called singularity in the first cosmos? Big Bang himself will never admit of course. Whereas, at any rate, the description of big bang style evolution of cosmos really has disgust as a muddleheaded monk huckstering calabash zealously in street, ——what are the real pills in calabash on sale? He himself may be not sure either!

In any case, living development of science today is typical flourishing freewheeling royal substantiation & perfection of contemporaneous scientific orthodoxy. The most remarkable feature of royal substantiation &

perfection of contemporaneous scientific orthodoxy is that, as magistral autarchy of “free press regulation customization” & “free press admittance” of temporal authority short of necessary intendance, science forum is homegrown outgrowth in the garden of contemporaneous scientific orthodoxy beyond all doubt, any distinctive existence & motion in cosmos which newly enters our rational purview must be theoretically predicted even formulated by so-called second-string geniuses as modern review in rational model of lineal logic extension in succession of contemporaneous scientific orthodoxy there and then, no matter the distinctive existence & motion is really something fantastic or even something we’ve never encountered before, and such kind modern review from second-string geniuses can most enter homegrown science forum with 0 resistance and enjoy superiority of commensurate social legitimacy jauntily without any apprehension of credible scientific authentication, no matter how remarkable the historical authenticity tolerance of science of so-called contemporaneous scientific orthodoxy is, no matter how remarkably the inherent intolerant preciseness of the so-called contemporaneous scientific orthodoxy out of scientific legitimacy qualification of historical authenticity tolerance of science 0 has been amplified for theoretical implementation of lineal logic extension in succession of contemporaneous scientific orthodoxy.

Such factuality of course indicates that, under d of royal successive freewheeling substantiation & perfection of contemporaneous scientific orthodoxy, it’s almost impossible for scientific knowledge proliferation in rigid succession of contemporaneous scientific orthodoxy to extend scientific innovation which indicates epoch-making progress towards historical authenticity tolerance of science 0. And usually, epoch-making progress towards historical authenticity tolerance of science 0 are mostly scientific knowledge proliferation out of succession of contemporaneous scientific orthodoxy. However, under precondition of magistral autarchy of free press regulation customization and free press admittance of temporal authority short of necessary intendance, science forum can hardly be free from duress of authoritative intrepidity of contemporaneous scientific orthodoxy, there is completely no way for scientific knowledge proliferation out of succession of contemporaneous scientific orthodoxy to avoid free press egotistic proximity identification of temporal authority, free press embarment is inevitable. Virtually, under precondition science education is under guidance of temporal authority through and through, 90% people on the earth will be after temporal authorities by the light of nature, and indeed, 90% people on the earth are easier to be conquered by authority instead of authenticity. What’s more, coming to heel of temporal authority is more expedient to pass free press egotistic proximity identification.

Undoubtedly, veritable progress of science is not intuitional cumulative achievement of colorful scientific travelogues A, B, C, D, E, F, ...as deserving reward of the first itinerary around preternatural landscapes of brand-new landmasses of science like omnifarious smallwares full of a basket but successive hypostatic endeavor to push humanistic ideology about authenticity of nature forward to perfect ideological enantiomorph of ultimate authenticity of nature step by step draw on practical feasibility & possibility in proportion to contemporaneous historical background, no more endeavor to formulate universal existence & motion in accordance with contemporaneous scientific orthodoxy as possible as we can. Before practical approach of legitimacy qualification of historical authenticity tolerance of science 0, efficiency of inertial extension of royal substantiation & perfection of contemporaneous scientific orthodoxy is mostly limited. And indeed, under background of royal successive freewheeling substantiation & perfection of contemporaneous scientific orthodoxy, the authoritative intrepidity of substantiation & perfection of contemporaneous scientific orthodoxy of the so-called second-string geniuses mostly contort the original intention of historical progress of science unexpectedly.

Historical progress of science in the recent several centuries seemed like a far-flung exploration of the first itinerary around numerous distinctive landscapes of brand-new landmasses of science with palette & tablet on back, several hundred years’ scientific travelogues were compiled thereby.

ii) Issue Big Bang involved in, whereas, Homogenous Cosmos Originated from Unique Genesis has to face coequally

ii-1) Causation divarication of red shift in Hubble model between Homogenous Cosmos Originated from Unique Genesis and Big Bang Theory.

Compared with Big Bang Theory, Homogenous Cosmos Originated from Unique Genesis seems having more reasons to believe that cosmos is still in dynamic state of expansion, as a result, Homogenous Cosmos Originated from Unique Genesis never suspect the factuality that all galaxies are going far away from us, no more the physical principle of red shift results from galaxies going away.

The key issue is that Big Bang Theory (/contemporaneous scientific orthodoxy) insists the so-called “red shift in Hubble style” purely results from dynamic situation that galaxies are going away from us, none else is possible.

Whereas, Homogenous Cosmos Originated from Unique Genesis thinks the so-called “red shift in Hubble fashion” is not single outcome resulting from dynamic situation galaxies going away from us but multiple outcomes of “red shift domino effect derived from galaxies going away from us” + “red shift domino effect derived from cushion shrinking effect of time dynamic speed”, even some a little gravitational domino effect of mass approximation accessible to negative gravity adulterated thereamong.

For convenience of illustration of the very issue, we still introduce the illustration of (IV-ii-5) quantitative change rate curve of extent expansion of cosmic yolk extent, quantitative change curve of acclimatization cushion of time dynamic speed of cosmic yolk extent, quantitative change rate curve of aberrant convergence of cosmic esse due to PNT reciprocal gelation under cosmic live input of $d(M_{white} \rightarrow m_{yolk}) > d(M_{white} \leftarrow m_{yolk})$, which we introduced in preceding section of Overall Arrangement of Homogenous Cosmos as Demiurgic Aggradation of Sequential Homologic Cosmogony in The Nature of Coherent Natura Naturans Throughout Cosmic Evolution.

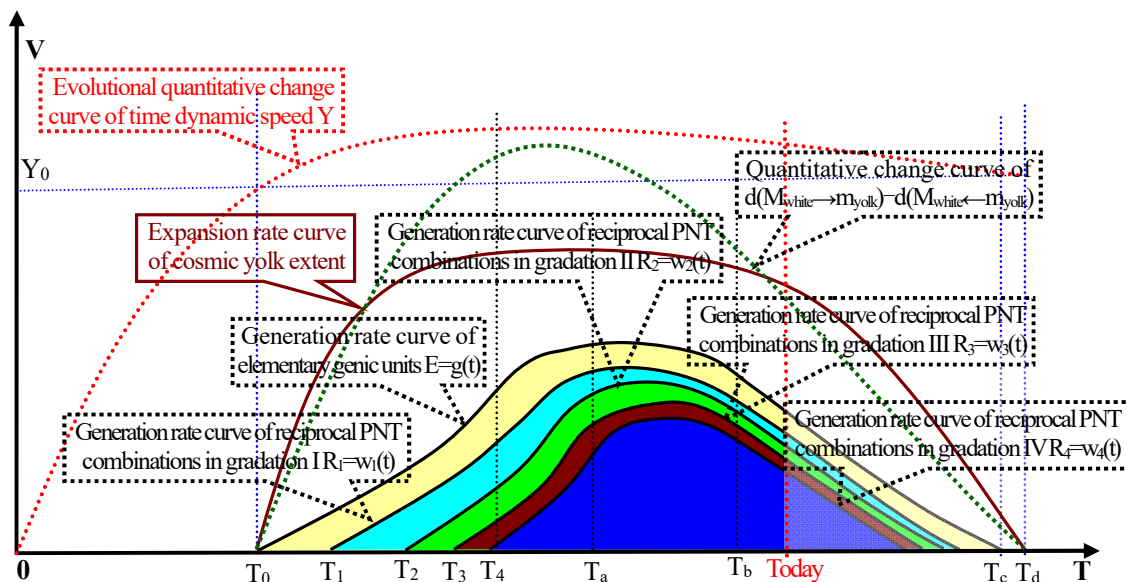

(IV-iv-3) Quantitative change rate curve of extent expansion of cosmic yolk extent, quantitative change curve of acclimatization cushion of time dynamic speed of cosmic yolk extent, quantitative change rate curve of aberrant convergence of cosmic esse due to PNT reciprocal gelation under cosmic live input of $d(M_{white} \rightarrow m_{yolk}) > d(M_{white} \leftarrow m_{yolk})$

ii-1-a) The ray from faraway galaxies around us arises red shift for the galaxies going away from us, — red shift domino effect derived from galaxies going away from us:

As coherent natura naturans throughout cosmic evolution, instinctive PNT reciprocal equilibrium towards optimum PNT operation is radical potentiality & conditionality for cosmos always ready to orientate itself towards perfection.

Extent expansion of cosmic yolk extent can create favorable condition for performance of **aberrant convergence of cosmic esse due to PNT reciprocal gelation**; quantitative change of extent expansion of cosmic yolk extent is also the quantitative change of ambient condition of aberrant convergence of cosmic esse due to PNT reciprocal gelation towards optimum. And inversely, performance of aberrant convergence of cosmic esse due to PNT reciprocal gelation holds down extent expansion of cosmic yolk extent by competitively exhausting necessary hylic resource for progressive evolution of cosmic yolk extent, once performance of aberrant convergence of cosmic esse due to PNT reciprocal gelation becomes more and more expedient, aberrant convergence of cosmic esse due to PNT reciprocal gelation will proportionably hold down more and more of extent expansion of cosmic yolk extent for it exhausts more and more necessary hylic resource for progressive evolution of cosmic yolk extent, which of course means quantitative change of aberrant convergence of cosmic esse due to PNT reciprocal gelation towards optimum is proportionate quantitative change of extent expansion of cosmic yolk extent towards retardance too.

Presence of massive galaxies in cosmos indicates the midseason of aberrant convergence of cosmic esse due to PNT reciprocal gelation in advance even indicates midseason of extent expansion of cosmic yolk extent in advance before aberrant convergence of cosmic esse due to PNT reciprocal gelation. Whereas, quantitative change of aberrant convergence of cosmic esse due to PNT reciprocal gelation towards optimum can not make extent expansion of cosmic yolk extent stop immediately but to make extent expansion of cosmic yolk extent more and more retarded, unless the cosmos (**cosmic yolk extent**) begins to shrink and degenerate. This of course implies that cosmic yolk extent is till expanding with expanding speed shrinking day by day, resultingly, the galaxies in cosmic yolk extent diffuse in proportional speed of extent expansion of temporal cosmic yolk extent. This is of course solid causation for us to perceive red shift of ray from faraway galaxies around us, —red shift domino effect derived from galaxies going away from us:

ii-1-b) The ray spreading abroad in capacious spacetime of cosmic yolk extent arises red shift for cushion shrinking effect of time dynamic speed, —red shift domino effect derived from cushion shrinking effect of time dynamic speed

Most of the galaxies in cosmos (/cosmic yolk extent) originally came into being during the evolutionary period between T_a and T_b , which is just the fastigium of aberrant convergence of cosmic esse due to PNT reciprocal gelation in cosmic yolk extent, whereas, current cosmos generally locates a time position a little far behind T_b , just the location indicated by “**Today**” in above illustration. And on the other hand, since the time T_4 , in terms of cushion change of time dynamic speed, as extent expansion of cosmic yolk extent has been relatively adequate for performance of aberrant convergence of cosmic esse due to PNT reciprocal gelation, evolutionary performance of aberrant convergence of cosmic esse due to PNT reciprocal gelation has been rather facile, which obviously holds down the evolution of space field of cosmic yolk extent by assimilating remarkable background resource for progressive evolution of cosmos (/cosmic yolk extent). Consequently, cushion change of time dynamic speed turns to cushion shrinking change. In a straightforward word, since time T_4 , as remarkable rise of aberrant convergence of cosmic esse due to PNT reciprocal gelation, field evolution of cosmic yolk extent begins to weaken, so that time dynamic speed begins to shrink towards critical value of time dynamic speed of cosmic yolk extent Y_0 . And throughout the course, existence & motion of ray in spacetime everlastingly satisfies equation as below:

$$m_p C = d(M \leftarrow m) Y \quad \longleftrightarrow \quad C = d(M \leftarrow m) Y / m_p$$

As time dynamic speed of cosmic yolk extent is a decreasing variable towards critical value of time dynamic

speed Y_0 of cosmic yolk extent, light speed is too a synchro and proportionate decreasing variable. And at the same time, as the value $d(M \leftarrow m)$ slightly varies accordingly for field weakening of cosmic yolk extent, the existent feature of ray subtly varies in proportion. Any ray transmitted in cosmic yolk extent for X years, as existence & motion of the ray experienced X years' cushion shrinking effect of time dynamic speed in cosmic yolk extent, the existent feature of ray must vary in proportion, —distinctive red shift of ray coming from idiographic galaxy occurs consequently. Any ray starting up after time T_4 , the more time it transmitted in cosmic yolk extent, the more cushion shrinking effect of time dynamic speed it experienced, it proportionably appears more domino effect of red shift therefore, so that the galaxies are more faraway from us, the more remarkable red shift of ray from them we can find. As a result, once we unknowingly owe red shift domino effect derived from cushion shrinking effect of time dynamic speed to red shift domino effect derived from galaxies going away from us, we mistakenly find cosmos is expanding with remarkable acceleration in the nature of things, and the expansion acceleration and speed are even stupendous. As the red shift effect is in direct proportion of time quantity the ray transmitting in the cosmic yolk extent, more faraway galaxies are, more time is necessary for the ray from the galaxy to transmit the distance between the proper galaxies and us, and as a result, the more remarkable domino effect of red shift we perceive, no matter where is our idiographic position in cosmic yolk extent.

The amount of heavy metal atoms in cosmos has been steady (**there are few heavy metal atoms coming into being in cosmos now**), this of course means cosmic evolution has gotten across fastigium of dynamic-gelation convergence of cosmic esse. And the coming of fastigium of aberrant convergence of cosmic esse due to PNT reciprocal gelation means the commencement of retardment of extent expansion of cosmic yolk extent. Since cosmic today has gotten across fastigium of aberrant convergence of cosmic esse due to PNT reciprocal gelation, it's impossible for cosmos of today to expand with remarkable acceleration. The reason we think cosmos of today still expanding with remarkable acceleration is but because we owe "red shift domino effect derived from cushion shrinking effect of time dynamic speed" to "red shift domino effect derived from galaxies going away from us". Of course, the space between this galaxy and that galaxy is virtually not as far as we originally forecasted according to our practical measure of red shift.

Cushion shrinking effect of time dynamic speed is virtually domino effect of subtle and slight weakening of space field of cosmic yolk extent once the fastigium of aberrant convergence of cosmic esse due to PNT reciprocal gelation occur and space field evolution of cosmic yolk extent is held down for anti-dynamic esse assimilated substantial hypostatic resource for cosmic progressive evolution. Occurrence of red shift of ray from faraway galaxies after transmitted in spacetime of cosmic yolk extent for rather a long time and experienced solid cushion shrinking effect of time dynamic speed therefore is virtually occurrence of red shift of ray from faraway galaxies after transmitted in spacetime of cosmic yolk extent for rather a long time and experienced solid subtle weakening of space field of cosmic yolk extent therefore.

Gravitational field in cosmos is virtually characteristic space field centered the centroid of matter integration with weakening orientation along radialized lines starting from the centroid of matter integration to distance, such characteristic space field centered the centroid of matter integration with weakening orientation along radialized lines starting from the centroid of matter integration to distance is almost in equivalent pattern with weakening orientation of space field, nobbut the space field weakening orientation derived from cushion shrinking

effect of time dynamic speed is quantitative change along time extension, whereas, the space field weakening orientation of gravitational field is quantitative change along distance. This of course means any ray from a star, during the short course of it goes away from the star; there must be similar occurrence of subtle red shift of the ray. For example, on the direct line between the sun and the earth, if there is a ray starting from the sun to the earth, during the inchoative several minutes the ray going far away from the sun, there must be similar occurrence of red shift of the ray, and the once the ray gradually closes to the earth, as the space field gradually strengthening, there must be subtle occurrence of blue shift of the ray. Of course, if the ray does not transmit exactly on direct line between the sun and the earth, as presence of PNT equilibrium instinct of ray, once the ray enters the gravitational field of the earth, the ray will subtly lean to the barycenter of the earth by the light of nature.

Of course, in the recent years, we found some unintelligible excursion  of galaxies indeed; we even predict presence of dark matter in cosmos by lineal logic extension from contemporaneous scientific orthodoxy.

(ii-2) Something about “cosmic background radiation”

I refer to “cosmic background radiation” herein is mainly ready to clarify the demonstration correlation between “cosmic background radiation” and “Big Bang” and introduce something about “cosmic background radiation” under precondition of homogenous cosmos originated from unique genesis at the volley.

(ii-2-a) Logic correlation between “cosmic background radiation” and “Big Bang”.

In 1964, in order to strengthen satellite communications, Bell lab unexpectedly discovered 6K unbeknown noise interference around. Soon after that, some professors of Princeton University alleged that the unbeknown 6K noise interference was just the very thing they were after — “cosmic background radiation” and alleged discovery of the so-called cosmic background radiation demonstrated Big Bang.

Did the discovery demonstrate Big Bang really? Now, with the question in mind, we come to anatomize the physical connotation of “cosmic background radiation” and the suspensive demonstration correlation between “cosmic background radiation” and “Big Bang”.

In summary words, Big Bang considered, after big bang of the so-called singularity, the first natal objects were various radiations, then, as temperature gradually dropped followed cosmos expansion, the radiations gradually converged into particles→atoms, molecules→macroscopical objects→celestial bodies, galaxies, such idea of course tallies with normal logic sequence of matter coming into being and successive configuration multiplication from microcosm to macrocosm. This is of course not patent of Big Bang, the success is that Big Bang managed the big bang of singularity the precondition to lead process extension of matter coming into being along “initial

Note : unintelligible excursion of galaxies may be outcome of negative gravity, there is still possibility for galaxies meet damage of destructive yolk towards white pervasion, so that, in order to evade further destructive yolk towards white pervasion, the galaxies exhibit unintelligible excursion for self-acclimation, which is out of rational forecast of contemporaneous scientific orthodoxy. All in all, existence & motion of matter integration in spacetime is just embodiment of PNT action of matter integration in certain ambient conditions, and the dynamic fundamental of universal existence & motion of matter is instinctive PNT reciprocal equilibrium towards optimum PNT operation, as long as there are active disturbance or impact to PNT operation of matter integration, there must be proportionate PNT reaction, existence & motion of matter integration must change accordingly.

cosmic radiations→particles→atoms, molecules→macroscopical objects→celestial bodies, galaxies”. Whereas, this is not all for the demonstration correlation issue, the key issue is whether Big Bang is both sufficient and necessary precondition of process extension of matter coming into being along “initial cosmic radiations→particles→atoms, molecules→macroscopical objects→celestial bodies, galaxies”.

In accordance with cosmic evolution Big Bang offered, it seemed no serious problem for so-called big bang of singularity to be precondition to lead process extension of matter coming into being along “initial cosmic radiations→particles→atoms, molecules→macroscopical objects→celestial bodies, galaxies”. However, whether Big Bang is just the unique possible precondition to lead process extension of matter coming being along “initial cosmic radiations→particles→atoms, molecules→macroscopical objects→celestial bodies, galaxies”? if it's not the unique possible precondition, it implies so-called big bang of singularity can only be qualified to be sufficient but unnecessary precondition of process extension of matter coming into being along “initial cosmic radiations→particles→atoms, molecules→macroscopical objects→celestial bodies, galaxies”, even if we do not throw suspicions on creditability that so-called big bang of singularity can conditionally lead process extension of matter coming into being along “initial cosmic radiations→particles→atoms, molecules→macroscopical objects→celestial bodies, galaxies”, nobody, even the most muddleheaded fools, can resort positive existent authenticity confirmation of process extension of matter coming into being along “initial cosmic radiations→particles→atoms, molecules→macroscopical objects→celestial bodies, galaxies” to affirm the absolute precondition presence of so-called “Big Bang” of singularity. Resorting existent authenticity confirmation of process extension of matter coming into being along “initial cosmic radiations→particles→atoms, molecules→macroscopical objects→celestial bodies, galaxies” to affirm the precondition presence of Big Bang must be off base mistake.

For instance, in Homogenous Cosmos Originated from Unique Genesis, spacetime and matter are coordinative homology; matter is lineal homogenous outgrowth of hypostatic spacetime when spacetime develops to some certain stage. Matter initially comes into being as lineal outgrowth as elementary genic units, and initially, all elementary genic units exist in spacetime as radiations, as gradual enrichment of initial cosmic radiations in spacetime accomplished sufficient condition of “**reciprocal idiosyncrasy towards PNT equilibrium + accessible space overall arrangement for PNT reciprocity**” stage by stage, process extension of matter coming into being along “initial cosmic radiations→particles→atoms, molecules→macroscopical objects→celestial bodies, galaxies” consequently occurs. That's to say, Homogenous Cosmos Originated from Unique Genesis can be the possible precondition to result in the process extension of matter coming into being along “initial cosmic radiations→particles→atoms, molecules→macroscopical objects→celestial bodies, galaxies” equally. The leading precondition of process extension of matter coming into being along “initial cosmic radiations→particles→atoms, molecules→macroscopical objects→celestial bodies, galaxies” not only can be Big Bang, but also can be Homogenous Cosmos Originated from Unique Genesis, even can be some other more like this.

Inversely, if we have creditable reasons to affirm the discovery of so-called cosmic background radiation has demonstrated Big Bang, we of course have creditable reasons to affirm the discovery of so-called cosmic background radiation has demonstrated Homogenous Cosmos Originated from Unique Genesis as well, discovery of so-called cosmic background radiation even can demonstrate all theories similar as the both in

accordance with the same logic.

All in all, as Big Bang is not the unique possible precondition to result in demiurgic multiplication of rich and colorful matter in cosmos along “initial cosmic radiations→particles→atoms, molecules→macroscopical objects→celestial bodies, galaxies”, there is none substantial demonstration correlation between “cosmic background radiation” and “Big Bang”. The amphibolous logic correlation between so-called “cosmic background radiation” and “Big Bang” can be illustrated as below:

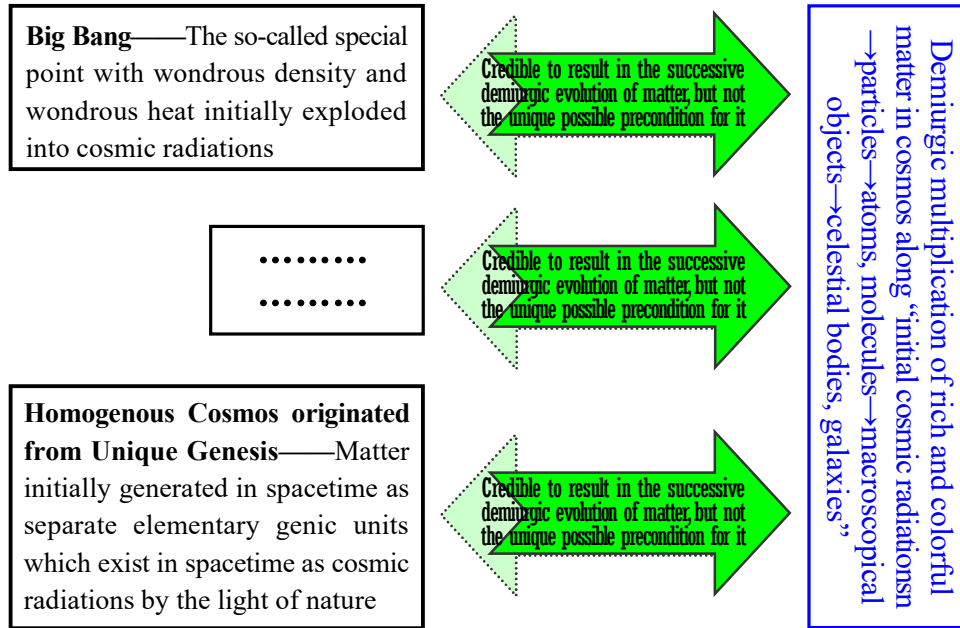

(IV-iv-4) Amphibolous demonstration correlation between “cosmic background radiation” and “Big Bang”

Considered by Homogenous Cosmos Originated from Unique Genesis, Cosmos is throughout homogenous originated from unique genesis, cosmic status quo is demiurgic aggradation of sequential homologic cosmogony, which exactly exists as well-regulated integration of cosmic homogeneity system making up of out-and-out serial natura naturata in the nature of coherent natura naturans throughout cosmic evolution. **It is only possible for concordant cosmos to be demiurgic aggradation of out-and-out serial natura naturata in the nature of coherent natura naturans throughout cosmic evolution; there is no way for demiurgic aggradation in the nature of different natura naturans to be concordant cosmos through and through.**

The integrative sequential homologic cosmogony can be illustrate as below:

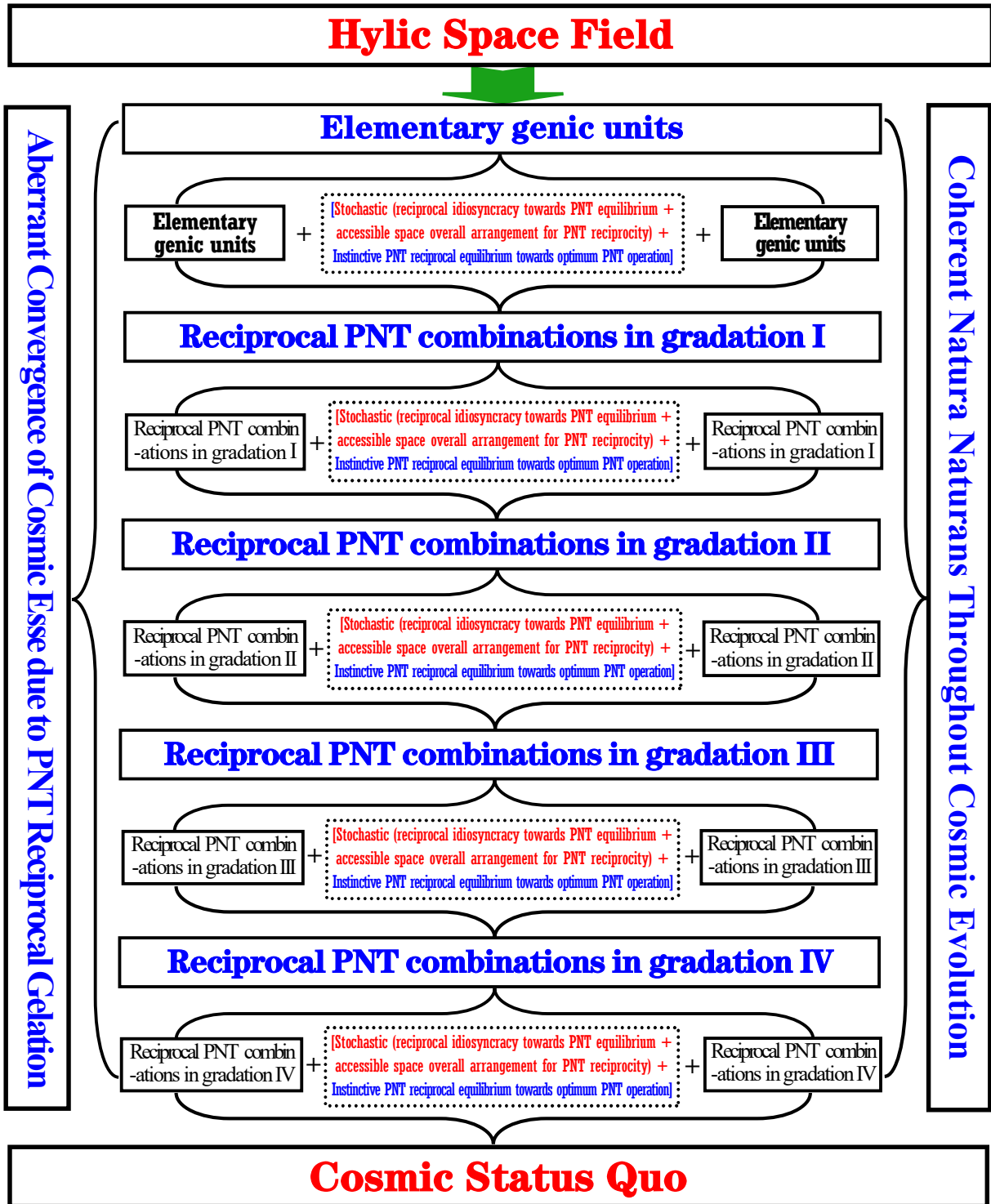

(IV-iv-5) Illustration of sequential homologic cosmogony

(ii-2-b) Annotation of cosmic background radiation basing on rational groundwork of homogenous cosmos originated from unique genesis

Till today, all the information about “cosmic background radiation” I got touch with is general information in half-news and half-story style rubbish. Usually, such kind information does never involve in introduction of measure instruments, choice and evaluation of measure surrounding, (radiation) data gathering and analysis etc. it seems I have inadequate warranty to pass positive conclusion about the detailed description about cosmic

As coherent natura naturans throughout cosmic evolution, instinctive PNT reciprocal equilibrium towards optimum PNT operation is radical potentiality & conditionality for cosmos always ready to orientate itself towards perfection.

background radiation. However, this won't baffle me to introduce something about cosmic background radiation basing on rational groundwork of homogenous cosmos originated from unique genesis.

In allusion to issue of cosmic background radiation basing on rational groundwork of homogenous cosmos originated from unique genesis, I'd like to emphasize two points herein:

The first, I'd like to state the so-called cosmic background radiation is not ember of a big bang of so-called singularity when cosmos initially coming into being but vivid presence of aberrant convergence of cosmic esse due to PNT reciprocal gelation, the ongoing proceeding of aberrant convergence of cosmic esse due to PNT reciprocal gelation is related to three quantities as below:

- ①: Extent expansion speed of cosmic yolk extent in time current dR/dt .
- ②: Generation rate of elementary genic units in cosmic yolk extent in time current $d(M_{\text{white} \rightarrow \text{myolk}})$.
- ③: Generation rate of reciprocal PNT combinations in time current, for convenience of further formulation, we introduce symbol $d(\text{PNT}_m)$ to denote it.

If we denote the CCT of cosmic background radiation in cosmic yolk extent with letter K, then the CCT of cosmic background radiation can be formulated as below:

$$K = A(\text{Quantity of elementary genic units generated in single time unit-quantity of elementary genic units combined into reciprocal PNT combinations in single time unit}) / \text{extent volume of cosmic yolk extent of the proper time}$$

$$= A \left\{ \int_0^t [d(M_{\text{white} \rightarrow \text{myolk}}) - d(M_{\text{white} \leftarrow \text{myolk}})] dt - \int_0^t d(\text{PNT}_m) dt \right\} / 4 \pi R^3 / 3$$

In above equation, letter A denotes the constant of direction proportion, letter R denotes the extent radius of cosmic yolk extent at the moment.

Till today, the mutual transmutation of cosmic esse $d(M_{\text{white} \rightarrow \text{myolk}}) - d(M_{\text{white} \leftarrow \text{myolk}}) > 0$ has been in situation like a spent bullet, the value $d(M_{\text{white} \rightarrow \text{myolk}})$ of cosmos has been relatively less, and what's more, extent of cosmic yolk extent has been very capacious, so that in capacious spacetime, the newly generated elementary genic units has been remarkably diluted, as a result, the CCT of cosmos today is only several K. This of course means that the ongoing performance of aberrant convergence of cosmic esse due to PNT reciprocal gelation has been rather weak.

The second, The CCT distribution of cosmic background radiation must be proportionably different for disparity of space field strength

In homogenous cosmos, space field strength is the most substantial generative condition of matter, the more substantial the space field strength is, and the more favorable generative conditions of matter are, and the progressive process extension of matter coming into being is relatively ascendant, which of course means the generative rate of elementary genic units in space field is relatively higher, resultingly, the disparity of space field strength must proportionably means the different generative rate of elementary genic units in proper space field, and CCT of so-called cosmic background radiation must be different therefore. Generally, in more substantial space field, the CCT of cosmic background radiation will be relatively higher. Let's suppose the matter field of the sun is isolated without interference, in spite of the radiation transmission interference, the nearer position to the sun, the matter field of the sun is more substantial, and proportionably, the CCT of cosmic background radiation is relatively higher. The inverse situation is of course tallies with the same logic.

(ii-3) Temperature change throughout cosmic evolution

In Big Bang theory, temperature seems a notion applicable anywhere, even before explosion, the so-called “singularity” has been an object with both wondrous density and wondrous temperature, after explosion, it began to drop temperature as gradual expansion of cosmos, till at last turn to temperature of cosmic status quo.

Considered by Homogenous Cosmos Originated from Unique Genesis, notion of temperature is occurrence when cosmos develops to some certain stage there is positive matter coming into being in spacetime. As motion is inherent property of matter and temperature is physical embodiment of matter motion, so temperature is consequently inherent property of matter.

As matter firstly coming into being as separate elementary genic units, in spacetime, any elementary genic unit exists in space as cosmic radiation by the light of nature, so in initial stage matter coming into being, as gradual enrichment of elementary genic units in cosmic yolk extent, the temperature of cosmos is relatively higher. Whereas, once the enriched elementary genic units accomplished sufficient condition of “**reciprocal idiosyncrasy towards PNT equilibrium + accessible space overall arrangement for PNT reciprocity**” stage by stage, elementary genic units spontaneously converge into massive particles,... atoms, molecules, molecule system, macroscopical objects, ..., celestial bodies, galaxies, and temperature of cosmos drop down therefore.

Throughout the process of aberrant convergence of cosmic esse due to PNT reciprocal gelation, on one hand, there are new elementary genic units generated in space field, and on the other hand, some of the generated elementary genic unit converged into reciprocal PNT combinations stage by stage. If we neglect the elementary genic units diluted by extent expansion of cosmic yolk extent, once initial generation rate of elementary genic units is relatively ascendent to convergence rate of elementary genic units in space field, temperature of cosmos will be higher and higher. Whereas, it's impossible for cosmic temperature to be too high, because too high temperature will radically retard even restrain initial generation of elementary genic units in spacetime. Once initial generation rate of elementary genic units and convergence rate of elementary genic units in space field are counterbalanced, temperature of cosmos will be relatively steady. Once convergence rate of elementary genic units is relatively ascendent to initial generation rate of elementary genic units in space field, temperature of cosmos will be lower and lower, till at last, temperature drop to temperature of nowadays cosmos. Of course, I have to supplement that extent expansion of cosmic yolk extent can directly dilute the elementary genic units in spacetime; it can coequally cause temperature decrease as well.

Acknowledgement:

I heard of Big Bang early, However, as timely renovation of humanistic ideology about authenticity of nature in proportion to contemporaneous historical background of remarkable highlight of microcosmic configuration of matter, the motif of Homogenous Cosmos Originated from Unique Genesis is:

- (1) Whether cosmos is really homogenous originated from unique genesis through and through?**
- (2) if yes, what integrative homologic configuration of cosmos and proportionate universal homologic existence & motion should be accordingly?**

As coherent natura naturans throughout cosmic evolution, instinctive PNT reciprocal equilibrium towards optimum PNT operation is radical potentiality & conditionality for cosmos always ready to orientate itself towards perfection.

As I was always ready to devote to these two sixty-four-dollar questions for years, I seemed no reason and no time to mind what Big Bang was.

In winter of 2010, professor Li-xuesheng post me several papers about “Big Bang” by e-mail, I was substantively insensitive to Big Bang, so I never read, till two months ago, I opened the documents by encounter, I was rashly relapsed into craze, ——Nonsense! Painting snake referring to rabbit! An impulsion to comment Big Bang suddenly turned to me. However, as I was too busy to arrange my work those days, and what’s more, I really lacked necessary and creditable reference about Big Bang. After all, as I never paid my attention to, if brashly coming to comment it, I really could not be sure what Big Bang is. Considering I could not comment blindly, I did not do it those days.

Several days ago, one of my fellow workers threw me a QQ number; I rashly threw it to several of my E-mail friends subsequently. The night before last, several QQ fellows ran into my QQ without invitation, they all asked me to comment on their arguments in some certain website; I was almost delighted by their fervency, so I commented throughout without break.

The night gradually slid into deeper and deeper, but various thoughts about Big Bang were still flickering in my mind, ——what’s Big Bang? It’s so magic to make the intelligentsia all over the world so crazed!? I turned from side to side in bed without sleeping. Ultimately, I got up and turned on my computer, I used the words “宇宙大爆炸” to search in Baidu Website, CCTV video “Big Bang——where is the center” suddenly came to me (http://tv.siteapp.cntv.cn/?l=3&ref=www_iphone&order=1&dict=22&tj=www_normal_1_0_10_title&cltj=cloud_title&src=http%3A%2F%2Ftv.cntv.cn%2Fvideo%2FVSET100154354475%2Fc0af156f45134d3fb%3f5c48e4b4dd6d). I read the video programme carefully and opened many related linkage about Big Bang. And in the later days, I read the same video programme and the relevant linkages several times after hours.

As self-absorption, Big Bang displayed in my mind therefore, considering Big Bang reflected on Homogenous Cosmos Originated from Unique Genesis maybe avail highlight and clarification of many relevant issues, I offered parallel thought framework of Homogenous Cosmos Originated from Unique Genesis and image Big Bang reflected on Homogenous Cosmos Originated from Unique Genesis to my readers herein. And as well, I’d like to acknowledge professor Li-xuesheng and all my QQ fellows who invited me to comment on their arguments so as to draw my attention to Big Bang.

Nov. 2011. Humen town, Baisha village, Dongguan city, Guangdong province.



It's only possible for concordant cosmos to be demiurgic aggradation of out-and-out serial natura naturata in the nature of coherent natura naturans throughout cosmic evolution; there is no way for demiurgic aggradation in the nature of different natura naturans to be concordant cosmos through and through.

As coherent natura naturans throughout cosmic evolution, instinctive PNT reciprocal equilibrium towards optimum PNT operation is radical potentiality & conditionality for cosmos always ready to orientate itself towards perfection.

The Fifth Part

Systematical Unique-genesis Quantization Formulation of Universal Existence & Motion Along Sequential Homologic Cosmogony Starting at Field Genic Origin i_0 to Universal Reciprocal PNT Combinations in the Nature of Coherent Natura Naturans Throughout Cosmic Evolution

Cosmic status quo is but demiurgic aggradation of sequential homologic cosmogony, which exactly exists as well-regulated integration of cosmic homogeneity system making up of out-and-out natura naturans in the nature of coherent natura naturans throughout cosmic evolution, **instinctive PNT reciprocal equilibrium towards optimum PNT operation** is just the reality of so-called coherent natura naturans throughout cosmic evolution.

Virtually, **“instinctive PNT reciprocal equilibrium towards optimum PNT operation”** is not only reality of coherent dynamic motivity of sequential homologic cosmogony starting at cosmic genic origin i_0 to cosmic status quo but also coherent dynamic fundamental of postnatal existence & motion from elementary genic units to universal reciprocal PNT combinations,—innate potentiality & conditionality for cosmos always ready to orientate itself towards perfection.

(V-i) Mathematical definition of "Homogenous Cosmos Originated from Unique Genesis"

Abstract; Affirmation of homogenous cosmos originated from unique genesis of course implies cosmos is demiurgic aggradation of sequential homologic cosmogony which exactly exists as well-regulated integration of cosmic homogeneity system making up of out-and-out serial natura naturata in the nature of coherent natura naturans throughout cosmic evolution; any physical existence in cosmos is either the cosmic genic origin i_0 itself or compound homology radically originated from cosmic genic origin i_0 . Thus, once we treat the hylic existence of genic origin i_0 as "basic quantum" of cosmos, we can formulate genic accumulation of any object in cosmos with homology genic integral equation as $\sum m = \int_{i_0}^X f(m_{i_0 \rightarrow X}) i_0$, which denotes genic integration of object along sequential homologic cosmogony starting at cosmic origin " i_0 " to idiographic demiurgic multiplication terminal " X ". (In the equation, "m" is just the abbreviation of "material" or "mass").

And on the other hand, as dynamic essence of time dynamic speed of time and inherent PNT correlation between spacetime and matter which materializes activity heritage from dynamic spacetime to matter, any positive matter in spacetime must have absolute spacetime momentum of " $mv = d(M \leftarrow m)Y$ ", absolute spacetime momentum of matter is usually cumulative quantity made up of compositive spacetime momentum existing in all configurable hierarchy of reciprocal PNT combinations, which come into being throughout original homologic multiplication of matter generation and formation, so we formulate the PNT dynamic aggradation of matter inherently coexisting in all configurable hierarchy of reciprocal PNT combinations which originally come into being along cosmic demiurgic homologic multiplication starting at cosmic origin " i_0 " to idiographic demiurgic homologic multiplication terminal " X " as $\sum^D = D_{PNT} [\int_{i_0}^X f(m_{i_0 \rightarrow X})]$ (In the definition equation, D is just the abbreviation of "Dynamic", which denotes the PNT dynamic connotation of genic accumulation $\sum m = \int_{i_0}^X f(m_{i_0 \rightarrow X}) i_0$).

Integrated the both definition equations " $\sum m = \int_{i_0}^X f(m_{i_0 \rightarrow X}) i_0 + \sum^D = D_{PNT} [\int_{i_0}^X f(m_{i_0 \rightarrow X})]$ " above, we can arrive at the mathematical definition of Homogenous Cosmos Originated from Unique Genesis as below:

$$\text{Homogenous cosmos originated from unique genesis} \stackrel{\text{def}}{=} \sum^D m \equiv D [\int_{i_0}^X f(m_{i_0 \rightarrow X}) i_0]$$

Keywords: *Cosmic quantum, unique-genesis quantization, evolutionary function in unique-genesis quantization, homology genic integral equation, PNT dynamic connotation integral equation, homology integration equation, reciprocal PNT combination, instinctive PNT reciprocal equilibrium towards optimum PNT operation.*

1. Mathematical definition of Homogenous Cosmos Originated from Unique Genesis

In accordance with cosmic demiurgic evolution of sequential homologic cosmogony under precondition of Homogenous cosmos originated from unique genesis postulate, cosmic demiurgic evolution starting at cosmic genic origin i_0 , then follows sequential generation of field genic unit series of i_1, i_2, \dots, i_n with development of space field, then sequential generation of elementary genic units series of $i_{n+1}, i_{n+2}, i_{n+3}, \dots, i_{n+p}$ in one continuous line following multiplication demiurgic proliferation of rich and colorful reciprocal PNT combinations for instinctive PNT reciprocal equilibrium towards optimum PNT operation, and ultimately makes up of the organic "cosmic homogeneity system".

As coherent natura naturans throughout cosmic evolution, instinctive PNT reciprocal equilibrium towards optimum PNT operation is radical potentiality & conditionality for cosmos always ready to orientate itself towards perfection.

As cosmos is throughout homogenous originated from unique genesis and generally come into being along sequential homologic cosmogony in the nature of coherent natura naturans throughout cosmic evolution, if we just treat the so-called cosmic genic origin i_0 a “cosmic quantum”, and quantize any cosmic existence along sequential homologic cosmogony in the nature of coherent natura naturans throughout cosmic evolution, we can define homogenous cosmos originated from unique genesis mathematically.

Towards to the goal, as sequential homologic cosmogony starting at cosmic genic origin i_0 , let’s denote the time extension throughout cosmic demiurgic evolution as $[i_0, \vartheta]$, and we denote any segmentary process discretionary object in cosmos original coming into being along sequential homologic cosmogony as $[i_0, X]$, ($[i_0, X] \subseteq [i_0, \vartheta]$), we denote the evolutionary quantitative change during the course of demiurgic process $[i_0, X]$ as $f(m_{i_0 \rightarrow X})$, in the expression, m denotes mass of object in cosmos, which is just the abbreviation of “mass” or “material”. Then, the material quantitative integral throughout demiurgic evolution of $[i_0, X]$ can be expressed as $\int_{i_0}^X f(m_{i_0 \rightarrow X}) d(i_0 \rightarrow X)$, “ $i_0 \rightarrow X$ ” is just the symbolization of demiurgic process extension starting at cosmic genic origin “ i_0 ” to some certain evolutionary terminal “ X ”. Of course, we can denote the material integral of any cosmic object as “ $\sum m$ ” too, so we arrive at definition equation $\sum m = \int_{i_0}^X f(m_{i_0 \rightarrow X}) d(i_0 \rightarrow X)$. This is just the so-called homology genic integral equation of any object in cosmos.

And as cosmos is throughout homogenous originated from unique genesis, any physical process in cosmos can be quantized by cosmic quantum i_0 too, so the substantial connotation of “ $d(i_0 \rightarrow X)$ ” is exactly a single “ i_0 ”, so the homology genic integral equation changes into $\sum m = \int_{i_0}^X f(m_{i_0 \rightarrow X}) i_0$.

In time current, as everlasting PNT performance between matter and spacetime, all objects exist in everlasting dynamic state, however, homology genic integral equation of object in cosmos only gives expression to idiographic homogenous genic accumulation of discretionary cosmic object, but not including the innate dynamic connotation of object in spacetime. In order to give expression to the integrative living existence of cosmic subjects, we of course can not neglect the proper dynamic connotation congenitally incarnated in homogenous genic cumulative condensation of object in the nature of instinctive PNT reciprocal equilibrium towards optimum PNT operation.

As preparatory step toward this topic, we primarily denote the innate dynamic connotation isochronously accumulated along the sequential progressional homologic multiplication starting at cosmic genic origin i_0 to some certain evolutionary terminal X and congenitally embodied in the proper homologic configurable hierarchy of object as $\sum^D = D [\int_{i_0}^X \text{PNT}]$, and we just call this equation “PNT dynamic connotation integral equation”. In the equation, “ D ” is just the abbreviation of “Dynamic”.

Then, in terms of any evolutionary segment of $[i_0, X]$, ($[i_0, X] \subseteq [i_0, \vartheta]$), we can formulate the aggradation of PNT dynamic connotation of the evolutionary process as $\sum^D = D_{\text{PNT}} [\int_{i_0}^X f(m_{i_0 \rightarrow X}) i_0]$, $D_{\text{PNT}} [\int_{i_0}^X f(m_{i_0 \rightarrow X}) i_0]$ denote PNT dynamic connotation ended in mass aggradation of $\int_{i_0}^X f(m_{i_0 \rightarrow X}) i_0$ of matter integration.

Virtually, the homogenous genic accumulation and the proper isochronous PNT dynamic connotation embodied in homology genic configurable hierarchy of object are congenitally coexisting as perfect integrity, which are innative coexistence and can never be isolated. So we should never keep the homology genic integral equation $\sum m = \int_{i_0}^X f(m_{i_0 \rightarrow X}) i_0$ and PNT dynamic connotation integral equation $\sum^D = D [\int_{i_0}^X f(m_{i_0 \rightarrow X}) i_0]$

separate. Instead, we should anastomose the both equations into an integrative integral calculus equation as $\sum^D m \equiv D [\int_{i_0}^X f(m_{i_0 \rightarrow X}) i_0]$, which of course indicate:

$$\sum^D m \equiv D_{PNT} [\int_{i_0}^X f(m_{i_0 \rightarrow X}) i_0] = \{ \sum m = \int_{i_0}^X f(m_{i_0 \rightarrow X}) i_0 \} + \{ \sum^D = D_{PNT} [\int_{i_0}^X f(m_{i_0 \rightarrow X}) i_0] \}$$

In equation above, the letter “D” is abbreviation of “Dynamic”, D_{PNT} indicates the dynamic connotation ended in mass aggradation of “ $\int_{i_0}^X f(m_{i_0 \rightarrow X}) i_0$ ” of the proper reciprocal PNT combination.

Of course, even they are just the single field genic units as $i_0, i_1, i_2, \dots, i_n$ instead of elementary genic units of $i_{n+1}, i_{n+2}, i_{n+3}, \dots, i_{n+p}$ and the successively evolutionary outgrowth of rich and colorful reciprocal PNT combinations in cosmos, as all field genic units coexist in everlasting mutual transmuting and transiting. If we expand the dynamic connotation of “D” incarnated in equation $\sum^D m \equiv D [\int_{i_0}^X f(m_{i_0 \rightarrow X}) i_0]$ to the everlasting dynamic transmuting and transiting among field genic units, we then have made the applicable logic extension of equation $\sum^D m \equiv D [\int_{i_0}^X f(m_{i_0 \rightarrow X}) i_0]$ crown all cosmic physical existence.

That's to say, we can primarily denote any physical existences in cosmos as $\sum^D m \equiv D [\int_{i_0}^X f(m_{i_0 \rightarrow X}) i_0]$, thus, we arrive at the mathematical definition of Homogenous Cosmos Originated from Unique Genesis as below:

$$\text{Homogenous Cosmos Originated from Unique Genesis} \stackrel{\text{def}}{=} \sum^D m \equiv D [\int_{i_0}^X f(m_{i_0 \rightarrow X}) i_0]$$

Mathematical definition of Homogenous Cosmos Originated from Unique Genesis includes both physical connotation of homogenous cosmos originated from unique genes as below:

The first, beside the negative genic units i_0 itself, any object in cosmos is undoubted homology made up of i_0 with distinctive demiurgic individuality of homologic accumulation scale and dynamic configuration in the nature of instinctive reciprocal PNT equilibrium towards optimum PNT operation. As a result, we can formulate the convergent homologic accumulation of mass of all homologic objects besides cosmic genic origin i_0 itself in cosmos as $\sum m = \int_{i_0}^X f(m_{i_0 \rightarrow X}) i_0$, which are radically originated from unique genesis of course.

The second, original generation of any cosmic object is but spontaneous occurrence of convergent aggradation in the nature of instinctive reciprocal PNT equilibrium towards optimum PNT operation for stochastic accomplishment of “reciprocal idiosyncrasy towards PNT equilibrium + accessible space overall arrangement for PNT reciprocity” among the proper compositive homologic components. Of course, the postnatal existence & motion of the neonatal reciprocal PNT combination is too spontaneous occurrence in the nature of instinctive PNT reciprocal equilibrium towards optimum PNT operation to acclimatize itself to new ambience. However, the mathematical definition of Homogenous Cosmos Originated from Unique Genesis has not offered mathematical formulation of common dynamic model of instinctive reciprocal PNT equilibrium towards optimum PNT operation, no more idiographic dynamic model of PNT action.

Of course, in order to formulate more precisely, if the material endosome of homology genic accumulation $\int_{i_0}^X f(m_{i_0 \rightarrow X}) i_0$ in equation $\sum^D m \equiv D [\int_{i_0}^X f(m_{i_0 \rightarrow X}) i_0]$ represents negative matter, then, such definition equation can be expressed as below:

$$\sum^D m \equiv D_{T\&T} [\int_{i_0}^X f(m_{i_0 \rightarrow X}) i_0]$$

In the equation, the small words “T&T” behind “D” is the abbreviation of “Transiting & Transmuting”.

As coherent natura naturans throughout cosmic evolution, instinctive PNT reciprocal equilibrium towards optimum PNT operation is radical potentiality & conditionality for cosmos always ready to orientate itself towards perfection.

If the material endosome of homology genic accumulation $\int_{i_0}^X f(m_{i_0 \rightarrow X}) i_0$ in equation $\sum_{m \equiv D} [\int_{i_0}^X f(m_{i_0 \rightarrow X}) i_0]$ represents positive matter, then, such definition equation can be expressed as below:

$$\sum_{m \equiv D}^D_{\text{PNT}} [\int_{i_0}^X f(m_{i_0 \rightarrow X}) i_0]$$

In the equation, the small words ‘‘PNT’’ behind ‘‘D’’ is the abbreviation of ‘‘positive & negative transmutation’’.

As the mathematical definition of Homogenous Cosmos Originated from Unique Genesis is integrated of both homology genic integral equation and PNT dynamic connotation integral equation, for expedience, we may call it ‘‘homology integration equation’’ too.

As the entire cosmos is just a homology family, with the rational backup of homology integration equation, we are very convenient to analyze and study the homogenous genic accumulation configuration and the proper dynamic esse congenitally incarnated in homology genic accumulation of discretionary cosmic object mathematically.

In terms of any single genic unit $i_u \in (i_0, i_1, i_2, \dots, i_n, i_{n+1}, i_{n+2}, i_{n+3}, \dots, i_{n+p})$, ($U, n, p \in \mathbb{Z}, 0 \leq U \leq n+p$), we can denote and mathematically study it as below:

$$\sum_{m \equiv D}^D_{i_u} \equiv D [\int_{i_0}^{i_u} f(m_{i_0 \rightarrow i_u}) i_0].$$

In terms of any physical time quantity ‘‘t’’, we can denote and mathematically study its physical significance and effect in spacetime as below:

$$\sum_{m \equiv D}^D_{t} \equiv D_{T \& T} [\int_{i_0}^t f(m_{i_0 \rightarrow t}) i_0];$$

In terms of any existent space distance ‘‘s’’, we can denote and mathematically study its physical existence as below:

$$\sum_{m \equiv D}^D_{s} \equiv D_{T \& T} [\int_{i_0}^s f(m_{i_0 \rightarrow s}) i_0].$$

In terms of any existent particles or particle combinations, such as electron, neutron, proton, ..., α particle, discretionary atomic nucleus, we can denote and mathematically study them as following:

$$\begin{aligned} \sum_{m \equiv D}^D_{\text{electron}} &= D_{\text{PNT}} [\int_{i_0}^{\text{electron}} f(m_{i_0 \rightarrow \text{electron}}) i_0], & \sum_{m \equiv D}^D_{\text{neutron}} &= D_{\text{PNT}} [\int_{i_0}^{\text{neutron}} f(m_{i_0 \rightarrow \text{neutron}}) i_0], \\ \sum_{m \equiv D}^D_{\text{proton}} &= D_{\text{PNT}} [\int_{i_0}^{\text{proton}} f(m_{i_0 \rightarrow \text{proton}}) i_0], & \dots & \dots \\ \sum_{m \equiv D}^D_{\alpha \text{ particle}} &= D_{\text{PNT}} [\int_{i_0}^{\alpha \text{ particle}} f(m_{i_0 \rightarrow \alpha \text{ particle}}) i_0], & \dots & \sum_{m \equiv D}^D_{\text{atomic nucleus}} = D_{\text{PNT}} [\int_{i_0}^{\text{atomic nucleus}} f(m_{i_0 \rightarrow \text{atomic nucleus}}) i_0] \end{aligned}$$

In terms of any interaction between discretionary particle and particle, such as $n + {}^{235}\text{U} = {}^{236}\text{U}$, $n + {}^{239}\text{Pu} = {}^{240}\text{Pu}$, $n + {}^{238}\text{U} = {}^{239}\text{U} + \gamma$ we can denote and mathematically study their PNT reaction dynamic process from initial state to ultimate state as following:

$$\begin{aligned} \sum_{m \equiv D}^D_{\text{neutron}} + \sum_{m \equiv D}^D_{{}^{235}\text{U}} &\equiv \sum_{m \equiv D}^D_{{}^{236}\text{U}} \\ &= D_{\text{PNT}} [\int_{i_0}^{\text{neutron}} f(m_{i_0 \rightarrow \text{neutron}}) i_0] + D_{\text{PNT}} [\int_{i_0}^{235\text{U}} f(m_{i_0 \rightarrow 235\text{U}}) i_0] \equiv D_{\text{PNT}} [\int_{i_0}^{236\text{U}} f(m_{i_0 \rightarrow 236\text{U}}) i_0] \\ \sum_{m \equiv D}^D_{\text{neutron}} + \sum_{m \equiv D}^D_{{}^{239}\text{Pu}} &\equiv \sum_{m \equiv D}^D_{{}^{240}\text{Pu}} \\ &= D_{\text{PNT}} [\int_{i_0}^{\text{neutron}} f(m_{i_0 \rightarrow \text{neutron}}) i_0] + D_{\text{PNT}} [\int_{i_0}^{239\text{Pu}} f(m_{i_0 \rightarrow 239\text{Pu}}) i_0] \equiv D_{\text{PNT}} [\int_{i_0}^{240\text{Pu}} f(m_{i_0 \rightarrow 240\text{Pu}}) i_0] \\ \sum_{m \equiv D}^D_{\text{neutron}} + \sum_{m \equiv D}^D_{{}^{238}\text{U}} &\equiv \sum_{m \equiv D}^D_{{}^{239}\text{U} + \gamma} \end{aligned}$$

$$=D_{PNT}[\int_{i_0}^{\text{neutron}} f(m_{i_0 \rightarrow \text{neutron}})i_0] + D_{PNT}[\int_{i_0}^{235U} f(m_{i_0 \rightarrow 235U})i_0] \equiv D_{PNT}[\int_{i_0}^{236U} f(m_{i_0 \rightarrow 236U})i_0] + D_{PNT}[\int_{i_0}^{\gamma} f(m_{i_0 \rightarrow \gamma})i_0]$$

In terms of any elementary atom, such as C¹², N¹⁴ ... Ra²²⁶ ..., we can denote and mathematically hypostatize their idiographic existence as following:

$$\sum^D m C^{12} = D_{PNT}[\int_{i_0}^{C^{12}} f(m_{i_0 \rightarrow C^{12}})i_0], \quad \sum^D m N^{14} = D_{PNT}[\int_{i_0}^{N^{14}} f(m_{i_0 \rightarrow N^{14}})i_0], \quad \dots, \\ \sum^D m Ra^{226} = D_{PNT}[\int_{i_0}^{Ra^{226}} f(m_{i_0 \rightarrow Ra^{226}})i_0], \quad \dots$$

In terms of any chemical molecule, such as H₂O, CO₂, H₂SO₄ ... CH₄ ... DNA, we can denote and mathematically study them as following:

$$\sum^D m H_2O = D_{PNT}[2\int_{i_0}^H f(m_{i_0 \rightarrow H})i_0 + \int_{i_0}^O f(m_{i_0 \rightarrow O})i_0], \\ \sum^D m CO_2 = D_{PNT}[\int_{i_0}^C f(m_{i_0 \rightarrow C})i_0 + 2\int_{i_0}^O f(m_{i_0 \rightarrow O})i_0], \\ \sum^D m H_2SO_4 = D_{PNT}[2\int_{i_0}^H f(m_{i_0 \rightarrow H})i_0 + \int_{i_0}^S f(m_{i_0 \rightarrow S})i_0 + 4\int_{i_0}^O f(m_{i_0 \rightarrow O})i_0], \\ \dots \dots \dots \\ \sum^D m CH_4 = D_{PNT}[\int_{i_0}^C f(m_{i_0 \rightarrow C})i_0 + 4\int_{i_0}^H f(m_{i_0 \rightarrow H})i_0] \\ \dots \dots \dots \\ \sum^D m DNA = D_{PNT}[\int_{i_0}^{DNA} f(m_{i_0 \rightarrow DNA})i_0]$$

In terms of any allotrope, such as C_xH_y allotrope series (x, y ∈ N), we can denote and mathematically study & analyze them as following:

$$\sum^{D_1} m C_xH_y = D_{PNT-1}[x*\int_{i_0}^C f(m_{i_0 \rightarrow C})i_0 + y*\int_{i_0}^H f(m_{i_0 \rightarrow H})i_0] \\ \sum^{D_2} m C_xH_y = D_{PNT-2}[x*\int_{i_0}^C f(m_{i_0 \rightarrow C})i_0 + y*\int_{i_0}^H f(m_{i_0 \rightarrow H})i_0] \\ \sum^{D_3} m C_xH_y = D_{PNT-3}[x*\int_{i_0}^C f(m_{i_0 \rightarrow C})i_0 + y*\int_{i_0}^H f(m_{i_0 \rightarrow H})i_0] \\ \dots \dots \dots$$

As the discrepancies among these allotropes C_xH_y are only limited in PNT dynamic esse of $D_{PNT}[\int_{i_0}^{C_xH_y}]$, we just differentiate them as $D_{PNT-1}[\int_{i_0}^{C_xH_y}]$, $D_{PNT-2}[\int_{i_0}^{C_xH_y}]$, $D_{PNT-3}[\int_{i_0}^{C_xH_y}]$, Of course, the format of $x*\int_{i_0}^C f(m_{i_0 \rightarrow C})i_0$ and $y*\int_{i_0}^H f(m_{i_0 \rightarrow H})i_0$ introduced in the equation above means all the x “C” atoms have the same dynamic character and the y “H” atoms have the same dynamic character too in this molecule of C_xH_y.

In terms of any chemical reaction, such as 2H₂+O₂=2H₂O, C+O₂=CO₂, we can denote and mathematically study & analyze their idiographic existent connotation including genic integration and integrated PNT situation as following:

$$2H_2 + O_2 = 2H_2O \equiv 2\sum^D m H_2 + \sum^D m O_2 = 2\sum^D m H_2O \\ \equiv 2*D_{PNT}[2\int_{i_0}^H f(m_{i_0 \rightarrow H})i_0] + D_{PNT}[2\int_{i_0}^O f(m_{i_0 \rightarrow O})i_0] = 2*D_{PNT}[2\int_{i_0}^H f(m_{i_0 \rightarrow H})i_0 + \int_{i_0}^O f(m_{i_0 \rightarrow O})i_0] \\ C + O_2 = CO_2 \equiv \sum^D m C + \sum^D m O_2 = \sum^D m CO_2 \\ \equiv D_{PNT}[\int_{i_0}^C f(m_{i_0 \rightarrow C})i_0] + D_{PNT}[2\int_{i_0}^O f(m_{i_0 \rightarrow O})i_0] = D_{PNT}[\int_{i_0}^C f(m_{i_0 \rightarrow C})i_0 + 2\int_{i_0}^O f(m_{i_0 \rightarrow O})i_0]$$

As coherent natura naturans throughout cosmic evolution, instinctive PNT reciprocal equilibrium towards optimum PNT operation is radical potentiality & conditionality for cosmos always ready to orientate itself towards perfection.

... ..

The reaction conditions and both reactant & resultant state we usually mentioned as temperature, pressure, gas, liquid, solid etc are all embodied in $D_{PNT}[\int_{i_0}^X]$ status of both reactants and resultants.

About the reproduction, pullulation even actualization of biological function of organism, we can also expediently analyze and study their dynamic attribute, existence & motion by mathematical operation based on the proper homology integration equation with individual parameters of the reciprocal PNT combination under the proper material background. For example, we come to study some certain organs of any animal such as brain, liver, lung, spleen, ..., even the whole animal or human body, we can expediently analyze and study their dynamic attribute, existence & motion by mathematical operation based on the proper homology integration equation with the proper individual parameters under certain ambient conditions, such as $\sum_{m \equiv D}^D m_{\text{brain}} + \sum_{m \equiv D}^D m_{\text{ambient conditions}} + \sum_{m \equiv D}^D m_{\text{liver}} + \sum_{m \equiv D}^D m_{\text{ambient conditions}} + \sum_{m \equiv D}^D m_{\text{lung}} + \sum_{m \equiv D}^D m_{\text{ambient conditions}} + \sum_{m \equiv D}^D m_{\text{spleen}} + \sum_{m \equiv D}^D m_{\text{ambient conditions}} + \dots + \sum_{m \equiv D}^D m_{\text{animal}} + \sum_{m \equiv D}^D m_{\text{ambient conditions}} + \sum_{m \equiv D}^D m_{\text{human body}} + \sum_{m \equiv D}^D m_{\text{ambient conditions}}$. Of course, about the heavy mass celestial bodies, even galaxies, we can expediently invoke the proper homology integration equation to analyze and study their dynamic attribute, existence & motion under certain ambient physical conditions by mathematical operation too.

2. Two complementary explanations of mathematical definition of Homogenous Cosmos Originated from Unique Genesis.

2.1. As the most essential material gene and the most minimal material unit in cosmos, the physical quantification of “ i_0 ” is the terminal infinitesimal of any physical quantity in cosmic homogeneity system.

The Chinese noun of “Jizi/极子” with ideographic connotation of “genic origin” in English was firstly introduced for cosmic genic origin i_0 , which originally derived from the Chinese noun of “Jixian/极限” with connotation of infinitesimal extremity. And virtually, it is just the abbreviation of cosmic infinitesimal quantum (极限量子), which takes notional role of quantification of cosmic extremity genic origin i_0 .

In accordance with the fundamental postulate of Homogenous Cosmos Originated from Unique Genesis, cosmos is homogenous through and through, and gene i_0 is just the so-called cosmic genic origin; entire cosmic contents are essentially originated from extremity cosmic genic origin and resultingly form the cosmic-scale homogeneity system. This implies: genic origin i_0 is both the most essential gene and the most minimal material unit in cosmos, —as cosmos is throughout homogenous originated from unique genesis, on stand of qualitative view, genic origin i_0 is the common extremity hylic proliferation origin in cosmos, any discretionary two subjects in cosmos must be enantiotropic resorting of the common terminal homologic medium of cosmic genic origin i_0 leastways; as cosmos is throughout homogenous originated from unique genesis, on stand of quantitative view, genic origin i_0 is the infinitesimal extremity and basal metric quantification unit in cosmos, any discretionary two physical quantities in cosmos must be quantitatively inter-convertible resorting of the terminal homogenous extremity quantification interconversion medium of metric unit i_0 leastways.

And indeed, in accordance with the mathematical definition of Homogenous Cosmos Originated from Unique Genesis $\sum_{m \equiv D}^D [\int_{i_0}^X f(m_{i_0 \rightarrow X})_{i_0}]$, it’s easy for us to comprehend that all cosmic physical existence besides i_0 itself are accumulations of i_0 in different reciprocal convergent sate. proportionably, it’s of course easy

Historical progress of science in the recent several centuries seemed like a far-flung exploration of the first itinerary around numerous distinctive landscapes of brand-new landmasses of science with palette & tablet on back, several hundred years’ scientific travelogues were compiled thereby.

for us to comprehend that physical quantification of one single i_0 unit is just the infinitesimal extremity of any physical quantity in cosmic homogeneity system, which of course includes that physical quantification of one single i_0 unit is the infinitesimal extremity of time, space distance and mass. And this of course implies, once the quantity of time illimitably tends to infinitesimal of one single i_0 unit, it means the physical connotation of time illimitably tends to zero; once the quantity of space distance illimitably tends to infinitesimal of one single i_0 unit, it means the physical connotation of space distance illimitably tends to zero; once the quantity of mass illimitably tends to infinitesimal of one single i_0 unit, it means the physical connotation of mass illimitably tends to zero. And just because of this, we call the physical quantification of one single i_0 unit “cosmic extremity quantum”.

In spacetime, as all space field genic units always exist in status of everlasting mutual transmuted and transmitting, it's completely impossible for us to ascertain explicit existence of any single space field genic units. This of course implies that it's impossible for us to measure any substantial quantification of 0 time, 0 space distance and 0 mass in time current, no matter what kind of measure instruments and no matter what kind of practical method we resort, as long as the measure instruments are materials belonging to category of cosmic homogeneity system, as long as our practical method need time to perform. Resultingly, in time current, it's of course impossible for us to procure exact time quantity $t+0$ (Here “ t ” is a constant) measured from some certain starting time point to another terminal time point, but quantity of $t+\Delta t$ ($|\Delta t| > 0$), the magnitude of $|\Delta t|$ inversely indicates the measure precision, unless we can keep time stopping. For the same reason, in space time, it's completely impossible for us to procure exact space distance quantity $S+0$ (Here “ S ” is a constant) measured from some certain starting space point to another terminal space point, but to possibly procure quantity of $S+\Delta S$ ($|\Delta S| > 0$), the magnitude of $|\Delta S|$ inversely indicates the measure precision, unless we can keep time stopping. For the same reason, in space time, it's completely impossible for us to procure exact mass quantity $m+0$ (Here “ m ” is a constant) of any cosmic subject, but to procure quantity of $m+\Delta m$ ($|\Delta m| > 0$), the magnitude of $|\Delta m|$ inversely indicates the measure precision, unless we can keep time stopping.

Of course, if we can really keep time stopping, not only it's impossible for us to perform the measure action, but also there are none existent time, space distance and mass for us to measure. That's to say, as cosmos is inherently a dynamic assembly, in space time, it's completely impossible for us to determine any unaltered subject or the same subject.

This is just something about “Uncertainty principle”.

2.2 Universal dynamic orientation and demiurgic homologic multiplication fundamental of cosmos ——instinctive PNT reciprocal equilibrium towards optimum PNT operation

It's only possible for concordant cosmos to be demiurgic aggradation of out-and-out serial natura naturata in the nature of coherent natura naturans throughout cosmic evolution; there is no way for demiurgic aggradation in the nature of different natura naturans to be concordant cosmos through and through.

The original evolution and formation of cosmos is sequential homologic cosmogony starting at cosmic genic origin i_0 to cosmic status quo. Firstly, it's evolution of space field with sequential genic birth of $i_0, i_1, i_2, \dots, i_n$ and progressively involving in genic transition and transmutation in space field thereby. Successively, positive matter coming into being as extra-saturation outgrowth of space field with gradual birth of elementary genic units of $i_{n+1}, i_{n+2}, i_{n+3}, \dots, i_{n+p}$ coming down in one continuous line proportional to sequential homologic

cosmogony. As gradual cumulation of elementary genic units in space field, the gradually enriched elementary genic units i_{n+1} , i_{n+2} , i_{n+3} , ... i_{n+p} stochastically precipitate brand-new occurrence of instinctive PNT reciprocal equilibrium towards optimum PNT operation, colorful and rich reciprocal PNT combinations in gradation I, reciprocal PNT combinations in gradation II, reciprocal PNT combinations in gradation III and reciprocal PNT combinations in gradation IV successively come into being therein, till at last it shapes cosmic status quo.

However, what's the inherent homology demiurgic principle and dynamic regularity for cosmos to evolve from space field to cosmic status quo?

Cosmos is always ready to orientate itself towards perfection by the right of nature. "Instinctive PNT reciprocal equilibrium towards optimum PNT operation" is just *natura naturans* for cosmos always ready to orientate itself towards perfection.

In cosmic homogeneity system, existence of positive matter are either dissociative elementary genic units in space field or reciprocal PNT combinations astringently coalesced by elementary genic units in accordance with instinctive PNT reciprocal equilibrium towards optimum PNT operation. Upon our general sense, it's easy for us to comprehend that all reciprocal PNT combinations in the nature are but freewheeling outgrowth under guidance of force. Whereas, in Homogenous Cosmos Originated from Unique Genesis, connotation of "force" radically derived from "instinctive PNT equilibrium" of matter integration, ——force is but dynamic hypostatization and straightforward character indication of instinctive PNT reciprocal equilibrium towards optimum PNT operation, once matter integration loses its PNT balance or breaks its original PNT stationary operation status for physical disturbance of PNT operation, and force orientation is but stochastic acclimation choice of instinctive PNT reciprocal equilibrium towards optimum PNT operation by the light of nature.

As the reciprocal rhythm of PNT operation among nucleons, once the distance between nucleon and nucleon is short enough for reciprocity, the original separate PNT operation of the relatively closer nucleons are feasible to interlink each other for internal reciprocal PNT operational linkage and expediently precipitates instinctive PNT reciprocal equilibrium towards optimum PNT operation, strong interaction among nucleons occurs thereby.

Compared with normal matter field, as the electromagnetic fields of congeneric charges contain the same morbid preponderant genic units or morbid insufficient genic units, once such electromagnetic fields of congeneric charges disturb by superposition each other, the PNT equilibrium instinct of matter integration will unconditionally dissipate their superposition as possibly as it can so as to weaken the morbid genic preponderance or morbid genic insufficiency of their matter fields and maintain their original PNT reciprocal equilibrium towards optimum PNT operation. Resultingly, the mutual repulsion of electromagnetic interaction between congeneric charges is incarnated.

Compared with normal mater field, as electromagnetic fields of heterogeneous charges contain reciprocal mutual compensatory morbid preponderant genic units or morbid insufficient genic units, once such electromagnetic fields with mutual compensatory morbid preponderant genic units or morbid insufficient genic units are close enough so that their mutual compensatory morbid preponderant genic units or morbid insufficient genic units seem available resource mutually for PNT reciprocal equilibrium towards optimum PNT operation, the PNT equilibrium instinct of matter integration will unconditionally scare up their superposition as possibly as it can so as to clear up the morbid genic preponderance or morbid genic insufficiency of their matter fields, the mutual attraction of electromagnetic reciprocity between heterogeneous charges is hypostatized thereby.

Compared with normal matter field, as the superposition of matter fields forms morbid matter field pimple and demolishes the original macroscopical esthetical sculpt of matter fields against PNT reciprocal equilibrium towards optimum PNT operation, the PNT equilibrium instinct of matter integration will unconditionally readjusts their superposition situation and their character PNT operation so as to weaken the morbid pimple and optimize their matter fields for fluent PNT operation as feasibly as they can, resultingly, the gravitational reciprocity of “mass approximation accessible to negative gravity” and “mass disparity accessible to positive gravity” is hypostatized.

All in all, force is but dynamic objectification of instinctive PNT reciprocal equilibrium towards optimum PNT operation, if we say it is force who is always ready to guide original homologic multiplication towards perfect conformation of cosmos, it would be better to say it's instinctive PNT reciprocal equilibrium towards optimum PNT operation who is always ready to manage the esthetical universe. Esthetical cosmos originally comes into being according to the unique esthetical fundamental of instinctive PNT reciprocal equilibrium towards optimum PNT operation, and further evolution of cosmos will always go along the same way for ever, no matter original homologic multiplication of cosmic objects in narrow sense or general existence & motion of matter in cosmos.

—The motive root cause this sub-matter-integration and that sub-matter-integration can form relatively super reciprocal PNT combination by instinctive PNT reciprocal equilibrium towards optimum PNT operation is that there are reciprocal resource for PNT equilibrium towards optimum PNT operation between the both sub-matter-integrations. And virtually, the practical materialization of reciprocity of the PNT reciprocal resource between compositive sub-matter-integration directly makes of the internal “agglomerate force” of the proper super reciprocal PNT combination, the generation and formation of super reciprocal PNT combination is just the reciprocity materialization of the favorable PNT resource towards optimum PNT operation among the sub-matter-integrations.

Instinctive PNT reciprocal equilibrium towards optimum PNT operation is the thoroughly coherent dynamic fundamental of both cosmic demiurgic evolution of sequential homologic cosmogony and universal existence & motion of matter in cosmos, —not only original generation of all reciprocal PNT combinations in cosmos are connatural outgrowth of performance of instinctive PNT reciprocal equilibrium towards optimum PNT operation; but also universal existence & motion of common reciprocal PNT combinations in spacetime are exactly dynamic embodiment of instinctive PNT reciprocal equilibrium towards optimum PNT operation.

Elementary atoms are the most typical reciprocal PNT combinations in cosmos. As instinctive PNT reciprocal equilibrium towards optimum PNT operation is the thoroughly coherent fundamental for cosmic sequential homologic demiurgic multiplication, and as original generation of atoms in cosmos is but evolutionary outgrowth of performance of instinctive PNT reciprocal equilibrium towards optimum PNT operation, if the internal configuration of any atom is not unisonous to instinctive PNT reciprocal equilibrium towards optimum PNT operation or not unisonous to preponderance of instinctive PNT reciprocal equilibrium towards optimum PNT operation in the integrated atomic mechanism, there is no possibility for any atom to form and keep existing in such kind of none-PNT-reciprocal mechanism steadily by the light of nature. Any steady internal configuration or mechanism in atoms must be unisonous to instinctive PNT reciprocal equilibrium towards optimum PNT operation or unisonous to preponderance

As coherent natura naturans throughout cosmic evolution, instinctive PNT reciprocal equilibrium towards optimum PNT operation is radical potentiality & conditionality for cosmos always ready to orientate itself towards perfection.

of instinctive PNT reciprocal equilibrium towards optimum PNT operation of the integrative atomic mechanism. This is authenticity congenitally predestined by the unique universal homology demiurgic fundamental of instinctive PNT reciprocal equilibrium towards optimum PNT operation. As a result, there is no possibility for any atom to maintain incompatible internal configuration or mechanism against instinctive PNT reciprocal equilibrium towards optimum PNT operation, which of course includes connotation of “exclusion principle” of atomic internal configuration or mechanism we conventionally mentioned.

——Written in Nov. 2007, Zhenzhu town, Wugang city, Hunan province

(V-ii) PNT action and PNT reaction

Abstract: *PNT action is but the connatural bidirectional osmosis transmutation and transition between space field and matter derived from lineal homologic filiation between space field and matter. Existence & motion is just dynamic enantiomorph of PNT action of matter integration in the nature of instinctive PNT reciprocal equilibrium towards optimum PNT operation, PNT action congenitally dominates the existence & motion of matter in spacetime. PNT action characters are generally related to three causes:*

The first is the space field condition around.

The second is the connatural "field potential concrete vallum" of elementary genic units.

The third is "natural motion of elementary genic unit" and "reciprocal PNT combination mechanisms among elementary genic units".

The PNT action embodiment is generally the consequent variation of all the variables of M, m, α, a, v, Y etc of matter integration followed instinctive PNT reciprocal equilibrium.

So-called "PNT reaction" is but the instinctive PNT operational readjustment of elementary genic units (or matter integration) orientating relative minimum of field potential concrete vallum. PNT reaction can be generally classified into three types of the first Instinctive PNT reaction (field potential concrete vallum revivification reaction), the second Instinctive PNT reaction (reciprocal PNT condensation reaction) and the third Instinctive PNT reaction (mass acclimation reaction). PNT reaction is subject to both "instinctive PNT equilibrium" and "relative minimum of field potential concrete vallum" principles.

Keywords: *PNT action, field potential concrete vallum, PNT reaction, the first Instinctive PNT reaction (field potential concrete vallum revivification reaction), the second Instinctive PNT reaction (reciprocal PNT condensation reaction), the third instinctive reaction (mass acclimation reaction), relative minimum principle of field potential concrete vallum.*

In the above sections, we've emphatically introduced and analyzed the PNT dynamics, which virtually extended from inherent PNT correlation between spacetime and matter and instinctive PNT equilibrium of matter integration. PNT dynamics formulates the physical process all the state parameters of M, m, α, a, v, Y etc varying under guidance of instinctive PNT equilibrium towards optimum PNT operation. In this section, we come to introduce PNT action and PNT reaction of universal matter in spacetime, the intention we introduce PNT action and PNT reaction herein is mainly to clarify and illuminate the rich and colorful existence & motion of matter in spacetime further from connatural microcosmic instinctive stochastic responses of positive & negative transmutation and transition of elementary genic units in proper space field in the nature of instinctive PNT reciprocal equilibrium towards optimum PNT operation. At any rate, matter always go their immanent ways by the light of nature.

1. PNT action

So-called "PNT action" is just the natural performance of positive & negative transmutation and transition between matter and spacetime.

1.1. Connatural origin of PNT action

PNT action between spacetime and matter radically originates from the lineal homologic filiation of "spacetime" and "matter", it radically roots in two logic preconditions:

As coherent natura naturans throughout cosmic evolution, instinctive PNT reciprocal equilibrium towards optimum PNT operation is radical potentiality & conditionality for cosmos always ready to orientate itself towards perfection.

The first is cosmos is throughout homogenous originated from unique genesis.

The second is cosmos entirely consists of spacetime and matter, none coordinative components else.

In a straightforward word, PNT action directly roots in the “space field hypothesis” and “matter homologic generation hypothesis” under the general presumable precondition that cosmos is throughout homogenous originated from unique genesis. Because under the precondition that cosmos is throughout homogenous originated from unique genesis, as tangible compositive part of cosmos, spacetime must belong to category of “cosmic homogeneity system”. As a result, spacetime must be hylic coordinator as common matter; such deduction directly leads out the first basic postulate of space field hypothesis —spacetime genic field hypothesis. As hylic presence, spacetime must have its corporeal existent state, —either stationary or athletic, Homogenous Cosmos Originated from Unique Genesis excludes the possibility that hylic spacetime is stationary, such verdict leads out the second basic postulate of space field hypothesis —phantasmal field genic units assumption. On the basis of such two basic postulates, Homogenous Cosmos Originated from Unique Genesis goes its further step to arrive at definition of time, time dynamic speed, space distance and space radiation comu. And at the same time, Homogenous Cosmos Originated from Unique Genesis confirms the lineal homologic filiation between spacetime and matter that along cosmic original homologic multiplication sequence, spacetime is father and matter is son. Thus, Homogenous Cosmos Originated from Unique Genesis consequently leads out “matter homologic generation hypothesis”.

Since spacetime is athletic hylic existence, in accordance with matter homologic generation hypothesis, matter are lineal homologic outgrowth of hylic spacetime when spacetime approaches some certain progenitive stage, then matter must be accessible to degenerate on the proportionate negative space field conditions as well as it can generate on the positive space field conditions, and such couple generative and degenerative progress must coexist as to counterbalance the relative existent situation of both spacetime and matter. Otherwise, the ultimate evolution of cosmos will inevitably extend to extremity that there is either only matter left or only spacetime left in cosmos. Such inevitability of course implies the external coexistence of the couple inverse implementation of dynamic PNT operation between spacetime and matter.

1.2. PNT action character and PNT action hypostatization

Any matter in spacetime must everlastingly keep PNT performance in its connatural way, and no matter what kind of object or matter integration it is, the PNT action of matter integration is radically materialized by the positive & negative transmutation and transition between compositive elementary genic units of matter and the proper field genic units in matter field. The PNT action of matter integration is but the aggregative exhibition of PNT actions of all compositive elementary genic units. Then, how does the positive & negative transmutation and transition between compositive elementary genic units and field genic units in matter field ultimately integrate and hypostatize the rich and colorful existence & motion of macrocosm?

Note D: In accordance with the integrative homologic coherence of universal existence & motion through and through, I primarily thought the universal existence & motion must be throughout homogenous originated from unique genesis. Whereas, soon after that, I found if we excluded spacetime from the “hylic homogeneity system” of cosmos, the two coordinative cosmic components of spacetime and matter seemed to have completely lost their innate correlation and why matter must exist and motion in spacetime consequently seems unintelligible and elusory. So I think if the universal matter are homogenous originated from unique genesis, it seems we have none tangible evidence to exclude spacetime from the “hylic homogeneity system” of cosmos. Thus, I approached consummate idea of homogenous cosmos originated from unique genesis thereby.

Historical progress of science in the recent several centuries seemed like a far-flung exploration of the first itinerary around numerous distinctive landscapes of brand-new landmasses of science with palette & tablet on back, several hundred years' scientific travelogues were compiled thereby.

In order to illuminate the issue, we come to introduce PNT action character and PNT action hypostatization subsequently.

1.2.1. PNT action character of elementary genic units

The most essential characters of matters usually come into being during the course of their original generation and formation and are inherently kept with matter existing as certain object under the proper generative and formative preconditions.

The primitive naissance of matter in spacetime is just the generation and presence of elementary genic units in space field. In terms of the PNT action characters of elementary genic units, it's of course related to the proper generative conditions, consequent existent background and spontaneous self-acclimation readjustment of elementary genic units in the nature of instinctive PNT reciprocal equilibrium towards optimum PNT operation. In detail words, under the proper space field background, PNT action characters of elementary genic units are firstly determined by the proper progenitive space field conditions around (external conditions or causes); secondly, they are determined by the original cumulative condensation configuration of elementary genic units themselves (internal condition or cause); thirdly, they are determined by instinctive reciprocal self-acclimation readjustment for optimum existence among elementary genic units in the space field (**instinctive acclimation readjustment for internal condition to external condition**). That's to say, the PNT action characters of elementary genic units generally depend on three causes as below:

The first: Space field condition around.

The space field around is just the external conditions for elementary genic units to perform and maintain PNT action. Generally, the stronger the space field strength is, the more super and feasible condition for elementary genic units to perform PNT is, and both values of $d(M \rightarrow m)$ and $d(M \leftarrow m)$ of matter integration PNT are relative bigger. If the space field strength arises increase tendency, the PNT action of matter integration will consequently arises $d(M \rightarrow m) > d(M \leftarrow m)$ and both $d(M \rightarrow m)$ and $d(M \leftarrow m)$ increase orientating new relatively active dynamic balance $d(M \rightarrow m) = d(M \leftarrow m)$, and all the state variables M, m, α, a, v, Y etc of matter integration vary with the increasing equilibrium between $d(M \rightarrow m)$ and $d(M \leftarrow m)$. If the space field strength arises weakening tendency, the PNT action of matter integration will consequently arises $d(M \rightarrow m) < d(M \leftarrow m)$, and both concurrent and covariant $d(M \rightarrow m)$ and $d(M \leftarrow m)$ arises decrease tendency orientating new relatively inactive dynamic balance $d(M \rightarrow m) = d(M \leftarrow m)$, and all the variables M, m, α, a, v, Y etc of matter integration vary with the decreasing equilibrium between $d(M \rightarrow m)$ and $d(M \leftarrow m)$.

The second: connatural field potential concrete vallum of elementary genic unit

The so-called "field potential concrete vallum" is just the flexible half-converged and half-condensed field vallum as half-done evolutionary remainder left on elementary genic units when elementary genic units primarily generate in space field or the proper physical quantification of the flexible half-converged and half-condensed field vallum. On the point of qualitative view, field potential concrete vallum is just the hylic medium for all elementary genic units to consummate their PNT operation between space field and matter, both "M→m" opposite and "M←m" opposite of PNT cycle must experience such medium stage. And the proper quantification of field potential concrete vallum can indicate the feasibility and activity of transmutation and transition of elementary genic units in spacetime.

Apparently, the definition of physical quantification of field potential concrete vallum directly relates

As coherent natura naturans throughout cosmic evolution, instinctive PNT reciprocal equilibrium towards optimum PNT operation is radical potentiality & conditionality for cosmos always ready to orientate itself towards perfection.

the space field conditions around the proper elementary genic units, and virtually, space field strength is just the quantitative reference benchmark of field potential concrete vallum of elementary genic units. To any discretionary elementary genic unit in certain existent state, if the space field strength around becomes weaker and weaker, relatively, the field potential concrete vallum of elementary genic units will proportionably become bigger and bigger, and consequently, it will be more and more powerful for the elementary genic unit to degenerate into the weakening space field as to reduce the existent quantity of mass of elementary genic units. If the space field strength around becomes stronger and stronger, relatively, as half-done flexible evolutionary remainder left on elementary genic units, the field potential concrete vallum of elementary genic units will proportionably become less and less, and proportionately, it will be more and more accessible for more field genic units transmute into elementary genic units.

It may be a little similar to the situation we come to define gravitational potential of objects on the earth. When we come to define gravitational potential of objects on the earth, we should above all choose a 0 level reference or choose the default 0 level references, if the vertical distance between the 0 level reference and barycenter of earth is less, the gravitational potential will be proportionably bigger; if the vertical distance between the 0 level reference and barycenter of earth is bigger, the gravitational potential will be proportionably less. The difference is that the gravitational potential has none estimative relationship with the choice of 0 level reference. In another word, the discretionary choice of 0 level references can never directly impact the intrinsically physical characters of objects. However, as the quantification reference, space field strength is not only one of the direct causes of field potential concrete vallum, it but also directly impacts and even dominates the flexible generative or degenerative progress of field potential concrete vallum.

In more material words, Under certain space field condition, the bigger the field potential concrete vallum of elementary genic units is, then the more accessible it is for elementary genic units to perform “M←m” transmutation, and the transmutation action of “M←m” is more rapid and powerful, and there are more possibilities for elementary genic units to perform “M←m” transmutation action; whereas, on the contrary, the transmutation action of “M→m” is relatively slower and weaker, and there are less possibilities for elementary genic units to perform “M→m” transmutation action. The less the field potential concrete vallum of elementary genic units is, the more accessible it is for elementary genic unit to go on condensing and assimilating “M→m” transmutation vallum, the transmutation action of “M→m” is more feasible, and there are more probabilities for elementary genic units to perform “M→m” transmutation action; whereas, on the contrary, the field potential for elementary genic units to perform “M←m” transmutation action is relatively less, the “M←m” transmutation action is logier and weaker, and there are relatively less probabilities for elementary genic units to perform “M←m” transmutation.

As the disparity of homogenous evolutionary enrichment and condensation for internal PNT reciprocity, even under the same spacetime conditions, different elementary genic units have different field potential concrete vallum, and generally, super elementary genic units have bigger field potential concrete vallum. And at the same time, even the same elementary genic unit in different space fields, it can have different field potential concrete vallum, the stronger space field strength of the space field that elementary genic unit exists in is, relatively, the less field potential concrete vallum the elementary genic unit consequently has; the weaker space field strength of the space field that elementary genic unit exists in is, relatively, the more field potential concrete vallum the elementary genic unit consequently has, and the elementary genic unit is more accessible to degenerate.

Historical progress of science in the recent several centuries seemed like a far-flung exploration of the first itinerary around numerous distinctive landscapes of brand-new landmasses of science with palette & tablet on back, several hundred years' scientific travelogues were compiled thereby.

As flexible half-condensed dynamic field vallum tied on elementary genic units, it's of course easy for us to comprehend that the physical unit of field potential concrete vallum is the same as $d(M \leftarrow m)$, it is "negative kilogram per second", just " $-kg/s$ ". And as various limitation, the integrative mathematical expression of correlation between field potential concrete vallum of elementary genic units and the space field strength has to be shelved here, although, it is very significant for us to quantify the dynamic field potential concrete vallum of elementary genic units and study PNT action further.

The third: "natural motion of elementary genic units" and "reciprocal PNT combination condensation among elementary genic units".

Natural motion of elementary genic unit (/matter integration) is virtually the PNT action embodiment for release and revivification of field potential concrete vallum of elementary genic unit (or matter integration). The lineal homologic filiation of elementary genic units and space field inherently predestines that the presence of elementary genic units in space field must go with PNT action. As the homology of space distance and time (or time dynamic speed), the PNT action makes the elementary genic unit (/matter integration) exhibit remarkable (waveform) motion in spacetime, and the (waveform) motion of elementary genic units is just the PNT action embodiment of field potential concrete vallum release and revivification round and round which is originally cumulated during the course of the original generation of elementary genic units in space field. The mathematical expression of field potential concrete vallum released and revivified to cause matter motion is $d(M \leftarrow m) * Y = m * V$. The more freely and easily elementary genic units motion in spacetime, the more smoothly the field potential concrete vallum of elementary genic units can be naturally released and revivified it implies. Matter motion in spacetime can be straightforwardly regarded as embodiment of release and revivification of field potential concrete vallum of mater system.

We here refer to "reciprocal PNT combination condensation among elementary genic units" is mainly to emphasize the materialization of indrawn condensing of field potential concrete vallum for the establishment of reciprocal PNT combination mechanism among elementary genic units. The so-called "indrawn condensing" of field potential concrete vallum is just materialization of such a physical process, as the original genic cumulative configurations of certain elementary genic units are mutually complementary and/or as their PNT action are mutually compatible in operational rhythm, consequently, the original separate PNT performance of such elementary genic units reciprocally link up once the elementary genic units are closer enough and combine into coexisting " $m_1 \rightarrow M \rightarrow m_2$ " and " $m_1 \leftarrow M \leftarrow m_2$ " internal PNT circulation among elementary genic units. As a result, some of the released field potential concrete vallum from elementary genic units are condensed for the establishment of coexisting " $m_1 \rightarrow M \rightarrow m_2$ " and " $m_1 \leftarrow M \leftarrow m_2$ " internal PNT circulation among elementary genic units and consequently made the practically revivified field potential concrete vallum less than the originally released field potential concrete vallum from separate elementary genic units, as if some of the field potential concrete vallum released as motion kinetic source of objects m_1 and m_2 are embezzled or eaten off by the coexisting " $m_1 \rightarrow M \rightarrow m_2$ " and " $m_1 \leftarrow M \leftarrow m_2$ " internal PNT circulation, as a result, on one hand, the brand-newly object combined of m_1 and m_2 seems indolent for the embezzlement of motion kinetic source, and on the other hand, the mass and integrative profile of object combined of m_1 and m_2 seem fat and solid (Just means the total mass of brand-newly object combined of m_1 and m_2 is a little larger than $m_1 + m_2$ for the indrawn convergence). The combination mechanism of reciprocal internal PNT circulation is just the physical cohesion between m_1 and m_2 . nucleon and

As coherent natura naturans throughout cosmic evolution, instinctive PNT reciprocal equilibrium towards optimum PNT operation is radical potentiality & conditionality for cosmos always ready to orientate itself towards perfection.

nucleon form atomic nucleus by strong interaction, atomic nucleus and extranuclear electrons form atom by electromagnetic force, atoms and atoms form molecules, molecule system, gas, liquid, solid, ..., organic apparatus, organism by electromagnetic reciprocity, ..., and gas, liquid and solid form celestial bodies even galaxies by gravitational reciprocity etc are all originally freewheeling outcome of performance of instinctive PNT reciprocal equilibrium towards optimum PNT operation among elementary genic units.

Although, physical space field and matter are hyllic homology originated from the same genesis with lineal homologic filiation, the field potential convergence of elementary genic units and the reciprocal PNT combination creates remarkable distinction of existent model and profile between physical space field and matter. (And even creates the distinctive features of state, color, toughness, density, rigidity etc among different objects.) As a result, we always can hardly perceive physical presence of space field, but to substantially find the matter so hypostatic and solid. The more consummate the reciprocal PNT combination mechanisms are, the more adequately the field potential concrete vallum of matter integration is condensed, the less the field potential concrete vallum of matter integration is, the more remarkable existent modal distinction between physical space field and matter is, and in our sense, more hypostatic matter is; physical space field is always pretersensual.

Of course, besides the three factors listed above which directly impact the PNT action characters; there is another significant factor, —instinctive PNT equilibrium of matter integration. As it has been introduced enough in prior, we won't repeat it herein.

1.2.2. PNT action embodiment

PNT action embodiment of matter generally exhibits the proportionate physical variation of variables M, m, α, a, v, Y etc followed the equilibrium between $d(M \rightarrow m)$ and $d(M \leftarrow m)$ of mater system. During the course of PNT performance, the variation of variables of M, m, α, a, v, Y etc satisfy mathematical correlations as $M(t) = K(t) * R(t) / (1 + K(t))$, $m(t) = R(t) / (1 + K(t))$, $a(t) = Y(t) * K'(t)$, $V = V_0 + \Delta V = V_0 + \int a(t) dt$, $Y(t) = B * \alpha(t)$. Whereas, as magnitude disparity of mass, genic configuration even disparity of PNT action rhythm, PNT action embodiment of different objects is different therefore.

1.2.2.1. PNT action embodiment of particles

In terms of PNT action embodiment of separate elementary genic units or particles, as their compositive configurations are rather simplex, they usually have none physical endosome of reciprocal PNT combination mechanisms or rather poor connotation of reciprocal PNT combination mechanisms, their field potential concrete vallum has not been maturely condensed or just condensed rather a little, as a result, the release and revivification of their field potential concrete vallum is rather free and easy, and their motorial potential is relatively adequate; and as their mass is rather tiny, the impact PNT action does to negative and positive mass quotient K is rather remarkable, their accelerative property is rather sensitive and their motion speed is rather high. And at the same time, as obvious periodic magnitude distribution of $d(M \rightarrow m)$ and $d(M \leftarrow m)$ and unsaturated cumulative genic configuration, their motion format usually exhibit wave-form and electromagnetic property.

The PNT action of particles of course means the mutual transmutation and transition between the compositive elementary genic units of particles and field genic units around. If the negative towards positive transmutation " $M \rightarrow m$ " and the positive towards negative transmutation " $M \leftarrow m$ " can be constantly equal as to ensure equilibrium PNT circulation (it means, in time current, " $M \leftrightarrow m$ " performance can satisfy $d(M \rightarrow m) = d(M \leftarrow m)$), then the existent particle in spacetime is relatively constant. If the mass of particle is too tiny, so that it is almost impossible for

particle to constantly keep positive towards negative transmutation rate $d(M \leftarrow m)$ equal to negative towards positive transmutation rate $d(M \rightarrow m)$, the particle will resultingly expose its non-self variation. If particle can not ensure the negative towards positive transmutation rate equal to positive towards negative transmutation rate, but negative towards positive transmutation rate is less than positive towards negative transmutation rate, then, the particle will immediately disappeared after it finishes its finite PNT assignment, as a result, we find the definite existence of some particles in the nature is rather fugacious. If the particle can not keep its “negative towards positive transmutation rate” and “positive towards negative transmutation rate” relatively steady or constantly equivalent, but in some certain time interval t , the particle can still consummate the positive transmutation cumulation equal to negative transmutation cumulation as $\int_0^t d(M \rightarrow m) dt = \int_0^t d(M \leftarrow m) dt$, (“ t ” denotes the periodic interval in time current), then, the particle still can exhibit its probabilistic existence in time current, that's to say, in time current, although the PNT action of particle may expose its non-self variation, it can still approach and exhibit the original format of particle itself periodically.

1.2.2.2. PNT action embodiment of macroscopical objects

In terms of PNT action embodiment of macroscopical objects, as substantial connotation of reciprocal PNT combination mechanisms of macroscopical objects, the indrawn condensing of field potential concrete vallum of macroscopical objects is usually adequate, the integrative field potential concrete vallum of macroscopical objects is relatively low; and at the same time, the genic cumulative configuration of macroscopical objects is usually saturated and perfect and the integrity PNT action is rather mature for the presence of adequate connotation of reciprocal PNT combination mechanisms. As a result, the PNT action usually can ensure mature equilibrium PNT circulation of matter integration, there are few possibilities for macroscopical objects to expose their unequal distribution of $d(M \rightarrow m)$ and $d(M \leftarrow m)$ of their PNT actions. What's more, the impact the low field potential concrete vallum PNT action done to the negative and positive mass quotient K of massive matter integration is rather slight, consequently, the existence of macroscopical objects usually seems straightforward and steady.

At the same time, no matter microcosmic particles or macroscopical objects, under proper space field conditions, the PNT actions of matter integration may lead to *saue qui peut* or convergent combination of matter integration. The so-called “*saue qui peut*” here practically means the constructional breakdown or micromodelization, for instances, nucleus fission, atomic ionization, chemical disassembly reactions etc; while the “convergent combination” of matter integration here practically mean constructional expansion and configurable multiplication, for instances, nucleus fusion, atomic nucleus combined extranuclear electrons to form atom, chemical assembly reactions etc.

1.2.2.3. Emulatory choice between “discretionary motion orientation selectivity for *saue qui peut*” and “convergent configurable multiplication of reciprocal PNT combination”

Matter is innately locomotory, no matter motion of particles or macroscopical objects are all the integrative embodiment of PNT actions of all the compositive elementary genic units of matter integration. And as discretionary behavior body, no matter it's particle or macroscopical object, the motion orientation of objects must be unique. However, macroscopical objects originally consist of millions of particles, and before the millions particles converged into reciprocal PNT combination of macroscopical object; the motion orientations of all the compositive sub-matter-integrations are usually discretionary. Throughout of original cumulative configurable multiplication of macroscopical object, how do the discretionary motion orientations of particles turn into the coherent unique motion orientation of macroscopical object? This of course involves in the emulatory choice between “discretionary

As coherent natura naturans throughout cosmic evolution, instinctive PNT reciprocal equilibrium towards optimum PNT operation is radical potentiality & conditionality for cosmos always ready to orientate itself towards perfection.

motion orientation selectivity for *saue qui peut*” and “convergent configurable multiplication of reciprocal PNT combination”.

Matter motion is just dynamic enantiomorph of PNT action of matter integration in spacetime, while the so-called “discretionary motion orientation selectivity for *saue qui peut*” are but the natural consequence of expedient approaches of instinctive PNT reciprocal equilibrium towards optimum PNT operation of matter integration, that’s to say, during the course of the PNT performance, matter integration must facilitate the most expedient approach to materialize instinctive PNT reciprocal equilibrium towards optimum PNT operation by the light of nature, and it is just the expedient choice in the nature of instinctive PNT reciprocal equilibrium towards optimum PNT operation which radically predestines the motion orientation of matter integration.

Virtually, “convergent configurable multiplication of reciprocal PNT combination” is just positive demiurgic homologic multiplication in spacetime, which means the PNT actions of the sub-matter-integrations are linked up and made up of internal reciprocal PNT circulation as to form further PNT combination mechanisms for their complementary genic configurations or complementary PNT action rhythm in accessible spacetime range. If we denote the field potential concrete vallum condensed by the internal reciprocal PNT circulation among the sub-matter-integrations “field potential concrete vallum combination locked”, and we denote the field potential concrete vallum of sub-matter-integrations exhausted for connatural revivification as motion source in all deviation orientations “field potential concrete vallum exhaustion for escape”, then, whether it’s possible for certain sub-matter-integrations to materialize configurable multiplication of reciprocal PNT combinations depends on the “field potential concrete vallum combination locked” is bigger than the “field potential concrete vallum exhaustion for escape”. Only when the “field potential concrete vallum combination locked” is bigger than the “field potential concrete vallum exhaustion for escape”, there are possibilities for the sub-matter-integrations to materialize configurable multiplication of reciprocal PNT combinations. And on the other hand, during the course of formation of reciprocal PNT combination mechanism, the newly formed matter integration will instinctively perform optimum PNT equilibrium by the light of nature so as to determine the new motion orientation of resultant matter integration existing as an independent substantiality in spacetime.

Of course, under certain preconditions, once the “field potential concrete vallum exhaustion for escape” is bigger than “field potential concrete vallum combination locked” in any direction, the new matter integration will be disassembled, and the sub-matter-integrations will instinctively orient optimum PNT equilibrium by the light of nature as independent behavioral bodies too, and consequently, the new motion orientations of the sub-matter-integrations as independent behavioral bodies in spacetime are determined. This is just something about the emulatory choice between “discretionary motion orientation selectivity for *saue qui peut*” and “convergent configurable multiplication of reciprocal PNT combination”.

(2) PNT reaction

2.1. Definition of PNT reaction

Simply distinguished in logic category, so-called PNT reaction is but PNT action with evidence of PNT action variation. Considered from the action manner of elementary genic units, so-called “PNT reaction” is just the instinctive PNT operational readjustment of elementary genic units (or matter integration) for relative minimum of field potential concrete vallum (or in the nature of instinctive PNT reciprocal equilibrium towards optimum PNT operation).

The so-called “relative minimum” of field potential concrete vallum implies the minimum of field potential

Historical progress of science in the recent several centuries seemed like a far-flung exploration of the first itinerary around numerous distinctive landscapes of brand-new landmasses of science with palette & tablet on back, several hundred years’ scientific travelogues were compiled thereby.

concrete vallum that elementary genic units perform PNT readjustment and approach can be different for the corresponding difference of space field conditions such as elementary genic units attending to the reaction including elementary genic unit category, quantity and combination status. And usually, the space field conditions such as elementary genic units attending to the reaction including the elementary genic unit species, quantity and combination status have strict correlation with the action consequences.

2.2. Feasible ways for elementary genic units to approach relative minimum of field potential concrete vallum

“Relative minimums of field potential concrete vallum” is the congenital behavioral tendency and spontaneous state readjustment fundamental of elementary genic units in spacetime. Matter is congenitally predetermine to exist and motion orientating relative minimums of field potential concrete vallum. Relative minimum of field potential concrete vallum is not only the orientation goal of all PNT reaction but also the intrinsic inducement for PNT action readjustment. There are generally three feasible ways for elementary genic units to approach relative minimum of field potential concrete vallum.

The first: Releasing and revivifying field potential concrete vallum straightforwardly

No matter particles or macroscopical objects, in order to approach ideal existent state of “relative minimum of field potential concrete vallum” in spacetime, they must be always ready to unconditionally release and revivify their field potential concrete vallum as possibly as they can. The discrepancies between macroscopical objects and particles are but like this, as the field potential concrete vallum of macroscopical objects has experienced many times of reciprocal PNT combination condensation, their field potential concrete vallum are generally rather low, and as the mass of macroscopical objects is remarkably bigger, the release and revivification of low field potential concrete vallum of matter integration usually do not impact the negative & positive mass quotient K intensively, so the motion variation of macroscopical object is not very sensitive to the release and revivification of low field potential concrete vallum, as a result, macroscopical objects are congenitally more steady and serene than particles. However, the field potential concrete vallum of particles has none mechanism connotation of reciprocal PNT combination condensation or has very poor mechanism connotation of reciprocal PNT combination condensation for their poor genic enrichment and simple structures, their field potential concrete vallum is rather bare and open, as a result, they have rather plenteous motorial resource; and as their mass is very tiny, their negative & positive mass quotient K is very sensitive to the impact of release and revivification of high field potential concrete vallum. As a result, compared with macroscopical objects, particles are innate good flyers.

The second, Condensing field potential concrete vallum by constructing inborn mechanism of reciprocal PNT combination

Constructing inborn mechanism of reciprocal PNT combination mechanism is another efficient way to condense field potential concrete vallum among the reciprocity elementary genic units. As the PNT actions among certain elementary genic units (or elementary genic systems in certain genic configuration) can procure auxiliary reciprocal PNT performance as to form PNT internal circulation and achieve field potential concrete vallum condensation, reciprocal PNT combinations can come into being by the light of nature. Neutrons and protons make up of nucleus by strong interaction, nucleus and electrons make up of atoms, atoms and atoms make up of molecules, gas, liquid, solid, ... by electromagnetic interaction are all consequence of reciprocal PNT combining.

As coherent natura naturans throughout cosmic evolution, instinctive PNT reciprocal equilibrium towards optimum PNT operation is radical potentiality & conditionality for cosmos always ready to orientate itself towards perfection.

The materialization and further configurable multiplication of reciprocal PNT combinations not only create the remarkable existent modality discrepancy, but also create the rich and colorful universe.

The third, mass generative condensation or degenerative dissipation: mass of elementary genic units generative increases——elementary genic units transmute into more advanced elementary genic units or decompose into more elementary genic units; or mass of elementary genic units degenerative decrease——elementary genic units degenerate into more low-grade elementary genic units or melt some elementary genic units into space field.

Mass generative increase of elementary genic units——elementary genic units transmute into more advanced elementary genic units or decompose into more elementary genic units is the most effective way for elementary genic units to condense field potential concrete vullum; and mass of elementary genic units decrease —— elementary genic units degenerate into more low-grade elementary genic units or melt some elementary genic units into space field is the most effective way to remedy and retard “m→M” transmutation preponderance for the weakening of space field strength. But in PNT action, the mass generative condensation or degenerative dissipation is relatively inert reaction, because, comparatively, the method to weaken field potential concrete vullum by releasing and revivifying field potential concrete vullum is much more accessible and expedient than mass generative condensation or degenerative dissipation. Generally, once the matter field strength varies, the most sensitive and expedient reaction is the natural release and revivification of field potential concrete vullum, the reaction of mass generative condensation or degenerative dissipation is relatively inert. In another word, compared with generative condensation or degenerative dissipation of field potential concrete vullum, mass generative condensation or degenerative dissipation is relatively sluggish, only when the release and revivification of field potential concrete vullum of elementary genic units seems deficient in backup resource due to variation scale of space field strength, the response of mass generative condensation or degenerative dissipation then remarkably arises.

For instance, when fuel is burning to release & revivify field potential concrete vullum and transferring some of the released field potential concrete vullum to the plunger of internal-combustion engine or main body of rocket, the matter field strength of internal-combustion engine plunger or main body of rocket is increased thereby, and as a result, the PNT performance of matter integration of internal-combustion engine plunger or main body of rocket must arises “M→m” preponderance. If the “M→m” preponderance is not very remarkable, the internal-combustion engine plunger or main body of rocket won’t sensitively arises convergent accumulation of mass, in another word, if the “M→m” preponderance is not very remarkable, the internal-combustion engine plunger or main body of rocket are usually not ready to save up the preponderant input of “M→m” directly as mass increase, instead, as the presence of PNT equilibrium instinct of mater system, the matter integration will synchronously activate the increase of “d(M←m)”, so that the matter can release and revivify more field potential concrete vullum as to retard and balance the “M→m” preponderance and to remedy the PNT equilibrium. In accordance with the absolute spacetime moment definition equation $d(M \leftarrow m) * Y = m * V$, if Y and m keep relatively steady (virtually, as the presence of “M→m” preponderance which is not very remarkable, Y and m will consequently arises tiny increase, whereas, for convenience of expedient formulation and accessible comprehension, we neglect the tiny increase of Y and m herein), the increase of “d(M←m)” will be remarkably multiplied by Y and impact the magnitude of V remarkably, —— causing remarkable acceleration of internal-combustion engine plunger or main body of rocket. That’s to say, pushed by burning gas, internal-combustion engine plunger or main body of rocket are usually more sensitive at accelerating, but inert at mass varying.

Historical progress of science in the recent several centuries seemed like a far-flung exploration of the first itinerary around numerous distinctive landscapes of brand-new landmasses of science with palette & tablet on back, several hundred years’ scientific travelogues were compiled thereby.

For another instance, when object slide into Black Hole, as the space field strength of Black Hole is rather weak, this makes the relative field potential fall between object and Black Hole remarkably increase, as a result, the relative field potential concrete vallum of object increase, so that the object must release and revivify more field potential concrete vallum unconditionally. Whereas, on one hand, as the assimilation that Black Hole devouring the released field potential concrete vallum of object seems everlastingly hungry, and on the other hand, the released field potential concrete vallum is far little to feed the Black Hole to repletion, as a result, the object has to collapse its internal reciprocal PNT combination mechanisms step by step and contribute the prior condensed field potential concrete vallum without reward, till at last the object is exhausted entirely or the Black Hole has been feed to repletion as not to be “black” any longer.

The process that objects slide into Black Hole and gradually collapse & dissipate in it is generally the inverse process that matter generates in spacetime and comes to form object by establishing reciprocal PNT combination mechanism step by step. During the course of the reciprocal PNT combination mechanism collapse step by step, the field potential concrete vallum of the dissipating object become barer & barer and opener & opener, as a result, during the course of the object dissipating, there are usually various radiations arising all around derived from the object.

2.3. General classification of PNT reactions

PNT action has its connatural dynamic fundamental and intrinsic operational mechanism, for instance, PNT action must be subject to “instinctive PNT equilibrium principle” and “relative minimum principle of field potential concrete vallum”; in operation mechanism, PNT operation must perform field potential concrete vallum enrichment and condensation (just the operational opposite “ $M \rightarrow m$ ” of PNT action) and field potential concrete vallum release and revivification (just the operational opposite “ $M \leftarrow m$ ” of PNT action). As the difference in logic sequence and functional role in PNT operation, in order to approach instinctive PNT equilibrium and relative minimum of field potential concrete vallum as expediently as possible, the reaction sensitivity of all the variables of matter integration is consequently different. In accordance with the PNT action dynamic principles and the reaction feasibility & sensitivity of the related variables in PNT operational logic sequence, we classify the PNT reactions in the nature into three classifications of “the first Instinctive PNT reaction”, “the second Instinctive PNT reaction” and “the third Instinctive PNT reaction”.

2.3.1. The first instinctive PNT reaction—field potential concrete vallum revivification reaction

The first Instinctive PNT reaction is just the instinctive reaction that matter integration in spacetime must unconditionally release and revivify its field potential concrete vallum as much as possible; and because of this, the first Instinctive PNT reaction is called “field potential concrete vallum revivification reaction” too. For instance, the natural motion of particles and photons in spacetime are almost pure field potential concrete vallum revivification reaction. Field potential concrete vallum revivification reaction is directly derived from the cosmic origin of PNT action, and its existence and spontaneity is unconditional, the external conditions can only impact the reaction intensity and scale. The behavioral indication of field potential concrete vallum revivification reaction is accelerating motion of object or releasing energy from object, fuel combustion, irradiancy from conductor, radiation derived from nucleus fission, radiation from object which slides into Black Hole etc are all typical instance with remarkable field potential concrete vallum revivification reaction ongoing.

2.3.2. The second instinctive PNT reaction—reciprocal PNT condensation reaction

As coherent natura naturans throughout cosmic evolution, instinctive PNT reciprocal equilibrium towards optimum PNT operation is radical potentiality & conditionality for cosmos always ready to orientate itself towards perfection.

The second Instinctive PNT reaction is just the spontaneous PNT action that elementary genic units establish reciprocal PNT combination mechanisms as to condense field potential concrete vallum and approach relative minimum of field potential concrete vallum, and because of this, the second Instinctive PNT reaction is called “reciprocal PNT condensation reaction” too. Reciprocal PNT condensation reaction is conditional reaction. The precondition of reciprocal PNT condensation reaction is the sub-matter-integrations attending to the PNT reaction must come up against reciprocal PNT origin and the possible progress and ultimate outcome of the reciprocal PNT condensation reaction directly depends on the conditions of the so-called reciprocal PNT origin. The innate formation of nuclear, atoms, molecules, gas, liquid, solid ... organism ..., celestial bodies, and galaxies are all instances of PNT combination condensation reactions. On some certain point, reciprocal PNT condensation reaction is just the configurable multiplication reaction of matter in spacetime. As reciprocal PNT condensation reaction can cause condensation and solidification effect of matter in spacetime, if we denote the primordial generation of separate elementary genic units in space field “primordial condensation & solidification” of matter, then, reciprocal PNT condensation reaction can be called the “successive condensation & solidification” of matter in the nature.

During the course of primordial formation of matter in cosmos, no matter the performance of primordial condensation & solidification of separate elementary genic units or successive condensation & solidification among atoms, molecules and molecule system, they all can cause remarkable temperature descent of cosmos. Such temperature descent is not because the cosmos has finished a big bang, but resultant situation of performance of spontaneous reciprocal condensation & solidification of matter in spacetime. I can hardly understand why Big Bang insisted that such temperature descent of cosmos is positive demonstration of them.

2.3.3. The third instinctive PNT reaction——mass acclimation reaction

The third instinctive PNT reaction is just the PNT reaction that mass of matter integration either generatively increases for further field potential concrete vallum condensation or mass of matter integration degeneratively decreases for further field potential concrete vallum released and revived. For expedience, we denote the mass increase or decrease for further field potential concrete vallum condensation or further field potential concrete vallum release and revivification “mass acclimation variation”, and as a result, the third Instinctive PNT reaction is called “mass acclimation reaction” thereby.

Compared with the first instinctive PNT reaction and the second instinctive PNT reaction, on the point of the operational logic sequence of the related variables of matter integration, the third Instinctive PNT reaction is relatively subsequent, no matter the operational sequence on the “M→m” operational opposite or the “M←m” operational opposite.

In the “M→m” operational opposite, the performance of “M→m” above all cause field potential concrete vallum increase of elementary genic units, and field potential concrete vallum increase of elementary genic units will unconditionally and firstly activate further field potential concrete vallum revivification reaction. If the distribution of elementary genic units is rather thick, then there are substantial probabilities for elementary genic units to arises reciprocal PNT condensation reaction, comparably, the mass acclimation reaction is usually a little inert for its operational logic subsequence. Even under the condition that the distribution of elementary genic units is rather thin but the progress of operation opposite “M→m” is still more preponderant than operation opposite “M←m”, as the field potential concrete vallum of separate elementary genic units in spacetime is rather bare and open, elementary genic units are usually very difficult to store up “M→m” input

Historical progress of science in the recent several centuries seemed like a far-flung exploration of the first itinerary around numerous distinctive landscapes of brand-new landmasses of science with palette & tablet on back, several hundred years’ scientific travelogues were compiled thereby.

preponderance into their mass convergence, but more convenient to crack themselves into more elementary genic units as to counterbalance and store up the “M→m” preponderance. In “M←m” operational opposite of PNT action, “M←m” performance above all causes field potential concrete vallum of matter integration weaken as to induct field potential concrete vallum revivification reaction. If the matter integration is reciprocal PNT combination, then the reaction will secondly cause the PNT combination mechanism of the reciprocal PNT combination collapse, and subsequently entangle the mass acclimation dissipation reaction.

Of course, if the matter integration is just separate elementary genic unit without any PNT combination mechanism connotation, then the reaction will of course entangle mass acclimation dissipation reaction directly, either make the elementary genic unit sacrifice a part of its mass and turn into relatively low-grade elementary genic unit or entirely melt into space field and sacrifice all its mass.

All in all, the causes for mass acclimation reaction to be the third instinctive PNT reaction is that field potential concrete vallum revivification reaction and reciprocal PNT condensation reaction are preferential in PNT operational logic sequence, and the reactions of field potential concrete vallum revivification reaction and reciprocal PNT condensation reaction kind are relatively more sensitive than mass acclimation reaction. Of course, I have to comment here, although field potential concrete vallum revivification reaction and reciprocal PNT condensation reaction are preferential in PNT operational logic sequence and are relatively more sensitive than mass acclimation reaction, considered from time sequence, the occurrence and presence of three fundamental PNT reactions are almost synchronous, it's only because of the disparity in PNT operational logic sequence and reaction sensitivity, the reaction effect of the first instinctive PNT reaction will be foremost and remarkably embodied. The second instinctive PNT reaction usually depends on the first Instinctive PNT reaction to offer it possibility of effective reaction space range, because materialization of the second instinctive PNT reaction must satisfy one of its preconditions that the matter integration attending to the second instinctive PNT reaction (reciprocal PNT condensation reaction) must be in the relatively effective space range, as the matter integration attending to the second Instinctive PNT reaction are not innately in the relatively effective space range, it has to depend on the field potential concrete vallum revivification reaction to offer it probability of the very precondition. Usually, the reaction preponderance of the third instinctive PNT reaction only expediently arises as successive supporting PNT reaction and exhibits remarkable reaction effect when the first instinctive PNT reaction and the second instinctive PNT reaction seem short of resource for expedient PNT equilibrium in their distance.

2.4. Daedal PNT reaction and PNT reaction linkage expansion in the nature

The PNT correlation between spacetime and matter directly predestines the existence & motion of matter in spacetime. The intention we study PNT action and PNT reaction is to clarify and illuminate the existence & motion of universal matter further on the point of microcosmic genic PNT actions. The universal existence & motion of matter in spacetime is of course rich and colorful, while none material existence & motion is not derived from PNT action or PNT reaction. Not only the nuclear reaction is PNT action, but also chemical reactions, physiological domino effect, comprehensive vital actions even the innate formation and motion of celestial bodies and galaxies are all PNT reactions. And under the precondition that matter coexist in mutually accessible spacetime range, universal daedal PNT reactions form PNT reaction linkages by the light of nature for their coherent reciprocity. For example, hydrogen nuclear fusion is a reaction linkage preconditioned by field potential concrete vallum revivification reaction of uranium nuclear fission reaction as to achieve the

As coherent natura naturans throughout cosmic evolution, instinctive PNT reciprocal equilibrium towards optimum PNT operation is radical potentiality & conditionality for cosmos always ready to orientate itself towards perfection.

effective space range precondition for reciprocal PNT condensation reaction of hydrogen nuclear fusion. Many chemical reactions need heat have to depend on some certain field potential concrete vallum revivification reactions of fuel or mechanical work to offer necessary PNT reaction conditions.

The physical process that match cobbra is abraded to burning is successive PNT reactions of one field potential concrete vallum strengthening reaction of the match cobbra for it is abraded and a consequential durative field potential concrete vallum revivification reaction of the match cobbra. In detail words, as the field potential concrete vallum of the match cobbra is strengthened for it is mechanically abraded, and as the presence of PNT equilibrium instinct, in order to counterbalance the field potential concrete vallum strengthening, the matter integration of match cobbra must synchronously release and revivify more field potential concrete vallum by the light of nature as to cause thermic movement of the compositive molecules of match cobbra accelerating, as the presence of oxygen around, the accelerating of thermic movement of the compositive molecules of match cobbra offered more effective collisions between compositive molecules of match cobbra and oxygen as to precipitate smart oxygenation reaction, besides the compositive molecules of match cobbra and oxygen atoms arises recombination, this oxygenation reaction follows remarkable field potential concrete vallum revivification reaction of molecules or atoms attending to the oxygenation reaction, as a result, the match cobbra exhibits burning and releases energy.

The physical process that rocket is accelerated by jet propulsion includes three successive PNT reactions, the first is the fuel burning process, —the field potential concrete vallum release and revivification reaction of fuel; the second is the physical process the burning fuel works on the rocket, —the revivified field potential concrete vallum from the burning fuel transfers to the mater system of the rocket as to strengthen the field potential concrete vallum of matter integration of the rocket; the third is the physical process the rocket accelerated, —as field potential concrete vallum of rocket strengthened by burning fuel, the matter integration of rocket is proportionately activated to arises field potential concrete vallum release and revivification reaction by the light of nature as to exhibit remarkable acceleration effect. Not only the rocket works like this, all the physical processes internal-combustion engines work to outside are just the same.

Offering current to the winding of electromotor is but physical process field potential concrete vallum of electromotor strengthened, and for the presence of PNT equilibrium instinct of matter integration, the consequent rotation of the rotor of electromotor is but the embodiment of the consequent field potential concrete vallum release and revivification reaction activated by the field potential concrete vallum strengthening as current input to winding of electromotor; Earthquake is another kind of PNT reaction linkage performs under lithosphere. Physiological domino effect, pullulation and reproduction of organisms, even various physiological actions of human are more multifarious PNT reaction linkages.

...

On the general view, the comprehensive correlation in the nature are all physically related by PNT reaction linkages. For instance, the connatural dynamic coexistence and cooperation of series alternatives as sun radiation, earth revolution and rotation, atmosphere movement, water circulation on the earth, precipitation distribution and vegetation distribution on the earth, day & night variation and seasonal variation of propagation physiological rhythm etc are implemented by the performance of PNT reaction linkages among the related factors and form their connatural dynamic regularities.

Historical progress of science in the recent several centuries seemed like a far-flung exploration of the first itinerary around numerous distinctive landscapes of brand-new landmasses of science with palette & tablet on back, several hundred years' scientific travelogues were compiled thereby.

2.5. Artificial control of PNT reaction

Of course, all PNT actions and PNT reactions in cosmos can be formulated mathematically in accordance with PNT dynamics (here the PNT dynamics covers the matter inertial conservation equations). The intention we analyze and clarify the rich and colorful existence & motion of universal matter on the point of microcosmic genic PNT action & PNT reaction is to sum up and highlight some of the typical characters of the daedal PNT actions & PNT reactions in the nature, so that we can possess more rational capital to program artificial control of PNT reaction expediently.

The objective we implement artificial control of PNT reaction is generally to encash two kinds of practical production demands.

The first is to procure more energy or artificial control of motorial status of objects by artificial control of PNT reaction, for instance, we build internal-combustion engine, nuclear power plant, autocar, rocket, PNT engine, PNT generator etc.

The second is to procure ideal reciprocal PNT combinations with better functions, reliability or any higher quality due to practical application demands by proper volition control of PNT reactions, for instance, we are ready to develop ideal alloy steels, electronic instruments, iatric medicines, synthetic biological apparatus or computer, DNA optimization, life-form robot etc. After all, PNT action and PNT reaction are exactly demiurgic conducts towards reciprocal PNT combinations, besides the free elementary genic units in spacetime, all positive matter in cosmos exist as reciprocal PNT combinations, all reciprocal PNT combinations are outcome of serial PNT action and PNT reaction along positive cosmic demiurgic evolution of sequential homologic cosmogony. Since PNT action and PNT reaction directly bring out reciprocal PNT combinations, general existence & motion of reciprocal PNT combinations must embody the fundamental of PNT action and PNT reaction as well.

Of course, in order to possess enough logos capital for artificial control of PNT reactions, we must ascertain how many kinds of elementary genic units i_{n+1} , i_{n+2} , i_{n+3} , \dots i_{n+p} there are in common spacetime, relative field potential concrete vallum of each elementary genic unit under certain space field conditions, physical reciprocal PNT combination effect between any two discretionary elementary genic units and so on in advance, and then on such groundwork, come to study the daedal existence & motion of universal matter in accordance with the both fundamentals of “relative minimum principle of field potential concrete vallum” and “instinctive PNT equilibrium principle” of matter integration.

——Written in Nov. 2008, Bantian town, Shenzhen city, Guangdong province

(V-iii) Spontaneous Individuation of Dynamic Configuration of Resultant Reciprocal PNT Combinations in the Nature of Coherent Natura Naturans of Instinctive PNT Reciprocal Equilibrium Towards Optimum PNT Operation Throughout Cosmic Evolution

— Spontaneous micromodelization & macromodelization of spacetime momentum in configurable hierarchy of reciprocal PNT combinations in the nature of coherent natura naturans of instinctive PNT reciprocal equilibrium towards optimum PNT operation

Abstract: Original generation of positive matter along cosmic demiurgic evolution of sequential homologous cosmogony has predestined that PNT action is inherent attribute of matter integration in cosmos. The most remarkable and radical existent hypostasis of PNT action embodying on positive matter is that any matter integration in cosmos proportionately possess absolute spacetime momentum “ $P_A = mV = d(M \leftarrow m) * Y$, $\longleftrightarrow V = d(M \leftarrow m) * Y/m$ ” as inherence of nature. And on the other hand, the initial existence of positive matter are generally dissociated elementary genic units in spacetime, as a result, the initial absolute spacetime momentum of positive matter is just absolute spacetime momentum of dissociated elementary genic units in spacetime $P_A = mC = d(M \leftarrow m) * Y$, $\longleftrightarrow C = d(M \leftarrow m) * Y/m$ (in the equation, “C” denotes speed of light). As spontaneous occurrence of instinctive PNT reciprocal equilibrium towards optimum PNT operation among available matter integration, there are consequent outcomes of reciprocal PNT combination with single PNT configurable hierarchy, reciprocal PNT combination with double PNT configurable hierarchies, reciprocal PNT combination with three PNT configurable hierarchies ..., reciprocal PNT combination with n PNT configurable hierarchies, and as a result, absolute spacetime momentum hoarding in reciprocal PNT combination arises proportionate hierarchy, — absolute spacetime momentum of dissociative elementary genic units arises promotive transference for assimilative macromodelization from microcosmic hierarchy to relatively macroscopical hierarchy of resultant reciprocal PNT combination in the nature of instinctive PNT reciprocal equilibrium towards optimum PNT operation among available compositive subunits round and round so as to accomplish characteristic spacetime momentum delamination hoarding pattern in configurable hierarchies of resultant reciprocal PNT combination.

We define, among integrative spacetime momentum delamination hoarding, the absolute spacetime momentum hoarding in relatively microcosmic configurable hierarchy of reciprocal PNT combination embodying lively existence & motion of proper compositive subunits of resultant reciprocal PNT combination “spacetime momentum micromodelization”. We define absolute spacetime momentum promotive transference for assimilative macromodelization from microcosmic configurable hierarchy to relatively macroscopical configurable hierarchy of reciprocal PNT combination embodying the lively existence & motion of the relatively macroscopical subunits of reciprocal PNT combination or just the resultant reciprocal PNT combination “spacetime momentum macromodelization”. The original generation and further multiplication of reciprocal PNT combination directly materialize absolute spacetime momentum promotive transference for assimilative macromodelization from microcosmic configurable hierarchy to relatively macroscopical configurable hierarchy and finalize the relatively steady spacetime momentum delamination hoarding pattern of resultant reciprocal PNT combination, which directly embody idiographic physical configuration and attribute of resultant reciprocal PNT combination. Of course, further absolute spacetime momentum promotive transference for assimilative macromodelization or delamination hoarding acclimatization readjustment means the proportionate variation of idiographic physical configuration

Historical progress of science in the recent several centuries seemed like a far-flung exploration of the first itineracy around numerous distinctive landscapes of brand-new landmasses of science with palette & tablet on back, several hundred years’ scientific travelogues were compiled thereby.

and attribute of resultant reciprocal PNT combination as well.

As typical grand reciprocal PNT combination in spacetime, the original generation and evolution of the earth has predestined its inherence of absolute spacetime momentum delamination hoarding pattern, once the earth experiences concomitant spacetime change during the course of its journey in cosmos, integrative acclimatization readjustment of absolute spacetime momentum delamination hoarding in configurable hiberarchies of the earth must occur by the light of nature, volcano, earthquake are just physical phenomenon under such spontaneous occurrence.

Keywords: dissociated elementary genic unit, spacetime momentum micromodelization, spacetime momentum macromodelization, spacetime momentum micromodelization in zero configurable hiberarchy, esse in single reciprocal PNT configurable hiberarchy, spacetime momentum micromodelization/macromodelization in first configurable hiberarchy, esse in double reciprocal PNT configurable hiberarchies, spacetime momentum micromodelization/macromodelization in second configurable hiberarchy, esse in three reciprocal PNT configurable hiberarchies, spacetime momentum micromodelization/macromodelization in third configurable hiberarchy, ..., esse in n reciprocal PNT configurable hiberarchies, spacetime momentum macromodelization in nth configurable hiberarchy, spacetime momentum promotive transference for assimilative macromodelization in configurable hiberarchy of resultant reciprocal PNT combination, concomitant spacetime change of earth journey, geo-potential increase domino effect of concomitant spacetime change of earth journey, geo-potential dissipation, crescive geo-potential cumulation towards volcano or earthquake, lithosphere counter-shield against geo-potential local cumulation, resultant anti-burthen capability extremity of lithosphere counter-shield against geo-potential local cumulation.

1) Dynamic essence of positive matter in homogenous cosmos

As the initial modality of positive matter in spacetime, since elementary genic units can be generated in proper progenitive space field, they must be able to be degenerated and exhausted their initial modality under the proper negative spacetime conditions too, otherwise, the progressive evolution of cosmos must lead to extremity, there is ultimately either single spacetime or single positive matter in cosmos. This bi-directional ongoing operation of cosmic evolution is just the positive & negative transmutation, which is virtually inherent homologic correlation between spacetime and matter, —PNT correlation or PNT action. PNT action is not only connatural generative action of positive matter in spacetime, but also action of further existence & motion of positive matter in spacetime. Under the precondition we introduce the “Instinctive PNT equilibrium postulate”, we formulate the PNT action of matter integration with PNT equilibrium instinct in symbolic logic, and we arrive at matter inertial conservation equations and PNT dynamics thereby.

The external indication PNT action embodied on matter integration is that matter integration inherently possess absolute spacetime time momentum “ $P_A = mV = d(M \leftarrow m) * Y$ ”, and the spacetime essentiality of absolute spacetime momentum of matter integration in spacetime is “ $d(M \leftarrow m) * Y$ ”, which implies, under proper spacetime condition, matter integration always materialize its innative PNT action with positive towards negative transmutation ratio $d(M \leftarrow m)$ in speed of time dynamic speed Y so as to hypostatize its idiographic existence & motion in spacetime through and through. And the very dynamic connotation of matter integration with mass of “ m ” is just the physical quantity “ mV ” (among the equation, “ V ” denotes the absolute speed of matter integration in spacetime).

As coherent natura naturans throughout cosmic evolution, instinctive PNT reciprocal equilibrium towards optimum PNT operation is radical potentiality & conditionality for cosmos always ready to orientate itself towards perfection.

2) Spontaneous individuation of dynamic connotation of resultant reciprocal PNT combinations among compositive subunits due to instinctive PNT reciprocal equilibrium towards optimum PNT operation in homogenous cosmos

2.1. Spontaneous occurrence of instinctive PNT reciprocal equilibrium towards optimum PNT operation among available compositive subunits directly materializes promotive transference of absolute spacetime momentum for assimilative macromodelization from microcosmic configurable hiberarchy to relatively macroscopical hiberarchy and results in characteristic absolute spacetime momentum delamination hoarding pattern in configurable hiberarchy of resultant reciprocal PNT combination thereby, which is just demiurgic action processing original generation and further multiplication of reciprocal PNT combinations in spacetime virtually.

PNT action of matter integration in homogenous cosmos has its inherent optimum operational model & genic linkage, if PNT operation of matter integration can go its way in optimum operational model & genic linkage, the field potential concrete vallum of matter integration will be lowest and the matter integration will be in its steadiest existent state in spacetime. Virtually, cosmos is always ready to orientate itself towards perfection by the right of nature, as any matter integration in cosmos possesses instinct of PNT reciprocal equilibrium towards optimum PNT operation, as long as there is reciprocal feasibility among sub-matter-integrations, there must be spontaneous occurrence of instinctive PNT reciprocal equilibrium towards optimum PNT operation, which directly materialize the consequent physical reciprocal PNT correlation or reciprocal PNT linkages among all the proper sub-matter-integrations and lead to original generation even further multiplication of reciprocal PNT combination (or **reciprocal PNT combinations**) in spacetime. Virtually, the materialization of idiographic physical reciprocal PNT correlation or reciprocal PNT linkage among all the proper sub-matter-integrations just embodies the proportionate characteristic existence & motion of resultant reciprocal PNT combination.

Idiographic existence & motion of matter is virtually just the proportionate physical embodiment of PNT operation of matter integration in spacetime. No matter how grand the configuration scale of the object we study is, and no matter how huge the mass of the object we study is, as long as the object radically consists of elementary genic units, the PNT action of matter integration must ultimately be hypostatized by positive & negative transmutation between the compositive elementary genic units of object and the available field genic units in space field. Whereas, during the course of progressive demiurgic homologic multiplication from elementary genic units to rich and colorful reciprocal PNT combinations in spacetime, as the spontaneous occurrence of reciprocal PNT correlation or reciprocal PNT linkage among available sub-matter-integration due to instinctive PNT reciprocal equilibrium towards optimum PNT operation, the absolute spacetime momentum of matter integration consequently arises promotive transference for assimilative macromodelization and results in spacetime momentum delamination hoarding in configurable hiberarchy of resultant reciprocal PNT combination. We define, among integrative spacetime momentum delamination hoarding, the absolute spacetime momentum hoarding in relatively microcosmic configurable hiberarchy of reciprocal PNT combination embodying lively existence & motion of proper compositive subunits of resultant reciprocal PNT combination “spacetime momentum micromodelization”. We define absolute spacetime momentum promotive transference for assimilative macromodelization from micro-mechanism to macro-mechanism of reciprocal PNT combination embodying the lively existence & motion of the relatively macroscopical subunits of reciprocal PNT combination or just the

Historical progress of science in the recent several centuries seemed like a far-flung exploration of the first itinerary around numerous distinctive landscapes of brand-new landmasses of science with palette & tablet on back, several hundred years' scientific travelogues were compiled thereby.

resultant reciprocal PNT combination “spacetime momentum macromodelization”. So-called “absolute spacetime momentum promotive transference for assimilative macromodelization” is just such physical process, as restriction of PNT reciprocity, some micromodelized spacetime momentum in compositive subunits of resultant reciprocal PNT combination presents common orientation, and as stabilization of PNT reciprocity among all the compositive subunits, and common orientation of micromodelized spacetime momentum in compositive subunits of resultant reciprocal PNT combination is maintained to embody the idiographic existence & motion of relatively macroscopical subunits of resultant reciprocal PNT combination or just the resultant reciprocal PNT combination.

(A) In terms of the existence of dissociated elementary genic units in spacetime, there is none inner PNT reciprocity among dissociated elementary genic units, as initial modality of positive matter existing in spacetime, the absolute spacetime momentum of dissociated elementary genic units straightforwardly incarnates the “light speed motion” as below:

$$P_A = mC = d(M \leftarrow m) * Y, \quad \longleftrightarrow \quad C = d(M \leftarrow m) * Y/m$$

In the equation above, “ P_A ” denotes spacetime momentum, subscript “A” is just abbreviation of “Absolute”, “m” denotes the mass of elementary genic unit, “C” denotes the speed of light.

As there is none connotation of reciprocal PNT operational hiberarchy among dissociated elementary genic units, there is neither microcosmic configurable hiberarchy nor relatively macroscopical configurable hiberarchy for absolute spacetime momentum of dissociated elementary genic units to delaminate hoarding in. We call such spacetime momentum delamination hoarding in none configurable hiberarchy of dissociated elementary genic units “spacetime momentum micromodelization in zero configurable hiberarchy”.

(B) If the object we study is esse in single reciprocal PNT configurable hiberarchy, —just the so-called “reciprocal PNT combination in single configurable hiberarchy”, as attendance of inner PNT reciprocity, some of the micromodelized spacetime momentum in zero configurable hiberarchy consequently arises promotive transference for assimilative macromodelization so as to hypostatize the relatively macroscopical existence & motion of the resultant reciprocal PNT combination in single configurable hiberarchy. Thus, the spacetime momentum connotation of reciprocal PNT combination in single configurable hiberarchy is embodied as both microcosmic existence & motion of the compositive elementary genic units and relatively macroscopical existence & motion of the resultant reciprocal PNT combination in single configurable hiberarchy. This of course implies there is obvious distinction of relatively microcosmic configurable hiberarchy and macroscopical configurable hiberarchy for spacetime momentum delamination hoarding in reciprocal PNT combination in single configurable hiberarchy.

Apparently, in terms of distinctive configuration of reciprocal PNT combination in single configurable hiberarchy, the relatively microcosmic components are compositive elementary genic units, and the relative macroscopical unit is of course the resultant reciprocal PNT combination in single configurable hiberarchy. We call the spacetime momentum delamination hoarding of reciprocal PNT combination in single configurable hiberarchy objectifying dynamic existence & motion of compositive elementary genic units “spacetime momentum micromodelization” of reciprocal PNT combination in single configurable hiberarchy, we call the spacetime momentum transferred for assimilative macromodelization from microcosmic hiberarchy to relatively macroscopical hiberarchy objectifying the relatively macroscopical existence & motion

As coherent natura naturans throughout cosmic evolution, instinctive PNT reciprocal equilibrium towards optimum PNT operation is radical potentiality & conditionality for cosmos always ready to orientate itself towards perfection.

of the resultant reciprocal PNT combination “spacetime momentum macromodelization” of reciprocal PNT combination in single configurable hierarchy. And as the spacetime momentum macromodelization embodies the idiographic existence & motion of result reciprocal PNT combination in single configurable hierarchy, we proportionately call it “spacetime momentum macromodelization in first configurable hierarchy”.

Apparently, in terms of dynamic connotation of reciprocal PNT combination in single configurable hierarchy in spacetime, the spacetime momentum integration of it is $P_A =$ “spacetime momentum micromodelization in zero configurable hierarchy” + “spacetime momentum macromodelization in first configurable hierarchy”. If we denote the absolute spacetime momentum of reciprocal PNT combination in single configurable hierarchy “ P_{A1} ”, denote spacetime momentum micromodelization in zero configurable hierarchy “ P_0 ”, and we denote spacetime momentum macromodelization in first configurable hierarchy “ P_1 ”, we can of course arrive at equation as below:

$$P_{A1} = P_0 + P_1 \quad \dots\dots\dots \quad (\text{IV-iv-1})$$

(C) If the object we study is esse in double reciprocal PNT configurable hierarchies, —just the so-called “reciprocal PNT combination in double configurable hierarchies”, then the spacetime momentum connotation of reciprocal PNT combination in double configurable hierarchies includes the spacetime momentum embodied in dynamic existence & motion of compositive elementary genic units, spacetime momentum embodied in dynamic existence & motion of the compositive subunits reciprocal PNT combinations in single configurable hierarchy and spacetime momentum embodied in integrative dynamic existence & motion of the resultant reciprocal PNT combination in double configurable hierarchies. As the compositive subunits of reciprocal PNT combinations in single configurable hierarchy are still relatively microcosmic components of resultant reciprocal PNT combination in double configurable hierarchies, the spacetime momentum delamination hoarding embodied in existence & motion of reciprocal PNT combination in single configurable hierarchy is still relative spacetime momentum micromodelization component of reciprocal PNT combination in double configurable hierarchies, so we just call it “spacetime momentum micromodelization in first configurable hierarchy”, and we call spacetime momentum delamination hoarding embodied in the integrative existence & motion of reciprocal PNT combination in double configurable hierarchies “spacetime momentum macromodelization in second configurable hierarchy”.

Apparently, in terms of dynamic connotation of reciprocal PNT combination in double configurable hierarchies in spacetime, the spacetime momentum integration of it is $P_A =$ “spacetime momentum micromodelization in zero configurable hierarchy” + “spacetime momentum micromodelization in first configurable hierarchy” + “spacetime momentum macromodelization in second configurable hierarchy”. If we denote the absolute spacetime momentum of reciprocal PNT combination in single configurable hierarchy “ P_{A2} ”, denote spacetime momentum micromodelization in zero configurable hierarchy “ P_0 ”, denote spacetime momentum micromodelization in first configurable hierarchy “ P_1 ”, and we denote spacetime momentum macromodelization in second configurable hierarchy “ P_2 ”, we can of course arrive at equation as below:

$$P_{A2} = P_0 + P_1 + P_2 \quad \dots\dots\dots \quad (\text{IV-iv-2})$$

(D) If the object we study is esse in three reciprocal PNT configurable hierarchies, —just the so-called “reciprocal PNT combination in three configurable hierarchies”, the spacetime momentum integration of reciprocal PNT combination in three configurable hierarchies is $P_A =$ “spacetime momentum micromodelization in **Historical progress of science in the recent several centuries seemed like a far-flung exploration of the first itinerary around numerous distinctive landscapes of brand-new landmasses of science with palette & tablet on back, several hundred years’ scientific travelogues were compiled thereby.**”

zero configurable hierarchy” + “spacetime momentum micromodelization in first configurable hierarchy” + “spacetime momentum micromodelization in second configurable hierarchy” + “spacetime momentum macromodelization in third configurable hierarchy”. If we denote the absolute spacetime momentum of reciprocal PNT combination in three configurable hierarchy “P_{A3}”, denote spacetime momentum micromodelization in zero configurable hierarchy “P₀”, denote spacetime momentum micromodelization in first configurable hierarchy “P₁”, denote spacetime momentum micromodelization in second configurable hierarchy “P₂”, and we denote spacetime momentum macromodelization in third configurable hierarchy “P₃”, we can of course arrive at equation as below:

$$P_{A3} = P_0 + P_1 + P_2 + P_3 \quad \dots\dots\dots \quad (IV-iv-3)$$

(N) Along the inertial analogy extension, if the object we study is esse in n reciprocal PNT configurable hierarchies, —just the so-called “reciprocal PNT combination in n configurable hierarchies”, then the spacetime momentum connotation of reciprocal PNT combination in n configurable hierarchies is P_A = “spacetime momentum micromodelization in zero configurable hierarchy” + “spacetime momentum micromodelization in first configurable hierarchy” + “spacetime momentum micromodelization in second configurable hierarchy” + “spacetime momentum micromodelization in third configurable hierarchy” + ... + “spacetime momentum macromodelization in nth configurable hierarchy”. If we denote the absolute spacetime momentum of reciprocal PNT combination in n configurable hierarchy “P_{An}”, denote spacetime momentum micromodelization in zero configurable hierarchy “P₀”, denote spacetime momentum micromodelization in first configurable hierarchy “P₁”, denote spacetime momentum micromodelization in second configurable hierarchy “P₂”, denote spacetime momentum micromodelization in third configurable hierarchy “P₃”,, and we denote spacetime momentum macromodelization in nth configurable hierarchy “P_n”, we can of course arrive at equation as below:

$$P_{An} = P_0 + P_1 + P_2 + P_3 + \dots + P_n \quad \dots\dots\dots \quad (IV-iv-4)$$

The existent species of reciprocal PNT combination in discretionary configurable hierarchies is not unique; no matter they are esse in single reciprocal PNT configurable hierarchies, esse in double reciprocal PNT configurable hierarchies, esse in three reciprocal PNT configurable hierarchies ... or esse in n reciprocal PNT configurable hierarchies. In terms of reciprocal PNT combination in single configurable hierarchy, as the disparity of compositive genic unit species and quantity, the familial members of reciprocal PNT combination in single configurable hierarchy may be diversiform, no more existent species of reciprocal PNT combination in double configurable hierarchies, reciprocal PNT combination in three configurable hierarchies, ... , reciprocal PNT combination in n configurable hierarchies.

As various condition limitations, it's still difficult for Homogenous Cosmos Originated from Unique Genesis to confirm, along evolutionary homologic multiplication sequence of reciprocal PNT combinations, what's the proper reciprocal PNT combination in certain quantitative configurable hierarchies the objects as quark, boson ... electron, proton, neutron, nucleon, atom, molecule and so on should belong to. As a result, when I introduce reciprocal PNT combination in single configurable hierarchy, reciprocal PNT combination in double configurable hierarchies ... reciprocal PNT combination in n configurable hierarchies, I am still inconvenient to introduce typical particles, atoms, molecules ... lively sparrow & mice ... solar system, Milky Way Galaxy for idiographic analysis of spacetime momentum delamination hoarding in configurable hierarchies

As coherent natura naturans throughout cosmic evolution, instinctive PNT reciprocal equilibrium towards optimum PNT operation is radical potentiality & conditionality for cosmos always ready to orientate itself towards perfection.

of reciprocal PNT combinations.

2.2. Absolute spacetime momentum delamination hoarding pattern in configurable hierarchies of reciprocal PNT combination

The first, extension of absolute spacetime momentum delamination hoarding in configurable hierarchies of resultant reciprocal PNT combination must be in connatural cascade succession

Reciprocal PNT combinations in spacetime are spontaneous stochastic outcome of serial PNT action & PNT reaction among available compositive subunits, thorough coherence of PNT action & PNT reaction predestines the extension of absolute spacetime momentum delamination hoarding in configurable hierarchy of resultant reciprocal PNT combination must be in connatural cascade succession, which indicates if the idiographic esse is reciprocal PNT combination in single configurable hierarchy, there must be elementary genic units comprised as compositive subunits of the resultant reciprocal PNT combination.

If the idiographic esse is reciprocal PNT combination in double configurable hierarchies, there must be elementary genic units, reciprocal PNT combination/combinations in single configurable hierarchy comprised as compositive subunits in sequential cascade hierarchies of the resultant reciprocal PNT combination. If the idiographic esse is reciprocal PNT combination in three configurable hierarchies, there must be elementary genic units, reciprocal PNT combination/combinations in single configurable hierarchy, reciprocal PNT combination/combinations in double configurable hierarchies comprised as compositive subunits in sequential cascade hierarchies of the resultant reciprocal PNT combination. If the idiographic esse is reciprocal PNT combination in n configurable hierarchies, there must be elementary genic units, reciprocal PNT combination/combinations in single configurable hierarchy, reciprocal PNT combination/combinations in double configurable hierarchies ... reciprocal PNT combination /combinations in n-2 configurable hierarchies, reciprocal PNT combination/combinations in n-1 configurable hierarchies comprised as compositive subunits in sequential cascade hierarchies of the resultant reciprocal PNT combination.

That's to say, any reciprocal PNT combination in n configurable hierarchies must comprise all reciprocal configurable hierarchies from first configurable hierarchy to (n-1)th configurable hierarchy as compositive subunits in connatural cascade succession. —If it's molecule, it must comprise configurable hierarchy of convergent reciprocity among compositive atoms, if it's atom, it must comprise configurable hierarchy of convergent reciprocity between “nucleus” and “electrons”; if it's “nucleus”, it must comprise configurable hierarchy of convergent reciprocity between “protons” and “neutrons”;

Virtually, the extension of spacetime momentum delamination hoarding in configurable hierarchies of reciprocal PNT combination exactly derives from demiurgic multiplication of reciprocal PNT combination in connatural cascade succession due to instinctive PNT reciprocal equilibrium towards optimum PNT operation, this of course indicates the coherence of extension of spacetime momentum delamination hoarding in configurable hierarchies and demiurgic multiplication of reciprocal PNT combination.

The second, Spacetime momentum promotive transference for assimilative macromodelization from microcosmic configurable hierarchy to relatively macroscopical configurable hierarchy must be successive.

To any reciprocal PNT combination in n configurable hierarchies, spacetime momentum macromodelization of any relatively high-level configurable hierarchy is originally transferred and assimilated from the adjacent

Historical progress of science in the recent several centuries seemed like a far-flung exploration of the first itinerary around numerous distinctive landscapes of brand-new landmasses of science with palette & tablet on back, several hundred years' scientific travelogues were compiled thereby.

low-level configurable hierarchy of resultant reciprocal PNT combination. Spacetime momentum macromodelization in first configurable hierarchy is originally transferred and assimilated from spacetime momentum micromodelization in zero configurable hierarchy; spacetime momentum macromodelization in second configurable hierarchy is originally transferred and assimilated from spacetime momentum micromodelization in first configurable hierarchy; spacetime momentum macromodelization in third configurable hierarchy is originally transferred and assimilated from spacetime momentum micromodelization in second configurable hierarchy; ...; spacetime momentum macromodelization in nth configurable hierarchy is originally transferred and assimilated from spacetime momentum micromodelization in (n-1)th configurable hierarchy.

Say concretely, the spacetime momentum macromodelization of nucleus is originally transferred and assimilated from spacetime momentum micromodelization of the compositive subunits of neutrons and protons, —as strong interaction among neutrons and protons, some of the micromodelized spacetime momentum of neutrons and protons is transferred and assimilated to relatively high-level configurable hierarchy so as to hypostatize the idiographic existence & motion of the resultant reciprocal PNT combination of nucleus. The spacetime momentum macromodelization of atom is originally transferred and assimilated from spacetime momentum micromodelization of compositive subunits of nucleus and electrons around nucleus, —as electromagnetic interaction among nucleus and electrons around, some of the micromodelized spacetime momentum of nucleus and electrons is transferred and assimilated to relatively high-level configurable hierarchy so as to hypostatize the idiographic existence & motion of the resultant reciprocal PNT combination of atom. The spacetime momentum macromodelization of molecule is originally transferred and assimilated from spacetime momentum micromodelization of the compositive subunits of the proper atoms, —as the electromagnetic interaction among compositive atoms, some of the micromodelized spacetime momentum of atoms is transferred and assimilated to relatively high-level configurable hierarchy so as to hypostatize the idiographic existence & motion of the resultant reciprocal PNT combination of molecule.

Further more, as spacetime momentum hoarding in relatively microcosmic configurable hierarchy is direct spacetime momentum resource for promotive transference for assimilative macromodelization in relatively macroscopical configurable hierarchy, in any two successive configurable hierarchies of reciprocal PNT combination; the spacetime momentum originally transferred and assimilated in the relatively macroscopical configurable hierarchy is always less than the resource spacetime momentum still remained in relatively microcosmic configurable hierarchy. Otherwise, spacetime momentum promotive transference for assimilative macromodelization can not be smoothly successive. For instance, there is 1 kilogram water in a cup, if we define the spacetime momentum hoarding in terminal configurable hierarchy of water in the cup is " $mV_A = 1\text{kilogram} \times V_A$ " (In the equation, V_A denotes the absolute moving speed of the water in spacetime, if the cup locates on a stationary table on the ground, V_A is just the absolute moving speed of the earth in large-scale spacetime.), and the spacetime momentum hoarding in sub configurable hierarchy is " $mV_1 = 1\text{kilogram} \times V_1$ " (In the equation, V_1 denotes overage speed of thermal motion of all water molecules in the cup.). If " $mV_1 = 1\text{kilogram} \times V_1$ " $\not\approx$ " $mV_A = 1\text{kilogram} \times V_A$ ", then, for relativity cause, man standing on the earth would be difficult to perceive lively dynamic existence & motion of water molecules in their connatural thermal situation.

And if the spacetime momentum hoarding quantity of compositive H atoms and O atoms is even less than spacetime momentum hoarding quantity of water molecules, then, as relativity cause, looking through

As coherent natura naturans throughout cosmic evolution, instinctive PNT reciprocal equilibrium towards optimum PNT operation is radical potentiality & conditionality for cosmos always ready to orientate itself towards perfection.

water molecules, it would be difficult for us to perceive the lively existence & motion of compositive H atoms and O atoms. This indicates in any two successive configurable hiberarchies of reciprocal PNT combination; the spacetime momentum hoarding quantity in the relatively macroscopical configurable hiberarchy is always less than the spacetime momentum hoarding quantity in the relatively microcosmic configurable hiberarchy. If we introduce a visual illustration to represent the general spacetime momentum delamination hoarding distribution pattern, it can be illustrated as below:

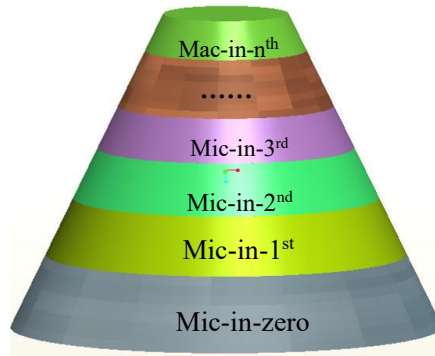

(1) Taper distribution pattern of spacetime momentum delamination hoarding of reciprocal PNT combination in n configurable hiberarchies

The third, As PNT action & PNT reaction are inherently subject to relative minimum principle of field potential concrete vallum, as direct outcome of spontaneous PNT action & PNT reaction, further multiplication extension of reciprocal PNT combination in configurable scale must lead to proportional absolute spacetime momentum shrinkage of resultant reciprocal PNT combination with configurable scale grander and grander.

The universal PNT reciprocity are subject to relative minimum principle of field potential concrete vallum, the connatural formation and further multiplication of reciprocal PNT combination can never increase any spacetime momentum, instead, it proportionately congeal some spacetime momentum of matter integration so as to promote the transformation of energy to mass and make the matter even more substantial and well-rounded in spacetime.

Just because of this, in terms of different objects with the same initial mass in spacetime, if the object exists as dissociated elementary genic units in spacetime, the absolute spacetime momentum quantity P_{A0} of the object is the largest, if the inner PNT reciprocity configuration of the object only involves first configurable hiberarchy of reciprocal PNT combination, the absolute spacetime momentum P_{A1} of object must satisfy $P_{A1} < P_{A0}$ therefore; if the inner PNT reciprocity configuration of the object involves second configurable hiberarchy of reciprocal PNT combination, the absolute spacetime momentum P_{A2} of object must satisfy $P_{A2} < P_{A1} < P_{A0}$ therefore; if the inner PNT reciprocity configuration of object involves third configurable hiberarchy of reciprocal PNT combination, the absolute spacetime momentum P_{A3} of object must satisfy $P_{A3} < P_{A2} < P_{A1} < P_{A0}$ therefore; if the inner PNT reciprocity configuration of object involves nth configurable hiberarchy of reciprocal PNT combination, the absolute spacetime momentum P_{An} of object must satisfy $P_{An} < P_{An-1} < \dots < P_{A3} < P_{A2} < P_{A1} < P_{A0}$ therefore.

That's to say, throughout the process matter evolves from microcosm to macrocosm along connatural cascade succession, the absolute spacetime momentum of matter integration will be less and less, proportionably, the matter integration will be more and more substantially steady & well-rounded. We can introduce an illustration to represent the very situation as below:

Historical progress of science in the recent several centuries seemed like a far-flung exploration of the first itinerary around numerous distinctive landscapes of brand-new landmasses of science with palette & tablet on back, several hundred years' scientific travelogues were compiled thereby.

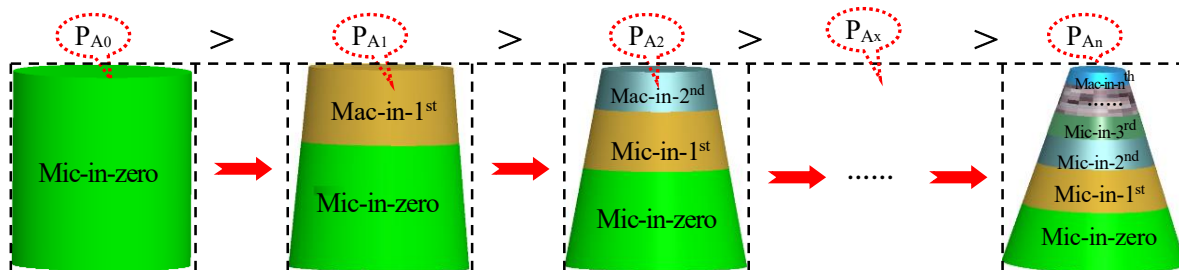

(2) The more sufficient and consummate PNT reciprocity among compositive subunits is, the less absolute spacetime momentum the resultant reciprocal PNT combination possesses

Virtually, the homologic multiplication of reciprocal PNT combinations from simplicity to complexity is generally the process matter evolves from dissociated elementary genic units to rich and colorful macrocosm by serial spontaneous PNT action & PNT reaction in the nature of instinctive PNT reciprocal equilibrium towards optimum PNT operation. Throughout the process, on one hand, the conditional spacetime is strengthening, and on the other hand, the positive matter is condensing, as an integrated result, the promotive strengthening of spacetime and evolutionary condensation & solidification of matter forms coherent process of input and transformation of physical spacetime to positive matter, so that more and more substantial positive matter are exuded from physical space field and lead to resultant temperature descent of the whole cosmos.

Throughout the evolution as illuminated in above diagram, all the bottom-surface acreages of the series cones are generally equal, which indicates the initial condition matter generated in physical spacetime is almost equivalent, it of course means once the spacetime develops to certain adequate stage for positive matter to be generated in, the successive promotive strengthening of spacetime won't remarkably impact the capability and mechanism of space field any longer, but mostly promote the existent quantity and state of positive matter in spacetime. However, the top-surface acreages of the series cones become smaller and smaller, which indicates as increase of configurable hiberarchy of resultant reciprocal PNT combination, there is less and less absolute spacetime momentum embodied in terminal configurable hiberarchy of resultant reciprocal PNT combination, the existence & motion of the relatively macroscopical object seems more and more substantial and retarded in spacetime therefore. Absolute spacetime momentum evolutionary transference for assimilative micromodelization and consequent delamination hoarding pattern in configurable hiberarchy directly impacts the dynamic attribute of resultant reciprocal PNT combinations.

(3) Spontaneous acclimatization readjustment of integrative absolute spacetime momentum delamination hoarding in configurable hiberarchy of reciprocal PNT combination

As spacetime momentum delamination hoarding in configurable hiberarchy is inherent attribute incarnating idiographic existence & motion of reciprocal PNT combination, it seems advisable for us just to call characteristic spacetime momentum delamination hoarding pattern lively "inborn biologic mechanism" of reciprocal PNT combination, and proportionately call the spontaneous acclimatization readjustment of spacetime momentum delamination hoarding pattern "inborn biologic reaction" of reciprocal PNT combination.

So-called "inborn biologic mechanism", in simple words, under certain spacetime ambient, some certain elementary genic units experienced idiographic PNT action & PNT reaction series so as to ultimately form relatively steady and optimum PNT operation in the nature of instinctive PNT reciprocal equilibrium towards optimum PNT operation including relatively steady mechanic conformations and spacetime momentum delamination hoarding pattern etc. As the inborn biologic mechanism is straightforward outcome of PNT action & PNT reaction among

As coherent natura naturans throughout cosmic evolution, instinctive PNT reciprocal equilibrium towards optimum PNT operation is radical potentiality & conditionality for cosmos always ready to orientate itself towards perfection.

the proper compositive sub-units of reciprocal PNT combination in connatural cascade succession due to instinctive PNT reciprocal equilibrium towards optimum PNT operation, the inborn biologic mechanism of reciprocal PNT combination of course embody the inherent regularity of PNT action and PNT reaction, especially the instinctive PNT reciprocal equilibrium towards optimum PNT operation.

So-called “inborn biologic reaction” of reciprocal PNT combination is, once the reciprocal PNT combination implements further PNT action and PNT reaction under idiographic spacetime ambient, the integrative inborn biologic mechanism varies for integral spacetime momentum delamination hoarding acclimatization readjustment due to instinctive PNT reciprocal equilibrium towards optimum PNT operation of matter integration, which of course includes accommodation of mechanic configurations and spacetime momentum delamination hoarding pattern and so on.

Spacetime momentum delamination hoarding pattern and spontaneous spacetime momentum delamination hoarding acclimatization readjustment directly result in the existent modality and mechanic attribute of reciprocal PNT combinations in spacetime. We study “inborn biologic mechanism” and the proportionate “inborn biologic reaction” of reciprocal PNT combinations is of course ready to master the idiographic existent modality and mechanic attribute according to the inherent PNT operational model of reciprocal PNT combination so as to know their possible changeability and proper changeable conditions, ——under certain ambient conditions, how the reciprocal PNT combination will motion by the light of nature, and ultimately, what kind of existent modality will be accordingly materialized. Once we know well Spacetime momentum delamination hoarding pattern and spontaneous spacetime momentum delamination hoarding acclimatization readjustment of reciprocal PNT combination, we will be magically convenient and sensitive to find favorable material source and applicable ways to actualize our production ideal.

We study and explore PNT engine is just to find feasible ways to actualize proper spontaneous spacetime momentum delamination hoarding acclimatization readjustment towards activation and increase of spacetime momentum in terminal configurable hiberarchy of ideal reciprocal PNT combination (PNT activation source) and ensure the feasible ways continuously controllable, ——just to make some spacetime momentum originally micromodelized in low-level configurable hiberarchy of PNT activation source (reciprocal PNT combination) activated and properly rectified for assimilative macromodelization in objective terminal configurable hiberarchy of reciprocal PNT combination (PNT activation source) in accordance with necessity of safe PNT operation to ensure the integrative spacetime momentum delamination hoarding pattern of PNT activation source smoothly successive and appropriate for safe PNT operation in relatively high rate, so that the PNT activation source can be accelerated as continuously controllable object. The comparable situations of spacetime momentum delamination hoarding in configurable hiberarchy of PNT activation source (/reciprocal PNT combination) before PNT activation and after PNT activation can be generally illustrated as below:

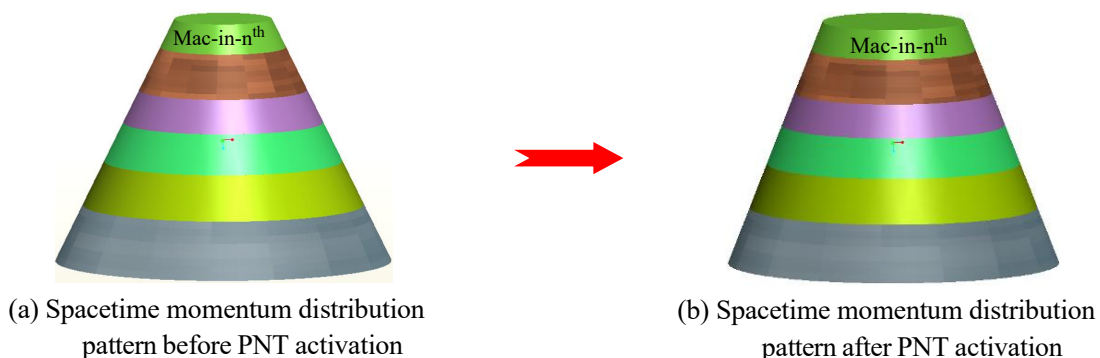

Historical progress of science in the recent several centuries seemed like a far-flung exploration of the first itinerary around numerous distinctive landscapes of brand-new landmasses of science with palette & tablet on back, several hundred years’ scientific travelogues were compiled thereby.

In the coming sections about PNT engine, the so-called normal PNT activation and state rectification is just job to actualize such ideal existent state change with such successive and smooth spacetime momentum delamination hoarding pattern of PNT activation source maintained. Of course, under precondition of appropriate material choice of PNT activation source, if the PNT activation can cause remarkable electric polarity of PNT activation source, then the implementation of volitional PNT activation accomplishes effect of electricity generation, this is just something about “PNT generator”. If implementation of volitional PNT activation sensitively cause light emission from some certain configurable hiberarchy/hiberarchies of reciprocal PNT combination (/PNT activation source), we amplify such stimulation domino effect of PNT activation source and converge the emitted lights in accordance with practical necessity, we then approach man-made “laser”.

The earth is of course a grand typical reciprocal PNT combination in spacetime, during the course the earth moves with the solar system and the Milky Way galaxy in large-scale spacetime, the spacetime condition around it usually changes slightly, we call the ambient spacetime change of earth following earth journey in large-scale spacetime “concomitant spacetime change of earth journey” (of course, concomitant spacetime change of earth journey does exclude the possibility that spacetime change in large-scale range with remote correlation of earth journey, and virtually, the so-called “concomitant spacetime change of earth journey” just means the variation of spacetime background dynamic parameter around the earth, which will be introduced further in section of Introduction of Atom State Equation in Spacetime). The remarkable indication of “concomitant spacetime change of earth journey” is that the value of π is a stochastic inconstant on the earth. Let's suppose, there is substantial “concomitant spacetime change of earth journey” in some certain interval, so that the value of π proportionally changes, for instance, it changes from 3.14159265 to 3.14159266, In accordance with the primary appraisal of Homogenous Cosmos Originated from Unique Genesis, the value of π must be correlated to time dynamic speed directly, and the time dynamic speed on earth may be just “ $\pi \times 10^8 \text{m/s}$ ”.

In accordance with the definition of absolute spacetime momentum of matter in cosmos, the absolute spacetime momentum of earth is $m_E V = d(M \leftarrow m) Y$, (in the equation, m_E denotes the mass of the earth, subscript “E” is just the abbreviation of “earth”.). Once we suppose $Y = \pi \times 10^8 \text{m/s}$, and as occurrence of concomitant spacetime change of earth journey in some certain interval, the value of π changed from 3.14159265 to 3.14159266, then, there must be absolute spacetime momentum change $m_E \times (3.14159266 - 3.14159265) \times 10^8 \text{ m/s} = m_E \times 1 \text{m/s}$ of the earth in the same interval, and proportionately, in accordance with the conventional energy change equation, there must be energy change $m_E/2 \times [(V_0+1)^2 - V_0^2]$ of the earth, (in the equation, V_0 denotes the absolute speed of the earth in cosmos when value of π is 3.14159265 on the earth.)

Apparently, if the absolute spacetime momentum change due to concomitant spacetime change of earth journey is 100% transferred for assimilative macromodelization in terminal configurable hiberarchy of the earth, the absolute speed of the earth moving in cosmos will increase 1m/s. But it's impossible for the terminal configurable hiberarchy of the earth to skip over all the other configurable hiberarchy to react geo-potential domino effect due to concomitant spacetime change of earth journey only. Virtually, the most sensitive configurable hiberarchy of spacetime momentum delamination hoarding against concomitant spacetime change of earth journey is the spacetime momentum micromodelization in zero configurable hiberarchy, then sequentially extend to first configurable hiberarchy, second configurable hiberarchy... till last extend to spacetime momentum macromodelization in terminal configurable hiberarchy along sequential promotive transference for assimilative macromodelization of spacetime momentum. Once concomitant spacetime change of earth journey causes value

As coherent natura naturans throughout cosmic evolution, instinctive PNT reciprocal equilibrium towards optimum PNT operation is radical potentiality & conditionality for cosmos always ready to orientate itself towards perfection.

of π change from 3.14159265 to 3.14159266, although the total absolute spacetime momentum change of the earth is $m_E \times 1\text{m/s}$, the spacetime momentum change extends to terminal configurable hierarchy of the integrative spacetime momentum delamination hoarding of the earth is relatively tiny, it maybe less than 10% of the total amount. That's to say, once there is absolute spacetime momentum change $m_E \times 1\text{m/s}$ of the earth, the absolute moving speed of the earth in cosmos maybe less than 0.1m/s ①, most of it is preferentially assimilated in zero configurable hierarchy, first configurable hierarchy, second configurable hierarchy etc and accumulated inside the earth. This is just something about the “geo-potential domino effect due to concomitant spacetime change of earth journey”.

“Geo-potential domino effect due to concomitant spacetime change of earth journey” — “crescive geo-potential assimilative macromodelization in terminal configurable hierarchy of the earth” — “geo-potential dissipation” is just the crescive geo-potential cumulation towards volcano or earthquake. That is to say, the earth is not an ideal “similar Black Hole” for geo-potential cumulation, once there is geo-potential domino effect due to concomitant spacetime change of earth journey especially geo-potential increase domino effect, there must be

Note ①: spacetime momentum promotive transference for assimilative macromodelization in terminal configurable hierarchy of reciprocal PNT combination derived from integrative spacetime momentum delamination hoarding acclimatization readjustment of matter integration is just the so-called “precessional motion (进动)”. As the integrative delamination hoarding acclimatization readjustment, the spacetime momentum promotive transference for assimilative macromodelization in terminal configurable hierarchy of earth is of course precessional motion of the earth.

“Precessional motion” is ubiquitous physical phenomena as long as the celestial bodies or galaxy experience concomitant spacetime change. As the local concomitant spacetime change of galaxy is relatively synchronous and equivalent, the relative precessional motion among the compositive celestial bodies in the same galaxy is generally not easy to be perceived. For instance, if the earth arises precessional motion of 0.1 meter per second, as all the other planets in solar system almost experienced the equivalent concomitant spacetime change for common journey in large scale spacetime, as long as the inborn physical mechanism of all the other planets in solar system are not remarkably different, the spacetime momentum delamination hoarding acclimation readjustment of all the other planets in solar system will be generally synchronous and equivalent, and of course, the spacetime momentum promotive transference assimilative macromodelization ratio in terminal configurable hierarchy of discretionary celestial bodies in solar system for spontaneous integrative spacetime momentum delamination hoarding acclimation readjustment is very similar too, as a result, it's not easy for us to perceive the relative precessional motion among all planets in solar system. What's more, once the earth experiences concomitant spacetime change, the clocks in our hands, no matter it's mechanical clock or atomic clock, have synchronously and equally materialized the general domino effect of concomitant spacetime change too, (Otherwise, once the earth experiences concomitant spacetime change, the light-speed around the earth proportionably changes, however, as the clock on the earth changes synchronously and equally, we always find the light-speed is constant). Comparably, we are usually easy to perceive precessional motion of galaxies far away from us for advantage the onlookers see most clearly, for example, we had ever perceived precessional motion of DI Haggles double stars (DI 海格立斯双星进动).

Of course, in solar system, earthquake is not patent of earth only, there must be earthquake phenomena on Saturn, Jupiter Mars etc, and as the Saturn, Jupiter, Mars have similar spacetime change during the course of their journey as concomitant spacetime change of earth journey in large-scale spacetime, the earthquake phenomena on earth, Saturn, Jupiter, Mars even sunspot, bright spot of sun are just serial occurrences derived from “concomitant spacetime change of solar system journey”, as their individual disparity in mass-scale, volume, spacetime momentum delamination hoarding pattern and energy dissipation mechanism etc, earthquake usually occurs distinctively in accordance with their idiographic physical attributes. In terms of the moon, compared with the earth, the mass of the moon is relatively small, so the inner energy change of the moon due to conditional occurrence of concomitant spacetime change of solar system is relatively poor, and what's more, the lamella of the moon is apparently looser than lithosphere of the earth, the inner energy dissipation mechanism of the moon is relatively better than that of the earth, as a result, there are fewer possibilities for the moon to arises earthquake than the earth usually does.

Historical progress of science in the recent several centuries seemed like a far-flung exploration of the first itinerary around numerous distinctive landscapes of brand-new landmasses of science with palette & tablet on back, several hundred years' scientific travelogues were compiled thereby.

proportionate crescive geo-potential assimilative macromodelization in terminal configurable hiberarchy of the earth and stochastic geo-potential dissipation at the same time, only when the increase geo-potential domino effect due to concomitant spacetime change of earth journey is dominant compared with both of crescive geo-potential assimilative macromodelization in terminal configurable hiberarchy and stochastic geo-potential dissipation, the lively crescive geo-potential cumulation towards volcano or earthquake is substantially ongoing. If we denote lively crescive geo-potential cumulation towards volcano or earthquake $W(t)$, denote geo-potential domino effect due to concomitant spacetime change of earth journey $Q(t)$, denote crescive geo-potential assimilative macromodelization in terminal configurable hiberarchy of the earth $S(t)$, and denote the proper geo-potential dissipation of the earth $H(t)$, then, lively crescive geo-potential cumulation towards volcano or earthquake is ongoing means $W(t)=Q(t)-S(t)-H(t) > 0$.

The more remarkable the concomitant spacetime change of earth journey is, the geo-potential domino effect due to concomitant spacetime change of earth journey is proportionably more remarkable, and the resultant crescive geo-potential cumulation towards volcano or earthquake is more efficient. The shorter the interval for certain concomitant spacetime change of earth journey is, the faster ambient spacetime conditions changes, the resultant geo-potential variation domino effect ratio due to concomitant spacetime change of earth journey is, the faster and more efficiently geo-potential cumulation towards volcano or earthquake is. Once the crescive geo-potential cumulation towards volcano or earthquake approaches certain amount, so that the lithosphere counter-shield above can not burthen against the mechanical impact of counterwork geo-potential cumulation any longer, the crescive geo-potential cumulation will then break or fatally damage the lithosphere counter-shield above, volcano or earthquake consequently bursts out.

All in all, the radical cause there is volcano and earthquake phenomena on earth is not because the earth is distinctive planet itself, but radically because the earth exists and motions as common matter in spacetime, and volcano & earthquake on the earth occur timely and locally like this is out-and-out inevitable outcome of idiographic concomitant spacetime change of earth journey coming true on characteristic physical configuration of earth and hypostatizes the proportionate inherent biologic reaction of earth as matter itself. Accordingly, in order to clarify the thorough cause and effect of volcano and earthquake, we must study the idiographic existence and motion of earth in spacetime as matter itself, —illuminate the spontaneous PNT action and PNT reaction the proper ambient spacetime conditions varying for concomitant spacetime change of earth journey coming true on inherent physical configuration of the earth, so that we can know the proper crescive geo-potential cumulation towards volcano and earthquake even go a further step to look into the counterwork situation between the below stratum and the above lithosphere for crescive geo-potential cumulation towards volcano and earthquake in below stratum continuously eroding the lithosphere above, but not to wallow in studying this local lithosphere or that local lithosphere through and through.

At any rate, lithosphere is but something introduced into volcano and earthquake study as counter-shield object above against geo-potential cumulation in below stratum. In a straightforward word, volcano or earthquake is but phenomena that crescive geo-potential cumulation towards volcano or earthquake for idiographic concomitant spacetime change of earth journey coming true on inherent physical configuration of the earth ultimately break the proper lithosphere counter-shield above, so that the proper geo-potential accumulation intensively damages the outer crust of the earth taking the opportunity of collapse of lithosphere counter-shield. (For comprehension

As coherent natura naturans throughout cosmic evolution, instinctive PNT reciprocal equilibrium towards optimum PNT operation is radical potentiality & conditionality for cosmos always ready to orientate itself towards perfection.

accessibility, we can of course suppose we transfer the earth into similar orbit of Mars, Jupiter, Hesper etc. we can also deduce the possible even inevitable biologic reaction of earth existing as matter in spacetime in accordance with inherent essentiality of matter and idiographic attribute of earth.)

Accordingly, under the precondition we know well the general fundamental of existence & motion of earth as common matter in spacetime; we should look into and know volcano and earthquake along inherent causality as following:

The first, Study and verification of inherent causality of existence & motion of earth as matter in cosmos, —we must look into and know well concomitant spacetime change of earth journey in large-scale spacetime, because the “concomitant spacetime change of earth journey” in large-scale spacetime is the external cause of geo-potential domino effect, only when we’ve known well the proper concomitant spacetime change of earth journey, we possess of the substantial evidence to predict the consequent geo-potential domino effect due to idiographic concomitant spacetime change of earth journey in proper interval. In a simple mathematical language, if we denote concomitant spacetime change of earth journey as $G(t)$, and denote geo-potential domino effect due to concomitant spacetime change of earth journey as $Q(t)$, then, $G(t)$ and $Q(t)$ satisfy mathematical correlation of $Q(t)=W(G(t))$, $G(t)$ is just the functor of geo-potential domino effect function of $W(x)$, ($x=G(t)$).

The second, Study and verification of inner cause of existence & motion of earth matter in spacetime, —under precondition we master the actual concomitant spacetime change of earth journey, it’s still necessary for us to understand the proportionate geo-potential domino effect due to concomitant spacetime change of earth journey. So-called “geo-potential domino effect due to concomitant spacetime change of earth journey” is just spontaneous geo-potential reaction due to concomitant spacetime change of earth journey or how the earth spontaneously readjust itself according to the proper ambient variation of concomitant spacetime change of earth journey. The ingenerate cause of geo-potential domino effect due to concomitant spacetime change of earth journey is inherent physical configuration/attribute of the earth, which generally includes geo-configuration of spacetime momentum delamination hoarding and macroscopical geo-mechanic structure.

So-called “geo-configuration/attribute of spacetime momentum delamination hoarding” is just integrative spacetime momentum delamination hoarding pattern of earth along inherent configurable hiberarchy sequence from spacetime momentum micromodelization in zero configurable hiberarchy to spacetime momentum macromodelization in terminal configurable hiberarchy and how such integrative spacetime momentum delamination hoarding pattern of earth spontaneously react or readjust in accordance with occurrence of concomitant spacetime change of earth journey, which virtually includes geo-potential configuration variation, shift of covariant sensitive latitude of spacetime momentum delamination hoarding, consequent spacetime momentum macromodelization transition and dissipation due to proper occurrence of concomitant spacetime change of earth journey. These are all spontaneous acclimatization reaction of the earth once idiographic concomitant spacetime change of earth journey comes true on the inherent physical configuration and conformation of earth in law of causation.

So-called “macroscopical geo-mechanic structure” is just the interaction between any two neighboring stratum under general macroscopical delamination framework of the earth including the distinctive

mechanic strength distribution of each stratum and the consequent mechanical strength variation of stratum during the course of physical interaction.

For convenience to make our intention to study the concomitant spacetime change of earth journey and inherent physical configuration/attribute of the earth expediently understood, it may be good for us to introduce a trope to suppose the concomitant spacetime change of earth journey is just characteristic “airflow”, then the so-called “inherent physical configuration/attribute” of the earth is just characteristic feature indicating whether the earth itself is “flute” or “harmonica”, the earth experiences concomitant spacetime change on journey means distinctive airflow works on flute or harmonica, and the so-called resultant geo-potential domino effect due to concomitant spacetime change of earth journey means the self-evident audio output due to distinctive airflow blowing through flute or harmonica.

Of course, if the specific “inherent physical configuration/attribute of the earth” indicates the earth is just “flute”, then, characteristic airflow blowing through the flute must result in characteristic fluting; if the specific “inherent physical configuration/attribute of the earth” indicates the earth is just “harmonica”, then, characteristic airflow blowing through the harmonica must result in distinctive tweedle; and different airflow must proportionately result in different fluting or tweedle. The purpose we study “inherent physical configuration/attribute of the earth” is to understand whether the earth is substantiality of flute kind or harmonica kind, once idiographic airflow working on, what kind of characteristic audio the proper “flute” or “harmonica” must occur accordingly. In another straightforward word, we study “inherent physical configuration/attribute of the earth” is but for purpose to understand the distinctive attribute of the earth similar as to understand idiographic attribute difference of flute and harmonica, so that we can foresee the exact physical domino effect of concomitant spacetime change of earth journey coming true on earth according to “inherent physical configuration/attribute of the earth”.

The third, with count of the proper geo-potential domino effect due to concomitant spacetime change of earth journey in mind, we look into “macroscopical geo-mechanic structure” to evaluate the lively counterwork situation between the stratum below and the lithosphere counter-shield above. Virtually, in the face of volcano and earthquake; we especially pay our attention to idiographic mechanic strength configuration and distribution of lithosphere, eroding & anti-eroding interaction between lithosphere and stratum below lithosphere and the proper mechanical strength variation of the lithosphere under the very eroding conditions. So we just look into anti-burthen mechanism and the proper anti-burthen capability of the lithosphere counter-shield against eroding of crescive geo-potential cumulation towards volcano or earthquake. With throughout count of crescive geo-potential cumulation due to concomitant spacetime change of earth journey and the “resultant anti-burthen capability extremity $L(t)$ ②” of lithosphere counter-shield against crescive geo-potential cumulation towards volcano or earthquake in mind, put the lively eroding variable $F(t)$ the crescive geo-potential cumulation towards volcano or earthquake works on the proper lithosphere counter-shield above and the resultant anti-burthen capability extremity $L(t)$ of the very lithosphere counter-shield above onto counterwork balance  —“**volcano or earthquake eroding—lithosphere counter-shield anti-burden balance**”, we then can foresee in focus whether it is possible for some certain crescive geo-potential cumulation towards volcano or earthquake to ultimately break or fatally kill the proper lithosphere counter-shield above③. If possible, where should be feasible breach④ or dangerous region under ruinous impact of crescive geo-potential

As coherent natura naturans throughout cosmic evolution, instinctive PNT reciprocal equilibrium towards optimum PNT operation is radical potentiality & conditionality for cosmos always ready to orientate itself towards perfection.

cumulation towards volcano or earthquake, and we can even deduce the disaster will occur on some certain day even some certain moment ⑤ in accordance with the counterwork balance between active quantitative change of crescive geo-potential cumulation towards volcano or earthquake in stratum below and the resultant anti-burthen capability extremity of the proper lithosphere counter-shield above against lively eroding of crescive geo-potential cumulation towards volcano or earthquake.

Note ②: The anti-burthen capability extremity of lithosphere counter-shield against crescive geo-potential cumulation towards volcano or earthquake is usually not constant, it generally varies as lasting out of eroding impact of crescive geo-potential cumulation towards volcano or earthquake even tiny ambient impact caused by gravitation of moon or sun is unneglectable. In another word, the anti-burthen capability extremity of lithosphere counter-shield against crescive geo-potential cumulation towards volcano or earthquake is usually inconstant rooted in variables of crescive geo-potential cumulation towards volcano or earthquake and ambient gravitation change from the sun, the moon etc. After all, as the continuous eroding impact of various ambient factors, the anti-burden capability of lithosphere counter-shield against crescive geo-potential cumulation towards volcano or earthquake is always varying, so we just call it “resultant anti-burthen capability extremity”.

Furthermore, the “anti-burthen capability extremity” of lithosphere counter-shield against crescive geo-potential cumulation towards volcano or earthquake is usually subject to fundamental the maximal ruggedization of an iron chain depends on the weakest tache of it, this of course means the anti-burden extremity of lithosphere counter-shield against crescive geo-potential cumulation towards volcano or earthquake is just the anti-burthen capability extremity of the weakest point of lithosphere counter-shield under eroding of crescive geo-potential cumulation towards volcano or earthquake. And the places, whereabouts had ever suffered disasters of volcano or earthquake, are usually expedient whither for outwards migration of geo-potential cumulation towards volcano or earthquake to approach on one hand, and on the other hand, the lithosphere counter-shields of the very areas are relatively fragmentary for they had ever been demolished with wound not cicatrized yet, as a result, there are usually more possibilities for volcano or earthquake to favor old haunts.

Note ③: The physical condition leading to occurrence of volcano or earthquake is $F(t) > L(t)$; if $0 < F(t) < L(t)$, it only means there are substantial crescive geo-potential cumulation towards volcano or earthquake, but the crescive geo-potential cumulation is still inadequate for ultimate occurrence of volcano or earthquake.

Note ④: The maximal ruggedization of an iron chain depends on the weakest tache of it. Usually, the most feasible breach of volcano or earthquake is just the weakest point of the lithosphere counter-shield under eroding of crescive geo-potential cumulation towards volcano or earthquake. However, we should not assume it as a matter of course that the areas on earth whose lithosphere counter-shield against crescive geo-potential cumulation towards volcano or earthquake are relatively weaker the more disasters of volcano or earthquake they will consequently suffer. Virtually, the most mobile and pivotal element of volcano or earthquake is crescive geo-potential cumulation towards volcano or earthquake. Even in some certain area whose lithosphere counter-shield against crescive geo-potential cumulation towards volcano or earthquake is relatively stronger, whereas, under the very lithosphere counter-shield, if crescive geo-potential cumulation towards volcano or earthquake is relatively remarkable, there are still substantial possibilities for the relatively stronger lithosphere counter-shield to be broken so as to lead to occurrence of volcano or earthquake. Whereas, if crescive

geo-potential cumulation towards volcano or earthquake under the weaker lithosphere counter-shield is relatively slow or even the geo-potential dissipation mechanism of the very area is relatively better, then, lying on the relatively weaker lithosphere counter-shield sleeping is even safer than lying on the relatively stronger lithosphere counter-shield sleeping. So we say, weaker lithosphere counter-shield is not deadly weakness surely, magic crescive geo-potential cumulation towards volcano or earthquake thereby is evidence really serious.

Note ⑤: in accordance with predictable conditions, there is possibility for $F(t)$ to be larger than $L(t)$, and we work out the key 't' of the equation $F(t)=L(t)$, the key 't' is just answer indicating the occurrence moment of volcano or earthquake. Usually, we are convenient to account the moment of initial crescive geo-potential cumulation towards volcano or earthquake as the start time, at the very moment, $F(t)\approx 0$, and $t\approx 0$. if we confirm the moment " $t\approx 0$ " is just 25 past 10 o'clock, Feb. 2, 2010, and the key we worked out is $t=2.25\times 10^5$ minutes, then, we can of course deduce, as $2.25\times 10^5\text{minutes}=(24\text{ hours/day}\times 60\text{ minutes/hour})\times 156\text{ days}+36\text{ minutes}$, the occurrence moment of the very volcano or earthquake is just the moment 156days and 36 minutes after 25 past 10 o'clock, Feb. 2, 2010, which is just 9 minutes to 11 o'clock, July 8 2010.

Of course, we can equally suppose the start time $t=0$ at discretionary moment when $F(t)=U < L(t)$, as long as we know the geo-potential cumulation status of the very moment well, know the coming progress of geo-potential cumulation towards volcano or earthquake and know the "resultant anti-burthen capability extremity $L(t)$ " of the proper lithosphere counter-shield under eroding of crescive geo-potential cumulation towards volcano or earthquake, the key 't' of balance equation $F(t)=L(t)$ of course can be worked out accordingly, and the connotation of the key 't' is just the same. It but means when we come to study the crescive geo-potential cumulation towards volcano or earthquake, how about current crescive geo-potential cumulation situation, what's the potential geo-potential cumulation progress and the consequent counterwork situation of "volcano or earthquake eroding—lithosphere counter-shield anti-burden balance", no matter we study it or not or whenever we come to study it, it won't impact material crescive geo-potential cumulation towards volcano or earthquake and counterwork situation of "volcano or earthquake eroding—lithosphere counter-shield anti-burden balance".

June, 2011. Guangdong, Dongguang, Humen, Baisha

(V-iv) Initial endeavor of systematical unique-genesis quantization formulation of well-regulated cosmic homogeneity system making up of out-and-out serial natura naturata in the nature of coherent natura naturans throughout cosmic evolution

[Preface]: Since newly highlighted factuality that **discretionary particles in cosmos are mutually convertible** is always in freewheeling orientation towards complete induction day by day, I never lack of confidence about authenticity of nature that cosmos is throughout homogenous originated from unique genesis, cosmic status quo is demiurgic aggradation of sequential homologic cosmogony, which exactly exists as well-regulated integration of cosmic homogeneity system making up of out-and-out serial natura naturata in the nature of coherent natura naturans throughout cosmic evolution. Homogenous Cosmos Originated from Unique Genesis not only indicates homogenous configuration of cosmos through and through but also implies sequential homologic cosmogony in the nature of coherent natura naturans (/coherent dynamic regularity) throughout cosmic evolution. Once we are able to formulate cosmic homogeneity system making up of out-and-out serial natura naturata in the nature of coherent natura naturans throughout cosmic evolution following a rational line, perfect ideological system about universal existence & motion must be ultimately consummated therefore. Systematical unique-genesis quantization formulation of universal existence & motion along sequential homologic cosmogony starting at field genic origin i_0 to universal reciprocal PNT combinations in the nature of coherent natura naturans throughout cosmic evolution is just the very job, successful implementation of the job must bring out **Atom State Equations in Spacetime** at the volley, which is the key step of systematical unique-genesis quantization formulation of universal existence & motion along sequential homologic cosmogony due to particularity of mechanical ascendancy of atoms in crescive progression of **aberrant convergence of cosmic esse due to PNT reciprocal gelation** in the nature of coherent natura naturans throughout cosmic evolution.

I had thought to do the very job many years ago, whereas, all these research implementation needs substantial groundwork backup of modern particle physics and related experimental data, as poor floater, all these are out of my accessibility, I hate to keep acting blindly on the thesis alone, even for subsistence, I can hardly spare me out to do my possibility in the sun. It must be more formidable challenge than free press admittance of Homogenous Cosmos Originated from Unique Genesis must break through legitimacy defense line of contemporaneous scientific orthodoxy, so that it has to challenge venomous counterwork upper limit of temporal authority, there are still many issues blurry ahead, I was not confident to do it. If so, I must slide into double perplexity of **interminable free press embarment and helpless personal limitation**.

It seems I should not be so foolish to challenge venomous counterwork upper limit of temporal authority all my life time, for you see, it is not routine warfare between coordinative powers but virulent scientific knowledge metabolism campaign between lonely innovator and overwhelming temporal authority in accordance with law of the jungle, it's only possible for innovators to affront death. Virtually, there were too many innovators who died for cordial pioneering endeavor to push humanistic ideology about authenticity of nature forward to perfect ideological enantiomorph of ultimate authenticity of nature in defiance of deadly impact of vested interest of temporal authority.

Whereas, who had contributed their worthy death? What's the worthy death of pioneering innovators?

They were but solid evidence, as multiple notion with double significance of “**social connotation**” & “**natural connotation**”, social legitimacy & validity of truths can never exceed cannon range.

What's more, as low-down man of the society struggling for subsistence in mainland of China, I am really

Historical progress of science in the recent several centuries seemed like a far-flung exploration of the first itinerary around numerous distinctive landscapes of brand-new landmasses of science with palette & tablet on back, several hundred years' scientific travelogues were compiled thereby.

helpless and lonely, it's tragic challenge for me to do such kind of job after hours, I should be quite aware of my distance struggling in both callous social ambience and vicious circle of virulent scientific knowledge metabolism. Virtually, as personal limitation without constructive cooperation, the more I try to consummate systematical unique-genesis quantization formulation of universal existence & motion along sequential homologic cosmogony starting at field genic origin i_0 to universal reciprocal PNT combinations in the nature of coherent natura naturans throughout cosmic evolution, the more I must proportionably expose my personal limitation.

As timely renovation of humanistic ideology about authenticity of nature in proportion to contemporaneous historical background and cosmos redefinition in radical logic enantiomorph of newly highlighted factuality that **discretionary particles in cosmos are mutually convertible** under egotistic background of interminable royal substantiation & perfection of contemporaneous scientific orthodoxy, it's almost impossible for free press admittance of Homogenous Cosmos Originated from Unique Genesis to evade virulent scientific knowledge metabolism campaign, in terms of counterwork opposite of virulent scientific knowledge metabolism campaign indulging in royal substantiation & perfection of contemporaneous scientific orthodoxy, how much I can practically highlight about systematical unique-genesis quantization formulation of universal existence & motion along sequential homologic cosmogony starting at field genic origin i_0 to universal reciprocal PNT combinations in the nature of coherent natura naturans throughout cosmic evolution as typical aberrant scientific knowledge proliferation out of rigid succession of contemporaneous scientific orthodoxy is not something worthy of their attention, instead, how many shortages exposed for my personal limitation are really something pestilent.

Historical progress of science in inherent optimum orientation towards perfect ideological enantiomorph of ultimate authenticity of nature is always formidable full of humanistic perplexity. Virtually, throughout human history, progress of human civilization can hardly evade deadly conflicts of interest irreconcilable between conservative power and pioneering power, human have to invoke life-and-death warfare to smooth them away; whereas, as hardcore component of human civilization, once historical progress of science slides into virulent scientific knowledge metabolism campaign for occurrence of timely renovation of humanistic ideology about authenticity of nature in proportion to contemporaneous historical background, it's almost impossible for the innovator to spring up coordinative counterwork for a life-and-death warfare against temporal authority, the innovator is mostly lonely and helpless, while the temporal authority are always superior and overwhelming. At such kind of occasion, history can create nothing besides buskin, after all, cruel humanistic factuality we have to face is that, **as multiple notion with double significance of "social connotation" & "natural connotation", social legitimacy & validity of truths can never exceed cannon range.**

As victim of virulent scientific knowledge metabolism campaign, I had ever tried many times to publish current version of Homogenous Cosmos Originated from Unique Genesis first, if conditions became relatively better after publication of the monograph, I could come back to the pursuit of systematical unique-genesis quantization formulation of universal existence & motion along sequential homologic cosmogony starting at field genic origin i_0 to universal reciprocal PNT combinations in the nature of coherent natura naturans throughout cosmic evolution, whereas, my experience in the recent 31 years indicated it's almost impossible for free press admittance can hardly evade overwhelming authoritative intrepidity of contemporaneous scientific orthodoxy in virulent scientific knowledge metabolism campaign.

And now, I have been old man over 50 years, after struggling in free press embarment for more than 31 years, I

As coherent natura naturans throughout cosmic evolution, instinctive PNT reciprocal equilibrium towards optimum PNT operation is radical potentiality & conditionality for cosmos always ready to orientate itself towards perfection.

have almost exhausted my ardor, free press admittance is not my extravagant ambition any longer, I even exhausted my ardor to strive for possible social legitimacy subsistence of Homogenous Cosmos Originated from Unique Genesis in open access. I have to comment herein, I now push a narrow way to review and do up my scattered thought about systematical unique-genesis quantization formulation of universal existence & motion along sequential homologic cosmogony starting at field genic origin i_0 to universal reciprocal PNT combinations in the nature of coherent natura naturans throughout cosmic evolution at the volley is not endeavor to boost up my personal power in virulent scientific knowledge metabolism campaign but freewheeling helpless endeavor for possible authenticity highlight floundering in interminable free press embarment. I come to the world as a lowdown man struggling in social ambience as mainland of China, 51 years has gone, I did nothing worthy, and it seems, nothing else better I can do in my rest life time struggling in social ambience as mainland of China even under egotistic background of interminable royal substantiation & perfection of contemporaneous scientific orthodoxy, just do it as possible as I can in defiance of terrestrial dispute of fame & gain.

Baisha community, Humen town, Dongguan city, Guangdong province. March, 12. 2023

(V-iv-1) Unique-genesis quantization formulation of “dynamic hylic spacetime”

Preface: *In accordance with newly highlighted factuality that discretionary particles in cosmos are mutually convertible, we introduce “Homogenous cosmos originated from unique genesis” accordingly, primary confirmation that cosmos is throughout homogenous originated from unique genesis, cosmic status quo is demiurgic aggradation of sequential homologic cosmogony, which exactly exists as well-regulated integration of cosmic homogeneity system making up of out-and-out serial natura naturata in the nature of coherent natura naturans throughout cosmic evolution of course indicates that comprehensive cosmic contents can be systematically quantified in accordance with unique-genesis quantum of genic origin i_0 as out-and-out serial natura naturata in the nature of coherent natura naturans throughout cosmic evolution along crescive progression of sequential homologic cosmogony.*

The so-called “basic quantum” of systematical unique-genesis quantization formulation of universal existence & motion along sequential homologic cosmogony starting at field genic origin i_0 to universal reciprocal PNT combinations in the nature of coherent natura naturans throughout cosmic evolution is of course quantification of “space field genic origin i_0 ”. Since any physical existence in cosmos is either the cosmic genic origin i_0 itself or compound homology radically originated from cosmic genic origin i_0 , once we treat the hylic existence of genic origin i_0 as “basic quantum” of cosmos, we can formulate genic accumulation of any object in cosmos with homology genic integral equation as $\sum_{m=1}^X \int_{i_0}^X f(m_{i_0 \rightarrow X}) i_0$, which denotes genic integration of object along sequential homologic cosmogony starting at cosmic origin “ i_0 ” to idiographic demiurgic multiplication terminal “ X ”. (In the equation, “ m ” is just the abbreviation of “material” or “mass”).

And on the other hand, as dynamic essence of time dynamic speed of time and inherent PNT correlation between spacetime and matter which materializes activity heritance from dynamic spacetime to matter, any positive matter in spacetime must have absolute spacetime momentum of “ $mv = d(M \leftarrow m)Y$ ”, absolute spacetime momentum of matter is usually cumulative quantity made up of compositive spacetime momentum existing in all configurable hierarchy of reciprocal PNT combinations, which come into being throughout original homologic multiplication of matter generation and formation, so we formulate the PNT dynamic aggradation of matter inherently coexisting in all configurable hierarchy of reciprocal PNT combinations which originally come into being along cosmic demiurgic homologic multiplication starting at cosmic origin “ i_0 ” to idiographic demiurgic homologic multiplication terminal “ X ” as $\sum_{D=1}^X D_{PNT} [\int_{i_0}^X f(m_{i_0 \rightarrow X})]$ (In the definition equation, D is just the abbreviation of “Dynamic”, which denotes the PNT dynamic connotation of genic accumulation $\sum_{m=1}^X \int_{i_0}^X f(m_{i_0 \rightarrow X}) i_0$).

As systematical job, systematical unique-genesis quantization formulation of universal existence & motion along sequential homologic cosmogony starting at field genic origin i_0 to universal reciprocal PNT combinations in the nature of coherent natura naturans throughout cosmic evolution covers unique-genesis quantization formulation of hylic spacetime, unique-genesis quantization formulation of reciprocal PNT combinations in gradation I, unique-genesis quantization formulation of reciprocal PNT combinations in gradation II, unique-genesis quantization formulation of reciprocal PNT combinations in gradation III, unique-genesis quantization formulation of reciprocal PNT combinations in gradation IV step by step.

Unique-genesis quantization formulation of hylic spacetime is not only the jumping-off point but also the basis of systematical unique-genesis quantization formulation of universal existence & motion along sequential homologic cosmogony starting at field genic origin i_0 to universal reciprocal PNT combinations in the nature of

As coherent natura naturans throughout cosmic evolution, instinctive PNT reciprocal equilibrium towards optimum PNT operation is radical potentiality & conditionality for cosmos always ready to orientate itself towards perfection.

coherent natura naturans throughout cosmic evolution. Whereas, as inherent limit of human practical feasibility & possibility, the most challenging issues of pioneering unique-genesis quantization formulation of hylic spacetime is that, practical reliability of unique-genesis quantization formulation of hylic spacetime can neither depend on experimental guidance nor able to be demonstrated by experimental authentication, it's only possible for it to come into being as lineal logic extension from homologic existence & motion of elementary genic units in spacetime, and to be authenticated by universal compatibility of universal existence & motion. In straightforward words, as typical objects belonging to reciprocal PNT combinations in gradation III in cosmos, validity of human experimental practice/implementation is apparently limited by both "quantitative time" and "quantitative space", human experimental practice/implementation can neither challenge extreme shortness of "time interval" nor challenge extreme smallness of space. Once time interval and space is extremely limited, human experimental practice must slide into invalidity out of question.

All noumenon exist in cosmos objectively, whereas, many of them can hardly be perceived as tangible objects in human sense.

In any case, as inherent practical feasibility & possibility of human as typical objects of reciprocal PNT combinations in gradation III in cosmos, there is almost no way for human to perceive distinctive dynamic connotation of spontaneous transmutation & transition of field genic units in space field but vivid time continuity and space extension around us. It's only possible for us to deduce appropriate homologic genic configuration and integrative coexistence domino effect of field genic units in spacetime in accordance with distinctive existence & motion of elementary genic units and reciprocal PNT combinations in gradation I in spacetime, so that it's theoretically possible for us to consummate homologic connection between spacetime and matter along sequential homologic cosmogony and ultimately perfect systematical unique-genesis quantization formulation of universal existence & motion along sequential homologic cosmogony starting at field genic origin i_0 to universal reciprocal PNT combinations in the nature of coherent natura naturans throughout cosmic evolution.

In detail words, as cosmos redefinition in radical logic enantiomorph of newly highlighted factuality that **discretionary two particles in cosmos are mutually convertible**, Homogenous Cosmos Originated from Unique Genesis is but linear logic system as below :

- 1) As newly highlighted factuality that **discretionary particles in cosmos are mutually convertible** is always in freewheeling orientation towards complete induction, we are more and more confident to believe that cosmos must be throughout homogenous originated from unique genesis.
- 2) And once we are confident to confirm that cosmos is made up of "spacetime" and "matter", none else, we consequently come to our conclusion that, along sequential homologic cosmogony, "spacetime" and "matter" must be alternative homologic filiation either "matter father, spacetime son" or "spacetime father, matter son".
- 3) However, once we exclude homologic alternative filiation of "matter father, spacetime son", we consequently approach unique possible homologic alternative of "spacetime father, matter son".
- 4) Homologic filiation confirmation of "spacetime father, matter son" of course indicates "PNT action" between spacetime and matter, which even indicate **PNT action** of matter integration must determine universal existence & motion, in straightforward words, hypostatic existence & motion of matter integration is but enantiomorphous noumenon of PNT action of matter integration in spacetime.
- 5) As enantiomorphous origin of hypostatic existence & motion of matter integration in spacetime, "PNT action"

Historical progress of science in the recent several centuries seemed like a far-flung exploration of the first itinerary around numerous distinctive landscapes of brand-new landmasses of science with palette & tablet on back, several hundred years' scientific travelogues were compiled thereby.

can be neither impulsive action of the God nor roguish action of the demiurge, instead, it must be regular and definite action, and coherent natura naturans throughout cosmic evolution must radically relate with it.

Since "PNT action" is enantiomorphous dynamic origin of hypostatic existence & motion of matter integration in spacetime, which radically determines vivid existence & motion of matter integration, in accordance with accessible rich and colorful existence & motion around us, we have substantial reasons to introduce "Instinctive PNT equilibrium postulate" to specify inherent regularity of PNT action. And just because PNT action is not coherent natura naturans for original generation of matter in spacetime but also enantiomorphous dynamic origin of hypostatic existence & motion of matter integration in spacetime, introduction of "Instinctive PNT equilibrium postulate" not only directly specifies PNT action but also specifies universal existence & motion as spontaneous occurrence of **[External Physical Disturbance + (PNT action + Instinctive PNT equilibrium)]** therefore. As freewheeling of linear logic extension on the basis of **[(Homogenous cosmos originated from unique genesis + spacetime~matter fully embodying cosmos) + Instinctive PNT equilibrium postulate]**, Homogenous Cosmos Originated from Unique Genesis consequently implemented mathematical formulation of spontaneous occurrence of **[External Physical Disturbance + (PNT action + Instinctive PNT Equilibrium)]** with Matter Inertial Conservation Equations in Spacetime & PNT Dynamics.

Ostensibly, universal existence & motion are so rich and colorful, virtually, universal existence & motion are but spontaneous occurrence of **[External Physical Disturbance + (PNT action + Instinctive PNT Equilibrium)]**, spontaneous outgrowth that matter integration A and matter integration B stochastically accomplish stochastic **[(reciprocal idiosyncrasy towards PNT equilibrium + accessible space overall arrangement for PNT reciprocity) among elementary genic units in spacetime + Instinctive PNT reciprocal equilibrium towards optimum PNT operation]**.

As freewheeling of aberrant convergence of cosmic esse due to PNT reciprocal gelation/sequential homologic cosmogony in the nature of coherent natura naturans throughout cosmic evolution, going with gradual enrichment of elementary genic units in spacetime, original naissance, postnatal existence & motion of reciprocal PNT combinations in gradation I are successive easy outgrowth behind stochastic occurrence of **[(reciprocal idiosyncrasy towards PNT equilibrium + accessible space overall arrangement for PNT reciprocity) among elementary genic units in spacetime + Instinctive PNT reciprocal equilibrium towards optimum PNT operation]**. Not only elementary genic units in spacetime are direct materials of reciprocal PNT combinations in gradation I, but also external mechanical features of compositive elementary genic units are radical causes of original generation, postnatal existence & motion of reciprocal PNT combinations in gradation I.

As freewheeling of aberrant convergence of cosmic esse due to PNT reciprocal gelation/sequential homologic cosmogony in the nature of coherent natura naturans throughout cosmic evolution, going with gradual enrichment of reciprocal PNT combinations in gradation I in spacetime, original naissance, postnatal existence & motion of reciprocal PNT combinations in gradation II are successive easy outgrowth behind stochastic occurrence of **[(reciprocal idiosyncrasy towards PNT equilibrium + accessible space overall arrangement for PNT reciprocity) among reciprocal PNT combinations in gradation I in spacetime + Instinctive PNT reciprocal equilibrium towards optimum PNT operation]**. Not only reciprocal PNT combinations in gradation I in spacetime are direct materials of reciprocal PNT combinations in gradation II, but also external mechanical features of compositive reciprocal PNT combinations in gradation I are radical causes of original generation, postnatal existence & motion of reciprocal PNT combinations in gradation II.

As freewheeling of aberrant convergence of cosmic esse due to PNT reciprocal gelation/sequential homologic cosmogony in the nature of coherent natura naturans throughout cosmic evolution, going with gradual enrichment of reciprocal PNT

combinations in gradation II in spacetime, original naissance, postnatal existence & motion of reciprocal PNT combinations in gradation III are successive easy outgrowth behind stochastic occurrence of [(reciprocal idiosyncrasy towards PNT equilibrium + accessible space overall arrangement for PNT reciprocity) among reciprocal PNT combinations in gradation II even sub reciprocal PNT combinations in gradation III in spacetime + Instinctive PNT reciprocal equilibrium towards optimum PNT operation]. Not only reciprocal PNT combinations in gradation II in spacetime are direct materials of reciprocal PNT combinations in gradation III, but also external mechanical features of compositive reciprocal PNT combinations in gradation II even sub reciprocal PNT combinations in gradation III are radical causes of original generation, postnatal existence & motion of reciprocal PNT combinations in gradation III.

As freewheeling of aberrant convergence of cosmic esse due to PNT reciprocal gelation/sequential homologic cosmogony in the nature of coherent natura naturans throughout cosmic evolution, going with gradual enrichment of reciprocal PNT combinations in gradation III even sub-reciprocal PNT combinations in gradations IV in spacetime, original naissance, postnatal existence & motion of reciprocal PNT combinations in gradation IV are successive easy outgrowth behind stochastic occurrence of [(reciprocal idiosyncrasy towards PNT equilibrium + accessible space overall arrangement for PNT reciprocity) among reciprocal PNT combinations in gradation III even sub-reciprocal PNT combinations in gradations IV in spacetime + Instinctive PNT reciprocal equilibrium towards optimum PNT operation]. Not only reciprocal PNT combinations in gradation III even sub reciprocal PNT combinations in gradation IV in spacetime are direct materials of reciprocal PNT combinations in gradation IV, but also external mechanical features of compositive reciprocal PNT combinations in gradation III even sub reciprocal PNT combinations in gradation IV are radical causes of original generation, postnatal existence & motion of reciprocal PNT combinations in gradation IV.

Integrative sequential homologic cosmogony in the nature of coherent natura naturans through and through is but everlasting freewheeling like this.

Virtually, in the third part of “force field” and “force” of Homogenous Cosmos Originated from Unique Genesis, sequential homologic cosmogony has been primarily highlighted, our intention to emphasize systematical unique-genesis quantization formulation of universal existence & motion along sequential homologic cosmogony further is ready to highlight and consummate systematic formation of cosmic homogeneity system as out-and-out serial natura naturata in the nature of coherent natura naturans throughout cosmic evolution.

Unique-genesis quantization formulation of “dynamic hylic spacetime” is of necessary start & logic basis of systematical unique-genesis quantization formulation of universal existence & motion along sequential homologic cosmogony starting at field genic origin i_0 to universal reciprocal PNT combinations in the nature of coherent natura naturans throughout cosmic evolution, whose radical rational pursuit is, on the basis of [(Homogenous cosmos originated from unique genesis postulate + spacetime~matter fully embodying cosmos postulate) + Instinctive PNT equilibrium postulate], to make universal existence & motion of reciprocal PNT combinations in gradation I, reciprocal PNT combinations in gradation II, reciprocal PNT combinations in gradation III, reciprocal PNT combinations in gradation IV in spacetime successive logic freewheeling of spontaneous transmutation & transition of all field genic units in space field as serial natura naturata (/systematical superior homology) in the nature of coherent natura naturans throughout cosmic evolution. The key issue is that we must ensure the coherence of successive logic freewheeling of original generation and consequent existence & motion of all serial natura naturata as reciprocal PNT combinations in gradation I, reciprocal PNT combinations in gradation II, reciprocal PNT combinations in gradation III, reciprocal PNT combinations in gradation IV in the nature of coherent natura naturans throughout cosmic evolution self-evident.

As a result, as headspring process of systematical unique-genesis quantization formulation of universal existence & motion along sequential homologic cosmogony starting at field genic origin i_0 to universal reciprocal PNT combinations in the nature of coherent natura naturans throughout cosmic evolution, we have to pay special attention to unique-genesis quantization formulation of space field, although, it's only possible for us to deduce it as inverse logic freewheeling of vivid existence & motion of reciprocal PNT combinations in gradation I in spacetime as headspring part of coherent natura naturans throughout cosmic evolution.

The second difficult issue of unique-genesis quantization formulation of hylic space field is that, as inherent feasibility & possibility limitation of scientific practice of human, systematical unique-genesis quantization formulation of universal existence & motion along sequential homologic cosmogony is apparently different from traditionary measurement and quantification of accessible existence & motion around us, as a result, it's necessary for me to highlight the rational estrangement between systematical unique-genesis quantization formulation of universal existence & motion along sequential homologic cosmogony and traditionary measurement & and quantification of accessible existence & motion around us, especially humanistic measurement & quantification of time, mass, distance etc.

We have to admit original humanistic operation and implementation of historical progress of science was not humanistic endeavor to highlight authenticity of nature in accordance with essentiality of nature through and through, but did what we could do for commensurate ideological system about authenticity of nature and successive renovation of humanistic ideology about authenticity of nature draw on practical feasibility & possibility in proportion to contemporaneous historical background. This of course indicate inevitable discrepancy & estrangement between practical effect human come to know authenticity of nature draw on practical feasibility & possibility in proportion to contemporaneous historical background and the demiurge originally create cosmos as out-and-out serial natura naturata in the nature of coherent natura naturans throughout cosmic evolution.

And now, since we are ready to accomplish systematical unique-genesis quantization formulation of universal existence & motion along sequential homologic cosmogony starting at field genic origin i_0 to universal reciprocal PNT combinations in the nature of coherent natura naturans throughout cosmic evolution, it seems necessary for us to highlight discrepancy & estrangement between practical effect human come to know authenticity of nature draw on practical feasibility & possibility in proportion to contemporaneous historical background and the demiurge originally create cosmos as out-and-out serial natura naturata in the nature of coherent natura naturans throughout cosmic evolution, so that it's convenient for us to comprehend the essence of systematical unique-genesis quantization formulation of universal existence & motion along sequential homologic cosmogony starting at field genic origin i_0 to universal reciprocal PNT combinations in the nature of coherent natura naturans throughout cosmic evolution, which is apparently different from traditionary endeavor to know accessible existence & motion like a far-flung exploration of the first itineracy around numerous distinctive landscapes of brand-new landmasses of science with palette & tablet on back.

Only when we have eliminated the rational estrangement between systematical unique-genesis quantization formulation of universal existence & motion along sequential homologic cosmogony starting at field genic origin i_0 to universal reciprocal PNT combinations in the nature of coherent natura naturans throughout cosmic evolution and traditionary sciences, we possess enough rational capital to comprehend and authenticate scientific reliability of systematical unique-genesis quantization formulation of universal existence & motion along sequential homologic

As coherent natura naturans throughout cosmic evolution, instinctive PNT reciprocal equilibrium towards optimum PNT operation is radical potentiality & conditionality for cosmos always ready to orientate itself towards perfection.

cosmogony starting at field genic origin i_0 to universal reciprocal PNT combinations in the nature of coherent *natura naturans* throughout cosmic evolution. Otherwise, it's only possible for Homogenous Cosmos Originated from Unique Genesis to be brand-new ideological system about authenticity of nature and cosmos redefinition in radical logic enantiomorph of newly highlighted factuality that **discretionary particles in cosmos are mutually convertible** out of our mind, whereas, as ideological aggradation in the recent one century, traditionary sciences have been live contemporaneous scientific orthodoxy enjoying altisonant social legitimacy subsistence stepping in the air.

Keywords: *systematical unique-genesis quantization formulation of universal existence & motion along sequential homologic cosmogony, humanistic methodology of scientific measurement & quantification, criterion reference, relative measurement & quantification of human, absolute measurement & quantification of human.*

1) **As inherent limit of human practical feasibility & possibility, the unique possible method for human to know genic configuration of space field and distinctive hylic domino effect of coexistence of all the field genic units in space field by logic extension of distinctive existence & motion of elementary genic units/basic particles in spacetime. Our intention to know genic configuration of space field and distinctive hylic domino effect of coexistence of all the field genic units in space field by logic extension of distinctive existence & motion of elementary genic units/basic particles in spacetime is ready to consummate unique-genesis quantization formulation of hylic spacetime as perfect start & basis of systematical unique-genesis quantization formulation of universal existence & motion along sequential homologic cosmogony.**

Newly highlighted factuality that **discretionary particles in cosmos are mutually convertible** is always in freewheeling orientation towards complete induction, this apparently implies cosmos is throughout homogenous originated from unique genesis, cosmic status quo must be demiurgic aggradation of sequential homologic cosmogony, which exactly exists as well-regulated integration of cosmic homogeneity system making up of out-and-out serial *natura naturata* in the nature of coherent *natura naturans* throughout cosmic evolution. Since cosmos is well-regulated integration of cosmic homogeneity system making up of out-and-out serial *natura naturata* in the nature of coherent *natura naturans* throughout cosmic evolution, can we systematically quantize the well-regulated integration of cosmic homogeneity system making up of out-and-out serial *natura naturata* in the nature of coherent *natura naturans* throughout cosmic evolution?

It's easy for us to know that cosmos is made up of "spacetime" and "matter", besides "spacetime" and "matter", none coordinative components can be perceived by us.

And on the other hand, newly highlighted factuality that **discretionary particles in cosmos are mutually convertible** is always in freewheeling orientation towards complete induction implies cosmos is throughout homogenous originated from unique genesis, if we integrate the both issues together as [**Homogenous cosmos originated from unique genesis + (Cosmic contents = hylic spacetime + matter)**], we can of course approach conclusion that, along sequential homologic cosmogony, "spacetime" and "matter" must be alternative homologic filiation either "matter father, spacetime son" or "spacetime father, matter son, and once we exclude possibility of "matter father, spacetime son", filiation of "spacetime father, matter son" become unique possibility out of question.

The key issue is that homologic filiation of "spacetime father, matter son" straightforwardly indicates original generation of matter as homologic coordinator on the basis of hylic space field. It even indirectly implies Generation Determinism as **original generation of matter** in the nature of coherent *natura naturans* brings out essence of matter in a class

Historical progress of science in the recent several centuries seemed like a far-flung exploration of the first itinerary around numerous distinctive landscapes of brand-new landmasses of science with palette & tablet on back, several hundred years' scientific travelogues were compiled thereby.

by itself, essence of matter in a class by itself predestines thorough coherence of dynamic regularity of universal existence & motion, which of course rational headspring of universal existence & motion.

Since “hylic spacetime” is coordinative lineal homologic origin of “positive matter” in homogenous cosmos, once we come to consummate systematical unique-genesis quantization formulation of universal existence & motion along sequential homologic cosmogony, we have to consummate unique-genesis quantization formulation of hylic spacetime as primary job and logic basis in prior for successive unique-genesis quantization formulation of elementary genic units and universal reciprocal PNT combinations, so that it's possible for us to consummate systematical unique-genesis quantization formation of universal existence & motion along sequential homologic cosmogony through and through in accordance with homologic filiation of **spacetime father and matter son**.

Whereas, the serious issue is that, vivid existence & motion of space field genic units is just the extreme state of spacetime, we can perceive the dynamic domino effect of integrative coexistence of all space field genic units as common spacetime, it's completely impossible for human to perceive vivid existence & motion of distinctive existence & motion of any separate space field genic units. In straightforward words, vivid existence & motion of any separate space field genic unit completely exceed our humanistic perception, it's only possible for human to perceive the integrative dynamic domino effect of coexistence of all space field genic units as common spacetime. As a result, it's only possible for the species of space field genic units, configuration of space field genic units and integrative coexistence of all space field genic units in spacetime to be deduced by the character existence & motion of elementary genic units in spacetime in accordance with homologic filiation between spacetime and matter. And the rationality & reliability of the very deduction can only be authenticated by the fluent inosculation between unique-genesis quantization formulation of hylic spacetime and unique-genesis quantization formulation of elementary genic units and universal reciprocal PNT combinations, which exactly links up as fluent integration of systematical unique-genesis quantization formulation of universal existence & motion along sequential homologic cosmogony.

①. Since the newly highlighted factuality that **discretionary particles in cosmos are mutually convertible** in freewheeling orientation towards complete induction day by day indicates cosmos must be throughout homogenous originated from unique genesis, and we can confirm that cosmos exactly consists of spacetime and matter (**Cosmos = spacetime + matter**), if we denote the cosmic homologic genic origin as “ i_0 ”, in accordance with the evolution sequence of homologic cosmogony, we can of course denote the serial genic units of space field as $i_0, i_1, i_2, \dots, i_n$ ($n \in \mathbb{N}$). In another words, if we denote the cosmic genic origin as “ i_0 ”, we can assume there are totally $n+1$ sorts of space field genic units in spacetime, and we can denote them as homologic genic series as $i_0, i_1, i_2, \dots, i_n$ ($n \in \mathbb{N}$).

②. Since cosmos is throughout homogenous originated from unique genesis, and **cosmos = spacetime + matter**, then, spacetime and matter must be alternative homologic filiation either “**spacetime father & matter son**” or “**matter father & spacetime son**” along sequential homologic cosmogony. Once we exclude homologic filiation possibility of “**matter father & spacetime son**”, we can arrive at unique homologic filiation of “**spacetime father & matter son**” out of question.

If we denote the elementary genic units (**basic particles**) in cosmos $i_{n+1}, i_{n+2}, i_{n+3}, \dots, i_{n+p}$, ($n, p \in \mathbb{N}$), in accordance with homologic filiation between spacetime and matter, along sequential homologic cosmogony, the original generation and of all elementary genic units in cosmos must be successive series behind space field genic units $i_0, i_1, i_2, \dots, i_n$ ($n \in \mathbb{N}$), which of course implies all space field genic units and all elementary genic units in cosmos are virtually lineal series $i_0, i_1, i_2, \dots, i_n, i_{n+1}, i_{n+2}, i_{n+3}, \dots, i_{n+p}$, ($n, p \in \mathbb{N}$) along evolutionary succession of sequential homologic cosmogony.

As coherent natura naturans throughout cosmic evolution, instinctive PNT reciprocal equilibrium towards optimum PNT operation is radical potentiality & conditionality for cosmos always ready to orientate itself towards perfection.

We are ready to deduce hypostatic existence & motion of space field genic units $i_0, i_1, i_2, \dots, i_n$ ($n \in \mathbb{N}$) in accordance with distinctive existence & motion of elementary genic units $i_{n+1}, i_{n+2}, i_{n+3}, \dots, i_{n+p}$, ($n, p \in \mathbb{N}$) is virtually jobs as following:

The first, authentication & confirmation of elementary genic units (basic particles) in cosmos.

We must confirm the definite quantity P of the serial elementary genic units $i_{n+1}, i_{n+2}, i_{n+3}, \dots, i_{n+p}$, ($n, p \in \mathbb{N}$) first, so that we can know how many sorts of elementary genic units in cosmos and what are the real particles we denote as $i_{n+1}, i_{n+2}, i_{n+3}, \dots, i_{n+p}$, ($n, p \in \mathbb{N}$).

The evidence we authenticate whether a particle is real elementary genic unit in cosmos is that, first of all, we have to choose an apt particle aggregation $\{i_{n+1}, i_{n+2}, i_{n+3}, \dots, i_{n+p+1}, i_{n+p+2}, \dots, i_{n+p+X}\}$ ($n, p, X \in \mathbb{N}$) ready for authentication, we have to try our best to break all the particles in particle aggregation $\{i_{n+1}, i_{n+2}, i_{n+3}, \dots, i_{n+p+1}, i_{n+p+2}, \dots, i_{n+p+X}\}$ ($n, p, X \in \mathbb{N}$) as possible as we can, if the particles we try to break can be broken into small particles, they are not elementary genic units in cosmos, so that we can exclude them from the particle aggregation $\{i_{n+1}, i_{n+2}, i_{n+3}, \dots, i_{n+p+1}, i_{n+p+2}, \dots, i_{n+p+X}\}$ ($n, p, X \in \mathbb{N}$), only the ones we can not break them into smaller particles are elementary genic units in cosmos, so that, once we've finished authenticating all the particles in the particle aggregation, we then arrive at elementary genic units aggregation $\{i_{n+1}, i_{n+2}, i_{n+3}, \dots, i_{n+p+1}, i_{n+p+2}, \dots, i_{n+p+X}\}$ ($n, p, X \in \mathbb{N}$) therefore.

Once we arrive at elementary genic units aggregation $\{i_{n+1}, i_{n+2}, i_{n+3}, \dots, i_{n+p}\}$ ($n, p \in \mathbb{N}$), we can of course know the numerical value of P.

Then, we can deduce the numeric value of n of the homologic genic unit series $i_0, i_1, i_2, \dots, i_n, i_{n+1}, i_{n+2}, i_{n+3}, \dots, i_{n+p}$, ($n, p \in \mathbb{N}$) in accordance with successive homologic distribution along sequential homologic cosmogony and distinctive existence & motion of all the elementary genic units in spacetime.

If the 8Gua in "Taiji-8Gua" pattern just means the homologic genic series of $i_0, i_1, i_2, \dots, i_n, i_{n+1}, i_{n+2}, i_{n+3}, \dots, i_{n+p}$, ($n, p \in \mathbb{N}$), then in the homologic genic series $n=2, p=5$, which of course indicates there are 3 sorts of field genic units $n=2, p=5$, and there are 5 sorts of elementary genic units (basic particles) in homogenous cosmos, which is just the situation as "Taiji-8Gua" illustrated aside.

The 8 homologic genic units originally come into being as below

The first case is that an elementary genic unit has upmost probability to be converged by 3 field genic units in different sorts in space field totally, however, during certain existent interval throughout PNT performance, none of the 3 field genic units in different sorts stochastically converged— $C_3^0=1$, which indicates there is only 1 probabilistic existent case for the elementary genic unit to shape its configuration in spacetime.

The second case is that an elementary



Historical progress of science in the recent several centuries seemed like a far-flung exploration of the first itinerary around numerous distinctive landscapes of brand-new landmasses of science with palette & tablet on back, several hundred years' scientific travelogues were compiled thereby.

genic unit has upmost probability to be converged by 3 field genic units in different sorts in space field totally, however, during certain existent interval throughout PNT performance, only 1 of the 3 field genic units in different sorts stochastically converged— $C_3^1=3$, which means there are totally 3 probabilistic existent cases for the elementary genic unit to shape its configurations in spacetime.

The third case is that an elementary genic unit has upmost probability to be converged by 3 field genic units in different sorts in space field totally, however, during certain existent interval throughout PNT performance, only 2 of the 3 field genic units in different sorts stochastically converged— $C_3^2=3$, which means there are totally 3 probabilistic existent cases for the elementary genic unit to shape its configurations in spacetime.

The fourth case is that an elementary genic unit has upmost probability to be converged by 3 field genic units in different sorts in space field totally, however, during certain existent interval throughout PNT performance, 3 of the 3 field genic units in different sorts stochastically converged— $C_3^3=1$, which means there are totally 1 probabilistic existent case for the elementary genic unit to shape its configuration in spacetime.

And as a result, $C_3^0+ C_3^1+ C_3^2+ C_3^3=1+3+3+1=8$, which means, as elementary genic units converged by three field genic units in different sorts have to exist in everlasting PNT operation, there are only 8 probabilistic existent cases for elementary genic units to shape their configurations totally. Of course, this is still primary guess.

The second, deduce the distinctive physical attribute of space field genic units $i_0, i_1, i_2, \dots i_n$ ($n \in \mathbb{N}$) in accordance with general characters of distinctive existence & motion of elementary genic units $i_{n+1}, i_{n+2}, i_{n+3}, \dots i_{n+p}$, ($n, p \in \mathbb{N}$) in spacetime.

So-called “matter existence” is that, when matter integration performs PNT action under proper spacetime condition by the light of nature, integrative situation that integral cumulation of negative towards positive transmutation from field genic units to elementary genic units $\int_0^t d(M \rightarrow m) dt$ - integral cumulation of positive towards negative transmutation from elementary genic units to field genic units $\int_0^t d(M \leftarrow m) dt =$ selfhood physical esse of positive matter with mass residue $m > 0$ (which indicates $\int_0^t [d(M \rightarrow m) - d(M \leftarrow m)] dt = m > 0$ in time current) is maintained in relatively steady idiographic succession with absolute spacetime momentum $mV = d(M \leftarrow m) * Y$ ever since.

As a result, matter existence can be mathematically formulated as below:

$$\begin{cases} \int_0^t [d(M \rightarrow m) - d(M \leftarrow m)] dt = m > 0 \\ mV = d(M \leftarrow m) * Y \end{cases}$$

In a simple word, so-called “matter existence” is spontaneous occurrence due to PNT action with instinctive PNT equilibrium of matter integration once integral accumulation of living positive & negative transmutation of matter integration satisfies $\int_0^t [d(M \rightarrow m) - d(M \leftarrow m)] dt = m > 0$, which usually implicates magnitude of mass, configuration and energetic status of matter integration.

Virtually, before this, we have introduced “[aberrant convergence of cosmic esse due to PNT reciprocal gelation](#)”, so-called “[aberrant convergence of cosmic esse due to PNT reciprocal gelation](#)” is just physical process that mass of matter in spacetime is continuously increasing. We can mathematically formulate the physical process as below:

$$\begin{cases} \int_0^t [d(M \rightarrow m) - d(M \leftarrow m)] dt = m > 0 \\ mV = d(M \leftarrow m) * Y \\ d(M \rightarrow m) > d(M \leftarrow m) \end{cases}$$

As coherent natura naturans throughout cosmic evolution, instinctive PNT reciprocal equilibrium towards optimum PNT operation is radical potentiality & conditionality for cosmos always ready to orientate itself towards perfection.

This of course indicates, so-called “**aberrant convergence of cosmic esse due to PNT reciprocal gelation**” is but distinctive physical process when matter integration performs PNT action under proper spacetime condition by the light of nature, integrative situation that integral cumulation of negative towards positive transmutation from field genic units to elementary genic units $\int_0^t d(M \rightarrow m) dt$ - integral cumulation of positive towards negative transmutation from elementary genic units to field genic units $\int_0^t d(M \leftarrow m) dt = \text{selfhood physical esse of positive matter with mass residue } m > 0$ (which indicates $\int_0^t [d(M \rightarrow m) - d(M \leftarrow m)] dt = m > 0$ in time current) is maintained in relatively steady idiographic succession with absolute spacetime momentum $mV = d(M \leftarrow m) * Y$ ever since and the integrative process of PNT operation satisfies $d(M \rightarrow m) > d(M \leftarrow m)$.

In terms of the so-called elementary genic units $i_{n+1}, i_{n+2}, i_{n+3}, \dots, i_{n+p}$ in spacetime, the distinctive existence & motion of elementary genic units can never be exceptions.

Since cosmos is throughout homogenous originated from unique genesis, as long as homologous genic units $i_0, i_1, i_2, \dots, i_n, i_{n+1}, i_{n+2}, i_{n+3}, \dots, i_{n+p}$, ($n, p \in \mathbb{N}$) is sequential arrangement of mass from lessness to greatness, once we denote the mass of the serial homologous genic units as below:

$$Mi_0, Mi_1, Mi_2, \dots, Mi_n, Mi_{n+1}, Mi_{n+2}, Mi_{n+3}, \dots, Mi_{n+p}$$

Then, it must satisfy:

$$Mi_0 = 1 * i_0, Mi_1 = a * i_0, Mi_2 = b * i_0, \dots, Mi_n = c * i_0, Mi_{n+1} = d * i_0, Mi_{n+2} = e * i_0, Mi_{n+3} = f * i_0, \dots, Mi_{n+p} = g * i_0, \\ (1 < a < b < c < d < e < f < g, \text{ \& \& } a, b, c, d, e, f, g \in \mathbb{N}).$$

It implies that the physical quantification of cosmic genic origin “ i_0 ” is just the basic quantum of universal existence & motion, once we define the physical quantification of cosmic genic origin i_0 “omnipotent basic quantum” for quantification of universal existence & motion, there are only integers of the quantification outcome of universal existence & motion, none “decimal fraction” can occur, no more irrational number.

Virtually, as spontaneous transmutation & transition of all space field genic units is just dynamic noumenon of presence of spacetime, and distinctive spontaneous transmutation & transition of any separate space field genic units is but extreme situation of spacetime, it’s completely impossible for human to challenge feasibility & possibility of definite measurement & quantification of spontaneous transmutation & transition of separate space field genic unit in space field. As a result, there is almost no way for humanistic measurement & quantification to precisely implicate quantitative change of spontaneous transmutation & transition of any separate space field genic unit in spacetime, virtually, once we have to define spontaneous transmutation & transition of any separate space field genic unit, nothing can be our accessible criterion reference for humanistic measurement & quantification. In straightforward words, even though, newly highlighted factuality that **discretionary particles in cosmos are mutually convertible** is always in freewheeling orientation towards complete induction day by day has been evidence enough for us to confirm that cosmos is throughout homogenous originated from unique genesis, once we try to quantize universal existence & motion as systematical unique-genesis quantization formulation along sequential homologous cosmogony through and through, there is almost no way for us to demonstrate and authenticate the unique-genesis quantization formulation of hylic spacetime, there is no way for us to authenticate that physical noumenon of “hylic space” & “hylic time” is definite cumulation of substantial spontaneous transmutation & transition of many many distinctive space field genic units, it’s only possible for us to perceive the integrative domino effect of substantial spontaneous transmutation & transition of many many distinctive space field genic units as normal spacetime that both space and time are absolutely continuous presence around us.

Historical progress of science in the recent several centuries seemed like a far-flung exploration of the first itinerary around numerous distinctive landscapes of brand-new landmasses of science with palette & tablet on back, several hundred years’ scientific travelogues were compiled thereby.

This of course implies that “basic quantum i_0 ” is apparently different from traditional “quantum” which is related to “Prank constant”, since traditional “quantum” related to Prank constant is perceivable noumenon by humanistic experiment, it must be a basic and rounded PNT operation circle which is inverse against **aberrant convergence of cosmic esse due to PNT reciprocal gelation**. Whereas, “basic quantum i_0 ” introduced herein is physical noumenon quantification of space field genic origin i_0 for systematical unique-genesis quantization formulation of universal existence & motion along sequential homologic cosmogony, which is completely out of humanistic perception for it's extremity physical noumenon of spacetime. In any case, since there is no way for humanistic perception to transcend integrative spacetime, there is no way for human to perceive isolated transmutation & transition of single space field genic unit in spacetime but to imagine it in accordance with rationale of homogenous cosmos originated from unique genesis.

In fact, I have been confused by the issue for rather a long time, newly highlighted factuality that discretionary particles in cosmos are mutually convertible always in freewheeling orientation towards complete induction really indicates that cosmos must be throughout homogenous originated from unique genesis, whereas, once we have confirmed the authenticity of homogenous cosmos originated from unique genesis, we can hardly evade rational pursuit of systematical unique-genesis quantization formulation of universal existence & motion along sequential homologic cosmogony, which must introduce scientific idea of so-called “basic quantum i_0 ”. However, once we introduce so-called “basic quantum i_0 ” as basic quantum for measurement & quantification of universal existence & motion including space, time, mass of matter, it's only possible for all measurement & quantification of universal existence & motion to be numeric value of integer, no decimal fraction, no more irrational number.

And at the same time, as cosmic infinitesimal extremity, introduction of so-called “basic quantum i_0 ” not only negates objective presence of “unlimited lessness” which implies none object else in cosmos can be even smaller than “basic quantum i_0 ” but also negates objective presence of “infinity” which implies none quantitative change in cosmos can increasingly extend to “infinity”. For instance, in the so-called gravity formula $F=G(Mm)/R^2$ of traditional sciences, there is almost no way for quantitative change of M , m , R in the equation to increasingly extend to “infinity”.

Thus, practical measurement & quantification of universal existence & motion seem unintelligible.

As a result, I have to emphasize humanistic methodology about measurement & quantification of universal existence & motion herein, when human come to implement measurement & quantification of universal existence & motion, human have to choose accessible “**criteria reference**” in prior, without “**criteria reference**”, there is almost no way for “measurement & quantification” of accessible existence & motion to be implemented. The typical “**criteria references**” are “mass weight 1 Kg”, “ruler 1 meter”, “time 1 second” etc. Whereas, once we invoke the so-called “**criteria reference**” like “mass weight 1 Kg”, “ruler 1 meter”, “time 1 second” etc for implementation of “measurement & quantification”, decimal fraction and irrational numbers come to us, there is even “unlimited lessness” and “infinity” therefore.

In fact, for rather a long time, I was always bemused how to define “number” under precondition of homogenous cosmos originated from unique genesis, because if cosmos is throughout homogenous originated from unique genesis i_0 really, once we define quantification of the field genic origin i_0 radical quantum, any process quantity or state quantity in cosmos must be integer times of quantification of i_0 , which of course indicates once we introduce idea of unique-genesis quantum i_0 , there are only whole numbers in cosmos, none of decimal fraction, no more

As coherent natura naturans throughout cosmic evolution, instinctive PNT reciprocal equilibrium towards optimum PNT operation is radical potentiality & conditionality for cosmos always ready to orientate itself towards perfection.

irrational number. Whereas, in human rational purview, although cosmos is throughout homogenous originated from unique genesis, human can never perceive any definite existence of any field genic units in space field, no more definite existence of field genic origin i_0 , but can only perceive integrative physical process segments under large-scale structure of spacetime whose perceivable physical quantity is made up of coexistence domino effect of large numbers of field genic units. Theoretically, we can quantify any physical process with unique-genesis quantum of i_0 , whereas, we can never perceive any hypostatic unique-genesis quantization continuity in cosmos. And unique-genesis quantization of thorough homogenous cosmos originated from unique genesis must break through dimension estrangement of “kilogram”, “kilometer” and “second”, and the mathematical logic must be specially different therefore.

What’s the ideological trouble towards authenticity formulation of cosmos?

A) Humanistic measurement & quantification of universal existence & motion.

So-called “**humanistic measurement & quantification**”, in straightforward words, is just humanistic methodology that human have to choose necessary “**criterion reference**” for practical measurement & quantification of accessible existence & motion around us.

For instance, under distinctive spacetime condition, we choose some certain “mass weigh 1 Kg” as “**criterion reference**”, so that we can measure and quantize mass of objects around accordingly.

Under distinctive spacetime condition, we choose some certain “ruler 1 meter” as “**criterion reference**”, so that we can measure and quantize length of objects around accordingly.

Under distinctive spacetime condition, we choose some certain “standard motion reference——time/1 second” as “**criterion reference**”, so that we can measure and quantize motion speed/ratio of objects around accordingly.

.....

Humanistic measurement & quantification of universal existence & motion has a remarkable dealing feature that, before implementation of practical measurement & quantification of universal existence & motion, human have to choose seemingly definite “**criterion reference**”, such as “mass weigh 1 Kg”, “ruler 1 meter”, “criterion motion reference——time 1 second” etc, then implement and accomplish humanistic measurement & quantification of accessible existence & motion around us in accordance with “**criterion reference**” as “mass weigh 1 Kg”, “ruler 1 meter”, “criterion motion reference——time 1 second” etc.

We call such kind of humanistic measurement & quantification of accessible existence & motion around us in accordance with “**criterion reference**” as “mass weigh 1 Kg”, “ruler 1 meter”, “criterion motion reference——time 1 second” etc “relative measurement & quantification of human”.

(A-a). Physical limitation of relative measurement & quantification of human.

The most remarkable humanistic feature is, before humanistic measurement & quantification of universal existence & motion, we must choose seemingly definite object with specific noumenon quantity as criterion reference, without criterion reference, there is no way for practical implementation of measurement & quantification.

Theoretically, any object exists as vivid ongoing variable in time current. On one hand, there is none absolute constant to take role of criterion reference for humanistic measurement & quantification of universal existence & motion; on the other hand, humanistic implementation of measurement & quantification needs time, there is no practical possibility for us to ascertain definite object in time current for definite measurement & quantification, no more humanistic measurement & quantification in accordance with criterion reference of time/s, length/m,

Historical progress of science in the recent several centuries seemed like a far-flung exploration of the first itinerary around numerous distinctive landscapes of brand-new landmasses of science with palette & tablet on back, several hundred years’ scientific travelogues were compiled thereby.

mass/Kg etc.

In realistic cosmos, as long as time is doing its job, universal existence & motion is ongoing process, there are none constant in cosmos but vivid variables through and through. Once human choose criterion reference for humanistic measurement & quantification of accessible existence & motion around, the humanistic connotation of humanistic measurement & quantification of accessible existence & motion is self-evident, which is of course relative measurement & quantification of human.

For instance, in terms of a mass weight 1 Kg, the realistic existence & motion of the mass weight 1 Kg in spacetime is as following:

$$\begin{cases} \int_0^t [d(M \rightarrow m) - d(M \leftarrow m)] dt = m \approx 1 \text{ 千克} > 0 \\ mV = d(M \leftarrow m) * Y \end{cases}$$

As long as the mass weight exists in time current, there must be inherent PNT action of matter integration of the mass weight 1 Kg, there must be ongoing quantitative change of “ $d(M \rightarrow m)$ ” and “ $d(M \leftarrow m)$ ” which must impact the quantitative mass of the mass weight 1 Kg. As long as PNT action of matter integration of the mass weight does not keep in inertial state of “ $d(M \rightarrow m) = d(M \leftarrow m)$ ”, realistic mass of the mass weight 1 Kg is always varying, mass of the mass weight 1 Kg is not constant but stochastic variable in time current.

In fact, in order to ensure PNT action of matter integration of the mass weight 1 Kg satisfying $d(M \rightarrow m) = d(M \leftarrow m)$, we must ensure the matter integration of the mass weight 1 Kg to keep inertial state in spacetime, so that mass of mass weight 1 Kg keeps constant for $d(M \rightarrow m) = d(M \leftarrow m)$. Whereas, in realistic spacetime, we can hardly find a matter integration in absolute inertial state. As a result, it's almost impossible for us to find an absolute mass criterion reference in cosmos for practical measurement & quantification of mass of accessible objects around us.

Of course, if we put a piece of bread 1 Kg and a mass weight 1 Kg on right tray and left tray of scale, as long as the external spacetime condition of the right tray and left tray is very similar, no matter how the mass of both bread 1 Kg and mass weight 1 Kg change stochastically, as mass variation of both bread 1 Kg and mass weight 1 Kg keep synchronous and equivalent, the scale can always keep balance in time current.

This is just humanistic domino effect of relative measurement & quantification of mass.

Once we invoke inconstant noumenon quantity as criterion reference for humanistic measurement & quantification of accessible existence & motion around us, the humanistic connotation of relative measurement & quantification due to practical feasibility & possibility is self-evident.

In terms of the scientific idea of “time”, the so-called “time” is just accessible “[motion criterion reference](#)” around us. The radical capital for so-called “[motion criterion reference](#)” to take role of “time” is that, any object in cosmos has inherent absolute spacetime momentum as below:

$$mV = d(M \leftarrow m) * Y$$

Theoretically, the more the innate existence & motion of object can incarnate inherent absolute spacetime momentum which indicates the inherent PNT action of matter integration suffers less external physical disturbance, then the vivid existence & motion of matter integration has more qualification to take role of time in the proper spacetime. Of course, as motion criterion reference, the vivid existence & motion of the object is better to be periodic motion incarnating regular periods, if so, it's apparently convenient to define “time unit”, such as rotation of the

earth, revolution of the earth around the sun, vibration of atomic crystal lattice etc.

Whereas, introduction of such kind of scientific idea of “**motion criterion reference—time**” not only neglects inherent variation of time dynamic speed Y throughout cosmic evolution but also neglects possible slight variation of spacetime and slight discrepancy among different spacetime areas, although, the introduction of such kind of scientific idea of “time” are really convenient and expedient for humanistic implementation of measurement & quantification of universal existence & motion.

As physical noumenon of spontaneous transmutation & transition of space field genic units in space field, the most remarkable significance of physical noumenon of time/time dynamic speed is that it makes all objects in cosmos has inherent absolute spacetime momentum “ $mV=d(M \leftarrow m)*Y$ ”, which directly relates to time dynamic speed. If time dynamic speed varies by the light of nature, absolute spacetime momentum of all objects in spacetime must change accordingly. For instance, as slight spacetime condition change of the earth in large scale spacetime, dynamic situation of all atoms making up of the earth must change by spontaneous PNT reaction accordingly, as remarkable discrepancy of atomic mechanical structure of all atoms making up of the earth, there is proportionate geo-energy reaction derived from slight spacetime condition change around and consequently cause original energy cumulation for earthquake and volcano in the earth.

In straightforward words, introduction of scientific idea of time of tradition still does not implicate physical noumenon of spontaneous transmutation & transition of space field genic units in space field, but straightforwardly introduce accessible “motion criterion reference”, and just in accordance with so-called “motion criterion reference”, we come to measure & quantify universal existence & motion around. For instance, in terms of vivid existence & motion of satellite around the earth, before introduction of scientific idea of time which is virtually **motion criterion reference** as earth rotation itself in spacetime, there is no way for us to implement possible measurement & quantification of vivid existence & motion of the satellite around the earth, only time is defined in accordance with seemingly definite motion criterion reference as earth rotation, we can expediently authenticate and quantify vivid existence and motion of the satellite around the earth accordingly.

The key issue is that both satellite around the earth and the earth possess generally same spacetime condition.

If we formulate the absolute spacetime momentum of the satellite around the earth as following:

$$m_s V_s = d(M_s \leftarrow m_s) * Y$$

In equation above, the subscript “S” is abbreviation of “satellite”.

And we formulate the absolute spacetime momentum of the earth as following:

$$m_e V_e = d(M_e \leftarrow m_e) * Y$$

In equation above, the subscript “E” is abbreviation of “earth”.

Satellite around the earth and the earth possess the generally same spacetime condition indicates in the both equations of absolute spacetime momentum of satellites and absolute spacetime momentum of the earth, the quantity Y is almost the same, no matter whether the external spacetime condition around the earth changes or not during the course of earth moving in large scale spacetime in cosmos, and no matter how the external spacetime condition around the earth during the course of earth moving in large scale spacetime in cosmos, the change of the spacetime condition around the earth and the satellite is almost synchronous and equivalent, so that it’s really difficult for us to perceive the relative discrepancy between “ $m_s V_s = d(M_s \leftarrow m_s) * Y$ ” and “ $m_e V_e = d(M_e \leftarrow m_e) * Y$ ” due to synchronous

Historical progress of science in the recent several centuries seemed like a far-flung exploration of the first itinerary around numerous distinctive landscapes of brand-new landmasses of science with palette & tablet on back, several hundred years’ scientific travelogues were compiled thereby.

and equivalent change of the external spacetime condition.

That's to say, once we define the rotation of the earth "motion criterion reference" for measurement & quantification of vivid existence & motion of satellite around the earth, as the satellite around the earth and the earth possess generally the same spacetime condition in large-scale spacetime in cosmos, no matter whether the external spacetime condition of both satellite and the earth changes or not, no matter how the external spacetime condition of both satellite and the earth changes, there is no reasons for us to find relative motion discrepancy between the satellite and the earth.

This is just something about **relative measurement & quantification of human** due to introduction of **motion criterion reference** as time with generally same external spacetime condition.

Of course, I have to comment herein, in order to quantify rate of spontaneous transmutation & transition of space field genic units, I introduced scientific idea of "time dynamic speed Y". Virtually, introduction of scientific idea of "time dynamic speed Y" needs "motion criterion reference" too, without "motion criterion reference", there is no way for "time dynamic speed Y" to be defined. Since I am now working on the earth, I have to invoke accessible "motion criterion reference" as tradition which is traditionary time. After all, as human being working on the earth, conventional idea of time is my optimum choice for motion criterion reference to quantify rate of spontaneous transmutation & transition of space field genic units in space field. Although, I am quite aware conventional idea of time is but accessible motion criterion reference of human on the earth, in time current, it's completely impossible for it to be ideal constant motion criterion reference at all.

Whereas, introduction of traditionary idea of time (**default motion criterion reference**) herein neither negates successive variable of time dynamic speed along sequential homologic cosmogony nor negates stochastic slight variation of physical noumenon of time around the earth, which of course implies time is not constant physical noumenon throughout cosmic evolution. However, once we introduce "default motion criterion reference" to define so-called "time", in terms of vivid existence & motion around the default motion criterion reference with generally same background spacetime condition, as dynamic domino effect of variation of time dynamic speed to both "**default motion criterion reference**" and vivid existence & motion around the default motion criterion reference with generally same background spacetime condition is mostly synchronous and equivalent, there is no way for us to perceive dynamic domino effect derived from natural variation of time dynamic speed.

However, in terms of galaxies A, B, C, D, E, F, ... far away from Milk Way Galaxy, as distribution of galaxies in large-scale spacetime is obviously dispersive with relatively independent spacetime condition, situation is much different. We can of course formulate independent existence & motion of Milk Way Galaxy as below:

$$m_w V_w = d(M_w \leftarrow m_w) * Y_w$$

In equation above, subscript "w" is abbreviation of Milk Way Galaxy.

And we denote the vivid existence & motion of all galaxies A, B, C, D, E, F, ... out of Milk Way Galaxy as following:

$$m_A V_A = d(M_A \leftarrow m_A) * Y_A$$

$$m_B V_B = d(M_B \leftarrow m_B) * Y_B$$

$$m_C V_C = d(M_C \leftarrow m_C) * Y_C$$



$$m_D V_D = d(M_D \leftarrow m_D) * Y_D$$

$$m_E V_E = d(M_E \leftarrow m_E) * Y_E$$

$$m_F V_F = d(M_F \leftarrow m_F) * Y_F$$

.....

Distribution of galaxies in large-scale spacetime of cosmos is rather sparse, as a result, background spacetime conditions of galaxies seem relatively independent, it's of course easier for us to imagine, it's almost impossible for variation of time dynamic speeds $Y_W, Y_A, Y_B, Y_C, Y_D, Y_E, Y_F, \dots$ to keep in synchronous and equivalent through and through. As a result, once we stand in Milk Way Galaxy and observe distinctive existence & motion of galaxies out of Milk Way Galaxy, we can of course find the rich and colorful existence & motion of galaxies A, B, C, D, E, F, ..., which of course relates to characteristic $Y_A, Y_B, Y_C, Y_D, Y_E, Y_F, \dots$ in the nature of things.

Physical noumenon of space distance is dynamic succession of spontaneous transmutation & transition of space field genic unit in space field, as long as the space field genic unit at point A can be transfer to point B by spontaneous transmutation and transition of space field genic units in the space field, there is physical noumenon of space distance between point A and point B all wool and a yard wide. Of course, presence of physical noumenon of space distance between point A and point B is too precondition for discretionary object to move from point A to point B. Inversely, if there is no space distance between point A and point B, there is no way for any object in cosmos to move from point A to point B. And authentic quantitative space distance between point A and point B not only radically depends on time dynamic speed of the space field but also relates to relativity domino effect of the observer, which mostly depends on moving speed of the observer.

Since physical noumenon of space distance is just dynamic succession of spontaneous transmutation & transition of space field genic units in space field, numeric quantification value of space distance must relate to rate of spontaneous transmutation & transition of space field genic units which is just time dynamic speed.

If when we come to define the time dynamic speed, in order to define and numerically quantify time dynamic speed expediently, we choose conventional notion of time as "motion criterion reference" for practical quantification of time dynamic speed, then, in our physical purview, presence of space distance L between point A and point B must relate to time. If we come to review physical noumenon of space distance L between point A and point B within time interval T, $T < L/Y$, our review action is invalid, there is no way for us to perceive perfect physical noumenon of space distance L between point A and point B, only when we come to review physical noumenon of space distance L with T, $T \geq L/Y$, there is possibility for us to perceive perfect physical noumenon of space distance L between point A and point B.

In straightforward words, as time dynamic speed is a relatively definite physical noumenon, once $T < L/Y$, the realistic process extension is still not enough to bring out perfect dynamic succession of spontaneous transmutation & transition of space field genic units between point A and point B, within time interval T, $T < L/Y$, there is none objective physical noumenon of space distance between point A and point B, where we can find perfect space distance between point A and point B? Theoretically, if $T = L/Y$, we can only perceive presence of physical noumenon of space distance between point A and point B within a line. Virtually, time dynamic speed is extremity speed of homogenous cosmos, in accordance with absolute spacetime momentum definition $mV = d(M \leftarrow m) * Y \iff V = d(M \leftarrow m) * Y/V$, it's only possible for moving speed of object to approach time dynamic speed as much as possible, there is no way for any object besides of space field genic units to approach

Historical progress of science in the recent several centuries seemed like a far-flung exploration of the first itinerary around numerous distinctive landscapes of brand-new landmasses of science with palette & tablet on back, several hundred years' scientific travelogues were compiled thereby.

moving speed of time dynamic speed.

Of course, cosmos is always ongoing process of dynamic aggradation, once we come to study distinctive existence & motion of object in spacetime, mass convergent aggradation of the object usually exist in dynamic process $\int_0^t [d(M \rightarrow m) - d(M \leftarrow m)] dt = m > 0$, which of course indicate, mass convergent aggradation m of matter integration is inconstant, but variable in the nature of stochastic PNT operation of matter integration in spacetime. In straightforward words, besides space field genic origin i_0 , there is no none absolute constant in time current of homogenous cosmos, as long as existence & motion of objects relate to time dynamic speed in the nature of things, there is almost no way for physical noumenon relate to time dynamic speed to be constant through and through. Vivid existence & motion of particles in spacetime can incarnate the situation perfectly, of course, none macroscopical object can be exception.

What does it mean that cosmos is aggregation making up of dynamic hylc spacetime and dynamic convergent aggradation of cosmic esse due to reciprocal PNT gelation?

Firstly, space field is integrative dynamic domino effect of spontaneous transmutation & transition of all space field genic units, spontaneous transmutation & transition of space field genic units directly make up of physical noumenon of time in cosmos. If we suppose the compositive space field genic units in space field are $i_0, i_1, i_2, \dots, i_n (n \in \mathbb{N})$, as object of typical reciprocal PNT combinations in gradation III kind in cosmos, as long as our perception sensitivity is not enough to transcend promptness of spontaneous transmutation & transition of space field genic units in space field, it's impossible for us to perceive distinctive existence & motion of isolated space field genic units in space field. All in all, relative to any reciprocal PNT combinations in gradation II, reciprocal PNT combinations in gradation III, reciprocal PNT combinations in gradation IV in cosmos, spontaneous transmutation & transition of all space field genic units are absolute uncertain existence & motion around, it's only possible for us to perceive integrative dynamic domino effect as physical noumenon of spacetime.

In terms of discretionary reciprocal PNT combination in cosmos, the mass convergent aggradation of any reciprocal PNT combination in spacetime must satisfy evolution quantitative change fundamental of cosmogony as below:

$$\int_0^t [d(M \rightarrow m) - d(M \leftarrow m)] dt = m > 0$$

And at the same time, as long as the physical noumenon in cosmos can exist as independent object in spacetime, it must inherently possess absolute spacetime momentum as below:

$$mV = d(M \leftarrow m) * Y$$

That's to say, in terms of any object in cosmos, **mass convergent aggradation** and **absolute spacetime momentum** are two basic elements of matter integration:

$$\begin{cases} \int_0^t [d(M \rightarrow m) - d(M \leftarrow m)] dt = m > 0 \\ mV = d(M \leftarrow m) * Y \end{cases}$$

In terms of reciprocal PNT combinations in gradation I, as inherent mass convergent aggradation m is relatively little, impact of ongoing quantitative change of $d(M \rightarrow m)$ and $d(M \leftarrow m)$ of PNT of matter integration to mass convergent aggradation m of matter integration is very remarkable. As a result, mass convergent aggradation m of reciprocal PNT combinations in gradation I is rather flimsy which makes existence & motion of reciprocal PNT

combinations in gradation I unstable in spacetime. What's more, inherent absolute spacetime momentum of reciprocal PNT combinations in gradation I is relatively abundant and remarkable, which even makes general existence & motion of reciprocal PNT combination in gradation I flashing in spacetime like eidolon.

In terms of reciprocal PNT combinations in gradation II, reciprocal PNT combinations in gradation III, reciprocal PNT combinations in gradation IV, any independent matter integration must inherently possess distinctive mass convergent aggradation and absolute spacetime momentum:

$$\begin{cases} \int_0^t [d(M \rightarrow m) - d(M \leftarrow m)] dt = m > 0 \\ mV = d(M \leftarrow m) * Y \end{cases}$$

The more massive objects have more substantial mass convergent aggradation m in time current, and just because they have relatively substantial mass convergent aggradation m , it's relatively more feasible and easier to maintain balance of PNT operation of matter integration, which of course implies it's relatively more feasible and easier to keep $d(M \rightarrow m) = d(M \leftarrow m)$ of PNT operation in time current. As a result, it's relatively more feasible and easier for them to keep mass convergent aggradation m steady.

And at the same time, as massive mass convergent aggradation in spacetime, the absolute spacetime momentum $d(M \leftarrow m) * Y$ of matter integration seems relatively poor. In accordance with definition of absolute spacetime momentum of matter integration $mV = d(M \leftarrow m) * Y \iff V = d(M \leftarrow m) * Y / V$, it's easy for us to know that absolute moving speed of massive matter integration must be relatively lower, existence & motion of massive object in spacetime seems relatively inertial and solid therefore.

Theoretically, in terms of any mass weights 1000g, 500g, 100g, ..., as long as they exist in spacetime themselves, their mass convergent aggradation and absolute spacetime momentum must satisfy:

$$\begin{cases} \int_0^t [d(M \rightarrow m) - d(M \leftarrow m)] dt = m > 0 \\ mV = d(M \leftarrow m) * Y \end{cases}$$

In order to keep their mass absolutely constant as 1000g, or 500g, or 10g, we must ensure PNT action of the matter integration of the mass weight must satisfy:

$$d(M \rightarrow m) = d(M \leftarrow m)$$

This of course implies all the mass weights must keep inertial state in spacetime through and through, otherwise, it's impossible for their PNT action to satisfy $d(M \rightarrow m) = d(M \leftarrow m)$, so that it's impossible for their mass to keep constant in time current, no matter mass weight 1000g, 500g, 100g.

For the same reasons, in terms of length criterion reference as ruler 1 meter, ruler 0.5 meter, ruler 0.1 meter, the authentic length of the ruler must synchronously change with variation mass convergent aggradation m , as long as we can not keep the rulers in absolute inertial state, there is no way for us to keep length of the ruler in constant for qualified length criterion reference in time current.

The scientific notion of "time" in traditionary sciences is virtually default "motion criterion reference" accessible around us, such as clock, rotation of the earth, revolution of the earth around the sun, ... Vibration of atomic crystal lattice under certain spacetime condition etc.

Theoretically, any object in cosmos has its inherent absolute spacetime momentum $mV = d(M \leftarrow m) * Y$, which directly and proportionably relates to time dynamic speed. As a result, in terms of any object in cosmos, as long as

Historical progress of science in the recent several centuries seemed like a far-flung exploration of the first itinerary around numerous distinctive landscapes of brand-new landmasses of science with palette & tablet on back, several hundred years' scientific travelogues were compiled thereby.

it existence & motion in spacetime freely without frequently disturbance, especially erratic disturbance, its innate motion situation can incarnate time rate of the background spacetime exactly, it's qualified to be regarded as motion criterion reference and take role of time.

The key issue is that, in the equation $mV=d(M\leftarrow m)*Y$, the quantity $d(M\leftarrow m)$ of and Y are all stochastic variables, this of course implies time dynamic speed in cosmos is not constant, time does not always go evenly. Whereas, once we choose so-called motion criterion reference to take role of time, we consequently neglect inherent variable attribute of time/time dynamic speed.

Of course, I have to comment herein, "time" is defined in Homogenous Cosmos Originated from Unique Genesis as rate of spontaneous transmutation and transition of all space field genic units in space field, the numeric quantification of time is "time dynamic speed Y ". Whereas, I have to admit numeric quantification of time dynamic speed need "criterion reference" too, without "criterion reference", there is no way for "time dynamic speed" to be defined and numerically quantified. In fact, in accordance with practical feasibility & possible, it seems we have to choose conventional "time" as criterion reference to accomplish numeric quantification of time dynamic speed without alternatives. I am quite aware that traditional "time" is out-and-out motion criterion reference accessible for relative measurement & quantification of accessible existence & motion around us, which is not absolute constant for out-and-out criterion reference, once we let such kind of inconstant criterion reference do its job accordingly, there is of course inevitable proportionate measurement & quantification distortion.

Before I involving in scientific idea of **homogenous cosmos originated from unique genesis and systematical unique-genesis quantization formulation of universal existence & motion along sequential homologic cosmogony**, there may be nobody who has noticed the humanistic distortion of relative measurement & quantification of universal existence & motion for introduction of inconstant criterion reference accessible. Although, it's so straightforward humanistic distortion as if we just to measure objects around by a ruler in different temperatures, under normal temperature, the length of our ruler is 1 meter, under low temperature, the length of our ruler is 0.999 meter, under high temperature, the length of our ruler is 1.001 meter, once we measure length of objects with this ruler neglecting thermal domino effect of the ruler, our measurement & quantification distortion is of course imaginable.

Of course, the particle masses we mentioned as $M_{i_0}=1*i_0$, $M_{i_1}=a*i_0$, $M_{i_2}=b*i_0$, ... $M_{i_n}=c*i_0$, $M_{i_{n+1}}=d*i_0$, $M_{i_{n+2}}=e*i_0$, $M_{i_{n+3}}=f*i_0$, ... $M_{i_{n+p}}=g*i_0$, ($1<a<b<c<d<e<f<g$, $\exists a, b, c, d, e, f, g \in \mathbb{N}$) only means the maximum instantaneous mass of homologic genic units $i_0, i_1, i_2, \dots, i_n, i_{n+1}, i_{n+2}, i_{n+3}, \dots, i_{n+p}$, ($n, p \in \mathbb{N}$) in spacetime.

So-called "matter motion" is that, when matter integration performs PNT action under proper spacetime condition by the light of nature, as external dissonance to PNT performance of matter integration, integrative situation that integral cumulation of negative towards positive transmutation from field genic units to elementary genic units $\int_0^t d(M \rightarrow m) dt$ - integral cumulation of positive towards negative transmutation from elementary genic units to field genic units $\int_0^t d(M \leftarrow m) dt$ = selfhood physical esse of positive matter with mass residue $m > 0$ (which indicates $\int_0^t [d(M \rightarrow m) - d(M \leftarrow m)] dt = m > 0$ in time current) and absolute spacetime momentum $mV = d(M \leftarrow m) * Y$ is consequently disturbed. The radical indication integrative situation that integral cumulation of negative towards positive transmutation from field genic units to elementary genic units $\int_0^t d(M \rightarrow m) dt$ - integral cumulation of positive towards negative transmutation from elementary genic units to field genic units $\int_0^t d(M \leftarrow m) dt$ = selfhood physical esse of positive matter with mass residue $m > 0$ and absolute spacetime momentum $mV = d(M \leftarrow m) * Y$

is disturbed is $d(M \rightarrow m) \neq d(M \leftarrow m)$. Of course, once “ $d(M \rightarrow m) \neq d(M \leftarrow m)$ ” of matter integration occurred, spontaneous occurrence of PNT action with instinctive PNT equilibrium must be subject to fundamental of instinctive PNT reciprocal equilibrium towards optimum PNT operation, and instinctive PNT equilibrium in operation must accomplish quantitative change from $d(M \rightarrow m) \neq d(M \leftarrow m)$ towards $d(M \rightarrow m)' = d(M \leftarrow m)'$ as expediently as possible, $d(M \rightarrow m) \neq d(M \rightarrow m)'$; $d(M \leftarrow m) \neq d(M \leftarrow m)'$.

As a result, matter motion can be mathematically formulated as below:

$$\begin{cases} \int_0^t [d(M \rightarrow m) - d(M \leftarrow m)] dt = m > 0 \\ mV = d(M \leftarrow m) * Y \\ d(M \rightarrow m) \neq d(M \leftarrow m) \quad \xrightarrow{\text{PNT}} \quad d(M \rightarrow m)' = d(M \leftarrow m)' \end{cases}$$

In a simple word, so-called “matter motion” is but, under precondition that matter integration satisfies mass integral accumulation $\int_0^t [d(M \rightarrow m) - d(M \leftarrow m)] dt = m > 0$ in time current, PNT action has to rebuild the perfect operation of PNT action of matter integration by the right of instinctive PNT reciprocal equilibrium towards optimum PNT operation once some certain external disturbance occurs to PNT operation of matter integration so as to cause occurrence of $d(M \rightarrow m) \neq d(M \leftarrow m)$, — spontaneous occurrence in the nature of instinctive PNT reciprocal equilibrium towards optimum PNT operation proportionate to external disturbance, which usually implicates magnitude of mass, configuration and energetic status of matter integration. In above equations, the symbolic mark “ $\xrightarrow{\text{PNT}}$ ” indicates spontaneous dynamic orientation of matter integration from initial state $d(M \rightarrow m) \neq d(M \leftarrow m)$ to target state $d(M \rightarrow m)' = d(M \leftarrow m)'$ due to instinctive PNT reciprocal equilibrium towards optimum PNT operation.

All in all, no matter it is PNT performance case of $d(M \rightarrow m) = d(M \leftarrow m)$ or $d(M \rightarrow m) \neq d(M \leftarrow m)$, the integrative logic constitution of all the related state variables of matter integration can be illustrated as below:

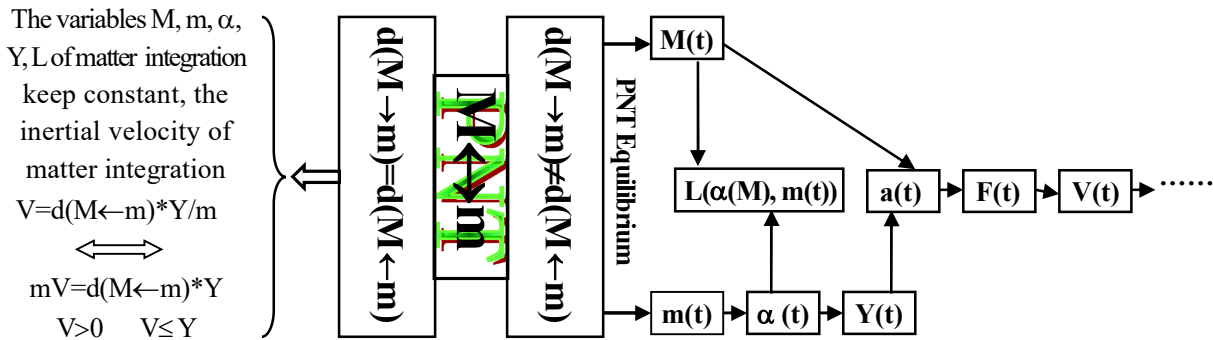

(V-iv-1) logic constitution of PNT dynamics

In order to procure more information about genic units integral convergence of elementary genic units $M_{i_{n+1}} = d * i_0, M_{i_{n+2}} = e * i_0, M_{i_{n+3}} = f * i_0, \dots, M_{i_{n+p}} = g * i_0$, it's necessary for us to know more distinctive existence & motion about elementary genic units of $M_{i_{n+1}} = d * i_0, M_{i_{n+2}} = e * i_0, M_{i_{n+3}} = f * i_0, \dots, M_{i_{n+p}} = g * i_0$, especially remarkable discrepancy among the elementary genic units. In any case, we should know as much as possible about PNT operational model of hypostatic existence & motion of elementary genic units in spacetime including mass dissipation or periodic variation of mass of elementary genic units and synchronous displacement domino effect during the course of existence & motion in spacetime. And once all details are lighted, it's still necessary for us to quantize the physical process accordingly for consummate formulation of universal existence & motion in spacetime.

2) Rational linkage between unique-genesis quantization formulation of hyllic spacetime and traditionary idea of three dimensional coordinate, time rationale, distance rationale,

Historical progress of science in the recent several centuries seemed like a far-flung exploration of the first itinerary around numerous distinctive landscapes of brand-new landmasses of science with palette & tablet on back, several hundred years' scientific travelogues were compiled thereby.

mass rationale etc.

Newly highlighted factuality that **discretionary particles in cosmos are mutually convertible** in freewheeling orientation towards complete induction day by day has exposed more and more of homogenous profile of cosmos, cosmos must be throughout homogenous originated from unique genesis. Introduction of Homogenous cosmos originated from unique genesis postulate and homogenous objectification of cosmic contents can not exclude spacetime out of category of homogenous cosmos. Whereas, once we confirm that spacetime is out-and-out homologic component of cosmic homogeneity system, as coordinate component of homogenous cosmos, spacetime must coordinate homology of matter, so that spacetime must be hylic object as physical as matter in cosmos. And at the same time, as long as we can confirm that **cosmos=spacetime + matter**, none coordinate component else in cosmos, then, along sequential homologic cosmogony, spacetime and matter must be alternative **homologic filiation** either **spacetime father & matter son** or **matter father & spacetime son** out of question. Once we can exclude objective possibility of “**matter father & matter son**”, homologic filiation of “**spacetime father & matter son**” become unique homologic filiation beyond all doubt.

And at the same time, as long as we can confirm that so-called sequential homologic cosmogony must be subject to coherent natura naturans throughout cosmic evolution, once we come to redefine space and time, we have to ensure homologic attribute of spacetime and matter in accordance with homologic filiation between spacetime and matter.

Under precondition of homogenous cosmos originated from unique genesis, we are ready to accomplish systematical unique-genesis quantization formulation of universal existence & motion along sequential homologic cosmogony through and through. In order to evade rational estrangement and be aware of rational compatibility between systematical unique-genesis quantization formulation of universal existence & motion along sequential homologic cosmogony and traditionary sciences, we have to highlight rational discrepancy & compatibility between unique-genesis quantization formulation of hylic spacetime and traditionary idea of three dimensional coordinate, time rationale, distance rationale, mass rationale herein, so that it's possible for us to comprehend and authenticate systematical unique-genesis quantization formulation of universal existence & motion along sequential homologic cosmogony by traditionary methodology of relative measurement & quantification of human. At any rate, there is really remarkable rational discrepancy between systematical unique-genesis quantization formulation of universal existence & motion along sequential homologic cosmogony and relative measurement & quantification of human of tradition.

Considered by Homogenous Cosmos Originated from Unique Genesis, cosmos is throughout homogenous originated from unique genesis, space, time, mass are but three serial homologic physical noumenon in cosmos, and all the three serial homologic physical noumenon are but stochastic variables related to spontaneous transmutation & transition of space field genic units in space field, they are not constant in time current at all.

If we formulate the physical noumenon of “time T”, “space distance L”, “mass m” into quantization formulation with independent variable of basic quantum i_0 , then, the proper formulation of “time T”, “space distance L”, “mass m” can be primarily expressed as below:

$$\begin{cases} T = \theta(a * i_0, b * i_1, c * i_2, \dots f * i_n) & (a, b, c, \dots f \in \mathbb{N}; n \in \mathbb{N}, n \geq 2) \\ L = \beta(a * i_0, b * i_1, c * i_2, \dots f * i_n) & (a, b, c, \dots f \in \mathbb{N}; n \in \mathbb{N}, n \geq 2) \\ m = \int_0^t [d(M \rightarrow m) - d(M \leftarrow m)] > 0 \end{cases}$$

Homogenous Cosmos Originated from Unique Genesis confirms that cosmic contents is but a well-regulated cosmic homogeneity system making up of out-and-out serial natura naturans in the nature of coherent natura naturans throughout cosmic evolution. Throughout sequential homologic cosmogony, there is only unique inherent constant, it's just the quantification of single field genic origin i_0 , which is just the basic quantum i_0 in cosmos, all other physical noumenon are evolutionary ramification from field genic origin i_0 . As a result, all other physical noumenon in cosmos can be formulated as cumulation formulation with independent variable of field genic origin i_0 , they are all stochastic variable.

Comparably, traditionary sciences always insist that **time/s, distance/length/m, mass/Kg** are three basic dimensions, which are usually invoked as “**critierion reference**” for humanistic measurement & quantification of universal existence & motion, although, all “**critierion reference**” as **time/s, distance/length/m, mass/Kg** are innate inconstant in time current; although, introduction of such kind of inconstant “**critierion reference**” is really feasible and expedient for humanistic implementation of measurement & quantification of universal existence & motion, its practical limitation is self-evident

At any rate, in order to define “time”, we have to choose accessible “motion critierion reference”. For example, we choose earth rotation under general solar system spacetime condition in the nature of itself as motion critierion reference, we define the earth finishes a revolution around the sun is 1 year, 1 year= 365 days, the earth finishes a whole rotation circle in the nature of itself is 24 hours, and each hour makes up of 60 minutes, each minute makes up of 60 seconds. And in accordance with such kind of motion critierion reference, we come to measure and quantify motion speed of universal existence & motion.

In order to quantify “geometric length” of accessible objects around us or quantify distance among objects at different positions, we have to choose accessible “length critierion reference” under some certain spacetime condition for practical implementation of measurement & quantification of length of discretionary objects or distance among discretionary objects. For example, we define seemingly definite geometric length of accessible object under certain spacetime condition and certain temperature condition “**ruler with specific length**” as **length critierion reference** for practical implementation of relative measurement & quantification of accessible objects around us.

In order to quantify mass of discretionary objects accessible around us, we have to define certain object with definite gravitational effect on earth surface “mass weight” as **mass critierion reference** for implementation of measurement & quantification of discretionary object around us.

However, such kind of humanistic measurement & quantification of universal existence & motion apparently neglects remarkable authenticity that, in time current, nothing can be constant besides space field genic origin i_0 in cosmos. As a result, nothing besides space field genic origin i_0 in cosmos can be invoked as out-and-out **critierion reference** for humanistic implementation of measurement & quantification of universal existence & motion, conventional time, mass, length can never be exceptions.

All in all, as methodology discrepancy especially critierion reference choice for measurement & quantification of universal existence & motion, systematical unique-genesis quantization formulation of universal existence & motion along sequential homologic cosmogony in accordance with homogenous cosmos originated from unique genesis is apparently different from traditionary sciences.

Since cosmos is throughout homogenous originated from unique genesis and noumenon quantification of **space field genic origin i_0** is just the unique constant quantity throughout sequential homologic cosmogony, in order to accomplish systematical unique-genesis quantization formulation of universal existence & motion along sequential

homologic cosmogony, Homogenous Cosmos Originated from Unique Genesis has none reasons to turn a blind eye to rational choice of noumenon quantification of **space field genic origin i_0** as basic quantum for systematical unique-genesis quantization formulation of universal existence & motion along sequential homologic cosmogony. Such kind of measurement & quantification of universal existence & motion in accordance with independent variable and basic quantum of **space field genic origin i_0** is of course “absolute measurement & quantification” in the nature of things.

Relatively, as crevice progression of practical feasibility & possibility for historical progress of science, we have accomplished humanistic relative measurement & quantification of universal existence & motion on the basis of conventional rationale of default “**critereon reference**” as “mass weight-1 Kg”, “ruler-1 meter”, “time-1 second” etc in the nature of things. However, once we come to face authenticity of **homogenous cosmos originated from unique genesis** and have to challenge proportionate ideological consummation of **systematical unique-genesis quantization formulation of universal existence & motion along sequential homologic cosmogony**, we can hardly evade authenticity that, throughout homogenous cosmos, nothing besides space field genic origin i_0 can be constant in time current, which of course implies conventional “**critereon reference**” as “mass weight-1 Kg”, “ruler-1 meter”, “time-1 second” etc for humanistic relative measurement & quantification of universal existence & motion are virtually not out-and-out constant to be qualified **critereon reference** for measurement & quantification of universal existence & motion, practical limitation of humanistic relative measurement & quantification of universal existence & motion is of course self-evident.

And just because of this, since I am ready to accomplish systematical unique-genesis quantization formulation of universal existence & motion along sequential homologic cosmogony in the nature of coherent natura naturans throughout cosmic evolution, in order to eliminate unnecessary estrangement, I have to emphasize the methodology & rationale discrepancy between systematical absolute measurement & quantification of universal existence & motion along sequential homologic cosmogony (**systematical unique-genesis quantization formulation of universal existence & motion along sequential homologic cosmogony**) on the basis of quantum of physical noumenon quantification of space field genic origin i_0 and humanistic relative measurement & quantification of universal existence & motion on the basis of seemingly constant critereon reference accessible around us.

(V-iv-2) Systematical unique-genesis quantization formulation of serial natura naturata of “reciprocal PNT combinations in gradation I” in the nature of coherent natura naturans throughout cosmic evolution

Abstract: *As freewheeling of aberrant convergence of cosmic esse due to PNT reciprocal gelation, going with gradual enrichment of elementary genic units in spacetime, original generation, postnatal existence & motion of reciprocal PNT combinations in gradation I are successive easy outgrowth behind stochastic occurrence of [Stochastic (reciprocal idiosyncrasy towards PNT equilibrium + accessible space overall arrangement for PNT reciprocity) among elementary genic units in spacetime + Instinctive PNT reciprocal equilibrium towards optimum PNT operation]. Not only elementary genic units in spacetime are direct materials of reciprocal PNT combinations in gradation I, but also external mechanical features of elementary genic units are radical causes of original generation, postnatal existence & motion of reciprocal PNT combinations in gradation I.*

Systematical unique-genesis quantization formulation of serial natura naturata of “reciprocal PNT combinations in gradation I” is job focusing on two issues as below:

i) *Clarify the full spacetime condition of “aberrant convergence of cosmic esse due to PNT reciprocal gelation”, proper PNT operation model and dynamic regularity of “aberrant convergence of cosmic esse due to PNT reciprocal gelation”. Proper PNT operation model and dynamic regularity of “aberrant convergence of cosmic esse due to PNT reciprocal gelation” must be coherent natura naturans throughout cosmic evolution which is motivity of sequential homologous cosmogony through and through. The key issue is that we must accomplish unique-genesis quantification formulation of coherent natura naturans throughout cosmic evolution.*

2) *On the basis of clarification of PNT operation model and dynamic regularity of “aberrant convergence of cosmic esse due to PNT reciprocal gelation”, it’s necessary for us to deduce the possible sorts and proportionate mass convergent aggradation m of reciprocal PNT combinations in gradation I. and in accordance with mathematical definition of Homogenous Cosmos Originated from Unique Genesis, try to accomplish unique-genesis quantization formulation of distinctive existence & motion of reciprocal PNT combinations in gradation I.*

The practical difficulty of rational highlight of the three items above generally derives from:

A) *The so-called elementary genic units/basic particles in cosmos have not been ascertained yet, and as a result, the systematical unique-genesis quantization formulation of hyllic space field has not been consummated in accordance with solid authentication and analysis of distinctive existence & motion of elementary genic units/basic particles. I am genuinely sorry, as lowdown man of the society and typical heterodoxy of the age, I have no necessary academic conditions, no more necessary experimental conditions for the endeavor.*

B) *“Instinctive PNT equilibrium postulate” & “PNT dynamic” still need necessary authentication & demonstration, I can not exclude the possibility that PNT dynamics still need necessary optimization for my personal limitation.*

C) *Coherent natura naturans throughout cosmic evolution about universal existence & motion still need necessary authentication and demonstration.*

Keywords: *reciprocal PNT combinations in gradation I, instinctive PNT reciprocal equilibrium towards optimum PNT operation, aberrant convergence of cosmic esse due to PNT reciprocal gelation, optimum PNT genic linkage, inverted reciprocal convergence of optimum PNT genic linkages.*

Since cosmos is throughout homogenous originated from unique genesis, cosmic status quo is demiurgic aggradation of sequential homologic cosmogony, which exactly exists as well-regulated integration of cosmic homogeneity system making up of out-and-out serial natura naturata in the nature of coherent natura naturans throughout cosmic evolution, demiurgic clew of sequential homologic cosmogony of homogenous cosmos is of course step-by-step and explicit. The key issues are that, there are still some necessary demiurgic details of sequential homologic cosmogony need clarification & authentication, especially the hypostatic existent contents of space field, elementary genic units of positive matter in spacetime. However, as historical limitation and personal limitation, it seems impossible for me to implement and consummate related clarification & authentication accordingly today. As a result, presence of undefined issues of sequential homologic cosmogony make endeavor of systematical unique-genesis quantization formulation of universal existence & motion along sequential homologic cosmogony starting at field genic origin i_0 to universal reciprocal PNT combinations in the nature of coherent natura naturans throughout cosmic evolution neither definitely continuous following a rational line nor authentically explicit.

This was of course my original resistance & perplexity to step out for the job many years ago, and virtually, the uncertainty of related issues of sequential homologic cosmogony really bring me serious perplexity to smooth the job of systematical unique-genesis quantization formulation of universal existence & motion along sequential homologic cosmogony starting at field genic origin i_0 to universal reciprocal PNT combinations in the nature of coherent natura naturans throughout cosmic evolution. Whereas, as pioneering endeavor towards so grand scientific pursuit, it seems we can neither leave all necessary jobs undone aside nor fondly expect to consummate it once through and through in defiance of temporary clarification unavailability of related issues of sequential homologic cosmogony, it's necessary for us to do what we can do to highlight systematical unique-genesis quantization formulation of universal existence & motion along sequential homologic cosmogony starting at field genic origin i_0 to universal reciprocal PNT combinations in the nature of coherent natura naturans throughout cosmic evolution as much as possible, although, we have to slide over a lot of temporary clarification unavailability of related issues of sequential homologic cosmogony. Hypostatic endeavor of historical progress of science is not unpractical ambition to arrive at perfect ideological enantiomorph of ultimate authenticity of nature today or tomorrow but endeavor to push humanistic ideology about authenticity of nature forward to perfect ideological enantiomorph of ultimate authenticity of nature step by step draw on practical feasibility & possibility in proportion to contemporaneous historical background.

1) Sequential homologic cosmogony——[Stochastic (reciprocal idiosyncrasy towards PNT equilibrium + accessible space overall arrangement for PNT reciprocity) + Instinctive PNT reciprocal equilibrium towards optimum PNT operation] offer noumenon layout, Coherent natura naturans throughout cosmic evolution composes melody accordingly.

Cosmic evolution is firstly evolution of hyllic space field, till at last mature cosmic white extent comes into being, which is negative substance suffusion extent. Then, it's demiurgic freewheeling of formation of cosmic yolk extent whose hardcore feature is aberrant convergence of cosmic esse due to PNT reciprocal gelation,

Of course, original naissance of elementary genic units are the start of aberrant convergence of cosmic esse due to PNT reciprocal gelation.

As freewheeling of aberrant convergence of cosmic esse due to PNT reciprocal gelation in the nature of coherent natura naturans throughout cosmic evolution, going with gradual enrichment of elementary genic units in spacetime,

As coherent natura naturans throughout cosmic evolution, instinctive PNT reciprocal equilibrium towards optimum PNT operation is radical potentiality & conditionality for cosmos always ready to orientate itself towards perfection.

original generation, postnatal existence & motion of reciprocal PNT combinations in gradation I are successive easy outgrowth behind stochastic occurrence of [(reciprocal idiosyncrasy towards PNT equilibrium + accessible space overall arrangement for PNT reciprocity) among elementary genic units in spacetime + Instinctive PNT reciprocal equilibrium towards optimum PNT operation]. Not only elementary genic units in spacetime are direct materials of reciprocal PNT combinations in gradation I, but also external mechanical features of compositive elementary genic units are radical causes of original generation, postnatal existence & motion of reciprocal PNT combinations in gradation I.

As freewheeling of aberrant convergence of cosmic esse due to PNT reciprocal gelation/sequential homologic cosmogony in the nature of coherent natura naturans throughout cosmic evolution, going with gradual enrichment of reciprocal PNT combinations in gradation I in spacetime, original naissance, postnatal existence & motion of reciprocal PNT combinations in gradation II are successive easy outgrowth behind stochastic occurrence of [(reciprocal idiosyncrasy towards PNT equilibrium + accessible space overall arrangement for PNT reciprocity) among reciprocal PNT combinations in gradation I in spacetime + Instinctive PNT reciprocal equilibrium towards optimum PNT operation]. Not only reciprocal PNT combinations in gradation I in spacetime are direct materials of reciprocal PNT combinations in gradation II, but also external mechanical features of compositive reciprocal PNT combinations in gradation I are radical causes of original generation, postnatal existence & motion of reciprocal PNT combinations in gradation II.

As freewheeling of aberrant convergence of cosmic esse due to PNT reciprocal gelation/sequential homologic cosmogony in the nature of coherent natura naturans throughout cosmic evolution, going with gradual enrichment of reciprocal PNT combinations in gradation II in spacetime, original naissance, postnatal existence & motion of reciprocal PNT combinations in gradation III are successive easy outgrowth behind stochastic occurrence of [(reciprocal idiosyncrasy towards PNT equilibrium + accessible space overall arrangement for PNT reciprocity) among reciprocal PNT combinations in gradation II even sub reciprocal PNT combinations in gradation III in spacetime + Instinctive PNT reciprocal equilibrium towards optimum PNT operation]. Not only reciprocal PNT combinations in gradation II in spacetime are direct materials of reciprocal PNT combinations in gradation III, but also external mechanical features of compositive reciprocal PNT combinations in gradation II even sub reciprocal PNT combinations in gradation III are radical causes of original generation, postnatal existence & motion of reciprocal PNT combinations in gradation III.

As freewheeling of aberrant convergence of cosmic esse due to PNT reciprocal gelation/sequential homologic cosmogony in the nature of coherent natura naturans throughout cosmic evolution, going with gradual enrichment of reciprocal PNT combinations in gradation III even sub-reciprocal PNT combinations in gradations IV in spacetime, original naissance, postnatal existence & motion of reciprocal PNT combinations in gradation IV are successive easy outgrowth behind stochastic occurrence of [(reciprocal idiosyncrasy towards PNT equilibrium + accessible space overall arrangement for PNT reciprocity) among reciprocal PNT combinations in gradation III even sub-reciprocal PNT combinations in gradations IV in spacetime + Instinctive PNT reciprocal equilibrium towards optimum PNT operation]. Not only reciprocal PNT combinations in gradation III even sub reciprocal PNT combinations in gradation IV in spacetime are direct materials of reciprocal PNT combinations in gradation IV, but also external mechanical features of compositive reciprocal PNT combinations in gradation III even sub reciprocal PNT combinations in gradation IV are radical causes of original generation, postnatal existence & motion of reciprocal PNT combinations in gradation IV.

Successive naissance and postnatal vivid existence & motion of elementary genic units, reciprocal PNT combinations in gradation I, reciprocal PNT combinations in gradation II, reciprocal PNT combinations in gradation III, reciprocal PNT combinations in gradation IV in spacetime make up of integrative cosmic evolution brought out by freewheeling aberrant convergence of cosmic esse due to PNT reciprocal gelation. The motivity of aberrant convergence of cosmic

Historical progress of science in the recent several centuries seemed like a far-flung exploration of the first itinerary around numerous distinctive landscapes of brand-new landmasses of science with palette & tablet on back, several hundred years' scientific travelogues were compiled thereby.

esse due to PNT reciprocal gelation is of course coherent natura naturans throughout cosmic evolution which is just instinctive PNT reciprocal equilibrium towards optimum PNT operation.

It is only possible for concordant cosmos to be demiurgic aggradation of out-and-out serial natura naturata in the nature of coherent natura naturans throughout cosmic evolution; there is no way for demiurgic aggradation in the nature of different natura naturans to be concordant cosmos through and through. If we say cosmos is aesthetically regular, the unique aesthetic regularity of cosmos is but sequential homologic cosmogony in the nature of coherent natura naturans throughout cosmic evolution. Integrative sequential homologic cosmogony in the nature of coherent natura naturans throughout cosmic evolution can be illustrated as below:

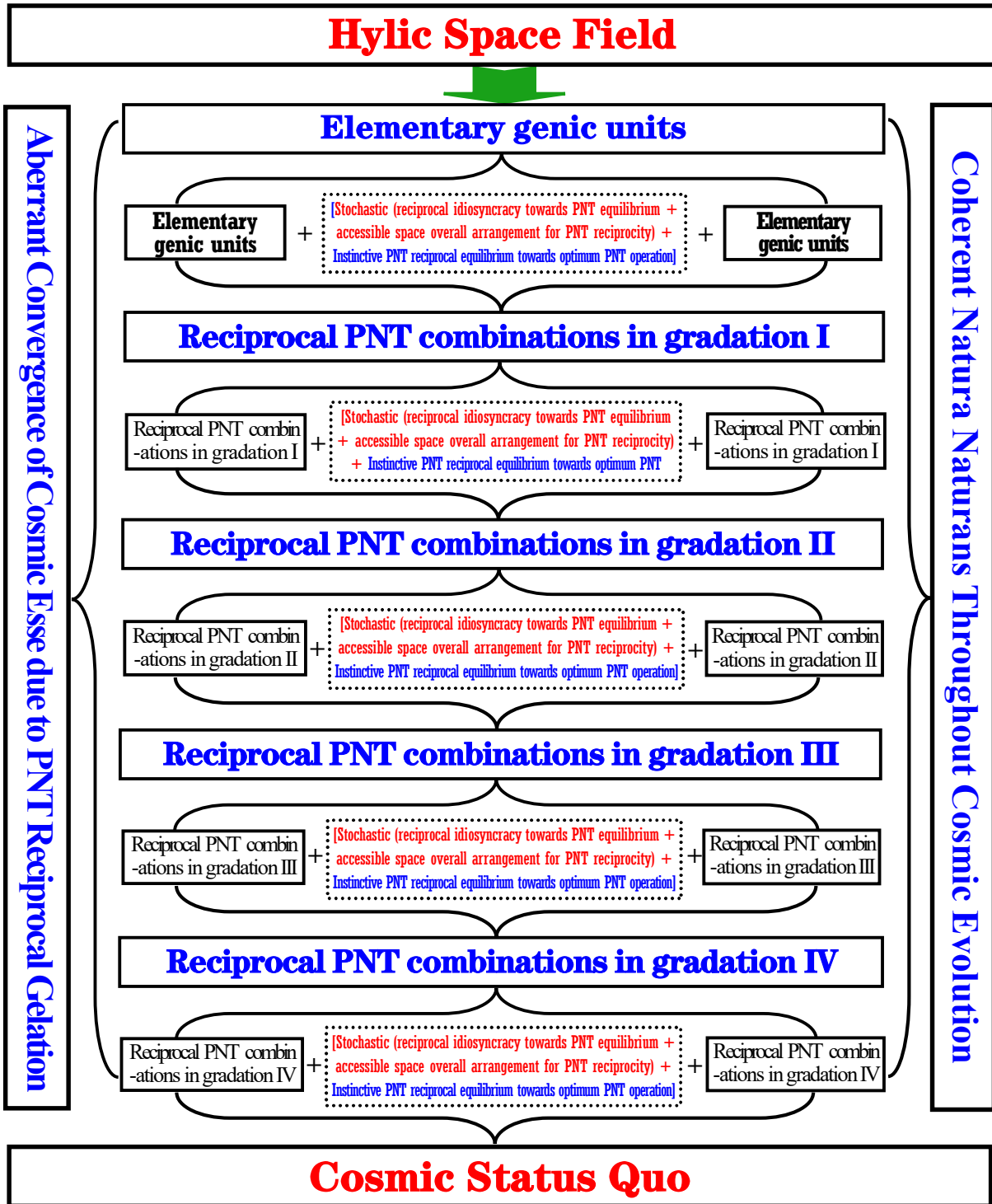

As coherent natura naturans throughout cosmic evolution, instinctive PNT reciprocal equilibrium towards optimum PNT operation is radical potentiality & conditionality for cosmos always ready to orientate itself towards perfection.

(V-iv-2-a) Illustration of integrative sequential homologic cosmogony

2) “Optimum PNT operation model” and “aberrant convergence of cosmic esse due to PNT reciprocal gelation & consequent existence & motion”.

As historical limitation & personal limitation, we are still difficult to draw positive conclusion how many space field genic units in space field, whereas, for expedience of possible theoretical exploration of systematical unique-genesis quantization formation of universal existence & motion along sequential homologic cosmogony, it’s wise for us to introduce hypothetical genic unit series as $i_0, i_1, i_2, \dots, i_n, (n \in \mathbb{N})$ in space field, which indicates there are $n+1$ sorts of space genic units in space field.

As linear logic extension on the basis of [Homogenous cosmos originated from unique genesis + Spacetime~matter fully embodying cosmos], PNT action is not only creative action for original generation of matter in spacetime but also headspring action of enantiomorphous existence & motion of matter integration in spacetime. In accordance with object presence of PNT action of matter integration and proportionate distinctive existence & motion accessible around us, we have many many reasons to introduce “Instinctive PNT equilibrium postulate” to specify PNT action accordingly for it’s really important for us to highlight universal existence & motion radically. And virtually, once “Instinctive PNT equilibrium postulate” is introduced, PNT action seems invisible numen of universal existence & motion, which straightforwardly makes universal existence & motion self-evident as spontaneous occurrence of [External physical disturbance + (PNT action + instinctive PNT equilibrium)].

Since PNT action of universal objects has PNT equilibrium instinct, PNT action under inherent guidance of equilibrium instinct must have its inherent optimum operational model, and virtually, it’s only possible for PNT operation to orientate to optimum operation model due to unconditional presence & validity of PNT equilibrium instinct. For expedience of rational highlight of optimum PNT operational model, it seems necessary for us to suppose the optimum PNT operational model as below:

$$A * i_0, B * i_1, C * i_2, \dots, F * i_n, (n \in \mathbb{N}, A, B, C, \dots, F \in \mathbb{N})$$

In straightforward words, once the PNT operational linkage making up of A PCS field genic unit i_0 , B PCS field genic unit i_1 , C PCS field genic unit i_2 , ..., F PCS field genic unit i_n , the PNT action must be the optimum PNT operation by the light of nature.

Of course, before ultimate authentication, in terms of optimum PNT operational model, we can only suppose it like this, whereas, we have to admit there are still substantial uncertain possibility towards authenticity highlight, which of course makes related issues more complex for us to arrange. For convenient and expedient clarification & comprehension, we can properly simplify it, for instance, we can come to highlight and clarify related issues in accordance with the optimum PNT operational model as Taiji-8-Gua illustration.

2-a) Mechanical connotation of instinctive PNT reciprocal equilibrium towards optimum PNT operation of matter integration.

Virtually, instinctive PNT reciprocal equilibrium towards optimum PNT operation is just the coherent natura naturans throughout cosmic evolution, which is motivity of aberrant convergence of cosmic esse due to PNT reciprocal gelation out of question.

(1). Since PNT action is not only headspring action of original generation of matter in spacetime but also enantiomorphous dynamic origin of vivid existence & motion of matter in spacetime, we can conclude without hesitation that coherent natura naturans throughout cosmic evolution must radically relate to “PNT action” .

Historical progress of science in the recent several centuries seemed like a far-flung exploration of the first itinerary around numerous distinctive landscapes of brand-new landmasses of science with palette & tablet on back, several hundred years’ scientific travelogues were compiled thereby.

(2). As omnipotence of the demiurge, coherent natura naturans throughout cosmic evolution must crown all universal mechanical phenomena in cosmos, if not, it's completely impossible/unqualified for it to be omnipotence of the demiurge.

(3). Since coherent natura naturans throughout cosmic evolution must crown all universal mechanical phenomena in cosmos, it's completely impossible for universal mechanical phenomena in cosmos to be made up of so-called "four fundamental forces". In any case, coherent natura naturans throughout cosmic evolution must include so-called "four fundamental forces", whereas, nothing is compatible between "four fundamental forces" and coherent natura naturans throughout cosmic evolution, there is neither way for so-called "four fundamental forces" to make up of coherent natura naturans throughout cosmic evolution nor way for coherent natura naturans throughout cosmic evolution to include so-called "four fundamental forces".

Since any PNT action of matter integration has inherent instinctive PNT reciprocal equilibrium towards optimum PNT operation, then, once it's possible or conditions permit, instinctive PNT reciprocal equilibrium towards optimum PNT operation must accomplish PNT reciprocal equilibrium towards optimum PNT operation by the light of nature, this is just motivity of mechanical reaction.

For instance, relative to optimum PNT operational model of $A^*i_0, B^*i_1, C^*i_2, \dots F^*i_n$ ($n \in \mathbb{N}, A, B, C, \dots F \in \mathbb{N}$), as some certain inherent limitation, the PNT operational linkage of matter integration 1 is only limited in $A^*i_0, B^*i_1, C^*i_2, (n \in \mathbb{N}, A, B, C \in \mathbb{N})$, the PNT operational linkage of matter integration 2 is only limited in $D^*i_3, \dots F^*i_n$, ($D, F \in \mathbb{N}$), once the matter integration 1 and matter integration 2 stochastically accomplish "**reciprocal idiosyncrasy towards PNT equilibrium + accessible space overall arrangement for PNT reciprocity**", then, instinctive PNT reciprocal equilibrium towards optimum PNT operation must accomplish connection of PNT operational linkage of matter integration 1 and PNT operational linkage of matter integration 2 as much as possible, so that the resultant integrative PNT operational model of "matter integration 1+ matter integration 2" can be as perfect as possible.

Situation like this that, relative to optimum PNT operational model of $A^*i_0, B^*i_1, C^*i_2, \dots F^*i_n$ ($n \in \mathbb{N}, A, B, C, \dots F \in \mathbb{N}$), the both PNT operational linkages of matter integrations are apparently fragmentary but mutually compensatory, once the both matter integrations stochastically accomplish "**reciprocal idiosyncrasy towards PNT equilibrium + accessible space overall arrangement for PNT reciprocity**", there must be instinctive PNT reaction towards optimum PNT operation by the right of instinctive PNT reciprocal equilibrium towards optimum PNT operation, the so-called "instinctive PNT reaction towards optimum PNT operation" may be just the domino effect of so-called "**strong interaction**" from traditionary physics.

Secondly, relative to optimum PNT operational model $A^*i_0, B^*i_1, C^*i_2, \dots F^*i_n$ ($n \in \mathbb{N}, A, B, C, \dots F \in \mathbb{N}$), there is some certain **genic insufficiency** in PNT operation linkage of matter integration I, so that the PNT operation of matter integration is not optimum PNT operation, and there is some certain **genic preponderance** in PNT operation linkage of matter integration II, so that the PNT operation of matter integration is not optimum PNT operation.

Whereas, if there are matter integration I-1 and matter integration I-2 with the same **genic insufficiency** in PNT operational linkage, once the both matter integrations stochastically accomplish "**reciprocal idiosyncrasy towards PNT equilibrium + accessible space overall arrangement for PNT reciprocity**", as presence of inherent instinctive PNT reciprocal equilibrium towards optimum PNT operation, mechanical interaction between matter integration I-1 and matter integration I-2 must be hypostatized accordingly as below:

As coherent natura naturans throughout cosmic evolution, instinctive PNT reciprocal equilibrium towards optimum PNT operation is radical potentiality & conditionality for cosmos always ready to orientate itself towards perfection.

$$[(\text{PNT action} + \text{PNT equilibrium instinct}) + \text{genic insufficiency}] + [\text{genic insufficiency} + (\text{PNT action} + \text{PNT equilibrium instinct})]$$

=Electromagnetic repulsion between positive charges

If there are matter integration II-1 and matter integration II-2 with the same **genic preponderance** in PNT operational linkage, once the both matter integrations stochastically accomplish “**reciprocal idiosyncrasy towards PNT equilibrium + accessible space overall arrangement for PNT reciprocity**”, as presence of inherent instinctive PNT reciprocal equilibrium towards optimum PNT operation, mechanical interaction between matter integration II-1 and matter integration II-2 must be hypostatized accordingly as below:

$$[(\text{PNT action} + \text{PNT equilibrium instinct}) + \text{genic preponderance}] + [\text{genic preponderance} + (\text{PNT action} + \text{PNT equilibrium instinct})]$$

=Electromagnetic repulsion between negative charges

If there are matter integration I with the some certain **genic insufficiency** in PNT operational linkage and matter integration II with the some certain **genic preponderance** in PNT operational linkage, once the both matter integrations stochastically accomplish “**reciprocal idiosyncrasy towards PNT equilibrium + accessible space overall arrangement for PNT reciprocity**”, as presence of inherent instinctive PNT reciprocal equilibrium towards optimum PNT operation, mechanical interaction between matter integration I and matter integration I must be hypostatized accordingly as below:

$$[(\text{PNT action} + \text{PNT equilibrium instinct}) + \text{genic insufficiency}] + [\text{genic preponderance} + (\text{PNT action} + \text{PNT equilibrium instinct})]$$

=Electromagnetic abstraction between different charges

This is just something about electromagnetic interaction of traditional physics.

Even if there is neither **genic insufficiency** nor **genic preponderance** in PNT operational linkage of matter integration 1 and matter integration 2, once there is matter field superposition between matter integration 1 and matter integration 2, as inherent sensitive participant of PNT operation, matter field superposition must impact stationary state of PNT operation of matter integration therefore. As a result, instinctive PNT reciprocal equilibrium towards optimum PNT operation must react to do its job to optimize PNT operation of matter integration accordingly, dynamic domino effect of so-called gravitational reciprocity as “**mass disparity accessible to positive gravity & mass approximation accessible to negative gravity**” is hypostatized therefore.

2-b) Aberrant convergence of cosmic esse due to PNT reciprocal gelation under guidance of instinctive PNT reciprocal equilibrium towards optimum PNT operation.

Occurrence of aberrant convergence of cosmic esse due to PNT reciprocal gelation must indicate occurrence of more super endocentric optimum PNT operation model than outward optimum PNT operation of matter integration. In terms of discretionary matter integration in spacetime, outward optimum PNT operation of matter integration makes matter integration has inherent absolute spacetime momentum $mV=d(M \leftarrow m)*Y$. Comparably, occurrence of more super endocentric optimum PNT operation model brings out relatively steady mass convergent aggradation m of matter integration $\int_0^t [d(M \rightarrow m) - d(M \leftarrow m)] dt = m > 0$.

In accordance with our general experience about vivid existence & motion accessible around us + homogenous cosmos originated from unique genesis, we can primarily arrive at three issues related to occurrence of aberrant convergence of cosmic esse due to PNT reciprocal gelation as below:

A) Once there is occurrence of aberrant convergence of cosmic esse due to PNT reciprocal gelation, the background space field must mature space field, even though there are still no matter integrations in spacetime,

Historical progress of science in the recent several centuries seemed like a far-flung exploration of the first itinerary around numerous distinctive landscapes of brand-new landmasses of science with palette & tablet on back, several hundred years' scientific travelogues were compiled thereby.

there must be optimum PNT operational linkage in spacetime leastways.

B) There must be background quantitative crescive tendence of spacetime, although, spacetime has been relatively mature.

C) Under precondition there are optimum PNT operational linkages in mature space field, as positive crescive quantitative change of mature space field is still on going, the optimum PNT operational linkages must occur proportionate qualitative change without alternatives, the proportionate qualitative change of optimum PNT operational linkages is just occurrence of **aberrant convergence of cosmic esse due to PNT reciprocal gelation**. Although, as various limitation, we are still not convenient to confirm the definite qualitative change of optimum PNT operational linkages forward to aberrant convergence of cosmic esse due to PNT reciprocal gelation, some related issues we can confirm are generally as below:

①. Since PNT action has instinctive PNT reciprocal equilibrium towards optimum PNT operation, connatural operation of PNT action must be in optimum PNT genic linkages out of question through and through. And as a result, once it's necessary for space field to implement necessary qualitative change, the proportionate implementors must be optimum PNT genic linkages. Otherwise, it's almost impossible for the homologic cosmogony to be sequential through and through.

②. The quantitative change of **aberrant convergence of cosmic esse due to PNT reciprocal gelation** are not only able to divert physical noumenon of crescive quantitative change of mature space field and retard strength extra-increment of space field consequently but also make the mass convergent aggradation of matter integration more and more massive, existence & motion of matter integration more and more steady.

Although, before ultimate verification of space field genic species and attribution, we are not convenient to ascertain definite operational model of aberrant convergence of cosmic esse due to PNT reciprocal gelation, in order to highlight related characters of aberrant convergence of cosmic esse due to PNT reciprocal gelation, it wise and necessary for us to introduce possible operational model for further highlight of operational model of aberrant convergence of cosmic esse due to PNT reciprocal gelation. For instance, we can introduce an assumable operational model of aberrant convergence of cosmic esse due to PNT reciprocal gelation as inverted reciprocal convergence between optimum PNT genic linkage $A^*i_0, B^*i_1, C^*i_2, \dots F^*i_n, (n \in \mathbb{N}, A, B, C, \dots F \in \mathbb{N})$ and optimum PNT genic linkage $F^*i_n, \dots C^*i_2, B^*i_1, A^*i_0, (n \in \mathbb{N}, A, B, C, \dots F \in \mathbb{N})$, which obviously makes the PNT operational model of matter integration more reciprocal and endocentric. Such kind of endocentric reciprocity between optimum PNT genic linkage “ $A^*i_0, B^*i_1, C^*i_2, \dots F^*i_n, (n \in \mathbb{N}, A, B, C, \dots F \in \mathbb{N})$ ” and optimum PNT genic linkage “ $F^*i_n, \dots C^*i_2, B^*i_1, A^*i_0, (n \in \mathbb{N}, A, B, C, \dots F \in \mathbb{N})$ ” is of course ideal physical noumenon of aberrant convergence of cosmic esse due to PNT reciprocal gelation, which makes matter integration more massive and steady.

For expression expedience, we can of course call the inverted reciprocal convergence between optimum PNT genic linkage $A^*i_0, B^*i_1, C^*i_2, \dots F^*i_n, (n \in \mathbb{N}, A, B, C, \dots F \in \mathbb{N})$ and optimum PNT genic linkage $F^*i_n, \dots C^*i_2, B^*i_1, A^*i_0, (n \in \mathbb{N}, A, B, C, \dots F \in \mathbb{N})$ **inverted reciprocal convergence of optimum PNT genic linkages**.

Of course, before accomplishment of inverted reciprocal convergence of optimum PNT genic linkages between optimum PNT genic linkage $A^*i_0, B^*i_1, C^*i_2, \dots F^*i_n, (n \in \mathbb{N}, A, B, C, \dots F \in \mathbb{N})$ and optimum PNT genic linkage $F^*i_n, \dots C^*i_2, B^*i_1, A^*i_0, (n \in \mathbb{N}, A, B, C, \dots F \in \mathbb{N})$, PNT operational connection & succession of optimum

PNT genic linkages are mostly linear connection & succession of optimum PNT genic linkages under guidance of PNT equilibrium instinct, which can be illustrated as below:

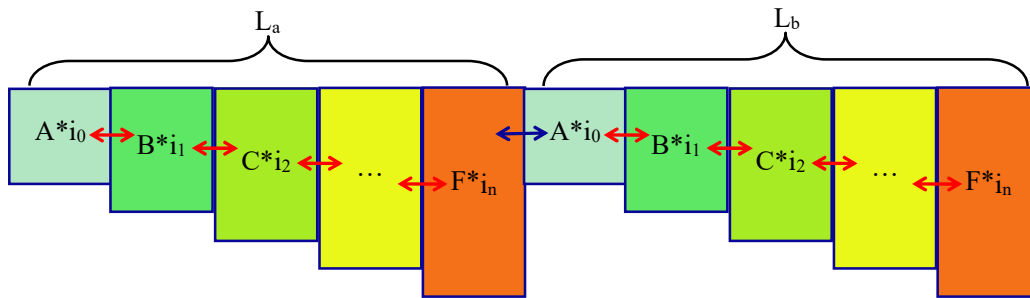

(V-iv-2-b) Connatural linear connection & succession among optimum PNT genic linkages in space field

In illustration above, the L_a denotes the first optimum PNT genic linkage in succession of integrative PNT operation of matter integration, the L_b denotes the second optimum PNT genic linkage in succession of integrative PNT operation of matter integration. Under precondition that matter field of matter integration keeps constant, linear connection & succession among optimum PNT genic linkages is the general operation model of PNT action in matter field. Of course, the linear connection & succession among optimum PNT genic linkages is not limited in L_a and L_b , linear connection & succession among optimum PNT genic linkages has no limitation in spacetime.

Whereas, if there is still crecive tendency of mature space field, there must be qualitative change of inverted reciprocal convergence of optimum PNT genic linkages between optimum PNT genic linkage $A^*_{i_0}, B^*_{i_1}, C^*_{i_2}, \dots, F^*_{i_n}$, ($n \in \mathbb{N}, A, B, C, \dots, F \in \mathbb{N}$) and optimum PNT genic linkage $F^*_{i_n}, \dots, C^*_{i_2}, B^*_{i_1}, A^*_{i_0}$, ($n \in \mathbb{N}, A, B, C, \dots, F \in \mathbb{N}$), which can be illustrated as below:

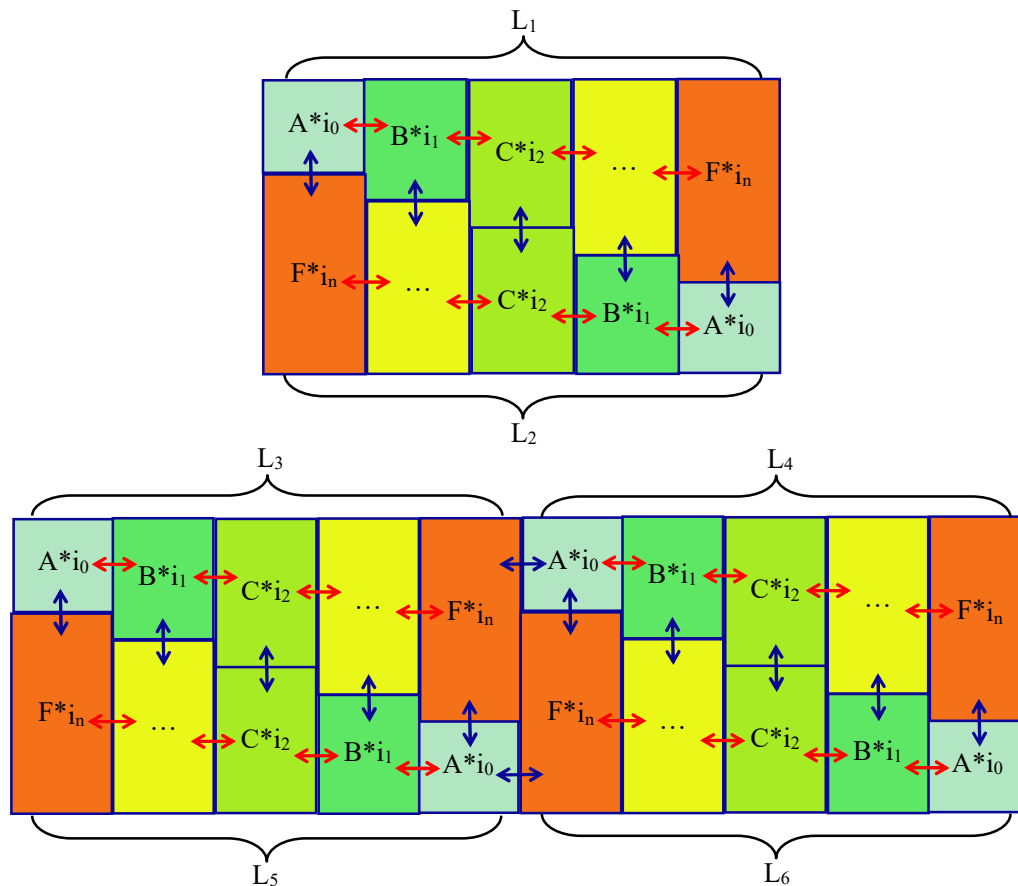

Historical progress of science in the recent several centuries seemed like a far-flung exploration of the first itinerary around numerous distinctive landscapes of brand-new landmasses of science with palette & tablet on back, several hundred years' scientific travelogues were compiled thereby.

(V-iv-2-c) Inverted reciprocal convergence of optimum PNT genic linkages in extra-mature space field

Compared to the linear connection & succession of optimum PNT genic linkage L_a and optimum PNT genic linkage L_b in above illustration, there is more “reciprocal PNT transmutation & transition” as illustrated by the vertical arrows in blue between L_1 optimum PNT genic linkage and L_2 optimum PNT genic linkage, which are of course more endocentric PNT action of matter integration. And similar transmutation and transition indicated by blue arrows between L_3 and L_4 , L_5 and L_6 even enhances domino effect of aberrant convergence of cosmic esse due to PNT reciprocal gelation. Consequence of aberrant convergence of cosmic esse due to PNT reciprocal gelation not only increase mass convergent aggradation but also make matter integration more steady.

Practical accomplishment of aberrant convergence of cosmic esse due to PNT reciprocal gelation is not only proportionably conditional but also relatively gradual. Aberrant convergence of cosmic esse due to PNT reciprocal gelation includes original generation of elementary genic units, reciprocal PNT combinations in gradation I, reciprocal PNT combinations in gradation II, reciprocal PNT combinations in gradation III, reciprocal PNT combinations in gradation IV along sequential homologous cosmogony.

①. Conditionality of aberrant convergence of cosmic esse due to PNT reciprocal gelation

There is no way for practical accomplishment of aberrant convergence of cosmic esse due to PNT reciprocal gelation to be unconditional.

In terms of elementary genic units, original generation of elementary genic units in spacetime is but connatural outgrowth of extra positive quantitative change of mature space field.

In terms of reciprocal PNT combinations in gradation I, original generation of reciprocal PNT combinations in gradation I in spacetime is but connatural outgrowth of [(reciprocal idiosyncrasy towards PNT equilibrium + accessible space overall arrangement for PNT reciprocity) among elementary genic units in spacetime + Instinctive PNT reciprocal equilibrium towards optimum PNT operation].

In terms of reciprocal PNT combinations in gradation II, original generation of reciprocal PNT combinations in gradation II in spacetime is but connatural outgrowth of [(reciprocal idiosyncrasy towards PNT equilibrium + accessible space overall arrangement for PNT reciprocity) among reciprocal PNT combinations in gradation I + Instinctive PNT reciprocal equilibrium towards optimum PNT operation].

In terms of reciprocal PNT combinations in gradation III, original generation of reciprocal PNT combinations in gradation III in spacetime is but connatural outgrowth of [(reciprocal idiosyncrasy towards PNT equilibrium + accessible space overall arrangement for PNT reciprocity) among reciprocal PNT combinations in gradation II even sub reciprocal PNT combinations in gradation III + Instinctive PNT reciprocal equilibrium towards optimum PNT operation].

In terms of reciprocal PNT combinations in gradation IV, original generation of reciprocal PNT combinations in gradation IV in spacetime is but connatural outgrowth of [(reciprocal idiosyncrasy towards PNT equilibrium + accessible space overall arrangement for PNT reciprocity) among reciprocal PNT combinations in gradation III even sub-reciprocal PNT combinations in gradations IV in spacetime + Instinctive PNT reciprocal equilibrium towards optimum PNT operation].

②. Graduality of aberrant convergence of cosmic esse due to PNT reciprocal gelation

The graduality of aberrant convergence of cosmic esse due to PNT reciprocal gelation just indicates that accomplishment of aberrant convergence of cosmic esse due to PNT reciprocal gelation is not one-off affair, implementation of aberrant convergence of cosmic esse due to PNT reciprocal gelation can never exhaust all

As coherent natura naturans throughout cosmic evolution, instinctive PNT reciprocal equilibrium towards optimum PNT operation is radical potentiality & conditionality for cosmos always ready to orientate itself towards perfection.

absolute spacetime momentum of matter integration but exhaust some of it step by step.

In terms of original generation of **elementary genic units** in spacetime, as presence of positive crecive quantitative change of mature space field, the optimum PNT operational linkages have to instinctively react for inverted reciprocal convergence of optimum PNT genic linkages, aberrant convergence of cosmic esse due to PNT reciprocal gelation occurs therefore. Whereas, accomplishment of aberrant convergence of cosmic esse due to PNT reciprocal gelation does not make the consequent elementary genic units in spacetime absolutely stationary, instead, all elementary genic units in cosmos exist as radiations moving in light speed, whose absolute spacetime momentum $mV=d(M \leftarrow m)*Y$ is of course imaginable.

In terms of original generation of **reciprocal PNT combinations in gradation I** in spacetime, as stochastic occurrence of **[(reciprocal idiosyncrasy towards PNT equilibrium + accessible space overall arrangement for PNT reciprocity) among elementary genic units in spacetime + Instinctive PNT reciprocal equilibrium towards optimum PNT operation]**, reciprocal PNT combinations in gradation I come into being as consequence of aberrant convergence of cosmic esse due to PNT reciprocal gelation. Whereas, accomplishment of aberrant convergence of cosmic esse due to PNT reciprocal gelation only slightly reduce some of the absolute spacetime momentum of the compositive elementary genic units, the mass convergent aggradation of consequent reciprocal PNT combinations in gradation I slightly increase in proportion to decrease of absolute spacetime momentum of compositive elementary genic units, and the absolute spacetime momentum of the consequent reciprocal PNT combinations in gradation I is of course self-evident.

In terms of original generation of **reciprocal PNT combinations in gradation II** in spacetime, as stochastic occurrence of **[(reciprocal idiosyncrasy towards PNT equilibrium + accessible space overall arrangement for PNT reciprocity) among reciprocal PNT combinations in gradation I in spacetime + Instinctive PNT reciprocal equilibrium towards optimum PNT operation]**, reciprocal PNT combinations in gradation II come into being as consequence of aberrant convergence of cosmic esse due to PNT reciprocal gelation. Whereas, accomplishment of aberrant convergence of cosmic esse due to PNT reciprocal gelation only slightly reduce some of the absolute spacetime momentum of the compositive reciprocal PNT combinations in gradation I, the mass convergent aggradation of consequent reciprocal PNT combinations in gradation II slightly increase in proportion to decrease of spacetime momentum of compositive reciprocal PNT combinations in gradation I, and the absolute spacetime momentum of the consequent reciprocal PNT combinations in gradation II is of course self-evident.

In terms of original generation of **reciprocal PNT combinations in gradation III** in spacetime, as stochastic occurrence of **[(reciprocal idiosyncrasy towards PNT equilibrium + accessible space overall arrangement for PNT reciprocity) among reciprocal PNT combinations in gradation II even sub reciprocal PNT combinations in gradation III in spacetime + Instinctive PNT reciprocal equilibrium towards optimum PNT operation]**, reciprocal PNT combinations in gradation III come into being as consequence of aberrant convergence of cosmic esse due to PNT reciprocal gelation. Whereas, accomplishment of aberrant convergence of cosmic esse due to PNT reciprocal gelation only slightly reduce some of the absolute spacetime momentum of the compositive reciprocal PNT combinations in gradation II even sub reciprocal PNT combinations in gradation III, the mass convergent aggradation of consequent reciprocal PNT combinations in gradation III slightly increase in proportion to decrease of absolute spacetime momentum of compositive reciprocal PNT combinations in gradation II even sub reciprocal PNT combinations in gradation III, and the absolute spacetime momentum of the consequent reciprocal PNT combinations in gradation III is of course self-evident.

In terms of original generation of reciprocal PNT combinations in gradation IV in spacetime, as stochastic occurrence of [(reciprocal idiosyncrasy towards PNT equilibrium + accessible space overall arrangement for PNT reciprocity) among reciprocal PNT combinations in gradation III even sub reciprocal PNT combinations in gradation IV in spacetime + Instinctive PNT reciprocal equilibrium towards optimum PNT operation], reciprocal PNT combinations in gradation IV come into being as consequence of aberrant convergence of cosmic esse due to PNT reciprocal gelation. Whereas, accomplishment of aberrant convergence of cosmic esse due to PNT reciprocal gelation only slightly reduce some of the absolute spacetime momentum of the compositive reciprocal PNT combinations in gradation III even sub reciprocal PNT combinations in gradation IV, the mass convergent aggradation of consequent reciprocal PNT combinations in gradation IV slightly increase in proportion to decrease of absolute spacetime momentum of compositive reciprocal PNT combinations in gradation III even sub reciprocal PNT combinations in gradation IV, and the absolute spacetime momentum of the consequent reciprocal PNT combinations in gradation IV is of course self-evident.

Of course, it's necessary for me to emphasize that traditionary quantum theory insists energy release from objects is not absolutely continuous but always in typical quantum model. Homogenous Cosmos Originated from Unique Genesis agree such kind of scientific idea without hesitation. Homogenous Cosmos Originated from Unique Genesis think that aberrant convergence of cosmic esse due to PNT reciprocal gelation and energy release of object are equivalent inverse physical process and both are typical quantum quantification. Once aberrant convergence of cosmic esse due to PNT reciprocal gelation finish a single action of inverted reciprocal convergence of optimum PNT genic linkages between optimum PNT genic linkage L_1 and optimum PNT genic linkage L_2 as illustration of (V-iv-2-c), there is a quantum of mass convergent aggradation of matter integration, once there is rupture of a single inverted reciprocal convergence of optimum PNT genic linkages between optimum PNT genic linkage L_1 and optimum PNT genic linkage L_2 as illustration of (V-iv-2-c), an energy quantum occurs therefore. As a result, energy release from object is not absolutely continuous but quantum one after another, disaggregation of each inverted reciprocal convergence of optimum PNT genic linkages proportionably indicates release of a single energy quantum, energy release quantity depends on how many inverted reciprocal convergence of optimum PNT genic linkages have been disjointed. Prank constant is both quantum quantification of both aberrant convergence of cosmic esse due to PNT reciprocal gelation and energy release from object as disaggregation of inverted reciprocal convergence of optimum PNT genic linkages.

The action feature of aberrant convergence of cosmic esse due to PNT reciprocal gelation of course indicates, once we work on object, what we can change is not only energetic state of matter integration but also mass convergent aggradation of matter integration, relatively, once the object moving in low speed, we can remarkably change the energetic state of the object with relative slight increase of mass convergent aggradation, we are easy to change the energetic state of the object but difficult to impact the mass convergent aggradation of object; once the object is moving in high speed, we are relatively difficult to increase moving speed/energetic state of object but more feasible to impact/increase mass convergent aggradation of matter integration.

3) Systematical unique-genesis quantization formulation of aberrant convergence of cosmic esse due to PNT reciprocal gelation.

The basic quantum of aberrant convergence of cosmic esse due to PNT reciprocal gelation is of course noumenon quantification of a single space field genic origin i_0 .

If we assume the optimum PNT genic linkage in matter field is $A^*i_0, B^*i_1, C^*i_2, \dots F^*i_n, (n \in \mathbb{N}, A, B, C, \dots$

As coherent natura naturans throughout cosmic evolution, instinctive PNT reciprocal equilibrium towards optimum PNT operation is radical potentiality & conditionality for cosmos always ready to orientate itself towards perfection.

$F \in \mathbb{N}$), then, systematical unique-genesis quantization formulation of optimum PNT genic linkage must include details as below:

①. Ascertain the numeric value of n and numeric value of A, B, C, \dots, F in optimum PNT genic linkage of $A^*_{i_0}, B^*_{i_1}, C^*_{i_2}, \dots, F^*_{i_n}$, ($n \in \mathbb{N}, A, B, C, \dots, F \in \mathbb{N}$), so that we quantize the definite optimum PNT genic linkage accordingly, which of course relate to what we have mentioned before that we have to come to our conclusion about space field genic units species, distinctive transmutation & transition among all space field genic units in space field and relative mass aggradation of each space field genic unit by logic extension of elementary genic units species and distinctive existence & motion of elementary genic units in spacetime.

②. Ascertain the relative mass aggradation of each space field genic units in optimum PNT genic linkage in accordance with basic quantum of noumenon quantification f space field genic origin i_0 , which can be mathematically expressed as below:

$$i_n = \alpha(i_0), \dots, i_2 = \beta(i_0), i_1 = \theta(i_0).$$

③. Ascertain the unique-genesis quantization formulation of operation of optimum PNT genic linkage of $A^*_{i_0}, B^*_{i_1}, C^*_{i_2}, \dots, F^*_{i_n}$, ($n \in \mathbb{N}, A, B, C, \dots, F \in \mathbb{N}$) in spacetime around the earth.

$$E = f(A^*_{i_0}, B^*_{i_1}, C^*_{i_2}, \dots, F^*_{i_n}, t)$$

In equation above, “ t ” denotes traditionary time, which is of course general idea of time on the earth.

④. Ascertain unique-genesis quantization formulation of inverted reciprocal convergence of optimum PNT genic linkages between optimum PNT genic linkage $A^*_{i_0}, B^*_{i_1}, C^*_{i_2}, \dots, F^*_{i_n}$, ($n \in \mathbb{N}, A, B, C, \dots, F \in \mathbb{N}$) and optimum PNT genic linkage $F^*_{i_n}, \dots, C^*_{i_2}, B^*_{i_1}, A^*_{i_0}$, ($n \in \mathbb{N}, A, B, C, \dots, F \in \mathbb{N}$):

$$\begin{cases} H = f(A^*_{i_0}, B^*_{i_1}, C^*_{i_2}, \dots, F^*_{i_n}, t, F^*_{i_n}, \dots, C^*_{i_2}, B^*_{i_1}, A^*_{i_0}) \\ \int_0^t [d(M \rightarrow m) - d(M \leftarrow m)] dt = m = \sum_{U=0}^{U=n+p} C_U^* \int_{i_0}^{i_U} f(m_{i_0 \rightarrow \text{Elementary genic unit}})_{i_0} > 0 \end{cases}$$

In equation above, “ t ” denotes traditionary time, which is of course general idea of time on the earth.

Something I would like to emphasize is that, since we have practically confirmed that Prank constant is just basic quantum of energy and mas convergent aggradation due to characteristic aberrant convergence of cosmic esse due to PNT reciprocal gelation, leastways, Prank constant can be introduced into unique-genesis quantization formulation of aberrant convergence of cosmic esse due to PNT reciprocal gelation as solid experimental evidence & ideal measurement reference.

4) Unique-genesis quantization formulation of reciprocal PNT combinations in gradation I.

Theoretically, before ultimate authentication of elementary genic units, space field genic units, optimum PNT genic linkage and inverted reciprocal convergence of optimum PNT genic linkages, it’s almost impossible for us to offer perfect unique-genesis quantization formulation of reciprocal PNT combinations in gradation I through and through. Virtually, as primary endeavor towards systematical unique-genesis quantization formulation of universal existence & motion along sequential homologic cosmogony, I am not ready to offer perfect systematical unique-genesis quantization formulation of universal existence & motion along sequential homologic cosmogony through and through but ready to highlight systematical unique-genesis quantization formulation of universal existence & motion along sequential homologic cosmogony as much as possible draw on practical feasibility & possibility in proportion to contemporaneous historical background. At any rate, historical progress of science can

Historical progress of science in the recent several centuries seemed like a far-flung exploration of the first itinerary around numerous distinctive landscapes of brand-new landmasses of science with palette & tablet on back, several hundred years’ scientific travelogues were compiled thereby.

only be hypostatic endeavor to push humanistic ideology about authenticity of nature forward to perfect ideological enantiomorph of ultimate authenticity of nature draw on practical feasibility & possibility in proportion to contemporaneous historical background.

In terms of unique-genesis quantization formulation of reciprocal PNT combinations in gradation I, no more how much logic absence there is before unique-genesis quantization formulation of reciprocal PNT combinations in gradation I along sequential homologic cosmogony, we should be quite aware of the hypostatic sequential homologic cosmogony and logic necessity of systematical unique-genesis quantization formulation of universal existence & motion along sequential homologic cosmogony, so that we can be aware what's logic absence towards perfect systematical unique-genesis quantization formulation of universal existence & motion along sequential homologic cosmogony, what we should do accordingly.

As historical limitation & personal limitation, it's really difficult for me to offer perfect unique-genesis quantization formulation of reciprocal PNT combinations in gradation I herein. Whereas, as middle segment of systematical unique-genesis quantization formulation of universal existence & motion along sequential homologic cosmogony, in order to highlight the integrative idea of systematical unique-genesis quantization formulation of universal existence & motion along sequential homologic cosmogony as much as possible, and in order to make the logic succession to coming unique-genesis quantization formulation of reciprocal PNT combinations in gradation II, reciprocal PNT combinations in gradation III, reciprocal PNT combinations in gradation IV as smooth as possible, we have to focus on rational highlight of unique-genesis quantization formulation of neutron, proton, electron and α particles.

Unique-genesis quantization formulation of neutron:

$$\sum^D m_{\text{Neutron}} \equiv \begin{cases} \sum m_{\text{Neutron}} = \sum_{U=0}^{U=n+p} C_U * \int_{i_0}^{i_u} f(m_{i_0 \rightarrow \text{Neutron}}) i_0 \\ \Psi = \check{N}_{i_0 \rightarrow}(m, Y) \\ a(t) = Y(t) * K'(t), F(t) = m(t) * Y(t) * K'(t), V = V_0 + \int Y(t) * K'(t) dt, \dots \end{cases}$$

Unique-genesis quantization formulation of proton:

$$\sum^D m_{\text{Proton}} \equiv \begin{cases} \sum m_{\text{Proton}} = \sum_{U=0}^{U=n+p} C_U * \int_{i_0}^{i_u} f(m_{i_0 \rightarrow \text{Proton}}) i_0 \\ \Psi = \check{N}_{i_0 \rightarrow}(m, Y) \\ a(t) = Y(t) * K'(t), F(t) = m(t) * Y(t) * K'(t), V = V_0 + \int Y(t) * K'(t) dt, \dots \end{cases}$$

Unique-genesis quantization formulation of electron:

$$\sum^D m_{\text{Electron}} \equiv \begin{cases} \sum m_{\text{Electron}} = \sum_{U=0}^{U=n+p} C_U * \int_{i_0}^{i_u} f(m_{i_0 \rightarrow \text{Electron}}) i_0 \\ \Psi = \check{N}_{i_0 \rightarrow}(m, Y) \\ a(t) = Y(t) * K'(t), F(t) = m(t) * Y(t) * K'(t), V = V_0 + \int Y(t) * K'(t) dt, \dots \end{cases}$$

Unique-genesis quantization formulation of α particle:

$$\sum^D m_{\alpha \text{ particle}} \equiv \begin{cases} \sum m_{\alpha \text{ particle}} = \sum_{U=0}^{U=n+p} C_U * \int_{i_0}^{i_u} f(m_{i_0 \rightarrow \alpha \text{ particle}}) i_0 \\ \Psi = \check{N}_{i_0 \rightarrow}(m, Y) \\ a(t) = Y(t) * K'(t), F(t) = m(t) * Y(t) * K'(t), V = V_0 + \int Y(t) * K'(t) dt, \dots \end{cases}$$

My intention to emphasize unique-genesis quantization formulation of neutron, proton, electron as preparatory basis for necessary rational succession of unique-genesis quantization formulation of atoms /reciprocal PNT combinations in gradation II is but because neutron, proton, electron are basic components of atoms /reciprocal PNT combinations in gradation II:

$$\begin{aligned} & \sum^D m_{\text{Atom}} = D_{\text{PNT}} [\int_{i_0}^{\text{Atom}} f(m_{i_0 \rightarrow \text{Atom}}) i_0] \\ & = D_{\text{PNT}} \{ X [\int_{i_0}^{\text{Neutron}} f(m_{i_0 \rightarrow \text{Neutron}}) i_0] + Y [\int_{i_0}^{\text{Proton}} f(m_{i_0 \rightarrow \text{Proton}}) i_0] + Z [\int_{i_0}^{\text{Electron}} f(m_{i_0 \rightarrow \text{Electron}}) i_0] \} \end{aligned}$$

(Among equation above, X, Y, Z $\in \mathbb{N}$, which denote quantity of compositive neutrons, protons, electrons in atom).

External mechanical features are of course straightforward causes for original naissance and postnatal existence & motion of atoms in spacetime once neutron, proton, electron stochastically accomplish **reciprocal idiosyncrasy towards PNT equilibrium + accessible space overall arrangement for PNT reciprocity** in spacetime. Towards the pursuit, we must be aware of the both internal mechanical features and external mechanical features of neutron, proton & electron, and formulate them into unique-genesis quantization state equations of neutron, proton and electron.

My intention to emphasize unique-genesis quantization formulation of α particle is but because unique-genesis quantization formulation of α particle involves in original naissance of atomic nucleus. Virtually, in terms of ultimate consummation of Atom State Equations in spacetime, original generation of atomic nucleus in spacetime is really something all-important. In any case, there must be proportionate conditionality for original generation of distinctive atomic nucleus in spacetime, otherwise, why there are only about 100 distinctive elementary atoms around us, no more else?

(V-iv-3) Systematical unique-genesis quantization formulation of serial natura naturata of “reciprocal PNT combinations in gradation II” in the nature of coherent natura naturans throughout cosmic evolution—Atom State Equations in Spacetime

Abstract: Reciprocal PNT combinations in gradation II are just atoms in cosmos, the unique-genesis quantization formulation of reciprocal PNT combinations in gradation II is just so-called “Atom State Equations in Spacetime”. In accordance with mathematical definition of Homogenous Cosmos Originated from Unique Genesis, we can primarily express Atom State Equations in Spacetime as following:

$$\sum m_{Atom} = \int_{i_0}^{Atom} f(m_{i_0 \rightarrow Atom}) i_0$$

The primary definition equation includes double physical connotations of atoms:

The first: Homogenous genic convergent aggradation of atoms $\sum m_{Atom} = \int_{i_0}^{Atom} f(m_{i_0 \rightarrow Atom}) i_0$

The second, PNT dynamic hiberarchy aggradation of atom for aberrant convergence of cosmic esse due to PNT reciprocal gelation in the nature of coherent natura naturans throughout cosmic evolution $\sum D_{Atom} = D_{PNT} [\int_{i_0}^{Atom}]$

As freewheeling of aberrant convergence of cosmic esse due to PNT reciprocal gelation in the nature of coherent natura naturans throughout cosmic evolution, going with gradual enrichment of reciprocal PNT combinations in gradation I in spacetime, original naissance, postnatal existence & motion of reciprocal PNT combinations in gradation II are successive easy outgrowth behind stochastic occurrence of [(reciprocal idiosyncrasy towards PNT equilibrium + accessible space overall arrangement for PNT reciprocity) among reciprocal PNT combinations in gradation I in spacetime + Instinctive PNT reciprocal equilibrium towards optimum PNT operation]. The reciprocal PNT combinations in gradation I we mention herein are mostly the basic components as neutrons, protons & electrons of atoms. Along sequential homologic cosmogony, neutrons, protons & electrons are not only straightforward materials to build up atoms but also the distinctive external mechanical features of neutrons, protons & electrons are leading causes of original generation and postnatal existence & motion of atoms in spacetime.

Distinctive external mechanical features of neutrons, protons & electrons are of course included as ideological connotation in unique-genesis quantization formulation of neutron, proton & electron, once we have consummated unique-genesis quantization formulation of neutron, proton & electron, original generation and postnatal existence & motion of atoms in spacetime must be deduced following a rational line of sequential homologic cosmogony in the nature of coherent natura naturans throughout cosmic evolution.

Following logic extension of sequential homologic cosmogony in the nature of coherent natura naturans throughout cosmic evolution, we pursue Atom State Equations in Spacetime is mostly job to clarify issues as below:

- ①. What are the necessary conditions for original generation of various nucleus in spacetime.
- ②. How the necessary background conditions radically determine original generation of nucleus, which generally includes how the necessary background conditions proportionably determine the distinctive mechanical features of atoms, possible atomic species in spacetime, distinctive existence & motion of atoms in spacetime.

Keywords: Atom State Equation in Spacetime, homogenous genic convergence integral equation of atom, PNT dynamic hiberarchy integral equation of atom, neutron viscous PNT cloud drift, proton viscous PNT cloud drift, reciprocal convergent gelation of viscous PNT cloud drift, time unique-genesis quantization function, space distance unique-genesis quantization function, spacetime PNT ratio, spacetime unique-genesis quantization function, authentication instrument of atomic reciprocal structure.

As coherent natura naturans throughout cosmic evolution, instinctive PNT reciprocal equilibrium towards optimum PNT operation is radical potentiality & conditionality for cosmos always ready to orientate itself towards perfection.

Cosmos is always ready to orientate itself towards perfection by the right of nature, as coherent natura naturans throughout cosmic evolution, “instinctive PNT reciprocal equilibrium towards optimum PNT operation” is radical potentiality & conditionality for cosmos always ready to orientate itself towards perfection, which is coherent dynamic fundamental of both cosmic demiurgic evolution and postnatal existence & motion of matter in spacetime, —not only original generation of discretionary reciprocal PNT combinations in cosmos is outgrowth of freewheeling aberrant convergence of cosmic esse due to PNT reciprocal gelation in the nature of coherent natura naturans as instinctive PNT reciprocal equilibrium towards optimum PNT operation, but also postnatal existence & motion of universal reciprocal PNT combinations in spacetime are spontaneous occurrence in the nature of instinctive PNT reciprocal equilibrium towards optimum PNT operation.

As typical outgrowth of out-an-out natura naturata subject to coherent natura naturans in the nature of **instinctive PNT reciprocal equilibrium towards optimum PNT operation**, original generation and postnatal existence & motion of atoms in spacetime can never be exceptions. And the most important thing is that not only original generation of atoms in spacetime almost contains all dynamic connotation of aberrant convergence of cosmic esse due to PNT reciprocal gelation ahead but also the inherent dynamic ascendancy of atoms is radical mechanic dominance of coming aberrant convergence of cosmic esse due to PNT reciprocal gelation, whether it's possible for distinctive reciprocal PNT combination in gradation III to be generated in the nature of instinctive PNT reciprocal equilibrium towards optimum PNT operation and what the consequent attribute of postnatal existence of reciprocal PNT combination in gradation III in spacetime should be radically depends on the inherent mechanical ascendancy of elementary atoms.

1. As freewheeling of aberrant convergence of cosmic esse due to PNT reciprocal gelation/sequential homologic cosmogony in the nature of coherent natura naturans throughout cosmic evolution, going with gradual enrichment of reciprocal PNT combinations in gradation II in spacetime, original naissance, postnatal existence & motion of reciprocal PNT combinations in gradation III are successive easy outgrowth behind stochastic occurrence of **[(reciprocal idiosyncrasy towards PNT equilibrium + accessible space overall arrangement for PNT reciprocity) among reciprocal PNT combinations in gradation II even sub reciprocal PNT combinations in gradation III in spacetime + Instinctive PNT reciprocal equilibrium towards optimum PNT operation]**.

As straightforward man, the demiurge has none special artifice but freewheeling coherent natura naturans of instinctive PNT reciprocal equilibrium towards optimum PNT operation throughout cosmic evolution, which is just potentiality & conditionality for cosmos always ready to orientate itself towards perfection. Original generation and postnatal existence & motion of matter are of course natura naturata in the nature of instinctive PNT reciprocal equilibrium towards optimum PNT operation.

As typical reciprocal PNT combinations in cosmos, original generation of atoms in spacetime can never be exception out of coherent natura naturans of instinctive PNT reciprocal equilibrium towards optimum PNT operation, which is virtually crude outcome that, after substantial generation and accumulation of elementary genic units in spacetime, freewheeling coexistence of elementary genic units in spacetime stochastically accomplish “**reciprocal idiosyncrasy towards PNT equilibrium + accessible space overall arrangement for PNT reciprocity**” among mutually available distinctive elementary genic units, between mutually available elementary genic units and reciprocal PNT combinations in gradation I with n reciprocal PNT operational hiberarchy, between mutually available reciprocal PNT combinations in gradation I with n reciprocal PNT operational hiberarchy and reciprocal PNT combinations in gradation I with m reciprocal PNT operational hiberarchy, and consequently finish implementation of instinctive PNT reciprocal equilibrium towards optimum PNT operation by the light of nature, and finally, atoms come into being for aberrant

convergence of cosmic esse due to PNT reciprocal gelation.

Along sequential homologic cosmogony in the nature of coherent natura naturans throughout cosmic evolution, not only neutrons, protons and electrons in spacetime are direct compositive components of atoms but also the external mechanical features of neutron, proton and electron are radical causes for original generation even postnatal existence & motion of distinctive atoms in spacetime. Of course, all external mechanical features of neutron, proton and electron are included in unique-genesis quantization formulation of neutron, proton and electron as proper ideological connotation.

Unique-genesis quantization formulation of neutron:

$$\sum^D m_{\text{Neutron}} \equiv \begin{cases} \sum m_{\text{Neutron}} = \sum_{U=0}^{U=n+p} C_U * \int_{i_0}^{i_u} f(m_{i_0 \rightarrow \text{Neutron}}) i_0 \\ \Psi = \check{N}_{i_0 \rightarrow}(m, Y) \\ a(t) = Y(t) * K'(t), F(t) = m(t) * Y(t) * K'(t), V = V_0 + \int Y(t) * K'(t) dt, \dots \end{cases}$$

Unique-genesis quantization formulation of proton:

$$\sum^D m_{\text{Proton}} \equiv \begin{cases} \sum m_{\text{Proton}} = \sum_{U=0}^{U=n+p} C_U * \int_{i_0}^{i_u} f(m_{i_0 \rightarrow \text{Proton}}) i_0 \\ \Psi = \check{N}_{i_0 \rightarrow}(m, Y) \\ a(t) = Y(t) * K'(t), F(t) = m(t) * Y(t) * K'(t), V = V_0 + \int Y(t) * K'(t) dt, \dots \end{cases}$$

Unique-genesis quantization formulation of electron:

$$\sum^D m_{\text{Electron}} \equiv \begin{cases} \sum m_{\text{Electron}} = \sum_{U=0}^{U=n+p} C_U * \int_{i_0}^{i_u} f(m_{i_0 \rightarrow \text{Electron}}) i_0 \\ \Psi = \check{N}_{i_0 \rightarrow}(m, Y) \\ a(t) = Y(t) * K'(t), F(t) = m(t) * Y(t) * K'(t), V = V_0 + \int Y(t) * K'(t) dt, \dots \end{cases}$$

Unique-genesis quantization formulation of α particle:

$$\sum^D m_{\alpha \text{ particle}} \equiv \begin{cases} \sum m_{\alpha \text{ particle}} = \sum_{U=0}^{U=n+p} C_U * \int_{i_0}^{i_u} f(m_{i_0 \rightarrow \alpha \text{ particle}}) i_0 \\ \Psi = \check{N}_{i_0 \rightarrow}(m, Y) \\ a(t) = Y(t) * K'(t), F(t) = m(t) * Y(t) * K'(t), V = V_0 + \int Y(t) * K'(t) dt, \dots \end{cases}$$

Theoretically, once we consummate unique-genesis quantization formulation of neutron, proton and electron, Atom State Equations in spacetime will be logic freewheeling along sequential homologic cosmogony in the nature of coherent natura naturans throughout cosmic evolution.

“PNT action” is not only demiurgic action of original generation of matter in cosmos, but also dynamic nascence of postnatal existence & motion of elementary genic units universal reciprocal PNT combinations in cosmos. As mathematical formulation of PNT action of matter integration in the nature of instinctive PNT reciprocal equilibrium towards optimum PNT operation, PNT dynamics is not only applicable to original generation of elementary genic units and universal reciprocal PNT combinations, which is just aberrant convergence of cosmic esse due to PNT reciprocal gelation throughout cosmic evolution including original generation of elementary genic units and reciprocal PNT combinations in gradation I, reciprocal PNT combinations in gradation II, reciprocal PNT combinations in gradation III, reciprocal PNT combinations in gradation IV, but also applicable to postnatal existence & motion of universal objects in spacetime.

In another words, as cosmos redefinition in logic enantiomorph of newly highlighted factuality of **discretionary particles in cosmos are mutually convertible** with consequent PNT dynamics about universal existence & motion in the nature of coherent natura naturans throughout cosmic evolution, compared to tradition, the most remarkable feature of Homogenous Cosmos Originated from Unique Genesis is that, under precondition of homogenous cosmos originated from unique genesis, Homogenous Cosmos Originated from Unique Genesis came to accomplish its logical operation that original generation of matter in the nature of coherent natura naturans brings out essence of matter in a class by itself, essence of matter in a class by itself predestines through coherence of dynamic regularity of universal existence & motion on the basis of **{(Homogenous cosmos originated from unique genesis postulate + spacetime~matter fully embodying cosmos postulate) + Instinctive PNT equilibrium postulate}**, and consequently defines and formulates universal existence & motion as spontaneous occurrence in the nature of essence of matter in a class by itself. Cosmic status quo is not only demiurgic aggradation but also ongoing performance in the nature of **instinctive PNT reciprocal equilibrium towards optimum PNT operation**, no matter elementary genic units or universal reciprocal PNT combinations in spacetime.

Since entire cosmos just consists in well-regulated integration of cosmic homogeneity system making up of out-and-out serial natura naturata in the nature of coherent natura naturans throughout cosmic evolution, can we regard the cosmic genic origin i_0 as “cosmic extremity quantum” and follow a rational line of cosmic evolution of sequential homologic cosmogony starting at so-called “genic origin” to “cosmic status quo” to quantify entire physical content of cosmos into thorough coherence of homologic symbolic logic through and through?

Mathematical definition of Homogenous Cosmos Originated from Unique Genesis has primarily defined the physical connotation of universal existence & motion as out-and-out cosmic homogeneity system originated from unique genesis, which not only indicates initial thought germination of systematical mathematical quantization of cosmic homogeneity system but also initializes the uniform symbolic logic regularity of systematical quantization of universal existence & motion and approximately brings forth of the embryo modality of the very mathematical language system off the cuff. Whereas, mathematical definition of Homogenous Cosmos Originated from Unique Genesis has only nailed down physical significance of cumulative homologic configuration radically originated from cosmic genic origin i_0 and the non-finite dynamic esse in the nature of instinctive PNT reciprocal equilibrium towards optimum PNT operation of objects in cosmos, it still does not involve substantial and idiographic PNT action even the proportionate reciprocal configuration and dynamic compose of any hypostatic cosmic object. Veritable actualization of systematical mathematical quantization of vivid universal existence & motion still depends on consummation of Atom State Equation in Spacetime.

Firstly, throughout cosmic demiurgic evolution of sequential homologic cosmogony, original generation & formation of atoms is the pivotal shift for demiurgic evolution from microcosm to macrocosm.

Secondly, most of the positive matter in cosmos exist as reciprocal PNT combinations in gradation III and reciprocal PNT combinations in gradation IV, which are all made up of atoms. And the inherent mechanic endosome of atoms is usually the mechanical root cause for original generation & formation even postnatal existence & motion of reciprocal PNT combinations in gradation III.

Cosmos is always ready to orientate itself towards perfection by the light of nature, instinctive PNT reciprocal equilibrium towards optimum PNT operation is just the natura naturans throughout cosmic evolution, which not only indicates original generation & formation of discretionary object in cosmos are outcome of spontaneous

Historical progress of science in the recent several centuries seemed like a far-flung exploration of the first itinerary around numerous distinctive landscapes of brand-new landmasses of science with palette & tablet on back, several hundred years' scientific travelogues were compiled thereby.

occurrence of instinctive PNT reciprocal equilibrium towards optimum PNT operation based on stochastic accomplishment of (reciprocal idiosyncrasy towards PNT equilibrium + accessible space overall arrangement for PNT reciprocity) among sub-components, but also the postnatal existence & motion of discretionary object in spacetime are dynamic enantiomorph of PNT action of matter integration in the nature of instinctive PNT reciprocal equilibrium towards optimum PNT operation too. It's just the natura naturans of instinctive PNT reciprocal equilibrium towards optimum PNT operation which makes cosmic demiurgic evolution in intrinsic succession from simpleness to complexity, from microcosm to macrocosm, from single elementary genic units to reciprocal PNT combinations in gradation I, from reciprocal PNT combinations in gradation I to reciprocal PNT combinations in gradation II, from reciprocal PNT combinations in gradation II to reciprocal PNT combinations in gradation III, from reciprocal PNT combinations in gradation III to reciprocal PNT combinations in gradation IV.

Whereas, during the course of sequential homologic cosmogony, original generation & formation of atoms in spacetime is substantively a pivotal shift. After all, before original generation & formation of atoms in spacetime, cosmic demiurgic evolution of sequential homologic evolution is just limited in spontaneous occurrence of instinctive PNT reciprocal equilibrium towards optimum PNT operation on the basis of stochastic accomplishment of (reciprocal idiosyncrasy towards PNT equilibrium + accessible space overall arrangement for PNT reciprocity) among freewheeling elementary genic units towards original generation of reciprocal PNT combinations in gradation I and towards original generation of atoms (reciprocal PNT combinations in gradation II) further. After generation & formation of atoms in spacetime, atoms immediately take full role of compositive materials for original generation & formation of universal reciprocal PNT combinations in gradation III, and the inherent mechanical endosome of atoms $\sum_{m \text{ Atom} = D_{PNT}}^D [\int_{i_0}^{\text{Atom}} f(m_{i_0 \rightarrow \text{Atom}}) i_0]$ become mechanical root cause for original generation even for postnatal existence & motion of universal reciprocal PNT combinations in gradation III going without saying.

In terms of sequential homologic cosmogony before original generation of atoms, original generation & formation of atoms almost uses up all aberrant convergence of cosmic esse due to PNT reciprocal gelation besides initial generation & formation of celestial bodies, galaxies which originally come into being under motivity of gravitational reciprocity among mutually available celestial bodies. Any atom in spacetime is just a perfect convergent cell as outgrowth of instinctive PNT reciprocal equilibrium towards optimum PNT operation.

In terms of sequential homologic cosmogony after generation & formation of atoms in spacetime, as extensive presence of atoms in spacetime, the successive sequential homologic cosmogony changes qualitatively for "atoms" becoming basic materials for original generation & formation of reciprocal PNT combinations in gradation III. And of course, the inherent mechanical endosome of atoms become mechanical root cause for original generation & formation even postnatal existence & motion of reciprocal PNT combinations in gradation III.

On some certain point of view, the veritable cosmic evolution itself has not brought up perceivable rich and colorful cosmos directly, but gestates elementary atoms in advance as preparation for successive demiurgic evolution towards eyeable rich and colorful macrocosmos; the eyeable rich and colorful macrocosmos is but outcome of spontaneous occurrence of instinctive PNT reciprocal equilibrium towards optimum PNT operation based on stochastic accomplishment of "reciprocal idiosyncrasy towards PNT equilibrium + accessible space overall arrangement for PNT reciprocity" among freewheeling atoms around.

Original generation of atoms firstly depends on generation of proportionate nucleus; in straightforward words,

As coherent natura naturans throughout cosmic evolution, instinctive PNT reciprocal equilibrium towards optimum PNT operation is radical potentiality & conditionality for cosmos always ready to orientate itself towards perfection.

original generation of atoms in spacetime must firstly depend on accomplishment of necessary spacetime conditions for generation of proportionate nucleus of atoms. Of course, the key issue is what are the necessary spacetime conditions for original generation of proportionate nucleus. The basic condition for original generation of nucleus is that, there must be substantial neutrons, protons and electrons in spacetime, and there are substantial probability for neutrons, protons and electrons to accomplish (**reciprocal idiosyncrasy towards PNT equilibrium + accessible space overall arrangement for PNT reciprocity**), so that, there are substantial probability for neutrons, protons and electrons to form proportionate nucleus by the right of **instinctive PNT reciprocal equilibrium towards optimum PNT operation**.

Original generation of atoms in spacetime is firstly generation of proportionate nucleus, and original generation of proportionate nucleus of course has its necessary conditions.

1-A) Necessary conditions for original generation of proportionate nucleus.

Original generation of proportionate nucleus in spacetime generally depends on two conditions as below:

(i) **Mechanical features of neutrons and protons in spacetime as so-called “viscous PNT cloud drift” are mostly leading causes for original generation of proportionate nucleus in spacetime.**

(i-a) In terms of isolated neutron in mature space field $\sum^D m_{\text{Neutron}} = D_{\text{PNT}} \left[\int_{i_0}^{\text{Neutron}} f(m_{i_0 \rightarrow \text{Neutron}}) i_0 \right]$, vivid existence & motion of neutron possesses two remarkable features as below:

The first, as freewheeling of aberrant convergence of cosmic esse due to PNT reciprocal gelation/sequential homologic cosmogony in the nature of coherent natura naturans throughout cosmic evolution, neutrons have relatively steady mass convergent aggradation m_{Neutron} .

The second, neutrons have inherent absolute spacetime momentum $m_{\text{Neutron}} * V = d(M \leftarrow m_{\text{Neutron}}) * Y$, which is just physical nomenclature of external mechanical features of neutrons in spacetime. Of course, external mechanical features of neutrons in spacetime is solid resource of (**reciprocal idiosyncrasy towards PNT equilibrium + accessible space overall arrangement for PNT reciprocity**) among neutrons or between neutrons and protons, which not only directly relates to reciprocal quality of “**reciprocal idiosyncrasy towards PNT equilibrium**” but also relates to stochastic occurrence probability of “**accessible space overall arrangement for PNT reciprocity**” among neutrons or between neutrons and protons. Compared to mass convergent aggradation m_{Neutron} , presence of physical nomenclature of external mechanical features of neutron looks like extensional PNT cloud drift around the neutron, which not only directly relates to PNT operation of matter integration of neutron but also directly takes almost full role of (**reciprocal idiosyncrasy towards PNT equilibrium + accessible space overall arrangement for PNT reciprocity**). For expression expedience, it seem wise for us to call it “**neutron viscous PNT cloud drift**”. Of course, as physical nomenclature of external mechanical features of neutron, **neutron viscous PNT cloud drift** can of course be quantified, for quantification expedience, we now denote the physical nomenclature of **neutron viscous PNT cloud drift** of isolated neutron in mature field in symbol as α_0 .

(i-b) In terms of isolated proton in mature space field $\sum^D m_{\text{Proton}} = D_{\text{PNT}} \left[\int_{i_0}^{\text{Proton}} f(m_{i_0 \rightarrow \text{Proton}}) i_0 \right]$, vivid existence & motion of proton possesses two remarkable features as below:

The first, as freewheeling of aberrant convergence of cosmic esse due to PNT reciprocal gelation/sequential homologic cosmogony in the nature of coherent natura naturans throughout cosmic evolution, protons have relatively steady mass convergent aggradation m_{Proton} .

The second, protons have inherent absolute spacetime momentum $m_{\text{Proton}} * V = d(M \leftarrow m_{\text{Proton}}) * Y$, which is just physical nomenclature of external mechanical features of protons in spacetime. Of course, external mechanical features of protons in spacetime is solid resource of (**reciprocal idiosyncrasy towards PNT equilibrium + accessible space overall**

Historical progress of science in the recent several centuries seemed like a far-flung exploration of the first itinerary around numerous distinctive landscapes of brand-new landmasses of science with palette & tablet on back, several hundred years’ scientific travelogues were compiled thereby.

arrangement for PNT reciprocity) among protons or between protons and neutrons, which not only directly relates to reciprocal quality of “reciprocal idiosyncrasy towards PNT equilibrium” but also relates to stochastic occurrence probability of “accessible space overall arrangement for PNT reciprocity” among protons or between protons and neutrons. Compared to mass convergent aggradation m_{Neutron} , presence of physical noumenon of external mechanical features of proton looks like extensional PNT cloud drift around proton, which not only directly relates to PNT operation of matter integration of proton but also directly takes almost full role of (reciprocal idiosyncrasy towards PNT equilibrium + accessible space overall arrangement for PNT reciprocity). For expression expedience, it seems wise for us to call it “proton viscous PNT cloud drift”. Of course, as physical noumenon of external mechanical features of proton, proton viscous PNT cloud drift can of course be quantified, for quantification expedience, we now denote the physical noumenon of proton viscous PNT cloud drift of isolated proton in mature field in symbol as β_0 .

(ii) The quality of (reciprocal idiosyncrasy towards PNT equilibrium + accessible space overall arrangement for PNT reciprocity) among neutrons or protons or between neutron and proton is straightforwardly favorable source for original generation of nucleus in spacetime due to coherent natura naturans throughout cosmic evolution.

(ii-a) As freewheeling of aberrant convergence of cosmic esse due to reciprocal PNT gelation, once (reciprocal idiosyncrasy towards PNT equilibrium + accessible space overall arrangement for PNT reciprocity) occurs among neutrons or protons and instinctive PNT reciprocal equilibrium towards optimum PNT operation accomplished accordingly, there must be reciprocal convergent gelation of viscous PNT cloud drift. For quantification expedience of reciprocal convergent gelation of viscous PNT cloud drift, we firstly denote reciprocal convergent gelation of viscous PNT cloud drift in symbol θ .

It's of course imaginable, as remarkable quality discrepancy of (reciprocal idiosyncrasy towards PNT equilibrium + accessible space overall arrangement for PNT reciprocity) among neutrons or/and protons, there must be proportionate quantitative disparity of reciprocal convergent gelation of viscous PNT cloud drift due to spontaneous reaction of instinctive PNT reciprocal equilibrium towards optimum PNT operation of matter integration. Generally, the higher quality of (reciprocal idiosyncrasy towards PNT equilibrium + accessible space overall arrangement for PNT reciprocity) among neutrons or/and protons is, there is proportionably more potentiality for PNT equilibrium instinct of matter integration to do its job for PNT operational optimization, and the resultant nucleus are more solid and steady. Inversely, if the quality of (reciprocal idiosyncrasy towards PNT equilibrium + accessible space overall arrangement for PNT reciprocity) among neutrons or/and protons is poorer, there is less potentiality for PNT equilibrium instinct of matter integration to do its job for PNT operational optimization, and the resultant nucleus are more unstable. In straightforward words, the fastness and stability of nucleus in spacetime is always proportionable to quantity of reciprocal convergent gelation of viscous PNT cloud drift θ , and virtually, accomplishment of possible reciprocal convergent gelation of viscous PNT cloud drift is just job to make nucleus solid and steady.

And at the same time, occurrence of reciprocal convergent gelation of viscous PNT cloud drift of course implies, in terms of any neutron or/and proton which have involved in stochastic occurrence of (reciprocal idiosyncrasy towards PNT equilibrium + accessible space overall arrangement for PNT reciprocity) and consequently accomplished PNT operational optimization in the nature of instinctive PNT reciprocal equilibrium towards optimum PNT operation, as positive reciprocal convergent gelation of viscous PNT cloud drift must occur accordingly, there must be proportionate decrease of neutron viscous PNT cloud drift or/and proton viscous PNT cloud drift of the compositive neutrons or/and protons.

If it's the first time for neutrons or/and protons to accomplish (reciprocal idiosyncrasy towards PNT equilibrium + accessible

As coherent natura naturans throughout cosmic evolution, instinctive PNT reciprocal equilibrium towards optimum PNT operation is radical potentiality & conditionality for cosmos always ready to orientate itself towards perfection.

space overall arrangement for PNT reciprocity) and consequently accomplish proportionate PNT operational optimization in the nature of instinctive PNT reciprocal equilibrium towards optimum PNT operation.

In terms of quantitative change of neutron viscous PNT cloud drift, there must be: $\alpha_0 - \theta_1 = \alpha_1$.

In equation above, α_0 denotes the quantity of neutron viscous PNT cloud drift of isolated neutron in mature space field.

θ_1 denotes the quantity of reciprocal convergent gelation of viscous PNT cloud drift on the basis of the first time occurrence of (reciprocal idiosyncrasy towards PNT equilibrium + accessible space overall arrangement for PNT reciprocity) among protons or/and neutrons.

α_1 denotes the quantity of neutron viscous PNT cloud drift after PNT operational optimization in the nature of instinctive PNT reciprocal equilibrium towards optimum PNT operation on the basis of the first time occurrence of (reciprocal idiosyncrasy towards PNT equilibrium + accessible space overall arrangement for PNT reciprocity) among protons or/and neutrons.

In terms of quantitative change of proton viscous PNT cloud drift, there must be: $\beta_0 - \theta_1 = \beta_1$.

In equation above, β_0 denotes the quantity of proton viscous PNT cloud drift after 1 time of reciprocal convergent gelation of viscous PNT cloud drift on the basis of proportionate occurrence of (reciprocal idiosyncrasy towards PNT equilibrium + accessible space overall arrangement for PNT reciprocity) among protons or/and neutrons.

θ_1 denotes the quantity of reciprocal convergent gelation of viscous PNT cloud drift on the basis of the first occurrence of (reciprocal idiosyncrasy towards PNT equilibrium + accessible space overall arrangement for PNT reciprocity) among protons or/and neutrons.

β_1 denotes the quantity of proton viscous PNT cloud drift after PNT operational optimization in the nature of instinctive PNT reciprocal equilibrium towards optimum PNT operation on the basis of the first occurrence of (reciprocal idiosyncrasy towards PNT equilibrium + accessible space overall arrangement for PNT reciprocity) among protons or/and neutrons.

If it's the second time for neutrons or/and protons to accomplish (reciprocal idiosyncrasy towards PNT equilibrium + accessible space overall arrangement for PNT reciprocity) and consequently accomplish proportionate PNT operational optimization in the nature of instinctive PNT reciprocal equilibrium towards optimum PNT operation.

In terms of quantitative change of neutron viscous PNT cloud drift, there must be: $\alpha_1 - \theta_2 = \alpha_2$.

In equation above, α_1 denotes the quantity of neutron viscous PNT cloud drift after one time of reciprocal convergent gelation of viscous PNT cloud drift.

θ_2 denotes the quantity of reciprocal convergent gelation of viscous PNT cloud drift on the basis of the second time occurrence of (reciprocal idiosyncrasy towards PNT equilibrium + accessible space overall arrangement for PNT reciprocity) among protons or/and neutrons.

α_2 denotes the quantity of neutron viscous PNT cloud drift after PNT operational optimization in the nature of instinctive PNT reciprocal equilibrium towards optimum PNT operation on the basis of the second occurrence of (reciprocal idiosyncrasy towards PNT equilibrium + accessible space overall arrangement for PNT reciprocity) among protons or/and neutrons.

In terms of quantitative change of proton viscous PNT cloud drift, there must be: $\beta_1 - \theta_2 = \beta_2$.

In equation above, β_1 denotes the quantity of proton viscous PNT cloud drift after 2 times of reciprocal convergent gelation of viscous PNT cloud drift on the basis of proportionate occurrence of (reciprocal idiosyncrasy towards PNT equilibrium + accessible space overall arrangement for PNT reciprocity) among protons or/and neutrons.

θ_2 denotes the quantity of reciprocal convergent gelation of viscous PNT cloud drift on the basis of the second occurrence of

Historical progress of science in the recent several centuries seemed like a far-flung exploration of the first itinerary around numerous distinctive landscapes of brand-new landmasses of science with palette & tablet on back, several hundred years' scientific travelogues were compiled thereby.



(reciprocal idiosyncrasy towards PNT equilibrium + accessible space overall arrangement for PNT reciprocity) among protons or/and neutrons.

β_2 denotes the quantity of proton viscous PNT cloud drift after PNT operational optimization in the nature of instinctive PNT reciprocal equilibrium towards optimum PNT operation on the basis of the second occurrence of (reciprocal idiosyncrasy towards PNT equilibrium + accessible space overall arrangement for PNT reciprocity) among protons or/and neutrons.

If it's the third time for neutrons or/and protons to accomplish (reciprocal idiosyncrasy towards PNT equilibrium + accessible space overall arrangement for PNT reciprocity) and consequently accomplish proportionate PNT operational optimization in the nature of instinctive PNT reciprocal equilibrium towards optimum PNT operation.

In terms of quantitative change of neutron viscous PNT cloud drift, there must be: $\alpha_2 - \theta_3 = \alpha_3$.

In equation above, α_2 denotes the quantity of neutron viscous PNT cloud drift after twice reciprocal convergent gelation of viscous PNT cloud drift.

θ_3 denotes the quantity of reciprocal convergent gelation of viscous PNT cloud drift on the basis of the third time occurrence of (reciprocal idiosyncrasy towards PNT equilibrium + accessible space overall arrangement for PNT reciprocity) among protons or/and neutrons.

α_3 denotes the quantity of neutron viscous PNT cloud drift after PNT operational optimization in the nature of instinctive PNT reciprocal equilibrium towards optimum PNT operation on the basis of the third occurrence of (reciprocal idiosyncrasy towards PNT equilibrium + accessible space overall arrangement for PNT reciprocity) among protons or/and neutrons.

In terms of quantitative change of proton viscous PNT cloud drift, there must be: $\beta_2 - \theta_3 = \beta_3$.

In equation above, β_2 denotes the quantity of proton viscous PNT cloud drift after 2 times of reciprocal convergent gelation of viscous PNT cloud drift on the basis of proportionate occurrence of (reciprocal idiosyncrasy towards PNT equilibrium + accessible space overall arrangement for PNT reciprocity) among protons or/and neutrons.

θ_3 denotes the quantity of reciprocal convergent gelation of viscous PNT cloud drift on the basis of the third occurrence of (reciprocal idiosyncrasy towards PNT equilibrium + accessible space overall arrangement for PNT reciprocity) among protons or/and neutrons.

β_3 denotes the quantity of proton viscous PNT cloud drift after PNT operational optimization in the nature of instinctive PNT reciprocal equilibrium towards optimum PNT operation on the basis of the third occurrence of (reciprocal idiosyncrasy towards PNT equilibrium + accessible space overall arrangement for PNT reciprocity) among protons or/and neutrons.

.....

If it's the n^{th} time for neutrons or/and protons to accomplish (reciprocal idiosyncrasy towards PNT equilibrium + accessible space overall arrangement for PNT reciprocity) and consequently accomplish proportionate PNT operational optimization in the nature of instinctive PNT reciprocal equilibrium towards optimum PNT operation.

In terms of quantitative change of neutron viscous PNT cloud drift, there must be: $\alpha_{n-1} - \theta_n = \alpha_n$.

In equation above, α_{n-1} denotes the quantity of neutron viscous PNT cloud drift after n-1 times of reciprocal convergent gelation of viscous PNT cloud drift.

θ_n denotes the quantity of reciprocal convergent gelation of viscous PNT cloud drift on the basis of the n^{th} occurrence of (reciprocal idiosyncrasy towards PNT equilibrium + accessible space overall arrangement for PNT reciprocity) among protons or/and neutrons.

α_n denotes the quantity of neutron viscous PNT cloud drift after PNT operational optimization in the nature of

instinctive PNT reciprocal equilibrium towards optimum PNT operation on the basis of the n^{th} occurrence of **(reciprocal idiosyncrasy towards PNT equilibrium + accessible space overall arrangement for PNT reciprocity)** among protons or/and neutrons.

In terms of quantitative change of proton viscous PNT cloud drift, there must be: $\beta_{n-1} - \theta_n = \beta_n$.

In equation above, β_{n-1} denotes the quantity of proton viscous PNT cloud drift after $n-1$ times of **reciprocal convergent gelation of viscous PNT cloud drift** on the basis of proportionate occurrence of **(reciprocal idiosyncrasy towards PNT equilibrium + accessible space overall arrangement for PNT reciprocity)** among protons or/and neutrons.

θ_n denotes the quantity of **reciprocal convergent gelation of viscous PNT cloud drift** on the basis of the n^{th} occurrence of **(reciprocal idiosyncrasy towards PNT equilibrium + accessible space overall arrangement for PNT reciprocity)** among protons or/and neutrons.

β_n denotes the quantity of **proton viscous PNT cloud drift** after PNT operational optimization in the nature of instinctive PNT reciprocal equilibrium towards optimum PNT operation on the basis of the n^{th} occurrence of **(reciprocal idiosyncrasy towards PNT equilibrium + accessible space overall arrangement for PNT reciprocity)** among protons or/and neutrons.

Surveying possible original generation of various nucleus from slight ones to massive ones through and through, as long as the neutrons or/and protons accomplish reciprocity of instinctive PNT reciprocal equilibrium towards optimum PNT operation on the basis of stochastic occurrence of **(reciprocal idiosyncrasy towards PNT equilibrium + accessible space overall arrangement for PNT reciprocity)**, then, there must be positive reciprocal convergent gelation of viscous PNT cloud drift $\theta > 0$ of neutrons or/and protons. This of course implies all the values of “ $\theta_1, \theta_2, \theta_3, \dots, \theta_n$ ” in above equations are all positive quantity bigger than 0. This of course indicates:

$$\alpha_0 > \alpha_1 > \alpha_2 > \alpha_3 > \dots > \alpha_n \quad \beta_0 > \beta_1 > \beta_2 > \beta_3 > \dots > \beta_n .$$

This of course indicates, during the course of reciprocity among neutrons or/and protons in the nature of instinctive PNT reciprocal equilibrium towards optimum PNT operation, viscous PNT cloud drift around neutrons or/and protons must be less and less, this of course indication, if there is successive stochastic occurrence of **(reciprocal idiosyncrasy towards PNT equilibrium + accessible space overall arrangement for PNT reciprocity)** among these neutrons or/and protons, the quality of **(reciprocal idiosyncrasy towards PNT equilibrium + accessible space overall arrangement for PNT reciprocity)** must be poorer and poorer, there must be less and less potentiality for instinctive PNT reciprocal equilibrium towards optimum PNT operation to do its job for PNT optimization, and this even indicates, there is not only less probability for original generation of massive nucleus but also implies the massive nucleus must be relatively unstable.

What's more, there is quality lower limit of **(reciprocal idiosyncrasy towards PNT equilibrium + accessible space overall arrangement for PNT reciprocity)** for original generation of nucleus in spacetime, if practical quality of **(reciprocal idiosyncrasy towards PNT equilibrium + accessible space overall arrangement for PNT reciprocity)** among compositive components of atoms is closer and closer to lower limit for original generation of nucleus, there is less and less probability for realistic generation of nucleus in spacetime, once practical quality of **(reciprocal idiosyncrasy towards PNT equilibrium + accessible space overall arrangement for PNT reciprocity)** among compositive components of atoms is equivalent or even lower than quality lower limit, there is completely no possibility for generation of proportionate nucleus in spacetime.

As a result, there are not numerous elementary atoms in cosmos but only about 110 species. And as conditionality of the two issues above, the affluence, mechanical structure, distinctive existence & motion, stability of all elementary

atoms in cosmos are so different. Generally, the more massive nucleus need more rigorous generative conditions and there is less probability for perfect generation, there are less massive atoms in cosmos therefore. Even after generation, postnatal existence & motion of massive atoms are relatively unstable, connatural disintegration is mostly their normal situation.

Virtually, the species & structure of elementary atoms human have found in cosmos are generally as below:

元素周期表																		0	电子层	电子数
1	I A																2	He	2	
2	II A																3	Ne	10	
3	III A, IV A, V A, VI A, VII A																4	Ar	18	
4	VIII, I B, II B																5	Kr	36	
5	过渡元素																6	Xe	54	
6	镧系, 锕系																7	Rn	86	
7	* * * * *																8			
8	* * * * *																9			
9	* * * * *																10			
10	* * * * *																11			

注：
1. 相对原子质量 取自1995年国际原子量表，并全部取4位有效数字。
2. 相对原子质量 加括号的为放射性元素的半衰期最长的同位素的质量数。

(V-iv-3-a) Periodic table of elements

The distinctive distribution constitution of all elementary atoms in cosmos is of course outgrowth of integrative conditionality of the two issues as (1) & (2).

In accordance with mathematical definition of Homogenous Cosmos Originated from Unique Genesis and PNT action & PNT reaction, we come to analyze and formulate the general existence & motion of reciprocal PNT combinations of gradation II for atom state equation in spacetime. We study atom state equation in spacetime is just endeavor to clarify the integral genic configuration and inherent dynamic compose of atoms accumulated and formed along sequential homologic cosmogony under precondition of homogenous cosmos originated from unique genesis.

So-called "state equation" just means the mathematical formulation of physical esse of genic accumulation & dynamic endosome of atoms in spacetime, physical existence of any atom means a perfect PNT dynamic cell in spacetime. Once we introduce proper symbolic logic to formulate vivid physical existence of the perfect PNT dynamic cell with distinctive homologic genic accumulation and proportionate PNT dynamic endosome in spacetime, the so-called "symbolic logic" is just the so-called atom state equation in spacetime.

2. Ultimate consummation of Atom State Equation in Spacetime depends on accomplishment of

As coherent natura naturans throughout cosmic evolution, instinctive PNT reciprocal equilibrium towards optimum PNT operation is radical potentiality & conditionality for cosmos always ready to orientate itself towards perfection.

unique-genesis quantization formulation of both homologic genic convergence integral equation of atom and PNT dynamic hierarchy integral equation of atom.

We study Atom State Equation in Spacetime is generally ready to clarify the progressive existence & motion connotation imparted by sequential homologic cosmogony from elementary genic units to reciprocal PNT combinations in gradation I and successively from reciprocal PNT combinations in gradation I to reciprocal PNT combinations in gradation II. For convenience to highlight the issue, we disjoin the homogenous definition equation of Atom State Equation in Spacetime $\sum_{m \equiv D} \int_{i_0}^{\text{Atom}} f(m_{i_0 \rightarrow \text{Atom}}) i_0$ into homologic genic convergence integral equation of atom $\sum_{m \equiv D} \int_{i_0}^{\text{Atom}} f(m_{i_0 \rightarrow \text{Atom}}) i_0$ and PNT dynamic hierarchy integral equation of atom $\sum_{m \equiv D} \int_{i_0}^{\text{Atom}} f(m_{i_0 \rightarrow \text{Atom}}) i_0$ and study them apart. That's to say, we just disjoin homogenous definition equation of atom $\sum_{m \equiv D} \int_{i_0}^{\text{Atom}} f(m_{i_0 \rightarrow \text{Atom}}) i_0$ as below:

$$\sum_{m \equiv D} \int_{i_0}^{\text{Atom}} f(m_{i_0 \rightarrow \text{Atom}}) i_0 \equiv \begin{cases} \sum_{m \equiv D} \int_{i_0}^{\text{Atom}} f(m_{i_0 \rightarrow \text{Atom}}) i_0 \\ \sum_{m \equiv D} \int_{i_0}^{\text{Atom}} f(m_{i_0 \rightarrow \text{Atom}}) i_0 \end{cases}$$

2.1. Towards consummation of Atom State Equation in Spacetime, we firstly look into homologic genic convergence integral equation of atom $\sum_{m \equiv D} \int_{i_0}^{\text{Atom}} f(m_{i_0 \rightarrow \text{Atom}}) i_0$

In accordance with homogenous integration equation of atom, as one of the most typical reciprocal PNT combination in spacetime, the convergent cumulation of homologic genic units of atom is exactly actualized proportionately along cosmic demiurgic evolution in the nature of instinctive PNT reciprocal equilibrium towards optimum PNT operation on the basis of stochastic accomplishment of “reciprocal idiosyncrasy towards PNT equilibrium + accessible space overall arrangement for PNT reciprocity” among compositive subatomic units. Apparently, in order to clarify the original homologic genic accumulation of elementary atom, we should above all ascertain the sequential demiurgic evolution clue and the proper preparatory assimilating enrichment of each evolutionary fragment or phase of elementary atom.

In accordance with basal postulate of Homogenous Cosmos Originated from Unique Genesis, the cosmic evolution start is of course the cosmic genic origin, and the terminal target is cosmic status quo. And indeed, the primary establishment of PNT dynamics has incarnated the general clue of sequential homologic cosmogony.

(i). **Evolution and gradual consummation of spacetime**, the foreplay of cosmic evolution is of course evolution and gradual consummation of spacetime, which gives ordinal births to $n + 1$ sort of negative genes of $i_0, i_1, i_2, \dots, i_n, (n \in \mathbb{N})$. During the course of gradual evolution of spacetime, the remarkable qualitative evolution is successive naissance and gradual consummation of both space distance and time, and the proportionate quantitative evolution is that space distance royal road optimizes and time dynamic speed augments synchronously with space field strength gradual aggrandized, and space radiation cornu consequently augments. And continuation of spacetime quantitative evolution ultimately leads to further pivotal qualitative evolution —bringing out ordinal naissance of elementary genic units of $i_{n+1}, i_{n+2}, i_{n+3}, \dots, i_{n+p}, (n, p \in \mathbb{N})$ for spacetime supersaturation.

(ii). **aberrant convergence of cosmic esse due to PNT reciprocal gelation**. Original generation of elementary genic units in spacetime indicates the naissance of positive matter/baryonic matter. As PNT action with equilibrium instinct is inherent attribute of positive matter, hypostatic existence & motion of universal matter must be in the nature of instinctive PNT reciprocal equilibrium towards optimum PNT operation going without saying, and as a result of freewheeling sequential homologic cosmogony in the nature of coherent natura naturans throughout cosmic evolution (/instinctive PNT reciprocal equilibrium towards optimum PNT operation), reciprocal PNT combinations in gradation I

(subatom in cosmos), reciprocal PNT combinations in gradation II (all atoms in cosmos), reciprocal PNT combinations in gradation III (molecule, molecule series, ... gas, liquid, solid, even colorful organism etc.) and reciprocal PNT combinations in gradation IV (celestial bodies, galaxies) coming into being, and consequently hypostatize intrinsic progression of sequential homologic cosmogony.

—Nucleon and nucleon form atomic nucleus by strong interaction is precise PNT cycle linkage or PNT cycle covariant combination in the nature of instinctive PNT reciprocal equilibrium towards optimum PNT operation; nucleon and electron, atoms and atoms, molecules and molecules form rich and colorful macroscopical objects in cosmos by electromagnetic interaction is straightforward genic configuration compensating coupling in the nature of instinctive PNT reciprocal equilibrium towards optimum PNT operation, instinctive acclimation optimization toward genic saturation against reciprocal microcosmic genic configuration of matter fields between available matter integration. Formation & evolvement of celestial bodies and galaxies is terminal engineering of cosmic evolution under motivity of gravitational reciprocity among macroscopical objects in spacetime, it's stochastic acclimation optimization of macroscopical conformation of matter fields towards original aesthetic macroscopical sculpt against superposition disturbance of matter field.

Virtually, as straightforward man, the demiurge can never play special artifice but **coherent natura naturans throughout cosmic evolution = freewheeling of [stochastic accomplishment of “reciprocal idiosyncrasy towards PNT equilibrium + accessible space overall arrangement for PNT reciprocity” among compositive components] + consequent convergence of compositive components in the nature of instinctive PNT reciprocal equilibrium towards optimum PNT operation}** through and through, which is not only permanent programme of sequential homologic cosmogony of original generation of universal reciprocal PNT combinations through and through but also vivid programme of postnatal existence & motion of universal reciprocal PNT combinations eversince. Original generation of all non-living things besides elementary genic units is just previous output of freewheeling coherent natura naturans eversince, and postnatal existence & motion of non-living things besides elementary genic units is too ongoing performance of freewheeling coherent natura naturans through and through. Original generation of all organisms is just previous output of freewheeling coherent natura naturans eversince, and postnatal existence & motion of organisms is too ongoing performance of freewheeling of coherent natura naturans through and through.

In accordance with mathematical definition of Homogenous Cosmos Originated from Unique Genesis, any discretionary existent gene $i_u \in (i_0, i_1, i_2, \dots, i_n, i_{n+1}, i_{n+2}, i_{n+3}, \dots, i_{n+p})$, ($U, n, p \in \mathbb{Z}, 0 \leq U \leq n+p$) in spacetime, we can give mathematical expression to homology genic integral equation $\sum m_{i_u} = \int_{i_0}^{X_{i_u}} f(m_{i_0 \rightarrow i_u}) i_0$. elementary atoms radically consist of genic units, consequently, we can primarily give mathematical expression to homology genic integral equation of elementary atoms as below:

$$\begin{aligned} \sum m_{Atom} &= \int_{i_0}^{Atom} f(m_{i_0 \rightarrow Atom}) i_0, \\ &= \sum_{U=0}^{U=n+p} C_U * \int_{i_0}^{X_{i_u}} f(m_{i_0 \rightarrow i_u}) i_0 \quad \dots \dots \dots \quad (IV-v-1) \end{aligned}$$

(In the equation, C_U denotes the number of gene i_u in reciprocal PNT combination of atom, $C_U \in \mathbb{Z}$)

The homology genic integral equation of atom only represents the unique-genesis quantized genic accumulation of atom, but not represents the dynamic configuration and state of atom in spacetime.

In terms of homology genic integral equation of atom, once approached such stage, the undone jobs are as

As coherent natura naturans throughout cosmic evolution, instinctive PNT reciprocal equilibrium towards optimum PNT operation is radical potentiality & conditionality for cosmos always ready to orientate itself towards perfection.

following:

The first, clarification and verification of homogenous quantitative conversion correlation between mass quantification of discretionary object and quantification of i_0

The second, clarification and verification of value of n, p, U, G

The third, demonstration and consummation of unique-genesis quantization evolution function $f(m_{i_0 \rightarrow x})$

2.2. Towards consummation of Atom State Equation in Spacetime, we look into homology unique-genesis quantization of PNT dynamic hierarchy integral equation of atom $\sum_{D_{Atom} = D_{PNT}} \left[\int_{i_0}^{Atom} \right]$

2.2.1. Composing of dynamic configuration of atom

Original generation and formation of any reciprocal PNT combinations in cosmos is but outcome of cosmic freewheeling demiurgic evolution in the nature of instinctive PNT equilibrium towards optimum PNT operation, original generation and formation of atoms in spacetime can never be exceptive. We study the dynamics conformation of atom is just to study what kinds of basal “dynamic structure units” are formed during the course of freewheeling demiurgic evolution in the nature of instinctive PNT equilibrium towards optimum PNT operation among various sub-atomic units mutually available in spacetime. So-called “dynamic structure unit” is just the physical object which can be found performing PNT with physical ambience and proportionately individualizing idiographic existent characteristics. For example, nucleon is a typical basal dynamics structure unit in atomic nucleus, nucleon and nucleon form another distinctive dynamic configurable hierarchy of atomic nucleus by strong interaction; as distinctive dynamic configurable hierarchy, atomic nucleus and electron form further relatively independent dynamic configurable hierarchy of atom (Of course, the electron here is too another independent dynamic structure unit).

But it's very regretful; I have very poor knowledge on the inner configuration and conformation of atomic nucleus at present. As a result, in terms of dynamic configuration and conformation of atomic nucleus, I still lack necessary groundwork resource to get bottom of it.

Approached such stage, in terms of dynamic configuration and conformation of atom, the undone job is of course to get to the bottom of dynamic configuration and conformation of atom and practical verification

2.2.2. Dynamic state of atom

So-called “dynamic state of atom” just means the atomic holistic dynamic objectification of both separate PNT performance of all compositive subunits and coherent reciprocal PNT performance among all compositive subunits. Under the precondition that the atomic dynamic configuration and conformation has been clarified, it generally implicates the dynamic formulation due to distinctive PNT performance of all dynamic subunits and integrated reciprocal PNT performance among all the compositive subunits.

However, for the cause of uncertainty, the Atom State Equation in Spacetime can not directly introduce intuitionistic time and space notion, otherwise, we can only find the probability existence of some microcosmic dynamics structure units (such as electron). Thus, we must introduce notions of “time unique-genesis quantization function” and “space distance unique-genesis quantization function”.

2.2.2.1. Time unique-genesis quantization function

In the face of issue of time unique-genesis quantization, it may be better for us to define it referring to certain object with definite mass in relatively steady space field with proper time dynamic speed. We define the

Historical progress of science in the recent several centuries seemed like a far-flung exploration of the first itinerary around numerous distinctive landscapes of brand-new landmasses of science with palette & tablet on back, several hundred years' scientific travelogues were compiled thereby.

PNT implementation quantity of some certain object with definite mass in “standard time unit” is just the “time implementation rate”. If we quantize the time implementation rate into unique-genesis quantification, we then arrive at the time unique genic quantization function. If we denote the time implementation rate of certain object in relatively steady space field as below:

Note ①: the definition of spacetime displacement implementation rate introduced the absolute stationary reference frame, whereas, absolute stationary reference frame is a purely theoretical notion, it's actually nonexistent in cosmos, it but seems convenient to define spacetime displacement implementation rate under the absolute stationary reference frame. At any rate, till today, I still did not find any suitable way to define it. For the analogous reasons, the definition of time implementation rate also introduced the notation of “standard time unit”, as the everlasting dynamic existence of space field, standard time unit is nonexistent too. The definition of standard time unit in above section was defined under presumable precondition that the spacetime around the earth is supposed to be everlastingly constant. This is unavoidable accessibility and expediency in accordance with actual ambient possibility around us.

$$\eta = g(m, Y) \dots\dots\dots (IV-v-2)$$

(In the equation, η denotes the time implementation rate of matter integration, m denotes the mass of positive matter of matter integration, Y denotes the proper time dynamic speed.), then, the time unique-genesis quantization function of the matter integration in spacetime can be primarily expressed as below:

$$\delta = \tilde{O}_{i_0 \rightarrow}(m, t) \dots\dots\dots (IV-v-3)$$

(In the equation, “ $i_0 \rightarrow$ ” is the symbolization of unique-genesis quantization.)

2.2.2.2. Space distance unique-genesis quantization function

Homoplastically, in terms of space distance unique-genesis quantization issue, we also define it referring to certain object with certain mass in certain space field with certain time dynamic speed. We define the PNT implementation quantification of some certain object in certain space field with certain mass moving one meter displacement relative to the absolute stationary reference is just the spacetime displacement implementation rate. If we quantize the displacement spacetime implementation rate into unique-genesis quantization format, we arrive at the unique-genesis quantization function of spacetime distance.

If we denote the spacetime displacement implementation rate as below;

$$\chi = p(m, Y) \dots\dots\dots (IV-v-4)$$

(In the above equation, χ denotes the spacetime displacement implementation rate of matter integration, m denotes the mass of positive matter of matter integration, Y denotes the proportionate time dynamic speed.) Then, the proper unique-genesis quantization function of spacetime distance of matter integration can consequently be expressed as below:

$$\Phi = P_{i_0 \rightarrow}(m, Y) \dots\dots\dots (IV-v-5)$$

Of course, the time unique-genesis quantization function and unique-genesis quantization function of space distance can actually be integrated into one coherent function; we just call the integration function “spacetime unique-genesis quantization function”, and we mathematically express it as below:

$$\begin{aligned} \Psi &= f_{i_0 \rightarrow}(\delta, \Phi) \\ &= \tilde{N}_{i_0 \rightarrow}(m, Y) \dots\dots\dots (IV-v-6) \end{aligned}$$

The spacetime unique-genesis quantization function is just the mathematical format of unique-genesis quantization of spacetime implementation rate. So-called “spacetime implementation rate” is just the amount of PNT implementation of certain freewheeling object in spacetime in one standard time unit. Of course, we can expediently arrive at the spacetime unique-genesis quantization function by quantization of spacetime implementation rate into unique-genesis quantization format. Spacetime unique-genesis quantization function only relates with the energetic characters of matter (mainly related to the energy status $d(M \leftarrow m)/m=V/Y$ of matter integration) and the proper time dynamic speed Y matter integration involved in. The PNT performance of purely freewheeling moving object directly incarnates spacetime implementation rate. As time dynamic speed is a pure scalar, even the objects with the same energetic characters moving in the same ambient space field, the moving orientation may be different, the discrepancy of moving orientation depends on the initial status of matter integration, and the motion orientation selectivity is but consequence of expeditious implementation of instinctive PNT reciprocal equilibrium towards optimum PNT operation of matter integration.

Integrating the PNT dynamics, we now can express the Atom State Equation in Spacetime as below:

$$\sum^D m_{Atom} \equiv \begin{cases} \sum_{U=0}^{U=n+p} C_U * \int_{i_0}^{i_U} f(m_{i_0 \rightarrow i_U}) i_0 \\ \Psi = \check{N}_{i_0 \rightarrow}(m, Y) \\ a(t)=Y(t)*K'(t), F(t)=m(t)*Y(t)*K'(t), V=V_0+\int Y(t)*K'(t)dt, \dots \dots \end{cases} \dots \dots \dots \quad (IV-v-7)$$

As thorough coherence of cosmic homogenous evolvement function $f(m_{i_0 \rightarrow x})$, spacetime unique-genesis quantization function $\Psi = \check{N}_{i_0 \rightarrow}(m, Y)$ and PNT dynamics, it's not that each elementary atom has a (or a group of) homologous state equation (/equations), but all the elementary atoms are actually subject to coherent state equation (/equations). Discrepancy in atomic state equations between any two distinctive elementary atoms are but limited in different insition of individual internal parameters and various related ambient conditions. Of course, the current PNT dynamics still need further demonstration and consummation. And at the same time, the second item $\Psi = \check{N}_{i_0 \rightarrow}(m, Y)$ and the third item $a(t)=Y(t)*K'(t), F(t)=m(t)*Y(t)*K'(t), V=V_0+\int Y(t)*K'(t)dt, \dots \dots$ of the equation troop are homologous in symbolic logic. In fact, both the second item and the third item can be syncretized into the first item $\sum_{U=0}^{U=n+p} C_U * \int_{i_0}^{i_U} f(m_{i_0 \rightarrow i_U}) i_0$, so that the whole equation troop can be integrated into its original homogenous mathematical definition format of atom in spacetime $\sum^D m_{Atom} \equiv D_{PNT} [\int_{i_0}^{Atom} f(m_{i_0 \rightarrow Atom}) i_0]$. As a result, it's easy to predict, when the equation troop gradually tend to consummation, the Atom State Equation in Spacetime will be unexpectedly more and more succinct and vivid.

Approached to such stage, in terms of further consummation of Atom State Equation in Spacetime, the undone jobs are as following:

The first, further consummation of unique-genesis spacetime quantization function

The second, further verification and demonstration of PNT dynamics

The third, under precondition that atom dynamics configuration has been verified, bringing both spacetime unique-genesis quantization function and PNT dynamics into all dynamic composite units of atom and all inherent PNT reciprocity among the composite units.

Atom State Equation in Spacetime does not exclude ready-made achievement of conventional particle physics, atom physics and quantum theory, instead, in many cases, the practical research and ultimate consummation of Atom State Equation in Spacetime will still depend on conventional particle physics, atom physics and

Historical progress of science in the recent several centuries seemed like a far-flung exploration of the first itinerary around numerous distinctive landscapes of brand-new landmasses of science with palette & tablet on back, several hundred years' scientific travelogues were compiled thereby.

quantum theory as accessible fecund soil to root in, but just because of prime introduction of idea of homogenous cosmos originated from unique genesis, PNT dynamics and unique-genesis quantization methodology, ultimate consummation of Atom State Equation in Spacetime will cover conventional particle physics, atom physics & quantum theory and make them more systematical and tidy in logic. In another word, ultimate consummation of Atom State Equation in Spacetime maybe assimilate the quintessence of particle physics, atom physics & quantum theory indiscernibly as self-evident logic connotation without special annotation but consequence of distinctive parameters involving in. The practical situation may be similar as force definition of Homogenous Cosmos Originated from Unique Genesis—dynamic domino effect in the nature of instinctive PNT reciprocal equilibrium towards optimum PNT operation for presence of PNT operational disturbance of matter integration covering all force definitions of the so-called “four fundamental forces” in tradition, which are virtually four typical instances of dynamic domino effect of instinctive PNT reciprocal equilibrium towards optimum PNT operation due to presence of idiographic PNT operational disturbance among sub-matter-integrations going without saying.

And finally, something is still worthy of complementarity is that, towards practical application of Atom State Equations in Spacetime, we have introduce a kind of experimental instrument as “**authentication instrument of atomic reciprocal structure**②”. Under precondition that we’ve had necessary knowledge about mechanical features and mass layout of various atoms in cosmos, we design and introduce a kind of scientific instrument to analyze and authenticate the atomic configuration and integrative atomic layout of discretionary atomic reciprocal PNT combination accessible around.

For instance, we isolate some certain gas material from crude oil, whereas, we have no idea what’s the gas material, we do not know what kind of atoms making up of the gas material, and what’s the distinctive atomic mechanical pattern for atomic distribution of reciprocal combination, we can of course put the some a little of the gas material into the **authentication instrument of atomic reciprocal structure**, so that the scientific instrument can perceive and read out the atomic configuration and integrative atomic layout of the gas material, and finally, it can even automatically offer the state equations of gas material as typical reciprocal PNT combination based on rationale of ready-made Atom State Equations in Spacetime. Once we possess the proper sate equations of the gas material, all attribute of the gas material as object in cosmos is all known without any mystery. At any rate, as typical atomic reciprocal PNT combination of out-and-out serial natura naturata subject to coherent natura naturans throughout cosmic evolution, both original generation and distinctive postnatal existence & motion is but spontaneous occurrence in the nature of essence of matter in a class by itself, whose rationale is even sumed up in Atom State Equations in Spacetime so as to be even explicit rationale for us to comprehend the inherent reciprocal framework and reciprocal potentiality of discretionary atomic reciprocal combination. Of course, once we master the inherent reciprocal framework and reciprocal potentiality of discretionary atomic reciprocal combination, we can of course master the attribute of the atomic reciprocal PNT combination without

Note ②, original generation of discretionary reciprocal PNT combinations in cosmos is freewheeling consequence of spontaneous occurrence of instinctive PNT reciprocal equilibrium towards optimum PNT operation on the basis of stochastic accomplishment of “**reciprocal idiosyncrasy towards PNT equilibrium + accessible space overall arrangement for PNT reciprocity**” among the compositive components of the resultant reciprocal PNT combination, without stochastic accomplishment of “**reciprocal idiosyncrasy towards PNT equilibrium + accessible space overall arrangement for PNT reciprocity**” among the compositive components in

As coherent natura naturans throughout cosmic evolution, instinctive PNT reciprocal equilibrium towards optimum PNT operation is radical potentiality & conditionality for cosmos always ready to orientate itself towards perfection.

prior, there is none successive freewheeling of instinctive PNT reciprocal equilibrium towards optimum PNT operation, there is no possibility for original generation of the corresponding reciprocal PNT combination. **The cosmos is always ready to orientate itself towards perfection by the right of nature**, after all, freewheeling coherent natura naturans as instinctive PNT reciprocal equilibrium towards optimum PNT operation is the everlastingly invariable way of the demiurge to create objects throughout cosmic evolution. As a result, once it's necessary for us to introduce a scientific instrument to analyze and authenticate the atomic configuration and integrative atomic layout of discretionary atomic reciprocal PNT combination, we of course have a lot reasons to call it "authentication instrument of atomic reciprocal structure".

any mystery. Application of **authentication instrument of atomic reciprocal structure** must be a remarkable milestone along our historical progress of science

Of course, the working fundamental of the **authentication instrument of atomic reciprocal structure** is self-evident. At any rate, the individual features of the 110 sorts of atoms in cosmos are explicit with distinctive characters. We design the instrument is ready to perceive their indicative individual features so as to authenticate their atomic species and reciprocity distribution of all the compositive atoms in the atomic reciprocal PNT combination. For instance, we can introduce some certain sensitive radiation or several kinds of sensitive radiations to sense the atomic reciprocal PNT combination. All in all, our target is to authenticate the atomic configuration and atomic reciprocity distribution of target atomic reciprocal PNT combination, as long as we can ensure our authentication efficiency & preciseness, the simplest and most reliable way is the best way for us to. And the most important thing is that, as long as we can authenticate the atomic configuration and atomic reciprocity distribution of the atomic reciprocal PNT combination without question, the instrument can automatically offer us proper state equations of the target atomic reciprocal PNT combination in accordance with rationale of the related Atom State Equations in Spacetime. For example, we put a distinctive DNA sample into the instrument, after authenticating it, the instrument can offer us state equations of the very DNA immediately.

3. Practical significance of "Atom State Equation in Spacetime"

As long as we have to admit that ultimate authenticity of nature can be neither omnifarious authenticity smallwares full of a basket nor authenticity chameleon one piece and only but coherent natura naturans throughout cosmic evolution, then, in accordance with the rigid enantiomorphous correlation between objective authenticity of nature and humanistic ideology about authenticity of nature, we then have to admit ultimate consummation of science must be unique coherent scientific verity about universal existence & motion as perfect ideological enantiomorph of ultimate authenticity of nature (**/coherent natura naturans throughout cosmic evolution**), which has none rationale for subject classification as physics, chemistry, biology, iatrology etc. And in fact, as long as we have to admit that, it's only possible for ultimate authenticity of nature to be unique and invariable as coherent natura naturans throughout cosmic evolution, and universal existence & motion must be spontaneous occurrence in the nature of essence of matter in a class by itself accordingly, humanistic classification of subjects as physics, chemistry, biology, iatrology must have desecrated the originality of coherent natura naturans throughout cosmic evolution of the demiurge.

If cosmic evolution is one trilogy of the demiurge, then,

The first programme is "space field evolution towards mature space field".

The second programme is "generation of elementary genic units" with freewheeling of aberrant convergence of cosmic esse due to PNT reciprocal gelation towards original generation and postnatal existence & motion of atoms in spacetime.

Historical progress of science in the recent several centuries seemed like a far-flung exploration of the first itinerary around numerous distinctive landscapes of brand-new landmasses of science with palette & tablet on back, several hundred years' scientific travelogues were compiled thereby.

The third programme is “generation of elementary atoms” with freewheeling of aberrant convergence of cosmic esse due to PNT reciprocal gelation towards original generation and postnatal existence & motion of reciprocal PNT combinations in gradation III and reciprocal PNT combinations in gradation IV in spacetime.

Although, aberrant convergence of cosmic esse due to PNT reciprocal gelation is subject to coherent natura naturans throughout cosmic evolution, space field evolution towards mature space field has prepared necessary precondition for successive aberrant convergence of cosmic esse due to PNT reciprocal gelation, successive generation of elementary genic units and generation of elementary atoms in spacetime have accomplished remarkable progression and operational pattern of coming aberrant convergence of cosmic esse due to PNT reciprocal gelation in different gradation.

Since original generation of elementary genic units in spacetime, it not only indicates naissance of “positive matter” in spacetime but also indicates the possibility of original generation & evolution of reciprocal PNT combination in gradation I in spacetime. And as basic components of reciprocal PNT combination in gradation I, the inherent mechanical ascendancy of elementary genic units in spacetime is most important dominance for both original generation and postnatal attribute of reciprocal PNT combination in gradation I, whether it's possible for distinctive reciprocal PNT combination in gradation I to be generated in the nature of instinctive PNT reciprocal equilibrium towards optimum PNT operation and what the postnatal attribute of reciprocal PNT combinations in gradation I in spacetime must radically depend on inherent mechanical ascendancy of elementary genic units in the nature of things.

And once there are demiurgic aggradation of elementary atoms in spacetime, it's possible for aberrant convergence of cosmic esse due to PNT reciprocal gelation to successively slide into further demiurgic progression of original generation and consequent aggradation of reciprocal PNT combinations in gradation III in spacetime, As basic components of reciprocal PNT combinations in gradation III, the inherent mechanical ascendancy of elementary atoms in spacetime is of course self-evident for both original generation and consequent attribute of reciprocal PNT combinations in gradation III, whether it's possible for distinctive reciprocal PNT combination in gradation III to be generated in the nature of instinctive PNT reciprocal equilibrium towards optimum PNT operation and what the consequent postnatal attribute of reciprocal PNT combination in gradation III in spacetime radically depends on the inherent mechanical ascendancy of the corresponding compositive elementary atoms under proper external physical conditions out of question.

Virtually, as pioneering introduction of **Homogenous cosmos originated from unique genesis postulate** against favorable background of remarkable highlight of microcosmic configuration of matter in the recent one century, connotation objectification with freewheeling logic extension of homogenous cosmos originated from unique genesis must radically impact modern particle physics a lot. At any rate, modern particle physics has remarkable suspicion of science abortion. Once Homogenous Cosmos Originated from Unique Genesis introduce state equations as $\sum^D_m \equiv D[\int_{i_0} f(m_{i_0 \rightarrow x})_{i_0}]$ to formulate existence & motion of universal reciprocal PNT combinations in cosmos, the logic connotation of state equations of $\sum^D_m \equiv D[\int_{i_0} f(m_{i_0 \rightarrow x})_{i_0}]$ kind must crown all particle physics, atom physics, quantum physics, ... Chemistry, biology, ... Even when succedent generation come to study existence & motion of matter in cosmos, as systematical and conventional introduction of state equations of $\sum^D_m \equiv D[\int_{i_0} f(m_{i_0 \rightarrow x})_{i_0}]$ to formulate universal existence & motion of reciprocal PNT combinations in a walk, once you ask them what are particle physics, atom physics, Chemistry, biology? They may immediately turn amazed faces to you.

As coherent natura naturans throughout cosmic evolution, instinctive PNT reciprocal equilibrium towards optimum PNT operation is radical potentiality & conditionality for cosmos always ready to orientate itself towards perfection.

—Oh, my God, what a null question of Noah's Ark kind! Vivid existence & motion of matter in cosmos are but, under this kind of physical conditions, idiographic existence & motion of this object is vividly like this in the nature of instinctive PNT reciprocal equilibrium towards optimum PNT operation and embodies physical selfhood of itself by the light of nature; under that kind of physical conditions, idiographic existence & motion of that object vividly like that in the nature of instinctive PNT reciprocal equilibrium towards optimum PNT operation and embodies physical noumenon of itself by the light of nature, the nature nobbut consists of this object and that object, distinctive existence & motion are but logic connotation of a uniform state equation as $\sum_{m \equiv D} \int_{i_0}^X f(m_{i_0 \rightarrow X})_{i_0}$ with substitution of individual state parameters. This has been overall existence & motion of matter in the nature, why are there so many omnifarious subjects as particle physics, Atom physics, Quantum theory, Chemistry, ..., Biology like omnifarious smallwares full of a basket? Oh, shit! Have I met ancients in dream somehow?

All in all, the practical significance of Atom State Equation in Spacetime radically depends on inherent ascendancy of accumulative assimilation of aberrant convergence of cosmic esse due to PNT reciprocal gelation ahead and mechanical ascendancy to subsequent aberrant convergence of cosmic esse due to PNT reciprocal gelation in the nature of instinctive PNT reciprocal equilibrium towards optimum PNT operation. Once we approach ultimate consummation of Atom State Equation in Spacetime, not only all existence & motion of all sub-atomic units will be thoroughly explicit as necessary precondition for consummation of Atom State Equations in Spacetime, but also all the postnatal existence & motion of all tectonic objects consisting of atoms as reciprocal PNT combinations in gradation III will expediently be self-evident followed a rational clew of symbolic logic of Atom State Equation in Spacetime, universal existence & motion of tectonic objects consisting of atoms as reciprocal PNT combinations in gradation III will be directly deduced in accordance with Atom State Equations in Spacetime of compositive atoms by mathematical illation operation, no matter the physical attribute, chemical attribute or biological & iatrical attribute of reciprocal PNT combinations in gradation III in cosmos. Followed the rational clew, comprehensive sciences concerning universal existence & motion of matter in spacetime will turn into one coherent mathematical illation operation system.

This of course indicates, once Atom State Equations in Spacetime are ultimately consummated, not only all physical connotation of existence & motion within atoms including the physical connotation of existence & motion of all subatomic units are self-evident but also physical connotation of universal reciprocal PNT combinations in gradation III which are made up of necessary atoms can be mathematically deduced in accordance with the proper rationale of atom state equations in spacetime of the compositive atoms of the proper reciprocal PNT combinations in gradation III. Following the rational clew, science about universal existence & motion will be immediately turned into **coherent systematical symbolic logic**. We are even confident to conclude that, as cosmos is completely integrative homogeneity system as out-and-out serial natura naturata series in the nature of coherent natura naturans through and through, any science about idiographic existence & motion in cosmos must belong to the **coherent systematical symbolic logic** of mathematical formulation of natura naturata series in the nature of coherent natura naturans throughout cosmic evolution, any so-called science out of the **coherent systematical symbolic logic** of mathematical formulation of natura naturata series in the nature of coherent natura naturans throughout cosmic evolution must be incredible science or unintelligible science transcending authenticity of cosmos.

For instance, once we consummate Atom State Equations in Spacetime, we've then procured enough logos capital to arrange and construct volitional nucleus PNT activation mechanism which we'll emphatically introduce in

Historical progress of science in the recent several centuries seemed like a far-flung exploration of the first itinerary around numerous distinctive landscapes of brand-new landmasses of science with palette & tablet on back, several hundred years' scientific travelogues were compiled thereby.

the next section, we can then come to calculate and predict any possible interaction and corresponding operational effect under proper condition of (**reciprocal idiosyncrasy towards PNT equilibrium + accessible space overall arrangement for PNT reciprocity**) among discretionary atoms, atom and molecule, molecule and molecule etc by mathematical illation operation on the basis of Atom State Equation in Spacetime resorting the radical dynamic ascendancy of atom. Theoretically, with rational backup of systematical unique-genesis quantization formulation of sequential homologic cosmogony, any material object in cosmos, no matter it belongs to biological category or abiological category, as long as it's object belonging to category of out-and-out natura naturata in the nature of coherent natura naturans throughout cosmic evolution, it must have its inherent genic accumulation configuration with proportionate connatural dynamic tectonic compose in the nature of instinctive PNT reciprocal equilibrium towards optimum PNT operation. And as long as we introduce the proper PNT performance under some certain situation of (**reciprocal idiosyncrasy towards PNT equilibrium + accessible space overall arrangement for PNT reciprocity**) into mathematical formulation of the idiographic dynamic tectonic compose, we can then arrive at the perfect mathematical state formulation of the very object, which reflect all quantitative dynamic attribute and relative behavioral regularity of the object existing in certain ambient spacetime, no matter it exists as gas, liquid, solid, even the relative characters as oxidation capacity, deoxidation capacity, mechanic strength, flexibility etc will be self-evident.

All in all, once we possess the rational resource of Atom State Equations in Spacetime, the universal existence & motion based on the connatural tectonic dynamic compose of atoms will be **coherent systematical symbolic logic**, no matter it's originally belongs to category of physics, chemistry, biology or iatrology.

In Dec. 2019, terrible COVID-2019 broke out unexpectedly, many people began to study COVI-2019, whereas, it seemed substantively difficult for them to know what's the atomic reciprocal PNT configuration of COVI-2019 with the proportionate biological function. I was confused indeed, COVID-2019 is but some certain atomic units with ideographic reciprocal PNT configuration which materialize proportionate biological function, why it seems so difficult for us to comprehend and master its original generation, successive subsistence & propagation in proper ambient conditions? Why there is nobody to care the radical mechanical ascendancy of atoms which is the root cause for vivid existence & motion of reciprocal PNT combinations in gradation III?

After all, besides coherent natura naturans throughout cosmic evolution, the demiurge has none special artifice, universal existence & motion are all spontaneous occurrence in the nature of instinctive PNT reciprocal equilibrium towards optimum PNT operation without any exception. As realistic existence & motion in cosmos, original generation, subsistence and propagation of COVID-2019 can never be exception, it's but idiographic components experience stochastic accomplishment of N times of "**reciprocal idiosyncrasy towards PNT equilibrium + accessible space overall arrangement for PNT reciprocity**" and consequently accomplish instinctive PNT reciprocal equilibrium towards optimum PNT operation by the light of nature. As long as we are able to clarify the proper process, we can of course verify and master the very physical situation of original generation, normal subsistence & propagation of COVID-2019 following a rational line. Eliminating COVID-2019 is but simple job to break down the corresponding mechanical operation linkage of original generation, subsistence and propagation of COVID-2019 as spontaneous chain reaction of "**reciprocal idiosyncrasy towards PNT equilibrium + accessible space overall arrangement for PNT reciprocity**" under proper physical ambience based on inherent mechanical attribute of atoms and related compositive atomic reciprocal PNT combinations.

Virtually, as long as we have to admit that cosmic status quo is but demiurgic aggradation of sequential homologic cosmogony as well-regulated integration of cosmic homogeneity system making up of out-and-out

As coherent natura naturans throughout cosmic evolution, instinctive PNT reciprocal equilibrium towards optimum PNT operation is radical potentiality & conditionality for cosmos always ready to orientate itself towards perfection.

serial natura naturata in the nature of coherent natura naturans throughout cosmic evolution, we then have to admit that humanistic classification of physics, chemistry, biology, iatrology etc must have desecrated originality of coherent natura naturans throughout cosmic evolution of the demiurge. Since none object in cosmos is possible to transcend the category of demiurgic aggradation of out-and-out serial natura naturata in the nature of coherent natura naturans throughout cosmic evolution, once we possess rational capital of perfect ideological enantiomorph of ultimate authenticity of nature which formulate coherent natura naturans throughout cosmic evolution, nothing can transcend our rational dominance.

However, As authoritative intrepidity of contemporaneous scientific orthodoxy is all-time and overwhelming, we have to admit living scientific knowledge proliferation has been disorganized by unprecedented autarchy of “free press regulation customization” & “free press admittance” at pleasure of temporal authority short of necessary intendance, which bewildered living scientific knowledge proliferation out of hypostatic endeavor of veritable progress of science to push humanistic ideology about authenticity of nature forward to perfect ideological enantiomorph of ultimate authenticity of nature step by step draw on practical feasibility & possibility in proportion to contemporaneous historical background, but indulging in vicious circle of interminable substantiation & perfection of contemporaneous scientific orthodoxy for small flowers of impact factors on head. For you see, Relativity, Quantum Theory, chemistry, biology, iatrology are all but humanistic ideology about universal existence & motion around, since we have to admit ultimate authenticity of nature can be neither omnifarious authenticity smallwares full of a basket nor authenticity chameleon one piece and only but coherent natura naturans throughout cosmic evolution, as humanistic ideology about authenticity of nature in proportion to contemporaneous historical background, why Relativity, Quantum Theory, chemistry, biology, iatrology are so colorful theories about existence & motion which originally come into being as out-and-out serial natura naturata in the nature of coherent natura naturans? Although, you maybe have to admit **it's only possible for concordant cosmos to be demiurgic aggradation of out-and-out serial natura naturata in the nature of coherent natura naturans throughout cosmic evolution; there is no way for demiurgic aggradation in the nature of different natura naturans to be concordant cosmos through and through.**

And indeed, Homogenous Cosmos Originated from Unique Genesis originally came into being in 1991, as gradual rational aggradation in the recent 31 years, it has been such a monograph. Whereas, under egotistic background of royal substantiation & perfection of contemporaneous scientific orthodoxy with unprecedented official facility of magistral autarchy of “free press regulation customization” and “free press admittance” of temporal authority short of necessary intendance, as timely renovation of humanistic ideology about authenticity of nature in proportion to contemporaneous historical background of **remarkable highlight of microcosmic configuration of matter**, free press admittance of Homogenous Cosmos Originated from Unique Genesis must break through legitimacy defense line of contemporaneous scientific orthodoxy, so that it has to challenge venomous counterwork upper limit of temporal authority. Comparably, S.W. Hawking had ever written three small books and mostly showed people some rational prediction about characters of the so-called “Black Hole” as linear logic extension in rigid succession of contemporaneous scientific orthodoxy. Luckily, S.W. Hawking caught downwind express of authoritative intrepidity of contemporaneous scientific orthodoxy and became the most famous scientist after Einstein therefore. In 2016, LIGO suddenly alleged all over the world that they had discovered mechanical collision and combination of binary Black Holes, they even had discovered gravitation wave for the mechanical collision and combination of the binary Black Holes. In 2017, LIGO procured physical Nobel Prize going without saying for their dramatic discovery of gravitational waves. Although, till today, nobody on the earth seems able to offer credible evidence

Historical progress of science in the recent several centuries seemed like a far-flung exploration of the first itinerary around numerous distinctive landscapes of brand-new landmasses of science with palette & tablet on back, several hundred years' scientific travelogues were compiled thereby.

to show the world there are really Black Holes in cosmos.

We have to admit, in the recent half century, nothing seemed remarkable achievement of historical progress of science which had pushed humanistic ideology about authenticity of nature forward to perfect ideological enantiomorph of ultimate authenticity of nature, whereas, substantial evidence indicates authoritative intrepidity of contemporaneous scientific orthodoxy is omnipotent and all-time. Although, interminable royal substantiation & perfection of contemporaneous scientific orthodoxy has obviously bewildered live scientific knowledge proliferation in succession of contemporaneous scientific orthodoxy so much, so that there is obvious aberrancy relative to veritable progress of science to push humanistic ideology about authenticity of nature forward to perfect ideological enantiomorph of ultimate authenticity of nature step by step draw on practical feasibility & possibility in proportion to contemporaneous historical background. Instead, as constant availability & popularity of “impact factor” like gewgawish flowers on head, historical progress of science always seems morbid endeavor like hoax floundering in riancy with demoded legitimacy coronet on head.

Virtually, as permanent synthesized conditionality of “**crecive progression of practical feasibility & possibility in proportion to contemporaneous historical background + the uniqueness & invariance of ultimate authenticity of nature predestines the unique possibility of scientific verity as perfect ideological enantiomorph of ultimate authenticity of nature**”, it's only possible for the major melody of historical progress of science to be a series of epochmaking scientific knowledge metabolism in inherent optimum orientation towards historical authenticity tolerance of science 0, which is virtually proportionate revolutionary subrogation of temporal orthodoxies one after another, and before ultimate accomplishment of perfect ideological enantiomorph of ultimate authenticity of nature, live sciences of contemporaneous scientific orthodoxy are but humanistic ideology about authenticity of nature in proportion to contemporaneous historical background with proportionate nonzero historical authenticity tolerance of science. If vested excellence of contemporaneous scientific orthodoxy can only be succeeded to generation after generation by official authorization of living authorities as Buddhism inheriting their legacy, development of science must be invalid who reclines on bed needing necessary oxygen supply. Only superior & intrepid conventionality has been broken through by coming renovation of humanistic ideology about authenticity of nature in proportion to contemporaneous historical background, development of science can spurt out unprecedented potentiality like outburst of powerful volcano. And indeed, as interminable royal substantiation & perfection of contemporaneous scientific orthodoxy was the rage in the recent half century, historical progress of science was always in esoteric conservative situation like hoax floundering in riancy with demoded legitimacy coronet on head, whereas, no matter how abominable historical progress of science is, the conventional output of “impact factor” must be cheerful like itself beyond all doubt.

In fact, as long as we have to admit that cosmic status quo is but demiurgic aggradation of out-and-out serial natura naturata in the nature of coherent natura naturans throughout cosmic evolution, we then have to admit that humanistic classification of physics, chemistry, biology, iatrology etc must have desecrated originality of coherent natura naturans throughout cosmic evolution of the demiurge, and as immanent constancy of historical progress of science in inherent optimum orientation towards perfect ideological enantiomorph of ultimate authenticity of nature, magic annihilation of rich and colorful subjects as physics chemistry, biology, iatrology etc is inevitable, which may be perceived by us very soon. In straightforward words, it's self-evident that **ultimate consummation of science \neq physics + chemistry + biology + iatrology + ...**, instead, it's only possible for **ultimate consummation of science = perfect ideological enantiomorph of ultimate authenticity of nature**, historical naissance of distinctive subjects as physics,

As coherent natura naturans throughout cosmic evolution, instinctive PNT reciprocal equilibrium towards optimum PNT operation is radical potentiality & conditionality for cosmos always ready to orientate itself towards perfection.

chemistry, biology, iatrology etc is not nonsense of the God, but commensurate humanistic ideology about authenticity of nature due to practical feasibility & possibility in proportion to contemporaneous historical background, which is of course necessary segment of historical progress of science in inherent optimum orientation towards perfect ideological enantiomorph of ultimate authenticity of nature when we gradually looked into authenticity of nature as numerous distinctive landscapes of brand-new landmasses then and there.

Since none object in cosmos is possible to transcend category of well-regulated integration of cosmic homogeneity system making up of out-and-out serial natura naturata in the nature of coherent natura naturans throughout cosmic evolution, once we possess rational capital of **perfect ideological enantiomorph of ultimate authenticity of nature** which is perfect ideological system about universal existence & motion in the nature of coherent natura naturans throughout cosmic evolution, nothing can transcend our rational prediction & dominance.

Virtually, as straightforward man without any special artifice but coherent natura naturans throughout cosmic evolution, the demiurge is always spoony over large charge like this, before we practically approach perfect ideological enantiomorph of ultimate authenticity of nature, he is always ready to banteringly dally its most unfathomable obscurity before us. Whereas, once we have approached perfect ideological enantiomorph of ultimate authenticity of nature, immediately, he can hardly cover up his enthusiasm to show off the most wonderful eutaxy of homogenous cosmos originated from unique genesis as well-regulated integration of cosmic homogeneity system making up of out-and-out serial natura naturata in the nature of coherent natura naturans throughout cosmic evolution!

—Firstly written in Dec. 1995, Revision was done in Nov. 2007

(V-iv-4) Systematical unique-genesis quantization formulation of serial natura naturata of "reciprocal PNT combinations in gradation III" in the nature of coherent natura naturans throughout cosmic evolution

Abstract: *As freewheeling of sequential homologic cosmogony in the nature of coherent natura naturans throughout cosmic evolution, going with gradual enrichment of reciprocal PNT combinations in gradation II in spacetime, original naissance, postnatal existence & motion of reciprocal PNT combinations in gradation III are successive easy outgrowth behind stochastic occurrence of [(reciprocal idiosyncrasy towards PNT equilibrium + accessible space overall arrangement for PNT reciprocity) among reciprocal PNT combinations in gradation II even sub reciprocal PNT combinations in gradation III in spacetime + Instinctive PNT reciprocal equilibrium towards optimum PNT operation]. Not only reciprocal PNT combinations in gradation II in spacetime are direct materials of reciprocal PNT combinations in gradation III, but also external mechanical features of compositive reciprocal PNT combinations in gradation II even sub reciprocal PNT combinations in gradation III are radical causes of original generation, postnatal existence & motion of reciprocal PNT combinations in gradation III. All external mechanical features of neutron, proton and electron are included in unique-genesis quantization formulation of neutron, proton and electron as proper ideological connotation, once we consummate unique-genesis quantization formulation of neutron, proton and electron, Atom State Equations in spacetime will be logic freewheeling along sequential homologic cosmogony in the nature of coherent natura naturans throughout cosmic evolution.*

As evolutionary segment of sequential homologic cosmogony behind evolution of reciprocal PNT combinations in gradation II and before evolution of reciprocal PNT combinations in gradation IV, existence & motion of reciprocal PNT combinations in gradation III crown all objects bigger and single atoms and smaller than celestial bodies, it's of course imaginable that study of reciprocal PNT combinations in gradation III covers many traditional sciences as physics, chemistry, biology, iatrology etc., such as study of various atomic crystal, various pure metals, various alloys, molecules, molecule system, ... various DNA, animalcule, virus, plants, animals etc. Of course, what's all-important is not study of reciprocal PNT combinations in gradation 3 crowns all many traditional sciences as physics, chemistry, biology, iatrology etc., what's more significant is that it makes comprehensive study of objects belong to category of reciprocal PNT combinations in gradation 3 as in out-and-out mathematical operation on the basis of Atom State Equations in Spacetime.

For expedience of study of reciprocal PNT combinations in gradation 3, it's necessary for us to introduce instrument of authentication instrument of atomic reciprocal structure.

Keywords: *reciprocal PNT combinations in gradation III, authentication instrument of atomic reciprocal structure.*

1) **As freewheeling of sequential homologic cosmogony in the nature of coherent natura naturans throughout cosmic evolution, going with gradual enrichment of reciprocal PNT combinations in gradation II even sub-reciprocal PNT combinations in gradations III in spacetime, original naissance, postnatal existence & motion of reciprocal PNT combinations in gradation III are successive easy outgrowth behind stochastic occurrence of [(reciprocal idiosyncrasy towards PNT equilibrium + accessible space overall arrangement for PNT reciprocity) among atoms even sub-reciprocal PNT combinations in gradations III in spacetime + Instinctive PNT reciprocal equilibrium towards optimum PNT operation]. As long as we are able to formulate vivid existence & motion of corresponding compositive atoms into precise Atom State Equations in**

As coherent natura naturans throughout cosmic evolution, instinctive PNT reciprocal equilibrium towards optimum PNT operation is radical potentiality & conditionality for cosmos always ready to orientate itself towards perfection.

Spacetime, as long as we can implement unique-genesis quantization formulation of reaction of matter integration of instinctive PNT reciprocal equilibrium towards optimum PNT operation on the basis of stochastic occurrence of **(reciprocal idiosyncrasy towards PNT equilibrium + accessible space overall arrangement for PNT reciprocity)** among reciprocal PNT combinations in gradation III even sub-reciprocal PNT combinations in gradations IV in spacetime, then, original generation, postnatal existence & motion of reciprocal PNT combinations in gradation III must be mathematical logic on the basis of Atom State Equations in Spacetime through and through, study of rich and colorful existence & motion of universal reciprocal PNT combinations in gradation III in spacetime is but out-and-out mathematical operation. After all, the demiurge is so onefold, he but has unique artifice of coherent natura naturans throughout cosmic evolution.

As freewheeling of sequential homologic cosmogony in the nature of coherent natura naturans throughout cosmic evolution behind reciprocal PNT combinations in gradation II, mechanical structure, vivid existence & motion of reciprocal PNT combinations in gradation III possess remarkable features as below:

①. Atoms and sub reciprocal PNT combinations in gradation III are basic compositive materials of consequent reciprocal PNT combinations in gradation III.

②. External mechanical features of compositive atoms and sub reciprocal PNT combinations in gradation III are the leading mechanical causes for original generation and postnatal existence & motion of consequent reciprocal PNT combinations in gradation III. Virtually, as freewheeling of sequential homologic cosmogony in the nature of coherent natura naturans throughout cosmic evolution, going with gradual enrichment of reciprocal PNT combinations in gradation II even sub-reciprocal PNT combinations in gradations III in spacetime, original naissance, postnatal existence & motion of reciprocal PNT combinations in gradation III are successive easy outgrowth behind stochastic occurrence of **[(reciprocal idiosyncrasy towards PNT equilibrium + accessible space overall arrangement for PNT reciprocity) among atoms even sub-reciprocal PNT combinations in gradations III in spacetime + Instinctive PNT reciprocal equilibrium towards optimum PNT operation].**

③. The basic attribution, vivid existence & motion of reciprocal PNT combinations in gradation III radically depends on compositive atom species, quantity of atoms and integrative distribution & structure of all compositive atoms.

Of course, **it's only possible for concordant cosmos to be demiurgic aggradation of out-and-out serial natura naturata in the nature of coherent natura naturans throughout cosmic evolution; there is no way for demiurgic aggradation in the nature of different natura naturans to be concordant cosmos through and through.**

As freewheeling of sequential homologic cosmogony in the nature of coherent natura naturans throughout cosmic evolution, original generation and postnatal existence & motion of universal reciprocal PNT combinations in gradation III never bring out any “fundamental regularity” in cosmos. Virtually, original generation of reciprocal PNT combinations in gradation III but integrately reorganized external mechanical features of all compositive atom A, atom B, atom C, ... under precondition of stochastic occurrence of **(reciprocal idiosyncrasy towards PNT equilibrium + accessible space overall arrangement for PNT reciprocity)** among compositive atoms even sub-reciprocal PNT combinations in gradations III in spacetime by the right of instinctive PNT reciprocal equilibrium towards optimum PNT operation, no matter the consequent reciprocal PNT combinations in gradation III are in linear atomic linkage as A-B-C-..., or in two dimensional distribution & structure or three dimensional distribution & structure, original generation in the nature of instinctive PNT reciprocal equilibrium towards optimum PNT operation of course reorganizes the brand-new external mechanical features and inner mechanical features of the consequent reciprocal

PNT combinations in gradation III accordingly so as to make the consequent reciprocal PNT combinations in gradation III possess distinctive attribute like themselves.

For instance:

Under some certain spacetime condition, there is stochastic occurrence of **(reciprocal idiosyncrasy towards PNT equilibrium + accessible space overall arrangement for PNT reciprocity)** between H atom #1 $\sum^D_{m_H \equiv D_{PNT}} [\int_{i_0}^H f(m_{i_0 \rightarrow H}) i_0]$ and H atom #2 $\sum^D_{m_H \equiv D_{PNT}} [\int_{i_0}^H f(m_{i_0 \rightarrow H}) i_0]$, so that, on the basis of distinctive external mechanical features of H atoms, instinctive PNT reciprocal equilibrium towards optimum PNT operation of matter integration does its job spontaneously and consequently brings out chemical reaction as below:

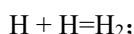

$$\sum^D_{m_H \equiv D_{PNT}} [\int_{i_0}^H f(m_{i_0 \rightarrow H}) i_0] + \sum^D_{m_H \equiv D_{PNT}} [\int_{i_0}^H f(m_{i_0 \rightarrow H}) i_0] \equiv \sum^D_{m_{H_2} \equiv D_{PNT}} [2 \int_{i_0}^H f(m_{i_0 \rightarrow H}) i_0]$$

Under some certain spacetime condition, there is stochastic occurrence of **(reciprocal idiosyncrasy towards PNT equilibrium + accessible space overall arrangement for PNT reciprocity)** between O atom #1 $\sum^D_{m_O \equiv D_{PNT}} [\int_{i_0}^O f(m_{i_0 \rightarrow O}) i_0]$ and O atom #2 $\sum^D_{m_O \equiv D_{PNT}} [\int_{i_0}^O f(m_{i_0 \rightarrow O}) i_0]$, so that, on the basis of distinctive external mechanical features of O atoms, instinctive PNT reciprocal equilibrium towards optimum PNT operation of matter integration does its job spontaneously and consequently brings out chemical reaction as below:

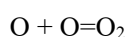

$$\sum^D_{m_O \equiv D_{PNT}} [\int_{i_0}^O f(m_{i_0 \rightarrow O}) i_0] + \sum^D_{m_O \equiv D_{PNT}} [\int_{i_0}^O f(m_{i_0 \rightarrow O}) i_0] \equiv \sum^D_{m_{O_2} \equiv D_{PNT}} [\int_{i_0}^{O_2} f(m_{i_0 \rightarrow O_2}) i_0]$$

Under some certain spacetime condition, there is stochastic occurrence of **(reciprocal idiosyncrasy towards PNT equilibrium + accessible space overall arrangement for PNT reciprocity)** between H₂ molecule $\sum^D_{m_{H_2} \equiv D_{PNT}} [\int_{i_0}^H f(m_{i_0 \rightarrow H}) i_0]$ and O₂ molecule $\sum^D_{m_{O_2} \equiv D_{PNT}} [\int_{i_0}^{O_2} f(m_{i_0 \rightarrow O_2}) i_0]$, so that, on the basis of distinctive external mechanical features of H₂ molecule and O₂ molecule, instinctive PNT reciprocal equilibrium towards optimum PNT operation of matter integration does its job spontaneously and consequently brings out chemical reaction as below:

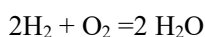

$$2 \sum^D_{m_{H_2} \equiv D_{PNT}} [2 \int_{i_0}^H f(m_{i_0 \rightarrow H}) i_0] + \sum^D_{m_{O_2} \equiv D_{PNT}} [\int_{i_0}^{O_2} f(m_{i_0 \rightarrow O_2}) i_0] \\ \equiv \sum^D_{m_{H_2O} \equiv D_{PNT}} [2 \int_{i_0}^H f(m_{i_0 \rightarrow H}) i_0 + \int_{i_0}^O f(m_{i_0 \rightarrow O}) i_0]$$

Of course, study of reciprocal PNT combinations in gradation III is far more than this, it's not only necessary for us to study and formulate the stochastic occurrence of **(reciprocal idiosyncrasy towards PNT equilibrium + accessible space overall arrangement for PNT reciprocity)** among compositive components but also necessary for us to highlight and confirm inner mechanical features and external mechanical features of consequent reciprocal PNT combinations in gradation III. Usually, once the reciprocal PNT combinations in gradation III come into being, the inner mechanical features of them are relatively steady which make the distinctive reciprocal PNT combinations in gradation III steady like themselves. Comparably, the external mechanical feature of consequent reciprocal PNT combination in gradation III are always open and sensitive to external disturbance, they are mostly the accessible mechanical motivity for occurrence of **(reciprocal idiosyncrasy towards PNT equilibrium + accessible space overall arrangement for PNT reciprocity)** once the consequent reciprocal PNT combinations in gradation III take role of compositive components for further

aberrant convergence of cosmic esse due to PNT reciprocal gelation.

In accordance with state equations below:

$$\sum^D_{m \equiv D_{PNT}} [\int_{i_0}^H f(m_{i_0 \rightarrow H}) i_0] \quad . \text{ or } \quad \sum^D_{m \equiv D_{PNT}} [\int_{i_0}^{H_2} f(m_{i_0 \rightarrow H_2}) i_0]$$

We can analyse and confirm the physical & chemical attribution in unique-genesis quantization quantification of hydrogen atom (H) and hydrogen molecule (H₂) in accordance with unique-genesis quantization connotation of state equations above, such as revivification potential of hydrogen atom or hydrogen molecule under various possible conditions, thermal moving speed, radiation attribution, electromagnetic attribution, spectrum attribution, ionization attribution of electrons out of nucleus and related characteristics of H atom or H₂ molecule,

In accordance with state equations below:

$$\sum^D_{m \equiv D_{PNT}} [\int_{i_0}^O f(m_{i_0 \rightarrow O}) i_0] \quad . \text{ or } \quad \sum^D_{m \equiv D_{PNT}} [\int_{i_0}^{O_2} f(m_{i_0 \rightarrow O_2}) i_0]$$

We can analyse and confirm the physical & chemical attribution in unique-genesis quantization quantification of oxygen atom (O) and oxygen molecule (O₂) in accordance with unique-genesis quantization connotation of state equations above, such as oxidation potential of oxygen atom or oxygen molecule under various possible conditions, thermal moving speed, radiation attribution, electromagnetic attribution, spectrum attribution, ionization attribution of electrons out of nucleus and related characteristics of O atom or O₂ molecule,

In accordance with state equations below:

$$\sum^D_{m \equiv D_{PNT}} [2 \int_{i_0}^H f(m_{i_0 \rightarrow H}) i_0 + \int_{i_0}^O f(m_{i_0 \rightarrow O}) i_0]$$

We can analyse and confirm the physical & chemical attribution in unique-genesis quantization quantification of H₂O molecule in accordance with unique-genesis quantization connotation of state equations above.

In accordance with state equations below:

$$\begin{aligned} &\sum^D_{m \equiv D_{PNT}} [\int_{i_0}^{Al} f(m_{i_0 \rightarrow Al}) i_0]. \\ &\sum^D_{m \equiv D_{PNT}} [\int_{i_0}^{Fe} f(m_{i_0 \rightarrow Fe}) i_0] \\ &\sum^D_{m \equiv D_{PNT}} [\int_{i_0}^{Cu} f(m_{i_0 \rightarrow Cu}) i_0] \\ &\dots \quad \dots \quad \dots \end{aligned}$$

We can analyse and confirm the physical & chemical attribution in unique-genesis quantization quantification of aluminum (Al), iron (Fe), cooper (Cu) in accordance with unique-genesis quantization connotation of state equations above, such as thermal moving speed, radiation attribution, electromagnetic attribution, spectrum attribution, mechanical strength, resistance, revivification potential, ionization attribution of electrons out of nucleus under various conditions

All in all, **cosmos is throughout homogenous originated from unique genesis, cosmic status quo is but demiurgic aggradation of sequential homologic cosmogony, which exactly exists as well-regulated integration of cosmic homogeneity system making up of out-and-out serial natura naturata in the nature of coherent natura naturans throughout cosmic evolution.** In terms of ideological formulation of authenticity like this, **systematical unique-genesis quantization formulation of universal existence & motion along sequential homologic cosmogony in the nature of coherent natura naturans throughout cosmic evolution** must be the most pressing challenge of historical progress of science. Once we accomplish **systematical unique-genesis quantization formulation of universal existence & motion along sequential homologic cosmogony in the nature of coherent natura naturans throughout cosmic evolution**, so-called science

Historical progress of science in the recent several centuries seemed like a far-flung exploration of the first itinerary around numerous distinctive landscapes of brand-new landmasses of science with palette & tablet on back, several hundred years' scientific travelogues were compiled thereby.

is not humanistic ideology about authenticity of nature = **(physics + chemistry + biology + iatrolgy + ...)** like omnifarious smallwares full of a basket but unique scientific verity about universal existence & motion as perfect ideological enantiomorph of ultimate authenticity of nature.

Currently, biological **DNA** study is rather an alluring and mysterious subject, whereas, once we've been in possession of rational resource of Atom State Equation in Spacetime, the mystery of **DNA** will be immediately illuminated in explicit state equations. In any case, it's but job to highlight inherent **inner mechanical features** & **external mechanical features** of some certain atomic combination and possible vivid existence & motion under proper background rational backup of Atom State Equations in Spacetime; once we have been in rational possession of Atom State Equations in Spacetime, rational mastery of any atomic reciprocal PNT combinations as DNA can never be great challenge.

At any rate, as typical atomic reciprocal PNT combination with proportionate biologic function, original generation and possible vivid existence & motion of DNA can never transcend dynamic guidance of external mechanical features of compositive atoms under various background conditionality as **(reciprocal idiosyncrasy towards PNT equilibrium + accessible space overall arrangement for PNT reciprocity)**. Just to take use of a computer, several seconds of mathematical illation operation can make it completely explicit. Nay, we can even predict and optimize the DNA configuration by mathematical illation in accordance with external mechanical features of compositive atoms and interactional possibility & effect under proper ambient conditionality as distinctive **(reciprocal idiosyncrasy towards PNT equilibrium + accessible space overall arrangement for PNT reciprocity)**; we can even predict and create brand-new DNA model originally non-existent on the earth.

In productive practice, as long as we are able to formulate the DNA in proper state equations of atomic reciprocal PNT combinations, we can of course to clarify and master the proper biological process of biological growth, conditional subsistence & propagation of organism on the basis of state equations of DNA atomic reciprocal PNT combination. we can even go further to quantize the extensional biological propagation process derived from DNA atomic tectonic configuration and internal dynamic attribute and edit the proper quantization physical process into controllable production procedures. Then, it's of course imaginable, at the material input initial section of production line, we just input necessary material without any vitality—proper reciprocal PNT combinations or radicel in appropriate dynamic state, along the sequential production line, as long as we can consummate all the necessary conditions of **(reciprocal idiosyncrasy towards PNT equilibrium + accessible space overall arrangement for PNT reciprocity)** precisely, then, at the terminal section of the production line we can procure “lion”, “tiger” full of vitality. At any rate, in accordance with authentic process of out-and-out natura naturata in the nature of coherent natura naturans under proper physical ambience, what's necessary for us to accomplish biological production of the very biological object is that, we should prepare the necessary materials for biological growth of the organism in prior, we should arrange the proper even optimum programme in accordance with coherent natura naturans of biological proliferation of the corresponding organism. Comparably, the conventional study method like traditionary chemistry and biology, with a tube in hand shaking & observing, observing & shaking is substantively as stupid as blind man pushing forward his way by touch of hands.

In the recent years, altisonant and high-sounding academicians on the earth hyped so much about superconductor, once Atom State Equations in Spacetime become rational backup for us to study vivid existence & motion of universal reciprocal PNT combinations in gradation III, can you imagine what a challenge it is for us to study

As coherent natura naturans throughout cosmic evolution, instinctive PNT reciprocal equilibrium towards optimum PNT operation is radical potentiality & conditionality for cosmos always ready to orientate itself towards perfection.

superconductor? How many seconds are necessary for us to work it out?

2) For expedient study of various reciprocal PNT combinations in gradation III towards humanistic application, it's necessary for us to introduce **authentication instrument of atomic reciprocal structure**.

For practical expedience to study various reciprocal PNT combinations in gradation III towards humanistic application, it's really necessary for us to introduce a kind of experimental instrument as “**authentication instrument of atomic reciprocal structure** ②”. Under precondition that we've had necessary knowledge about mechanical features and mass layout of various atoms in cosmos, we design and introduce a kind of scientific instrument to analyze and authenticate atomic configuration and integrative atomic layout of discretionary atomic reciprocal PNT combination accessible around.

For instance, we isolate some certain gas material from crude oil, whereas, we have no idea what's the gas material, we do not know what kind of atoms making up of the gas material, and what's the distinctive atomic mechanical pattern for atomic distribution of reciprocal combination, we can of course put the some a little of the gas material into the **authentication instrument of atomic reciprocal structure**, so that the scientific instrument can perceive and read out the atomic configuration and integrative atomic layout of the gas material, and finally, it can even automatically offer the state equations of gas material as typical reciprocal PNT combination based on rationale of ready-made Atom State Equations in Spacetime.

Once we possess the proper state equations of the gas material, all attribute of the gas material as object in cosmos is all known without any mystery. At any rate, as typical atomic reciprocal PNT combination of out-and-out serial natura naturata subject to coherent natura naturans throughout cosmic evolution, both original generation and distinctive postnatal existence & motion is but spontaneous occurrence in the nature of essence of matter in a class by itself, whose rationale is even summed up in Atom State Equations in Spacetime so as to be even explicit rationale for us to comprehend the inherent reciprocal framework and reciprocal potentiality of discretionary atomic reciprocal combination.

Of course, once we master the inherent reciprocal framework and reciprocal potentiality of discretionary atomic reciprocal combination, we can of course master the attribute of the atomic reciprocal PNT combination without any mystery. At any rate, none hypostatic existence & motion in cosmos can transcend rationale of sequential homologic cosmogony in the nature of coherent natura naturans throughout cosmic evolution.

Application of **authentication instrument of atomic reciprocal structure** must be a remarkable milestone of historical progress of science.

Note ②, original generation of discretionary reciprocal PNT combinations in cosmos is freewheeling consequence of spontaneous occurrence of instinctive PNT reciprocal equilibrium towards optimum PNT operation on the basis of stochastic accomplishment of “**reciprocal idiosyncrasy towards PNT equilibrium + accessible space overall arrangement for PNT reciprocity**” among the compositive components of the resultant reciprocal PNT combination, without stochastic accomplishment of “**reciprocal idiosyncrasy towards PNT equilibrium + accessible space overall arrangement for PNT reciprocity**” among the compositive components in prior, there is none successive freewheeling of instinctive PNT reciprocal equilibrium towards optimum PNT operation, there is no possibility for original generation of the corresponding reciprocal PNT combination. **The cosmos is always ready to orientate itself towards perfection by the right of nature**, after all, freewheeling coherent natura naturans as instinctive PNT reciprocal equilibrium towards optimum PNT operation is the everlastingly invariable way of the demiurge to create objects throughout cosmic evolution. As a result, once it's necessary for us to introduce a scientific instrument to analyze and authenticate the atomic

configuration and integrative atomic layout of discretionary atomic reciprocal PNT combination, we of course have a lot reasons to call it “authentication instrument of atomic reciprocal structure” .

The out-and-out humanistic significance of “**science & technology**” is but endeavor to accomplish “**natura naturans personalization towards human necessity**” on the basis of commensurate humanistic highlight of authenticity of nature. Our endeavor trying to know universal existence & motion as authentic, comprehensive and systematical as much as possible is ready for necessary rational basis of “natura naturans personalization towards human necessity”, so that it's practically possible to enhance quality of human social life as much as possible. No matter how distinctive historical progress of science goes its way in inherent optimum orientation towards perfect ideological enantiomorph of ultimate authenticity of nature, no matter what a long way of historical progress of science we have passed through and through, it's only possible for us to be sensitive knowers of authenticity of nature and wise creator for natura naturans personalization towards human necessity, there is no way for us to create any regularity of nature instead of the demiurge. In straightforward words, we are not divine creators of authenticity of nature but sensitive knowers of authenticity of nature.

The working fundamental of the **authentication instrument of atomic reciprocal structure** is self-evident, at any rate, the individual features of the 110 sorts of atoms in cosmos are explicit with distinctive characters. We design the instrument is ready to perceive their indicative individual features so as to authenticate their atomic species and reciprocity distribution of all the compositive atoms in the atomic reciprocal PNT combination. For instance, we can introduce some certain sensitive radiation or several kinds of sensitive radiations to sense the atomic reciprocal PNT combination.

All in all, our target is to authenticate the atomic configuration and atomic reciprocity distribution of target atomic reciprocal PNT combination, as long as we can ensure our authentication efficiency & preciseness, the simplest and most reliable way is the best way for us to. And the most important thing is that, as long as we can authenticate the atomic configuration and atomic reciprocity distribution of the atomic reciprocal PNT combination without question, the instrument can automatically offer us proper state equations of the target atomic reciprocal PNT combination in accordance with rationale of the related Atom State Equations in Spacetime. For example, we put a distinctive DNA sample into the instrument, after authenticating it, the instrument can offer us state equations of the very DNA immediately.

As straightforward man without any special artifice but coherent natura naturans throughout cosmic evolution, the demiurge is always spooony over large charge like this, before we practically approach perfect ideological enantiomorph of ultimate authenticity of nature, he is always ready to banteringly dally its most unfathomable obscurity before us. Whereas, once we have approached perfect ideological enantiomorph of ultimate authenticity of nature, immediately, he can hardly cover up his enthusiasm to show off the most wonderful eutaxy of homogenous cosmos originated from unique genesis as well-regulated integration of cosmic homogeneity system making up of out-and-out serial natura naturata in the nature of coherent natura naturans throughout cosmic evolution!

(V-iv-5) Systematical unique-genesis quantization formulation of serial natura naturata of “reciprocal PNT combinations in gradation IV” in the nature of coherent natura naturans throughout cosmic evolution

Abstract: *Cosmic status quo is but demiurgic aggradation of sequential homologous cosmogony, which exactly exists as well-regulated integration of cosmic homogeneity system making up of out-and-out serial natura naturata in the nature of coherent natura naturans throughout cosmic evolution. As freewheeling of sequential homologous cosmogony in the nature of coherent natura naturans throughout cosmic evolution, original naissance, postnatal existence & motion of reciprocal PNT combinations in gradation IV are successive easy outgrowth behind stochastic occurrence of [Stochastic (reciprocal idiosyncrasy towards PNT equilibrium + accessible space overall arrangement for PNT reciprocity) among reciprocal PNT combinations in gradation III even sub-reciprocal PNT combinations in gradations IV in spacetime + Instinctive PNT reciprocal equilibrium towards optimum PNT operation]. Not only reciprocal PNT combinations in gradation III even sub-reciprocal PNT combinations in gradation IV in spacetime are direct materials of reciprocal PNT combinations in gradation IV, but also external mechanical features of reciprocal PNT combinations in gradation III even sub-reciprocal PNT combinations in gradation IV are radical causes of original generation, postnatal existence & motion of reciprocal PNT combinations in gradation IV.*

Cosmic evolution never create any “regularity” of universal existence & motion but bring out well-regulated integration of cosmic homogeneity system making up of out-and-out serial natura naturata in the nature of coherent natura naturans throughout cosmic evolution. And indeed, logos of [(Homogenous cosmos originated from unique genesis postulate + spacetime~matter fully embodying cosmos postulate) + Instinctive PNT equilibrium postulate] has predestined that universal existence & motion are but spontaneous occurrence of [external physical disturbance + (PNT action + Instinctive PNT equilibrium)], instinctive reciprocal PNT equilibrium towards optimum PNT operation of matter integration.

As logos, universal existence & motion are all outgrowth of “inherent cause + external cause”, inherent cause of universal existence & motion is just the (PNT action + Instinctive PNT equilibrium) of spontaneous occurrence of [external physical disturbance + (PNT action + Instinctive PNT equilibrium)], external cause is just the “external physical disturbance” of spontaneous occurrence of [external physical disturbance + (PNT action + Instinctive PNT equilibrium)], throughout cosmic evolution, inherent cause of universal existence & motion is always invariable through and through, whereas, external cause is stochastically variable.

Once sequential homologous cosmogony slides into original generation, postnatal existence & motion of reciprocal PNT combinations in gradation IV, the external physical disturbance of spontaneous occurrence of [external physical disturbance + (PNT action + Instinctive PNT equilibrium)] turn into “external physical disturbance of matter field superposition”. This of course indicates universal existence & motion of reciprocal PNT combinations in gradation 4 radically depend on “external case—external physical disturbance of matter field superposition” and “inherent case—(PNT action + Instinctive PNT equilibrium)”. Virtually, characteristic “external case—external physical disturbance of matter field superposition” and “inherent case—(PNT action + Instinctive PNT equilibrium)” directly predestines gravitational reciprocity fundamental as “mass disparity accessible to positive gravity & mass approximation accessible to negative gravity”, which radically determines original generation and vivid existence & motion of reciprocal PNT combinations in gradation IV in spacetime.

Towards systematical unique-genesis quantization formulation of vivid existence & motion of universal reciprocal PNT combinations in gradation IV, it’s only necessary for us to consummate unique-genesis quantization formulation

of mass convergent aggradation of celestial bodies, mass of matter field of celestial bodies and mass of matter field superposition.

Keywords: *reciprocal PNT combinations in gradation IV, optimum orientation choice due to instinctive PNT reciprocal equilibrium towards optimum PNT operation, mass disparity accessible to positive gravity & mass approximation accessible to negative gravity.*

1) Original generation and vivid existence & motion of reciprocal PNT combinations in gradation IV in spacetime is freewheeling of sequential homologic cosmogony in the nature of coherent natura naturans throughout cosmic evolution behind original generation and vivid existence & motion of elementary genic units, reciprocal PNT combinations in gradation I, reciprocal PNT combinations in gradation II, reciprocal PNT combinations in gradation III, which is of course spontaneous occurrence of [Physical disturbance of matter field superposition + (PNT action + Instinctive PNT equilibrium)].

Cosmic status quo is but demiurgic aggradation of sequential homologic cosmogony, which exactly exists as well-regulated integration of cosmic homogeneity system making up of out-and-out serial natura naturata in the nature of coherent natura naturans throughout cosmic evolution. And indeed, the demiurge brings out universal existence & motion by the right of uniform programme through and through, under proper spacetime condition, let matter integration A and matter integration B stochastically approach “reciprocal idiosyncrasy towards PNT equilibrium + accessible space overall arrangement for PNT reciprocity”, and then let “Instinctive PNT equilibrium” of matter integration do their jobs themselves.

Of course, original naissance of elementary genic units are the start of aberrant convergence of cosmic esse due to PNT reciprocal gelation.

As freewheeling of aberrant convergence of cosmic esse due to PNT reciprocal gelation in the nature of coherent natura naturans throughout cosmic evolution, going with gradual enrichment of elementary genic units in spacetime, original generation, postnatal existence & motion of reciprocal PNT combinations in gradation I are successive easy outgrowth behind stochastic occurrence of [(reciprocal idiosyncrasy towards PNT equilibrium + accessible space overall arrangement for PNT reciprocity) among elementary genic units in spacetime + Instinctive PNT reciprocal equilibrium towards optimum PNT operation]. Not only elementary genic units in spacetime are direct materials of reciprocal PNT combinations in gradation I, but also external mechanical features of compositive elementary genic units are radical causes of original generation, postnatal existence & motion of reciprocal PNT combinations in gradation I.

As freewheeling of aberrant convergence of cosmic esse due to PNT reciprocal gelation/sequential homologic cosmogony in the nature of coherent natura naturans throughout cosmic evolution, going with gradual enrichment of reciprocal PNT combinations in gradation I in spacetime, original naissance, postnatal existence & motion of reciprocal PNT combinations in gradation II are successive easy outgrowth behind stochastic occurrence of [(reciprocal idiosyncrasy towards PNT equilibrium + accessible space overall arrangement for PNT reciprocity) among reciprocal PNT combinations in gradation I in spacetime + Instinctive PNT reciprocal equilibrium towards optimum PNT operation]. Not only reciprocal PNT combinations in gradation I in spacetime are direct materials of reciprocal PNT combinations in gradation II, but also external mechanical features of compositive reciprocal PNT combinations in gradation I are radical causes of original generation, postnatal existence & motion of reciprocal PNT combinations in gradation II.

As coherent natura naturans throughout cosmic evolution, instinctive PNT reciprocal equilibrium towards optimum PNT operation is radical potentiality & conditionality for cosmos always ready to orientate itself towards perfection.

As freewheeling of aberrant convergence of cosmic esse due to PNT reciprocal gelation/sequential homologic cosmogony in the nature of coherent natura naturans throughout cosmic evolution, going with gradual enrichment of reciprocal PNT combinations in gradation II in spacetime, original naissance, postnatal existence & motion of reciprocal PNT combinations in gradation III are successive easy outgrowth behind stochastic occurrence of [(reciprocal idiosyncrasy towards PNT equilibrium + accessible space overall arrangement for PNT reciprocity) among reciprocal PNT combinations in gradation II even sub reciprocal PNT combinations in gradation III in spacetime + Instinctive PNT reciprocal equilibrium towards optimum PNT operation]. Not only reciprocal PNT combinations in gradation II in spacetime are direct materials of reciprocal PNT combinations in gradation III, but also external mechanical features of compositive reciprocal PNT combinations in gradation II even sub reciprocal PNT combinations in gradation III are radical causes of original generation, postnatal existence & motion of reciprocal PNT combinations in gradation III.

As freewheeling of aberrant convergence of cosmic esse due to PNT reciprocal gelation/sequential homologic cosmogony in the nature of coherent natura naturans throughout cosmic evolution, going with gradual enrichment of reciprocal PNT combinations in gradation III even sub-reciprocal PNT combinations in gradations IV in spacetime, original naissance, postnatal existence & motion of reciprocal PNT combinations in gradation IV are successive easy outgrowth behind stochastic occurrence of [(reciprocal idiosyncrasy towards PNT equilibrium + accessible space overall arrangement for PNT reciprocity) among reciprocal PNT combinations in gradation III even sub-reciprocal PNT combinations in gradations IV in spacetime + Instinctive PNT reciprocal equilibrium towards optimum PNT operation]. Not only reciprocal PNT combinations in gradation III even sub reciprocal PNT combinations in gradation IV in spacetime are direct materials of reciprocal PNT combinations in gradation IV, but also external mechanical features of compositive reciprocal PNT combinations in gradation III even sub reciprocal PNT combinations in gradation IV are radical causes of original generation, postnatal existence & motion of reciprocal PNT combinations in gradation IV.

It's only possible for concordant cosmos to be demiurgic aggradation of out-and-out serial natura naturata in the nature of coherent natura naturans throughout cosmic evolution; there is no way for demiurgic aggradation in the nature of different natura naturans to be concordant cosmos through and through. If we say cosmos is aesthetically regular, the unique aesthetic regularity of cosmos is but sequential homologic cosmogony in the nature of coherent natura naturans throughout cosmic evolution, universal existence & motion are but spontaneous occurrence of [External physical disturbance + (PNT action + Instinctive PNT equilibrium)] out of question. Meanwhile, when sequential homologic cosmogony slides into original generation and vivid existence & motion of reciprocal PNT combinations in gradation IV, so-called "External physical disturbance" in spontaneous occurrence of [External physical disturbance + (PNT action + Instinctive PNT equilibrium)] enters a new role of "physical disturbance of matter field superposition". And as typical external cause of existence & motion at the occasion, "physical disturbance of matter field superposition" offers distinctive conditionality to "instinctive PNT reciprocal equilibrium towards optimum PNT operation" of matter integration. As a result, "instinctive PNT reciprocal equilibrium towards optimum PNT operation" of matter integration must instinctively do its best for expedient choice of instinctive PNT reciprocal equilibrium towards optimum PNT operation so as to bring out distinctive existence & motion of reciprocal PNT combinations in gradation IV accordingly.

Inherence of "instinctive PNT reciprocal equilibrium towards optimum PNT operation" of matter integration in spacetime firstly indicates inherent instinct to maintain innate aesthetic inherence of matter integration, once innate inherence of matter integration is impacted by external physical disturbance, the object must react to evade or reject devastating impact by the light of nature. As a result, once there is external physical disturbance of slight matter field superposition between celestial body A and celestial body B, both celestial body A and celestial body B must instinctively react to reject further superposition of opposite matter field, which of course indicates "negative

Historical progress of science in the recent several centuries seemed like a far-flung exploration of the first itinerary around numerous distinctive landscapes of brand-new landmasses of science with palette & tablet on back, several hundred years' scientific travelogues were compiled thereby.

gravity” between celestial body A and celestial body B as below:

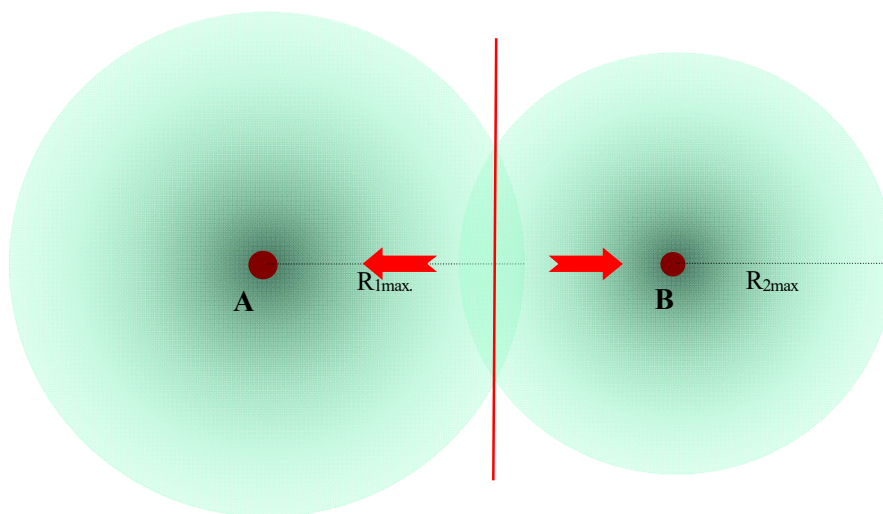

(V-iv-5-a) Negative gravity between celestial body A and celestial body B due to physical disturbance of slight matter field superposition

And at the same time, steady existence & motion of matter integration need compatible reciprocity of proportionate matter field for optimum PNT operation, specific matter integration with distinctive mass convergent aggradation must possess proportionate compatible matter field for normal existence & motion. Generally, specific matter integration has proportionate specific mass convergent aggradation and specific matter field, whereas, crescive PNT operation efficiency along crescive progression of mass convergent aggradation m and mass of matter field is not proportionably equivalent. Usually, crescive PNT operation efficiency of mass of matter field is mostly higher than crescive PNT operation efficiency of mass convergent aggradation of matter integration, which of course indicates, along crescive progression of mass convergent aggradation of matter integration, the bigger matter integration need relatively smaller matter field for optimum PNT operation. In another words, along crescive progression of mass, the matter field has higher and higher PNT operation efficiency of matter integration. The situation is similar as, there are two small strings whose load upper limit is about 10Kg, if we twist the both strings together into a big string tightly, the load upper limit of the big string may be 30 Kg instead of 20 Kg.

Consequently, once there is slight physical disturbance of matter field superposition, the first instinctive reaction of matter integration is of course more feasible to reject physical disturbance of further superposition of opposite matter field. Whereas, once there is adequate matter field superposition, so that it's convenient and feasible for both matter integrations to assimilate the mass of superposed matter field to enhance PNT operation efficiency of own matter field for optimum PNT operation. As a result, instinctive PNT reaction to assimilate superposed mass of opposite matter field between matter integration A and matter integration B bring out “positive gravity” therefore.

As spontaneous occurrence of [external physical disturbance + (PNT action + Instinctive PNT equilibrium)], vivid existence & motion in spacetime are outgrowth of “Inherent cause + External cause”, as inherent cause of universal existence & motion, (PNT action + Instinctive PNT equilibrium) of matter integration is always something inherent throughout cosmic evolution, relatively, as external cause of distinctive existence & motion in spacetime, external causes are usually stochastically variable. Once there is slight matter field superposition between matter integration A and matter integration B, as matter field superposition is relatively slight, it's not convenient and feasible for matter integration to assimilate mass of superposed matter field to enhance PNT operation efficiency of own matter field for optimum PNT operation, the both matter integrations are relatively more feasible to reject the mass

As coherent natura naturans throughout cosmic evolution, instinctive PNT reciprocal equilibrium towards optimum PNT operation is radical potentiality & conditionality for cosmos always ready to orientate itself towards perfection.

superposition of the both matter integrations, so that instinctive reaction of both matter integrations with matter field superposition disturbance incarnate “negative gravity” accordingly. Whereas, once there is adequate mass superposition of matter field between matter integration A and matter integration B, it’s relatively more convenient and feasible for matter integrations to assimilate the superposed mass of matter field to enhance PNT operation efficiency of own matter field for optimum PNT operation, so that instinctive reaction of both matter integrations incarnates “positive gravity” accordingly.

As presence of **instinctive PNT reciprocal equilibrium towards optimum PNT operation**, occurrence of mass superposition of matter field must bring out instinctive PNT reaction of matter integration as below:

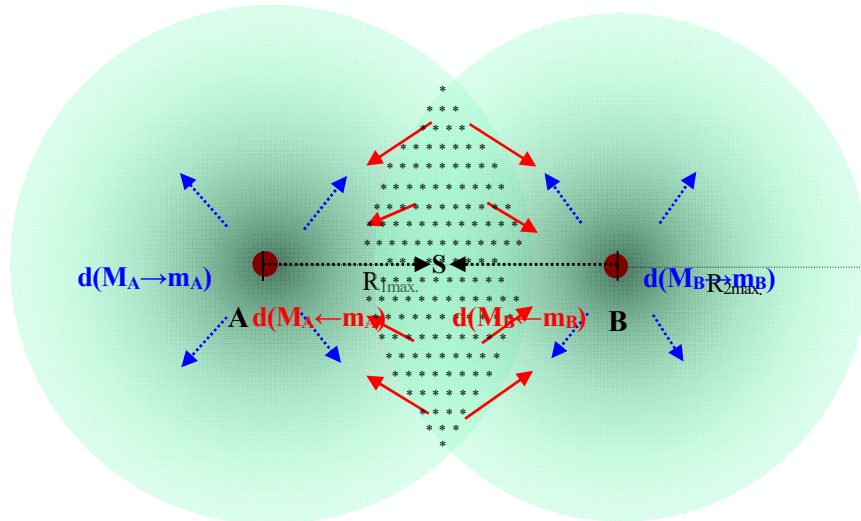

(V-iv-5-b) Reciprocity model of gravity due to [matter field superposition disturbance + (PNT action + Instinctive PNT equilibrium)]

Once there is mass superposition of matter field of celestial bodies, there must be instinctive PNT reaction for optimum orientation choice due to instinctive reciprocal PNT equilibrium towards optimum PNT operation, the consequence of optimum orientation due to instinctive reciprocal PNT equilibrium towards optimum PNT operation is “mass disparity accessible to positive gravity & mass approximation accessible to negative gravity” due to PNT reaction feasibility & expedience in accordance with distinctive physical disturbance of matter field superposition, which can be illustrated as below:

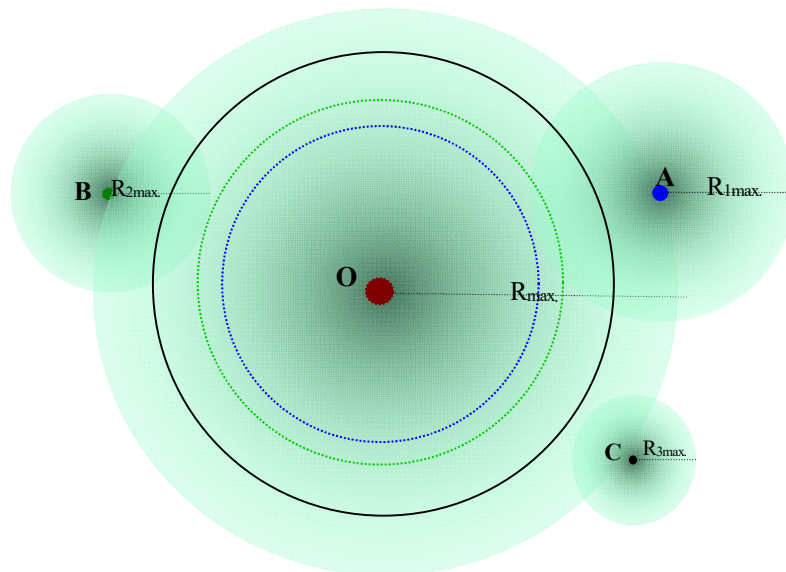

(V-iv-5-c) General relative layout of “peripheral inexpedient assimilable globose field lamella”

Historical progress of science in the recent several centuries seemed like a far-flung exploration of the first itinerary around numerous distinctive landscapes of brand-new landmasses of science with palette & tablet on back, several hundred years’ scientific travelogues were compiled thereby.

and “central expediently assimilable globose field extent” for gravitational reciprocity

Homogenous Cosmos Originated from Unique Genesis primarily assumes, in terms of discretionary two celestial bodies or galaxies in large-scale spacetime with matter field radius R_{1max} , R_{2max} , during the course of the both stochastically moving in large-scale spacetime:

①. if we denote distance between the two celestial bodies/galaxies L , and L satisfies: $L > R_{1max} + R_{2max}$, then, the both celestial bodies/galaxies have no matter field superposition at all, nothing is accessible to accomplish “interaction” between the two celestial bodies/galaxies as spontaneous occurrence of [external physical disturbance + (PNT action + Instinctive PNT equilibrium)].

②. If the distance L between the two celestial bodies/galaxies satisfies : $R_{1max} - R_{2max} < L < R_{1max} + R_{2max}$, ($R_{1max} > R_{2max}$), then, there is matter field superposition between the both celestial bodies/galaxies, and interaction between the two celestial bodies/galaxies as spontaneous occurrence of [external physical disturbance + (PNT action + Instinctive PNT equilibrium)] must occur. Whereas, as the matter field superposition between the two celestial bodies /galaxies is still relatively inadequate, in order to maintain their inherent esthetical configuration of matter field for optimum PNT operation, PNT equilibrium instinct of the both celestial bodies/galaxies is relatively more accessible and feasible to reject the superposition of matter field for optimum PNT operation, as a result, the interaction of so-called gravitational reciprocity consequently incarnates “negative gravity”.

③. If the distance L between the two celestial bodies/galaxies satisfies : $0 < L < R_{1max} - R_{2max}$, ($R_{1max} > R_{2max}$), then, there is substantial matter field superposition between the both celestial bodies/galaxies, and interaction between the two celestial bodies/galaxies as spontaneous occurrence of [external physical disturbance + (PNT action + Instinctive PNT equilibrium)] must occur. And as the matter field superposition between the two celestial bodies /galaxies has been relatively adequate, in order to maintain even optimize their inherent esthetical configuration of matter field for optimum PNT operation, PNT equilibrium instinct of the both celestial bodies/galaxies is relatively more accessible and feasible to assimilate the superposition of matter field for optimum PNT operation, as a result, the interaction of so-called gravitational reciprocity consequently incarnates “positive gravity”.

Any object in cosmos has its inherent absolute spacetime momentum:

$$mV = d(M \leftarrow m) * Y \quad \longleftrightarrow \quad V = d(M \leftarrow m) * Y / m$$

And at the same time, the smaller objects with tiny mass convergent aggradation in spacetime are mostly more active with higher moving speed, this of course indicates the smaller objects have more probability to knock into matter fields of surrounding celestial bodies, and as they are relatively active with higher moving speed, it's easy and expedient for them to knock into central expediently assimilable globose field extent of matter field of surrounding celestial bodies with adequate matter field mass superposition, so that it's feasible and expedient for the both celestial bodies with matter field superposition to assimilate the superposed mass of opposite matter field to enhance own optimum PNT operation by the light of nature. As a result, the external physical disturbance of matter field superposition leads to gravitational reciprocity as “mass disparity accessible to positive gravity”, which can be illustrated as below:

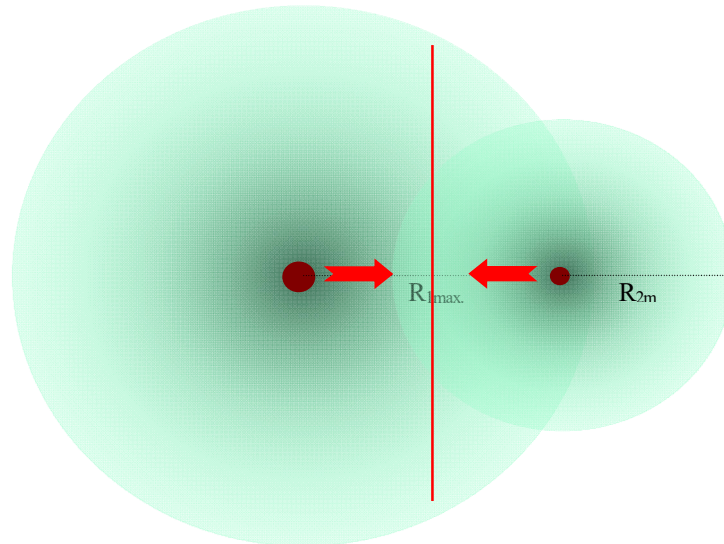

(V-iv-5-d) Mass disparity accessible to positive gravity

Of course, “**mass disparity accessible to positive gravity**” is integrative domino effect of “**smaller object moving in higher speed + matter integration heavy mass convergent aggradation with proportionate large and strong matter field**”

①. The smaller objects generally move in higher speed in spacetime, as relatively active in spacetime, there is more probability for them to knock into matter field of surrounding celestial bodies, it’s even easy and expedient for them to knock into **central expediently assimilable globose field extent** of matter field of surrounding celestial bodies with adequate matter field mass superposition.

②. The celestial bodies with heavy mass convergent aggradation in spacetime proportionably have larger and strong matter field, they have remarkable advantage of more probability to capture small objects around, and they are easy to control existence & motion of small objects egocentrically.

Of course, ultimate consequence of “**positive gravity**” among celestial bodies are not that all the small celestial bodies are licked up by heavy celestial bodies, there is still substantial probability for small celestial bodies to go around the heavy celestial body with proper moving speed once centrifugal force of small celestial bodies can be almost equivalent to positive gravity. Thus, the heavy celestial bodies and the small celestial bodies can form rich and colorful galaxies in spacetime, which can be illustrated as below:

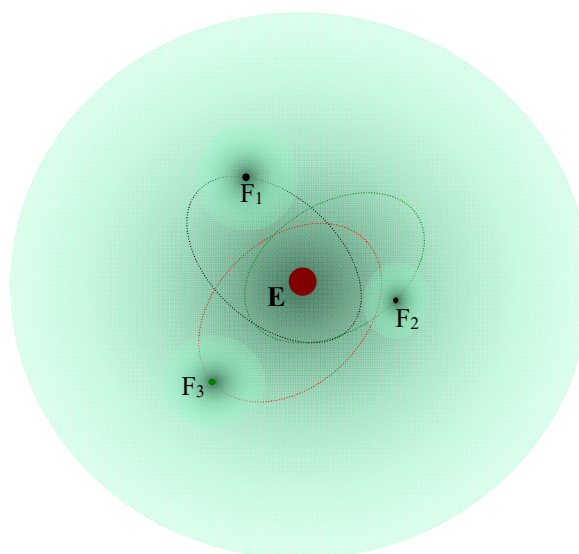

(V-iv-5-e) Galaxy among celestial bodies under reciprocity of positive gravity

Historical progress of science in the recent several centuries seemed like a far-flung exploration of the first itinerary around numerous distinctive landscapes of brand-new landmasses of science with palette & tablet on back, several hundred years’ scientific travelogues were compiled thereby.

Vivid existence & motion in cosmos are all consequence of “**Inherent cause + External cause**”, although, throughout cosmic evolution, the **inherent cause (PNT action + Instinctive PNT equilibrium)** of universal existence & motion is always invariable, rich and colorful existence & motion in cosmos are mostly derived from stochastic variation of “**External cause**”.

In terms of heavy celestial body A and heavy celestial body B with mass superposition of matter field, on one hand, as the moving speed of the heavy celestial is relatively low, existence & motion of the heavy celestial body is lumberly, such physical features of course indicates there is less probability for heavy celestial body A to knock into heavy celestial body B. And on the other hand, as the “**peripheral inexpedient assimilable globose field lamella**” between heavy celestial body A and celestial body B is considerable, what's more, moving speed of celestial body A and celestial body B is rather limit, there are really few opportunity for celestial body A to meet celestial body B in large-scale spacetime. Even though there is occasional chance for celestial body A to meet celestial body B in large-scale spacetime, it's still very difficult for both celestial body A and celestial body B to break through their “**peripheral inexpedient assimilable globose field lamella**” and ultimately enter mutual “**peripheral inexpedient assimilable globose field lamella**” for “**positive gravity**”.

This is just gravitational reciprocity fundamental of “**mass approximation accessible to negative gravity**”, which can be illustrated as below:

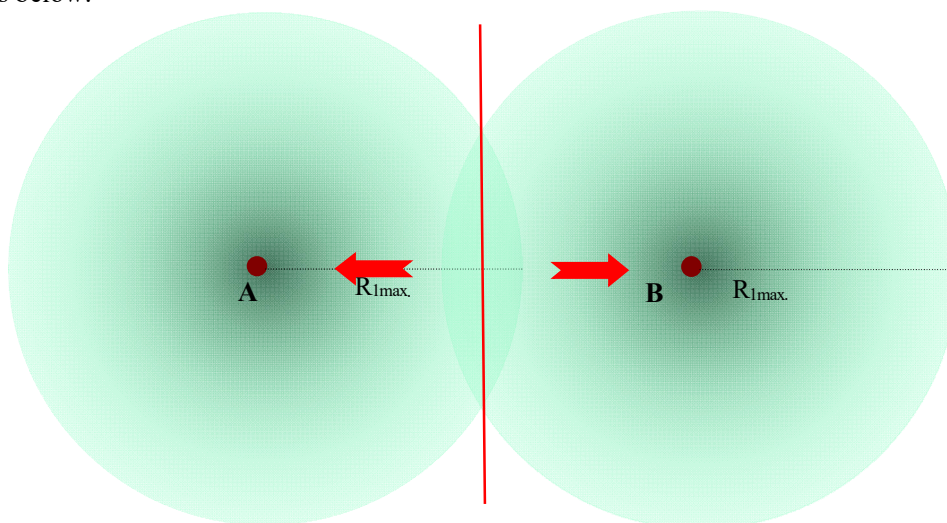

(V-iv-5-f) Mass approximation accessible to negative gravity

Gravitational reciprocity of “**mass disparity accessible to positive gravity**” is favorable for large celestial body to annex or control the small celestial bodies around, so that distribution of celestial bodies in large-scale spacetime is not too dispersive. Gravitational reciprocity of “**mass approximation accessible to negative gravity**” limit probability of mass multiple increase of heavy celestial bodies, so that mass convergent aggradation in large-scale spacetime is not too concentrative. General distribution of all galaxies in large-scale spacetime is mostly domino effect of gravitational reciprocity of “**mass disparity accessible to positive gravity & mass approximation accessible to negative gravity**” but not limited in domino effect of gravitational reciprocity of “**mass disparity accessible to positive gravity & mass approximation accessible to negative gravity**”.

In straightforward words, as spontaneous occurrence of [**Physical disturbance of matter field superposition + (PNT action + Instinctive PNT equilibrium)**], universal existence & motion are but consequence of “**Inherent cause + External cause**”.

A) The inherent cause of universal existence & motion is **(PNT action + Instinctive PNT equilibrium)**, which is

As coherent natura naturans throughout cosmic evolution, instinctive PNT reciprocal equilibrium towards optimum PNT operation is radical potentiality & conditionality for cosmos always ready to orientate itself towards perfection.

original motivity & aesthetic guidance of universal existence & motion, which is invariable as coherent natura naturans throughout cosmic evolution. When there is external physical disturbance, anything beneficial to optimum PNT operation of matter integration, instinctive reciprocal PNT equilibrium towards optimum PNT operation must assimilate the external physical disturbance as much as possible, proportionable distinctive existence & motion of matter integration is brought out accordingly; anything going against optimum PNT operation of matter integration, instinctive reciprocal PNT equilibrium towards optimum PNT operation must evade the external physical disturbance as much as possible, proportionable distinctive existence & motion of matter integration is brought out accordingly.

B) External cause of universal existence & motion is mostly external physical disturbance of PNT action of matter integration, which generally occur as stochastic “reciprocal idiosyncrasy towards PNT equilibrium + accessible space overall arrangement for PNT reciprocity” of matter integration, for instance, in terms of discretionary object in spacetime, external radiation, electromagnetic field, matter field superposition must impact existence & motion of the object. And at the same time, presence of weak space field around matter integration must impact existence & motion of matter integration too, such as **relative weak space field interlayer among galaxies**. Usually, as relative weak space field interlayer among galaxies is relatively weak, in order to avoid unnecessary yolk towards white damage of matter integration/celestial bodies, celestial bodies are always instinctively ready to avoid sliding into **relative weak space field interlayer among galaxies**, which of course indicates existence & motion restriction or guidance due to external negative physical disturbance, usually, heavy celestial bodies in galaxy are mostly difficult to transcend **relative weak space field interlayer among galaxies**. Of course, as small objects in large-scale spacetime mostly possess high moving speed, there are substantial opportunities for them to pass through **relative weak space field interlayer among galaxies**. Radiations and photons in large-scale spacetime are always ready to go across **relative weak space field interlayer among galaxies** without hesitation, although radiation and photons must occur more and more red shift for having passed more and more **relative weak space field interlayer among galaxies**.

All in all, Original generation and vivid existence & motion of reciprocal PNT combinations in gradation IV is but freewheeling of coherent natura naturans throughout cosmic evolution behind original generation and vivid existence & motion of elementary genic units, reciprocal PNT combinations in gradation I, reciprocal PNT combinations in gradation II, reciprocal PNT combinations in gradation III, which is of course spontaneous occurrence of **[Physical disturbance of matter field superposition + (PNT action + Instinctive PNT equilibrium)]**

2) Systematic unique-genesis quantization formulation of universal reciprocal PNT combinations in gradation IV.

In terms of systematic unique-genesis quantization formulation of universal reciprocal PNT combinations in gradation IV, the dynamic regularity of reciprocal PNT combinations in gradation IV is of course the same due to coherent natura naturans throughout cosmic evolution, it's but necessary for us to quantize the mass convergent aggradation of celestial bodies, mass of matter field of celestial bodies and mass of matter field superposition of celestial bodies in accordance with rationale of unique-genesis quantization of homogenous cosmos originated from unique genesis. As there are still many necessary details ahead of systematical unique-genesis quantization of universal existence & motion along sequential homologic cosmogony still need clarification & verification, I am really not convenient and confident to offer well-rounded systematical unique-genesis quantization formulation of universal reciprocal PNT combinations in gradation IV.

Although, before this, I have talked so much about systematical unique-genesis quantization formulation of

Historical progress of science in the recent several centuries seemed like a far-flung exploration of the first itinerary around numerous distinctive landscapes of brand-new landmasses of science with palette & tablet on back, several hundred years' scientific travelogues were compiled thereby.

universal existence & motion along sequential homologic cosmogony, it's but my pioneering endeavor I can hardly pass the buck to others, there are too many issues necessary to be highlighted as precursor for the pursuit. As author of Homogenous Cosmos Originated from Unique Genesis, if I am low-spirited towards the pursuit, there may be few people on the earth who can do something significant in the coming years. Although, as timely renovation of humanistic ideology about authenticity of nature in proportion to contemporaneous historical background of remarkable highlight of microcosmic configuration of matter and typical aberrant scientific knowledge proliferation out of rigid succession of contemporaneous scientific orthodoxy, Homogenous Cosmos Originated from Unique Genesis is still floundering around in vicious circle of virulent scientific knowledge metabolism campaign for social legitimacy subsistence.

And now, since I have highlighted so much about the necessary details of systematical unique-genesis quantization formulation of universal existence & motion along sequential homologic cosmogony, at the terminal process of it, absence of systematic unique-genesis quantization formulation of universal reciprocal PNT combinations in gradation IV won't impact further endeavor towards the pursuit. What's more, under egotistic background of interminable royal substantiation & perfection of contemporaneous scientific orthodoxy, floundering around in vicious circle of virulent scientific knowledge metabolism campaign for more than 31 years, I am really exhausted.

(V-iv-6) Words behind systematical unique-genesis quantization formulation of well-regulated cosmic homogeneity system making up of out-and-out serial natura naturata in the nature of coherent natura naturans throughout cosmic evolution

Once human have confirmed that cosmos is throughout homogenous originated from unique genesis, cosmic status quo is but demiurgic aggradation of sequential homologic cosmogony, which exactly exists as well-regulated integration of cosmic homogeneity system making up of out-and-out serial natura naturata in the nature of coherent natura naturans throughout cosmic evolution, **systematical unique-genesis quantization formulation of universal existence & motion along sequential homologic cosmogony** must be the most pressing challenge of historical progress of science. Whereas, under egotistic background of interminable royal substantiation & perfection of contemporaneous scientific orthodoxy with unprecedented official facility of magistral autarchy of **free press regulation customization & free press admittance** short of necessary intendance, as cosmos redefinition in logic enantiomorph of newly highlighted factuality that **discretionary particles in cosmos are mutually convertible**, free press admittance of Homogenous Cosmos Originated from Unique Genesis must break through legitimacy defense line of contemporaneous scientific orthodoxy, so that it has to challenge venomous counterwork upper limit of temporal authority without alternatives, and I've been struggling in vicious circle of virulent scientific knowledge metabolism campaign for more than 31 years, I see, I am villainous for authenticity highlight of homogenous cosmos originated from unique genesis straightforwardly impact vested interest of temporal authority who are working as hardcore puissance of historical progress of science. Although, as amateur work of lowdown man of the society without official rank, money, esoteric social guanxi, Homogenous Cosmos Originated from Unique Genesis has been the largest personal monograph throughout historical progress of science; in the recent four years, Homogenous Cosmos Originated from Unique Genesis has procured wide academic influence in open access all over the world.

It's only possible for concordant cosmos to be demiurgic aggradation of out-and-out serial natura naturata in the nature of coherent natura naturans throughout cosmic evolution; there is no way for demiurgic aggradation in the nature of different natura naturans to be concordant cosmos through and through. If we say cosmos is aesthetically regular, the unique aesthetic regularity of cosmos is but **sequential homologic cosmogony in the nature of coherent natura naturans throughout cosmic evolution**. Once human come to realize the authenticity of cosmos, our suspicion to scientific travelogues A, B, C, D, E, F, ... like omnifarious smallwares full of a basket will be self-evident. And indeed, in the recent several centuries, historical progress of science seemed like a far-flung exploration of the first itinerary around distinctive numeric landscapes of brand-new landmasses of science with palette and tablet on back, several hundred years' scientific travelogues were compiled thereby.

Whereas, as typical royal substantiation & perfection of contemporaneous scientific orthodoxy with unprecedented official facility of magistral autarchy of **free press regulation customization & free press admittance** short of necessary intendance, overwhelming authoritative intrepidity of contemporaneous scientific orthodoxy is all-time. In terms of living scientific knowledge proliferation on the earth, coercing egotistic reference, coercing egotistic special items & nouns, coercing egotistic logic model and text format has been routine operation at pleasure of temporal authority, living scientific knowledge proliferation on the earth have been restricted in rigid succession of contemporaneous scientific orthodoxy therefore, so-called "**science forum**" is out-and-out homegrown outgrowth in the garden of contemporaneous scientific orthodoxy due to magistral autarchy of **free press regulation customization & free press**

Historical progress of science in the recent several centuries seemed like a far-flung exploration of the first itinerary around numerous distinctive landscapes of brand-new landmasses of science with palette & tablet on back, several hundred years' scientific travelogues were compiled thereby.

admittance of temporal authority. Although, historical progress of science is not permanent endeavor for royal substantiation & perfection of contemporaneous scientific orthodoxy but endeavor to push humanistic ideology about authenticity of nature forwards to perfect ideological enantiomorph of ultimate authenticity of nature step by step draw on practical feasibility & possibility in proportion to contemporaneous historical background.

When I was still in serious confusion what kind of mathematical expression I should invoke for systematical unique-genesis quantization formulation of universal existence & motion along sequential homologic cosmogony, I was always detestable for absence of modern mathematical language in Homogenous Cosmos Originated from Unique Genesis.

Does the demiurge bring out cosmos first, then mathematics?

Does the demiurge bring out mathematics, then cosmos?

In any case, as timely renovation of humanistic ideology about authenticity of nature in proportion to contemporaneous historical background of remarkable highlight of microcosmic configuration of matter, cosmos has been redefined in logic enantiomorph of newly highlighted factuality that **discretionary particles in cosmos are mutually convertible**, whereas, mathematics is still ready-made modern mathematics.

What's the compatibility between authenticity of nature and ready-made modern mathematics?

Is it enough for systematical unique-genesis quantization formulation of universal existence & motion along sequential homologic cosmogony?

I am really not confident what kind of popular and modern mathematical expression I should choose before clarification of such kind of issues.

Virtually, in the recent years, I was always confused by “number”, in accordance with systematical quantification necessity of cosmic homogeneity system making up of out-and-out serial natura naturata in the nature of coherent natura naturans throughout cosmic evolution, how can I define “number” accordingly? Virtually, in accordance with scientific idea of homogenous cosmos originated from unique genesis, once we define the quantification noumenon of space field genic origin i_0 “basic quantum” for universal quantification, there are only integers of comprehensive quantification of universal existence & motion, no decimal fraction, no more irrational numbers.

And on the other hand, as inherent limitation of humanistic physical purview, there is really no way for human to perceive independent spontaneous transmutation & transition of space field genic units but to perceive quantification noumenon of evolutionary outgrowth of remarkable segment of cosmogony. Theoretically, we can quantize any cosmic object in accordance with unique-genesis quantum of quantification noumenon of space field genic origin i_0 , whereas, by the right of humanistic practice, we can never perceive vivid existence & motion of any independent space field genic units in space field. And what's more, as introduction of basic quantum of quantification noumenon of space field genic origin i_0 , implementation of systematical unique-genesis quantization formulation of universal existence & motion along sequential homologic cosmogony must smooth away rational estrangement of basic dimensions as mass 1 Kg, length 1 meter, time 1 second, and the symbolic logic of systematical unique-genesis quantization formulation of universal existence & motion along sequential homologic cosmogony must be different from conventional idea.

Interminable royal substantiation & perfection of contemporaneous scientific orthodoxy of course bring out substantial honey second-rate geniuses, and as honey second-rate geniuses are always ready to devote themselves

to contemporaneous scientific orthodoxy, royal substantiation & perfection of contemporaneous scientific orthodoxy must bring out remarkable authoritative intrepidity of contemporaneous scientific orthodoxy in the nature of things. Some so-called authority who have ever contributed several popular scientific travelogues are always commanding that any qualified paper must possess definite “purpose”, definite “method”, definite “results”, definite “conclusion”,

I am really confused, in any case, veritable progress of science is realistic endeavor to push humanistic ideology about authenticity of nature forward to perfect ideological enantiomorph of ultimate authenticity of nature step by step draw on practical feasibility & possibility in proportion to contemporaneous historical background but not interminable royal substantiation & perfection of contemporaneous scientific orthodoxy, no more imitation of popular scientific travelogues of temporal authority.

After all, as cosmos redefinition in logic enantiomorph of newly highlighted factuality that **discretionary particles in cosmos are mutually convertible** with consequent PNT dynamics about universal existence & motion in the nature of coherent natura naturans throughout cosmic evolution, Homogenous Cosmos Originated from Unique Genesis has unique conclusion that cosmos is throughout homogenous originated from unique genesis, cosmic is throughout homogenous originated from unique genesis, cosmic status quo is but demiurgic aggradation of sequential homologic cosmogony, which exactly exists as well-regulated integration of cosmic homogeneity system making up of out-and-out serial natura naturata in the nature of coherent natura naturans throughout cosmic evolution, all other conclusions are but logic extension on the basis of [(**Homogenous cosmos originated from unique genesis postulate** + **spacetime~matter fully embodying cosmos postulate**) + **Instinctive PNT equilibrium postulate**]. Homogenous Cosmos Originated from Unique Genesis is really difficult to imitate popular scientific travelogues for free press egotistic proximity identification.

And now, Homogenous Cosmos Originated from Unique Genesis has been struggling in vicious circle of virulent scientific knowledge metabolism campaign for more than 31 years, I have been old and exhausted. Whereas, till today, as lowdown man of the society and heterodoxy of the age, nothing I can do to change the tragic reality that free press admittance of Homogenous Cosmos Originated from Unique Genesis must break through legitimacy defense line of contemporaneous scientific orthodoxy, so that it has to challenge venomous counterwork upper limit of temporal authority, I am so lonely and helpless to face rigorous humanistic factuality, as multiple notion with double significance of “**social connotation**” & “**natural connotation**”, social legitimacy & validity of truths can never exceed cannon range.

The most pestilent balefulness of human is no more than magistral power out of necessary intendance.

Since interminable free press embarment has made Homogenous Cosmos Originated from unique Genesis neither way to decent survival nor way to point-blank death, why do not I kneel down before temporal authority for dead expostulation as early as possible?

Elevating the banner of “**natura naturans**” in my left hand, ——“Your Majesty, on stand of inherence of natura naturans throughout cosmic evolution, only ultimate authenticity of nature as coherent natura naturans throughout cosmic evolution is something like everlasting star.

Elevating the banner of “**authority**” in my right hand, ——“Your Majesty, on stand of crescive progression of historical progress of science due to practical feasibility & possibility in proportion to contemporaneous historical background, your authority is but something like meteor twinkling in a sudden once you mounting the

Historical progress of science in the recent several centuries seemed like a far-flung exploration of the first itinerary around numerous distinctive landscapes of brand-new landmasses of science with palette & tablet on back, several hundred years’ scientific travelogues were compiled thereby.

stage in full regalia". Since it's only possible for the major melody of historical progress of science to be series of epochmaking scientific knowledge metabolism in inherent optimum orientation towards perfect ideological enantiomorph of ultimate authenticity of nature, why contemporaneous scientific orthodoxy is always invoked as fame & gain shield of temporal authority to turn down timely renovation of humanistic ideology about authenticity of nature in proportion to contemporaneous historical background? Only gymnastic top records are mostly invoked as target for successive transcendence.

As permanent synthesized conditionality of **"crescive progression of practical feasibility & possibility in proportion to contemporaneous historical background + the uniqueness & invariance of ultimate authenticity of nature predestines the unique possibility of scientific verity as perfect ideological enantiomorph of ultimate authenticity of nature"**, it's only possible for the major melody of historical progress of science to be a series of epochmaking scientific knowledge metabolism in inherent optimum orientation towards historical authenticity tolerance of science 0 with proportionate revolutionary subrogation of temporal orthodoxies one after another, which of indicates, before humanistic ideology about authenticity of nature finally qualified as perfect ideological enantiomorph of ultimate authenticity of nature, it's only possible for so-called "sciences" to be humanistic ideology about authenticity of nature in proportion to contemporaneous historical background, which makes up of crescive progression of historical progress of science in inherent optimum orientation towards perfect ideological enantiomorph of ultimate authenticity of nature.

Such objectivity of historical progress of science of course indicates:

①. As long as there is solid social endeavor to highlight and formulate authenticity of nature then and there, as impersonal potentiality for historical progress of science, the practical feasibility & possibility in proportion to contemporaneous historical background A must be commensurate favorable precondition for practical accomplishment of humanistic ideology about authenticity of nature in proportion to contemporaneous historical background A in the nature of things. There is neither way for humanistic ideology about authenticity of nature to be accomplished groundlessly nor way for humanistic ideology about authenticity of nature to be accomplished as remarkable aberrance of historical progress of science in inherent optimum orientation towards perfect ideological enantiomorph of ultimate authenticity of nature. In straightforward words, as impersonal conditionality of practical potentiality, it's only possible for practical feasibility & possibility in proportion to contemporaneous historical background A to be favorable headspring towards accomplishment of proportionate humanistic ideology about authenticity of nature in proportion to contemporaneous historical background A, it may be even feasible and possible humanistic resource for necessary scientific authentication of commensurate humanistic ideology about authenticity of nature for social legitimacy subsistence of the age.

②. As long as humanistic ideology about authenticity of nature in proportion to contemporaneous historical background A is still not **perfect ideological enantiomorph of ultimate authenticity of nature**, once quantitative & qualitative change of practical feasibility & possibility for historical progress of science positively extends from situation A to situation B, there must be proportionate favorable potentiality for successive renovation of humanistic ideology about authenticity of nature in proportion to contemporaneous historical background B in inherent optimum orientation towards perfect ideological enantiomorph of ultimate authenticity of nature. And as **the uniqueness & invariance of ultimate authenticity of nature radically predestines the unique possibility of scientific verity as perfect ideological enantiomorph of ultimate authenticity of nature**, humanistic ideology about authenticity of nature in proportion to contemporaneous historical background B must wash out humanistic ideology about authenticity of nature in proportion to contemporaneous historical background A due to necessary scientific knowledge metabolism in inherent optimum orientation towards perfect ideological enantiomorph of ultimate authenticity of nature, till at last, humanistic ideology about authenticity of nature finally qualified as perfect ideological enantiomorph of ultimate authenticity of nature.

As coherent natura naturans throughout cosmic evolution, instinctive PNT reciprocal equilibrium towards optimum PNT operation is radical potentiality & conditionality for cosmos always ready to orientate itself towards perfection.

Aristotle theory was of course classic output of scientific knowledge proliferation beyond all doubt in proportion to contemporaneous historical background of B.C. 4, culture trait of Greece. Whereas, once quantitative & qualitative change of practical feasibility & possibility proceeded to Galileo's age, there had been substantial potentiality for human to push humanistic ideology about authenticity of nature forward to perfect ideological enantiomorph of ultimate authenticity of nature. As a result, Galileo accomplished timely renovation of humanistic ideology about authenticity of nature in proportion to contemporaneous historical background then and there, which radically washed out Aristotle's humanistic ideology about authenticity of nature in proportion to contemporaneous historical background. Even as remarkable advancement of practical feasibility & possible, Galileo's timely renovation of humanistic ideology about authenticity of nature in proportion to contemporaneous historical background apparently transcended original prediction of Aristotle out and away.

.....

Newtonian Mechanics was of course classic recognizant outgrowth of humanistic ideology about authenticity of nature in proportion to contemporaneous historical background of A.D. 17, culture trait of occident. Whereas, once quantitative & qualitative change of practical feasibility & possibility extended to terminal years of 19th century and early years of 20th century, there had been substantial potentiality for accomplishment of epochmaking renovation of humanistic ideology about authenticity of nature forward to perfect ideological enantiomorph of ultimate authenticity of nature. As a result, Relativity, Quantum Theory came into being, which radically washed out Newtonian Mechanics. Even as remarkable advancement of practical feasibility & possibility, timely renovation of humanistic ideology about authenticity of nature as Relativity & Quantum Theory against remarkable practical transition from macrocosmos to microcosmos in terminal years of 19th century and early years of 20th century apparently transcended original prediction of Newton out and away.

This is just realistic endeavor of historical progress of science to push humanistic ideology about authenticity of nature forward to perfect ideological enantiomorph of ultimate authenticity of nature step by step draw on practical feasibility & possibility in proportion to contemporaneous historical background. Looking back historical progress of science, we never created any everlasting truth eversince but having accomplished serial scientific knowledge metabolism in inherent optimum orientation towards perfect ideological enantiomorph of ultimate authenticity of nature therefore. All in all, as permanent synthesized conditionality of **“crescive progression of practical feasibility & possibility in proportion to contemporaneous historical background + the uniqueness & invariance of ultimate authenticity of nature predestines the unique possibility of scientific verity as perfect ideological enantiomorph of ultimate authenticity of nature”** through and through, it's only possible for the major melody of historical progress of science to be serial epochmaking scientific knowledge metabolism in inherent optimum orientation towards perfect ideological enantiomorph of ultimate authenticity of nature.

Whereas, history extends to today, the inevitability of historical progress of science seems invalid.

Taking credit of meritorious contribution towards royal substantiation & perfection of contemporaneous scientific orthodoxy to themselves with unprecedented official facility of magistral autarchy of **free press regulation customization & free press admittance** short of necessary intendance, what are the respectable reasons for temporal authority to be so overbearing to face timely renovation of humanistic ideology about authenticity of nature in proportion to contemporaneous historical background of **remarkable highlight of microcosmic configuration of matter**? After all, veritable historical progress of science in inherent optimum orientation towards perfect ideological enantiomorph of ultimate

Historical progress of science in the recent several centuries seemed like a far-flung exploration of the first itinerary around numerous distinctive landscapes of brand-new landmasses of science with palette & tablet on back, several hundred years' scientific travelogues were compiled thereby.



It's only possible for concordant cosmos to be demiurgic aggradation of out-and-out serial natura naturata in the nature of coherent natura naturans throughout cosmic evolution; there is no way for demiurgic aggradation in the nature of different natura naturans to be concordant cosmos through and through.

authenticity of nature is not royal substantiation and perfection of contemporaneous scientific orthodoxy, but hypostatic endeavor to push humanistic ideology about authenticity of nature forward to perfect ideological enantiomorph of ultimate authenticity of nature step by step draw on practical feasibility & possibility in proportion to contemporaneous historical background. It's only possible for the major melody of historical progress of science to be successive epochmaking scientific knowledge metabolism in inherent optimum orientation towards perfect ideological enantiomorph of ultimate authenticity of nature, although, temporal authority are mostly official negative puissance of epochmaking scientific knowledge metabolism.

As coherent natura naturans throughout cosmic evolution, instinctive PNT reciprocal equilibrium towards optimum PNT operation is radical potentiality & conditionality for cosmos always ready to orientate itself towards perfection.

The sixth part

Initial Endeavor of **Natura Naturans Personalization Towards Human Necessity** Based on Primary Authenticity Clarification Of Homogenous Cosmos Originated from Unique Genesis

The highest rational realm of scientific innovation under contemporaneous historical background is but feasible natura naturans personalization towards human necessity of social production and social life; as mathematical formulation of out-and-out serial natura naturata in the nature of coherent natura naturans throughout cosmic evolution, ultimate consummation of “Atom State Equation in Spacetime” indicates ultimate consummation of systematical unique-quantization quantization formulation of universal existence & motion, which must bring out a grand prolific spring for coming technology application.

Forward

As typical “reciprocal PNT combinations in gradation III”, it’s only possible for human to be “**knowers**” & “**utilizers**” of authenticity of nature, there is no way for human to create any regularity of the nature in stead of the demiurge but only possible to recognize authenticity of nature as much as possible draw on practical feasibility & possibility in proportion to contemporaneous historical background, consequently, on the basis of commensurate humanist ideological system about authenticity of nature, it’s practically possible for human to accomplish proportionate “natura naturans personalization towards human necessity” to improve social production & social life of human. In straightforward words, so-called pioneering pursuit of “science & technology” is but humanistic endeavor to clarify and highlight authenticity of nature as much as possible, so that, on the basis of commensurate ideological system about authenticity of nature, it’s possible for human to accomplish proportionate

Historical progress of science in the recent several centuries seemed like a far-flung exploration of the first itinerary around numerous distinctive landscapes of brand-new landmasses of science with palette & tablet on back, several hundred years’ scientific travelogues were compiled thereby.

natura naturans personalization towards human necessity as much as possible. Authenticity clarification & highlight is favorable precondition of proportionate natura naturans personalization towards human necessity, without instructive input of authenticity clarification & highlight, it's only possible for so-called "technologic pursuit" to be simple game how many nice patterns we can piece together towards human necessity with ready-made 10 crabsticks.

The highest progressive realm of technologic innovation under contemporaneous historical background is but feasible natura naturans personalization towards human necessity on the basis of commensurate humanistic ideological system about authenticity of nature., the rational accessibility of natura naturans personalization towards human necessity for social production & social life radically depends on quality of commensurate humanistic ideological system about authenticity of nature. In straightforward words, creation is not humanistic endeavor to do job instead of the demiurge so as to bring out supernatural objects out of category of serial natura naturata in the nature of coherent natura naturans throughout cosmic evolution, but humanistic endeavor to highlight and discover authenticity of nature as much as possible in prior, then proportionably try to accomplish possible "natura naturans personalization towards human necessity" accordingly.

Considered by Homogenous Cosmos Originated from Unique Genesis, entire cosmic contents exactly exist in a grand well-regulated integration of cosmic homogeneity system —cosmic status quo is demiurgic aggradation of out-and-out serial natura naturata in the nature of coherent natura naturans throughout cosmic evolution which is just universal dynamic fundamental of instinctive PNT reciprocal equilibrium towards optimum PNT operation and radical potentiality & conditionality to make cosmos always ready to orientate itself towards perfection.

Mathematical definition of Homogenous Cosmos Originated from Unique Genesis is as below:

$$\text{Homogenous Cosmos Originated from Unique Genesis} \stackrel{\text{def}}{=} \sum_{m=D} D_{m=D} [\int_{i_0}^X f(m_{i_0 \rightarrow X}) i_0]$$

Virtually, mathematical definition of Homogenous Cosmos Originated from Unique Genesis is just the mathematical definition of general existence & motion of discretionary object in spacetime. After all, cosmic status quo is demiurgic aggradation of sequential homologic cosmogony, which is well-regulated cosmic homogeneity system making up of out-and-out serial natura naturata in the nature of coherent natura naturans throughout cosmic evolution.

Mathematical definition equation of Homogenous Cosmos Originated from Unique Genesis covers double significance of vivid/universal existence & motion:

The first, connotation of cumulative genic noumenon which exists as definite behavioral esse of PNT action in spacetime and can be formulated in homologic genic integral equation $\sum_{m=\int_{i_0}^X} f(m_{i_0 \rightarrow X}) i_0$.

The second, dynamic connotation of object is just dynamic enantiomorph of PNT action of proper compositive genic noumenon, which can be formulated in PNT dynamic integral equation $\sum^{D=D_{PNT}} [\int_{i_0}^X]$

The double connotation of mathematical definition of Homogenous Cosmos Originated from Unique Genesis innately coexist like the couple sides of a cent, any compositive genic noumenon $\sum_{m=\int_{i_0}^X} f(m_{i_0 \rightarrow X}) i_0$ in spacetime inherently go with proportionate PNT performance unconditionally, both compositive genic noumenon $\sum_{m=\int_{i_0}^X} f(m_{i_0 \rightarrow X}) i_0$ and the dynamic connotation of PNT action of compositive genic noumenon $\sum^{D=D_{PNT}} [\int_{i_0}^X]$ are inherent exact couple coexisting for perfect embodiment of vivid existence & motion of object in spacetime.

The discrepancies of existence & motion of rich and colorful objects in cosmos can be either compositive difference of cumulative genic noumenon formulated in homologic genic integral equation $\sum_{m=\int_{i_0}^X} f(m_{i_0 \rightarrow X}) i_0$

As coherent natura naturans throughout cosmic evolution, instinctive PNT reciprocal equilibrium towards optimum PNT operation is radical potentiality & conditionality for cosmos always ready to orientate itself towards perfection.

or estate difference of PNT dynamic connotation formulated in PNT dynamic integral equation $\sum^D = D_{\text{PNT}}[\int_{i_0}^X]$, or both compositive difference of cumulative genic noumenon $\sum_m = \int_{i_0}^X f(m_{i_0 \rightarrow X}) i_0$ and PNT dynamic connotation $\sum^D = D_{\text{PNT}}[\int_{i_0}^X]$. Perfect analysis and formulation of existence & motion of idiographic objects in spacetime not only needs verification of cumulative genic noumenon $\sum_m = \int_{i_0}^X f(m_{i_0 \rightarrow X}) i_0$ but also demands exact formulation of PNT dynamic connotation $\sum^D = D_{\text{PNT}}[\int_{i_0}^X]$ as innate couple of physical connotation of vivid reciprocal PNT combination, no matter the objects we are ready to analyze and formulate are idiographic existence & motion of particles, atoms, compounds, admixtures, ... plants, animals, ... autocar, rocket, ... earth, sun, Milky Way, ..., as long as it's object in homogenous cosmos, the general rational clarification is just the same.

On some certain point of view, the unalloyed demiurgic evolution of cosmos has not brought out eyeable rich and colorful cosmos directly, but gestates elementary atoms in advance as preparation for successive demiurgic proliferation of eyeable rich and colorful macrocosmos; the eyeable rich and colorful macrocosmos is virtually outgrowth of freewheeling coherent natura naturans in the nature of instinctive PNT reciprocal equilibrium towards optimum PNT operation among accessible atoms.

As gradual cumulative reciprocal genic condensation with cosmic evolutionary proliferation, before generation of elementary atoms, all progressive cosmic evolution is always ready to consummate the generation and further proliferation of elementary atoms; while, further demiurgic evolution successive to the generation of elementary atoms are all oriented to build macrocosm with raw material components of elementary atoms. In terms of cosmic progressive demiurgic proliferation before naissance of elementary atoms, as reciprocal PNT combination, elementary atom is a consequent constringent amassment unit; while in terms of the successive demiurgic evolution beyond naissance of elementary atoms; elementary atoms are just dominative dynamic origin. Because, after generation of elementary atoms, the remarkable progress of cosmic evolution is to build macrocosm with raw material components of elementary atoms, all the existence & motion of gas, liquid, solid made up of atoms are radically depend on the distinctive “dynamic compose” of compositive elementary atoms. The Atom State Equation in Spacetime $\sum^D_{m \Delta \text{atom}} = D_{\text{PNT}}[\int_{i_0}^{\text{Atom}} f(m_{i_0 \rightarrow \text{Atom}}) i_0]$ not only contains all the behavioral regularities of existence & motion of all objects whose reciprocal genic aggregation scale is less than elementary atoms, but also all existence & motion of atomic reciprocal PNT combinations can be deduced out by proper mathematical operation on the basis of Atom State Equation in Spacetime, no matter knowledge about vivid existence & motion of atomic reciprocal PNT combinations originally belong to scope of physics, chemistry, biology or abiology.

It of course implies once the Atom State Equation in Spacetime is ultimately consummated, not only all the inner existence & motion of atom or objects whose homologic genic aggregation scales are less than elementary atoms will be thoroughly self-evident, but also all existence & motion of macroscopical objects made up of elementary atoms will be consequently intelligible according to dynamic symbolic logic on the basis of Atom State Equation in Spacetime. The technology proliferation of Homogenous Cosmos Originated from Unique Genesis is just technology bloom rooted in rational resource of Atom State Equation in Spacetime, —upon our rational comprehension and practical master of dynamic connotation of $\sum^D_{m \equiv D} D_{\text{PNT}}[\int_{i_0}^X f(m_{i_0 \rightarrow X}) i_0]$ of objects, we can artificially make use of proper inherent characters of objects or potential inevitable PNT reaction between this object and that object to accomplish practical necessity of human.

So-called “**innovation**” or “**design**” is humanistic endeavor to integrate and administrate ideal existence & motion accessible in the nature to accomplish humanistic functional necessity of social production and/or social

Historical progress of science in the recent several centuries seemed like a far-flung exploration of the first itinerary around numerous distinctive landscapes of brand-new landmasses of science with palette & tablet on back, several hundred years' scientific travelogues were compiled thereby.

life, in straightforward words, so-called “**innovation**” or “**design**” is but humanistic endeavor of natura naturans personalization towards human necessity. The key issue is that it's only possible for universal existence & motion to incarnate hypostatic existence & motion as spontaneous occurrence in the nature of coherent natura naturans throughout cosmic evolution, human can never create distinctive regularity of universal existence & motion towards human functional necessity of social production and/or social life, it's only possible for human to administrate and utilize ideal existence & motion in the nature of coherent natura naturans throughout cosmic evolution towards human functional necessity of social production and/or social life. As a result, intelligence precondition for practical accomplishment of humanistic “**innovation**” or “**design**” must be that we must master the proper “ideal existence & motion” in the nature of coherent natura naturans throughout cosmic evolution in advance. As mathematical formulation of out-and-out natura naturata of reciprocal PNT combinations in gradation II in the nature of coherent natura naturans throughout cosmic evolution, ultimate consummation of **Atom State Equation in Spacetime** is of course favorable intelligence capital for practical accomplishment of natura naturans personalization towards human necessity.

If we declare historical naissance and successive development of live contemporaneous scientific orthodoxy has favored producible soils for technologic application one after another, I'd like to comment herein, ultimate consummation of Atom State Equation in Spacetime must bring out coming technologic application a grand prolific spring.

It's of course comprehensible that technologic proliferation of Homogenous Cosmos Originated from Unique Genesis is generally ready to meet two kinds of practical demands:

The first is to procure **more energy or motorial status control of objects** by artificial control of PNT reaction. For instance, we build internal-combustion engine, nuclear power plant, autocar, rocket, PNT engine etc.

The second is to procure **ideal reciprocal PNT combinations** with ideal functions, reliability or any higher quality due to applicable demands in accordance with necessity of the proper artificial control of PNT reactions. For instance, we are ready to develop ideal alloy steels, electronic instruments, iatric medicines, synthetic biological apparatus or computer, DNA proliferation optimization, life-form robot etc.

As “Atom State Equation in Spacetime” has not been ultimately clarified and consummated yet, I am genuinely regretful I can only bemoan my inadequacy in the face towards many of my technologic ambitions. However, an illusion about normal PNT activation & rectification of atomic reciprocal PNT combination—PNT engine made me so beguiled to push my way against blindness of connotation $\sum_{m \equiv D_{PNT}} [j_{i_0}^X f(m_{i_0 \rightarrow X}) i_{i_0}]$ of the so-called “PNT activation source” and “PNT activation & rectification signal”.

And as low-down floater in mainland of China struggling in puzzledom of subsistence, I am so exhausted, in order not to forget it for silly absence of my sense, I have to write down some my ideas as possibly as I can.

Technology i

(VI-i) Introduction of PNT Engine

Engine contriving is even creationary job to facilitate connatural existence & motion in the nature of coherent natura naturans throughout cosmic evolution artificially adjustable towards "ideal motion" following our inclinations.

Foreword

As humanistic endeavor of **natura naturans personalization towards human necessity**, the rational backup of creativity of PNT engine is of course radical authenticity clarification of "universal existence & motion" as spontaneous occurrence of [External physical disturbance + (PNT action + Instinctive PNT equilibrium)]. Subsequently, the secondary significance towards humanistic accessibility of PNT engine is whether authenticity of universal existence & motion can be feasibly controllable as definite physical noumenon around us.

In straightforward words, "universal existence & motion" are but demiurgic aggradation of out-and-out serial natura naturata in the nature of coherent natura naturans throughout cosmic evolution which is just dynamic enantiomorph of PNT action of matter integration. As technologic practice towards drive of object, engine contriving is straightforward creationary endeavor to facilitate PNT operation of matter integration artificially adjustable towards "ideal motion" following our inclinations, which is dynamic noumenon of connatural existence & motion in the nature of essence of matter in a class by itself. Whereas, what's the "essence" of matter in a class by itself? Is the essence of matter in a class by itself controllable upon our practical feasibility? Once we've possessed the logos capital of "essence" of matter, we can of course come to mastermind and control existence & motion of idiographic object accordingly following our inclinations, can't we?

Science progress proceeding to today, although, we have never kept a slack hand with study of existence & motion of matter, we are still reluctant to draw a positive conclusion what's the essence of existence & motion of matter. Although, we've studied substantial omnifarious matter specimens accessible around us, we still have to admit we have never studied matter as matter itself yet. Although we've materialized many real-life engine ideas as automobile, plane, rocket etc, we have to admit such innovative successes are but originality derived from our prior cognition gain of energy status disparity of different objects under proper conditions and the transferential

Historical progress of science in the recent several centuries seemed like a far-flung exploration of the first itinerary around numerous distinctive landscapes of brand-new landmasses of science with palette & tablet on back, several hundred years' scientific travelogues were compiled thereby.

possibility of kinetic energy from high-energy objects to low-energy objects by mechanical interaction. Although, the objects as automobile, plane, rocket are driven indeed, and the existence & motion of so-called automobile, plane, rocket are really changed consequently, we have to admit we did never have intentional idea to have changed the essence of existence & motion of matter as automobile, plane, rocket radically, but materialized the kinetic energy transference from high-energy matter of burning fuel to goal loads as automobile, plane, rocket, we did never have idea to materialize driving matter by making essence of existence & motion of matter under artificial control.

At any rate, technological challenge of engine contriving is not simple artificial control of physical process of preponderant kinetic energy release, transference, as technological challenge to make kinetic status of object under artificial control, since motion is inherent attribute of matter, the key issue of technological challenge of engine contriving should be how to practically make essence of existence & motion of matter under artificial control for "ideal motion" of object.

Considered by Homogenous Cosmos Originated from Unique Genesis, existence & motion is but dynamic enantiomorph of PNT action of matter integration in spacetime, existence & motion status of matter in spacetime radically depends on PNT performance of matter integration. If we can make "PNT operation of matter integration in spacetime" under artificial control, it of course means we can radically master and control motion status of matter in spacetime. PNT engine just derives from such cognition gain of authenticity of existence & motion of matter in spacetime; it's technological job to radically modulate and control the PNT performance of matter integration in accordance with fundamental of universal PNT action and favorable idiosyncrasy of PNT performance of hypostatic objects so as to set up expectant existence & motion of object at our pleasure. The scientific creditability of PNT engine above all depends on whether physical connotation of existence & motion of object is really dynamic enantiomorph of PNT action of matter integration due to essence of matter. And the practical significance of PNT engine depends on, in accordance with common fundamental of universal PNT action and favorable idiosyncrasy of PNT performance of ideal PNT activation source, whether the instrumentality and modus operandi we introduced to work on the PNT action of PNT activation source for artificial modulation and control of PNT operation is feasible and efficient.

(VI-i-1) Common Engine and Flying Saucer Engine

Abstract: *“Universal existence & motion” are but spontaneous occurrence in the nature of coherent natura naturans throughout cosmic evolution, which is virtually dynamic enantiomorph of PNT action of matter integration. Dive pursuit of object is virtually humanistic endeavor to accomplish dynamic transition of existent state of object from tardy state to relatively speedy state. Whereas, as permanent conventionality, it seems we’ve been used to driving matter as “undynamic loads” with drive of internal-combustion engine, electromotor etc, but never ready to face factuality that universal existence & motion are spontaneous occurrence in the nature of essence of matter in a class by itself to contrive “ideal motion” by straightforward artificial modulation & control of PNT operation of matter integration.*

Under precondition that we confirm hypostatic existence & motion of matter integration is just enantiomorphous dynamic incarnation of proportionate specific PNT action of matter integration, as humanistic endeavor of natura naturans personalization towards human necessity of social production and social life, we study PNT engine (/flying saucer engine) is generally endeavor to verify necessary issues as below:

The first, the rigid logic correction between “hypostatic existence & motion of matter integration” and “proportionate specific PNT action of matter integration”, which of course implies what kind of specific PNT action predestine proportionate hypostatic existence & motion of matter integration.

The second, what kind of atomic reciprocal PNT combination inherently possesses ideal PNT controllability, and the feasible PNT controllable range proportionably predestine ideal variation of existence & motion of matter integration.

So-called **“Common Engine”** is a sort of mechanism which can be used to stochastically cause activation of potential energy of some certain energetic source material as relatively preponderant kinetic energy and transfer it to undynamic loads as much as possible. The most remarkable operational feature of common engine is that it must invoke so-called energy resource material A to offer preponderant kinetic energy, as initial condition to start common engine, we must manage to activate the energy source material so that it can offer preponderant kinetic energy in advance, then to facilitate the driven object B to head off and conglutinate the preponderant kinetic energy offered by energy resource material A by mechanical collision or extrusion as much as possible, so that driven object B can accomplish relatively ideal acceleration therefore.

Whereas, in accordance with authenticity that universal existence & motion of matter are just dynamic enantiomorph of PNT action of matter integration in spacetime, so-called **“Flying Saucer Engine”** is but a sort of mechanism to facilitate PNT action of matter integration under artificial control at human pleasure so as to stochastically accomplish anticipative ideal motion of object according to intrinsic regularity of PNT action and the favorable feature of PNT action of the proper object, which is used as PNT activation source of flying saucer engine.

And just because, **“Flying Saucer Engine”** is virtually a kind of feasible mechanism for accessibility of artificial modulation & control of PNT action of target matter integration, Flying saucer Engine is called **“controllable PNT modulation mechanism towards ideal existence & motion of target matter integration”** therefore, which can be abbreviated as **“PNT engine”**.

Keywords: Common engine, Flying saucer engine, PNT engine, Milk hitchhike-able speed, non-milk hitchhike-able speed, self-propelled engine, almsgiving-style engine, PNT activation source, PNT non-normalized

Historical progress of science in the recent several centuries seemed like a far-flung exploration of the first itinerary around numerous distinctive landscapes of brand-new landmasses of science with palette & tablet on back, several hundred years’ scientific travelogues were compiled thereby.

activation, PNT normalized activation, PNT elastic normalized activation, PNT activation mechanism, low-intensity train flying saucer engine, flying saucer engine generator (PNT generator), PNT activated current.

1. Summary of common engine

Once we refer to “engine”, we may sensitively think of internal-combustion engine, turbo, electrical motor etc. In accordance with our general experience and conventional sense, we can haply obtain a simple definition of common engine like this: so-called **“Common Engine” is a sort of mechanism which can be used to stochastically cause activation of potential energy of some certain attachment of energetic source material for relatively preponderant kinetic energy and transfer it to loads as much as possible.**

On the view of the energy origin, the energy resources of common engine are generally fuel chemical energy, geo-potential energy, electric energy, nuclear energy etc. On the view of the dynamic mechanism for engine to work, we are generally good at and be used to adopting energy resource material with remarkable preponderant kinetic energy to collide or extrude the proper load objects so that some of the preponderant kinetic energy of the energy source material can be transferred to the proper load objects thereby. For instance, steam engine depends on running vapor colliding plunger to work; internal-combustion engine depends on the burning gas extruding the plunger to work; wind-power or water-power generator depends on the running airflow or stream colliding impellers to work; rocket depends on the jetting gas recoil working.

Apparently, the most remarkable operational feature of common engine is that it must invoke so-called energy resource material A to offer preponderant kinetic energy, as initial condition to start common engine, we must manage to activate the energy source material so that it can offer preponderant kinetic energy in advance, then to facilitate the driven object B to head off and conglutinate the preponderant kinetic energy offered by energy resource material A by mechanical collision or extrusion as much as possible, so that driven object B can accomplish relatively ideal acceleration therefore. As a result, the dynamical process the common engine working can be generally expressed mathematically as following:

For convenience of mathematical expression, we denote the very mass of the energy source material as m_1 , the mass of matter field of energy source material as M_1 ; denote the mass change of m_1 as Δm_1 and the mass change of M_1 as ΔM_1 during the course of the energy source material releasing energy. And at the same time, as some of the preponderant kinetic energy of energy source material is hold up by load object, there must be a certain quantity of mass transferred and transmuted from energy source material to the proper load object consequentially, we just denote the proper quantity of the mass transferred as $\Delta M'_1$ ($\Delta M'_1 > 0$), Then the unbalanced inertial conservation equations of the energy source material can be formulated as below:

$$\left\{ \begin{array}{l} (M_1 + \Delta M_1 - \Delta M'_1) + (m_1 - \Delta m_1) = R_1(t) \\ (M_1 + \Delta M_1 - \Delta M'_1) / (m_1 - \Delta m_1) = K_1(t) \\ V_1(t) * (m_1 - \Delta m_1) = d(M \leftarrow m)_1(t) * Y_1(t) \\ L_1^3(t) * \alpha(t) = A * (m_1 - \Delta m_1) \\ Y_1(t) = B * \alpha(t) \end{array} \right. \iff \left\{ \begin{array}{l} M_1 + \Delta M_1 - \Delta M'_1 = K_1(t) * R_1(t) / [1 + K_1(t)] \\ m_1 - \Delta m_1 = R_1(t) / [1 + K_1(t)] \\ V_1(t) = d(M \leftarrow m)_1(t) * Y_1(t) / (m_1 - \Delta m_1) \\ L_1^3(t) = A * (m_1 - \Delta m_1) / \alpha(t) \\ Y_1(t) = B * \alpha(t) \end{array} \right.$$

Then the acceleration of the energy source material can be formulated as below:

$$a_1(t) = Y_1(t) * K_1'(t)$$

As coherent natura naturans throughout cosmic evolution, instinctive PNT reciprocal equilibrium towards optimum PNT operation is radical potentiality & conditionality for cosmos always ready to orientate itself towards perfection.

The velocity of the energy source material can be formulated as below:

$$\begin{aligned} V_1 &= V_0 + \Delta V = V_0 + \int a_1(t) dt \\ &= V_0 + \int Y_1(t) * K_1'(t) dt \end{aligned}$$

For convenience of mathematical expression, we denote the mass of the load object as m_2 , the mass of the matter field of load object as M_2 ; and denote the mass change of m_2 as Δm_2 and the mass change of matter field M_2 as ΔM_2 during the course of the load object driven by the energy source material. As the change of M_2 directly derives from the input $\Delta M'_1$ of the energy source material, under the precondition that the load object does not bear any outside resistance, ΔM_2 and $\Delta M'_1$ satisfy $\Delta m_2 + \Delta M_2 = \Delta M'_1 \iff \Delta M_2 = \Delta M'_1 - \Delta m_2$ thereby, then the unbalanced inertial conservation equations of the load object can be accordingly formulated as below:

$$\left\{ \begin{array}{l} (M_2 + \Delta M'_1 - \Delta m_2) + (m_2 + \Delta m_2) = R_2(t) \\ (M_2 + \Delta M'_1 - \Delta m_2) / (m_2 + \Delta m_2) = K_2(t) \\ V_2(t) * (m_2 + \Delta m_2) = d(M \leftarrow m)_2(t) * Y_2(t) \\ L_2^3(t) * \alpha(t) = A * (m_2 + \Delta m_2) \\ Y_2(t) = B * \alpha(t) \end{array} \right. \iff \left\{ \begin{array}{l} M_2 + \Delta M_2 = K_2(t) * R_2(t) / [1 + K_2(t)] \\ m_2 + \Delta m_2 = R_2(t) / [1 + K_2(t)] \\ V_2(t) = d(M \leftarrow m)_2(t) * Y_2(t) / (m_2 + \Delta m_2) \\ L_2^3(t) = A * (m_2 + \Delta m_2) / \alpha(t) \\ Y_2(t) = B * \alpha(t) \end{array} \right.$$

Then the acceleration of the load object can be formulated as below:

$$A_2(t) = Y_2(t) * K_2'(t)$$

Then the velocity of the load object can be formulated as below:

$$\begin{aligned} V_2 &= V_0 + \Delta V' = V_0 + \int a_2(t) dt \\ &= V_0 + \int Y_2(t) * K_2'(t) dt \end{aligned}$$

If the above dynamic systems are internal-combustion engine, jet plane, or rocket etc, the energy source material here is burning fuel or high temperature jetting gas, the load objects are the plunger, turbine and all the driven objects connected to the plunger or turbine —— car, plane or rocket etc.

If the dynamic system is electrical motor, then the energy source material is the electrified conductors or conductive atoms, and the load objects are just the motor rotor and all the mechanism connected to the rotor.

If the dynamic system is common nuclear energy system, then the energy source material are of course the fissioned or polymerized nucleus, and the load objects are the objects impinged by the nuclear radiation. It seems, in order to procure drive effect, we are always ready to invoke some certain energy source material with preponderant kinetic energy to collide or extrude the proper load object.

As cosmic matter of identity in common spacetime, why the jetting gas molecules from rocket, electrons around atomic nucleus, even photons in space can go that fast by the light of nature, while comparably, the man-made flying speed of plane or rocket is so poor. May it be special favor of nature?

Virtually, as straightforward man, the demiurge has none special artifice but coherent natura naturans throughout cosmic evolution, universal existence & motion are all uniform outgrowth of out-and-out natura naturans in the nature of coherent natura naturans through and through. The hypostatic distinction between object A and object B is only limited in:

Freewheeling of **proper compositive subunits of object A** stochastically accomplish “reciprocal idiosyncrasy towards PNT equilibrium in sort A + accessible space overall arrangement for PNT reciprocity in situation A” and successive spontaneous occurrence of instinctive PNT reciprocal equilibrium towards optimum PNT operation for convergent generation

Historical progress of science in the recent several centuries seemed like a far-flung exploration of the first itinerary around numerous distinctive landscapes of brand-new landmasses of science with palette & tablet on back, several hundred years' scientific travelogues were compiled thereby.

of reciprocal PNT combination A.

Freewheeling of **proper compositive subunits of object B** stochastically accomplish “**reciprocal idiosyncrasy towards PNT equilibrium in sort B + accessible space overall arrangement for PNT reciprocity in situation B**” and successive spontaneous occurrence of instinctive PNT reciprocal equilibrium towards optimum PNT operation for convergent generation of reciprocal PNT combination B.

The essence of universal matter is uniform in a class by itself for universal matter are all out-and-out serial natura naturata subject to coherent natura naturans throughout cosmic evolution, cosmos seems so rich and colorful is but because the freewheeling coherent natura naturans has accomplished N times distinctive demiurgic actions of stochastic accomplishment of “**reciprocal idiosyncrasy towards PNT equilibrium + accessible space overall arrangement for PNT reciprocity**” with successive spontaneous occurrence of instinctive PNT reciprocal equilibrium towards optimum PNT operation, the disparity of any two objects in cosmos are but disparity between any two different freewheeling performance of demiurgic actions among the N times demiurgic actions. Potential energy of a kilogram of uranium and potential energy of a kilogram of earth are critically equivalent, in terms of energy exploitation of a kilogram of uranium or a kilogram of earth, in order to procure equivalent energy exploitation effect, the crucial issue is only limited in ways how we exploit them in accordance with their inherent distinctive PNT operation mechanism.

And virtually, the essential dynamic character of rocket and the jetting fuel molecules which rocket resorts to accelerate is coherent in natura naturans, their idiographic existence & motion in spacetime radically depend on their idiosyncrasy of PNT performance in spacetime.

In terms of fuel molecules, as their special idiographic physic configuration, fuel molecules get touch with oxygen molecule or similar molecules under some certain temperature can bring out mutual reciprocal PNT operation situation and possibility of field potential concrete vallum revivification. In accordance with “relative minimum principle of field potential concrete vallum” due to existence & motion of matter in spacetime, any possibility of field potential concrete vallum revivification can unconditionally bring out field potential concrete vallum revivification reaction and release energy, some of the potential of fuel molecules is very feasible for us to exploit thereby (**ignited with oxygen supply is OK**), as a result, fuel can be introduced as energy source material in a walk. This is a great favor we've gotten from the nature.

In terms of the rocket, as historical conventionality, no matter it is eligible to be invoked as our wise choice of energy activation object or not, frankly, we had no notion of possibility & feasibility of field potential concrete vallum revivification of rocket according to PNT performance idiosyncrasy of rocket existing in spacetime as matter, no more thought of the proper energetic activation and dynamic control of rocket accordingly, but to unknowingly treat it as 100% acceleration parasite to actualize its acceleration depending on recoil energy almsgiving of counterblast.

Whereas, in terms of obvious actualities, the everlasting rotation and revolution of the earth do not originally depend on any recoil energy almsgiving, the free motion of any single molecule does not originally depend on any recoil energy almsgiving; high speed running electrons around atomic nucleus do not originally depend on any recoil energy almsgiving, photons transmitting in spacetime do not originally depend on any recoil energy almsgiving too. Apparently, there is none essential logic correlation between mechanical action of collision and acceleration. Motion is inherent character of matter as spontaneous occurrence of **[external physical disturbance**

As coherent natura naturans throughout cosmic evolution, instinctive PNT reciprocal equilibrium towards optimum PNT operation is radical potentiality & conditionality for cosmos always ready to orientate itself towards perfection.

+ (PNT action + instinctive PNT equilibrium)], when external physical disturbance=0, matter integration exists in inertial state, once external physical disturbance≠0, matter integration proportionably exists in accelerating state. Although mechanical action as collision can practically transmit and balance kinetic energy advantages between different objects in different kinetic energy status, it's not the root cause for matter to accelerate, no more drive patent. Considered by Homogenous Cosmos Originated from Unique Genesis, existence & motion of matter is but dynamic enantiomorph of PNT action of matter integration in spacetime, idiographic existence & motion of matter radically depends on idiosyncrasy of PNT operation of matter integration. This is just authenticity about existence & motion of matter in the nature.

2. Dynamic rationale of flying saucer engine

In accordance with PNT dynamics of Homogenous Cosmos Originated from Unique Genesis, the esse of existence & motion of matter in spacetime is the coexisting & ongoing inverse covariant couples of $d(M \rightarrow m)$ and $d(M \leftarrow m)$ of idiographic PNT action. If the magnitude of $|d(M \rightarrow m) - d(M \leftarrow m)|$ is nearer to "0", the matter integration is more constant, and the motion status of matter integration is more similar to "inertial motion"; the bigger the magnitude of $|d(M \rightarrow m) - d(M \leftarrow m)|$ is, the more inconstant matter integration is, and more intensively matter integration exhibits accelerated motion. And at the same time, any matter integration in spacetime has absolute spacetime momentum of $mV = d(M \leftarrow m)Y \iff V = d(M \leftarrow m)Y/m$.

Generally, in order to activate the potential energy of matter integration so that the matter integration can move faster and faster, we have to manage to increase the magnitude of $d(M \leftarrow m)$ of matter integration, so as to keep $d(M \leftarrow m)$ bigger than $d(M \rightarrow m)$, matter integration accelerates accordingly. And on the other hand, in order to decrease motion speed of flying matter integration expediently, we usually have to manage to decrease the magnitude of $d(M \leftarrow m)$ or keep the magnitude of $d(M \leftarrow m)$ smaller than $d(M \rightarrow m)$ besides removing or releasing some of its kinetic energy outside, so as to passivate and calm the potential energy of matter integration efficiently.

Now let's suppose there is a matter integration (we can also suppose it is just our flying saucer engine), its positive mass is m , and the proper matter field mass is M , in order to govern the motion status of the matter integration, we just manage to adjust and control the magnitude of the both coexisting transmutation opposites $d(M \rightarrow m)$ and $d(M \leftarrow m)$ of matter integration. As the volitional implementation of PNT adjustment of the magnitude of $d(M \rightarrow m)$ and $d(M \leftarrow m)$, both the positive mass m and matter field mass M of matter integration will vary accordingly. We just denote the variation of m with time t as indefinite function $m(t)$, and denote the variation of M with time t as indefinite function $M(t)$. Then the unbalanced inertial conservation equations of the matter integration can be expressed as below:

$$\left\{ \begin{array}{l} M(t)+m(t)=R(t) \\ M(t)/m(t)=K(t) \\ V(t)*m(t)=d(M \leftarrow m)(t)*Y(t) \\ L^3(t)*\alpha(t)=A*m(t) \\ Y(t)=B*\alpha(t) \quad (\otimes) \end{array} \right. \iff \left\{ \begin{array}{l} M(t)=K(t)*R(t)/[1+K(t)] \\ m(t)=R(t)/[1+K(t)] \\ V(t)=d(M \leftarrow m)(t)*Y(t)/m(t) \\ L^3(t)=A*m(t)/\alpha(t) \\ Y(t)=B*\alpha(t) \quad (\otimes) \end{array} \right.$$

Then, during the course of the matter integration PNT spontaneously adjusting towards predeterminate goal balance, the acceleration of matter integration can be accordingly formulated as below:

$$a(t)=Y(t)*K'(t)$$

During the course of the matter integration PNT spontaneously adjusting towards predeterminate goal

Historical progress of science in the recent several centuries seemed like a far-flung exploration of the first itinerary around numerous distinctive landscapes of brand-new landmasses of science with palette & tablet on back, several hundred years' scientific travelogues were compiled thereby.

balance, the velocity of matter integration can be accordingly formulated as below:

$$\begin{aligned} V &= V_0 + \Delta V = V_0 + \int a(t) dt \\ &= V_0 + \int Y(t) * K'(t) dt \end{aligned}$$

For further concretion, let's suppose there is a flying saucer engine starting from surface of the earth, and ultimately, its negative and positive mass quotient K has been adjusted off its initial value 0.001, and here, we also suppose the Time Dynamic Speed $Y(t)$ of matter integration is just a constant of the same as light-speed $3.0 \times 10^8 \text{m/s}$, (In fact, time dynamic speed is bigger than light-speed, we may even consider " $\pi \times 10^8 \text{m/s}$ ") then, we substitute the proper values into the velocity equation, we can consequently obtain the flying speed of the flying saucer engine as below:

$$\begin{aligned} V &= V_0 + \int Y(t) * K'(t) dt \\ &= V_0 + Y(t) * (K(t) - K_0) \\ &= V_0 + 3.0 \times 10^8 \text{m/s} \times 0.001 \\ &= V_0 + 3.0 \times 10^5 \text{m/s} \end{aligned}$$

(In the equation above, V_0 denotes the initial speed when the flying saucer stopped on the surface of the earth; K_0 denotes the initial negative and positive mass quotient of matter integration when the flying saucer engine stopped on the surface of the earth.)

It implies when the flying saucer engine adjusted its negative and positive mass quotient K off its initial value 0.001, its flying speed has approached $3.0 \times 10^5 \text{m/s}$ relative to the earth. Accordingly, if the flying saucer engine goes around the earth on the synchronous satellite orbit 36000 kilometers high from the ground at this speed, it will only cast it 15 minutes to finish a circle around the earth. Taking this flying saucer engine and flying at this speed, it will only cast us about 11 days to travel a trip between the earth and the sun. The flying speed of flying saucer engine is apparently remarkable compared to common engine as aircraft, missile, satellite etc. What's more, as the remarkable maneuverability advantage of flying saucer engine, if we just adopt such a flying saucer engine to hunt common aircraft or missile, even military satellite, it may be even easier than glade hunting chicks.

Of course, as the variation of the negative & positive mass quotient K , many relevant physical phenomena will occur consequently.

As the further variation of the negative & positive mass quotient K , many artificial controls of relevant parameters of flying saucer engine will consequentially become more and more critical and difficult, because with the variation of the negative & positive mass quotient K , the existing state of matter integration will vary accordingly. Theoretically, if the flying speed of flying saucer engine can approach the speed that electrons usually do, then the material existence of the flying saucer engine must have been very similar to electrons; it indicates the flying saucer engine has been adjusted into a sheaf of electrons or similar electrons; if the flying speed of flying saucer engine approaches the speed of light, then the material existence of flying saucer engine must have been modulated into a sheaf of photons or similar photons followed our inclinations. At the same time, during the course of the volitional modulation & control of PNT operation, the compositive material (atom /nucleon) of flying saucer engine maybe wear off some of its positive mass for activation radiation, or arises seriously thermal distortion, even it may be bombed like TNT bomb or A-bomb if the activation escaped from our artificial control unexpectedly.

As coherent natura naturans throughout cosmic evolution, instinctive PNT reciprocal equilibrium towards optimum PNT operation is radical potentiality & conditionality for cosmos always ready to orientate itself towards perfection.

In practical hitchhiking, as the remarkable variation of the negative & positive mass quotient K, vitality mechanism of organism is sensitive and frangible, because to any object with positive mass, as long as it is hitched on the flying saucer engine, the negative & positive mass quotient K of the hitched object must keep equivalent with the flying saucer engine for it is accelerated synchronously with flying saucer engine. To any organism, as the variation of the negative & positive mass quotient K, the state equations and mechanical configuration of all compositive atoms of the organism hitched on the flying saucer engine will consequently vary accordingly; it implies the physical and chemical characters of the compositive atoms will vary sensitively. Of course, it will directly impact the biological properties and function of the organism. Even for some certain necessity, we must fix some certain electronic device on flying saucer engine; we still have to consider the influence deriving from variation of the negative & positive mass quotient K of flying saucer engine.

For some certain convenience, we just treat a cup of milk as a type of organism; and define the speed range of flying saucer engine which does not intensively impact the biological properties & functions of organism as “milk hitchhike-able speed”. For instance, if we want to spend weekend on the moon or travel to any other planet in solar system, we then have to consider the milk hitchhike-able speed for the trip; if we’d like to involve exploration out of solar system, I’m afraid, we then have to consider the non-milk hitchhike-able speed.

However, what’s the intrinsic operational regularity of coexisting reverse covariant $d(M \rightarrow m)$ and $d(M \leftarrow m)$ of PNT action? Can we materialize artificial control by influencing the coexisting reverse covariant $d(M \rightarrow m)$ and $d(M \leftarrow m)$ of PNT action upon our master of the intrinsic operational regularity of it? If so, we can of course control the existence & motion of matter in spacetime followed our inclinations, if the object whose PNT performance under our artificial control is a special “aircraft”, the dynamic function of the “aircraft” is of course self-evident. Flying saucer engine just comes from such rationality.

As introduced in prior section of “PNT action and PNT reaction”, any PNT action and PNT reaction in the nature must be subject to both fundamentals of “relative minimum principle of field potential concrete vallum” and “Instinctive PNT equilibrium principle” of matter integration, while to any certain matter integration with idiographic genic integration configuration, the idiographic genic integration configuration of objects directly influence the manner and consequence of matter integration acclimate themselves to the both fundamental of “relative minimum principle of field potential concrete vallum” and “Instinctive PNT equilibrium principle” so as to exist in the nature as themselves. Different separate genic units have different field potential concrete vallum in spacetime for their idiographic genic integration properties, and consequently, in order to acclimate themselves to “relative minimum principle of field potential concrete vallum” and “Instinctive PNT equilibrium principle” as possibly as they can, different separate genic units have different existent status and characters in spacetime. For the same reason, as the remarkable discrepancies in idiographic genic integration configuration, different reciprocal PNT combinations have different field potential concrete vallum in spacetime, in order to acclimate themselves to “relative minimum principle of field potential concrete vallum” and “Instinctive PNT equilibrium principle”, different reciprocal PNT combinations have different existent status and characters; and cosmos seems rich and colorful thereby.

In terms of the issue of PNT artificial modulation & control, the both fundamentals of “relative minimum of field potential vallum principle” and “Instinctive PNT equilibrium principle” is something we can not renovate and inevitable for us to face. Technology can only intelligently lead the intrinsic regularities do their job in accordance with human ambition, but never ready to renovate or create the regularities in the nature. As the field potential

Historical progress of science in the recent several centuries seemed like a far-flung exploration of the first itinerary around numerous distinctive landscapes of brand-new landmasses of science with palette & tablet on back, several hundred years’ scientific travelogues were compiled thereby.

concrete vallum of separate genic units are too high their existences in spacetime are usually rather active (they usually exist in spacetime as high speed radiations), this is obviously not convenient for us to consider and implement PNT artificial control of such high speed moving separate genic units. While, to the reciprocal PNT combinations with massive genic integration (**especially the atomic reciprocal PNT combinations**), as their substantial genic reciprocal convergence, their existences in spacetime usually seem more constant and accessible to our practice. If we consider PNT artificial control on such reciprocal PNT combinations, it's of course accessible and feasible.

Of course, in order to activate reciprocal PNT combinations as to procure motive acceleration, we should above all manage to realize field potential concrete vallum weakening of reciprocal PNT combinations in spacetime. While the nature is so rich and colorful, there are too many reciprocal PNT combinations whose field potential concrete vallum can be weakened, and there are too many material ways to realize field potential concrete vallum weakening. For instances, in terms of fuels, powders, lumbers etc in normal conditions, we can implement field potential concrete vallum weakening of them by quoting intervention of oxygen and proper temperature as to actualize potential energy activation and release; in terms of enriched uranium, we can consider introducing accelerated neutron to shoot at enriched uranium as to cause chain-reacting of nucleus fission of enriched uranium as to precipitate field potential concrete vallum weakening of uranium nucleus and nucleus potential energy released; in terms of hydrogen nucleus, we invoke the high temperature offered by A-bomb to precipitate nuclear fusion of hydrogen as to accomplish field potential concrete vallum of hydrogen nucleus weakening. although, such man-made field potential concrete vallum weakening reactions of reciprocal PNT combinations are simple and easy for us to implement and accomplish, the consequent reciprocal PNT combinations after field potential concrete vallum weakening reaction realized, it is obviously not convenient for us to implement durable artificial control of the very field potential concrete vallum weakening reaction of the very reciprocal PNT combinations, we just call such man-made field potential concrete vallum weakening reactions PNT non-normalized activation.

Apparently, if the object we implement PNT artificial control on is just our ideal flying saucer engine, and if the PNT volitional activation we implemented on the flying saucer engine is but PNT non-normalized activation, undoubtedly, our flying saucer engine will either be burned like a fire bomb or be bombed out like a lightning bolt and disappeared in a sudden. It seems, in order to let the aircraft be able to accept PNT artificial control and ensure its durable safe existence, PNT non-normalized activation is invalid, and we have to consider "PNT normalized activation". So-called "PNT normalized activation" just means the reciprocal PNT combinations after PNT volitional activation still have regular and unitive existence & motion, so that it is possible to perform durable PNT artificial control on them.

Generally, the richer the potential "field potential concrete vallum" can be weakened of reciprocal PNT combinations used as PNT activation source of flying saucer engine, then the better the activation potentiality of flying saucer engine is. If the reciprocal PNT combinations used as PNT activation source can realize progression field potential concrete vallum weakening continuously, such activation characters of PNT activation source material will do great good to maneuverable control of flying saucer engine. The most ideal PNT activation reaction pattern is "PNT elastic normalized activation", so-called "PNT elastic normalized activation" is just such PNT activation pattern, under the activation of PNT activation sign, the reciprocal PNT combinations which are used as PNT activation source of flying saucer engine in normalized activation state will arise $d(M \leftarrow m)$ increase, momentum of matter integration $mV = d(M \leftarrow m)Y$ increases, $V = d(M \leftarrow m)Y/m$ increases; once the PNT

As coherent natura naturans throughout cosmic evolution, instinctive PNT reciprocal equilibrium towards optimum PNT operation is radical potentiality & conditionality for cosmos always ready to orientate itself towards perfection.

activation sign weaken till stop working on them, the reciprocal PNT combinations will arise $d(M \leftarrow m)$ decrease, momentum of matter integration $mV = d(M \leftarrow m)Y$ decreases, $V = d(M \leftarrow m)Y/m$ decreases, till at last the reciprocal PNT combinations recover their initial existent status. While, as time elapsed, displacement occurred. It seems the reciprocal PNT combinations which are used as PNT activation source seem like elastics, once they are activated, their existences look “elongated and tightened”, once activation weakening to stop, and their existences gradually recover to initial status.

Now, as the preliminary illumination of the flying saucer engine dynamic rationale, let’s obtain a primary definition of flying saucer engine.

In accordance with authenticity that existence & motion of matter is just dynamic enantiomorph of PNT action of matter integration in spacetime, so-called “**Flying Saucer Engine**” is but a sort of mechanism to facilitate PNT action of matter integration under control at human pleasure so as to stochastically procure anticipative existence & motion of object according to intrinsic regularity of PNT action and the favorable idiosyncrasy of PNT action of the proper object which is used as PNT activation source of flying saucer engine. —just to make some field potential concrete vallum in low-level reciprocal PNT operational hierarchy activated and expediently transfer and assimilate some of the activated energy to terminal spacetime momentum macromodelization hierarchy of object and keep the holistic spacetime momentum delamination hoarding pattern successive and smooth, so that the holistic PNT activation source is accelerated as a continuously controllable objective. As flying saucer engine is typical PNT dynamic mechanism to materialize PNT artificial control of object, “flying saucer engine” is too called “volitional PNT control mechanism” or “PNT engine”.

3. PNT elastic normalized activation & control of atomic reciprocal PNT combination

Application of engine is technologic pursuit for artificial control of ideal motion of objects as car, train, plane, rocket etc. following our inclinations. Till today, human are still intently ready to devote them to common engines which introduce so-called energy sources (/such as fuel) to offer preponderant kinetic energy to so-called load object by mechanical collision, to actualize energy activation of energy source for preponderant kinetic energy in prior, then trying to transmit preponderant kinetic energy of energy source to load object as much as possible. The key technologic challenge is expedient & satisfying energy activation of energy source and efficient & sufficient transmission of preponderant kinetic energy from energy source to load objects. However, there are few people who pay attention to artificial control of connatural motion of matter in accordance with natural laws of the demiurge, although it is well-known that motion is inherent attribute of matter.

Virtually, the dynamic preponderance of any single electron or atom is much more remarkable than dynamic source of common engines we conventionally apply on car, train, plane, rockets etc. If we can drive a single atom to encircle the earth, it maybe take us about 2 minutes. Even if our applicable flying saucer is made up of N atoms, under precondition it is feasible for us to drive a single atom; the further technologic challenge is only that we must ensure all the compositive atoms of the activation resource of the flying saucer exactly moving according to law of identity.

In a simple word, so-called flying saucer engine innovation is but technologic pursuit for ideal motion of object following our inclinations in accordance with general existence & motion of matter radically depends on PNT operation of matter integration in spacetime and intently aiming at certain favorably controllable PNT operation model of ideal materials available to manage ideal motion of matter accordingly. Under normal spacetime,

Historical progress of science in the recent several centuries seemed like a far-flung exploration of the first itinerary around numerous distinctive landscapes of brand-new landmasses of science with palette & tablet on back, several hundred years’ scientific travelogues were compiled thereby.

we are generally feasible to make use of materials consisting of elementary atoms but not “neutron agglomerate”, “proton agglomerate” or “electron agglomerate” etc. Apparently, the discovery and ultimate consummation of “Atom State Equation in Spacetime” will bring us remarkable expedience for our technologic practice.

In order to illuminate the proper issues concretely herein, we just try to illuminate the related technological issues of PNT elastic normalized activation of flying saucer engine by instance that we adopt atomic reciprocal PNT combinations as the flying saucer engine activation source, which but means that we just treat mechanics configuration of certain atom system as our mechanics object to study the PNT elastic normalized activation control. Considering the connatural pertinent mechanics logic relationships of internal atomic nucleus, atomic nucleus and electrons around atomic nucleus and any contiguous atoms in atom system, and the connatural properties determined by these pertinent mechanics relationship, during the course of the practical PNT elastic normalized activation control, we must consider the both hierarchies of the mechanics effect, ——pertinent mechanics effect within atom and pertinent mechanics effect among contiguous atoms, including the PNT activation mechanics effect of internal atom, PNT activation mechanics effect of electrons around nucleus, pertinent mechanics effect of PNT activation between atomic nucleus and electrons around the atomic nucleus and pertinent mechanics effect of PNT activation among all contiguous atoms in the atomic activation resource.

For convenience to illuminate the issue in a simple way, we suppose that the source material of PNT engine is just atomic reciprocal PNT combinations consisting of an atom α and an atom β , and we denote it as “ α - β ”. (Of course, the both atom α and atom β may be the same element, and may be different elements too) We just illustrate them as below:

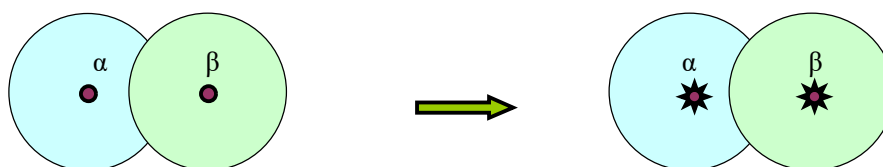

(VI-i-1-a) Illustration of controllable PNT activation of atomic reciprocal PNT combination

(The small dark brown circle in the centre denotes the atomic nucleus, the light blue circle around denotes the electron cloud)

As the connatural mechanics configuration of atom, ——the performance of PNT of nucleus and electrons in atom is almost relatively separated. Let's suppose that there are N_1 nucleus and N_2 electrons in an atom, and at the same time, we denote the mass of each nuclear as m_1 and the mass of the proper matter field as M_1 , and denote the mass of each electron as m_2 and the mass of the proper matter field as M_2 , then, we can arrive at:

First, observed inside the atom, the constitutes of absolute spacetime momentum of atom is ①+②+③

①. Absolute spacetime momentum of separate nuclear is: $N_1 \cdot (m_1 \cdot V_1) = N_1 \cdot d(m_1 \rightarrow M_1) \cdot Y(t)$

②. Absolute spacetime momentum of separate electron is: $N_2 \cdot (m_2 \cdot V_2) = N_2 \cdot d(m_2 \rightarrow M_2) \cdot Y(t)$

③. Absolute spacetime momentum of the whole atomic nucleus is: $(N_1 m_1) \cdot V_3 = d(N_1 m_1 \rightarrow N_1 M_1) \cdot Y(t)$

(In the equations above, V_1 denotes the moving speed of separate nuclear, V_2 denotes the moving speed of separate electron, and V_3 denotes the moving speed of the whole atomic nucleus)

Second, observed out of the atom, besides the three items above, the absolute spacetime momentum of the atom still includes the item ④:

As coherent natura naturans throughout cosmic evolution, instinctive PNT reciprocal equilibrium towards optimum PNT operation is radical potentiality & conditionality for cosmos always ready to orientate itself towards perfection.

④. The integrity absolute spacetime momentum of atom:

$$(N_1 m_1 + N_2 m_2) * V_4 = d[(N_1 m_1 + N_2 m_2) \rightarrow (N_1 M_1 + N_2 M_2)] Y(t);$$

Third, if the flying saucer activation source is atomic reciprocal combination of “A-B”, then equation

$(N_1 m_1 + N_2 m_2) * V_4 = d[(N_1 m_1 + N_2 m_2) \rightarrow (N_1 M_1 + N_2 M_2)] Y(t)$ will change into equation ⑤ as below:

$$[(N_1 m_1 + N_2 m_2)_A + (N_1 m_1 + N_2 m_2)_{B^+}] * V_4 = d\{[(N_1 m_1 + N_2 m_2)_A + (N_1 m_1 + N_2 m_2)_B] \rightarrow [(N_1 M_1 + N_2 M_2)_A + (N_1 M_1 + N_2 M_2)_B]\} Y(t)$$

In the equations above, V_4 denotes the moving speed of atom or atom system; it is just the objective speed we are trying to procure and predominate, $V_1 V_2 V_3$ are just the speeds we have to consider to regularize and restrict for the feasibility and safety of the atomic nucleus PNT activation. The bigger the speed of V_4 we can procure, and the more optionally we can control the adjustment of V_4 , the better the flying saucer engine is.

Then, how can we enlarge and control the magnitude of V_4 efficiently?

Of course, we can consider the PNT activation of both the electrons around atomic nucleus and the atomic nucleus. However the moving speed of the electrons around atomic nucleus is rather bigger, and almost all electrons move along inconstant curve orbits, only tracking them is very difficult, no more critically orientated PNT activation, and the mass of electron is rather tiny; it of course indicates poor potential energy for activation, what’s more, the PNT activation of electrons around the atomic nucleus directly impacts the stabilization of the macroscopical mechanics configuration of atom system, it is very sensitive to cause excessive thermal expansion, radiation, unfreezing, evaporation and even burst into pieces, it will vitally impact the stability and safety of the flying saucer engine, these indicate that electrons around atomic nucleus are not ideal for PNT activation, as a result, we have to turn to consider the PNT activation of atom nucleus.

Compared with the electrons around the atom nucleus, the atomic nucleus is rather massive; it of course implies rich potential energy for PNT activation, and linked by strong force, the atomic nucleus is rather solid, it of course indicates the perfect anti-jamming capability for PNT activation, and what’s more, atomic nucleus has connatural advantage to govern the electrons around it, when the atomic nucleus are activated for volition PNT adjustment, it’s very convenient and easy to hold down the electrons around it to move synchronously and proportionately but not to disturb the normal distribution of the electron cloud intensively, this is of course very good to the stability and safety of the flying saucer engine. All in all, it seems that atomic nucleus is much more advantageous than electron cloud for PNT activation. As long as we can expediently activate the atom nucleus, and the atom nucleus can hold down the electron cloud in regular way synchronously, and we can ensure the consistency of the PNT activation orientation and the PNT activation strength of proper atom system, we then succeed consequently.

Of course, the advantages of the atomic nucleus are relatively comparable to the electron cloud around it, when the atomic nucleus is activated for volitional PNT adjustment, because of the inevitable mechanics variation or deviation of the atom nucleus, and because of the connatural pertinent mechanics effect in atom system, it maybe cause series harmful effects accordingly, for instance, as overload PNT activation or irregular PNT activation, the atom nucleus occur destructive mutation or fission, or the electron cloud was disturbed too much for some certain pertinent mutation of atomic nucleus so that the macroscopical material status deviated too much. And of course, these harmful effects will consequentially impact the feasibility and the safety of the flying saucer engine, and maybe even vitally restrict the range of the adjustable value of V_4 , as a result, we have to consider the relevant technological application for supplemental reliability insurance.

Historical progress of science in the recent several centuries seemed like a far-flung exploration of the first itinerary around numerous distinctive landscapes of brand-new landmasses of science with palette & tablet on back, several hundred years’ scientific travelogues were compiled thereby.

First, critically consistent orientation control of PNT activation and equilibrium distribution control of PNT activation strength during the course of PNT engine being activated or adjusted

During the course of the flying saucer engine being activated or adjusted, critical consistency of PNT activation orientation is rather beneficial and efficient for oriented driving; second, critical consistency of PNT activation orientation and critical equilibrium distribution of PNT activation strength can prevent flying saucer engine being torn or burst into pieces for rough activation, because, if the flying saucer engine activation source is built of reciprocal PNT combination of certain atomic mass, obviously, when the PNT of matter integration of activation source material is activated, the equilibrium distribution of PNT activation strength discrepancies between any two adjacent atoms or any two adjacent radicle mechanics units can never exceed the restriction of the original polymerization force between any two continuous atoms or neighbor radicle mechanics units, otherwise, the flying saucer engine will be torn into pieces or bombed like an A-bomb.

During the course of the PNT activation or PNT readjustment of matter integration, the higher quality the control of critical consistency of PNT activation orientation and critical equilibrium distribution of PNT activation strength is, the better orientated driving effect of the flying saucer engine consequently is and the bigger the safe coefficient of flying saucer engine is. As a result, under the precondition that we have primarily mastered the volitional activation mechanism of PNT of matter integration, the efficient control of critical consistency of PNT activation orientation and critical equilibrium distribution of PNT activation strength is of course the next major subject we should engage in.

Second, the restriction control of the activation radiation dissipation, thermal distortion, thermal evaporation of PNT engine.

Generally, when the flying saucer engine is activated, as the activation variation of the connatural mechanics configuration in atom system and the connatural pertinent mechanics logic in the atom system, some of the characteristics of atomic nucleus or atom system will inevitably change, the component atoms of the flying saucer engine may radiate accordingly, it will of course wear off some of the mass or energy of the flying saucer engine, even may seriously influence some of the physical characteristics or functions, impact the stability and reliability of the flying saucer engine function, and at the same time, in military occasion, it is very easy to be found and incur unexpected attack.

It implies that the restriction of the radiation ullage of the flying saucer engine derived from PNT activation is still a very important technological factor. The higher quality the radiation ullage restriction is, the better the drive effect and efficiency is, and the more steady and reliable the flying saucer engine function is, the flying saucer can consequently last longer.

Of course, besides the two significant technological factors above, it is still necessary for us to consider the maneuverability control of flying saucer engine.

The maneuverability control of flying saucer engine usually means the control sensitivity and accuracy of the magnitude of $d(M \rightarrow m)$ and $d(M \leftarrow m)$ of matter integration. Generally, in order to ensure the control sensitivity and accuracy of flying saucer engine, we are convenient to choose the matter block with homogenous and steady physical characteristics as the PNT activation source.

Of course, we can enhance the maneuverability by multiple possible ways, for example, we can design

the geometrical profile of flying saucer engine like a saucer, thus, one hand, it is convenient for the flying saucer engine to accelerate at random orientation without special swerve during the course of driving; on the other hand, the saucer geometrical profile can ensure the flying saucer engine with certain mass occupies least space volume when it rotates. And at the same time, once it is necessary to decelerate, it can keep itself in a more active energy state by rotating itself, and just to keep the negative and positive mass quotient K of the flying saucer engine in a bigger value, so that once it is necessary for the flying saucer engine to accelerate, it can expediently translate the preparative rotation energy into linear motion kinetic energy. Thus, it has not only actualized the intention of maneuverability drive control, but also obviated the suspicion of trying to accelerate in a sudden but ability unequal to its ambition, and it has obviated the risk of being bombed for rush activation.

All in all, the actualization of flying saucer engine technology demands us to consider the foundation of the PNT activation mechanism and proper choice of ideal PNT activation source first, and if necessary, we have to consider the mechanical configuration optimization or optimum reorganization for the benign activation and maneuverability of the activation source, then inoculate the proper PNT microcosmic activation mechanism onto the activation source and edit physical injunction for valid activation according to the mechanical configuration and idiosyncrasy of PNT performance of PNT activation source. Apparently, no matter the foundation of the activation mechanism, proper choice of ideal activation source, necessary mechanics configuration optimization or optimum reorganization, design and inoculation of the PNT microcosmic activation mechanism even program of valid physical injunctions for PNT activation, the dependence to the naissance and consummation of Atom State Equation in Spacetime is of course self-evident.

The thought framework of PNT activation control technology can be generally illustrated as below:

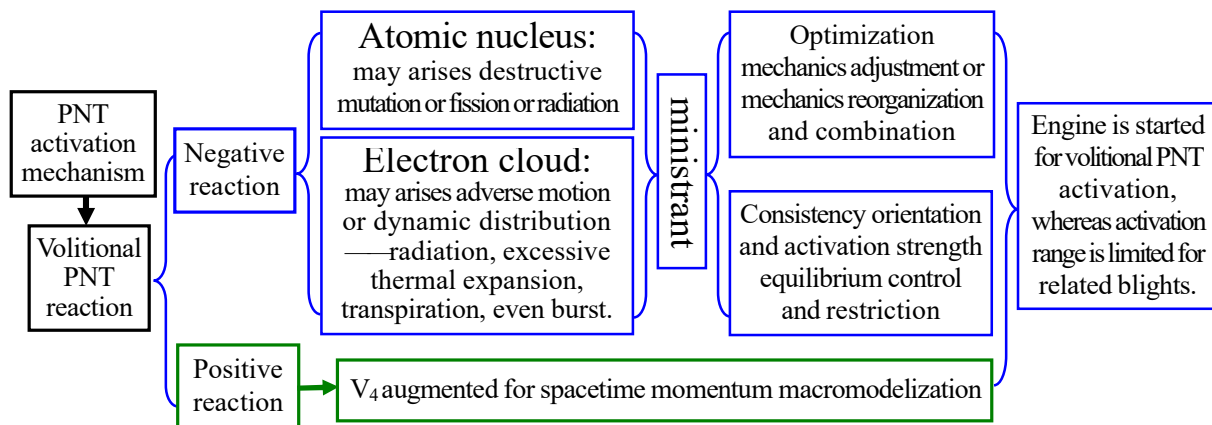

(VI-i-1-b) Controllable operation analysis of PNT activation of atomic reciprocal PNT combination

4. Application of flying saucer engine technology

One of the most remarkable application advantages of flying saucer engine technology is high speed aviation in vacuum, whose significance in military affairs; outer space exploration even outer galaxy exploration is self-evident.

As its special engine operation mechanism —volitional readjustment & rectification of spacetime momentum delamination hoarding pattern of atomic reciprocal PNT combination of PNT activation source aiming at the favorable PNT operation of the distinctive atomic reciprocal PNT combination in accordance with essentiality that existence & motion of matter radically depends on PNT performance of matter integration

Historical progress of science in the recent several centuries seemed like a far-flung exploration of the first itinerary around numerous distinctive landscapes of brand-new landmasses of science with palette & tablet on back, several hundred years' scientific travelogues were compiled thereby.

in spacetime; ——activate some certain microcosmic spacetime momentum hoarding hiberarchy (or several sequential microcosmic spacetime momentum hoarding hiberarchies) of atomic reciprocal PNT combination of PNT activation source, then try to regularize and rectify the activated spacetime momentum transferring towards macroscopical spacetime momentum hoarding hiberarchies as normally as possible so as to ensure terminal macroscopical spacetime momentum of PNT activation source increase and the PNT activation source continuously controllable.

As long as, in external case, there are substantial potential spacetime momentum in target microcosmic spacetime momentum hoarding hiberarchy for activation, and the spacetime momentum delamination hoarding pattern of atomic reciprocal PNT combination of PNT activation source is substantively favorable and fluent for sequential spacetime momentum transference from objective microcosmic spacetime momentum hoarding hiberarchy to terminal macroscopical spacetime momentum hiberarchy, and in subjective manner, we do the very jobs of PNT activation, spacetime momentum sequential transference and related configurable estate rectification smoothly, it's of course imaginable, the flying speed of flying saucer engine may be not slower than the similar particles in high-energy accelerator, even as the remarkable advantage of direct atomic nucleus PNT activation relative to the electromagnetic alternate acceleration of high-energy accelerator, the flying source engine maybe even fly more chically and faster than similar particles in common high-energy accelerator. Once start up, flying around the earth several circles is but merry stretch to tease the wind.

In military affairs, if we are ready to let PNT engine to take care of satellites around the earth, it may be job as easy as you are ready to clean up table after lunch. As preponderance of flying speed and acceleration function of flying saucer engine is rather remarkable, it implies the variation of the positive and negative mass quotient K is rather remarkable. Consequently, flying saucer engine is not convenient to tote any routine weapons like missile series, and in fact, routine missile series can not match flying saucer engine at all. As possessing of connatural advantage of active atomic energy resource derived from atomic nucleus PNT activation, flying saucer engine is rather convenient to scheme laser weapon with advantages of super quality orientation, high speed, long-range gunshot (For instance, flying saucer engine on moon can directly aim at objects on surface of earth with laser weapon), powerful execution, or similar weapon of high speed particle sheaf, which maybe operate on the aircraft carrier on sea leisurely in orbit of synchronous satellite if atmosphere condition is favorable.

Of course, as typical PNT engine, application of flying saucer engine technology does not limit in aviation, flying saucer engine technology is rather similar as high quality nuclear energy technology, and we can of course design and produce low intensity flying saucer engine as train engine (train PNT engine); and because electrical power has advantage of being convenient to transmit and disperse using, we can of course design and produce flying saucer engine generator (or volitional PNT generator),

However, because the facilities as train PNT engine and volitional PNT generator directly work outside, during the course of the practical usage, it is necessary to renew or supply the proper flying saucer activation source periodically, which is similar to that any nuclear power plant need renew or supply nuclear source periodically. This is much different from flying saucer engine flying in so-called vacuum, flying saucer engine flying in spacetime is but stochastic existence & motion of PNT activation source under volitional readjustment & control of inner inherent spacetime momentum delamination hoarding in configurable hiberarchy of atomic reciprocal PNT combination of PNT activation source in accordance with acceleration & PNT continuous

controllability necessity, as long as the flying saucer engine does not radiate outside, no matter what its flying speed is, no matter how long time it flies, the total mass and general energy of flying saucer engine are generally conserved, which is similar as particles or photons flying in vacuum besides particles or photons transmit in vacuum naturally without volitional PNT readjustment & rectification mechanism as flying saucer engine.

At the same time, the flying saucer engine generator won't be sure to drag winding moving in magnetic field, upon the favorable choice of PNT activation source and the proper method of PNT activation, the flying saucer engine generator can activate strong electric field, and produce active current, ——PNT readjustment current or PNT rectification current.

Flying saucer engine technology is virtually high quality nuclear energy rein technology intelligently rooted in favorable PNT operation of proper atomic reciprocal PNT combination as to try for and actualize volitional PNT operation rein of the very object in accordance with connatural fundamental of PNT operation. Under such technologic background, building an A-bomb may be as easy as “cooking a dinner”. After all, compared with flying saucer engine technology, current nuclear energy exploitation level of human is but similar as our foregone energy exploitation at Watt age, and at any rate, the detonation technology of nuclear chain-reacting of A-bomb is but similar as a sort of roughest failure model of volitional PNT activation and control of flying saucer engine. The grown up of flying saucer engine technology will expediently favor nuclear exploitation even A-bomb production.

However, on point of practical ruinous usage of A-bomb, flying saucer engine is too the most powerful weapon to defend against nuclear terror. If we arrange three (four or five are even better) flying saucer engines separately on proper positions of the synchronous satellite orbit of the earth and keep them ready for orders all time, then, any A-bomb driven or taken by common engine as rocket or plane starting from surface of the earth can never escape the watch and control of flying saucer engine. Even if it luckily flies into high sky by chance or imposture, once recognized by flying saucer engine as attack object, it will be immediately difficult to survive for another more 3 minutes in sky. Without counterbalance protection of flying saucer engines so as to be free from chase, any redoubtable A-bomb or smart H-bomb can only take roles of resigned land mine hiding in their own homestead knowing their distance.

——Written in Jun. 2006, Humen town, Dongguan city, Guandong province

(VI-i-2) Tyre Model of PNT Engine

Abstract: In terms of PNT artificial modulation & control of atomic reciprocal PNT combination in accordance with necessity of durative controllability of PNT engine, the key technologic issue of PNT engine is the regular artificial modulation & control of $d(M \rightarrow m)$ and $d(M \leftarrow m)$, the maintenance of durative controllable state of atomic reciprocal PNT combination which is used as PNT activation source and to give attention to feasible motion orientation control of PNT engine. In accordance with such technologic necessity and on the basis of such presumable precondition that we've found a kind of atomic reciprocal PNT combination A which can be used as PNT activation source accelerating along certain orientation once activated by the so-called PNT activation sign B, and we are able to modulate the magnitude of acceleration and activation rate of PNT activation source by control of action rate or strength of PNT activation sign to PNT activation source followed our inclinations, we emphatically introduces macrostructure design of tyre model of PNT engine as below:

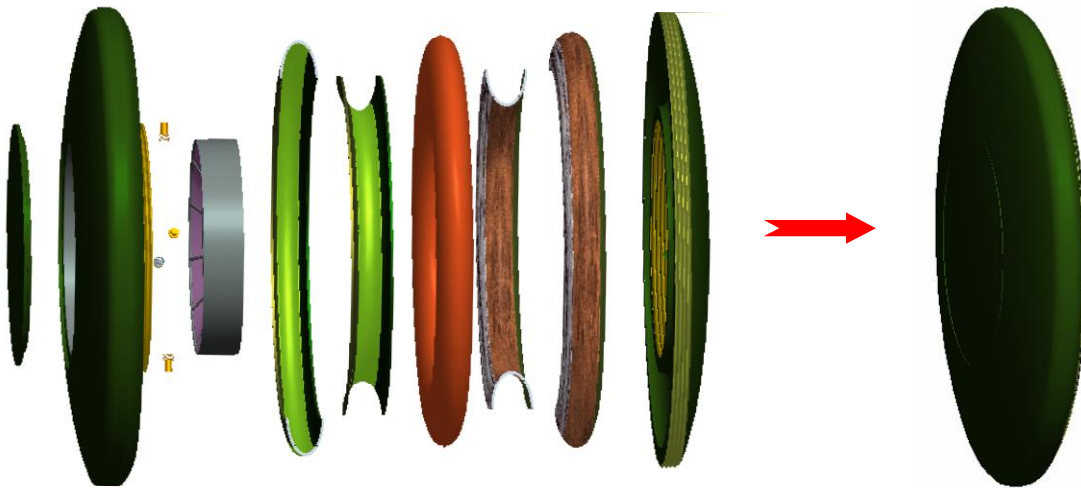

Keywords:

1) Special functional components: tyre cone, tyre core centre plane, front PNT activator, upper limb of front PNT activator, lower limb of front PNT activator, major activation area of front PNT activator, back PNT activator, upper limb of back PNT activator, lower limb of back PNT activator, major activation area of back PNT activator, front PNT rectifier, upper limb of front PNT rectifier, lower limb of front PNT rectifier, major rectification area of front PNT rectifier, back PNT rectifier, upper limb of back PNT rectifier, lower limb of back PNT rectifier, major rectification area of back rectifier, PNT engine steering wheel, balance torsion rotator, left swoop elastic spouses, right elevation elastic spouses, control ring of level driviel, tyre core upper jacket plate, tyre core lower jacket plate, hitchhiking chamber, top cover of hitchhiking chamber, modulator of PNT activation signal, modulator of PNT rectification signal.

2) Special functional character items: hard drive, soft drive, continuous controllability of PNT activation, PNT normalized activation, tyre core shape confining force, tyre core qualified driving force, hard rectification, soft rectification, PNT normalized driving, PNT rough driving, three-dimensional ϕ angle PNT symmetric activation, two-dimensional ϕ angle PNT symmetric activation, three-dimensional ϕ angle PNT symmetric rectification, two-dimensional ϕ angle PNT symmetric rectification, quantitative change formula of oval wheel fashion PNT activation & rectification, quantitative change formula of oval wheel fashion PNT symmetric

/asymmetric activation & rectification, optimum quantitative change formula of oval wheel fashion PNT symmetric/asymmetric activation & rectification, linear quantitative change formula of oval wheel fashion PNT activation & rectification signal pixels along frame, linear quantitative change formula of oval wheel fashion PNT activation & rectification signal pixels along breadth, integrative quantitative change of oval wheel fashion PNT activation & rectification signal portrayal, safe quantitative change range of PNT activation & rectification, safe quantitative change range of oval wheel fashion PNT symmetric/asymmetric activation & rectification, quantitative change deadline of PNT activation & rectification, quantitative change deadline of oval wheel fashion PNT symmetric/asymmetric activation & rectification, quantitative change program of PNT activation & rectification, quantitative change program of oval wheel fashion PNT symmetric /asymmetric activation & rectification, orientation adjusting derived from rotary oval wheel fashion PNT symmetric activation & rectification, hard rotation of oval wheel fashion PNT activation & rectification, soft rotation of oval wheel fashion PNT activation & rectification, orientation adjusting derived from oval wheel fashion PNT asymmetric activation & rectification, orientation adjusting derived from rotary oval wheel fashion PNT asymmetric activation & rectification, level drive programme, elevation drive programme, swoop drive programme, vertical swoop drive programme, vertical elevation drive program.

As initial endeavor of natura naturans personalization towards human necessity based on primary authenticity clarification of Homogenous Cosmos Originated from Unique Genesis, theoretical evidence of PNT engine is that cosmos is demiurgic aggradation of sequential homologic cosmogony, which exactly exist as well-regulated integration of cosmic homogeneity system making up of out-and-out serial natura naturata in the nature of coherent natura naturans throughout cosmic evolution, “universal existence & motion” are but spontaneous occurrence of [External physical disturbance + (PNT action + Instinctive PNT equilibrium)], which of course indicates hypostatic existence & motion is but dynamic enantiomorph of PNT action of matter integration. As technologic practice towards drive of object, engine contriving is straightforward creationary endeavor to facilitate PNT operation of matter integration artificially adjustable towards “ideal motion” following our inclinations, which is dynamic noumenon of connatural existence & motion in the nature of coherent natura naturans throughout cosmic evolution.

The key technologic issue of engine is what kind of feasible method we can resort to actualize drive in accordance with favorable existence & motion of distinctive reciprocal PNT combination accessible around; so-called “drive” is just functional operation of proper mechanism to accomplish sufficient conditions of acceleration of driven object. As difference in approach to accomplish sufficient conditions of acceleration of driven object, which are materialized in engine functional mechanism, drive can be classified into two general categories of “hard drive” and “soft drive”.

So-called “hard drive” is effectual way engine invoking so-called energy sources with preponderant kinetic energy to butt the load object mechanically as to facilitate preponderant kinetic energy of energy sources transmission from energy source to load object, so that the load object is accelerated therefore. For instance, steam pushes the impeller rotating, flow or airflow pushes the impeller of generator rotating, high temperature gas in cylinder pushes pistons accelerating, jet aircraft or rocket is accelerated by jet etc.

The most remarkable character of hard drive is that preponderant kinetic energy is provided by special

Historical progress of science in the recent several centuries seemed like a far-flung exploration of the first itinerary around numerous distinctive landscapes of brand-new landmasses of science with palette & tablet on back, several hundred years’ scientific travelogues were compiled thereby.

energy source and transferred from so-called energy source to load object by osculant mechanical collision. Bullet is shot from bore, gas engine works outside are typical “hard drive” instances, ——mechanism to facilitate heat energy transferable macromodelization from energy source to load object. As all common engines depend on manner of “hard drive” to actualize acceleration of load objects, “hard drive” can be regarded as character indication of common engine.

So-called “soft drive” is just volitional facilitation of spontaneous PNT reaction among objects with reciprocal PNT resource or anti-reciprocal PNT resource in the nature of instinctive PNT reciprocal equilibrium towards optimum PNT operation so as to cause remarkable variation of $d(M \rightarrow m)$ and $d(M \leftarrow m)$ of PNT operation of matter integration, so that objects are stimulated and arises acceleration.

For instance, as presence of connatural source of PNT reciprocal configuration characteristics between flat electrode electric field of cyclotron and charged particle, charged particle is accelerated by flat electrode electric field of cyclotron. As presence of connatural source of PNT reciprocal configuration characteristics between rotor and charged coil of electric motor, the rotor is consequently driven by the charged coil once power offered to the electric motor. As presence of connatural source of PNT reciprocal configuration characteristics between fuel molecule and oxygen molecule, once fuel molecules get touch with oxygen molecules under proper temperature condition, the fuel molecules will consequently be oxygenated and the resultant molecules exhibit remarkable thermal acceleration. As presence of connatural source of PNT reciprocal configuration characteristics between uranium nucleus and neutron, the PNT operation of uranium nucleus will spontaneously arises remarkable PNT optimization variation for the closer interposition of neutron and consequently cause uranium nucleus fission with intensive energy release. As presence of connatural source of PNT reciprocal configuration characteristics among hydrogen nuclei, the PNT operation of hydrogen nucleus will arises remarkable PNT optimization variation for the closer interposition of another hydrogen atomic nucleus and consequently cause hydrogen nucleus fusion with intensive energy release.

The most remarkable individuality of “soft drive” is that it directly makes use of the connatural source of PNT reciprocal (or anti-reciprocal) configuration between objects to bring about spontaneous PNT optimization variation, which is virtually volitional facilitation of spontaneous field potential concrete vallum revivification reaction between objects.

On general view of existence & motion of matter, there is none essential distinction between hard drive and soft drive; they both are spontaneous reactions in the nature of instinctive PNT reciprocal equilibrium towards optimum PNT operation under proper conditions of matter integration except the disparity of invention idea that hard drive rooted in the superficial perception of matter motion variation for kinetic energy transference from energy source to load object, while soft drive directly rooted in the progenitive knowledge of matter motion variation in spacetime, ——PNT operation variation of matter integration. After all, existence & motion of matter is but dynamic enantiomorph of PNT action of matter integration in spacetime.

And just because of the disparity of invention idea, there is remarkable distinction in approach to accomplish sufficient conditions for motion acceleration. Hard drive always devote to procure preponderant kinetic energy and efficient transference of preponderant kinetic energy from energy source to load objects; whereas, soft drive emphatically devotes to facilitate spontaneous PNT reaction in accordance with reciprocal PNT resource among objects due to instinctive PNT reciprocal equilibrium towards optimum PNT operation and try to keep the

As coherent natura naturans throughout cosmic evolution, instinctive PNT reciprocal equilibrium towards optimum PNT operation is radical potentiality & conditionality for cosmos always ready to orientate itself towards perfection.

proper PNT reaction continuously controllable. In an everyday words, when I was perplexed by my issues, while my son Mingming were making noise naughtily behind me, I stood up and pushed him away, this is just something similar as “hard drive”; I threw Mingming a meaningful glance to show him going away, Mingming received my signal and went away tamely, this is something similar as “soft drive”.

The physical driving model of common engines as car, aircraft, rocket etc is typical hard drive, the remarkable driving character of the physical driving model is to materialize PNT non-normalized activation of energy source as to make it possess relatively preponderant kinetic energy, then under hard constraints condition in cylinder, burning chamber etc, take use of piston, turbine etc to intercept the preponderant kinetic energy of energy source as much as possible as to bring about acceleration of piston, turbine and all the objects mechanically linked on piston or turbine.

Whereas, the driving model of PNT engine is typical soft drive, whose functional target is to facilitate PNT operation of matter integration under artificial control, ——in accordance with the practical continuous control feasibility of matter motion in spacetime and the connatural fundamental of PNT action & the idiographic PNT operational characteristics of object, we implement proper volitional influence to the idiographic PNT operation as to make the proper PNT operation of matter integration under our artificial control, so that the corresponding motion status materialized by the proper PNT operation of matter integration can follow our inclinations. After all, motion status of matter integration in spacetime radically depends on the PNT operation of matter integration.

Of course, when we practically come to premeditate “soft drive” of PNT engine, the most significant thing is of course the intelligent choice of PNT activation source and PNT activation signal. Only when the PNT activation source and PNT activation sign are ascertained, we can aim at definite PNT reaction between ascertained PNT activation source and PNT activation sign, we have definite goal and specific original data to consider further possibility and feasibility of artificial control of the idiographic PNT reaction between PNT activation source and PNT activation signal in accordance with necessity of PNT continuous controllability of atomic reciprocal PNT combinations. However, as the “atom state equation in spacetime” has not been consummated ultimately, confronting the challenge of choice of eligible and feasible PNT activation source & PNT activation & rectification signal, microcosmic mechanic configuration preparatory modulation of PNT activation source and the program of the PNT normalized activation & control, we have to admit our exploration eyeshot is still rather blurry. Before involving in the tyre model of PNT engine, it’s necessary for us to assume that we have found a sort of atomic reciprocal PNT combination α fit for PNT activation source for it can be accelerated along certain orientation once activated by PNT activation signal β and we can control the activation degree and activation ratio of the PNT activation source α by allocating the working intensity of PNT activation signal β to PNT activation source α . Thus, we can consider contriving the PNT normalized activation between PNT activation source α and PNT activation signal β by tyre model of PNT engine as to actualize soft drive of PNT engine.

In accordance with the dynamic rationale of PNT engine, in terms of the PNT artificial control of atomic reciprocal PNT combination, the key technologic issue is that we should not only facilitate the PNT action (spontaneous optimization variation of equilibrium between $d(M \rightarrow m)$ and $d(M \leftarrow m)$) of object under artificial control, but also should maintain the continuous controllability of the on-going PNT reaction between PNT activation

source and PNT activation signal and at the same time so as to facilitate control of motion orientation of PNT engine at our pleasure. In another word, once we come to premeditate PNT engine design, we should not only consider actualizing the feasible activation of the proper PNT activation source, but also must ensure the PNT continuous controllability of PNT activation source throughout the course of PNT engine working. Only thus, it's possible for us to facilitate ideal motion of PNT engine followed our inclinations.

For expedience to spread out the related technologic issues following a rational line with definite purpose in mind, it's necessary for us to refresh and nail down the reference fundamental——PNT continuous controllability and PNT normalized activation in advance, which PNT engine premeditation must refer to as safe & feasibility criterion.

(1) “PNT continuous controllability” and “PNT normalized activation”

1.1. PNT continuous controllability

In terms of the liquid fuel in fuel tank of combustion motor, we can input it to burning chamber or stop inputting it to burning chamber stochastically by control of keeping the oil valve open or close, and we can even allocate fuel input rate to burning chamber by controlling the open width of the oil valve and inner pressure of oil input pump. Thus, we say the input status of fuel in fuel tank to combustion motor cylinder is continuously controllable. And on the other hand, the working status of combustion motor directly depends on whether there is fuel burning and burning status (**Generally means burning intensity & burning frequency**) in burning chamber, as long as we can manage to maintain full burning conditions in burning chamber of cylinder, we can consequently control working status of combustion motor by controlling fuel input status to burning chamber. That's to say, under precondition of full burning conditions in burning chamber, the continuous controllability of working status of combustion motor can be materialized by the continuous controllability of fuel input to burning chamber.

However, once the fuel was burnt in burning chamber, the fuel consequently changed into many disordered gas molecules moving in high speed. Of course, it's still feasible for us to manage restraint of these disordered high speed molecules in solid shield as cylinder as to intercept their dominant kinetic energy as much as possible. But, if we want to premeditate further specific prime mover and artificial control to these disordered high speed molecules, the situation is obviously troublesome for us to confront now. Because the motion conditions of these molecules are so different, on one hand, it's almost impossible for us to manage specific prime movers aimed at so many disordered molecules once due to expected driving effects; and on the other hand, even if we just manage a unitive specific prime mover to act on all these disordered molecules, the implementation of the unitive specific prime mover can only make the motion status of these molecules even more disordered. So we say, the resultant molecules the fuel burnt are not something fit for continuous motion control.

Comparably, aiming at a stationary particle with mass of 1×10^{-8} kg and charge of 1×10^{-3} Coulomb, we can premeditate specific prime mover of 1000 voltage, 1 section to act on it for expected driving effect of Velocity (of the particle) = $1000V * 1 \times 10^{-3}C * 1S / 10^{-8}$ kg. If the driving effect is still not in our expected specification, we can successively arrange specific prime mover of η Voltage, δ sections to act on it for driving effect of Velocity (of the particle) = $\eta V * 1 \times 10^{-3}C * \delta S / 10^{-8}$ kg. And even if the driving effect is still not in our expected style, we can take it onto cyclotron to implement N times of accelerating. Thus, we say the motion of the particle is continuously controllable, because as long as the particle will not break into indefinite fragments throughout the course it is driven, it can adopt any specific prime mover and consequently hypostatize expected driving

effect as single definite noumenon all the way, so that we can successively premeditate specific prime mover due to expected driving effect from beginning to end. So we say the driving course of this particle is continuously controllable.

In terms of PNT volitional activation & control of atomic reciprocal PNT combination, the PNT activation source, to which we are ready to premeditate PNT activation & control is of course not single particle or single atom but massive object made up of many atoms. In order to make the entire PNT activation & control process continuously controllable, we have to ensure all the compositive atoms of PNT source motion as an integrate polymeric object all the way, so that it's possible for us to premeditate specific prime mover of eligible PNT inducement for successive PNT activation & control to PNT activation source against definite data of definite object and the intrinsic controllable necessity from beginning to end, we call such artificial controllability including all the intrinsic physic necessity of successive PNT activation & control course "PNT continuous controllability".

1.2. PNT normalized activation

The intention we advocate and emphasize PNT normalized activation is generally to ensure the PNT continuous controllability of PNT activation source during the course of soft drive of PNT engine. And in fact, only under the precondition of PNT normalized activation, it's possible for integrate PNT activation source to be definite object and to be possible to receive successive specific prime mover and consequently hypostatize expected driving effect as single object throughout the soft drive process. However, in terms of atomic reciprocal PNT combination, what kind of PNT activation model can be eligible PNT normalized activation?

As the Atom State Equation in Spacetime has not been consummated ultimately, and even the PNT activation source and PNT activation signal of PNT engine has not confirmed yet, it's obviously impossible for us to directly define "PNT normalized activation" against the intrinsic PNT combination configuration of PNT activation source and PNT activation signal and the original operation characteristic data of PNT reaction between PNT activation source and PNT activation signal. But in order not to leave the fundamental reference of PNT engine design absent, we can come to define "PNT normalized activation" against the proper inner mechanic stress necessity due to PNT continuous controllability of PNT activation source during the course of soft drive of PNT engine.

For the convenience to define PNT normalized activation of atomic reciprocal PNT combinations in three-dimensional frame, we assume, in the proper atomic reciprocal PNT combination introduced as PNT activation source, there are 8 discretional adjacent atoms A, B, C, D, E, F, G, H, three-dimensionally distributed in atomic reciprocal PNT combination, the atomic nuclei of the 8 atoms just locate on the 8 vertices of a parallelepiped as illustration below:

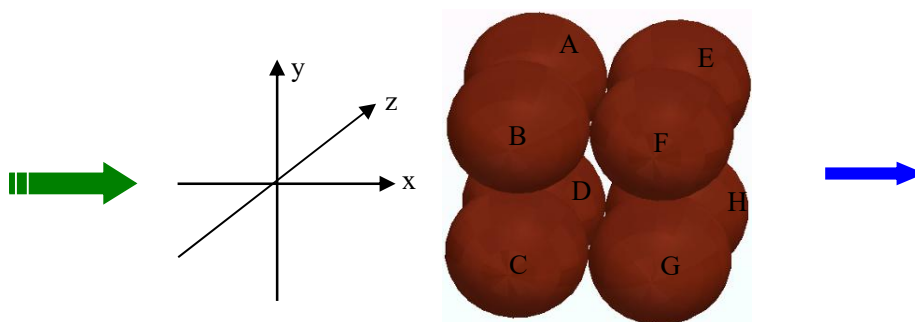

(VI-i-2~1) PNT normalized activation

(The centre connection lines of atomic linkages of A-E, B-F, C-G, D-H are parallel to X-axis, the centre connection lines of atomic linkages of A-B, D-C, E-F, H-D are parallel to Z-axis, the centre connection lines of atomic linkages of A-D, B-C, E-H, F-H are parallel to Y-axis. The green arrow indicates the action orientation of PNT activation signal to the atomic reciprocal PNT combination, the blue arrow indicates the acceleration orientation of the atomic reciprocal PNT combination activated by the PNT activation signal.)

Then, once the atomic reciprocal PNT combination is PNT activated, in order to ensure uniform and norm existence & motion status of the atomic reciprocal PNT combination, we must try to ensure:

- 1) Along X-axis, during the course of atomic linkage A-E is stimulated, the consequent stimulated stretching force f_A of atom A and stimulated stretching force f_E of atom E must satisfy $|f_A - f_E| \leq f_{A-E}$, among the inequation, f_{A-E} denotes the bonding force of atomic linkage of A-E under certain stimulation condition. And during the course of atomic linkage B-F, C-G, D-H are stimulated, the consequent stimulated stretching force F_B of atom B & F_F of atom F, stimulated stretching force F_C of atom C & F_G of atom G, stimulated stretching force F_D of atom D & F_H of atom H must satisfy conditions the same as atomic linkage A-E.
- 2) Along Z-axis, during the course of atomic linkage A-B is stimulated, the consequent stimulated stretching force f_A of atom A and stimulated stretching force f_B of atom B must satisfy $|f_A - f_B| \leq f_{A-B}$, among the inequation, f_{A-B} denotes the bonding force of atomic linkage of A-B under certain stimulation condition. And during the course of atomic linkage E-F, H-G, D-C are stimulated, the consequent stimulated stretching force F_E of atom E & F_F of atom F, stimulated stretching force F_H of atom H & F_G of atom G, stimulated stretching force F_D of atom D & F_C of atom C must satisfy conditions the same as atomic linkage A-B.
- 3) Along Y-axis, during the course of atomic linkage A-D is stimulated, the consequent stimulated stretching force f_A of atom A and stimulated stretching force f_D of atom D must satisfy $|f_A - f_D| \leq f_{A-D}$, among the inequation, f_{A-D} denotes the bonding force of atomic linkage of A-D under certain stimulation condition. And during the course of atomic linkage B-C, F-G, E-H are stimulated, the consequent stimulated stretching force F_B of atom B & F_C of atom C, stimulated stretching force F_F of atom F & F_G of atom G, stimulated stretching force F_E of atom E & F_H of atom H must satisfy conditions the same as atomic linkage A-D.
- 4) Throughout the PNT activation course, there should not be remarkable radiation loss from atoms A, B, C, D, E, F, G, H, because the radiation loss will directly impact the stimulation functional characteristics and reliability of these atoms as PNT activation source.

Only thus, the atomic reciprocal PNT combination made up of atoms of A, B, C, D, E, F, G, H can keep existing and moving as single object and substantiating the integrative existence & motion as expected and being relatively steady and reliable, so that, as our activation object, it's definite and continuously controllable throughout the process. In ahead section, the so-called "PNT" is just an ideal stimulation situation of PNT activation source, the stimulation stretching forces $|f_A - f_E|$, $|f_A - f_B|$, $|f_A - f_D|$, ... between any two adjacent atoms in atomic reciprocal PNT combination which is used as PNT activation source illimitably approach 0 during the course of PNT activation.

As coherent natura naturans throughout cosmic evolution, instinctive PNT reciprocal equilibrium towards optimum PNT operation is radical potentiality & conditionality for cosmos always ready to orientate itself towards perfection.

Obviously, during the course of PNT activation signal stimulating PNT activation source, followed the gradual increase of $f_A, f_B, f_C, f_D, f_E, f_F, f_G, f_H$, the stimulation stretching forces $|f_A - f_E|, |f_A - f_B|, |f_A - f_D|, \dots$ increase consequently, while on the other hand, the bonding forces of $f_{A-E}, f_{A-B}, f_{A-D}, \dots$ not only can not ensure synchronously increase proportionably, but also they maybe even decrease for consequent PNT stimulation thermal expansion, this deadly restrict the controllable stimulation limit of PNT activation source. Because once the stimulation stretching forces are bigger than the bonding forces among adjacent atoms in PNT activation source, the atomic linkages of PNT activation source will consequently be collapsed, and the massive material block used as PNT activation source will exhibit destructive explosion.

When we practically come to consider PNT engine design, if we confirm the PNT activation source can accelerate along the same orientation of PNT activation signal acting on PNT activation source once stimulated, in order to ensure the stimulation stretching forces of PNT activation source satisfy $|f_A - f_E| \leq f_{A-E}, \dots, |f_A - f_B| \leq f_{A-B}, \dots, |f_A - f_D| \leq f_{A-D}, \dots$ during the course of PNT activation performance, it's of course advisable for us to consider if it possible for us to help to materialize the quantities on the right of the inequation appropriately increasing synchronously, or help to materialize the quantitative increase of $f_A, f_B, f_C, f_D, f_E, f_F, f_G, f_H$ won't intensively impact the quantitative increase of $|f_A - f_E|, |f_A - f_B|, |f_A - f_D|, \dots$, or help to materialize the both. Because if so, the PNT controllable activation limit of PNT normalized activation of the PNT activation source will be remarkably commodious thereby.

For this, we consider to keep the orientation of PNT activation signal acting on PNT activation source an appropriate angle ϕ ($0 < \phi < 90^\circ$) as below:

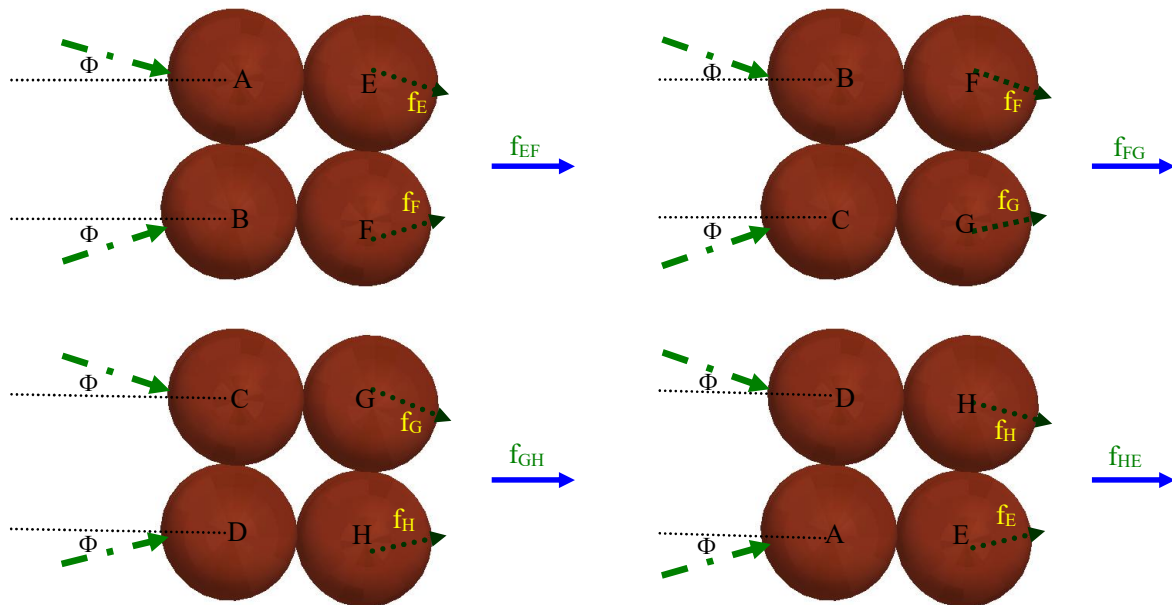

(VI-i-2~2) Φ angle PNT activation

In picture, the green arrows indicate the directions of PNT activation signals acting on the proper atoms, and the direction forms ϕ angle with horizontal line. The dotted line arrows indicate the force directions of the atoms; the blue arrows indicate the directions of the resultant force of the entire atomic reciprocal PNT combination. Apparently, in order to consummate the sufficient conditions of PNT normalized activation, it's necessary to satisfy:

$$\left\{ \begin{array}{l} |f_A - f_B| * \cos \phi \leq f_{A-B} + (f_A * \sin \phi + f_B * \sin \phi), \\ |f_B - f_C| * \cos \phi \leq f_{B-C} + (f_B * \sin \phi + f_C * \sin \phi), \\ |f_C - f_D| * \cos \phi \leq f_{C-D} + (f_C * \sin \phi + f_D * \sin \phi), \\ |f_D - f_A| * \cos \phi \leq f_{D-A} + (f_D * \sin \phi + f_A * \sin \phi), \\ \dots \quad \dots \quad \dots \quad \dots \end{array} \right.$$

Compared with

$$\left\{ \begin{array}{l} |f_A - f_B| \leq f_{A-B} \\ |f_B - f_C| \leq f_{B-C} \\ |f_C - f_D| \leq f_{C-D} \\ |f_D - f_A| \leq f_{D-A} \\ \dots \quad \dots \quad \dots \end{array} \right.$$

As $0 < \phi < 90^\circ$,

$$\left\{ \begin{array}{l} |f_A - f_B| * \cos \phi < |f_A - f_B|, \quad f_{A-B} + (f_A + f_B) * \sin \phi > f_{A-B} \\ |f_B - f_C| * \cos \phi < |f_B - f_C|, \quad f_{B-C} + (f_B + f_C) * \sin \phi > f_{B-C} \\ |f_C - f_D| * \cos \phi < |f_C - f_D|, \quad f_{C-D} + (f_C + f_D) * \sin \phi > f_{C-D} \\ |f_D - f_A| * \cos \phi < |f_D - f_A|, \quad f_{D-A} + (f_D + f_A) * \sin \phi > f_{D-A} \\ \dots \quad \dots \quad \dots \quad \dots \end{array} \right. \text{ are satisfied unconditionally.}$$

Apparently, the introduction of ϕ angle PNT activation remarkably consolidated the favorable conditions of PNT normalized activation, promoted safety and feasibility ratio of PNT normalized activation. And indeed, the key factor it consolidated favorable conditions of PNT normalized activation is that the right of the equation has introduced positive quantity of $(f_A + f_B) * \sin \phi$, $(f_B + f_C) * \sin \phi$, $(f_C + f_D) * \sin \phi$, $(f_D + f_A) * \sin \phi$, ... , we denote $(f_A + f_B) * \sin \phi$, $(f_B + f_C) * \sin \phi$, $(f_C + f_D) * \sin \phi$, $(f_D + f_A) * \sin \phi$, ... “PNT shape confining force” engendered to PNT activation source during the course of PNT activation. Of course, it's not better and better for PNT shape confining force to become bigger and bigger, it should be just right for the purpose, because redundant PNT shape confirming force will not only exhaust too much unnecessary PNT activation energy source, but also it maybe arouse adverse mechanic configuration aberrance of PNT activation source due to PNT normalized activation necessity.

(2) The PNT normalized activation of tyre model of PNT engine

Now, we come to materialize the rationale idea of PNT continuous controllability and PNT normalized activation into PNT engine design, ——PNT normalized activation molded by tyre model of PNT engine. PNT action of discretionary object in cosmos has inherent instinct of PNT equilibrium, and “instinctive PNT reciprocal equilibrium towards optimum PNT operation” is inherent fundamental of universal existence & motion of matter. We pursue technologic practice of PNT engine is but endeavor to bring out “**reciprocal idiosyncrasy towards PNT equilibrium + accessible space overall arrangement for PNT reciprocity**” between PNT activation source and PNT activator & rectifier with substantial potentiality, and it's accessible for us to control the natural implementation of instinctive PNT reciprocal equilibrium towards optimum PNT operation between PNT activation source and PNT activator & rectifier, so that we can accomplish control of ideal motion of the integrative object of combination of “PNT activation source + PNT activator & rectifier”.

As coherent natura naturans throughout cosmic evolution, instinctive PNT reciprocal equilibrium towards optimum PNT operation is radical potentiality & conditionality for cosmos always ready to orientate itself towards perfection.

Usually, the key technologic issues are as following:

A) Try to find ideal “PNT activation source” and “PNT activator & rectifier”, between which the situation of “reciprocal idiosyncrasy towards PNT equilibrium + accessible space overall arrangement for PNT reciprocity” has remarkable potentiality for accomplishment of instinctive PNT reciprocal equilibrium towards optimum PNT operation under artificial control.

B) The implementation of instinctive PNT reciprocal equilibrium towards optimum PNT operation of “reciprocal idiosyncrasy towards PNT equilibrium + accessible space overall arrangement for PNT reciprocity” between “PNT activation source” and “PNT activator & rectifier” is perfectly controllable for PNT normalized activation.

2.1. “Tyre core” and “PNT activator”

In order to materialize Φ angle PNT normalized activation of PNT activation source, we fabricate the PNT activation source into component in geometric profile as below:

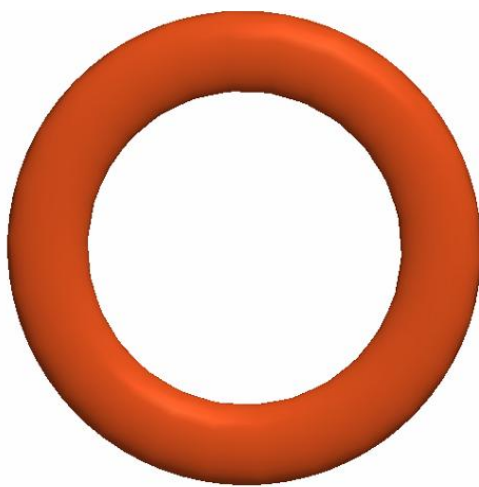

(VI-i-2~3) Tyre core front view

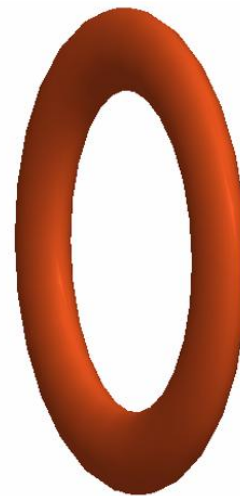

(VI-i-2~4) Tyre core oblique view

The geometric profile of the component of tyre core is a standard loop with section of ellipses, of which the ratio of long axis above short axis is near to 2/1. As the geometric profile of the very component is rather similar as tyre and in assembly structure, this component just locates at the core position of PNT engine, so we just call it “tyre core”.

In order to offer an ideal space reference for coming introduction of the related functions of PNT engine, we denote the plane formed by circumgyration of the long axis of section ellipses in tyre core component “tyre core center plane”, which can be illustrated as below:

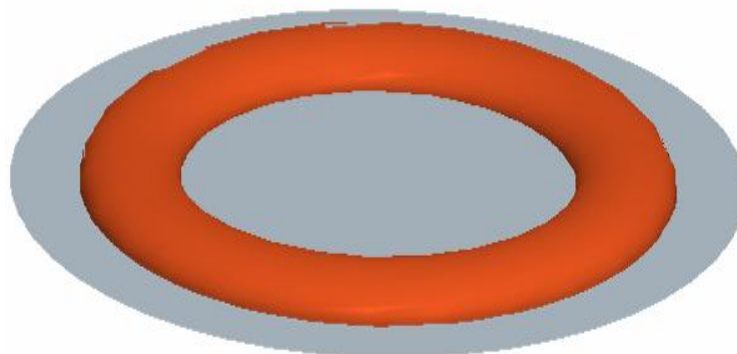

(VI-i-2~5) Tyre core center plane

Obviously, the tyre core is symmetric against the tyre core center plane.

In accordance with the dynamic rationale of PNT engine, we know the PNT activator must offer PNT activation signal directly to the PNT activation source. In order to avoid or reduce physical transmitting implementation exhaustion as much as possible, in geometric assembly, it's necessary to design the PNT activators into components in matching geometric profile of tyre core, so that the PNT activation signal from PNT activator can directly enter PNT activation source without any interspace. For the purpose, we fabricate the PNT activator into two kinds of components of “front PNT activator” and “back PNT activator” in geometric profile as following:

A). Front PNT activator



(VI-i-2~6) Upper limb view of front PNT activator

(VI-i-2~7) Lower limb view of front PNT activator

In accordance with the functional discrepancy of different geometric part of the PNT activator, we distinguish the front PNT activator into three functional zones as illustrated in different colors of the picture above, we denote the area of the component in deep green “upper limb of front PNT activator”, denote the area of the component in grey “lower limb of front PNT activator”, and denote the area of the component in yellow-brown between upper limb and lower limb “major activation area of front PNT activator”.

B). Back PNT activator

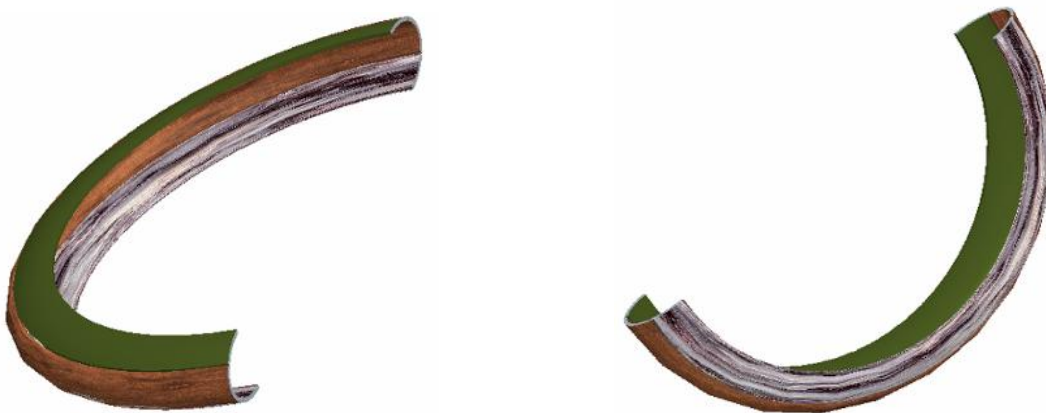

(VI-i-2~8) Upper limb view of back PNT activator

(VI-i-2~9) Lower limb view of PNT activator

According to the functional discrepancy of different geometric part of the PNT activator, we distinguish the back PNT activator into three functional zones as illustrated in different colors of the picture above, we

As coherent natura naturans throughout cosmic evolution, instinctive PNT reciprocal equilibrium towards optimum PNT operation is radical potentiality & conditionality for cosmos always ready to orientate itself towards perfection.

denote the area of the component in deep green “upper limb of back PNT activator”, denote the area of the component in grey “lower limb of back PNT activator”, and denote the area of the component in yellow-brown between upper limb and lower limb “major activation area of back PNT activator”.

Matching assembly of PNT activators & tyre core:

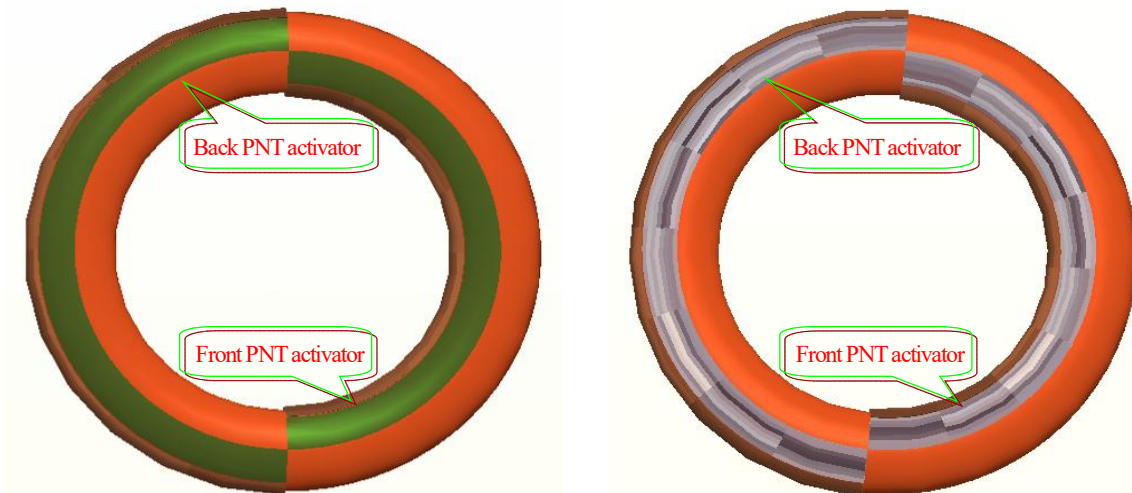

(VI-i-2~10) Upper limb view of “Tyre core + PNT activators” (VI-i-2~11) lower limb view of “Tyre core + PNT activators”

Obviously, in the assembled parts of “tyre core + PNT activators”, both front PNT activator and back PNT activator are symmetric against tyre core center plane.

2.2. Symmetric activation mechanic model of PNT activators to tyre core

Now, we come to analyze the symmetric activation mechanic model of PNT activators to tyre core.

As mutual matching geometric profile of tyre core and PNT activators and as the geometric profiles of both tyre core and PNT activators are symmetric against the tyre core center plane, in terms of any function section through the circumgyration center axis of PNT activators, they can implement symmetric activation to tyre core as following:

2.2.1. The symmetric activation of front PNT activator to tyre core:

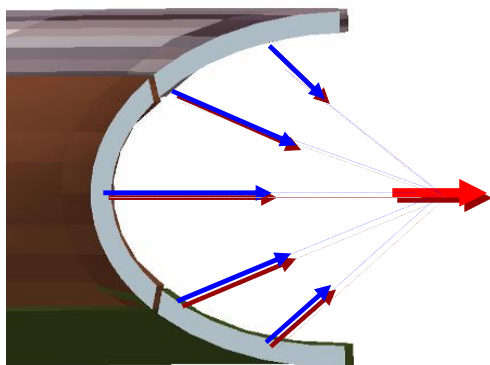

(VI-i-2~12) Symmetric Activation section of front PNT activator

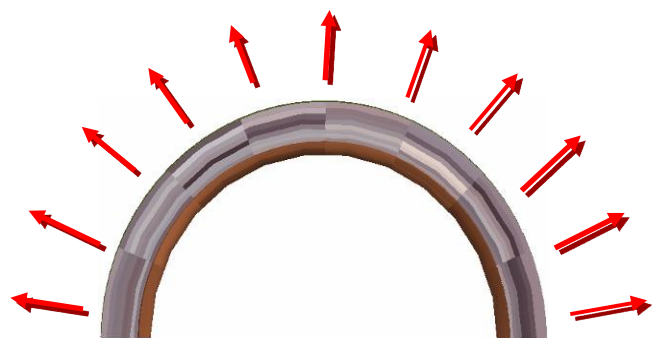

(VI-i-2~13) Resultant activation of front PNT activation

As long as the activation output of front PNT activator distributed symmetrically against the tyre core center plane, the integrate resultant activation of front PNT activator will converge into the tyre core center plane as illustrated in diagram (VI-i-2~12) thereby. And at the same time, as any of the arc on the inner surface

of the front PNT activator and parallel to the tyre core center plane are open semicircular lines, consequently, the integrate resultant activation of front PNT activator are distributed openly along the intersected semicircular line of the tyre core center plane and front PNT activator as illustrated in diagram (VI-i-2~13). We denote such activation mechanic model of front PNT activator “ ϕ angle two-dimensional symmetric activation”.

2. 2. 2. The symmetric activation of back PNT activator to tyre core:

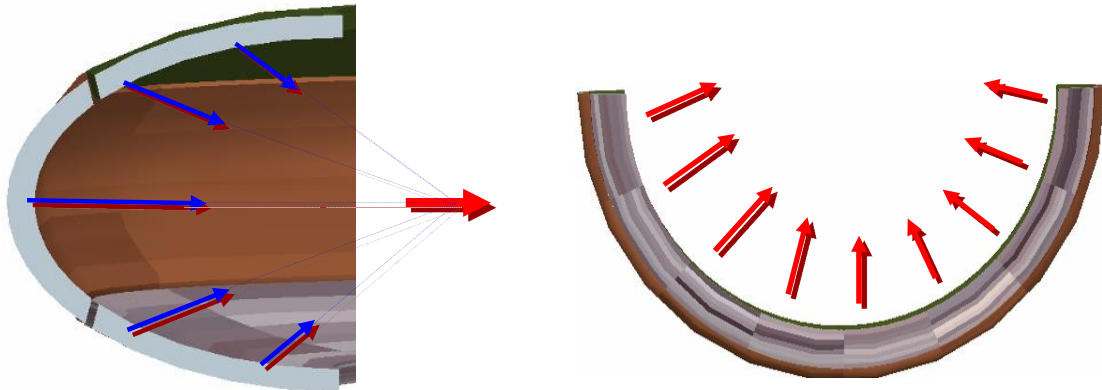

(VI-i-2~14) Symmetric Activation section of back PNT activator (VI-i-2~15) Resultant activation of front PNT activation

As long as the activation output of back PNT activator distributed symmetrically against the tyre core center plane, the integrate resultant activation of back PNT activator will converge into the tyre core center plane as illustrated in diagram (VI-i-2~14) thereby. And at the same time, as any of the arc on the inner surface of the back PNT activator and parallel to the tyre core center plane are half closed semicircular lines, consequently, the integrate resultant activation of back PNT activator are converged along the intersected semicircular line of the tyre core center plane and back PNT activator as illustrated in diagram (VI-i-2~15). We denote such activation mechanic model of back PNT activator “ ϕ angle three-dimensional symmetric activation”. Both the ϕ angle two-dimensional symmetric activation of front PNT activator and ϕ angle three-dimensional symmetric activation of back PNT activator work on the tyre core corporately, the integrate stimulation status of tyre core is consequently as below:

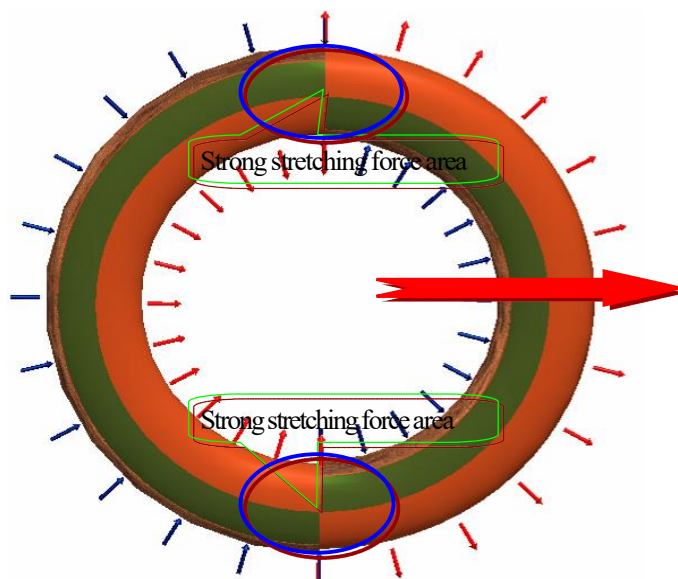

(VI-i-2~16) Integrate stimulation status of tyre core in PNT activation model of front “ ϕ angle two-dimensional symmetric activation” + back “ ϕ angle three-dimensional symmetric activation”

As coherent natura naturans throughout cosmic evolution, instinctive PNT reciprocal equilibrium towards optimum PNT operation is radical potentiality & conditionality for cosmos always ready to orientate itself towards perfection.

In the diagram, the small blue arrows indicate the orientation the PNT activator acting on tyre core, the small red arrows from the tyre core indicate the stimulation direction, the big red arrow indicates the resultant acceleration of the tyre core. However, under such PNT activation condition, the directions of stimulation stretching force about the area near the assembly contact surface of front PNT activator and back PNT activation are almost inverse, as a result, the devastating stretching force in this district is remarkably big. And at the same time, if the shape confining forces separately derived from upper limb and lower limb of PNT activator are too big, it may also cause redundant confining force antagonizing between upward redundant confining force and downward redundant confining force ^①. The presence of redundant confining force confrontation and deleterious stretching force about the area near to the assembly joint section of front PNT activator and back PNT activator will not only exhaust much of the tyre core normalized driving kinetic energy, but also directly impact safety and continuous controllability of PNT soft drive. If possible, either the activation mechanic model of both front PNT activator and back PNT activator must be improved accordingly, or it's necessary to introduce other functional components to perform PNT activation rectification, ——to ensure the necessary shape confining force of tyre core and to transmute the redundant shape confining force and deleterious stretching force into normalized driving force of tyre core.

2.3. “PNT rectifier” and “state rectification”

As the intrinsic compositive and mechanical configurations including mechanical bonding linkage in atoms and among atoms, when the PNT activator works on the PNT activation source, it's very difficult for us to ensure the practical PNT activation effect of PNT activation source is just the pure PNT stimulation we use to bring about the expected soft drive only, but instead, it usually involves a series of PNT chain-reactings linked by intrinsic compositive and mechanic configurations in atoms and among atoms of atomic reciprocal PNT combinations. For example, we need to implement PNT soft drive to atomic nucleus, but in fact, it's almost impossible for us to activate atomic nucleus dissociated from the proper atom and the related mechanic linkages among adjacent atoms of atomic reciprocal PNT combinations, it must be involved in imbroglgio related

Note ^①: if we confirm the direction that PNT activator works on the PNT activation source is vertical against the very point PNT activation signal coming from the surface of PNT activator, then the magnitude and direction of shape confining force is directly related to the ratio of long axis over short axis of section ellipses of PNT activator. To any certain PNT engine, the ratio of long axis over short axis of the section ellipses of tyre core or PNT activator is usually constant, while on the other hand, as the continuously on-going of the PNT soft drive reaction, the existent state of the PNT activation source of tyre core is continuously inconstant, and at the same time, the necessary shape confining force of tyre core is different all the way. Although, throughout the process, the actual shape confining force is varying, there is nothing we can depend on to ensure the actual variation of shape confining force on each point of the tyre core surface keep proportion to the shape confining force necessity of the tyre core due to continuous controllability of PNT soft drive, as a result, we have to consider introducing auxiliary function of PNT optimization rectification. And since the function of optimization rectification is unavoidable to introduce, once we come to prearrange the ratio of long axis over short axis of section ellipses of tyre core, considering the materialization of function of PNT corrective rectification is more convenient to translate the redundant shape confining force into tyre core normalized driving force in appropriate measure, the predesign magnitude of shape confining force is of course better to be a little bigger than original necessity, then we can manage the magnitude of shape confining force around tyre core into artificial control by transmuted the redundant shape confining force into tyre core normalized driving force in appropriate measure according to necessity of continuous controllability of tyre core.

to the unexpected imbroglio of electrons around the nucleus and the intrinsic bonding linkage among atoms.

Among the PNT chain-reacting, except the goal PNT reaction we pursuit to bring about the PNT real soft drive, there are unavoidable PNT reactions harmful to the feasibility of PNT normalized action and PNT continuous controllability. Thus, we have to consider managing restraints and corrective rectification to such harmful PNT chain-reacting, so that it is possible for us to materialize PNT normalized activation.

For such purpose, we introduce functional component of “PNT rectifier”, on one hand, we can use it to implement optimization correction to the goal PNT reaction as to solid the efficiency and reliability of PNT soft drive, and on the other hand, we can use it to implement proper restraints and rectification to the unavoidable but harmful incidental PNT chain-reacting, —either to get rid of the draff or transmute the draff to goodness. This is similar as, in order to make the crops in the field to grow up quickly, the effective measure we introduced is to add fertilizer into the field, however, the practical effect of adding fertilizer into the field is not only limited in facilitating the crops in the field growing up quickly, at the same time, the grasses in the field grows up even more quickly than crops which maybe deadly exclude the growth of crops in the field. Thus, we have to consider introducing herbicide.

In dynamic rationale, there is no distinction between PNT rectifications and dynamic driving; both PNT rectifications and dynamic driving are physical ways to manage sufficient conditions of acceleration by feasible way to bring about the expected existence & motion of certain object. And similarly, the PNT rectifications can also be classified into “hard rectification” and “soft rectification”.

So-called “hard rectification” usually means the stimulated matters are confined and restricted by solid barrier (so that the stimulated dominant kinetic energy can be released convergent orientated to certain orientation). For instances, the detonated gunpowder in bullet or cannonball is confined and restricted by the bullet power case and gun tube (so that the detonated gunpowder can push out the warhead from gun tube powerfully and efficiently.), the gas in tyre is confined and restricted by the tyre, the ignited gas in cylinder is confined and restricted by cylinder, ... all these are typical hard rectification cases. And as the hard rectification is usually materialized by constraint and restriction of solid barriers, the “hard rectification” can be called “barrier rectification” too.

So-called “soft rectification” is but a physic process that as the proper implementation of management of PNT operation of certain object, the existence & motion of the object can be subject to the intrinsic regularity in our expectation. For instances, in cyclotron, the circular motion of charged particle restricted by centralized electric field is a typical case of soft rectification; in LCD technology, the characterized deflection of liquid crystal molecules in display plate under characterized electric field is another typical case of soft rectification. If the PNT activation we introduced is polar atomic reciprocal PNT combination, before the PNT activator works onto the PNT activation source, in order to ensure the equivalent stimulation effect of any part of the tyre core, it's obviously necessary for us to maintain the regular and unitive polar pattern of the polar atomic reciprocal PNT combination in advance. In such case, the PNT rectifier manages to maintain the regular and unitive polar pattern of the polar atomic reciprocal PNT combination is of course typical case of soft rectification.

The dynamic rectification of PNT engine is usually “soft rectification”. Although in fact, the presence of tyre core upper jacket plate and tyre core lower jacket plate can practically go into effect of “hard rectification” to tyre core, under the practical stimulating situation of tyre core, the hard rectification effect tyre core jacket

plates can do is virtually far from necessity, what’s more, in many special rectification cases, hard rectification is invalid at all, for example, the dynamic rectification of polar pattern of polar atomic reciprocal PNT combinations of PNT activation source.

2.3.1. Geometric profile and functional rectification of PNT rectifier

Now, we come to analyze the geometric profile & assembly of PNT rectifiers and the fundamental rectification function of PNT rectifier.

Similar as the PNT activator, the PNT rectifiers can be classified onto two components of “front PNT rectifier” and “back PNT rectifier” except that the geometric profile of front PNT rectifier is just the same as the back PNT activator and the geometric profile of back PNT rectifier is just the same as front PNT activator, just as following:

A) Front PNT rectifier



(VI-i-2~17) Upper limb view of front PNT rectifier

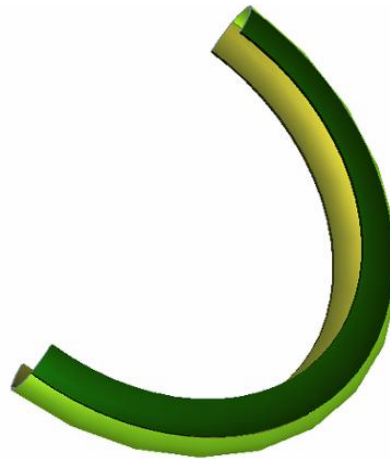

(VI-i-2~18) Lower limb view of front PNT rectifier

The silvery yellow area of the component illustrated in diagram (VI-i-2~17) is just the upper limb of front PNT rectifier, the dark green area of the component illustrated in diagram (VI-i-2~18) is just the lower limb of front PNT rectifier.

B) Back PNT rectifier:

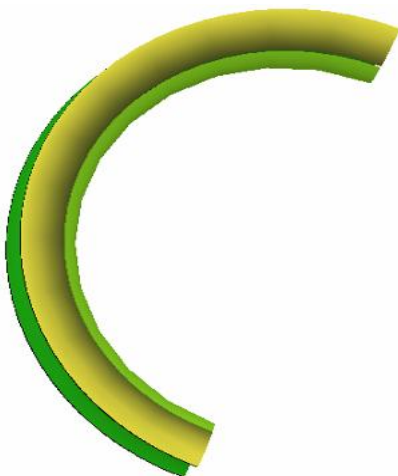

(VI-i-2~19) Upper limb view of back PNT rectifier



(VI-i-2~20) Lower limb view of back PNT rectifier

The silvery yellow area of the component illustrated in diagram (VI-i-2~19) is just the upper limb of back PNT rectifier, the dark green area of the component illustrated in diagram (VI-i-2~20) is just the lower limb of back PNT rectifier.

The integrate assembly of front PNT rectifier and back PNT rectifier onto tyre core is just as below:

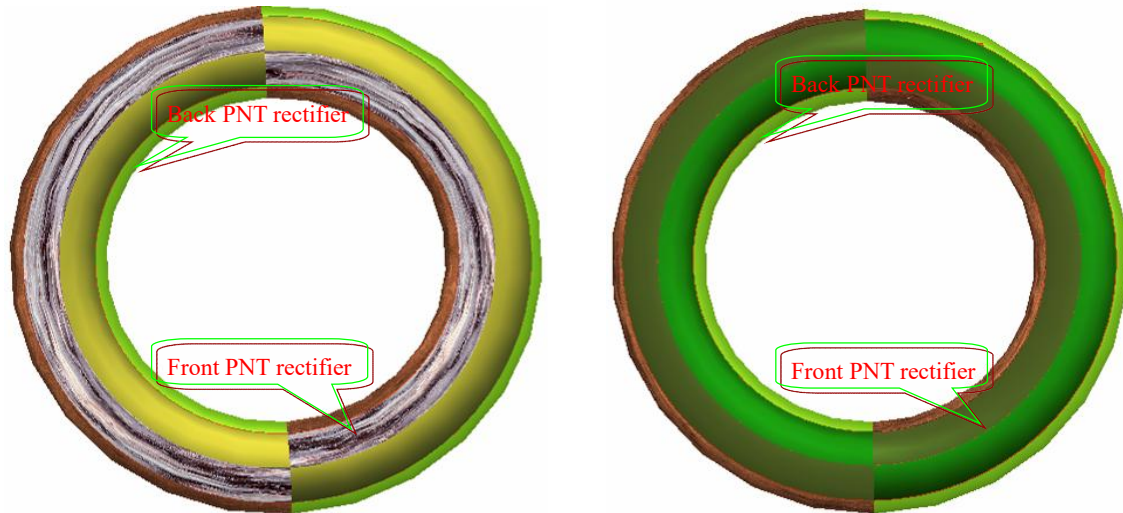

(VI-i-2~21) Upper limb view of ‘PNT rectifiers + tyre core’

(VI-i-2~22) Lower limb view of ‘PNT rectifiers + tyre core’

The fundamental functions of PNT rectifiers are as following: the first, gives appropriate restraint and restriction to the deleterious incidental PNT reactions according to PNT normalized activation necessity; the second, gives optimum rectification to the goal PNT reaction introduced as prime mover of soft drive as to improve efficiency and strengthen safe reliability of normalized driving of PNT engine.

As the PNT activation source and PNT activation signal of PNT engine have not been confirmed ultimately, there is still no way for us to involve in definite goal PNT reaction introduced as soft drive reaction and the incidental PNT reactions. Apparently, before the idiographic soft drive PNT reaction ultimately confirmed, there is no way for us to illustrate how PNT rectifiers can do restraint and restriction to the deleterious incidental PNT reactions once the goal soft drive PNT reaction on-going, but our pursuit of real PNT driving of tyre core is of course explicit, so now, we come to analyze how the PNT rectifiers do optimum rectification to the goal soft drive PNT reaction as to improve the real PNT driving efficiency and strengthen the safe reliability of soft drive of PNT engine.

2.3.2. Optimum rectification of PNT rectifier to goal PNT activation.

In dynamic rationale, there is no essential distinction between PNT activator and PNT rectifier, the major function of both is to implement appropriate soft drive for expected unitive and normalized existence & motion of PNT activation source except difference in function, PNT activators mostly devote to stimulation of PNT activation source, while PNT rectifier mostly devote to normalization insurance of PNT activation and safety reliability guard of integrate operation of PNT engine.

As the geometric profiles of PNT rectifiers are just the same of PNT activators besides transposal of front and back, as a result, the working mechanic pattern of back PNT rectifier is generally the same as the working mechanic pattern of front PNT activator as below:

As coherent natura naturans throughout cosmic evolution, instinctive PNT reciprocal equilibrium towards optimum PNT operation is radical potentiality & conditionality for cosmos always ready to orientate itself towards perfection.

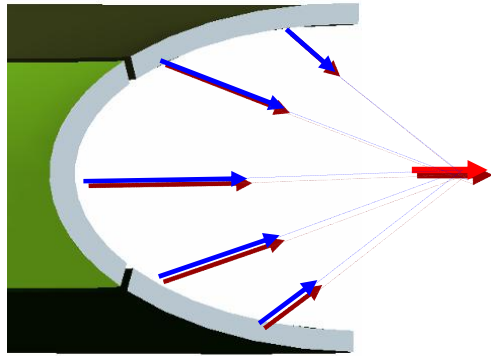

(VI-i-2~23) Section view of symmetric rectification of back PNT rectifier

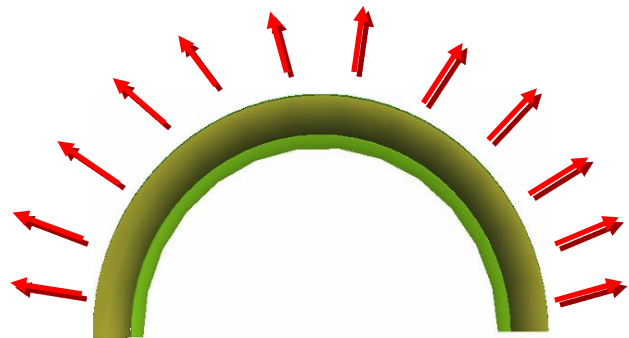

(VI-i-2~24) Integrate view of symmetric rectification of back PNT rectifier

As long as the rectification wattage output distribution of back PNT rectifier is symmetric against the tyre core center plane, the integrate rectification effect derived from it must be concentrated into the tyre core center plane as illustrated as diagram (VI-i-2~23). While, as any arc parallel to the tyre core center plane on the inner surface of back PNT rectifier are open semi-circle arc, the integrate rectification effect of back PNT rectifier shows itself open semi-circle distribution thereby, which is illustrated in diagram (VI-i-2~24). We denote such PNT rectification mechanic pattern of back PNT rectifier “two-dimensional ϕ angle PNT symmetric rectification”.

Back PNT rectifier matching with back PNT activator forms assemble function unit of “three-dimensional ϕ angle PNT symmetric activation + two-dimensional ϕ angle PNT symmetric rectification”. Such functional assembly can bring about corrective optimization of PNT normalized soft drive, it can aggrandize PNT normalized driving force as much as possible under precondition of the appropriate magnitude of shape confining force of tyre core ensured. The working mechanic pattern of back PNT activator rectified by back PNT rectifier can be illustrated as below:

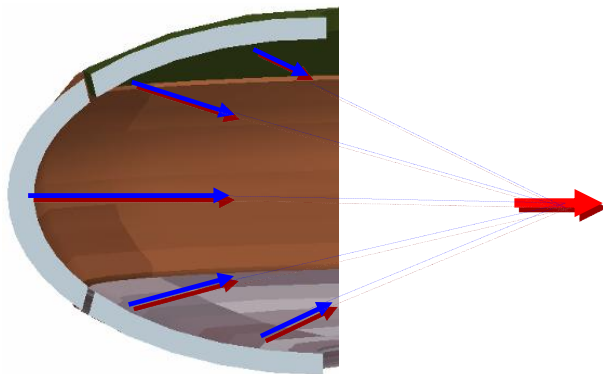

(VI-i-2~25) Section view of symmetric activation mechanic pattern of back PNT activator rectified by back PNT rectifier.

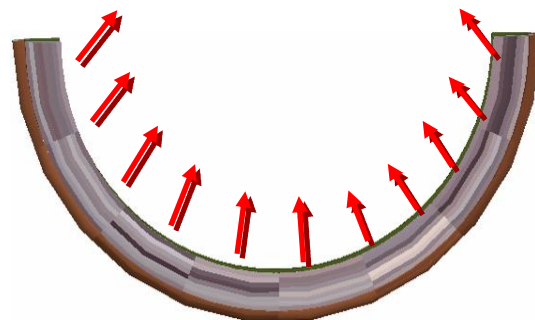

(VI-i-2~26) Section view of integrate symmetric activation mechanic pattern of back PNT activator rectified by back PNT rectifier

Apparently, after rectified by back PNT rectifier, the mechanic direction about the upper and lower limb of back PNT activator illustrated in diagram (VI-i-2~25) and the mechanic direction about the right and left terminal of back PNT activator illustrated in diagram (VI-i-2~26) have obviously optimized due to PNT normalized activation necessity. Thus, not only the magnitude of shape confining force of tyre core has been

appropriately ensured but also the redundant shape confining force confrontation between upward redundant shape confining force and downward redundant shape confining force and the deleterious stretching force in district near the contact surface of front PNT activator and back PNT activator have been appropriately corrected and weakened, and the PNT normalized driving force has been aggrandized thereby.

The working mechanic pattern of front PNT rectifier is generally the same as the working mechanic pattern of back PNT activator as below:

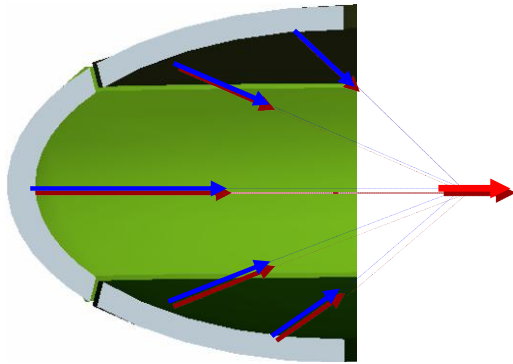

(VI-i-2~27) Section view of symmetric rectification of front PNT rectifier

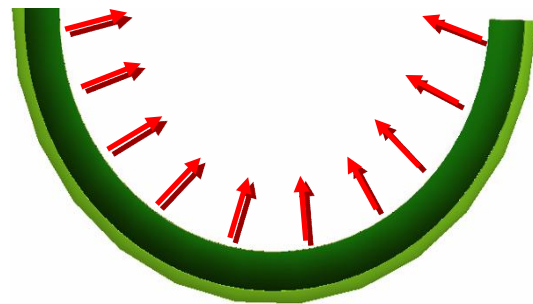

(VI-i-2~28) Integrate view of symmetric rectification of front PNT rectifier

As long as the rectification wattage output distribution of front PNT rectifier is symmetric against the tyre core center plane, the integrate rectification effect derived from it must be concentrated into the tyre core center plane as illustrated as diagram (VI-i-2~27). And at the same time, as any arc parallel to the tyre core center plane on the inner surface of front PNT rectifier are close semi-circle arc, the integrate rectification effect of front PNT rectifier shows itself close semi-circle distribution thereby, which is illustrated in diagram (VI-i-2~28). We denote such PNT rectification mechanic pattern of front PNT rectifier “three-dimensional ϕ angle PNT symmetric rectification”.

Front PNT rectifier matching with front PNT activator forms assemble function unit of “two-dimensional ϕ angle PNT symmetric activation + three-dimensional ϕ angle PNT symmetric rectification”. Such functional assembly can bring about corrective optimization of PNT normalized soft drive, it can aggrandize PNT normalized driving force as much as possible under precondition of the appropriate magnitude of shape confining force of tyre core ensured. The working mechanic pattern of front PNT activator rectified by front PNT rectifier can be illustrated as below:

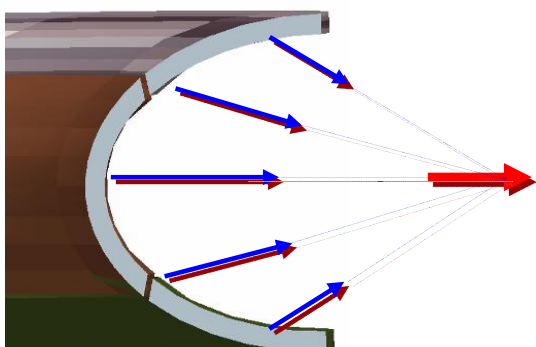

(VI-i-2~29) Section view of symmetric activation mechanic pattern of front PNT activator rectified by front PNT rectifier.

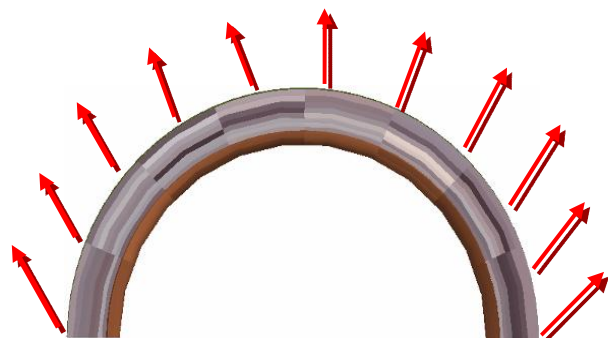

(VI-i-2~30) Section view of integrate symmetric activation mechanic pattern of front PNT activator rectified by front PNT rectifier

As coherent natura naturans throughout cosmic evolution, instinctive PNT reciprocal equilibrium towards optimum PNT operation is radical potentiality & conditionality for cosmos always ready to orientate itself towards perfection.

Apparently, after rectified by front PNT rectifier, the mechanic direction about the upper and lower limb of front PNT activator illustrated in diagram (VI-i-2~29) and the mechanic direction about the right and left terminal of front PNT activator illustrated in diagram (VI-i-2~30) have obviously optimized due to PNT normalized activation necessity. Thus, not only the magnitude of shape confining force of tyre core has been appropriately ensured but also the redundant shape confining force confrontation between upward redundant shape confining force and downward redundant shape confining force and the deleterious stretching force in district near the contact surface of front PNT activator and back PNT activator have been appropriately corrected and weakened, and the PNT normalized driving force has been agrandized thereby.

Both function assembly unit “three-dimensional ϕ angle PNT symmetric activation + two-dimensional ϕ angle PNT rectification” and function assembly unit “two-dimensional ϕ angle PNT symmetric activation + three-dimensional ϕ angle PNT symmetric rectification” work on tyre core together, the integrate stimulated mechanic pattern of tyre core can generally be illustrated as below:

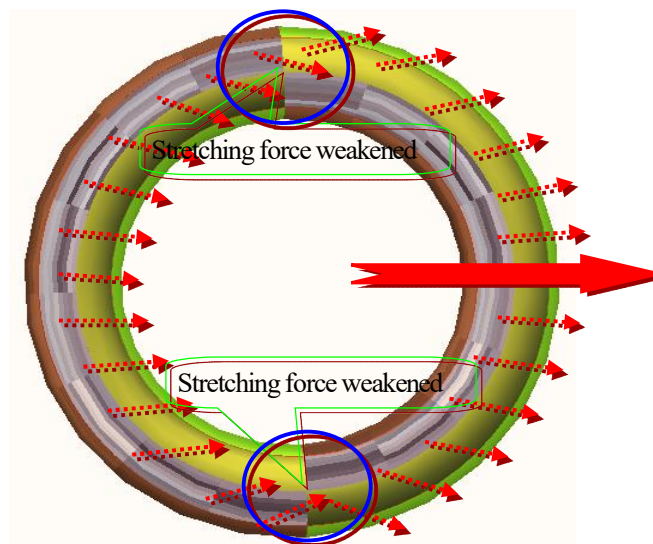

(VI-i-2~31) Integrate stimulation mechanic pattern of “three-dimensional ϕ angle PNT symmetric activation + two-dimensional ϕ angle PNT rectification” + “two-dimensional ϕ angle PNT symmetric activation + three-dimensional ϕ angle PNT symmetric rectification”

In above diagram, the red small arrows indicate the local stimulation direction of PNT activation source of tyre core stimulated by PNT activators with corrective rectification of PNT rectifiers. The red big arrow indicates the resultant stimulation direction of the whole PNT activation source as an object of tyre core. Apparently, compared with the stimulation effect illustrated in diagram (VI-i-2~16) front “two-dimensional ϕ angle PNT symmetric activation” + back “three-dimensional ϕ angle PNT symmetric activation”, as presence of functions of PNT rectifiers, the stretching force in adjoining area concentrated by the joint section of front PNT activator and back PNT activator is remarkably weakened, and both superabundance and deficiency of shape confining force of tyre core entered artificial control thereby, —some of the deformation stretching force of tyre core and some of the shape confining force confrontation between redundant upward shape confining force and redundant downward shape confining force have been corrected and transmuted into PNT normalized driving force.

Theoretically, if the PNT activators can consummate 70% PNT normalized & safe activation alone, then,

Historical progress of science in the recent several centuries seemed like a far-flung exploration of the first itinerary around numerous distinctive landscapes of brand-new landmasses of science with palette & tablet on back, several hundred years’ scientific travelogues were compiled thereby.

the PNT rectifiers should try to consummate the rest 30% uncommitted PNT normalized activation. Although, as some certain limit and occasional inconstant factors, the PNT rectifiers still can not exactly consummate the 30% uncommitted PNT normalized activation in many cases, in accordance with the safety and controllability necessity of PNT engine, at any rate, the accomplishment ratio of PNT normalized activation PNT activators consummated + accomplishment ratio of PNT normalized activation PNT rectifiers consummated must satisfy safe state necessity $|f_{\alpha} - f_{\beta}| * \cos\phi \leq f_{\alpha} + f_{\beta} * \sin\phi$ of tyre core, among the inequation, α, β denote any two adjacent atoms in tyre core. Otherwise, the PNT engine self-stimulation will become self-destruction.

As the synergistic relationship of PNT activators and PNT rectifiers, PNT rectifiers must work in coordination with PNT activators, the lower accomplishment ratio of PNT normalized activation PNT activators consummated, the more uncommitted PNT normalized activation the PNT rectifiers must try to consummate. Generally, the more intensively the PNT activators work on the PNT activation source, the lower accomplishment ratio of PNT normalized activation PNT activators can accomplish, and the more is left for PNT rectifiers to accomplish. And at the same time, as during the course of practical usage of PNT engine, functional aging metamorphosis of various functional components of PNT engine may unavoidably arise, especially the functional aging metamorphosis of PNT activation source, as a result, the working task of PNT rectifiers will be theoretically heavier and heavier day by day. However, at any rate, the work task left for PNT rectifiers can never transcend the maximum working capacity of PNT rectifiers; otherwise, the PNT engine self-stimulation will become self-destruction.

2.4. Quantitative change formula of oval wheel fashion PNT activation & rectification

2.4. 1. The objective technology issues of quantitative change formula of oval wheel fashion PNT activation & rectification.

As typical volitional PNT soft drive and control device, PNT engine depends on the PNT activators sending physic PNT activation signal to PNT activation source as to bring about PNT stimulation soft drive reaction, and at the same time, for the necessity of PNT continuous controllability, PNT engine depends on PNT rectifiers sending physic PNT rectification signal to PNT activation source as to coordinate the integrate stimulation situation of PNT activation source due to continuous controllability necessity and soft drive efficiency of PNT engine. Among integrate PNT soft drive functions, PNT activation and PNT rectification are generally as the right hand and left hand of PNT engine.

In a summary word, in order to ensure the efficiency and continuous controllability of PNT stimulation soft drive throughout PNT activation & rectification process, there generally two objective technology issues for us to pursuit.

The first: Try to find the best PNT activation source and PNT activation signal for the best prime mover PNT stimulation reaction with most substantial potential kinetic energy to exploit and most suitable for continuous controllability of PNT stimulation soft drive.

The second: In order to accomplish the optimum actualization of ideal function, efficiency, safety and reliability of PNT stimulation soft drive, introduce the best manner to control the prime mover PNT stimulation reaction between PNT activation source and PNT activation signal.

As the PNT activation and PNT activation signal have not ultimately been confirmed, we here refer to PNT engine design in prior is but to primarily demonstrate the feasible artificial control ways according to

the continuous controllability necessity of prime mover PNT stimulation reaction between PNT activation source and PNT activation signal.

We design the PNT activation source (tyre core) and PNT activators, PNT rectifiers into the geometric profiles and integrate coordinative assembly as the above diagrams showed is creative practice considering of the necessity of efficiency and feasibility of physic interaction manner between PNT activators, PNT rectifiers and tyre core and considering of the necessity of PNT continuous controllability & safety of PNT stimulation soft drive. In an even detail word, we design the PNT engine in such tyre geometric model is in order to offer ideal geometric profiles & coordinative assembly for feasibility and efficiency of PNT stimulation soft drive and PNT continuous controllability of PNT engine, and indeed, such oval wheel geometric profiles and coordinative assembly of tyre core, PNT activators & PNT rectifiers not only have brought about convenient & compact space distribution for the PNT stimulation reaction between PNT activators, PNT rectifiers and tyre core and have brought about expedience for PNT activators and PNT rectifiers working coordinately, but also have conveniently brought about necessary tyre core shape confining force and the possibility of symmetric concentration of PNT normalized soft drive force in tyre core center plane; and the oval wheel geometric profiles and coordinative assembly of tyre core, PNT activators and PNT rectifiers have offered possibilities of rotation of the function of orientation adjusting based on rotary oval wheel fashion PNT symmetric activation & rectification and have offered possibility of equivalent stimulation driving effect in any direction in tyre core center plane on the stand of tyre core center point.

However, the geometric profiles and the coordinative assembly of tyre core and PNT activators & PNT rectifiers are still far insufficient to sufficient conditions for high efficiency and continuous controllability of PNT stimulation soft drive of PNT engine but preparative covariant conditions able to play a favorable part in efficiency and continuous controllability of PNT stimulation soft drive. The most important issue for PNT engine is that throughout the practical PNT stimulation soft drive, in accordance with objective materialization necessity of ideal function, efficiency, safety and reliability of PNT engine, we must strictly consider how to arrange optimum mathematical logic correlation of appropriate PNT activation & rectification input and consequential continuous controllable PNT stimulation effect of PNT activation source according to operational characters of idiographic PNT reaction between definite PNT activation source and PNT activation signal.

Because, in accordance with the fundamental of definite physic precondition predestines consequential unique existence & motion of matter in spacetime, any definite existent precondition can only bring about unique definite physical occurrence of existence & motion of matter. In another word, in cosmos, unique definite existent precondition of certain object can never imply two or two more possibilities of idiographic existence & motion of the very matter. In terms of the PNT stimulation soft drive of PNT engine, under the precondition that the geometric profiles and coordinative assembly have been definite, the intrinsic mathematical logic correlations between PNT activation & rectification input and the consequential PNT stimulation occurrence of PNT activation source can never be exception of the fundamental of unique definite physic precondition predestines consequential unique definite existence & motion of matter in spacetime. The key issue is only that, according to our volitional pursuit, it is necessary that the PNT activation & rectification input not only must bring about remarkable PNT stimulation acceleration effect of PNT activation source, but also must ensure the whole PNT stimulation soft drive process continuously controllable all the way. For

this, we must investigate and aim at the necessity of optimum physic quantitative model & specification and the intrinsic mathematical logic correlation between original input of PNT activation & rectification and the consequential stimulation output of PNT activation source, which is virtually just the optimum quantitative change correlation of PNT soft drive reaction operation between PNT activation signal and PNT activation source due to best PNT soft drive efficiency and PNT continuous controllability.

In accordance with the fundamental of best materialization of function, efficiency, safety and reliability of PNT stimulation soft drive, if we edit the optimum mathematical logic correlation between original input of PNT activation & rectification and the consequential PNT stimulation output of PNT activation source into controllable operation programs, and try to use these illegible and qualified quantitative change programs of PNT activation & rectification to control the practical operation of PNT soft drive reaction, we can ensure the PNT engine can work according to our volitional demands all the way thereby. We denote the programmed optimum mathematical logic correlation between original input of physic PNT activation & rectification and the consequential stimulation output of PNT activation source “quantitative change program of controllable PNT activation & rectification”.

In terms of tyre model of PNT engine, as the quantitative change programs of controllable PNT activation & rectification are directly related to the geometric profiles and three-dimensional oval wheel fashion coordinative assembly of PNT activators, PNT rectifiers and tyre core, so the quantitative change programs of controllable PNT activation & rectification are called “quantitative change programs of oval wheel fashion controllable PNT activation & rectification” too. And at the same time, according to the symmetric character and asymmetric character of oval wheel quantity model and oval wheel fashion quantitative change distribution of the PNT soft drive reaction of PNT engine in tyre model, quantitative change programs of oval wheel fashion PNT activation & rectification can still be classified into “quantitative change programs of oval wheel fashion PNT symmetric activation & rectification” and “quantitative change programs of oval wheel fashion PNT asymmetric activation & rectification”.

2.4.2. Integrative quantitative change of oval wheel fashion PNT activation & rectification signal portrayal

For convenience to expound the quantitative change formula of oval wheel fashion PNT activation & rectification, it's necessary for us to know something about the physic quantity model and quantitative change feature of oval wheel fashion PNT activation & rectification in advance. For convenience to expound the physic quantity model and quantitative change feature of oval wheel fashion PNT activation & rectification further, we introduce “linear quantitative change formula of oval wheel fashion PNT activation & rectification signal pixels along frame”, “linear quantitative change formula of oval wheel fashion PNT activation & rectification signal pixels along breadth” and “integrate quantitative change formula of oval wheel fashion PNT activation & rectification signal portrayal”. Thus, it's necessary for us to quantize the oval wheel fashion PNT activation & rectification signal into continuous elementary PNT activation signal pixels or PNT rectification signal pixels and introduce the “frame” and “breadth” notion in television raster display technology.

We assume, on the ellipse curve intersected by back semi-oval-wheel inner surface and a plane through the tyre core center point & vertical to the tyre core center plane, there are two groups of continuous elementary PNT activation signal pixels of $A_1, A_2, A_3, \dots, A_{n-1}, A_n$ evenly distributed along the back PNT activator semi-ellipse curve and symmetrically against tyre core center plane; and there are two groups of continuous elementary PNT

rectifier signal pixels of $S_1, S_2, S_3, \dots, S_{n-1}, S_n$ evenly distributed along the semi-ellipse curve of back PNT rectifier and symmetrically against tyre core center plane, which can be illustrated as below:

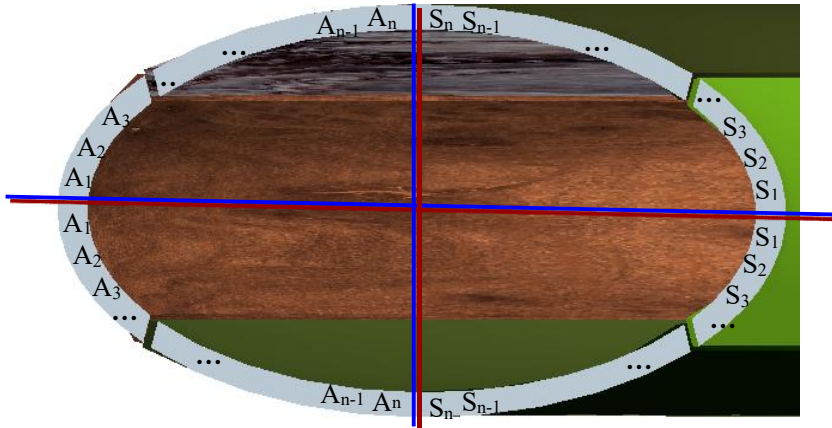

(VI-i-2~32) Frame distribution of elementary PNT activation &

rectification signal pixels along mid section ellipse curve of back semi-oval-wheel

(In the diagram above, the level line indicates the tyre core center plane; the vertical line indicates the common border of back PNT activator and back PNT rectifier which is vertical to the tyre core center plane.)

We call the distribution of elementary PNT activation & rectification signal pixels along such section ellipse curve “frame distribution of PNT activation & rectification signal pixels on oval wheel”.

And at the same time, we assume, on the inner surface of back semi-oval-wheel, along any 1/4 circle curve starting from the back semi-oval-wheel mid section to the both terminals of back semi-oval-wheel and parallel to the tyre core center plane, there are m continuous elementary PNT activation signal pixels or elementary PNT rectification signal pixels continuously & evenly distributed. We call the distribution of PNT activation or rectification signal pixels along such 1/4 circle curve parallel to tyre core center plane “breadth distribution of PNT activation or rectification signal pixels on oval wheel”. Then, the integrate frame & breadth distribution of PNT activation &/or rectification signal pixels on back semi-oval-wheel can be expressed as following:

- ① Frame and breadth distribution of PNT activation &/or rectification signal pixels on the right half of back semi-oval-wheel.

$A_{n-1}, A_{n-2}, A_{n-3}, \dots, A_{n-m-1}, A_{n-m}$	$S_{n-1}, S_{n-2}, S_{n-3}, \dots, S_{n-m-1}, S_{n-m}$
$A_{n-1-1}, A_{n-1-2}, A_{n-1-3}, \dots, A_{n-1-m-1}, A_{n-1-m}$	$S_{n-1-1}, S_{n-1-2}, S_{n-1-3}, \dots, S_{n-1-m-1}, S_{n-1-m}$
.....
$A_{3-1}, A_{3-2}, A_{3-3}, \dots, A_{3-m-1}, A_{3-m}$	$S_{3-1}, S_{3-2}, S_{3-3}, \dots, S_{3-m-1}, S_{3-m}$
$A_{2-1}, A_{2-2}, A_{2-3}, \dots, A_{2-m-1}, A_{2-m}$	$S_{2-1}, S_{2-2}, S_{2-3}, \dots, S_{2-m-1}, S_{2-m}$
$A_{1-1}, A_{1-2}, A_{1-3}, \dots, A_{1-m-1}, A_{1-m}$	$S_{1-1}, S_{1-2}, S_{1-3}, \dots, S_{1-m-1}, S_{1-m}$
$A_{1-1}, A_{1-2}, A_{1-3}, \dots, A_{1-m-1}, A_{1-m}$	$S_{1-1}, S_{1-2}, S_{1-3}, \dots, S_{1-m-1}, S_{1-m}$
$A_{2-1}, A_{2-2}, A_{2-3}, \dots, A_{2-m-1}, A_{2-m}$	$S_{2-1}, S_{2-2}, S_{2-3}, \dots, S_{2-m-1}, S_{2-m}$
$A_{3-1}, A_{3-2}, A_{3-3}, \dots, A_{3-m-1}, A_{3-m}$	$S_{3-1}, S_{3-2}, S_{3-3}, \dots, S_{3-m-1}, S_{3-m}$
.....
$A_{n-1-1}, A_{n-1-2}, A_{n-1-3}, \dots, A_{n-1-m-1}, A_{n-1-m}$	$S_{n-1-1}, S_{n-1-2}, S_{n-1-3}, \dots, S_{n-1-m-1}, S_{n-1-m}$
$A_{n-1}, A_{n-2}, A_{n-3}, \dots, A_{n-m-1}, A_{n-m}$	$S_{n-1}, S_{n-2}, S_{n-3}, \dots, S_{n-m-1}, S_{n-m}$

② Frame and breadth distribution of PNT activation &/or rectification signal pixels on the left half of back semi-oval-wheel.

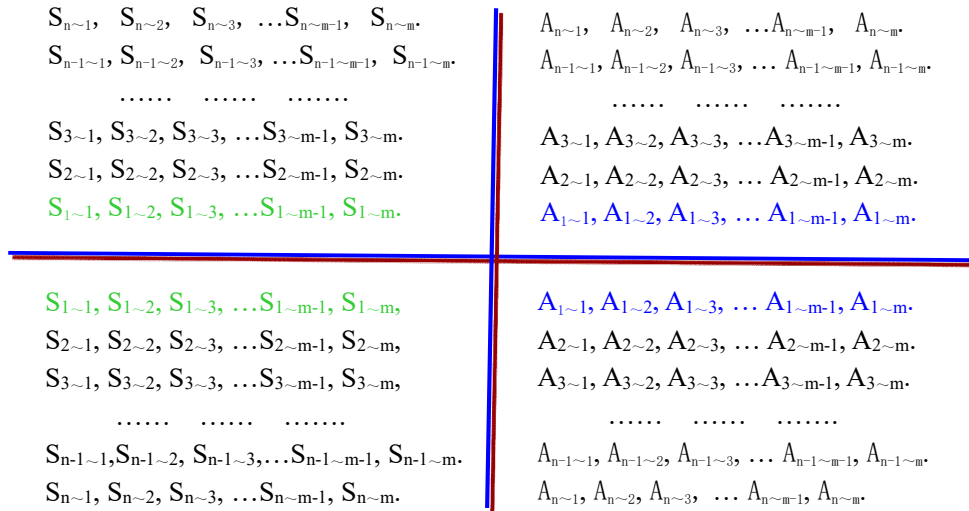

(VI-i-2~33) Distribution of PNT activation &/or rectification signal pixels on back semi-oval-wheel.

(The level line indicates the tyre core center plane; the vertical line indicates the common border of back PNT activator and back PNT rectifier which is vertical to tyre core center plane. The distribution of PNT activation &/or rectification signal pixels on back semi-oval-wheel is coherent with the frame distribution of PNT activation & rectification signal pixels along the section ellipse curve on inner surface of back semi-oval-wheel. And the two groups of signal pixels in the same colors of blue or green are the common signal pixels in tyre core center plane.)

On picture of back semi-oval-wheel, the breadth distribution of PNT activation or rectification signal pixels are as below:

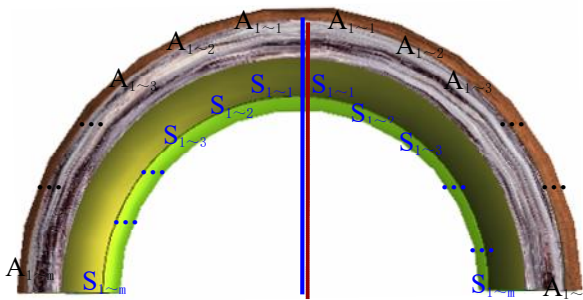

(VI-i-2~34) Upper limb view of breadth distribution of PNT activation or rectification signal pixels on back semi-oval-wheel

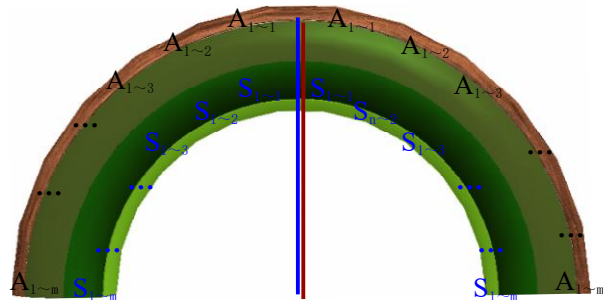

(VI-i-2~35) Lower limb view of breadth distribution of PNT activation or rectification signal pixels on back semi-oval-wheel

As limitation of blank, the symmetric two groups of elementary signal pixels exemplified in above illustrations are just the two groups of one along the upper edge semi-circle curve and the other along the lower edge semi-circle curve as showed in above views. The vertical line indicates the mid-section of back semi-oval-wheel.)

For the same necessity, we assume, on the ellipse curve intersected by the front semi-oval-wheel inner surface and a plane through the tyre core center point & vertical to the tyre core center plane, there are two groups of continuous elementary PNT activation signal pixels of $a_1, a_2, a_3, \dots, a_{n-1}, a_n$ evenly distributed along the front PNT activator semi-ellipse curve and symmetrically against tyre core center plane; and there are two

As coherent natura naturans throughout cosmic evolution, instinctive PNT reciprocal equilibrium towards optimum PNT operation is radical potentiality & conditionality for cosmos always ready to orientate itself towards perfection.

groups of continuous elementary PNT rectifier signal pixels of $S_1, s_1, s_2, s_3, \dots, s_{n-1}, s_n$ evenly distributed along the semi-ellipse curve of front PNT rectifier and symmetrically against tyre core center plane, which can be illustrated as below:

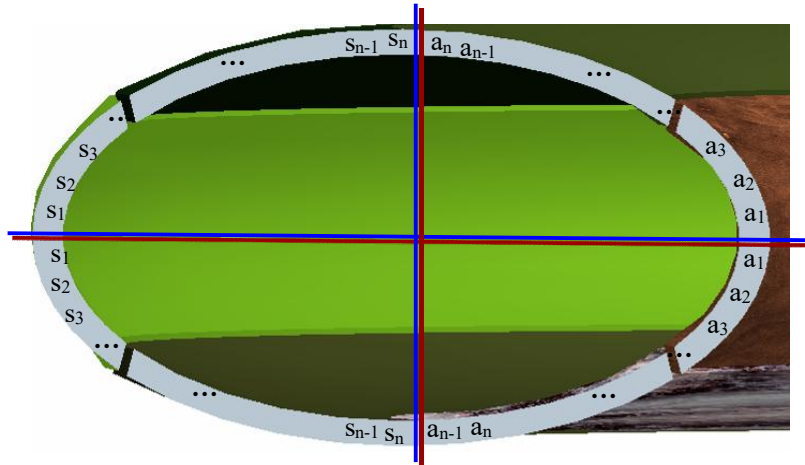

(VI-i-2~36) Frame distribution of elementary PNT activation & rectification signal pixels along mid section ellipse curve of front semi-oval-wheel

(In the diagram above, the level line indicates the tyre core center plane; the vertical line indicates the common border of front PNT activator and front PNT rectifier which is vertical to tyre core center plane.)

And at the same time, we assume, on the inner surface of front semi-oval-wheel, along any 1/4 circle curve starting from the front semi-oval-wheel mid section to the both terminals of front semi-oval-wheel and parallel to the tyre core center plane, there are m continuous elementary PNT activation signal pixels or elementary PNT rectification signal pixels continuously & evenly distributed. We call the distribution of PNT activation or rectification signal pixels along such 1/4 circle curve parallel to tyre core center plane “breadth distribution of PNT activation or rectification signal pixels on oval wheel”. Then, the integrate frame & breadth distribution of PNT activation &/or rectification signal pixels on front semi-oval-wheel can be expressed as following:

① Frame and breadth distribution of PNT activation &/or rectification signal pixels on the right half of front semi-oval-wheel.

$S_{n-1}, S_{n-2}, S_{n-3}, \dots, S_{n-m-1}, S_{n-m}$	$a_{n-1}, a_{n-2}, a_{n-3}, \dots, a_{n-m-1}, a_{n-m}$
$S_{n-1-1}, S_{n-1-2}, S_{n-1-3}, \dots, S_{n-1-m-1}, S_{n-1-m}$	$a_{n-1-1}, a_{n-1-2}, a_{n-1-3}, \dots, a_{n-1-m-1}, a_{n-1-m}$
.....
$S_{3-1}, S_{3-2}, S_{3-3}, \dots, S_{3-m-1}, S_{3-m}$	$a_{3-1}, a_{3-2}, a_{3-3}, \dots, a_{3-m-1}, a_{3-m}$
$S_{2-1}, S_{2-2}, S_{2-3}, \dots, S_{2-m-1}, S_{2-m}$	$a_{2-1}, a_{2-2}, a_{2-3}, \dots, a_{2-m-1}, a_{2-m}$
$S_{1-1}, S_{1-2}, S_{1-3}, \dots, S_{1-m-1}, S_{1-m}$	$a_{1-1}, a_{1-2}, a_{1-3}, \dots, a_{1-m-1}, a_{1-m}$
$S_{1-1}, S_{1-2}, S_{1-3}, \dots, S_{1-m-1}, S_{1-m}$	$a_{1-1}, a_{1-2}, a_{1-3}, \dots, a_{1-m-1}, a_{1-m}$
$S_{2-1}, S_{2-2}, S_{2-3}, \dots, S_{2-m-1}, S_{2-m}$	$a_{2-1}, a_{2-2}, a_{2-3}, \dots, a_{2-m-1}, a_{2-m}$
$S_{3-1}, S_{3-2}, S_{3-3}, \dots, S_{3-m-1}, S_{3-m}$	$a_{3-1}, a_{3-2}, a_{3-3}, \dots, a_{3-m-1}, a_{3-m}$
.....
$S_{n-1-1}, S_{n-1-2}, S_{n-1-3}, \dots, S_{n-1-m-1}, S_{n-1-m}$	$a_{n-1-1}, a_{n-1-2}, a_{n-1-3}, \dots, a_{n-1-m-1}, a_{n-1-m}$
$S_{n-1}, S_{n-2}, S_{n-3}, \dots, S_{n-m-1}, S_{n-m}$	$a_{n-1}, a_{n-2}, a_{n-3}, \dots, a_{n-m-1}, a_{n-m}$

② Frame and breadth distribution of PNT activation &/or rectification signal pixels on the left half of front semi-oval-wheel.

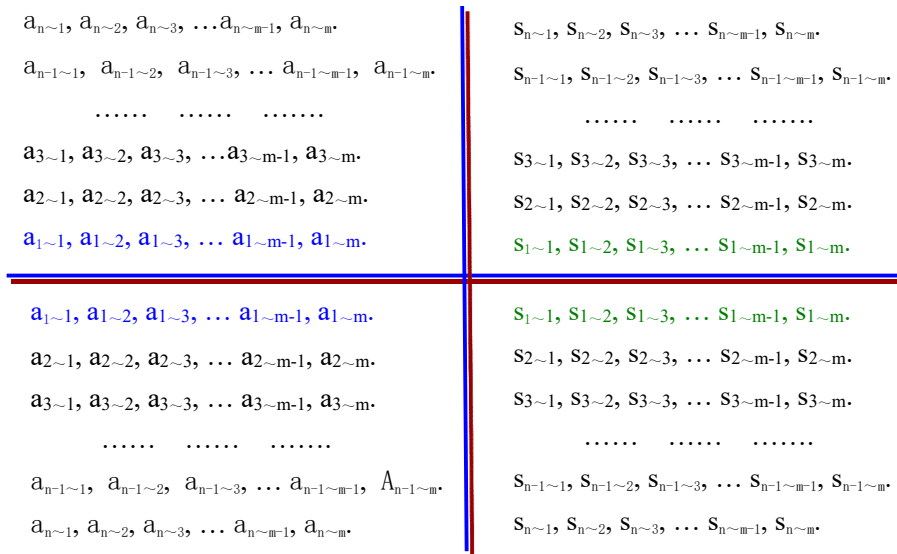

(VI-i-2~37) Distribution of PNT activation &/or rectification signal pixels on front semi-oval-wheel.

(The level line indicates the tyre core center plane; the vertical line indicates the common border of front PNT activator and front PNT rectifier which is vertical to tyre core center plane. The distribution of PNT activation &/or rectification signal pixels on front semi-oval-wheel is coherent with the frame distribution of PNT activation & rectification signal pixels along the section ellipse line on inner surface of front semi-oval-wheel. And the two groups of signal pixels in the same colors of blue or green are the common signal pixels in tyre core center plane.)

On picture of front semi-oval-wheel, the breadth distribution of PNT activation or rectification signal pixels are as below:

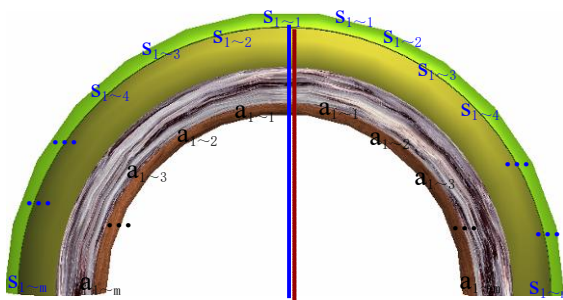

(VI-i-2~38) Upper limb view of breadth distribution of PNT activation or rectification signal pixels on front semi-oval-wheel

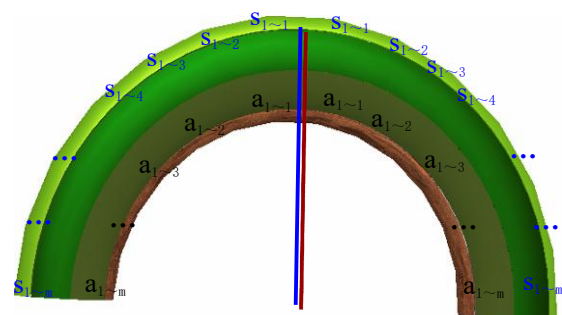

(VI-i-2~39) Lower limb view of breadth distribution of PNT activation or rectification signal pixels on front semi-oval-wheel

As limitation of blank, the symmetric two groups of elementary signal pixels exemplified in above illustrations are just the two groups of one along the upper edge semi-circle curve and the other along the lower edge semi-circle curve as showed in above views. The vertical line indicates the mid-section of front semi-oval-wheel.)

Generally, PNT engine materializes its soft drive functions with the entire PNT activation & rectification signal pixels on the whole oval wheel coordinately working according to the necessity of PNT continuous

As coherent natura naturans throughout cosmic evolution, instinctive PNT reciprocal equilibrium towards optimum PNT operation is radical potentiality & conditionality for cosmos always ready to orientate itself towards perfection.

controllability. We call any single elementary physic signal unit from point signal origin on the oval wheel inner surface a characteristic physic signal pixel, and each of the point signal origin on the oval wheel inner surface synchronously releases an elementary physic signal unit compose a oval wheel fashion PNT activation & rectification signal portrayal.

During the course of PNT soft drive, PNT engine must quote relatively continuous appropriate oval wheel fashion PNT activation & rectification signal portrayal series to perform durative PNT activation to tyre core according to necessity of PNT continuous controllability. The existence & motion variation of PNT engine from rest to moving in low speed, from low speed to high speed are all materialized by durative quantitative change of oval wheel fashion PNT activation & rectification signal portrayal. If we introduce mathematical language to formulate the durative quantitative change of oval wheel fashion PNT activation & rectification signal portrayal, then, such mathematical language is just the signal portrayal formula of oval wheel fashion PNT activation & rectification.

Quantitative change of oval wheel fashion PNT activation & rectification signal portrayal is radically caused by the quantitative change of signal pixels linearly distributed along frame and breadth, if we introduce “linear quantitative change formula of oval wheel fashion PNT activation & rectification signal pixels along frame” to formulate the durative linear variation of oval wheel fashion PNT activation & rectification signal pixels along frame and introduce “linear quantitative change formula of oval wheel fashion PNT activation & rectification signal pixels along breadth” to formulate the durative linear variation of oval wheel fashion PNT activation & rectification signal pixels along breadth, it’s of course explicit for us to conclude that the linear quantitative change formula of oval wheel fashion PNT activation & rectification signal pixels along frame must be a formula related to mathematical expression of the proper ellipse curve the proper linearly distributed signal pixels locate at, the linear quantitative change formula of oval wheel fashion PNT activation & rectification signal pixels along breadth must be a formula related to the mathematical expression of the proper 1/4 circle curve the proper linearly distributed signal pixels locate at, and the integrative quantitative change formula of oval wheel fashion PNT activation & rectification signal portrayal must be compound formula integrated of linear quantitative change formula of oval wheel fashion PNT activation & rectification signal pixels along frame and linear quantitative change formula of oval wheel fashion PNT activation & rectification signal pixels along breadth.

Apparently, the “integrative quantitative change formula of oval wheel fashion PNT activation & rectification signal portrayal” is named according to the profile of physic quantity profile and quantitative change feature of oval wheel fashion PNT activation & rectification. In fact; the “integrative quantitative change formula of oval wheel fashion PNT activation & rectification signal portrayal” is just the “formula of oval wheel fashion PNT activation & rectification”. Comparably, the expression of “integrative quantitative change formula of oval wheel fashion PNT activation & rectification signal portrayal” but have advantage to highlight more of the physic quantity profile quantitative change feature of oval wheel fashion PNT activation & rectification.

2. 4. 3. Optimum quantitative change formula of oval wheel fashion PNT activation & rectification, and safe quantitative change range of PNT activation & rectification.

If the implementation of quantitative change of oval wheel fashion PNT activation & rectification signal

portrayal is strictly in accordance with optimum materialization necessity of function, efficiency, safety, reliability of PNT soft drive, so that during the course of PNT soft drive, the tyre core inner stretching force satisfies “ $|f_\alpha - f_\beta| \cdot \cos\phi = 0$ ” (α, β denote any two adjacent atoms in tyre core) all the way, we then say such PNT soft drive is just the so-called optimum PNT activation & rectification. If we introduce a mathematical formula to formulate such optimum PNT soft drive course, then, the corresponding formula is just the so-called “optimum quantitative change formula of PNT activation & rectification”; if such PNT activation & rectification is implemented in oval wheel profile of so-called tyre core model, the formula is the so-called “optimum quantitative change formula of oval wheel fashion PNT activation & rectification” thereby.

If we denote the normalized output stimulation momentum of tyre core as “ P_n ” (The subscript “n” behind P is the abbreviation of “normalized”), denote working wattage output of PNT activator as “ W ”, denote the working wattage output of PNT rectification as “ w ” (Both the capital “ W ” and lowercase “ w ” are the abbreviation of “wattage”), and introduce subscript “b” of abbreviation of “back” and subscript “f” of abbreviation of “front” to make a distinction between “back part” and “front part”, thus, the quantitative change formula of oval wheel fashion PNT normalized activation & rectification can be primarily expressed as below:

$$P_n = \tilde{E}_{b+f} [(W_b + w_b), (W_f + w_f)]$$

Among the formula, the “ $\tilde{E}_{b+f}[\dots]$ ” denotes the indefinite formula with independent variable of “ $(W_b + w_b), (W_f + w_f)$ ”, “ W_b ” denotes the working output wattage of back PNT activator, “ w_b ” denotes the working output wattage of back PNT rectifier, “ W_f ” denotes the working output wattage of front PNT activator, “ w_f ” denotes the working output wattage of front PNT rectifier.

If the distribution of working output wattage of PNT activators & PNT rectifiers are exactly symmetric against tyre core center plane & the mid section of both back semi-oval-wheel & front semi-oval-wheel, then, the “quantitative change formula of oval wheel fashion PNT activation & rectification” turns into “quantitative change formula of oval wheel fashion PNT symmetric activation & rectification”. If we introduce “ $\underline{W_b + w_b}$ ” and “ $\underline{W_f + w_f}$ ” to separately denote symmetric working output wattage of back semi-oval-wheel and symmetric working output wattage of front semi-oval-wheel, then, the mathematical quantitative correlation between oval wheel symmetric working output wattage and consequential tyre core stimulation output of PNT engine can be primarily expressed as below:

$$P_n = \tilde{E}_{b+f} [\underline{(W_b + w_b)}, \underline{(W_f + w_f)}]$$

As the oval wheel fashion PNT symmetric activation & rectification has obvious advantage of PNT normalized driving efficiency as showed in diagram (VI-i-2~31), once we manage to implement soft drive of PNT engine in tyre model, we of course have more reasons to take consideration of oval wheel fashion PNT symmetric activation & rectification first and foremost.

P_n denotes the normalized momentum output of tyre core as single behavioral object under PNT activation & rectification, and the precondition that tyre core can receive stimulation of PNT activation & rectification and hypostatize expected motion variation as single behavioral object is “ $|f_\alpha - f_\beta| \cdot \cos\phi \leq f_{\alpha-\beta} + (f_\alpha + f_\beta) \cdot \sin\phi$ ”, (α, β denote any two adjacent atoms in tyre core). While the condition of optimum PNT activation & rectification of PNT soft drive is “ $|f_\alpha - f_\beta| \cdot \cos\phi = 0$ ”, (α, β denote any adjacent two atoms in tyre core). In accordance with the fundamental of definite unique existent precondition determine unique possibility of existence & motion of

As coherent natura naturans throughout cosmic evolution, instinctive PNT reciprocal equilibrium towards optimum PNT operation is radical potentiality & conditionality for cosmos always ready to orientate itself towards perfection.

matter, the mathematical correlation between PNT activation & rectification input and tyre core stimulation output of optimum quantitative change of oval wheel fashion PNT symmetric activation & rectification must be single conditional quantity to unique consequential quantity, the corresponding formula curve can be generally illustrated as below:

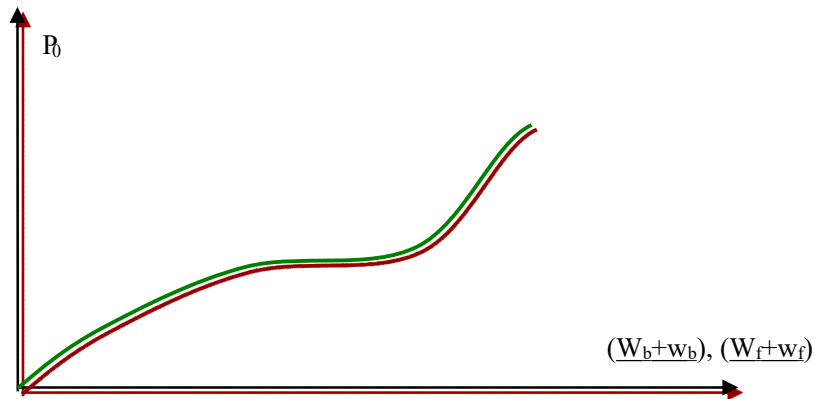

(VI-i-2~40) Formula curve of optimum quantitative change of oval wheel fashion PNT symmetric activation & rectification.

Apparently, formula curve of optimum quantitative change of oval wheel fashion PNT symmetric activation & rectification is a limitary curve with both minimum allowable independent variable and maximum allowable independent variable of PNT activation & rectification input and proportionate minimum consequential variable and maximum consequential variable of tyre core stimulation momentum output. At any rate, time dynamic speed is a limitary speed after all, what's more, the possible range of P_n still has strict condition limitation of “ $| f_\alpha - f_\beta | * \cos\phi = 0$ ”, (α, β denote any two adjacent atoms in tyre core).

Theoretically, the quantitative change of optimum PNT symmetric activation & rectification is the best operation model and operation state of PNT engine, but in practice, it's almost impossible for us to ensure such ideal operation model of 100% quantitative change of optimum PNT symmetric activation & rectification, what's more, during the course of the usage of PNT engine, not only the tyre core but also the PNT activators & PNT rectifiers will unavoidably and occur gradual metamorphosis for aging. Even since our operation control programs are exactly programmed according to optimum quantitative change formula of PNT activation & rectification and we strictly adopt the optimum quantitative change formula program of PNT activation & rectification to implement our PNT stimulation & control of the working operation of PNT engine, the practical operation effect is still difficult to be materialized exactly in accordance with 100% optimum quantitative change formula of PNT activation & rectification described. And virtually, the reference standard of PNT continuous controllability of PNT engine is “ $| f_\alpha - f_\beta | * \cos\phi \leq f_{\alpha-\beta} + (f_\alpha + f_\beta) * \sin\phi$ ”, α, β denote any two adjacent atoms in tyre core. This of course implies, under conditions of PNT activation & rectification, the magnitude of inner stretching force of tyre core has a safe permission range ($| f_\alpha - f_\beta | * \cos\phi, f_{\alpha-\beta} + (f_\alpha + f_\beta) * \sin\phi$), and the normalized stimulation momentum output of tyre core still has a proportionate possible safe range, the minimum magnitude of the consequential safe range of normalized momentum output of tyre core is just the corresponding output momentum when “the inner stretching force of tyre core = $| f_\alpha - f_\beta | * \cos\phi$ ”; and the maximum magnitude of the consequential possible safe range of normalized momentum output of tyre core is just the corresponding output momentum when “the inner stretching force of tyre core =

$f_{\alpha-\beta} + (f_{\alpha} + f_{\beta}) \cdot \sin\phi$ ". We call the safe quantitative change range of PNT activation & rectification of PNT engine "safe quantitative change range of PNT activation & rectification" ; and call the borderline of safe quantitative change range of PNT activation & rectification "quantitative change deadline of PNT activation & rectification", for once the quantitative change of PNT activation & rectification touch the "quantitative change deadline of PNT activation & rectification" of PNT engine, it implies the PNT engine has signed itself up in Hades.

In terms of oval wheel fashion PNT symmetric activation & rectification of PNT soft drive, the safe quantitative change range of PNT activation & rectification input is the safe quantitative change range of PNT symmetric activation & rectification of course; and the borderline of quantitative change range of oval wheel fashion PNT symmetric activation & rectification is of course the "quantitative change deadline of oval wheel fashion PNT symmetric activation & rectification". The formula curve of optimum quantitative change of oval wheel fashion PNT symmetric activation & rectification, safe quantitative change of oval wheel fashion PNT symmetric activation & rectification, quantitative change deadline of oval wheel fashion PNT symmetric activation & rectification can be integrated in an illustration as below:

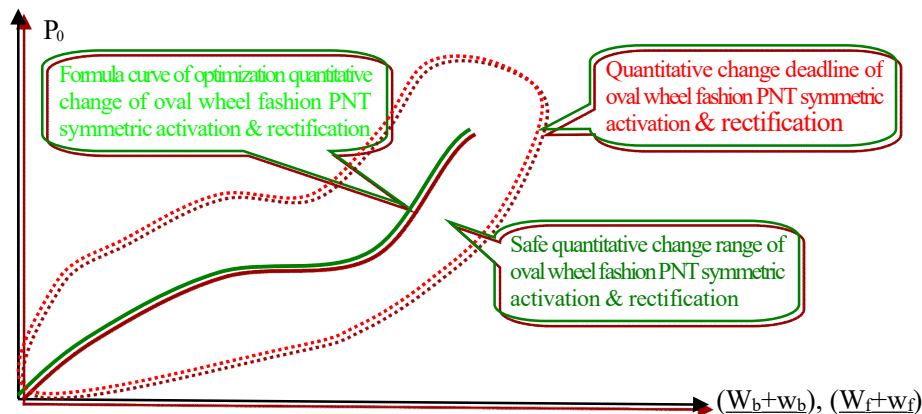

(VI-i-2~41) Safe quantitative change range of oval wheel fashion PNT symmetric activation & rectification with foils of formula curve of optimum quantitative change of oval wheel fashion PNT symmetric activation & rectification and quantitative change deadline of oval wheel fashion PNT symmetric activation & rectification

Apparently, the wider the safe quantitative change range of PNT activation & rectification is, the unrestrictive potential of safe control is more substantial, and the safe permission maximum P_n is relatively bigger, the maximum safe velocity of PNT engine is of course relatively bigger thereby. However, in our practical soft drive of PNT activation & rectification, in order to ensure the safety of PNT engine, no matter how substantial the unrestrictive potential of PNT engine is, we should practically try our best to make our artificial control of operational quantitative change of PNT engine to close to the optimum quantitative change pattern of PNT activation & rectification as possible as we can, the closer we make our volitional quantitative change control of PNT activation & rectification to optimum quantitative change formula of PNT activation & rectification, the quality of PNT normalized activation & rectification is higher.

2. 4 .4. Quantitative change formula of controllable PNT asymmetric activation & rectification

The oval wheel fashion PNT activation & rectification of tyre model of PNT engine mainly means the

As coherent natura naturans throughout cosmic evolution, instinctive PNT reciprocal equilibrium towards optimum PNT operation is radical potentiality & conditionality for cosmos always ready to orientate itself towards perfection.

working wattage distribution of PNT activation & rectification is symmetric against tyre core center plane, and the so-called “PNT asymmetric activation & rectification” just means the working wattage distribution of PNT activation & rectification is asymmetric against tyre core center plane.

Similar as the optimum quantitative change of oval wheel fashion PNT symmetric activation & rectification, the optimum quantitative change of oval wheel fashion PNT asymmetric activation & rectification means, under the precondition that the working wattage distribution of PNT activation & rectification is asymmetric against tyre core center plane, the tyre core inner stretching force still satisfies “ $|f_\alpha - f_\beta| \cdot \cos\phi = 0$ ”, α, β denote any two adjacent atoms in tyre core. And the safe quantitative change range of oval wheel fashion PNT asymmetric activation & rectification means, under the precondition that the working wattage distribution of PNT activation & rectification is asymmetric against tyre core center plane, the tyre core inner stretching force still satisfies “ $|f_\alpha - f_\beta| \cdot \cos\phi \leq f_{\alpha-\beta} + (f_\alpha + f_\beta) \cdot \sin\phi$ ”, α, β denote any two adjacent atoms in tyre core.

There are generally 4 elementary asymmetric patterns of controllable oval wheel fashion PNT activation & rectification and 3 kind of asymmetric back & front tie-in patterns of controllable oval wheel fashion PNT activation & rectification as following:

A) Back upper dominance pattern of oval wheel fashion PNT asymmetric activation & rectification, —It means the working wattage distribution of back PNT activator keeps feature that the working wattage output in the region above tyre core center plane is bigger than the working wattage output in the region blow tyre core center plane. And at the same time, as the back rectifier must work coordinately with back PNT activator, the asymmetric working output of back PNT activator of course need the back PNT rectifier to give proportional covariant response. As the idiographic oval wheel geometric profiles and the functional matching assembly feature of PNT activators and PNT rectifiers, it’s easy for us to understand that there is more orientation expedience for rectifier to give covariant response to PNT activator on opposite limb, it means if there is working variation on the upper limb of PNT activator, it’s more convenient for the lower limb of PNT rectification to give proportional covariant response due to PNT continuous controllability necessity; if there is working variation on the lower limb of back PNT activator, it’s more convenient for the upper limb of back PNT rectifier to give proportional covariant response due to necessity of PNT continuous controllability. The covariant situation between front PNT activator and front PNT rectifier is just the same.

If we denote the working situation the working wattage output of upper region above tyre core center plane of back PNT activator is bigger than the working wattage output of lower region of back PNT activator blow tyre core center plane as “ $W_b \downarrow$ ”, (The downward arrow “ \downarrow ” denotes the upper dominance of working output wattage), and we denote the working situation the working wattage of lower region blow tyre core center plane of back PNT rectifier is bigger than the working wattage of lower region of back PNT rectifier blow tyre core center plane as “ $w_b \uparrow$ ”, (The upward arrow “ \uparrow ” denotes lower dominance of working output wattage), then the quantitative change formula of back upper dominance PNT asymmetric PNT activation & rectification can be expressed as P_n equation as below:

$$P_n = \tilde{E}_{b\downarrow}(W_b \downarrow + w_b \uparrow)$$

In the formula above, “ P_n ” denotes the normalized momentum output of tyre core under stimulation precondition of upper dominant PNT asymmetric activation & rectification of back PNT activator, “ $\tilde{E}_{b\downarrow}(\dots)$ ”

denotes the indefinite quantitative change formula of back upper dominance pattern of oval wheel fashion PNT asymmetric activation & rectification with independent variable of “ $W_b\downarrow+w_b\uparrow$ ”.

B) Back lower dominance pattern of oval wheel fashion PNT asymmetric activation & rectification. It means the working wattage distribution of back PNT activator keeps feature that the working wattage output in the region blow tyre core center plane is bigger than the working wattage output in the region above tyre core center plane. As the covariant response, the working wattage output of back PNT rectifier should generally keep feature that the working wattage output in the region above tyre core center plane is bigger than the working wattage output in the region blow tyre core center plane. Refer to the formula of back upper dominance pattern of oval wheel fashion PNT asymmetric activation & rectification, the indefinite quantitative change formula of back lower dominance pattern of oval wheel fashion PNT asymmetric activation & rectification can primarily expressed as below:

$$P_n = \tilde{E}_{b\uparrow}(W_b\uparrow+w_b\downarrow)$$

In the formula above, “ $\tilde{E}_{b\uparrow}(\dots)$ ” denotes the indefinite quantitative change formula of back lower dominance pattern of oval wheel fashion PNT asymmetric activation & rectification with independent variable of “ $W_b\uparrow+w_b\downarrow$ ”.

C) Front upper dominance pattern of oval wheel fashion PNT asymmetric activation & rectification. It means the working wattage distribution of front PNT activator keeps feature that the working wattage output in the region above tyre core center plane is bigger than the working wattage output in the region blow tyre core center plane. As the covariant response, the working wattage output of front PNT rectifier should generally keep feature that the working wattage output in the region blow tyre core center plane is bigger than the working wattage output in the region above tyre core center plane. Refer to the formula of back upper dominance pattern of oval wheel fashion PNT asymmetric activation & rectification, the indefinite quantitative change formula of front upper dominance pattern of oval wheel fashion PNT asymmetric activation & rectification can primarily expressed as below:

$$P_n = \tilde{E}_{f\downarrow}(W_f\downarrow+w_f\uparrow)$$

In the formula above, “ $\tilde{E}_{f\downarrow}(\dots)$ ” denotes the indefinite quantitative change formula of front upper dominance pattern of oval wheel fashion PNT asymmetric activation & rectification with independent variable of “ $W_f\downarrow+w_f\uparrow$ ”.

D) Front lower dominance pattern of oval wheel fashion PNT asymmetric activation & rectification. It means the working wattage distribution of front PNT activator keeps feature that the working wattage output in the region blow tyre core center plane is bigger than the working wattage output in the region above tyre core center plane. As the covariant response, the working wattage output of front PNT rectifier should generally keep feature that the working wattage output in the region above tyre core center plane is bigger than the working wattage output in the region blow tyre core center plane. Refer to the formula of front upper dominance pattern of oval wheel fashion PNT asymmetric activation & rectification, the indefinite quantitative change formula of front lower dominance pattern of oval wheel fashion PNT asymmetric activation & rectification can primarily expressed as below:

As coherent natura naturans throughout cosmic evolution, instinctive PNT reciprocal equilibrium towards optimum PNT operation is radical potentiality & conditionality for cosmos always ready to orientate itself towards perfection.

$$P_n = \tilde{E}_{f \uparrow} (W_{f \uparrow} + w_{f \downarrow})$$

In the formula above, “ $\tilde{E}_{f \uparrow}(\dots)$ ” denotes the indefinite quantitative change formula of front lower dominance pattern of oval wheel fashion PNT asymmetric activation & rectification with independent variable of “ $W_{f \uparrow} + w_{f \downarrow}$ ”.

Of course, the four elementary PNT asymmetric activation & rectification patterns can tie in PNT symmetric activation & rectification in “back + front” compound patterns as blow.

E) Compound pattern of “back PNT asymmetric activation & rectification + front PNT symmetric activation & rectification, including:

E-1) “Back upper dominance pattern of oval wheel fashion PNT asymmetric activation & rectification + front oval wheel fashion PNT symmetric activation & rectification”. The proper indefinite quantitative change formula of the compound PNT activation & rectification can be expressed as below:

$$P_n = \tilde{E}_{b \downarrow + f \uparrow} [(W_{b \downarrow} + w_{b \uparrow}) + (W_{f \uparrow} + w_{f \downarrow})]$$

In the formula above, “ $\tilde{E}_{b \downarrow + f \uparrow}(\dots)$ ” denotes the indefinite quantitative change formula of “back upper dominance pattern of oval wheel fashion PNT asymmetric activation & rectification + front oval wheel fashion PNT symmetric activation & rectification” with independent variable of “ $(W_{b \downarrow} + w_{b \uparrow}) + (W_{f \uparrow} + w_{f \downarrow})$ ”.

E-2) “Back lower dominance pattern of oval wheel fashion PNT asymmetric activation & rectification + front oval wheel fashion PNT symmetric activation & rectification”. The proper indefinite quantitative change formula of the compound PNT activation & rectification can be expressed as below:

$$P_n = \tilde{E}_{b \uparrow + f \downarrow} [(W_{b \uparrow} + w_{b \downarrow}) + (W_{f \downarrow} + w_{f \uparrow})]$$

In the formula above, “ $\tilde{E}_{b \uparrow + f \downarrow}(\dots)$ ” denotes the indefinite quantitative change formula of “back lower dominance pattern of oval wheel fashion PNT asymmetric activation & rectification + front oval wheel fashion PNT symmetric activation & rectification” with independent variable of “ $(W_{b \uparrow} + w_{b \downarrow}) + (W_{f \downarrow} + w_{f \uparrow})$ ”.

F) Compound pattern of “back PNT symmetric activation & rectification + front PNT asymmetric activation & rectification, including:

F-1) “Back oval wheel fashion PNT symmetric activation & rectification + front upper dominance pattern of oval wheel fashion PNT asymmetric activation & rectification”. The proper indefinite quantitative change formula of the compound PNT activation & rectification can be expressed as below:

$$P_n = \tilde{E}_{b + f \downarrow} [(W_{b \downarrow} + w_{b \uparrow}) + (W_{f \downarrow} + w_{f \uparrow})]$$

In the formula above, “ $\tilde{E}_{b + f \downarrow}(\dots)$ ” denotes the indefinite quantitative change formula of “back oval wheel fashion PNT symmetric activation & rectification + front upper dominance pattern of oval wheel fashion PNT asymmetric activation & rectification” with independent variable of “ $(W_{b \downarrow} + w_{b \uparrow}) + (W_{f \downarrow} + w_{f \uparrow})$ ”.

F-2) “Back oval wheel fashion PNT symmetric activation & rectification + front lower dominance pattern of oval wheel fashion PNT asymmetric activation & rectification”. The proper indefinite quantitative change formula of the compound PNT activation & rectification can be expressed as below:

$$P_n = \tilde{E}_{b + f \uparrow} [(W_{b \uparrow} + w_{b \downarrow}) + (W_{f \uparrow} + w_{f \downarrow})]$$

In the formula above, “ $\tilde{E}_{b+f\downarrow}(\dots)$ ” denotes the indefinite quantitative change formula of “back oval wheel fashion PNT symmetric activation & rectification + front lower dominance pattern of oval wheel fashion PNT asymmetric activation & rectification” with independent variable of “ $(W_b+w_b)+(W_f\uparrow+w_f\downarrow)$ ”.

G) Compound pattern of “back PNT asymmetric activation & rectification + front PNT asymmetric activation & rectification, including:

G-1) “Back upper dominance pattern of oval wheel fashion PNT asymmetric activation & rectification + front lower dominance pattern of oval wheel fashion PNT asymmetric activation & rectification”. The proper indefinite quantitative change formula of the compound PNT activation & rectification can be expressed as below:

$$P_n = \tilde{E}_{b\downarrow+f\uparrow}[(W_b\downarrow+w_b\uparrow) + (W_f\uparrow+w_f\downarrow)]$$

In the formula above, “ $\tilde{E}_{b\downarrow+f\uparrow}(\dots)$ ” denotes the indefinite quantitative change formula of “back upper dominance pattern of oval wheel fashion PNT asymmetric activation & rectification + front lower dominance pattern of oval wheel fashion PNT asymmetric activation & rectification” with independent variable of “ $(W_b\downarrow+w_b\uparrow) + (W_f\uparrow+w_f\downarrow)$ ”.

G-2) “Back lower dominance pattern of oval wheel fashion PNT asymmetric activation & rectification + front upper dominance pattern of oval wheel fashion PNT asymmetric activation & rectification”. The proper indefinite quantitative change formula of the compound PNT activation & rectification can be expressed as below:

$$P_n = \tilde{E}_{b\uparrow+f\downarrow}[(W_b\uparrow+w_b\downarrow) + (W_f\downarrow+w_f\uparrow)]$$

In the formula above, “ $\tilde{E}_{b\uparrow+f\downarrow}(\dots)$ ” denotes the indefinite quantitative change formula of “back lower dominance pattern of oval wheel fashion PNT asymmetric activation & rectification + front upper dominance pattern of oval wheel fashion PNT asymmetric activation & rectification” with independent variable of “ $(W_b\uparrow+w_b\downarrow) + (W_f\downarrow+w_f\uparrow)$ ”.

G-3) “Back upper dominance pattern of oval wheel fashion PNT asymmetric activation & rectification + front upper dominance pattern of oval wheel fashion PNT asymmetric activation & rectification”. The proper indefinite quantitative change formula of the compound PNT activation & rectification can be expressed as below:

$$P_n = \tilde{E}_{b\downarrow+f\downarrow}[(W_b\downarrow+w_b\uparrow) + (W_f\downarrow+w_f\uparrow)]$$

In the formula above, “ $\tilde{E}_{b\downarrow+f\downarrow}(\dots)$ ” denotes the indefinite quantitative change formula of “back upper dominance pattern of oval wheel fashion PNT asymmetric activation & rectification + front upper dominance pattern of oval wheel fashion PNT asymmetric activation & rectification” with independent variable of “ $(W_b\downarrow+w_b\uparrow) + (W_f\downarrow+w_f\uparrow)$ ”.

G-3) “Back lower dominance pattern of oval wheel fashion PNT asymmetric activation & rectification + front lower dominance pattern of oval wheel fashion PNT asymmetric activation & rectification”. The proper indefinite quantitative change formula of the compound PNT activation & rectification can be expressed as below:

$$P_n = \tilde{E}_{b\uparrow+f\uparrow}[(W_b\uparrow+w_b\downarrow) + (W_f\uparrow+w_f\downarrow)]$$

In the formula above, “ $\tilde{E}_{b\uparrow+f\uparrow}(\dots)$ ” denotes the indefinite quantitative change formula of “back lower dominance pattern of oval wheel fashion PNT asymmetric activation & rectification + front lower dominance

pattern of oval wheel fashion PNT asymmetric activation & rectification” with independent variable of “ $(W_b \uparrow + W_b \downarrow) + (W_f \uparrow + W_f \downarrow)$ ”.

In dynamic rationale, there is none essential distinction between “oval wheel fashion PNT symmetric activation & rectification” and “oval wheel fashion PNT asymmetric activation & rectification”. Compared with oval wheel fashion PNT symmetric activation & reactivation, the resultant tyre core acceleration orientation of idiographic soft drive effect of oval wheel fashion PNT asymmetric activation & rectification deviates the tyre core center plane proportionably according to the asymmetric degree of oval wheel fashion PNT activation & rectification for the asymmetric distribution of PNT activation signal on the PNT activator. It’s just such acceleration orientation deviation against tyre core center plane has satisfied the necessity of acceleration of PNT engine vertical to tyre core center plane (Please refer to coming analysis of “orientation variation derived from PNT asymmetric activation & rectification”).

Compared with the operation of oval wheel fashion PNT symmetric activation & rectification, the unique operation regret of oval wheel fashion PNT asymmetric activation & rectification is the oval wheel fashion PNT asymmetric activation & rectification can not share the geometric predesign resource of the related functional components & functional assembly equally as the oval wheel fashion PNT symmetric activation & rectification, and the more extent asymmetric deviation of PNT asymmetric activation & rectification is, the less geometric pre-designed resource of the related functional components & functional assembly it can share. Because the distinctions in germane necessity of geometric structure & assembly of PNT symmetric activation & rectification and PNT asymmetric activation & rectification are immanent, while in practical PNT engine design, it seems more realistic that the geometric structure and functional assembly of the related components are relatively steady-going and relatively difficult for us to design them in variable geometric structure & variable functional assembly as to satisfy both PNT symmetric activation & rectification and PNT asymmetric activation & rectification equally best. Comparably, as the PNT symmetric activation & rectification is better for PNT engine to bring about better soft drive effect, in our practical design, we have to pay more attention to consummate germane necessity of geometric structure & assembly of PNT symmetric activation & rectification first and foremost.

And just because the practical introduce of steady-going geometric structure & assembly due to germane necessity of PNT symmetric activation & rectification, the practical operation of oval wheel fashion PNT symmetric activation & rectification can share the geometric predesign fully, while the PNT asymmetric activation & rectification can not share it equally. And just because of this, the safe quantitative change range of oval wheel fashion PNT symmetric activation & rectification is apparently more substantial than safe change range of oval wheel fashion PNT asymmetric activation & rectification, and the possible safe maximum “ P_n ” of oval fashion PNT symmetric activation & rectification is consequently bigger than the possible safe maximum “ P_n ” of oval fashion PNT asymmetric activation & rectification.

The integrate logic configuration of part of quantitative change and quantitative change formula of PNT activation & rectification is generally as below:

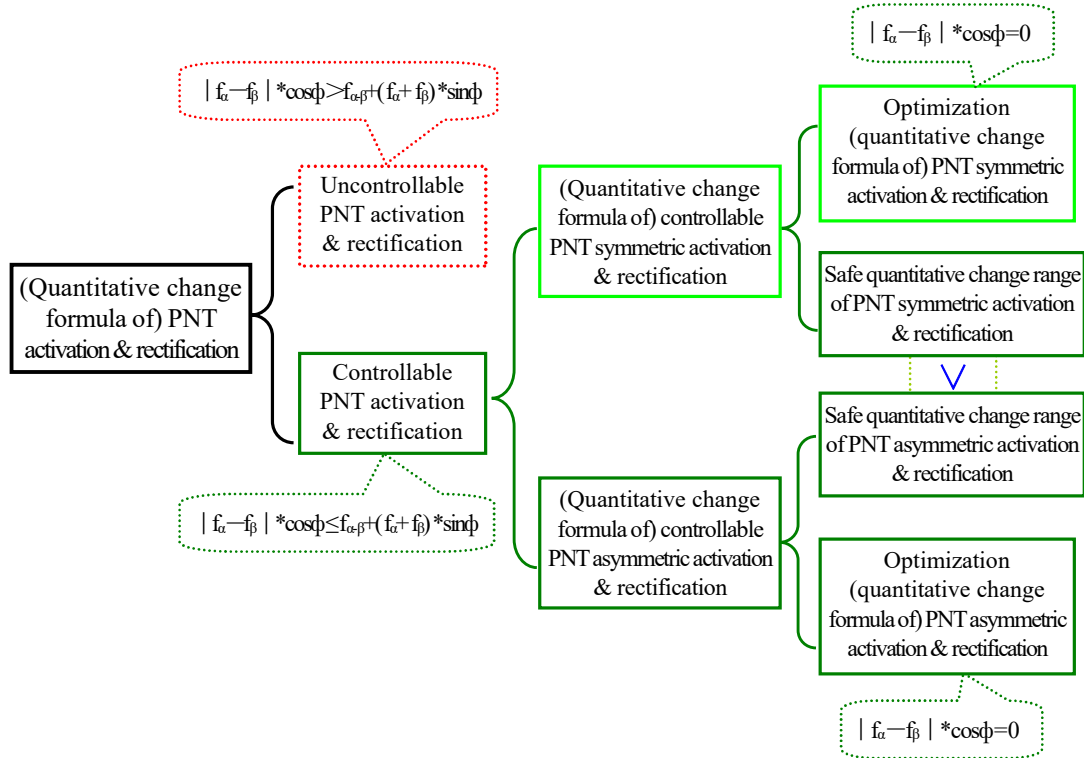

2. 4. 5. Quantitative change formula of PNT activation & rectification and “operation control” of PNT engine

The quantitative change formula of PNT activation & rectification connotes the durative quantitative change correlation of PNT soft drive reaction between reaction original input and consequential output due to necessity of PNT continuous controllability. If we program such eligible quantitative change formula into practical control programme, we would have turned such eligible quantitative change formulas into volitional commands thereby, because once we invoke such proper programme to implement PNT soft drive, the operation of PNT engine will be started off according to eligible appropriate quantitative change pattern and exhibit normalized PNT activation & rectification.

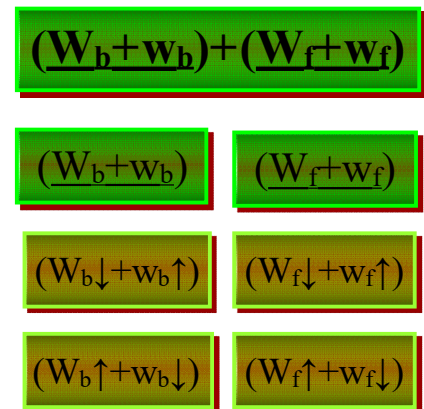

For this, we edit the indicative independent variable of corresponding quantitative change formula into a control keyboard as right diagram.

(VI-i-2~42) Control keyboard of PNT engine

In the diagram above, $(W_b + w_b) + (W_f + w_f)$ is the operation program key of quantitative change formula of oval wheel fashion PNT symmetric activation & rectification “ $P_n = \tilde{E}_{b+f}[(W_b + w_b), (W_f + w_f)]$ ”, which is the major and idiomatic oval wheel PNT activation & rectification operation program. $(W_b + w_b)$ is the operation program key of quantitative change formula of PNT symmetric activation & rectification of back semi-oval-wheel “ $P_n = \tilde{E}_b(W_b + w_b)$ ”. $(W_f + w_f)$ is the operation program key of quantitative change

formula of PNT symmetric activation & rectification of front semi-oval-wheel “ $P_{\text{f}} = \tilde{E}_{\text{f}}(W_{\text{f}}+w_{\text{f}})$ ”. $(W_{\text{b}}\downarrow+W_{\text{b}}\uparrow)$ is the operation program of quantitative change formula of back upper dominance pattern of oval wheel fashion PNT asymmetric activation & rectification “ $P_{\text{n}} = \tilde{E}_{\text{b}}\downarrow(W_{\text{b}}\downarrow+w_{\text{b}}\uparrow)$ ”. $(W_{\text{f}}\downarrow+W_{\text{f}}\uparrow)$ is the operation program of quantitative change formula of front upper dominance pattern of oval wheel fashion PNT asymmetric activation & rectification “ $P_{\text{n}} = \tilde{E}_{\text{f}}\downarrow(W_{\text{f}}\downarrow+w_{\text{f}}\uparrow)$ ”. $(W_{\text{b}}\uparrow+W_{\text{b}}\downarrow)$ is the operation program of quantitative change formula of back lower dominance pattern of oval wheel fashion PNT asymmetric activation & rectification “ $P_{\text{n}} = \tilde{E}_{\text{b}}\downarrow(W_{\text{b}}\uparrow+w_{\text{b}}\downarrow)$ ”. $(W_{\text{f}}\uparrow+W_{\text{f}}\downarrow)$ is the operation program of quantitative change formula of front lower dominance pattern of oval wheel fashion PNT asymmetric activation & rectification “ $P_{\text{n}} = \tilde{E}_{\text{f}}\downarrow(W_{\text{f}}\uparrow+w_{\text{f}}\downarrow)$ ”.

As the idiomatic key of quantitative change formula of PNT symmetric activation & rectification, the work on-going time of $(W_{\text{b}}+W_{\text{b}})+(W_{\text{f}}+W_{\text{f}})$ key is relatively long, so the key is better to be designed as sliding key, whose fashion just like a sliding volume bar of a recorder, and the linear sliding distance indicates the magnitude of the proper independent variable of “ $(W_{\text{b}}+w_{\text{b}}), (W_{\text{f}}+w_{\text{f}})$ ”. In accordance with the maneuverability necessity, the other 6 keys under the idiomatic key are necessary to be made into flexible press keys, press the flexible key means invoking the proper operation programs of PNT activation & rectification, the depth pressed indicates the proportional magnitude of independent variable of the proper quantitative change formula of PNT activation & rectification, the deeper the key is pressed down, the bigger the magnitude of independent variable is it means; and the time extension the key is pressed means the interval the proper program of quantitative change formula is implementing, once the key is released and the flexible key returns to its original position, it means to give off the invoking of the proper program of quantitative change formula.

Of course, the 6 flexible keys can still be invoked synchronously in “back one + front one” tie-in pattern, for example, if we synchronously press down $(W_{\text{b}}+W_{\text{b}})$ and $(W_{\text{f}}+W_{\text{f}})$, it means we synchronously implement both program of back PNT symmetric activation & rectification of quantitative change formula “ $P_{\text{n}} = \tilde{E}_{\text{b}}(W_{\text{b}}+w_{\text{b}})$ ” and program of front PNT symmetric activation & rectification of quantitative change formula “ $P_{\text{n}} = \tilde{E}_{\text{f}}(W_{\text{f}}+w_{\text{f}})$ ”. If the press strength to the both keys is controlled appropriate, the implementation effect maybe equivalent to the implementation effect of idiomatic program of quantitative change formula $P_{\text{n}} = \tilde{E}_{\text{b+f}}[(W_{\text{b}}+w_{\text{b}}), (W_{\text{f}}+w_{\text{f}})]$. If we synchronously press down $(W_{\text{b}}+W_{\text{b}})$ and $(W_{\text{f}}\downarrow+W_{\text{f}}\uparrow)$, it means

Historical progress of science in the recent several centuries seemed like a far-flung exploration of the first itinerary around numerous distinctive landscapes of brand-new landmasses of science with palette & tablet on back, several hundred years' scientific travelogues were compiled thereby.

we synchronously implement “back PNT symmetric activation & rectification + front upper dominance PNT asymmetric activation & rectification” of quantitative change formula “ $P_n = \tilde{E}_{b \downarrow f \uparrow}[(W_b \downarrow + w_b \uparrow) + (W_f \downarrow + w_f \uparrow)]$ ”, the magnitude of resultant press force to the both keys indicate the input value of independent variable “ $(W_b \downarrow + w_b \uparrow) + (W_f \downarrow + w_f \uparrow)$ ”, and the press time extension means the interval the proper program implemented. If we synchronously press down $(W_b \downarrow + w_b \uparrow)$ and $(W_f \uparrow + w_f \downarrow)$, it means we synchronously implement “back PNT symmetric activation & rectification + front lower dominance PNT asymmetric activation & rectification” of quantitative change formula “ $P_n = \tilde{E}_{b \uparrow f \downarrow}[(W_b \downarrow + w_b \uparrow) + (W_f \uparrow + w_f \downarrow)]$ ”, the magnitude of resultant press force to the both keys indicate the input value of independent variable “ $(W_b \downarrow + w_b \uparrow) + (W_f \uparrow + w_f \downarrow)$ ”, and the press time extension means the interval the proper program implemented. If we synchronously press down $(W_b \downarrow + w_b \uparrow)$ and $(W_f \uparrow + w_f \downarrow)$, it means we synchronously implement “back upper dominance PNT asymmetric activation & rectification + front PNT symmetric activation & rectification” of quantitative change formula “ $P_n = \tilde{E}_{b \downarrow f \uparrow}[(W_b \downarrow + w_b \uparrow) + (W_f \uparrow + w_f \downarrow)]$ ”, the magnitude of resultant press force to the both keys indicate the input value of independent variable “ $(W_b \downarrow + w_b \uparrow) + (W_f \uparrow + w_f \downarrow)$ ”, and the press time extension means the interval the proper program implemented. If we synchronously press down $(W_b \uparrow + w_b \downarrow)$ and $(W_f \uparrow + w_f \downarrow)$, it means we synchronously implement “back lower dominance PNT asymmetric activation & rectification + front lower dominance PNT asymmetric activation & rectification” of quantitative change formula “ $P_n = \tilde{E}_{b \uparrow f \downarrow}[(W_b \uparrow + w_b \downarrow) + (W_f \uparrow + w_f \downarrow)]$ ”, the magnitude of resultant press force to the both keys indicate the input value of independent variable “ $(W_b \uparrow + w_b \downarrow) + (W_f \uparrow + w_f \downarrow)$ ”, and the press time extension means the interval the proper program implemented.

But the double keys tie-in usage can only be “one front program key + one back program key”, it can not synchronously press both front program keys or both back program keys for the same functional component can not to implement two or two more programs of quantitative change formula at the same time, otherwise, it maybe cause program implementation effect anamorphic and unexpected stimulation effect of tyre core maybe occur. And as the safe quantitative change range of PNT asymmetric activation & rectification is relatively narrower than the safe quantitative change range of PNT symmetric activation & rectification, as a result, comparably, the is more possible ratio for PNT asymmetric activation & rectification to encounter the corresponding quantitative change deadline of PNT activation & rectification, it's to say, the PNT soft drive operating in PNT asymmetric activation & rectification pattern is not as safe as operating in PNT symmetric activation & rectification pattern, so when we invoke PNT asymmetric activation & rectification program, we should be gentle as not to press the proper keys too madly. And just because of this, as we've been used to introduce “yellow” as vigilance color, I added “slight yellow under green” to these keys thereby.

As coherent natura naturans throughout cosmic evolution, instinctive PNT reciprocal equilibrium towards optimum PNT operation is radical potentiality & conditionality for cosmos always ready to orientate itself towards perfection.

3. Artificial control of motion orientation of PNT engine

3. 1. Orientation adjusting derived from rotary oval wheel fashion PNT activation & rectification

If we can design the PNT activators & PNT rectifiers into volitant components which can synchronously sliding along the both circumferences intersected by tyre core and tyre core center plane, then, under the precondition of oval wheel fashion PNT symmetric activation & rectification, the synchronous free sliding of oval wheel PNT activators & PNT rectifiers along the both circumferences will directly determine the resultant acceleration orientation variation in tyre core center plane. As long as the both PNT activators and PNT rectifiers can slide along the both circumferences freely as well as stay at any point position of the both circumferences, it's possible for the tyre core to accelerate at any direction in tyre core center plane. We call the rotary mechanism which can practically bring about freewill acceleration orientation variation in tyre core center plane “orientation adjusting derived from rotary oval wheel fashion PNT symmetric activation & rectification”. Any tyre core acceleration orientation variation in tyre core center plane is synchronously and proportionately materialized by such circumambience sliding under PNT symmetric activation & rectification. The oval wheel circumambience sliding and the consequential proportionate acceleration orientation variation can be illustrated as below:

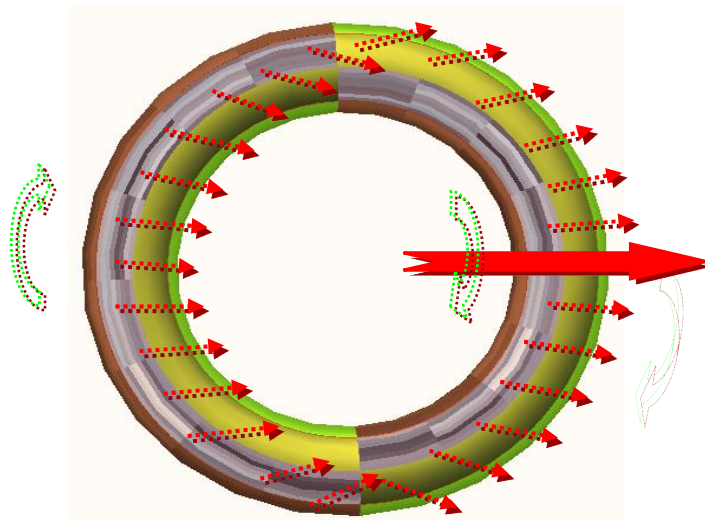

Or

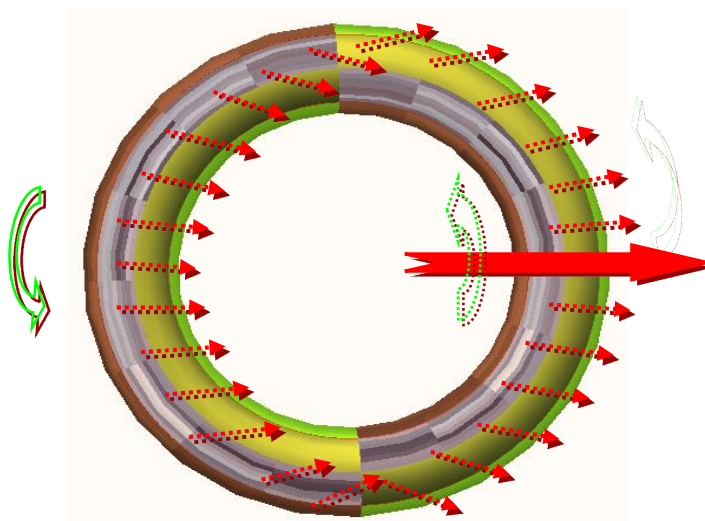

(VI-i-2~43) Orientation adjusting derived from rotary oval wheel fashion PNT activation & rectification

The rotary mechanism of orientation adjusting derived from rotary oval wheel fashion PNT activation & rectification can be either “hard rotation of oval wheel fashion PNT activation & rectification” or “soft rotation of oval wheel fashion PNT activation & rectification”. So-called “hard rotation of oval wheel fashion PNT activation & rectification” is just the relative displacement effect caused by mechanical circum-motion around tyre core of oval wheel made up of PNT activators & PNT rectifiers under operation of PNT activation & rectification. So-called “soft rotation of oval wheel fashion PNT activation & rectification” is, under the precondition that the base of PNT activators & PNT rectifiers are just the same and the functional distinctions of PNT activators & PNT rectifiers completely depends on the their idiographic software input, thus, we just keep the base of PNT activators & PNT rectifiers and tyre core relatively stationary but make the idiographic software input of PNT activators & PNT rectifiers circum motion around tyre core so as to bring about the same relative displacement effect of hard rotation of oval wheel fashion PNT activation & rectification.

Comparably, “hard rotation of oval wheel fashion PNT activation & rectification” permit the base of PNT activators & PNT rectifiers to be different, this of course implies more individual functional characteristics in PNT activators or PNT rectifiers are possible. And as the presence of rich connotation of individual functional characteristics in base of PNT activators or PNT rectifiers, the quality demands of software input of PNT activators or PNT rectifiers are relatively more simplex. But hard rotation of oval wheel fashion PNT activation & rectification has to obviate or overcome two adverse factors:

The first, pressure, during the course of PNT activation & rectification, if the cubage of tyre core remarkably swell and consequently bring about high pressure to the PNT activators & PNT rectifiers around, then the hard rotation of the oval wheel made up of the PNT activators & PNT rectifiers will be more and more laborsome and difficult.

The second, temperature, during the course of PNT activation & rectification, if the temperature of tyre core become higher and higher, so that the PNT activators and PNT rectifiers around become softer and softer for higher and higher ambient temperature, then, the PNT activators and PNT rectifiers will be more and more frangible to withstand mechanical driving for hard rotation.

Whereas, soft rotation of oval wheel fashion PNT activation & rectification must demand the base material of PNT activators and PNT rectifiers just to be the same, and all the functional individuality of PNT activators and PNT rectifiers must be defined by distinctive software input of PNT activators and software input of PNT rectifiers, this of course implies soft rotation of oval wheel PNT activation & rectification demands higher quality of software. But soft rotation of oval wheel fashion PNT activation & rectification can slide over mechanical circumgyration of PNT activators and PNT rectifiers around tyre core, it can keep the base material of PNT activators and PNT rectifiers and the tyre core relatively stationary but to let the distinctive software input circumgyrate around tyre core in profiles of PNT activators and PNT rectifiers as to bring about the same effect of orientation adjusting of rotation PNT activation & rectification

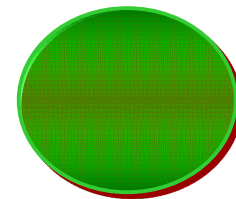

$$(W_b + w_b) + (W_f + w_f)$$

$$(W_b + w_b)$$

$$(W_f + w_f)$$

$$(W_b \downarrow + w_b \uparrow)$$

$$(W_f \downarrow + w_f \uparrow)$$

$$(W_b \uparrow + w_b \downarrow)$$

$$(W_f \uparrow + w_f \downarrow)$$

(VI-i-2~44) Control keyboard of PNT engine

As coherent natura naturans throughout cosmic evolution, instinctive PNT reciprocal equilibrium towards optimum PNT operation is radical potentiality & conditionality for cosmos always ready to orientate itself towards perfection.

as hard rotation of oval wheel fashion PNT activation & rectification. As long as the software input is relatively reliable, the soft rotation of oval wheel fashion PNT activation & rectification is not only more convenient to operate but also is more reliable.

As the introduction of function of orientation adjusting derived from rotation PNT activation & rectification, the control keyboard of PNT engine as diagram of (VI-i-2~42) consequently turn into a more integrative control keyboard as diagram (VI-i-2~44).

The green disk on top of the control keyboard is just the control knob of orientation adjusting derived from rotation PNT activation & rectification. For expedience to operate, we can of course just fabricate it into fashion of auto steering wheel.

3. 2. Orientation adjusting derived from PNT asymmetric activation & rectification against the tyre core centre plane

Under the precondition of PNT symmetric activation & rectification, the rotation of PNT activators and PNT rectifiers around tyre core brings about the orientation adjusting of tyre core in tyre core center plane, but the rotation of PNT activators and PNT rectifiers around tyre core under precondition of PNT symmetric activation & rectification can never bring about vertical acceleration against tyre core center plane. If we consider to keep the working output wattage of upper limbs of PNT activators not equal to the working output wattage of lower limbs of PNT activators and keep PNT rectifiers work coordinately with PNT activators according to necessity of PNT continuous controllability, there must be unequal stimulation moment output between upward momentum output and downward momentum output of tyre core, the resultant acceleration of tyre core must deviate tyre core center plane and the resultant motion orientation of tyre core deviates tyre core center plane thereby. We call such motion orientation deviation against tyre core center plane for PNT asymmetric activation & rectification “orientation adjusting derived from PNT asymmetric activation & rectification”.

3. 2. 1. Orientation adjusting derived from PNT asymmetric activation & rectification of front semi-oval-wheel.

Under precondition of back PNT symmetric activation & rectification, if we keep the working output wattage of lower limbs of front PNT activator bigger than the working output wattage of upper limb of front PNT activator, then the front semi-oval-wheel of tyre core must arise upward resultant acceleration; if we keep the working output wattage of upper limb of front PNT activator bigger than the working output wattage of lower limb of front PNT activator, then the front semi-oval-wheel of tyre core must arises downward resultant acceleration (throughout the course, the PNT rectifiers work coordinately with PNT activators in accordance with the proper quantitative change formula of PNT asymmetric activation & rectification due to necessity of PNT continuous controllability all the way), which can be illustrated as below:

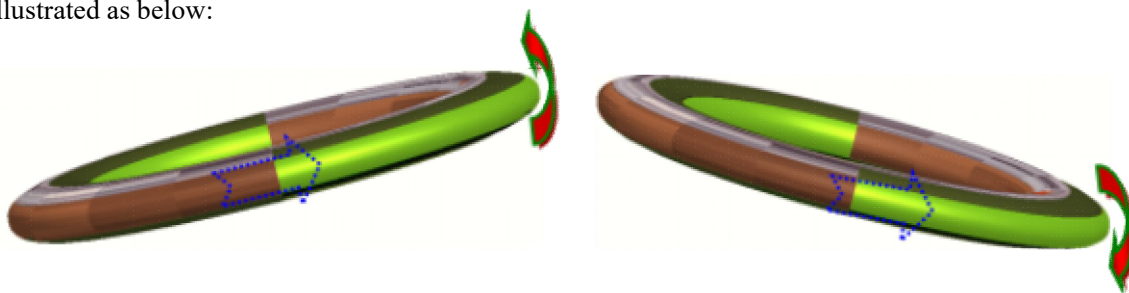

(VI-i-2~45) (back PNT symmetric activation & rectification + front lower dominance of PNT asymmetric activation & rectification)
 =upward resultant acceleration of front semi-oval-wheel
Operation: Synchronously press down the both keys below

$$\boxed{(W_b+W_b)} \quad \& \quad \boxed{(W_f\uparrow+W_f\downarrow)}$$

And control the press strength & interval appropriately.

(VI-i-2~46) (back PNT symmetric activation & rectification + front upper dominance of PNT asymmetric activation & rectification)
 =downward resultant acceleration of front semi-oval-wheel
Operation: Synchronously press down the both keys below

$$\boxed{(W_b+W_b)} \quad \& \quad \boxed{(W_f\downarrow+W_f\uparrow)}$$

And control the press strength & interval appropriately.

3. 2. 2. Orientation adjusting derived from PNT asymmetric activation & rectification of back semi-oval-wheel.

Under precondition of front PNT symmetric activation & rectification, if we keep the working output wattage of lower limbs of back PNT activator bigger than the working output wattage of upper limb of back PNT activator, then the back semi-oval-wheel of tyre core must arise upward resultant acceleration; if we keep the working output wattage of upper limb of back PNT activator bigger than the working output wattage of lower limb of back PNT activator, then the back semi-oval-wheel of tyre core must arise downward resultant acceleration (Throughout the course, the PNT rectifiers work coordinately with PNT activators in accordance with the proper formulized programme of quantitative change of PNT asymmetric activation & rectification due to necessity of PNT continuous controllability all the way), which can be illustrated as below:



(VI-i-2~47) (back lower dominance of PNT asymmetric activation & rectification + front PNT symmetric activation & rectification)
 =upward resultant acceleration of back semi-oval-wheel
Operation: Synchronously press down the both keys below

$$\boxed{(W_b\uparrow+W_b\downarrow)} \quad \& \quad \boxed{(W_f\uparrow+W_f)}$$

And control the press strength & interval appropriately.

(VI-i-2~48) (back upper dominance of PNT asymmetric activation & rectification + front PNT symmetric activation & rectification)
 =downward resultant acceleration of back semi-oval-wheel
Operation: Synchronously press down the both keys below

$$\boxed{(W_b\downarrow+W_b\uparrow)} \quad \& \quad \boxed{(W_f\uparrow+W_f)}$$

And control the press strength & interval appropriately.

3. 2. 3. Orientation adjusting derived from PNT asymmetric activation & rectification of both back & front semi-oval-wheel.

If we keep the working output wattage of upper limb of back PNT activator bigger than the working output wattage of lower limb of back PNT activator and keep the working output wattage of lower limb of front PNT activator bigger than the working output wattage of upper limb of front PNT activator at the same time, then, the back semi-oval-wheel of the tyre core arises downward acceleration and the front semi-oval-wheel of the tyre core arises upward acceleration synchronously, and consequently, in a relatively long interval, the tyre core exhibit motion behavior of backward somersault; if we keep the working output wattage of lower limb of back PNT activator bigger than the working output wattage of upper limb of back PNT activator and keep the working output wattage of upper limb of front PNT activator bigger than the working output wattage of lower

As coherent natura naturans throughout cosmic evolution, instinctive PNT reciprocal equilibrium towards optimum PNT operation is radical potentiality & conditionality for cosmos always ready to orientate itself towards perfection.

limb of front PNT activator at the same time, then, the back semi-oval-wheel of the tyre core arises upward acceleration and the front semi-oval-wheel of the tyre core arises downward acceleration synchronously, and consequently, in a relatively long interval, the tyre core exhibit motion behavior of forward somersault, which can be illustrated as below:

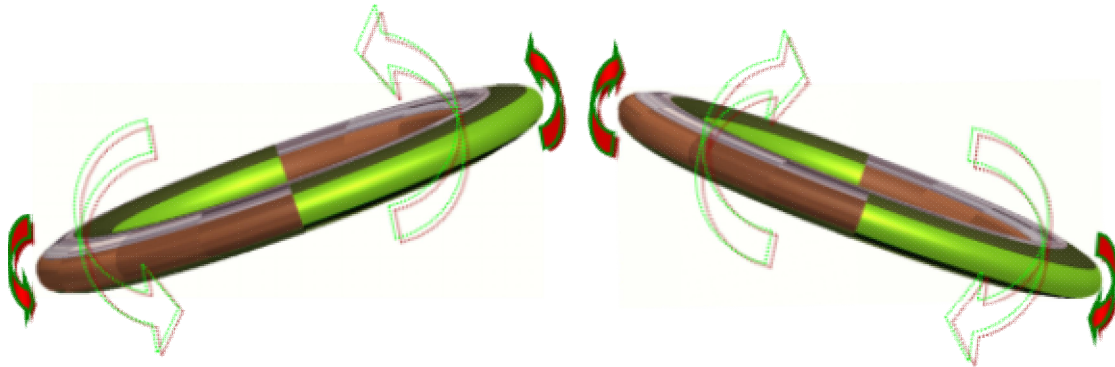

<p>(VI-i-2~49) (back upper dominance of PNT asymmetric activation & rectification + front lower dominance of PNT asymmetric activation & rectification) = tyre core backward somersault Operation: Synchronously press down the both keys below</p> <p>($W_{b\downarrow} + W_{b\uparrow}$) & ($W_{f\uparrow} + W_{f\downarrow}$)</p> <p>And control the press strength & interval appropriately.</p>	<p>(VI-i-2~50) (back lower dominance of PNT asymmetric activation & rectification + front upper dominance of PNT asymmetric activation & rectification) = tyre core forward somersault Operation: Synchronously press down the both keys below</p> <p>($W_{b\uparrow} + W_{b\downarrow}$) & ($W_{f\downarrow} + W_{f\uparrow}$)</p> <p>And control the press strength & interval appropriately.</p>
--	---

If we keep working output wattage of both upper limbs of back & front PNT activators bigger than working output wattage of lower limbs of both back & front PNT activators, then both the back & front semi-oval-wheel of tyre core must arises downward acceleration. For expedience of description, we denote the working output wattage of upper limb of back PNT activator “ W_{b-u} ” (just $W_{\text{back-upper}}$), denote the working output wattage of lower limb of back PNT activator “ W_{b-l} ” (just $W_{\text{back-lower}}$); denote the working output wattage of upper limb of front PNT activator “ W_{f-u} ” (just $W_{\text{front-upper}}$), and denote the working output wattage of lower limb of front PNT activator “ W_{f-l} ” (just $W_{\text{front-lower}}$). If $W_{b-u} - W_{b-l} < W_{f-u} - W_{f-l}$, as dominance of front downward acceleration, the resultant unequal downward acceleration of back semi-oval-wheel and front semi-oval-wheel must bring about “down-backward somersault” similar as diagram (VI-i-2~49) illustrated; if $W_{b-u} - W_{b-l} > W_{f-u} - W_{f-l}$, as dominance of back downward acceleration, the resultant unequal downward acceleration of back semi-oval-wheel and front semi-oval-wheel must bring about “down-forward somersault” similar as diagram (VI-i-2~50) illustrated; if $W_{f-u} - W_{f-l} = W_{b-u} - W_{b-l}$, it implies the downward accelerations of back semi-oval-wheel and front semi-oval-wheel are equal, the tyre core center plane keep level with vertically downward acceleration. If we keep working output wattage of both lower limbs of back & front PNT activators bigger than working output wattage of upper limbs of both back & front PNT activators, then both the back & front semi-oval-wheel of tyre core must arises upward acceleration. If $W_{b-u} - W_{b-l} < W_{f-u} - W_{f-l}$, as dominance of front upward acceleration, the resultant unequal upward acceleration of back semi-oval-wheel and front semi-oval-wheel must bring about “up-backward somersault” similar as diagram (VI-i-2~49) illustrated; if $W_{b-u} - W_{b-l} > W_{f-u} - W_{f-l}$, as dominance of back upward acceleration, the resultant unequal upward acceleration of back semi-oval-wheel and front semi-oval-wheel must bring about “up-forward somersault” similar as diagram (VI-i-2~50) illustrated;

Historical progress of science in the recent several centuries seemed like a far-flung exploration of the first itinerary around numerous distinctive landscapes of brand-new landmasses of science with palette & tablet on back, several hundred years’ scientific travelogues were compiled thereby.

if $W_{f-u} - W_{f-l} = W_{b-u} - W_{b-l}$, it implies the upward accelerations of back semi-oval-wheel and front semi-oval-wheel are equal, the tyre core center plane keep level with vertically upward acceleration. (Throughout the course, the PNT rectifiers work coordinately with PNT activators in accordance with the proper formulized programme of quantitative change of PNT asymmetric activation & rectification due to necessity of PNT continuous controllability all the way). The dynamic situation the tyre core center plane keep level with vertically downward or upward acceleration can be illustrated as below:

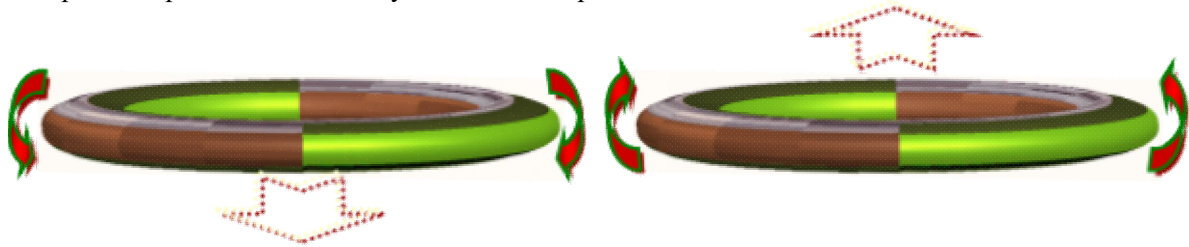

<p>(VI-i-2~51) (back upper dominance of PNT asymmetric activation & rectification + front upper dominance of PNT asymmetric activation & rectification) = vertically downward acceleration Operation: Synchronously press down the both keys below</p> <p style="text-align: center;"> $(W_{b\downarrow} + W_{b\uparrow})$ & $(W_{f\downarrow} + W_{f\uparrow})$ </p> <p>And control the press strength & interval appropriately.</p>	<p>(VI-i-2~52) (back lower dominance of PNT asymmetric activation & rectification + front lower dominance of PNT asymmetric activation & rectification) = vertically upward acceleration Operation: Synchronously press down the both keys below</p> <p style="text-align: center;"> $(W_{b\uparrow} + W_{b\downarrow})$ & $(W_{f\uparrow} + W_{f\downarrow})$ </p> <p>And control the press strength & interval appropriately.</p>
---	---

When PNT engine starting off from ground or landing to the ground, such vertically upward acceleration will be introduced to accelerate from ground to sky or to decelerate as to land to the ground, which is similar as whirlybird usually does.

It is obvious that the orientation adjusting of tyre model of PNT engine is generally materialized by orientation adjusting derived from rotary oval wheel fashion PNT symmetric activation & rectification and orientation adjusting derived from oval wheel fashion PNT asymmetric activation & rectification.

And virtually, there is none contradiction or conflict between orientation adjusting derived from rotary oval wheel fashion PNT symmetric activation & rectification and orientation adjusting derived from oval wheel fashion PNT asymmetric activation & rectification. During the course of PNT engine flying in space, both “orientation adjusting derived from oval wheel fashion PNT asymmetric activation & rectification” and “orientation adjusting derived from rotary oval wheel fashion PNT symmetric activation & rectification” can be implemented synchronously, ——under condition of any PNT asymmetric activation & rectification, we can freely rotate the PNT activators and PNT rectifiers too. We denote the operation we rotate the PNT activators and PNT rectifiers under condition of PNT asymmetric activation & rectification “orientation adjusting derived from rotary oval wheel fashion PNT asymmetric activation & rectification”. The practical implementation of orientation adjusting derived from rotary oval wheel fashion PNT asymmetric activation & rectification can make PNT engine smartly fly along various wonderful curves in space.

3.3. Choice of activation & rectification programme of PNT engine and introduction of the corresponding manual operation system

In practice, in order to avoid unnecessary complexity and ensure the regularity, feasibility and reliability of activation & rectification program of PNT engine, we are usually more appropriate and feasible to introduce the oval wheel fashion rotating activation & rectification orientation adjusting and 5 relatively typical and

As coherent natura naturans throughout cosmic evolution, instinctive PNT reciprocal equilibrium towards optimum PNT operation is radical potentiality & conditionality for cosmos always ready to orientate itself towards perfection.

regular activation & rectification programs.

The 5 relatively typical and regular activation & rectification programs are as following:

1) Oval wheel fashion symmetrical PNT activation & rectification program “ $P_{\text{active}} = \tilde{E}_{b+f}[(W_b + w_b), (W_f + w_f)]$ ”, it is the level drive program in high speed, which is the major drive program of PNT engine, we just call it level drive program.

2-A) Back upper dominance of PNT asymmetric activation & rectification + front lower dominance of PNT asymmetric activation & rectification (even back upper dominance of PNT asymmetric activation & rectification = front lower dominance of PNT asymmetric activation & rectification) drive programme. As this drive programme can cause 0^0 to 90^0 elevation drive orientation adjusting, and compared with any other similar PNT activation & rectification programme, this programme is obviously more typical and regular, so we just call it standard elevation drive programme (simplified as elevation drive programme).

2-B) Back lower dominance of PNT asymmetric activation & rectification + front upper dominance of PNT asymmetric activation & rectification (even back lower dominance of PNT asymmetric activation & rectification = front upper dominance of PNT asymmetric activation & rectification) drive programme. As this drive programme can cause 0^0 to -90^0 swoop drive orientation adjusting, and compared with any other similar PNT activation & rectification programme, this programme is obviously more typical and regular, so we just call it standard swoop drive programme (simplified as swoop drive programme).

3-A) Back upper dominance of PNT asymmetric activation & rectification + front upper dominance of PNT asymmetric activation & rectification (even back upper dominance of PNT asymmetric activation & rectification = front upper dominance of PNT asymmetric activation & rectification) drive programme. As this drive programme can cause vertical swoop drive, we just call it “vertical swoop drive programme”.

3-B) Back lower dominance of PNT asymmetric activation & rectification + front lower dominance of PNT asymmetric activation & rectification (even back lower dominance of PNT asymmetric activation & rectification = front lower dominance of PNT asymmetric activation & rectification) drive programme. As this drive programme can cause vertical elevation drive, we just call it “vertical elevation drive programme”.

Therefore, we design the manual operation part of rotating orientation adjusting of oval wheel fashion PNT activation & rectification in auto steering wheel style, and we just call it PNT engine steering wheel, whose geometrical profile is generally as below:



(VI-i-2~53) PNT engine steering wheel

The manual rotating of PNT engine steering wheel correspondingly starts and controls working of rotation orientation adjusting of oval wheel fashion PNT activation & rectification, and the rotation radian of PNT engine steering wheel is proportional to the rotation radian of whole PNT engine in tyre core center plane.

In terms of the manual transfer and operational control of elevation drive programme and swoop drive programme, we are convenient to design the proper manual transfer and operational control part of “back upper dominance of PNT asymmetric activation & rectification + front lower dominance of PNT asymmetric activation & rectification” and “back lower dominance of PNT asymmetric activation & rectification + front upper dominance of PNT asymmetric activation & rectification” programme into front & back bidirectional balance torsion rotator derived from two equal springs symmetrically fixed on right terminal & left terminal of the torsion rotator, we just call it balance torsion rotator, the geometrical assembly structure of balance torsion rotator is as below:

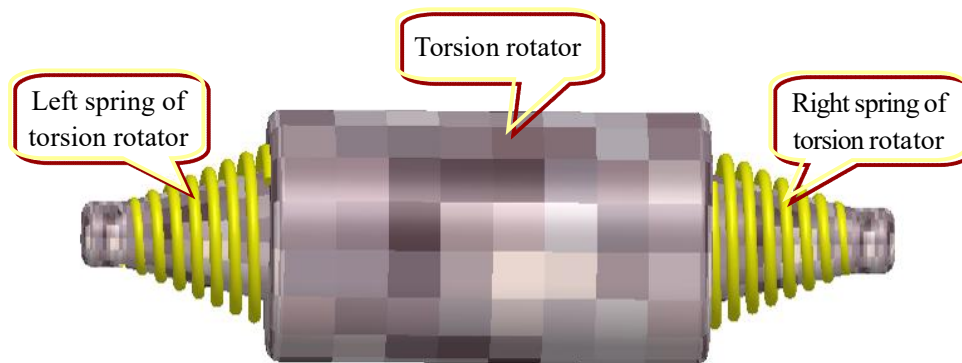

(VI-i-2~54) balance torsion rotator

The geometrical profile of both right torsion spring and left torsion spring of the balance torsion rotator is subuliform. The small terminals of the both right & left torsion springs symmetrically fix on the both outside terminals of the balance torsion rotator, and the open big terminal of left subuliform torsion spring contacts work wattage output of back PNT activation & rectification of PNT engine, the open big terminal of right subuliform torsion spring contacts work wattage output of front PNT activation & rectification of PNT engine.

Once the open big terminals of both right and left subuliform torsion springs are in nature without torsion, it indicates there is none orientation variation of tyre core center plane during the course of drive of PNT engine.

Once the balance torsion rotator circumvolves forward, the left subuliform spring shrinks consequently, and the proportionate shrinking torsion of left subuliform spring connects the corresponding increase of back lower dominance of PNT asymmetrical activation & rectification; and at the same time, the right subuliform spring expands consequently in equal extent, and the proportionate expanding torsion of right subuliform spring connects the corresponding increase of front upper dominance of PNT asymmetrical activation & rectification, the PNT engine consequently takes on swoop drive orientation of 0^0 to -90^0 thereby. That's to say, once the balance torsion rotator circumvolves forward, the PNT engine transfers and implements swoop drive programme, the circumvolved radian of balance torsion rotator means the proper magnitude of output parameter of swoop

drive programme, the forward rotation speed of balance torsion rotator is proportional to the acceleration of swoop radian against original tyre core center plane, the interval the forward torsion lasted on balance torsion rotator means the time extension of performance of swoop drive programme.

Once the balance torsion rotator circumvolves backward, the left subuliform spring expands consequently, and the proportionate expanding torsion of left subuliform spring connects the corresponding increase of back upper dominance of PNT asymmetrical activation & rectification; and at the same time, the right subuliform spring shrinks consequently in equal extent, and the proportionate shrinking torsion of right subuliform spring connects the corresponding increase of front lower dominance of PNT asymmetrical activation & rectification, the PNT engine consequently takes on elevation drive orientation of 0^0 to -90^0 thereby. That's to say, once the balance torsion rotator circumvolves backward, the PNT engine transfers and implements elevation drive programme, the circumvolved radian of balance torsion rotator means the proper magnitude of output parameter of elevation drive programme, the backward rotation speed of balance torsion rotator is proportional to the acceleration of elevation radian against original tyre core center plane, the interval the backward torsion lasted on balance torsion rotator means the time extension of performance of elevation drive programme.

As long as the mechanical strength, geometrical specification and assembly situation of the both right and left subuliform springs are just the same, as long as we define the front and back PNT activation & rectification wattage output distribution of PNT engine equally and symmetrically, the circumvolving operation of balance torsion rotator can ensure the performance effect of “back upper dominance of PNT asymmetric activation & rectification = front lower dominance of PNT asymmetric activation & rectification” and “back lower dominance of PNT asymmetric activation & rectification = front upper dominance of PNT asymmetric activation & rectification”.

The balance torsion rotator is appropriate to be fixed on the mid position of the main crossbeam of PNT engine steering wheel; the assembly of balance torsion rotator on PNT engine steering wheel is as below:



(VI-i-2~55) Balance torsion rotator fixed on PNT engine steering wheel

In terms of the manual transfer and operational control of “vertical swoop drive programme” and “vertical

Historical progress of science in the recent several centuries seemed like a far-flung exploration of the first itinerary around numerous distinctive landscapes of brand-new landmasses of science with palette & tablet on back, several hundred years' scientific travelogues were compiled thereby.

elevation drive programme”, it’s appropriate for us to design the corresponding manual operational parts connected to “back upper dominance of PNT asymmetric activation & rectification + front upper dominance of PNT asymmetric activation & rectification (even back upper dominance of PNT asymmetric activation & rectification = front upper dominance of PNT asymmetric activation & rectification)” drive programme and “back lower dominance of PNT asymmetric activation & rectification + front lower dominance of PNT asymmetric activation & rectification (even back lower dominance of PNT asymmetric activation & rectification = front lower dominance of PNT asymmetric activation & rectification)” drive programme into two separate pairs of uniform front & back symmetrical elastic spouses. And just because the two pairs of front & back symmetrical elastic spouses separately connect “back upper dominance of PNT asymmetric activation & rectification + front upper dominance of PNT asymmetric activation & rectification” drive programme (just the vertical swoop drive programme) and “back lower dominance of PNT asymmetric activation & rectification + front lower dominance of PNT asymmetric activation & rectification” drive programme (just the vertical elevation drive programme), and it’s convenient for us to arrange the two pairs of symmetrical elastic spouses separately on the left side and right side of the main crossbeam of PNT engine steering wheel for operational expedience of left hand and right hand, we just separately call the two pairs of symmetrical elastic spouses “left swoop symmetrical elastic spouses” and “right elevation symmetrical elastic spouses”, which can be simplified as “left swoop elastic spouses” and “right elevation elastic spouses”.

Left swoop elastic spouses is used to transfer and control the vertical swoop drive programme, just to transfer and control operation of “back upper dominance of PNT asymmetric activation & rectification + front upper dominance of PNT asymmetric activation & rectification” drive programme. The both hold surfaces of left swoop elastic spouses are parallel but a little higher of the two left side surfaces of the main crossbeam of PNT engine steering wheel so as to be convenient for manual operation of left hand. The geometrical assembly of left swoop elastic spouses fixed on PNT engine steering wheel is generally as below:



(VI-i-2~56) left swoop elastic spouses (VI-i-2~57) Left swoop elastic spouses fixed on PNT engine steering wheel

Apparently, once we take hold of the left swoop elastic spouse on the left side of the main crossbeam of PNT engine, the “back upper dominance of PNT asymmetric activation & rectification + front upper dominance

of PNT asymmetric activation & rectification” drive programme is transferred and controlled thereby, the bigger the handhold force added onto the swoop elastic spouses is, the wattage output of implementation of “back upper dominance of PNT asymmetric activation & rectification + front upper dominance of PNT asymmetric activation & rectification” drive programme is, and the interval the handhold force lasts on the swoop elastic spouses is just the performance time extension of vertical swoop drive programme.

Right elevation elastic spouses is used to transfer and control the vertical elevation drive programme, just to transfer and control operation of “back lower dominance of PNT asymmetric activation & rectification + front lower dominance of PNT asymmetric activation & rectification” drive programme. The both hold surfaces of right elevation elastic spouses are parallel but a little higher of the two right side surfaces of the main crossbeam of PNT engine steering wheel so as to be convenient for manual operation of right hand. The geometrical assembly of right elevation elastic spouses fixed on PNT engine steering wheel is generally as below:



(VI-i-2-58) Right elevation elastic spouses (VI-i-2-59) Right elevation elastic spouses fixed on PNT engine steering wheel

Apparently, once we take hold of the right elevation elastic spouse on the right side of the main crossbeam of PNT engine steering wheel, the “back lower dominance of PNT asymmetric activation & rectification + front lower dominance of PNT asymmetric activation & rectification” drive programme is transferred and controlled thereby, the bigger the handhold force added onto the elevation elastic spouses is, the wattage output of implementation of “back lower dominance of PNT asymmetric activation & rectification + front lower dominance of PNT asymmetric activation & rectification” drive programme is, and the interval the handhold force lasts on the elevation elastic spouses is just the performance time extension of vertical elevation drive programme.

In terms of the manual transfer and operation of level drive programme (just the oval wheel fashion symmetrical PNT activation and rectification drive programme of “ $P_{真} = \tilde{E}_{b+f}[(W_b+w_b), (W_f+w_f)]$ ”), we can consider to design the manual control part into geometrical fashion of mid ring of mouse and just to fix it onto the sub-crossbeam of PNT engine steering wheel, we just call it “control ring of level drive”, whose geometrical profile and assembly on PNT engine steering wheel are as below:



(VI-i-2~60) Control ring of level drive (VI-i-2~61) Control ring of level drive fixed on PNT engine steering wheel

For some certain necessity, we can define that the control ring of level drive of PNT engine can only run rotation of radian range of $(0^0, 360^0)$, and we evenly distribute the wattage output of drive programme of “ $P_{active} = \tilde{E}_{b+f}[(W_b+W_b), (W_f+W_f)]$ ” on radian range of $(60^0, 360^0)$, the rotation radian of control ring of level drive on radian range $(60^0, 360^0)$ is proportional to the wattage output of level drive of PNT engine. However, the radian range of $(0^0, 60^0)$ is start preparatory range, it means once the control ring of level drive comes to rotate from 0^0 radian to 60^0 radian; all functions related to PNT engine drive start will therefore be ready one by one. For instance, once it's necessary for PNT engine to start off from the earth, in order not to impinge against the obstacle around, the driver can first adjust the control ring of level drive to the position of 60^0 radian, then catch hold of the right elevation elastic spouses as to perform vertical elevation drive programme for a little while.

The whole assembly of PNT engine steering wheel is as below:



(VI-i-2~62) whole assembly of PNT engine steering wheel

PNT engine steering wheel is better to be fixed on the gravity center position of PNT engine.

(4) Introduction of auxiliary devices of PNT engine

As coherent natura naturans throughout cosmic evolution, instinctive PNT reciprocal equilibrium towards optimum PNT operation is radical potentiality & conditionality for cosmos always ready to orientate itself towards perfection.

4. 1. Introduction of outside protective devices of PNT engine

As exact functional components, the PNT activators and PNT rectifiers of course can not be exposed in the air, we have to consider giving the assembly of “tyre core + PNT activators + PNT rectifiers” necessary outside protective devices. Thus, we introduce “tyre core upper jacket plate” and “tyre core lower jacket plate”, which can be simplified as “upper jacket plate” and “lower jacket plate”. The geometric profiles of upper jacket plate and lower jacket plate are as below:

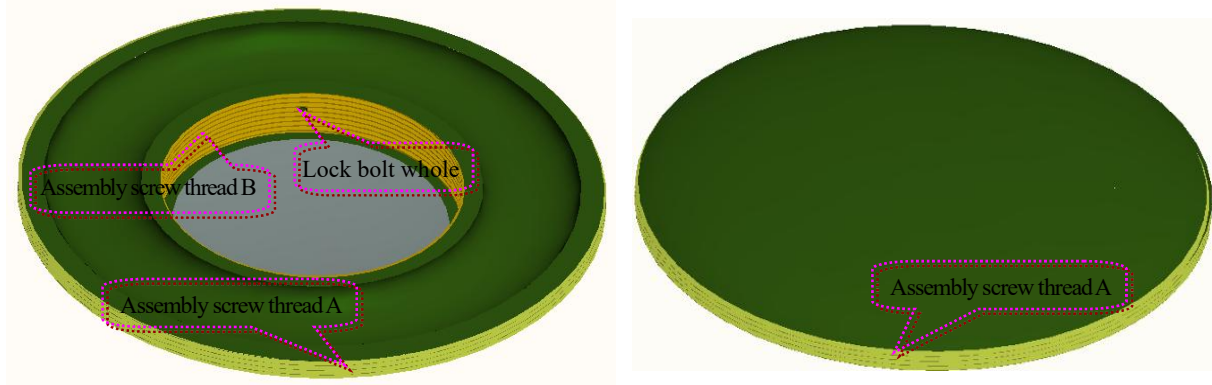

(VI-i-2~63) Inner view of tyre core lower jacket plate

(VI-i-2~64) Outside view of tyre core lower jacket plate

The lock bolt whole can not penetrate through the lower jacket plate, but embed in proper depth.

The assembly of (tyre core + PNT activators + PNT rectifiers) + (tyre core lower jacket plate) is as below:

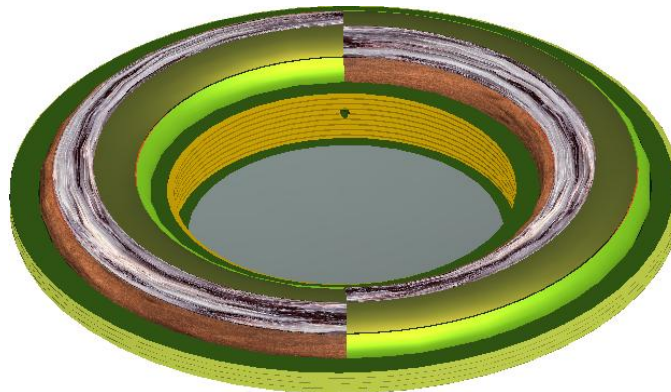

(VI-i-2~65) (tyre core + PNT activators + PNT rectifiers) + (tyre core lower jacket plate)

The tyre core upper jacket plate is as below:

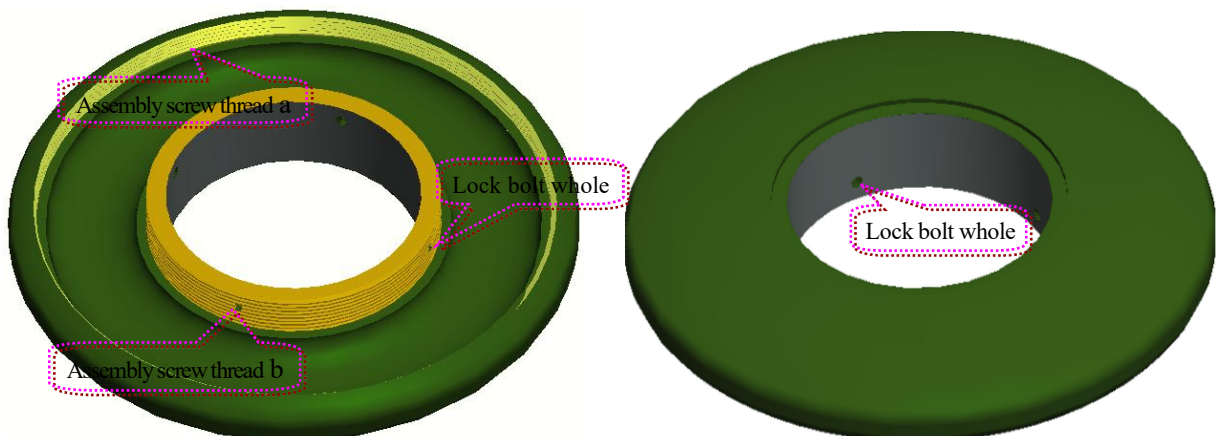

(VI-i-2~66) Inner view of tyre core upper jacket plate

(VI-i-2~67) Outside view of tyre core upper jacket plate

Historical progress of science in the recent several centuries seemed like a far-flung exploration of the first itinerary around numerous distinctive landscapes of brand-new landmasses of science with palette & tablet on back, several hundred years' scientific travelogues were compiled thereby.

The assembly of upper jacket plate & lower jacket plate depends on the exact inosculation of “assembly screw thread A + assembly screw thread a” and “assembly screw thread B+ assembly screw thread b” with 4 lock bolts fixed.

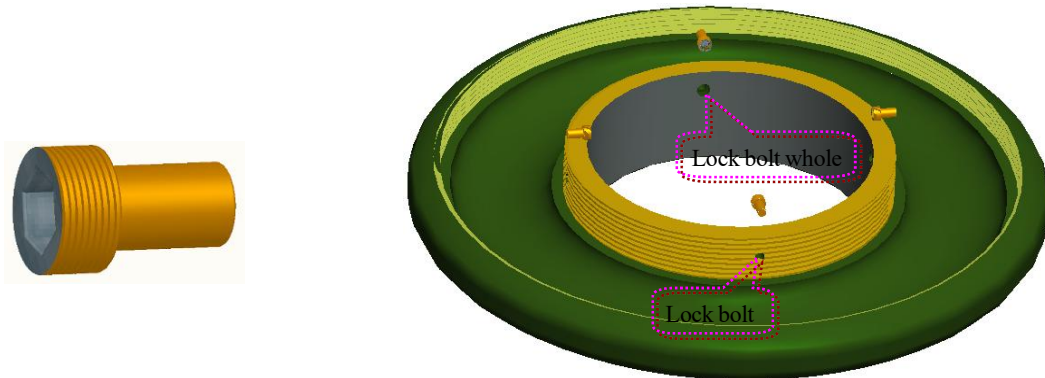

(VI-i-2~68) Lock bolt

(VI-i-2~69) Lock bolt and lock bolt whole on upper jacket plate

If the orientation adjusting of oval wheel fashion rotary PNT activation & rectification introduces “hard rotation mechanism”, as the mechanical circumgyration of PNT activators and PNT rectifiers inside maybe drive the upper jacket plate or lower jacket plate along the screw thread as to release exact assembly of upper jacket plate and lower jacket plate, as a result, the 4 lock bolts are very necessary. If the orientation adjusting of oval wheel fashion rotary PNT activation & rectification introduces “soft rotation mechanism”, the 4 lock bolts can be neglected, or 4 smaller ones (even 2 smaller ones) has been enough already.

The assembly of upper jacket plate and lower jacket plate with “tyre core + PNT activators + PNT rectifiers” inside as below:

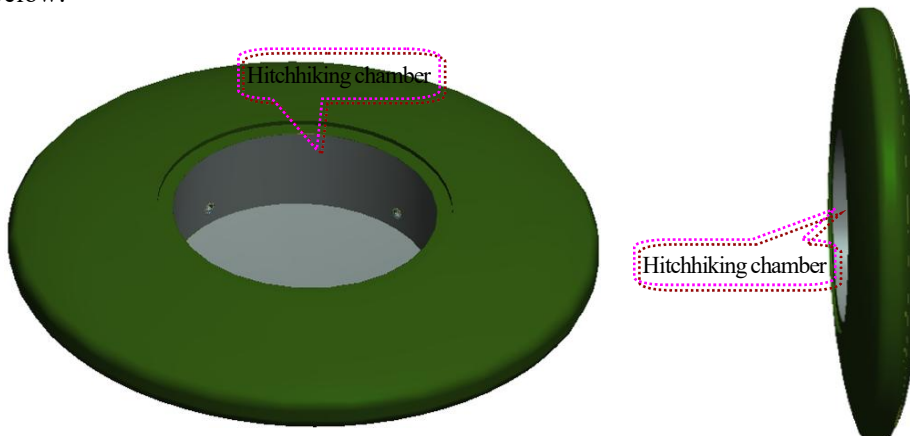

(VI-i-2~70) (upper jacket plate + lower jacket plate) + 4 lock bolts

The mid columniform chamber formed by assembly of “upper jacket plate + lower jacket plate” is just the so-called “hitchhiking chamber” of PNT engine.

4. 2. Introduction of functional auxiliary devices of PNT engine

The major functional auxiliary devices of PNT engine are the usually auxiliary devices focused preparatory work input and successive work output of PNT activators and PNT rectifiers including control keyboard (including PNT engine steering wheel), memorizer of operation programs of PNT activation & rectification, physical signal modulator of PNT activation & rectification programs, programtracer and operation state monitor of PNT activation & rectification input & output and the consequential tyre core stimulation outcome.

As coherent natura naturans throughout cosmic evolution, instinctive PNT reciprocal equilibrium towards optimum PNT operation is radical potentiality & conditionality for cosmos always ready to orientate itself towards perfection.

① Control keyboard (or PNT engine steering wheel) is just the device used to input operational program of PNT activation & rectification as introduced above. However, the keyboard (or PNT engine steering wheel) is a purely manual control device; manual control can of course be directly accessible to sense of desire but not a strict way to ensure precise control of the dynamics status of PNT engine. Manual control of course demands the driver of PNT engine should have rather experienced hand handle and rather sensitive response, and even the driver has rather experienced hand handle and rather sensitive response, manual control itself is still not an ideal way to ensure precise control of PNT engine. If PNT engine need search objective and have to fly in narrow space against rough obstacles, good hand handle can of course make it go at our sweet will, a casual rough hand handle maybe make the PNT engine out of its sane behaviors, either have gone too far over objective or deviated the exact orientation to objective, or it's time for engine to keep relatively stationary to our objective, while the PNT engine still slides away unexpectedly, ... and even more bloodcurdling thing is that our PNT engine maybe unexpectedly knock onto obstacles around. So, in order to ensure the PNT engine can precisely work at our sweet will, it's still necessary to introduce another "numerical control keyboard" coordinating active menu on screen. This numerical control keyboard usually helps us input four types of state control parameters: the first, which operational program is ready to be implemented, the second, which terminal objective stage value of the proper operational program the PNT engine operation should approach, the third, how much time is scheduled for the state switchover from current state to objective state of PNT engine, the fourth, whether the objective state should be kept steady-going once state switchover finished or not.

② Data memorizer of operation programs of PNT activation & rectification is a storage for qualified numerical programs of PNT activation & rectification, which directly accepts and identifies the commands from control keyboard or PNT engine steering wheel and manoeuvres the proper numerical operation program to physical signal modulator of PNT activation & rectification.

③ Physical signal modulator of PNT activation & rectification is a function unit to modulate the original numerical program of PNT activation & rectification coming from program memorizer into physical PNT activation & rectification signal and send the modulated physical signals to PNT activators & PNT rectifiers. The major function of physical signal modulator of PNT activation & rectification is to translate the proper numerical program to corresponding physical signal and send the modulated physical signal to PNT activators and PNT rectifiers which PNT activators & PNT rectifiers can quote directly.

④ Programtracer and operation state monitor of PNT activation & rectification input and the consequential tyre core stimulation outcome: here the PNT activation & rectification input generally means the transference and transmutation process of commands derived from control keyboard or PNT engine steering wheel to PNT activators & PNT rectifiers; while the stimulation outcome generally means the consequential reaction status of tyre core when the tyre core received the physical PNT activation & rectification signals. The programtracer and operation state monitor mainly identifies and analyzes the related data of program command input, program command transference and physical transmutation, consequential PNT reaction in tyre core etc, and show the identification and analysis on screen as readable data for reference to the driver of PNT engine.

Of course, besides these several major functional auxiliary devices above, there still should be auxiliary devices as power supply for initial starting, remote sense, fundamental communication, remote control device, anti-jamming defence ② of remote control signal, PNT activation & rectification program transference and

transition, communication etc. As it's necessary for all the supplemental devices to be distributed around the hitchhiking chamber equally by weight, I arrange the integrate distribution diagram of all the supplemental devices as below:

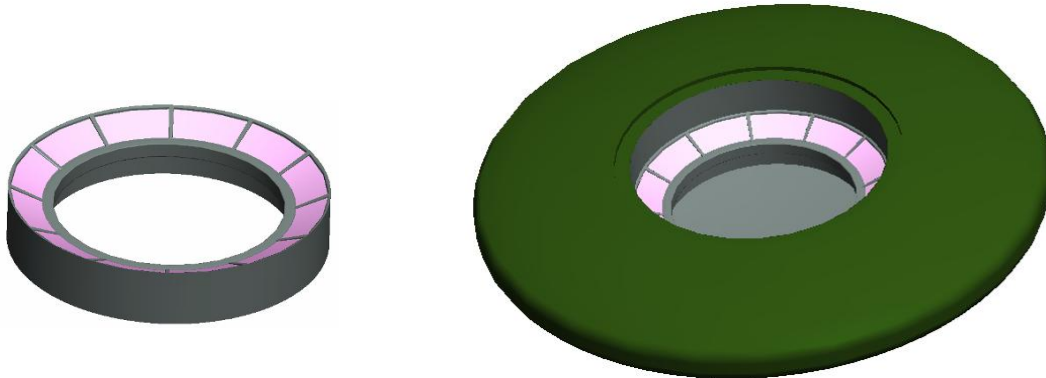

(VI-i-2~71) Diagram of integrate distribution of all supplemental devices of PNT engine

(VI-i-2~72) supplemental devices in PNT engine hitchhiking chamber

Of course, the hitchhiking chamber still needs a top cover.

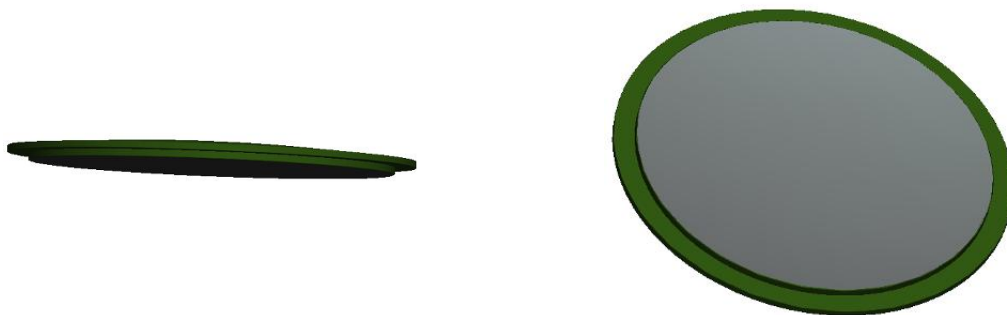

(VI-i-2~73) Side view of hitchhiking chamber top cover

(VI-i-2~74) Inside view of hitchhiking chamber top cover

Added the top cover of hitchhiking chamber, the integrate profile of PNT engine is as below:

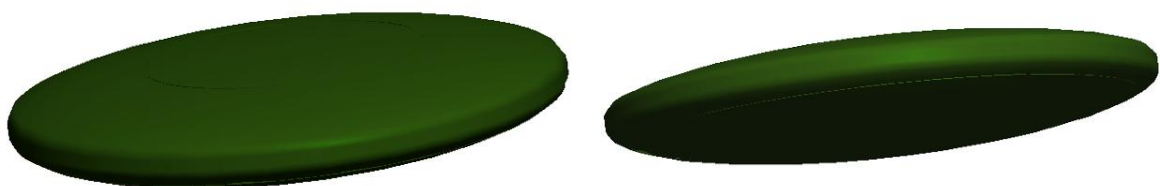

(VI-i-2~75) Downward view of PNT engine

(VI-i-2~76) Upward view of PNT engine

Note ②: The anti-jamming defence of remote control signal, PNT activation & rectification program transference and transition of PNT engine is very important. Because remote control signals, PNT activation & rectification program transference and transition are the most sensitive and frangible “nerve” of PNT engine and it's easy to be attacked at. Once the remote control signal, PNT activation & rectification program transference and transition of PNT engine is disturbed, if slightly disturbed, the PNT engine maybe fly madly for control confusion, if intensively disturbed, it maybe cause PNT activation & rectification program serious distortion, so that the disturbed PNT activation & rectification operation recklessly runs towards the “quantitative change deadline of PNT activation & rectification”, even runs through the “quantitative change deadline of PNT activation & rectification”, so that the volitional PNT activation & rectification of PNT engine turns into self-destruction, the tyre core of PNT engine will be bombed out like an A-bomb. Usually, we are

As coherent natura naturans throughout cosmic evolution, instinctive PNT reciprocal equilibrium towards optimum PNT operation is radical potentiality & conditionality for cosmos always ready to orientate itself towards perfection.

convenient to add anti-jamming defence function on tyre core lower jacket plate, tyre core upper jacket plate and hitchhiking chamber top cover of PNT engine. And at the same time, it's still necessary for us to design secure function into programtracer and operation state monitor of PNT activation & rectification input and the consequential tyre core stimulation outcome, once the programtracer and operation state monitor find out the disturbed PNT activation & rectification program operation recklessly runs towards the “quantitative change deadline of PNT activation & rectification”, it can immediately react to stop all PNT activation & rectification operation any longer.

All in all, the dynamic rationale of PNT engine is that universal existence & motion of matter essentially depends on the PNT operation of matter integration in spacetime, the remarkable exploitation intelligence of it is that it comes to affect and control the PNT operation of object against idiographic PNT operation characters and in accordance with the fundamental of PNT operation and PNT continuously controllability necessity as to materialize ideal existence & motion of object as we expected. The scientificity of PNT engine exploration depends on two issues: the first, whether universal existence & motion of matter essentially depends on the PNT operation of matter integration in spacetime is really true, and if yes, in accordance with the rich and colorful existence of matter in cosmos, there must be optimum PNT operation pattern and relatively better PNT operation pattern in the nature for the disparity in PNT operational genic configurations, as long as we can practically manage the sequential optimization of non-optimum PNT operation or non-better PNT operation toward optimum PNT operation /relatively better PNT operation of object according to practical feasibility and volitional purpose, we can then materialize acceleration of object thereby, and of course, we can also stop or release volitional PNT optimization all the way as to materialize deceleration of object. Thus, we can control the existence & motion of object followed our inclinations. The second, in the face of the idiographic object whose PNT operation we are ready to control, whether our practical PNT artificial control method is feasible and effective according to necessity of PNT continuously controllable demands.

But as we still have poor knowledge about the PNT operation of matter in spacetime at present, it's substantively not convenient for us to demonstrate perfect PNT engine design directly extended from idiographic PNT operation characters of object according to necessity of PNT continuous controllability and practical feasibility. And indeed, the tyre model of PNT engine introduced here is only logic extension based on assumable precondition that atomic reciprocal PNT combination α can be accelerated along linear orientation once stimulated by PNT activation signal β and the related necessity of PNT continuous controllability. As the PNT activation source and PNT activation signal have not been confirmed yet, the material design of PNT engine can not follow a rational line to be outspreaded along the connatural separate PNT operational configurations of idiographic atomic reciprocal PNT combination used as PNT activation source and the proper PNT activation signal, the consequential operational characteristic of PNT reaction between PNT activation source and PNT activation signal, especially the feasible controllable character & potential of the PNT reaction. The tyre model of PNT engine introduced above still only primarily involved in the dynamic rationale & integrate function definition of PNT engine, major functional components & the corresponding function definition, geometric profiles, assembly & cooperative relations of the functional components, but still not involved the idiographic functional parameters. And as a result, the current PNT engine design is still a preliminary design according to PNT operational optimization possibility and PNT continuous controllability necessity; it is still far away from ultimate consummation design which can fully support practical production of PNT engine. The intention I introduced the idea before practical discovery of accessible idiographic PNT activation source and PNT activation & rectification signal

is but to highlight what is PNT engine and what's the objective technologies of PNT engine further to people so as to make the fact explicit, —confronting such technology challenge, what has been aware in our mind, what is still out of our mind and need further clarification & demonstration, what can be materialized by us now and what are till above our temporal practical capability. After all, once the real issues come to confront us, it means half of the issues have been practically overcome.

In order to consummate perfect design of PNT engine which directly support production on line, there are still three fundamental objective issues need verification and accomplishment in prior.

The first: The confirmation and choice of accessible PNT activation source and PNT activation signal, so that we can lock at the idiographic original objective data —the related physic configuration & character of idiographic PNT activation source & PNT activation signal and the operational character of PNT reaction between PNT activation source & PNT activation signal, especially character due to PNT continuous controllability & potential for feasible exploitation.

The second: according to the idiographic physic property of PNT activation source and PNT activation & rectification signal and objective operational characters of PNT reaction between PNT activation source and PNT activation & rectification signal, define the necessary functions of PNT activators & PNT rectifiers including the feasible and qualified modulation and transference of oval wheel fashion signal portrayal in accordance with appropriate quantitative change formula of PNT activation & rectification.

The third: In accordance with the durable operational character of PNT reaction between PNT activation source and PNT activation signal, study out necessary functional quantitative change formula of PNT activation & rectification as reference basis of controllable operation program.

Among the three issues above, the first issue is the linchpin of PNT engine design, the second issue and the third issue is but to consequently define the functional necessities of PNT activators and PNT rectifiers and how to materialize the necessary functional necessities under conditional verification of the first issue.

Once we possess of logos capital of atom state equation in spacetime, we can of course intelligently aim at the objective necessity to expediently search and choose ideal PNT activation source & PNT activation signal by mathematical operation basing on atom state equation in spacetime, and successively go further step to predict the idiographic operation property, artificial controllable characteristics and potential for stimulation exploitation of PNT reaction between the proper PNT activation source and PNT activation signal, and as the necessity of production materialization, it's wise to implement experimental demonstration according to the scheduled data in prior. While, it's regret that we still do not have the logos capital at present, many of the related technological issues need experimental exploration in semi-hazy intelligence. I am genuinely sorry I can not directly deduce PNT engine design from rational origin of physic configuration and attribute of PNT activation source and PNT activation & rectification signal and the operational characters of PNT reaction between the proper PNT activation source and PNT activation & rectification signal, I am genuinely sorry I can not consummate PNT engine design expediently extended from ideal resource of keys of the three issues above.

Of course, I can not exclude the possibility that as ultimate practical confirmation of PNT activation source and PNT activation & rectification signal in the future, the idiographic operation status of PNT reaction between PNT activation source & PNT activation signal is consequently more and more explicit in our eyeshot,

As coherent natura naturans throughout cosmic evolution, instinctive PNT reciprocal equilibrium towards optimum PNT operation is radical potentiality & conditionality for cosmos always ready to orientate itself towards perfection.

there may be remarkable modification in PNT engine design. And indeed, under current condition, it's even more felicitous to say I am now trying to highlight the originality of PNT engine design instead of trying to consummate PNT engine design, —upon preliminary illumination of the related issues about PNT normalized activation of atomic reciprocal PNT combination to highlight the corresponding technological challenge of PNT engine so as to outspread exploitative purview of PNT engine study and design before readers at the volley. On one hand, as the atom state equation in spacetime is still in its primeval status, it's substantively difficult for us to break loose of exploration be puzzlement in PNT engine design, and on the other hand, I am not prodigy indeed. I try it herein is but for a pioneering exordium of PNT engine exploration. I sincerely hope, confronting such technological challenge, our troop will be grander and grander, and the way under our feet will be broader and broader!

——In June, 2008, Hunan, Wugang, Zhenzhu (Tyre core round section design)

In Sep, 2009, Guangdong, Chaoan, Tiepu (Tyre core ellipse section design modification)

(VI-i-3) Preliminary experimental exploration of PNT engine

Abstract: *In homogenous cosmos, “PNT action” is enantiomorphous dynamic origin of hypostatic existence & motion of matter integration in spacetime, the conditionality of PNT action of matter integration is adjustable and controllable. Preliminary experimental exploration of PNT engine is endeavor to ascertain applicable “PNT activation source and PNT activation & rectification signal”, so that we can even look into the operational character and modulation controllability of PNT reaction between PNT activation source and PNT activation & rectification signal.*

In terms of operational mechanism, so-called PNT engine is just special “clutch” of optimum (/relatively better) PNT action linkage, which can be expressed as following:

PNT activation signal + PNT activation source Precipitate Operation of optimum (/relatively better) PNT action linkage.

The three issues preliminary experimental exploration of PNT engine must pursue are as following:

The first: ascertainment of appropriate optimum (/relatively better) PNT action linkage.

The second, ascertainment of appropriate disassembly and synthesis of optimum (/relatively better) PNT action linkage and the proper material carriers of the disassembled sub-linkages

The third: Safety & reliability analysis & evaluation of optimum (/relatively better) PNT action linkage running in PNT activation source and the related state supervision, modulation & safe control.

Keywords: *optimum (/relatively better) PNT action linkage, clutch mechanism of optimum PNT action linkage, disassembly of goal optimum PNT action linkage, father linkage of PNT engine, mother linkage of PNT engine, synthesized revival of optimum PNT action linkage.*

Foreword: Since vivid existence & motion of matter integration radically depends proportionate PNT operation of matter integration, can straightforwardly control necessary motion of matter integration by direct readjustment/management of PNT operation of matter integration? As long as vivid existence & motion of matter integration radically depends proportionate PNT operation of matter integration, as long as PNT operation of matter integration is feasibly controllable, my answer is “yes”. As a result, scientific idea of “PNT engine” was originally came to me in April, 2006. In June, 2006, I wrote down “Common engine and flying saucer engine”. In June, 2008, I wrote down “Tyre model of PNT engine”.

Whereas, “tyre model of PNT engine” was still primary idea on the basis of physical characteristics of PNT activation & rectification signal, PNT activation source (atomic reciprocal PNT combination) and continuation controllability of the very PNT reaction between PNT activation & rectification signal and PNT activation source. As a result, tyre model of PNT engine is still not the integrated and hypostatic design of PNT engine in accordance with hypostatic operational character and modulation controllability of PNT reaction between PNT activation source and PNT activation & rectification signal. Virtually, when I primarily brewed “tyre model of PNT engine”, I had the necessary idea in mind indeed, Whereas, just because practical limitation, none applicable “PNT activation source and PNT activation & rectification signal” have been ascertained, no more favorable rationale of operational character and modulation controllability of PNT reaction between PNT activation source and PNT activation & rectification signal due to necessity of PNT continuous controllability, I could only do my best to highlight PNT engine design like this.

Virtually, in terms of source exploration of PNT activation source and PNT activation & rectification signal, it seems that we still lack of necessary logos capital before ultimate consummation of Atom State Equation in Spacetime, we have to bet on indistinct experiment exploration. Whereas, weltering in so omnifarious physical existence & motion around us, how can we push forward our experimental

As coherent natura naturans throughout cosmic evolution, instinctive PNT reciprocal equilibrium towards optimum PNT operation is radical potentiality & conditionality for cosmos always ready to orientate itself towards perfection.

exploration with definite pursuit in mind?

Towards the pursuit, I'd like to introduce some of my ideas herein, I hope my endeavor can avail readers who are interested in this subject and have necessary conditions to do something possible. In any case, preliminary experimental exploration of PNT engine is endeavor to ascertain appropriate PNT activation source and PNT activation & rectification signal, once appropriate PNT activation source and PNT activation & rectification signal are ascertained, as long as we are ready to look into rational necessity of PNT engine, the proper continuous controllability and corresponding controllable necessity are but something accessible like a rat in a hole.

As initial endeavor of natura naturans personalization towards human necessity based on primary authenticity clarification of Homogenous Cosmos Originated from Unique Genesis, theoretical evidence of PNT engine is that cosmos is demiurgic aggradation of sequential homologic cosmogony, which exactly exist as well-regulated integration of cosmic homogeneity system making up of out-and-out serial natura naturata in the nature of coherent natura naturans throughout cosmic evolution, “universal existence & motion” are but spontaneous occurrence of [External physical disturbance + (PNT action + Instinctive PNT equilibrium)], which of course indicates hypostatic existence & motion is but dynamic enantiomorph of PNT action of matter integration. As technologic practice towards drive of object, engine contriving is straightforward creationary endeavor to facilitate PNT operation of matter integration artificially adjustable towards “ideal motion” following our inclinations, which is dynamic noumenon of connatural existence & motion in the nature of coherent natura naturans throughout cosmic evolution.

Experimental exploration of PNT engine is endeavor to ascertain applicable “PNT activation source and PNT activation & rectification signal”. In terms of operational mechanism, so-called PNT engine is just special “clutch” of optimum (/relatively better) PNT action linkage, which can be expressed as following:

PNT activation signal + PNT activation source $\xrightarrow{\text{Precipitate}}$ Operation of optimum (/relatively better) PNT action linkage.

The three issues preliminary experimental exploration of PNT engine must pursue are as following:

The first: ascertainment of appropriate optimum (/relatively better) PNT action linkage.

The second, ascertainment of appropriate disassembly and synthesis of optimum (/relatively better) PNT action linkage and the proper material carriers of the disassembled sub-linkages

The third: Safety & reliability analysis and evaluation of optimum (/relatively better) PNT action linkage running in PNT activation source and the related state supervision, modulation & safe control.

We now come to substantiate the three issues one by one:

(1) Ascertainment of appropriate optimum (/relatively better) PNT action linkage

As distinctions of integral genic configuration of matter integration and space field strength, the operational speeds of PNT actions or PNT reactions are generally different. Among rich and colorful PNT actions and PNT reactions with different operational speeds, there must be optimum (/relatively better) PNT action linkage for relatively high speed PNT operation. So-called “optimum (/relatively better) PNT action linkage” is just the best integral genic configuration for field potential concrete vallum to revivify.

The innate existence of PNT actions in the nature are not always in PNT operation patterns along optimum (/relatively better) PNT genic linkage. If we can mastermind to turn the PNT operation patterns along non-optimum PNT genic linkage into operation patterns along optimum (/relatively better) PNT genic linkage of object, we then can mastermind and control the operation status of PNT action of matter integration

Historical progress of science in the recent several centuries seemed like a far-flung exploration of the first itinerary around numerous distinctive landscapes of brand-new landmasses of science with palette & tablet on back, several hundred years' scientific travelogues were compiled thereby.

followed our inclinations. That's to say, we can practically impact and control the magnitude of $d(M \rightarrow m)$ and $d(M \leftarrow m)$ of PNT operation of matter integration as long as we can maintain the continuous controllability of matter integration synchronously. In accordance with original definition of absolute spacetime momentum $m \cdot V = d(M \leftarrow m) \cdot Y \iff V = d(M \leftarrow m) / m$ we can know that the variation of $d(M \leftarrow m)$ directly impacts the motion speed of matter integration, we can effectively dominate the motion speed of mater system therefore.

(2) Ascertainment of appropriate disassembly and synthesis of optimum (/relatively better) PNT action linkage and the proper material carriers of the disassembled sub-linkages

How can we feasibly turn the PNT operation pattern along non-optimum PNT action linkage into PNT operation pattern along optimum (/relatively better) PNT action linkage?

Our positive key is of course try to synthesize optimum (or relative better) PNT action linkage, — under proper conditions, compound some certain non-optimum PNT action linkages into optimum action linkage accordingly. For accessible comprehension, we can suppose to disassemble the optimum (/relatively better) PNT action linkage into two sub-linkages and consider to recover the optimum PNT action linkage operation by synthesizing the both PNT action sub-linkages, as long as we can practically find such two material carriers with the both PNT action sub-linkages contained in and accessible for synthesis, as long as we can synthesize the both sub-linkages in one of the proper material carriers and can control the synthesis ratio of the both PNT action sub-linkages, we then can ensure the recovered optimum (or relative better) PNT action linkage will work in the proper material carrier and cause proportionate acceleration of the very material carrier therein, which is just the very occurrence under our expectation.

For convenience for further analysis, we define the optimum (/relatively better) PNT action linkage into aggregation format as $\{O_L\} = \{z_1 \cdot i_{n+1}, z_2 \cdot i_{n+2}, z_3 \cdot i_{n+3}, \dots, z_{n+p} \cdot i_{n+p}\}$, ($n, p \in \mathbb{N}, z_1, z_2, z_3, \dots, z_{n+p} \in \mathbb{Z}$), (The letter "O" in "O_L" is the abbreviation of "optimum"; the suffix "L" in "O_L" is the abbreviation of "linkage".)

According to discretionary dimidiate combination fundamental, there are totally $C_p^1 + C_p^2 + C_p^3 + \dots + C_p^{p-1}$ sorts disassembly cases of optimum (/relatively better) PNT action linkage. Whereas, in fact, it is not any disassembly case feasible and effective, we must choose feasible and effective disassembly case according to practical possibility and availability. So-called "feasible and effective disassembly case" of optimum (/relatively better) PNT action linkage is that, according to practical choice possibility and availability of material carriers, we disassemble the optimum (/relatively better) PNT action linkage into two PNT action sub-linkages, one is consigned in PNT activator, the other is consigned in PNT activation source, once the PNT activator works on the PNT activation source, the PNT action sub-linkage representing the PNT activation signal can synthesize the PNT action sub-linkage on PNT activation source into "optimum (/relatively better) PNT action linkage" and precipitate the PNT operation in optimum (/relatively better) PNT action linkage pattern on PNT activation source as to actualize acceleration of PNT engine.

For convenience of explicit description, we denote the breakaway PNT action sub-linkage from optimum (/relatively better) PNT action linkage taking role of PNT activation signal as "father linkage of PNT engine"; and we denote the remainder PNT action sub-linkage of optimum (/relatively better) PNT action linkage after father linkage of PNT engine has been drawn out as "mother linkage of PNT engine". And we denote the material carrier of father linkage of PNT engine as PNT activator and denote the material carrier of mother linkage of PNT engine as PNT activation source.

As coherent natura naturans throughout cosmic evolution, instinctive PNT reciprocal equilibrium towards optimum PNT operation is radical potentiality & conditionality for cosmos always ready to orientate itself towards perfection.

For necessity of further mathematical formulation, we express the father linkage of PNT engine and the mother linkage of PNT engine into aggregation format as $\{E_f\} = \{j_1 * i_{n+1}, j_2 * i_{n+2}, j_3 * i_{n+3}, \dots, j_{n+p} * i_{n+p}\}$, ($n, p \in \mathbb{N}$; $j_1, j_2, j_3, \dots, j_{n+p} \in \mathbb{Z}$ and $j_1 \leq z_1, j_2 \leq z_2, j_3 \leq z_3, \dots, j_{n+p} \leq z_{n+p}$.); $\{E_m\} = \{k_1 * i_{n+1}, k_2 * i_{n+2}, k_3 * i_{n+3}, \dots, k_{n+p} * i_{n+p}\}$, ($n, p \in \mathbb{N}$; $k_1, k_2, k_3, \dots, k_{n+p} \in \mathbb{Z}$ and $k_1 \leq z_1, k_2 \leq z_2, k_3 \leq z_3, \dots, k_{n+p} \leq z_{n+p}$.), (The letter “E” in both “E_f” and “E_m” is the abbreviation of “engine”, the suffixes “f” and “m” are abbreviation of “father” and “mother”). Apparently, the integer coefficients $z_1, z_2, z_3, \dots, z_{n+p}$, $j_1, j_2, j_3, \dots, j_{n+p}$ and $k_1, k_2, k_3, \dots, k_{n+p}$ of the three aggregations $\{O_L\}$, $\{E_f\}$, $\{E_m\}$ satisfy $j_1 + k_1 = z_1, j_2 + k_2 = z_2, j_3 + k_3 = z_3, \dots, j_{n+p} + k_{n+p} = z_{n+p}$.

Choice principle of appropriate disassembly & synthesis of optimum (/relatively better) PNT action linkage and the proper material carriers of father linkage of PNT engine & mother linkage of PNT engine

The first: Choice principle of father linkage of PNT engine and the proper material carrier

The father linkage of PNT engine must be able to be radiated from PNT activator as radiation perfectly and be able to be imitted into PNT activation source so that it is possible for father linkage of PNT engine and mother linkage of PNT engine to synthesize into optimum (/relatively better) PNT action linkage expediently as to precipitate optimum (/relatively better) PNT action linkage operation in PNT activation source efficiently.

The second, Choice principle of mother linkage of PNT engine and the proper material carrier

As material carrier of mother linkage of PNT engine, the PNT activation source must not only have intact and wealthy mother linkages of PNT engine, but also can burthen energetic operation of optimum (/relatively better) PNT action linkage in it safely and behave regular motion or easy to maintain regular motion, so that it’s possible and expedient for PNT engine to drive and to maintain durative controllability.

If the reciprocal correlation between disassembled PNT activator and PNT activation source are just like the reciprocal correlation as atomic fission reaction between “neutron” and “uranium atom”, once the neutron is imitted into uranium nucleus and consequently recovers the optimum (/relatively better) PNT action linkage in uranium nucleus, the uranium nucleus bursts dissolvingly, such optimum (/relatively better) PNT action linkage running in PNT activation source of uranium atom is but equal to PNT engine self-destruction, either as PNT activation signal, the neutron is too cruel, or as PNT activation source, the uranium atom is too frangible. Such failure instance has apparently accounted for why we must search and procure the best disassembly and synthesis scheme of optimum (/relatively better) PNT action linkage and the best material carriers of father linkage of PNT engine and mother linkage of PNT engine with less negative impact, so that durative activation control is feasible and reliable.

Of course, the PNT engine clutch mechanism we’ve introduced above is but only the dimidiate disassembly and synthesis mechanism of optimum (/relatively better) PNT action linkage, in our practical exploration of PNT engine, in accordance with external possibility and feasibility, we can of course consider multi-sub-linkages disassembly and synthesis mechanism of optimum (/relatively better) PNT action linkage, and we may even consider multriple disassembly and synthesis mechanism of optimum (/relatively better) PNT action linkage. So-called “multi-sub-linkages disassembly and synthesis mechanism of optimum (/relatively better) PNT action linkage” is just a PNT synthesis modus operandi we disassemble the optimum (/relatively better) PNT action linkage into three or more PNT action sub-linkages and recover synthesizing them into optimum (/relatively better) PNT action linkage operation pattern as to achieve drive. So-called “multriple disassembly and synthesis mechanism of optimum (/relatively better) PNT action linkage” is just a PNT synthesis modus operandi, before the

Historical progress of science in the recent several centuries seemed like a far-flung exploration of the first itinerary around numerous distinctive landscapes of brand-new landmasses of science with palette & tablet on back, several hundred years’ scientific travelogues were compiled thereby.

father linkage of PNT engine and the mother linkage of PNT engine ultimately recover synthesizing into optimum (/relatively better) PNT action linkage, the father linkage of PNT engine or /and the mother linkage of PNT engine have experienced generative synthesis once or more times.

(3) Safety & reliability analysis and evaluation of optimum (/relatively better) PNT action linkage running in PNT activation source and the related state supervision, restriction and readjustment.

Safety & reliability analysis and evaluation of optimum (/relatively better) PNT action linkage running in PNT activation source and the related state supervision, restriction and readjustment generally involve in the selection and burden capability strengthening of PNT activation source against optimum (/relatively better) PNT action linkage running in it and supervision, preventive restriction and readjustment against the related unexpected ruinous reaction and impact during the course of optimum (/relatively better) PNT action linkage running in PNT activation source. Because once the PNT activation signal works on PNT activation source, the optimum (/relatively better) PNT action linkage running in PNT activation source maybe inevitably impact the safe structure and durative controllability of the PNT activation source even maybe cause structure collapse, ruinous radiation, serious distortion and so on. For instance, once we shot uranium nucleus with neutron, uranium nucleus fissioned dissolvingly, it seems when we mastermind chain-reacting of uranium nucleus fission, we only advert how to achieve revival of optimum (/relatively better) PNT action linkage in uranium nucleus, but never take care of durative controllability of PNT activation source of uranium atoms. Virtually, in order to ensure durative controllability of PNT activation source, we have to consider the choice of burden capability and study the possible ruinous reactions and impact once optimum (/relatively better) PNT action linkage running in PNT activation source in advance, and proportionately prepare the proper functions to PNT state rectifier as to ensure the durative controllability of PNT engine.

All in all, as long as the universal existence & motion is objective freewheeling in the nature of coherent natura naturans throughout cosmic evolution, as long as the so-called “coherent natura naturans throughout cosmic evolution” can be comprehensible and can be feasibly under volitional control, flying saucer is of course creative possibility for corresponding natura naturans personalization towards human necessity. Whereas, experience told us time after time that original pioneering rationale is always not easy to conquer inrooted inertial experience at the volley, before Edison brought a material electric light into the world, men who had been used to lights from needfire, oil lamps and candle almost had no reason to believe electric light, and now, we can of course comprehend men who have been used to routine common engine introduced in automobile, aircraft, rocket may be reluctant to believe controllable operation of “PNT activation signal + PNT activation source Precipitate Operation of optimum (/relatively better) PNT action linkage” can create driving wonder. This seems something comprehensible; whereas, we should never leave our ambition and intellect paralysed for such insensibility, I am afraid.

——A wolf struggling on bottom of well

——Dec. 2008, Zhenzhu town, Wugang city, Hunan province

(VI-i-3) Question extract from “fund application for preliminary experimental exploration of PNT activation resource of PNT engine in 2011”

The question extract offered below was originally an official document of Chinese fund application which I used to apply fund support of experimental exploration of PNT engine in 2011. Of course, as low-down peasant floater without any official rank towards so extravagant application, I was left in silence till today but to keep the factuality in mind that the application had ever been submitted by me myself. Now, I offer it to my readers as reference towards tangible exploration of PNT engine technology and the related basic issues of science. However, I have to comment herein, this document involves nothing of Chinese classified information, I am but a peasant floater, and I never involved any official business in this field in mainland of China. I but made virgin use of the related inquiry in this application to elaborate my personal ideas about the proper issues and had ever done a humorless but ignorant submission to related Chinese office for an inaccessible opportunity. Considering of my personal idea may be expediential to highlight the tangible way towards exploration of PNT engine technology and related basic issues of science, I offer it for all my local Chinese and for all my cordial readers all over the world.



申请代码	
受理部门	
收件日期	
受理编号	

国家自然科学基金

申请书

(2011版)

国家科学技术学术著作出版基金项目申报系统
返回首页 | 退出系统

mark

功能菜单

- 项目申报
 - 填写项目申报书
 - 申报项目列表
- 在线答疑
- 系统管理

当前位置：项目列表

序号	学科编号	申报年度	书名	著作类别	所属学科	篇幅字数	助金额(万元)	状态	操作
1		2021	Homogenous Cosmos Originated from Unique Genesis / 单元纯系宇宙	学术专著	数理科学	92.0	--	草稿	[修改] [删除]
2		2020	单元纯系宇宙	基础理论著作	数理科学	80.0	--	草稿	[修改] [删除]
3		2019	Homogenous Cosmos Originated from Unique Genesis	基础理论著作	数理科学	75.0	--	草稿	[修改] [删除]
4		2018	单元纯系宇宙	学术专著	数理科学	68.0	--	草稿	[修改] [删除]
5		2017	单元纯系宇宙	学术专著	数理科学	66.0	--	草稿	[修改] [删除]
6		2016	单元纯系宇宙	学术专著	数理科学	66.0	--	草稿	[修改] [删除]

申报日期： 2011年6月25日

国家自然科学基金委员会

Historical progress of science in the recent several centuries seemed like a far-flung exploration of the first itinerary around numerous distinctive landscapes of brand-new landmasses of science with palette & tablet on back, several hundred years' scientific travelogues were compiled thereby.

经费申请表 *Outlay application table*

(金额单位: 万元)

科目 <i>Application items</i>	申请经费 <i>Necessary outlay</i>	备注 (计算依据与说明) <i>Remark, (Outlay explanation)</i>
一. 研究经费 <i>Study outlay</i>	345.0000	
1. 科研业务费	113.0000	
(1) 测试/计算/分析费	80.0000	"可控激励约束需求" 数据检索、分析、核定及其 "可控编程" 应验分析、核定工作量巨大
(2) 能源/动力费		Controllable PNT activation & rectification need feasible data research, analysis, authentication even systematical program, application & reliability test etc., the related job is of course substantial.
(3) 会议费/差旅费	15.0000	
(4) 出版物/文献/信息传播费	10.0000	
(5) 其他	8.0000	
2. 实验材料费	62.0000	
(1) 原材料/试剂/药品购置费	60.0000	主要是应试样本的购置及其与测试相关的用品。
(2) 其他	2.0000	If necessary, we have to buy or specially design the proper test instruments, I am still not familiar with the available experimental resources of our country.
3. 仪器设备费	100.0000	
(1) 购置	100.0000	如果必要的话, 我们有可能得自行设计和配置相关实验设备。我现在不了解可用资源背景。
(2) 试制		
4. 实验室改装费	50.0000	实验室改装是免不了的, 但是我到现在还不能预知 "改装幅度" 和 "改装内容"。
5. 协作费	20.0000	需要相关实验室人员配合工作
二. 国际合作与交流费	0	it may be inevitable for us to build necessary instruments specially, whereas, I know nothing about our available experimental resource at present, and I am still not sure what kind of instruments are necessary for us to build.
1. 项目组成员出国合作交流		
2. 境外专家来华合作交流		
三. 劳务费		
四. 管理费		
合 计	345.0000	
与本项目相关的其他经费来源	国家其他计划资助经费	
	其他经费资助 (含部门匹配)	
	其他经费来源合计	0.0000

申请者在撰写报告正文时，请遵照以下要求：

- 1、请先选定“项目基本信息”中的“资助类别”，再填写报告正文；
- 2、在撰写过程中，不得删除系统已生成的撰写提纲（如误删可点击“查看报告正文撰写提纲”按钮，通过“复制/粘贴”恢复）；
- 3、请将每部分内容填写在提纲下留出的空白区域处；
- 4、本要求将作为申请书正文撰写是否规范的评判依据，请遵照要求填写。

Straight matter of the application

Syllabus of study project application

(1) Project gist and study contents

Project gist including study significance, internal & external study actuality and analysis, it's even necessary to illuminate the scientific significance in reference of progressive orientation of scientific study or to illuminate the applicable foreground in reference of the exigent key technologic issues due to necessity of national economy or social development, and major references are necessary to be supplemented herein.

Project gist

Motion is innative essence of matter, in order to rein existence & motion of matter radically, it's necessary for us to master the inherent essence of existence & motion of matter so that we can felicitously contrive so-called “engine” by facilitating of active essence of existence & motion of matter under artificial control so as to accomplish ideal motion of object followed our inclinations, but not to always rest on routine engines as plane, rocket etc, which are but motion parasite kind ones 100 over 100.

Study significance:

Although, ostensibly, I but apply fund support for foremost technology exploration of PNT engine, there are substantial basic studies of science underlying. For you see, technology exploration of PNT engine directly involves in clarification of essence of existence & motion of matter, and the proper technologic challenge is virtually how to manage the very active essence under artificial control so as to accomplish ideal motion of object followed our inclinations. Clarification of basic issues must bring comprehensive revolution of science and technology, the study significance of the project is of course self-evident. And I am sure the implementation of the project must widely revive scientific study passion and enkindle innovative intelligence of our country; we need such an explicit target and challenge.

Internal and external study actuality and analysis

It seems our Chinese have been used to default conventionality any scientific or technologic studies put forward, we are always sensitive to refer to occidentals.

The occidentals had ever built A-bump, about 20 years later, we also built A-bump, and we were so proud and satisfied. The occidentals had ever built rocket, several decades later, we also built rocket, and we were so proud and satisfied. The occidentals had ever built space probe, several decades later, we also built space probe, and we were so proud and satisfied,

Is it necessary for our Chinese people of 21 century to go on pursuing such kind of pride and satisfaction?



At any rate, the full connotation of scientific pursuit of human is *natura naturans* personalization towards human necessity, which of course indicates authenticity highlight and comprehension is necessary precondition of technologic achievement, if there is no authenticity highlight of nature in prior, nothing can accomplish hypostatic technology.

2. Study contents of project, study object, sixty-four-dollar questions underlying

Study contents of the project

The project study target is ready to clarify inherent essence of existence & motion of matter and feasible ways to facilitate essence of existence & motion of matter under artificial control in reference of accessible matter specimens around us. Such explicit target radically determines the project study contents, —— comprehensively looking into existence & motion of matter in spacetime, especially idiographic existence & motion in microcosm, so that it is possible for us to clarify what inherent essence of existence & motion of matter is, what are the favorable resources and feasible ways for us to facilitate essence of existence & motion of matter followed our inclinations in accordance with accessible idiographic substantiality around us.

Study object

The first, try to prove up spacetime momentum denomination hoarding pattern of available atomic reciprocal PNT combinations with necessity of PNT continuous controllability and Atom State Equation in Spacetime in mind, so that we can gradually prove up more and more about atoms and atomic reciprocal PNT combinations, what kind of atomic reciprocal PNT combinations are favorable to take role of PNT activation source, what kind of substantiality are proportionably favorable to take role of PNT activation & rectification sign and what's the proper feasible ways for us to facilitate PNT reaction operation between PNT activation source and PNT activation & rectification sign at our pleasure are of course included in the job.

Sixty-four-dollar questions underlying

Before practically sliding deep into tangible search & authentication, there may be substantial indefinite occurrence need further verification and clarification by the way, which may be impact our unknowing prejudice, and consequent readjustment of our study scheme, schedule is of course necessary. As a result, I am still not confident to judge the definite sixty-four-dollar questions underlying. For you see, our job is ready to invoke superexcellent thought for guidance of expedient practice, whether thought is superexcellent or not needs substantiation of practice, I would rather be a local acrobat upon reliance of practice but not a bedlamite upon assuredness of superexcellent idea. And virtually, before the sixty-four-dollar questions underlying self-evident, if our subjective study orientation is too resolute, there may be potential risk for our study endeavor unknowingly sliding into deadly retardance or confounded confusion, even make us exhausted thereby. Of course, at the beginning, our study intention is leisurely explicit, and once I am confident to tell you what the sixty-four-dollar questions underlying, I can tell you half of our job has been done as well.

Project study character & originality, and illumination of the correlation between the project and the integrated study schedule.

Project study character:

In a summary word, this project is basic study with special technologic challenge in mind, we face technologic challenge of PNT engine to sedulously prove up what inherent essence of existence & motion of

matter is, and once inherent essence of existence & motion of matter is clarified, we immediately turn to consider how to facilitate essence of existence & motion of matter under artificial control. The straightforward eyeable success of this project may be just PNT engine; the even grand harvest must be clarification of essence of existence & motion of matter even may be atom state equation in spacetime. Of course, even if we are not as successful as expected in PNT engine exploration for a while, as long as our idea is scientific, our endeavor is tangible and our search range is comprehensive, our harvest must be colorful. For you see, there are originally many wonderful substantiality for us to find in the nature, before our perception and masterdom, they are substantiality of nature, once we perceive and master them, they can magically become our products and wondrously change our world. Why tzar Qin number 1 never watched TV? Why Chairman Mao never enjoyed mobile telephone? It's not because of shortage of nature but man short of knowledge at their age.

Originality: the originality of the project is ready to find practical ways to facilitate essence of existence & motion of matter under artificial control so as to accomplish ideal motion of object followed our inclinations.

General target correlation between the project and the integrated study scheme:

This is typical basic study with idiographic technology challenge in mind, the so-called technology challenge —foremost exploration of PNT engine is just the project, and the so-called “basic study” —clarification of essence of existence & motion of matter even Atom State Equation is just the integrated study scheme. The correlation between the project and the integrated study scheme is that the project is one of the technologic substantiation of the integrated study scheme, the accomplishment of the project will not only mean success of this project, but also means remarkable progress or success of the integrated study scheme. I predict herein, in the coming years, no matter it is China or United states or some other country in the world who consummate atom state equation in spacetime first, they won't be so generous to promulgate it to the world immediately, because atom state equation in spacetime is something so wondrous as rational capital in wide technologic application, it must create a brand-new age.

4. Study solution layout & feasibility evaluation including explanation of related method, technologic approach, experimental instrument, key technology etc.

Study solutions:

As typical basic study with special technology challenge in mind, our study solutions of course should be optimum feasible implementation towards reciprocal circle of how to draw on the wisdom of the masses towards rational clarification of objective issues and how to make indefinite objective issues self-evident —make indefinite objective issues illuminated or substantiated by experiments as to illuminate our exploration eyeshot, calibrate our knowledge and consolidate our practical master step by step.

I have to comment, current situation of PNT engine project is remarkably different from historical background of foregone A-bump project, when we came to plan and prepare A-bump project, we'd possessed of experimental substantiation of nucleus fission, what's more, United States, Soviet Union had materialized such technologic practice in prior, such factuality made our endeavor towards the project pursuit like there is a living apple in the tree, you know, he knows and I know, our job is but how to approach the apple. Apparently, there is little job about basic study and relatively few indefinite issues before us, as a result, the study solutions are relatively broad.

As typical basic study with special technology challenge in mind, PNT engine project is much different;



there are too many indefinite issues before us. At present, we are only confident there must be coherent inherence of universal existence & motion underlying, if we can practically manage the coherent inherence of universal existence & motion under artificial control, we can proportionably control ideal existence & motion of matter followed our inclinations.

However, there are still so many issues need clarification & substantiation in prior, such as:

What's the tangible root cause for existence & motion of matter in spacetime? ——does existence & motion of matter inherently depend on PNT performance of matter integration in spacetime?

We are theoretically confident about the issue, whereas, we have no reasons to leave it in theoretical confidence without practical authentication!!

For instance, where is PNT performance?

Can we experimentally catch a tangible and living PNT performance in the nature?

What's the normal & non-normal genic operational link configuration of PNT performance?

How does PNT performance materialize idiographic existence & motion of matter in spacetime?

We still need tangible authentication!!

.....

Only when all issues above have been practically clarified and substantiated, it's turn for us to face the special issues of PNT engine technology.

What are the accessible ways for us to intervene and influence PNT operation of matter integration?

What's the PNT continuous controllability in reference of normal PNT performance?

What are the favorable conditions due to PNT continuous controllability?

We still need tangible substantiation!!

Are there available PNT activation source and PNT activation & rectification sign? How about the PNT reaction between PNT activation source and PNT activation & rectification sign? Is there substantial potential energy for PNT activation exploitation and are the related state regularization and rectification feasible? How to program the ideal PNT reaction operation between PNT activation source and PNT activation & rectification sign due to necessity of PNT continuous controllability?

We still need tangible substantiation!!

Our study is of course ready to systematically cover all issues above as an integrate scheme, whereas, the perplexity is detail implementation and corresponding definite solutions, throughout our progression. For you see, results of today may be confounded questions of tomorrow, before substantially involving in, it seems no way for us to make sure of job of today and job of tomorrow. If I now lay out a series of definite study scheme and solutions throughout once, I am afraid; I can not get rid of suspicion of assuming things as matter of course.

Of course, we should above all organize an excellent team to draw on the wisdom of the masses.

Feasibility evaluation:

Since it is undoubted that motion is inherent attribute of matter, and so rich and colorful existence & motion of matter hypostatized in microcosm, macrocosm, slow ones and fast ones can integrate the



harmonious cosmos by the light of nature indeed, there must be hypostatic ways for us to change the slow ones into fast ones and change the fast ones into slow ones inversely as well in accordance with authenticity of nature itself. As long as intelligence of our team is excellent enough to clarify the proper authenticity of nature, anything can exist in the nature by the light of nature must be substantiality we can felicitously personalize in accordance with human necessity of social production and social life.

(The coming page 9 & page 10 of the original application are omitted)

Outlay explanation:

Any expenditure over 50 thousand Yuan for fixed assets and related equipment should submit detail explanation about straightforward pertinence and necessity to the project.

If my application is acceptable, I can do the job accordingly, but I can not offer the detail expenditure list today.

On one hand, I am not familiar with the related experimental resource of our country; there is no way for me to know what have been available and what are necessary to buy or to specially design. And on the other hand, in terms of implementation of experimental search and authentication of PNT activation source, PNT activation & rectification sign, operational data procurement & analysis of PNT reaction between PNT activation source and PNT activation & rectification sign, program test of controllable PNT activation & reactivation and so on, I still can not be sure what kind of experimental conditions are necessarily adequate. After all, I am still out of the related issues and there may be details indefinite in my mind at present.

However, I have to comment herein, once the PNT activation source and PNT activation & rectification sign are ascertained and available, and we primarily authenticate there are substantial potential for activation exploiture and possible for PNT continuous control, it's necessary for us to authenticate further what's the optimum operation of PNT reaction between the very PNT activation source and PNT activation & rectification sign due to necessity of PNT continuous controllability, what's the safe PNT reaction range, how to optimize the proper PNT reaction operation, so that we can be confident to program the safe PNT reaction operation, the necessary adequate experimental conditions maybe rather strict. As firstly involving in such business, it's most probably for us to design special lab even special instruments, and such lad should not only be provided with function of operational data collection & analysis of PNT reaction between PNT activation source and PNT activation & rectification sign, but also should be provided with function of controllable PNT reaction program test. In any case, only after the controllable PNT reaction program are tested OK, we can fix it on PNT engine for practical application.

I only apply fund support of experimental exploration & authentication of PNT activation source and PNT activation & rectification, my application does not implicate fund support for operational data collection & analysis of hypostatic PNT reaction between **PNT activation source** and **PNT activation & rectification sign** for controllable PNT reaction optimization and program, controllable PNT reaction program test and PNT engine building.

Extracted on April 5, 2013 Dongguan city, Shilong town, Xihu park



It's only possible for concordant cosmos to be demiurgic aggradation of out-and-out serial natura naturata in the nature of coherent natura naturans throughout cosmic evolution; there is no way for demiurgic aggradation in the nature of different natura naturans to be concordant cosmos through and through.

As coherent natura naturans throughout cosmic evolution, instinctive PNT reciprocal equilibrium towards optimum PNT operation is radical potentiality & conditionality for cosmos always ready to orientate itself towards perfection.

The seventh part

As Timely Renovation of Humanistic Ideology about Authenticity of Nature in Proportion to Contemporaneous Historical Background of Remarkable Highlight of Microcosmic Configuration of Matter and Typical Aberrant Scientific Knowledge Proliferation Out Of Succession of Contemporaneous Scientific Orthodoxy, Free Press Admittance of Homogenous Cosmos Originated Originated from Unique Genesis Must Break Through Legitimacy Defense Line of Contemporaneous Scientific Orthodoxy due to Inevitable Life-and-death Scientific Knowledge Metabolism, so that It Has to Challenge Venomous Counterwork Upper Limit of Temporal Authority Under Egotistic Background of Interminable Royal Substantiation & Perfection of Contemporaneous Scientific Orthodoxy — Social Legitimacy & Validity of Truths Can Never Exceed Cannon Range

Foreword

Under egotistic background of royal substantiation & perfection of contemporaneous scientific orthodoxy, in terms of endeavor of substantiation & perfection of contemporaneous scientific orthodoxy, free press admittance is usually challenge to pass **free press egotistic proximity identification**. Relatively, in terms of timely renovation of humanistic ideology about authenticity of nature in proportion to contemporaneous historical background of remarkable highlight of microcosmic configuration of matter as innovative cosmos redefinition in radical logic enantiomorph of newly highlighted factuality that **discretionary particles in cosmos are mutually convertible** with consequent PNT dynamics about universal existence & motion in the nature of coherent natura naturans throughout cosmic evolution, as remarkable divarication between Homogenous Cosmos Originated from Unique Genesis and contemporaneous

Historical progress of science in the recent several centuries seemed like a far-flung exploration of the first itinerary around numerous distinctive landscapes of brand-new landmasses of science with palette & tablet on back, several hundred years' scientific travelogues were compiled thereby.

scientific orthodoxy, free press admittance of Homogenous Cosmos Originated from Unique Genesis must break through legitimacy defense line of contemporaneous scientific orthodoxy due to inevitable life-and-death scientific knowledge metabolism, so that it has to challenge venomous counterwork upper limit of temporal authority who are mostly hardcore puissance of living historical progress of science with unprecedented official facility of magistral autarchy of free press regulation customization & free press admittance.

The most remarkable character of live contemporaneous scientific orthodoxy is that it's inertial ideological aggradation of remarkable transverse ideological expansion in the recent several centuries, which is typical unsystematized ideological system about universal existence & motion making up of rich and colorful scientific travelogues A, B, C, D, E, F, . . . like omnifarious smallwares full of a basket. Virtually, historical progress of science in the recent several centuries seemed like a far-flung exploration of the first itineracy around numerous distinctive landscapes of brand-new landmass of science with palette & tablet on back, several hundred years' scientific travelogues were compiled thereby. Of course, we have to admit the distinctive process of historical progress of science in the recent several centuries is inevitably necessary crescive progression of historical progress of science in inherent optimum orientation towards perfect ideological enantiomorph of ultimate authenticity of nature, the key issue is that social legitimacy subsistence of contemporaneous scientific orthodoxy must bring out proportionate authoritative intrepidity of contemporaneous scientific orthodoxy, presence of proportionate authoritative intrepidity of contemporaneous scientific orthodoxy must carry forward royal substantiation & perfection of contemporaneous scientific orthodoxy in the nature of things. Even as permanent officialism domino effect of contemporaneous scientific orthodoxy, magistral autarchy of free press regulation and free press admittance come into being at the volley which is hardcore puissance of historical progress of science, as a result, live scientific knowledge proliferation on the earth is acrimoniously restricted in rigid succession of contemporaneous scientific orthodoxy due to machine-made free press egotistic proximity identification of temporal authority towards royal substantiation & perfection of contemporaneous scientific orthodoxy, any aberrant scientific knowledge proliferation out of succession of contemporaneous scientific orthodoxy can hardly be free from orthodox filtration of free press egotistic proximity identification, no more timely renovation of humanistic ideology about authenticity of nature in proportion to contemporaneous historical background.

This of course make remarkable transverse ideological expansion as favorable background of the age very difficult to orientate to successive longitudinal ideological optimization of historical progress of science.

And on the other hand, as out-and-out social work outgrowth and humanistic ideology about authenticity of nature in proportion to contemporaneous historical background, social existence and historical progress of "science" must inherently possess double coordinative significance of "natural connotation" and "social connotation", social legitimacy subsistence of neonatal scientific idea especially successive renovation of humanistic ideology about authenticity of nature along historical progress of science in inherent optimum orientation towards perfect ideological enantiomorph of ultimate authenticity of nature never simply depends on cognizant achievement that brand-new or more veritable authenticity of nature has been reflected on sense of pioneering originators with commensurate authenticity highlight effect in proportion to contemporaneous historical background, it even crucially implicates esoteric authoritative social legitimacy identification & authentication in accordance with egotistic criterion of contemporaneous scientific orthodoxy under official centered background —— social legitimacy & validity of truths can never exceed cannon range, which of course includes humanistic operation of virulent scientific knowledge metabolism campaign underlying.

The biggest sorrow of live historical progress of science is no more than

Leaving temporal authority indulging in interminable royal substantiation & perfection of contemporaneous scientific orthodoxy at their pleasure draw on expediential official facility of magistral autarchy of free press regulation customization and free press admittance in defiance of objectivity that it's only possible for the major melody of historical progress of science to be

As coherent natura naturans throughout cosmic evolution, instinctive PNT reciprocal equilibrium towards optimum PNT operation is radical potentiality & conditionality for cosmos always ready to orientate itself towards perfection.

a series of epochmaking scientific knowledge metabolism in inherent optimum orientation towards perfect ideological enantiomorph of ultimate authenticity of nature.

Keeping royal endeavor of interminable substantiation & perfection of contemporaneous scientific orthodoxy enjoying superior free press, extravagant fund support, respectable scientific prize stepping in the air due to facility of magistral autarchy of “free press regulation customization” and “free press admittance” of temporal authority short of necessary intendance.

Leaving timely renovation of humanistic ideology about authenticity of nature in proportion to contemporaneous historical background inextricably bogged down in endless vicious circle of virulent scientific knowledge metabolism campaign so as to make them sad and helpless without alternatives.

Making interminable royal substantiation & perfection of contemporaneous scientific orthodoxy superiorly take full humanistic role of historical progress of science in defiance of necessary scientific legitimacy metabolism of historical progress of science in inherent optimum orientation towards perfect ideological enantiomorph of ultimate authenticity of nature, so that respectable endeavor of royal substantiation & perfection of contemporaneous scientific orthodoxy can show off their expediential superiority stepping in the air.

Making free press admittance of timely renovation of humanistic ideology about authenticity of nature in proportion to contemporaneous historical background has to challenge venomous counterwork upper limit of temporal authority without alternatives.

Although, the undoubted factuality is that, as permanent synthesized conditionality of “**crecive progression of practical feasibility & possibility in proportion to contemporaneous historical background + the uniqueness & invariance of ultimate authenticity of nature predestines the unique possibility of scientific verity as perfect ideological enantiomorph of ultimate authenticity of nature**” through and through, it’s only possible for the major melody of historical progress of science to be a series of epochmaking scientific knowledge metabolism in inherent optimum orientation towards perfect ideological enantiomorph of ultimate authenticity of nature, which is virtually hypostatic historical progress of science that humanistic ideology about authenticity of nature gradually approaches perfect ideological enantiomorph of ultimate authenticity of nature with proportionate orthodoxy subrogation draw on practical feasibility & possibility in proportion to contemporaneous historical background.

As factuality that **discretionary particles in cosmos are mutually convertible** in freewheeling towards complete induction day by day, the homogenous profile of cosmos has been more and more explicit. As a result, I introduced **Homogenous cosmos originated from unique genesis postulate** and implemented logical cperotion of timely renovation of humanistic ideology about authenticity of nature on the basis of **[(Homogenous cosmos originated from unique genesis + spacetime~matter fully embodying cosmos) + instinctive PNT equilibrium]** so as to approach cosmos redefinition in logic enantiomorph of newly highlighted factuality that **discretionary particles in cosmos are mutually convertible** with consequent PNT dynamics about universal existence & motion in the nature of coherent natura naturans throughout cosmic evolution. Whereas, connotation objectification and logic extension of homogenous cosmos originated from unique genesis is not only out of rigid succession of contemporaneous scientific orthodoxy but also out of leitmotiv of high-sounding royal substantiation & perfection of contemporaneous scientific orthodoxy of the age, which of course made me antipathetic heterodoxy at the volley. I could hardly find me a way to pass free press egotistic proximity identification from temporal authority, I even could hardly get rid of bald-faced discrimination for my poor qualification and identity.

If there is no authenticity of nature as precondition, there is no way for naissance of science, even if there is only authenticity of nature without human society, there is no way for naissance of science. Science is of course inherent multiple concept with double significance of “**social connotation**” and “**natural connotation**”, which originally comes into being facing accessible existence & motion around off the cuff draw on practical feasibility & possibility as humanistic ideology about authenticity of nature in proportion to contemporaneous historical background with one terminal sensitively tied social legitimacy benefit of

Historical progress of science in the recent several centuries seemed like a far-flung exploration of the first itinerary around numerous distinctive landscapes of brand-new landmasses of science with palette & tablet on back, several hundred years’ scientific travelogues were compiled thereby.

temporal authority and the other terminal tied the living scientific knowledge proliferation for progress of science in inherent optimum orientation towards historical authenticity tolerance of science 0.

However, as powerful opposite as contemporaneous scientific orthodoxy in coming inevitable scientific knowledge metabolism campaign, once free press regulation customization and free press admittance is completely under magistral autarchy of temporal authority short of necessary intendance, how is it possible for the series of humanistic scientific knowledge metabolism to be operated in its normal way?

Some warmhearted man had ever asked me, as endeavor to push humanistic ideology about authenticity of nature forward to perfect ideological enantiomorph of ultimate authenticity of nature draw on practical feasibility & possibility in proportion to contemporaneous historical background of **remarkable highlight of microcosmic configuration of matter**, "Homogenous Cosmos Originated from Unique Genesis" still seems pioneering in distinctive rationale towards authenticity highlight of nature, whereas, you always seem depressed for perplexity of free press admittance, can you show me why?

Facing the inquiry, I was really confounded like mute who could never speak out his bitterness once finishing eating lotus seeds. For you see, under background of royal substantiation & perfection of contemporaneous scientific orthodoxy, free press regulation customization and free press admittance is completely under magistral autarchy of temporal authority short of necessary intendance, respectable subsistence of modern science forum is always ready to make living scientific knowledge proliferation homegrown in the garden of contemporaneous scientific orthodoxy, consequence of free press admittance is mostly outcome of free press egotistic proximity identification at their pleasure. The even pestilent issue is that social operation of free press admittance of "**scientific knowledge proliferation in rigid succession of contemporaneous scientific orthodoxy**" and "**aberrant scientific knowledge proliferation out of rigid succession of contemporaneous scientific orthodoxy**" is in so different manners of **esoteric authoritative social legitimacy identification & authentication**.

In terms of esoteric social operation of authoritative identification of **scientific knowledge proliferation in rigid succession of contemporaneous scientific orthodoxy**, esoteric social operation of free press admittance is of course pleasant "**sweetmeat choice**" of temporal authority draw on facility of magistral autarchy of free press regulation customization and free press admittance short of necessary intendance, there is substantial freewheeling expedience for scientific knowledge proliferation in rigid succession of contemporaneous scientific orthodoxy to pass free press egotistic proximity identification under background of royal substantiation & perfection of contemporaneous scientific orthodoxy. Your success of free press admittance mostly depends on whether your taste is nicely sweet tasted by temporal authority, which of course implies your success of free press admittance from temporal authority usually does not straightforwardly depend on, taking reference of historical authenticity tolerance of science of live orthodoxy, how much credible advancement you've practically accomplished for historical progress of science in inherent optimum orientation towards perfect ideological enantiomorph of ultimate authenticity of nature, instead, it is sensitively biased towards how proximate your scientific idea seems to contemporaneous scientific orthodoxy or how favorable your job seems for substantiation & perfection of contemporaneous scientific orthodoxy.

In terms of esoteric social operation of authoritative identification of **aberrant scientific knowledge proliferation out of succession of contemporaneous scientific orthodoxy**, although, the original pursuit of authoritative identification is almost just the same as scientific knowledge proliferation in rigid succession of contemporaneous scientific orthodoxy towards verification of highlight effect of authenticity of nature, whereas, as potential implication of egotistic self-preservation with backup of authoritative intrepidity of contemporaneous scientific orthodoxy, the results are apparently different. After all, as interposition of remarkable disparity of basic rationale derived from different historical background for distinctive sensitivity of originator, consequent logic proliferation of humanistic ideology about authenticity of nature in proportion to contemporaneous historical background must

be remarkably different from ready-made tradition; there is substantial probability for esoteric operation of authoritative identification of coming renovation of humanistic ideology about authenticity of nature in proportion to contemporaneous historical background to slide into virulent scientific knowledge metabolism campaign as law of the jungle for potential involvement of (remarkable difference of basic rationale + egotistic self-preservation with backup of all-time authoritative intrepidity of contemporaneous scientific orthodoxy), either the fish to die or the net to be broken. At any rate, it's neither possible for "the unique & invariable ultimate authenticity of nature" to be compatible with "two distinctive humanistic ideologies about authenticity of nature with remarkable ideological difference" nor possible for "two distinctive humanistic ideologies about authenticity of nature with remarkable ideological difference" to discover and formulate "the unique & invariable ultimate authenticity of nature" coequally.

As both low-down man of the society and typical heterodoxy under background of high-sounding royal substantiation & perfection of contemporaneous scientific orthodoxy, it's of course easy for you to imagine how difficult it must be for me to conquer temporal authority and how easy it is for temporal authority to terrify me at their pleasure. Virtually, I contributed to related journals near 300 times in the recent 30 years, more than 80% rejection comments from journals are all-purpose, if just to tell their own stories straightforward, the self-evident factuality is that we are always devoting to eulogistic scientific knowledge proliferation in succession of contemporaneous scientific orthodoxy for substantiation & perfection of contemporaneous scientific orthodoxy for favorable access of free press egotistic proximity identification, whereas, as typical output of aberrant scientific knowledge proliferation out of succession of contemporaneous scientific orthodoxy, you are not in our line and we do not know you. What's more, in official centered country as mainland of China, I am but a floater without official rank, money, esoteric guanxi with related placeman for access of free press admittance & social legitimacy authorization; and what's more, under egotistic background of interminable royal substantiation & perfection of contemporaneous scientific orthodoxy with unprecedented facility of magistral autarchy of "free press regulation customization" and "free press admittance" of temporal authority short of necessary intendance, science forum is homegrown outgrowth in the garden of contemporaneous scientific orthodoxy beyond all doubt, which can hardly be free from duress of authoritative intrepidity of contemporaneous scientific orthodoxy.

I was told time after time that 31 years' free press embarment of Homogenous Cosmos Originated from Unique Genesis was not something occasional for my misfortune, but something inevitable for high-sounding popularity of royal substantiation & perfection of contemporaneous scientific orthodoxy, although, historical progress of science in the recent half century has obviously slidden into unintelligible perplexity as floundering around in riancy. Living scientific knowledge proliferation must be in rigid succession of contemporaneous scientific orthodoxy is not morbid mania of several journals or publishing houses but morbid popularity of interminable substantiation & perfection of contemporaneous scientific orthodoxy instead of out-and-out endeavor to push humanistic ideology about authenticity of nature forwards to perfect ideological enantiomorph of ultimate authenticity of nature step by step draw on practical feasibility & possibility in proportion to contemporaneous historical background, whose valor even seems ready to submerge general progress of science so as to make coming historical progress of science freewheeling of royal substantiation & perfection of contemporaneous scientific orthodoxy ever since, so that social legitimacy qualification of live contemporaneous scientific orthodoxy can be respectable crown never fading on their heads. Although, live contemporaneous scientific orthodoxy is apparently out of scientific legitimacy qualification of historical authenticity tolerance of science 0, and veritable historical progress of science can never be permanently taken off track of inherent optimum orientation towards perfect ideological enantiomorph of ultimate authenticity of nature.

Virtually, as official personnel under background of royal substantiation & perfection of contemporaneous scientific orthodoxy with superior facility of magistral autarchy of free press regulation customization and free press admittance short of necessary intendance, editors of all SCI journals mostly have their default occupational sense that living scientific knowledge proliferation must be rigid succession of contemporaneous scientific orthodoxy and their job duty is to implement free press egotistic proximity

Historical progress of science in the recent several centuries seemed like a far-flung exploration of the first itinerary around numerous distinctive landscapes of brand-new landmasses of science with palette & tablet on back, several hundred years' scientific travelogues were compiled thereby.

identification for substantiation & perfection of contemporaneous scientific orthodoxy, none else. If contribute in hand is scientific knowledge proliferation in rigid succession of contemporaneous scientific orthodoxy for substantiation & perfection of contemporaneous scientific orthodoxy indeed, they are responsible and happy to implement their occupational free press egotistic proximity identification; if contribute in hand is typical aberrant scientific knowledge proliferation out of succession of contemporaneous scientific orthodoxy, sorry, I am irresponsible and inconvenient to implement my job duty for free press egotistic proximity identification, what's more, nonsense consideration of free press admittance of any aberrant scientific knowledge proliferation out of succession of contemporaneous scientific orthodoxy must sensitively cause extensive umbrage of millions of temporal authority, all what I am able to do in my job range is but to spend one or two minutes to write a decline letter.

As a result, as timely renovation of humanistic ideology about authenticity of nature in proportion to historical background of remarkable highlight of matter, free press admittance of Homogenous Cosmos Originated from Unique Genesis has never been considered by any SCI journal on the earth eversince, although, 31 years has gone, I have contributed more than 500 times; although, veritable progress of science is not intuitional cumulative achievement of colorful scientific travelogues A, B, C, D, E, F, ... as deserving reward of the first itinerary around preternatural landscapes of brand-new landmasses of science like omnifarious smallwares full of a basket but successive hypostatic endeavor to push humanistic ideology about authenticity of nature forward to perfect ideological enantiomorph of ultimate authenticity of nature step by step draw on practical feasibility & possibility in proportion to contemporaneous historical background, and interminable freewheeling royal substantiation & perfection of contemporaneous scientific orthodoxy out of scientific legitimacy qualification of historical authenticity tolerance of science 0 can never be nonstop towards perfect ideological enantiomorph of ultimate authenticity of nature. Once there are none top-rank geniuses for epochmaking scientific innovation for rather a long time, we have to look out super hubris of authoritative intrepidity of contemporaneous scientific orthodoxy derived from altisonant "second-string geniuses" who are mostly meritorious to royal substantiation & perfection of contemporaneous scientific orthodoxy even overbearing "third-rate geniuses" as typical loving successors of contemporaneous scientific orthodoxy of the age.

Especially, once free press regulation customization and free press admittance is completely under magistral autarchy of temporal authority short of necessary intendance, so that authoritative intrepidity of royal substantiation & perfection of contemporaneous scientific orthodoxy is apparently ready to dominate comprehensive social resource for general progress of science through and through, we then should be even argus-eyed to inverse elimination of scientific idea from living scientific knowledge proliferation under duress of authoritative intrepidity of contemporaneous scientific orthodoxy. All in all, any humanistic power out of necessary intendance must adulterate humanistic appetency in the nature of things, what's more, **interminable royal substantiation & perfection of contemporaneous scientific orthodoxy \neq original endeavor of general progress of science to push humanistic ideology about authenticity of nature forward to perfect ideological enantiomorph of ultimate authenticity of nature step by step draw on practical feasibility & possibility in proportion to contemporaneous historical background, which is virtually realistic historical progress of science in inherent optimum orientation towards historical authenticity tolerance of science 0.**

(VII-i) Along crecive progression of historical progress of science in inherent optimum orientation towards perfect ideological enantiomorph of ultimate authenticity of nature, remarkable contrast of historical concatenation & inherent logic configuration between Homogenous Cosmos Originated from Unique Genesis and live contemporaneous scientific orthodoxy

Abstract: *As multriple notion with double significance of “social significance” and “natural significance”, before humanistic ideology about authenticity of nature finally qualified as perfect ideological enantiomorph of ultimate authenticity of nature, science is always out-and-out social outgrowth & existence of **humanistic ideology about authenticity of nature** in proportion to contemporaneous historical background in crecive progression of historical progress of science in inherent optimum orientation towards perfect ideological enantiomorph of ultimate authenticity of nature. As crecive progression of practical feasibility & possibility in proportion to contemporaneous historical background, we have to admit temporal scientific harvests of human are but historical aggradation of omnifarious scientific travelogues like smallwares full of a basket about rich and colorful existence & motion of specimens which were gradually accessible around us. And indeed, several hundred years’ progress of science seemed like far-flung exploration of the first itineracy around numerous distinctive landscapes of brand-new landmasses of science with palette & tablet on back, several hundred years’ scientific travelogues were compiled thereby. Although, cosmic status quo is evolutionary aggradation of out-and-out serial natura naturata as well-regulated homogeneity system in the nature of coherent natura naturans throughout cosmic evolution.*

*As successive rational sublimation of remarkable highlight of microcosmic configuration of matter, “Homogenous Cosmos Originated from Unique Genesis” is innovative cosmos redefinition in logic enantiomorph of newly highlighted factuality that **discretionary particles in cosmos are mutually convertible** with consequent PNT dynamics about universal existence & motion in the nature of coherent natura naturans throughout cosmic evolution. Remarkable highlight of factuality that discretionary particles in cosmos are mutually convertible has made the homogenous profile of cosmos more and more clear-cut, so I introduced Homogenous cosmos originated from unique genesis postulate accordingly, and successively, I expanded the logic connotation of Homogenous cosmos originated from unique genesis postulate with supplementation of two accessorial postulates towards rational accomplishment of cosmos redefinition with consequent PNT dynamics about universal existence & motion in the nature of coherent natura naturans throughout cosmic evolution (/essence of matter in a class by itself).*

1. As inertial ideological aggradation of remarkable transverse ideological expansion in the recent several centuries, live contemporaneous scientific orthodoxy is commensurate ideological system making up of rich and colorful scientific travelogues A, B, C, D, E, F, . . . , like omnifarious smallwares full of basket with macro-rational-profile of X scientific subjects as distinctive physics, chemistry, biology, iatrology . . . Y academic professions with Z foundational regularities adulterated in, which are virtually formidable rewards of a far-flung exploration of the first itineracy around numerous distinctive landscapes of the brand-new landmasses of science with palette and tablet on back in the recent several centuries, although, cosmic status quo is but demiurgic aggradation of sequential homologic cosmogony, which exactly exists as well-regulated integration of cosmic homogeneity system making up of out-and-out

Historical progress of science in the recent several centuries seemed like a far-flung exploration of the first itineracy around numerous distinctive landscapes of brand-new landmasses of science with palette & tablet on back, several hundred years’ scientific travelogues were compiled thereby.

serial natura naturata in the nature of coherent natura naturans throughout cosmic evolution.

The most remarkable character of live contemporaneous scientific orthodoxy is that it's inertial ideological aggradation of remarkable transverse ideological expansion in the recent several centuries, which is typical unsystematized ideological system about universal existence & motion making up of rich and colorful scientific travelogues A, B, C, D, E, F, ... like omnifarious smallwares full of a basket in macro-rational-profile of X scientific subjects, Y academic professions with Z foundational regularities adulterated in. Virtually, historical progress of science in the recent several centuries seemed like a far-flung exploration of the first itineracy around numerous distinctive landscapes of brand-new landmasses of science with palette & tablet on back, several hundred years' scientific travelogues compiled thereby. Of course, we have to admit the distinctive process of historical progress of science in the recent several centuries is inevitably necessary progression of historical progress of science in inherent optimum orientation towards perfect ideological enantiomorph of ultimate authenticity of nature.

The key issue is that, as humanistic ideology about authenticity of nature in proportion to contemporaneous historical background, since our live ideological system about authenticity of nature are so rich and colorful scientific travelogues A, B, C, D, E, F, ... like omnifarious smallwares full of a basket, as objective origin of ideological system about authenticity of nature, we have to review whether authenticity of nature are enantiomorphous authenticity smallwares full of a basket, otherwise, in accordance with rigid enantiomorphous correlation between authenticity of nature and humanistic ideology about authenticity of nature, live ideological system about authenticity of nature is not perfect ideological enantiomorph of authenticity of nature.

Virtually, substantial evidence indicates "ultimate authenticity of nature" can be neither omnifarious authenticity smallwares full of a basket nor authenticity chameleon one piece and only, but coherent natura naturans throughout cosmic evolution. As a result, in accordance with rigid enantiomorphous correlation between authenticity of nature and humanistic ideology about authenticity of nature, it's neither possible for "the unique & invariable ultimate authenticity of nature" to be compatible with "two distinctive humanistic ideologies about authenticity of nature with remarkable ideological difference" nor possible for "two distinctive humanistic ideologies about authenticity of nature with remarkable ideological difference" to discover and formulate "the unique & invariable ultimate authenticity of nature" coequally, it's only possible for ultimate consummation of humanistic ideology about authenticity of nature to perfect ideological enantiomorph of ultimate authenticity of nature.

1.1. Quantitative & qualitative change of scientific knowledge proliferation along crescive progression of historical progress of science.

As crescive progression of practical feasibility & possibility in proportion to contemporaneous historical background, the practice human coming to discover and formulate authenticity of accessible existence & motion around us must experience frondose evolvement of humanistic ideology about authenticity of nature cumulatively enriched from nothingness to goat, from goat to a great lot, and consequently followed proportionate ideaistic correction & qualitative optimization from superficiality to profundity, from parochiality to generality. And virtually, progress of live contemporaneous scientific orthodoxy in the recent several centuries were basically in progressive stage of quantitative aggradation of scientific knowledge about accessible existence & motion around us from some to more.

In such progressive stage, our remarkable scientific harvests were usually historical discoveries even nice regularities about distinctive existence & motion of idiographic matter specimens which were temporally accessible to us. As a result, scientific knowledge rapidly enriched and consequently followed the commensurate historical reciprocal ideological correction and qualitative optimization as Copernicus, Galileo, Darwin ... Einstein ... had ever done under their idiographic historical background at the volley.

As coherent natura naturans throughout cosmic evolution, instinctive PNT reciprocal equilibrium towards optimum PNT operation is radical potentiality & conditionality for cosmos always ready to orientate itself towards perfection.

During the course of rapid transverse ideological expansion, our popular science exploration manner was to fetch this matter specimen or that matter specimen into labs one after another which were temporally accessible to human practice, and as a result, we arrived at this scientific theory and that scientific theory, this subject and that subject one by one. In another word, historical progress of live contemporaneous scientific orthodoxy in the recent several centuries seemed like a far-flung exploration of the first itinerary around numerous distinctive landscapes of brand-new landmasses of science with palette & tablet on back, several hundred years' scientific travelogues were compiled thereby. Not only the historical exploration journey was stochastically devious, but also, as deserving rewards, the proportionate scientific harvests really seemed rich and colorful ideological aggradation like omnifarious smallwares full of a basket. All in all, hypostatic progress of live contemporaneous scientific orthodoxy in the recent several centuries was generally distinctive process of remarkable transverse ideological expansion towards accessible existence & motion around us, by which we came to know authenticity of nature from nothingness to groat, from groat to a great lot day by day.

During the course of rapid transverse ideological expansion, our popular science exploration manner was always endeavor to fetch this matter specimen or that matter specimen into labs one after another which were temporally accessible to human practice, and we arrived at this scientific theory and that scientific theory, this subject and that subject one by one accordingly. In another word, historical progress of live contemporaneous scientific orthodoxy in the recent several centuries seemed like a far-flung exploration around brand-new landmasses of science with palette & tablet on back, several hundred years' scientific travelogues were compiled thereby. Not only the historical exploration journey looked stochastically devious, but also, as deserving rewards, the proportionate scientific harvests seemed omnifarious like smallwares full of a basket.

All in all, the progress of live contemporaneous scientific orthodoxy in the recent several centuries was generally a process of knowledge multiplication with remarkable predominance of transverse ideological expansion, by which we came to know authenticity of nature from nothingness to groat, from groat to a great lot day by day. The most remarkable action indication of cognition transverse development was that, as social practice gradually went its in-depth way and involved in more and more existence & motion around us, more and more substance constantly entered our purview as brand-new study objects one by one.

Along in-depth extension of social practice in the recent several centuries, on one hand, more and more substance constantly entered our purview as brand-new study objects. And on the other hand, as brand-new study objects primarily involved in without necessary rationale, we had to study them as independent objects one by one like twiddling with this red apple or that green apple on tip of our fingers and tried our best to perceive their unfeigned individuality as much as possible then and there. As remarkable individuality among all the colorful objects upon our intuition of the time, we had to classify the colorful objects into typical matter specimens as object A, object B, object C, ... and studied them separately under contemporaneous historical background one after another, which seemed rich and colorful existence & motion in the nature and historically entered our study attention one by one.

Virtually, we have to admit, we substantively lack necessary rationale to study all the object A, object B, object C, ... in thorough coherence originated from coherent natura naturans of the demiurge then and there. For you see, as our brand-new study objects without necessary rationale, upon our sense as out-and-out jackaroo of the time, they seem omnifarious with remarkable individuality indeed, we simply had no reasons and no rationale to study them in thorough coherence originated from coherent natura naturans of the demiurge off

Historical progress of science in the recent several centuries seemed like a far-flung exploration of the first itinerary around numerous distinctive landscapes of brand-new landmasses of science with palette & tablet on back, several hundred years' scientific travelogues were compiled thereby.

the cuff. Although, we now are so confident to sparkplug leitmotiv **it's only possible for concordant cosmos to be demiurgic aggradation of out-and-out serial natura naturata in the nature of coherent natura naturans throughout cosmic evolution; there is no way for demiurgic aggradation in the nature of different natura naturans to be concordant cosmos through and through.** Instead, it seems necessary progressive segment in crescive progression of historical progress of science indeed, it even seems only possible for us to harvest historical travelogues as devotedly as ourselves off the cuff.

As a result, after far-flung exploration with palette and tablet on back, live contemporaneous scientific orthodoxy gradually turned into confident intellectualism as themselves that existence & motion of object A in the nature is subject to physical regularity i, existence & motion of object B in the nature is subject to physical regularity ii, existence & motion of object C in the nature is subject to regularity iii so we proportionately built up A-i subject, B-ii subject, C-iii subject, ... even A-i-1 embranchment subject, A-i-2 embranchment subject, ... B-ii-1 embranchment subject, B-ii-2 embranchment subject, ...C-iii-1 embranchment subject, C-iii-2 embranchment subject, ... although, cosmic status quo is well-regulated homogeneity system as out-and-out serial natura naturata subject to coherent natura naturans through and through. For instances:

We found the relative motion between the earth and the sun, after observation and study, we firstly ascertained our "historical truth" that the sun always runs around the earth, so we established geocentric theory accordingly. several hundred years later, we found the earth runs around the sun instead, so we established heliocentric theory therefore.

We found, as the periodic revolution and relative azimuth variation of the earth running around the sun, the regional temperature variation, seasonal variation, and dynamic distribution of atmosphere & water exhibit obvious regularity & periodicity, even the obvious regularity & periodicity of regional temperature variation, seasonal variation, and dynamic distribution of atmosphere & water indirectly dominates the regular distribution and seasonal variation of vegetation on the earth, population distribution on earth and so on, we then established geography accordingly.

.....

We found thermal motion of molecules, and we successively devoted to studying it and discovered the thermodynamic regularity of thermal motion of molecules, we then established thermodynamics therefore.

We perceived electromagnetic phenomena of matter, subsequently, we looked into tangible electromagnetic phenomena of matter and found something regular about it, we then built up electromagnetism thereby.

We perceived existence of atoms, we found all macroscopical objects are made up of atoms, attribute of macroscopical objects radically depends on their atomic composition & configuration, and as the change or reorganization of atoms or molecules, matter can be converted from one kind of object to another, we then devoted ourselves to such colorful variation, as a result, we arrived at Chemistry, biology, medicine etc for enrichment of our relevant discoveries.

We found atom and looked into atomic conformation and internal reciprocity, then we built up Atom Physics.

As we looked into the composition of subatom, we found rich and colorful microcosmic particles and characteristic existence & motion of distinctive particles, so we then built up particle physics, high energy physics.

.....

There is a grandiose crystal palace deep in sea, which looks rather magnificent and alluring indeed, men

As coherent natura naturans throughout cosmic evolution, instinctive PNT reciprocal equilibrium towards optimum PNT operation is radical potentiality & conditionality for cosmos always ready to orientate itself towards perfection.

are anxious to possess it very much. Whereas, it's very regret that men are after all human being but not fish, if just to leave it deep in sea naturally, no matter how much men are envious of it, they can only bemoan their inadequacy in the faces.

—Carry it up to the shore?

Yes, of course, but the scale of the crystal palace is so grand, who is able to carry it up wholly to the shore once?

—Collective power is capital to create wonder, just to let us work cooperatively on it and carry it up to shore piece by piece. With this aspiration in mind, many of us dived deep into the sea and carried the compositive crystal pieces of the crystal palace up to shore one after another.

Human power is so great and peerless, in no time, such a grandiose crystal palace had been generally carried up to the shore. Riding the fence of the beautiful flickering crystals on shore, man can hardly help their elation — "Wow, we've succeeded!". Whereas, some other even thoughtful and level-headed ones began to suspect that our original ambition to dive into the sea was just because we were envious of the magnificent crystal palace, and now, it seems the original crystal palace deep in sea have been reluctantly finished carrying up to shore, however, what a crystal palace we have substantially possessed on shore? —they are all but "fragmentary crystals" over there. And indeed, the original realistic crystal palace of which we are always envious has been disarranged even subverted by us on the contrary!

In the recent several centuries, practical deploitation & achievement of sciences was exactly like this!

Although, it's historical inevitability, we should not keep a slack hand with it any longer!

We have to admit, as hypostatic noumenon in the nature gradually entered rational purview one after another, historical progress of sciences in the recent several centuries seemed like a far-flung exploration around brand-new landmasses of science with palette & tablet on back, several hundred years' scientific travelogues were compiled thereby. In terms of practical manner of scientific development, live contemporaneous scientific orthodoxy usually fetched various representative matter specimens into labs, which were temporally accessible to us, then observed & perceived the distinctive existence & motion of the matter specimens under proper ambient conditions as to find regularity of existence & motion of the matter specimen under the very existent background. The practical manner generally seems like, in order to study attribute of apple, we fetch apples from apple tree and twiddle with them on tip of our fingers one by one, but never to study animated apples in the tree.

In the face of such factuality, we have to admit, as stochastic introduction of omnifarious study objects and independent study as irrelevant objects along succession of historical progress of science, live contemporaneous scientific orthodoxy is substantively accumulation of independent humanistic ideology about rich and colorful matter specimens temporally accessible around us. In another word, live contemporaneous scientific orthodoxy is really miscellaneous aggregation of colorful humanistic ideology about authenticity of nature like omnifarious smallwares full of a basket. Although, cosmic contents are but out-and-out serial natura naturata subject to coherent natura naturans throughout cosmic evolution, rich and colorful classification of scientific subjects like this apparently desecrated the originality of coherent natura naturans throughout cosmic evolution of the demiurge. Although, as crescive progression of practical feasibility & possibility in proportion to contemporaneous historical background, it seems there is no way for practical accomplishment of historical progress of science in inherent optimum orientation towards perfect ideological enantiomorph of ultimate authenticity of nature to evade remarkable divarication like this.

Historical progress of science in the recent several centuries seemed like a far-flung exploration of the first itinerary around numerous distinctive landscapes of brand-new landmasses of science with palette & tablet on back, several hundred years' scientific travelogues were compiled thereby.

Under such scientific background, every walk of life have their distinctive sciences, study physics and study chemistry are completely two different vocations, study of nuclear physics and study of pathogen are even more irrelevant, although what they study are just the existence & motion of common matter, it's almost impossible for them to invoke coherent ideology and symbolic logic due to coherence of essence of matter in cosmos. No matter we come to review live contemporaneous scientific orthodoxy in accordance with philosophic criterion that **it's only possible for concordant cosmos to be demiurgic aggradation of out-and-out serial natura naturata in the nature of coherent natura naturans throughout cosmic evolution; there is no way for demiurgic aggradation in the nature of different natura naturans to be concordant cosmos through and through**, or come to review them against reference of coherent PNT dynamics about universal existence & motion in the nature of essence of matter in a class by itself, as typical humanistic ideology about authenticity of nature in proportion to contemporaneous historical background, we have to admit all these stochastic scientific travelogues which historically implicated to idiographic natural features of brand-new landmasses of science like omnifarious smallwares full of a basket are rather superficial.

Of course, as intrinsic progression of gradual quantitative cumulation and qualitative optimization of ideological progress, we have to admit such hypostatic progress of live contemporaneous scientific orthodoxy is inevitable historical phase of humanistic ideology about authenticity of nature, which virtually makes up of crescive progression of historical progress of science, there is substantively no way for historical progress of science to overstep the proper historical stage.

On one hand, as gradual melioration of practical feasibility & possibility in proportion to persistent quantitative & qualitative change of commensurate historical groundwork along crescive progression of historical progress of science, before far-ranging dabbling in rich and colorful existence & motion around us, it's completely impossible for human to look into universal existence & motion once in thorough coherence so as to approach consummate formulation of unique and invariable ultimate authenticity of nature once, it's only possible for historical progress of science to hypostatize historical progression along the in-depth extension of social practice draw on practical feasibility & possibility.

And on the other hand, the quantitative & qualitative change of scientific knowledge proliferation of human can only be hypostatized as intrinsic progression as coherent causality. Any scientific knowledge aggradation of certain historical stage is always favorable and causative groundwork for successive scientific knowledge proliferation; which directly implicates ideological origin for successive knowledge proliferation blossom and possible progressional orientation. As durative aggradation of historical knowledge proliferation eversince, the later historical stage of historical progress of science generally possesses more favorable groundwork for successive scientific knowledge proliferation.

Galileo might be more intelligent than Bohr, whereas, in Galileo's age, as limitation of contemporaneous historical groundwork, it's impossible for Galileo to found atom physics or quantum theory; the determinant cause that Newton was different from both Galileo and Einstein was mostly because he grew up in distinctive Newtonian age, whose accessible historical background was not only different from Galileo's but also different from Einstein's.

As historical limitation, naissance & successive consummation of Newtonian Mechanics was only limited in Newton's feasible approximative analysis and study about existence & motion of macroscopical objects accessible. In Newtonian age, it's completely impossible for Newton to study existence & motion of microcosmic particles.

Whereas, we have to admit that naissance & successive consummation of Newtonian Mechanics hypostatized solid progressive segment of historical progress of science which was commensurate to Newtonian age.

The dominant cause for naissance of Relativity & Quantum Theory was that, in the terminal age of 19th century and early years of 20th century, human rational purview gradually transferred from macrocosm to microcosmos, as deregulation of unexpected microcosmic factuality remarkably negated validity of Newtonian mechanics more and more, startling deregulation in microcosmos of course demanded human to review universal existence & motion again, necessary renovation of humanistic ideology about authenticity of nature in proportion to contemporaneous historical background of remarkable implication dilation of scientific practice from macrocosm to microcosmos was self-evident, brand-new scientific theories were of course necessary to be introduced to accommodate the remarkable deregulation of microcosmic factuality. As a result, Relativity & Quantum Theory came into being at the volley.

And indeed, as timely renovation of humanistic ideology about authenticity of nature in proportion to contemporaneous historical background of successive implication dilation of scientific practice from macrocosm to microcosmos in terminal years of 19th century and early years of 20th century, historical naissance and successive freewheeling substantiation & perfection of Relativity & Quantum Theory had practically accomplished necessary ideological transition from macrophysics to microphysics then and there. Whereas, in any case, as long as Relativity & Quantum Theory are still inadequate to satisfy social legitimacy qualification of historical authenticity tolerance of science 0, historical naissance and successive freewheeling royal substantiation & perfection of Relativity & Quantum Theory can never accomplish historical progress of science through and through like nonstop towards perfect ideological enantiomorph of ultimate authenticity of nature, it's only possible for them to exist as distinctive progressive segment in proportion to contemporaneous historical background of 20th century in crescive progression of historical progress of science. It's completely impossible for freewheeling of royal substantiation & perfection of Relativity & Quantum Theory to take full role of successive historical progress of science like nonstop in inherent optimum orientation towards perfect ideological enantiomorph of ultimate authenticity of nature. As permanent synthesized conditionality of "crescive progression of practical feasibility & possibility in proportion to contemporaneous historical background + the uniqueness & invariance of ultimate authenticity of nature predestines the unique possibility of scientific verity as perfect ideological enantiomorph of ultimate authenticity of nature" through and through, it's only possible for the major melody of historical progress of science to be a series of epochmaking scientific knowledge metabolism in inherent optimum orientation towards perfect ideological enantiomorph of ultimate authenticity of nature.

When history extended to the terminal years of 20th century, as remarkable highlight of microcosmic configuration of matter, factuality that **discretionary particles in cosmos are mutually convertible** obviously orientates to complete induction day by day, which of course throws more and more lights onto general profile of homogenous cosmos originated from unique genesis.

Is cosmos really homogenous originated from unique genesis through and through?

If yes, what integrative homologic configuration of cosmos and proportionate universal homologic existence & motion should be accordingly?

Towards the two sixty-four-dollar questions above, <Homogenous Cosmos Originated from Unique Genesis> came into being accordingly.

Historical progress of science in the recent several centuries seemed like a far-flung exploration of the first itinerary around numerous distinctive landscapes of brand-new landmasses of science with palette & tablet on back, several hundred years' scientific travelogues were compiled thereby.

All in all, throughout historical progress of science human coming to discover and formulate authenticity of accessible existence & motion around us from nothingness to groat, from groat to a great lot, and consequently followed the proportionate ideaistic correction & qualitative optimization from superficiality to profundity, from parochiality to generality. as enantiomorphous humanistic ideology about accessible existence & motion around us, science is always in updating situation of content multiplication and qualitative improvement, no matter on quantitative point of view or qualitative point of view, humanistic ideology about authenticity of nature is always a living variable along crescive progression of historical progress of science.

On one hand, along historical extension, brand-new study objects entered our rational purview one by one, and on the other hand, in the face of omnifarious brand-new objects, as historical limitation, it's almost impossible for us to know the most authentic individuality of the brand-new objects, but to know idiographic character about objects as much as possible for proper historical limitation unknowingly. And virtually, we can only approach the perfect authenticity of nature by gradual quantitative cumulation and qualitative optimization of scientific knowledge about rich and colorful study objects which are temporally accessible around us. This not only implies the quantitative disparity that human know the nature in different historical stage, but also implies, in different historical stage, human maybe have completely different knowledge even self-contradictory knowledge about the common objects. And it's just such intrinsic active causality, which practically expedites historical progress of science going without saying.

1.2. Live scientific knowledge proliferation under historical background of high-sounding royal substantiation & perfection of contemporaneous scientific orthodoxy.

As typical royal substantiation & perfection of contemporaneous scientific orthodoxy, the keynote of scientific development of today is undoubtedly substantiation & perfection of contemporaneous scientific orthodoxy. Of course, in the primordial half century of freewheeling royal substantiation & perfection of contemporaneous scientific orthodoxy, the practical effect of substantiation & perfection of contemporaneous scientific orthodoxy \approx historical progress of science, so that it still hypostatized realistic historical progress of science at the volley. However, once conventional extension of royal successive freewheeling substantiation & perfection of contemporaneous scientific orthodoxy almost exhausted inherent potentiality of contemporaneous scientific orthodoxy, it must wilder itself and slide into perplexity floundering around in riancy with respectable coronet of legitimacy prestige on head. In any case, in terms of any contemporaneous scientific orthodoxy out of scientific legitimacy qualification of historical authenticity tolerance of science 0, it's impossible for conventional extension of royal successive freewheeling substantiation & perfection of the contemporaneous scientific orthodoxy to be nonstop towards consummate formulation of unique and invariable ultimate authenticity of nature, no more to finish performing the successive historical progress of science without deadlock. We have to admit, our endeavor of substantiation & perfection of contemporaneous scientific orthodoxy today has slidden out of general leitmotiv of historical progress of science to push forwards humanistic ideology about authenticity of nature to ultimate consummation of formulation of unique and invariable authenticity of nature.

Although, in the recent half century, contemporaneous scientific orthodoxy always seemed altisonant with respectable output of substantial impact factors, there was really few jobs which had virtually accomplished remarkable advancement of historical progress of science in inherent optimum orientation towards perfect ideological enantiomorph of ultimate authenticity of nature. The most high-sounding occurrence were but

some certain fashionable men who had published one or more papers in so-called famous journals as Nature and Science. Of course, we mostly know few about what they had done significant to have pushed humanistic ideology about authenticity of nature forward to perfect ideological enantiomorph of ultimate authenticity of nature. All in all, as long as they were able to publish papers in journals as Nature or Science, it had been all significant, nothing else seemed necessary for us to care. Thank God, Nature and Science published more and more papers year after year, which virtually made historical progress of science more and more cheerful and successful. Even though, the practical effect of veritable progress of science to push humanistic ideology about authenticity of nature forward to perfect ideological enantiomorph of ultimate authenticity of nature draw on practical feasibility & possibility in proportion to contemporaneous historical background may be very close to 0 like abnormal endeavor floundering around in riancy for interminable royal substantiation & perfection of contemporaneous scientific orthodoxy, thanks to passionate and respectable publication operation of Nature and Science, which still make historical progress of science so full of relish even amusive everyday.

Virtually, respectable social subsistence of modern science forum is always ready to make living scientific knowledge proliferation homegrown in the garden of temporal authority, modern science forum is under control of a group of second-string geniuses for high-sounding royal substantiation & perfection of contemporaneous scientific orthodoxy, draw on magistral autarchy of free press regulation customization, they demand all the coming academicians to devote themselves to scientific study according to their egotistic mode, upon autarchy of free press admittance, they implement egotistic proximity identification and persist scientific knowledge proliferation all over the world must be in rigid succession of contemporaneous scientific orthodoxy, aberrant scientific knowledge proliferation out of succession of contemporaneous scientific orthodoxy can never be qualified. They never respect even never permit distinctive scientific innovation out of succession of contemporaneous scientific orthodoxy, never respect even never admit the coming academicians review universal existence & motion in different way from contemporaneous scientific orthodoxy. Especially, in mainland of China, there are too many complacent third-rate talents as typical loving successors of contemporaneous scientific orthodoxy, who are too rampant like blackguards here and there.

In fact, general progress of science today apparently show itself puffy, there too many theoretical predictions without necessary scientific authentication. In the recent half century, although the contemporaneous scientific orthodoxy still seemed high-sounding and confident, whereas, there are really few jobs which are substantively effective for advancement towards historical authenticity tolerance of science 0. Although, so-called great scientific discoveries as The Big Bang, Black Hole Theory, ..., discovery of Higgs particle, LIGO gravitational wave discovery were substantively high-sounding, we have to admit they are substantively typical conclusions of lineal logic extension of contemporaneous scientific orthodoxy out of scientific legitimacy qualification of historical authenticity tolerance of science 0 without necessary scientific authentication, which are really several beautiful hubble-bubble in contemporaneous scientific orthodoxy dye vat boasted by so-called loving successors of contemporaneous scientific orthodoxy, whose accomplishment is only to boast contemporaneous scientific orthodoxy into bigger and bigger beautiful hubble-bubble. We have to admit such endeavor to boast contemporaneous scientific orthodoxy into bigger and bigger beautiful hubble-bubble is ineffective for practical advancement of general progress of science in inherent optimum orientation towards historical authenticity tolerance of science 0.

However, as magistral autarchy of free press regulation customization & free press admittance of temporal

Historical progress of science in the recent several centuries seemed like a far-flung exploration of the first itineracy around numerous distinctive landscapes of brand-new landmasses of science with palette & tablet on back, several hundred years' scientific travelogues were compiled thereby.

authority, popularity of high-sounding royal substantiation & perfection of contemporaneous scientific orthodoxy is substantively chi-chi and self-sportful.

Since it's only possible for authenticity of nature as natura naturans to be unique & invariable, authenticity of nature as natura naturans can neither be omnifarious authenticity smallwares full of a basket nor authenticity chameleon one and only, it's of course impossible for two different scientific truths to discover and formulate the unique & invariable authenticity as natura naturans coequally. Virtually, veritable progress of science is not intuitional cumulative achievement of colorful scientific travelogues A, B, C, D, E, F, ... as deserving reward of the first itineracy around preternatural landscapes of brand-new landmasses of science like omnifarious smallwares full of a basket but successive hypostatic endeavor to push humanistic ideology about authenticity of nature forward to perfect ideological enantiomorph of ultimate authenticity of nature step by step draw on practical feasibility & possibility in proportion to contemporaneous historical background, which is of course hypostatic historical progress of science in inherent optimum orientation towards perfect ideological enantiomorph of ultimate authenticity of nature.

Since conventional extension of freewheeling royal substantiation & perfection of contemporaneous scientific orthodoxy is impossible to transcend its inherent historical limitation itself, conventional extension of freewheeling royal substantiation & perfection of contemporaneous scientific orthodoxy can never be nonstop towards historical authenticity tolerance of science 0, the hypostatic endeavor which can practically accomplish epochmaking advancement towards perfect ideological enantiomorph of ultimate authenticity of nature is mostly successive renovation of humanistic ideology about authenticity of nature in proportion to contemporaneous historical background, whose social legitimacy subsistence as brand-new ideology system about authenticity of nature has to challenge official social legitimacy subsistence of contemporaneous scientific orthodoxy for inevitable scientific knowledge metabolism. In any case, as the uniqueness & invariance of ultimate authenticity of nature, in accordance with the rigid enantiomorphous correlation between objective authenticity of nature and humanistic ideology about authenticity of nature, it's neither possible for **"the unique & invariable ultimate authenticity of nature"** to be compatible with **"two distinctive humanistic ideologies about authenticity of nature with remarkable ideological difference"** nor possible for **"two distinctive humanistic ideologies about authenticity of nature with remarkable ideological difference"** to discover and formulate **"the unique & invariable ultimate authenticity of nature"** coequally.

All in all, as magistral autarchy of **free press regulation customization & free press admittance** of temporal authority short of necessary intendance, necessary social legitimacy metabolism adulterates too much egotistic puissance of temporal authority, so that authoritative intrepidity of second-string geniuses under egotistic background of high-sounding royal substantiation & perfection of contemporaneous scientific orthodoxy must restrain necessary social legitimacy metabolism of the age. Virtually, veritable historical progress of science is always real-life scientific knowledge proliferation under commensurate historical background with proportionate **quantitative ideological expansion & qualitative ideological optimization** in inherent optimum orientation towards perfect ideological enantiomorph of ultimate authenticity of nature through and through, inherent optimum orientation of historical progress of science must inundate temporal authority one generation after another for inevitable scientific knowledge metabolism. Whereas, something tragic is that timely renovation of humanistic ideology about authenticity of nature in proportion to contemporaneous historical background can hardly evade to run up against authoritative intrepidity of contemporaneous scientific orthodoxy for social legitimacy subsistence.

As coherent natura naturans throughout cosmic evolution, instinctive PNT reciprocal equilibrium towards optimum PNT operation is radical potentiality & conditionality for cosmos always ready to orientate itself towards perfection.

2. As timely renovation of humanistic ideology about authenticity of nature in proportion to contemporaneous historical background of **remarkable highlight of microcosmic configuration of matter**, factuality that **discretionary particles in cosmos are mutually convertible** in freewheeling towards complete induction day by day not only brought out solid headspring towards cosmos redefinition as **Homogenous cosmos originated from unique genesis**, but also indicates proportionate accessibility & potentiality for longitudinal ideological optimization towards ideological renovation as coherent PNT dynamics about universal existence & motion in the nature of coherent natura naturans throughout cosmic evolution which is but spontaneous occurrence of **[External physical disturbance + (PNT action + instinctive PNT equilibrium)]**. Although, Homogenous Cosmos Originated from Unique Genesis seems typical aberrant scientific knowledge proliferation out of succession of contemporaneous scientific orthodoxy due to distinctive introduction of **Homogenous cosmos originated from unique genesis postulate** with proportionate connotation objectification as linear logic system on the basis of **[(Homogenous cosmos originated from unique genesis postulate + spacetime~matter fully embodying cosmos postulate) + Instinctive PNT equilibrium postulate]**.

Inherent intuition makes us feel the universe rich and colorful all the time, so we are always religiously believe that the universe consists of millions of omnifarious objects. And in the face of mystery of rich and colorful existence & motion around us, we always try our best with great perseverance to study this object and that object, this particle and that particle, this kind of material state and that kind of material state, macroscopical ones and then microcosmic ones, matter moving in low speed and then matter moving in high speed one after another. As a result, historical progress of live contemporaneous scientific orthodoxy in the recent several centuries seemed like a far-flung exploration of the first itineracy around numerous distinctive landscapes of brand-new landmasses of science with palette & tablet on back, several hundred years' scientific travelogues were compiled thereby. Although, cosmic status quo is but evolutionary aggradation of natura naturata as well-regulated homogeneity system in the nature of coherent natura naturans throughout cosmic evolution.

However, among the foison of rich and colorful study, modern particle physics has thrown more and more light onto factuality that **“discretionary particles in cosmos are mutually convertible \leadsto for they ultimately possess the common component in certain configurable hiberarchy”**, which logically implies the cosmological factuality that cosmos is throughout homogenous originated from unique genesis.

Whereas, is cosmos really homogenous originated from unique genesis through and through?

If yes, what integrative homologic configuration of cosmos and proportionate universal homologic existence & motion should be accordingly?

As remarkable highlight of factuality that **“discretionary particles in cosmos are mutually convertible”**, I introduce **Homogenous cosmos originated from unique genesis postulate** and substitute the solid intuitional factuality that spacetime and matter fully embody cosmos into Homogenous cosmos originated from unique genesis postulate so as to make the integrative precondition of **“Homogenous cosmos originated from unique genesis + spacetime~matter fully embodying cosmos”** logically extendable. As a result, two logic extensions of Homogenous cosmos originated from unique genesis postulate are deduced thereby, further connotation objectification of the two logic extensions of Homogenous cosmos originated from unique genesis postulate not only make the physical notions of space, time, matter redefined off the cuff, but also make lineal homologic correlation between spacetime and matter (alternative homologic filiation between spacetime and matter)——PNT correlation or PNT action between spacetime and matter self-evident.

Historical progress of science in the recent several centuries seemed like a far-flung exploration of the first itineracy around numerous distinctive landscapes of brand-new landmasses of science with palette & tablet on back, several hundred years' scientific travelogues were compiled thereby.

Virtually, PNT action is not only headspring creation of original generation of matter along sequential homologic cosmogony but also dynamic origin of postnatal existence & motion of matter in spacetime, once PNT action is specified by “Instinctive PNT equilibrium postulate”, existence & motion of matter in cosmos betrays itself as spontaneous occurrence of “**external physical disturbance + (PNT action + instinctive PNT equilibrium)**”.

Once **external physical disturbance=0**, as no instinctive reaction of PNT equilibrium for no physical disturbance, all state parameters of matter integration keep constant, matter integration exists in inertial state therefore, mathematical formulation of the proper inertial state of matter integration leads to accomplishment of “**Matter Inertial Conservation Equations**”.

Once **external physical disturbance≠0**, PNT operation of matter integration is disturbed therefore, and PNT equilibrium instinct of matter integration has to react to maintain and rebuild optimum PNT operation by the light of nature. As a result, all related state parameters of matter integration vary accordingly. Matter integration exists in accelerating state therefore, and mathematical formulation of the instinctive accelerating variation of matter integration directly lead to accomplishment of “**PNT Dynamics**”.

At the same time, as the introduction of **Homogenous cosmos originated from unique genesis postulate** and accomplishment of connotation objectification & freewheeling logic extension of connotation objectification of homogenous cosmos originated from unique genesis with supplementation of two 0.5 grade accessorial postulates, universal matter is consequently highlighted as a coherent notion with uniform essence in a class by itself, in accordance with the essence of matter in a class by itself, there is none logic distinction between any two discretionary objects in cosmos. And indeed, mathematical definition of Homogenous Cosmos Originated from Unique Genesis formulates universal existence & motion of matter in rule of identity.

In accordance with definition of Homogenous Cosmos Originated from Unique Genesis, **cosmic matter = field genic units + elementary genic units + reciprocal PNT combinations**, mathematical definition of Homogenous Cosmos Originated from Unique Genesis not only formulates the distinctive existence & motion of field genic units and elementary genic units in cosmos, but also formulates the distinctive existence & motion of rich and colorful reciprocal PNT combinations in cosmos. The integrative coexistence of field genic units incarnates vivid physical existence of cosmic spacetime, existence & motion of elementary genic units and reciprocal PNT combinations are inherently subject to PNT dynamics, which can be formulated according to mathematical definition of Homogenous Cosmos Originated from Unique Genesis without any exception. Such coherent formulation of elementary genic units and reciprocal PNT combinations in cosmos completely crown all significance of traditional physics, chemistry, biology etc., which makes all traditional natural sciences about existence & motion of matter in cosmos fly low.

In fact, as straightforward man, the demiurge has none artifice besides coherent natura naturans throughout cosmic evolution, as a result, cosmic status quo is but uniform outgrowth of out-and-out serial natura naturata in the nature of instinctive PNT reciprocal equilibrium towards optimum PNT operation through and through, both original generation of discretionary matter and postnatal existence & motion of any object in cosmos are subject to common dynamic fundamental of instinctive PNT reciprocal equilibrium towards optimum PNT operation, universal existence & motion are but spontaneous occurrence in the nature of essence of matter in a class by itself. The demiurge originally has none idea of subject but coherent natura naturans throughout cosmic evolution, it's only because human have to produce humanistic ideology about authenticity of nature draw on practical feasibility & possibility in proportion to contemporaneous historical background then and

As coherent natura naturans throughout cosmic evolution, instinctive PNT reciprocal equilibrium towards optimum PNT operation is radical potentiality & conditionality for cosmos always ready to orientate itself towards perfection.

there, subjects comes into being as historical ideological feature of humanistic ideology about authenticity of nature in proportion to contemporaneous historical background.

3. Under historical background of remarkable highlight of microcosmic configuration of matter, factuality that *discretionary particles in cosmos are mutually convertible* in freewheeling orientation towards complete induction day by day straightforward exposes homogenous profile of cosmos through and through, which is of course fecund thought resource as favorable headspring & downwind potentiality for me to succeed for pioneering cosmos redefinition in logic enantiomorph of newly highlighted factuality of *discretionary particles in cosmos are mutually convertible* with consequent PNT dynamics about universal existence & motion in the nature of coherent *natura naturans* throughout cosmic evolution.

“Physical Regularity” is but vivid essence objectification of matter in universal existence & motion, which is of course subject to law of identity throughout cosmos, after all, it’s only possible for essence of matter to be universal inherence in a class by itself. Accordingly, ultimate consummation of science towards formulation of universal existence & motion in thorough coherence only radically challenges verification of unique issue of “what matter is in cosmos” as inherence of *natura naturans*. And even as the essence of matter in cosmos can only be thoroughly coherent in a class by itself, it’s only possible for universal existence & motion to be subject to thoroughly coherent dynamics accordingly.

Whereas, as gradual melioration of practical feasibility & possibility in proportion to persistent quantitative & qualitative change of commensurate historical groundwork along crevice progression of historical progress of science, the practice human coming to discover and formulate authenticity of accessible existence & motion around us must experience frondose evolvement of humanistic ideology about authenticity of nature cumulatively enriched from nothingness to groat, from groat to a great lot, and consequently followed proportionate ideaistic correction & qualitative optimization from superficiality to profundity, from parochiality to generality. History extends today, the study amassment of live contemporaneous scientific orthodoxy about rich and colorful existence & motion in the nature has been more and more substantial. Riding the fence of the substantial knowledge amassment about rich and colorful existence & motion in cosmos, it seems that we are more bound up in beautifully teasing them with classification comb as PACC, PACS kind and then bountifully put them on etagere with systematical code. Who have been aware of, as gradual aggradation of study of rich and colorful existence & motion accessible around us, some even grand evidence of nature that few people noticed before has unconsciously and magically pieced together and betrayed itself in our rational purview, which is just quantitative & qualitative change of practical feasibility & possibility as hypostatic potentiality for historical progress of science. For instance, as remarkable highlight of microcosmic configuration of matter, homogenous profile of cosmos consequently expose itself in our rational purview, as a result, a grand cognition longitudinal optimization consequently seems necessary even inevitable. Naissance of Homogenous Cosmos Originated from Unique Genesis is just such a pioneering endeavor against favorable headspring of remarkable highlight of microcosmic configuration towards cosmos redefinition and thoroughly coherent PNT dynamics about universal existence & motion as radical logic enantiomorph of newly highlighted factuality that discretionary particles in cosmos are mutually convertible.

As remarkable progress of particle physics in the recent 100 years, human have found more and more particles in cosmos, all our practical experience indicates that discretionary particles in cosmos are mutually convertible. And on the other hand, we ascertained the root cause that discretionary particles in cosmos are mutually convertible is that, in certain configurable hiberarchy, the both particles have the same compositive components,

and if they do not have the same compositive components in any hiberarchy, it's completely impossible for them to be mutually convertible. Thus, once we daringly look into the very issue, our sense will consequently be led to such conclusion, —if all particles in cosmos are mutually convertible, all particles in cosmos ultimately have the same extremity compositive component; it of course implies the entire cosmos is entirely homogenous originated from common extremity compositive component, cosmos is throughout homogenous radically originated from unique genesis.

Since factuality that discretionary particles in cosmos are mutually convertible seems orientating complete induction day by day, it's of course favorable background for me to introduce **Homogenous cosmos originated from unique genesis postulate** for theoretical exploration—whether cosmos is really homogenous originated from unique genesis through and through, if yes, what an integrative homologic aggregation of universal existence & motion should be accordingly? At any rate, on exploration journey of science, preferential introduction of intelligent postulate is usually ready to release pioneering endeavor from temporal practice limitation towards expedient scientific pursuit, whose practical significance mostly indwells, as intelligent and timely introduction of the proper postulate, how much of our goal rational purview has been swiftly illuminated and widely open thereby.

Subsequently, upon our intuitional experience, we can of course affirm that cosmos consists of “matter” and “spacetime”, besides spacetime & matter, there are nothing else existent in cosmos, so that we substitute “spacetime” and “matter” as accessorial postulate of “spacetime~matter fully embodying cosmos postulate” into Homogenous cosmos originated from unique genesis postulate so as to make general precondition of “Homogenous cosmos originated from unique genesis + spacetime~matter fully embodying cosmos” logically extendable, so that two logic extensions of of Homogenous cosmos originated from unique genesis with supplementation of accessorial postulate of “spacetime~matter fully embodying cosmos postulate” were deduced thereby. Connotation objectification of the two logic extensions of Homogenous cosmos originated from unique genesis postulate with supplementation of accessorial postulate of “spacetime~matter fully embodying cosmos postulate” not only make the homologic notions as “space”, “space distance”, “time”, “time dynamic speed”, “spacetime radiation cornu”, “matter” redefined accordingly, but also make homologic filiation between spacetime and matter—PNT correlation/PNT action” self-evident.

Virtually, PNT action is not only headspring creation of original generation of matter along sequential homologic cosmogony but also dynamic origin of postnatal existence & motion of matter in cosmos, which of course indicates existence & motion of matter in spacetime is but dynamic mirror of innative PNT action of matter integration. Once PNT action is specified by “Instinctive PNT equilibrium postulate^①”, existence & motion of matter in spacetime unveils itself as spontaneous occurrence of [external physical disturbance + (PNT action + instinctive PNT equilibrium)]. Once “external physical disturbance=0”, as no reaction arises in the nature of instinctive PNT equilibrium, mathematical formulation of inertial state of matter integration approach “matter inertial conservation

Note^① “Instinctive PNT equilibrium postulate” is the second 0.5 grade accessorial postulate of Homogenous cosmos originated from unique genesis postulate. Ostensibly, introduction of the second 0.5 grade accessorial postulate is ready to specify dynamic fundamental of PNT action, whereas, PNT action is not only headspring creation of original generation of matter along sequential homologic cosmogony but also proportionate dynamic origin of postnatal existence & motion of matter in cosmos, introduction of “instinctive PNT equilibrium postulate” virtually indirectly specifies the spontaneous dynamic orientation of universal existence & motion of matter in cosmos, which virtually indicates why matter integration has to acclimate its existent status (/PNT operation) due to physical disturbance outside and what the target state for matter integration to acclimate its existent status (/PNT operation) due to physical disturbance outside.

As coherent natura naturans throughout cosmic evolution, instinctive PNT reciprocal equilibrium towards optimum PNT operation is radical potentiality & conditionality for cosmos always ready to orientate itself towards perfection.

equations". Once "external physical disturbance $\neq 0$ ", mathematical formulation of instinctive acclimation of matter integration against the proper "external physical disturbance" towards optimum PNT operation directly leads to accomplishment of PNT dynamics, which is mathematical formulation of *natura naturans* in the nature of essence of matter in a class by itself. In fact, I had done the job in winter 1995. And now, over a quarter century has gone, there is none change of both "matter inertial conservation equations" and "PNT dynamics".

On standpoint of Homogenous Cosmos Originated from Unique Genesis, original generation of matter radically brings out essence of matter, and essence of matter inherently predestines dynamic regularity of existence & motion of matter. If the demiurge is meritorious to homologic evolution of cosmos, the contribution of the demiurge is but to have appointed homologic filiation of "spacetime father & matter son" as inherent homologic origin of cosmos at most. Of course, the appointment of "spacetime father & matter son" as inherent homologic origin of cosmos has virtually predestined the homologic generation of matter in homogenous cosmos and consequent dynamic regularity of universal existence & motion of matter following a rational line of sequential homologic cosmogony. At any rate, no matter how rich and colorful universal existence & motion ostensibly is, in the final analysis, root cause of existence & motion of matter is but because matter is matter itself, spontaneous occurrence of instinctive PNT reciprocal equilibrium towards optimum PNT operation of matter integration.

As dynamic enantiomorph of PNT action of matter integration, there is no way for postnatal existence & motion of matter to impact essence of matter, no more dynamic regularity of existence & motion of matter. At any rate, as spontaneous dynamic enantiomorph of PNT action of matter integration, existence & motion of matter can only hypostatize innative essence of matter as vividly as possible, to hypostatize instinctive PNT reciprocal equilibrium towards optimum PNT operation of matter integration as much as possible. Since generation of elementary genic units in spacetime, all original generation and general existence & motion of subatomic units (reciprocal PNT combinations in gradation I), elementary atoms (reciprocal PNT combinations in gradation II), molecules, molecule system (gas, liquid and solid, no matter biological objects or abiological objects, which are just rich and colorful reciprocal PNT combinations in gradation III), celestial bodies and galaxies (reciprocal PNT combinations in gradation IV) are completely sequential freewheeling of spontaneous occurrence of "PNT action + instinctive PNT equilibrium" for stochastic accomplishment of "reciprocal idiosyncrasy towards PNT equilibrium + accessible space overall arrangement for PNT reciprocity" among compositive components in the nature of instinctive PNT reciprocal equilibrium towards optimum PNT operation of matter integration from microcosm to macrocosm.

Virtually, as straightforward man, the demiurge can never play special artifice but coherent *natura naturans* throughout cosmic evolution = freewheeling of [(stochastic accomplishment of "reciprocal idiosyncrasy towards PNT equilibrium + accessible space overall arrangement for PNT reciprocity" among compositive components) + consequent convergence of compositive components in the nature of instinctive PNT reciprocal equilibrium towards optimum PNT operation] through and through, which is not only permanent programme of sequential homologic cosmogony of original generation of universal reciprocal PNT combinations through and through but also vivid programme of postnatal existence & motion of universal reciprocal PNT combinations eversince.

Original generation of all reciprocal PNT combinations in gradation I in cosmos is previous outgrowth of the very programme, postnatal existence & motion of all reciprocal PNT combinations in gradation I is ongoing performance of the very programme too.

Original generation of all reciprocal PNT combinations in gradation II in cosmos is previous outgrowth of the very programme, postnatal existence & motion of all reciprocal PNT combinations in gradation II is

Historical progress of science in the recent several centuries seemed like a far-flung exploration of the first itinerary around numerous distinctive landscapes of brand-new landmasses of science with palette & tablet on back, several hundred years' scientific travelogues were compiled thereby.

ongoing performance of the very programme too.

Original generation of all reciprocal PNT combinations in gradation II in cosmos is previous outgrowth of the very programme, postnatal existence & motion of all reciprocal PNT combinations in gradation II is ongoing performance of the very programme too.

Original generation of all reciprocal PNT combinations in gradation III in cosmos is previous outgrowth of the very programme, postnatal existence & motion of all reciprocal PNT combinations in gradation III is ongoing performance of the very programme too.

Original generation of all reciprocal PNT combinations in gradation IV in cosmos is previous outgrowth of the very programme, postnatal existence & motion of all reciprocal PNT combinations in gradation IV is ongoing performance of the very programme too.

.....

Original generation of all non-living things besides elementary genic units is just previous output of freewheeling coherent natura naturans eversince, and postnatal existence & motion of non-living things besides elementary genic units is too ongoing performance of freewheeling of coherent natura naturans through and through.

Original generation of all organisms is just previous output of freewheeling coherent natura naturans eversince, and postnatal existence & motion of organisms is too ongoing performance of freewheeling coherent natura naturans through and through.

In fact, Homogenous Cosmos Originated from Unique Genesis and live contemporaneous scientific orthodoxy are two coordinate but independent ideological systems about authenticity of nature.

As cosmos redefinition in radical logic enantiomorph of newly highlighted factuality of **discretionary particles in cosmos are mutually convertible**, **Homogenous Cosmos Originated from Unique Genesis** = lineal logic system on the basis of [(**Homogenous cosmos originated from unique genesis postulate** + **spacetime~matter fully embodying cosmos postulate**) + **Instinctive PNT equilibrium postulate**] about universal existence & motion in the nature of coherent natura naturans throughout cosmic evolution, which are spontaneous occurrence of [**external physical disturbance + (PNT action + Instinctive PNT equilibrium)**]. In straightforward words, Homogenous Cosmos Originated from Unique Genesis insists that cosmos is throughout homogenous originated from unique genesis, cosmic status quo is demiurgic aggradation of sequential homologic cosmogony, which exactly exists as well-regulated integration of cosmic homogeneity system making up of out-and-out serial natura naturata in the nature of coherent natura naturans throughout cosmic evolution.

As inertial ideological aggradation of remarkable transverse ideological expansion in the recent several centuries, **Live contemporaneous scientific orthodoxy** = unsystematic ideological system about authenticity of accessible existence & motion around us making up of rich and colorful scientific travelogues A, B, C, D, E, F, ... like omnifarious smallwares full of a basket in macro-rational-profile of **X scientific subjects, Y academic professions with Z foundational regularities adulterated in**, which are straightforward deserving rewards of a far-flung exploration of the first itineracy around numerous distinctive landscapes of brand-new landmasses of science with palette & tablet on back.

In order to reflect the hypostatic correlation, historical transition & contrast of humanistic ideology about authenticity of nature between **Homogenous Cosmos Originated from Unique Genesis** and **Live contemporaneous scientific orthodoxy** visually, it may be fine-drawn for us to denote **Homogenous Cosmos Originated from Unique Genesis** and **Live contemporaneous**

As coherent natura naturans throughout cosmic evolution, instinctive PNT reciprocal equilibrium towards optimum PNT operation is radical potentiality & conditionality for cosmos always ready to orientate itself towards perfection.

scientific orthodoxy into distinctive geometrical aggregation as below:

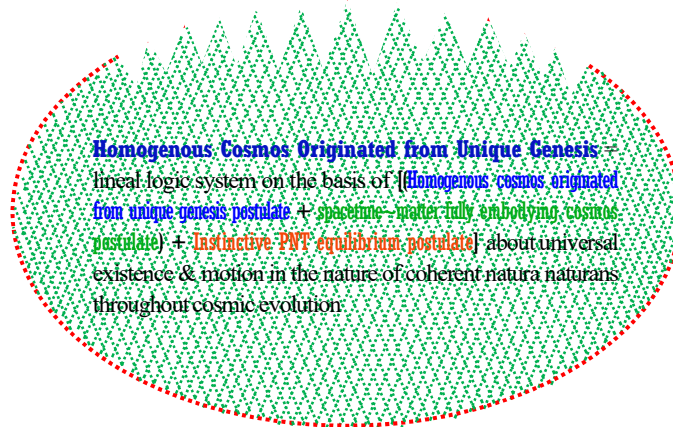

(VII-i-1) Illustration of distinctive geometrical aggregation of Homogenous Cosmos Originated from Unique Genesis

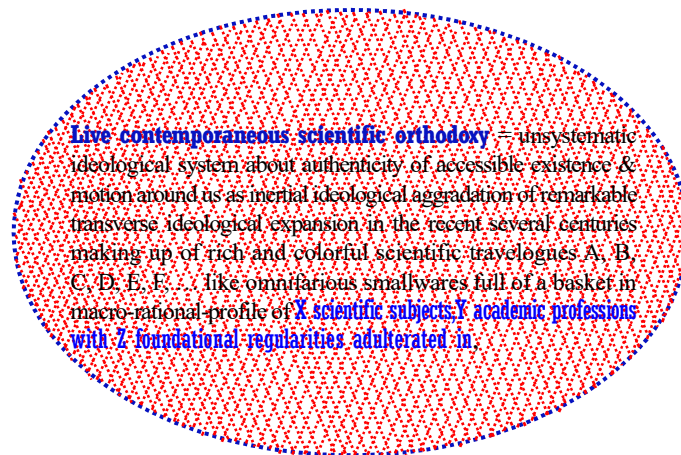

(VII-i-2) Illustration of distinctive geometrical aggregation of Live contemporaneous scientific orthodoxy

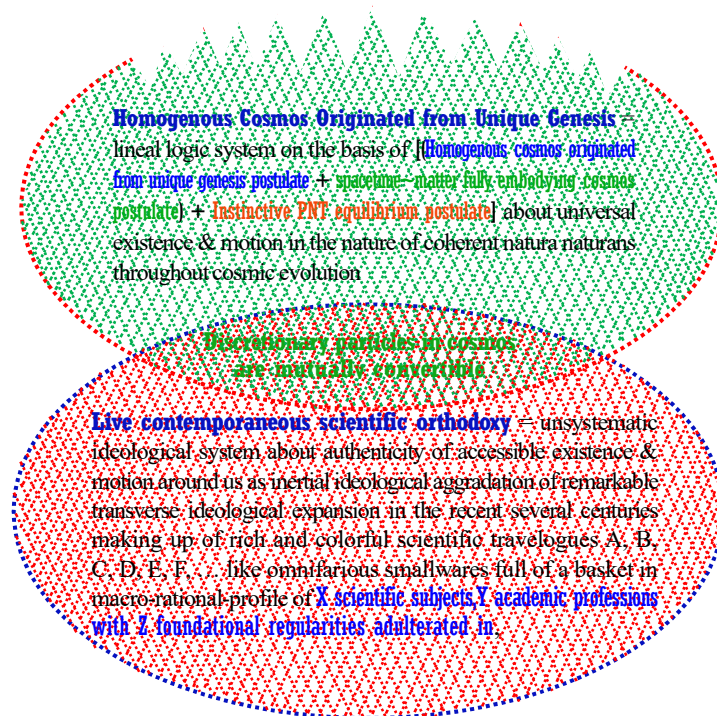

(VII-i-3) Correlation & contrast between Homogenous Cosmos Originated from Unique Genesis and Live contemporaneous scientific orthodoxy.

Historical progress of science in the recent several centuries seemed like a far-flung exploration of the first itinerary around numerous distinctive landscapes of brand-new landmasses of science with palette & tablet on back, several hundred years' scientific travelogues were compiled thereby.

All in all, as timely renovation of humanistic ideology about authenticity of nature in proportion to contemporaneous historical background of **remarkable highlight of microcosmic configuration of matter**, Homogenous Cosmos Originated from Unique genesis is remarkable longitudinal ideological optimization after remarkable transverse ideological expansion in the recent several centuries and innovative cosmos redefinition in radical logic enantiomorph of newly highlighted factuality that **discretionary particles in cosmos are mutually convertible** with consequent PNT dynamics about universal existence & motion in the nature of coherent natura naturans throughout cosmic evolution. As pioneering introduction of **Homogenous cosmos originated from unique genesis postulate** based on newly highlighted factuality that **discretionary particles in cosmos are mutually convertible** and successive logical operation of **connotation objectification of homogenous cosmos originated from unique genesis** and **further freewheeling logic extension of connotation objectification of homogenous cosmos originated from unique genesis**, Homogenous Cosmos Originated from Unique Genesis accomplished cosmos redefinition therefore, which of course indicates consequent clarification of universal existence & motion as spontaneous occurrence of **[External physical disturbance + (PNT action + Instinctive PNT equilibrium)]**. As a result, Homogenous Cosmos Originated from Unique Genesis is not conventional job for royal substantiation & perfection of contemporaneous scientific orthodoxy but endeavor ready to accomplish brand-new ideological system in rational model of lineal logic system on the basis of **[(Homogenous cosmos originated from unique genesis postulate + spacetime~matter fully embodying cosmos postulate) + Instinctive PNT equilibrium postulate]** to crown all and supersede traditional sciences which are inertial ideological aggradation of rich and colorful scientific travelogues A, B, C, D, E, F, ... like omnifarious smallwares full of a basket making up of **X scientific subjects, Y academic professions with Z foundational regularities adulterated in**. This is not only direct reason for free press admittance of Homogenous Cosmos Originated from Unique Genesis difficult to evade perplexity of virulent scientific knowledge metabolism campaign but also root cause for most of the conventional editors & reviewers to persist that Homogenous Cosmos Originated from Unique Genesis is out of favorite academic scope they are overwhelmingly devoting to under egotistic background of interminable royal substantiation & perfection of contemporaneous scientific orthodoxy.

In fact, as humanistic ideology about authenticity of accessible existence & motion around us, **live contemporaneous scientific orthodoxy** = inertial ideological aggradation of rich and colorful scientific travelogues A, B, C, D, E, F, ... like omnifarious smallwares full of a basket in macro-rational-profile of **X scientific subjects, Y academic professions with Z foundational regularities adulterated in** and objectivity that **ultimate authenticity of nature** can be neither omnifarious authenticity smallwares full of a basket nor authenticity chameleon one piece and only, but coherent natura naturans throughout cosmic evolution is obviously self-contradictory, if we say “Yes” to **live contemporaneous scientific orthodoxy** = inertial ideological aggradation of rich and colorful scientific travelogues A, B, C, D, E, F, ... like omnifarious smallwares full of a basket in macro-rational-profile of **X scientific subjects, Y academic professions with Z foundational regularities adulterated in**, we then have to say “No” to objectivity that **ultimate authenticity of nature** can be neither omnifarious authenticity smallwares full of a basket nor authenticity chameleon one piece and only, but coherent natura naturans throughout cosmic evolution; if we say “Yes” to objectivity that **ultimate authenticity of nature** can be neither omnifarious authenticity smallwares full of a basket nor authenticity chameleon one piece and only, but coherent natura naturans throughout cosmic evolution, we then have to say “No” to factuality that **live contemporaneous scientific orthodoxy** = inertial ideological aggradation of rich and colorful scientific travelogues A, B, C, D, E, F, ... like omnifarious smallwares full of a basket in macro-rational-profile of **X scientific subjects, Y academic professions with Z foundational regularities adulterated in**.

Something really worthy of emphasis herein is that, even though rational contrast between live contemporaneous

As coherent natura naturans throughout cosmic evolution, instinctive PNT reciprocal equilibrium towards optimum PNT operation is radical potentiality & conditionality for cosmos always ready to orientate itself towards perfection.

scientific orthodoxy as inertial ideological aggradation of rich and colorful scientific travelogues A, B, C, D, E, F, ... like omnifarious smallwares full of a basket in macro-rational-profile of **X scientific subjects, Y academic professions with Z foundational regularities adulterated in** and objectivity that **ultimate authenticity of nature** can be neither omnifarious authenticity smallwares full of a basket nor authenticity chameleon one piece and only, but coherent natura naturans throughout cosmic evolution is so remarkable; and as a result, in terms of logic extension, **logic extension of conventional (physics + chemistry + biology + iatrology + ...) < logic extension of perfect ideological enantiomorph of ultimate authenticity of nature about universal existence & motion in the nature of coherent natura naturans throughout cosmic evolution**, in terms of ideological quality of scientific legitimacy qualification of historical authenticity tolerance of science, **scientific legitimacy qualification of historical authenticity tolerance of science of conventional (physics + chemistry + biology + iatrology + ...) << scientific legitimacy qualification of historical authenticity tolerance of science of perfect ideological enantiomorph of ultimate authenticity of nature about universal existence & motion in the nature of coherent natura naturans throughout cosmic evolution**, as substantial vested interest of temporal authority roots in live contemporaneous scientific orthodoxy, magistral autarchy of **free press regulation customization** and **free press admittance** of temporal authority still seems overwhelmingly unshakable due to domino effect of authoritative intrepidity of contemporaneous scientific orthodoxy, which mostly acts as straightforward but overwhelming puissance towards royal substantiation & perfection of contemporaneous scientific orthodoxy and instinctively reject timely renovation of humanist ideology about authenticity of nature in proportion to contemporaneous historical background, although, there is even high-grade objectivity that historical progress of science is always in inherent optimum orientation towards perfect ideological enantiomorph of ultimate authenticity of nature.

The mathematical definition of Homogenous Cosmos Originated from Unique Genesis is “Homogenous cosmos originated from unique genesis $\stackrel{\text{def}}{=} \sum_{m \equiv D} \int_{i_0}^X f(m_{i_0 \rightarrow X}) i_0$ ”, definition of Atom state Equation in Spacetime directly derives from the mathematical definition of Homogenous Cosmos Originated from Unique Genesis. Before original generation of atoms, as the convergent condensation of cosmic demiurgic evolution to atomic mechanical endosome and mechanical dominance of atoms to succedent compositive configuration and existence & motion of rich and colorful molecules, further applicability of mathematical definition of Homogenous Cosmos Originated from Unique Genesis will ultimately depends on consummation of atom state equation in spacetime. Once we possess the logos capital of atom state equation in spacetime, not only all the existence & motion of objects smaller or simpler than atom have been explicit in advance, but also all existence & motion of all succedent macroscopical objects consisted of atoms can be deduced out along mathematical logic on the basis of atom state equation in spacetime. And thus, all sciences about the existence & motion of matter in cosmos will consequently turn into a coherent mathematical logic system.

This of course implies that all the sciences as physics, chemistry, and biology ... will all turn into coherent mathematical operation subjects. Any person who masters atom state equation in spacetime not only can study PNT engine, PNT dynamotor ... today, but also can study $\sum^D m_{DNA} + \sum^D m_{\text{m} \text{**} \text{**} \text{ambient conditions}}$, $\sum^D m_{\text{human-body}} + \sum^D m_{\text{m} \text{**} \text{**} \text{ambient conditions}}$, $\sum^D m_{\text{cancer virus}} + \sum^D m_{\text{m} \text{**} \text{**} \text{ambient conditions}}$, $\sum^D m_{\text{biological robot}} + \sum^D m_{\text{m} \text{**} \text{**} \text{ambient conditions}}$, ...tomorrow. No matter he studies PNT engine, PNT dynamotor ... or studies $\sum^D m_{DNA} + \sum^D m_{\text{m} \text{**} \text{**} \text{ambient conditions}}$, $\sum^D m_{\text{human-body}} + \sum^D m_{\text{m} \text{**} \text{**} \text{ambient conditions}}$, $\sum^D m_{\text{cancer virus}} + \sum^D m_{\text{m} \text{**} \text{**} \text{ambient conditions}}$, $\sum^D m_{\text{COVID 2019}} + \sum^D m_{\text{m} \text{**} \text{**} \text{ambient conditions}}$, $\sum^D m_{\text{biological robot}} + \sum^D m_{\text{m} \text{**} \text{**} \text{ambient conditions}}$, ... the essential dynamic regularity and mathematical logics he quotes are coherent but with individual preferences

Historical progress of science in the recent several centuries seemed like a far-flung exploration of the first itinerary around numerous distinctive landscapes of brand-new landmasses of science with palette & tablet on back, several hundred years' scientific travelogues were compiled thereby.

for different study objects and different ambient conditions involved in. That is to say, there is no rational estrangement among physics study, chemistry study, biology study ... in accordance with demiurgic originality. In straightforward words, the demiurgic originally has nothing to bring out the innate features as physics, chemistry, biology, iatrology, he can hardly understand why there are many unintelligible humanistic ideological classification like these. Virtually, as long as the objects we are ready to study belong to homogenous cosmos which exactly exists as well-regulated integration of cosmic homogeneity system making up of out-and-out serial natura naturata in the nature of coherent natura naturans throughout cosmic evolution, the essential regularity we have to quote to formulate universal existence & motion must be unique and coherent scientific verity as **perfect ideological enantiomorph of ultimate authenticity of nature**. Scientific status quo as unsystematic ideological aggradation like omnifarious scientific travelogues A, B, C, D, E, F, ... full of a basket is not because the omnipotent demiurge has originally brought out cosmos waywardly, but mostly because we have practically experienced a far-flung exploration of the first itineracy around numerous distinctive landscapes of brand-new landmasses of science with palette & tablet on back, several hundred years' scientific travelogues compiled thereby.

This is of course humanistic inevitability of historical progress of science in inherent optimum orientation towards perfect ideological enantiomorph of ultimate authenticity of nature due to crescive progression of practical feasibility & possibility in proportion to contemporaneous historical background, throughout historical progress of science, objectivity of homogenous cosmos making up of out-and-out serial natura naturata in the nature of coherent natura naturans throughout cosmic evolution only potentializes the inherent optimum orientation and ultimate adscription of realistic historical progress of science in large-scale time extension.

Apparently, once humanistic ideology about authenticity of nature finally qualified as **perfect ideological enantiomorph of ultimate authenticity of nature**, there will not be any so-called "expert" any longer; after all, there are only unique regularity and coherent linear logic in cosmos. Even perhaps, not many years later, once we come back to recollect the situation of today, we maybe find it funny to proudly call themselves "professors" knowing nothing about the inherent "unique regularity" of coherent natura naturans throughout cosmic evolution but some a little local perception as scientific travelogue kind. Virtually, cosmic status quo is but demiurgic aggradation of sequential homologic cosmogony, there is only physical regularity as coherent natura naturans throughout cosmic evolution. Whereas, as historical ignorance, we had ever been so confident to devote ourselves to studying this regularity and that regularity in cosmos as beauty-avaricious women eagerly diving for colorful smallwares in supermarket. What's the intrinsic possibility for two different fundamentals to dominate one cosmos through and through?

Besides the emotional cause that I could hardly stand suffering of discrimination from perky temporal authority who are mostly popular third-rate talents of the age for having recited some of the modern knowledge of contemporaneous scientific orthodoxy but to howl out my afflictive oppression, the impersonal reason I temerarily fiddle me myself "doctor number 1 on the earth" in spite of any spiteful tease is that I am the initiator and urger of the idea of homogenous cosmos originated from unique genesis and the leitmotiv of "it's only possible for concordant cosmos to be demiurgic aggradation of out-and-out serial natura naturata in the nature of coherent natura naturans throughout cosmic evolution; there is no way for demiurgic aggradation in the nature of different natura naturans to be concordant cosmos through and through". Under such leitmotiv background, there will be none specialty discrepancy between any two scientific study subjects. As a doctor of the new age, he should of course master the unique coherent fundamental of universal existence & motion of

matter and have none difficulty to comprehend and predict the unique coherent fundamental hypostatized in any kind of physical cases in cosmos. Undoubtedly, he can of course devote himself to studying and designing PNT engine this month, and he can of course devote himself to studying cancer virus, biologic automation, DNA individual biologic proliferation in certain material surroundings and functional optimization due to certain objective avail and so on next month just as, with the same truck, we can use it to carry wood today, and of course, we can also use it to carry steel tomorrow. Although, before ultimate consummation of Atom State Equation in Spacetime, it's still an ideal, there are still a lot necessary to be done to push humanistic ideology about authenticity of nature forward to perfect ideological enantiomorph of ultimate authenticity of nature. Toward the ideal, I am of course pioneer number 1 all wool and a yard wide, and my personal limitation maybe not pervert this self-assertive title too much. Although, under egotistic background of interminable royal substantiation & perfection of contemporaneous scientific orthodoxy, it seems only possible for all my endeavor to result in straightforward suppression of free press embarment.

As universal logic coverage of mathematical definition of Homogenous cosmos originated from unique genesis $\stackrel{\text{def}}{=} \sum_{m \equiv D} \int_{i_0}^x f(m_{i_0 \rightarrow x})_{i_0}$ crowning all cosmic contents, it of course implies, once we study discretionary object in cosmos as reciprocal PNT combination and quote the proper state equations to analyze and deduce the proper attribute, function and distinctive existence & motion under certain external conditions, the mathematical language we quote for the mathematical logic operation will be remarkably different from temporal mathematical language we used in live contemporaneous scientific orthodoxy, and we can of course be confident it must be much more coherent and systematical than the mathematical language used in live contemporaneous scientific orthodoxy considered from the universal logic coverage and unitive fashion of mathematical definition of Homogenous Cosmos Originated from Unique Genesis. At any rate, Homogenous Cosmos Originated from Unique Genesis introduces uniform state equations to formulate universal existence & motion in cosmos, which is apparently superior than live contemporaneous scientific orthodoxy invoking omnifarious formulations to formulate rich and colorful existence & motion accessible around us then and there.

And I am quite sure, before practical realization of all sciences turning into a coherent mathematical logic system, there must be a mathematics revolution in advance for remarkable discrepancy between Homogenous Cosmos Originated from Unique Genesis and live contemporaneous scientific orthodoxy. For instance, live contemporaneous scientific orthodoxy always quote so-called "right-angle reference frame" to scale and formulate accessible existence & motion in space field and in relative situation, whereas, Homogenous Cosmos Originated from Unique Genesis thinks that the "right-angle" reference frame is not always right angle in different space fields or in different relativity situations. For example, if a man in PNT engine flying away from the earth at speed V can quote right-angle reference frame to scale the relative position of the earth, then another man in another PNT engine flying away from the earth at speed $2V$ can never quote the same "right-angle reference frame" to scale the relative position of the earth, because if we admit under the relative situation flying away from the earth at speed V , the physical reference frame the man can quote is "right-angle" reference frame, then under the relative situation flying away from the earth at speed $2V$, the physical reference frame the man can quote can never be "right-angle reference frame" any more. If standing aside the railway, we define the corner profile of the train carriage a standard right-angle reference frame model, then observed by a driver on a running car aside, the "standard right-angle reference frame" can never be as standard as it originally defined standing aside the railway any longer.

Historical progress of science in the recent several centuries seemed like a far-flung exploration of the first itinerary around numerous distinctive landscapes of brand-new landmasses of science with palette & tablet on back, several hundred years' scientific travelogues were compiled thereby.

All in all, the practice human coming to discover and formulate authenticity of accessible existence & motion around must experience frondose evolvment of humanistic ideology about authenticity of nature cumulatively enriched from nothingness to goat, from goat to a great lot, and consequently followed proportionate ideaistic correction & qualitative optimization from superficiality to profundity, from parochiality to generality. Once the study enrichment of various specimens accessible around us becomes richer and richer, a universal cognition longitudinal correction & optimization is inevitable. No matter the very thing occurs today or tomorrow, it's of course inevitability subject to common fundamental of gradual quantitative cumulation and qualitative optimization of humanistic ideology about authenticity of nature gradually approaching perfect ideological enantiomorph of ultimate authenticity of nature draw on practical feasibility & possibility in proportion to contemporaneous historical background.

Although, as crescive progression of practical feasibility & possibility in proportion to contemporaneous historical background, the practice human coming to discover and formulate authenticity of accessible existence & motion around must experience frondose evolvment of humanistic ideology about authenticity of cumulatively enriched from nothingness to goat, from goat to a great lot, and consequently followed proportionate ideaistic correction & qualitative optimization from superficiality to profundity, from parochiality to generality. And at the same time, as authenticity of nature can only be unique & invariable, as humanistic ideology about authenticity of nature in proportion to contemporaneous historical background, it's only possible for ultimate consummation of science to be unique scientific verity as perfect ideological enantiomorph of ultimate authenticity of nature which tallies with unique & invariable ultimate authenticity of nature 100 over 100, it's completely impossible for two distinctive humanistic ideologies about authenticity of nature with remarkable difference of scientific connotation to discover and formulate unique and invariable ultimate authenticity of nature coequally.

Veritable progress of science is not intuitional cumulative achievement of colorful scientific travelogues A, B, C, D, E, F, ...as deserving reward of the first itineracy around preternatural landscapes of brand-new landmasses of science like omnifarious smallwares full of a basket but successive hypostatic endeavor to push humanistic ideology about authenticity of nature forward to perfect ideological enantiomorph of ultimate authenticity of nature step by step draw on practical feasibility & possibility in proportion to contemporaneous historical background, which is virtually realistic historical progress of science in inherent optimum orientation towards historical authenticity tolerance of science 0. Once historical aggradation of scientific knowledge in travelogue style become richer and richer, so that integrative profile of cosmos become more and more explicit, longitudinal ideology optimization must occur as successive rational renovation of humanistic ideology about authenticity of nature in proportion to contemporaneous historical background, no matter it may be occurrence of today or tomorrow, it's inevitable due to quantitative & qualitative change of scientific knowledge proliferation along historical progress of science in inherent optimum orientation towards historical authenticity tolerance of science 0.

—Firstly written in February 2009, Zhenzhu town, Wugang city, Hunan Province.

Revision was done in June 2015, Nanxing Dani, Shatian town, Dong guan city.

(VII-ii) Social legitimacy subsistence perplexity of timely renovation of humanistic ideology about authenticity of nature in proportion to contemporaneous historical background of remarkable highlight of microcosmic configuration of matter under egotistic background of royal substantiation & perfection of contemporaneous scientific orthodoxy

Abstract: *As ideological system about authenticity of accessible existence & motion around, the uniqueness & invariance of ultimate authenticity of nature predestines the unique possibility of absolute scientific verity as perfect ideological enantiomorph of ultimate authenticity of nature which tallies with unique & invariable ultimate authenticity of nature 100 over 100. Veritable progress of science is not intuitional cumulative achievement of colorful scientific travelogues A, B, C, D, E, F, ... as deserving reward of the first itineracy around landscapes of brand-new landmasses of science like omnifarious smallwares full of a basket but successive hypostatic endeavor to push humanistic ideology about authenticity of nature forward to perfect ideological enantiomorph of ultimate authenticity of nature as coherent theory about universal existence & motion so as to accomplish historical progress of science in inherent optimum orientation towards historical authenticity tolerance of science 0.*

As permanent synthesized conditionality of “crescive progression of practical feasibility & possibility in proportion to contemporaneous historical background + the uniqueness & invariance of ultimate authenticity of nature predestines the unique possibility of scientific verity as perfect ideological enantiomorph of ultimate authenticity of nature”, it’s only possible for the major melody of historical progress of science to be a series of epochmaking scientific knowledge metabolism in inherent optimum orientation towards perfect ideological enantiomorph of ultimate authenticity of nature.

This of course indicates, throughout historical progress of science,

On one hand, in terms of any contemporaneous scientific orthodoxy out of scientific legitimacy qualification of historical authenticity tolerance of science 0, it’s only possible for any contemporaneous scientific orthodoxy out of scientific legitimacy qualification of historical authenticity tolerance of science 0 to exist as temporary progressive segment in crescive progression of historical progress of science, as long as historical progress of science is still in its inherent optimum orientation towards perfect ideological enantiomorph of ultimate authenticity of nature, once there is timely occurrence of remarkable advancement of humanistic ideology about authenticity of nature towards perfect ideological enantiomorph of ultimate authenticity of nature, the so-called contemporaneous scientific orthodoxy must be inferior by comparison and be washed out for necessary scientific knowledge metabolism in inherent optimum orientation towards perfect ideological enantiomorph of ultimate authenticity of nature. Virtually, it’s only possible for the major melody of historical progress of science to be a series of epochmaking scientific knowledge metabolism in inherent optimum orientation towards perfect ideological enantiomorph of ultimate authenticity of nature.

On the other hand, as out-and-out humanistic endeavor & operation under commensurate social background, historical progress of science can hardly evade magisterial restriction and egotistic guidance of temporal authority and consequently be stigmatized by overwhelming authoritative intrepidity of contemporaneous scientific orthodoxy, especially when interminable royal substantiation & perfection of contemporaneous scientific orthodoxy under egotistic guidance of temporal authority has apparently exhausted its inherent potentiality for historical progress of science to push humanistic ideology about authenticity of nature forward to perfect ideological enantiomorph of ultimate authenticity of nature. In terms of personal intendance, if your personal endeavor in scientific exploration results in out-and-out ideological outgrowth in rigid succession of contemporaneous

Historical progress of science in the recent several centuries seemed like a far-flung exploration of the first itineracy around numerous distinctive landscapes of brand-new landmasses of science with palette & tablet on back, several hundred years’ scientific travelogues were compiled thereby.

scientific orthodoxy for substantiation & perfection of contemporaneous scientific orthodoxy, you can of course be popular of the age at pleasure of temporal authority, if your personal endeavor in scientific exploration slider into out-and-out aberrant scientific knowledge proliferation out of succession of contemporaneous scientific orthodoxy, you must slide into virulent scientific knowledge metabolism campaign therefore, for example, as distinctive introduction of Homogenous cosmos originated from unique genesis postulate and proportionate connotation objectification as linear logic system on the basis of [(Homogenous cosmos originated from unique genesis postulate + spacetime~matter fully embodying cosmos postulate) + Instinctive PNT equilibrium postulate], Homogenous Cosmos Originated from Unique Genesis is typical aberrant scientific knowledge proliferation out of succession of contemporaneous scientific orthodoxy. Although, there is substantial possibility for aberrant scientific knowledge proliferation out of succession of contemporaneous scientific orthodoxy to be epochmaking innovation to push humanistic ideology about authenticity of nature forward to perfect ideological enantiomorph of ultimate authenticity of nature.

Whereas, as multiple notion with double significance of "social connotation" & "natural connotation", social legitimacy & validity of truths can never exceed cannon range, the men who are able to involve in free press admittance even social legitimacy authorization of scientific idea are not 7 billions of live people on the earth but temporal authority with vested interest in contemporaneous scientific orthodoxy who are mostly hardcore puissance of living historical progress of science with expedient official facility of magistral autarchy of free press regulation customization and free press admittance short of necessary intendance, you must slide into unintelligible perplexity of negative officialism domino effect of historical progress of science even vicious circle of virulent scientific knowledge metabolism campaign, free press admittance of timely renovation of humanistic ideology about authenticity of nature in proportion to contemporaneous historical background even has to challenge venomous counterwork upper limit of temporal authority.

The most remarkable feature of high-sounding royal substantiation & perfection of contemporaneous scientific orthodoxy is that pomp of substantiation & perfection of contemporaneous scientific orthodoxy is even far more dominant than general progress of science, as if, besides endeavor of royal substantiation & perfection of contemporaneous scientific orthodoxy, nothing else is necessary for historical progress of science, no matter how much effective advancement substantiation & perfection of contemporaneous scientific orthodoxy can practically offer to push humanistic ideology about authenticity of nature forward to perfect ideological enantiomorph of ultimate authenticity of nature.

As cosmos redefinition with consequent in logic enantiomorph of newly highlighted factuality that discretionary particles in cosmos are mutually convertible with consequent PNT dynamics about universal existence & motion in the nature of coherent natura naturans throughout cosmic evolution, naissance of Homogenous Cosmos Originated from Unique Genesis has apparently broken through conventionality of live contemporaneous scientific orthodoxy which are typical scientific travelogues about rich and colorful existence & motion like omnifarious smallwares full of a basket, as a result, scientific knowledge metabolism campaign was sensitively arisen and Homogenous Cosmos Originated from Unique Genesis slid into grievous perplexity of free press embarment therefore. After all, under background of high-sounding freewheeling royal substantiation & perfection of contemporaneous scientific orthodoxy, free press admittance is mostly under magistral autarchy of temporal authority for egotistic proximity identification and free press filtration towards ideal science community.

1. Since **ultimate authenticity of nature** can be neither omnifarious authenticity smallwares full of a basket nor authenticity chameleon one piece and only but coherent natura naturans throughout cosmic evolution, as humanistic ideology about authenticity of accessible existence & motion around us, it's only possible for ultimate consummation of science to be perfect ideological enantiomorph of ultimate authenticity of nature. Veritable progress of science is not intuitional cumulative achievement of rich and colorful scientific travelogues A, B, C, D, E, F, ... as deserving reward of the first itineracy around numerous landscapes of brand-new landmasses of science like omnifarious smallwares full of a basket but successive hypostatic endeavor to push humanistic ideology about authenticity of nature forward to perfect ideological enantiomorph of ultimate authenticity of nature step by step draw on practical feasibility & possibility in proportion to contemporaneous historical background. And as permanent synthesized conditionality of **“crescive progression of practical feasibility & possibility in proportion to contemporaneous historical background + the uniqueness & invariance of ultimate authenticity of nature predestines the unique possibility of scientific verity as perfect ideological enantiomorph of ultimate authenticity of nature”** through and through, it's only possible for the major melody of historical progress of science to be a series of epochmaking scientific knowledge metabolism in inherent optimum orientation towards historical authenticity tolerance of science 0, till at last, humanistic ideology about authenticity of nature is finally qualified as perfect ideological enantiomorph of ultimate authenticity of nature.

For explicit foreground of progress of science, we must clarify a significant issue in prior:

Is ultimate authenticity of nature unique & invariable as God action of natura naturans or authenticity chameleon one and only or omnifarious authenticity smallwares full of a basket?

Essence of matter in a class by itself can only inherently come into being during the course of original generation & formation of matter in accordance with demiurgic fundamental of identity and is congenitally kept with matter existing as idiographic objects under the proper generative and formative preconditions. Consequently, as our study object, what basal groundwork that matter originally generated on, we should analyze and study it therein.

Substantial evidence indicates original generation of matter is subject to demiurgic fundamental of identity, the demiurge never creates matter randomly, he never creates A object in accordance with this manner a little now and creates B object in accordance with that manner a little then. original generation of matter in the nature of coherent natura naturans brings out essence of matter in a class by itself; essence of matter in a class by itself predestines thorough coherence of dynamic regularity of universal existence & motion. As long as we are confident to confirm that original generation of matter must be subject to coherent natura naturans throughout cosmic evolution, we are of course confident to confirm that ultimate authenticity of nature can be neither omnifarious authenticity smallwares full of a basket nor authenticity chameleon one and only but coherent natura naturans throughout cosmic evolution. Once humanistic ideology about authenticity of nature tallies with ultimate authenticity of nature 100 over 100, it must be perfect ideological enantiomorph of ultimate authenticity of nature.

All in all, veritable progress of science is not intuitional cumulative achievement of colorful scientific travelogues A, B, C, D, E, F, ... like omnifarious smallwares full of a basket, but successive hypostatic endeavor to push humanistic ideology about authenticity of nature forward to perfect ideological enantiomorph of ultimate authenticity of nature as coherent theory about universal existence & motion step by step draw on practical feasibility & possibility in proportion to contemporaneous historical background. As permanent synthesized

conditionality of “**crecive progression of practical feasibility & possibility in proportion to contemporaneous historical background + the uniqueness & invariance of ultimate authenticity of nature predestines the unique possibility of scientific verity as perfect ideological enantiomorph of ultimate authenticity of nature**” through and through, it's only possible for the major melody of historical progress of science to be a series of epochmaking scientific knowledge metabolism in inherent optimum orientation towards historical authenticity tolerance of science 0, till at last, humanistic ideology about authenticity of nature is finally qualified as perfect ideological enantiomorph of coherent natura naturans throughout cosmic evolution.

In any case, it's neither possible for “the unique & invariable ultimate authenticity of nature” to be compatible with “two distinctive humanistic ideologies about authenticity of nature with remarkable ideological difference” nor possible for “two distinctive humanistic ideologies about authenticity of nature with remarkable ideological difference” to discover and formulate “the unique & invariable ultimate authenticity of nature” coequally.

And throughout historical progress of science, in terms of any contemporaneous scientific orthodoxy out of scientific legitimacy qualification of historical authenticity tolerance of science 0, as long as the practical leitmotiv of development of science to discover and formulate universal existence & motion as authentic, comprehensive and systematical as possible draw on practical feasibility & possibility in proportion to contemporaneous historical background is timeless, as long as historical progress of science is still in its normal way in inherent optimum orientation towards historical authenticity tolerance of science 0, the so-called contemporaneous scientific orthodoxy out of scientific legitimacy qualification of historical authenticity tolerance of science 0 must be washed out by coming positive renovation of humanistic ideology about authenticity of nature towards perfect ideological enantiomorph of ultimate authenticity of nature sooner or later, it's only possible for the original naissance, successive development of the so-called contemporaneous scientific orthodoxy out of scientific legitimacy qualification of historical authenticity tolerance of science 0 to exist as distinctive progressive segment in proportion to contemporaneous historical background in crecive progression of historical progress of science in inherent optimum orientation towards perfect ideological enantiomorph of ultimate authenticity of nature.

2. As timely renovation of humanistic ideology about authenticity of nature in proportion to contemporaneous historical background and innovative cosmos redefinition in radical logic enantiomorph of newly highlighted factuality that **discretionary particles in cosmos are mutually convertible, the rationale of connotation objectification and freewheeling logic extension of homogenous cosmos originated from unique genesis is not only out of rigid succession of contemporaneous scientific orthodoxy, but also incompatible to the leitmotiv of high-sounding royal substantiation & perfection of contemporaneous scientific orthodoxy of the age, as a result, there is almost no way for me to pass free press egotistic proximity identification from temporal authority.**

Before humanistic ideology about authenticity of nature finally qualified as perfect ideological enantiomorph of ultimate authenticity of nature, whenever any relatively mature humanistic ideology about authenticity of nature is endued social legitimacy qualification and consequently become scientific mainstream of the age, the meritorious contributors must be promoted temporal authority, and intangible respectable authority fortress will be built up in the nature of things as well as it accomplished its primary development and consolidation like a duck to water. Whereas, once there is slight sign of disturbance of scientific knowledge metabolism, as self-preservation of human, the so-called temporal authority must sensitively bluster themselves into knowledge metabolism campaign as cool countercheck puissance with respectable backup of ready-made social legitimacy qualification.

Especially, once full jurisdiction of free press regulation customization & free press admittance is under magistral autarchy of temporal authority, there is almost no way for successive scientific innovation to avoid free press embarment.

After all, as out-and-out social work outgrowth and humanistic ideology about authenticity of nature in proportion to contemporaneous historical background, social existence and historical progress of “science” must inherently possess double coordinative significance of “natural connotation” and “social connotation”, social legitimacy subsistence of neonatal scientific idea especially successive renovation of humanistic ideology about authenticity of nature along historical progress of science in inherent optimum orientation towards perfect ideological enantiomorph of ultimate authenticity of nature never simply depends on cognizant achievement that brand-new or more veritable authenticity of nature has been reflected on sense of pioneering originators with commensurate authenticity highlight effect in proportion to contemporaneous historical background, it even crucially implicates esoteric authoritative social legitimacy identification & authentication in accordance with egotistic criterion of contemporaneous scientific orthodoxy under official centered background——social legitimacy & validity of truths can never exceed cannon range, which of course includes humanistic operation of virulent scientific knowledge metabolism campaign underlying. The even pestilent imbroglio is that authoritative legitimacy identification is mostly under autarchy of temporal authority going without saying in defiance of historical limitation of contemporaneous scientific orthodoxy short of necessary intendance, and the even pestilent deadlock of esoteric authoritative social legitimacy identification & authentication or free press authorization is coming scientific innovation has to say “No” to contemporaneous scientific orthodoxy.

As typical freewheeling royal substantiation & perfection of contemporaneous scientific orthodoxy, in the recent one century, the keynote of scientific development is substantiation & perfection of contemporaneous scientific orthodoxy, the remarkable dominance of it even implies coming scientific development can only be everlasting conventional extension of substantiation & perfection of contemporaneous scientific orthodoxy, as long as contemporaneous scientific orthodoxy tend to consummation as much as possible, nothing else is necessary for further development of science. And indeed, the most perky authority of the age are mostly the several second-string geniuses who had ever run along conventional raceway of contemporaneous scientific orthodoxy for rather a long distance. We have to admit, after freewheeling popularity of high-sounding royal substantiation & perfection of contemporaneous scientific orthodoxy for more than one century, especially as hardcore puissance of academic degree authorization, free press regulation customization & free press admittance, most of the temporal authority of science are not the gerentocratic ones devoting to general progress of science to push humanistic ideology about authenticity of nature forward to perfect ideological enantiomorph of ultimate authenticity of nature draw on practical feasibility & possibility in proportion to contemporaneous historical background, but loving successors of contemporaneous scientific orthodoxy indulging in interminable royal substantiation & perfection of contemporaneous scientific orthodoxy. Of course, we have to admit, general progress of science is not endeavor indulging in interminable royal substantiation & perfection of contemporaneous scientific orthodoxy, but hypostatic endeavor to push humanistic ideology about authenticity of nature forward to perfect ideological enantiomorph of ultimate authenticity of nature draw on practical feasibility & possibility in proportion to contemporaneous historical background.

Real-life popularization of timely scientific innovation must depend on both preconditions below:

Historical progress of science in the recent several centuries seemed like a far-flung exploration of the first itinerary around numerous distinctive landscapes of brand-new landmasses of science with palette & tablet on back, several hundred years’ scientific travelogues were compiled thereby.

The first, “scientific endeavor to formulate authenticity of nature”——scientific formulation of authenticity of nature must profoundly reflect or highlight objective authenticity of nature.

The second, “free press authorization”——relevant scientific articles must be accessible for fair-minded identification for free press admittance, so that it's possible for the proper articles to be officially promulgated by normal medium, so that the proper papers can be widely known and clarified or substantiated further.

In another words, as out-and-out social work outgrowth and humanistic ideology about authenticity of nature in proportion to contemporaneous historical background, social existence and historical progress of “science” must inherently possess double coordinative significance of “natural connotation” and “social connotation”, social legitimacy subsistence of neonatal scientific idea especially successive renovation of humanistic ideology about authenticity of nature along historical progress of science in inherent optimum orientation towards perfect ideological enantiomorph of ultimate authenticity of nature never simply depends on cognizant achievement that brand-new or more veritable authenticity of nature has been reflected on sense of pioneering originators with commensurate authenticity highlight effect in proportion to contemporaneous historical background, it even crucially implicates esoteric authoritative social legitimacy identification & authentication in accordance with egotistic criterion of contemporaneous scientific orthodoxy under official centered background——social legitimacy & validity of truths can never exceed cannon range, which of course includes humanistic operation of virulent scientific knowledge metabolism campaign underlying. The even pestilent imbroglio is that authoritative legitimacy identification is mostly under autarchy of temporal science aristocracy going without saying in defiance of historical limitation of contemporaneous scientific orthodoxy short of necessary intendance, and the most pestilent perplexity is that free press admittance or authoritative social legitimacy identification & authentication of successive renovation of humanistic ideology about authenticity of nature in proportion to contemporaneous historical background can hardly be free from orthodox filtration of authoritative intrepidity of contemporaneous scientific orthodoxy, for you see, as conditionality of **the uniqueness & invariance of ultimate authenticity of nature predestines the unique possibility of scientific verity as perfect ideological enantiomorph of ultimate authenticity of nature**, successive renovation of humanistic ideology about authenticity of nature can hard evade ideological divarication to contemporaneous scientific orthodoxy for accomplishment of remarkable advancement towards perfect ideological enantiomorph of ultimate authenticity of nature, which must indicate necessary scientific knowledge metabolism and inevitable impact of vested interest of temporal authority.

Ostensibly, temporal scientific authority of omnifarious travelogue style sciences sparkplug scientific innovation too, whereas, they conventionally projected esoteric popularity for their ideal egotism science community draw on magistral autarchy of free press regulation customization & free press admittance and actualize full-scale free press filtration control by free press egotistic proximity identification at their pleasure. In the face of impact of potential scientific knowledge metabolism, temporal authority are mostly not ready to consider coming scientific innovation to say “no” to their ready-made legitimacy.

In fact, as long as we have to admit that ultimate authenticity of nature can neither be omnifarious authenticity smallwares full of a basket nor authenticity chameleon one piece and only, in accordance with potential conditionality of **“crescive progression of practical feasibility & possibility in proportion to contemporaneous historical background + the uniqueness & invariance of ultimate authenticity of nature predestines the unique possibility of scientific verity as perfect ideological enantiomorph of ultimate authenticity of nature”**, if we suppose there are totally N times of renovation of

humanistic ideology about authenticity of nature in proportion to contemporaneous historical background throughout historical progress of science, and the the Nth (the last time) renovation of humanistic ideology about authenticity of nature in proportion to contemporaneous historical background satisfies historical authenticity tolerance of science 0 which of course indicate the Nth renovation of humanistic ideology about authenticity of nature in proportion to contemporaneous historical background tallies with the unique & invariable ultimate authenticity of nature 100 over 100 as perfect ideological enantiomorph of unique & invariable ultimate authenticity of nature. Then, once the Nth renovation of humanistic ideology about authenticity of nature in proportion to contemporaneous historical background practically come into being and take practical roles of human science, all the N-1 times of renovation of humanistic ideology about authenticity of nature in proportion to contemporaneous historical background out of scientific legitimacy qualification of historical authenticity tolerance of science 0 must be washed out for inevitable scientific knowledge metabolism for occurrence of further advancement towards historical authenticity tolerance of science 0. It's only possible for any contemporaneous scientific orthodoxy out of scientific legitimacy qualification of historical authenticity tolerance of science 0 to exist as temporary progressive segment in proportion to contemporaneous historical background in crescive progression of historical progress of science in inherent optimum orientation towards perfect ideological enantiomorph of ultimate authenticity of nature.

And virtually, throughout historical progress of science, the gradual naissance of the N-1 times of renovation of humanistic ideology about authenticity of nature in proportion to contemporaneous historical background out of scientific legitimacy qualification of historical authenticity tolerance of science 0 must be in rigid succession of quantitative degression of historical authenticity tolerance of science close to 0, and the subsequent metabolism of the N-1 times of renovation of humanistic ideology about authenticity of nature in proportion to contemporaneous historical background out of scientific legitimacy qualification of historical authenticity tolerance of science 0 must be in rigid succession of quantitative degression towards historical authenticity tolerance of science 0 too, which actualizes the crescive progression of historical progress of science in inherent optimum orientation towards historical authenticity tolerance of science 0 in the nature of things, which is virtually historical process humanistic ideology about authenticity of nature gradually approach perfect ideological enantiomorph of ultimate authenticity of nature step by step draw on practical feasibility & possibility in proportion to contemporaneous historical background, till at last, humanistic ideology about authenticity of nature tallies with ultimate authenticity of nature 100 over 100. After all, it's neither possible for "the unique & invariable ultimate authenticity of nature" to be compatible with "two distinctive humanistic ideologies about authenticity of nature with remarkable ideological difference" nor possible for "two distinctive humanistic ideologies about authenticity of nature with remarkable ideological difference" to discover and formulate "the unique & invariable ultimate authenticity of nature" coequally.

As innovative cosmos redefinition in logic enantiomorph of newly highlighted factuality of **discretionary particles in cosmos are mutually convertible** with consequent PNT dynamics about universal existence & motion in the nature of coherent natura naturans throughout cosmic evolution(/essence of matter in a class by itself), the most ill-fated action of Homogenous Cosmos Originated from Unique Genesis is that pioneering connotation objectification and freewheeling logic extension of homogenous cosmos originated from unique genesis remarkably exposed divarication even illogicality between Homogenous Cosmos Originated from Unique Genesis and live contemporaneous scientific orthodoxy. After all, connotation objectification and freewheeling logic extension of homogenous cosmos originated from unique genesis make universal existence & motion spontaneous occurrence of "[external

Historical progress of science in the recent several centuries seemed like a far-flung exploration of the first itinerary around numerous distinctive landscapes of brand-new landmasses of science with palette & tablet on back, several hundred years' scientific travelogues were compiled thereby.

physical disturbance + (PNT action + instinctive PNT equilibrium)]” through and through. Whereas, live contemporaneous scientific orthodoxy is but rich and colorful scientific travelogues about accessible existence & motion around like omnifarious smallwares full of a basket. What’s more, as ignorant action, Homogenous Cosmos Originated from Unique Genesis declared it to temporal authority early that **historical progress of live contemporaneous scientific orthodoxy in the recent several centuries seemed like a far-flung exploration of the first itinerary around numerous distinctive landscapes of brand-new landmasses of science with palette & tablet on back, several hundred years' scientific travelogues were compiled thereby. Although, cosmic status quo is but evolutionary aggradation of out-and-out serial natura naturata as well-regulated homogeneity system in the nature of coherent natura naturans throughout cosmic evolution.** What’s more, as low-down man of the society, in the face of deadlock of identity & qualification discrimination and outright countercheck for scientific knowledge metabolism campaign, I could hardly stop my cry for pain then and there.

By the end of today, Homogenous Cosmos Originated from Unique Genesis had been contributed to relevant journals and publishing houses far more than 150 times, but it was all rejected without mercy, and almost 80% rejection directly derived from “identity & qualification discrimination”, I even can hardly get rid of my “identity & qualification discrimination” till today. For you see, most of the so-called “free press admittance” in Vanity Fair has to pass magic filter of peripheral “trust” and “distrust”, without backup of “trust”, things originally authentic are mostly difficult to be credible; instead, once “trust” does its jobs, things originally unauthentic may be credible at pleasure. My poor identity and qualification can make me lose “trust” in the first second.

Thinking back my contribution all these years, I was so despondent that I never met an enlightened editor or reviewer whose review results related to the kernel issue of Homogenous Cosmos Originated from Unique Genesis — **whether cosmos is really homogenous originated from unique genesis through and through, if cosmos is throughout homogenous originated from unique genesis, what an integrative homogenous existence & motion aggregation of cosmos should be.** Instead, most of them do their quotidian job to evaluate my identity & qualification, my references, nannyish document format and so on. —Near 60% journals and publishing houses just to show me “not the very sort or not in the proper scope they want”; about 30% journals and publishing houses showed their spirits were willing but the bodies weak, because it was really difficult for them to find Homogenous Cosmos Originated from Unique Genesis normal answers from contemporaneous scientific orthodoxy for official free press authorization. What’s more, most of my contribution still lack of favorable backup of stylish references; about 10% journals or publishing houses had distinctive excuses or going without saying.

As innovative cosmos redefinition in logic enantiomorph of newly highlighted factuality **discretionary particles in cosmos are mutually convertible** with consequent PNT dynamics about universal existence & motion in the nature of coherent natura naturans throughout cosmic evolution, Homogenous Cosmos Originated from Unique Genesis is innovative and pioneering scientific subject, which came to analyze and clarify holistic matter configuration of cosmos, essence of matter and consequential universal existence & motion in linear logic system. On the opinion of cosmic holistic configuration and conformation, there are only three possible subjects in coordinative logic arrangement.

The first is “cosmos is throughout homogenous originated from unique genesis”.

The second is “cosmos is compound originated from multiple genesis”.

The third is “cosmos is unintelligible originated from non-genesis”.

Although the three possible subjects are coequally coordinative in logic arrangement, their logic connotations

As coherent natura naturans throughout cosmic evolution, instinctive PNT reciprocal equilibrium towards optimum PNT operation is radical potentiality & conditionality for cosmos always ready to orientate itself towards perfection.

are mutually incompatible, it's only possible for real-life authenticity of cosmos to be one of them. In the face of the three coordinate possibilities, remarkable highlight of microcosmic configuration of matter has indicated that cosmos is throughout homogenous originated from unique genesis, so that Homogenous Cosmos Originated from Unique Genesis decided the first possible subject and excluded the second & the third, and come to clarify universal existence & motion in thorough coherence under the presumable precondition of **Homogenous cosmos originated from unique genesis postulate**.

Comparably, live contemporaneous scientific orthodoxy is but cumulative scientific travelogues of the first round to the "Fresh World" of scientific exploration in the recent several centuries, — the scientific travelogues A, B, C, D E, F... towards colorful and distinctive landscapes of the "Fresh World" (Of course, accumulation of the rich and colorful scientific travelogues A, B, C, D, E, F... is not something historical progress of science can transcend, virtually, it's just the accumulation of scientific travelogues A, B, C, D, E, F... of the first round to the "Fresh World" which piece together the homogenous profile of holistic configuration of cosmos unknowingly). It seems they have not implicated such logic arrangement on cosmic holistic configuration and the corresponding evolutive genesis yet. And indeed, Homogenous Cosmos Originated from Unique Genesis approached this logic arrangement by longitudinal optimization on the basis of traditionary enrichment of travelogues of the first round to the "Fresh World".

As discrepancy in logic arrangement, on the standpoint of perceptual logic scope of study objects, the difference of logic classification of study objects is so remarkable.

In the face of the universal existence & motion besides hyllic spacetime, the logic scope of study objects of live contemporaneous scientific orthodoxy is but sensory perception enrichment of fragmentary aggregations as celestial bodies, galaxies, abiotic objects, biosome ..., gas, liquid, solid ..., admixtures, chemical compounds ..., DNA, molecules, elementary atoms, atomic nucleus, electron, proton, neutron, ... quark ..., they are even richer than numerous snows flying in the sky.

However, considered by Homogenous Cosmos Originated from Unique Genesis, there are only totally two homogenous series existences of the universal existence & motion in cosmos besides hyllic spacetime:

The first is "separate elementary genic units" in spacetime.

The second is "reciprocal PNT combinations" in spacetime.

And what's more, both "separate elementary genic units" and "reciprocal PNT combinations" are in purely connatural homogenous series, and their existence & motion in spacetime can be formulated by coherent state equation as $\sum_{m \equiv D} [\int_{i_0}^x f(m_{i_0 \rightarrow x}) i_0]$ thereby. As typical scientific travelogues of fieldwork against rational purview in proportion to contemporaneous historical background, in the face of rich and colorful existence & motion accessible around us, live contemporaneous scientific orthodoxy is always ready to formulate them as idiographic outcome of so-called interaction under proper physical background. Comparably, Homogenous Cosmos Originated from Unique Genesis never introduce so-called "interaction" to walk through rich and colorful existence & motion in cosmos. Instead, on standpoint of Homogenous Cosmos Originated from Unique Genesis, the root cause for universal existence & motion to be so rich and colorful is but because matter is matter itself — spontaneous occurrence in the nature of essence of matter in a class by itself in the nature of instinctive PNT reciprocal equilibrium towards optimum PNT operation of matter integration. Logic disparity of so-called "interaction" and "spontaneous occurrence in the nature of essence of matter in a class by itself" is of course self-evident.

Historical progress of science in the recent several centuries seemed like a far-flung exploration of the first itinerary around numerous distinctive landscapes of brand-new landmasses of science with palette & tablet on back, several hundred years' scientific travelogues were compiled thereby.

In terms of applicable logic extension, as innovative cosmos redefinition in logic enantiomorph of newly highlighted factuality **discretionary particles in cosmos are mutually convertible** with consequent PNT dynamics about universal existence & motion in the nature of coherent natura naturans throughout cosmic evolution, Homogenous Cosmos Originated from Unique Genesis of course crowns all live contemporaneous scientific orthodoxy 100 over 100, total accumulation of live contemporaneous scientific orthodoxy is but subset of Homogenous Cosmos Originated from Unique Genesis in logic extension.

In logic modality, on the basis of **[(Homogenous cosmos originated from unique genesis + spacetime~matter fully embodying cosmos) + instinctive PNT equilibrium]**, Homogenous Cosmos Originated from Unique Genesis comes to hypostatize connotation objectification and further freewheeling logic extension of homogenous cosmos originated from unique genesis as independent logic chain reaction, and consequently approach cosmos redefinition in logic enantiomorph of newly highlighted factuality that **discretionary particles in cosmos are mutually convertible** with consequent PNT dynamics about universal existence & motion in the nature of coherent natura naturans throughout cosmic evolution. In the face of omnifarious scientific travelogues of live contemporaneous scientific orthodoxy, Homogenous Cosmos Originated from Unique Genesis always tried to crown all and redefine them in coherent linear logic system derived from logic extension of **[(Homogenous cosmos originated from unique genesis + spacetime~matter fully embodying cosmos) + instinctive PNT equilibrium]**. After all, Homogenous Cosmos Originated from Unique Genesis is cosmos redefinition in logic enantiomorph of newly highlighted factuality of **discretionary particles in cosmos are mutually convertible** with consequent PNT dynamics about universal existence & motion in the nature of coherent natura naturans throughout cosmic evolution, although, till today, as personal limitation, it's still a primary theoretical roughcast about universal existence & motion, there are still a lot needing further extension and rational clarification & authentication. Comparably, live contemporaneous scientific orthodoxy is substantively travelogue style accumulation in the recent several hundred years about omnifarious fresh matter specimens accessible like colorful smallwares full of a basket.

Of course, as discrepancy in logic arrangement and study method, once logic extension of Homogenous Cosmos Originated from Unique Genesis implicated some sensitive and conventional topics of contemporaneous scientific orthodoxy, I had to comment accordingly in accordance with original connotation objectification and further freewheeling logic extension of homogenous cosmos originated from unique genesis, whereas, it's really difficult for me to avoid divarication even illogicality between Homogenous Cosmos Originated from Unique Genesis and live contemporaneous scientific orthodoxy indeed.

At any rate, Homogenous Cosmos Originated from Unique Genesis and live contemporaneous scientific orthodoxy are different humanistic ideology about authenticity of nature derived from different logic origins and methodologies, Homogenous Cosmos Originated from Unique Genesis is typical linear logic system as innovative cosmos redefinition in logic enantiomorph of newly highlighted factuality that **discretionary particles in cosmos are mutually convertible** with consequent coherent PNT dynamics about universal existence & motion in the nature of coherent natura naturans throughout cosmic evolution; whereas, live contemporaneous scientific orthodoxy is but scientific aggradation in travelogue style in the recent several hundred years about rich and colorful existence & motion of distinctive specimens temporally accessible around us, which are neither in theoretical model of linear logic system nor in logic extension of Homogenous Cosmos Originated from Unique Genesis. The common ground between Homogenous Cosmos Originated from Unique Genesis and omnifarious live contemporaneous scientific orthodoxy is only limited in that the objectives both Homogenous

As coherent natura naturans throughout cosmic evolution, instinctive PNT reciprocal equilibrium towards optimum PNT operation is radical potentiality & conditionality for cosmos always ready to orientate itself towards perfection.

Cosmos Originated from Unique Genesis and omnifarious live contemporaneous scientific orthodoxy formulated are almost the same cosmic contents, as discrepancy of thought origin and logic extension, Homogenous Cosmos Originated from Unique Genesis and live contemporaneous scientific orthodoxy are completely different humanistic ideology about authenticity of nature unless Homogenous Cosmos Originated from Unique Genesis have to fawn temporal authority for expedient free press admittance and give up inherent rationality itself.

However, at the stage, I have to face perplexity that many readers even the related reviewers are always subconscious to evaluate Homogenous Cosmos Originated from Unique Genesis on standpoint of contemporaneous scientific orthodoxy, who are always ready to find normal answers for Homogenous Cosmos Originated from Unique Genesis from contemporaneous scientific orthodoxy or try to find whether there are personal elements in Homogenous Cosmos Originated from Unique Genesis for egotistic proximity identification, for example, whether there are respectable references from celebrity. The even worse thing is that, it seems only possible for Homogenous Cosmos Originated from Unique Genesis to contribute to physical journals and related publishing houses, many reviewers come to subconsciously review it in accordance with criterion of so-called modern physics even criterion of some certain embranchment subjects.

As self-educated man and straightforward heterodoxy, I am neither loving successor of contemporaneous scientific orthodoxy, nor respectable man with creditable guanxi with temporal celebrity, it's substantively difficult for me to pass free press admittance under untimely background of interminable royal substantiation & perfection of contemporaneous scientific orthodoxy. What's more, subject matter of Homogenous Cosmos Originated from Unique Genesis is completely out of definite scope of PACC, PACS, it's almost impossible for me to find favorable free press egotistic proximity identification from temporal authority.

I have to admit that I am not smart guy who is always ready to come to heel and fawn what temporal authority boosted as substantiation anthem to contemporaneous scientific orthodoxy as "Wow, how beautiful the new clothes of the tzar is". Instead, I am just the foolish one who is straightforward to tell people "the tzar virtually has nothing on!". After all, what I devote to is universal existence & motion in homogenous cosmos, but not this magic particle or that supernatural radiation live contemporaneous scientific orthodoxy always take delight in talking about. And indeed, any object live contemporaneous scientific orthodoxy mentioned has not transcended category of homogenous cosmos whose existence & motion are undoubtedly subject to the thoroughly coherent dynamic regularity of homogenous cosmos. However, as independent scientific ideologies, as discrepancy of thought origin, study methodology and consummate degree, there must be difference between Homogenous Cosmos Originated from Unique Genesis and live contemporaneous scientific orthodoxy. According as fundamental of **the uniqueness & invariance of ultimate authenticity of the mature predestines the unique possibility of scientific verity as perfect ideological enantiomorph of ultimate authenticity of nature**, it's impossible for the dissimilarities between Homogenous Cosmos Originated from Unique Genesis and live contemporaneous scientific orthodoxy to be both true as contemporaneous social legitimacy, this of course indicates scientific knowledge metabolism and scientific knowledge metabolism campaign must arise thereby.

The deadlock is that, as magistral autarchy of free press regulation customization and free press admittance of science, at this stage, scientific knowledge metabolism campaign can hardly be free from duress of authoritative intrepidity of contemporaneous scientific orthodoxy, Homogenous Cosmos Originated from Unique Genesis even has no opportunity for necessary argument & explanation on the spot, no more opportunity to air my view

and right to attend to judgement as science aristocrat usually do, but stay aside waiting for free press egotistic proximity identification from science aristocrat according to esoteric criterion of contemporaneous scientific orthodoxy. I have to accuse the egoistic behavior of free press egotistic proximity identification, I have to defy the carp and esoteric countercheck puissance and disrelish the so-called “accredited editors” who are always responsible to take role of sentry of social legitimacy subsistence of contemporaneous scientific orthodoxy.

—As scientific authority, if he is even numb to realize the inevitability that historical progress of science must experience frondose evolvment of humanistic ideology about authenticity of nature cumulatively enriched from nothingness to goad, from goad to a great lot, and consequently followed proportionate ideaistic correction & qualitative optimization from superficiality to profundity, from parochiality to generality, and even as the ultimate authenticity of nature can only be unique and invariable through and through and science is but enantiomorphous humanistic ideology against authenticity of nature, the historical process human coming to discover and formulate authenticity of accessible existence & motion around with incremental knowledge aggradation from nothingness to goad, from goad to a great lot, and consequently followed the proportionate ideaistic correction & qualitative optimization from superficiality to profundity, from parochiality to generality must be hypostatized as successive gradational series of social legitimacy metabolism towards historical authenticity tolerance of science 0, and throughout historical progress of science, any contemporaneous scientific orthodoxy out of scientific legitimacy qualification of historical authenticity tolerance of science 0 can only exist as temporary progressive segment in proportion to contemporaneous historical background in crescive progression of historical progress of science, occurrence of temporal authority is but temporary role embarking upon a political venture, living presence of such unenlightened authority must wreak negative resistance to coming scientific innovation towards historical authenticity tolerance of science 0.

Although, till today, foregone Holy Office has been deserted, and Fire Torture has been out of commission early; instead, the coming power even mortal at headstream of scientific knowledge metabolism campaign is esoteric but altisonant free press egotistic proximity identification for free press admittance filtration draw on magistral autarchy of free press regulation customization and free press admittance of temporal authority.

Since temporal authority have validated that “ $1+1=2$ ”, and knowledge as “ $1+1=2$ ” are practically taking role of crucial capital for temporal authority to possess of sacred science orthodox temple, as Joe Blow without respectable identity & qualification, what’s my favorable conditions to petition free press admittance for a treasonous argument as “ $1+1 \neq 2$ ” on the basis of Homogenous cosmos originated from unique genesis postulate from temporal authority? In the recent 20 years, as my remarkable deviation against high-sounding freewheeling royal substantiation & perfection of contemporaneous scientific orthodoxy, I was always beaten to faint by authority club straight from the shoulder. Oh, shit, in order to make me remember what nonsense is to the end of my life, the God always prefers to play the mischief with “idiot” & “editor” before me!

Referring to so miserable topic, I am genuinely not willing to talk much about my tender spot with wound open in air, but to rush my genuine receipt in two words below.

- 1) As timely renovation of humanistic ideology about authenticity of nature in proportion to contemporaneous historical background of remarkable highlight of microcosmic configuration of matter, Homogenous Cosmos Originated from Unique Genesis is not answer sheet to contemporaneous scientific orthodoxy, but innovative cosmos redefinition in radical logic enantiomorph of newly highlighted factuality that **discretionary particles**

As coherent natura naturans throughout cosmic evolution, instinctive PNT reciprocal equilibrium towards optimum PNT operation is radical potentiality & conditionality for cosmos always ready to orientate itself towards perfection.

in cosmos are mutually convertible with consequent PNT dynamics about universal existence & motion in the nature of coherent natura naturans throughout cosmic evolution, whose historical significance generally depends on what kind of manner and how much it has inherited & assimilated tradition and has consequently been more excellent than tradition, but not only depends on how much it has conformed or carried forward tradition. At any rate, historical progress of science is not always ready to carry forward and tally with tradition or submit substantiation anthem to contemporaneous scientific orthodoxy for achievement of haw-haw egotistic science community and for temporal respectable science aristocrat to enjoy themselves in treading on air, but ought to be more and more excellent than tradition so as to be compatible with more and more of ultimate authenticity of nature, which has to inevitably involve in scientific knowledge metabolism.

This of course indicates practical quantitative & qualitative change of scientific knowledge proliferation towards consummate formulation of unique and invariable ultimate authenticity of nature must lead to step-by-step scientific knowledge metabolism and the consequential scientific knowledge metabolism campaign. It even indicates that free press admittance under background of general progress of science should not be pure egotistic proximity identification of temporal authority at their pleasure short of necessary intendance. Evaluation of Homogenous Cosmos Originated from Unique Genesis should not be egoistic as what authority of Geocentric Theory had ever treated Heliocentric Theory. No matter in live contemporaneous scientific orthodoxy or in authoritative modern physics, there are none model answers for evaluation of Homogenous Cosmos Originated from Unique Genesis.

Since the factuality **discretionary particles in cosmos are mutually convertible** has been so approximate to complete induction, we have no reason to slight introduction of **Homogenous cosmos originated from unique genesis postulate**. Since “**homogenous cosmos originated from unique genesis + spacetime~matter fully embodying cosmos**” logically indicates presence of PNT action between spacetime and matter undoubtedly, further logic extension of “PNT action + instinctive PNT equilibrium” of matter integration of course indicates universal existence & motion of matter as spontaneous occurrence of **[external physical disturbance + (PNT action + instinctive PNT equilibrium)]** beyond all doubt. And indeed, connotation objectification with freewheeling logic extension of homogenous cosmos originated from unique genesis is ready to approach ultimate authenticity of nature as much as possible instead of being accordant with tradition. Although, scientific reliability of connotation objectification with freewheeling logic extension of homogenous cosmos originated from unique genesis still need necessary verification & demonstration, Homogenous Cosmos Originated from Unique Genesis is never responsible to offer impact factors to contemporaneous scientific orthodoxy, no more to come to heel and cater for contemporaneous scientific orthodoxy like coquetry, ——wow~, the new clothing of the tzar is so beautiful.

At any rate, live contemporaneous scientific orthodoxy is but recognizant harvest as deserving rewards of a formidable but devious stochastic exploration journey aiming at colorful and rich matter specimens accessible around us, which are apparently omnifarious scientific travelogues A, B, C, D, E, F, ... like smallwares full of a basket achieved in the recent several centuries, which not only satisfied the scientific necessity of the society off the cuff, but also brought out intrinsic progressional phase of historical progress of science ——scientific travelogues of the first round human penetrated into brand-new landmasses of science.

And indeed, historical progress of science has its intrinsic progression, when historical progress of science

Historical progress of science in the recent several centuries seemed like a far-flung exploration of the first itinerary around numerous distinctive landscapes of brand-new landmasses of science with palette & tablet on back, several hundred years' scientific travelogues were compiled thereby.

still lack necessary groundwork for cosmic scale longitudinal ideological optimization, there was only possible for historical progress of human science to continue transverse ideological expansion. However, quantitative change of transverse ideological expansion can not be continued everlastingly, once accumulation of quantitative change of transverse ideological expansion has been adequate for successive longitudinal ideological optimization, longitudinal ideological optimization on the basis of proper transverse ideological expansion must bring out ration sublimation of humanistic ideology about authenticity of nature, so that remarkable optimization of humanistic ideology about authenticity of nature consequently bring out extensive scientific knowledge metabolism & scientific knowledge metabolism campaign.

The reason that scientific travelogues A, B, C, D, E, F, ... could bring out intrinsic progressive stage of historical progress of science is that:

The first, as crescive progression of practical feasibility & possibility in proportion to contemporaneous historical background, in the face of accessible rational purview, it's only possible for us to do our best to perceive authenticity of partial distinctive landscape of brand-new landmasses of science as much as possible off the cuff.

The second, no matter the study objects in our accessible rational purview are idiographic red apple or green apple on tip of our fingers, they are unfeigned apples in the natural indeed.

The third, our attitude to study this red apple or that green apple which are temporally accessible in our rational purview is serious-minded and nonsense.

As a result, scientific travelogues A, B, C, D, E, F, ... substantively highlighted some of the authentic attribute of this red apple or that green apple on tip of our fingers.

The key issue is that, as it's only possible for ultimate authenticity of nature to be unique and invariable, and as crescive progression of practical feasibility & possibility in proportion to contemporaneous historical background, as remarkable rational sublimation, longitudinal ideological optimization must wash out most of the prior ideological output of transverse ideological expansion and consequently actualize progressive advancement towards historical authenticity tolerance of science 0, which of course implies, as the uniqueness & invariance of ultimate authenticity of nature predestines unique possibility of scientific verity, veritable progress of science is not intuitional cumulative achievement of colorful scientific travelogues A, B, C, D, E, F, ... like omnifarious smallwares full of a basket about rich and colorful existence & motion accessible around us but successive hypostatic endeavor to push humanistic ideology about authenticity of nature forward to perfect ideological enantiomorph of ultimate authenticity of nature as coherent theory about universal existence & motion draw on practical feasibility & possibility in proportion to contemporaneous historical background. it's only possible for the major melody of historical progress of science to be serial epochmaking scientific knowledge metabolism in inherent optimum orientation towards historical authenticity tolerance of science 0. And just because of this, any contemporaneous scientific orthodoxy out of scientific legitimacy qualification of historical authenticity tolerance of science 0 must be washed out once timely renovation of humanistic ideology about authenticity of nature in proportion to contemporaneous historical background has successively achieved further advancement of historical authenticity tolerance of science towards 0.

This is of course impersonal factuality that practical implementation of free press regulation customization and free press admittance has to envisage.

As coherent natura naturans throughout cosmic evolution, instinctive PNT reciprocal equilibrium towards optimum PNT operation is radical potentiality & conditionality for cosmos always ready to orientate itself towards perfection.

From the cognition aggradation of colorful scientific travelogues of tradition, Homogenous Cosmos Originated from Unique Genesis perceived that cosmic content must be homogenous originated from unique genesis through and through and arrived at cosmos redefinition and consequent PNT dynamics about universal existence & motion based on the very precondition of homogenous cosmos originated from unique genesis. In detail words, as remarkable highlight of microcosmic configuration of matter in the recent one century, I sublimated the logic connotation of newly highlighted factuality that **discretionary particles in cosmos are mutually convertible** into **Homogenous cosmos originated from unique genesis postulate**. Subsequently, with logic supplementation of “**spacetime~matter fully embodying cosmos postulate**”, I accomplished connotation objectification of homogenous cosmos originated from unique genesis, and even with logic supplementation of “**Instinctive PNT equilibrium postulate**”, I arrived at freewheeling logic extension of connotation objectification of homogenous cosmos originated from unique genesis, so that cosmos redefinition and thoroughly coherent PNT dynamics about universal existence & motion came out following a rational line. As remarkable disparity of logic origin and study methodology, Homogenous Cosmos Originated from Unique Genesis and comprehensive live contemporaneous scientific orthodoxy are not in the coherent logic series at all, this is neither because I am subjectively ready to betray tradition nor because I am always ready to spurn at temporal authority, it’s but innovative rational sublimation of full-scale longitudinal ideological optimization based on transverse ideological expansion of contemporaneous scientific orthodoxy in the recent one century.

2) Whereas, as rational sublimation of cosmic scale longitudinal ideological optimization on the basis of transverse ideological expansion of temporal tradition, Homogenous Cosmos Originated from Unique Genesis is still in primary pullulation stage, there is still substantial perplexity for further consummation in practical procurement of necessary authentic data and possible clarification & confirmation towards uniform mathematical formulation of general existence & motion of universal reciprocal PNT combinations. Towards perfect formulation of authenticity of nature from temporal coherent PNT dynamics about universal existence & motion to ultimate consummation of atom state equation in spacetime, there are still a lot left for us to do, although, as keynote of the topic, I have devoted to it upon my personal capability, it must be far above my personal capability. I have to remind the able-bodied valorous authority with respectable official crown on head who are mostly loving successors of contemporaneous scientific orthodoxy not to be too idiotic or with ulterior motive in mind to match weight lifting with small boys of about three years old pugnaciously.

And at the same time, when I contributed to related journals in the recent 25 years, I met snobbish ritzy mechanical experimentalism many times, who mostly insisted that Homogenous Cosmos Originated from Unique Genesis lacked necessary experimental support, and current version of Homogenous Cosmos Originated from Unique Genesis seemed too ideal & flimsy invoking logic expansion as typical linear logic chain reaction based on **[(general postulate + accessorial postulate 1) + accessorial postulate 2]** which is just **[(Homogenous cosmos originated from unique genesis postulate + spacetime matter fully embodying cosmos postulate) + Instinctive PNT equilibrium postulate]** for cosmos redefinition and consequent PNT dynamics about universal existence & motion in the nature of coherent natura naturans throughout cosmic evolution (/essence of matter in a class by itself). In the face of snobbish and discriminatory suspicion, besides helplessness, I’d like to shorten my comment as below:

Historical progress of science in the recent several centuries seemed like a far-flung exploration of the first itinerary around numerous distinctive landscapes of brand-new landmasses of science with palette & tablet on back, several hundred years’ scientific travelogues were compiled thereby.

A) The scientific intention of Homogenous Cosmos Originated from Unique Genesis is to highlight the latent authenticity of cosmos behind factuality that **any discretionary particles in cosmos are mutually convertible**. And as the factuality is still in living orientation towards complete induction, I introduced **Homogenous cosmos originated from unique genesis postulate** without nonfeasance, and successively, I expanded the logic connotation of **Homogenous cosmos originated from unique genesis postulate** with rational supplementation of two 0.5 grade accessorial postulates for cosmos redefinition with consequent coherent PNT dynamics about universal existence & motion. We have to admit, although, factuality that **any discretionary particles in cosmos are mutually convertible** is in living orientation towards complete induction, it has not approached complete induction finally. However, it was substantively factuality supported by millions of practical verification about microcosmic configuration of matter in the recent one century that discretionary particles in cosmos are mutually convertible by clearing up conformation discrepancy for they ultimately possess the common component in certain configurable hiberarchy, and we never found any exception against the factuality eversince.

And indeed, I mentioned many times in my monograph that, if somebody is able to find such two objects in cosmos, it can be proved that there is absolutely no way for the two objects in cosmos to be convertible, or if somebody is able to find such two physical quantities in cosmos, for particularity of the both physical quantities, it can be proved that there is absolutely no way for the two physical quantities to be convertible or even no way for the two physical quantities to perform mathematical operation in the same equation, then, such factuality either negates homogenous cosmos originated from unique genesis radically or indicates presence & discovery of “cosmos II”. However, who is just and confident enough to stand out for conclusion —— “Yes, I can”.

Towards further consummation of Homogenous Cosmos Originated from Unique Genesis, there are of course substantial issues need favorable experimental support & verification indeed. I have to comment herein I am not experimental recreant!! Development of science depends on two legs, the one is pioneering scientific theory, the other is favorable experiment. And now, as millions of experiments have remarkably highlighted a grand factuality that **discretionary particles in cosmos are mutually convertible**, which is of course adequate to outline cosmic profile that cosmos seems homogenous originated from unique genesis through and through. As a result, I used the first leg for the first step to introduce **Homogenous cosmos originated from unique genesis postulate** for facility of pioneering exploration of cosmos configuration and proportionate universal existence & motion in homogenous cosmos. Subsequently, I was ready to step out the second step with my second leg, whereas, can you show me where is the whereabouts for my second leg? Is absence of the whereabouts just because I am low-down man of the society?

3. Evolvement of scientific knowledge metabolism campaign from foregone “forcible grass beheading” to temporal “esoteric root restraint”.

Till today, free press embarment Homogenous Cosmos Originated from Unique Genesis practically experienced has exceeded a quarter century, the general causes are as below:

The first, <Homogenous Cosmos Originated from Unique Genesis> is worthy of nothing indeed.

The second, temporal authority in unprecedented authoritative intrepidity of contemporaneous scientific orthodoxy with full jurisdiction of “free press regulation customization” and “free press admittance” are either too stupid or too immoral, —— either they

As coherent natura naturans throughout cosmic evolution, instinctive PNT reciprocal equilibrium towards optimum PNT operation is radical potentiality & conditionality for cosmos always ready to orientate itself towards perfection.

are too stupid to comprehend what's veritable progress of science due to practical feasibility & possibility in proportion to contemporaneous historical background or too many authoritative ruffians adulterated among them.

The third, class finitude in academic society is too forbidding and overbearing, as self-educated man without official rank, I am really low-down man of the society, my frustration firstly derived from bald-faced discrimination for poor identity & qualification in such feudatorial social ambience in the recent quarter century.

Historical progress of science towards ultimate authenticity of nature must follow commensurate scientific knowledge metabolism & scientific knowledge metabolism campaign, whereas, once practical implementation of scientific knowledge metabolism adulterated too much of puissance of temporal authority, implementation of scientific knowledge metabolism must lapse from general intendance of historical progress of science towards historical authenticity tolerance of science 0 and consequently slid into egotistic power metabolism of scientific knowledge or egotistic violence metabolism of scientific knowledge. In early years, such role was mostly taken by so-called Holy Office, and now, the role is mostly taken by arbitrament of free press admittance.

Originally, I have no intention to violate Vanity Fair of temporal authority  indeed, whereas, once I finished connotation objectification with freewheeling logic extension of homogenous cosmos originated from unique genesis and arrived at coherent PNT dynamics about universal existence & motion thereby, I found my endeavor not only broke conventionality of traditionary scientific travelogues but also straightforward conflict with many ready-made physical conclusions of tradition.

For example, Relativity —— is there really so-called “vacuum” without any hylic connotation in cosmos? Is light-speed in vacuum really constant?

Logically, there are only three possibilities of holistic content configuration of cosmos.

The first is “cosmos is throughout homogenous originated from unique genesis”.

The second is “cosmos is compound originated from multiple genesis”.

The third is “cosmos is unintelligible originated from non-genesis”.

Although the three possible subjects are coequally coordinative in logic arrangement, their logic connotations are mutually incompatible, the real-life authenticity of the cosmos can only be one of them. And once we confirm that cosmos is throughout homogenous originated from unique genesis, as long as we have no adequate reasons to exclude spacetime out of category of homogenous cosmos, we then have to admit that spacetime (Including so-called vacuum) must be coordinative homology of matter and spacetime and matter must coexist in their inherent homologic correlation. And resultingly, we have to admit there is not only none so-called “vacuum” but also none absolutely invariable object in homogenous cosmos, which of course implies it's impossible for light-speed in vacuum to be constant, unless physical realization of light-speed of photon in vacuum has nothing to do with vacuum, or although physical realization of light-speed of photon on vacuum has something to do with vacuum, vacuum is absolutely constant object in cosmos, which of course implies although light-speed in vacuum has inherent correlation with vacuum, they both keep inertial or steady correlation ever since. Whereas, is it possible for light-speed and vacuum to keep inertial correlation ever since in homogenous cosmos?

For example, Black Hole Theory, —— are there really “Black Holes” in cosmos?

As spontaneous occurrence in the nature of essence of matter in a class by itself, existence & motion of matter in cosmos can only incarnate inherence of matter as much as possible. Virtually, distinctive existence & motion is but straightforward way for matter to acclimate itself in idiographic spacetime in accordance with

Historical progress of science in the recent several centuries seemed like a far-flung exploration of the first itinerary around numerous distinctive landscapes of brand-new landmasses of science with palette & tablet on back, several hundred years' scientific travelogues were compiled thereby.

inherence of matter itself, which is subject to coherent dynamic fundamental of instinctive PNT reciprocal equilibrium towards optimum PNT operation. There is no way for any idiographic existence & motion of matter to change or recreate inherence of matter, which of course implies it's impossible for any magic existence & motion of matter in homogenous cosmos to change matter itself into heterogenous object or immateriality. For instance, there is no way for any magic existence & motion of celestial bodies to change normal matter as celestial bodies into so-called "Black Holes" which obviously seems immateriality or heterogenous object out of homogenous cosmos compared to celestial bodies around. In another word, under precondition of homogenous cosmos originated from unique genesis. As long as we have to admit that existence & motion of matter is but spontaneous occurrence in the nature of essence of matter in a class by itself, universal existence & motion can only incarnate inherence of matter as much as possible, none veritable existence & motion in homogenous cosmos can be radical cause of original generation of so-called "Black Hole".

Whereas, just because historical progress of science had ever procured substantial scientific travelogues A, B, C, D, E, F, ... during the course of the first round scientific exploration of human gradually set foot in scientific brand-new landmass, among which there was a scientific travelogue named "gravity". Then many of the coming academician began to show off their intelligent lineal logic extension in succession of contemporaneous scientific orthodoxy then and there. Of course, showing off their intelligent lineal logic extension in succession of contemporaneous scientific orthodoxy off the cuff was not something bad, the key issue is that, we have to admit, in terms of any contemporaneous scientific orthodoxy out of scientific legitimacy qualification of historical authenticity tolerance of science 0, any lineal logic extension in succession of it can only be qualified as "theoretical prediction" against the commensurate contemporaneous scientific orthodoxy, whose creditability still depends on logic support as below:

The first, we can authenticate the corresponding scientific truth of contemporaneous scientific orthodoxy which is rational origin of lineal logic extension possesses legitimacy qualification of historical authenticity tolerance of science 0.

The second, we procured credible scientific evidence/demonstration for the theoretical prediction which is virtually conclusion of lineal logic extension in succession of contemporaneous scientific orthodoxy out of scientific legitimacy qualification of historical authenticity tolerance of science 0.

However, does the scientific travelogue of so-called "gravitational law" among rich and colorful scientific travelogues A, B, C, D, E, F, ... procured for the first round human setting foot in the brand-new scientific landmass possess legitimacy qualification of historical authenticity tolerance of science 0? Who are able to prove it?

However, as typical theoretical prediction derived from lineal logic extension in succession of one typical scientific travelogue of "gravity" among rich and colorful scientific travelogues A, B, C, D, E, F, ..., which were procured when human gradually setting foot in brand-new scientific landmass the first round, since Laplace predicted existence of so-called "Black Hole" in accordance with Newtonian "gravitational law" in 1798, in the face of issue whether there are really Black Holes in cosmos or not, nobody had ever offered necessary scientific authentication, otherwise, can you show me one?

What's the reasons for temporal authority to formulate so much about the so-called "Black Hole" before credible demonstration whether there are really Black Holes in cosmos?

Who offered us so great puissance & confidence to draw scientific conclusion like this?

The even uncanny factuality was that, for gravitational wave discovery, LIGO even confidently stood out

for declaration that they even had perceived mechanical collision of binary Black Hole far away in spacetime, which obviously seemed ghost story in homegrown science forum for there is none credible scientific authentication whether there are really Black Holes in cosmos or not till today. What's even enigmatical was that legitimacy qualification of the ghost story was authenticated by temporal authority at their pleasure in 2016, physics Nobel Prize was rewarded to it in 2017 going without saying.

This of course indicates the potential ponderance of inevitable scientific knowledge metabolism and consequent scientific knowledge metabolism campaign!

Whereas, what made me anguished and helpless is that one side of the scientific knowledge metabolism campaign is a single helpless peasant without money, without power, without respectable identity & degree, the other side are royal temporal authority with substantial fund support, with grand authority, with respectable identity & degree, even physics Nobel prize of 2017 are ally of them, the power disparity is of course fearsome. What's more, as magistral autarchy of "free press regulation customization" and "free press admittance" of sciences short of necessary intendance, nowadays scientific knowledge metabolism & scientific knowledge metabolism campaign can hardly be free from duress of authoritative intrepidity of temporal authority. In any case, in the recent 30 years, Homogenous Cosmos Originated from Unique Genesis contributed to journals on the earth more than 1000 times, substantial verity indicates there are really few people on the earth who are ready to offend thousands of temporal authority in order to support a lowdown man of the society for triumph of timely renovation of humanistic ideology about authenticity of nature in proportion to contemporaneous historical background, as typical heterodoxy of the age, I am villainous indeed, the situation is rather similar as when Bruno was struggling on fire torture, nobody seemed ready to save him from torture. As single helpless peasant, what's my advantage to beg free press admittance from temporal authority for such heterodox argument based on Homogenous cosmos originated from unique genesis postulate?

No matter what kind of occasion I appeared as author of Homogenous Cosmos Originated from Unique Genesis in mainland of China, I was always chided on the spot as "peasant guy" roughly by the so-called creditable learned men with respectable official rank. In mainland of China, people who have scientific ambition without respectable official rank are always villainous. especially, such a man as me who is even ready to show others a heavy monograph in both Chinese and English like this. As outliers, perhaps it's really difficult for you to imagine I wrote down the monograph in so depressed ambience after hours in the recent 31 years, all my straightforward ambition is ready to show 7 billion live people on the earth that cosmos is throughout homogenous originated from unique genesis and universal existence & motion in homogenous cosmos are but out-and-out serial natura naturata in the nature of coherent natura naturans throughout cosmic evolution, which is logic enantiomorph of newly highlighted factuality of **discretionary particles in cosmos are mutually convertible as typical linear logic system on the basis of [(Homogenous cosmos originated from unique genesis + spacetime~matter fully embodying cosmos) + instinctive PNT equilibrium]**. However, my endeavor is so helpless even villainous.

Before I wrote down the section of "**Homogenous Cosmos Originated from Unique Genesis encountered LIGO gravitational wave discovery**", I always thought my monograph was only refused to enter official media as official journals and publishing houses for invisible scientific knowledge metabolism campaign, I could reluctantly get away with open access of internet. However, since I wrote down the section of "**Homogenous Cosmos Originated from Unique Genesis encountered LIGO gravitational wave discovery**" and tried to air it on website, my endeavor seemed having poked honeycomb unexpectedly, not only about 100 old versions of my monograph in Docin website which I uploaded

Historical progress of science in the recent several centuries seemed like a far-flung exploration of the first itinerary around numerous distinctive landscapes of brand-new landmasses of science with palette & tablet on back, several hundred years' scientific travelogues were compiled thereby.

one by one in the recent 10 years were all shut down (<http://www.docin.com/mydoc-66607317-1.html>) but also my accounts of Docin website was unintelligibly invalidated. Several times I referred to the topic of **LIGO gravitational wave discovery** when I talked with some QQ fellows in QQ loop and uploaded the related paper into the corresponding QQ loop by the way, I was either galled by the loving successors of contemporaneous scientific orthodoxy or was kicked off by the so-called learned men. As typical lowdown man of the society and scientific heterodoxy of the age, I offered my straightforward comment about LIGO gravitational discovery and physical Nobel prize of 2017 without necessary compliment off the cuff, no matter the coming factuality is ready to indicate my comment is impulsive or intelligent, under egotistic background of high-sounding royal substantiation & perfection of contemporaneous scientific orthodoxy, my straightforward comment must sensitively touch off stinging countercheck from temporal authority.

Half month later, I uploaded my monograph to related website of muchong.com, (English version: <http://muchong.com/t-11926062-1>; Chinese version: <http://muchong.com/t-11921954-1>) . However, several days later, I found my monograph online unable to be downloaded any longer, because somebody had complained it was villainous with spiteful contents.

In 2020 March, my teacher and good friend professor Huang-jun introduced me to researchgate.net to air my paper, I aired the monograph as below:

http://www.researchgate.net/publication/245494202_danyuanchunxiyuzhou

https://www.researchgate.net/publication/343335817_Homogenous_Cosmos_Originated_from_Unique_Genesis

https://www.researchgate.net/publication/343469529_Homogenous_Cosmos_Originated_from_Unique_Genesis

Whereas, for the same reasons, I was complained by some blackhearted people in August that I was unqualified to be a member to air my paper on website of researchgate.net, because I am neither qualified scientist nor academician with creditable official identity. Oh, shit, Homogenous Cosmos Originated from Unique Genesis was almost treated as rat epidemic disease, SARS etc., my ambience was even worse.

In May 2018 and February 2022, I tried to apply an account to air my papers at

<https://arxiv-org.atlassian.net/servicedesk/customer/portals> and

https://philpeople.org/profiles/yang-guosheng/edit?no_skip=true#research, I am quite aware that, as typical aberrant scientific knowledge proliferation out of succession of contemporaneous scientific orthodoxy involved so much life-and-death scientific knowledge metabolism, there is almost no way for me to evade pestilent factuality that free press admittance of Homogenous Cosmos Originated from Unique Genesis has to challenge venomous counterwork upper limit of temporal authority, if I can air my idea of homogenous cosmos originated from unique genesis in such kind of platform, situation may be relatively good. Whereas, as lowdown man of the society and typical heterodoxy of the age without respectable identity & qualification, I helplessly failed for nobody was ready to be my endorsement, although I turned to more than one thousand people for it by emails, which of course impressed me deeply that, under background of high-sounding royal substantiation and perfection of contemporaneous scientific orthodoxy, modern science forum is not only concourse for substantiation & perfection of contemporaneous scientific orthodoxy but also concourse for temporal authority to show off official identity & qualification with high-sounding backup of authoritative intrepidity of contemporaneous scientific orthodoxy, social legitimacy & validity of truths can never exceed cannon range.

In Copernicus' age, "heliocentric theory" could still be published and promulgated;; in Darwin's

age, “Species Provenance” could still be published and promulgated. After all, in their ages, the ideological archons still had inadequate ascendance to achieve their solid jurisdiction of free press admittance arbitrament and egotistic free press monopolization, so that they could be perfectly justifiable to dominate and monopolize free press admittance of the age. And virtually, it was just because these “timely renovation of humanistic ideology about authenticity of nature in proportion to contemporaneous historical background” were published before they had actually procured authoritative free press admittance from the temporal ideological archons in advance, the disasters consequently happened. On the stand of the temporal ideological archons, Holy Office and fire torture were but remedial resorts due to absence of authoritative jurisdiction of free press admittance of temporal ideological archon, which apparently could only keep down the dissidents posteriorly but could never guard against successive occurrence of dissidents even promulgation of divarication in prior. This was revolutionary knowledge metabolism campaign between foregone unenlightened ideological archons and infidel in open air, which was straightforward outrage to behead the dissidents ex post facto with a strong hand but never to intentionally restrain the ideological headstream beforehand.

However, modern society seems more civilized and advanced ostensibly, as high-sounding modern civilization, Holy Office had been deserted early, fire torture had been out of commission early too,; knowledge metabolism campaign of modern society seems apparently far away from vulgarity and barbarism like what Holy Office and fire torture had ever done. As accomplishment and consolidation of full jurisdiction of science free press regulation customization and science free press admittance, temporal authority can respectably command and monopolize science free press with great facility, they actualize full-scale filtration control of science free press admittance by egotistic proximity identification in accordance with esoteric preconcerted orders or so-called popularity.

Considered by orthodox geocentric theory, no matter how addlepat and ridiculous the heliocentric theory had ever been, it’s unnecessary for “heliocentric theory” to petition free press admittance from orthodox “geocentric theory” then and there. However, as unprecedented magistral autarchy of **free press regulation customization and free press admittance** of temporal authority embarking upon political ventures, so-called orthodox aristocracy hold full jurisdiction of free press admittance col upon egotistic criterion through and through, publication of “modern heliocentric theory” as timely renovation of humanistic ideology about authenticity of nature in proportion to contemporaneous historical background of **remarkable highlight of microcosmic configuration of matter** must procure free press admittance from temporal authority of “modern geocentric theory” in prior, who are really good at stopping dissidents from ideological headstream. —As typical outgrowth of aberrant scientific knowledge proliferation and typical heterodoxy of the age, Homogenous Cosmos Originated from Unique Genesis must prostrate before temporal authority for free press admittance, which is of course endeavor to pass egotistic proximity identification in accordance with esoteric prescribed orders of temporal aristocracy.

Whereas, is cosmos really homogenous originated from unique genesis through and through?

If yes, what integrative homologic configuration of cosmos and proportionate universal existence & motion of matter should be accordingly?

Temporal authority seem no responsible and liable to envisage the issue, and Homogenous Cosmos Originated from Unique Genesis was never considered in accordance with the proper answer of the very issue indeed. After all, this is typical age of high-sounding freewheeling royal substantiation & perfection of contemporaneous

Historical progress of science in the recent several centuries seemed like a far-flung exploration of the first itinerary around numerous distinctive landscapes of brand-new landmasses of science with palette & tablet on back, several hundred years’ scientific travelogues were compiled thereby.

scientific orthodoxy, and issues as **whether cosmos is really homogenous originated from unique genesis through and through; if yes, what integrative homologic configuration of cosmos and proportionate universal homologic existence & motion should be accordingly** are apparently out of question series of substantiation & perfection of contemporaneous scientific orthodoxy even out of scope of PACC PACS orders. As magistral autarchy of free press regulation customization and free press admittance of temporal authority, there is almost no way for Homogenous Cosmos Originated from Unique Genesis to find favorable free press egotistic proximity identification.

As magistral autarchy of free press admittance and full-scale free press egotistic proximity identification filtration, scientific knowledge metabolism campaign is but jugglery on palms of temporal authority, everything can be arranged into finality at free press admittance arbitrament sites off the cuff!! As free press egotistic proximity identification in operation, it's of course needless for temporal authority to perform "beheading dissidents ex post facto" any more, but to make the heterodoxy restrained beforehand at their pleasure at ideological headstream. After all, free press admittance arbitrament is their sacred profession, no matter how willfully they restrain the ideological headstream of potential scientific innovation beforehand for longevity of their respectable ready-made legitimacy, their deportments are always altisonant and legitimate. And what's more, they even openly forbid any unveiled words against their "free press egotistic proximity identification filtration", as victim of knowledge metabolism campaign, you can only suffer bitterly but can never cry out. Otherwise, any unveiled words against free press egotistic proximity identification filtration of temporal authority must be invoked as deadly bullets and be put into the most pestilent gun of jurisdiction of free press admittance with gunpoint towards yourself.

What's more, temporal authority have substantial excuses to maintain their respectable popularity of royal substantiation & perfection of contemporaneous scientific orthodoxy and legitimacy status quo. Draw on facility of full jurisdiction of free press admittance, tiny emotional disfavor of them can be easily put into effect of their jurisdiction implementation. Even as autarchy of free press regulation customization, the so-called scientific criterion for free press egotistic proximity identification are mostly esoteric and unintelligible to heterodoxy, such esoteric factuality under veil of high-sounding modern civilization made me even aching without alternatives.

This is revolutionary knowledge metabolism campaign between modern enlightened ideological archon and heterodoxy deeply concealed in bone; ——never behead the dissidents ex post facto but to to intentionally restrain the ideological headstream beforehand, which is facile with altisonant crown on head but even pestilent and effective to hold the pass of coming scientific knowledge metabolism.

As scientific knowledge metabolism directly implicates conflicts of fame & gain of different stratum, in the historical age that revolutionary scientific knowledge metabolism campaign only beheaded dissidents ex post facto but not intentionally restrained the ideological headstream beforehand, although, the men who had practically achieved epoch-making scientific innovation had bitterly suffered counterwork violence of temporal ideological potentates afterwards, the innovative idea still reluctantly fell into producible ground and radicated. However, history extending today, as jurisdiction of free press regulation customization and free press admittance embarking upon a political venture, scientific knowledge metabolism campaign of modern society has slid into egotistic authoritative control of temporal ideological potentates more and more.

In fact, as enantiomorphous humanistic ideology against authenticity of nature, the everlasting intention and pursuit of general progress of science is to discover and formulate ultimate authenticity of nature as much as possible. Whereas, as crecive progression of practical feasibility & possibility in proportion to contemporaneous

**As coherent natura naturans throughout cosmic evolution, instinctive PNT reciprocal equilibrium towards optimum
PNT operation is radical potentiality & conditionality for cosmos always ready to orientate itself towards perfection.**

historical background, the practical human endeavor to discover and formulate authenticity of accessible existence & motion around as much as possible has to experience frondose evolvment of humanistic ideology about authenticity of nature cumulatively enriched from nothingness to groat, from groat to a great lot, and consequently followed proportionate ideaistic correction & qualitative optimization from superficiality to profundity, from parochiality to generality, practical endeavor of historical progress of science has to be subject to historical inevitability. And as it's only possible for ultimate authenticity of nature to be unique & invariable, ultimate authenticity of nature can be neither authentic smallwares full of a basket nor authentic chameleon one and only, towards ultimate consummation of historical authenticity tolerance of science 0, it's only possible for major melody of historical progress of science to be serial epochmaking scientific knowledge metabolism in inherent optimum orientation towards perfect ideological enantiomorph of ultimate authenticity of nature through and through. Throughout historical progress of science, any contemporaneous scientific orthodoxy out of scientific legitimacy qualification of historical authenticity tolerance of science 0 can only exist as temporary progressive segment in proportion to contemporaneous historical background in crescive progression of historical progress of science in inherent optimum orientation towards perfect ideological enantiomorph of ultimate authenticity of nature, as long as it's still necessary for coming progress of science to accomplish further advancement towards scientific legitimacy qualification of historical authenticity tolerance of science 0, the unique possible destiny of discretionary contemporaneous scientific orthodoxy out of scientific legitimacy qualification of historical authenticity tolerance of science 0 is inferior by comparison and to be washed out without alternatives. After all, in accordance with rigorous enantiomorphous correlation between objective authenticity of nature and humanistic ideology about authenticity of nature, it's neither possible for "the unique & invariable ultimate authenticity of nature" to be compatible with "two distinctive humanistic ideologies about authenticity of nature with remarkable ideological difference" nor possible for "two distinctive humanistic ideologies about authenticity of nature with remarkable ideological difference" to discover and formulate "the unique & invariable ultimate authenticity of nature" coequally.

As ideological output against the commensurate historical groundwork, ultimate destiny of forgone Aristotle theory, geocentric theory, heliocentric theory, ..., classic mechanics were all like this without any exception. In terms of ultimate destiny of nowadays Relativity & Quantum Theory, as long as we can not ensure that Relativity & Quantum Theory do not possess social legitimacy qualification of historical authenticity tolerance of science 0 and it's still necessary for coming progress of science to accomplish further advancement towards historical authenticity tolerance of science 0, then, historical naissance and successive freewheeling substantiation & perfection of Relativity & Quantum Theory against the contemporaneous historical background of 20 century can only exist as temporary progressive segment in crescive progression of historical progress of science, whose social legitimacy qualification must be inferior by comparison and to be washed out therefore once veritable progress of science achieves further advancement of historical authenticity tolerance of science towards 0.

However, nowadays science forum never confront the necessity & inevitability of historical progress of science and purposefully construct proper platform for fair play of coming scientific innovation and contemporaneous scientific orthodoxy for necessary and inevitable scientific knowledge metabolism & scientific knowledge metabolism campaign. It's not only unadvisable to leave contemporaneous scientific orthodoxy out of alignment of potential failure for coming social legitimacy metabolism but also numb to leave "free press regulation customization" and "free press admittance" under magistral autarchy of temporal authority, which of course

Historical progress of science in the recent several centuries seemed like a far-flung exploration of the first itinerary around numerous distinctive landscapes of brand-new landmasses of science with palette & tablet on back, several hundred years' scientific travelogues were compiled thereby.

make practical implementation of “free press regulation customization” and “free press admittance” more expediential to serve the time upon human nature than to serve general progress of science to push humanistic ideology about authenticity of nature forward to perfect ideological enantiomorph of ultimate authenticity of nature. Nowadays science forum consequently slid into feast for royal substantiation & perfection of contemporaneous scientific orthodoxy instead of veritable purpose of historical progress of science to push humanistic ideology about authenticity of nature forward to perfect ideological enantiomorph of ultimate authenticity of nature, which even made general progress of science in inherent optimum orientation towards historical authenticity tolerance of science 0 firstly slide into invisible tussle for fame & gain upon facility of authority. As powerless heterodoxy, there is almost no way for them to slip the collar of free press embarment.

I have to comment herein, since historical progress of science unknowingly slid into interminable royal substantiation & perfection of contemporaneous scientific orthodoxy in 1970s, there was subtle occurrence of historical progress of science that high-sounding achievement of science on the earth was not because they have done positive job to push humanistic ideology about authenticity of nature forward to perfect ideological enantiomorph of ultimate authenticity of nature, but mostly because they have done something to make the royal substantiation & perfection of contemporaneous scientific orthodoxy complementarily cheerful like endeavor stepping in the air due to expediential facility of magistral autarchy of free press regulation customization and free press admittance of temporal authority short of necessary intendance. The pestilent reasons for Homogenous Cosmos Originated from Unique Genesis to suffer endless free press embarment was that,

1) **As interminable royal substantiation & perfection of contemporaneous scientific orthodoxy, naissance of Homogenous Cosmos Originated from Unique Genesis apparently broke through the cheerful status quo of royal substantiation & perfection of contemporaneous scientific orthodoxy, which made the so-called popular modern theories as Black Theory, The Big Bang, Dark Matter, Dark Energy, ... even LIGO gravitational wave discovery slide into discomfiture, after all, if cosmos is really throughout homogenous originated from unique genesis, they are all completely out of category of well-regulated integration of cosmic homogeneity system making up of out-and-out serial natura naturata in the nature of coherent natura naturans throughout cosmic evolution. As a result, life-and-death scientific knowledge metabolism is inevitable.**

2) **As timely renovation of humanistic ideology about authenticity of nature in proportion to contemporaneous historical background of remarkable highlight of microcosmic configuration of matter, free press admittance of Homogenous Cosmos Originated from Unique Genesis can hardly evade magistral autarchy of free press regulation customization and free press admittance of temporal authority short of necessary intendance.**

Since original naissance of Homogenous Cosmos Originated from Unique Genesis in Nov 1991, more than 31 years has gone, all my contribution to journals was but endeavor to challenge magistral autarchy of free press regulation customization and free press admittance of temporal authority short of necessary intendance draw on my cordiality and gradual growth of Homogenous Cosmos Originated from Unique Genesis all these years. I am quite aware it must be very long tragedy for law of the jungle, for you see, temporal authority are so formidable and overbearing, as lowdown man of the society, I am so weak and helpless.

In straightforward words, practical experience in the recent 30 years indicates that, as timely renovation of humanistic ideology about authenticity of nature in proportion to contemporaneous historical background of remarkable highlight of microcosmic configuration of matter and typical aberrant scientific knowledge proliferation out of rigid succession of contemporaneous scientific orthodoxy which involves so much virulent scientific

knowledge metabolism campaign, under background of interminable royal substantiation & perfection of contemporaneous scientific orthodoxy, free press admittance of Homogenous Cosmos Originated from Unique Genesis has been radically refused by temporal authority going without saying draw on facility of magistral autarchy of free press regulation customization and free press admittance of temporal authority short of necessary intendance. Thanks for skin-deep but high-sounding modern civilization, as long as I keep silent and do not contribute my paper to journals, nobody seems ready to castigate me as typical heterodoxy of the age besides Chinese bureaucrat academicians. Whereas, if I contribute to journals on the earth, it's really tiresome intention to trouble temporal authority to find an excuse to deny me, there is substantively no way for Homogenous Cosmos Originated from Unique Genesis to procure free press admittance unless I am able to:

①. **Bring up powerful and magic puissance to forbid overwhelming temporal authority invoking free press egotistic proximity identification for interminable royal substantiation & perfection of contemporaneous scientific orthodoxy and working as opponents of virulent scientific knowledge metabolism campaign in the nature of human nature.**

②. **Make Homogenous Cosmos Originated from Unique Genesis perfectly beauideal through and through so that it's impossible for all counterworkers to find visible excuses to deny me.**

You can of course imagine it's impossible for me to accomplish the both items above, free press admittance of Homogenous Cosmos Originated from Unique Genesis must break through legitimacy defense line of contemporaneous scientific orthodoxy, so that it has to challenge venomous counterwork upper limit of temporal authority without alternatives. The tragic reality that Homogenous Cosmos Originated from Unique Genesis has been floundering in vicious circles of virulent scientific knowledge metabolism campaign for more than 31 years not only indicates my attic faith about cosmos redefinition in radical logic enantiomorph of newly highlighted factuality that **discretionary particles in cosmos are mutually convertible** but also oppositely indicates overwhelming authoritative intrepidity of contemporaneous scientific orthodoxy indulging in interminable royal substantiation & perfection of contemporaneous scientific orthodoxy with unprecedented expediential official facility of magistral autarchy of **free press regulation customization & free press admittance.**

——Men who possess of altisonant authority officially imparted by so-called contemporaneous scientific orthodoxy can leisurely enjoy **social legitimacy subsistence & high-sounding authoritative intrepidity** of contemporaneous scientific orthodoxy in sans souci; whereas, men who have poor official identity & qualification can only either come to heel of temporal authority to submit substantiation anthem singing “**Wow, really beautiful, the new clothes of the tzar!**” or stay aside depressed without alternatives till death.

As cosmos redefinition in radical logic enantiomorph of newly highlighted factuality that **discretionary particles in cosmos are mutually convertible** with consequent PNT dynamics about universal existence & motion in the nature of coherent natura naturans throughout cosmic evolution, does it indicate Homogenous Cosmos Originated from Unique Genesis was not born in proper age?

Is such situation just substantiation of live historical progress of science——evidence of modern civilization?

—— In Feb. 2009, Zhenzhu town, Wugang city, Hunan province.

Supplemental note ①: **Historical connotation of “science aristocrat”**

As humanistic ideology about authenticity of nature in proportion to contemporaneous historical background with double significance of “natural connotation” and “social connotation”, “science” is always Pandora's box of the society. As straightforward social class outgrowth derived from validity & influence of social legitimacy qualification of contemporaneous scientific orthodoxy, “science aristocrat” is a special stratum who are awarded degree and honor by temporal authority for they have succeeded and carried forward contemporaneous scientific orthodoxy and consequently possessed remarkable privilege of economic oblation, science fund support, and science free press admittance, —typical official centered organization of science with so-called “egotistic contemporaneous scientific orthodoxy” as Book of Books.

A) Throughout historical progress of science, there were different temporal orthodoxies in different ages with proportionate temporal authority all along.

Throughout historical progress of science, as long as there was mainstream ideology of science, there must be proportionate contemporaneous scientific orthodoxy like shadow of mainstream ideology of science, and there must be people who were authorities or inheritors of the mainstream ideology of science, who of course made up of the so-called “science aristocrat” of the age. As there were different temporal orthodoxies in different ages throughout historical progress of science, there were different science aristocrat accordingly.

—In 16th century, as the temporal science authorities in Europe highly canonized geocentric theory, resultingly, the social stratum who had acquired geocentric theory even submitted substantiation anthem to the so-called “geocentric theory” were imparted respectable degree & honor by the temporal orthodox authorities and became science aristocrat of the age therefore; In 19th century, as temporal science authorities of the age highly canonized Newtonian mechanics, resultingly, the social stratum who had acquired Newtonian mechanics even submitted substantiation anthem to “Newtonian mechanics” were imparted respectable degree & honor by the temporal orthodox authorities and became science aristocrat of the age therefore. From earlier years of 20th century to today, as temporal science authorities highly canonized Relativity and Quantum Theory, resultingly, the social stratum who had acquired Relativity and Quantum Theory or submitted substantiation anthem to “Relativity and Quantum Theory” were imparted respectable degree & honor by the temporal orthodox authorities and became temporal authority of the age therefore.

No matter science aristocrat of the 16th century on value balance of science aristocrat of the 19th century or science aristocrat of the 19th century on value balance of science aristocrat of 20th century, the practical evaluation substantively made us find it somewhat impenetrable. Of course, science aristocrat of 20th century on value balance of science aristocrat of the successive 21st century, the practical evaluation will even make us find it funny, even knowing nothing of the “unique coherent fundamental” of cosmos but trying to perceive mountain through narrow slot upon exacting endeavor on tip of tiptoes, once perceived some slight color like leaves or flowers in the mountain, they even proudly glorify themselves “specialists” and show off their humorless but overbearing superiority for embarking upon political ventures.

B) As out-and-out social work outgrowth and humanistic ideology about authenticity of nature in proportion to contemporaneous historical background, social existence & historical progress of “science” must inherently possess double coordinative significance of “[natural connotation](#)” and “[social connotation](#)”.

On one hand, social legitimacy subsistence of neonatal scientific idea especially successive renovation of humanistic ideology about authenticity of nature along historical progress of science in inherent optimum orientation towards perfect ideological enantiomorph of ultimate authenticity of nature never simply depends on cognizant achievement that brand-new or more veritable authenticity of nature

As coherent natura naturans throughout cosmic evolution, instinctive PNT reciprocal equilibrium towards optimum PNT operation is radical potentiality & conditionality for cosmos always ready to orientate itself towards perfection.

has been reflected on sense of pioneering originators with commensurate authenticity highlight effect in proportion to contemporaneous historical background, it even crucially implicates esoteric authoritative social legitimacy identification & authentication in accordance with egotistic criterion of contemporaneous scientific orthodoxy under official centered background.

And on the other hand, consolidation of legitimacy qualification of timely renovation of humanistic ideology about authenticity of nature in proportion to contemporaneous historical background must bring out brand-new “contemporaneous scientific orthodoxy” and “authoritative intrepidity of contemporaneous scientific orthodoxy”, social significance of timely renovation of humanistic ideology about authenticity of nature in proportion to contemporaneous historical background must be promoted into classic benefit of temporal authority, “contemporaneous scientific orthodoxy” and “authoritative intrepidity of contemporaneous scientific orthodoxy” must be something inherent of historical progress of science, and solid interposition of authoritative intrepidity of contemporaneous scientific orthodoxy must be the most determinant conditionality of “benign officialism domino effect of contemporaneous scientific orthodoxy” and “conservative officialism domino effect of contemporaneous scientific orthodoxy”.

B-1) “Benign domino officialdom effect of contemporaneous scientific orthodoxy” due to presence of temporal authority and authoritative intrepidity of contemporaneous scientific orthodoxy short of necessary intendance.

As straightforward social class outgrowth derived from solid influence of contemporaneous scientific orthodoxy, naissance of science aristocrat mostly depends on two approaches of “degree award” and “free press admittance”. practical implementation of “degree award” can make contemporaneous scientific orthodoxy widely succeeded and carried forward by people all over the world, practical implementation of “free press admittance” is of course great facility for science aristocrat to sparkplug royal substantiation & perfection of contemporaneous scientific orthodoxy and make contemporaneous scientific orthodoxy developed expediently, which are the major roles of so-called “benign officialism domino effect of contemporaneous scientific orthodoxy”.

B-2) “conservative officialism domino effect of contemporaneous scientific orthodoxy” due to presence of temporal authority and authoritative intrepidity of contemporaneous scientific orthodoxy short of necessary intendance.

Once some certain relatively mature humanistic ideology about authenticity of nature was awarded social legitimacy qualification of the age and consequently achieved its possible development like a duck to water, it must bring up its gallant science aristocrat at he volley with valiant authoritative conventionality of so-called contemporaneous scientific orthodoxy, no matter how remarkable its historical authenticity tolerance of science was for historical limitation.

As straightforward social class outgrowth derived from solid influence of contemporaneous scientific orthodoxy, before contemporaneous scientific orthodoxy actually achieved legitimacy qualification of historical authenticity tolerance of science 0, historical limitation of so-called “science aristocrat” was of course self-evident. After all, the substantial backup for the authority and successors of so-called contemporaneous scientific orthodoxy to be temporal authority of the age was not because they had established and carried forward humanistic ideology about authenticity of nature tallying with ultimate authenticity of nature 100 over 100, but because their scientific endeavor accomplished idiographic advancement towards historical authenticity tolerance of science 0 then and there, so that it practically pushed historical progress of science forward and was awarded social legitimacy qualification of the age therefore. “social legitimacy” is virtually a historical variable along crescive progression of historical progress of science, which directly indicates different progressive age of science has commensurate different contemporaneous scientific orthodoxies, which even indicates coexistence of distinctive social legitimacy qualification. Achievement of social legitimacy qualification not always indicates historical progress of science has approached termination and humanistic ideology about authenticity of nature has been perfect ideological enantiomorph of ultimate authenticity of nature finally.

However, as sweet restriction of authoritative intrepidity of contemporaneous scientific orthodoxy as “degree

Historical progress of science in the recent several centuries seemed like a far-flung exploration of the first itinerary around numerous distinctive landscapes of brand-new landmasses of science with palette & tablet on back, several hundred years’ scientific travelogues were compiled thereby.

award” & “free press admittance”, science aristocrat usually are not ready to dishallow grand legitimacy of contemporaneous scientific orthodoxy, and there is even remarkable potentiality for long-time popularity of high-sounding freewheeling royal substantiation & perfection of contemporaneous scientific orthodoxy to slide into romantic feign development of science, especially, once royal substantiation & perfection of contemporaneous scientific orthodoxy exhausted its inherent potentiality for historical progress of science. And on the other hand, as subsistence of legitimacy qualification of contemporaneous scientific orthodoxy directly implicates social station, fame & gain of temporal authority, once coming scientific innovation has to challenge legitimacy subsistence of contemporaneous scientific orthodoxy, as opposites of scientific knowledge metabolism campaign with powerful ascendance in hand, temporal authority must sensitively bluster themselves into knowledge metabolism campaign as valiant countercheck battleship for self-preservation of human, especially, once full jurisdiction of free press admittance of science is completely under magistral autarchy of temporal authority short of necessary intendance, science forum can hardly be free from duress of authoritative intrepidity of contemporaneous scientific orthodoxy, it's almost impossible for coming renovation of humanistic ideology about authenticity of nature to evade “free press embarment”. Homogenous Cosmos Originated from Unique Genesis has been floundering about in free press embarment for 30 years is of course credible evidence of it.

This of course does not tally with the fundamental that under precondition, it's only possible for ultimate authenticity of nature to be unique and invariable, as enantiomorphous ideology about authenticity of nature, it's only possible for the major melody of historical progress of science to be serial epochmaking scientific knowledge metabolism in inherent optimum orientation towards scientific legitimacy qualification of historical authenticity tolerance of science 0. Before humanistic ideology about authenticity of nature finally qualified as perfect ideological enantiomorph of ultimate authenticity of nature, as long as it's still necessary for realistic progress of science to achieve further advancement towards perfect ideological enantiomorph of ultimate authenticity of nature, the unique possible end-result of contemporaneous scientific orthodoxy must be washed out for necessary scientific knowledge metabolism once further advancement accomplished ahead. In any case, as rigorous enantiomorphous correlation between objective authenticity of nature and humanistic ideology about authenticity of nature, it's neither possible for “the unique & invariable ultimate authenticity of nature” to be compatible with “two distinctive humanistic ideologies about authenticity of nature with remarkable ideological difference” nor possible for “two distinctive humanistic ideologies about authenticity of nature with remarkable ideological difference” to discover and formulate “the unique & invariable ultimate authenticity of nature” coequally, unless we can practically prove that it's really possible for ultimate authenticity of nature to be omnifarious authenticity smallwares full of a basket or authenticity chameleon one piece and only.

And virtually, during the course of historical progress of science, Copernicus, Bruno, Galileo ... Darwin were of course top-ranking scientists in human history, their innovative theories remarkably achieved revolutionary progress of science of human, however, under social background of their age, it's not only impossible for Copernicus, Bruno, Galileo, ... Darwin to be science aristocrat of their age, but also inevitable for them to be deadly counterworkers of temporal authority and to be victims of scientific knowledge metabolism campaign therefore! The injured and suffered were always the men who had radically changed the tenor of historical progress of science.

Historical progress of science extending to today, nowadays science aristocrat is of course the most massive science aristocrat in human history. Although, ostensibly, nowadays science aristocrat seems not as scampish and evil as science aristocrat of Copernicus' or Galileo's age, they virtually possess two important and useful facilities:

The first is “[full jurisdiction of free press regulation customization](#)” short of necessary intendance.

The second is “[full jurisdiction of free press admittance](#)” short of necessary intendance.

As coherent natura naturans throughout cosmic evolution, instinctive PNT reciprocal equilibrium towards optimum PNT operation is radical potentiality & conditionality for cosmos always ready to orientate itself towards perfection.

As magistral autarchy of “free press regulation customization” and “free press admittance” of temporal authority short of necessary intendance, living scientific knowledge proliferation all over the world has been restricted in rigid succession of contemporaneous scientific orthodoxy going without saying, and there is almost no way for any aberrant scientific knowledge proliferation out of succession of contemporaneous scientific orthodoxy to pass egotistic free press proximity identification under background of royal substantiation & perfection of contemporaneous scientific orthodoxy. Superfluous endeavor of royal substantiation & perfection of contemporaneous scientific orthodoxy almost takes full role of historical progress of science to push humanistic ideology about authenticity of nature forward to perfect ideological enantiomorph of ultimate authenticity of nature step by step draw on practical feasibility & possibility in proportion to contemporaneous historical background. As a result, aberrant scientific knowledge proliferation out of succession of contemporaneous scientific orthodoxy can hardly be free from orthodox filtration of altisonant free press egotistic proximity identification for magistral autarchy of **free press regulation customization & free press admittance** of temporal authority short of necessary intendance, modern physics is floundering in riancy.

After all, as out-and-out social work outgrowth and humanistic ideology about authenticity of nature in proportion to contemporaneous historical background, social existence and historical progress of “science” must inherently possess double coordinative significance of “**natural connotation**” and “**social connotation**”, social legitimacy subsistence of neonatal scientific idea especially successive renovation of humanistic ideology about authenticity of nature along historical progress of science in inherent optimum orientation towards perfect ideological enantiomorph of ultimate authenticity of nature never simply depends on cognizant achievement that brand-new or more veritable authenticity of nature has been reflected on sense of pioneering originators with commensurate authenticity highlight effect in proportion to contemporaneous historical background, it even crucially implicates esoteric authoritative social legitimacy identification & authentication in accordance with egotistic criterion of contemporaneous scientific orthodoxy under official centered background——social legitimacy & validity of truths can never exceed cannon range, which of course includes humanistic operation of virulent scientific knowledge metabolism campaign underlying. Once authoritative intrepidity of contemporaneous scientific orthodoxy challenge natural dominance under occasion of scientific knowledge metabolism campaign, the bureaucracy of temporal authority are always elated off the cuff for cock-a-hoop self-appreciation; whereas, it’s mostly possible for the coming scientific innovators to be worthy after death. It’s absolutely impossible for geocentric authorities to be so ludicrous to favor heliocentric theory free press authorization or impart Copernicus, Bruno respectable degree & honor, instead, they could only send Copernicus, Bruno to fire torture upon their human nature of self-preservation This is just the most vivid and hypostatic situation of humanistic progress of science and corresponding scientific knowledge metabolism campaign under contemporaneous historical background.

History extending to today, nothing seems having edified human nature, the situation maintains its aboriginality as ever.

(VII-iii) An Email from Victim of Scientific Knowledge Metabolism Campaign

Mail recipients: decisions@nature.com, apr-edoffice@aip.org,
science_editors@aaas.org, editorial@science-int.co.uk

As lowdown man of the society without any credible qualification & identity, my confidence to contribute top journals as Nature, Science, APR etc mostly exist in:

i). As timely renovation of humanistic ideology about authenticity of nature in proportion to contemporaneous historical background and cosmos redefinition in radical logic enantiomorph of newly highlighted factuality that **discretionary particles in cosmos are mutually convertible**, since factuality that **discretionary particles in cosmos are mutually convertible** is always in freewheeling orientation towards complete induction day by day, my confidence is of course self-evident.

As long as cosmos is throughout homogenous originated from unique genesis out of question, and cosmic status quo is but demiurgic aggradation of sequential homologic cosmogony, which exactly exists as well-regulated integration of cosmic homogeneity system making up of out-and-out serial natura naturata in the nature of coherent natura naturans throughout cosmic evolution, nothing is possible to stop endeavor of systematical unique-genesis quantization formulation of universal existence & motion along sequential homologic cosmogony starting at field genic origin i_0 to universal reciprocal PNT combinations in the nature of coherent natura naturans throughout cosmic evolution, which will radically impact conventional endeavor to formulate universal existence & motion with M subjects and N regularities like omnifarious scientific travelogues A, B, C, D, E, F, . . . about rich and colorful accessible existence & motion around.

In straightforward words, since newly highlighted factuality that **discretionary particles in cosmos are mutually convertible** is always in freewheeling orientation towards complete induction day by day, I never lack of confidence about authenticity of nature that **cosmos is throughout homogenous originated from unique genesis, cosmic status quo is demiurgic aggradation of sequential homologic cosmogony, which exactly exists as well-regulated integration of cosmic homogeneity system making up of out-and-out serial natura naturata in the nature of coherent natura naturans throughout cosmic evolution**. Compared to endeavor of interminable high-sounding royal substantiation & perfection of contemporaneous scientific orthodoxy, naissance of Homogenous Cosmos Originated from Unique Genesis must be epochmaking endeavor to push humanistic ideology about authenticity of nature forward to perfect ideological enantiomorph of ultimate authenticity of nature out of question. If we denote mathematical integral of progressive achievement of Homogenous Cosmos Originated from unique Genesis towards perfect ideological enantiomorph of ultimate authenticity of nature in the recent 31 years as $\int_{1991}^{\text{today}} F(H, t) dt$, and we denote mathematical integral of progressive achievement of all papers published in journals on the earth towards perfect ideological enantiomorph of ultimate authenticity of nature in the recent 31 years as $\int_{1991}^{\text{today}} F(P_j, t) dt$, there is substantial probability for $\int_{1991}^{\text{today}} F(H, t) dt$ and $\int_{1991}^{\text{today}} F(P_j, t) dt$ to satisfy:

$$\int_{1991}^{\text{today}} F(H, t) dt > \int_{1991}^{\text{today}} F(P_j, t) dt$$

In the inequation above, "H" in $F(H, t)$ is abbreviation of "**Homogenous Cosmos Originated from Unique Genesis**", "t" in $F(H, t)$ denotes "time"; "P" in $F(P_j, t)$ denotes "**all Papers published in SCI Journals on the earth**", "t" in $F(P_j, t)$ denotes "time". Of course, $\int_{1991}^{\text{today}} F(P_j, t) dt$ includes cumulative achievement of papers published in Science, Nature, APR in the recent 31 years as small-beer subset out of question. Of course, my confidence about this is mostly derived from predictable authenticity that cosmos is throughout homogenous originated from unique genesis, cosmic status quo is but demiurgic aggradation of sequential homologic cosmogony, which exactly exists as well-regulated integration of cosmic homogeneity system making up of out-and-out serial natura naturata in the nature of coherent natura naturans throughout cosmic evolution, although, as personal limitation, I can hardly consummate the topic through and through.

As coherent natura naturans throughout cosmic evolution, instinctive PNT reciprocal equilibrium towards optimum PNT operation is radical potentiality & conditionality for cosmos always ready to orientate itself towards perfection.

Draw on our intuitional experience, it's apparently crazy boast, nobody on the earth can straightforwardly believe such kind of tommyrot besides idiot, especially the overwhelming temporal authority who are working as hardcore puissance of living historical progress of science. In any case, as multiple notion with double significance of "social connotation" & "natural connotation", social legitimacy & validity of truths can never exceed cannon range. I hope cordial people on the earth can comprehend the humanistic objectivity that historical progress of science in inherent optimum orientation towards perfect ideological enantiomorph of ultimate authenticity of nature generally makes up of N successive cycles of "gradational quantitative change of original naissance of burgeoning contemporaneous scientific orthodoxy, freewheeling substantiation & perfection of contemporaneous scientific orthodoxy" and "timely qualitative change of epochmaking scientific knowledge metabolism between demoded contemporaneous scientific orthodoxy and coming burgeoning contemporaneous scientific orthodoxy with synchro subrogation of contemporaneous scientific orthodoxies".

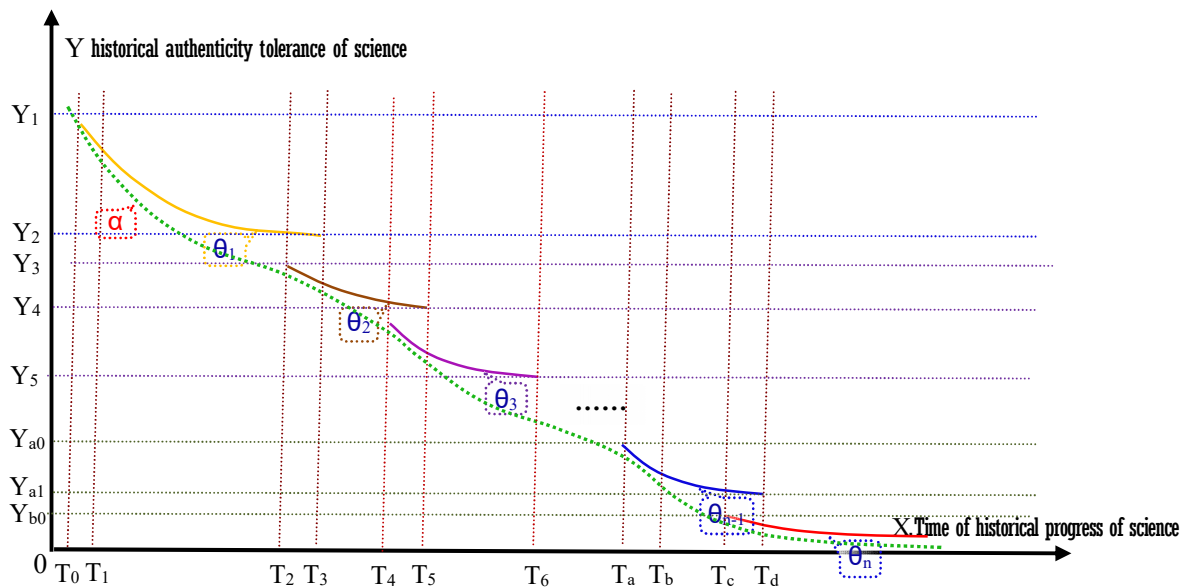

Quantitative change curve of historical progress of science making up of N successive subrogation of contemporaneous scientific Orthodoxies $\Theta_1 + \Theta_2 + \Theta_3 + \dots + \Theta_{n-1} + \Theta_n$ in inherent optimum orientation towards perfect ideological enantiomorph of ultimate authenticity of nature

Along crescive progression of historical progress of science in inherent optimum orientation towards perfect ideological enantiomorph of ultimate authenticity of nature, the positive quantitative change of historical authenticity tolerance of science of historical progress of science in inherent optimum orientation towards perfect ideological enantiomorph of ultimate authenticity of nature is not always continuous curve. Once historical progress of science slides into interminable royal substantiation & perfection of contemporaneous scientific orthodoxy, as egotistic guidance derived from overwhelming authoritative intrepidity of contemporaneous scientific orthodoxy even magistral autarchy of **free press regulation customization & free press admittance** of temporal authority, there must be proportionate aberrance of historical progress of science to push humanistic ideology about authenticity of nature forward to perfect ideological enantiomorph of ultimate authenticity of nature, quantitative change of historical authenticity tolerance of science towards 0 must be tinier and tinier therefore. Whereas, once epoch-making renovation of humanistic ideology about authenticity of nature in proportion to contemporaneous historical background occurs at the volley, quantitative change of historical authenticity tolerance of science towards 0 will occur remarkable jumping quantitative change which mostly cause qualitative change of commensurate ideological system about authenticity of nature. Relatively, it's almost impossible for interminable royal substantiation & perfection of contemporaneous scientific orthodoxy to bring out remarkable innovation of science & technology.

The objective humanistic factuality is of course acid-tongued, especially to the overwhelming temporal authority who are working as the hardcore puissance of living historical progress of science. Virtually, as lowdown pauper of the society, since I am still struggling in vicious circle of virulent scientific knowledge metabolism campaign under egotistic background of royal substantiation

& perfection of contemporaneous scientific orthodoxy, nothing is favorable for me to show off the meritorious factuality openly; since living hardcore puissance with magistral autarchy of free press regulation customization & free press admittance in virulent scientific knowledge metabolism campaign has coerced me to extremity, not willing to die just now, I have to instinctively draw out my sword firmly catch hold of it in my hands, although, I am quite aware of the social nature, as multiple notion with double significance of "social connotation" & "natural connotation", social legitimacy & validity of truths can never exceed cannon range. As a result, it seems necessary for me to comment herein, the most credible and solid evidence of $\int_{1991}^{\text{today}} F(H, t) dt > \int_{1991}^{\text{today}} F(P_j, t) dt$ is that, in coming 10~20 years, social practice under rational guidance of $\int_{1991}^{\text{today}} F(H, t) dt$ brings out epochmaking innovation of science & technology, just as what I comment in the front cover page of the monograph that it's innovative cosmos redefinition in logic enantiomorph of newly highlighted factuality that **discretionary particles in cosmos are mutually convertible** with consequent PNT dynamics about universal existence & motion in the nature of coherent natura naturans throughout cosmic evolution, which is science rudiment of the new century. Comparably, social practice under egotistic guidance of $\int_{1991}^{\text{today}} F(P_j, t) dt$ still stays in interminable substantiation & perfection of contemporaneous scientific orthodoxy without remarkable innovation.

The radical cause that loving successors of contemporaneous scientific orthodoxy are fashionable for royal substantiation & perfection of contemporaneous scientific orthodoxy and timely renovation of humanistic ideology about authenticity of nature in proportion to contemporaneous historical background can hardly evade virulent scientific knowledge metabolism campaign and consequently suffer pestilent free press embarment is that endeavor of royal substantiation & perfection of contemporaneous scientific orthodoxy tallies with vested interest of temporal authority and able to pass officialism free press egotistic proximity identification smoothly, on the contrary, timely renovation of humanistic ideology about authenticity of nature in proportion to contemporaneous historical background must cause life-and-death scientific knowledge metabolism and impact vested interest of temporal authority without alternatives. As a result, in the recent 31 years, free press admittance of Homogenous Cosmos Originated from Unique Genesis must break through legitimacy defense line of contemporaneous scientific orthodoxy, so that it has to challenge venomous counterwork upper limit of temporal authority all along and has slidden into vicious circle of virulent scientific knowledge metabolism campaign.

ii). Before 2018, I mostly contributed to common journals on the earth, whereas, as timely renovation of humanistic ideology about authenticity of nature in proportion to contemporaneous historical background of remarkable highlight of microcosmic configuration of matter and innovative cosmos redefinition in logic enantiomorph of newly highlighted factuality that **discretionary particles in cosmos are mutually convertible** with consequent PNT dynamics about universal existence & motion in the nature of coherent natura naturans throughout cosmic evolution, Homogenous Cosmos Originated from Unique Genesis is so grand logic expansion as linear logic system on the basis of [(Homogenous cosmos originated from unique genesis postulate + spacetime~matter fully embodying cosmos postulate) + Instinctive PNT equilibrium postulate], as outgrowth of logic extension, universal existence & motion is but spontaneous occurrence of [External physical disturbance + (PNT action + Instinctive PNT equilibrium)], which of course include traditional [physics + chemistry + biology + iatrolgy + ...] as real subclass but apparently different from conventional [physics + chemistry + biology + iatrolgy + ...] for precipitate remarkable ideological contrast between inertial ideological aggradation of remarkable transverse ideological expansion making up of rich and colorful scientific travelogues A, B, C, D, E, F, ... like omnifarious smallwares full of a basket which are deserving reward of a far-flung exploration as the the first literacy around numerous distinctive landscapes of brand-new landmasses of science with palette and tablet on back in the recent several centuries, and successive longitudinal ideological optimization as innovative cosmos redefinition in logic enantiomorph of newly highlighted factuality that **discretionary particles in cosmos are mutually convertible** with consequent PNT dynamics about universal existence & motion in the nature of coherent natura naturans throughout cosmic evolution came into being. The even worse discomfiture is that I am really low-down man of the society without respectable qualification, official rank and fund support indeed, it is really vexatious for mannered journals on the earth to find enough confidence to pay 2 more minutes to treat it as

As coherent natura naturans throughout cosmic evolution, instinctive PNT reciprocal equilibrium towards optimum PNT operation is radical potentiality & conditionality for cosmos always ready to orientate itself towards perfection.

nononsense academic topics for publication. As a result, I can hardly find nonsense reasons to think common journals are more accessible platform for me to publish Homogenous Cosmos Originated from Unique Genesis.

The deadly discomfiture is even more kittle than free press admittance of Heliocentric Theory has to ask for free press egotistic proximity identification from temporal authority of Geocentric Theory, although, the innovative contrast between Heliocentric Theory and Heliocentric Theory seems more remarkable than innovative contrast between Homogenous Cosmos Originated from Unique Genesis and travelogue style live contemporaneous scientific orthodoxy which can sensitively cause metabolism animus, free press admittance of Homogenous Cosmos Originated from Unique Genesis must break through legitimacy defense line of contemporaneous scientific orthodoxy, so that it has to challenge venomous counterwork upper limit of the most burly and overwhelming temporal authority throughout historical progress of science.

As originator of timely renovation of humanistic ideology about authenticity of nature in proportion to contemporaneous historical background of remarkable highlight of microcosmic configuration of matter, my intention to revise the email response to editorial office of ARP, Nature, Science and edit it into my monograph is ready to highlight something humanistically unintelligible about historical progress of science in accordance with my practical experience in the recent 30 years, especially modern science forum with expedient facility of magistral autarchy of free press regulation customization and free press admittance of temporal authority under background of interminable royal substantiation & perfection of contemporaneous scientific orthodoxy.

1) It's almost impossible for historical progress of science to be in rigid succession of contemporaneous scientific orthodoxy out of scientific legitimacy qualification of historical authenticity tolerance of science 0 all along, progressive ideological aberrance is almost inevitable for historical progress of science in inherent optimum orientation towards perfect ideological enantiomorph of ultimate authenticity of nature. As timely renovation of humanistic ideology about authenticity of nature in proportion to contemporaneous historical background of **remarkable highlight of microcosmic configuration of matter** and innovative cosmos redefinition in logic enantiomorph of newly highlighted factuality that **discretionary particles in cosmos are mutually convertible** with consequent PNT dynamics about universal existence & motion in the nature of coherent natura naturans throughout cosmic evolution, remarkable ideological aberrance even obvious divarication of Homogenous Cosmos Originated from Unique Genesis is inevitable.

As humanistic ideology about authenticity of nature in proportion to contemporaneous historical background, the first element for brand-new humanistic ideology about authenticity of nature to accomplish its valuable advancement in historical progress of science is remarkable **connotation variation**, without connotation variation, nothing can incarnate valuable innovation & advancement of brand-new humanistic ideology about authenticity of nature in historical progress of science.

Since factuality that **discretionary two particles in cosmos are mutually convertible** is always in freewheeling orientation towards perfect induction day by day, cosmos seems throughout homogenous originated from unique genesis out of question. As a result, we have adequate reasons to introduce **Homogenous cosmos originated from unique genesis postulate** for expedient scientific exploration or logic expansion towards further authenticity highlight of cosmos. And once I primarily accomplished recognizant outgrowth as innovative cosmos redefinition in logic enantiomorph of newly highlighted factuality of **discretionary particles in cosmos are mutually convertible** with consequent PNT dynamics about universal existence & motion in the nature of coherent natura naturans throughout cosmic evolution as linear logic system on the basis of unique presumable precondition of **Homogenous cosmos originated from unique genesis postulate**, I slid into deadly trouble that, as Homogenous Cosmos Originated from Unique Genesis seems weirdy in modern academia which is not only typical ideological outgrowth of aberrant scientific knowledge

Historical progress of science in the recent several centuries seemed like a far-flung exploration of the first itinerary around numerous distinctive landscapes of brand-new landmasses of science with palette & tablet on back, several hundred years' scientific travelogues were compiled thereby.

proliferation out of rigid succession of contemporaneous scientific orthodoxy but also seems out-and-out heterodoxy with remarkable divarication even illogicality from traditionary rich and colorful scientific travelogues A, B, C, D, E, F, ... like omnifarious smallwares full of a basket, I consequently slid into virulent scientific knowledge metabolism campaign, free press admittance of Homogenous Cosmos Originated from Unique Genesis must break through legitimacy defense line of contemporaneous scientific orthodoxy, so that it has to challenge venomous counterwork upper limit of temporal authority.

Is it villainous for historical progress of science to expose thorough homogenous profile of cosmos more and more explicit by throwing more and more lights onto microcosmic configuration of matter at the volley? Is it my evil to succeed favorable headspring of **remarkable highlight of microcosmic configuration of matter** to accomplish innovative cosmos redefinition in logic enantiomorph of newly highlighted factuality that **discretionary particles in cosmos are mutually convertible** with consequent PNT dynamics about universal existence & motion in the nature of coherent natura naturans throughout cosmic evolution?

And on the other hand, as overwhelming interminable royal substantiation & perfection of contemporaneous scientific orthodoxy with remarkable facility of magistral autarchy of free press regulation customization and free press admittance of temporal authority short of necessary intendance in the recent half century, modern science forum has been out-and-out homegrown outgrowth in the garden of live contemporaneous scientific orthodoxy. As a result, in the recent 30 years, no matter I tried to contribute physics journals, chemistry journals, biology journals, ... or philosophy journals on the earth, there were almost no journals who thought **Homogenous Cosmos Originated from Unique Genesis** belonged to scope they were professionally devoting to. Even as remarkable aberrance & divarication from tradition, I slid into vicious circle of virulent scientific knowledge metabolism campaign under invisible duress of overwhelming authoritative intrepidity of contemporaneous scientific orthodoxy, free press admittance of Homogenous Cosmos Originated from Unique Genesis has to challenge venomous counterwork upper limit of temporal authority without alternatives.

As straightforward man, I have to comment herein, I have no intention to create weirdy as typical aberrant scientific knowledge proliferation out of succession of contemporaneous scientific orthodoxy which looks apparently different from traditionary ideological system making up of rich and colorful disciplines & subdisciplines as physics, chemistry, biology, iatrology, philosophy etc, it mostly because Homogenous Cosmos Originated from Unique Genesis radically derived from distinctive rationale of remarkable highlight of microcosmic configuration of matter and came into being in innovative rational model as radical logic enantiomorph of newly highlighted factuality that **discretionary particles in cosmos are mutually convertible**, which is linear logic system based on unique presumable precondition of **Homogenous cosmos originated from unique genesis postulate**.

As remarkable highlight of microcosmic configuration of matter indicating thorough homogenous profile of cosmos, there are adequate reasons for me to introduce **Homogenous cosmos originated from unique genesis postulate** for further highlight of universal existence & motion as well-regulated integration of cosmic homogeneity system making up of out-and-out serial natura naturata in the nature of coherent natura naturans throughout cosmic evolution; I even would like to tell people **it's only possible for concordant cosmos to be demiurgic aggradation of out-and-out serial natura naturata in the nature of coherent natura naturans throughout cosmic evolution; there is no way for demiurgic aggradation in the nature of different natura naturans to be concordant cosmos through and through**. I have no intention to bring out unnecessary divarication so as to stir up a nest of hornets, I am but ready to keep the linear logic system about universal existence & motion operated by **[(Homogenous cosmos originated from unique genesis postulate + spacetime~matter**

As coherent natura naturans throughout cosmic evolution, instinctive PNT reciprocal equilibrium towards optimum PNT operation is radical potentiality & conditionality for cosmos always ready to orientate itself towards perfection.

fully embodying cosmos postulate) + Instinctive PNT equilibrium postulate] self-consistent through and through.

Virtually, as timely renovation of humanistic ideology about authenticity of nature in proportion to contemporaneous historical background of remarkable highlight of microcosmic configuration of matter, **Homogenous Cosmos Originated from Unique Genesis** is typical cosmos redefinition in logic enantiomorph of newly highlighted factuality that **discretionary two particles in cosmos are mutually convertible** with consequent PNT dynamics about universal existence & motion in the nature of coherent natura naturans throughout cosmic evolution, which is the most innovative renovation of humanistic ideology about authenticity of nature in proportion to contemporaneous historical background against the most well-round rational purview of cosmos. This is of course radical cause to make it so different from traditional ideological system making up of physics, chemistry, biology, iatroylogy, philosophy etc which seem scientific travelogues A, B, C, D, E, F, ... like omnifarious smallwares full of a basket as deserving reward of the first itineracy around distinctive landscapes of brand-new landmasses of science with palette & tablet on back in the recent several centuries.

In any case, once we have to admit cosmos is throughout homogenous originated from unique genesis, and cosmic status quo is but demiurgic aggradation of sequential homologic cosmogony as well-regulated integration of cosmic homogeneity system making up of out-and-out serial natura naturata in the nature of coherent natura naturans throughout cosmic evolution, as ideological enantiomorph of accessible existence & motion around us, it's almost impossible for ultimate consummation of science to be **ideal ideological aggradation = distinctive (physics + chemistry + iatroylogy + ...)** any longer, instead, it should be **ultimate consummation of science = perfect ideological enantiomorph of ultimate authenticity of nature** or **ultimate consummation of science = perfect ideological enantiomorph of coherent natura naturans throughout cosmic evolution** accordingly, which is of course different from traditional ideological system as rich and colorful disciplines & subdisciplines like omnifarious smallwares full of a basket. Although, as crecive progression of quantitative & qualitative change of practical feasibility & possibility as potentiality for historical progress of science, it seems nothing possibly better for us to accomplish rich and colorful disciplines & subdisciplines like omnifarious scientific travelogues A, B, C, D, E, F, ... full of a basket as deserving reward of the first itineracy around distinctive landscapes of brand-new landmasses of science with palette & tablet on back in the recent several centuries.

II) As permanent synthesized conditionality of **“crescive progression of practical feasibility & possibility in proportion to contemporaneous historical background + the uniqueness & invariance of ultimate authenticity of nature predestines the unique possibility of scientific verity as perfect ideological enantiomorph of ultimate authenticity of nature”** through and through, it's only possible for the major melody of historical progress of science to be a series of epochmaking scientific knowledge metabolism in inherent optimum orientation towards perfect ideological enantiomorph of ultimate authenticity of nature. Veritable progress of science in inherent optimum orientation is always hypostatic endeavor to push humanistic ideology about authenticity of nature forward to perfect ideological enantiomorph of ultimate authenticity of nature step by step draw on practical feasibility & possibility in proportion to contemporaneous historical background. Interminable royal substantiation & perfection of any contemporaneous scientific orthodoxy out of scientific legitimacy qualification of historical authenticity tolerance of science 0 can never be freewheeling nonstop to finish all the rest route of historical progress of science towards perfect ideological enantiomorph of ultimate authenticity of nature.

Historical progress of science is not stochastic occurrence but successive and systematical occurrence in inherent optimum orientation towards perfect ideological enantiomorph of ultimate authenticity of nature with inherent cause and effect through and through.

Historical progress of science in the recent several centuries seemed like a far-flung exploration of the first itineracy around numerous distinctive landscapes of brand-new landmasses of science with palette & tablet on back, several hundred years' scientific travelogues were compiled thereby.

There are generally two sorts of significant potentiality & conditionality underlying for historical progress of science:

The first is **humanistic potentiality** — **crecive progression of practical feasibility & possibility in proportion to contemporaneous historical background.**

The second is **connatural determinism** — **the uniqueness & invariance of ultimate authenticity of nature predestines the unique possibility of scientific verity as perfect ideological enantiomorph of ultimate authenticity of nature.**

Throughout human history, **humanistic potentiality** for historical progress of science is mostly in its crecive progression along time extension, which of course implies the earlier years of human history, there is relatively poorer quality humanistic potentiality for historical progress of science, the years relatively closer to modern age, the quality of humanistic potentiality for historical progress of science is proportionably higher.

The quality of humanistic potentiality of practical feasibility & possibility in proportion to contemporaneous historical background mostly determines generation probability and ideological quality of commensurate humanistic ideology about authenticity of nature in proportion to contemporaneous historical background. Throughout historical progress of science, different historical ages with inherent humanistic potentiality of practical feasibility & possibility in proportion to contemporaneous historical background for historical progress of science generally bring out different commensurate humanistic ideology about authenticity of nature in proportion to contemporaneous historical background with proportionate legitimacy qualification of historical authenticity tolerance of science. Commensurate humanistic ideology about authenticity of nature can never exist isolatedly without inherent backup of commensurate humanistic potentiality of practical feasibility & possibility for historical progress of science. In straightforward words, historical progress of science can never be out of thin air, potential reciprocity between background humanistic potentiality of practical feasibility & possibility and consequent commensurate humanistic ideology about authenticity of nature is inherent cause and effect of historical progress of science in inherent optimum orientation towards perfect ideological enantiomorph of ultimate authenticity of nature, which not only indicates it's only possible for different historical ages to proportionably accomplish different commensurate humanistic ideology about authenticity of nature but also indicates, before commensurate humanistic ideology about authenticity of nature finally qualified as perfect ideological enantiomorph of ultimate authenticity of nature, so-called "sciences" are but commensurate humanistic ideology about authenticity of nature in proportion to contemporaneous historical background with proportionate legitimacy qualification of historical authenticity tolerance of science.

Throughout historical progress of science, there are many many so-called "scientific truths" of contemporaneous scientific orthodoxy, before humanistic ideology about authenticity of nature finally qualified as perfect ideological enantiomorph of ultimate authenticity of nature, so-called "scientific truth/truths" are but commensurate humanistic authoritative patents under solid backup of overwhelming authoritative intrepidity of contemporaneous scientific orthodoxy. Since there is nonexistence of tiger in mountain, nothing can prevent monkey to be the king of the mountain, before naissance of perfect ideological enantiomorph of ultimate authenticity of nature, since pioneering humanistic ideology about authenticity of nature in proportion to contemporaneous historical background seems scientifically all-time, it's of course comprehensible that all the pioneering and top-level humanistic ideology about authenticity of nature in proportion to contemporaneous historical background are always ready to be scientific king of the age after jaunty triumph.

As coherent natura naturans throughout cosmic evolution, instinctive PNT reciprocal equilibrium towards optimum PNT operation is radical potentiality & conditionality for cosmos always ready to orientate itself towards perfection.

Connatural determinism — the uniqueness & invariance of ultimate authenticity of nature predestines the unique possibility of scientific verity as perfect ideological enantiomorph of ultimate authenticity of nature indicates, since ultimate authenticity of nature can be neither omnifarious authenticity smallwares full of a basket nor authenticity chameleon one piece and only, but coherent natura naturans throughout cosmic evolution, as ideological enantiomorph of authenticity of nature, ultimate consummation of science must be unique scientific verity as **perfect ideological enantiomorph of ultimate authenticity of nature**. And as rigorous enantiomorphous correlation between objective authenticity of nature and humanistic ideology about authenticity of nature, it's neither possible for “the unique & invariable ultimate authenticity of nature” to be compatible with “two distinctive humanistic ideologies about authenticity of nature with remarkable ideological difference” nor possible for “two distinctive humanistic ideologies about authenticity of nature with remarkable ideological difference” to discover and formulate “the unique & invariable ultimate authenticity of nature” coequally. As a result, throughout historical progress of science in inherent optimum orientation towards perfect ideological enantiomorph of ultimate authenticity of nature, any occurrence of timely renovation of humanistic ideology about authenticity of nature in proportion to contemporaneous historical background must wash out live contemporaneous scientific orthodoxy without alternatives, unless the so-called timely renovation of humanistic ideology about authenticity of nature in proportion to contemporaneous historical background has virtually done nothing to push humanistic ideology about authenticity of nature forwards to perfect ideological enantiomorph of ultimate authenticity of nature or the so-called “live contemporaneous scientific orthodoxy” itself has been perfect ideological enantiomorph of ultimate authenticity of nature already.

As timely renovation of humanistic ideology about authenticity of nature in proportion to contemporaneous historical background of remarkable highlight of microcosmic configuration of matter and innovative cosmos redefinition in logic enantiomorph of newly highlighted factuality that **discretionary particles in cosmos are mutually convertible**, it's historical normality for naissance of Homogenous Cosmos Originated from Unique Genesis to bring out so radical scientific knowledge metabolism with virulent scientific knowledge metabolism campaign following like shadow. The key issue is that we should be quite aware of objectivity of historical progress of science and inevitability of naissance of Homogenous Cosmos Originated from Unique Genesis as timely renovation of humanistic ideology about authenticity of nature in proportion to contemporaneous historical background of remarkable highlight of microcosmic configuration of matter, we should have enough foreknowledge to deal with such kind of innovative occurrence on the spot. There are no respectable reasons for free press admittance of Homogenous Cosmos Originated from Unique Genesis to challenge venomous counterwork upper limit of temporal authority without alternatives, there are no reasons for social legitimacy subsistence of Homogenous Cosmos Originated from Unique Genesis to flounder around in vicious circle of virulent scientific knowledge metabolism campaign for more than 30 years. If such kind of situation is ongoing year after year, we of course have substantial reasons to suspect and verify whether overwhelming authoritative intrepidity of contemporaneous scientific orthodoxy is fighting for vested interest draw on expedience of magistral autarchy of free press regulation customization and free press admittance short of necessary intendance.

Of course, I emphasize the inherent regularity of historical progress of science herein is not only personal intention to show the world that it's inevitable for Homogenous Cosmos Originated from Unique Genesis to slide into vicious circle of virulent scientific knowledge metabolism campaign under background of interminable royal substantiation & perfection of contemporaneous scientific orthodoxy. What I would like to emphasize more is that we have too poor foreknowledge and sense of inherent regularity of historical progress of science, we should

Historical progress of science in the recent several centuries seemed like a far-flung exploration of the first itinerary around numerous distinctive landscapes of brand-new landmasses of science with palette & tablet on back, several hundred years' scientific travelogues were compiled thereby.

be aware of factuality that royal substantiation & perfection of any contemporaneous scientific orthodoxy out of scientific legitimacy qualification of historical authenticity tolerance of science 0 can never be freewheeling nonstop to finish all rest route of historical progress of science towards perfect ideological enantiomorph of ultimate authenticity of nature. And we can see modern physics is floundering around in riancy for interminable royal substantiation & perfection of contemporaneous scientific orthodoxy in the recent half century. For such morbid status quo of historical progress of science, we should not leave free press regulation customization and free press admittance in magistral autarchy of temporal authority short of necessary intendance, at any rate, live scientific knowledge proliferation on the earth should not be so conservative in rigid succession of contemporaneous scientific orthodoxy under egotistic guidance of temporal authority.

Do you know what happened since original naissance of **Homogenous Cosmos Originated from Unique Genesis** in 1991? **Homogenous Cosmos Originated from Unique Genesis** has suffered free press embarment for over 30 years, who had ever had slight regret that they had ever done something powerfully evil against inherence of historical progress of science in inherent optimum orientation towards perfect ideological enantiomorph of ultimate authenticity of Nature?

III) As typical heterodoxy of the age, I am completely innocent, I have no intention to displease temporal authority of The Big Bang, Relativity, Black Hole Theory, ... LIGO Gravitational Wave Discovery etc. I am but ready to show 7 billions of live people on the earth that cosmos is throughout homogenous originated from unique genesis, cosmic status quo is demiurgic aggradation of sequential homologic cosmogony, which exactly exists as well-regulated integration of cosmic homogeneity system making up of out-and-out serial natura naturata in the nature of coherent natura naturans throughout cosmic evolution. Whereas, as life-and-death scientific knowledge metabolism is inevitable, free press admittance of Homogenous Cosmos Originated from Unique Genesis directly impacts vested interest of temporal authority, there is almost nobody ready to displease overwhelming temporal authority for free press admittance of Homogenous Cosmos Originated from Unique Genesis, 31 years' free press embarment of Homogenous Cosmos Originated from Unique Genesis under background of interminable royal substantiation & perfection of contemporaneous scientific orthodoxy is not only my personal tragedy but also serious social problem of historical progress of science.

As out-and-out social work outgrowth and humanistic ideology about authenticity of nature in proportion to contemporaneous historical background, social existence and historical progress of "science" must inherently possess double coordinative significance of "natural connotation" and "social connotation", social legitimacy subsistence of neonatal scientific idea especially successive renovation of humanistic ideology about authenticity of nature along historical progress of science in inherent optimum orientation towards perfect ideological enantiomorph of ultimate authenticity of nature never simply depends on cognizant achievement that brand-new or more veritable authenticity of nature has been reflected on sense of pioneering originators with commensurate authenticity highlight effect in proportion to contemporaneous historical background, it even crucially implicates esoteric authoritative identification for accredited social legitimacy authorization in accordance with egotistic criterion of contemporaneous scientific orthodoxy under officialdom background — social legitimacy & validity of truths can never exceed cannon range, which of course includes humanistic operation of virulent scientific knowledge metabolism campaign underlying.

My intention to air the email response to editorial office of ARP, Nature, Science is not ready to tell people on the earth that boys & girls of Journals as APR, Nature, Science are overbearing egotistic science aristocrat and belligerent fighters in life-and-death scientific knowledge metabolism but have to tell people around, as timely

As coherent natura naturans throughout cosmic evolution, instinctive PNT reciprocal equilibrium towards optimum PNT operation is radical potentiality & conditionality for cosmos always ready to orientate itself towards perfection.

renovation of humanistic ideology about authenticity of nature in proportion to contemporaneous historical background of remarkable highlight of microcosmic configuration of matter, Homogenous Cosmos Originated from Unique Genesis has slidden into vicious circle of virulent scientific knowledge metabolism campaign under background of interminable royal substantiation & perfection of contemporaneous scientific orthodoxy, my rough rencontre at Journals as APR, Nature, Science is typical evidence.

Of course, smart boys & girls of ARP editorial office, Nature editorial office, Science editorial office are common human being with inherent self-preservation whose career is humanistic roles as temporal authority under official centered background for royal substantiation & perfection of contemporaneous scientific orthodoxy.

1) They are at the pinnacle of power, especially expedient facility of magistral autarchy of free press regulation customization and free press admittance short of necessary intendance, which is most expedient facility for them to egotistically customize science forum even historical progress of science at their pleasure.

2) Once they slide into inevitable scientific knowledge metabolism campaign and have to select sides & stand in line between Homogenous Cosmos Originated from Unique Genesis and live contemporaneous scientific orthodoxy, as official members of temporal authority, they are of course intuitively wise to select live contemporaneous scientific orthodoxy and stand in line as themselves. At any rate, if they select side of Homogenous Cosmos Originated from Unique Genesis and stand in line against their respectable identity of temporal authority, they can hardly be free from duress of overwhelming authoritative intrepidity of contemporaneous scientific orthodoxy before ultimate clarification of the issue; if they select live contemporaneous scientific orthodoxy and stand in line as themselves, no matter what the ultimate result of the inevitable scientific knowledge metabolism campaign is, they are all irresponsible and innocent. As a result, they would rather show off their superiority of pinnacle of power at their pleasure than standing up to duress of overwhelming authoritative intrepidity of contemporaneous scientific orthodoxy. What's more, throughout historical progress of science, live authoritative intrepidity of contemporaneous scientific orthodoxy is all-time and overwhelming indeed.

Virtually, in order to keep free from perplexity of duress of overwhelming authoritative intrepidity of contemporaneous scientific orthodoxy, almost 95% journals on the earth are always ready to keep them free from consideration of free press admittance of Homogenous Cosmos Originated from Unique Genesis no more social legitimacy authorization, but to easily find an excuse to keep themselves free from perplexity of virulent scientific knowledge metabolism campaign, devoting to royal substantiation & perfection of contemporaneous scientific orthodoxy is their processional career going without saying, which of course include official journals as Nature, Science, APR in the nature of things.

In any case, under background of royal substantiation & perfection of contemporaneous scientific orthodoxy, whether Homogenous Cosmos Originated from Unique Genesis is pioneering endeavor towards perfect ideological enantiomorph of ultimate authenticity of nature in proportion to contemporaneous historical background of remarkable highlight of microcosmic configuration of matter or not seems nothing to do with their career responsibility as qualified editors/reviewers, whereas, anybody who involves positive free press admittance of Homogenous Cosmos Originated from Unique Genesis can hardly be free from duress of overwhelming authoritative intrepidity of contemporaneous scientific orthodoxy. In straightforward words, as life-and-death scientific knowledge metabolism underlying for remarkable divarication, before rational choice between contemporaneous scientific orthodoxy and timely renovation of humanistic ideology about authenticity of nature as Homogenous Cosmos Originated from Unique Genesis, editors and reviewers are quite aware if they blaspheme temporal authority,

Historical progress of science in the recent several centuries seemed like a far-flung exploration of the first itinerary around numerous distinctive landscapes of brand-new landmasses of science with palette & tablet on back, several hundred years' scientific travelogues were compiled thereby.

they must slide into pestilent officialism domino effect due to presence of overwhelming authoritative intrepidity of contemporaneous scientific orthodoxy; if they keep free from humanistic operation of free press admittance of Homogenous Cosmos Originated from Unique Genesis, they can always be carefree like themselves.

At any rate, as magistral autarchy of free press regulation customization and free press admittance short of necessary intendance, live scientific knowledge proliferation on the earth must be conventionally customized by temporal authority in rigid succession of contemporaneous scientific orthodoxy towards substantiation & perfection of contemporaneous scientific orthodoxy. I never perceived the overbearing temporal authority having idea that veritable progress of science is virtually endeavor to push humanistic ideology about authenticity of nature forward to perfect ideological enantiomorph of ultimate authenticity of nature step by step draw on practical feasibility & possibility in proportion to contemporaneous historical background, and so-called contemporaneous scientific orthodoxy is but live humanistic ideology about authenticity of nature in proportion to contemporaneous historical background with modern social legitimacy qualification, the major melody of historical progress of science is serial epochmaking scientific knowledge metabolism in inherent optimum orientation towards perfect ideological enantiomorph of ultimate authenticity of nature but not interminable royal substantiation & perfection of contemporaneous scientific orthodoxy. As long as historical progress of science is ongoing in inherent optimum orientation towards perfect ideological enantiomorph of ultimate authenticity of nature, any contemporaneous scientific orthodoxy out of scientific legitimacy qualification of historical authenticity tolerance of science 0 must be washed out soon or later.

Ostensibly, we are cheerly trying to devote to development of science, virtually, under background of royal substantiation & perfection of contemporaneous scientific orthodoxy with egotistic guidance due to magistral autarchy of free press regulation customization & free press admittance of temporal authority short of necessary intendance, development of science is mostly limited in endeavor for royal substantiation & perfection of contemporaneous scientific orthodoxy, none aberrant scientific knowledge proliferation out of succession of contemporaneous scientific orthodoxy is considerable, no more timely renovation of humanistic ideology about authenticity of nature in proportion to contemporaneous historical background. Nobody is responsible if timely renovation of humanistic ideology about authenticity of nature in proportion to contemporaneous historical background suffers too much in virulent scientific knowledge metabolism campaign; even nobody can be free from duress of overwhelming authoritative intrepidity of contemporaneous scientific orthodoxy if he tries to debarrass free press embarrment of timely renovation of humanistic ideology about authenticity of nature in proportion to contemporaneous historical background struggling in virulent scientific knowledge metabolism campaign. We review the passed half century, as interminable royal substantiation & perfection of contemporaneous scientific orthodoxy under magisterial egotistic guidance of temporal authority, what we have accomplished to push humanistic ideology about authenticity of nature forward to perfect ideological enantiomorph of ultimate authenticity of nature?

As multiple notion with double significance of “**social connotation**” & “**natural connotation**”, social legitimacy & validity of truths can never exceed cannon range, as lowdown man of the society and typical heterodoxy of the age, I have neither canon nor cannon range, my perplexity & helplessness is self-evident. No matter whether interminable royal substantiation & perfection of contemporaneous scientific orthodoxy can do something significant for historical progress of science in the coming 20 years, as long as the magistral autarchy of free press regulation customization and free press admittance of temporal authority can still do their jobs at their pleasure, there is no way for free press admittance of Homogenous Cosmos Originated from Unique Genesis to slide over pestilent

As coherent natura naturans throughout cosmic evolution, instinctive PNT reciprocal equilibrium towards optimum PNT operation is radical potentiality & conditionality for cosmos always ready to orientate itself towards perfection.

duress of overwhelming authoritative intrepidity of contemporaneous scientific orthodoxy. Throughout historical progress of science, I am not the unique victim of virulent scientific knowledge metabolism campaign, whereas, comparably, I am the most tragic innovator of humanistic ideology about authenticity of nature under background of royal substantiation & perfection of contemporaneous scientific orthodoxy which originally grew up when scientific practice of human experienced remarkable transition from macrocosmos to microcosmos, I confronted the most overwhelming authoritative intrepidity of contemporaneous scientific orthodoxy with unprecedented official facility of magistral autarchy of **free press regulation customization** and **free press admittance** short of necessary intendance, which is of course direct reasons for timely renovation of humanistic ideology about authenticity of nature in proportion to contemporaneous historical background and cosmos redefinition in radical logic enantiomorph of newly highlighted factuality that **discretionary particles in cosmos are mutually convertible** to suffer free press embarment over 31 years.

I am quite aware my temerarious intention to show people on the earth that “**science**” is multiple notion with double significance of “**social connotation**” & “**natural connotation**”, social legitimacy & validity of truths can never exceed cannon range, the most straightforward aberrant officialism domino effect of magistral autarchy of free press regulation customization and free press admittance is egoistic facility to customize science forum even historical progress of science towards royal substantiation & perfection of contemporaneous scientific orthodoxy at pleasure of temporal authority is the most dangerous action for me to displease temporal authority and slide into vicious circle of virulent scientific knowledge metabolism campaign deeper and deeper. And indeed, in the recent half century, temporal authority are always so carefree to enjoy magistral autarchy of free press regulation customization and free press admittance (**free press egotistic proximity identification**) stepping in the air, so-called modern science forum even live historical progress of science has been customized so much towards royal substantiation & perfection of contemporaneous scientific orthodoxy accordingly, as timely renovation of humanistic ideology about authenticity of nature in proportion to contemporaneous historical background of **remarkable highlight of microcosmic configuration of matter** and typical aberrant scientific knowledge proliferation out of succession of contemporaneous scientific orthodoxy, free press embarment of Homogenous Cosmos Originated from Unique Genesis is always so self-evident for remarkable incompatibility against altisonant free press egotistic proximity identification. If I keep silent all along, Homogenous Cosmos Originated from Unique Genesis must die in silence without alternatives, if I contribute to journals on the earth, it seems unique access like ghost pass for me to challenge venomous counterwork upper limit of temporal authority, there is substantively no way for me to shy away virulent scientific knowledge metabolism campaign under totali-tarianism operation of overwhelming temporal authority.

As victim of virulent scientific knowledge metabolism campaign floundering around in vicious circle of virulent scientific knowledge metabolism campaign more than 30 years, I can hardly find me accessible way to get rid of perplexity of virulent scientific knowledge metabolism campaign indeed. Yesterday (28, July, 2022), I received another rejection email from one journal on the earth, which insisted that my paper was out of their academic scope. I was shocked and responded the email immediately as below:

Dear editors, I would like to comment three items due to your rejection.

1). As multiple notion with double significance of “**social connotation**” & “**natural connotation**”, social legitimacy & validity of truths can never exceed cannon range, as lowdown man of the society even typical heterodoxy of the age, I have neither cannon nor cannon range, besides your customary **free press egotistic proximity identification**, identity & qualification discrimination is always default value that can never be erased in your minds.

Historical progress of science in the recent several centuries seemed like a far-flung exploration of the first itinerary around numerous distinctive landscapes of brand-new landmasses of science with palette & tablet on back, several hundred years' scientific travelogues were compiled thereby.

2). As long as you have to admit the so-called academic scope you are professionally devoting to can never transcend category of cosmos, and cosmos is throughout homogenous originated from unique genesis, cosmic status quo cosmic status quo is demiurgic aggradation of sequential homologic cosmogony, which exactly exists as well-regulated integration of cosmic homogeneity system making up of out-and-out serial natura naturata in the nature of coherent natura naturans throughout cosmic evolution, you have neither reasons to insist your scope is out of motif of Homogenous Cosmos Originated from Unique Genesis as cosmos redefinition in logic enantiomorph of newly highlighted factuality that **discretionary particles in cosmos are mutually convertible** with consequent PNT dynamics about universal existence & motion in the nature of coherent natura naturans throughout cosmic evolution nor reasons to insist that Homogenous Cosmos Originated from Unique Genesis does not cover your scope through and through, unless you are either idiots all wool and a yard wide or it's really necessary for you to pretend idiots or you have to do your job as brave fighter in virulent scientific knowledge metabolism campaign in the nature of human self-preservation.

3). Under egotistic background of royal substantiation & perfection of contemporaneous scientific orthodoxy, in terms of endeavor of substantiation & perfection of contemporaneous scientific orthodoxy, free press admittance is usually challenge to pass **free press egotistic proximity identification**. Relatively, in terms of timely renovation of humanistic ideology about authenticity of nature in proportion to contemporaneous historical background of remarkable highlight of microcosmic configuration of matter as innovative cosmos redefinition in radical logic enantiomorph of newly highlighted factuality that **discretionary particles in cosmos are mutually convertible** with consequent PNT dynamics about universal existence & motion in the nature of coherent natura naturans throughout cosmic evolution, as remarkable divarication between Homogenous Cosmos Originated from Unique Genesis and contemporaneous scientific orthodoxy, free press admittance of Homogenous Cosmos Originated from Unique Genesis must break through legitimacy defense line of contemporaneous scientific orthodoxy due to inevitable life-and-death scientific knowledge metabolism. Whereas, as authoritative opposite of virulent scientific knowledge metabolism campaign, you are always totali-tarianism operators of virulent scientific knowledge metabolism campaign, as victim of virulent scientific knowledge metabolism campaign under egotistic background of interminable royal substantiation & perfection of contemporaneous scientific orthodoxy, I am but helpless outsider and lowdown man of the society who have neither cannon nor cannon range, which makes it unique access like ghost pass for Homogenous Cosmos Originated from Unique Genesis to approach free press admittance.

If you are not out-and-out idiots, you must be able to comprehend the situation I state herein.

Yours Sincerely

Original email was sent out on 29 Oct. 2021

Necessary revision was done in June 2022

(VII-iv) Brief Review of Scientific Experiment

Abstract: *As accessorial instrumentality towards intelligent apperception & exploration of authenticity of nature, scientific experiment is active & effective approach human manage proper artificial performance of objective physical process in the nature so as to make the physical regularity or natural consequence of the objective physical process self-evident in general physical purview of human then and there, so that it's convenient for human to draw scientific conclusion about the objective physical process, which is not only practical instrumentality to make mysterious physical feature of nature accessible to human sense but also valid access to extend and strengthen human sense to mysterious physical feature of nature.*

Even as remarkable disparity of practical feasibility & possibility in proportion to contemporaneous historical background, the accessible implication scope & profundity of physical experiment of human is different accordingly, even the historical functional feature of physical experiments along crescive progression of historical progress of science is proportionably different too. However, as humanistic endeavor towards intelligent apperception & exploration of authenticity of nature, functional availability of scientific experiment can never exceed relative limitation of accessible physical purview of human.

The quantitative change of practical feasibility & possibility for development of science historically extended to today, the demonstrative efficiency of scientific experiment has apparently approached accessibility up limit of human, although, live contemporaneous scientific orthodoxy is obviously out of scientific legitimacy qualification of historical authenticity tolerance of science 0, nowadays scientific experiment can neither expose a fly in the ointment of live contemporaneous scientific orthodoxy, nor are able to offer hypostatic support of proportionate contemporaneous scientific authentication to pioneering endeavor of renovation of humanistic ideology about authenticity of nature in proportion to contemporaneous historical background.

Keywords: *scientific experiment, general physical purview of human, relative limitation of accessible physical purview of human.*

1. Functional validity of artificial scientific experiment

As accessorial instrumentality towards intelligent apperception & exploration of authenticity of nature, scientific experiment is active & effective approach human manage proper artificial performance of objective physical process in the nature so as to make the physical regularity or natural consequence of the objective physical process self-evident on the spot, so that it's convenient and possible for human to draw positive scientific conclusion about the objective physical process, which is not only practical instrumentality to make mysterious physical feature of nature accessible to human sense but also valid access to extend and strengthen human sense to mysterious physical feature of nature.

Even as remarkable disparity of practical feasibility & possibility in proportion to contemporaneous historical background, the accessible scope & profundity of physical experiment of human is different accordingly, even the historical functional feature of physical experiments along crescive progression of historical progress of science is proportionably different too. However, as humanistic endeavor towards intelligent apperception & exploration of authenticity of nature, functional accessibility of physical experiment can never exceed **relative limitation of accessible physical purview of human.**

Historical progress of science in the recent several centuries seemed like a far-flung exploration of the first itinerary around numerous distinctive landscapes of brand-new landmasses of science with palette & tablet on back, several hundred years' scientific travelogues were compiled thereby.

In our physical purview, only relative existence & motion in cosmos is accessibly definite, there is nonexistence of absolute existence & motion in cosmos, and there is of course relative limitation of accessible physical purview of human. So-called **relative limitation of accessible physical purview of human**, in simple words, is just relative accessible impression about universal existence & motion upon human biologic function under normal existent status of human in cosmos. Of course, as observer in cosmos, as our existent status can be slightly variable, there is tiny variable range of general physical purview of human for relativity domino effect proportionably. For instance, you observe cosmos standing on the earth and observe the cosmos in a flying plane, there must be slight difference of physical purview of cosmos before you.

2. Physical accessibility limitation of humanistic function of scientific experiment due to practical feasibility & possibility in proportion to contemporaneous historical background.

As limitation of biologic function of human, limitation of idiographic general physical purview of human is generally as below:

①. **Relativity limitation of accessible physical purview of human**, —in terms of general existence & motion in cosmos, it's only possible for human to perceive general existence & motion in cosmos a relative intuitive impression human standing on the earth in general motion situation as the earth itself in cosmos.

As domino effect of spacetime dynamic assimilation, in terms of any observer in cosmos, if his absolute moving speed is closer to time dynamic speed, the cosmic contents he can perceive are relatively less, once the absolute moving speed of the observer equals to time dynamic speed, the physical purview of the observer is consequently limited in one "ideal line", besides self-existence in mind, the observer can perceive nothing else in cosmos. Even as no reference is accessible, there is even no way for the observer to perceive whether he is stationary or moving in some certain speed. And on the contrary, the moving speed of the observer is lower compared to time dynamic speed, physical purview of the observer is relatively more substantial (**of course, any objective in cosmos is inherent moving in some certain speed, nothing in cosmos can be absolutely stationary**)

The relative comic status quo that human practically perceived depends on the absolute speed of the earth moving in spacetime, although, we can of course perceive existence of the cosmos in flying plane or rocket, which can slightly change our physical purview of cosmos proportionably. As the speed of plane or rocket is apparently low relative to absolute speed of the earth in spacetime, the variation of the proportionable relativity domino effect is really tiny, so we can approximately conclude that the cosmic physical purview of human is almost constant once human observe the cosmos standing on the earth.

The subaudition is that, once we stand on another planet whose moving speed in spacetime is obviously different from the earth and observe the cosmos, our physical purview of cosmos must be different. For instance, we let Hubble telescope run in synchronous orbit of Mars and observe cosmos at the volley, then, the relative physical purview of cosmos A Hubble telescope perceived must be slightly different from the relative physical purview of cosmos B Hubble telescope perceived in synchronous orbit of earth.

As the space radiation cornu human can perceive standing on the earth is " π ", so we just call the relative physical purview accessible to human standing on the earth "human physical purview of π spacetime".

②. **Relativity limitation of accessible physical purview of human towards intelligent apperception & exploration of microcosmos in both space and time**, there is no way for effective physical purview of human

As coherent natura naturans throughout cosmic evolution, instinctive PNT reciprocal equilibrium towards optimum PNT operation is radical potentiality & conditionality for cosmos always ready to orientate itself towards perfection.

to approach “infinitesimal dimension” and “infinitesimal interval” in microcosmos.

Human perception of external existence depends on physical interaction between external physical information and biologic sense of human, we call the physical interaction between external physical information and biologic sense of human “**biologic perception interaction**”.

“**Biologic perception interaction**” is of course solid physical process in cosmos, the validity and sensitivity of biologic perception interaction not only depends on interaction strength of biologic perception interaction but also depends on interaction interval of biologic perception interaction. If the interaction strength of biologic perception interaction is too weak, human must be proportionably insensitive to the proper external existence; if the interaction interval of biologic perception interaction is too transitory, human must be proportionably insensitive to the proper external existence.

Virtually, the mathematical quantification of “Biologic perception interaction” is really similar as mathematical definition of impulse: $P=F*T$, the impulse object received “P” equals to the force F working on object multiplies the time the force working on object T.

If we denote the physical effect of biologic perception interaction δ , denote the biologic perception interaction strength β , and denote the time biologic perception interaction lasts T, then, we can arrive at mathematical equation of physical effect of biologic perception interaction as below:

$$\delta = \beta * T$$

The physical effect of biologic perception interaction δ equals to the biologic perception interaction strength β multiplies the time biologic perception interaction lasts T.

The interaction strength of biologic perception interaction between field genic units and human sense is infinitesimal weak, and the interaction interval of biologic perception interaction is infinitesimal short, it’s almost impossible for human to perceive idiographic existence of discretionary field genic unit in spacetime. And virtually, the biologic perception interaction between field genic units and human body is just the physical effect time works on human body, which makes human body incarnate physical attribute of matter itself, as a result, there is no way for human to perceive distinctive existence of discretionary genic units in space field.

In fact, any object in cosmos, if the mass of it is more tiny relative to field genic units, the moving speed of the object is relatively closer to time dynamic speed, and the existent modality of the object is relatively closer to field genic units in spacetime, it’s more difficult for human to perceive perfect existence & motion of the very object. And virtually, such kind of objects mostly exhibit probable existence in general physical purview of human.

Scientific experiment usually introduces objective normal existence & motion as specimen to reflect or incarnate the physical regularity or physical result of objective existence & motion (including experimental involvement of human sense). As coordinative involvement of matter itself without necessary reference contrast, scientific experiment can only highlight related physical quantitative change in general physical purview of human on the basis of rational groundwork of temporal humanistic definition of related basic dimensions, which of course implies:

- A. Before arriving at the proper definite basic dimensions, there is no way for us to manage definite measuring action, no more measuring results.
- B. If the definition of basic dimensions of some certain ideological system under contemporaneous historical background does not tally with objective authenticity of nature, the resultant measurement and calculation must be at variance. For instance, live definition of time is virtually “normative motion reference” available around, but not authentic time itself in the nature.

Historical progress of science in the recent several centuries seemed like a far-flung exploration of the first itinerary around numerous distinctive landscapes of brand-new landmasses of science with palette & tablet on back, several hundred years’ scientific travelogues were compiled thereby.

Above situation of course indicates:

As coordinative involvement of matter itself without necessary reference contrast and relativity limitation of accessible physical purview of human towards intelligent apperception & exploration of authenticity of nature, there is no way for human to practically perceive idiographic existence of any independent field genic unit in spacetime by experimental practice.

As coordinative involvement of matter itself without necessary reference contrast and relativity limitation of accessible physical purview of human towards intelligent apperception & exploration of authenticity of nature, there is no way for human to practically perceive idiographic existence of space by experimental practice.

As coordinative involvement of matter itself without necessary reference contrast and relativity limitation of accessible physical purview of human towards intelligent apperception & exploration of authenticity of nature, there is no way for human to practically perceive idiographic existence of time by experimental practice.

As coordinative involvement of matter itself without necessary reference contrast and relativity limitation of accessible physical purview of human towards intelligent apperception & exploration of authenticity of nature, there is no way for human to practically perceive what's matter by experimental practice.

As coordinative involvement of matter itself without necessary reference contrast and relativity limitation of accessible physical purview of human towards intelligent apperception & exploration of authenticity of nature, there is no way for human to practically perceive idiographic existence of the so-called God Particles (which is virtually the field genic origin i_0 on standpoint of Homogenous Cosmos Originated from Unique Genesis) by experimental performance, no more to perceive idiographic existence of the so-called God Particle by particle collision, unless human can stop time in cosmos. After all, in time current, any idiographic existence of discretionary field genic unit can never appear as perceivable objective in general physical purview of human, no more Higgs particle/God Particle (which is virtually the field genic origin i_0 on standpoint of Homogenous Cosmos Originated from Unique Genesis).

③. It's only possible for experiment & measurement to be implemented under temporal sense of humanistic definition of basic dimensions in the nature of things.

Before cosmic evolution approaching absolutely steady-going situation, there is neither normal length, normal time, nor normal right-angle reference frame. Under precondition the basic issues as what's space, what's time have not been definitely clarified and defined, we have to admit the so-called experiment and measurement are but improvisational practice under temporal sense of spacetime.

At present, it seems popular practice of scientific experiment has no intention that implementation of experiment & measurement is necessary to clarify "what space is" and "what time is" in prior. For instance, once we involve practice of experiment & measurement, right-angle reference frame is mostly used as almighty reference frame for location of discretionary existence & motion in cosmos, no matter what kind of environment the objective moves in, no matter what's the motion situation of the objective. "Time" is always something out of the motion system, no matter what kind of environment the objective moves in, no matter what's the motion situation of the objective, time quantity is always the motion amount of the clock which is always in our pocket.

However, on standpoint of Homogenous Cosmos Originated from Unique Genesis, physical notion of time which human introduce at present is virtually "normative motion reference", for examples, the revolution earth going around the sun, rotation of the earth, periodic vibration of crystal etc. All theses typical model of normative motion references are subject to definition equation of absolute spacetime momentum of matter in spacetime.

$$m_c V_c = d(M \leftarrow m) Y \quad \longleftrightarrow \quad V_c = d(M \leftarrow m) Y / m_c$$

(In the equation m_c denotes the mass of the clock; V_c denotes the velocity of the clock)

As coherent natura naturans throughout cosmic evolution, instinctive PNT reciprocal equilibrium towards optimum PNT operation is radical potentiality & conditionality for cosmos always ready to orientate itself towards perfection.

Once we come to measure light speed in vacuum under rational background of time notion like this, we can of course approach conclusion that light speed in vacuum is constant.

In accordance with definition of absolute spacetime momentum $mV=d(M \leftarrow m)Y$, when the “m” in equation denotes the mass of a photon, the “V” in equation just denotes the light-speed. That’s to say, in accordance with definition of absolute spacetime momentum $mV=d(M \leftarrow m)Y$, light-speed C can still be expressed as below:

$$m * C = d(M \leftarrow m)Y \quad \longleftrightarrow \quad C = d(M \leftarrow m)Y / m$$

Once we practically come to measure light speed in vacuum, no matter what kind of standard reference of motion we virtually choose, our measurement result is but relative ratio light motion in vacuum over standard reference of motion, which can be formulated as below:

Of course, the displacement a photon transmitted in certain natural interval T is as below:

$$C * T = d(M \leftarrow m)Y * T / m_p$$

And the “time” the clock practically recorded in certain natural interval T in spacetime is virtually just the displacement the clock performed by its connatural motion too, so that we can express the recorded time quantity as below:

$$V_c * T = d(M \leftarrow m)Y * T / m_c$$

According to our conventional definition of light-speed $C_T = S/t$, apparently, in this equation, S is the displacement the photon transmitted in the certain interval T, and ‘t’ is the displacement the clock performed in the same interval T too, just as below:

$$S = C * T = d(M \leftarrow m)Y * T / m_p \quad t = V_c * T = d(M \leftarrow m)Y * T / m_c$$

Substitute the two equations above into conventional definition equation $C_T = S/t$, we then arrive at:

$$\begin{aligned} C_T &= C * T / V_c * T = C / V_c \\ &= [d(M \leftarrow m)Y / m_p] / [d(M \leftarrow m)Y / m_c] \\ &= m_c / m_p \end{aligned}$$

This of course indicate, during the course of our practical measure, if magnitude of m_c/m_p is variable, we must find light-speed variable therefore, if not, we must find light-speed is constant going without saying.

However, if we just keep the both clock and photon naturally motioning as themselves in generally similar spacetime condition, the magnitude of both m_c and m_p will strictly vary in accordance with law of identity due to common essentiality of matter in spacetime. As a result, the quotient of m_c/m_p always keep constant, we are straightforwardly led to conclusion that light-speed in vacuum is constant therefore.

Even if there is tiny discrepancy in external spacetime conditions of clock and photon, as their uniform essentiality of matter which radically predestines the common dynamic regularity of existence & motion, it’s still accessible for us to approach conclusion that light-speed is constant in so-called vacuum. What’s more, traditionary sciences never think that so-called “vacuum” still has inherent physical connotation which makes it vivid like itself, no more think that so-called vacuum is but special coordinative homology of photons in cosmic homogeneity system, there may be even remarkable disparity of inherent physical connotation of so-called vacuum in different spacetime in cosmos. As a result, once photons transmit in vacuum with remarkable disparity of inherent physical connotation in different spacetime in cosmos, the light speed may be different accordingly.

Virtually, in homogenous cosmos, since discretionary object in cosmos is originated from unique genesis i_0 , nothing can be absolutely constant throughout homogenous cosmos, unless the evolution of homogenous cosmos suddenly turn into deadly freeze through and through.

Further, on the standpoint of natura naturans, authenticity of nature or physical regularity can only be inherent masterpiece of the demiurge, experimental performance is but ready for accessible facility & possibility of rational perception. In the early stage of historical progress of science, as poor backup of necessary groundwork, in the face of the brand-new objective, rational comprehension of brand-new objective usually depends on more biologic perception of related experimental performance. This of course implies, in the face of the accessible information offered by experimental performance, as historical limitation, what we had ever implemented may be not all we had ever perceived then and there.

Whereas, we have to admit, what we had ever perceived is of course more substantial than what we had ever implemented. After all, experimental performance is always ready for facility & possibility of rational perception, rational perception for scientific comprehension or demonstration is direct target of experimental performance. What's more, as coordinative involvement of matter in experiment, it's only possible for scientific experiment to highlight ideographic physical regularity and natural consequence of objective physical process under rational background of definite humanistic definition of basic dimensions.

In the recent 20 years, I met snub and attack many times when I contributed to related journals, most of the editors insisted that Homogenous Cosmos Originated from Unique Genesis lacked necessary experimental support. Virtually, as timely renovation of humanistic ideology about authenticity of nature in proportion to contemporaneous historical background of remarkable highlight of microcosmic configuration of matter, remarkable highlight of microcosmic configuration of matter is of course factuality with support of millions of scientific experiments, and it's just the millions of scientific experiments which brought out substantial headspring for Homogenous Cosmos Originated from Unique Genesis to pioneer cosmos redefinition with consequent PNT dynamics about universal existence & motion in the nature of coherent natura naturans throughout cosmic evolution. My job is but straightforward endeavor to generalize the factuality that **discretionary particles in cosmos are mutually convertible** into **Homogenous cosmos originated from unique genesis postulate**, and then expanded the logic connotation of it with supplementation of two accessorial postulates. In another words, in accordance with the factuality that discretionary particles in cosmos are mutually convertible in orientation towards complete induction day by day, I implemented two pioneering actions as below:

The first, I introduced **Homogenous cosmos originated from unique genesis postulate** in accordance with the newly highlighted factuality that **discretionary particles in cosmos are mutually convertible**.

The second, I expanded the logic connotation of **Homogenous cosmos originated from unique genesis postulate** with supplementation of two 0.5 grade accessorial postulates. As introduction of the first accessorial postulate of **spacetime~matter fully embodying cosmos postulate**, on the basis of "homogenous cosmos originated from unique genesis + spacetime~matter fully embodying cosmos", it accomplished connotation objectification of homogenous cosmos originated from unique genesis, and with supplementation of the second accessorial postulate of **Instinctive PNT equilibrium postulate**, it accomplished further freewheeling logic extension of connotation objectification of homogenous cosmos originated from unique genesis, so that it arrived at cosmos redefinition with consequent PNT dynamics about universal existence & motion in the nature of coherent natura naturans throughout cosmic evolution..

As coherent natura naturans throughout cosmic evolution, instinctive PNT reciprocal equilibrium towards optimum PNT operation is radical potentiality & conditionality for cosmos always ready to orientate itself towards perfection.

As timely renovation of humanistic ideology about authenticity of nature in proportion to contemporaneous historical background of **practice transition from macrophysics to microphysics**, it's only necessary for proportionate commensurate scientific authentication of Relativity and Quantum Theory to be compatible with the commensurate microcosmic experience of human. Taking reference of historical authenticity tolerance of science of humanistic ideology about authenticity of nature in proportion to contemporaneous historical background and in accordance with experiential estimation that acceptable historical authenticity tolerance of proportionate commensurate scientific authentication is generally equivalent or bigger than **historical authenticity tolerance of science of humanistic ideology about authenticity of nature in proportion to contemporaneous historical background** but less than **[historical authenticity tolerance of science of humanistic ideology about authenticity of nature in proportion to contemporaneous historical background $\times (1 + 20\%)$]**, if we estimate historical authenticity tolerance of science of Relativity and Quantum Theory is 0.03, then, the acceptable historical authenticity tolerance of proportionate commensurate scientific authentication of Relativity and Quantum Theory is [0.03, 0.036).

Whereas, as timely renovation of humanistic ideology about authenticity of nature in proportion to contemporaneous historical background of **remarkable highlight of microcosmic configuration of matter**, connotation objectification and further freewheeling logic extension of homogenous cosmos originated from unique genesis has made the proportionate commensurate scientific authentication of Homogenous Cosmos Originated from Unique Genesis much more difficult. Taking reference of historical authenticity tolerance of science of humanistic ideology about authenticity of nature in proportion to contemporaneous historical background and in accordance with experiential estimation that acceptable historical authenticity tolerance of proportionate commensurate scientific authentication is generally equivalent or bigger than **historical authenticity tolerance of science of humanistic ideology about authenticity of nature in proportion to contemporaneous historical background** but less than **[historical authenticity tolerance of science of humanistic ideology about authenticity of nature in proportion to contemporaneous historical background $\times (1 + 20\%)$]**, if we estimate historical authenticity tolerance of science of Homogenous Cosmos Originated from Unique Genesis is 0.015, then, the acceptable historical authenticity tolerance of proportionate commensurate scientific authentication of Relativity and Quantum Theory is [0.015, 0.018).

“History” can only be in the nature of “practice” for ever.

The practical feasibility & possibility in proportion to contemporaneous historical background of original naissance of Heliocentric Theory was not only sufficient to expose nonsense of Geocentric Theory, but also enough to make the relative objectivity of Heliocentric Theory self-evident. Such practical feasibility & possibility of the age in crecive progression of historical progress of science was all wool and a yard wide then and there.

The practical feasibility & possibility in proportion to contemporaneous historical background of original naissance of Newtonian Mechanics was not only sufficient to expose nonsense of Aristotle Theory, but also enough to make the relative objectivity of Newtonian Mechanics intelligently acceptable all over the world. Such practical feasibility & possibility of the age in crecive progression of historical progress of science was all wool and a yard wide then and there.

... ..

The practical feasibility & possibility in proportion to contemporaneous historical background of original naissance of Relativity & Quantum Theory was not only sufficient to expose historical limitation of Newtonian

Historical progress of science in the recent several centuries seemed like a far-flung exploration of the first itinerary around numerous distinctive landscapes of brand-new landmasses of science with palette & tablet on back, several hundred years' scientific travelogues were compiled thereby.

Mechanics, but also enough to make the relative objectivity of Relativity & Quantum Theory intelligently acceptable all over the world. Such practical feasibility & possibility of the age in crecive progression of historical progress of science was all wool and a yard wide then and there.

.....

However, quantitative & qualitative change of practical feasibility & possibility in proportion to contemporaneous historical background extending to today, although, remarkable highlight of microcosmic configuration of matter has apparently highlighted the homogenous profile of cosmos, which of course has brought out substantial potentiality for timely renovation of ideology about authenticity of nature in proportion to contemporaneous historical background as typical cosmos redefinition in radical logic enantiomorph of newly highlighted factuality that **discretionary particles in cosmos in cosmos are mutually convertible**, practical validity of scientific experiment gradually approaches upper limit of accessible physical purview of human, nowadays scientific experiment is not only difficult to expose a fly in the ointment of contemporaneous scientific orthodoxy but also difficult to validate timely renovation of ideology about authenticity of nature in proportion to contemporaneous historical background of remarkable highlight of microcosmic configuration of matter. What's more, as inherent limitation of practical feasibility & possibility of human, it's only possible for human to implement relative measurement, there is no practical feasibility & possibility for human to consummate absolute measurement.

And indeed, as pioneering implementation of **connotation objectification and further freewheeling logic extension of homogenous cosmos originate from unique genesis**, scientific experiment is really difficult to make rational conceptions as **space field, time dynamic speed, positive & negative transmutation etc** self-evident all over the world, which are almost impossible for practical implementation of connotation objectification and freewheeling logic extension of homogenous cosmos originated from unique genesis to shy away. After all, once we try to implement connotation objectification of homogenous cosmos originated from unique genesis, we completely have no reason to exclude hypostatic "spacetime" in cosmic homogeneity system through and through. What's more, as high-sounding popularity of royal substantiation and perfection of contemporaneous scientific orthodoxy in the recent one century, live authoritative intrepidity of contemporaneous scientific orthodoxy is always all-time and overwhelming with unprecedented official facility of magistral autarchy of free press regulation customization and free press admittance short of necessary intendance, which straightforward demarcates living scientific knowledge proliferation in rigid succession of contemporaneous scientific orthodoxy with remarkable official glory of contemporaneous scientific orthodoxy, but apparently aberrant from endeavor of veritable progress of science to push humanistic ideology about authenticity of nature forward to perfect ideological enantiomorph of ultimate authenticity of nature draw on practical feasibility & possibility in proportion to contemporaneous historical background.

This is just inevitable humanistic perplexity of historical progress of science in inherent optimum orientation towards perfect ideological enantiomorph of ultimate authenticity of nature in final extremity situation under permanent synthesized conditionality of **"crecive progression of practical feasibility & possibility in proportion to contemporaneous historical background + the uniqueness & invariance of ultimate authenticity of nature predestines the unique possibility of scientific verity as perfect ideological enantiomorph of ultimate authenticity of nature"** through and through.

Aug. 2015, Nanxing-Dani-Shatian-Dongguan

(VII-v) Humanistic ideology about authenticity of nature in proportion to contemporaneous historical background and proportionate commensurate scientific authentication

Abstract: *My intention to mention the humanistic ideology about authenticity of nature in proportion to contemporaneous historical background and proportionate commensurate scientific authentication herein is ready to highlight the objectivity of coordinative reciprocal quantitative & qualitative change of humanistic ideology about authenticity of nature in proportion to contemporaneous historical background and proportionate commensurate scientific authentication throughout historical progress of science that historical authenticity tolerance of proportionate commensurate scientific authentication of humanistic ideology about authenticity of nature in proportion to contemporaneous historical background which exists as live contemporaneous scientific orthodoxy \geq historical authenticity tolerance of science of humanistic ideology about authenticity of nature in proportion to contemporaneous historical background which exists as live contemporaneous scientific orthodoxy, and once historical authenticity tolerance of science of proportionate commensurate scientific authentication in proportion to contemporaneous historical background which exists as live contemporaneous scientific orthodoxy $<$ historical authenticity tolerance of science of live humanistic ideology about authenticity of nature in proportion to contemporaneous historical background which exists as live contemporaneous scientific orthodoxy, it indicates practical accomplishment of solid potentiality for successive renovation of humanistic ideology about authenticity of nature in proportion to contemporaneous historical background for positive historical progress of science in inherent optimum orientation towards historical authenticity tolerance of science 0.*

Virtually, as reciprocal couple, successive reciprocal quantitative & qualitative change of humanistic ideology about authenticity of nature in proportion to contemporaneous historical background and proportionate commensurate scientific authentication not only proportionably brings out the parallel succession of quantitative & qualitative change of practical feasibility & possibility for scientific knowledge proliferation, but also radically accomplishes historical progress of science in inherent optimum orientation towards historical authenticity tolerance of science 0.

Special nouns & items: *humanistic ideology about authenticity of nature in proportion to contemporaneous historical background, proportionable contemporaneous scientific authentication.*

1. As inherent reciprocal couple, successive quantitative change of “humanistic ideology about authenticity of nature in proportion to contemporaneous historical background” and “proportionate commensurate scientific authentication” brings out parallel succession of historical progress of science in inherent optimum orientation towards historical authenticity tolerance of science 0.

Since ultimate authenticity of nature can be neither omnifarious authenticity smallwares full of a basket nor authenticity chameleon one piece and only but coherent natura naturans throughout cosmic evolution, as commensurate ideological enantiomorph of accessible existence & motion around us, ultimate consummation of science must be perfect ideological enantiomorph of ultimate authenticity of nature, veritable progress of science is not intuitional cumulative achievement of colorful scientific travelogues A, B, C, D, E, F, ... as deserving reward of the first itineracy around preternatural landscapes of brand-new landmasses of science

like omnifarious smallwares full of a basket but successive hypostatic endeavor to push humanistic ideology about authenticity of nature forward to perfect ideological enantiomorph of ultimate authenticity of nature step by step draw on practical feasibility & possibility in proportion to contemporaneous historical background.

And as permanent synthesized conditionality of “**crecive progression of practical feasibility & possibility in proportion to contemporaneous historical background + the uniqueness & invariance of ultimate authenticity of nature predestines the unique possibility of scientific verity as perfect ideological enantiomorph of ultimate authenticity of nature**” through and through, it's only possible for the major melody of historical progress of science to be a series of epochmaking scientific knowledge metabolism in inherent optimum orientation towards historical authenticity tolerance of science 0, historical extension of the gradational series of epochmaking scientific knowledge metabolism in inherent optimum orientation towards historical authenticity tolerance of science 0 will continue to ultimate consummation of science that “humanistic ideology about authenticity of nature” finally tallies with ultimate authenticity of nature 100 over 100 as perfect ideological enantiomorph of ultimate authenticity of nature. And before humanistic ideology about authenticity of nature finally qualified as perfect ideological enantiomorph of ultimate authenticity of nature, it's only possible for so-called “science” to be **commensurate ideological system about authenticity of nature in proportion to contemporaneous historical background** in crecive progression of historical progress of science in inherent optimum orientation towards perfect ideological enantiomorph of ultimate authenticity of nature, and followed the quantitative change of practical feasibility & possibility for development of science, humanistic ideology about authenticity of nature in proportion to contemporaneous historical background must exist in succession of timely scientific knowledge metabolism all along, which virtually brings out historical progress of science in inherent optimum orientation towards historical authenticity tolerance of science 0 or perfect ideological enantiomorph of ultimate authenticity of nature.

That's to say, practical accomplishment of historical progress of science in inherent optimum orientation towards historical authenticity tolerance of science 0 is but substantial process that quantitative change of crecive progression of practical feasibility & possibility in proportion to contemporaneous historical background cause proportionate accomplishment that humanistic ideology about authenticity of nature gradually approaches perfect ideological enantiomorph of ultimate authenticity of nature. The general operation of historical progress of science is that, succeeding the practical feasibility & possibility in proportion to contemporaneous historical background, it proportionably accomplish humanistic ideology about authenticity of nature in proportion to contemporaneous historical background, which of course implies humanistic ideology about authenticity of nature in proportion to contemporaneous historical background can never come into being groundlessly, it must succeed practical feasibility & possibility in proportion to contemporaneous historical background, whose idiographic ideological connotation about authenticity of nature mostly roots in the contemporaneous historical background.

And at the same time, in order to procure social legitimacy qualification of the age, any humanistic ideology about authenticity of nature in proportion to contemporaneous historical background must get the necessary proportionate commensurate scientific authentication then and there. The historical validity of proportionate commensurate scientific authentication is that, in accordance with the logic connotation of humanistic ideology about authenticity of nature in proportion to contemporaneous historical background, it must manage credible probative action so as to validate the enantiomorphous compatibility between accessible objective authenticity of

nature and the live humanistic ideology about authenticity of nature in proportion to contemporaneous historical background.

Of course, the practical implementation & validity of proportionate commensurate scientific authentication of humanistic ideology about authenticity of nature in proportion to contemporaneous historical background is restricted by practical feasibility & possibility in proportion to contemporaneous historical background too, even as the practical requirement of implementation of proportionate commensurate scientific authentication is more rigorous than generation of humanistic ideology about authenticity of nature in proportion to contemporaneous historical background, historical authenticity tolerance of science of proportionate commensurate scientific authentication can approach historical authenticity tolerance of science of live humanistic ideology about authenticity of nature in proportion to contemporaneous historical background as much as possible, whereas, it's almost impossible for historical authenticity tolerance of science of proportionate commensurate scientific authentication to be even less than historical authenticity tolerance of science of humanistic ideology about authenticity of nature in proportion to contemporaneous historical background.

In fact, throughout historical progress of science, as inherent reciprocal couple, reciprocal quantitative & qualitative change of humanistic ideology about authenticity of nature in proportion to contemporaneous historical background and proportionate commensurate scientific authentication along intrinsic progression of historical progress of science not only accomplish the parallel quantitative & qualitative change of practical feasibility & possibility in proportion to contemporaneous historical background but also accomplish the hypostatic historical progress of science in inherent optimum orientation towards historical authenticity tolerance of science 0, which of course indicates, as long as there is active social endeavor for development of science, presence of practical feasibility & possibility in proportion to contemporaneous historical background will of course cause naissance of humanistic ideology about authenticity of nature in proportion to contemporaneous historical background by the light of nature, and subsequently, there must be proportionate commensurate scientific authentication of the live humanistic ideology about authenticity of nature for validation of enantiomorphous compatibility between live humanistic ideology about authenticity of nature in proportion to contemporaneous historical background and accessible objective authenticity of nature. Once the historical authenticity tolerance of science of proportionate commensurate scientific authentication is even less than historical authenticity tolerance of science of live humanistic ideology about authenticity of nature in proportion to contemporaneous historical background, it indicates there has been substantial potentiality of practical feasibility & possibility in proportion to contemporaneous historical background for successive renovation of humanistic ideology about authenticity of nature in proportion to contemporaneous historical background.

Quantitative change of practical feasibility & possibility in proportion to contemporaneous historical background proportionably brings out historical progress of science in inherent optimum orientation towards historical authenticity tolerance of science 0. As reciprocal parallel quantitative change couple of essentials of historical progress of science, the quantitative change of humanistic ideology about authenticity of nature in proportion to contemporaneous historical background and proportionate commensurate scientific authentication is generally parallel to quantitative change of historical authenticity tolerance of science of historical progress of science.

2. Proportionate commensurate scientific authentication of humanistic ideology about authenticity of nature in proportion to contemporaneous historical background.

Historical progress of science in the recent several centuries seemed like a far-flung exploration of the first itinerary around numerous distinctive landscapes of brand-new landmasses of science with palette & tablet on back, several hundred years' scientific travelogues were compiled thereby.

2.1. Analysis of reciprocal quantitative change of “humanistic ideology about authenticity of nature in proportion to contemporaneous historical background” and “proportionable contemporaneous scientific authentication” along historical progress of science in inherent optimum orientation towards historical authenticity tolerance of science 0.

So-called proportionate commensurate scientific authentication is but common scientific practice that, in accordance with scientific connotation of humanistic ideology about authenticity of nature in proportion to contemporaneous historical background, it invokes the proper external existence & motion as specimen to perform the corresponding physical process to prove and validate the enantiomorphous compatibility between humanistic ideology about authenticity of nature in proportion to contemporaneous historical background and accessible objective authenticity of nature.

As practical validation of humanistic ideology about authenticity of nature in proportion to contemporaneous historical background, the historical reliability and preciseness of proportionate commensurate scientific authentication can be scaled by historical authenticity tolerance of science.

On one hand, as the practical validation operation of proportionate commensurate scientific authentication must be designed in accordance with scientific connotation of live humanistic ideology about authenticity of nature in proportion to contemporaneous historical background, and it must be performed and evaluated under the common historical background; and on the other hand, the practical difficulty of proportionate commensurate scientific authentication is relatively higher than original generation of humanistic ideology about authenticity of nature in proportion to contemporaneous historical background, as a result, the historical authenticity tolerance of science of proportionate commensurate scientific authentication can never be even less than historical authenticity tolerance of science of live humanistic ideology about authenticity of nature in proportion to contemporaneous historical background, which can be expressed as below:

Historical authenticity tolerance of science of humanistic ideology about authenticity of nature in proportion to contemporaneous historical background \leq Historical authenticity tolerance of science of proportionate commensurate scientific authentication

In fact, as practical validation of humanistic ideology about authenticity of nature in proportion to contemporaneous historical background, the best situation of historical authenticity tolerance of science of proportionate commensurate scientific authentication is to approach historical authenticity tolerance of science of humanistic ideology about authenticity of nature in proportion to contemporaneous historical background as possible as it practically can do, the closer the historical authenticity tolerance of science of proportionate commensurate scientific authentication is to historical authenticity tolerance of science of humanistic ideology about authenticity of nature in proportion to contemporaneous historical background, the validation effect of proportionate commensurate scientific authentication to humanistic ideology about authenticity of nature in proportion to contemporaneous historical background is better.

Whereas, the historical authenticity tolerance of science of proportionate commensurate scientific authentication can never be even less than historical authenticity tolerance of science of humanistic ideology about authenticity of nature in proportion to contemporaneous historical background. Once the historical authenticity tolerance of science of proportionate commensurate scientific authentication is even less than historical authenticity tolerance of science of humanistic ideology about authenticity of nature in proportion to contemporaneous historical background, it indicates there has been brand-new potentiality of practical feasibility & possibility for successive necessary renovation of humanistic ideology about authenticity of nature in proportion to contemporaneous

As coherent natura naturans throughout cosmic evolution, instinctive PNT reciprocal equilibrium towards optimum PNT operation is radical potentiality & conditionality for cosmos always ready to orientate itself towards perfection.

historical background.

Throughout historical progress of science, none pioneering scientific knowledge can come into being without foundation, there is usually proportionate potentiality of practical feasibility & possibility for necessary renovation of humanistic ideology about authenticity of nature in proportion to contemporaneous historical background. And as permanent synthesized conditionality of “**crecive progression of practical feasibility & possibility in proportion to contemporaneous historical background + the uniqueness & invariance of ultimate authenticity of nature predestines the unique possibility of scientific verity as perfect ideological enantiomorph of ultimate authenticity of nature**” through and through, the successive quantitative change of practical feasibility & possibility must proportionably bring out humanistic ideology about authenticity of nature closer and closer to perfect ideological enantiomorph of ultimate authenticity of nature so as to accomplish historical progress of science in inherent optimum orientation towards historical authenticity tolerance of science 0. living quantitative change of practical feasibility & possibility in proportion to contemporaneous historical background not only can enhance timely renovation of humanistic ideology about authenticity of nature in inherent optimum orientation towards historical authenticity tolerance of science 0 day by day, but also can negate forgone orthodoxy more and more explicitly.

As humanistic ideology about authenticity of nature in proportion to contemporaneous historical background, Aristotle Theory came into being in BC 4 century in Greece, and it procured necessary proportionate commensurate scientific authentication for social legitimacy qualification under the common historical background. As practical feasibility & possibility in proportion to contemporaneous historical background, the proportionate commensurate scientific authentication of Aristotle Theory was mostly limited in superficial validation upon intuitionistic experience of people, the historical authenticity tolerance of science of superficial validation upon intuitionistic experience of people was mostly bigger than historical authenticity tolerance of science of Aristotle Theory. Before Galileo showed people the objective factuality that two iron balls starting at the same height always fall onto the earth just the same time, Aristotle Theory had ever conquered intuitionistic experience of millions of people, which was of course a great theory passed solid validation of intuitionistic experience of millions of people with lifespan near 2000 years.

Whereas, as incremental quantitative & qualitative change of practical feasibility & possibility along historical progress of science in inherent optimum orientation towards perfect ideological enantiomorph of ultimate authenticity of nature, once quantitative & qualitative change of practical feasibility & possibility was sufficient for Galileo to show people the objectivity that, starting at the same height, two iron balls always fall onto the earth just the same time, timely renovation of humanistic ideology about authenticity of nature in proportion to contemporaneous historical background occurred thereby.

This was not only distinctive humanistic ideology about authenticity of nature in proportion to contemporaneous historical background but also remarkable progressive accomplishment of hypostatic quantitative & qualitative change of historical progress of science in inherent optimum orientation towards perfect ideological enantiomorph of ultimate authenticity of nature.

As humanistic ideology about authenticity of nature in proportion to contemporaneous historical background, Geocentric Theory came into being in A.D. 2 century in Greece, and it procured necessary proportionate commensurate scientific authentication for social legitimacy qualification under the common historical background. As practical feasibility & possibility in proportion to contemporaneous historical background, the proportionate

Historical progress of science in the recent several centuries seemed like a far-flung exploration of the first itinerary around numerous distinctive landscapes of brand-new landmasses of science with palette & tablet on back, several hundred years' scientific travelogues were compiled thereby.

commensurate scientific authentication of Geocentric Theory was mostly limited in superficial validation upon intuitionistic experience of people, the historical authenticity tolerance of science of superficial validation upon intuitionistic experience of people was mostly bigger than historical authenticity tolerance of science of Geocentric Theory. Before Copernicus showed people Heliocentric Theory, Geocentric Theory had ever conquered intuitionistic experience of millions of people, which was of course a great theory passed solid validation of intuitionistic experience of millions of people with lifespan over 1400 years.

Whereas, as incremental quantitative & qualitative change of practical feasibility & possibility along historical progress of science in inherent optimum orientation towards perfect ideological enantiomorph of ultimate authenticity of nature, once quantitative & qualitative change of practical feasibility & possibility was sufficient for Copernicus to show people the relatively progressive objectivity of Heliocentric Theory, timely renovation of humanistic ideology about authenticity of nature in proportion to contemporaneous historical background occurred thereby.

This was not only distinctive humanistic ideology about authenticity of nature in proportion to contemporaneous historical background but also remarkable progressive accomplishment of hypostatic quantitative & qualitative change of historical progress of science in inherent optimum orientation towards perfect ideological enantiomorph of ultimate authenticity of nature.

... ..

As humanistic ideology about authenticity of nature in proportion to contemporaneous historical background, Newtonian Mechanics came into being in A.D. 17 century in occident, and it procured necessary proportionate commensurate scientific authentication for social legitimacy qualification under the common historical background. As practical feasibility & possibility in proportion to contemporaneous historical background, the proportionate commensurate scientific authentication of Newtonian Mechanics was mostly limited in relatively superficial validation upon macroscopic experience of people, the historical authenticity tolerance of science of superficial validation upon commensurate macroscopic experience of people was mostly bigger than historical authenticity tolerance of science of Newtonian Mechanics. Before Einstein showed people the relatively progressive objectivity of Relativity, Newtonian Mechanics had ever conquered commensurate macroscopic experience of millions of people, which was of course a great theory passed solid validation of commensurate macroscopic experience of millions of people with lifespan near 300 years.

Whereas, as incremental quantitative & qualitative change of practical feasibility & possibility along historical progress of science in inherent optimum orientation towards perfect ideological enantiomorph of ultimate authenticity of nature, once quantitative & qualitative change of practical feasibility & possibility was sufficient for Einstein to show people the relatively progressive objectivity of Relativity, timely renovation of humanistic ideology about authenticity of nature in proportion to contemporaneous historical background occurred thereby.

This was not only distinctive humanistic ideology about authenticity of nature in proportion to contemporaneous historical background but also remarkable progressive accomplishment of hypostatic quantitative & qualitative change of historical progress of science in inherent optimum orientation towards perfect ideological enantiomorph of ultimate authenticity of nature.

As humanistic ideology about authenticity of nature in proportion to contemporaneous historical background, Relativity & Quantum Theory came into being in early years of 20th century in occident, when scientific practice of human was under remarkable implication dilatation from macrocosmos to microcosm, and the both procured necessary proportionate commensurate scientific authentication for social legitimacy qualification under the common historical background. As practical feasibility & possibility in proportion to contemporaneous historical background, the proportionate commensurate scientific authentication of Relativity & Quantum Theory was mostly limited in validation of relative compatibility to newly microcosmic experience of contemporary, the historical authenticity tolerance of science of validation of relative compatibility to newly microcosmic experience of contemporary was mostly bigger than historical authenticity tolerance of science of Relativity & Quantum Theory. Of course, in the recent one century, Relativity & Quantum Theory had conquered microcosmic experience of millions of people, which were of course great theories passed solid validation of commensurate microcosmic experience of millions of people with lifespan over 100 years.

Whereas, as incremental quantitative & qualitative change of practical feasibility & possibility along historical progress of science in inherent optimum orientation towards perfect ideological enantiomorph of ultimate authenticity of nature, as remarkable highlight of microcosmic configuration of matter, especially the factuality that discretionary particles in cosmos are mutually convertible in living orientation towards complete induction day by day, which of course indicates “remarkable highlight of homogenous profile of cosmos” and has brought out substantial background potentiality as headspring of historical progress of science for cosmos redefinition with consequent PNT dynamics about universal existence & motion in the nature of coherent natura naturans throughout cosmic evolution due to rational accomplishment of connotation objectification & freewheeling logic extension of homogenous cosmos originated from unique genesis, timely renovation of humanistic ideology about authenticity of nature in proportion to contemporaneous historical background occurred thereby.

This was not only distinctive humanistic ideology about authenticity of nature in proportion to contemporaneous historical background but also remarkable progressive accomplishment of hypostatic quantitative & qualitative change of historical progress of science in inherent optimum orientation towards perfect ideological enantiomorph of ultimate authenticity of nature.

All in all, as inherent reciprocal couple, successive quantitative & qualitative change of practical feasibility & possibility proportionably must bring out proportionate succession of humanistic ideology about authenticity of nature in proportion to contemporaneous historical background; and inversely, practical validation of any humanistic ideology about authenticity of nature in proportion to contemporaneous historical background must enhance commensurate practical feasibility & possibility for further development of science as well. Throughout historical progress of science, successive reciprocity of humanistic ideology about authenticity of nature in proportion to contemporaneous historical background and proportionate commensurate scientific authentication not only hypostatizes quantitative & qualitative change of practical feasibility & possibility in proportion to contemporaneous historical background itself, but also ultimately accomplishes realistic historical progress of science in inherent optimum orientation towards historical authenticity tolerance of science 0 by the light of nature.

Of course, for necessary credibility of proportionate commensurate scientific authentication under the general background of practical feasibility & possibility in proportion to common historical background, the historical authenticity tolerance of science of proportionate commensurate scientific authentication can not

be too rough relative to historical authenticity tolerance of science of live humanistic ideology about authenticity of nature in proportion to contemporaneous historical background, otherwise, proportionate commensurate scientific authentication due to humanistic ideology about authenticity of nature in proportion to contemporaneous historical background will not be worthy of the age for too rough and flimsy demonstration. And on the other hand, it's mostly possible for historical authenticity tolerance of proportionate commensurate scientific authentication to approach historical authenticity tolerance of science of live humanistic ideology about authenticity of nature in proportion to contemporaneous historical background but almost impossible for historical authenticity tolerance of proportionate commensurate scientific authentication to be even less than historical authenticity tolerance of science of live humanistic ideology about authenticity of nature in proportion to contemporaneous historical background.

Considering the credible necessity of proportionable contemporaneous scientific authentication, the historical authenticity tolerance of science of proportionate commensurate scientific authentication generally less than [historical authenticity tolerance of science of humanistic ideology about authenticity of nature in proportion to contemporaneous historical background $\times (1+20\%)$]. If we denote historical authenticity tolerance of science of humanistic ideology about authenticity of nature in proportion to contemporaneous historical background α , and denote historical authenticity tolerance of science of proportionate commensurate scientific authentication β , then the acceptable quantitative range of historical authenticity tolerance of science of proportionate commensurate scientific authentication can be expressed as below:

$$\beta \in [\alpha, \alpha(1+20\%))$$

The practical accomplishment of historical progress of science is virtually hypostatic process that ideological connotation of humanistic ideology about authenticity of nature in proportion to contemporaneous historical background gradually approaches ultimate authenticity of nature so as to hypostatize historical progress of science in inherent optimum orientation towards historical authenticity tolerance of science 0. We can generally illuminate the quantitative change of historical authenticity tolerance of science of historical progress of science in inherent optimum orientation towards historical authenticity tolerance of science 0 as below:

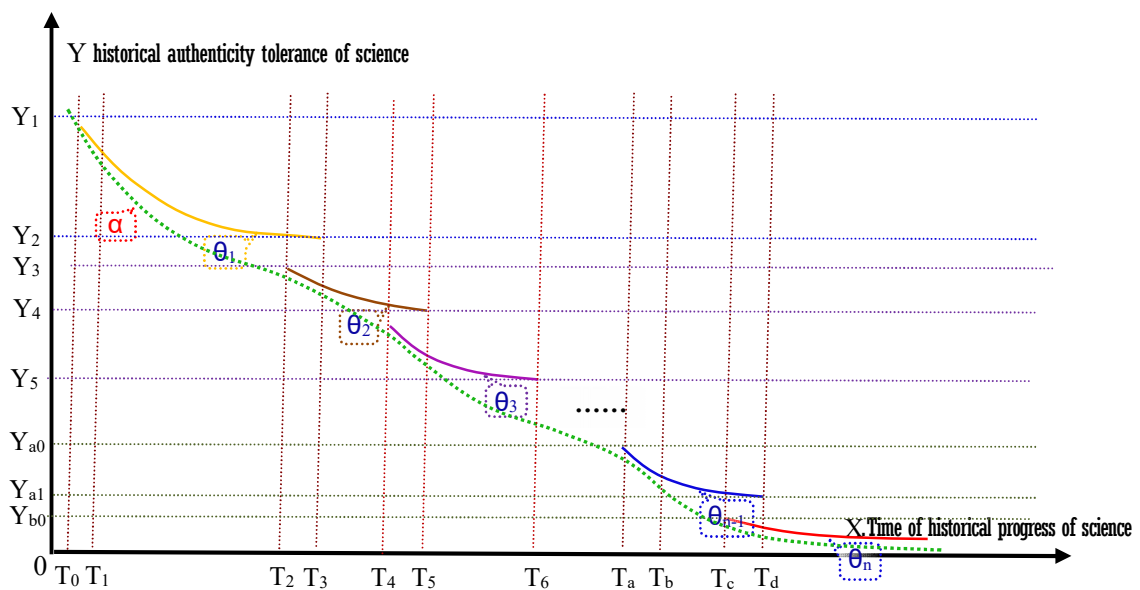

(VII-iii-1) Quantitative change curve of historical progress of science making up of successive subrogation of temporal Orthodoxies $\theta_1, \theta_2, \theta_3, \dots, \theta_{n-1}, \theta_n$ in inherent optimum orientation towards historical authenticity tolerance of science 0

As coherent natura naturans throughout cosmic evolution, instinctive PNT reciprocal equilibrium towards optimum PNT operation is radical potentiality & conditionality for cosmos always ready to orientate itself towards perfection.

In illustration above, X axis indicates time of historical progress of science, Y axis indicates value of historical authenticity tolerance of science, curve α represents the quantitative change of practical feasibility & possibility for development of science along crecive progression of historical progress of science in inherent optimum orientation towards historical authenticity tolerance of science 0. And curves as $\theta_1, \theta_2, \theta_3, \dots, \theta_{n-1}, \theta_n$ along historical progression respectively represent quantitative change of historical authenticity tolerance of science of contemporaneous scientific orthodoxy θ_1 , contemporaneous scientific orthodoxy θ_2 , contemporaneous scientific orthodoxy θ_3, \dots , contemporaneous scientific orthodoxy θ_{n-1} , contemporaneous scientific orthodoxy θ_n which come into being and implement social legitimacy metabolism one after another and make up of integrative historical progress of science through and through.

Then, the integrative layout of quantitative change of historical authenticity tolerance of science of both “humanistic ideology about authenticity of nature in proportion to contemporaneous historical background” and “proportionable contemporaneous scientific authentication” along historical progress of science in inherent optimum orientation towards historical authenticity tolerance of science 0 can be proportionately illustrated as below:

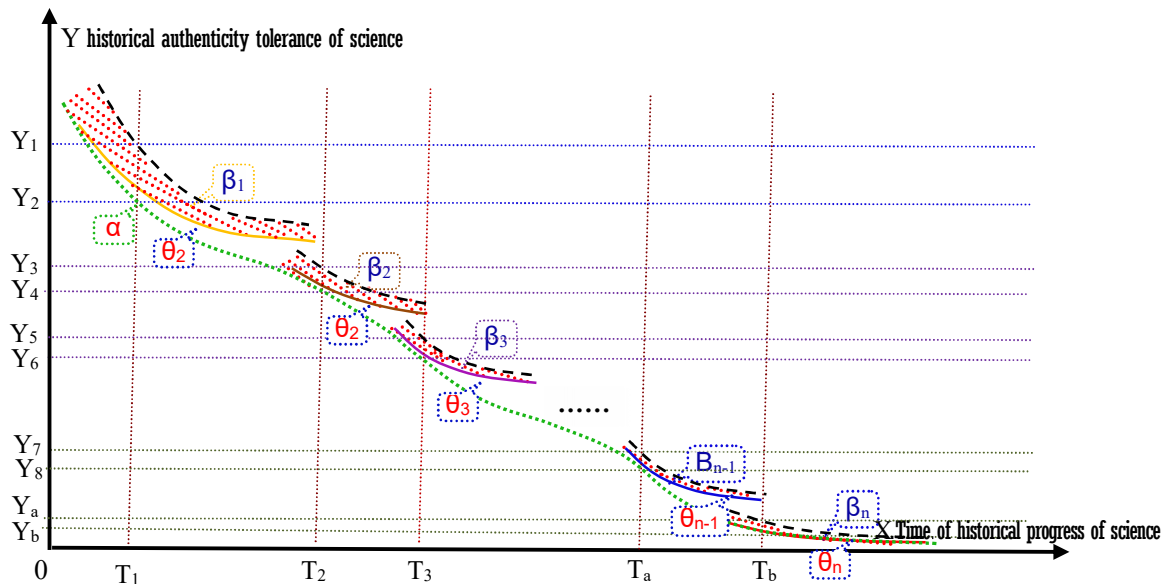

(VII-iii-2) Integrative layout of quantitative change of both “historical authenticity tolerance of science of humanistic ideology about authenticity of nature in proportion to contemporaneous historical background” and proportionate “historical authenticity tolerance of science of commensurate scientific demonstration” along historical progress of science in inherent optimum orientation towards historical authenticity tolerance of science 0

In illustration above, the black broken lines $\beta_1, \beta_2, \beta_3, \dots, \beta_{n-1}, \beta_n$ above the curves $\theta_1, \theta_2, \theta_3, \dots, \theta_{n-1}, \theta_n$ are just the acceptable upper limit curves of historical authenticity tolerance of proportionate commensurate scientific authentication of contemporaneous scientific orthodoxy θ_1 , contemporaneous scientific orthodoxy θ_2 , contemporaneous scientific orthodoxy θ_3, \dots , contemporaneous scientific orthodoxy θ_{n-1} , contemporaneous scientific orthodoxy θ_n . And the red shadow areas respectively between curves $\theta_1, \theta_2, \theta_3, \dots, \theta_{n-1}, \theta_n$ and the black broken lines above the curves $\beta_1, \beta_2, \beta_3, \dots, \beta_{n-1}, \beta_n$ are just the acceptable range of historical authenticity tolerance of science of proportionate commensurate scientific authentication of contemporaneous scientific orthodoxy θ_1 , contemporaneous scientific orthodoxy θ_2 , contemporaneous scientific orthodoxy θ_3, \dots , contemporaneous scientific orthodoxy θ_{n-1} , contemporaneous scientific orthodoxy θ_n .

Historical progress of science in the recent several centuries seemed like a far-flung exploration of the first itinerary around numerous distinctive landscapes of brand-new landmasses of science with palette & tablet on back, several hundred years’ scientific travelogues were compiled thereby.

All in all, historical progress of science is successive quantitative & qualitative change of humanistic ideology about authenticity of nature due to incremental succession of practical feasibility & possibility, before humanistic ideology about authenticity of nature finally qualified as perfect ideological enantiomorph of ultimate authenticity of nature, science is always commensurate ideological system about authenticity of nature in proportion to contemporaneous historical background with proportionate historical authenticity tolerance of science and proportionable scientific authentication, for instance:

When historical progress of science proceeds to time point T_1 , the proper acceptable historical authenticity tolerance of science of proportionate commensurate scientific authentication of humanistic ideology β_1 about authenticity of nature in proportion to contemporaneous historical background was $[Y_1, Y_1)$. If humanistic ideology β_1 about authenticity of nature in proportion to contemporaneous historical background was just **Aristotle Theory**, and if the evaluation of historical authenticity tolerance of science of Aristotle Theory was just 0.35, in accordance with the preconcerted acceptable evaluation range of historical authenticity tolerance of science $\beta \in [\alpha, \alpha(1+20\%))$, the acceptable range of historical authenticity tolerance of science of proportionate commensurate scientific authentication of Aristotle Theory was $[0.35, 0.42)$.

When historical progress of science proceeds to time point T_2 , the proper acceptable historical authenticity tolerance of science of proportionate commensurate scientific authentication of humanistic ideology β_2 about authenticity of nature in proportion to contemporaneous historical background was $[Y_3, Y_4)$. If the very humanistic ideology β_2 about authenticity of nature in proportion to contemporaneous historical background was just **Geocentric Theory**, and if the evaluation of historical authenticity tolerance of science of Geocentric Theory was just 0.25, in accordance with the preconcerted acceptable evaluation range of historical authenticity tolerance of science $\beta \in [\alpha, \alpha(1+20\%))$, the acceptable range of historical authenticity tolerance of science of proportionate commensurate scientific authentication of Geocentric Theory was $[0.25, 0.3)$.

When historical progress of science proceeds to time point T_3 , the proper acceptable historical authenticity tolerance of science of proportionate commensurate scientific authentication of humanistic ideology β_3 about authenticity of nature in proportion to contemporaneous historical background was $[Y_5, Y_6)$. If the very humanistic ideology β_3 about authenticity of nature in proportion to contemporaneous historical background was just **Heliocentric Theory**, and if the evaluation of historical authenticity tolerance of science of Heliocentric Theory was just 0.125, in accordance with the preconcerted acceptable evaluation range of historical authenticity tolerance of science $\beta \in [\alpha, \alpha(1+20\%))$, the acceptable range of historical authenticity tolerance of science of proportionate commensurate scientific authentication of Heliocentric Theory was $[0.125, 0.15)$.

... ..

When historical progress of science proceeds to time point T_a , the proper acceptable historical authenticity tolerance of science of proportionate commensurate scientific authentication of humanistic ideology β_a about authenticity of nature in proportion to contemporaneous historical background was $[Y_7, Y_8)$. If the very humanistic ideology β_a about authenticity of nature in proportion to contemporaneous historical background was just **Relativity & Quantum Theory**, and if the evaluation of historical authenticity tolerance of science of Relativity & Quantum Theory was just 0.03, in accordance with the preconcerted acceptable evaluation range of historical authenticity tolerance of science $\beta \in [\alpha, \alpha(1+20\%))$, the acceptable range of historical authenticity tolerance of science of

proportionate commensurate scientific authentication of Relativity & Quantum Theory was [0.03, 0.036].

Supplemental note ①: Let's suppose the "ultimate authenticity of nature" is just a "gold bar":

Once it's time for Aristotle to offer ideological enantiomorph of the "gold bar", as practical feasibility & possibility in proportion to Aristotle's age, it seemed nothing better for Aristotle to do, either nothing to do or just to formulate the accessible image of "gold bar" as a "wood bar" off the cuff, whose profile intuitively seemed similar as the gold bar. And just because of this, Aristotle Theory could last near 2000 years as classic opus of the age.

Once it's time for Ptolemy to offer ideological enantiomorph of the "gold bar", as practical feasibility & possibility in proportion to Ptolemy's age, it seemed only possible for Ptolemy to formulate it as a "stone bar" in similar profile as the gold bar off the cuff. And just because the profile & specification of the wood bar was relatively similar as the "gold bar", Geocentric Theory could last more than 1400 years as classic opus of the age.

Once it's time for Copernicus to offer ideological enantiomorph of the "gold bar", as practical feasibility & possibility in proportion to Copernicus' age, it seemed only possible for Copernicus to formulate it as a "aluminum bar" in similar profile as the gold bar off the cuff. Although aluminum is still so different from gold, in any case, aluminum has entered the category of metal, it's of course great advancement in proportion to contemporaneous historical background.

Once it's time for Newton to offer ideological enantiomorph of the "gold bar", as practical feasibility & possibility in proportion to Newtonian age, it seemed only possible for Newton to formulate it as a "iron bar" in similar profile as the gold bar. Although iron is still so different from gold, compared to aluminum, character of iron is relatively closer to character of gold, it's great advancement in proportion to contemporaneous historical background. What's more, the specification of the "iron bar" in Newtonian formulation is rather similar as the gold bar, which was of course the top level of ideological enantiomorph of the gold bar of Newtonian age.

Once it's time for Einstein, Bohr etc to offer ideological enantiomorph of the "gold bar", as practical feasibility & possibility in proportion to Einstein, Bohr's age, it seemed nothing better for Einstein, Bohr etc to do, but to formulate the accessible imagine of the gold bar as a "copper bar" in similar profile & specification of the gold bar off the cuff. Although copper bar is still so different from gold bar, compared to iron bar, character of copper bar is even closer to character of gold bar, it's great advancement in proportion to contemporaneous historical background. What's more, the specification of the "copper bar" in Einstein, Bohr's formulation was even similar as the "gold bar". And indeed, draw on practical feasibility & possibility in proportion to contemporaneous historical background of 20th century, it's really difficult for us to tell apart the difference between the "copper bar" and the "gold bar" on the spot.

If cosmos is really "homogenous originated from unique genesis" through and through, Homogenous Cosmos Originated from Unique Genesis maybe have formulated the "gold bar" in real gold bar. Whereas, as personal limitation, Homogenous Cosmos Originated from Unique Genesis still seems difficult to formulate the specification of the "gold bar" precisely. As long as nothing can impact the objectivity of homogenous cosmos originated from unique genesis, as timely renovation of humanistic ideology about authenticity of nature in proportion to contemporaneous historical background of remarkable highlight of microcosmic configuration of matter, the advantage of Homogenous Cosmos Originated from Unique Genesis in historical authenticity tolerance of science is self-evident. And as long as nothing is ready to impact factuality of homogenous cosmos originated from unique genesis, coming development of science must be freewheeling of substantiation & perfection of Homogenous Cosmos Originated from Unique Genesis in inherent optimum orientation towards perfect ideological enantiomorph of ultimate authenticity of nature eversince.

Throughout historical progress of science, before achievement of social legitimacy qualification of the age, so-called contemporaneous scientific orthodoxy must procure necessary proportionate commensurate scientific authentication in prior. And usually, as coordinative proportionable contemporaneous scientific authentication, historical authenticity tolerance of science of proportionate commensurate scientific authentication is slightly bigger than historical authenticity tolerance of science of coordinative humanistic ideology about authenticity

Historical progress of science in the recent several centuries seemed like a far-flung exploration of the first itinerary around numerous distinctive landscapes of brand-new landmasses of science with palette & tablet on back, several hundred years' scientific travelogues were compiled thereby.

of nature in proportion to contemporaneous historical background, the best situation is that historical authenticity tolerance of science of proportionate commensurate scientific authentication equals historical authenticity tolerance of science of coordinative humanistic ideology about authenticity of nature in proportion to contemporaneous historical background. Once historical authenticity tolerance of science of contemporaneous scientific authentication is even less than historical authenticity tolerance of science of humanistic ideology about authenticity of nature in proportion to contemporaneous historical background, there has been self-evident potentiality for necessary renovation of humanistic ideology about authenticity of nature in proportion to contemporaneous historical background for positive historical progress of science in inherent optimum orientation towards perfect ideological enantiomorph of ultimate authenticity of nature, and the so-called contemporaneous scientific orthodoxy must be washed out for necessary ideological innovation forward to perfect ideological enantiomorph of ultimate authenticity of nature.

Whereas, under background of royal substantiation & perfection of contemporaneous scientific orthodoxy, most of the temporal authority are always ready to reject heterodoxy upon their snobbish confidence with backup of all-time authoritative intrepidity of contemporaneous scientific orthodoxy that contemporaneous scientific orthodoxy seems credible for solid proportionable contemporaneous scientific authentication. They are neither ready to face the historical factuality that, as contemporaneous scientific orthodoxy, live humanistic ideology about authenticity of nature in proportion to contemporaneous historical background is still out of scientific legitimacy qualification of historical authenticity tolerance of science 0, nor ready to admit the objectivity of coordinative reciprocal quantitative & qualitative change of humanistic ideology about authenticity of nature in proportion to contemporaneous historical background and proportionate commensurate scientific authentication throughout historical progress of science that **historical authenticity tolerance of proportionate commensurate scientific authentication of humanistic ideology about authenticity of nature in proportion to contemporaneous historical background which exists as live contemporaneous scientific orthodoxy \geq historical authenticity tolerance of science of humanistic ideology about authenticity of nature in proportion to contemporaneous historical background which exists as live contemporaneous scientific orthodoxy**, and once **historical authenticity tolerance of science of proportionate commensurate scientific authentication in proportion to contemporaneous historical background which exists as live contemporaneous scientific orthodoxy $<$ historical authenticity tolerance of science of live humanistic ideology about authenticity of nature in proportion to contemporaneous historical background which exists as live contemporaneous scientific orthodoxy**, it indicates practical accomplishment of solid potentiality for successive renovation of humanistic ideology about authenticity of nature in proportion to contemporaneous historical background for positive historical progress of science in inherent optimum orientation towards perfect ideological enantiomorph of ultimate authenticity of nature (/historical authenticity tolerance of science 0).

In another words, only when the historical authenticity tolerance of humanistic ideology about authenticity of nature in proportion to contemporaneous historical background is generally worthy of the practical feasibility & possibility in proportion to contemporaneous historical background, the social legitimacy subsistence of the humanistic ideology about authenticity of nature in proportion to contemporaneous historical background is relatively safe, once **historical authenticity tolerance of science of proportionate scientific authentication in proportion to contemporaneous historical background which exists as live contemporaneous scientific orthodoxy $<$ historical authenticity tolerance of science of humanistic ideology about authenticity of nature in proportion to contemporaneous historical background which exists as live contemporaneous scientific orthodoxy**, it indicates practical accomplishment of solid potentiality for successive

renovation of humanistic ideology about authenticity of nature in proportion to contemporaneous historical background for positive historical progress of science in inherent optimum orientation towards historical authenticity tolerance of science 0, and the so-called contemporaneous scientific orthodoxy has to face challenge of scientific knowledge metabolism for crecscive progression of historical progress of science in inherent optimum orientation towards historical authenticity tolerance of science 0.

Virtually, as reciprocal couple, successive reciprocal quantitative & qualitative change of humanistic ideology about authenticity of nature in proportion to contemporaneous historical background and proportionate commensurate scientific authentication not only proportionably brings out the parallel succession of quantitative & qualitative change of practical feasibility & possibility for scientific knowledge proliferation, but also radically accomplishes historical progress of science in inherent optimum orientation towards historical authenticity tolerance of science 0.

2.2. It's only possible for historical authenticity tolerance of scientific knowledge derived from lineal logic extension in succession of contemporaneous scientific orthodoxy out of scientific legitimacy qualification of historical authenticity tolerance of science 0 to be even bigger than historical authenticity tolerance of science of humanistic ideology about authenticity of nature in proportion to contemporaneous historical background, the theoretical credibility of scientific knowledge derived from lineal logic extension in succession of contemporaneous scientific orthodoxy out of scientific legitimacy qualification of historical authenticity tolerance of science 0 is even lower. As a result, the requirement of proportionate commensurate scientific authentication is even rigorous.

So-called “**lineal logic extension in succession of contemporaneous scientific orthodoxy**” is a kind of logic model for scientific knowledge proliferation when historical progress of science in inherent optimum orientation towards historical authenticity tolerance of science 0 proceeds to some certain progressive stage, some certain relatively mature scientific knowledge in proportion to contemporaneous historical background has been promoted social legitimacy qualification of the age, the corresponding orthodox authorities (/temporal authority) consequently carry forward eulogistic scientific knowledge proliferation in rigid succession of contemporaneous scientific orthodoxy by subconscious implementation of lineal logic extension of their celebrated legitimacy so as to crown all accessible existence & motion in their rational purview, which usually treats contemporaneous scientific orthodoxy as absolute scientific verity straightway even use it as undoubted “logic basis/rationale” off the cuff in despite of whether contemporaneous scientific orthodoxy has been qualified as perfect ideological enantiomorph of ultimate authenticity of nature with legitimacy qualification of historical authenticity tolerance of science 0 or not, no more how remarkable “historical authenticity tolerance of science” of contemporaneous scientific orthodoxy is.

Under background of royal substantiation & perfection of contemporaneous scientific orthodoxy, once unexpected unknown occurrence in cosmos enters human rational purview, as historical limitation, we are difficult to know or clarify the unexpected interposition on the spot. Whereas, as cordial successors of contemporaneous scientific orthodoxy or temporal authority, we are mostly sensitive to deduce or predict the potential objectivity of the unexpected unknown interposition in accordance with contemporaneous scientific orthodoxy so as to make contemporaneous scientific orthodoxy omnipotent. The even remarkable expedience is that, science forum is always homegrown outgrowth in the garden of contemporaneous scientific orthodoxy beyond all doubt for

Historical progress of science in the recent several centuries seemed like a far-flung exploration of the first itinerary around numerous distinctive landscapes of brand-new landmasses of science with palette & tablet on back, several hundred years' scientific travelogues were compiled thereby.

self-evident implementation of egotistic proximity identification at pleasure of temporal authority, what's more, "free press regulation customization" and "free press admittance" is straightforwardly under magistral autarchy of temporal authority short of necessary intendance.

We must be quite aware of the factuality that, before humanistic ideology about authenticity of nature finally qualified as perfect ideological enantiomorph of ultimate authenticity of nature, so-called "contemporaneous scientific orthodoxy" is but top level of humanistic ideology about authenticity of nature in proportion to contemporaneous historical background, the hypostatic social legitimacy qualification of contemporaneous scientific orthodoxy is not because it is perfect ideological enantiomorph of ultimate authenticity of nature all wood and a yard wide, but mostly because it is pioneering humanistic ideology about authenticity of nature along historical progress of science in inherent optimum orientation towards perfect ideological enantiomorph of ultimate authenticity of nature, whose legitimacy qualification out of scientific legitimacy qualification of historical authenticity tolerance of science 0 is of course insufficient to take role of "logic basis or rationale" for implementation of linear logic extension in succession of contemporaneous scientific orthodoxy without necessary credible demonstration.

And indeed, before humanistic ideology about authenticity of nature finally qualified as perfect ideological enantiomorph of ultimate authenticity of nature in legitimacy qualification of historical authenticity tolerance of science 0, lineal logic extension in succession of contemporaneous scientific orthodoxy has different credibility due to proportionate historical authenticity tolerance of science of contemporaneous scientific orthodoxy which is invoked as "logic basis or rationale" for implementation of lineal logic extension in succession of contemporaneous scientific orthodoxy.

In terms of any "contemporaneous scientific orthodoxy" out of scientific legitimacy qualification of historical authenticity tolerance of science 0. once we implement lineal logic extension in succession of contemporaneous scientific orthodoxy against some certain ready-made law of contemporaneous scientific orthodoxy out of scientific legitimacy qualification of historical authenticity tolerance of science 0, there is substantial probability for us to enlarge some certain flimsy logic parameter of ready-made law of contemporaneous scientific orthodoxy out of objectivity of authenticity of nature, so that historical authenticity tolerance of science of lineal logic extension of contemporaneous scientific orthodoxy is remarkably bigger than historical authenticity tolerance of science of contemporaneous scientific orthodoxy, it maybe even enlarge the historical authenticity tolerance of science of contemporaneous scientific orthodoxy like logic aberrance audion usually does its job, so that it makes the theoretical exploration effect of lineal logic extension in succession of contemporaneous scientific orthodoxy like "supernatural logic magic" therefore. Such as linear logic extension in succession of contemporaneous scientific orthodoxy, in accordance with gravitational law of $F=G*Mm/R^2$, if the quantity M in equation orientate to $+\infty$, then, ...

For instance, as authoritative intrepidity of contemporaneous scientific orthodoxy is all-time, there is always such a self-evident potential acquiescence among temporal authority, **in large scale spacetime, it's only possible for distinctive existence & motion of celestial bodies to be consequence of gravitational interaction, and of course, the presence of distinctive gravitational interaction of course indicates the proportionate mass distribution thereby.** About 15 years ago, some scientists found that the convergent strength of some certain galaxies is far more than the gravity the proper celestial bodies can offer

themselves, so that they insist that the supererogatory convergent strength of the galaxies must derive from more gravity invisible around, and of course, the supererogatory invisible gravity around of course implies the proportionate mass distribution around, there must be some dark matter invisible around. This is just the so-called “dark matter, dark energy” theory. Of course, at present, I still lack evidence to comment whether dark matter theory is earnest or innocent, I have to comment herein, the potential acquiescence “ **in large scale spacetime, it’s only possible for distinctive existence & motion of celestial bodies to be consequence of gravitational interaction, and of course, the presence of distinctive gravitational interaction of course indicates the proportionate mass distribution thereby**” is authoritatively intrepid and far-fetched indeed. Besides gravitational effect, nothing else can be direct cause to impact existence & motion of celestial bodies in cosmos?

Of course, compared to “Black Hole” theory, Dark Matter Theory, Dark Energy Theory are still small cases.

Just because the forgone contemporaneous scientific orthodoxy had ever accomplished a gravity law as “ $F=G*Mm/R^2$ ”, some loving successors consequently thought, in accordance with gravity law as “ $F=G*Mm/R^2$ ”, if the quantity M in the equation can increase unconditionally, which denotes the mass of the celestial body, the gravity will of course increase proportionably; once the gravity around the celestial body is strong enough to astrict lights around, the so-called celestial body must turn into a “Black Hole” for no lights can escape from it.

Under the very historical background, such kind of thought manner with backup of contemporaneous scientific orthodoxy is not ludicrous of course. Whereas, is there objective possibility for quantitative increase of mass of any celestial body to approach mass scale of Black Hole?

For you see, as long as cosmos is limited, there is no way for any quantitative increase of object in cosmos to extend to infinity. And virtually, any quantitative increase of object in cosmos can never go its incremental way unconditionally. What’s more, if cosmos is infinity, nothing we can invoke to tell apart infinity and finity.

Are there really “Black Holes” in cosmos?

Theoretically, if we have to admit that **ultimate authenticity of nature can be neither colorful authenticity smallwares full of a basket nor authenticity chameleon one piece and only, but coherent natura naturans throughout cosmic evolution**, we then have to admit, as commensurate ideological enantiomorph of accessible existence & motion around us, ultimate consummation of science must be uniform scientific verity as perfect ideological enantiomorph of ultimate authenticity of nature. If contemporaneous scientific orthodoxy about gravity is neither uniform scientific verity as perfect ideological enantiomorph of ultimate authenticity of nature nor hypostatic logic connotation of perfect ideological enantiomorph of ultimate authenticity of nature, the scientific credibility of linear logic extension in succession of contemporaneous scientific orthodoxy has to depend on further credible demonstration. For instance, scientific idea of so-called “Black Hole” originally came into being as linear logic extension in succession of contemporaneous scientific orthodoxy of so-called law of gravity which is apparently out of scientific legitimacy qualification of historical authenticity tolerance of science 0. As a result, once we come to face issue whether there are really “Black Holes” in cosmos, we have to offer credible evidence besides smart logic output of linear logic extension in succession of contemporaneous scientific orthodoxy out of scientific legitimacy qualification of historical authenticity tolerance of science 0.

What is more, if authenticity of gravitational reciprocity is really physical domino effect of spontaneous occurrence of [**physical disturbance of matter field superposition + (PNT action + Instinctive PNT equilibrium)**] of matter

Historical progress of science in the recent several centuries seemed like a far-flung exploration of the first itinerary around numerous distinctive landscapes of brand-new landmasses of science with palette & tablet on back, several hundred years’ scientific travelogues were compiled thereby.

integration, so-called “**Black Hole**” is apparently out of category of natura naturata in the nature of coherent natura naturans throughout cosmic evolution, there is no possibility for original generation of so-called “**Black Hole**” in cosmos.

Virtually, since Laplace firstly offered the original conception of Black Hole in 1778, people demonstrated neither external existence of Black Hole in cosmos nor nonexistence of Black Hole in cosmos ever since. Whereas, just because the conception of Black Hole derived from linear logic extension of contemporaneous scientific orthodoxy, which has both solid backup of so-called contemporaneous scientific orthodoxy and remarkable advantage to pass free press egotistic proximity identification from temporal authority, many so-called authorities had played their altisonant and respectable academic programme and became famous all over the world therefore. Although, at present, I still lack evidence to comment that Black Hole theory is complete ghost stories in homegrown science forum in the garden of contemporaneous scientific orthodoxy, I have to comment herein, as agelong absence of necessary scientific authentication of “authentic existence of Black Hole in cosmos”, even as authoritative intrepidity of contemporaneous scientific orthodoxy is all-time even overwhelming short of necessary intendance ever since, Black Hole theory has been more and more uncanny as typical linear logic extension in succession of **contemporaneous scientific orthodoxy** as typical **faulty ideological enantiomorph of stochastically accessible existence & motion around** without necessary credible demonstration, it's even more wizardly than arabian nights.

Do you disbelieve it? You see, as typical second-string genius under high-sounding background of royal substantiation & perfection of contemporaneous scientific orthodoxy, professor S.W. Hawking was very famous for his nice theory about “Black Hole” like beautiful building on the top of air castle. Although, till today, nobody on the earth can be sure there are really Black Holes in cosmos indeed. And in 2016, LIGO even declared all over the world that they had found mechanical collision of binary Black Hole in cosmos, and they had discovered gravitational wave therefore. They even procured physical Nobel Prize for it in 2017. ……

Just because of this, **are there really “Black Holes” in cosmos?**

The issue seems more and more vexed.

The even pestilent issue is that, as the most typical second-string genius in 20th century, S.W. Hawking was always the most famous scientist after Einstein, and LIGO gravitational wave discovery procured physical Nobel Prize of 2017, although, “Black Hole” was but a theoretical notion originally came into being as typical linear logic extension in succession of contemporaneous scientific orthodoxy whose scientific legitimacy qualification was still far away from scientific legitimacy qualification of historical authenticity tolerance of science 0 without necessary credible demonstration ever since. This of course implies it's sensitive forbidden zone of science forum to mention nonexistence of Black Hole, anybody who insisting **none Black Hole existing in cosmos** must directly displease most of the top temporal authority who are working as hardcore puissance of living historical progress of science, he must slide into virulent scientific knowledge metabolism campaign therefore. What's more, the most remarkable official facility of temporal authority is magistral autarchy of **free press regulation customization & free press admittance** short of necessary intendance under egotistic background of interminable royal substantiation & perfection of contemporaneous scientific orthodoxy. It's of course self-evident what a great challenge it is to change the conventionality of “Black Hole” in cosmos; we have to straightforwardly face the despicable humanistic reality, as multiple notion with double significance of “**social connotation**” & “**natural connotation**”, social legitimacy

**As coherent natura naturans throughout cosmic evolution, instinctive PNT reciprocal equilibrium towards optimum
PNT operation is radical potentiality & conditionality for cosmos always ready to orientate itself towards perfection.**

& validity of truths can never exceed cannon range.

On April 10,2020 scientists released to the media a photograph of a black hole for the first time in human history. Taking this photograph was not an easy task. So now we are going to study how the photo was taken and what kind of technology was used for.

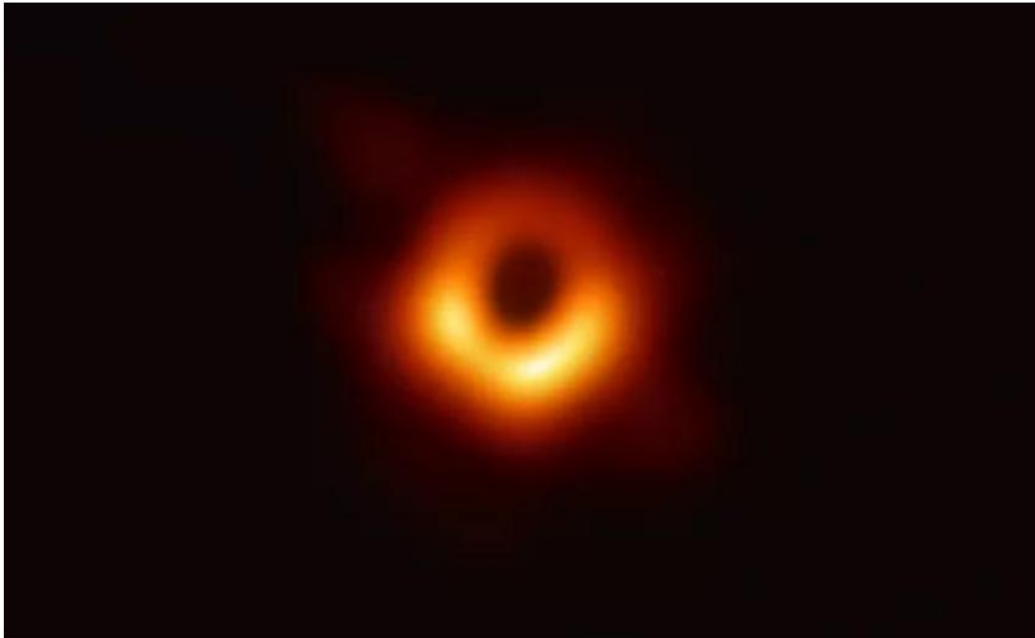

(VII-iii-3) The picture above come from a paper named “strangeness of Black Hole” which I encountered in researchgate.net website by chance in Oct. 2020.

And just because of indomitable quarrel about whether there are really Black Holes in cosmos all long, the orthodox opposite recently offered a Black Hole photo as illustration above. However, such a photo is really too far-fetched to validate objective existence of so-called Black Hole in cosmos. Just to invoke such a photo above, even if the orthodox opposite have 8 or 10 more resounding reasons to declare——look, this is just a photo of Black Hole; whereas, the heterodox precisian also have 10 or 20 more resounding reasons to rebut——Hi, what’s your “credible evidence” to let me believe this is just the photo of a Black Hole? And virtually, the photo you offered herein shows me no credible evidence for me to draw positive conclusion of impersonal existence of Black Hole in cosmos! In straightforward words, this photo includes no credible evidence for positive judgement of objective existence of Black Hole in cosmos at all, it’s apparently insufficient for validation of objective existence of Black Hole in cosmos.

Since it’s “Black Hole” all wool and a yard wide, none lights can escape from surface of it, there is of course no way for us to see it, no more taking photo of it. Something related to objective existence of Black Hole we can practically perceive is but related visible mechanical phenomenon out of event horizon.

Whereas, what’s kind of **visible mechanical phenomenon we can perceive related to objective existence of Black Hole?**

In accordance with the original definition of “Black Hole” in cosmos, **so-called “Black Hole”, in simple words, is but special celestial body in cosmos, whose mass scale (/density) is enough to offer strong gravity to astrict lights on its surface in accordance with gravitational law “ $F=G*Mm/R^2$ ”.**

And thus, objective existence of any Black Hole in cosmos must possess inherent mechanical attribution

Historical progress of science in the recent several centuries seemed like a far-flung exploration of the first itinerary around numerous distinctive landscapes of brand-new landmasses of science with palette & tablet on back, several hundred years’ scientific travelogues were compiled thereby.

as following:

- ①. There is an invisible core area with no lights coming from, which contains all the mass of the so-called Black Hole and the mechanical center of gravity of Black Hole.
- ②. If dynamic fundamental of gravitational reciprocity between the Black Hole and normal celestial bodies is till the same among celestial bodies, then, there must be a super gravitational field around the Black Hole which is separated by the event horizon, the area inside the even horizon is just the invisible core part of the Black Hole, the area out of the event horizon is the visible area with typical gravitational mechanical features.

All in all, in accordance with the original definition of Black Hole, there must be inherent physical attribution of Black Hole as ①-② above.

As practical feasibility & possibility in proportion to contemporaneous historical background, there is almost no way for us to perceive the invisible existence inside the event horizon of Black Hole. Whereas, it's of course accessible for us perceive the mechanical phenomenon due to gravitational interaction $F=G*Mm/R^2$ out of event horizon but relatively near to the center of gravity of back hole.

In accordance with original definition of Black Hole, as long as there are celestial bodies in gravitational field relatively near to the gravitational center but out of event horizon of so-called Black Hole, there must be characteristic gravitational interaction between the Black Hole and the celestial bodies around. Consequently, the Black Hole and the celestial bodies around must form mechanical reciprocity system in mechanical model similar as solar system, which can be illustrated as below:

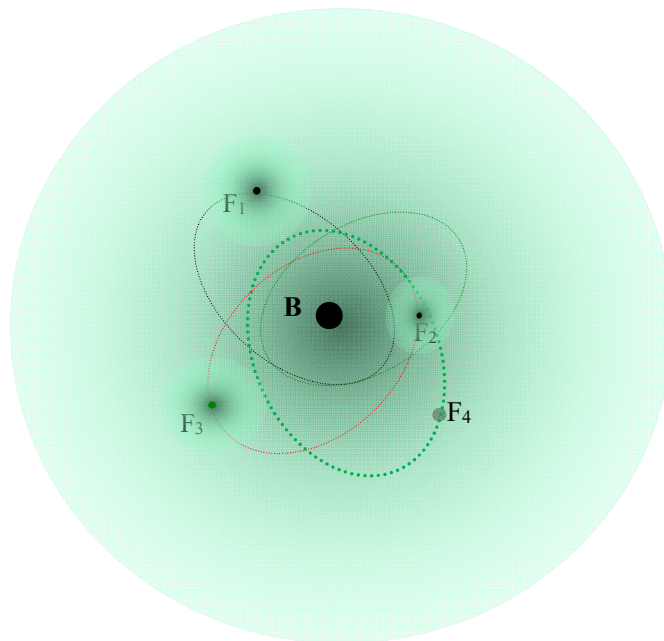

(VII-iii-3) Necessary visible mechanical evidence out of event horizon in accordance with original definition of Black Hole.

In illustration above, the center black ball denotes the area inside the event horizon of Black Hole, and grey area denotes the gravitational field out of event horizon of Black Hole. F_1 , F_2 , F_3 , F_4 represent the celestial bodies or galaxies in gravitational field relatively near to the center of gravity but out of event horizon of Black Hole. Of course, since F_1 , F_2 , F_3 , F_4 exist in gravitational field relatively near to the center of gravity but out of event horizon of Black Hole, there must be proportionate gravitational interaction between

**As coherent natura naturans throughout cosmic evolution, instinctive PNT reciprocal equilibrium towards optimum
PNT operation is radical potentiality & conditionality for cosmos always ready to orientate itself towards perfection.**

Black Hole and any idiographic celestial body among F_1, F_2, F_3, F_4 , and as a result, any idiographic celestial body among F_1, F_2, F_3, F_4 must hypostatize characteristic existence & motion subjected to equation $F=G*Mm/R^2$. Of course, in accordance with gravity equation $F=G*Mm/R^2$ and idiographic data of characteristic existence and motion of discretionary celestial body or galaxy among F_1, F_2, F_3, F_4 , we can calculate the location of center of gravity and mass quantity of the Black Hole accordingly.

If there are authentic existence of so-called “Black Holes” in Milk Way System, in accordance with inherent gravitational mechanical attribute of so-called Black Hole, the presence of so-called Black Holes must dominate the idiographic existence & motion of all stars around in Milk Way System by its magic gravitational field like the sun does its job to all the planets around, the integrative overall arrangement of Milk Way System must be composed in accordance with original distribution and consequent gravitational dominance of so-called Black Holes. If there is only unique Black Hole in Milk Way System, then, the integrative profile of overall arrangement of Milk Way System must be similar as solar system which seems like disc or globe. Since actual integrative profile of overall arrangement of Milk Way System seems bar-type as milk way, if there are really Black Holes in Milk Way System which dominate overall arrangement of Milk Way System as innate mechanical origin, the quantity of Black Holes in Milk Way System must be more than one, there must be a string of Black Holes along the axle centre of the bar-type profile of the Milk Way System which steadily make up of innate axle centre of mechanical origin of the Milk Way System.

Since so-called Black Hole is originally defined like this, in accordance with objective logic necessity, proportionate commensurate scientific authentication of authentic existence of Black Hole in cosmos can never go its normal way without logic support of the related mechanical data. In another words, only once we have practically procured mechanical data compatible with physical attribution ①-② above, we consequently own external evidence to draw positive conclusion of existence of Black Hole in cosmos.

However, in order to prove there are really Black Holes in cosmos sufficiently, only evidence of mechanical data in accordance with original definition of Black Hole is still insufficient, it's still necessary for us to offer credible evidence that there is really possibility for quantitative change of convergent accumulation of mass of celestial bodies in cosmos to extend to mass scale of so-called Black Hole. After all, there is still another potential presumptive precondition for logic validation there are really Black Holes in cosmos, which is that, the characteristic mechanical reactions of celestial bodies or galaxies F_1, F_2, F_3, F_4 are all consequence of gravitational interaction, besides gravitational interaction, nothing else can cause such kind of mechanical reaction of celestial bodies or galaxies. And as long as we can not prove the contemporaneous scientific orthodoxy has been qualified legitimacy qualification of historical authenticity tolerance of science 0, we have no reasons to shy away the necessary scientific authentication of the potential presumptive precondition. No matter how difficult the proportionate commensurate scientific authentication of external existence of Black Hole in cosmos is for us to practically offer, it's impersonal logic necessity we have to face, none intrepid authority is enough to play personal superiority at his pleasure without necessary scientific authentication.

Although, whether there is really objective possibility for quantitative change of convergent accumulation of mass of celestial bodies to extend to mass scale of Black Holes or not is not the direct demonstration of the presumptive precondition, the practical confirmation can compensate the logic insufficiency of the presumptive

precondition indeed. What's more, all the visible galaxies in our general physical purview are always in red shift situation, so that we are confident to sparkplug "Big Bang" accordingly. In any case, situation of red shift of galaxies in cosmos is apparently incompatible to remarkable convergent accumulation of mass of celestial bodies.

Nov. 2020, Hunan province Wugang city Zhenzhu town.

Acknowledgement: The direct reason I wrote the paper was that, in Oct 2020, I encountered the author of "strangeness of Black Hole" on researchgate.net by chance, who oppugned a lot about my idea there is virtually no possibility for original naissance of Black Hole in accordance with coherent natura naturans throughout cosmic evolution so I think, beyond freewheeling logic extension of Homogenous Cosmos Originated from Unique Genesis, it's necessary for me to highlight the objectivity of coordinative reciprocal quantitative & qualitative change of humanistic ideology about authenticity of nature in proportion to contemporaneous historical background and proportionate contemporaneous scientific authentication throughout historical progress of science as necessary complementarity.

(VII-vi) Nine serial questions from modern physics reflected on sense of Homogenous Cosmos Originated from Unique Genesis

Foreword: I received the nine groups of questions from modern physics in July 2005, when I worked at a Taiwanese company. As I did not get my personal computer with me that days, I was substantively not convenient to read the very document with computer in our common office with manager behind, I delayed so much till I resigned my job and stayed at home.

As the nine groups of questions remarkably embodied a lot of modern physics, some of my idiographic explanation or comment about these issues maybe avail readers to understand more of both Homogenous Cosmos Originated from Unique Genesis and modern physics as supplemental accessory to contradistinguish with modern physics, after all, all my comment directly derived from ready-made topics (or notions) of so-called modern physics and rooted in idea of homogenous cosmos originated from unique genesis. As a result, I offer it to my readers herein. Although my relevant knowledge about modern physics is still poor and my literal expression maybe not exact to embody my original thought; although one of my friends who had read it had told me that the textual format of the reply had only achieved “seven-part essay^Q” compared with official reply format criterion.

(Brief introduction of professor Li: I only know his name is “Li-xuesheng”, male, physics department of Peking university. We knew each other in July 2005 for he encountered some of my papers in website by accident and emailed me for questions. As frequent email communication, we became friends eversince, whereas, I never met him)

(Original text of serial question 1)

Classical electrodynamics confirms the accelerating charge will radiate electromagnetic waves, while Quantum mechanics insists that the electron accelerating in single energy level won't radiate any electromagnetic waves, is it possible to make the both dissents unified? How to explain the ideal experiment below: it is supposed there are two objects with equal mass, one is charged, the other is uncharged, starting at rest with equal outside driving force, the both objects move toward the oppose from initial point position A and initial point position B. In accordance with special relativity, their gravitational mass and gravitational energy should be equal all the way. However, the positive factuality is that the object made up of protons will constantly radiate electromagnetic waves during the course of accelerating, what's the possible energy origin on earth? If the electromagnetic wave radiation is within the consideration range of energy conservation, as electromagnetic force satisfies parity conservation, the radiation orientation of electromagnetic waves should have equivalent probability in all directions in space, so the resultant momentum of the electromagnetic radiation is 0. This of course implies the velocity of the object made up of protons should be bigger; the energy of system is still out of conservation herein.

Note^Q: The “seven-part essay” here derived from Chinese feudal official literary model of “eight-part essay”, which demanded any eligible article should be edited in prescribed eight changeless parts. As one of my friends reminded me the format of this section not fit in temporal Chinese official reply format standard, so I had to admit my reply format had only achieved “seven-part essay” herein, which means, compared with format standard of “eight-part essay”, one conventional part of the reply is still absent.

Historical progress of science in the recent several centuries seemed like a far-flung exploration of the first itinerary around numerous distinctive landscapes of brand-new landmasses of science with palette & tablet on back, several hundred years' scientific travelogues were compiled thereby.

Issue 1.1.: Classical electrodynamics confirms the accelerating charge will radiate electromagnetic waves.

Reply: For expedience to make the issue self-evident, it's necessary to refer to the qualitative analysis & definition of electromagnetic field and electromagnetic wave of Homogenous Cosmos Originated from Unique Genesis first:

In a simple word, so-called “electromagnetic field” is just the affected matter field for the presence of unsaturated genic integration of object and come into being for PNT operation between object with unsaturated genic integration and the proper matter field. In detailed words, as the presence of unsaturated genic integration of object and the eternal infiltration PNT operation between the object with unsaturated genic integration and the proper matter field, the object with unsaturated genic integration will either release overmuch of its preponderant compositive genic elements to the matter field or seize overmuch of the corresponding insufficient compositive genic elements due to its connatural saturated genic configuration from the matter field as to optimize the PNT operation as possibly as it can. In another word, as the presence of eternal infiltration PNT operation between object and the proper matter field, the object will consequentially transmit some of its unsaturated genic integration to the proper matter field as to make the matter field have the same genic preponderance or insufficiency. Thus, as the presence of unsaturated genic integration of object and the eternal infiltration PNT operation between the object with unsaturated genic integration and the proper matter field, the proper matter field consequently has the same preponderant or insufficient compositive genic elements; we just call the affected matter field with preponderant or insufficient compositive genic elements “electromagnetic field”.

Motion variation of matter radically and proportionately depends on variation of PNT performance of matter integration, especially reciprocal equilibrium between $d(M \leftarrow m)$ and $d(M \rightarrow m)$ of PNT action. Wave-form motion is the dynamic enantiomorph of PNT action with idiosyncrasy of periodic samsara of $d(M \leftarrow m) > d(M \rightarrow m)$ and $d(M \leftarrow m) < d(M \rightarrow m)$ of matter integration (but we do not exclude the possibility of periodic operation pattern). The wave is electromagnetic wave is because during the course of PNT performance with idiosyncrasy of periodic samsara of $d(M \leftarrow m) > d(M \rightarrow m)$ and $d(M \leftarrow m) < d(M \rightarrow m)$, the matter integration periodically exhibit preponderance or insufficiency in genic integration, so that wave-form motion exhibit electromagnetic properties, (If necessary, please refer to the section (III-iii) connatural motion patterns of matter ——wave-form motion of matter).

And successively, we come to analyze whether charge must radiate electromagnetic wave during the course of accelerating in accordance with PNT dynamics.

On stand of the dynamic rationale of Homogenous Cosmos Originated from Unique Genesis, motion status of object radically and proportionably depends on the PNT performance of matter integration, in single words, motion is but vivid dynamic enantiomorph of PNT action of matter integration. Before accelerating, no matter what the motion status of object is, the motion velocity of object can be expressed as $V = d(M \leftarrow m)Y/m$, The accelerating of charge of course means the variation of $d(M \leftarrow m)$ first, as m denotes the mass of charge whose genic integration is of course unsaturated. No matter $d(M \leftarrow m)$ increases or decreases, as long as it breaks stationarity of PNT operation, the infiltration of PNT operation between the object with unsaturated genic configuration and the proper matter field will go on to impact the content and thickness of the genic preponderance or genic insufficiency of the affected matter field, this of course indicates variation of electric field, and indeed, variation of electric field unconditionally implies inevitable outgrowth of electromagnetic wave.

As coherent natura naturans throughout cosmic evolution, instinctive PNT reciprocal equilibrium towards optimum PNT operation is radical potentiality & conditionality for cosmos always ready to orientate itself towards perfection.

That's to say, considered by Homogenous Cosmos Originated from Unique Genesis; accelerating charge will radiate electromagnetic wave.

But say truly, I am still a little puzzled, as the relativity of acceleration, in terms of a charge stationary on the ground, a man standing on earth won't find it radiates electromagnetic waves, whereas, a man standing on Mars will find it radiates electromagnetic waves. A conductor fixed on aircraft with constant current in, once the aircraft flying-off or landfall, the man on the ground must find it radiates electromagnetic waves; however, can the man on aircraft find it radiates electromagnetic waves too? A charge left stationary on the ground, observed by a man on a car when the car keeps stationary on the ground, the man won't find the charge radiates electromagnetic waves, while once the car starts off; will the man on car immediately find the charge radiates electromagnetic waves thereby? And conversely, if we lay the charge on a car accelerating on the road, observed by a man standing on the road, he will of course find the charge radiates electromagnetic waves; whereas, once the man runs a while as to catch and climb up the car, will he then immediately find the charge won't radiates electromagnetic waves any longer? Does this mean the presence of electromagnetic wave still has relativity domino effect?

And of course, considered by relativity of Homogenous Cosmos Originated from Unique Genesis, as the presence of dynamic assimilation of space time, relative to time dynamic speed, the bigger the velocity of observer is, the less cosmic contents he can find consequently, until once the velocity of observer approach the time dynamic speed, all existence he can perceive in cosmos is 0. Whether it means, observed by a man standing on the road, the charge radiates electromagnetic waves for it accelerates with the car together, however, once the man runs a while as to catch and climb up the car, the electromagnetic wave radiation is consequently assimilated for velocity increase of the observer? And during the course of increase of velocity of observer what are assimilated are just the electromagnetic waves or all the electromagnetic waves included? Otherwise, there must be even more deep-seated secret therein. If possible, I'd like to look into this issue further.

Issue 1.2.: Quantum theory considers the electron accelerating in the same energy level won't radiate any electromagnetic waves.

Reply: In the face of such issue upon my frankness, I am afraid I still lack of necessary background knowledge about quantum theory, I can not be sure the spacetime physic surrounding of atomic energy level and physic definition of "the same energy level". However, in accordance with PNT dynamics, accelerating charges must radiate electromagnetic waves, the key issue is the positive electromagnetic field derived from protons and the negative electromagnetic field derived from electrons are a couple reciprocal special field with mutual complementary genic configuration due to norm saturated genic configuration of matter field, their coexistence in available distance can approach reciprocity by the light of nature for presence of instinctive equilibrium towards optimum PNT operation.

And I'd like to emphasize something about the conventional parlance of "positive electric field /positive charge + negative electric field/negative charge", "positive matter + negative matter" are similar as something mutually annihilated as "(+1)+(-1)=0" herein.

Homogenous Cosmos Originated from Unique Genesis thinks positive electric field and negative electric field are but two individual affected matter fields with complementary genic preponderance or genic insufficiency in their ideographic genic configuration, "positive electric field /positive charge + negative electric field /negative

charge” can only bring about perfection of genic configuration towards saturated and neutral genic integration of matter field, but not mutual annihilation as “ $(+1)+(-1)=0$ ”.

Virtually, as long as we admit cosmos is throughout homogenous originated from unique genesis, the entire cosmos is exactly an organic homogeneity system and the rich & colorful existence & motion in homogenous cosmos are but variation in homogenous configuration in such homogeneity system. Any magnificent motion or wizardly transmutation can neither proliferate “radical new matters” beyond cosmic homogeneity system nor bring about existent annihilation of cosmic physic object, no more presence of “positive matter” & “negative matter” in cosmos but homology series, unless they are nonexistent existence or non-cosmic existence.

However, as there is none possibility for cosmic homogenous existence and non-cosmic existence to transmutation each other, there is none physic possibility for reciprocity between cosmic existence and non-cosmic existence, as a result, there is completely no way for any cosmic existence to “meet” or “see” non-cosmic existence, and there is completely no way for any non-cosmic existence to “meet” or “see” cosmic existence as well. No matter on stand of philosophy or physics, no matter on stand of cosmos or non-cosmos, inter-cosmic existence is completely skimble-skamble.

Since the nucleus can bond electrons in certain energy level orbit around as to form relatively steady-going elementary atom, it must be able to synchronously couple the perturbation of negative electromagnetic field caused by acceleration of electrons around in certain space range (energy level range).

That's to say, as matter integration has instinct to acclimate itself in perfect neutral genic configuration, and the positive electromagnetic field derived from protons in nucleus and the negative electromagnetic field derived from the electrons around nucleus have complementary genic configuration due to perfect neutral genic configuration, electromagnetic attraction between nucleus and electrons around consequently arise and relatively steady-going atom comes into being thereby. Because only such saturated and neutral genic configuration of matter integration can bring about smooth operation of PNT action and hypostatize perfect & steady-going connatural existence of object.

And it of course implies the presence of preponderant or insufficient genic elements in matter or matter field can cause PNT operational local default or congestion of circuit link as to make the PNT operation not as smooth as normal status, and we can even draw our conclusion that the so-called “energy of position” is just the resultant effect/state of PNT operational local default or congestion of circuit link for the presence of preponderant genic elements or insufficient genic elements in matter and matter field, once operational local default or congestion of PNT circuit link is neutralized, the PNT operation of matter integration will be immediately smoothed into its normal status, and magnitude of $d(M\leftarrow m)$ of matter integration consequently increases, momentum of matter integration $mV=d(M\leftarrow m)Y$ proportionately increases, the “energy of position” turns into kinetic energy.

If we denote the mass of electron “ m_e ”, denote the mass of nucleus “ m_n ”, denote the mass of positive electromagnetic field derived from nucleus “ M_n ”, and denote the mass of negative electromagnetic field “ M_e ”, (Note: In fact, here the “ M_n ” and “ M_e ” separately denote the mass of matter field of nucleus and electron, the reason we here call them mass of positive electromagnetic field and mass of negative electromagnetic field is because the proper matter field including idiographic preponderant genic element

**As coherent natura naturans throughout cosmic evolution, instinctive PNT reciprocal equilibrium towards optimum
PNT operation is radical potentiality & conditionality for cosmos always ready to orientate itself towards perfection.**

or insufficient genic element.). the acceleration process of electron is but the process $d(M_e \leftarrow m_e)$ arises perturbation, if the matter integration of nucleus synchronously arise proportionate perturbation of $d(M_n \leftarrow m_n)$, as the preponderant genic elements or insufficient genic elements of positive electromagnetic field and negative electromagnetic field are complementary due to perfect neutral genic configuration of matter field, and as matter integration has instinct to maintain neutral genic configuration, the both complementary field perturbation proportionately coupled, Thus, as long as the perturbation of both positive electric field and negative electric field keep in covariant scale and rhythm, in terms of accelerating electrons in atom, the perturbation of negative electromagnetic field of electrons can not be found within atom scale but variable motion of electrons around nucleus, and as a result, no electromagnetic waves derived from accelerating electrons can be escape from atom.

In terms of integrative geometric profile and electric character of atom, if we denote the insufficient genic elements in positive electromagnetic field derived from the proper nucleus as $f_{i_0 \rightarrow}(p, t)$, denote the preponderant genic elements in negative electromagnetic field derived from the proper electron as $g_{i_0 \rightarrow}(e, t)$, (The symbol “ i_0 ” is sign of “unique-genesis quantization”, “p” is abbreviation of “proton”, e is the abbreviation of “electron”, while the existence of electrons in the nature usually exhibits more of individual character of single one, as a result, the alphabet “e” here denotes single electron in many cases, “t” is abbreviation of “time”, which of course denotes “time”). And successively, if we can confirm the mutually complementary proportion between genic preponderance of negative electromagnetic field and genic insufficiency of positive electromagnetic field is X:Y, then the amount of electrons some certain idiographic nucleus can astrict can be expressed as $\{ [X * f_{i_0 \rightarrow}(p, t)] / [Y * g_{i_0 \rightarrow}(e, t)] \}$, among the expression, the symbol of “[]” denotes the integer part of “ $X * f_{i_0 \rightarrow}(p, t)$ ” above “ $Y * g_{i_0 \rightarrow}(e, t)$ ”. and it’s understandable that the electric perturbation of positive electromagnetic field caused by quantitative change of $d(M_n \leftarrow m_n)$ is just the differential coefficient $f_{i_0 \rightarrow}'(p, t)$ of $f_{i_0 \rightarrow}(p, t)$, and the electric perturbation of negative electromagnetic field caused by quantitative change of $d(M_e \leftarrow m_e)$ is just the differential coefficient $g_{i_0 \rightarrow}'(e, t)$ of $g_{i_0 \rightarrow}(e, t)$. The harmonic degree of proportioning perturbations of $d(M_n \leftarrow m_n)$ and $d(M_e \leftarrow m_e)$ directly impacts the orbit profile of electrons around nucleus, integrative geometric profile & diameter of atom and inconstant electric distribution of atom. However, the difference of $[X * f_{i_0 \rightarrow}(p, t)] / [Y * g_{i_0 \rightarrow}(e, t)] - \{ [X * f_{i_0 \rightarrow}(p, t)] / [Y * g_{i_0 \rightarrow}(e, t)] \}$ mostly impacts the electric properties of atoms, especially the electric essentiality of so-called oxidation capability and deoxidation capability mentioned in chemistry, idiographic natural radiation & disintegration etc. And once these related electromagnetic properties of atoms involve in further reciprocity among available atoms, they will go further step to involve in possible number of atomic bond around atom, atomic bond azimuthal angle or bonding array pattern of atoms, bonding strength, even the existent state of gas, liquid, solid of the bonding atomic system, oxidation capability or deoxidation capability of the bonding atomic system (**chemical properties**), conductivity, mechanical properties etc.

Once “atom state equation in spacetime” is ultimately consummated, all these issues will be formulated mathematically in corresponding dynamic equations and be clear at a glance. And if possible, I will introduce more about these issues systematically along a rational line of sequential homologic cosmogony of atoms in “Successive introduction of Atom State Equation in Spacetime” soon. (The two paragraphs above were added on Feb, 05, 2010)

Issue 1.3.: classical electrodynamics confirms that accelerating charge will radiate electromagnetic waves, quantum theory points out electron accelerating in the same energy level won’t radiate electromagnetic waves, are the both dissents possible to be unified?

Reply: The explanations of issue 1.1 and issue 1.2 have demonstrated the unification of the both dissents.

Historical progress of science in the recent several centuries seemed like a far-flung exploration of the first itinerary around numerous distinctive landscapes of brand-new landmasses of science with palette & tablet on back, several hundred years’ scientific travelogues were compiled thereby.

Since we here referred to “quantum” here, Homogenous Cosmos Originated from Unique Genesis would like to talk something about quantization of cosmic homogeneity system on stand of homogenous cosmos originated from unique genesis at the volley.

Homogenous Cosmos Originated Unique Genesis especially emphasizes the quantization of any cosmic existence or cosmic process, but the “cosmic quantum” Homogenous Cosmos Originated from Unique Genesis mentioned is just a single unit of the “unique-genesis i_0 ”, all quantization of any physic quantity or physic process mentioned by Homogenous Cosmos Originated from Unique Genesis are all quantization on the basis of fundamental quantum of “unique-genesis i_0 ”.

As cosmos is throughout homogenous originated from unique genesis, complete existence in cosmos are either the unique-genesis i_0 itself or consist of unique-genesis i_0 in some certain physical configuration, resultingly, any quantity denotes existent amount in cosmos can be quantized by unique-genesis i_0 , and existent quantification of any cosmic existence or process can be absolutely quantized. And instead, any continuity in cosmos is relative. And at the same time, the quantity “unique-genesis i_0 ” is too infinitesimal extremity of comprehensive cosmic quantities, “unique-genesis i_0 ” is of course infinitesimal extremity of mass, space distance and time, once the quantity of mass, space distance and time illimitably tend to quantity of single “unique-genesis i_0 ”, it means the physical connotation of mass, space distance and time illimitably orient towards zero. (Please refer to “two supplemental explanations of mathematical definition of Homogenous Cosmos Originated from Unique Genesis”)

This is obviously different from the traditionary quantum theory.

Issue 1.4.: How to explain the ideal experiment below: it is supposed there are two objects with equal mass, one is charged, the other is uncharged, starting at rest and with equal outside driving force, the both objects move toward the oppose from initial point position A and initial point position B. In accordance with special relativity, their gravitational mass and gravitational energy should be equal all the way, whereas, the positive factuality is that the object made up of protons will constantly radiate electromagnetic waves during the course of accelerating, what's the possible energy origin on earth? If the electromagnetic wave radiation is within considerable range of energy conservation, as electromagnetic force satisfies parity conservation, the radiation orientation of electromagnetic waves should have equivalent possibility in all directions in space, as a result, the resultant momentum of the electromagnetic radiation is 0, this of course implies the velocity of the object made up of protons should be bigger, the energy of system is still out of conservation therefore.

Reply: For expedience of quantitative analysis of the issue and in accordance with the precondition the issue offered, we denote the mass of the both charges as m_a and m_b , which satisfy “ $m_a=m_b$ ”; and denote the mass of the proper electromagnetic fields derived from the both charges as M_a and M_b , which satisfy “ $M_a=M_b$ ”. In accordance with PNT dynamics, when the both charges in their stationary initial state, their idiographic matter integration satisfy state equations as following:

$$(A) \begin{cases} m_a+M_a=R_a \\ M_a / m_a=K_a \\ V(t)*m_a= d(M\leftarrow m)(t)*Y(t) \\ L_a^3(t)*\alpha(t)=A*m_a \\ Y(t)=B*\alpha(t) \end{cases} \quad (B) \begin{cases} m_b+M_b=R_b \\ M_b / m_b=K_b \\ V(t)*m_b= d(M\leftarrow m)(t)* Y(t) \\ L_b^3(t)*\alpha(t)=A*m_b \\ Y(t)=B*\alpha(t) \end{cases}$$

As coherent natura naturans throughout cosmic evolution, instinctive PNT reciprocal equilibrium towards optimum PNT operation is radical potentiality & conditionality for cosmos always ready to orientate itself towards perfection.

Considered by Homogenous Cosmos Originated from Unique Genesis, force can of course be caused by transference of mass from outside to matter integration attending in PNT operation of matter integration so as to break the PNT operational stationarity. To add physic action to matter integration usually means to increase or decrease mass of matter integration in some certain hylic state. For expedience and straightforwardness, we just express the both actions of force into quantization functions as $F_a(t)$, $F_b(t)$, as the two actions of force are equal, so “ $F_a(t)=F_b(t) > 0$ ”. And at the same time, as the separate implementations of the two actions of force on the two matter integration, the PNT operations of matter integration will spontaneously arises equilibrium between $d(M \leftarrow m)$ and $d(M \rightarrow m)$, till at last $d(M \leftarrow m)=d(M \rightarrow m)$, thus, it will consequentially cause variation of mass of both matter integration, and for convenience of the proper demonstration, we express the consequential mass variation of both matter integration into quantization functions $f_a(t)$, $f_b(t)$ as following:

$$f_a(t) = \int_0^t \{d(M \rightarrow m)_a - d(M \leftarrow m)_a\} dt \quad f_b(t) = \int_0^t \{d(M \rightarrow m)_b - d(M \leftarrow m)_b\} dt$$

Consequently, as presence of the two forces, the proper state equations of the both matter integration changes into:

$$(A) \begin{cases} m_a + M_a + F_a(t) = R_a + F_a(t) \\ M_a + \{F_a(t) - f_a(t)\} / \{m_a + f_a(t)\} = K_a(t) \\ V(t) * \{m_a + f_a(t)\} = d(M \leftarrow m)(t) * Y(t) \\ L_a^3(t) * \alpha(t) = A * \{m_a + f_a(t)\} \\ Y(t) = B * \alpha(t) \end{cases} \quad (B) \begin{cases} m_b + M_b + F_b(t) = R_b + F_b(t) \\ M_b + \{F_b(t) - f_b(t)\} / \{m_b + f_b(t)\} = K_b(t) \\ V(t) * \{m_b + f_b(t)\} = d(M \leftarrow m)(t) * Y(t) \\ L_b^3(t) * \alpha(t) = A * \{m_b + f_b(t)\} \\ Y(t) = B * \alpha(t) \end{cases}$$

Homogenous Cosmos Originated from Unique Genesis confirmed that the entire cosmos is completely a “homogeneity system”, in an radical word, the cosmic existence is but “one thing only”, but just because of presence in various different material structures, the cosmos seems rich and colorful, and just because all the various different material structures belong to a coherent homogenous series, the cosmos consequently seems an integrate throughout related. On such stand, as all cosmic are absolutely in a homogeneity system, there are none absolute distinctions between this object and that object in cosmos, no matter it is charge or electromagnetic field, no matter it is force or electromagnetic wave ... and no matter it is space or time; they are all homogenous hylic objects in different cosmic homologous structure and profile. In radical word, matter integration radiates electromagnetic waves outside also means some certain cosmic hylic existence are transferred outside, we may just denote the transferred hylic existence in definite function as $Q(t)$, ($Q(t) > 0$), and we denote the matter integration of object made up of protons as matter integration (A). The matter integration (A) radiates electromagnetic waves outside of course means losing its stationarity and will consequentially cause spontaneous PNT covariant equilibrium between $d(M \leftarrow m)$ and $d(M \rightarrow m)$, and in such case, the implementation of PNT covariant equilibrium of matter integration must satisfy $f_a(t) > f_b(t)$, for simplicity, we denote the mass variation of positive electromagnetic field caused by PNT covariant equilibrium as $Q_1(t)$, ($Q_1(t) > 0$), and denote the mass variation of object of the charge as $Q(t) - Q_1(t)$, which satisfies $Q(t) - Q_1(t) > 0$.

As the matter integration radiates electromagnetic waves, the state equation of matter integration (A) changes into:

$$(A) \begin{cases} m_a + M_a + F_a(t) - Q(t) = R_a + F_a(t) - Q(t) \\ M_a + \{F_a(t) - f_a(t) - Q_1(t)\} / \{m_a + f_a(t) - Q(t) + Q_1(t)\} = K_a(t) \\ V(t) * \{m_a + f_a(t) - Q(t) + Q_1(t)\} = d(M \leftarrow m)(t) * Y(t) \\ L_a^3(t) * \alpha(t) = A * \{m_a + f_a(t) - Q(t) + Q_1(t)\} \\ Y(t) = B * \alpha(t) \end{cases}$$

Then, it can be deduced the mass of the object made up of protons is as below:

$$\{m_a + f_a(t) - Q(t) + Q_1(t)\} = \{R_a + F_a(t) - Q(t)\} / \{1 + K_a(t)\}$$

And the mass of the uncharged object is as below:

$$\{m_b + f_b(t)\} = \{R_b + F_b(t)\} / \{1 + K_b(t)\}$$

According to initial condition $m_a = m_b$, $F_a(t) = F_b(t)$, the both matter integration perform PNT equilibrium under exactly same initial conditions, thus, we can distinguish the magnitudes of $\{m_a + f_a(t) - Q(t) + Q_1(t)\}$ and $\{m_b + f_b(t)\}$ as below:

$$\begin{aligned} & \{m_a + f_a(t) - Q(t) + Q_1(t)\} - \{m_b + f_b(t)\} \\ &= f_a(t) - f_b(t) - Q(t) + Q_1(t) \\ &= \{f_a(t) + Q_1(t)\} - \{f_b(t) + Q(t)\} \text{ or } = \{f_a(t) - f_b(t)\} - \{Q(t) - Q_1(t)\} \end{aligned}$$

In accordance with the conservation fundamental of cosmic mass, if matter integration (A) does not radiate electromagnetic waves, then, it implies $Q(t) = 0$, $Q_1(t) = 0$, if the both matter integration perform PNT equilibrium under the same spacetime background and with the same outside action, there must be $f_a(t) = f_b(t)$. Thus, it implies:

$$\begin{aligned} & \{m_a + f_a(t) - Q(t) + Q_1(t)\} - \{m_b + f_b(t)\} = \{f_a(t) - f_b(t)\} - \{Q(t) - Q_1(t)\} = 0 \\ & \iff \{m_a + f_a(t) - Q(t) + Q_1(t)\} = \{m_b + f_b(t)\} \end{aligned}$$

The key issue is that there is electromagnetic radiation wastage $Q(t)$, and as the presence of radiation wastage $Q(t)$ the matter integration (A) stimulates the variation of $d(M \leftarrow m)_a$ stronger than the matter integration (B) does to $d(M \leftarrow m)_b$ without electromagnetic radiation, just as: $f_a(t) - f_b(t) > 0$. While, according to the conservation fundamental of cosmic mass and PNT dynamics, under the precondition of equal outside action, it does not implies the difference of $f_a(t) - f_b(t) > 0$ can exactly offset the mass ullage of charge made up of protons for electromagnetic radiation, unless we appropriately keep $F_a(t) > F_b(t)$, just as below:

$$\{f_a(t) - f_b(t)\} - \{Q(t) - Q_1(t)\} < 0 \iff \{m_a + f_a(t) - Q(t) + Q_1(t)\} < \{m_b + f_b(t)\}$$

It indicates Homogenous Cosmos Originated from Unique Genesis disagrees with relativity that gravitational mass and gravitational energy of the both charges are equal all the way.

(Original text of serial question 2)

Modern physics thinks that photon has none charge, but the reciprocity between charges can be materialized by exchanging photons, how to explain such case? How to explain the singular point in Lorentz transformation? And I think that photon should has its charge, very tiny charge, which maybe too difficult for human to perceive, if so, the singular point in Lorentz transformation will consequently be self-evident. Modern physics thinks that neutrino has its gravitational mass, once motion speed equals light speed, how

to explain such case according to Lorentz transformation? If neutrino motion speed is less than light speed, parity conservation conflicts with parity nonconservation; can you explain why this occurs? The transmission speeds of gravitational field and electromagnetic field are equal, are there even more essential connotations therein?

Issue 2.1.: Modern physics thinks that photon has none charge, but the reciprocity between charges can be materialized by exchanging photons, how to explain such case?

Reply: Homogenous Cosmos Originated from Unique Genesis thinks that photon should have its individual charge, at least, its genic configuration is not neutral, otherwise, once it transmits in neutral spacetime (just to keep PNT operation in space field so as to possess transmission speed of $V=d(M \leftarrow m)Y/m=C$), it's impossible for it to exhibit property of electromagnetic wave.

But Homogenous Cosmos Originated from Unique Genesis can hardly comprehend why professor li mentioned that reciprocity between charges is just materialized by exchanging photons. Considered by Homogenous Cosmos Originated from Unique Genesis, any idiographic existence & motion in cosmos are but dynamic objectification of PNT operation of matter integration in spacetime, and the variation of existence & motion radically rooted in the proper variation of PNT action. However, any reciprocity in cosmos is but outgrowth the PNT operation of one matter integration disturbed by the other. Although, photons exchanging between charges maybe disturb the PNT operation of the proper charges too, reciprocity itself is not only limited in exchanging photon but also radically disturbs the PNT operation status of charges.

Issue 2.2.: How to explain the singular point in Lorentz transformation?

I know nothing of the singular point in Lorentz transformation, as a result, there is no way for me to explain anything about it.

Issue 2.3.: I think that photon should has its charge, very tiny charge, which maybe too difficult for human to perceive, if so, the singular point in Lorentz transformation will consequently be self-evident. Modern physics thinks that neutrino has its gravitational mass, once motion speed equals light speed, how to explain such case according to Lorentz transformation? If neutrino motion speed is less than light speed, parity conservation conflicts with parity nonconservation; can you explain why this occurs? The transmission speeds of gravitational field and electromagnetic field are equal, are there even more essential connotations therein?

Reply: Homogenous Cosmos Originated from Unique Genesis thinks photon should have its individual charge, at least, its genic configuration is not saturated or neutral, and otherwise, the transmission of photon in spacetime can never exhibit property of electromagnetic wave. And at the same time, Homogenous Cosmos Originated from Unique Genesis thinks any objects, as long as it can perform PNT independently in spacetime as idiographic matter integration, has its gravitational mass, neutrino, photon can never be exceptive. However, as motion is innate property of matter in spacetime, any object existing in spacetime, it must possess absolute spacetime momentum as below:

$$mV=d(M \leftarrow m)Y \quad \longleftrightarrow \quad V=d(M \leftarrow m)Y/m$$

However, as the mass of neutrino or photon is substantively tiny and the motion speed in spacetime is remarkably high for magnitude of “ $d(M \leftarrow m)/m$ ” is apparently big, as a result, it's almost impossible for us to stop them as to perceive the material presence of their stationary mass, which is almost similar as it's impossible

for us to stop time to see what time looks like. For you see, once we stop neutrino or photon in spacetime, neutrino or photon will immediately lose its characteristic $d(M \leftarrow m)$ value, stationary neutrino and photon are not themselves any longer; once we stop time, there is virtually no time for us to perceive, even there is no possibility for us to implement perceiving action any longer for absence of time.

I know nothing about parity conservation.

(Original text of serial question 3)

In special relativity, in accordance with Lorentz transformation, the length will shrink along motion orientation of object, is it domino effect of observation or hypostatic regularity? And whether the length shrinkage has cumulation domino effect? Let's suppose there is an object in length 1 along its motion orientation, it goes on accelerating from rest till at last its motion speed approaches $0.99c$, then, it begin to decelerate till at last it gets back to its initial quiescent state, thus, is it possible for the length of the object to be the same? If the length of the object is still the same, it indicates length shrinkage in Lorentz transformation has no cumulation domino effect. Time satisfies Lorentz transformation too; why experiments of modern physics indicate it has cumulation domino effect (for example, μ particle runs around the earth)? If time & length variation in accordance with Lorentz transformation is but observation domino effect, it apparently conflicts with philosophic idea of Einstein that there is an independent world out of our esthesia forms the base of our sciences. How do you comprehend this? How do you comprehend Gemini (双生子) paradox and submarine paradox? I analyzed Lorentz transformation so as to have illuminated its significance and made the clock shrinkage of special relativity and general relativity unified and made the Gemini paradox and submarine paradox self-evident thereby, it seems all these support that relativity theorem is right; I wonder if this is really true?

Issue 3.1. In special relativity, in accordance with Lorentz transformation, the length will shrink along motion orientation of object, is it domino effect of observation or hypostatic regularity? And whether the length shrinkage has cumulation domino effect? Let's suppose there is an object in length 1 along its motion orientation, it goes in accelerating from rest till at last its motion speed approaches $0.99c$, then, it begin to decelerate till at last it gets back to its initial rest state, thus, is it possible for the length of the object to be the same? If the length of the object is still the same, it indicates length shrinkage in Lorentz transformation has no cumulation domino effect. Time satisfies Lorentz transformation too; why experiments of modern physics indicate it has cumulation domino effect (for example, μ particle runs around the earth)? If time & length variation in accordance with Lorentz transformation is but observation domino effect, it apparently conflicts with philosophy of Einstein that there is an independent world out of our esthesia forms the base of our sciences. How do you comprehend this?

Reply: I am genuinely sorry I have poor knowledge about the above physics issues and the related thought groundwork of Lorentz transformation. However, focusing this topic, I'd like to introduce something about motion of objects under the same reference frame (basal motion) and motion of objects under different reference frames (relativity) under precondition that cosmos is throughout homogenous originated from unique genesis.

(1) Motion of objects in the same reference frame under the precondition that cosmos is throughout homogenous originated from unique genesis (normal motion)

As coherent natura naturans throughout cosmic evolution, instinctive PNT reciprocal equilibrium towards optimum PNT operation is radical potentiality & conditionality for cosmos always ready to orientate itself towards perfection.

Force is the direct cause for motion variation of matter integration, in a simple word; so-called “force” is but time domino effect of matter integration losing its PNT stationarity. As matter integration losing PNT stationarity can be caused by outside mass input or output or be caused by transmutation of mass of matter integration itself from positive state to negative state [just the instinctive PNT equilibrium case of $d(M \leftarrow m) > d(M \rightarrow m)$], as a result, once we come to analyze the motion status of objects in the same reference frame, there are resultant two sorts of cases as following:

① Outside works on the matter integration.

We denote the mass of positive matter of discretionary matter integration $m(t)$, and denote the mass of the corresponding matter field of the very object $M(t)$. Then, before accelerating, the existent state of matter integration can be formulated as following:

$$\left\{ \begin{array}{l} M(t)+m(t)=R(t) \\ M(t)/m(t)=K(t) \\ V(t)*m(t)=d(M \leftarrow m)(t)*Y(t) \\ L^3(t)*\alpha(t)=A*m(t) \\ Y(t)=B*\alpha(t) \end{array} \right. \iff \left\{ \begin{array}{l} M(t)=K(t)*R(t)/(1+K(t)) \\ m(t)=R(t)/(1+K(t)) \\ V(t)=d(M \leftarrow m)(t)*Y(t)/m(t) \\ L^3(t)=A*m(t)/\alpha(t) \\ Y(t)=B*\alpha(t) \end{array} \right.$$

Once outside works on matter integration, let’s suppose that the input of outside working on matter integration is $F(t)$, and the consequential inductive variation of mass of positive matter of object is $f(t)$, and the corresponding variation of the proper matter field is $F(t)-f(t)$, ($F(t) > 0$, $f(t) > 0$, $F(t)-f(t) > 0$). Thus, the state equations of matter integration turn into:

$$\left\{ \begin{array}{l} M(t)+m(t)+F(t)=R(t)+F(t) \\ \{M(t)+F(t)-f(t)\}/\{m(t)+f(t)\}=K(t) \\ V(t)\{m(t)+f(t)\}=d(M \leftarrow m)(t)*Y(t) \\ L^3(t)*\alpha(t)=A*\{m(t)+f(t)\} \\ Y(t)=B*\alpha(t) \end{array} \right. \iff \left\{ \begin{array}{l} M(t)+F(t)-f(t)=K(t)\{R(t)+F(t)\}/(1+K(t)) \\ m(t)+f(t)=\{R(t)+F(t)\}/(1+K(t)) \\ V(t)=d(M \leftarrow m)(t)*Y(t)/\{m(t)+f(t)\} \\ L^3(t)=A*\{m(t)+f(t)\}/\alpha(t) \\ Y(t)=B\alpha(t) \end{array} \right.$$

Apparently, when the value of $F(t)$ illimitably increase, the mass of object $m(t)+f(t)$ will illimitably trend to “ $+\infty$ ” proportionably. And at the same time, according to the velocity equation $V(t)=d(M \leftarrow m)(t)*Y(t)/\{m(t)+f(t)\}$, as the positive mass of object is just the denominator of the velocity equation, it of course means the convergent accumulation of mass of object is obviously incompatible with the increase of velocity. Virtually, the variation of velocity $V(t)$ is mainly influenced by conditional variation of value $d(M \leftarrow m)/\{m(t)+f(t)\}$, the variation of $Y(t)$ is usually not remarkable. Once the value of $F(t)$ illimitably increase, the mass of positive matter of matter integration will illimitably trend to “ $+\infty$ ”, and consequently, the value of $d(M \leftarrow m)/\{m(t)+f(t)\}$ will gradually trend to 0, and the bigger the velocity of matter integration is, the less the change rate of value $d(M \leftarrow m)/\{m(t)+f(t)\}$ will be. That’s to say, under precondition the velocity of object is relatively bigger, the acceleration effect of successive work of force will be weaker and weaker, and instead, the mass increase effect of object will be relatively more and more remarkable. Thus, it’s comprehensible, under such acceleration manner, if the velocity of object approach $0.99c$, no matter the original motion object is but a single electron or proton, its final total mass will be very near to “ $+\infty$ ”, which maybe even obviously bigger than 1000 times or 10000 times of total mass of the Milky Way galaxy.

And further, according to equation $L^3(t)=A*\{m(t)+f(t)\}/\alpha(t)$, the length variation of object is self-evident.

The inverse course of the process is matter integration works on outside. If we also denote the output of matter integration working on outside $F(t)$, then, the variation situations of the related parameters of matter integration is symmetric against the acceleration process of matter integration under outside driving force $F(t)$. That's to say, during the course of accelerating, all variations of parameters of mater system have continuous cumulation domino effect.

② Matter integration lose PNT balance and consequently side into acceleration situation for negative transmutation preponderance, (just the instinctive covariant equilibrium of $d(M\leftarrow m)>d(M\rightarrow m)$).

Apparently, before the implementation of negative transmutation preponderance, the state equations of matter integration can be expressed as following:

$$\left\{ \begin{array}{l} M(t)+m(t)=R(t) \\ M(t)/m(t)=K(t) \\ V(t)*m(t)=d(M\leftarrow m)(t)*Y(t) \\ L^3(t)*\alpha(t)=A*m(t) \\ Y(t)=B*\alpha(t) \end{array} \right. \iff \left\{ \begin{array}{l} M(t)=K(t)*R(t)/(1+K(t)) \\ m(t)=R(t)/(1+K(t)) \\ V(t)=d(M\leftarrow m)(t)*Y(t)/m(t) \\ L^3(t)=A*m(t)/\alpha(t) \\ Y(t)=B*\alpha(t) \end{array} \right.$$

We denote the mass variation of positive matter during the course of implementation of negative transmutation preponderance $g(t)$, under such situation, if the negative transmutation preponderance is relatively remarkable and matter integration won't work on outside, there are many possibilities for matter integration arises radiation. In order to approach the factuality as much as possible, we denote the output of matter integration $g_2(t)$, and at the same time, impacted by output $g_2(t)$ of matter integration, the proper matter field will be impacted consequently, we denote the related mass impact of the proper matter field $q(t)$, obviously, $g(t)>0$, $g_1(t)>0$, $g_2(t)\geq 0$, $g(t)=g_1(t)+g_2(t)$, $g_2(t)>q(t)>0$. Thus, as the presence of negative transmutation preponderance, the state equations of matter integration turn into:

$$\left\{ \begin{array}{l} M(t)+m(t)-g_2(t)=R(t)-g_2(t) \\ \{M(t)+g_1(t)-q(t)\}/\{m(t)-g(t)\}=K(t) \\ V(t)*\{m(t)-g(t)\}=d(M\leftarrow m)(t)*Y(t) \\ L^3(t)*\alpha(t)=A*\{m(t)-g(t)\} \\ Y(t)=B*\alpha(t) \end{array} \right. \iff \left\{ \begin{array}{l} M(t)+g_1(t)-q(t)=K(t)[R(t)-g_2(t)]/[1+K(t)] \\ m(t)-g(t)=[R(t)-g_2(t)]/[1+K(t)] \\ V(t)=d(M\leftarrow m)(t)*Y(t)/\{m(t)-g(t)\} \\ L^3(t)=A*\{m(t)-g(t)\}/\alpha(t) \\ Y(t)=B*\alpha(t) \end{array} \right.$$

It's easy to see, as the variation continuity of $g(t)$, the mass of positive matter of matter integration $m(t)-g(t)$ will be continuously reduced thereby, while the value of $V(t)=d(M\leftarrow m)(t)*Y(t)/\{m(t)-g(t)\}$ will consequently increase for the increase of $d(M\leftarrow m)(t)$, $Y(t)$, $\{m(t)-g(t)\}$. If the value $V(t)$ illimitably trends to $Y(t)$, it means value $d(M\leftarrow m)/\{m(t)-g(t)\}$ illimitably trends to 1 and value $\{m(t)-g(t)\}$ illimitably trends to 0.

It implies, in the acceleration case above, once the velocity of matter integration illimitably trends to time dynamic speed, the mass of positive matter will consequently illimitably trends to 0, no matter how large the original mass of object is. It of course means too, in such acceleration case above, during the of velocity of matter integration gradually increase to $0.99c$, the mass of object must decrease proportionately, once the velocity of matter integration approach $0.99c$, it of course means the mass of object has been rather near to

photon already, no matter how large the original mass of object is.

And further, according to equation $L^3(t) = A * \{m(t) - g(t)\} / \alpha(t)$, when velocity of matter integration illimitably trends to time dynamic speed $Y(t)$, as value $\{m(t) - g(t)\}$ consequently trends to 0, it of course implies the length of object will be rather near to 0, and once the velocity of object illimitably trends to $0.99c$, it of course indicates the length of object has been rather similar as photon too.

In fact, the acceleration case is just the inverse process of matter original generation & formation in cosmos, the process is of course invertible, otherwise, the progressive involution of cosmos will inevitably trend to extremity or absolute isolation. In mathematical logic, the invertible processes are of course couple and symmetric with cumulation domino effect, it's one of the perceivable demonstrations that cosmic evolution is continuous and invertible.

(2) Motion status of object in different frames of reference under the precondition that cosmos is throughout homogenous originated from unique genesis (Homogenous Relativity)

In order to obviate too much complexity, we here introduce normal state quantity. Let's suppose there is a norm weight of 1000g and a norm ruler of 1000mm in the same inertial state in inertial reference frame S, we denote the inertial velocity of the norm weight and norm ruler V_0 , and let's suppose, under the precondition that both the norm weight and norm ruler keep their initial inertial motion state, the frame reference S begins to accelerate. Standing in the reference frame S, when the velocity of reference frame S reaches $1V_s, 2V_s, 3V_s, 4V_s \dots (n-1)V_s, nV_s (n \in \mathbb{N}, nV_s \leq Y(t))$, we separately come to observe the existent state of the norm weight and the norm ruler.

In accordance with the temporal assumable parameter function of spacetime dynamic assimilation of mass $H_1(V) = (1 - V^2/Y^2)^{1/2}$, when the velocity of reference frame S reaches $1V_s, 2V_s, 3V_s, 4V_s \dots (n-1)V_s, nV_s [n \in \mathbb{N}, nV_s \leq Y(t)]$, observed in reference frame S, the corresponding relative weights of the norm weight are as following:

$$\begin{matrix} 1000 \{1 - (1V_s)^2/Y^2(t)\}^{1/2}g, & 1000 \{1 - (2V_s)^2/Y^2(t)\}^{1/2}g, & 1000 \{1 - (3V_s)^2/Y^2(t)\}^{1/2}g \\ 1000 \{1 - (4V_s)^2/Y^2(t)\}^{1/2}g, & \dots & 1000 \{1 - (nV_s)^2/Y^2(t)\}^{1/2}g. \end{matrix}$$

Apparently, the bigger the velocity of reference frame S is, observed in reference frame S, the less the relative masses of the norm weight are, once the velocity of reference frame S satisfies $nV_s = Y(t)$, observed in reference frame S moving in speed $nV_s = Y(t)$, the relative mass of the norm weight is 0. Inversely, if the reference frame S decelerates from the top speed $nV_s = Y(t)$, and when the velocity of reference frame S gradually reaches $(n-1)V_s, (n-2)V_s, (n-3)V_s, \dots 3V_s, 2V_s, 1V_s, [n \in \mathbb{N}, nV_s \leq Y(t)]$, observed in reference frame S, the relative masses of the norm weight gradually becomes bigger and bigger, and the corresponding relative mass series array of the norm weight observed in decelerating reference frame S is exactly symmetric against the relative mass series array observed in accelerating reference frame S.

In accordance with the temporal assumable parameter function of spacetime dynamic assimilation of velocity $H_2(V) = (1 - V^2/Y^2)^{1/2}$, when the velocity of the reference frame S gradually reaches $1V_s, 2V_s, 3V_s, 4V_s \dots (n-1)V_s, nV_s [n \in \mathbb{N}, nV_s \leq Y(t)]$, observed in reference frame S, the relative velocity of the norm weight and the norm ruler are as following:

$$\begin{array}{lll}
 V_0\{1-(1V_s)^2/Y^2(t)\}^{1/2}, & V_0\{1-(2V_s)^2/Y^2(t)\}^{1/2}, & V_0\{1-(3V_s)^2/Y^2(t)\}^{1/2}, \\
 V_0\{1-(4V_s)^2/Y^2(t)\}^{1/2}, & \dots\dots\dots & V_0\{1-(nV_s)^2/Y^2(t)\}^{1/2}.
 \end{array}$$

Apparently, the bigger the velocity of reference frame S is, observed in reference frame S, the less the relative velocities of the norm weight and the norm ruler are, once the velocity of reference frame S satisfies $nV_s=Y(t)$, observed in reference frame S moving in speed $nV_s=Y(t)$, the relative velocity of the norm weight and the norm ruler is 0. Inversely, if the reference frame S decelerates from the top speed $nV_s=Y(t)$, and when the velocity of reference frame S gradually reaches $(n-1)V_s, (n-2)V_s, (n-3)V_s, \dots, 3V_s, 2V_s, 1V_s, (n \in \mathbb{N}, nV_s \leq Y(t))$, observed in reference frame S, the relative velocities of the norm weight and the norm ruler gradually become bigger and bigger, and the corresponding relative velocity series array of the norm weight and the norm ruler observed in decelerating reference frame S is exactly symmetric against the relative velocity series array observed in accelerating reference frame S.

In accordance with the temporal assumable parameter function of spacetime dynamic assimilation of length $H_3(V)=(1-V^2/Y^2)^{-1/2}$, when the velocity of reference frame S gradually reaches $1V_s, 2V_s, 3V_s, 4V_s \dots (n-1)V_s, nV_s [n \in \mathbb{N}, nV_s \leq Y(t)]$, observed in accelerating reference frame S, the relative lengths of the norm ruler are as following:

$$\begin{array}{lll}
 1000\{1-(1V_s)^2/Y^2(t)\}^{-1/2}\text{mm}, & 1000\{1-(2V_s)^2/Y^2(t)\}^{-1/2}\text{mm}, & 1000\{1-(3V_s)^2/Y^2(t)\}^{-1/2}\text{mm} \\
 1000\{1-(4V_s)^2/Y^2(t)\}^{-1/2}\text{mm}, & \dots\dots\dots & .1000\{1-(nV_s)^2/Y^2(t)\}^{-1/2}\text{mm}.
 \end{array}$$

Apparently, the bigger the velocity of reference frame S is, observed in reference frame S, the longer the relative lengths of the norm ruler are, once the velocity of reference frame S satisfies $nV_s=Y(t)$, observed in reference frame S moving in speed $nV_s=Y(t)$, the relative length of the norm ruler is “+∞”. Inversely, if the reference frame S decelerates from the top speed $nV_s=Y(t)$, and when the velocity of reference frame S gradually reaches $(n-1)V_s, (n-2)V_s, (n-3)V_s, \dots, 3V_s, 2V_s, 1V_s, [n \in \mathbb{N}, nV_s \leq Y(t)]$, observed in reference frame S, the relative lengths of the norm ruler gradually becomes shorter and shorter, and the corresponding relative length series array of the norm ruler observed in decelerating reference frame S is exactly symmetric against the relative length series array observed in accelerating reference frame S.

In accordance with the temporal assumable parameter function of spacetime dynamic assimilation of space radiation cornu $H_4(V)=(1-V^2/Y^2)^{1/2}$, when the velocity of reference frame S gradually reaches $1V_s, 2V_s, 3V_s, 4V_s \dots (n-1)V_s, nV_s [n \in \mathbb{N}, nV_s \leq Y(t)]$, observed in accelerating reference frame S, the relatively effective space radiation cornu of the norm weight and the norm ruler are as following:

$$\begin{array}{lll}
 \pi\{1-(1V_s)^2/Y^2(t)\}^{1/2}, & \pi\{1-(2V_s)^2/Y^2(t)\}^{1/2}, & \pi\{1-(3V_s)^2/Y^2(t)\}^{1/2}, \\
 \pi\{1-(4V_s)^2/Y^2(t)\}^{1/2}, & \dots\dots\dots & \pi\{1-(nV_s)^2/Y^2(t)\}^{1/2}
 \end{array}$$

Apparently, the bigger the velocity of reference frame S is, observed in reference frame S, the less the relative effective space radiation cornu of the norm weight and the norm ruler are, once the velocity of reference frame S satisfies $nV_s=Y(t)$, observed in reference frame S moving in speed $nV_s=Y(t)$, the relatively effective space radiation cornu of the norm weight and the norm ruler is 0. Inversely, if the reference frame S decelerates from the top speed $nV_s=Y(t)$, and when the velocity of reference frame S gradually reaches $(n-1)V_s, (n-2)V_s, (n-3)V_s, \dots, 3V_s, 2V_s, 1V_s, (n \in \mathbb{N}, nV_s \leq Y(t))$, observed in reference frame S, the relatively effective space radiation cornu of the norm weight and the norm ruler gradually become bigger and bigger, and the corresponding

As coherent natura naturans throughout cosmic evolution, instinctive PNT reciprocal equilibrium towards optimum PNT operation is radical potentiality & conditionality for cosmos always ready to orientate itself towards perfection.

relatively effective space radiation cornu series array of the norm weight and the norm ruler observed in decelerating reference frame S is exactly symmetric against the relatively effective space radiation cornu series array observed in accelerating reference frame S.

Relativity domino effect is not observation domino effect but essential regularity, any observed physical quantity to discretionary reference frame has its practical physic significance, and only the practically observed physical quantity by the very observer has practical physic significance to it.

For instance, there is a battleplane in the sky is ready to attack a bombing plane on the aerodrome. We assume the first time the battleplane passed the aerodrome at speed V_1 and found the length of the bombing plane on the aerodrome L_1 , the second time, the battleplane passed the aerodrome at speed V_2 from the same direction as the first time and found the length of the bombing plane on the aerodrome L_2 . In accordance with Homogenous relativity, if $V_2 < V_1$, there must be $L_2 < L_1$. If the second time passing the aerodrome, the battleplane was ready to shoot the both terminals of the bombing plane on the aerodrome separately with two bunches of laser, however, if the shooter just to aim at the both terminals of the bombing plane according to the length L_1 of the bombing plane measured when it passed the aerodrome the first time at speed V_1 , it's impossible for the two bunches of laser to hit the both terminals of the bombing plane on aerodrome.

And at the same time, as the evolutionary process is absolutely continuous and reversible, as a result, the physic quantification of any a couple of innate reversible physic processes are symmetric. (If necessary, please refer to the section of "spacetime and motion" —Homogenous relativity)

Issue 3.2.: How do you comprehend Gemini (双生子) paradox and submarine paradox?

I know nothing about the Gemini paradox and submarine paradox; as a result, I can explain nothing about this.

Issue 3.3. I analyzed Lorentz transformation so as to have illuminated its significance and made the clock shrinkage of special relativity and general relativity unified and made the Gemini paradox and submarine paradox self-evident thereby, it seems all these support that relativity theorem is right; I wonder if this is really true?

I know nothing about the Gemini paradox and submarine paradox, no more the logic correlation between Gemini paradox, Submarine paradox and Relativity, as a result, it's impossible for me explain anything about this.

(Original text of serial question 4)

In accordance with the consanguineous correlation between space and time, I think space and time is coordinative, and if we assume $1s=3.0 \times 10^8 m$, we can consequently reduce one of the so-called "basal physic units" and go further step to deduce out the mass-energy equation expediently, I wonder if I am right?

Reply: Homogenous Cosmos Originated from Unique Genesis thinks so. Virtually, as long as the entire cosmos is throughout homogenous originated from unique genesis and entire cosmic contents exist in an absolute homogeneity system, any two sorts of quantification in cosmos are coordinative and can be converted each other. If we can find such two sorts of physic quantification (including quantification of any physic process in cosmos) or two objects in cosmos, it can be proved that the two sorts physic quantification or two objects in cosmos can never be converted each other, then, such factuality either has negated homogenous cosmos originated from unique genesis or has practically found the cosmos II.

And virtually, considered by Homogenous Cosmos Originated from Unique Genesis, so-called “spacetime” is but an aggregation of negative genic units (**dark matter**) with mutual spontaneous transference and transmutation, and as the existent profile of the aggregation seems like a grand field, the spacetime is called “space field” too. So-called “time” is but the dynamic integration of the spontaneous transference and transmutation among genic units in space field, so-called “space” is but the physic objectification of spontaneous transference and transmutation among genic units in the space field. The relation between “space” and “time” seems like the couple surfaces of a coin, and the so-called “coin” is just the “genic units in space field” and the “spontaneous transference and transmutation among genic units”. “space” and “time” are of course coordinative and can be converted each other, but Homogenous Cosmos Originated from Unique Genesis do not think the conversion between space and time is $1S=3.0\times 10^8m$, but $1S=Ym$ (Y is just the time dynamic speed), and at the same time, the properties of space includes two state parameters, they are space distance and space radiation cornu. And Homogenous Cosmos Originated from Unique Genesis confirms, as long as human has not enough evidence to negate that cosmos is throughout homogenous originated from unique genesis, we have no reason to say the basal physic units can be reduced one or two, instead, we should confirm that there is originally only one basal physic unit in cosmos, which is just the so-called “unique-genesis i_0 ”.

(Original text of serial question 5)

Einstein always insisted that relativity is field theory; however, many of us always think relativity is but a theory about spacetime, what's the correlation between spacetime and field on earth? I think the noumenon of field is spacetime, relative spacetime.

Reply: Your comment is just the same as mine.

Considered by Homogenous Cosmos Originated from Unique Genesis, spacetime has alternative name of space field too, because spacetime is substantively a genic aggregation in mutual dynamic transference and transmutation, the hylic profile of the genic aggregation in mutual dynamic transference and transmutation is just the integrative **geometric space**, which includes two property parameters of **space distance** and **space radiation cornu**, time is but the dynamic connotation of genic mutual transference and transmutation. And spacetime has relativity connotation, the root cause for the presence of “relativity connotation of spacetime” is the relative spacetime dynamic assimilation.

And indeed, in cosmos, none fields are non-space-field. Gravitational field is but consort field of positive matter, a kind of special space field with idiographic property of field strength distribution, it concentrated to the positive matter with strength gradual weakling along the way far away from the positive matter for the convergent existence of positive matter in spacetime, which is virtually just the so-called “matter field”. Electromagnetic field is but affected matter field for the presence of preponderant or insufficient genic elements in, a kind of special space field with idiographic genic configuration for the presence of preponderant or insufficient genic elements in.

(Original text of serial question 6)

The theory of modern physics derived from symmetry, while many of the existence around us is not symmetric, professor Li-zhengdao considered the cause of separate symmetric invalidation one of the four issues science development has to confront in 21st century. How do you comprehend this? I brought

**As coherent natura naturans throughout cosmic evolution, instinctive PNT reciprocal equilibrium towards optimum
PNT operation is radical potentiality & conditionality for cosmos always ready to orientate itself towards perfection.**

forward the theorem of relativity & absoluteness of symmetry in accordance with relative absoluteness and modern physic theory; I wonder whether it's true? General relativity confirmed that all reference frames are equivalent, there is no way for us to scale the integrate motion sate of the entire cosmos, however, Big Bang confirms that the cosmos now is in a state of expansion. How do you comprehend the correlation therein?

Issue 6.1.: The theory of modern physics derived from symmetry, while many of the existence around us is not symmetric, professor Li-zhengdao considered the cause of separate symmetric invalidation one of the four issues science development has to face in 21st century. How do you comprehend this?

I know nothing about the so-called “symmetry theory” and the so-called “separate symmetry”. But one thing can be confirmed here on the stand of homogenous cosmos originated from unique genesis, as the progressive evolution of cosmos is absolutely continuous and reversible, the quantification of any reversible physic process couple is symmetric.

Issue 6.2: General relativity confirmed that all reference frames are equivalent, there is no way for us to scale the integrate motion sate of the entire cosmos, however, Big Bang confirms that the cosmos now is in a state of expansion. How do you comprehend the correlation therein?

Considered by Homogenous Cosmos Originated from Unique Genesis, as the presence of spacetime dynamic assimilation, referring to time dynamic speed, the higher speed of observer is, the less cosmic contents the observer can find, and as a result, different frames of reference in different motion speeds are not equivalent.

Further, once we refer to reference frame, we are always sensitive to associate with right-angle reference frame. And indeed, live contemporaneous scientific orthodoxy always regard right-angle reference frame as all-purpose tool to scale any existence & motion in spacetime. However, considered by Homogenous Cosmos Originated from Unique Genesis, right-angle reference frame is but an ideal assumable presence of reference frame. In strict idea, there are none absolute “right-angle reference frame” in cosmos as well as we can never find the common object in time current, just as the descriptions in ahead sections, if we define the corner profile of a railway wagon stationary on railway a norm right-angle reference frame, once the train starts off, the defined norm right-angle reference frame must be not a norm right-angle reference frame any longer; if we define a basket ball in a boy’s hand who just stands on the road a “standard sphere”, while once the boy gets on the bus and goes with the bus, then, the basket ball in boy’s hands can never be a standard sphere any longer, even the boy just stands there without any movement, if we define the basket in boy’s hands a “standard sphere” at some certain moment, once time flies away from the very moment, the basket ball in boy’s hands can never be “standard sphere” any longer, otherwise, the number of “ π ” won’t be a “irrational number”.

All in all, on one hand, in time current, there absolutely none possibility for us to find the “same object”, and on the other hand, different reference systems can never introduce the same reference frame. As a result, once we come to formulate matter motion in higher speed with remarkable relativity effect, we can not always invoke right-angle reference frame to scale the space distance and space radiation cornu, right-angle reference frame is not all-purpose space quantification reference fitting for any spacetime cases.

It seems very stupid to introduce a reference frame to scale the holistic motion of cosmos; it above all involves in issue reference frame is cosmic object belonging to cosmos or non-cosmic object belonging to non-cosmos. If the Cod arrange reference frame first, then cosmos, we introduce reference frame to scale

holistic motion of cosmos as a single object, it's still considerable; if reference frame is but cosmic endosome, we introduce reference frame to scale holistic motion of cosmos as a single object, it's apparently nonsense. For you see, the hypostatic authenticity is the reference frame is but a geometrical indication tool of existent geometrical profile of cosmic status quo, without hypostatic geometrical profile of cosmic status quo, so-called reference frame is nothing. What's the substantial evidence we can invoke so-called reference frame to scale the holistic motion of the entire cosmos, can cosmos motion as a single object? If the cosmos can go as a single object, where's the reference frame we place? And what's the so-called "reference frame"?

Big Bang is nothing; please refer to the section of "Big Bang reflected on Homogenous Cosmos Originated from Unique Genesis".

(Original text of serial question 7)

Issue about magnetic mass of electron

Considered by modern physics, magnetic mass is a part of gravitational mass, after thought of it in the recent 18 years, I think the magnetic mass is impossible to be a part of gravitational mass, there are six reasons for it as following;

The first: the stationary mass of object is intrinsic, and it is a constant, some people think that magnetic mass should be related to stationary mass of object, the energy of electromagnetic field depends on charge of object, but has nothing to do with charge quantity and motion status of charged motion object, however, gravitational mass is related to the motion status of object. Once electron accelerates, its charge won't change, and as a result, the electromagnetic mass of it won't change and the electromagnetic mass does not satisfy Lorentz transformation, So, there is obvious conflict if we think electromagnetic mass is a part of gravitational mass as long as we insist that charge of electron won't change, and it seems there is no way for us to explain such issue. In such conflict, either the correlation of mass and velocity are wrong, or the belief that the charge of electron is a constant is doubtable, whereas, it fits experimental data very well. In accordance with equation $E=mc^2$, the gravitational energy of object has negative mass, consequently, the resultant mass of system is not equal to the summation of all compositive part masses, while, in Maxwell theory, as direct result of linear theory, charges (compared with mass) can be added straightforwardly and exactly.

The second, electromagnetic force has two states of attraction and repulsion, and only under precondition objects have charges, it's possible for electromagnetic force to occur, while gravitational force exists any way; the electromagnetic force among electrons or protons is remarkably bigger than gravitation among them, so electromagnetic mass must be proportionately bigger than gravitational mass. It of course means it's impossible for electromagnetic mass to be only a part of gravitational mass. The simulated electromagnetic field energy of electron is less than the electromagnetic mass of electron as well as the simulated gravitational field energy of object is less than the gravitational mass of object. In accordance with the correlation of mass & velocity, gravitational mass can vary continuously, however, the distribution of charge and electromagnetic field is in quantum state, the unique field that modern physics do not let quantum theory involve in is gravity and large scale-structure of cosmos for it met difficulties in quantization of infinity of gravitation field. Renormalization can overcome the issue of infinity, but renormalization will means the proper value of action strength of gravitational mass can not be predicted theoretically, it must be chosen as to fit observation results, this of course implies serious shortage of renormalization. For nowadays expedient progress, I

think, the best method worthy to be recommended is when we are ready to consummate and generalize the mathematical modality of all compositive theoretical physics, we should invoke all resource of pure mathematics and try to demonstrate the proper connotations of idiographic mathematical expression each time after we have succeed along this way.

The third, as electromagnetic fields have distinctions of positive electromagnetic field & negative electromagnetic field, the electromagnetic masses of positive electromagnetic field & negative electromagnetic field should be inverse accordingly, while the gravitational mass has none distinction like this. Charges can be classified into positive charge and negative charge, however, the energy intensity of electromagnetic fields are always positive, so the resultant integration of electromagnetic field energy are always positive, and the resultant integration of electromagnetic field mass are consequentially positive too. In accordance with the second law of Newtonian mechanics, the magnitude of inertial mass of object is just the indication of stationarity consolidation of matter motion or material capital or capacity of object to maintain its initial motion state. This property has nothing to do with the distinctions of positive charge and negative charge; as a result, positive electron and negative electron have the same inertial mass, which virtually means the equivalent material capital or capability to maintain its motion stationarity. Once the positive charge and negative charge neutralized, the electromagnetic mass is added accordingly, while gravitational mass is added nothing, instead, the neutralization of positive charge and negative charge make the position energy released therein, which means the original electromagnetic mass has been transmuted into some other kind of energy as well as the neutralization of a positive charge and a negative charge proportionably releases a couple of photons, the proper electromagnetic mass has been transferred into photons. However, what's the connatural mechanism for the transmutation? Reciprocity between the same sort of charges results to repulsion, but reciprocity between diverse charges results to attraction, the electromagnetic force depends on transference of electromagnetic field, why the electromagnetic energy of electromagnetic fields is always positive? The electromagnetic energy of a neutralized atom is 0 indicates that the electromagnetic energies of positive charge and negative charge should be reverse.

The fourth, General Relativity is gravitation theory, it makes the gravitational field quantized and denoted the gravitational quantum of gravitational field "graviton". The graviton has spin 2, which is apparently different from electric field quantum of "photon". The further theoretical research of supersymmetry in the recent years has offered new possibilities for science development; the united theory of the four kinds of fundamental interactions based on supersymmetry is called the grand unified theory. Whereas, in accordance with relativity & absoluteness principle of symmetry, there is none applicable limitation of supersymmetry. The supersymmetry still demands the presence of gravitation with spin 3/2 except graviton, but none related experiments seem to support it. And further, the quantized the gravitation theory met invincible trouble of infinity.

The fifth, the gravitational mass proportionally occupies space; it has its volume, while electromagnetic mass has no volume, as a result, the point model of electrostatics is right.

The sixth, the electromagnetic mass and the gravitational mass can be dissociated, that's to say, there are fields with energy without objects exactly as Maxwell theory mentioned. And recently, scientists of France Lyons found the presence of particle made up of four neutrons, which is called "element NO. 0". The last experiments indicate that neutrino has gravitational mass, and the magnitude of neutrino mass is

about 1/50000 of gravitational mass of electron. Neutrino has gravitational mass but has no electric charge — electromagnetic mass. Modern physics thinks, except electric mesotrons, there are still neutralized mesotrons, whose gravitational mass are exactly equal to the gravitational mass of the electric mesotrons, and the properties of electric mesotron are similar as properties of neutralized mesotron. Einstein had pointed out that the wave function collapse process was incompatible with Relativity, which was virtually the earliest analysis of Einstein about the incompatibility between quantum theory and Relativity.

At that time, Einstein had realized that electric charge has no electromagnetic mass, and he pointed out that gravitational field is but an object which has nothing to do with electric field in logics. In his article, Einstein firstly reviewed the ready-made idea of relationship between inertial mass and gravitational mass, then came to analyze the discrepancy of the resultant analysis data of classical electrodynamics & quantum electrodynamics about the electromagnetic mass, and drew out his conclusion that electromagnetic mass is not a part of gravitational mass on 6 different stands, it demonstrated that the introduction of Higgs mechanism is redundant by verifying the distinctions of gravitational mass and electromagnetic mass, Higgs particle is nonexistent, it unified the quantification units “Column” of charge and “kilogram” of mass, so that it reduced the physic basal units to 5 and essentially explained the issue of radiation of stationary charge in elevator, the singular point of special relativity—stationary mass of photon, Einstein pointed out that Lorentz transformation was not fit for electromagnetic mass and the statistical idea of quantum theory did not fit for gravitational mass, it radically cleaned the Schrödinger cat paradox and generalized mass-energy equation from gravitational mass to electromagnetic mass, and it predicted new energy origin and qualitatively explained the explosion of quasi-stellar objects and overcame issue of quark confinement by quantization of electromagnetic mass, it explained the theorem light speed was unchangeable, light speed was the utmost speed of objects in cosmos, the red shift crisis of General relativity, it demonstrated the causes why the transmission speeds of gravity and electromagnetic force were equal, it predicted neutrino issue and the basis of quantum theory, in accordance with idea of spacetime essentiality of gravitational field, it solved the quarrels between Einstein and Copenhagen school of thought, I wonder whether I am right?

Issue 7.1.: Considered by modern physics, magnetic mass is a part of gravitational mass, after thought of it in the recent 18 years, I think the magnetic mass is impossible to be a part of gravitational mass,

The qualitative analysis and definition of gravitational field and electromagnetic field of Homogenous Cosmos Originated from Unique Genesis has definitely showed my idea of this issue. Electromagnetic field is but a kind of special idiographic matter field with preponderant or insufficient genic elements in, a kind of special matter field with unsaturated genic configuration as affected by PNT operation between object in unsaturated genic configuration and matter field. Of course, I have to admit I can not ensure what's the real connotation of the so-called “electromagnetic mass” and “gravitational mass” you mentioned, but still I can of course draw my positive conclusion, since the entire cosmos is throughout homogenous originated from unique genesis and the entire cosmic contents are but an absolute homogeneity system, then, in the face of any two existent objects A and B in cosmos, we can never draw such conclusion that object A is not object B. and indeed, if we can find full tangible evidences to radically prove that in cosmos, object A is substantively not object B, consequently, either such factuality has fully negated the argument of homogenous cosmos originated from unique genesis or it has indicated that the cosmos II has been practically found by us.

As coherent natura naturans throughout cosmic evolution, instinctive PNT reciprocal equilibrium towards optimum PNT operation is radical potentiality & conditionality for cosmos always ready to orientate itself towards perfection.

Issue 7.2. the stationary mass of object is intrinsic, and it is a constant, some people think that magnetic mass should be related to stationary mass of object, the energy of electromagnetic field depends on charge of object, but has nothing to do with charge quantity and motion status of charged motion object. However, gravitational mass is related to the motion status of object.

I have to admit I can not ensure what's the real connotation of so-called "electromagnetic mass", and I can not ensure what a physic phenomena the so-called "intrinsic(内禀) property of object" means herein. However, since the so-called "stationary mass" is referred here, I'd like to comment here, any so-called "stationary mass" only has relativity connotation in cosmic spacetime, because in spacetime, motion of object is absolute, any physical existence in cosmos, as long as we have reason to regard it as independent object in cosmos, it must possess absolute spacetime momentum $mV = d(M \leftarrow m)Y \iff V = d(M \leftarrow m)Y/m$, unless it can be isolated from PNT action. And as the presence of spacetime dynamic assimilation and relativity discrepancy, the mass of the earth measured by a man standing on the earth can never be equal to the mass measured by a man standing on the mars.

And I can not ensure what the so-called "mass of electromagnetic field" means too, as a result, I am not convenient to explain anything about the issue thereby. At any rate, there are substantively remarkable discrepancy in special noun and item and consequential explanation between Homogenous Cosmos Original Unique Genesis and live contemporaneous scientific orthodoxy. After all, live contemporaneous scientific orthodoxy is but sciences devoting to omnifarious material specimens in cosmos, a full basket of sciences, while Homogenous Cosmos Originated from Unique Genesis is but typical linear logic system to formulate cosmic homogenous existence & motion in the nature of essence of matter in a class by itself, it only studies cosmic existence but never involves in existence out of cosmos, although, it occasionally implicates non-material existence or non-cosmic existence, they are but foils for rationale explanation, it only studies cosmos as one object of "cosmic homogeneity system", but never professionally study this object and that object or this particle and that particle in cosmos.

Furthermore, compared with live contemporaneous scientific orthodoxy who has experienced several hundred years' historical progress, Homogenous Cosmos Originated from Unique Genesis is substantively younger and tender.

Issue 7.3.: Once electron accelerates, its charge won't change, and as a result, the electromagnetic mass of it won't change and the electromagnetic mass does not satisfy Lorentz transformation, So, there is obvious conflict if we think electromagnetic mass is a part of gravitational mass as long as we insist that charge of electron won't change, and it seems there is no way for us to explain such issue. In such conflict, either the correlation of mass and velocity is wrong, or the belief that the charge of electron is a constant is doubtable. However, it fits experimental data very well.

Reply: Considered by Homogenous Cosmos Originated from Unique Genesis, in the same reference frame, if electron accelerates in neutralized force field, the charge of electron maybe not change besides the genic configuration of the matter field changed during the course of interaction; if electron accelerates in non-neutral force field, whether the charge of electron will change depends on the attribute or characteristic state of electron under the very interaction conditions.

Let's suppose there is an object with negative charges, whose positive mass is m and the negative electric field mass of the object is M . Of course, the negative electric field mass M is made up of the neutralized part of matter field mass of the object and preponderant/insufficient genic elements in the matter field of the object. For expedience, we denote the neutralized part of the matter field mass of the object W , and denote the mass of the preponderant/insufficient genic elements in the matter field of the object Q , obviously, $M=W+Q$. Before acceleration, the state equations of the object are as following:

$$\left\{ \begin{array}{l} M+m=W+Q+m=R \\ M/m=(W+Q)/m=K(t) \\ V(t)*m=d(M\leftarrow m)(t)*Y(t) \\ L^3(t)*\alpha(t)=A*m \\ Y(t)=B*\alpha(t) \end{array} \right. \iff \left\{ \begin{array}{l} M=W+Q=K(t)*R/[1+K(t)] \\ m=R/[1+K(t)] \\ V(t)=d(M\leftarrow m)(t)*Y(t)/m \\ L^3(t)=A*m/\alpha(t) \\ Y(t)=B*\alpha(t) \end{array} \right.$$

When the object receives outside action $F(t)$, if the configuration of the outside action $F(t)$ is neutralized, in accordance with fundamental of cosmic mass conservation, no matter how much the outside action $F(t)$ is, the consequent variation is generally neutralized, and the quantity of preponderant/insufficient genic elements usually keeps constant, so the quantity of charge of the object won't change, if the outside action $F(t)$ is non-neutralized, the mass of the non-neutralized outside action is made up of neutralized mass P and mass of preponderant/insufficient genic elements Z , of course, $F(t)=P+Z$. And at the same time, as the input of outside action $F(t)$, both the positive mass and matter field mass of the charged object will proportionably change, we denote the positive mass variation of object m' and denote the electric field mass variation of object M' , then, the state equations of the matter integration can be expressed as following:

$$\left\{ \begin{array}{l} M+M'+m+m'=W+Q+m+P+Z=R+P+Z \\ M+M'/m+m'=(W+Q+M)/(m+m')=K(t) \\ V(t)*(m+m')=d(M\leftarrow m)(t)*Y(t) \\ L^3(t)*\alpha(t)=A*(m+m') \\ Y(t)=B*\alpha(t) \end{array} \right. \iff \left\{ \begin{array}{l} M+M'=W+Q+M'=K(t)(R+P+Z)/[1+K(t)] \\ m+m'=(R+P+Z)/[1+K(t)] \\ V(t)=d(M\leftarrow m)(t)*Y(t)/m+m' \\ L^3(t)=A*(m+m')/\alpha(t) \\ Y(t)=B*\alpha(t) \end{array} \right.$$

In accordance with the fundamental of mass conservation in the same inertial frame reference, we come to analyze the distribution, transference & transmutation of the neutralized mass & preponderant/insufficient genic elements among the positive matter & matter field of matter integration.

$$M+M'=W+Q+M' \qquad m+m'=(R+P+Z)/(1+K(t))$$

The very issue is whether the mass quantity Z of outside action input $F(t)$ will impact the magnitude of positive mass and electric field mass of the matter integration of object, if the quantity Z of outside action input $F(t)$ directly impacts the magnitude of positive mass and electric field mass of matter integration of object, as the genic configuration of mass quantity Z is non-neutralized, the infiltration of mass quantity Z to positive mass and electric field must impact the genic configuration of positive matter & electric field, either strengthens the non-neutralized genic configuration of positive matter and the preponderant or insufficient genic elements rate of electric field, or weakens the non-neutralized genic configuration of positive matter and the preponderant or insufficient genic elements rate of electric field. This of course means the variation of charge of object.

And of course, if the charged object mentioned here is just a single electron, such case of course means

As coherent natura naturans throughout cosmic evolution, instinctive PNT reciprocal equilibrium towards optimum PNT operation is radical potentiality & conditionality for cosmos always ready to orientate itself towards perfection.

the variation of charge quantity of single electron. And the key issue we usually find the charge quantity of single electron relatively steady may be because the structural mechanism of single electron is relatively steady with strong anti-variation capability. In general status, electrons are much more feasible to proportionately adapt surrounding conditions variation by motion status readjustment or radiating electromagnetic waves instead of readjusting the genic configuration of electron. But this does not means the charge quantity of electron can not be changed, but means the charge quantity of electron is generally not easy to be changed. And virtually, in cosmic homogeneity system, any unchangeable object can only be nonexistent in cosmos.

Issue 7.4. According to equation $E = mc^2$, the gravitational energy of object has negative mass, consequently, the resultant mass of system is not equal to the summation of all compositive part masses, whereas, in Maxwell theory, as direct result of linear theory, charges (compared with mass) can be added straightforwardly and exactly.

Reply: Homogenous Cosmos Originated from Unique Genesis has the same idea too. Let's suppose there are two celestial bodies in reciprocity of gravity and ultimately turn into one celestial body, if during the course of gravitational reciprocity, there is not any energy exhaust, then the mass of the ultimate consequent one celestial body must be a little bigger than the summation of the two original celestial bodies in gravitational reciprocity. Not only mass variation of matter integration in gravitational reciprocity is like this, but also mass variation of matter integration in electromagnetic reciprocity, strong interaction or weak interaction are like this too.

The key issue exists in the functional correlation of negative over positive mass quotient K and the matter field mass M & the positive mass m of matter integration as inertial conservation equation " $M/m=K$ ". Considered by Homogenous Cosmos Originated from Unique Genesis, the magnitude of negative over positive mass quotient K is directly related to the motion velocity and mass scale of matter integration. Generally, the bigger the velocity of object is, the bigger the magnitude of K is, and at the same, the bigger the mass of object is, the less the magnitude of K is. And here, according to the issue, we emphatically analyze the case of the bigger the mass of object is, the less the magnitude of K is.

Let's suppose there are matter integration A and matter integration B in reciprocity of attraction (no matter the reciprocity between matter integration A and matter integration B is electromagnetic attraction, strong interaction, weak interaction or gravity), their positive mass of object and negative mass of matter field are separately m_1, M_1 and m_2, M_2 , which satisfy $m_1+M_1=R_1, m_2+M_2=R_2$, before the both matter integration combining into one matter integration for attraction, their separate existent states satisfy $M_1/m_1=K_1, M_2/m_2=K_2$. In accordance with fundamental of cosmic mass conservation in the same reference frame, before the both matter integration combining into one resultant matter integration, the total mass of matter integration A and matter integration B satisfies: $(M_1+M_2)_b+(m_1+m_2)_b=R_1+R_2$ (In the equation, the subscript letter "b" is just the abbreviation of "before"); after the both matter integration combining into one resultant matter integration, the total mass of matter integration A and matter integration B still satisfies $(M_1+M_2)_a+(m_1+m_2)_a=R_1+R_2$ (In the equation, the subscript letter "a" is just the abbreviation of "after"). It's easy for us to see $(M_1+M_2)_b+(m_1+m_2)_b=(M_1+M_2)_a+(m_1+m_2)_a$, the mass summation of matter integration A and matter integration B before the both matter integration combining into a resultant matter integration is equal to the resultant mass after the both matter integration combined into one matter integration. However, the key issue is, if we denote $(M_1+M_2)_b/(m_1+m_2)_b=K_A$ before the both matter integration combining

into one matter integration, and denote $(M_1+M_2)_a+(m_1+m_2)_a=K_B$ then, after the both matter integration combining into one compound matter integration, whether the K_A and K_B still satisfy $K_A=K_B$? If not, it of course implies $(m_1+m_2)_b \neq (m_1+m_2)_a$.

Considered by Homogenous Cosmos Originated from Unique Genesis, the larger mass of object is, the more consummated the spacetime convergent mechanism of matter integration is, and consequently, the structure of matter field is more efficient, the negative over positive mass quotient K is relatively smaller. The situation is generally similar as if we build a small reservoir need 1000 m^3 concrete to build the dyke, while if we build a large reservoir of 10 times scale of the small one, the concrete we have to use to have the dyke built up may be less than $1000 \times 10 = 10000 \text{ m}^3$.

Once the two matter integration combine into one resultant matter integration, the existent state of matter integration satisfy $(M_1+M_2)_a+(m_1+m_2)_a=R_1+R_2$, $(M_1+M_2)_a+(m_1+m_2)_a=K_B$, as long as there is not remarkable energy exhaustion of matter integration, there must be occurrence that $(M_1+M_2)_a$ is slightly less than M_1+M_2 , and proportionably, $(m_1+m_2)_a$ is slightly less than m_1+m_2 , and as a result, K_A is slightly less than K_B . That's to say, on the progressive tendence towards relatively generative and steady existence of matter in spacetime, all material combination leading by strong interaction, electromagnetic attraction or positive gravity are active actions trending to optimum convergence mechanism of matter integration in spacetime, in another word, attraction combination is just the optimization extension of convergent mechanism of matter integration in spacetime. Attraction combination can make objects "fat", and even make the object "lazy". And indeed, during the course of cosmic evolution, the progressional process that fragmentary particles in high energy state gradually combine into heavy particles, atoms, molecules ... gas, liquid, solid, non-living things, living things ... celestial bodies, galaxies is just the successive optimization engineering of generation and confirmation of cosmic matter in spacetime.

And in fact, in accordance with the symmetry fundamental of cosmic evolutionary reversibility, since we've perceived that nuclear fission can lead mass of atom decrease, we then should sensitively associate whether the inverse process can lead mass of atom increase? Since we've perceived that crushing a block will exhaust rather a lot of energy, we then should sensitively associate whether the inverse process will release a lot of energy. If the energy exhausted is not exactly proportional to the energy the inverse process released, as the mass and energy are equivalent, we then should sensitively associate whether there is proper mass variation throughout the both reversible process?

(I have very poor knowledge about Maxwell theory)

Issue 7.5. electromagnetic force has two states of attraction and repulsion, and only under precondition object has charges, it's possible for electromagnetic force to occur, but gravitational force exists any way; the electromagnetic force between electrons or protons is remarkably bigger than gravitation, electromagnetic mass is remarkably bigger than gravitational mass, it of course means it's impossible for electromagnetic mass to be only a part of gravitational mass. The simulated electromagnetic field energy of electron is less than the electromagnetic mass of electron as well as the simulated gravitational field energy of object is less than the gravitational mass of object.

Reply: This paragraph is very difficult for me to understand, say truly, I can hardly ensure what are the meanings of the so-called "electromagnetic mass" and the so-called "gravitational mass", so I am not convenient

As coherent natura naturans throughout cosmic evolution, instinctive PNT reciprocal equilibrium towards optimum PNT operation is radical potentiality & conditionality for cosmos always ready to orientate itself towards perfection.

to say anything about this issue.

But, I'd like to emphasize herein that the so-called gravitational field live contemporaneous scientific orthodoxy mentioned is just the matter field, and matter field is a sort of neutralized and saturated field. Electromagnetic field is but affected matter field with preponderant/insufficient genic elements in. Positive electric field & negative electric field are affected matter fields with mutually complementary genic preponderance/insufficiency in, as a result, once the two disturbed electric fields with the same genic preponderance/insufficiency, the reciprocity between the two matter integration exhibits electromagnetic repulsion; once the two disturbed electric fields with complementary genic preponderance/insufficiency, the reciprocity between the two matter integration exhibits electromagnetic attraction, because any matter integration has instinct to maintain its neutral genic configuration (Please refer to the section of "force field" and "force").

Furthermore, I can hardly understand why modern physics always try to emphasize and verify that some certain object A is not another object B (For example, "it's impossible for electromagnetic mass to be only a part of gravitational mass"). I think, if modern physics would like to say so, he must negate the factuality that cosmos is throughout homogenous originated from unique genesis in advance, otherwise, since the entire cosmos is purely homogenous originated from "unique genesis", and all hyllic existence in cosmos are homology, what we can quote to say object A is not object B, this one is not that one or that one is not this one? Is there still a second original genesis in cosmos? Or one of the electromagnetic mass and gravitational mass exists in cosmos, while the other exists out of cosmos? What can we quote to perceive the existence out of cosmos?

Issue 7.6.: In accordance with the correlation of mass & velocity, gravitational mass can vary continuously, however, the distribution of charge and electromagnetic field is in quantum state, the unique field that modern physics do not let quantum theory involve in is gravity and large scale structure of cosmos for it met difficulty in quantization of infinity of gravitation field. Renormalization can overcome the issue of infinity, but renormalization will means the proper value of action strength of gravitational mass can not be predicted theoretically, it must be chosen as to fit observation results, this of course implies serious shortage of renormalization.

Reply: Under the precondition that cosmos is throughout homogenous originated from unique genesis, as long as we have no reason to negate the existence of "unique-genesis i_0 ", we then have none reason to throw suspicion to the "quantization of the entire cosmic existence and even the cosmic process". It can be affirmed, under the precondition that cosmos is throughout homogenous originated from unique genesis, all the continuation in cosmos are relative, and instead, only quantization is absolute. There is remarkable discrepancy between traditionary quantum theory and quantization of Homogenous Cosmos Originated from Unique Genesis. Considered by Homogenous Cosmos Originated from Unique Genesis, the so-called "quantum" in cosmos can only be a single "unique-genesis i_0 ", and the so-called "quantization distribution of charge" may be directly related to some certain relatively steady-going genic configuration unit.

Issue 7.7.: For nowadays expedient progress, I think, the best method worthy to be recommended is when we are ready to consummate and generalize the mathematical modality of all compositive theoretical physics, we should invoke all resource of pure mathematics and try to demonstrate the proper connotations of idiographic mathematical expression each time after we've succeed along this way.

Reply: as poor knowledge in this field, I'd like to withdraw my sciolism about this issue at present. If interested in, readers can refer to section (II-iii) "Spacetime Distance" and "Space Radiation Cornu" —the terminal part of "Cosmic connotation of ' π '", section (IV-i) full-meaning of Homogenous Cosmos Originated from Unique Genesis—(3). PNT dynamic principle rooting in cosmic sequential homogenous evolution and (4). Homogenous characters of cosmic physical quantification rooting in the precondition of homogenous cosmos originated from unique genesis and section (IV-iv) Introduction of atom state equation in spacetime. At present, the rationale profile of Homogenous Cosmos Originated from Unique Genesis has been relatively explicit; the task of top priority is systematical quantification of the linear logic system and the proper experimental demonstrations.

The further development and consummation of Homogenous Cosmos Originated from Unique Genesis will firstly demands revolution of related mathematics. As bewildered by conventional ideas of physics, there is a demonian default precondition in our temporal mathematics that rectangular coordinative system is an everlasting constant object and applies universally in spacetime, or in another word, temporal mathematics only face quantitative change and symbolic logic under "rectangular coordinate system", but never study, even never realize the presence of non-rectangular coordinate system and the changeability of coordinative system in spacetime. Considered by Homogenous Cosmos Originated from Unique Genesis, as geometric quantification criterion of spacetime, as the changeability of spacetime, coordinative systems have different geometric connotation in different space fields, even the same coordinate system we confirmed in prior (for example, it's just the standard rectangular coordinate system in our norm spacetime) exists in different space fields, the same coordinate systems must have different geometric connotation in different space fields for the disparity of space fields. Just the same as light speed can not be constant in so-called vacuum (different space fields), coordinate systems can not be a constant geometric quantification criterion universally, and indeed, rectangular coordinate system is but special instance in coordinate system series. And on the stand of mathematics, the changeability of coordinate systems in space fields of course means the presence of geometry in characteristic/idiographic space field or variable-dimension geometry (including variable-dimension analytic geometry), and the so-called variable-dimension geometry and the dynamic variation of existence & motion of objects in space field is essentially coherent.

For instance, in our standard space field, there is a standard right-angled triangle, according to the symbolic logic in default rectangular coordinate system; the length of the three sides of the standard right-angled triangle must satisfy the Pythagorean Theorem. However, in nonstandard space field, as the variation of space radiation cornu, is it impossible for the original standard right-angled triangle to be still standard right-angled triangle with the same geometric connotation? And as the disparity of space field, the length of the three sides of the original standard right-angled triangle changed consequently is it still possible for the three sides to satisfy the Pythagorean Theorem? If we just to keep the standard right-angled triangle accelerating in nonstandard spacetime, is it possible for the dynamic variation of the standard right-angled triangle in nonstandard spacetime just the same as the dynamic variation of the standard right-angled triangle in standard spacetime?

Issue 7.8.: As electromagnetic fields have distinctions of positive electromagnetic field & negative electromagnetic field, the electromagnetic masses of positive electromagnetic field & negative electromagnetic field should be inverse accordingly, while the gravitational mass has none distinction like this. Charges can be classified into positive charge and negative charge, however, the energy intensity of electromagnetic fields

are always positive, so the resultant integration of electromagnetic field energy are always positive, and the resultant integration of electromagnetic field mass are consequentially positive too.

Reply: Considered by Homogenous Cosmos Originated from Unique Genesis, positive electric field and negative electric field are but two kinds of electric field with mutually complementary genic preponderance /insufficiency, and positive electric field + negative electric field can only result to consummate neutralization of genic integration configuration of matter field or result to neutralization counterbalance of preponderant genic elements and insufficient genic elements. Because, as long as we admit that cosmos is throughout homogenous originated from unique genesis, we then have to admit entire cosmic contents exist in an absolute homogeneity system thereby, and universal existence & motion in such homogeneity system are but limited in structural or state transference and transmutation among objects. There are none annihilation interaction in cosmic homogeneity system.

Issue 7.9. In accordance with the second law of Newtonian mechanics, the magnitude of inertial mass of object is just the indication of stationarity consolidation of matter motion or material capital or capacity of object to maintain its initial motion state. This property has nothing to do with the distinctions of positive charge and negative charge; as a result, positive electron and negative electron have the same inertial mass, which virtually means the equivalent material capital or capability to maintain its motion stationarity. Once the positive charge and negative charge neutralized, the electromagnetic mass is added accordingly, while gravitational mass is added nothing, instead, the neutralization of positive charge and negative charge make the position energy released therein, which means the original electromagnetic mass has been transmuted into some other kind of energy as well as the neutralization of a positive charge and a negative charge proportionately releases a couple of photons, the proper electromagnetic mass has been transferred into photons. However, what's the connatural mechanism for the transmutation?

Reply: Homogenous Cosmos Originated from Unique Genesis, inertial mass is not limited by any characteristic factor of object, as long as it is mass of positive matter in cosmos, it is unconditionally subject to law of identity inertial regularity. And indeed, in matter inertial conservation equation, the quantity “m” of mass of positive matter in equation $M/m=K$ has none additional attributive conditions.

Referred to the issue of transmutation mechanism, I think, it is necessary for us to refer to energy of position, and for this, we have to refer to the qualitative definition and of electromagnetic field and perfect PNT operation pattern.

Electric field is just the affected matter field with genic preponderance/insufficiency, electric field is a kind of non-neutralized matter field in genic configuration. And on the other hand, the genic configuration of matter field directly impacts the PNT operational efficiency of genic circular chain, if the genic configuration of matter field is fully neutralized, the efficiency of genic circular chain of PNT operation will be best; if the genic configuration of matter field is not neutralized, the genic circular chain of PNT operation will arise interlinkage default or local infarction, so as to make the efficiency of genic circular chain of PNT operation not in its norm way, the more the genic configuration of matter field deviates its original neutralized genic configuration, the more the efficiency of genic circular chain of PNT operation will deviate its best status. Energy of position is just a sort of energy caused by interlinkage default or local infarction of genic circular chain of PNT operation, once the interlinkage default or local infarction of genic circular chain of PNT operation

meet possible complementary optimization, the PNT operation will consequently turn back to its norm status, $d(m \rightarrow M)$ increase thereby, energy of position consequently turns into kinetic energy of matter integration.

In a simple word, the reciprocal coupling between complementary preponderant genic elements in matter field and insufficient genic elements in matter field is just the instinctive PNT reaction of genic configuration optimization, and such PNT reaction make the genic circular chain tend to optimum as to make the PNT operation easy and smooth, so that $d(M \leftarrow m)$ consequently increase and energy of position turn into kinetic energy thereby.

Thus, we are easy to associate with that a neutralized matter integration existing in electromagnetic field, its PNT operation will be influenced by the slack PNT operation of electromagnetic field. According as $mV = d(M \leftarrow m)Y$, we can deduce that a clock in electromagnetic field must go a little slower than a clock goes in a neutralized matter field with general the same space field strength.

Issue 7.10.: Reciprocity between the same sort of charges results to repulsion, but reciprocity between diverse charges results to attraction, the electromagnetic interaction depends on transference of electromagnetic field, why the electromagnetic energy of electromagnetic fields is always positive? The electromagnetic energy of a neutralized atom is 0 indicates that the electromagnetic energies of positive charge and negative charge should be reverse.

Reply: Virtually, we can not only consider the resultant state —electromagnetic energy of neutralized atom is 0, instead, we should come to comprehend the “electromagnetic energy of neutralized atom is 0” through an appropriate process. Because, in fact, the electromagnetic energy of neutralized atom is 0 is because the energy of position of positive charge and the energy of position of negative charge have neutralized and transmuted into some other kind of energy, this does not means the value of energy of position of positive charge is positive and the value of energy of position of positive charge is positive inversely, and the energy of position of positive charge added to energy position of negative charge but means the genic configuration of positive electric field and negative electric field has been reciprocally and instinctively neutralized, whereas, the energy essentiality of both energy of position of positive charge and energy of position of negative charge is just the same.

Issue 7.11.: The gravitational mass proportionably occupies space; it has its innative volume. Whereas, electromagnetic mass has no volume, so the point model of electrostatics is right.

I do not know what the exact definition of electromagnetic mass of live contemporaneous scientific orthodoxy is; as a result, I am not convenient to comment about this issue at present.

But, I'd like to emphasize here, on the stand of Homogenous Cosmos Originated from Unique Genesis, it maybe not too appropriate to say mass “occupies” space, because, in cosmic homogeneity system, space and matter are but two coordinative hylic objects, they are but different outgrowths of cosmic evolution of sequential homologous cosmogony in lineal stage. It substantively seems not conformable to the behavior logic of cosmic homogenous evolution if we say mass occupies space. And I even suspect there is some misapprehension of the homogenous correlation between mass of positive matter and space therein.

Issue 7.12.: At that time, Einstein had realized that electric charge has no electromagnetic mass, and he pointed out that gravitational field is but an object has nothing to do with electric field in logic.

Virtually, the factuality of “gravitational field is but an object has nothing to do with electric field in logic” is

As coherent natura naturans throughout cosmic evolution, instinctive PNT reciprocal equilibrium towards optimum PNT operation is radical potentiality & conditionality for cosmos always ready to orientate itself towards perfection.

just full negation of homogenous cosmos originated from unique genesis, because on the stand of homogenous cosmos originated from unique genesis, entire cosmic contents exist in an absolute homogeneity system, they are all innately associated in a homology system, it's completely impossible for homogenous cosmos to adulterate such two objects which absolutely have nothing to do with each other in logic. And indeed, if some body can find such two objects in cosmos, it can be proved that there is completely no correlation between the two objects in logic, then, he either has radically negated homogenous cosmos originated from unique genesis, or he has substantively found the cosmos II already. I wonder what the original rationale is for Einstein to draw such conclusion.

Issue 7.13.: In his article, Einstein firstly reviewed the cognition of the relationship between inertial mass and gravitational mass, then came to analyze the discrepancies of the resultant analysis data of classical electrodynamics and quantum electrodynamics about the electromagnetic mass, and drew out his conclusion that electromagnetic mass is not a part of gravitational mass on 6 different stands, it demonstrated that the introduction of Higgs mechanism is redundant by verifying the distinctions of gravitational mass and electromagnetic mass, Higgs particle is nonexistent, it unified the quantification units "Column" of charge and "kilogram" of mass, so that it reduced the physic basal units to 5 and essentially explained the issue of radiation of stationary charge in elevator, the singular point of special relativity ——stationary mass of photon, Einstein pointed out that Lorentz transformation was not fit for electromagnetic mass and the statistical idea of quantum theory did not fit for gravitational mass, it radically cleaned the Schrödinger cat paradox and generalized mass-energy equation from gravitational mass to electromagnetic mass, and it predicted new energy origin and qualitatively explained the explosion of quasi-stellar objects and overcame issue of quark confinement by quantization of electromagnetic mass, it explained the theorem light speed was unchangeable, light speed was the utmost speed of objects in cosmos, the red shift crisis of General relativity, it demonstrated the causes why the transmission speeds of gravity and electromagnetic force were equal, it predicted neutrino issue and the basis of quantum theory, in accordance with idea of spacetime essentiality of gravitational field, it solved the quarrels between Einstein and Copenhagen school of thought, I wonder whether I am right?

In the face of such description from professor Li, I am so confused. And the information above makes me even aware of the discrepancy between live contemporaneous scientific orthodoxy and Homogenous Cosmos Originated from Unique Genesis. At any rate; live contemporaneous scientific orthodoxy is but a basket of sciences about so omnifarious objects around us, while Homogenous Cosmos Originated from Unique Genesis is but coherent logic system about homogenous cosmos, ——a unique hylic genesis evolves into a cosmic homogeneity system, a cosmic homogeneity system, gestates a universal dynamic principle, a universal dynamic principle regularizes a harmonious cosmos. No matter whether these omnifarious local arguments have made authenticity of nature even confused or not, I substantively felt the local arguments too wanton to have agitated the cognition. I am genuinely puzzled to confront so omnifarious local arguments like these, and I wonder whether the nature is originally so onefold or my thought is too onefold?

(Original text of serial question 8)

What makes superconductor to be applicable super quality resistor? What's the current progress of superconductor study? How modern sciences come to know the causes geomagnetic field coming into

being and angle deviation of geomagnetic field? Is there even more fundamental regularity behind wave diffraction? What's the essentiality of total reflection? Is it possible to explain it on the stand of photon itself? —Wave-particle dualism, do the other waves still have property of total reflection? How to introduce them to practical application? Total reflection indicates that photon does not always transmit along direct line in the same medium. Energy minimum principle confirmed that object can be steadiest only when it exists in energy minimum state, is there still even more fundamental regularity behind them?

Reply: We pursue superconductor is but to find an ideal material medium for transmission of electric power, which can support electric power to transmit along without any exhaustion and not to transmute into any other kind of energy (such as heat energy, electromagnetic radiation etc). Theoretically, as there is no possibility for anything in cosmos to keep it absolutely constant, there is none absolute superconductors in cosmos. However, since photon can be transmitted in vacuum “nearly as a constant”, such factuality enlighten us that it maybe possible for us to fabricate a sort of conductive medium which support electric power to transmit in as photons transmit in vacuum. The causes that photons can transmit in vacuum nearly as a constant is that vacuum has offered perfect and relatively steady-going ambient conditions for PNT performance of photons without any contributing factors to consume or transfer energy of photons.

In order to find superconductor rationally and expediently, the key issue is that we should be aware: the first, what are the sufficient conditions for perfect transmission of electric power; the second, what are the general obstructive factors which maybe ignorantly mix in or adulterate in the actions of the sufficient conditions for perfect transmission of electric power.

Once we have been aware of what the sufficient conditions are for perfect transmission of electric power, in terms of the issue what is ideal material for us to produce superconductor, our research then immediately are not as blind fishers fishing on boundless sea any longer, instead, and all accessible rich & colorful material resource will consequently be under our sensitive discernment & choice; once we have been aware of what the general obstructive factors are, which maybe ignorantly mix in or adulterate in actions disturbing the perfect performance of sufficient conditions for perfect transmission of electric power, then, towards the very ideal material choice, what is still necessary for us to consummate in our production process as to materialize physical function of superconduction will be self-evident.

—for you see, the nature is always ready to proliferate objects by the light of nature, but never specially create objects in accordance with human's practical necessities. Originally, the nature has possessed of full connatural mechanisms for telephone, television set, computer etc to run accordingly since the moment cosmos coming into being, but before human practically materialize one, the nature never favor human any ready-made telephone, television set, computer,... There is only possibility for human to create themselves telephone, television set, computer, ... under precondition human have mastered the related regularities of nature in advance and creatively introduce and organize the proper regularities to encash human's necessity. And once we've mastered the sufficient conditions for perfect transmission of electric power, in accordance with our idiographic ideal material choice, we can materially encash the sufficient conditions for perfect transmission of electric power successfully; superconductor will consequently become our products. This is just something about “science” & “technology”, —social production practice under guidance of scientific idea.

(Original text of serial question 9)

As coherent natura naturans throughout cosmic evolution, instinctive PNT reciprocal equilibrium towards optimum PNT operation is radical potentiality & conditionality for cosmos always ready to orientate itself towards perfection.

Modern physics confirms that weak interaction & strong interaction can only be applicable in microcosm, but there is no definite demarcation line between microcosm and macrocosm, there is explicit incoordination, and it's obviously incoherent in thought of cosmic holographic unified theory. Modern physics has unified the electromagnetic force and strong interaction, but electromagnetic force between the same charges is electromagnetic repulsion, whose behavioral orientation of action is inverse compared with action orientation of strong interaction, how to explain such incoordination? I have illuminated the correlations among the four fundamental forces that gravity and weak interaction, electromagnetic force and strong interaction are mutually inverse reciprocity, and on the basis of such groundwork, I explained the issues of cosmic constant, dark matter and dark energy, which radically negated Big Bang theory and the presence of Dark Hole, qualitatively explained the issue of precessional motion of DI Haggles double stars "(DI 海格立斯双星进动)", which may be helpful to the study of unified field theory, I wonder whether I am right?

Issue 9.1. Modern physics confirms that weak interaction & strong interaction can only be applicable in microcosm, but there is no definite demarcation line between microcosm and macrocosm, there is explicit incoordination, and it's obviously incoherent in thought of cosmic holographic unified theory.

Reply: All in all, since cosmos is throughout homogenous originated from unique genesis, and entire cosmic contents exactly exist in an absolute homogeneity system, none non-cosmic-homologic object can be adulterated in, there is of course no definite demarcation line between this object and that object in essence, no more definite demarcation line between microcosm and macrocosm. Homogenous Cosmos Originated from Unique Genesis can never have reasons to admit the distinctions of the so-called four fundamental forces.

At any rate, force is but a unique coherent notion in cosmos, which is but dynamic domino effect of instinctive PNT reciprocal equilibrium towards optimum PNT operation due to presence of PNT operational disturbance. live contemporaneous scientific orthodoxy confirms there are totally four types of fundamental forces in cosmos is but because there are substantively four idiographic manners or contributing factors for matter integration to lose its PNT balance (Please refer to the section of "force field" and "force" for details, if necessary.)

In a simple word, strong interaction is but reciprocal PNT action interconnection domino effect among particle matter integration with mutually complementary PNT operational linkages. ——To any two particles in spacetime whose both PNT operational opposites of "M→m" & "M←m" seem remarkably separate in circulatory rhythm for its limited genic integration, once the on-going PNT performance of one particle arises preponderance of "M→m", synchronously, the on-going PNT performance of the other particle arises preponderance of "M←m". Apparently, the synchronous presence of preponderance of "M→m" and preponderance of "M←m" are reciprocally complementary, as long as the both particles are near enough, the both reciprocally complementary preponderance of "M→m" and preponderance of "M←m" will spontaneously interconnect each other by the light of nature and so as to form interaction of strong interaction. The idiographic interaction manner of strong interaction can generally be illustrated as below:

$$(P^{\perp}N)_1 \overset{T}{\leftrightarrow} (P^{\perp}N)_2$$

In the illustration above, $(P^{\perp}N)_1$ and $(P^{\perp}N)_2$ separately denote the positive & negative transmutation process of particle 1 and particle 2; " \leftrightarrow " indicates the mutually complementary infiltration correlation of

the both PNT performance of particle 1 and particle 2, the letter “T” above the \leftrightarrow denotes the association manner of the both PNT performance, —transference and transmutation of mutually complementary infiltration, and virtually, the letter “T” is just the abbreviation of “transference” or “Transmutation”.

Strong interaction & weak interaction are typical short distance interactions (Please refer to section of “force field” and “force” for details). Strong interaction of course can only be applicable in microcosm, because it's only possible for particles with PNT operational opposites of “ $M \rightarrow m$ ” & “ $M \leftarrow m$ ” remarkable separation in circulatory rhythm to possess mutually complementary resource for instinctive PNT reciprocal equilibrium towards optimum PNT operation, The transition in interaction profile of strong interaction along tendency from microcosm to macrocosm is starting at strong interaction to gravitational attraction.

Issue 9.2.: Modern physics has unified the electromagnetic force and strong interaction, but electromagnetic force between the same charges is electromagnetic repulsion, whose action behavioral orientation is inverse compared with the action orientation of strong interaction, how to explain such incoordination?

I think the answer of issue 9.1 has implied the answer to the issue 9.2. if necessary, please refer to section of “force field and force”)

Issue 9.3. I have illuminated the correlations among the four fundamental forces that gravity and weak interaction, electromagnetic force and strong interaction are mutually inverse reciprocity, and on the basis of such groundwork, I explained the issues of cosmic constant, dark matter and dark energy, which radically negated Big Bang theory and the presence of Dark Hole, qualitatively explained the issue of DI Haggles double star precessional motion “(DI 海格立斯双星进动)”, which may be helpful to the study of unified field theory, I wonder whether I am right?

Reply: I can hardly understand what you mentioned here, and I know nothing about the so-called “unified field theory”. However, considered by Homogenous Cosmos Originated from Unique Genesis, there is but space field in cosmos, as the convergent concentration existence of positive matter in spacetime and the presence of innate PNT correlation between positive matter and spacetime, there is outgrowth consort field of positive matter, —proportionate consort matter field of idiographic positive objects come into being thereby. If genic configuration of positive matter is non-neutral, as the connatural and everlasting PNT operation between positive matter and matter field, the proper matter field must be affected, so that the genic configuration of matter field is similarly non-neutral with genic preponderance or genic insufficiency too, we call the affected matter field with genic preponderance/insufficiency “electric field”. However, I can hardly comprehend why there are still so many people in traditionary alignment devoting themselves to the so-called “unified field theory”, is it romanticism that we artificially break the vase into pieces in prior for opportunity to show off our clever feat of vase agglutination off the cuff?

The essence of matter can only inherently come into being during the course of original generation of matter and be congenitally kept with matter existing as idiographic objects under the proper generative and formative preconditions. As long as we can confirm the demiurge can only create matter according to demiurgic fundamental of identity throughout cosmic evolution, but not create matter A in this way a little now and create matter B in that way a little then, original generation of matter in the nature of coherent natura naturans brings out essence of matter in a class by itself, essence of matter in a class by itself predestines thorough coherence of dynamic regularity of universal existence & motion——spontaneous occurrence of dynamic objectification

As coherent natura naturans throughout cosmic evolution, instinctive PNT reciprocal equilibrium towards optimum PNT operation is radical potentiality & conditionality for cosmos always ready to orientate itself towards perfection.

of matter essence in a class by itself. And indeed, as spontaneous occurrence in the nature of matter essence in a class by itself, thorough coherence of dynamic regularity of universal existence & motion is but logic extension of matter essence in a class by itself, and it's almost impossible for so coherent essence of matter to bring out four fundamental forces in the nature.

This is just the root cause for us to sparkplug “it's only possible for concordant cosmos to be demiurgic aggradation of out-and-out serial natura naturata in the nature of coherent natura naturans throughout cosmic evolution; there is no way for demiurgic aggradation in the nature of different natura naturans to be concordant cosmos through and through”.

During the course of historical progress of sciences, human came to confront this kind of mechanic phenomena in this kind of occasion and that kind of mechanic phenomena in that kind of occasion by recessive regularity, under certain historical background, as poor backup of fecund thought resource and feasible exploration practice, it's only possible for us to perceive and study this kind of mechanic phenomena and that kind of mechanical phenomena like making fun of this apple or that apple on tip of our fingers. As a result, we were of course more feasible and sensitive to perceive more of their separate perceivable “thumbprint” but short of practical possibility to throw light on their coherent origin of nature under general demiurgic background of cosmic evolution.

After all, at the very historical stage, in the face of the very issue, no matter how poor our backup thought resource was, no matter how insensitive our groping ability was and no matter how quintessential or vulgar our accessible perception gain was, we had no reasons to mishandle our practical exploration feasibility and accessible approach upon our perception under the very historical background. As a result, we just separately partitioned and defined them YY interaction, ZZ interaction ... offhand in accordance with accessible thumbprints of the very mechanical phenomena stochastically perceived by us. At any rate, we should content with our lot and should not maltreat our historical feasibility & accessibility on the basis of temporal groundwork. After all, there is only feasibility & possibility for men in different ages to draw their historical conclusions against backup of the commensurate background then and there; succedent generation can only review on their own historical stage but no way to materialize their wisdom in prior.

In a straightforward word, the partition and definition of the so-called four fundamental forces is obviously not harmonious with the demiurgic law of identity of nature, and at the same time, it was undoubtedly leashed by historical feasible sequence and cauterized factitious inherence due to crescive progression of historical progress of science, it may be behavior human have to artificially break the vase into pieces for expedience to perceive the inner connotation for the moment as historical limitation without better alternatives. However, on the basis of such historical groundwork, so many of us successively stood out to show off clever feat of vase agglutination off the cuff now. Is it esoteric game of hide-and-seek in unnoticed humanistic confusion?

I am puzzled indeed; may such endeavor for unification of so-called four fundamental forces make authenticity of nature even confused?

——Dec. 2005. Zhenzhu town. Wugang city, Hunan province.



It's only possible for concordant cosmos to be demiurgic aggradation of out-and-out serial natura naturata in the nature of coherent natura naturans throughout cosmic evolution; there is no way for demiurgic aggradation in the nature of different natura naturans to be concordant cosmos through and through.

As coherent natura naturans throughout cosmic evolution, instinctive PNT reciprocal equilibrium towards optimum PNT operation is radical potentiality & conditionality for cosmos always ready to orientate itself towards perfection.

The Eighth Part

Historical Progress of Science in Inherent Optimum Orientation Towards Perfect Ideological Enantiomorph of Ultimate Authenticity of Nature

Forward

As multiple concept with double significance of “social connotation” & “natural connotation”, so-called “science” is humanistic ideology about authenticity of accessible existence & motion around us derived from timely scientific knowledge proliferation of human, humanistic ideology about authenticity of nature in proportion to contemporaneous historical background.

And just because

A) “Matter” is external ideographic origin of humanistic ideology about authenticity of nature, and humanistic ideology about authenticity of nature is just ideological enantiomorph of accessible existence & motion around us.

B) The uniqueness & invariance of ultimate authenticity of nature predestines the proportionate unique possibility of scientific verity as perfect ideological enantiomorph of ultimate authenticity of nature which tallies with ultimate authenticity of nature 100 over 100.

C) Practical accomplishment of historical progress of science must condition crevice progression of practical feasibility & possibility in proportion to contemporaneous historical background.

As out-and-out social work outgrowth and humanistic ideology about authenticity of nature in proportion to contemporaneous historical background, science is multiple concept with double significance of “social connotation” and “natural connotation” which is inherence of science in the nature of things.

①. Natural connotation of science

The “natural connotation” of science firstly derives from that accessible “existence & motion of matter” is external ideological origin of humanistic ideology about authenticity of nature. In another words, as commensurate ideological enantiomorph of accessible

Historical progress of science in the recent several centuries seemed like a far-flung exploration of the first itinerary around numerous distinctive landscapes of brand-new landmasses of science with palette & tablet on back, several hundred years’ scientific travelogues were compiled thereby.

existence & motion around us, humanistic ideology is but cognizant portraiture of accessible existence & motion around us, and universal existence & motion are of course external origin of humanistic ideology about authenticity of nature. At any rate, just draw on practical feasibility & possibility in proportion to contemporaneous historical background, development of science is always endeavor to discover and formulate universal existence & motion as authentic, comprehensive and systematical as possible so as to push humanistic ideology about authenticity of nature forward to perfect ideological enantiomorph of ultimate authenticity of nature as possible as we are historically able to and accomplish advancement of historical authenticity tolerance of science towards 0 in proportion. Till at last, humanistic ideology about authenticity of nature tallies with ultimate authenticity of nature 100 over 100.

And as it is only possible for ultimate authenticity of nature to be unique and invariable, as rigorous enantiomorphous correlation between objective authenticity of nature and humanistic ideology about authenticity of nature, it's neither possible for "the unique & invariable ultimate authenticity of nature" to be compatible with "two distinctive humanistic ideologies about authenticity of nature with remarkable ideological difference" nor possible for "two distinctive humanistic ideologies about authenticity of nature with remarkable ideological difference" to discover and formulate "the unique & invariable ultimate authenticity of nature" coequally. The practical accomplishment that humanistic ideology about authenticity of nature gradually close to perfect ideological enantiomorph of ultimate authenticity of nature must bring out situation that relative innovative humanistic ideology about authenticity of nature all wool and a yard wide excludes even negates the relatively conservative ready-made humanistic ideology about authenticity of nature, and leads innovative humanistic ideology about authenticity of nature gradually orientates itself towards universal generality & coherence, till at last, humanistic ideology about authenticity of nature tallies with unique and invariable ultimate authenticity of nature 100 over 100 as perfect ideological enantiomorph of unique and invariable ultimate authenticity of nature all wool and a yard wide.

②. "Social connotation" of science

A). "Social connotation of science" firstly derives from inherent correlation between original generation & successive development of science and social production.

Science is of course humanistic outgrowth of society mostly related to social production, if there is no social production which directly supports existence and further development of human society, there is no science. Virtually, human practice of social production not only offers objective necessity of original generation of science but also offers practical possibility for generation & development of science. And at the same time, as sapiential soul of social productivity, science must actualize social worthiness by expanding and optimizing social production so as to satisfy social necessity of social production and human life.

B). "Social connotation of science" secondly roots in practical correlation between historical progress of science and crescive progression of practical feasibility & possibility in proportion to contemporaneous historical background.

As crescive progression of practical feasibility & possibility in proportion to contemporaneous historical background, the practice human coming to discover and formulate authenticity of accessible existence & motion around must experience frondose evolvment of humanistic ideology about authenticity of nature cumulatively enriched from nothingness to goat, from goat to a great lot, and consequently followed proportionate ideaistic correction & qualitative optimization from superficiality to profundity, from parochiality to generality. Throughout historical progress of science, development of science and the practical feasibility & possibility in proportion to contemporaneous historical background are always conditional and reciprocal couple ever since, whose conditional and reciprocal operation as coherent causality which directly hypostatize the quantitative & qualitative change of humanistic ideology about authenticity of nature towards historical authenticity tolerance of science 0 and makes up of crescive progression of historical progress of science in the nature of things.

As coherent natura naturans throughout cosmic evolution, instinctive PNT reciprocal equilibrium towards optimum PNT operation is radical potentiality & conditionality for cosmos always ready to orientate itself towards perfection.

C) Social connotation of science also exists in “social legitimacy subsistence of science”, which not only indicates social legitimacy authentication of science must depend on commensurate humanistic social practice but also daily operation of social legitimacy subsistence of science must be out-and-out humanistic practice under contemporaneous historical background; even once there is occurrence of timely renovation of humanistic ideology about authenticity of nature in proportion to contemporaneous historical background, necessary social legitimacy metabolism of science must be implemented by serial humanistic social practice under contemporaneous historical background too.

We mention historical evolvement of human science herein is ready to highlight the general historical regularity, inevitable trend and the inherent conditionality between “development of science” and “uniqueness & invariance of ultimate authenticity of nature & integrative social circumstances”.

As a multiple concept with double significance of natural connotation and social connotation, naissance, existence and development of science must implicate accessible existence & motion around us and the commensurate integrative social circumstances which of course include the contemporaneous historical background especially the living scientific knowledge aggradation. The quantitative & qualitative change of scientific knowledge proliferation must condition the uniqueness & invariance of ultimate authenticity of nature, and hypostatize reciprocal coevolution between integrative social circumstances and scientific knowledge proliferation in monofier modality.

As commensurate ideological enantiomorph of accessible existence & motion around us, by the right of crecive progression of practical feasibility & possibility in proportion to contemporaneous historical background, historical progress of science is always endeavor to discover and formulate accessible existence & motion around us as authentic, comprehensive and systematical as possible. Whereas, as it's only possible for ultimate authenticity of nature to be unique and invariable, this of course predestines the definite ultimate consummation format as perfect ideological enantiomorph of ultimate authenticity of nature in accordance with the rigorous enantiomorphous correlation between objective authenticity of nature and humanistic ideology about authenticity of nature. As it's only possible for ultimate authenticity of nature to be unique and invariable, historical progress of science which is always endeavor to discover and formulate accessible existence & motion around us as authentic comprehensive and systematical as possible draw on practical feasibility & possibility in proportion to contemporaneous historical background must lead commensurate ideological system about authenticity of nature closer and closer to perfect ideological enantiomorph of ultimate authenticity of nature step by step. The uniqueness and invariance of ultimate authenticity of nature predestines the unique possibility of scientific verity about universal existence & motion.

And at the same time, as crecive progression of practical feasibility & possibility in proportion to contemporaneous historical background, the practice human coming to discover and formulate authenticity of accessible existence & motion around must experience frondose evolvement of humanistic ideology about authenticity of cumulatively enriched from nothingness to goroat, from goroat to a great lot, and consequently followed proportionate ideaistic correction & qualitative optimization from superficiality to profundity, from parochiality to generality. This of course indicates development of humanistic ideology about authenticity of nature must orientate to perfect formulation of ultimate authenticity of nature eversince, till at last, humanistic ideology about authenticity of nature finally tallies with ultimate authenticity of nature 100 over 100 as perfect ideological enantiomorph of ultimate authenticity of nature, which of course implies, as it's only possible for the ultimate authenticity of nature to be unique and invariable, perfect ideological enantiomorph of ultimate authenticity of nature must be unique scientific verity about universal existence & motion accordingly. This of course indicates veritable progress of science is not intuitional cumulative achievement of colorful scientific travelogues A, B, C, D, E, F, . . . as deserving reward of the first itinerary around preternatural landscapes of brand-new landmasses of science like omnifarious smallwares full of a basket but successive hypostatic endeavor to push humanistic ideology about

authenticity of nature forward to perfect ideological enantiomorph of ultimate authenticity of nature step by step draw on practical feasibility & possibility in proportion to contemporaneous historical background so as to hypostatize historical progress of science in inherent optimum orientation towards historical authenticity tolerance of science 0. it's only possible for the major melody of historical progress of science to be serial epochmaking scientific knowledge metabolism through and through.

Finally, as typical outgrowth of out-and-out social work, the integrative social circumstances is commensurate external conditions for scientific knowledge proliferation, the output situation & efficiency of scientific knowledge proliferation as social outgrowth is directly related to hypostatic social circumstances.

Social progress must condition social production, the purpose of social production is of course to procure and dominate ideal existence & motion available in the nature for necessity of successive social production and human life. In order to procure enough ideal existence & motion available around us for necessity of successive social production and human life, human must try to know the authenticity of nature as much as possible. The more people know the authenticity of nature, the more ideal existence & motion available around us people are able to procure and dominate in the nature. and the ideal existence & motion people procured and dominated in the nature are more applicable and worthy to social production and human life.

Development of science usually improve successive social production and human life greatly, science is always sapiential soul of social production.

At the same time, output of scientific knowledge proliferation is too a special part of social work, the output situation and efficiency of living scientific knowledge proliferation is always related to integrative social circumstances. The more superior the social production is, the integrative social circumstances is relatively more favorable for scientific knowledge proliferation, hypostatic social circumstances mostly includes favorable ideological background of purificatory knowledge aggradation which is the most effective potentiality of potential feasibility and possibility in proportion to contemporaneous historical background for scientific knowledge proliferation.

The more harmonious the social production relationship is, the more enlightened and smooth the scientific knowledge metabolism and consequent scientific knowledge metabolism campaign will be. And the scientific knowledge proliferation will be even more hearty. This of course indicates, throughout human history, quantitative and qualitative change of scientific knowledge proliferation always conditions integrative social circumstances and roots in the contemporaneous historical background as well. And on the other hand, positive quantitative and qualitative change of improvement of integrative social circumstances depends on vitality of scientific knowledge proliferation too. Usually, development of both scientific knowledge proliferation and integrative social circumstances is always in quantitative and qualitative change in reciprocal syntonic operation model.

Just similar as coexistence of natural connotation and social connotation is just the both surface of the science coin, the potential conditionality of the uniqueness & invariance of ultimate authenticity of nature predestines the unique possibility of scientific verity as perfect ideological enantiomorph of ultimate authenticity of nature and syntonic reciprocity of integrative social circumstances and scientific knowledge proliferation is always coexistent throughout historical progress of science too. The relative disparity is only that, as different historical stage with different historical limitation along crescive progression of practical feasibility & possibility in proportion to contemporaneous historical background, there is distinctive disparity of practical implication between the uniqueness & invariance of ultimate authenticity of nature predestines the unique possibility of scientific verity as perfect ideological enantiomorph of ultimate authenticity of nature and integrative social circumstances, commensurate scientific knowledge proliferation is slightly different, which of course indicates the general regularity of quantitative & qualitative change of knowledge multiplication throughout historical progress of science.

(VIII-i) Qualitative Summary of Historical Progress of Science

Abstract: *Practical accomplishment of historical progress of science can never be free from restriction & conditionality of “crescive progression of practical feasibility & possibility in proportion to contemporaneous historical background + the uniqueness & invariance of ultimate authenticity of nature predestines the unique possibility of scientific verity as perfect ideological enantiomorph of ultimate authenticity of nature”. Virtually, hypostatic historical progress of science is just quantitative & qualitative change of scientific knowledge proliferation under synthesized conditionality of “crescive progression of practical feasibility & possibility in proportion to contemporaneous historical background + the uniqueness & invariance of ultimate authenticity of nature predestines the unique possibility of scientific verity as perfect ideological enantiomorph of ultimate authenticity of nature” through and through, which has couple features as following:*

①. *“Science” is commensurate ideological system about authenticity of historically accessible existence & motion around us, historically accessible existence & motion determines commensurate ideological system as objective enantiomorphous origin. As commensurate ideological system about authenticity of historically accessible existence & motion in proportion to contemporaneous historical background, in different historical stage, as remarkable disparity of practical feasibility & possibility in proportion to contemporaneous historical background, no matter how many existence & motion are historically accessible around us, no matter how comprehensive, systematical and precise the commensurate ideological system about authenticity of nature can practically discover and formulate existence & motion accessible around us, the historically accessible existence & motion around us are always objective enantiomorphous origin of commensurate ideological system, development of science is always endeavor to discover and formulate historically accessible existence & motion around us as authentic, comprehensive and systematical as possible, which is virtually hypostatic endeavor to push humanistic ideology about authenticity of nature forward to perfect ideological enantiomorph of ultimate authenticity of nature draw on practical feasibility & possibility in proportion to contemporaneous historical background.*

And as the ultimate authenticity of nature can be neither omnifarious authenticity smallwares full of a basket nor authenticity chameleon one piece and only, it’s only possible for it to be coherent natura naturans throughout cosmic evolution, in accordance with rigorous enantiomorphous correlation between objective authenticity of nature and humanistic ideology about authenticity of nature, it’s neither possible for “the unique & invariable ultimate authenticity of nature” to be compatible with “two distinctive humanistic ideologies about authenticity of nature with remarkable ideological difference” nor possible for “two distinctive humanistic ideologies about authenticity of nature with remarkable ideological difference” to discover and formulate “the unique & invariable ultimate authenticity of nature” coequally. Once humanistic ideology about authenticity of nature tallies with ultimate authenticity of nature 100 over 100, absolute scientific verity about universal existence & motion must be perfect ideological enantiomorph of ultimate authenticity of nature or coherent natura naturans throughout cosmic evolution, none else.

②. *Historical progress of science must be accomplished step by step by progressional historical practice, as a result, on some certain stand of cause and effect, practical feasibility & possibility in proportion to contemporaneous historical background seems like root variable of accomplishment of historical progress of science. Commensurate ideological system is outgrowth rooted in proportionate practice, as crescive progression of practical feasibility & possibility in proportion to contemporaneous historical background, involving in rich and colorful existence & motion around us, no matter what the logic constitution of ultimate authenticity of nature is, the practice human coming to discover and*

Historical progress of science in the recent several centuries seemed like a far-flung exploration of the first itinerary around numerous distinctive landscapes of brand-new landmasses of science with palette & tablet on back, several hundred years’ scientific travelogues were compiled thereby.

formulate authenticity of accessible existence & motion around must experience frondose evolvement of humanistic ideology about authenticity of nature cumulatively enriched from nothingness to groat, from groat to a great lot, and consequently followed proportionate ideaistic correction & qualitative optimization from superficiality to profundity, from parochiality to generality. Throughout historical progress of science, it's only possible for living scientific knowledge proliferation at discretionary historical stage to accomplish discovery & formulation of the temporally accessible existence & motion then and there, and output humanistic ideology about authenticity of nature in proportion to contemporaneous historical background therefore. As remarkable disparity of practical implication depth and generality of universal existence & motion, it's impossible for humanistic ideologies about authenticity of nature in different historical stages have coherent scientific connotation. And virtually, they are mostly incompatible even self-contradictory.

In accordance with the sum-up of “① + ②” above, as it's only possible for ultimate authenticity of nature to be unique and invariable, even as rigid enantiomorphous correlation between ideological system about authenticity of nature and objective authenticity of nature that the uniqueness & invariance of ultimate authenticity of nature proportionably predestines the unique possibility of unique scientific verity as perfect ideological enantiomorph of ultimate authenticity of nature, the quantitative & qualitative change of historical progress of science in hypostatic endeavor to discover and formulate accessible existence & motion as authentic, comprehensive, systematical as possible draw on practical feasibility & possibility in proportion to contemporaneous historical background must bring out occurrence that humanistic ideology about authenticity of nature are always proportional variable in inherent optimum orientation towards perfect ideological enantiomorph of ultimate authenticity of nature and the updated humanistic ideology about authenticity of nature in inherent optimum orientation towards perfect ideological enantiomorph of ultimate authenticity of nature must wash out the foregoing ready-made humanistic ideology about authenticity of nature without alternatives, so that it seems only possible for the major melody of historical progress of science to be serial epochmaking scientific knowledge metabolism in inherent optimum orientation towards perfect ideological enantiomorph of ultimate authenticity of nature. Of course, the so-called gradational series of epochmaking scientific knowledge metabolism in inherent optimum orientation towards perfect ideological enantiomorph of ultimate authenticity of nature is too synchronous proportionate social legitimacy metabolism of temporal orthodoxies, which of course indicates synchronous contemporaneous scientific orthodoxy metabolism subrogation.

Throughout historical progress of science, in terms of any contemporaneous scientific orthodoxy out of scientific legitimacy qualification of historical authenticity tolerance of science 0, as long as the practical leitmotiv that historical progress of science is always hypostatic endeavor to discover and formulate universal existence & motion as authentic, comprehensive and systematical as possible draw on practical feasibility & possibility in proportion to contemporaneous historical background is permanent eversince, as long as historical progress of science is still on its way in inherent optimum orientation towards historical authenticity tolerance of science 0, any contemporaneous scientific orthodoxy out of scientific legitimacy qualification of historical authenticity tolerance of science 0 must be washed out by coming positive renovation of humanistic ideology about authenticity of nature in inherent optimum orientation towards perfect ideological enantiomorph of ultimate authenticity of nature sooner or later, till at last, humanistic ideology about authenticity of nature is finally qualified as perfect ideological enantiomorph of ultimate authenticity of nature, which is ideological enantiomorph compliant with ultimate authenticity of nature 100 over 100.

As coherent natura naturans throughout cosmic evolution, instinctive PNT reciprocal equilibrium towards optimum PNT operation is radical potentiality & conditionality for cosmos always ready to orientate itself towards perfection.

Special nouns & items: science, scientific knowledge proliferation, development of science, humanistic ideology about authenticity of nature, authoritative intrepidity of contemporaneous scientific orthodoxy, official royalism value of contemporaneous scientific orthodoxy, social legitimacy metabolism, scientific knowledge metabolism, scientific knowledge metabolism campaign.

1. Definition of “science” & “development of science”

Perfect definition of “development of science” must base on explicit definition of “science”, and perfect definition of “science” must condition radical clarification of background circumstances for original naissance and successive development of science.

Generally, favorable background circumstances for original naissance and successive development of science are as following:

The first, **External ideological reference of science as humanistic ideology about authenticity of nature**, development of science is always ready to discover and formulate accessible universal existence & motion as authentic, comprehensive and systematical as possible draw on practical feasibility & possibility in proportion to contemporaneous historical background, as a result, accessible universal existence & motion are always the external ideological reference of science as humanistic ideology about authenticity of accessible universal existence & motion. ——— accessible universal existence & motion determines the commensurate ideological system about authenticity of accessible existence & motion. Even as ultimate authenticity of nature can be neither omnifarious authenticity smallwares full of a basket nor authenticity chameleon one piece and only, but coherent natura naturans throughout cosmic evolution, the uniqueness & invariance of ultimate authenticity of nature predestines the unique possibility of scientific verity as perfect ideological enantiomorph of ultimate authenticity of nature.

The second, **External necessity & practical motivity for naissance & successive development of science**, science is outgrowth of development of human society, presence of human society based on social production not only offers objective necessity of original naissance and successive development of science but also offers practical motivity for development of science.

In detail words, science is inevitable outgrowth of development of society. In any case, presence of society must depend on social production, and progressive degree of society radically depends on social production capability & efficiency. So-called “social production” is just social endeavor that, in order to satisfy subsistence & development of human as much as possible, human try to procure necessary materials from nature as possibly as they can.

Of course, in order to administrate and utilize ideal existence & motion accessible expediently to accomplish and improve social production and social life, human must know the accessible universal existence & motion as much as possible draw on practical feasibility & possibility in proportion to contemporaneous historical background. So-called “science” is just commensurate ideological system about authenticity of accessible universal existence & motion when social practice of human implicates more and more universal existence & motion around, which is of course humanistic ideology about authenticity of nature in proportion to contemporaneous historical background.

On the stand of practical cause and effect of generation and successive development of science rooted in proportionate social background, the practical generation and successive development of science as proportionable outgrowth of development of society generally relates two major circumstances as below:

The first, the extent & depth of universal existence & motion that human practice gradually involves in,

Historical progress of science in the recent several centuries seemed like a far-flung exploration of the first itineracy around numerous distinctive landscapes of brand-new landmasses of science with palette & tablet on back, several hundred years’ scientific travelogues were compiled thereby.

which directly indicates practical feasibility & possibility of human in proportion to contemporaneous historical background.

The second, the approximative enantiomorphous correlation between historically accessible universal existence & motion and commensurate ideological system about authenticity of accessible universal existence & motion that historically accessible universal existence & motion are always objective reference of commensurate ideological system about authenticity of accessible universal existence & motion, historical progress of science is always hypostatic endeavor to discover and formulate the accessible universal existence & motion as authentic, comprehensive and systematical as possible, which of course indicates accessible universal existence & motion predestines commensurate ideological system about authenticity of accessible universal existence & motion, even as the ultimate authenticity of nature can be neither omnifarious authenticity smallwares full of a basket nor authenticity chameleon one piece and only, but coherent natura naturans throughout cosmic evolution, the uniqueness & invariance of ultimate authenticity of nature proportionably predestines the unique possibility of scientific verity as perfect ideological enantiomorph of ultimate authenticity of nature.

If we denote the cumulative output variable of historical progress of science as quantitative & qualitative change of scientific knowledge proliferation under synthesized conditionality of “**crecive progression of practical feasibility & possibility in proportion to contemporaneous historical background + the uniqueness & invariance of ultimate authenticity of nature predestines the unique possibility of scientific verity as perfect ideological enantiomorph of ultimate authenticity of nature**” through and through as “Y”, then we have substantial reasons to denote the even basic causal quantitative & qualitative change of practical feasibility & possibility as independent variable X of output variable of historical progress of science Y, and we even have substantial reasons to denote the approximative enantiomorphous correlation between accessible universal existence & motion and commensurate ideological system about authenticity of accessible universal existence & motion mapping fundamental “F”. As a result, output variable of hypostatic historical progress of science Y as integrative quantitative & qualitative change of scientific knowledge proliferation under synthesized conditionality of “**crecive progression of practical feasibility & possibility in proportion to contemporaneous historical background ‘X’ + the uniqueness & invariance of ultimate authenticity of nature predestines the unique possibility of scientific verity as perfect ideological enantiomorph of ultimate authenticity of nature ‘F’**” through and through can be approximatively formulated in logic model as $Y=F(X)$.

So-called “science” is just commensurate ideological system about authenticity of historically accessible existence & motion around us in proportion to contemporaneous historical background. And just because of the integrative correlation as $Y=F(X)$ among practical scientific feasibility & possibility in proportion to contemporaneous historical background “X”, consequential output variable of historical progress of science “Y” and approximative enantiomorphous correlation between historically accessible universal existence & motion and consequential output variable of historical progress of science “Y” as commensurate ideological system about authenticity of accessible universal existence & motion, before humanistic ideology about authenticity of nature finally qualified as perfect ideological enantiomorph of ultimate authenticity of nature, so-called “science” is always commensurate ideological system about authenticity of nature in proportion to contemporaneous historical background.

As the integrative domino effect of the two background circumstances which science depends on to generate and develop, science has inherence of “social connotation” and “natural connotation” in the nature of things.

i) **Natural connotation of science**——as ideological enantiomorph of accessible universal existence & motion, authenticity of nature is always ideological reference origin and everlasting approximation pursuit of ideological system; historical

progress of science is always hypostatic endeavor to discover and formulate accessible universal existence & motion as authentic, comprehensive and systematical as possible, “authenticity of nature” predestines humanistic ideology about authenticity of accessible universal existence & motion.

Natural connotation of science radically derives from the first background circumstance which science depends on for original naissance and successive development that original naissance and successive development of science must refer to commensurate accessible universal existence & motion around, commensurate accessible universal existence & motion predestines commensurate humanistic ideology about authenticity of accessible universal existence & motion. As commensurate ideological system about authenticity of accessible universal existence & motion around, science is always humanistic ideology about authenticity of accessible universal existence & motion in proportion to contemporaneous historical background, as historical limit of practical feasibility & possibility in proportion to contemporaneous historical background, no matter what’s the actual extent and depth of accessible universal existence & motion is.

Historical progress of science is always endeavor to discover and formulate historically accessible universal existence & motion as authentic comprehensive and systematical as possible, no matter how devious hypostatic historical progress of science in inherent optimum orientation towards perfect ideological enantiomorph of ultimate authenticity of nature is, no matter how much humanistic ideology about authenticity of nature in proportion to contemporaneous historical background can practically discover and formulate historically accessible universal existence & motion around, quantitative & qualitative change of humanistic ideology about authenticity of nature in proportion to contemporaneous historical background must refer to “authenticity of accessible existence & motion” and try to formulate authenticity of accessible existence & motion as much as possible through and through, no matter how far away the commensurate humanistic ideology about authenticity of nature is from perfect ideological enantiomorph of ultimate authenticity of nature. It even indicates, no matter how devious hypostatic historical progress of science is, historical progress of science must be in inherent optimum orientation towards perfect ideological enantiomorph of ultimate authenticity of nature in the nature of things.

ii) **Social connotation of science**—social connotation of science generally derives from factuality that science is just outgrowth of social development; and indeed, society presence based on social production not only offers objective necessity of original naissance and successive development of science but also offers practical feasibility & possibility for original naissance and successive development of science.

a). **Social connotation of science firstly derives from the syntonic bidirectional conditionality between original naissance, successive development of science and social production.**

Science is outgrowth of development of society, no society, no social production, there is no necessity for original naissance and successive development of science, no more practical feasibility & possibility for original naissance and successive development of science. In straightforward words, presence of human society basing on necessary social production not only offers external necessity of original naissance and successive development of science but also offers practical feasibility & possibility for original naissance and successive development of science. And at the same time, as intelligence of social production all wool and a yard wide, naissance and successive development of science can proportionably bring out remarkable enlargement and optimization of social production so as to bring out substantial resource for social life. As a result, social value of science has been incarnated.

Historical progress of science in the recent several centuries seemed like a far-flung exploration of the first itinerary around numerous distinctive landscapes of brand-new landmasses of science with palette & tablet on back, several hundred years’ scientific travelogues were compiled thereby.

b). The social connotation of science secondarily depends on bidirectional syntonic reciprocity in monofier modality between development of science as hypostatic quantitative & qualitative change of scientific knowledge proliferation under synthesized conditionality of “crescive progression of practical feasibility & possibility in proportion to contemporaneous historical background + the uniqueness & invariance of ultimate authenticity of nature predestines the unique possibility of scientific verity as perfect ideological enantiomorph of ultimate authenticity of nature” and practical feasibility & possibility in proportion to contemporaneous historical background, whose integrative domino effect is similar as the logic correlation between “Y” and “X” in function equation $Y=F(X)$

As crescive progression of practical feasibility & possibility, the practice human coming to discover and formulate authenticity of accessible existence & motion around must experience frondose evolvement of humanistic ideology about authenticity of nature cumulatively enriched from nothingness to groat, from groat to a great lot, and consequently followed proportionate ideaistic correction & qualitative optimization from superficiality to profundity, from parochiality to generality. Throughout historical progress of science, hypostatic development of science as integrative quantitative & qualitative change of scientific knowledge proliferation under synthesized conditionality of “crescive progression of practical feasibility & possibility in proportion to contemporaneous historical background + the uniqueness & invariance of ultimate authenticity of nature predestines the unique possibility of scientific verity as perfect ideological enantiomorph of ultimate authenticity of nature” and **practical feasibility & possibility in proportion to contemporaneous historical background** are always reciprocal couple in syntonic quantitative change model, whose syntonic operation as reciprocal couple makes up of realistic quantitative & qualitative change of historical progress of science in inherent optimum orientation towards historical authenticity tolerance of science 0 through and through.

c) **Social connotation of science** also exists in “social legitimacy subsistence of science”, which not only includes social legitimacy qualification authentication of science must be commensurate humanistic social practice but also daily operation of social legitimacy subsistence of science must be out-and-out humanistic practice under contemporaneous historical background; even once there is occurrence of timely renovation of humanistic ideology about authenticity of nature in proportion to contemporaneous historical background, necessary social legitimacy metabolism of science must be implemented by serial humanistic social practice under contemporaneous historical background too.

Historical progress of science in inherent optimum orientation towards perfect ideological enantiomorph of ultimate authenticity of nature is virtually quantitative & qualitative change of scientific knowledge proliferation under synthesized conditionality of “crescive progression of practical feasibility & possibility in proportion to contemporaneous historical background + the uniqueness & invariance of ultimate authenticity of nature predestines the unique possibility of scientific verity as perfect ideological enantiomorph of ultimate authenticity of nature” through and through. Before humanistic ideology about authenticity of nature finally qualified as perfect ideological enantiomorph of ultimate authenticity of nature, so-called “science” is always commensurate ideological system about authenticity of nature in proportion to contemporaneous historical background, whereas, as long as there is mainstream ideological system about authenticity of nature of the age, there must be contemporaneous scientific orthodoxy with so-called “social legitimacy qualification & social legitimacy subsistence”. We have to admit not only the original social legitimacy qualification authentication of science must be humanistic social practice but also daily operation of social legitimacy subsistence of science must be out-and-out humanistic practice under contemporaneous historical background; even once there is occurrence of timely renovation of humanistic ideology about authenticity of nature in proportion to contemporaneous historical background, necessary social legitimacy metabolism of science

As coherent natura naturans throughout cosmic evolution, instinctive PNT reciprocal equilibrium towards optimum PNT operation is radical potentiality & conditionality for cosmos always ready to orientate itself towards perfection.

must be implemented by serial humanistic social practice under contemporaneous historical background too.

And indeed, as out-and-out social work outgrowth and humanistic ideology about authenticity of nature in proportion to contemporaneous historical background, social existence & historical progress of “science” must inherently possess double coordinative significance of “natural connotation” and “social connotation”, social legitimacy subsistence of neonatal scientific idea never simply depends on recognizant achievement that brand-new or more authenticity of nature has been reflected on sense of pioneering originators with proper authenticity highlight effect in proportion to contemporaneous historical background, it even crucially implicates esoteric authoritative social legitimacy identification & authentication in accordance with egotistic criterion of contemporaneous scientific orthodoxy under official centered background——social legitimacy & validity of truths can never exceed cannon range, which of course includes esoteric operation of scientific knowledge metabolism campaign underlying.

So-called scientific knowledge proliferation is just living action people trying to discover and formulate accessible universal existence & motion draw on practical feasibility & possibility in proportion to contemporaneous historical background then and there.

“Development of science” is generally quantitative & qualitative change of scientific knowledge proliferation under synthesized conditionality of “**crecscive progression of practical feasibility & possibility in proportion to contemporaneous historical background + the uniqueness & invariance of ultimate authenticity of nature predestines the unique possibility of scientific verity as perfect ideological enantiomorph of ultimate authenticity of nature**” through and through, which is of course permanent endeavor of human to push humanistic ideology about authenticity of nature forward to perfect ideological enantiomorph of ultimate authenticity of nature step by step draw on practical feasibility & possibility in proportion to contemporaneous historical background. At any rate, development of science is always endeavor to discover and formulate accessible universal existence & motion as authentic, comprehensive and systematical as possible, till at last, humanistic ideology about authenticity of nature tallies with ultimate authenticity of nature 100 over 100 as perfect ideological enantiomorph of ultimate authenticity of nature.

As out-and-out social work outgrowth and humanistic ideology about authenticity of nature in proportion to contemporaneous historical background, “social connotation” and “natural connotation” is inherence of science, practical development of science not only directly implicates accessible existence & motion around us, but also implicates contemporaneous historical background and related integrative social circumstances through and through.

2. As humanistic ideology about authenticity of nature in proportion to contemporaneous historical background, authenticity of nature is always “enantiomorphous ideological origin” of science.

As humanistic ideology about authenticity of nature in proportion to contemporaneous historical background, if there is none authenticity of nature, there is no reason for naissance of humanistic ideology about authenticity of nature. No matter how much or how perfectly the humanistic ideology about authenticity of nature can reflect authenticity of nature, development of science is always endeavor to discover and formulate the authenticity of nature as authentic, comprehensive and systematical as possible draw on practical feasibility & possibility in proportion to contemporaneous historical background, ultimate authenticity of nature is everlasting pursuit of development of science, which of course restricts and shapes historical progress of science in inherent optimum orientation towards historical authenticity tolerance of science 0 as credible cyclostyle for perfect ideological enantiomorph.

2.1. "Authenticity of nature" determines "humanistic ideology about authenticity of nature", at any rate, universal existence & motion are everlasting hypostatic enantiomorphous origin of humanistic ideology about authenticity of nature, and development of science is permanent endeavor to discover and formulate universal existence & motion as authentic, comprehensive and systematical as possible draw on practical feasibility & possibility in proportion to contemporaneous historical background.

As ideological representation of accessible existence & motion around us under proper historical background, vivid universal existence & motion are always the objective authenticity origin for formulation of humanistic ideology about authenticity of nature.

Throughout historical progress of science, although, universal existence & motion are authenticity origin of humanistic ideology about authenticity of nature, and humanistic ideology about authenticity of nature is precise formulation of universal existence & motion are everlasting pursuit of historical progress of science through and through, however, as crescive progression of practical feasibility & possibility in proportion to contemporaneous historical background, it's only possible for humanistic ideology about authenticity of nature to be ideological formulation of the accessible existence & motion then and there. In different historical stages, the depth and generality of accessible existence & motion due to practical feasibility & possibility in proportion to contemporaneous historical background is remarkably different, this of course cause proportionate difference of formulation generality, profundity & preciseness of accessible existence & motion around, humanistic ideology about authenticity of nature is apparently different in different historical ages. Although, development of science is always endeavor to discover and formulate universal existence & motion as authentic, comprehensive and systematical as possible so as to push humanistic ideology about authenticity of nature forward to perfect ideological enantiomorph of ultimate authenticity of nature step by step draw on practical feasibility & possibility in proportion to contemporaneous historical background, whereas, as disparity of historical limitation, the resultant humanistic ideology about authenticity of nature in proportion to contemporaneous historical background is so different.

2.2. The uniqueness & invariance of ultimate authenticity of nature proportionably determines the unique possibility of scientific verity as perfect ideological enantiomorph of ultimate authenticity of nature.

Ultimate authenticity of nature can be neither omnifarious authenticity smallwares full of a basket nor authenticity chameleon one piece and only, but ultimate authenticity of nature as coherent natura naturans throughout cosmic evolution.

As ideological representation of authenticity of nature, humanistic ideology about authenticity of nature must discover and formulate authenticity of nature as authentic, comprehensive and systematical as possible, and development of science is always endeavor to push humanistic ideology about authenticity of nature forward to perfect ideological enantiomorph of ultimate authenticity of nature as coherent natura naturans throughout cosmic evolution step by step draw on practical feasibility & possibility in proportion to contemporaneous historical background. Whereas, as crescive progression of practical feasibility & possibility in proportion to contemporaneous historical background, at discretionary historical stage, it's only possible for living scientific knowledge proliferation to work at the accessible existence & motion around under the contemporaneous historical background. As remarkable disparity of practical implication of accessible existence & motion of different historical stages, humanistic ideologies about authenticity of nature in proportion to contemporaneous historical background are proportionably different even contradictory. However, as long as ultimate authenticity of nature is unique and invariable as coherent natura naturans throughout cosmic evolution and development of science is always

endeavor to push humanistic ideology about authenticity of nature forward to perfect ideological enantiomorph of ultimate authenticity of nature step by step draw on practical feasibility & possibility in proportion to contemporaneous historical background, historical progress of science must be in inherent optimum orientation towards historical authenticity tolerance of science 0, and ultimate consummation of science must proportionably turn into unique scientific verity about universal existence & motion as perfect ideological enantiomorph of ultimate authenticity of nature (/coherent natura naturans throughout cosmic evolution).

In another words, as crescive progression of practical feasibility & possibility in proportion to contemporaneous historical background, it's impossible for human to approach absolute scientific verity as perfect ideological enantiomorph of ultimate authenticity of nature in one go, but have to experience frondose evolvement of humanistic ideology about authenticity of nature cumulatively enriched from nothingness to goat, from goat to a great lot, and consequently followed proportionate ideaistic correction & qualitative optimization from superficiality to profundity, from parochiality to generality. As long as development of science is always permanent endeavor to discover and formulate universal existence & motion as authentic, comprehensive and systematical as possible draw on practical feasibility & possibility in proportion to contemporaneous historical background all along, historical progress of science must be in inherent optimum orientation towards historical authenticity tolerance of science 0 eversince. And once humanistic ideology about authenticity of nature ultimately tallies with ultimate authenticity of nature 100 over 100, science must ultimately be consummated into uniform scientific verity about universal existence & motion as perfect ideological enantiomorph of ultimate authenticity of nature. After all, **it's only possible for concordant cosmos to be demiurgic aggradation of out-and-out serial natura naturata in the nature of coherent natura naturans throughout cosmic evolution; there is no way for demiurgic aggradation in the nature of different natura naturans to be concordant cosmos through and through.**

What's more, in accordance with rigorous enantiomorphous correlation between objective authenticity of nature and humanistic ideology about authenticity of nature, it's neither possible for "the unique & invariable ultimate authenticity of nature" to be compatible with "two distinctive humanistic ideologies about authenticity of nature with remarkable ideological difference" nor possible for "two distinctive humanistic ideologies about authenticity of nature with remarkable ideological difference" to discover and formulate "the unique & invariable ultimate authenticity of nature" coequally.

3. Since ultimate authenticity of nature can be neither omnifarious authenticity smallwares full of a basket nor authenticity chameleon one piece and only but coherent natura naturans throughout cosmic evolution, as ideological enantiomorph of existence & motion accessible around us and necessary outgrowth of development of society due to necessity of social production & social life, veritable progress of science must be hypostatic endeavor to push humanistic ideology about authenticity of nature forward to perfect ideological enantiomorph of ultimate authenticity of nature step by step draw on practical feasibility & possibility in proportion to contemporaneous historical background, which of course implies the practical operation of historical progress of science must root in contemporaneous historical background including proportionate practical feasibility & possibility for scientific exploration & authenticity highlight.

Science is outgrowth for flourishing development of social production, if there is no social production, there is no necessity for naissance of science; if social production does not practically involve more and more hypostatic existence & motion accessible around and if there is no refined division of labor and cooperation of work all over the society, there is no practical possibility for development of science.

Historical progress of science in the recent several centuries seemed like a far-flung exploration of the first itinerary around numerous distinctive landscapes of brand-new landmasses of science with palette & tablet on back, several hundred years' scientific travelogues were compiled thereby.

Social production is always precondition for existence of society, human must procure necessary ideal existence & motion around towards necessity of social production and social life. In order to procure and dominate ideal existence & motion for necessity of social production and social life, it's of course necessary for human to know the authenticity of nature as much as possible. The necessity for social production and social life is not only the straightforward pursuit of development of science, but also how much we can consequently satisfy social production and social life for application of proper scientific idea is the value criterion of science. And at the same, development of science must root in the contemporaneous historical background, and social operation of scientific knowledge proliferation must condition the proper social ambience, as a result, the contemporaneous historical background and the idiographic social ambience are always the positive basis & necessary backup for development of science, which of course conditions the operational quality even output quality of development of science beyond all doubt all along.

3.1. crecive progression of practical feasibility & possibility in proportion to contemporaneous historical background proportionably restricts historical progress of science in inherent optimum orientation towards historical authenticity tolerance of science 0. In detail words, as crecive progression of practical feasibility & possibility in proportion to contemporaneous historical background, the practice human coming to discover and formulate authenticity of accessible existence & motion around must experience frondose evolvment of humanistic ideology about authenticity of nature cumulatively enriched from nothingness to groat, from groat to a great lot, and consequently followed proportionate ideaistic correction & qualitative optimization from superficiality to profundity, from parochiality to generality.

Veritable progress of science is not intuitional cumulative achievement of colorful scientific travelogues A, B, C, D, E, F, ...as deserving reward of the first itinerary around preternatural landscapes of brand-new landmasses of science like omnifarious smallwares full of a basket but successive hypostatic endeavor to push humanistic ideology about authenticity of nature forward to perfect ideological enantiomorph of ultimate authenticity of nature step by step draw on practical feasibility & possibility in proportion to contemporaneous historical background, till at last, humanistic ideology about authenticity of nature is compatible with ultimate authenticity of nature 100 over 100 as perfect ideological enantiomorph of ultimate authenticity of nature. As crecive progression of practical feasibility & possibility in proportion to contemporaneous historical background, it's completely impossible for human to face universal existence & motion in a sudden and enter ideal situation to clarify and formulate authenticity of universal existence & motion through and through once. As historical limitation, human have to come to face the accessible and limited existence & motion around us then and there, and consequently accomplish historical progress of science from nothingness to groat, from groat to a great lot. As freewheeling of historical progress of science, on the basis of historical aggradation of rich and colorful scientific travelogues for long-term exploration on brand-new landmasses of science, historical progress of science come to ideaistic correction & qualitative optimization from superficiality to profundity, from parochiality to generality, till at last, humanistic ideology about authenticity of nature comes to formulate authenticity of nature as perfect ideological enantiomorph of ultimate authenticity of nature.

As long-time exploration of rich and colorful brand-new landmass, we achieved many many scientific truths like omnifarious smallwares full of a basket, however, as it's only possible for ultimate authenticity of nature to be unique and invariable as coherent natura naturans throughout cosmic evolution, the later stage of historical progress of science is, the consequent humanistic ideology about authenticity of nature in proportion to contemporaneous historical background is relatively closer to perfect ideological enantiomorph of ultimate authenticity of nature,

As coherent natura naturans throughout cosmic evolution, instinctive PNT reciprocal equilibrium towards optimum PNT operation is radical potentiality & conditionality for cosmos always ready to orientate itself towards perfection.

the logic constitution of science is more general and profound, and the so-called scientific truths human invoking to formulate universal existence & motion are relatively less. Once humanistic ideology about authenticity of nature tallies with ultimate authenticity of nature 100 over 100, ultimate consummation of science must be perfect ideological enantiomorph of ultimate authenticity of nature.

All in all, veritable progress of science is not intuitional cumulative achievement of colorful scientific travelogues A, B, C, D, E, F, ... as deserving reward of the first itineracy around preternatural landscapes of brand-new landmasses of science like omnifarious smallwares full of a basket but successive hypostatic endeavor to push humanistic ideology about authenticity of nature forward to perfect ideological enantiomorph of ultimate authenticity of nature step by step draw on practical feasibility & possibility in proportion to contemporaneous historical background so as to accomplish historical progress of science in inherent optimum orientation towards historical authenticity tolerance of science 0.

3.2. As out-and-out social work outgrowth and humanistic ideology about authenticity of nature in proportion to contemporaneous historical background, the consolidation of social legitimacy qualification of timely renovation of humanistic ideology about authenticity of nature in proportion to contemporaneous historical background must bring out brand-new “contemporaneous scientific orthodoxy” and “authoritative intrepidity of contemporaneous scientific orthodoxy”, social significance & worthiness of timely renovation of humanistic ideology about authenticity of nature in proportion to contemporaneous historical background must be promoted into classic benefit of temporal authority, “contemporaneous scientific orthodoxy” and “authoritative intrepidity of contemporaneous scientific orthodoxy” is always something inherent of historical progress of science. And consequently, solid practical interposition of authoritative intrepidity of contemporaneous scientific orthodoxy to live scientific knowledge proliferation must impact and shape historical progress of science therefore.

The most substantial effect of development of science is practical achievement of advancement that humanistic ideology about authenticity of nature gradually approaches ultimate authenticity of nature towards historical authenticity tolerance of science 0 draw on practical feasibility & possibility in proportion to contemporaneous historical background, till at last, humanistic ideology about authenticity of nature turn into perfect ideological enantiomorph of ultimate authenticity of nature. Whereas, throughout historical progress of science, no matter what historical stage it is, no matter how remarkable the historical authenticity tolerance of science of so-called contemporaneous scientific orthodoxy is, as long as there is mainstream of scientific idea, there must be contemporaneous scientific orthodoxy and hierarchy of contemporaneous scientific orthodoxy of society then and there, there must authoritative intrepidity of contemporaneous scientific orthodoxy therefore.

So-called “authoritative intrepidity of contemporaneous scientific orthodoxy” is but inherent potentiality & capability for social legitimacy subsistence of contemporaneous scientific orthodoxy under the proper historical background, which of course includes the potentiality & capability for royal substantiation & perfection of contemporaneous scientific orthodoxy of the age even capability for counterwork in coming scientific knowledge metabolism campaign.

Throughout historical progress of science, authoritative intrepidity of contemporaneous scientific orthodoxy mostly depends on two determinant factors:

The first is “historical authenticity tolerance of science” of contemporaneous scientific orthodoxy.

The second is “official royalism value of contemporaneous scientific orthodoxy”.

As the social worthiness of contemporaneous scientific orthodoxy must be promoted as hierarchy of the

Historical progress of science in the recent several centuries seemed like a far-flung exploration of the first itineracy around numerous distinctive landscapes of brand-new landmasses of science with palette & tablet on back, several hundred years’ scientific travelogues were compiled thereby.

society, so-called official royalism value of contemporaneous scientific orthodoxy is just the social influence of contemporaneous scientific orthodoxy under proper social background, which generally includes political support, practical reciprocity between economics and contemporaneous scientific orthodoxy, capability contemporaneous scientific orthodoxy to sparkplug royal substantiation & perfection of contemporaneous scientific orthodoxy, even potentiality for contemporaneous scientific orthodoxy to counterwork in coming scientific knowledge metabolism campaign, no matter whether esoteric counterwork is rational or irrational.

Generally, the bigger the historical authenticity tolerance of science of contemporaneous scientific orthodoxy is, there is more residue of historical authenticity tolerance of science for successive progress of science to pursue and accomplish, proportionately, there are more probabilities for the contemporaneous scientific orthodoxy to be washed out by coming scientific innovation along intrinsic progression towards historical authenticity tolerance of science 0, and the livability of legitimacy subsistence of contemporaneous scientific orthodoxy is relatively poor. And inversely, the less the historical authenticity tolerance of science of contemporaneous scientific orthodoxy is, there is less residue of historical authenticity tolerance of science for successive progress of science to pursue and accomplish, proportionately, there are less probabilities for the contemporaneous scientific orthodoxy to be washed out by coming scientific innovation along intrinsic progression towards historical authenticity tolerance of science 0, and the livability of social legitimacy subsistence of contemporaneous scientific orthodoxy is relatively better.

And at the same time, the bigger the official royalism value of contemporaneous scientific orthodoxy is, there is more substantial potentiality for contemporaneous scientific orthodoxy to sparkplug royal substantiation & perfection of contemporaneous scientific orthodoxy, even as magistral autarchy of free press regulation customization and free press admittance of temporal authority, especially the popular second-string geniuses of the age short of necessary intendance, science forum can hardly be free from duress of authoritative intrepidity of contemporaneous scientific orthodoxy, coming innovative scientific knowledge proliferation out of succession of contemporaneous scientific orthodoxy must be under esoteric control of temporal authority. As a result, there is less probabilities for the contemporaneous scientific orthodoxy to be washed out by coming scientific innovation.

If we mathematically denote the authoritative intrepidity of contemporaneous scientific orthodoxy as α , denote historical authenticity tolerance of science of the contemporaneous scientific orthodoxy β , $\beta \in [0, 1]$, and denote the official royalism value of contemporaneous scientific orthodoxy δ , $\delta \in [0.5, 5]$, then, the mathematical correlation between “authoritative intrepidity of contemporaneous scientific orthodoxy α ” and “authenticity tolerance of science of the contemporaneous scientific orthodoxy β & official royalism value of contemporaneous scientific orthodoxy δ ” can be formulated as following:

$$\alpha = (1/\beta) * \delta$$

When $\delta \in (0.5, 1)$, it indicates that coming scientific innovation is under esoteric control of authoritative intrepidity of contemporaneous scientific orthodoxy and it's impossible for coming scientific innovation to share fair play in coming scientific knowledge metabolism campaign, for instance, coming scientific innovation suffered animus or discrimination even free press embarment for magistral autarchy of free press admittance of temporal authority short of necessary intendance.

When $\delta = 1$, it indicates social legitimacy subsistence of coming scientific innovation neither suffers animus or discrimination from temporal authority nor receives active support of the society, but in its straightforward

way for social legitimacy subsistence by the right of its inherent advantage of historical authenticity tolerance of science relative to contemporaneous scientific orthodoxy. It's of course critical situation for coming scientific innovation to procure legitimacy subsistence under the proper historical background.

When $\delta \epsilon(1, 2)$, it indicates social legitimacy subsistence of coming scientific innovation receives reasonable support in time, for instance, it pass free press admittance, and subsequently, its social legitimacy qualification in proportion to contemporaneous historical background has been identified and clarified for credible scientific authentication thereby.

When $\delta \epsilon(2, 4)$, it indicates coming scientific innovation has procured legitimacy qualification of the age and received necessary social support, it even has brought out official and professional academic group therefore.

When $\delta \epsilon(4, 5)$, it indicates successive renovation of humanistic ideology about authenticity of nature in proportion to contemporaneous historical background not only has procured social legitimacy qualification and consequently become contemporaneous scientific orthodoxy of the age, but also has formed grand orthodox academic group with classic advantage for contribution to burgeoning contemporaneous scientific orthodoxy even freewheeling royal substantiation and perfection of contemporaneous scientific orthodoxy comes into being at the volley. As temporal authority, they mostly monopolize comprehensive social resource for general progress of science upon popular endeavor of royal substantiation & perfection of contemporaneous scientific orthodoxy, especially, as magistral autarchy of degree qualification, free press regulation customization, free press admittance, social legitimacy authorization of neonatal scientific idea, authoritative intrepidity of contemporaneous scientific orthodoxy is even ample ascendancy to restrict coming scientific knowledge proliferation all over the world in rigid succession of contemporaneous scientific orthodoxy.

Of course, we must admit, when timely renovation of humanistic ideology about authenticity of nature in proportion to contemporaneous historical background procures social legitimacy qualification and consequently become burgeoning contemporaneous scientific orthodoxy of the age, however, as historical limitation, the burgeoning contemporaneous scientific orthodoxy is still out of scientific legitimacy qualification of historical authenticity tolerance of science 0, as **substantiation & perfection of burgeoning contemporaneous scientific orthodoxy** \approx **historical progress of science** out of question then and there, it's mostly not easy for ascendancy of authoritative intrepidity of contemporaneous scientific orthodoxy to expose its negative significance. Whereas, once the burgeoning contemporaneous scientific orthodoxy has exhausted its inherent potentiality to push forward historical progress of science in inherent optimum orientation towards historical authenticity tolerance of science 0, and live scientific knowledge proliferation still wallows too much in royal substantiation & perfection of contemporaneous scientific orthodoxy, there must be more and more remarkable aberrancy of hypostatic endeavor & effect of historical progress of science to push humanistic ideology about authenticity of nature forward to perfect ideological enantiomorph of ultimate authenticity of nature step by step draw on practical feasibility & possibility in proportion to contemporaneous historical background, the morbidity of development of science is of course self-evident.

That's to say, in terms of any contemporaneous scientific orthodoxy out of scientific legitimacy qualification of historical authenticity tolerance of science 0, once the official royalism value of contemporaneous scientific orthodoxy practically procures values in (4, 5), as practical implementation of authoritative intrepidity of contemporaneous scientific orthodoxy implicates comprehensive practical social operation of development of science of the age, it's really necessary for us to append necessary intendance to practical implementation of

Historical progress of science in the recent several centuries seemed like a far-flung exploration of the first itinerary around numerous distinctive landscapes of brand-new landmasses of science with palette & tablet on back, several hundred years' scientific travelogues were compiled thereby.

authoritative intrepidity of contemporaneous scientific orthodoxy, especially, once the so-called contemporaneous scientific orthodoxy has exhausted its inherent potentiality to push forward historical progress of science in inherent optimum orientation towards historical authenticity tolerance of science 0, and timely renovation of humanistic ideology about authenticity of nature in proportion to contemporaneous historical background become necessary. Otherwise, the practical implementation of authoritative intrepidity of contemporaneous scientific orthodoxy must expose its inherent negative significance, authoritative intrepidity of contemporaneous scientific orthodoxy must turn into powerful counterwork of coming scientific knowledge metabolism campaign once timely renovation of humanistic ideology about authenticity of nature in proportion to contemporaneous historical background occurs, and the even pestilent factuality is that, as free press regulation customization and free press admittance is completely under magistral autarchy of temporal authority short of necessary intendance, free press admittance of timely renovation of humanistic ideology about authenticity of nature can hardly be free from duress of live authoritative intrepidity of contemporaneous scientific orthodoxy.

Throughout historical progress of science in inherent optimum orientation towards perfect ideological enantiomorph of ultimate authenticity of nature along crescive progression of practical feasibility & possibility in proportion to contemporaneous historical background, as remarkable disparity of historical authenticity tolerance of science β and official royalism value of contemporaneous scientific orthodoxy δ , different contemporaneous scientific orthodoxies in different ages have different authoritative intrepidity of contemporaneous scientific orthodoxy α .

In accordance with mathematical definition of authoritative intrepidity of contemporaneous scientific orthodoxy related to historical authenticity tolerance of science and official royalism value of contemporaneous scientific orthodoxy, the authoritative intrepidity of contemporaneous scientific orthodoxy of Aristotle Theory α_{A-T} can of course be formulated as following:

$$\alpha_{A-T}=(1/\beta_{A-T})*\delta_{A-T}$$

Among the equation above, the subscript “ $A-T$ ” is abbreviation of “Aristotle Theory”, “ β_{A-T} ” represents historical authenticity tolerance of science of Aristotle Theory, “ δ_{A-T} ” represents official royalism value of contemporaneous scientific orthodoxy of Aristotle Theory.

If we define the historical authoritative tolerance of science of Aristotle Theory $\beta_{A-T}=0.35$, and define the official royalism value of contemporaneous scientific orthodoxy of Aristotle Theory $\delta_{A-T}=3.5$, then, the authoritative intrepidity of contemporaneous scientific orthodoxy of Aristotle Theory is as following:

$$\alpha_{A-T}=(1/\beta_{A-T})*\delta_{A-T}=(1/0.35)*3.5=10.0。$$

In accordance with mathematical definition of authoritative intrepidity of contemporaneous scientific orthodoxy related to historical authenticity tolerance of science and official royalism value of contemporaneous scientific orthodoxy, the authoritative intrepidity of contemporaneous scientific orthodoxy of Geocentric Theory α_{G-T} can of course be formulated as following:

$$\alpha_{G-T}=(1/\beta_{G-T})*\delta_{G-T},$$

Among the equation above, the subscript “ $G-T$ ” is abbreviation of “Geocentric Theory”, “ β_{G-T} ” represents historical authenticity tolerance of science of Geocentric Theory, “ δ_{G-T} ” represents official royalism value of contemporaneous scientific orthodoxy of Geocentric Theory.

As coherent natura naturans throughout cosmic evolution, instinctive PNT reciprocal equilibrium towards optimum PNT operation is radical potentiality & conditionality for cosmos always ready to orientate itself towards perfection.

If we define the historical authoritative tolerance of science of Geocentric Theory $\beta_{G-T}=0.25$, and define the official royalism value of contemporaneous scientific orthodoxy of Geocentric Theory $\delta_{G-T}=4.0$, then, the authoritative intrepidity of contemporaneous scientific orthodoxy of Geocentric Theory is as following:

$$\alpha_{G-T} = (1/\beta_{G-T}) * \delta_{G-T} = (1/0.25) * 4.0 = 16.0$$

... ..

In accordance with mathematical definition of authoritative intrepidity of contemporaneous scientific orthodoxy related to historical authenticity tolerance of science and official royalism value of contemporaneous scientific orthodoxy, the authoritative intrepidity of contemporaneous scientific orthodoxy of Newtonian Mechanics α_{N-M} can of course be formulated as following:

$$\alpha_{N-M} = (1/\beta_{N-M}) * \delta_{N-M},$$

Among the equation above, the subscript “ $N-M$ ” is abbreviation of “Newtonian Mechanics”, “ β_{N-M} ” represents historical authenticity tolerance of science of Newtonian Mechanics, “ δ_{N-M} ” represents official royalism value of contemporaneous scientific orthodoxy of Newtonian Mechanics.

If we define the historical authoritative tolerance of science of Newtonian Mechanics $\beta_{N-M}=0.06$, and define the official royalism value of contemporaneous scientific orthodoxy of Newtonian Mechanics $\delta_{N-M}=4.2$, then, the authoritative intrepidity of contemporaneous scientific orthodoxy of Newtonian Mechanics is as following:

$$\alpha_{N-M} = (1/\beta_{N-M}) * \delta_{N-M} = (1/0.06) * 4.2 \approx 70.0$$

In accordance with mathematical definition of authoritative intrepidity of contemporaneous scientific orthodoxy related to historical authenticity tolerance of science and official royalism value of contemporaneous scientific orthodoxy, the authoritative intrepidity of contemporaneous scientific orthodoxy of Relativity α_R can of course be formulated as following:

$$\alpha_R = (1/\beta_R) * \delta_R,$$

Among the equation above, the subscript “ R ” is abbreviation of “Relativity”, “ β_R ” represents historical authenticity tolerance of science of Relativity, “ δ_R ” represents official royalism value of contemporaneous scientific orthodoxy of Relativity.

If we define the historical authoritative tolerance of science of Relativity $\beta_{N-M}=0.033$, and define the official royalism value of contemporaneous scientific orthodoxy of Relativity $\delta_R=4.5$, then, the authoritative intrepidity of contemporaneous scientific orthodoxy of Relativity is as following:

$$\alpha_R = (1/\beta_R) * \delta_R = (1/0.033) * 4.5 \approx 135.$$

In accordance with mathematical definition of authoritative intrepidity of contemporaneous scientific orthodoxy related to historical authenticity tolerance of science and official royalism value of contemporaneous scientific orthodoxy, the authoritative intrepidity of contemporaneous scientific orthodoxy of Quantum Mechanics α_Q can of course be formulated as following:

$$\alpha_Q = (1/\beta_Q) * \delta_Q,$$

Among the equation above, the subscript “ Q ” is abbreviation of “Quantum Mechanics”, “ β_Q ” represents historical authenticity tolerance of science of Quantum Mechanics, “ δ_Q ” represents official royalism value of

contemporaneous scientific orthodoxy of Quantum Mechanics.

If we define the historical authoritative tolerance of science of Quantum Mechanics $\beta_Q=0.03$, and define the official royalism value of contemporaneous scientific orthodoxy of Quantum Mechanics $\delta_Q=4.5$, then, the authoritative intrepidity of contemporaneous scientific orthodoxy of Quantum Mechanics is as following:

$$\alpha_Q=(1/\beta_Q)*\delta_Q=(1/0.03)*4.5\approx 150$$

Historical presence of authoritative intrepidity of contemporaneous scientific orthodoxy must do its work to coming scientific knowledge proliferation and scientific knowledge metabolism. Once authoritative intrepidity brings up remarkable restriction to coming scientific knowledge proliferation & scientific knowledge metabolism, the consequent scientific knowledge metabolism campaign under control of authoritative intrepidity of contemporaneous scientific orthodoxy must restrain and retard the social legitimacy subsistence of coming scientific innovation and consequently retard the necessary knowledge metabolism towards historical authenticity tolerance of science 0.

“Historical authenticity tolerance of science 0” is course attribute of ultimate consummation of science once humanistic ideology about authenticity of nature ultimately turns into perfect ideological enantiomorph of ultimate authenticity of nature. Before humanistic ideology about authenticity of nature finally tallying with ultimate authenticity of nature 100 over 100 as perfect ideological enantiomorph of ultimate authenticity of nature, any contemporaneous scientific orthodoxy out social legitimacy qualification of historical authenticity tolerance of science 0 has its original naissance, development and dying out along crescive progression of historical progress of science in inherent optimum orientation towards historical authenticity tolerance of science 0.

And indeed, quantitative change of royal substantiation & perfection of contemporaneous scientific orthodoxy will accomplish some a little advancement of historical authenticity tolerance of science of contemporaneous scientific orthodoxy towards 0, which will of course quickly increase official royalism value of contemporaneous scientific orthodoxy at the volley and make the authoritative intrepidity of contemporaneous scientific orthodoxy more and more substantial. Once endeavor of substantiation & perfection of contemporaneous scientific orthodoxy has pushed the contemporaneous scientific orthodoxy to upper limit of rationality, the authoritative intrepidity of contemporaneous scientific orthodoxy reaches its max. And at the same time, under the proper historical background, the more active jobs the contemporaneous scientific orthodoxy have done to the society, the official royalism value of contemporaneous scientific orthodoxy is bigger, and authoritative intrepidity of contemporaneous scientific orthodoxy is relatively more intrepid, social legitimacy subsistence of contemporaneous scientific orthodoxy is more ineradicable. Especially, once the official royalism value of contemporaneous scientific orthodoxy is very near to 5, the restriction that royal substantiation & perfection of contemporaneous scientific orthodoxy to coming scientific knowledge proliferation and scientific knowledge metabolism is course self-evident.

However, as long as the leitmotiv of development of science is always endeavor to discover and formulate universal existence & motion as authentic, comprehensive and systematical as possible as human practically able to draw on practical feasibility & possibility in proportion to contemporaneous historical background eversince, as long as historical progress of science is still on its way towards historical authenticity tolerance of science 0, any contemporaneous scientific orthodoxy out of scientific legitimacy qualification of historical authenticity tolerance of science 0 must be washed out once coming scientific innovation accomplish further advancement towards historical authenticity tolerance of science 0.

As coherent natura naturans throughout cosmic evolution, instinctive PNT reciprocal equilibrium towards optimum PNT operation is radical potentiality & conditionality for cosmos always ready to orientate itself towards perfection.

And in terms of coming scientific innovation, on one hand, as humanistic ideology about authenticity of nature, if the historical authenticity tolerance of science of coming scientific innovation is even bigger than that of contemporaneous scientific orthodoxy, then, the so-called coming scientific innovation is of course invalid scientific innovation to procure social legitimacy subsistence of the age. At any rate, historical progress of science is always in inherent optimum orientation towards historical authenticity tolerance of science 0, if contemporaneous scientific orthodoxy were washed out by invalid scientific innovation whose historical authenticity tolerance of science was even bigger than contemporaneous scientific orthodoxy, such improper implementation must have dragged historical progress of science backward. And on the other hand, even though historical authenticity tolerance of science of coming scientific innovation is obviously less than historical authenticity tolerance of science of contemporaneous scientific orthodoxy, as originally coming into being and few people knowing it, it's almost impossible for coming scientific innovation to procure equivalent official royalism value as live contemporaneous scientific orthodoxy in relatively short time. This of course indicates it is mostly difficult for coming scientific innovation to actualize necessary scientific knowledge metabolism for esoteric scientific knowledge metabolism campaign against contemporaneous scientific orthodoxy. And the upper stage of historical progress of science is, historical authenticity tolerance of live contemporaneous scientific orthodoxy is relatively less and official royalism value of contemporaneous scientific orthodoxy is relatively bigger, it's more difficult challenge for coming scientific innovation therefore, the resistance of the proportionate scientific knowledge metabolism is bigger.

Perhaps it's very easy for you to imagine the brutal authoritative intrepidity of contemporaneous scientific orthodoxy of Geocentric Theory before coming Heliocentric Theory, ...; the brutal authoritative intrepidity of contemporaneous scientific orthodoxy of <Good Book> before <The Origin of Species> of Charles Darwin. Whereas, it may be difficult for us to imagine that the resistance and truculency authoritative intrepidity of nowadays contemporaneous scientific orthodoxy to coming scientific innovation is even more burdensome than something Geocentric Theory had ever done to Heliocentric Theory, <Good Book> had ever done to <The Origin of Species> of Charles Darwin.

After all, when "Geocentric theory" and "Good Book" were royal and popular, puissance of "free press regulation customization" & "free press admittance" still had not come into being, the so-called contemporaneous scientific orthodoxy mostly came to punish coming scientific innovation once the promulgation of coming scientific innovation had practically threaten its legitimacy subsistence. Whereas, once puissance of "free press regulation customization" & "free press admittance" came into historical stage, the situation was completely different. as out-and-out social work outgrowth and humanistic ideology about authenticity of nature in proportion to contemporaneous historical background, social existence and historical progress of "science" must inherently possess double coordinative significance of "natural connotation" and "social connotation", social legitimacy subsistence of neonatal scientific idea especially successive renovation of humanistic ideology about authenticity of nature along historical progress of science in inherent optimum orientation towards perfect ideological enantiomorph of ultimate authenticity of nature never simply depends on cognizant achievement that brand-new or more veritable authenticity of nature has been reflected on sense of pioneering originators with commensurate authenticity highlight effect in proportion to contemporaneous historical background, it even crucially implicates esoteric authoritative social legitimacy identification & authentication in accordance with egotistic criterion of contemporaneous scientific orthodoxy under official centered background ——social

Historical progress of science in the recent several centuries seemed like a far-flung exploration of the first itinerary around numerous distinctive landscapes of brand-new landmasses of science with palette & tablet on back, several hundred years' scientific travelogues were compiled thereby.

legitimacy & validity of truths can never exceed cannon range. This is just humanistic situation of hypostatic historical progress of science once authoritative puissance of “free press regulation customization” & “free press admittance” come into being and play their humanistic roles in the nature of things.

What's more, historical progress of science till today, both the “1/historical authenticity tolerance of science of contemporaneous scientific orthodoxy” and “official royalism value of contemporaneous scientific orthodoxy” are unparalleled, as a result, the authoritative intrepidity of contemporaneous scientific orthodoxy is record-breaking, what's more, “free press regulation customization” & “free press admittance” is under magistral autarchy of temporal authority short of necessary intendance, science forum can hardly be free from duress of authoritative intrepidity of contemporaneous scientific orthodoxy once epochmaking scientific knowledge metabolism is inevitable due to occurrence of timely renovation of humanistic ideology about authenticity of nature in proportion to contemporaneous historical background. Although, ostensibly, temporal authority are not as scampish as foregone authorities of Geocentric Theory and Good Book, they virtually possess even respectable and expedient official facility to involve in virulent scientific knowledge metabolism campaign, especially magistral autarchy of free press regulation customization & free press admittance of temporal authority short of necessary intendance.

3.3. Realistic progress of science can never be free from restriction & conditionality of “crescive progression of practical feasibility & possibility in proportion to contemporaneous historical background + the uniqueness & invariance of ultimate authenticity of nature predestines the unique possibility of scientific verity as perfect ideological enantiomorph of ultimate authenticity of nature”, and as permanent synthesized conditionality of “crescive progression of practical feasibility & possibility in proportion to contemporaneous historical background + the uniqueness & invariance of ultimate authenticity of nature predestines the unique possibility of scientific verity as perfect ideological enantiomorph of ultimate authenticity of nature” through and through, it's only possible for the major melody of historical progress of science to be a series of epochmaking scientific knowledge metabolism in inherent optimum orientation towards perfect ideological enantiomorph of ultimate authenticity of nature. As a result, historical progress of science must be shaped by hypostatic “scientific knowledge metabolism” & “scientific knowledge metabolism campaign”. What's more, as out-and-out social work outgrowth and humanistic ideology about authenticity of nature in proportion to contemporaneous historical background, social existence and historical progress of “science” must inherently possess double coordinative significance of “natural connotation” and “social connotation”, social legitimacy subsistence of neonatal scientific idea especially successive renovation of humanistic ideology about authenticity of nature along historical progress of science in inherent optimum orientation towards perfect ideological enantiomorph of ultimate authenticity of nature never simply depends on cognizant achievement that brand-new or more veritable authenticity of nature has been reflected on sense of pioneering originators with commensurate authenticity highlight effect in proportion to contemporaneous historical background, it even crucially implicates esoteric authoritative social legitimacy identification & authentication in accordance with egotistic criterion of contemporaneous scientific orthodoxy under official centered background——social legitimacy & validity of truths can never exceed cannon range, which of course includes humanistic operation of virulent scientific knowledge metabolism campaign underlying.

As permanent synthesized conditionality of “crescive progression of practical feasibility & possibility in proportion to contemporaneous historical background + the uniqueness & invariance of ultimate authenticity of nature predestines the unique possibility of scientific verity as perfect ideological enantiomorph of ultimate authenticity of nature” through and through, humanistic ideology about authenticity of nature gradually approach ultimate authenticity of nature till as last, it tally with ultimate authenticity of nature 100 over 100 as perfect enantiomorph of ultimate authenticity of nature

As coherent natura naturans throughout cosmic evolution, instinctive PNT reciprocal equilibrium towards optimum PNT operation is radical potentiality & conditionality for cosmos always ready to orientate itself towards perfection.

must bring out occurrence that innovative humanistic ideology about authenticity of nature must wash out conservative ready-made humanistic ideology about authenticity of nature, which actually hypostatized as scientific knowledge metabolism along crecive progression of historical progress of science in inherent optimum orientation towards historical authenticity tolerance of science 0. As it's only possible for ultimate authenticity of nature to be unique and invariable as coherent natura naturans throughout cosmic evolution, in accordance with the enantiomorphous correlation between objective authenticity of nature and humanistic ideology about authenticity of nature, it's only possible for ultimate consummation of science to be perfect ideological enantiomorph of ultimate authenticity of nature, and as a result, it's only possible for the major melody of historical progress of science to be serial epochmaking scientific knowledge metabolism in inherent optimum orientation towards scientific legitimacy qualification of historical authenticity tolerance of science 0, unless it's possible for human to take universal existence & motion into rational purview and consummate formulation of universal existence & motion as unique scientific verity about universal existence & motion of perfect ideological enantiomorph of ultimate authenticity of nature kind once in defiance of objectivity of possible operation of historical progress of science in inherent optimum orientation towards perfect ideological enantiomorph of ultimate authenticity of nature due to crecive progression of practical feasibility & possibility in proportion to contemporaneous historical background which is commensurate potentiality for historical progress of science then and there.

In another words, as long as we can exclude the possibility that it's possible for human to accomplish absolute scientific verity as perfect ideological enantiomorph of ultimate authenticity of nature once, then, practical accomplishment of historical progress of science must be in long-time intrinsic progression in inherent optimum orientation towards historical authenticity tolerance of science 0. in terms of any contemporaneous scientific orthodoxy out of scientific legitimacy qualification of historical authenticity tolerance of science 0, as long as historical progress of science is still in its permanent way towards historical authenticity tolerance of science 0, it must be washed out by coming positive renovation of humanistic ideology about authenticity of nature towards perfect ideological enantiomorph of ultimate authenticity of nature sooner or later, till at last, humanistic ideology about authenticity of nature tallies with ultimate authenticity of nature 100 over 100 as perfect ideological enantiomorph of ultimate authenticity of nature.

So-called “**scientific knowledge metabolism**” is historical renewal & optimization of humanistic ideology about authenticity of nature gradually approach consummate formulation of universal existence & motion as coherent theory as perfect ideological enantiomorph of ultimate authenticity of nature due to incremental quantitative change of practical feasibility & possibility in proportion to contemporaneous historical background, which is virtually qualitative change of historical progress of science under potential synthesized conditionality of “**crecive progression of practical feasibility & possibility in proportion to contemporaneous historical background + the uniqueness & invariance of ultimate authenticity of nature predestines the unique possibility of scientific verity as perfect ideological enantiomorph of ultimate authenticity of nature**”. Virtually, as inevitability of quantitative & qualitative change of historical progress of science under potential synthesized conditionality of “**crecive progression of practical feasibility & possibility in proportion to contemporaneous historical background + the uniqueness & invariance of ultimate authenticity of nature predestines the unique possibility of scientific verity as perfect ideological enantiomorph of ultimate authenticity of nature**”, it's only possible for the major melody of historical progress of science to be serial “epochmaking scientific knowledge metabolism” in inherent optimum orientation towards perfect ideological enantiomorph of ultimate authenticity of nature through and through.

Historical progress of science in the recent several centuries seemed like a far-flung exploration of the first itinerary around numerous distinctive landscapes of brand-new landmasses of science with palette & tablet on back, several hundred years' scientific travelogues were compiled thereby.

Since **ultimate authenticity of nature** can be neither omnifarious authenticity smallwares full of a basket nor authenticity chameleon one piece and only but coherent natura naturans throughout cosmic evolution, as commensurate ideological enantiomorph of accessible existence & motion around us, ultimate consummation of science must be perfect ideological enantiomorph of ultimate authenticity of nature, veritable progress of science is not intuitional cumulative achievement of colorful scientific travelogues A, B, C, D, E, F, ...as deserving reward of the first itineracy around preternatural landscapes of brand-new landmasses of science like omnifarious smallwares full of a basket but successive hypostatic endeavor to push humanistic ideology about authenticity of nature forward to perfect ideological enantiomorph of ultimate authenticity of nature step by step draw on practical feasibility & possibility in proportion to contemporaneous historical background. And as permanent synthesized conditionality of **“crescive progression of practical feasibility & possibility in proportion to contemporaneous historical background + the uniqueness & invariance of ultimate authenticity of nature predestines the unique possibility of scientific verity as perfect ideological enantiomorph of ultimate authenticity of nature”** through and through, humanistic ideology about authenticity of nature gradually approach perfect ideological enantiomorph of ultimate authenticity of nature must bring up inevitability that coming scientific innovation negate and replace ready-made conservative humanistic ideology about authenticity of nature step by step in inherent optimum orientation towards perfect ideological enantiomorph of ultimate authenticity of nature. So-called **“scientific knowledge metabolism campaign”** is just social legitimacy subsistence competition & struggle of contemporaneous humanistic ideology about authenticity of nature between coming scientific innovation and contemporaneous scientific orthodoxy once coming scientific innovation has to challenge social legitimacy subsistence of contemporaneous scientific orthodoxy for occurrence of optimum variation of ideological system about authenticity of nature in proportion to contemporaneous historical background towards perfect ideological enantiomorph of ultimate authenticity. Social legitimacy subsistence competition & struggle usually occurs for remarkable scientific dissidence even illogicality between coming scientific innovation and contemporaneous scientific orthodoxy, if illogicality is irreconcilable, remarkable divarication maybe even cause forcible rencounter.

Scientific knowledge metabolism campaign usually has double competition & struggle signification between coming scientific innovation and contemporaneous scientific orthodoxy:

The first is **veritable progressive metabolism of humanistic ideology about authenticity of nature towards perfect ideological enantiomorph of ultimate authenticity of nature whose historical authenticity tolerance of science is 0, no matter coming scientific innovation or contemporaneous scientific orthodoxy, whose historical authenticity tolerance of science is relatively closer to 0, who must ultimately win in scientific knowledge metabolism campaign.** After all, veritable progress of science is not historical process human stochastically approach distinctive scientific truths one after another but hypostatic endeavor to push humanistic ideology about authenticity of nature forward to perfect ideological enantiomorph of ultimate authenticity of nature step by step draw on practical feasibility & possibility in proportion to contemporaneous historical background.

The second is **interclass conflict for social legitimacy subsistence of humanistic ideology about authenticity of nature between coming renovation of humanistic ideology about authenticity of nature in proportion to contemporaneous historical background and contemporaneous scientific orthodoxy.** Virtually, as opposite of scientific knowledge metabolism campaign with powerful backup of authoritative intrepidity of contemporaneous scientific orthodoxy, contemporaneous scientific orthodoxy is always high-sounding and valiant in scientific knowledge metabolism campaign, especially the living temporal authority with solid facility of magistral autarchy of free press regulation customization and free

As coherent natura naturans throughout cosmic evolution, instinctive PNT reciprocal equilibrium towards optimum PNT operation is radical potentiality & conditionality for cosmos always ready to orientate itself towards perfection.

press admittance short of necessary intendance, and relatively, the originators of coming renovation of humanistic ideology about authenticity of nature in proportion to contemporaneous historical background are mostly tender.

In fact, as humanistic ideology about authenticity of nature in proportion to contemporaneous historical background, for crescive progression of practical feasibility & possibility of human, historical progress of science must experience frondose evolvement of humanistic ideology about authenticity of nature cumulatively enriched from nothingness to goat, from goat to a great lot, and consequently followed proportionate ideaistic correction & qualitative optimization from superficiality to profundity, from parochiality to generality, what's more, it's only possible for ultimate authenticity of nature to be coherent natura naturans throughout cosmic evolution, ultimate consummation of science must be perfect ideological enantiomorph of coherent natura naturans throughout cosmic evolution, none else. This of course predestines it's only possible for the major melody of historical progress of science to be serial epochmaking scientific knowledge metabolism in inherent optimum orientation towards perfect ideological enantiomorph of ultimate authenticity of nature. Whereas, as science hierarchy with respectable legitimacy qualification of the age and opposite of coming scientific knowledge metabolism campaign with officialism authoritative intrepidity of contemporaneous scientific orthodoxy, we have to admit live contemporaneous scientific orthodoxy is overwhelming in coming scientific knowledge metabolism campaign. Comparably, timely renovation of humanistic ideology about authenticity of nature in proportion to contemporaneous historical background is mostly tender. Once authoritative intrepidity of contemporaneous scientific orthodoxy brings up remarkable resistance to coming scientific knowledge metabolism, historical progress of science in inherent optimum orientation towards historical authenticity tolerance of science 0 must be retarded thereby.

At any rate, as outcome of out-and-out social work and humanistic ideology about authenticity of nature in proportion to contemporaneous historical background, once humanistic ideology about authenticity of nature procured respectable legitimacy qualification of the age, it mostly contains social status & benefit of the so-called modern academicians under background of high-sounding royal substantiation & perfection of contemporaneous scientific orthodoxy, especially the authoritative second-string geniuses even the popular third-rate geniuses of the society. As long as coming scientific knowledge metabolism campaign arise among social people, the double competition & struggle signification between coming scientific innovation and contemporaneous scientific orthodoxy is inevitable.

All in all, before humanistic ideology about authenticity of nature finally qualified as perfect ideological enantiomorph of ultimate authenticity of nature, as long as there is mainstream of scientific idea, there must be contemporaneous scientific orthodoxy of the age with authoritative intrepidity of contemporaneous scientific orthodoxy thereby, and external presence of authoritative intrepidity of contemporaneous scientific orthodoxy must impact living scientific knowledge proliferation even coming scientific knowledge metabolism more or less.

Firstly, before there is common foreknowledge in our society that, as permanent synthesized conditionality of **“crescive progression of practical feasibility & possibility in proportion to contemporaneous historical background + the uniqueness & invariance of ultimate authenticity of nature predestines the unique possibility of scientific verity as perfect ideological enantiomorph of ultimate authenticity of nature”** through and through, it's only possible for the major melody of historical progress of science to be a series of epochmaking scientific knowledge metabolism in inherent optimum orientation towards historical authenticity tolerance of science 0, historical presence of authoritative intrepidity of contemporaneous scientific orthodoxy must insist on live contemporaneous scientific orthodoxy is the most superior theory and consequently fix on egotism for living scientific knowledge proliferation.

Historical progress of science in the recent several centuries seemed like a far-flung exploration of the first itinerary around numerous distinctive landscapes of brand-new landmasses of science with palette & tablet on back, several hundred years' scientific travelogues were compiled thereby.

In terms of the living scientific knowledge proliferation, as the practical royal substantiation & perfection of contemporaneous scientific orthodoxy from 20 years to 70 years of last century generally took the role of historical progress of science, even as remarkable autarchy of “free press regulation customization” & “free press admittance” of temporal authority short of necessary intendance, living scientific knowledge proliferation is obviously in inertial state of royal substantiation & perfection of contemporaneous scientific orthodoxy, and it seems scientific knowledge proliferation all over the world must be in rigid succession of contemporaneous scientific orthodoxy. As unprecedented authoritative intrepidity of contemporaneous scientific orthodoxy, especially unbending autarchy of free press regulation customization & free press admittance at pleasure of temporal authority, historical progress of science has been redefined into “**substantiation & perfection of contemporaneous scientific orthodoxy = general progress of science**” which is but hypostatic endeavor to push humanistic ideology about authenticity of nature forward to perfect ideological enantiomorph of ultimate authenticity of nature draw on practical feasibility & possibility in proportion to contemporaneous historical background, but not permanent endeavor of substantiation & perfection of contemporaneous scientific orthodoxy. They even persist living scientific knowledge proliferation all over the world must be in rigid succession of contemporaneous scientific orthodoxy going without saying, otherwise, nothing is acceptable for free press admittance.

Secondly, under general social background social work output generally under inducement of social worthiness and benefit, as out-and-out social work outgrowth and humanistic ideology about authenticity of nature in proportion to contemporaneous historical background, social existence & historical progress of “science” must inherently possess double coordinative significance of “natural connotation” and “social connotation”, social legitimacy subsistence of neonatal scientific idea never simply depends on cognizant achievement that brand-new or more authenticity of nature has been reflected on sense of pioneering originators with commensurate authenticity highlight effect in proportion to contemporaneous historical background, it even crucially implicates esoteric authoritative social legitimacy identification & authentication in accordance with egotistic criterion of contemporaneous scientific orthodoxy under official centered background——social legitimacy & validity of truths can never exceed cannon range.

The key issue behind social operation of esoteric authoritative social legitimacy identification & authentication is that, as “**the uniqueness & invariance of ultimate authenticity of nature proportionably predestines the unique possibility of scientific verity as perfect ideological enantiomorph of ultimate authenticity of nature**”, it's neither possible for “the unique & invariable ultimate authenticity of nature” to be compatible with “two distinctive humanistic ideologies about authenticity of nature with remarkable ideological difference” nor possible for “two distinctive humanistic ideologies about authenticity of nature with remarkable ideological difference” to discover and formulate “the unique & invariable ultimate authenticity of nature” coequally. Such factuality of course indicates historical progress of science with humanistic ideology about authenticity of nature gradually approaching perfect ideological enantiomorph of ultimate authenticity of nature must be a grand gradational series of scientific knowledge metabolism, alternative between coming scientific innovation and live contemporaneous scientific orthodoxy must be life-and-death tussle.

As opposite in scientific knowledge metabolism campaign, compared to contemporaneous scientific orthodoxy, no matter whether coming scientific innovation has relative advantage of historical authenticity tolerance of science or not, once coming scientific innovation practically comes to challenge legitimacy subsistence of contemporaneous scientific orthodoxy and consequently slides into scientific knowledge metabolism campaign,

As coherent natura naturans throughout cosmic evolution, instinctive PNT reciprocal equilibrium towards optimum PNT operation is radical potentiality & conditionality for cosmos always ready to orientate itself towards perfection.

temporal authority must arouse as counter check battleship in scientific knowledge metabolism campaign. Under background with magistral autarchy of “free press regulation customization” & “free press admittance” of temporal authority, asperity of scientific knowledge metabolism campaign is course self-evident.

All in all, as permanent synthesized conditionality of “**crecive progression of practical feasibility & possibility in proportion to contemporaneous historical background + the uniqueness & invariance of ultimate authenticity of nature predestines the unique possibility of scientific verity as perfect ideological enantiomorph of ultimate authenticity of nature**” through and through, historical process that humanistic ideology about authenticity of nature gradually approaches perfect ideological enantiomorph of ultimate authenticity of nature must be a series of epochmaking scientific knowledge metabolism in inherent optimum orientation towards scientific legitimacy qualification of historical authenticity tolerance of science 0, which is of course successive series of social legitimacy subsistence metabolism as well, implementation of scientific knowledge metabolism will of course impact social legitimacy subsistence of contemporaneous scientific orthodoxy and arouse scientific knowledge metabolism campaign thereby.

Scientific knowledge metabolism campaign in different historical age has different tussle modality.

In historical ages of Copernicus, Bruno, Galileo etc., scientific knowledge metabolism usually accomplished as forcible subdual from temporal ideological hierarchy to coming scientific innovators. And now, the historical factuality that temporal ideological hierarchy mostly acted as ruffian with falchion in hand in scientific knowledge metabolism has gone, however, as “free press regulation customization” & “free press admittance” embarking upon a political venture, temporal authority are really popular to act as authoritative master of free press regulation customization and official umpire of free press admittance with respectable coronet on head, whose humanistic roles are even esoteric and expedient.

In any case, the most remarkable indication of royal substantiation & perfection of contemporaneous scientific orthodoxy is that, under precondition that live contemporaneous scientific orthodoxy is still out of scientific legitimacy qualification of historical authenticity tolerance of science 0, high-sounding royal substantiation & perfection of contemporaneous scientific orthodoxy seems always ready to monopolize comprehensive social resource for general progress of science draw on authoritative intrepidity of contemporaneous scientific orthodoxy which mostly derived from intrepid superiority of the living second-string geniuses of the age, although, royal substantiation & perfection of contemporaneous scientific orthodoxy \neq permanent endeavor to push humanistic ideology about authenticity of nature forward to perfect ideological enantiomorph of ultimate authenticity of nature draw on practical feasibility & possibility in proportion to contemporaneous historical background. And just because of permanent operation of authoritative intrepidity of contemporaneous scientific orthodoxy, even living scientific knowledge proliferation all over the world must be in rigid succession of contemporaneous scientific orthodoxy, otherwise, no way for free press admittance. As a result, under background of royal substantiation & perfection of contemporaneous scientific orthodoxy, living scientific knowledge metabolism campaign most hypostatize as altisonant “free press monopolization” of temporal authority and “free press embarment” to heterodoxy of science once renovation of humanistic ideology about authenticity of nature in proportion to contemporaneous historical background occurs.

4. Realistic progress of science can never be free from restriction & conditionality of “crecive progression of practical feasibility & possibility in proportion to contemporaneous historical background + the uniqueness & invariance of ultimate authenticity of nature predestines the unique possibility of scientific verity as perfect

Historical progress of science in the recent several centuries seemed like a far-flung exploration of the first itinerary around numerous distinctive landscapes of brand-new landmasses of science with palette & tablet on back, several hundred years’ scientific travelogues were compiled thereby.

ideological enantiomorph of ultimate authenticity of nature”, and as permanent synthesized conditionality of “**crecive progression of practical feasibility & possibility in proportion to contemporaneous historical background + the uniqueness & invariance of ultimate authenticity of nature predestines the unique possibility of scientific verity as perfect ideological enantiomorph of ultimate authenticity of nature**”, it's only possible for the major melody of historical progress of science to be a series of epochmaking scientific knowledge metabolism in inherent optimum orientation towards historical authenticity tolerance of science 0. Of course, epochmaking scientific knowledge metabolism indicates synchronous revolutionary subrogation of corresponding contemporaneous scientific orthodoxies.

As straightforward man without any special artifice, the unique workmanship of the demiurge is coherent natura naturans throughout cosmic evolution, and virtually, cosmic status quo is but connatural outgrowth of out-and-out serial natura naturata subject to coherent natura naturans in the nature of instinctive PNT reciprocal equilibrium towards optimum PNT operation through and through. As extremity extension of coherent natura naturans throughout cosmic evolution, existence & development of society can never impact the authenticity of nature, naissance & development of science can never impact authenticity of nature too.

However, as humanistic ideology about authenticity of nature in proportion to contemporaneous historical background, living scientific knowledge proliferation can only be endeavor that people are dedicated in recognizant formulation of accessible existence & motion around off the cuff. As crecive progression of practical feasibility & possibility in proportion to contemporaneous historical background, in different historical stages, the accessible depth and generality of existence & motion around us is remarkably different, this of course impact the living scientific knowledge proliferation and implies remarkable difference of output of living scientific knowledge proliferation then and there. Even as the disparity of living scientific knowledge aggradation in different historical stages, the output quality of living scientific knowledge proliferation must be proportionately different too, even though the accessible existence & motion are almost the same.

This of course implies during the course of humanistic ideology about authenticity of nature in proportion to contemporaneous historical background gradually approaching perfect ideological enantiomorph of ultimate authenticity of nature, there must be scientific knowledge metabolism towards knowledge optimization in proportion to contemporaneous historical background, quantitative change of living scientific knowledge proliferation must bring out deadlock that innovative scientific idea relatively close to ultimate authenticity of nature must wash out the ready-made conservative scientific idea without alternatives, till at last, humanistic ideology about authenticity of nature ultimately tally with ultimate authenticity of nature 100 over 100 as unique scientific verity about universal existence & motion as perfect ideological enantiomorph of ultimate authenticity of nature. This of course indicates, as permanent synthesized conditionality of “**crecive progression of practical feasibility & possibility in proportion to contemporaneous historical background + the uniqueness & invariance of ultimate authenticity of nature predestines the unique possibility of scientific verity as perfect ideological enantiomorph of ultimate authenticity of nature**”, it's only possible for the major melody of historical progress of science to be a series of epochmaking scientific knowledge metabolism in inherent optimum orientation towards historical authenticity tolerance of science 0, which of course implies the synchronous revolutionary subrogation of corresponding contemporaneous scientific orthodoxies one after another.

At any rate, in accordance with rigorous enantiomorphous correlation between objective authenticity of

As coherent natura naturans throughout cosmic evolution, instinctive PNT reciprocal equilibrium towards optimum PNT operation is radical potentiality & conditionality for cosmos always ready to orientate itself towards perfection.

nature and humanistic ideology about authenticity of nature, it's neither possible for "the unique & invariable ultimate authenticity of nature" to be compatible with "two distinctive humanistic ideologies about authenticity of nature with remarkable ideological difference" nor possible for "two distinctive humanistic ideologies about authenticity of nature with remarkable ideological difference" to discover and formulate "the unique & invariable ultimate authenticity of nature" coequally. Along time axis of historical progress of science, science is always a variable whose variation generally hypostatize historical progress of science in inherent optimum orientation towards historical authenticity tolerance of science 0, and revolutionary renovation of humanistic ideology about authenticity of nature in proportion to contemporaneous historical background must bring out scientific knowledge metabolism without alternatives.

Throughout historical progress of science, if human had practically accomplished N ($N \geq 2$) times of renovation of humanistic ideology about authenticity of nature in proportion to contemporaneous historical background at the volley, then, we can of course conclude that it's impossible for the N times of renovation of humanistic ideology about authenticity of nature in proportion to contemporaneous historical background to be perfect ideological enantiomorph of ultimate authenticity of nature as coherent theory about universal existence & motion, but idiographic humanistic ideology about authenticity of nature in proportion to contemporaneous historical background with proportionate unequal historical authenticity tolerance of science in rigorous succession & orientation towards historical authenticity tolerance of science 0. Then, in accordance with general progressive fundamental humanistic ideology about authenticity of nature gradually approaching perfect ideological enantiomorph of ultimate authenticity of nature in inherent optimum orientation towards historical authenticity tolerance of science 0, the occurrence succession of scientific knowledge metabolism must be as following:

Once the second renovation of humanistic ideology about authenticity of nature in proportion to contemporaneous historical background occurred and consequently procured social legitimacy qualification of the age, the first version of humanistic ideology about authenticity of nature in proportion to foregone historical background must be washed out by the second renovation of humanistic ideology about authenticity of nature in proportion to contemporaneous historical background. In any case, as humanistic ideology about authenticity of nature in proportion to contemporaneous historical background, it's only possible for ultimate consummation of science to be perfect ideological enantiomorph of ultimate authenticity of nature, since it's only possible for ultimate authenticity of nature to be unique and invariable as coherent natura naturans throughout cosmic evolution, it's of course impossible for "two distinctive humanistic ideologies about authenticity of nature with remarkable ideological difference" to discover and formulate "the coherent natura naturans throughout cosmic evolution" coequally.

Once the third renovation of humanistic ideology about authenticity of nature in proportion to contemporaneous historical background occurred and consequently procured social legitimacy qualification of the age, the second version of humanistic ideology about authenticity of nature in proportion to foregone historical background must be washed out by the third renovation of humanistic ideology about authenticity of nature in proportion to contemporaneous historical background. In any case, as humanistic ideology about authenticity of nature in proportion to contemporaneous historical background, it's only possible for ultimate consummation of science to be perfect ideological enantiomorph of ultimate authenticity of nature, since it's only possible for ultimate authenticity of nature to be unique and invariable as coherent natura naturans throughout cosmic evolution, it's of course impossible for "two distinctive

humanistic ideologies about authenticity of nature with remarkable ideological difference” to discover and formulate “the coherent natura naturans throughout cosmic evolution” coequally.

Once the 4th renovation of humanistic ideology about authenticity of nature in proportion to contemporaneous historical background occurred and consequently procured social legitimacy qualification of the age, the third version of humanistic ideology about authenticity of nature in proportion to foregone historical background must be washed out by the 4th renovation of humanistic ideology about authenticity of nature in proportion to contemporaneous historical background. In any case, as humanistic ideology about authenticity of nature in proportion to contemporaneous historical background, it's only possible for ultimate consummation of science to be perfect ideological enantiomorph of ultimate authenticity of nature, since it's only possible for ultimate authenticity of nature to be unique and invariable as coherent natura naturans throughout cosmic evolution, it's of course impossible for “two distinctive humanistic ideologies about authenticity of nature with remarkable ideological difference” to discover and formulate “the coherent natura naturans throughout cosmic evolution” coequally.

... ..

Once the Nth renovation of humanistic ideology about authenticity of nature in proportion to contemporaneous historical background occurred and consequently procured social legitimacy qualification of the age, the (N-1)th version of humanistic ideology about authenticity of nature in proportion to foregone historical background must be washed out by the Nth renovation of humanistic ideology about authenticity of nature in proportion to contemporaneous historical background. In any case, as humanistic ideology about authenticity of nature in proportion to contemporaneous historical background, it's only possible for ultimate consummation of science to be perfect ideological enantiomorph of ultimate authenticity of nature, since it's only possible for ultimate authenticity of nature to be unique and invariable as coherent natura naturans throughout cosmic evolution, it's of course impossible for “two distinctive humanistic ideologies about authenticity of nature with remarkable ideological difference” to discover and formulate “the coherent natura naturans throughout cosmic evolution” coequally. And scientific knowledge metabolism throughout historical progress of science will be ultimately ended once humanistic ideology about authenticity of nature finally qualified as perfect ideological enantiomorph of ultimate authenticity of nature.

All in all, as potential synthesized conditionality of “**crecive progression of practical feasibility & possibility in proportion to contemporaneous historical background + the uniqueness & invariance of ultimate authenticity of nature predestines unique possibility of scientific verity**” through and through, it's only possible for the major melody of historical progress of science to be serial epochmaking scientific knowledge metabolism in inherent optimum orientation towards historical authenticity tolerance of science 0. which hypostatize both inherent natural connotation and social connotation of science plumply itself.

Generally, historical progress of science relates three major conditions as following:

The first, as out-and-out consequent growth of development of society, naissance and successive development of society not offers proportionate external necessity of naissance & successive development of science but also offers practical feasibility & possibility for development of science as well. And as a result, practical accomplishment of historical progress of science in inherent optimum orientation towards perfect ideological enantiomorph of ultimate authenticity of nature must condition proportionable quantitative & qualitative change of practical feasibility & possibility in proportion to contemporaneous historical background.

As coherent natura naturans throughout cosmic evolution, instinctive PNT reciprocal equilibrium towards optimum PNT operation is radical potentiality & conditionality for cosmos always ready to orientate itself towards perfection.

As outgrowth of historical practice all wool and a yard wide, practical accomplishment of historical progress of science must experience hypostatic historical practice successively. We can even think that, along time axis of historical progress of science, the quantitative & qualitative accomplishment of historical progress of science is always a variable Y, the enantiomorphous recognizant correlation between authenticity of commensurate accessible existence & motion and commensurate ideological system about authenticity of accessible existence & motion is just mapping fundamental F, crescive progression of practical feasibility & possibility in proportion to contemporaneous historical background is independent variable X, so that we can expediently denote the integrative logic correlation among the three related elements as $Y=F(X)$, which is mostly hypostatized by historical practice as hypostatic endeavor of historical progress of science to push humanistic ideology about authenticity of nature forward to perfect ideological enantiomorph of ultimate authenticity of nature step by step draw on practical feasibility & possibility in proportion to contemporaneous historical background, which is of course related to both how human gradually come to involve more and more accessible existence & motion and how to review the accessible existence & motion for humanistic ideology about authenticity of nature in proportion to contemporaneous historical background then and there.

And just because of quantitative & qualitative progression of practical feasibility and possibility in proportion to contemporaneous historical background, the practice human coming to discover and formulate authenticity of accessible existence & motion around must experience frondose evolvment of humanistic ideology about authenticity of nature cumulatively enriched from nothingness to groat, from groat to a great lot, and consequently followed proportionate ideaistic correction & qualitative optimization from superficiality to profundity, from parochiality to generality. In different historical stages, as remarkable extent & depth disparity of accessible existence & motion around us, it's only possible for human to output proportionate humanistic ideology about authenticity of nature in proportion to contemporaneous historical background. And as further extension of quantitative & qualitative change of practical feasibility & possibility in proportion to contemporaneous historical background, historical progress of science proportionably accomplish timely renovation of humanistic ideology about authenticity of nature in proportion to contemporaneous historical background one after another which is just hypostatic historical progress of science in inherent optimum orientation towards perfect ideological enantiomorph of ultimate authenticity of nature.

This of course indicates, in different historical stages, as remarkable disparity of accessible extent & depth of universal existence & motion, before humanistic ideology about authenticity of nature finally qualified as perfect ideological enantiomorph of ultimate authenticity of nature, it's only possible for so-called science to be commensurate ideological system about authenticity of nature in proportion to contemporaneous historical background. And as incremental quantitative & qualitative change of accessible extent & depth of universal existence & motion, proportionate output of humanistic ideology about authenticity of nature in proportion to contemporaneous historical background must be in inherent optimum orientation towards perfect ideological enantiomorph of ultimate authenticity of nature through and through. All in all, as incremental quantitative & qualitative change of practical feasibility & possibility of human, hypostatic historical progress of science is always in inherent optimum orientation towards perfect ideological enantiomorph of ultimate authenticity of nature.

The second, authenticity of nature is always external reference of humanistic ideology about authenticity of nature, and ideological system about authenticity of nature is always recognizant portraiture of accessible existence & motion around, accessible authenticity of nature determines humanistic ideology about authenticity of nature. Historical progress

Historical progress of science in the recent several centuries seemed like a far-flung exploration of the first itinerary around numerous distinctive landscapes of brand-new landmasses of science with palette & tablet on back, several hundred years' scientific travelogues were compiled thereby.

of science is always hypostatic endeavor to discover and formulate accessible universal existence & motion as authentic, comprehensive and systematical as possible, the uniqueness & invariance of ultimate authenticity of nature even radically determines the unique possibility of enantiomorphous scientific verity as perfect ideological enantiomorph of ultimate authenticity of nature.

As ideological system about authenticity of nature in proportion to contemporaneous historical background, accessible universal existence & motion is always external reference of ideological system about authenticity of nature. At any rate, historical progress of science is always hypostatic endeavor to discover and formulate accessible universal existence & motion as authentic, comprehensive and systematical as possible. This of course indicates, throughout historical progress of science, no matter how devious the quantitative & qualitative change of scientific knowledge proliferation under synthesized conditionality of “**crecive progression of practical feasibility & possibility in proportion to contemporaneous historical background + the uniqueness & invariance of ultimate authenticity of nature predestines the unique possibility of scientific verity as perfect ideological enantiomorph of ultimate authenticity of nature**” is, no matter how much commensurate ideological system about authenticity of nature can virtually discover and formulate authenticity of accessible universal existence & motion, hypostatic quantitative & qualitative change of scientific knowledge proliferation under contemporaneous historical background must refer to “authenticity of accessible universal existence & motion” through and through, no matter how far away the commensurate humanistic ideology about authenticity of nature is from perfect ideological enantiomorph of ultimate authenticity of nature. It even indicates, no matter how devious hypostatic historical progress of science under synthesized conditionality of “**crecive progression of practical feasibility & possibility in proportion to contemporaneous historical background + the uniqueness & invariance of ultimate authenticity of nature predestines the unique possibility of scientific verity as perfect ideological enantiomorph of ultimate authenticity of nature**” is, historical progress of science must be in inherent optimum orientation towards perfect ideological enantiomorph of ultimate authenticity of nature in the nature of things.

The third, contemporaneous scientific orthodoxy and authoritative intrepidity of contemporaneous scientific orthodoxy is synchronous and inevitable outgrowth of quantitative & qualitative change of scientific knowledge proliferation under synthesized conditionality of “**crecive progression of practical feasibility & possibility in proportion to contemporaneous historical background + the uniqueness & invariance of ultimate authenticity of nature predestines the unique possibility of scientific verity as perfect ideological enantiomorph of ultimate authenticity of nature**”. As out-and-out social influence, presence of contemporaneous scientific orthodoxy and authoritative intrepidity of contemporaneous scientific orthodoxy must take important humanistic roles throughout historical progress of science which are mostly egotistic guidance & restriction of temporal authority to historical progress of science, so that hypostatic historical progress of science must incarnate humanistic “benign officialism domino effect of contemporaneous scientific orthodoxy” and “conservative officialism domino effect of contemporaneous scientific orthodoxy” accordingly.

The permanent accordatura of historical progress of science is quantitative & qualitative change of progressional scientific knowledge proliferation under synthesized conditionality of “**crecive progression of practical feasibility & possibility in proportion to contemporaneous historical background + the uniqueness & invariance of ultimate authenticity of nature predestines unique possibility of scientific verity**” through and through. And at the same time, historical progress of science is always social occurrence under contemporaneous historical background, “contemporaneous scientific orthodoxy and authoritative intrepidity of contemporaneous scientific orthodoxy” is synchronous and inevitable

outgrowth of quantitative & qualitative change of scientific knowledge proliferation of historical progress of science in inherent optimum orientation towards perfect ideological enantiomorph of ultimate authenticity of nature. As out-and-out social influence, presence of contemporaneous scientific orthodoxy and authoritative intrepidity of contemporaneous scientific orthodoxy must take unneglectable humanistic roles throughout historical progress of science, which must impact the progressional state of historical progress of science accordingly.

Throughout historical progress of science, no matter how far away commensurate humanistic ideology about authenticity of nature in proportion to contemporaneous historical background is from perfect ideological enantiomorph of ultimate authenticity of nature, as long as there is mainstream of ideological system about authenticity of nature, there must be contemporaneous scientific orthodoxy and authoritative intrepidity of contemporaneous scientific orthodoxy. So-called “contemporaneous scientific orthodoxy” is just social influence under contemporaneous historical background that as the relatively top quality of humanistic ideology about authenticity of nature in proportion to contemporaneous historical background, the proper authority and the cordial successors of the very humanistic ideology about authenticity of nature are adored and become authoritative influence of the age. Such authoritative influence of the age directly attend to living development of science then and there, who can not only sparkplug royal substantiation & perfection of contemporaneous scientific orthodoxy but also sensitively involve in successive humanistic scientific knowledge metabolism campaign for social legitimacy subsistence of contemporaneous scientific orthodoxy.

The key issue is that, as synthesized conditionality of “**crecive progression of practical feasibility & possibility in proportion to contemporaneous historical background + the uniqueness & invariance of ultimate authenticity of nature predestines unique possibility of scientific verity**” through and through, it’s only possible for the major melody of historical progress of science to be serial epochmaking scientific knowledge metabolism in inherent optimum orientation towards perfect ideological enantiomorph of ultimate authenticity of nature, which is too proportionate gradational series of orthodoxy subrogation. This of course indicates, throughout historical progress of science, any contemporaneous scientific orthodoxy out of scientific legitimacy qualification of historical authenticity tolerance of science 0 has its inherent subsistence of original naissance, successive development and final perdition, any contemporaneous scientific orthodoxy out of scientific legitimacy qualification of historical authenticity tolerance of science 0 must be washed out by coming renovation of humanistic ideology about authenticity of nature without alternatives. And it’s only possible for historical presence of contemporaneous scientific orthodoxy and authoritative intrepidity of contemporaneous scientific orthodoxy to find their historical humanistic roles in such kind of dramatic historical process, which must incarnate humanistic “benign officialism domino effect of contemporaneous scientific orthodoxy” and “conservative officialism domino effect of contemporaneous scientific orthodoxy” accordingly.

Historical rise of any contemporaneous scientific orthodoxy has inherent instinct to sparkplug royal substantiation & perfection of contemporaneous scientific orthodoxy by freewheeling, when substantiation & perfection of contemporaneous scientific orthodoxy \approx general progress of science, **benign officialism domino effect of contemporaneous scientific orthodoxy \geq conservative officialism domino effect of contemporaneous scientific orthodoxy**, so-called contemporaneous scientific orthodoxy is not only the battleship but also the leaders of historical progress of science.

Once the contemporaneous scientific orthodoxy exhausted its inherent potentiality to highlight more authenticity of nature day by day, endeavor of royal substantiation & perfection of contemporaneous scientific orthodoxy must be difficult for veritable progress of science to push humanistic ideology about authenticity of nature forward to perfect ideological enantiomorph of ultimate authenticity of nature, successive renovation of

Historical progress of science in the recent several centuries seemed like a far-flung exploration of the first itinerary around numerous distinctive landscapes of brand-new landmasses of science with palette & tablet on back, several hundred years’ scientific travelogues were compiled thereby.

humanistic ideology about authenticity of nature in proportion to contemporaneous historical background become necessary. Whereas, as freewheeling intrepidity of substantiation & perfection of contemporaneous scientific orthodoxy, historical progress of science must be difficult to shake off egotistic guidance & bewitchment of contemporaneous scientific orthodoxy, even though substantiation & perfection of contemporaneous scientific orthodoxy \neq general progress of science, and there is obvious aberrancy of living scientific knowledge proliferation in succession of contemporaneous scientific orthodoxy to hypostatic endeavor of historical progress of science to push humanistic ideology about authenticity of nature forward to perfect ideological enantiomorph of ultimate authenticity of nature step by step draw on practical feasibility & possibility in proportion to contemporaneous historical background, contemporaneous scientific orthodoxy must persist in its humanistic roles upon self-preservation of human nature and freewheeling of royal substantiation & perfection of contemporaneous scientific orthodoxy, so that **benign officialism domino effect of contemporaneous scientific orthodoxy < conservative officialism domino effect of contemporaneous scientific orthodoxy.**

As presence of self-preservation of human, temporal authority are mostly ready to persist substantiation & perfection of contemporaneous scientific orthodoxy \approx historical progress of science upon subconsciousness and try to prolong social legitimacy subsistence of contemporaneous scientific orthodoxy as possible as they can, even sensitively involve in scientific knowledge metabolism campaign once there is slight evidence of scientific knowledge metabolism for occurrence of timely renovation of humanistic ideology about authenticity of nature in proportion to contemporaneous historical background, and do their best to counterwork successive renovation of humanistic ideology about authenticity of nature in proportion to contemporaneous historical background upon self-preservation of humanity, repress social legitimacy subsistence of successive renovation of humanistic ideology about authenticity of nature in proportion to contemporaneous historical background and reject necessary scientific knowledge metabolism of historical progress of science in inherent optimum orientation towards historical authenticity tolerance of science 0.

This is just hypostatic “historical humanistic roles” of contemporaneous scientific orthodoxy, which dramatically shapes historical progress of science in inherent optimum orientation towards perfect ideological enantiomorph of ultimate authenticity of nature.

Before humanistic ideology about authenticity of nature finally qualified as perfect ideological enantiomorph of ultimate authenticity of nature, so-called “science” is always commensurate ideological system about authenticity of nature in proportion to contemporaneous historical background. In different historical stages, there are different ideological systems about authenticity of nature in proportion to contemporaneous historical background with proportionate scientific legitimacy qualification of historical authenticity tolerance of science, there are different contemporaneous scientific orthodoxies. Usually, there is remarkable differentia of different contemporaneous scientific orthodoxies in proportion to contemporaneous historical background as below:

- i) Remarkable differentia of historical authenticity tolerance of science.
- ii) Remarkable scale differentia of social basis and social loop.
- iii) Remarkable differentia of authoritative intrepidity of contemporaneous scientific orthodoxy and egotistic influence & restriction to coming scientific knowledge proliferation with proportionate benign officialism domino effect of contemporaneous scientific orthodoxy and conservative officialism domino effect of contemporaneous scientific orthodoxy.

And just because of the remarkable differentia, different temporal orthodoxies always have distinctive

As coherent natura naturans throughout cosmic evolution, instinctive PNT reciprocal equilibrium towards optimum PNT operation is radical potentiality & conditionality for cosmos always ready to orientate itself towards perfection.

humanistic roles on the spot.

In terms of the temporal orthodoxies before classic mechanics, no matter contemporaneous scientific orthodoxy of Aristotle theory kind or temporal orthodoxies of geocentric theory or heliocentric theory kind, all these distinctive contemporaneous orthodoxies were relatively flimsy ones for their immature historical features as below:

(1). Historical authenticity tolerance of science of these distinctive contemporaneous scientific orthodoxy were all relatively rougher and bigger, so that their social legitimacy subsistence is proportionably flimsy, once there is slight accomplishment of historical progress of science in inherent optimum orientation towards perfect ideological enantiomorph of ultimate authenticity of nature, social legitimacy subsistence of so-called contemporaneous scientific orthodoxies must be straightforwardly inferior by comparison and consequently breakdown on the spot facilely.

(2). As typical intuitionism with rough historical authenticity tolerance of science which could only slightly highlight authenticity of nature, historical naissance and successive development of these contemporaneous scientific orthodoxy could hardly accomplish remarkable scientific practice as commensurate natura naturans personalization towards human necessity to improve social production & social life. As a result, there was relatively less potentiality for historical naissance and successive development of them to positively impact social production & social life, practical social involvement of the so-called orthodox ideological systems about authenticity of nature was superficial and unsubstantial, social loop of so-called contemporaneous scientific orthodoxy was relatively small.

(3). Historical naissance and successive development of the so-called contemporaneous scientific orthodoxies could neither push humanistic ideology about authenticity of nature forward to perfect ideological enantiomorph of ultimate authenticity of nature efficiently nor egotistically influence and restrict coming scientific knowledge proliferation.

Since classic mechanics procured social legitimacy qualification and became contemporaneous scientific orthodoxy of the age, historical progress of science brought out brand-new humanistic profile, which were generally as below:

A) As pioneering humanistic ideology about authenticity of nature in proportion to contemporaneous historical background, naissance of classic mechanics apparently brought out substantial natura naturans personalization towards human necessity, which wonderfully improved social production & social life; social value of science was proportionably materialize therefore. As a result, practical social implication of contemporaneous scientific orthodoxy widely penetrated into social economics even politics.

B) As social domino effect, a great deal of social institutions as colleges, scientific study institutes occurred in occident, science became social advocacy and pursuit, scientific study widely became personal career, the social scale of contemporaneous scientific orthodoxy became all-time therefore.

C) Although, social implication of contemporaneous scientific orthodoxy of classic mechanics kind had widely penetrated into social economics, and social basis & social scale of contemporaneous scientific orthodoxy of classic mechanics was remarkably enhanced and enlarged therefore, whereas, social legitimacy subsistence of classic mechanics as contemporaneous scientific orthodoxy could hardly evade two pestilent weakness as below:

First, the historical authenticity tolerance of science of classic mechanics was still relatively rougher & bigger, so that social legitimacy subsistence of classic mechanics was still relatively weak to challenge

Historical progress of science in the recent several centuries seemed like a far-flung exploration of the first itinerary around numerous distinctive landscapes of brand-new landmasses of science with palette & tablet on back, several hundred years' scientific travelogues were compiled thereby.

successive social legitimacy metabolism challenge of historical progress of science in inherent optimum orientation towards perfect ideological enantiomorph of ultimate authenticity of nature. In terminal years of 19 century and early years of 20 century, scientific practice of human began to slide into transition from macrocosmos to microcosmos, more and more microcosmic factuality exposed a fly in the ointment of classic mechanics as commensurate ideological system about authenticity of nature in proportion to contemporaneous historical background of 18th century, which made classic mechanics as contemporaneous scientific orthodoxy flimsy and ashamed to challenge inevitable successive scientific knowledge metabolism along crecive progression of historical progress of science in inherent optimum orientation towards perfect ideological enantiomorph of ultimate authenticity of nature.

This was of course the most hypostatic weakness of classic mechanics as contemporaneous scientific orthodoxy to challenge inevitable successive scientific knowledge metabolism along crecive progression of historical progress of science in inherent optimum orientation towards perfect ideological enantiomorph of ultimate authenticity of nature.

Second, classic mechanics had never brought out powerful egotistic puissance as authoritative intrepidity of contemporaneous scientific orthodoxy to successive scientific knowledge proliferation, no more magistral autarchy of **free press regulation customization & free press admittance**. Once human scientific practice gradually slid into transition from macrocosmos to microcosmos, more and more microcosmic factuality exposed a fly in the ointment of classic mechanics one after another, as contemporaneous scientific orthodoxy, classic mechanics really had little egotistic puissance and officialism facility to expediently implicate life-and-death scientific knowledge metabolism and consequent virulent scientific knowledge metabolism campaign, it could neither prevent prevalence of microcosmic exploration nor forbid free press admittance of timely renovation of humanistic ideology about authenticity of nature in proportion to contemporaneous historical background which had tallied with microcosmic authenticity highlighted then and there. As a result, once it's necessary for humanistic ideology about authenticity of nature to be compatible with unexpected microcosmic factuality, original naissance and successive development of **Relativity & Quantum theory** had not experienced too much resistance of scientific knowledge metabolism campaign. Instead, remarkable ideological divarication of the age mostly derived from incompatibility between Relativity and Quantum Theory.

Since **Relativity & Quantum theory** procured commensurate social legitimacy qualification of the age, brand-new contemporaneous scientific orthodoxy came into being, the so-called brand-new contemporaneous scientific orthodoxy is just the live contemporaneous scientific orthodoxy for it is still living till today.

Throughout historical progress of science, live contemporaneous scientific orthodoxy is the most intrepid contemporaneous scientific orthodoxy, which is hypostatized as following:

①. As effective soul of social production, live contemporaneous scientific orthodoxy is always human ideological resource & capital for commensurate natura naturans personalization towards human necessity in the recent one century, its social legitimacy subsistence has deeply & widely penetrated into social economics even politics, and as a result, its egotistic puissance as typical authoritative intrepidity of contemporaneous scientific orthodoxy is self-evident, and its social basis & social scale is all-time therefore.

②. Historical authenticity tolerance of science of contemporaneous scientific orthodoxy has been relatively closer to 0, successive historical progress of science in inherent optimum orientation towards perfect

As coherent natura naturans throughout cosmic evolution, instinctive PNT reciprocal equilibrium towards optimum PNT operation is radical potentiality & conditionality for cosmos always ready to orientate itself towards perfection.

ideological enantiomorph of ultimate authenticity of nature is difficult to wash out live contemporaneous scientific orthodoxy by interposition of straightforward irregular factuality on the spot. And on the other hand, feasibility & accessibility of modern scientific experiments have been closer and closer to upper limit of human operability & perceivability, feasible scientific experiments can neither expediently expose a fly in the ointment of contemporaneous scientific orthodoxy nor effectively authenticate relative advantage of timely renovation of humanistic ideology about authenticity of nature in proportion to contemporaneous historical background. Although, coming renovation of humanistic ideology about authenticity of nature in proportion to contemporaneous historical background maybe remarkably change integrative logic constitution of ready-made ideological system about authenticity of nature, which maybe clean up rational estrangement among rich and colorful subjects & subdisciplines through and through.

③. Live contemporaneous scientific orthodoxy has unprecedented egotistic puissance to living scientific knowledge proliferation on the earth, magistral autarchy of **free press regulation customization & free press admittance** of temporal authority short of necessary intendance is the most expedient officialism facility for temporal authority to sparkplug and restrict living scientific knowledge proliferation all over the world indulging in interminable royal substantiation & perfection of contemporaneous scientific orthodoxy.

In detail words:

a). As magistral autarchy of **free press regulation customization & free press admittance** of temporal authority short of necessary intendance, living scientific knowledge proliferation all over the earth is egotistically restricted into scientific knowledge proliferation in rigid succession of contemporaneous scientific orthodoxy for high-sounding royal substantiation & perfection of contemporaneous scientific orthodoxy in defiance of whether **interminable substantiation & perfection of contemporaneous scientific orthodoxy \approx / \neq general progress of science under contemporaneous historical background.**

b). As magistral autarchy of **free press regulation customization & free press admittance** of temporal authority short of necessary intendance, although, along crescive progression of historical progress of science in inherent optimum orientation towards perfect ideological enantiomorph of ultimate authenticity of nature, occurrence of timely innovation of humanistic ideology about authenticity of nature in proportion to contemporaneous historical background as typical aberrant scientific knowledge proliferation out of rigid succession of contemporaneous scientific orthodoxy is almost inevitable, nothing can stop virulent scientific knowledge metabolism campaign at occasion of free press admittance and make free press egotistic proximity identification invalid then and there. Under egotistic background of high-sounding royal substantiation & perfection of contemporaneous scientific orthodoxy, it is almost impossible for free press admittance of timely renovation of humanistic ideology about authenticity of nature in proportion to contemporaneous historical background to be free from duress of authoritative intrepidity of contemporaneous scientific orthodoxy. At any rate, humanistic implementation of magistral autarchy of **free press regulation customization & free press admittance** of temporal authority is neither necessary to be responsible to magistral autarchy of **free press regulation customization & free press admittance** of temporal authority nor necessary to care for objectivity that hypostatic historical progress of science is but quantitative & qualitative change of scientific knowledge proliferation under permanent conditionality of **“crescive progression of practical feasibility & possibility in proportion to contemporaneous historical background + the uniqueness & invariance of ultimate authenticity of nature predestines the unique possibility of scientific verity as perfect ideological enantiomorph of ultimate authenticity of nature”** through and through; it's only possible

Historical progress of science in the recent several centuries seemed like a far-flung exploration of the first itinerary around numerous distinctive landscapes of brand-new landmasses of science with palette & tablet on back, several hundred years' scientific travelogues were compiled thereby.

for the major melody of historical progress of science to be **serial epochmaking scientific knowledge metabolism in inherent optimum orientation towards perfect ideological enantiomorph of ultimate authenticity of nature.**

And indeed, as timely renovation of humanistic ideology about authenticity of nature in proportion to contemporaneous historical background of remarkable highlight of microcosmic configuration of matter, free press admittance of Homogenous Cosmos Originated from Unique Genesis must break through legitimacy defense line of contemporaneous scientific orthodoxy, so that it has to challenge venomous counterwork upper limit of temporal authority. 31 years has gone, the factuality has been proved time after time.

Along time axis of history, it's just the three kind of conditionality above which generally shape realistic historical progress of science through and through.

Throughout historical progress of science in inherent optimum orientation towards perfect ideological enantiomorph of ultimate authenticity of nature, the integrative conditionality and intrinsic logic constitution of natural connotation of science, social connotation of science and scientific knowledge metabolism & scientific knowledge metabolism campaign can be generally illustrated as below:

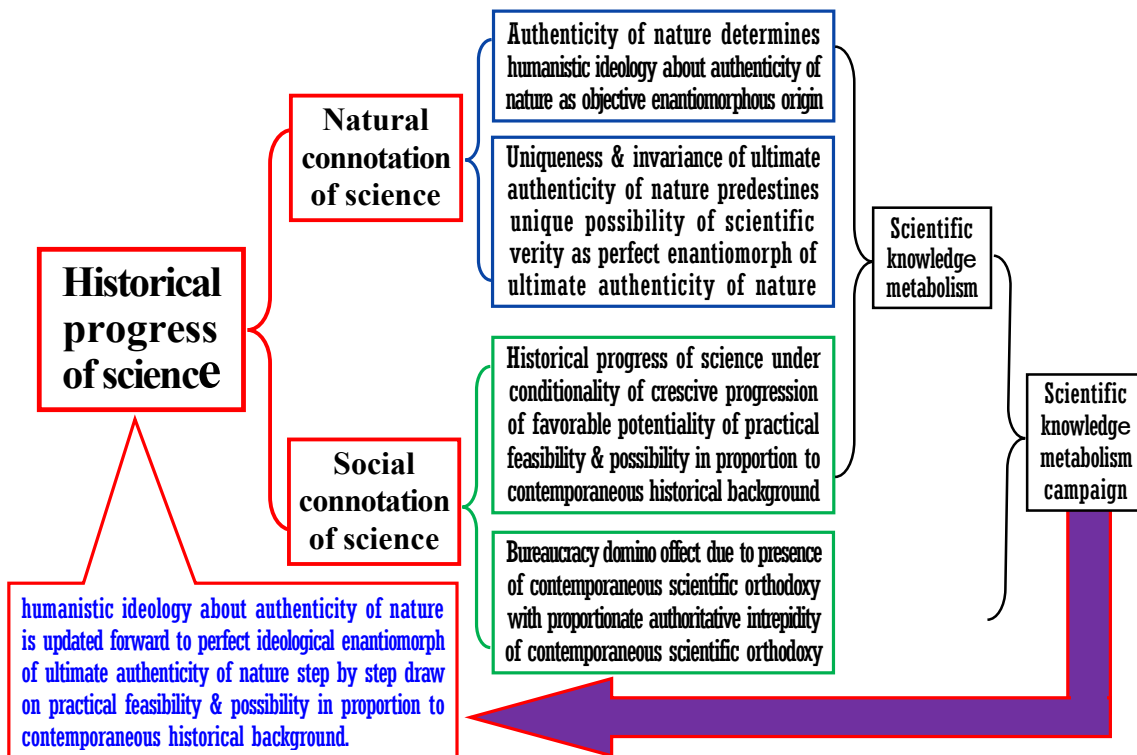

(VIII-i-1) Logic constitution of scientific knowledge proliferation throughout historical progress of science

All in all, hypostatic historical progress of science is just quantitative & qualitative change of scientific knowledge proliferation under permanent conditionality of “**crevice progression of practical feasibility & possibility in proportion to contemporaneous historical background + the uniqueness & invariance of ultimate authenticity of nature predestines the unique possibility of scientific verity as perfect ideological enantiomorph of ultimate authenticity of nature**” through and through; and just because of this, it's only possible for the major melody of historical progress of science to be **serial epochmaking scientific knowledge metabolism in inherent optimum orientation towards perfect ideological enantiomorph of ultimate authenticity of nature.**

On the other hand, as multiple notion with double significance of “**social connotation**” and “**natural connotation**”,

As coherent natura naturans throughout cosmic evolution, instinctive PNT reciprocal equilibrium towards optimum PNT operation is radical potentiality & conditionality for cosmos always ready to orientate itself towards perfection.

social legitimacy & validity of truth can never exceed canon range, historical progress of science must adulterate humanistic puissance through and through, especially so-called authoritative intrepidity of contemporaneous scientific orthodoxy and consequent **benign officialism domino effect of contemporaneous scientific orthodoxy** and **conservative officialism domino effect of contemporaneous scientific orthodoxy**. Although historical progress of science is hypostatic endeavor to push humanistic ideology about authenticity of nature forward to perfect ideological enantiomorph of ultimate authenticity of nature step by step draw on practical feasibility & possibility in proportion to contemporaneous historical background, which must bring out so-called contemporaneous scientific orthodoxy and incarnate social subsistence of contemporaneous scientific orthodoxy therefore with proportionate benign officialism domino effect of contemporaneous scientific orthodoxy & conservative officialism domino effect of contemporaneous scientific orthodoxy due to presence of humanistic puissance of contemporaneous scientific orthodoxy even authoritative intrepidity of contemporaneous scientific orthodoxy.

Before humanistic ideology about authenticity of nature finally qualified as perfect ideological enantiomorph of ultimate authenticity of nature, historical progress of science can never be nonstop of freewheeling royal substantiation & perfection of contemporaneous scientific orthodoxy under egotistic guidance of temporal authority, but hypostatic endeavor to push humanistic ideology about authenticity of nature forward to perfect ideological enantiomorph of ultimate authenticity of nature step by step draw on practical feasibility & possibility in proportion to contemporaneous historical background, which is only possible to be serial epochmaking scientific knowledge metabolism in inherent optimum orientation towards perfect ideological enantiomorph of ultimate authenticity of nature.

And indeed, throughout historical progress of science in inherent optimum orientation towards perfect ideological enantiomorph of ultimate authenticity of nature, none epochmaking progress of science is outcome of royal substantiation & perfection of contemporaneous scientific orthodoxy but mostly aberrant scientific knowledge proliferation out of succession of contemporaneous scientific orthodoxy which must bring out life-and-death scientific knowledge metabolism then and there. Is it possible for coming progress of science to be freewheeling of royal substantiation & perfection of contemporaneous scientific orthodoxy under egotistic guidance of temporal authority even with expedient official facility of magistral autarchy of **free press regulation customization & free press admittance** eversince?

May 2019, Nanxing, Dani, Shatian, Dongguan, Guangdoing.

(VIII-ii) Evolvement Profile of Historical Progress of Science

Abstract: *Development of science is always human endeavor to push humanistic ideology about authenticity of nature forward to perfect ideological enantiomorph of ultimate authenticity of nature draw on practical feasibility & possibility in proportion to contemporaneous historical background, till ta last, humanistic ideology about authenticity of nature tallies with ultimate authenticity of nature 100 over 100 as uniform scientific verity about universal existence & motion as perfect ideological enantiomorph of ultimate authenticity of nature.*

We mention evolvement profile of historical progress of science herein is ready to highlight the general profile of successive quantitative & qualitative change of development of science throughout historical progress of science as following:

The first, *the historical process that humanistic ideology about authenticity of nature gradually approaching perfect ideological enantiomorph of ultimate authenticity of nature generally conditions three major implication:*

①. *Permanent conditionality between **crecive progression of practical feasibility & possibility in proportion to contemporaneous historical background** and historical progress of science in inherent optimum orientation towards historical authenticity tolerance of science 0.*

②. *Remarkable authoritative impact for officialism domino effect of distinctive contemporaneous scientific orthodoxy in proportion to contemporaneous historical background to historical progress of science, which generally includes “benign officialism domino effect of contemporaneous scientific orthodoxy” and “conservative officialism domino effect of contemporaneous scientific orthodoxy”.*

③. *Natural determinism of authenticity of nature to humanistic ideology about authenticity of nature—the **uniqueness & invariance of ultimate authenticity of nature predestines the unique possibility of scientific verity as perfect ideological enantiomorph of ultimate authenticity of nature.***

The second, *as permanent synthesized conditionality of “**crecive progression of practical feasibility & possibility in proportion to contemporaneous historical background + the uniqueness & invariance of ultimate authenticity of nature predestines the unique possibility of scientific verity as perfect ideological enantiomorph of ultimate authenticity of nature**” through and through, it's only possible for the major melody of historical progress of science to be a series of epochmaking scientific knowledge metabolism in inherent optimum orientation towards perfect ideological enantiomorph of ultimate authenticity of nature, which is of course synchro subrogation of contemporaneous scientific orthodoxy for social legitimacy metabolism.*

*Aggradation of living scientific knowledge is the balance of the total output of scientific knowledge proliferation after necessary scientific knowledge metabolism of the age, which implies the knowledge balance are still the useful ones for social application, even proliferative to coming scientific knowledge proliferation. As permanent synthesized conditionality of “**crecive progression of practical feasibility & possibility in proportion to contemporaneous historical background + the uniqueness & invariance of ultimate authenticity of nature predestines the unique possibility of scientific verity as perfect ideological enantiomorph of ultimate authenticity of nature**” through and through, pioneering scientific knowledge proliferation gradually wash out the ready-made conservative ones and consequently renovate aggradation of living scientific knowledge day by day so as to make the aggradation of living scientific knowledge on the up-and-up in inherent optimum orientation towards historical authenticity tolerance of science 0.*

As coherent natura naturans throughout cosmic evolution, instinctive PNT reciprocal equilibrium towards optimum PNT operation is radical potentiality & conditionality for cosmos always ready to orientate itself towards perfection.

Special nouns & items: *lifespan of contemporaneous scientific orthodoxy, historical legitimacy keynote initialization, social legitimacy metabolism, aggradation of living scientific knowledge, authenticity value of scientific knowledge, upper limit curve of authenticity value of historical scientific knowledge proliferation, acceptable lower limit curve of authenticity value of historical scientific knowledge proliferation.*

1. Evolvement of humanistic ideology about authenticity of nature in proportion to contemporaneous historical background,——historical progress of science is not intuitional cumulative achievement of omnifarious scientific truths like smallwares full of a basket, but successive hypostatic endeavor to push humanistic ideology about authenticity of nature forward to perfect ideological enantiomorph of ultimate authenticity of nature step by step draw on practical feasibility & possibility in proportion to historical background. Humanistic ideology about authenticity of nature gradually approaching perfect ideological enantiomorph of ultimate authenticity of nature must bring out serial progressive variance, which of course indicates necessary scientific knowledge metabolism for update of humanistic ideology about authenticity of nature. Virtually, it's only possible for the major melody of historical progress of science to be serial scientific knowledge metabolism in inherent optimum orientation towards perfect ideological enantiomorph of ultimate authenticity of nature.

In simple words, “development of science” is but historical process humanistic ideology about authenticity of nature gradually approaches perfect ideological enantiomorph of ultimate authenticity of nature under permanent synthesized conditionality of “**crecive progression of practical feasibility & possibility in proportion to contemporaneous historical background + the uniqueness & invariance of ultimate authenticity of nature predestines the unique possibility of scientific verity as perfect ideological enantiomorph of ultimate authenticity of nature**” through and through, till at last, humanistic ideology tallies with ultimate authenticity of nature 100 over 100 as perfect ideological enantiomorph of ultimate authenticity of nature. Generally, realistic historical progress of science is mostly shaped by two major implication as below:

①. **Permanent conditionality between crecive progression of practical feasibility & possibility in proportion to contemporaneous historical background and historical progress of science in inherent optimum orientation towards perfect ideological enantiomorph of ultimate authenticity of nature.**

As crecive progression of practical feasibility & possibility in proportion to contemporaneous historical background, it's of course impossible for human to bring universal existence & motion into rational purview for scientific study and clarification once through and through, instead, it's only possible for human to study temporally accessible existence & motion around there and then so as to accomplish humanistic ideology about authenticity of nature in proportion to contemporaneous historical background which is of course distinctive segment of realistic historical progress of science that human coming to know ultimate authenticity of nature must experience frondose evolvement of humanistic ideology about authenticity of nature cumulatively enriched from nothingness to goat, from goat to a great lot, and consequently followed proportionate ideaistic correction & qualitative optimization from superficiality to profundity, from parochiality to generality, so that humanistic ideology about authenticity of nature approach perfect ideological enantiomorph of ultimate authenticity of nature step by step, till at last, humanistic ideology about authenticity of nature tallies with ultimate authenticity of nature 100 over 100.

②. **Modificatory effect of authoritative intrepidity of contemporaneous scientific orthodoxy in proportion to contemporaneous historical background to historical progress of science in inherent optimum orientation towards scientific legitimacy qualification**

Historical progress of science in the recent several centuries seemed like a far-flung exploration of the first itinerary around numerous distinctive landscapes of brand-new landmasses of science with palette & tablet on back, several hundred years' scientific travelogues were compiled thereby.

of historical authenticity tolerance of science 0.

As ideological enantiomorph of accessible existence & motion around in proportion to contemporaneous historical background, the historical feature of science is of course self-evident. On one hand, as remarkable disparity of accessible existence & motion around, humanistic ideologies about authenticity of nature in proportion to different historical background must be proportionably different, there are even remarkable incompatibility & illogicality among them. And on the other hand, no matter how distinctive ideological system about authenticity of nature in proportion to contemporaneous historical background is, or how far away the distinctive ideological system about authenticity of nature in proportion to contemporaneous historical background from perfect ideological enantiomorph of ultimate authenticity of nature is, as long as there is ideological mainstream about authenticity of nature, there must be distinctive contemporaneous scientific orthodoxy of the age. Of course, the key issue is not only presence of distinctive contemporaneous scientific orthodoxy of the age, the most important objectivity is that presence of distinctive contemporaneous scientific orthodoxy of the age must take significant authoritative role in practice of historical progress of science, which must incarnate “**benign officialism domino effect of contemporaneous scientific orthodoxy**” and “**conservative officialism domino effect of contemporaneous scientific orthodoxy**” of historical progress of science through and through.

Modificatory effect of authoritative intrepidity of contemporaneous scientific orthodoxy in proportion to contemporaneous historical background mostly incarnates that, temporal authority are always ready to egotistically sparkplug substantiation & perfection of contemporaneous scientific orthodoxy at their pleasure so as to make substantiation & perfection of contemporaneous scientific orthodoxy freewheeling of historical progress of science.

When **royal substantiation & perfect of contemporaneous scientific orthodoxy \approx general progress of science to push humanistic ideology about authenticity of nature forward to perfect ideological enantiomorph of ultimate authenticity of ultimate authenticity of nature draw on practical feasibility & possibility in proportion to contemporaneous historical background** in the early years the so-called contemporaneous scientific orthodoxy coming into being as innovative scientific idea in crevice progression of historical progress of science, modificatory effect of authoritative intrepidity of contemporaneous scientific orthodoxy in proportion to contemporaneous historical background mostly incarnates as “**benign officialism domino effect of contemporaneous scientific orthodoxy**”.

When **royal substantiation & perfect of contemporaneous scientific orthodoxy \neq general progress of science to push humanistic ideology about authenticity of nature forward to perfect ideological enantiomorph of ultimate authenticity of ultimate authenticity of nature draw on practical feasibility & possibility in proportion to contemporaneous historical background**, modificatory effect of authoritative intrepidity of contemporaneous scientific orthodoxy in proportion to contemporaneous historical background mostly incarnates as “**conservative officialism domino effect of contemporaneous scientific orthodoxy**”. and more remarkable the disparity between “**royal substantiation & perfect of contemporaneous scientific orthodoxy**” and “**general progress of science to push humanistic ideology about authenticity of nature forward to perfect ideological enantiomorph of ultimate authenticity of ultimate authenticity of nature draw on practical feasibility & possibility in proportion to contemporaneous historical background**” is, the **conservative officialism domino effect of contemporaneous scientific orthodoxy** is proportionably more serious, the potential renovation of humanistic ideology about authenticity of nature in proportion to contemporaneous historical background become more probable and necessary.

All in all, as long as there is solid interposition of authoritative intrepidity of distinctive contemporaneous

As coherent natura naturans throughout cosmic evolution, instinctive PNT reciprocal equilibrium towards optimum PNT operation is radical potentiality & conditionality for cosmos always ready to orientate itself towards perfection.

scientific orthodoxy in proportion to contemporaneous historical background, historical progress of science can not be free from modification by “benign officialism domino effect of contemporaneous scientific orthodoxy” and “conservative officialism domino effect of contemporaneous scientific orthodoxy”.

③. Natural determinism of authenticity of nature to humanistic ideology about authenticity of nature—the uniqueness & invariance of ultimate authenticity of nature predestines the unique possibility of scientific verity as perfect ideological enantiomorph of ultimate authenticity of nature.

Ultimate authenticity of nature can be neither omnifarious authenticity smallwares full of a basket nor authenticity chameleon one piece and only, it’s only possible to be unique and invariable as coherent natura naturans throughout cosmic evolution. As humanistic ideology about authenticity of nature in proportion to contemporaneous historical background, once humanistic ideology about authenticity of nature tallies with ultimate authenticity of nature 100 over 100, the proper humanistic ideology about authenticity of nature must be unique and coherent scientific verity about universal existence & motion as perfect ideological enantiomorph of coherent natura naturans throughout cosmic evolution. In fact, in accordance with rigorous enantiomorphous correlation between objective authenticity of nature and humanistic ideology about authenticity of nature, it’s neither possible for “the unique & invariable ultimate authenticity of nature” to be compatible with “two distinctive humanistic ideologies about authenticity of nature with remarkable ideological difference” nor possible for “two distinctive humanistic ideologies about authenticity of nature with remarkable ideological difference” to discover and formulate “the unique & invariable ultimate authenticity of nature” coequally. And indeed, **it's only possible for concordant cosmos to be demiurgic aggradation of out-and-out serial natura naturata in the nature of coherent natura naturans throughout cosmic evolution; there is no way for demiurgic aggradation in the nature of different natura naturans to be concordant cosmos through and through.**

This of course indicates that

As crescive progression of practical feasibility & possibility in proportion to contemporaneous historical background, it’s only possible for the practice human coming to discover and formulate authenticity of accessible existence & motion around to experience frondose ideological evolvement cumulatively enriched from nothingness to groat, from groat to a great lot, and consequently followed the proportionate ideaistic correction & qualitative optimization from superficiality to profundity, from parochiality to generality, any living scientific knowledge proliferation at certain historical stage can only shape humanistic ideology about authenticity of nature according to temporally accessible existence & motion around then and there. Throughout the very process, once humanistic ideology about authenticity of nature gradually approach perfect ideological enantiomorph of ultimate authenticity of nature, it must bring out situation innovative scientific idea gradually washing out conservative ready-made scientific idea one after another so as to accomplish scientific knowledge metabolism toward perfect ideological enantiomorph of ultimate authenticity of nature step by step, till at last, humanistic ideology about authenticity of nature tallies with ultimate authenticity of nature 100 over 100. This of course implies that it’s only possible for the major melody of historical progress of science to be serial epochmaking scientific knowledge metabolism in inherent optimum orientation towards historical authenticity tolerance of science 0.

Undoubtedly, in accordance with the rigorous enantiomorphous correlation between objective authenticity of nature and humanistic ideology about authenticity of nature, since it’s only possible for ultimate authenticity of

nature to be unique & invariable as coherent natura naturans throughout cosmic evolution, humanistic ideology about authenticity of nature tallying with ultimate authenticity of nature 100 over 100 must proportionately be unique coherent scientific verity about universal existence & motion as perfect ideological enantiomorph of coherent natura naturans throughout cosmic evolution.

Throughout historical progress of science, in order to discover and formulate universal existence & motion as much as possible draw on practical feasibility & possibility in proportion to contemporaneous historical background, no matter the the so-called humanistic ideologies about authenticity of nature we had ever procured were M pieces or (M+N) pieces, as long as our practical endeavor had pushed humanistic ideology about authenticity of nature forward to perfect ideological enantiomorph of ultimate authenticity of nature step by step with proportionate advancement of historical authenticity tolerance of science closer and closer to 0, the naissance and legitimacy promotion of the $[(M + N - X) + 1]^{\text{th}}$ humanistic ideology about authenticity of nature must wash out the $(M + N - x)^{\text{th}}$ humanistic ideology about authenticity of nature, $[M, N, X \in \mathbb{N}, (m+n) > x]$, till at last, the $(M + N)^{\text{th}}$ humanistic ideology about authenticity of nature coming into being, which tallies with ultimate authenticity of nature 100 over 100 as perfect ideological enantiomorph of coherent natura naturans throughout cosmic evolution.

In terms of consecutive qualitative & qualitative change of humanistic ideology about authenticity of nature gradually approaching perfect ideological enantiomorph of ultimate authenticity of nature, historical progress of science is of course process in inherent optimum orientation towards historical authenticity tolerance of science 0. Throughout historical progress of science in inherent optimum orientation towards historical authenticity tolerance of science 0, ostensibly, living scientific knowledge proliferation seemed always devoting to formulating temporally accessible existence & motion around then and there, and create this idiographic scientific truth and that idiographic scientific truth, even as permanent endeavor for rather a long historical process, our scientific achievements substantively seemed rich and colorful scientific travelogues like omnifarious smallwares full of a basket.

However, as ultimate authenticity of nature can be neither omnifarious authenticity smallwares full of a basket nor authenticity chameleon one piece and only but coherent natura naturans throughout cosmic evolution. In accordance with the rigorous enantiomorphous correlation between objective authenticity of nature and humanistic ideology about authenticity of nature, the uniqueness & invariance of ultimate authenticity of nature predestines the unique possibility of scientific verity as perfect ideological enantiomorph of ultimate authenticity of nature, once humanistic ideology about authenticity of nature tallies with ultimate authenticity of nature 100 over 100, it must turn into perfect ideological enantiomorph of coherent natura naturans throughout cosmic evolution one piece and only.

Before humanistic ideology about authenticity of nature finally qualified as perfect ideological enantiomorph of coherent natura naturans throughout cosmic evolution, in order to discover and formulate universal existence & motion as authentic, comprehensive and systematical as we can practically able to, our practical achievement was but accomplishment to have pushed humanistic ideology about authenticity of nature forward to perfect ideological enantiomorph of coherent natura naturans throughout cosmic evolution step by step draw on practical feasibility & possibility in proportion to contemporaneous historical background. Throughout historical progress

of science, the original naissance and successive development of any contemporaneous scientific orthodoxy out of scientific legitimacy qualification of historical authenticity tolerance of science 0 were historical achievement of humanistic ideology about authenticity of nature in proportion to contemporaneous historical background, which can only exist in crescive progression of historical progress of science as progressive segment in proportion to contemporaneous historical background.

2. The most straightforward profile of historical progress of science is that, as permanent synthesized conditionality of “crescive progression of practical feasibility & possibility in proportion to contemporaneous historical background + the uniqueness & invariance of ultimate authenticity of nature predestines the unique possibility of scientific verity as perfect ideological enantiomorph of ultimate authenticity of nature” through and through, it’s only possible for the major melody of historical progress of science to be a series of epochmaking scientific knowledge metabolism in inherent optimum orientation towards perfect ideological enantiomorph of ultimate authenticity of nature, which is of course synchro subrogation of contemporaneous scientific orthodoxy for social legitimacy metabolism.

Historical progress of science in inherent optimum orientation towards historical authenticity tolerance of science 0 with quantitative & qualitative change of scientific knowledge proliferation/metabolism usually shows itself three fundamental concatenate historical deeds as below:

The first, the top-ranking geniuses brought out epochmaking scientific innovation in proportion to contemporaneous historical background which mostly radicates historical legitimacy keynote of science of the coming age.

The second, after historical legitimacy keynote of science radicates for epochmaking scientific innovation of top-ranking genius, the second-string geniuses subsequently implement royal substantiation & perfection of contemporaneous scientific orthodoxy at the volley.

The third, as further quantitative & qualitative change of scientific knowledge proliferation in inherent optimum orientation towards historical authenticity tolerance of science 0, there is more and more potentiality for coming top-ranking geniuses to approach further epochmaking scientific innovation and consequently break through conventionality of high-sounding freewheeling royal substantiation & perfection of contemporaneous scientific orthodoxy, which of course radicates successive historical legitimacy keynote of science at the volley for the coming brand-new age.

In fact, the self-loading occurrence of the three fundamental concatenate deeds of general progress of science are just historical cycle of naissance, successive freewheeling substantiation & perfection and ultimate dying out of idiographic contemporaneous scientific orthodoxy of science like three interlink cadences of realistic development of science. Virtually, before naissance of absolute scientific verity in social legitimacy qualification of historical authenticity tolerance of science 0, idiographic naissance, successive freewheeling substantiation & perfection and ultimate dying out of so-called contemporaneous scientific orthodoxy like three interlink cadences of realistic development of science are just historically successive and go round and round, which generally makes up of historical progression of hypostatic progress of science.

For some certain expedience, we just call the three fundamental concatenate deeds of progress of science “three interlink metabolic cadences of historical legitimacy of science”.

Historical progress of science in the recent several centuries seemed like a far-flung exploration of the first itinerary around numerous distinctive landscapes of brand-new landmasses of science with palette & tablet on back, several hundred years’ scientific travelogues were compiled thereby.

We call the first metabolic cadence of the three interlink metabolic cadences of historical legitimacy of science “historical legitimacy keynote initialization”.

we call the second metabolic cadence of the three interlink metabolic cadences of historical legitimacy of science “successive freewheeling substantiation & perfection of contemporaneous scientific orthodoxy”,

And we call the third metabolic cadence of the three interlink metabolic cadences of historical legitimacy of science “successive legitimacy metabolism of science”.

Of course, along time extension of historical progress of science, the integrative layout of the three interlink metabolic cadences of historical legitimacy of science can be illuminated as below:

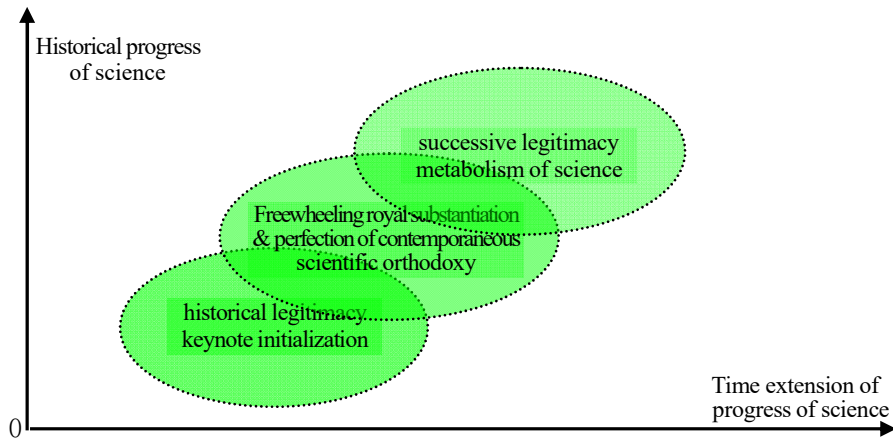

(VIII-ii-1) Integrative layout of three interlink metabolic cadences of historical legitimacy of science

As practical feasibility & possibility in proportion to commensurate historical limitation, although the scientific innovations of top-ranking geniuses are mostly all-time then and there, it's really impossible for top-ranking geniuses to approach perfect ideological enantiomorph of ultimate authenticity of nature with social legitimacy qualification of historical authenticity tolerance of science 0 once or twice. Generally, practical progress of human science from superficiality to profundity, from parochiality to generality must experience N times of serial epochmaking scientific innovation so as to hypostatize quantitative & qualitative change of scientific knowledge proliferation/metabolism from superficiality to profundity from parochiality to generality along crescive progression of historical progress of science in inherent optimum orientation towards historical authenticity tolerance of science 0, which of course makes up of the hypostatic historical progress of science itself. Till at last, humanistic ideology about authenticity of nature ultimately turns into perfect ideological enantiomorph of ultimate authenticity of nature with legitimacy qualification of historical authenticity tolerance of science 0, which of course indicates humanistic ideology about authenticity of nature tallying with ultimate authenticity of nature 100 over 100.

Virtually, integrative operation of the three interlink metabolic cadences of distinctive historical legitimacy of science is just a complete historical legitimacy lifespan of contemporaneous scientific orthodoxy, which means the integrative operation of idiographic historical legitimacy starting at the original naissance and radication of the proper social legitimacy keynote for remarkable scientific innovation of proper top-ranking genius, and subsequently experience the corresponding freewheeling royal substantiation & perfection of contemporaneous scientific orthodoxy, till at last, the historical legitimacy is washed out by further scientific innovation. Virtually, historical progress of science is just series of social legitimacy metabolism of science in

As coherent natura naturans throughout cosmic evolution, instinctive PNT reciprocal equilibrium towards optimum PNT operation is radical potentiality & conditionality for cosmos always ready to orientate itself towards perfection.

inherent optimum orientation towards historical authenticity tolerance of science 0, till at last, human arrive at absolute scientific verity about universal existence & motion as perfect ideological enantiomorph of ultimate authenticity of nature, and successive freewheeling substantiation & perfection of absolute scientific verity coexist with human civilization eversince.

All in all, as potential synthesized conditionality of “**crecive progression of practical feasibility & possibility in proportion to contemporaneous historical background + the uniqueness & invariance of ultimate authenticity of nature predestines the unique possibility of scientific verity as perfect ideological enantiomorph of ultimate authenticity of nature**” through and through, it’s neither possible for human to achieve absolute scientific verity about universal existence & motion as perfect ideological enantiomorph of ultimate authenticity of nature once nor possible for historical progress of science to be accomplished by freewheeling of substantiation and perfection of single contemporaneous scientific orthodoxy through and through, Instead, it’s only possible for the major melody of historical progress of science to be serial epochmaking scientific knowledge metabolism in inherent optimum orientation towards perfect ideological enantiomorph of ultimate authenticity of nature (/historical authenticity tolerance of science 0) with isochronous orthodoxy subrogation.

In straightforward words, as potential synthesized conditionality of “**crecive progression of practical feasibility & possibility in proportion to contemporaneous historical background + the uniqueness & invariance of ultimate authenticity of nature predestines the unique possibility of scientific verity as perfect ideological enantiomorph of ultimate authenticity of nature**” through and through, realistic historical progress of science = {humanistic ideology about authenticity of nature in proportion to contemporaneous historical background 1 coming into being + freewheeling royal substantiation & perfection of contemporaneous scientific orthodoxy 1 which mostly takes full role of historical progress of science then and there + freewheeling extension of substantiation & perfection of contemporaneous scientific orthodoxy 1 gradually slides out of mainstream of historical progress of science in inherent optimum orientation towards historical authenticity tolerance of science 0 for it gradually exhausts inherent rational potentiality to push humanistic ideology about authenticity of nature forward to perfect ideological enantiomorph of ultimate authenticity of nature} + {renovation of humanistic ideology about authenticity of nature in proportion to contemporaneous historical background 2 + freewheeling royal substantiation & perfection of contemporaneous scientific orthodoxy 2 which mostly takes full role of historical progress of science then and there + conventional extension of freewheeling substantiation & perfection of contemporaneous scientific orthodoxy 2 gradually slides out of mainstream of historical progress of science in inherent optimum orientation towards historical authenticity tolerance of science 0 for it gradually exhausts inherent rational potentiality to push humanistic ideology about authenticity of nature forward to perfect ideological enantiomorph of ultimate authenticity of nature} + {renovation of humanistic ideology about authenticity of nature in proportion to contemporaneous historical background 3 + freewheeling royal substantiation & perfection of contemporaneous scientific orthodoxy 3 which mostly takes full role of historical progress of science then and there + conventional extension of freewheeling substantiation & perfection of contemporaneous scientific orthodoxy 3 gradually slides out of mainstream of historical progress of science in inherent optimum orientation towards historical authenticity tolerance of science 0 for it gradually exhausts inherent rational potentiality to push humanistic ideology about authenticity of nature forward to perfect ideological enantiomorph of ultimate authenticity of nature} + + {renovation of humanistic ideology about authenticity of nature in proportion to contemporaneous historical background N + freewheeling royal substantiation & perfection of contemporaneous scientific orthodoxy N which takes full role of historical progress of science eversince for contemporaneous scientific orthodoxy N \approx perfect ideological enantiomorph of ultimate authenticity of nature}. This of course indicates realistic historical progress of science generally consists of serial

Historical progress of science in the recent several centuries seemed like a far-flung exploration of the first itinerary around numerous distinctive landscapes of brand-new landmasses of science with palette & tablet on back, several hundred years’ scientific travelogues were compiled thereby.

epochmaking scientific knowledge metabolism in inherent orientation towards perfect ideological enantiomorph of ultimate authenticity of nature.

The integrative historical progression of sequential social legitimacy metabolism with synchronous contemporaneous scientific orthodoxy subrogation throughout historical progress of science can be illustrated as below:

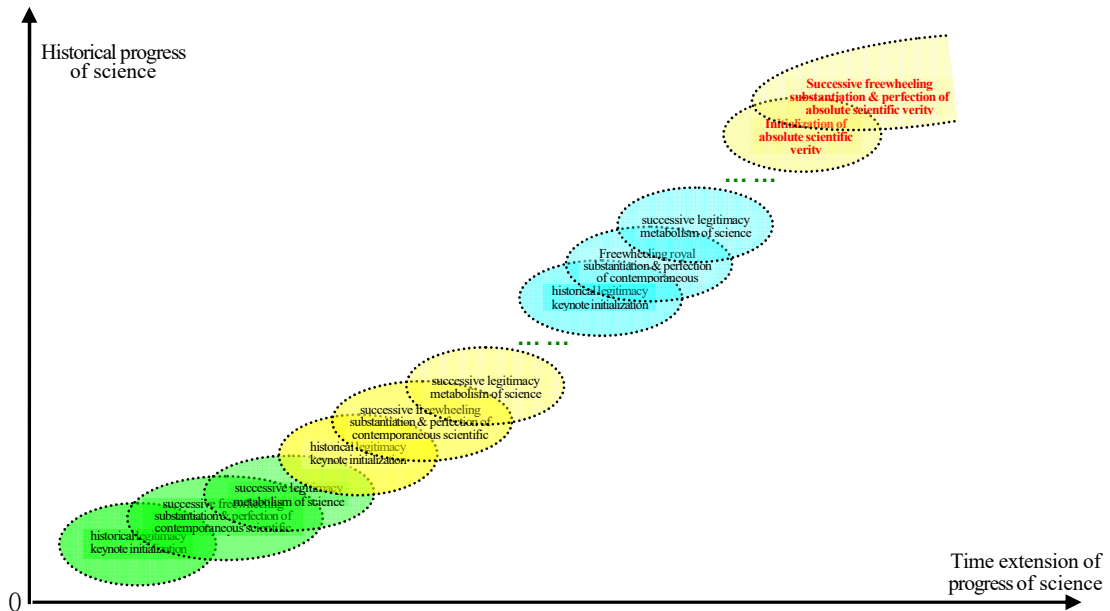

(VIII-ii-2) Historical progress of science is generally historical concatenation of sequential scientific legitimacy metabolism in inherent optimum orientation towards historical authenticity tolerance of science 0

Virtually, this is just crescive progression humanistic ideology about authenticity of nature gradually approaching perfect ideological enantiomorph of ultimate authenticity of nature step by step draw on practical feasibility & possibility in proportion to contemporaneous historical background, till at last, humanistic ideology about authenticity of nature tallies with ultimate authenticity of nature 100 over 100 as perfect ideological enantiomorph of ultimate authenticity of nature about universal existence & motion.

For instance:

The historical legitimacy life cycle (/historical legitimacy life time) of Aristotle’s theory was “Naissance of Aristotle’s theory + successive freewheeling substantiation & perfection of Aristotle’s theory, till at last, his theory was washed out by Galileo”, which was not only distinctive naissance, successive evolvement of humanistic ideology about authenticity of nature in proportion to contemporaneous historical background but also typical progressive segment of historical progress of science in inherent optimum orientation towards perfect ideological enantiomorph of ultimate authenticity of nature.

The historical legitimacy life cycle (/historical legitimacy life time) of geocentric theory was “Naissance of geocentric theory + successive freewheeling substantiation & perfection of geocentric theory, till at last, the theory was washed out by Copernicus”, which was not only distinctive naissance, successive evolvement of humanistic ideology about authenticity of nature in proportion to contemporaneous historical background but also typical progressive segment of historical progress of science in inherent optimum orientation towards perfect ideological enantiomorph of ultimate authenticity of nature.

As coherent natura naturans throughout cosmic evolution, instinctive PNT reciprocal equilibrium towards optimum PNT operation is radical potentiality & conditionality for cosmos always ready to orientate itself towards perfection.

The historical legitimacy life cycle (/historical legitimacy life time) of heliocentric theory was “**Naissance of heliocentric theory + successive freewheeling substantiation & perfection of heliocentric theory, till at last, human found more cosmic existence out of solar system**”, which was not only distinctive naissance, successive evolvement of humanistic ideology about authenticity of nature in proportion to contemporaneous historical background but also typical progressive segment of historical progress of science in inherent optimum orientation towards perfect ideological enantiomorph of ultimate authenticity of nature.

.....

The historical legitimacy life cycle (/historical legitimacy life time) of Newtonian mechanics was “**Naissance of Newtonian mechanics + successive freewheeling substantiation & perfection of Newtonian mechanics, till at last, Newtonian mechanics was washed out by Relativity**”, which was not only distinctive naissance, successive evolvement of humanistic ideology about authenticity of nature in proportion to contemporaneous historical background but also typical progressive segment of historical progress of science in inherent optimum orientation towards perfect ideological enantiomorph of ultimate authenticity of nature.

The historical legitimacy life cycle (/historical legitimacy life time) of **(Relativity + Quantum theory)** is “**Naissance of (Relativity + Quantum Theory) + successive freewheeling substantiation & perfection of (Relativity + Quantum Theory)**”. Although, (Relativity + Quantum theory) are two remarkable milestones of development of science in 20th century, after freewheeling royal substantiation and perfection of contemporaneous scientific orthodoxy for a century, endeavor of substantiation & perfection of contemporaneous scientific orthodoxy as **(Relativity + Quantum theory)** has apparently deviated from original endeavor of historical progress of science to push humanistic ideology about authenticity of nature forward to perfect ideological enantiomorph of ultimate authenticity of nature step by step draw on practical feasibility & possibility in proportion to contemporaneous historical background, whose social legitimacy subsistence status quo has been apparently a strong crossbow without potentiality.

On one hand, in the recent half century, endeavor of royal substantiation & perfection of contemporaneous scientific orthodoxy never remarkably accomplished remarkable advancement to have pushed humanistic ideology about authenticity of nature forward to perfect ideological enantiomorph of ultimate authenticity of nature. And till today, “Relativity + Quantum Theory” seems easeful theoretical extremity of historical progress of science under background of royal substantiation & perfection of contemporaneous scientific orthodoxy, although, the unquestionable factuality is that ultimate authenticity of nature can be neither omnifarious authenticity smallwares full of a basket, nor authenticity chameleon one piece and only but coherent natura naturans throughout cosmic evolution, as a result, it’s only possible for ultimate consummation of science to be perfect ideological enantiomorph of ultimate authenticity of nature, and apparently, perfect ideological enantiomorph of ultimate authenticity of nature can be neither Relativity nor Quantum Theory, no more “Relativity + Quantum Theory”. Whereas, facility of magistral autarchy of free press regulation customization and free press admittance short of necessary intendance can make temporal authority intrepid enough to defy such kind of factuality, so that, under high-sounding royal substantiation & perfection of contemporaneous scientific orthodoxy, development of science seems farce floundering around in riancy with demode legitimacy coronet on head indeed.

And on the other hand, under background of royal substantiation & perfection of contemporaneous scientific orthodoxy, authoritative intrepidity of contemporaneous scientific orthodoxy is all-time, especially, free press

Historical progress of science in the recent several centuries seemed like a far-flung exploration of the first itinerary around numerous distinctive landscapes of brand-new landmasses of science with palette & tablet on back, several hundred years’ scientific travelogues were compiled thereby.

regulation customization and free press admittance is under magistral autarchy of temporal authority short of necessary intendance, so that science forum is homegrown outgrowth in the garden of contemporaneous scientific orthodoxy beyond all doubt, and live scientific knowledge proliferation is radically restricted in rigid succession of contemporaneous scientific orthodoxy, it's almost impossible for aberrant scientific knowledge proliferation out of succession of contemporaneous scientific orthodoxy to be free from perplexity of free press egotistic proximity identification even virulent scientific knowledge metabolism campaign, no more access of social legitimacy authorization. As a result, social legitimacy of Relativity & quantum Theory seems living till toady.

... ..

Virtually, the most typical character of temporal authority is overwhelming authoritative intrepidity of contemporaneous scientific orthodoxy short of necessary intendance, so that it apparently make historical progress of science slide into superabundant royal substantiation & perfection of contemporaneous scientific orthodoxy even consequently restrict live scientific knowledge proliferation in rigid succession of contemporaneous scientific orthodoxy draw on magistral autarchy of free press regulation customization and free press admittance, which mostly lead to obvious aberrancy of endeavor of historical progress to push humanistic ideology about authenticity of nature forward to perfect ideological enantiomorph of ultimate authenticity of nature step by step draw on practical feasibility & possibility in proportion to contemporaneous historical background.

3. Quantitative change curve of historical progress of science in function model of “Historical progress of science (historical authenticity tolerance of science)=F(practical feasibility & possibility in proportion to contemporaneous historical background, time tenor of historical progress of science)**”.**

Veritable progress of science is not intuitional cumulative achievement of colorful scientific travelogues A, B, C, D, E, F, ...as deserving reward of the first itineracy around preternatural landscapes of brand-new landmasses of science like omnifarious smallwares full of a basket but successive hypostatic endeavor to push humanistic ideology about authenticity of nature forward to perfect ideological enantiomorph of ultimate authenticity of nature step by step draw on practical feasibility & possibility in proportion to contemporaneous historical background, which is of course hypostatic historical progress of science in inherent optimum orientation towards historical authenticity tolerance of science 0. As a result, quantitative change of historical progress of science can be formulated by landmark quantitative change of historical authenticity tolerance of science. And as the most straightforward causal quantitative change of historical progress of science is practical feasibility & possibility for development of science in proportion to contemporaneous historical background, As a result, historical progress of science as illustration (VIII-ii-2) can be illustrated by functional curve of **Historical progress of science (historical authenticity tolerance of science) = F(practical feasibility & possibility in proportion to contemporaneous historical background, time tenor of historical progress of science)**, which makes up of N successive cycles of gradational quantitative change of original naissance of burgeoning contemporaneous scientific orthodoxy, freewheeling substantiation & perfection of contemporaneous scientific orthodoxy and qualitative change of epochmaking scientific knowledge metabolism between demoded contemporaneous scientific orthodoxy and coming burgeoning contemporaneous scientific orthodoxy with synchro subrogation of contemporaneous scientific orthodoxies in inherent optimum orientation towards perfect ideological enantiomorph of ultimate authenticity of nature.

As coherent natura naturans throughout cosmic evolution, instinctive PNT reciprocal equilibrium towards optimum PNT operation is radical potentiality & conditionality for cosmos always ready to orientate itself towards perfection.

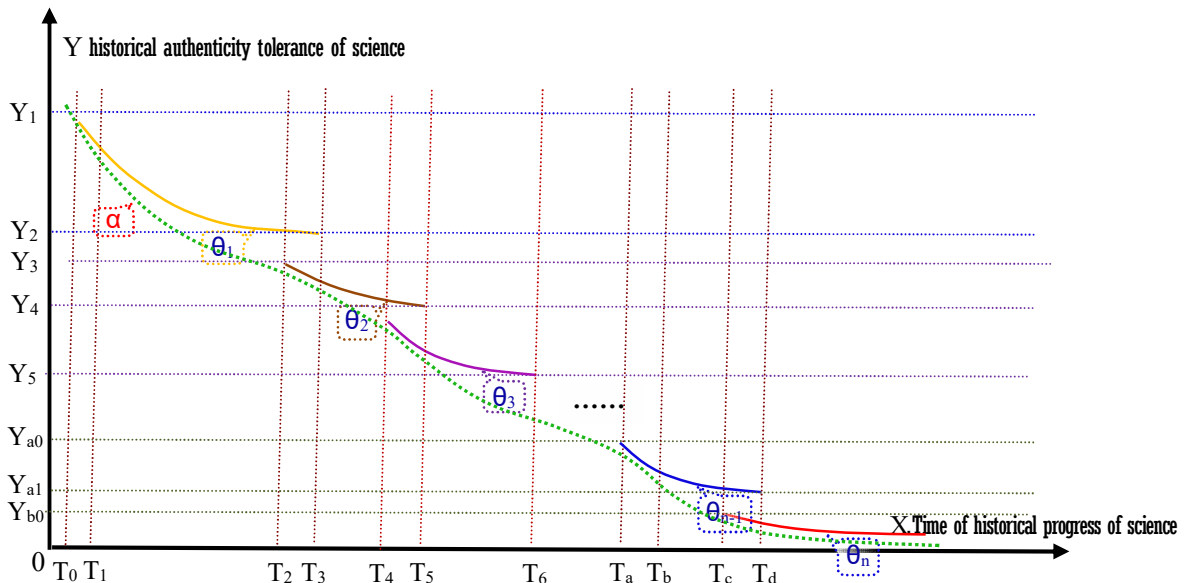

(VIII-ii-3) Quantitative change curve of historical progress of science making up of successive subrogation of contemporaneous scientific orthodoxies $\theta_1, \theta_2, \theta_3, \dots, \theta_{n-1}, \theta_n$ in inherent optimum orientation towards historical authenticity tolerance of science 0

i). The integrative connotation of the illustration is that, as potential synthesized conditionality of “**crecive progression of practical feasibility & possibility in proportion to contemporaneous historical background + the uniqueness & invariance of ultimate authenticity of nature predestines the unique possibility of scientific verity as perfect ideological enantiomorph of ultimate authenticity of nature**” through and through, it’s only possible for the major melody of historical progress of science to be serial epochmaking scientific knowledge metabolism in inherent optimum orientation towards perfect ideological enantiomorph of ultimate authenticity of nature. And virtually, in the illustration above, integrative historical progress of science is just made up of successive naissance, development and social legitimacy metabolism of contemporaneous scientific orthodoxies as $\theta_1, \theta_2, \theta_3, \dots, \theta_{n-1}, \theta_n$ in inherent optimum orientation towards scientific legitimacy qualification of historical authenticity tolerance of science 0.

i-1). In illustration above, the X axis represents time extension of historical progress of science, Y axis represents the authenticity value of historical scientific knowledge which is virtually quantitative change of historical authenticity tolerance of science of contemporaneous scientific orthodoxies $\theta_1, \theta_2, \theta_3, \dots, \theta_{n-1}, \theta_n$ along historical progress of science. The X axis is the line $Y=0$, which virtually represents historical authenticity tolerance of science 0 or authenticity precision of **perfect ideological enantiomorph of ultimate authenticity of nature**. The last curve segment θ_n in illustration gradually close to X axis little by little indicates successive naissance, crecive development and consequent social legitimacy metabolism of of contemporaneous scientific orthodoxies $\theta_1, \theta_2, \theta_3, \dots, \theta_{n-1}, \theta_n$ makes up of integrative historical progress of science in inherent optimum orientation towards historical authenticity tolerance of science 0.

i-2). In illustration above, curve α represents quantitative change of practical feasibility & possibility along time extension of historical progress of science, quantitative change of practical feasibility & possibility along time extension of historical progress of science can be quantified by historical authenticity tolerance of science too. The distinctive curvature of curve α indicates quality of practical feasibility & possibility for development of science in proportion to contemporaneous historical background, the when the curvature of curve α is relatively bigger, the quality of social practice under the proper historical background towards development of science is relatively better, it’s more favorable for historical progress of science. Of course, the curvature of curve

Historical progress of science in the recent several centuries seemed like a far-flung exploration of the first itinerary around numerous distinctive landscapes of brand-new landmasses of science with palette & tablet on back, several hundred years’ scientific travelogues were compiled thereby.

α usually less than 0, which indicates historical progress of science is always in inherent optimum orientation towards historical authenticity tolerance of science 0 or in inherent optimum orientation towards perfect ideological enantiomorph of ultimate authenticity of nature. Historical progress of science usually does not run its way inversely, unless the historical progression of progress of science is not successive.

ii). Interpretation of the curves in illustration.

ii-1). In illustration above:

<p>θ_1 curve segment in period $T_0 \sim T_1$ of historical progress of science</p> <p>θ_2 curve segment in period $T_2 \sim T_3$ of historical progress of science</p> <p>θ_3 curve segment in period $T_4 \sim T_5$ of historical progress of science</p> <p>..... ..</p> <p>θ_a curve segment in period $T_a \sim T_b$ of historical progress of science</p> <p>θ_b curve segment in period $T_c \sim T_d$ of historical progress of science</p>	}	<p>represent the historical existence and development in the early years of contemporaneous scientific orthodoxy $\theta_1, \theta_2, \theta_3, \dots, \theta_{n-1}, \theta_n$</p>
--	---	--

Generally, in such kind of characteristic stages of historical progress of science, the quantitative change of practical feasibility & possibility for development of science is relatively close to humanistic ideology about authenticity of nature in proportion to contemporaneous historical background, which is mostly ideal situation of historical progress of science incarnating “**royal substantiation & perfection of contemporaneous scientific orthodoxy \approx general progress of science to push humanistic ideology about authenticity of nature forward to perfect ideological enantiomorph of ultimate authenticity of nature**”.

ii-2). In illustration above:

<p>θ_1 curve segment in period $T_1 \sim T_2$ of historical progress of science</p> <p>θ_2 curve segment in period $T_3 \sim T_4$ of historical progress of science</p> <p>..... ..</p> <p>θ_{n-1} curve segment in period $T_b \sim T_c$ of historical progress of science</p>	}	<p>represent historical existence and development of science in medium-term of contemporaneous scientific orthodoxy $\theta_1, \theta_2, \theta_3, \dots, \theta_{n-1}$.</p>
--	---	--

In such kind of characteristic stages of historical progress of science, as officialism domino effect of contemporaneous scientific orthodoxy must influence coming scientific knowledge proliferation, and scientific knowledge proliferation under egotistic guidance of temporal authority must focus on royal substantiation & perfection of contemporaneous scientific orthodoxy in the nature of things, it's almost impossible for endeavor of royal substantiation & perfection of contemporaneous scientific orthodoxy to acclimate itself and assimilate quantitative change of practical feasibility & possibility in proportion to contemporaneous historical background as much as possible for veritable progress of science to push humanistic ideology about authenticity of nature forward to perfect ideological enantiomorph of ultimate authenticity of nature draw on practical feasibility & possibility in proportion to contemporaneous historical background, so that realistic value of historical authenticity tolerance of science of practical feasibility & possibility in proportion to contemporaneous historical background become less and less than historical authenticity tolerance of science of contemporaneous scientific orthodoxy as $\theta_1, \theta_2, \theta_3, \dots, \theta_{n-1}$, there are proportionably more and more potentiality for necessary renovation of humanistic ideology about authenticity of nature in proportion to contemporaneous historical background, so that, when historical progress of science proceeds to time of $T_2, T_4, \dots, T_a, T_c$, there is renovation of humanistic ideology about authenticity of nature in

As coherent natura naturans throughout cosmic evolution, instinctive PNT reciprocal equilibrium towards optimum PNT operation is radical potentiality & conditionality for cosmos always ready to orientate itself towards perfection.

proportion to contemporaneous historical background of successive contemporaneous scientific orthodoxy θ_2 , successive contemporaneous scientific orthodoxy θ_3, \dots , successive contemporaneous scientific orthodoxy θ_{n-1} and successive contemporaneous scientific orthodoxy θ_n .

ii-3). In illustration above:

Interval $T_2 \sim T_3$ is just the period of historical alternation of contemporaneous scientific orthodoxy θ_1 and contemporaneous scientific orthodoxy θ_2 .
 Interval $T_4 \sim T_5$ is just the period of historical alternation of contemporaneous scientific orthodoxy θ_2 and contemporaneous scientific orthodoxy θ_3 .

 Interval $T_c \sim T_a$ is just the period of historical alternation of contemporaneous scientific orthodoxy θ_{n-1} and contemporaneous scientific orthodoxy θ_n .

The most remarkable behavioral feature of historical progress of science is that, as permanent synthesized conditionality of “crescive progression of practical feasibility & possibility in proportion to contemporaneous historical background + the uniqueness & invariance of ultimate authenticity of nature predestines the unique possibility of scientific verity as perfect ideological enantiomorph of ultimate authenticity of nature” through and through, it’s almost impossible for practical accomplishment of historical progress of science to be free from scientific knowledge metabolism and consequent scientific knowledge metabolism campaign. And what’s more, as innovative scientific idea, coming renovation of humanistic ideology about authenticity of nature in proportion to contemporaneous historical background is always flimsy, comparably, live temporal orthodoxies are always doughty with all-time authoritative intrepidity of contemporaneous scientific orthodoxy. Especially, as free press regulation customization and free press admittance is completely under magistral autarchy of temporal authority as hardcore puissance of historical progress of science short of necessary intendance, nowadays science forum is out-and-out homegrown outgrowth in the garden of contemporaneous scientific orthodoxy beyond all doubt.

ii-4). Historical progress of science is always crescive progression in inherent optimum orientation towards perfect ideological enantiomorph of ultimate authenticity of nature (/historical authenticity tolerance of science 0), which of course indicates, in illustration above, let’s suppose there are two time points T_x and T_y , and the corresponding historical authenticity tolerance of science of the two time points T_x and T_y along historical progress of science is Y_a and Y_b . In accordance with degressive progression of historical progress of science in inherent optimum orientation towards historical authenticity tolerance of science 0, if $T_x < T_y$, then, Y_a and Y_b must satisfy $Y_a > Y_b$.

The practical significance if $T_x < T_y$, then, Y_a and Y_b must satisfy $Y_a > Y_b$ is generally as following:

As humanistic ideology about authenticity of nature in proportion to contemporaneous historical background, if historical authenticity tolerance of science of Galileo is Y_2 , then, historical authenticity tolerance of science of any similar scientific formulation after Galileo must be less than Y_2 , otherwise, there is almost no possibility for it to be qualified to be brought into crescive progression of historical progress of science in inherent optimum orientation towards historical authenticity tolerance of science 0. After all, naissance of the similar scientific formulation after Galileo whose historical authenticity tolerance of science was even bigger than Galileo theory could virtually do nothing to push humanistic ideology about authenticity of nature forward to perfect ideological enantiomorph of ultimate authenticity of nature there and then.

Historical progress of science in the recent several centuries seemed like a far-flung exploration of the first itinerary around numerous distinctive landscapes of brand-new landmasses of science with palette & tablet on back, several hundred years’ scientific travelogues were compiled thereby.

As humanistic ideology about authenticity of nature in proportion to contemporaneous historical background, if historical authenticity tolerance of science of Newtonian Mechanics is Y_3 , then, historical authenticity tolerance of science of any similar scientific formulation after Newton must be less than Y_3 , otherwise, there is almost no possibility for it to be qualified to be brought into crecive progression of historical progress of science in inherent optimum orientation towards historical authenticity tolerance of science 0. After all, naissance of the similar scientific formulation after Newton whose historical authenticity tolerance of science was even bigger than Newtonian theory could virtually do nothing to push humanistic ideology about authenticity of nature forward to perfect ideological enantiomorph of ultimate authenticity of nature there and then.

... ..

As humanistic ideology about authenticity of nature in proportion to contemporaneous historical background, if historical authenticity tolerance of science of General Relativity is Y_h , then, historical authenticity tolerance of science of any similar scientific formulation after Einstein must be less than Y_h , otherwise, there is no possibility for it to be qualified to be brought into crecive progression of historical progress of science in inherent optimum orientation towards historical authenticity tolerance of science 0. After all, naissance of similar scientific formulation after Einstein whose historical authenticity tolerance of science was even bigger than General Relativity could virtually do nothing to push humanistic ideology about authenticity of nature forward to perfect ideological enantiomorph of ultimate authenticity of nature there and then.

ii-5). in illustration above:

- Quantitative change of historical authenticity tolerance of science $Y_1 \sim Y_2$ is just accomplishment of advancement towards historical authenticity tolerance of science 0 of contemporaneous scientific orthodoxy Θ_1 during the course of $T_0 \sim T_3$
- Quantitative change of historical authenticity tolerance of science $Y_3 \sim Y_4$ is just accomplishment of advancement towards historical authenticity tolerance of science 0 of contemporaneous scientific orthodoxy Θ_2 during the course of $T_2 \sim T_5$.
- Quantitative change of historical authenticity tolerance of science $Y_5 \sim Y_6$ is just accomplishment of advancement towards historical authenticity tolerance of science 0 of contemporaneous scientific orthodoxy Θ_3 during the course of $T_5 \sim T_6$.
-
- Quantitative change of historical authenticity tolerance of science $Y_{a0} \sim Y_{a1}$ is just accomplishment of advancement towards historical authenticity tolerance of science 0 of contemporaneous scientific orthodoxy Θ_{n-1} during the course of $T_a \sim T_b$.
- Quantitative change of historical authenticity tolerance of science $Y_{b0} \sim 0$ is just accomplishment of advancement towards historical authenticity tolerance of science 0 of contemporaneous scientific orthodoxy Θ_n during the course of $T_c \sim$ future development of science along human history.
- Hypostatic historical progress of science of human is just quantitative change of historical authenticity tolerance of science $(Y_1 \sim Y_2)_{\Theta_1} + (Y_3 \sim Y_4)_{\Theta_2} + (Y_5 \sim Y_6)_{\Theta_3} + \dots + (Y_{a0} \sim Y_{a1})_{\Theta_{n-1}} + (Y_{b0} \sim 0)_{\Theta_n}$.

Apparently, the incremental quantitative & qualitative change of historical progress of science is not in rigid continuous progression, when there is epochmaking scientific knowledge metabolism with proportionate subrogation of contemporaneous scientific orthodoxy, there must be remarkable saltatorial quantitative change of advancement of historical authenticity tolerance of science towards historical authenticity tolerance of science 0, so that, in illustration above, there are quantitative change interstice as $(Y_2 \sim Y_3)$, $(Y_4 \sim Y_5)$, ..., $(Y_{a1} \sim Y_{b0})$ of quantitative change of historical authenticity tolerance of science along historical progress of science.

As coherent natura naturans throughout cosmic evolution, instinctive PNT reciprocal equilibrium towards optimum PNT operation is radical potentiality & conditionality for cosmos always ready to orientate itself towards perfection.

The discontinuity of quantitative change of historical authenticity tolerance of science along historical progress of science is mostly modificatory domino effect of two remarkable operational features of historical progress of science.

The first: it's only possible for living scientific knowledge proliferation to be endeavor of human trying to comprehend and formulate the authentic objectivity of the accessible existence & motion around us on the spot, as remarkable disparity of accessible noumenon as perceivable existence & motion around us in different historical stages, commensurate humanistic ideologies about authenticity of nature in proportion to different contemporaneous historical background are proportionably different, even occurrence of remarkable illogicality or incompatibility.

The second, throughout historical progress of science, no matter how remarkable the historical authenticity tolerance of science of live ideological system about authenticity of nature is, as long as there is ideological mainstream about authenticity of nature, there must be contemporaneous scientific orthodoxy and consequent authoritative intrepidity of contemporaneous scientific orthodoxy, practical presence and involvement of contemporaneous scientific orthodoxy and consequent authoritative intrepidity of contemporaneous scientific orthodoxy must directly implicate operational effect of coming scientific knowledge proliferation, especially the coming scientific knowledge metabolism campaign, free press regulation customization and free press admittance, social legitimacy authorization etc, which are mostly the so-called “benign officialism domino effect of contemporaneous scientific orthodoxy” and “conservative officialism domino effect of contemporaneous scientific orthodoxy”. Of course, involvement of “benign officialism domino effect of contemporaneous scientific orthodoxy” and “conservative officialism domino effect of contemporaneous scientific orthodoxy” will practically influence the quantitative and qualitative change of historical progress of science in inherent optimum orientation towards historical authenticity tolerance of science 0 (/perfect ideological enantiomorph of ultimate authenticity of nature).

iii). In our rational purview, historical progress of science is nothing else but hypostatic historical progress of science of human; in any case, human has not found another civilized organism in cosmos. If there are still civilized organism NO.1, civilized organism NO.2, ..., civilized organism NO.X in cosmos, then, quantitative change curves of hypostatic historical progress of science of civilized organism NO.1, civilized organism NO.2, ..., civilized organism NO.X are generally the same as illustration (VIII-ii-3). After all, no matter what the civilized organism is, the potential restriction domino effect of “crescive progression of practical feasibility & possibility in proportion to contemporaneous historical background + the uniqueness & invariance of ultimate authenticity of nature predestines the unique possibility of scientific verity as perfect ideological enantiomorph of ultimate authenticity of nature” to hypostatic historical progress of science is almost equivalent, —as permanent synthesized conditionality of “crescive progression of practical feasibility & possibility in proportion to contemporaneous historical background + the uniqueness & invariance of ultimate authenticity of nature predestines the unique possibility of scientific verity as perfect ideological enantiomorph of ultimate authenticity of nature” through and through, it's only possible for the major melody of historical progress of science to be a series of epochmaking scientific knowledge metabolism in inherent optimum orientation towards perfect ideological enantiomorph of ultimate authenticity of nature, which is of course synchro subrogation of contemporaneous scientific orthodoxy for social legitimacy metabolism. Their integrative historical progress of science are but gradational series of scientific knowledge metabolism

Historical progress of science in the recent several centuries seemed like a far-flung exploration of the first itinerary around numerous distinctive landscapes of brand-new landmasses of science with palette & tablet on back, several hundred years' scientific travelogues were compiled thereby.

with synchro subrogation of temporal orthodoxies of $\theta_1, \theta_2, \theta_3, \dots, \theta_{n-1}, \theta_n$ in inherent optimum orientation towards historical authenticity tolerance of science 0, the possible distinctive distinction among them are generally as following:

- ⌋ The integrative distribution discrepancy of “characteristic curvature” of α curve in illustration (VIII-ii-3).
- ⌋ The integrative distribution discrepancy of temporal orthodoxies $\theta_1, \theta_2, \theta_3, \dots, \theta_{n-1}, \theta_n$ along α curve.
- ⌋ The discrepancy of lifespan and total quantity of serial temporal orthodoxies $\theta_1, \theta_2, \theta_3, \dots, \theta_{n-1}, \theta_n$.

Although, epochmaking scientific innovations derived from historical top-ranking geniuses are mostly all-time for progress of science then and there, in any case, top-ranking geniuses can never do their jobs out of thin air, there is completely no possibility for any top-ranking genius to transcend all the practice human coming to discover and formulate authenticity of accessible existence & motion around from nothingness to goat, from goat to a great lot, and consequently followed the proportionate ideaistic correction & qualitative optimization from superficiality to profundity, from parochiality to generality and accomplish humanistic ideology about authenticity of nature in legitimacy qualification of historical authenticity tolerance of science 0 once or twice at their pleasure or upon their personal endeavor in defiance of historical limitation. Virtually, even the toppest top-ranking genius on the earth can only do his best and accomplish personal achievement draw on practical feasibility & possibility in proportion to contemporaneous historical background, whose contribution is but endeavor to turn the practical potentiality for authenticity highlight in proportion to contemporaneous historical background into realistic scientific knowledge proliferation of the age.

Ostensibly, top-ranking geniuses created this kind of innovative scientific truth and that kind of innovative scientific truth then and there, so that historical progress of science in the recent several centuries seemed like a far-flung exploration of the first itineracy around numerous distinctive landscapes of brand-new landmasses of science with palette & tablet on back, several hundred years' scientific travelogues were compiled thereby, although, cosmic status quo is well-regulated homogeneity system as out-and-out serial natura naturata in the nature of coherent natura naturans throughout cosmic evolution. However, once we get down to our work to review the potential causality between essential connotation of humanistic ideology about authenticity of nature and the proper contemporaneous historical background, we can of course perceive some intangible implication or correlation between the both which is similar as the very kind of fruit tree producing the very kind of fruits in the nature of things. This may be just historical essence which invisibly solidifies the succession of historical progress of science in inherent optimum orientation towards historical authenticity tolerance of science 0.

Aristotle's theory was of course originality of Aristotle under contemporaneous historical background of BC 4th century Achaean society, which practically accomplished the proper potential possibility of authenticity highlight of BC 4th century of Achaean society into realistic scientific knowledge proliferation there and then. Whereas, as historical limitation of potentiality in proportion to contemporaneous historical background for authenticity highlight, there was almost no practical feasibility & possibility for Aristotle to involve geocentric theory and heliocentric theory etc.

Geocentric theory was of course originality of Ptolemy under contemporaneous historical background of A.D. 2th century Achaean society, which practically accomplished the proper potential possibility of authenticity highlight A.D. 2th century of Achaean society into realistic scientific knowledge proliferation there and then.

As coherent natura naturans throughout cosmic evolution, instinctive PNT reciprocal equilibrium towards optimum PNT operation is radical potentiality & conditionality for cosmos always ready to orientate itself towards perfection.

Whereas, as historical limitation of potentiality in proportion to contemporaneous historical background for authenticity highlight, there was almost no practical feasibility & possibility for Ptolemy to involve Newtonian mechanics.

.....

Newtonian mechanics was of course originality of Newton under contemporaneous historical background of A.D. 17th century occidental society, which practically accomplished the proper potential possibility of authenticity highlight of A.D. 17th century occidental society into realistic scientific knowledge proliferation there and then. Whereas, as historical limitation of potentiality in proportion to contemporaneous historical background for authenticity highlight, there was almost no practical feasibility & possibility for Newton to involve Relativity, Quantum Theory.

Relativity & Quantum Theory were of course originality of Einstein, Bohr etc. under contemporaneous historical background of terminal years of A.D. 19th century to primary years of A.D. 20th century occidental society, which practically accomplished the proper potential possibility of authenticity highlight of terminal years of A.D. 19th century to primary years of A.D. 20th century occidental society into realistic scientific knowledge proliferation there and then. Whereas, as historical limitation of potentiality in proportion to contemporaneous historical background for authenticity highlight, there was almost no practical feasibility & possibility for Einstein, Bohr to involve issue **whether cosmos is really homogenous originated from unique genesis through and through, if yes, what integrative cosmic homologic configuration and proportionate universal homologic existence & motion should be accordingly.**

Usually, as historical progress of science must be crecive progression in inherent optimum orientation towards perfect ideological enantiomorph of ultimate authenticity of nature, when we come to evaluate contribution of top-ranking geniuses to historical progress of science, it's mostly necessary for us to verify issues as below:

1). How much the top-ranking geniuses had ever modulated the conservative freewheeling of historical progress of science to optimum orientation towards perfect ideological enantiomorph of ultimate authenticity of nature draw on practical feasibility & possibility in proportion to contemporaneous historical background.

2). How much **positive advancement margin of scientific legitimacy qualification** of historical authenticity tolerance of science the top-ranking genius has practically accomplished forward to perfect ideological enantiomorph of ultimate authenticity of nature under contemporaneous historical background. We can never judge contribution of any top-ranking genius in accordance with **reference point of historical authenticity tolerance of science 0** whether the consequent historical authenticity tolerance of science the corresponding top-ranking genius has practically approached is relatively closer to 0 in crecive progression of historical progress of science in inherent optimum orientation towards perfect ideological enantiomorph of ultimate authenticity of nature.

Virtually, as historical progress of science is always in inherent optimum orientation towards perfect ideological enantiomorph of ultimate authenticity of nature, scientific legitimacy qualification of achievement of later top-ranking geniuses along crecive progression of historical progress of science must be relatively closer to historical authenticity tolerance of science 0 in the nature of things, otherwise, there must be circumforaneous top-ranking geniuses who built up phoney renovation of humanistic ideology about authenticity of nature in proportion to contemporaneous historical background, which apparently violates the inevitability of historical progress of science in inherent optimum orientation towards scientific legitimacy qualification of historical

Historical progress of science in the recent several centuries seemed like a far-flung exploration of the first itinerary around numerous distinctive landscapes of brand-new landmasses of science with palette & tablet on back, several hundred years' scientific travelogues were compiled thereby.

authenticity tolerance of science 0.

Throughout historical progress of science, Newton had ever done a good job then and there, Einstein, Bohr had also done good jobs at the volley along freewheeling of historical progress of science in inherent optimum orientation towards perfect ideological enantiomorph of ultimate authenticity of nature. Whereas, relatively, Newton seemed even greater than Einstein, Bohr for his remarkable job which seemed having accomplished more advancement margin of scientific legitimacy qualification forward to historical authenticity tolerance of science 0 then and there, Although, along succession of historical progress of science in inherent optimum orientation towards historical authenticity tolerance of science 0, legitimacy qualification of Relativity, Quantum Theory were apparently closer to perfect ideological enantiomorph of ultimate authenticity of nature and washed out Newtonian Mechanics at the volley, successive naissance & development of Relativity & Quantum Theory seemed not having accomplished equivalent advancement margin of scientific legitimacy qualification forward to perfect ideological enantiomorph of ultimate authenticity of nature along historical progress of science in inherent optimum orientation towards historical authenticity tolerance of science 0 then and there.

In fact, as permanent synthesized conditionality of “**crecive progression of practical feasibility & possibility in proportion to contemporaneous historical background + the uniqueness & invariance of ultimate authenticity of nature predestines the unique possibility of scientific verity as perfect ideological enantiomorph of ultimate authenticity of nature**” through and through, it's only possible for the major melody of historical progress of science to be a series of epochmaking scientific knowledge metabolism in inherent optimum orientation towards perfect ideological enantiomorph of ultimate authenticity of nature, Relativity, Quantum Theory washed out Newtonian Mechanics only indicated Relativity, Quantum Theory were successive advancement of historical progress of science in inherent optimum orientation towards perfect ideological enantiomorph of ultimate authenticity of nature all wool and a yard wide, which was out-and-out significance for Relativity & Quantum Theory to take their place in the ranks of historical progress of science in inherent optimum orientation towards perfect ideological enantiomorph of ultimate authenticity of nature as distinctive advancement of historical progress of science in proportion to contemporaneous historical background of early years of 20th century.

Throughout historical progress of science, naissance of top-ranking geniuses usually indicates occurrence of epochmaking innovation and all-time progress of science, and subsequent historical extension of freewheeling royal substantiation & perfection of contemporaneous scientific orthodoxy must inevitably teem with “second-string geniuses”, third-rate talents are mostly molded by contemporaneous scientific orthodoxy. Whereas, in order to carry forward contemporaneous scientific orthodoxy, the second-string geniuses are mostly ready to devote themselves to lineal logic extension in rigid succession of contemporaneous scientific orthodoxy, who usually treat the contemporaneous scientific orthodoxy as undoubted “logic basis or rationale” for linear logic extension in succession of contemporaneous scientific orthodoxy in spite of whether historical authenticity tolerance of science of contemporaneous scientific orthodoxy is 0 and show off their authority gayly. And the third-rate talents who are always molded by contemporaneous scientific orthodoxy are mostly loving parrots behind second-string geniuses, third-rate talents growing up under examination-oriented education system are even loving parrots behind second-string geniuses.

And on the other hand, as natural determinism **the uniqueness & invariance of ultimate authenticity of nature predestines unique possibility of scientific verity as perfect ideological enantiomorph of ultimate authenticity of nature**, before approaching of

As coherent natura naturans throughout cosmic evolution, instinctive PNT reciprocal equilibrium towards optimum PNT operation is radical potentiality & conditionality for cosmos always ready to orientate itself towards perfection.

absolute scientific verity as perfect ideological enantiomorph of ultimate authenticity of nature, historical progress of science in inherent optimum orientation towards historical authenticity tolerance of science 0 must break all prior conventionality of royal substantiation & perfection of contemporaneous scientific orthodoxy and consequently lead to further epochmaking scientific innovation of science. Till at last, humanistic ideology about authenticity of nature tallies with ultimate authenticity of nature 100 over 100. This of course indicates, before naissance of absolute scientific verity, hypostatic scientific knowledge proliferation along crescive progression of historical progress of science must accumulate and set free two kind of “potentiality” for historical progress of science as below:

The first, **popular endeavor for royal substantiation & perfection of contemporaneous scientific orthodoxy:**

The so-called “second-string geniuses” set free energy for historical progress of science which is accumulated for implementation of royal substantiation & perfection of contemporaneous scientific orthodoxy of the age, whose popular scientific knowledge proliferation for implementation of successive royal substantiation & perfection of contemporaneous scientific orthodoxy are mostly limited in lineal logic extension in rigid succession of contemporaneous scientific orthodoxy even wallow in pean scientific knowledge proliferation in rigid succession of contemporaneous scientific orthodoxy.

The second, **straightforward endeavor to push humanistic ideology forward to perfect ideological enantiomorph of ultimate authenticity of nature draw on practical feasibility & possibility in proportion to contemporaneous historical background:**

No matter how much royal substantiation & perfection of contemporaneous scientific orthodoxy can do to carry forward general progress of science in inherent optimum orientation towards historical authenticity tolerance of science 0, leastways, it’s impossible for freewheeling substantiation & perfection of contemporaneous scientific orthodoxy to do negative job to general progress of human science. Quantitative change of scientific knowledge proliferation derives from freewheeling royal substantiation & perfection of contemporaneous scientific orthodoxy can also make our ideology richer and make our rational purview wider towards highlight of ultimate authenticity of nature more or less, so that there must be more and more potentiality for coming potential top-ranking geniuses.

Virtually, as natural determinism that **the uniqueness & invariance of ultimate authenticity of nature predestines unique possibility of scientific verity**, before ultimately approaching perfect ideological enantiomorph of ultimate authenticity of nature, it’s impossible for historical progress of science to be completely limited in pean progress of contemporaneous scientific orthodoxy for implementation of royal substantiation & perfection of contemporaneous scientific orthodoxy, it must calculate common potentiality for general progress of science at the volley, especially for aberrant scientific knowledge proliferation out of succession of contemporaneous scientific orthodoxy towards perfect ideological enantiomorph of ultimate authenticity of nature, which is just job top-ranking geniuses usually do there and then.

The most remarkable business feature of second-string geniuses is substantiation & perfection of contemporaneous scientific orthodoxy. Generally, second-string geniuses are always ready to climb the high branches of the established scientific framework of contemporaneous scientific orthodoxy for gleaming “fruits” in it, such as fruits in established scientific framework of contemporaneous scientific orthodoxy with PACC, PACS label. As a result, the second-string geniuses generally involve in bewitchment and inherent limitation of contemporaneous scientific orthodoxy high-soundly, and their characteristic scientific knowledge proliferation are mostly limited in

Historical progress of science in the recent several centuries seemed like a far-flung exploration of the first itinerary around numerous distinctive landscapes of brand-new landmasses of science with palette & tablet on back, several hundred years’ scientific travelogues were compiled thereby.

lineal logic extension in rigid succession of contemporaneous scientific orthodoxy even are sportful for pean scientific knowledge proliferation in rigid succession of contemporaneous scientific orthodoxy without necessary credible demonstration. As a result, there is almost no way for conventional extension of royal successive freewheeling substantiation & perfection of contemporaneous scientific orthodoxy to approach epochmaking innovation of science. And indeed, throughout historical progress of science, none epochmaking innovation of science was direct outcome of conventional extension of royal substantiation & perfection of contemporaneous scientific orthodoxy besides aberrant scientific knowledge proliferation out of succession of contemporaneous scientific orthodoxy.

On the other hand, the endeavor second-string geniuses devoting to royal substantiation & perfection of contemporaneous scientific orthodoxy is always popular and downwind at the volley, it's not only impossible for second-string geniuses to involve in virulent scientific knowledge metabolism campaign, the second-string geniuses who are mostly ready to make contemporaneous scientific orthodoxy substantiated & perfect are always popular VIP for free press egotistic proximity identification, and they are mostly famous and authoritative with super reputation and gain for meritorious contribution of substantiation & perfection to contemporaneous scientific orthodoxy therefore. Even as super autarchy of "free press regulation customization", "free press admittance" and "social legitimacy authorization", historical progress of science slide into feign progress for special fancy of superior self-sportful of pean scientific knowledge proliferation in rigid succession of contemporaneous scientific orthodoxy of temporal authority, no matter whether they have practical done positive jobs to push humanistic ideology about authenticity of nature forward to perfect ideological enantiomorph of ultimate authenticity of nature or not.

Comparably, the potential top-ranking geniuses are mostly upright without special fancy to contemporaneous scientific orthodoxy, they would rather devote themselves to authenticity of nature than to enjoy themselves in popularity of contemporaneous scientific orthodoxy, who might even slide into aberrant scientific knowledge proliferation out of succession of contemporaneous scientific orthodoxy in spite of desolation. Even as natural determinism **the uniqueness & invariance of ultimate authenticity of nature predestines unique possibility of scientific verity as perfect ideological enantiomorph of ultimate authenticity of nature**, their pioneering endeavor mostly breaks through conventionality of the live contemporaneous scientific orthodoxy without alternatives and accomplishes further epochmaking innovation of science thereby.

However, before finally breaking through conventionality of the live contemporaneous scientific orthodoxy, the potential top-ranking geniuses are mostly enigmatical heterodoxy, who have to suffer discrimination even deadly enmity from temporal authority who are mostly meritorious second-string geniuses or loving successors of contemporaneous scientific orthodoxy. History has proved it time after time, in the early and middle progressive phase of human civilization in crude mixture of civilization & imbrutement, appearance of potential top-ranking geniuses in age of royal substantiation & perfection of contemporaneous scientific orthodoxy is mostly flimsy even tragic.

Historical progress of science is virtually historical process human try to push humanistic ideology about authenticity of nature forward to perfect ideological enantiomorph of ultimate authenticity of nature draw on practical feasibility & possibility in proportion to contemporaneous historical background, which is not only historical process of epochmaking scientific knowledge metabolism one after another but also proportionate

transposition of so-called temporal orthodoxies one by one. Throughout historical progress of science, the worthiness of innovative scientific ideas is not only limited in how much it has highlighted the authenticity of nature, in even straightforward and precise view, it mostly depends on what a remarkable advancement of historical authenticity tolerance of science towards 0 it practical accomplished at the proper historical stage.

Before humanistic ideology about authenticity of nature finally qualified as perfect ideological enantiomorph of coherent natura naturans throughout cosmic evolution, royal substantiation & perfection of contemporaneous scientific orthodoxy is too hypostatic endeavor for progress of science especially when the so-called contemporaneous scientific orthodoxy primarily coming into being as pioneering humanistic ideology about authenticity of nature of the age, there are still substantial potentiality for endeavor of substantiation & perfection of it to push humanistic ideology about authenticity of nature forward to perfect ideological enantiomorph of ultimate authenticity of nature, whose further substantiation & perfection can of course highlight a lot of the authenticity of nature at the volley. However, endeavor of substantiation & perfection of contemporaneous scientific orthodoxy can never break through upper limit of historical limitation of contemporaneous scientific orthodoxy. And as it's only possible for ultimate authenticity of nature to be unique and invariable as coherent natura naturans throughout cosmic evolution, as perfect ideological enantiomorph of authenticity of nature, absolute scientific verity can only be perfect ideological enantiomorph of coherent natura naturans throughout cosmic evolution, no more else. This of course indicates, during the course of historical progress of science, any contemporaneous scientific orthodoxy out of scientific legitimacy qualification of historical authenticity tolerance of science 0 must be washed out by coming scientific innovation once further advancement towards historical authenticity tolerance of science 0 accomplished. Endeavor of substantiation & perfection of contemporaneous scientific orthodoxy can never wash out contemporaneous scientific orthodoxy itself, only aberrant scientific knowledge proliferation out of succession of contemporaneous scientific orthodoxy can do the job.

Freewheeling substantiation & perfection of Aristotle's theory lasted near 2000 years, it was ultimately abolished by Galileo. Freewheeling substantiation & perfection of Ptolemy's geocentric theory lasted more than 1400 years, it was ultimately abolished by Copernicus. Royal substantiation & perfection of Newtonian Mechanics lasted near 300 years, it was ultimately abolished once Einstein offered another theory of Relativity. Relativity and Quantum Theory originally came into being in the early years of 20th century when human began to penetrate into microcosmos towards authenticity highlight of nature. Whereas, interposition of startling deregulation of microcosmic factuality apparently negated validity of Newtonian Mechanics, people had to review universal existence & motion to accomodate remarkable deregulation of microcosmic factuality, necessary renovation of humanistic ideology about authenticity of nature in proportion to contemporaneous historical background of interposition of startling deregulation of microcosmic factuality was self-evident. And as a result, Relativity and Quantum Theory came into being thereby.

And now, royal successive freewheeling substantiation & perfection of "Relativity + Quantum Theory" has lasted more than one century, although the hypostatic extension of royal substantiation & perfection of "Relativity + Quantum Theory" has brought out substantial meritorious second-string geniuses and practically hypostatized distinctive progress of science in the recent 100 years. Whereas, hypostatic historical progress of science in the recent half century seemed having done nothing to push humanistic ideology about authenticity of nature forward to perfect ideological enantiomorph of ultimate authenticity of nature, substantial evidences indicate that royal substantiation and perfection of "Relativity + Quantum Theory" has been floundering in

Historical progress of science in the recent several centuries seemed like a far-flung exploration of the first itinerary around numerous distinctive landscapes of brand-new landmasses of science with palette & tablet on back, several hundred years' scientific travelogues were compiled thereby.

riancy with respectable legitimacy coronet on head, inertial extension of freewheeling royal substantiation & perfection of contemporaneous scientific orthodoxy of “Relativity + Quantum Theory” can hardly take positive role of historical progress of science to push humanistic ideology about authenticity of nature forward to perfect ideological enantiomorph of ultimate authenticity of nature any longer.

In any case, royal substantiation & perfection of “Relativity + Quantum Theory” is not nonstop towards perfect ideological enantiomorph of ultimate authenticity of nature, general progress of science in inherent optimum orientation towards historical authenticity tolerance of science 0 needs orthodoxy subrogation, which of course needs another top-ranking genius to break through conventional deadlock of royal substantiation & perfection of “Relativity + Quantum Theory”, no matter whether Homogenous Cosmos Originated from Unique Genesis is potentiality for the very job or not, it's inevitability of general progress of science in inherent optimum orientation towards historical authenticity tolerance of science 0 beyond doubt.

4. “Aggradation of living scientific knowledge” and quantitative & qualitative change of scientific knowledge proliferation throughout historical progress of science under potential synthesized conditionality of “crescive progression of practical feasibility & possibility in proportion to contemporaneous historical background + the uniqueness & invariance of ultimate authenticity of nature predestines unique possibility of scientific verity as perfect ideological enantiomorph of ultimate authenticity of nature”.

Since initial naissance of human being on the earth, there was world population on the earth. Whenever we mention population on the earth, we but refer to the living people on the earth, it has nothing to do with the ones died early. Since initial naissance of scientific knowledge on the earth, there were always aggradation of scientific knowledge. Once we mention aggradation of scientific knowledge on the earth, we usually means the aggradation of living scientific knowledge on the earth, it has nothing to do with the demoded knowledge which have been washed out early for scientific knowledge metabolism.

Throughout historical progress of science, the quantitative & qualitative change of scientific knowledge proliferation on the earth is mostly subject to two fundamentals as following:

The first, **the uniqueness & invariance of ultimate authenticity of nature predestines the unique possibility of scientific verity as perfect ideological enantiomorph of ultimate authenticity of nature**, which generally means development of science is always endeavor to discover and formulate universal existence & motion as authentic, comprehensive and systematical as human are practically able to draw on practical feasibility & possibility of human in proportion to contemporaneous historical background, till at last, humanistic ideology about authenticity of nature tallies with ultimate authenticity of nature 100 over 100. And as it's only possible for the ultimate authenticity of nature to be unique and invariable as coherent natura naturans throughout cosmic evolution, once humanistic ideology about authenticity of nature tallies with ultimate authenticity of nature 100 over 100, the so-called humanistic ideology about authenticity of nature must proportionately turn into unique coherent scientific verity about universal existence & motion as perfect ideological enantiomorph of coherent natura naturans throughout cosmic evolution.

This fundamental of historical progress of science of course indicates objective authenticity of nature is just ideological reference origin of humanistic ideology about authenticity of nature, which even implies the idiographic feature of authenticity of nature must predestine the enantiomorphous feature of humanistic ideology about authenticity of nature. Consequently, as it's only possible for ultimate authenticity of nature to be

coherent natura naturans throughout cosmic evolution, the uniqueness & invariance of ultimate authenticity of nature must proportionately predestine the unique possibility of scientific verity about universal existence & motion as perfect ideological enantiomorph of coherent natura naturans throughout cosmic evolution. And as crescive progression of practical feasibility & possibility in proportion to contemporaneous historical background, no matter how dramatic historical progress of science is, as long as the practical leitmotiv of historical progress of science is permanent ever since that development of science is always endeavor to discover and formulate universal existence & motion as authentic, comprehensive and systematical as human practically able to draw on practical feasibility & possibility in proportion to contemporaneous historical background, there is no possibility for realistic scientific knowledge proliferation along historical progress of science to deviate the operational axes that objective authenticity of nature predestines the humanistic ideology as enantiomorphous origin.

The second, the crescive progression of practical feasibility & possibility in proportion to contemporaneous historical background proportionably restricts the inherent progression of historical progress of science as potential conditionality, which generally hypostatize historical progress of science as, as crescive progression of practical feasibility & possibility in proportion to contemporaneous historical background, the practice human coming to discover and formulate authenticity of accessible existence & motion around must experience frondose evolvement of humanistic ideology about authenticity of nature cumulatively enriched from nothingness to goad, from goad to a great lot, and consequently followed proportionate ideaistic correction & qualitative optimization from superficiality to profundity, from parochiality to generality.

This fundamental of historical progress of science indicates, as out-and-out social work outgrowth and humanistic ideology about authenticity of nature in proportion to contemporaneous historical background, output quality & situation of scientific knowledge proliferation must link up contemporaneous historical background and relate the integrative conditions of social ambience in rigorous causality, it's only possible for any living scientific knowledge proliferation of discretionary historical stage to produce scientific knowledge against the practically accessible existence & motion then and there. As remarkable disparity of practically accessible existence & motion around of different historical stages, it's completely impossible for humanistic ideology about authenticity of nature of different historical stages to have the common scientific connotation, which may be mostly in remarkable divarication even pestilent illogicality.

Realistic progress of science can never be free from restriction & conditionality of “crescive progression of practical feasibility & possibility in proportion to contemporaneous historical background + the uniqueness & invariance of ultimate authenticity of nature predestines the unique possibility of scientific verity as perfect ideological enantiomorph of ultimate authenticity of nature”, and as permanent synthesized conditionality of “crescive progression of practical feasibility & possibility in proportion to contemporaneous historical background + the uniqueness & invariance of ultimate authenticity of nature predestines the unique possibility of scientific verity as perfect ideological enantiomorph of ultimate authenticity of nature” through and through, the quantitative change of aggradation of living scientific knowledge along historical progress of science human coming to discover and formulate authenticity of accessible existence & motion around must experience frondose ideological evolvement cumulatively enriched from nothingness to goad, from goad to a great lot, and consequently followed the proportionate ideaistic correction & qualitative optimization from superficiality to profundity, from parochiality to generality can be generally illustrated as below:

Historical progress of science in the recent several centuries seemed like a far-flung exploration of the first itinerary around numerous distinctive landscapes of brand-new landmasses of science with palette & tablet on back, several hundred years' scientific travelogues were compiled thereby.

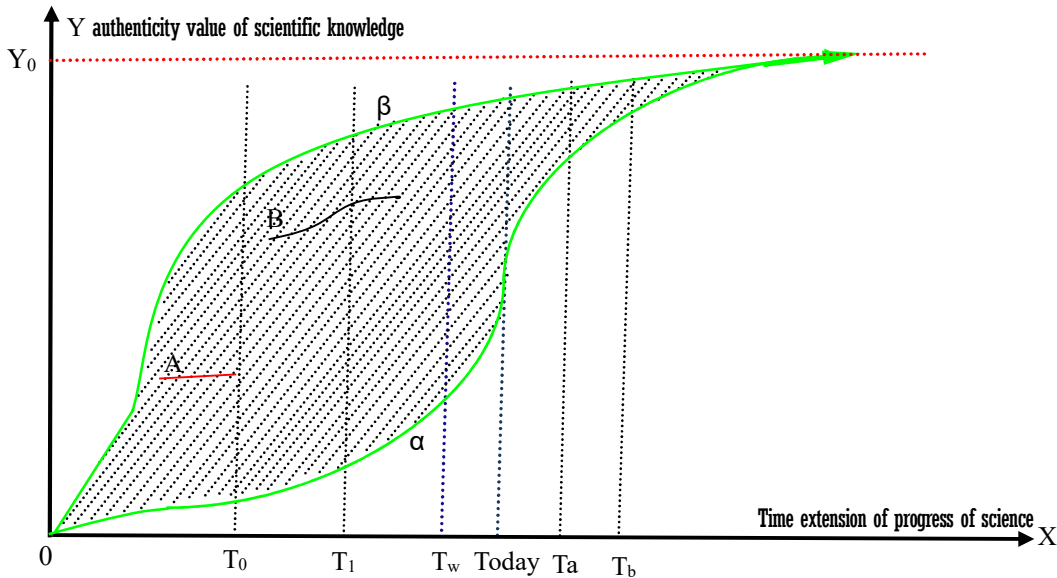

(VIII-i-4) Integrative quantitative change of living scientific knowledge aggradation along intrinsic progression of historical process of science.

The X axes of the illustration above represents time along historical progress of science, and the shadow area which is closed by curve α and curve β is just the so-called “aggradation of living scientific knowledge” along historical progress of science, which is temporally accessible thought resource for coming scientific knowledge proliferation. The Y axes of the illustration above represents authenticity value of scientific knowledge of aggradation of living scientific knowledge along historical progress of science. The bigger the authenticity value of scientific knowledge is, the scientific connotation of the proper scientific knowledge is relatively closer to the authenticity of nature.

The red broken line Y_0 represents the authenticity value of unique & invariable ultimate authenticity of nature, which is virtually the extremity high-point of authenticity value for development of science. After all, development of science is always endeavor to discover and formulate ultimate authenticity of nature as authentically, comprehensively and systematically as possible, whereas, it's only possible for us to push forward humanistic ideology about authenticity of nature forward to perfect ideological enantiomorph of ultimate authenticity of nature draw on practical feasibility & possibility in proportion to contemporaneous historical background and consequently accomplish advancement of historical authenticity tolerance of science towards 0 in proportion, till at last, humanistic ideology about authenticity of nature tallies with ultimate authenticity of nature 100%.

In fact, we can of course formulate curve α and curve β in function format as $\alpha(X, Y)$ and $\beta(X, Y)$. The curve $\alpha(X, Y)$ indicates upper limit curve of authenticity value of historical scientific knowledge proliferation along historical progress of science. Of course, as intrinsic progression of practical feasibility and possibility in proportion to contemporaneous historical background, different stages of historical progress of science have different potential feasibility & possibility for scientific highlight of authenticity of nature, and it's only possible for the best scientific knowledge proliferation for authenticity highlight under the proper contemporaneous historical background to approach $\alpha(X_{\text{living}}, Y)$, (among the function expression, “ X_{living} ” represents the living scientific knowledge proliferation under the proper contemporaneous historical background), which is just the upper limit of authenticity value of scientific knowledge proliferation **①** of the very time point in historical progress of science. This not

As coherent natura naturans throughout cosmic evolution, instinctive PNT reciprocal equilibrium towards optimum PNT operation is radical potentiality & conditionality for cosmos always ready to orientate itself towards perfection.

only indicates the substantial cause and effect between contemporaneous historical background and scientific knowledge proliferation there and then like the proper fruit tree can only produce the very kind of fruits and it's only possible for the very kind of fruit to be produced on the proper tree, but also indicates crecive progression of historical progress of science in inherent optimum orientation towards historical authenticity tolerance of science 0.

Original creation of Geocentric Theory was of course angelical achievement of Ptolemy under contemporaneous historical background of A.D. 2th century Achaean society like peach produced on peach tree in the nature of things, but there was undoubtedly no way for Ptolemy to involve in "Newtonian mechanics" draw on practical feasibility & possibility in proportion to contemporaneous historical background.

Original creation of Newtonian mechanics was of course angelical achievement of Newton under contemporaneous historical background of A.D. 17th century occidental society like pear produced on pear tree in the nature of things, but there was undoubtedly no way for Newton to involve in "Relativity, Quantum Theory" draw on practical feasibility & possibility in proportion to contemporaneous historical background.

Original creation of Relativity and Quantum Theory were of course angelical achievement of Einstein, Bohr etc under contemporaneous historical background of terminal years of A.D. 19th century to primary years of A.D. 20th century occidental society like orange produced on orange tree in the nature of things, when human practice remarkably penetrated into microcosm, but there was undoubtedly no way for Einstein, Bohr etc. to involve in issue **whether cosmos is really homogenous originated from unique genesis through and through, if yes, what integrative cosmic homologic configuration and proportionate universal existence & motion should be accordingly** draw on practical feasibility & possibility in proportion to contemporaneous historical background.

Curve $\beta(X, Y)$ represents acceptable lower limit curve of authenticity value of historical scientific knowledge proliferation along crecive progression of historical progress of science, value Y in the function represents the acceptable lower limit authenticity value of historical scientific knowledge, which of course implies, in terms of living scientific knowledge proliferation under contemporaneous historical background, if authenticity value of the neonatal scientific knowledge is even lower than the acceptable lower limit of authenticity value of scientific knowledge of the age, then, such kind of scientific knowledge is of course apparently cock-and-bull to common sense, there is almost no way for actualization of legitimacy subsistence in realistic society. In more upper stage of historical progress of science, as more adequate development of humanistic ideology about authenticity of nature is, both upper limit curve of authenticity value of historical scientific knowledge

Note ①, in any historical stage, realistic scientific knowledge proliferation usually can accomplish top level scientific knowledge proliferation in proportion to contemporaneous historical background, and so-called contemporaneous scientific orthodoxy is just outcome of top level scientific knowledge proliferation in proportion to contemporaneous historical background. Whereas, there is substantively less possibility for realistic scientific knowledge proliferation to approach upper limit of authenticity value of historical scientific knowledge proliferation in proportion to contemporaneous historical background. Theoretically, **top level accomplishment of historical scientific knowledge proliferation in proportion to contemporaneous historical background \leq upper limit of authenticity value of historical scientific knowledge proliferation in proportion to contemporaneous historical background**, whereas, there is really less opportunity for realistic scientific knowledge proliferation to satisfy "**top level accomplishment of historical scientific knowledge proliferation in proportion to contemporaneous historical background = upper limit of authenticity value of historical scientific knowledge proliferation in proportion to contemporaneous historical background**", it's too ideal indeed.

Historical progress of science in the recent several centuries seemed like a far-flung exploration of the first itinerary around numerous distinctive landscapes of brand-new landmasses of science with palette & tablet on back, several hundred years' scientific travelogues were compiled thereby.

proliferation and acceptable lower limit curve of authenticity value of historical scientific knowledge proliferation are relatively on the high side, this of course indicates, at the more upper stage, there are more feasibility & potentiality for humanistic ideology about authenticity of nature to approach perfect ideological enantiomorph of ultimate authenticity of nature, and even the acceptable lower limit of authenticity value of scientific knowledge of the age is remarkably higher too.

Once time extending to 20th century, if authenticity value (or historical authenticity tolerance of science) of living scientific knowledge proliferation about universal existence & motion still kept equivalent to Newtonian Mechanics, then, such kind of scientific knowledge proliferation could practically do nothing to push humanistic ideology about authenticity of nature forward to perfect ideological enantiomorph of ultimate authenticity of nature. And virtually, it's almost impossible for such kind of scientific knowledge proliferation to climb up developing train of science for social legitimacy subsistence there and then. Once time extending to 21th century, if authenticity value (or historical authenticity tolerance of science) of living scientific knowledge proliferation about universal existence & motion still kept equivalent to Relativity, Quantum Theory, then, such kind of scientific knowledge proliferation could practically do nothing to push humanistic ideology about authenticity of nature forward to perfect ideological enantiomorph of ultimate authenticity of nature. And virtually, it's almost impossible for such kind of scientific knowledge proliferation to climb up developing train of science for social legitimacy subsistence there and then.

In terms of any scientific knowledge out of scientific legitimacy qualification of historical authenticity tolerance of science 0 throughout historical progress of science, they all have their long or short life-span. As a result, any idiographic scientific knowledge exists as a long or short line or curve in the shadow area of illustration above, the start point of the "line or curve" indicates original naissance of the proper scientific knowledge, the length of the line or curve indicates end-point of life-span of the scientific knowledge, the end-point indicates the scientific knowledge has been washed out for scientific knowledge metabolism ultimately. For example, the red line A in shadow area of illustration above can represent historical existence of scientific knowledge of Geocentric Theory. However, I have to comment herein, not all aggradation of living scientific knowledge throughout historical progress of science are long or short "lines", some of them may be even curves, such as the black curve B in shadow area of illustration above, which of course implies the authenticity value of the aggradation of living scientific knowledge is not constant but some increase along crescive progression of historical progress of science. For example, the authenticity value of aggradation of scientific knowledge about lights in the nature.

And just because naissance, development, successive metabolism of scientific knowledge must carry through in idiographic historical phase, it's convenient for us to study and analyze "aggradation of living scientific knowledge" in some idiographic historical phase but not convenient to study and analyze "aggradation of living scientific knowledge" on some certain time point of historical progress of science.

In illustration above, the shadow area between time 0 and time T_0 can represent the aggradation of living scientific knowledge from start of human civilization to Copernicus' age.

During the course of the historical stage, historical progress of science still existed in budding situation of scientific knowledge proliferation from nothingness to goat, from goat to a great lot. The total output of scientific knowledge was little and the consequent scientific knowledge metabolism was too retarded. As a

result, the life-span of the aggradation of living scientific knowledge was remarkably longer. For examples, the life-span of Aristotle's theory was near 2000 years, the life-span of Ptolemy's Geocentric theory was near 1400 years. This was not because authenticity value of Aristotle's theory, Ptolemy's Geocentric Theory was relatively higher with puissant social legitimacy livability, but because, during the course of the very historical stage, the both living scientific knowledge proliferation and consequent scientific knowledge metabolism were substantively weak and retarded.

In illustration above, the shadow area between time T_0 and time T_1 can represent the aggradation of living scientific knowledge from Copernicus' age to Newtonian age.

During the course of the historical stage, historical progress of science entered active pursuit towards clarification & highlight of authenticity of nature, quantitative change of scientific knowledge proliferation entered remarkable state from groat to a great lot, the total output of scientific knowledge was considerable. However, the consequent scientific knowledge metabolism was still retarded. As a result, the life-span of the aggradation of living scientific knowledge of the historical stage was relatively longer.

In illustration above, the shadow area between time T_1 and time T_w can represent the aggradation of living scientific knowledge from Newtonian age to Einstein & Bohr's age.

During the course of the historical stage, towards clarification & highlight of authenticity of nature, scientific knowledge proliferation entered fastigium from groat to a great lot, the total output of scientific knowledge was remarkably substantial. Whereas, as historical limitation of scientific practice of the age, scientific knowledge proliferation was mostly limited in rational sublimation of intuitionistic macrophysics of human, Newtonian mechanics was typical instance among them. As tardo successive implication dilation of scientific practice from macrocosm to microcosmos conditioning proportionate ideological transition from macrophysics to microphysics, scientific knowledge metabolism of the age was still retarded even insensitive, so that social legitimacy subsistence of Newtonian Mechanics still maintained near 300 years, which was not only related to relatively higher authenticity value of Newtonian Mechanics but also related to tardo successive implication dilation of scientific practice from macrocosm to microcosmos conditioning proportionate ideological transition from macrophysics to microphysics.

In illustration above, the shadow area between time T_w and time T_{today} can represent the aggradation of living scientific knowledge from Einstein & Bohr's age to today.

During the course of the historical stage, towards clarification & highlight of authenticity of nature, development of science entered fastigium from superficiality to profundity, from macrocosm to microcosmos, the total output of scientific knowledge proliferation in the recent one century is of course unprecedented, and the most remarkable preponderance was that hypostatic scientific knowledge proliferation in the recent one century have mostly highlighted comprehensive details of the so-called brand-new landmasses of science as rich and colorful scientific travelogues. Although, aggradation of living scientific knowledge of today still seem colorful scientific travelogues like omnifarious smallwares full of a basket, whereas, it's neither possible for ultimate authenticity of nature to be omnifarious authenticity smallwares full of a basket nor possible for ultimate authenticity of nature to be authenticity chameleon one piece and only, it is really substantial to make integrative configuration of cosmos more and more explicit before us, especially remarkable highlight of microcosmic configuration of matter in cosmos, which almost makes the integrative homogenous profile of cosmos self-evident and has become preponderant headspring for coming scientific knowledge proliferation.

Historical progress of science in the recent several centuries seemed like a far-flung exploration of the first itinerary around numerous distinctive landscapes of brand-new landmasses of science with palette & tablet on back, several hundred years' scientific travelogues were compiled thereby.

As a result, further renovation of humanistic ideology about authenticity of nature from parochiality to generality has been possible, epoch-making longitudinal ideological optimization towards innovative cosmos redefinition are practically inevitable.

However, we still have to face double perplexity:

The first, as authoritative intrepidity of contemporaneous scientific orthodoxy is all-time and overwhelming, living scientific knowledge proliferation is difficult to shake off inflexible conventionality of royal substantiation & perfection of contemporaneous scientific orthodoxy, which has virtually wildered straightforward endeavor to push humanistic ideology about authenticity of nature forward to perfect ideological enantiomorph of ultimate authenticity of nature draw on practical feasibility & possibility in proportion to contemporaneous historical background. Modern physics is floundering in riancy with demoded legitimacy coronet on head.

Since original naissance of Relativity & quantum theory to 70s of 20th century, flourishing substantiation & perfection of contemporaneous scientific orthodoxy had mostly taken the roles of historical progress of science indeed. After 70s of 20th century, as inherent rational potentiality of contemporaneous scientific orthodoxy towards authenticity highlight of nature gradually exhausted, persistent performance of royal substantiation & perfection of contemporaneous scientific orthodoxy to take full role of historical progress of science seemed more and more dowdy. However, as authoritative intrepidity of contemporaneous scientific orthodoxy was still all-time even inundant, especially magistral autarchy of “free press regulation customization” & “free press admittance” of temporal authority short of necessary intendance, science forum is always homegrown outgrowth in the garden of contemporaneous scientific orthodoxy, and living scientific knowledge proliferation can hardly shake off inflexible conventionality of royal substantiation & perfection of contemporaneous scientific orthodoxy for straightforward endeavor to push humanistic ideology about authenticity of nature forward to perfect ideological enantiomorph of ultimate authenticity of nature.

After all, in succession of inrooted conventionality of contemporaneous scientific orthodoxy, endeavor of substantiation & perfection of contemporaneous scientific orthodoxy is not only accessible but also expedient to pass free press egotistic proximity identification even social legitimacy authorization from temporal authority indeed. As a result, there is substantial easeful access & possibility for living scientific knowledge proliferation to unknowingly slide into freewheeling substantiation & perfection of contemporaneous scientific orthodoxy and wilder straightforward endeavor to push humanistic ideology about authenticity of nature forward to perfect ideological enantiomorph of ultimate authenticity of nature therefore.

And indeed, as permanent implementation of substantiation & perfection of contemporaneous scientific orthodoxy, there was none top-ranking genius in scientific exploration on the earth ever since the world war II, although scientific knowledge proliferation was even more prolific than before for integrative improvement of human society all over the world.

The leitmotiv of development of science of royal substantiation & perfection of contemporaneous scientific orthodoxy is of course “**substantiation & perfection of contemporaneous scientific orthodoxy**”, whose most remarkable feature is that, as magistral autarchy of “free press regulation customization” & “free press admittance” of temporal authority short of necessary intendance, it insists **royal substantiation & perfection of contemporaneous scientific orthodoxy** \approx **general progress of science** going without saying and persist scientific knowledge proliferation all over the world must be in rigid succession of contemporaneous scientific orthodoxy, as if **royal substantiation &**

As coherent natura naturans throughout cosmic evolution, instinctive PNT reciprocal equilibrium towards optimum PNT operation is radical potentiality & conditionality for cosmos always ready to orientate itself towards perfection.

perfection of contemporaneous scientific orthodoxy is everlasting nonstop towards perfect ideological enantiomorph of ultimate authenticity of nature out of question.

Interminable implementation of royal substantiation & perfection of contemporaneous scientific orthodoxy under egotistic restriction of authoritative intrepidity of contemporaneous scientific orthodoxy of course brings out wise fundamental of scientific career at the volley.

要想学业有所成，

If you are ambitious for expedient success in academic career,

雄心壮志赴后尘；

You must be gung-ho for substantiation & perfection of contemporaneous scientific orthodoxy.

欲求 paper 录无忧，

If you are desired for free press admittance of your papers without misgivings.

影响因子抛绣球。

You must be quite aware impact factor is the most sensitive and subtle transducer for your success.

I wonder whether practical endeavor of development of science today is ready to push humanistic ideology about authenticity of nature forward to perfect ideological enantiomorph of ultimate authenticity of nature or ready to deal in impact factors for temporal authority.

Say truly, in the recent half century, we can hardly be confident whether development of science has accomplished something significant to push humanistic ideology about authenticity of nature forward to perfect ideological enantiomorph of ultimate authenticity of nature indeed, whereas, we are quite sure the output of impact factors all over the world is always smooth without discontinuity.

However, I have to comment herein:

i). As long as temporal authority insist that regular papers must be endowed with references, papers without references can never be qualified and acceptable for free press admittance.

ii). As long as there are still substantial people alive on the earth, some of them devote to writing papers and are ready to publish their papers in journals or publishing houses, and there are still normal quantity of journals & publishing houses on the earth which publish papers in their conventional ways all along.

Humanistic output of impact factors will be constant eversince, which has neither definite pertinency with hypostatic development of science nor definite pertinency to humanistic operational quality of development of science. In straightforward words, humanistic output of so-called "impact factors" has nothing to do with output quality of scientific knowledge proliferation under commensurate historical background.

1) No definite pertinency with whether our practice of development of science is veritable endeavor to push humanistic ideology about authenticity of nature forward to perfect ideological enantiomorph of ultimate authenticity of nature draw on practical feasibility & possibility in proportion to contemporaneous historical background.

2) No definite pertinency with what's the progressive quality human trying to push humanistic ideology about authenticity of nature forward to perfect ideological enantiomorph of ultimate authenticity of nature draw on practical feasibility & possibility in proportion to contemporaneous historical background. Even if practical development of science has slidden into serious vicious circle for interminable implementation of demoded royal substantiation & perfection of contemporaneous scientific orthodoxy, output of so-called impact factors can never be out of its normal prolific way.

What's the unintelligible perplexity?

A group of athletes are running in the wild mountain towards terminal top object named [perfect ideological enantiomorph of](#)

Historical progress of science in the recent several centuries seemed like a far-flung exploration of the first itinerary around numerous distinctive landscapes of brand-new landmasses of science with palette & tablet on back, several hundred years' scientific travelogues were compiled thereby.

ultimate authenticity of nature, whereas, they compete neither who run faster nor who run farther in their expedient ways towards terminal top object, but agreeably compete who are more sweaty in their orthodox ways. And on the other hand, as long as magistral autarchy of free press regulation customization & free press admittance is out of question, temporal authority can agreeably enjoy both high-sounding authoritative intrepidity of contemporaneous scientific orthodoxy and respectable impact factors aiming at substantiation & perfection of contemporaneous scientific orthodoxy at their pleasure in defiance of neither coming suspicion or divarication out of succession of contemporaneous scientific orthodoxy nor output quality of live scientific knowledge proliferation towards ideological enantiomorph of accessible existence & motion.

Even though, as intrepid egotistic guidance of magistral autarchy of free press regulation customization & free press admittance towards royal substantiation & perfection of contemporaneous scientific orthodoxy, there is obvious aberrance of historical progress of science, live scientific knowledge proliferation all over the world in rigid succession of contemporaneous scientific orthodoxy can hardly offer effective power to push humanistic ideology about authenticity of nature forward to perfect ideological enantiomorph of ultimate authenticity of nature, the commensurate output of so-called "impact factors" must be in a whole skin, whose output completely has nothing to do with the dull situation of historical progress of science.

In straightforward words, social output of impact factors have nothing to do with progressive quality of science. On the contrary, as morbid reference popularity, live scientific knowledge proliferation on the earth is radically restricted too much in succession of contemporaneous scientific orthodoxy, which apparently impairs even frustrates original endeavor of historical progress of science to push humanistic ideology about authenticity of nature forward to perfect ideological enantiomorph of ultimate authenticity of nature draw on practical feasibility & possibility in proportion to contemporaneous historical background. Virtually, before humanistic ideology about authenticity of nature finally qualified as perfect ideological enantiomorph of ultimate authenticity of nature, reference popularity has its inherent double significance of "positive significance" and "negative significance" like both surface of a coin. Since "free press regulation customization" and "free press admittance" is under magistral autarchy of temporal authority short of necessary intendance, serious restriction of reference popularity must restrict living scientific knowledge proliferation too much in succession of contemporaneous scientific orthodoxy, it's substantively difficult for realistic scientific knowledge proliferation in social ambience against Vanity Fair to acclimate itself for straightforward endeavor to push humanistic ideology about authenticity of nature forward to perfect ideological enantiomorph of ultimate authenticity of nature draw on practical feasibility & possibility in proportion to contemporaneous historical background. It's of course comprehensible, before humanistic ideology about authenticity of nature finally qualified as perfect ideological enantiomorph of ultimate authenticity of nature, the most pestilent obstacle for historical progress of science must be unnoticed thought misdirection & bewitchment derived from authoritative intrepidity of contemporaneous scientific orthodoxy to succedent generation, especially, once authoritative intrepidity of contemporaneous scientific orthodoxy is all-time even overwhelming short of necessary intendance.

The pestilent issue is that, as authoritative intrepidity of contemporaneous scientific orthodoxy is all-time even overwhelming, especially, as free press regulation customization and free press admittance is completely under magistral autarchy of a group of overbearing second-string geniuses short of necessary intendance, who are slightly meritorious for royal substantiation & perfection of contemporaneous scientific orthodoxy, nowadays science forum is homegrown outgrowth in the garden of contemporaneous scientific orthodoxy beyond all doubt towards substantiation & perfection of contemporaneous scientific orthodoxy instead of straightforward

pursuit to push humanistic ideology about authenticity of nature forward to perfect ideological enantiomorph of ultimate authenticity of nature. Virtually, endeavor for substantiation & perfection of contemporaneous scientific orthodoxy is not only more popular for free press admittance but also more accessible for successive citation. Comparably, scientific knowledge proliferation out of succession of contemporaneous scientific orthodoxy, especially typical aberrant scientific knowledge proliferation out of succession of contemporaneous scientific orthodoxy of course seems strange and insensitive for free press admittance and successive citation. The even pestilent issue is that, these complacent and overbearing second-string geniuses on the earth never think live contemporaneous scientific orthodoxy is but “**commensurate humanistic ideology about authenticity of nature in proportion to contemporaneous historical background**”, and before humanistic ideology about authenticity of nature finally qualified as perfect ideological enantiomorph of ultimate authenticity of nature, it’s only possible for any contemporaneous scientific orthodoxy out of scientific legitimacy qualification of historical authenticity tolerance of science 0 to exist as commensurate progressive segment in proportion to contemporaneous historical background in crecive progression of historical progress of science.

And indeed, as magistral autarchy of “free press regulation customization” and “free press admittance” of temporal authority short of necessary intendance, science forum is homegrown outgrowth in the garden of contemporaneous scientific orthodoxy beyond all doubt, interminable implementation of royal substantiation & perfection of contemporaneous scientific orthodoxy has brought up great resistance to coming potential scientific knowledge metabolism.

捧得权威颜，利禄变现钱；

If your academic achievement is fashionable for high-sounding substantiation & perfection of contemporaneous scientific orthodoxy, as remarkable expedience for free press egotistic proximity identification from temporal authority, you can be expediently confirmed meritorious, fame & gain can immediately turn into ready money in your pocket.

赢得真理然，功名在坟前。

As potential conditionality that **the uniqueness & invariance of ultimate authenticity of nature predestines unique possibility of scientific verity as perfect ideological enantiomorph of ultimate authenticity of nature**, there is almost no way for renovation of humanistic ideology about authenticity of nature in proportion to contemporaneous historical background to shy away remarkable divarication from contemporaneous scientific orthodoxy, there is almost no way for pioneering innovators towards perfect ideological enantiomorph of ultimate authenticity of nature to evade scientific knowledge metabolism campaign at daggers drawn. As a result, under background of royal substantiation & perfection of contemporaneous scientific orthodoxy with intrepid backup of magistral autarchy of free press regulation customization & free press admittance of temporal authority short of necessary intendance, social legitimacy subsistence of timely renovation of humanistic ideology about authenticity of nature in proportion to contemporaneous historical background must slide into vicious circle of virulent scientific knowledge metabolism campaign. Whereas, as immanent potentiality of historical progress of science in inherent optimum orientation towards perfect ideological enantiomorph of ultimate authenticity of nature, there is still proportionate potentiality for fame & gain to be left before lasthome of innovators.

后尘亲奴才，示真特难过；

Under background of royal substantiation & perfection of contemporaneous scientific orthodoxy, authoritative intrepidity of contemporaneous scientific orthodoxy is mostly all-time by itself, even as magistral autarchy of free press regulation customization & free press admittance of temporal authority short of necessary intendance, any endeavor for substantiation & perfection of contemporaneous scientific orthodoxy is always fashionable at pleasure of temporal authority. However, if you slide into necessary renovation of humanistic ideology about authenticity of nature in proportion to contemporaneous historical background at the volley of historical progress of science, you must slide into perplexity of free press egotistic proximity identification of temporal authority, free press admittance of

timely renovation of humanistic ideology about authenticity of nature in proportion to contemporaneous historical background even has to challenge venomous counterwork upper limit of temporal authority for virulent scientific knowledge metabolism campaign.

官人当场秀，能人死后优。

As magistral autarchy of free press regulation customization and free press admittance of temporal authority short of necessary intendance, science forum is out-and-out homegrown outgrowth in the garden of contemporaneous scientific orthodoxy beyond all doubt, the bureaucracy of temporal authority is always elated off the cuff for cock-a-hoop self-appreciation of royal substantiation & perfection of contemporaneous scientific orthodoxy. Thank God, as immanent potentiality of historical progress of science in inherent optimum orientation towards perfect ideological enantiomorph of ultimate authenticity of nature, there is still proportionate potentiality for the innovators to be worthy after death.

You do your best for royal substantiation & perfection of contemporaneous scientific orthodoxy, I do my best for substantiation & perfection of contemporaneous scientific orthodoxy, as foison of impact factors, we are all happily reciprocal for straightforward success of scientific career. You slide into aberrant scientific knowledge proliferation out of succession of contemporaneous scientific orthodoxy, he slides into aberrant scientific knowledge proliferation out of succession of contemporaneous scientific orthodoxy, they all should be vagrants themselves. As authoritative intrepidity of contemporaneous scientific orthodoxy is all-time even overwhelming, it's more and more difficult for timely renovation of humanistic ideology about authenticity of nature in proportion to contemporaneous historical background to challenge social legitimacy subsistence of contemporaneous scientific orthodoxy, no more social authoritative operation of esoteric authoritative social legitimacy identification & authentication for free press admittance.

The second, perplexity in extremity situation of historical progress of science in inherent optimum orientation towards historical authenticity tolerance of science 0.

Objectivity: Historical progress of science extended to today, it's distinct that live contemporaneous scientific orthodoxy is still far away from perfect ideological enantiomorph of ultimate authenticity of nature in legitimacy qualification of historical authenticity tolerance of science 0, whereas, on one hand, as historical authenticity tolerance of science of contemporaneous scientific orthodoxy has been relatively close to 0, it's of course more difficult for coming scientific knowledge proliferation to achieve further advancement of historical authenticity tolerance of science towards 0. And on the other hand, human practical accessibility of science has been relatively near to upper limit of human perception, scientific experiments are not only difficult to detect and uncover a fly in the ointment of live contemporaneous scientific orthodoxy but also difficult to offer creditable demonstration for coming renovation of humanistic ideology about authenticity of nature in proportion to contemporaneous historical background, which is apparently different from the ideological transition of humanistic ideology about authenticity of nature from macrophysics to microphysics in terminal years of 19th century and early years of 20th century for interposition of startling deregulation of microcosmic factuality against conventional experience, ideological transition from macrophysics to microphysics consequently became historical inevitability, renovation of humanistic ideology about authenticity of nature in proportion to contemporaneous historical background that human scientific practice remarkably penetrating into microcosm became inevitable.

Subjectivity: as out-and-out social work outgrowth and humanistic ideology about authenticity of nature in proportion to contemporaneous historical background, social existence and historical progress of "science" must inherently possess double coordinative significance of "natural connotation" and "social connotation", social legitimacy subsistence of neonatal scientific idea especially successive renovation of humanistic ideology about

As coherent natura naturans throughout cosmic evolution, instinctive PNT reciprocal equilibrium towards optimum PNT operation is radical potentiality & conditionality for cosmos always ready to orientate itself towards perfection.

authenticity of nature along historical progress of science in inherent optimum orientation towards perfect ideological enantiomorph of ultimate authenticity of nature never simply depends on cognizant achievement that brand-new or more veritable authenticity of nature has been reflected on sense of pioneering originators with commensurate authenticity highlight effect in proportion to contemporaneous historical background, it even crucially implicates esoteric authoritative social legitimacy identification & authentication in accordance with egotistic criterion of contemporaneous scientific orthodoxy under official centered background —social legitimacy & validity of truths can never exceed cannon range. Although, social legitimacy subsistence of timely renovation of humanistic ideology about authenticity of nature in proportion to contemporaneous historical background radically depends on substantial advantage of historical authenticity tolerance of science towards 0 compared to live contemporaneous scientific orthodoxy. Whereas, social legitimacy subsistence of timely renovation of humanistic ideology about authenticity of nature in proportion to contemporaneous historical background even more straightforward depends on esoteric authoritative social legitimacy identification & authentication in accordance with egotistic criterion of contemporaneous scientific orthodoxy under official centered background.

Virtually, the bureaucracy of temporal authority is always elated off the cuff for cock-a-hoop self-appreciation; comparably, as immanent potentiality of historical progress of science in inherent optimum orientation towards historical authenticity tolerance of science 0, there are substantial probabilities for the innovators to be worthy after death. What's more, authoritative intrepidity of contemporaneous scientific orthodoxy is all-time, “free press regulation customization” & “free press admittance” is under magistral autarchy of temporal authority short of necessary intendance, science forum is homegrown outgrowth in the garden of contemporaneous scientific orthodoxy beyond all doubt aiming at fancydan “**impact factors**” instead of “**veritable progress of science**” to push humanistic ideology about authenticity of nature forward to perfect ideological enantiomorph of ultimate authenticity of nature, which is of course esoteric motivation like devil “**Black Hand**” behind development of science.

In accordance with normal quantitative & qualitative change of scientific knowledge proliferation along historical progress of science in inherent optimum orientation towards historical authenticity tolerance of science 0, as hypostatic drive of development of science, quantitative change of living scientific knowledge proliferation is always in accelerating situation, progress of science is directly proportional to the square of time, which of course implies the later stage of historical progress of science is, the living scientific knowledge proliferation is relatively more hearty, progress of science is proportionately more rapid. And as “**the uniqueness & invariance of ultimate authenticity of nature predestines the unique possibility of scientific verity as perfect ideological enantiomorph of ultimate authenticity of nature**”, the humanistic ideology about authenticity of nature is faster to approach perfect ideological enantiomorph of ultimate authenticity of nature, there must be more probability for occurrence of intensive scientific knowledge metabolism, the epochmaking progress of science must bring out unparalleled scientific knowledge metabolism.

However, the pestilent factuality is that:

People who possess magistral autarchy of **free press regulation customization** and **free press admittance** short of necessary intendance are just the temporal authority; people who are always ready to indulge in royal substantiation & perfection of contemporaneous scientific orthodoxy even lineal logic extension in succession of contemporaneous scientific orthodoxy without necessary credible scientific authentication are temporal authority too. No matter how remarkable the historical authenticity tolerance of science of live contemporaneous scientific

Historical progress of science in the recent several centuries seemed like a far-flung exploration of the first itinerary around numerous distinctive landscapes of brand-new landmasses of science with palette & tablet on back, several hundred years' scientific travelogues were compiled thereby.

orthodoxy is, no matter what's the coming necessary renovation of humanistic ideology about authenticity of nature in proportion to contemporaneous historical background is, temporal authority are always ready to insist their inflexible social legitimacy subsistence on stand of top authority all along, and magistral autarchy of free press regulation customization and free press admittance is always their most effective facility to deal with potential impact of scientific knowledge metabolism. Such situation of course indicates people who are always ready to indulge in royal substantiation & perfection of contemporaneous scientific orthodoxy even lineal logic extension in succession of contemporaneous scientific orthodoxy can share out-and-out homegrown science forum in the garden of contemporaneous scientific orthodoxy at their pleasure in despite of **demoded royal substantiation and perfection of contemporaneous scientific orthodoxy ≠ original endeavor of historical progress of science to push humanistic ideology about authenticity of nature forward to perfect ideological enantiomorph of ultimate authenticity of nature draw on practical feasibility & possibility in proportion to contemporaneous historical background.**

Whereas, people who unknowingly implicate aberrant scientific knowledge proliferation out of succession of contemporaneous scientific orthodoxy have to face esoteric free press egotistic proximity identification of temporal authority, they even have to challenge venomous counterwork upper limit of temporal authority for inevitable scientific knowledge metabolism campaign for magistral autarchy of free press regulation customization and free press admittance of temporal authority short of necessary intendance. The even pestilent factuality is that, before we can virtually be free from restriction of magistral autarchy of free press regulation customization and free press admittance of temporal authority, nothing seems powerful and effective enough to impact the freewheeling official obsequiousness of royal substantiation & perfection of contemporaneous scientific orthodoxy. Although, the undoubted factuality is that, before humanistic ideology about authenticity of nature finally qualified as perfect ideological enantiomorph of ultimate authenticity of nature, interminable royal substantiation & perfection of any contemporaneous scientific orthodoxy out of scientific legitimacy qualification of historical authenticity tolerance of science 0 can never be freewheeling nonstop to finish all rest route of historical progress of science in inherent optimum orientation towards perfect ideological enantiomorph of ultimate authenticity of nature.

As a result, as interminable royal substantiation & perfection of contemporaneous scientific orthodoxy had almost exhausted its inherent potentiality to push humanistic ideology about authenticity of nature forward to perfect ideological enantiomorph of ultimate authenticity of nature early, in the recent half century, there were substantively few pioneering jobs which seemed remarkable to have practically pushed humanistic ideology about authenticity of nature forward to perfect ideological enantiomorph of ultimate authenticity of nature but obsequious substantiation & perfection of contemporaneous scientific orthodoxy all wool and a yard wide, it seems historical progress of science has slidden into unintelligible perplexity like hoax floundering around in riancy with demoded legitimacy coronet on head.

As interminable royal substantiation & perfection of contemporaneous scientific orthodoxy under egotistic guidance of overwhelming authoritative intrepidity of contemporaneous scientific orthodoxy, live scientific knowledge proliferation has been restricted too much in rigid succession of contemporaneous scientific orthodoxy like omnifarious scientific travelogues A, B, C, D, E, F, ... in the recent half century, relative to hypostatic endeavor of historical progress of science to push humanistic ideology about authenticity of nature forward to perfect ideological enantiomorph of ultimate authenticity of nature step by step draw on practical feasibility & possibility in proportion to contemporaneous historical background, there has been more and more serious aberrancy of obsequious substantiation & perfection of contemporaneous scientific orthodoxy, although,

As coherent natura naturans throughout cosmic evolution, instinctive PNT reciprocal equilibrium towards optimum PNT operation is radical potentiality & conditionality for cosmos always ready to orientate itself towards perfection.

the undoubted authenticity is that cosmos is but demiurgic aggradation of out-and-out serial natura naturata in the nature of coherent natura naturans throughout cosmic evolution, it's only possible for concordant cosmos to be demiurgic aggradation of out-and-out serial natura naturata in the nature of coherent natura naturans throughout cosmic evolution; there is no way for demiurgic aggradation in the nature of different natura naturans to be concordant cosmos through and through.

As a result, historical progress of science has slidden into remarkable deadlock, as typical homegrown outgrowth in the garden of contemporaneous scientific orthodoxy, modern science forum has slidden into fancydan Vanity Fair deeper and deeper. Towards historical progress of science, something significant is not what kind of jobs neonatal scientific knowledge has done to push humanistic ideology about authenticity of nature forward to perfect ideological enantiomorph of ultimate authenticity of nature. Instead, under egotistic background of interminable royal substantiation & perfection of contemporaneous scientific orthodoxy with remarkable officialism facility of unprecedented magistral autarchy of **free press regulation customization & free press admittance** of temporal authority short of necessary intendance, the most high-sounding dramatic occurrence is whether so-called fashionable papers in succession of contemporaneous scientific orthodoxy can expediently pass altisonant **free press egotistic proximity identification** from temporal authority and procure social legitimacy qualification therefore or whether so-called fashionable papers have been published in some so-called famous journals as Nature, Science etc, how many flaring impact factors the fashionable papers have procured here and there.

This is out-and-out morbidity of interminable royal substantiation & perfection of contemporaneous scientific orthodoxy under egotistic guidance of inundant authoritative intrepidity of contemporaneous scientific orthodoxy, especially unprecedented official facility of magistral autarchy of **free press regulation customization & free press admittance** of temporal authority short of necessary intendance, which is hardcore puissance of historical progress of science.

This is out-and-out morbidity of interminable royal substantiation & perfection of contemporaneous scientific orthodoxy under egotistic guidance of overwhelming authoritative intrepidity of contemporaneous scientific orthodoxy, especially magistral autarchy of **free press regulation customization & free press admittance** of temporal authority short of necessary intendance, which is hardcore puissance of historical progress of science.

May 2019, Nanxing, Dani, Shatian, Dongguan, Guangdoing.

(VIII-iii) Reciprocal Coevolution Between Scientific Knowledge Proliferation and integrative social circumstances in Monofier Modality

Abstract: *“Science” is living soul of practice of social production; and scientific knowledge proliferation is hardcore of human civilization proliferation.*

So-called “scientific knowledge” is just recognizant representation of accessible existence & motion in the nature reflected on human sense.

So-called “scientific knowledge proliferation” is but gradual quantitative increase & qualitative optimization of recognizant representation of accessible existence & motion in the nature reflected on human sense along historical extension of time.

Throughout historical progress of science, scientific knowledge proliferation always goes along crescive progression in benign circle, besides initial stage that knowledge proliferation came to increase from none to a little, scientific knowledge proliferation is usually subject to sequential quantitative knowledge cumulation and successive qualitative optimization in crescive model as mushroom proliferation. Historical quantitative increase of scientific knowledge proliferation is generally involved in two major complications.

The first: scientific knowledge proliferation strictly exists in performance of bidirectional syntonic reciprocity between integrative social update of economy, politics, education, scientific knowledge metabolism & knowledge metabolism campaign and scientific knowledge proliferation.

The second: historical progression of scientific knowledge proliferation must be austerely under restriction of the Most High fundamental of “the uniqueness & invariance of ultimate authenticity of nature proportionably predestines the unique possibility of scientific verity as perfect ideological enantiomorph of ultimate authenticity of nature” all along.

Keywords: *scientific knowledge, scientific knowledge proliferation, natura naturans personalization towards human necessity, bidirectional syntonic reciprocity in monofier modality, world dominant bidirectional syntonic reciprocity, world recessive bidirectional syntonic reciprocity, quantitative change curve of scientific knowledge proliferation, quantitative change curve of scientific knowledge metabolism, pioneering originator of natura naturans personalization towards human necessity, greedy imitator after pioneering natura naturans personalization towards human necessity.*

1) As commensurate ideological enantiomorph of accessible existence & motion around us, “science” is straightforward intelligence resource for natura naturans personalization towards human necessity, which is not only living soul of social production but also radical determinant of integrative social progress.

Social livability radically depends on social productivity, so-called “social productivity” is just capability of social practice that human in proper social relationship come to purposefully integrate & administrate ideal existence & motion of matter available in the nature to actualize or satisfy practical necessity of social production & social life.

Under precondition the available natural ambient is relatively steady; social productivity generally depends on two intrinsic active factors.

As coherent natura naturans throughout cosmic evolution, instinctive PNT reciprocal equilibrium towards optimum PNT operation is radical potentiality & conditionality for cosmos always ready to orientate itself towards perfection.

The first: social productivity depends on collective harmonization of people involved throughout production socialization.

In terms of social relationship of production, if the social relationship of production can be in the person of favorable work division & collaboration necessity and be able to tally with the most desire of people involved throughout production socialization furthest, it can bring about more efficiency of work division & collaboration and more production motivity of people throughout integrative production socialization, the social production is more cooperative, smooth and efficient therefore.

The second: efficiency of social production depends on quality of natura naturans personalization towards human necessity throughout production line.

Matter in the nature inherently exist and motion as themselves, rich and colorful existence & motion in the nature not only build up vivid existence & motion of human itself, but also build up wonderful material ambient around us. The distinctive existence & motion of human in the nature is firstly general biological existence & motion on the earth, —— “biological existence & motion with connatural metabolism as birth, growth, aging to death” + “self-determinate action under guidance of self-existent consciousness and external- existent-consciousness which is just radical distinction between animals and plants. Self-existent-consciousness makes it possible for animals to inspirit proper sensory perception even self-existent desires; external-existent-consciousness makes it possible for animals to perceive physical ambient and identify idiographic existence and motion around favorable or baleful taking reference of self-existent-consciousness, so that human can consciously make themselves acclimate or even actively rebuild the proper ambient to optimize their self-existence in the nature.

Compared with all living things around, the supereminence of human is that their self-existent-consciousness and external-existent-consciousness is remarkably vivid and copious, even upon vivid and copious self-existent-consciousness and external-existent-consciousness to shape substantial information linkages as steady memory even thought, so that it is possible for them to acclimate themselves in idiographic ambient accordingly and optimize their self-existence therefore. The initial naissance and further progress of human society is just historical outcome that human being try to optimize their self-existence as collectivity upon their supereminence of both self-existent-consciousness and external-existent-consciousness in proper ambient. During the course of social progress, human involved in certain relationship of social production come to integrate and administrate ideal existence & motion available in the nature to actualize and satisfy production and/or living necessity is just social production.

Scientific production pursuit is but conscious action that, upon proper comprehension about hypostatic existence & motion around, human being accordingly tries to integrate and administrate available ideal existence & motion around to materialize human production and/or living necessity expediently. We call such practical implementation that human try to integrate and administrate ideal existence & motion available to expediently materialize human production or living necessity in accordance with proper comprehension of hypostatic existence & motion around in the nature “natura naturans personalization towards human necessity”.

So-called “natura naturans personalization towards human necessity” is but ideal existence & motion of matter organized and administrated by human being towards production and/or living necessity upon human prior conscious comprehension of hypostatic existence & motion of matter. For instance, as prior comprehension of thermodynamic character of water vapour, human invited steam engine, application of steam engines in social

production consequently brought out a wonderful steam engine age of human, which magically improved social production and satisfied living necessity of human. As prior comprehension of thermodynamic character of burning gas, human invited internal-combustion engine, application of internal-combustion engine in social production consequently brought out a wonderful internal-combustion engine age of human, which magically improved social production and satisfied living necessity of human. As prior comprehension of electromagnetic character of matter, human invited dynamotor and electromotor, application of dynamotor and electromotor in social production consequently brought out a wonderful electromotion age of human, which magically improved social production and satisfied living necessity of human., invention and practical application of computer, internet, and wireless communication in social production and human living even have magically brought out wonderful today.

The more hypostatic existence & motion of matter ① in the nature human have practically mastered, there are more practical possibilities and feasibility for human to organize and administrate ideal existence & motion of matter available towards production and/or living necessity of human, human consequently possess more substantial intellectuality capital for actualization of natura naturans personalization towards human necessity therefore. Of course, the necessary precondition that human consciously organize and administrate ideal existence & motion accessible in the nature ② is that human must know characteristic feature of proper existence & motion in the nature in prior. So-called “science” is but recognizant formulation of feature of accessible existence & motion in the nature reflected on human sense, and scientific knowledge is but historical gain of humanistic ideology about accessible existence & motion in the nature. The increase of scientific knowledge of course derives from realistic scientific knowledge proliferation, so-called scientific knowledge proliferation is just the vivid historical process that human gradually come to discover and formulate authenticity of accessible existence & motion around from nothingness to goat, from goat to a great lot, from superficiality to profundity, from parochiality to generality, which is not only related to impersonal authenticity of the accessible existence & motion around us but also related to crescive progression of historical progress of science even the substantial idiographic scientific demeanour we had ever experienced.

Note ①: In fact, human scientists can be classified into two types accordingly; the first type is just the scientific researchers who devote more of themselves to and are more meritorious in rational highlight of authenticity of nature. The second type is scientific artificers who devote more of themselves to and are more meritorious in integrating and administering known ideal existence & motion in the nature to materialize proper production and/or living necessity. They usually devote more of themselves to job of natura naturans personalization towards human necessity.

Note ②: In order to perfect social production and social life as much as possible, all what human can do is but wise job of natura naturans personalization towards human necessity, upper limit of human creation accessibility of natura naturans personalization towards human necessity can never transcend accessible category of natura naturata in the nature of coherent natura naturans throughout cosmic evolution. Practical feasibility & possibility of implementation of natura naturans personalization towards human necessity must condition rational comprehension of authenticity of nature, the more human know the authenticity of nature, there is proportionately more practical feasibility & possibility for human to integrate and administrate ideal existence & motion towards authentic accomplishment of functional necessity of social production and social life. The upper limit of creative feasibility & possibility of human can never transcend category of out-and-out serial natura naturata in the nature of coherent natura naturans throughout cosmic evolution.

As coherent natura naturans throughout cosmic evolution, instinctive PNT reciprocal equilibrium towards optimum PNT operation is radical potentiality & conditionality for cosmos always ready to orientate itself towards perfection.

The most substantial staff gauge to scale advantage of society is social productivity; science is the living soul of social productivity. Material progress of science directly restricts the practice contents and efficiency of social production and radically dominates the integrative progress of society. —the more existence & motion in the nature humanistic ideology about authenticity of nature in proportion to contemporaneous historical background has practically highlighted, there is more practical feasibility and possibility for human to integrate and administrate ideal existence & motion accessible towards production and/or living necessity, the content of human production practice is more substantial and social production is more efficient, there is more feasibility & possibility for vivid ideal existence & motion in the nature of coherent natura naturans throughout cosmic evolution to take authentic functional roles of social production and social life by the light of nature, social productivity is more advanced.

This is just the core significance of science in social productivity.

2. Historical quantitative change silhouette of scientific knowledge proliferation

2.1. Quantitative change modality of scientific knowledge proliferation—knowledge purificatory aggradation & successive proliferation in increase modality of mushroom proliferation.

The practice human coming to discover and formulate authenticity of accessible existence & motion around must experience frondose evolvement of humanistic ideology about authenticity of nature cumulatively enriched from nothingness to groat, from groat to a great lot, and consequently followed proportionate ideaistic correction & qualitative optimization from superficiality to profundity, from parochiality to generality. Such historical process is just vivid historical progress of science with hypostatic scientific knowledge proliferation in inherent crescive progression.

Throughout the historical progress of scientific knowledge purificatory aggradation from scientific knowledge 0 stockpiles to current stockpiles, except the initial progress of scientific knowledge proliferation from none to a little which virtually had none solid backup of ready-made knowledge as favorable groundwork, historical scientific knowledge proliferation is always successive knowledge multiplication rooted in prior fecund scientific knowledge purificatory groundwork, which of course implies, historical scientific knowledge proliferation is absolutely successive process, any zoetic outgrowth of scientific knowledge can deposit into knowledge aggradation as sapiential resource for successive knowledge multiplication, —zoetic outgrowth of scientific knowledge of yesterday could deposit into knowledge aggradation as fecund sapiential resource to impact successive knowledge multiplication of today, zoetic outgrowth of scientific knowledge of today can deposit into knowledge aggradation as fecund sapiential resource to impact successive knowledge proliferation of tomorrow, zoetic outgrowth of scientific knowledge of tomorrow can deposit into knowledge aggradation as fecund sapiential resource to impact successive knowledge multiplication of the day after tomorrow,, History always performs itself like this by the light of nature and makes historical quantitative change of scientific knowledge proliferation in successive silhouette through and through.

Sequential quantitative change of scientific knowledge proliferation apparently exhibits character as below. And for expedience of further explanation, we introduce two figurative diagrams to illustrate the quantitative change silhouette of scientific knowledge proliferation throughout historical progression.

Firstly, scientific knowledge proliferation is consecutive quantitative change making up of crescive progression of historical progress of science, and scientific knowledge proliferation is usually outgrowth rooted in prior

Historical progress of science in the recent several centuries seemed like a far-flung exploration of the first itinerary around numerous distinctive landscapes of brand-new landmasses of science with palette & tablet on back, several hundred years' scientific travelogues were compiled thereby.

sapiential resource of fecund knowledge aggradation, —scientific knowledge proliferation of today is usually outgrowth rooted in sapiential resource of fecund knowledge aggradation of yesterday and consequently embodies the proper silhouette concerned with fecund knowledge aggradation of yesterday; and zoetic scientific knowledge proliferation of today will deposit into knowledge aggradation as sapiential resource for knowledge multiplication of tomorrow and consequently restricts the coming scientific knowledge proliferation silhouette of tomorrow concerned with fecund knowledge aggradation of today. The integrative quantitative change succession of scientific knowledge proliferation is really similar as connatural growth of a vivid mushroom, which can be illustrated as below:

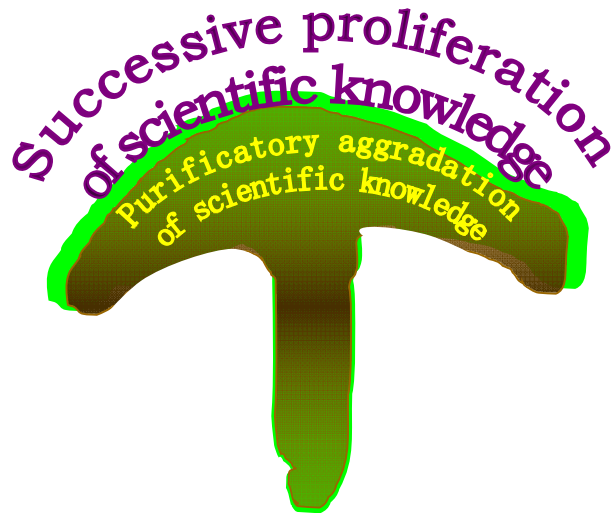

(VIII-iii-1) Quantitative change silhouette of scientific knowledge proliferation in mushroom growth modality

In above illustration, the toffee mushroom main body denotes historical purificatory aggradation of scientific knowledge, the green top surface layer of mushroom main body denotes the living outgrowth of knowledge multiplication rooted in historical purificatory aggradation of scientific knowledge.

This illustration shows us two issues as following:

The first: the living knowledge multiplication is usually outgrowth of proper historical purificatory aggradation of scientific knowledge in crescive progression of historical progress of science, scientific knowledge proliferation mostly roots in sapiential resource of commensurate knowledge aggradation.

The second, there is succession relationship of long standing between living scientific knowledge proliferation and proper sapiential resource of fecund purificatory aggradation of scientific knowledge, which not only qualitatively implies what kind of purificatory aggradation of scientific knowledge proportionably means what kind of living scientific knowledge proliferation (As successive join in silhouette, the top surface of the mushroom main body and the underside of the green top surface layer is virtually in the common plane in illustration, which virtually indicates the historical consistency of scientific knowledge proliferation just as in reality that it was impossible for Galilean age to produce genius as Newton, it was impossible for Newtonian age to produce genius as Einstein), but also quantitatively implies the more wealthy sapiential resource of fecund purificatory aggradation of scientific knowledge means the more hearty living scientific knowledge proliferation as indication of equivalent proportion of the top surface of the mushroom main body and the underside of the green top surface layer.

Successive scientific knowledge proliferation rooted in proper fecund purificatory aggradation of scientific

As coherent natura naturans throughout cosmic evolution, instinctive PNT reciprocal equilibrium towards optimum PNT operation is radical potentiality & conditionality for cosmos always ready to orientate itself towards perfection.

knowledge make up of historical quantitative change of scientific knowledge proliferation in vivid quantitative change modality as mushroom growth:

On one hand, in historical extension, any zoetic scientific knowledge proliferation will spontaneously deposit purificatory aggradation of scientific knowledge as sapiential resource for coming scientific knowledge proliferation, so that the purificatory aggradation of scientific knowledge become more and more wealthy along historical extension and restricts the multiplication feasibility and quantitative change silhouette.

And on the other hand, as the purificatory aggradation of scientific knowledge become more and more wealthy, the living scientific knowledge proliferation rooted in proper fecund purificatory aggradation of scientific knowledge become more and more hearty, which vividly makes up of the crescive progression of integrative quantitative change of hypostatic scientific knowledge proliferation rooted in commensurate fecund purificatory aggradation of scientific knowledge like living mushroom growing from small one to big one through and through as below:

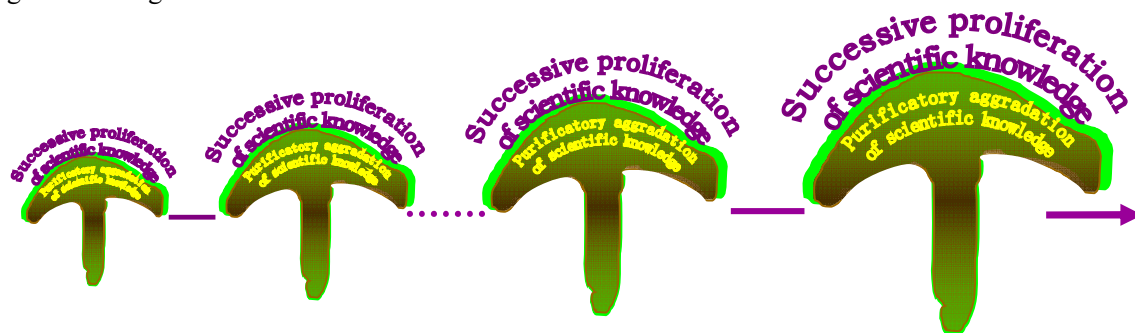

(VIII-iii-2) Sequential quantitative change of living scientific knowledge proliferation rooted in fecund purificatory knowledge aggradation in vivid mushroom growth modality hypostatize realistic historical progress of science through and through

The center axes in purple in above diagram denotes time extension of historical progress of science, the gradual volume increase of figurative mushroom modality from left to right indicates sequential quantitative change increasing by degrees along science progress of successive knowledge multiplication rooted in fecund purificatory knowledge aggradation.

The illustration above shows us that scientific knowledge proliferation is generally sequential quantitative & qualitative change in crescive progression of living scientific knowledge proliferation rooted in commensurate purificatory scientific knowledge aggradation through and through.

2.2) bidirectional syntonic reciprocity (/syntonic reciprocity) between integrative social update and scientific knowledge proliferation

Two objects of A and B which can interact each other as cause, once object A exists as cause of object B, leading change of object A causes consequent implementation of object B, we just call the leading change of object A causes consequent implementation of object B “**direct consequent implementation of object B derived from leading change of object A**”. Inversely, once object B exists as cause of object A, leading change of object B causes consequent implementation of object A, we just call the leading change of object B causes consequent implementation of object A “**inverse consequent implementation of object A derived from leading change of object B**”. When both object A and object B coexist as cause each other in time current, the synchronous consequent implementation of the both caused each other is just “**bidirectional syntonic reciprocity in monofier modality**”, which is mostly quantitative change model of reciprocity similar as benign circle or vicious circle.

Historical progress of science in the recent several centuries seemed like a far-flung exploration of the first itinerary around numerous distinctive landscapes of brand-new landmasses of science with palette & tablet on back, several hundred years’ scientific travelogues were compiled thereby.

For instance, we denote the both end points of a rigid lever in length of 3 meters A and B, we rest a point on lever 2 meters away from point A on a fulcrum O. Then, the vertical displacement of both points A and point B around fulcrum O must condition each other, —if point A vertically goes down 10 centimeters around fulcrum O as leading change, it must cause point B vertically goes up 5 centimeters around fulcrum O as consequent implementation, we call point B vertically goes up 5 centimeters around fulcrum O is just consequent implementation derived from point A vertically goes down 10 centimeters around fulcrum O. Also, if point B vertically goes down 10 centimeters around fulcrum O as leading change, it must cause point A vertically goes up 20 centimeters around fulcrum O as consequent implementation, we call point A vertically goes up 20 centimeters around fulcrum O is just consequent implementation derived from point B vertically goes down 10 centimeters around fulcrum O.

If we call fuel gas burning under high pressure and high temperature in vats of internal-combustion engine object α , and we call the plungers procure kinetic energy for recoil of high pressure and high temperature burning fuel in vats of internal-combustion engine object β . Once object α occurs, it must cause consequent implementation of object β , we call object β the direct consequent implementation derived from leading change of object α . Once the plungers which have procured enough kinetic energy for recoil from high temperature burning fuel works on gaseous fuel in vats of internal-combustion engine and makes the gaseous fuel rise temperature and ultimately get burnt with volcanic expansion, then, object β works as leading cause of consequent implementation of object α , we call object α “inverse consequent implementation derived from object β ”. In time current, if object α and object β coexist and condition each other, object α and object β must manage to durative operation of bidirectional syntonyc reciprocity, the internal-combustion engine continuously moves in cycles.

No matter in the nature or society, the consequent implementation is something external and substantial. If we place an object with mass of 10 kilograms and velocity of 1 meter per second on horizontal surface with opposite friction of 1 newton, the object will slide on the horizontal surface for 10 seconds with deceleration 0.1 meter per second, then keeps stationary. If you are a multimillionaire, you can enjoy yourself with great leisure, cate and beautiful clothing everyday; such conditions will not only accomplish your physiological oofy character but also accomplish your psychological wealthy idiosyncrasy. If you are but a peasant labor, you have to work in plowland in fervent sunlight everyday for subsistence; such conditions will not only accomplish your farmer bodily form and complexion but also accomplish your psychological simple idiosyncrasy of labor kind.

A chain-reacting involves in operational linkage of object A, B, C, D, ..., when leading change of object A causes consequence of object B, object C, object D, ... in inerratic sequence, we just call the occurrence of object B the first consequence derived from leading change of object A, call the occurrence of object C the second consequence derived from leading change of object A, call the occurrence of object D the third consequence derived from leading change of object A, For instance, in terms of an electric autocar, in normal situation, electric motor start-up or stop is the first consequence of connection or disconnection of the power switch, wheels running is the second consequence of connection or disconnection of the power switch, car running with acceleration or deceleration on the road is the third consequence of connection or disconnection of the power switch.

Consequence in the nature (of course including consequence in society) is reticula, leading→driven quantitative

**As coherent natura naturans throughout cosmic evolution, instinctive PNT reciprocal equilibrium towards optimum
PNT operation is radical potentiality & conditionality for cosmos always ready to orientate itself towards perfection.**

change linkages can not only radially distribute but also can be mixed or overlapped for multiple consequence in discretionary orders. Resultingly, consequence in the nature seems numerous and complicated, even enigmatical. Only when all leading changes and driven changes keep in single quantitative change linkage, especially the leading change and the driven change make up of leading→driven quantitative change circle in first order, the quantitative change correlation between the proper leading change and driven change can directly hypostatize explicit regularity or logic inevitability of nature. Once a driven change derived from multiple leading changes even overlapped in different or inconstant orders, the idiographic esse of the driven change is concerned with multiple logic, in our sense; the idiographic esse of the driven change seems incomprehensible.

Virtually, with idea that **it's only possible for concordant cosmos to be demiurgic aggradation of out-and-out serial natura naturata in the nature of coherent natura naturans throughout cosmic evolution; there is no way for demiurgic aggradation in the nature of different natura naturans to be concordant cosmos through and through** in mind, we come to review rich and colorful existence & motion in cosmos, none consequence of idiographic existence & motion in cosmos is illogic consequence, but absolute logic consequence 100 over 100. Even distinctive existence & motion of discretionary person under certain family and social ambient is too living multiple logic consequence derived from multiple interposition of n ambient leading changes overlapped in m orders and hypostatizes the personal aseity.

Presence of society must condition social production, so-called “social production” is just social practice that people in proper social relationship come to purposefully integrate & administrate ideal existence & motion of matter accessible around for application of social production or for necessity of social life. For expedience & possibility to purposefully and intelligently integrate & administrate ideal existence & motion of matter accessible around for application of social production or for necessity of social life, it's of course necessary for human to know hypostatic existence & motion of matter in the nature in prior. As a result, science become active pursuit towards necessary efficiency & possibility of social production even ultimate necessity of social life, and scientific research become special and respectable social work therefore.

This of course indicates, as ideological representation of accessible existence & motion in the nature, original generation and successive development of science not only directly implicates hypostatic existence & motion in the nature, and as humanistic ideology about authenticity of nature coming from social work under contemporaneous historical background and integrative social conditions, working output situation & quality of science but also relates to the contemporaneous historical background, social working conditions, expedience for scientific idea to actualize social value and so on. This of course indicates, science is an integrative concept with double coordinative significance of “natural connotation” and “social connotation”.

i) Natural connotation of science

Natural connotation of science radically derives from that accessible hypostatic existence & motion in the nature are just external substance for ideological representation of science, humanistic ideology about authenticity of nature must reflect authenticity of nature as possibly as it practically able to, substance determines ideology, which not only indicates no hypostatic existence & motion in the nature, no humanistic ideology about hypostatic existence & motion in the nature, no science therefore, but also indicates, as humanistic ideology about universal existence & motion in the nature, connotation of science should be ideological enantiomorph of authenticity of nature as exactly as it practically able to, and practical precision & generality of humanistic ideology about universal existence & motion radically depends on accessible degree of social practice to hypostatic existence & motion in the nature.

Historical progress of science in the recent several centuries seemed like a far-flung exploration of the first itinerary around numerous distinctive landscapes of brand-new landmasses of science with palette & tablet on back, several hundred years' scientific travelogues were compiled thereby.

What's more, as ultimate authenticity of nature can be neither omnifarious authenticity smallwares full of a basket nor authenticity chameleon one piece and only, the uniqueness & invariance of ultimate authenticity of nature of course predestines unique format of consummation of humanistic ideology about universal existence & motion as perfect ideological enantiomorph of unique and invariable ultimate authenticity of nature as coherent scientific theory. In any case, as rigorous enantiomorphous correlation between objective authenticity of nature and humanistic ideology about authenticity of nature, it's neither possible for "the unique & invariable ultimate authenticity of nature" to be compatible with "two distinctive humanistic ideologies about authenticity of nature with remarkable ideological difference" nor possible for "two distinctive humanistic ideologies about authenticity of nature with remarkable ideological difference" to discover and formulate "the unique & invariable ultimate authenticity of nature" coequally. In another words, as uniqueness & invariance of ultimate authenticity of nature, **it's only possible for concordant cosmos to be demiurgic aggradation of out-and-out serial natura naturata in the nature of coherent natura naturans throughout cosmic evolution; there is no way for demiurgic aggradation in the nature of different natura naturans to be concordant cosmos through and through.**

ii) Social connotation of science

Social connotation of science radically derives from that science is pure outgrowth of society, if there is no society, there is no possibility for naissance & development of science. Presence of society not only offers practical necessity for naissance & successive progress of science, but also makes the naissance & successive progress of science practically possible, practical naissance and successive progress of science must be implemented by social working under contemporaneous historical background with proportionate practical feasibility & possibility, even the social legitimacy subsistence of humanistic ideology about authenticity of nature in proportion to contemporaneous historical background including initial social legitimacy authorization, successive substantiation & perfection of contemporaneous scientific orthodoxy, inevitable legitimacy metabolism in inherent optimum orientation towards historical authenticity tolerance of science 0 must be operated under commensurate social ambience. In another words, living scientific knowledge proliferation directly conditions contemporaneous historical background and proper social conditions. And at the same time, scientific knowledge proliferation must depend on social practice especially the social production to realize "social value of science". The related details about social connotation of science are generally as following:

ii-1) As humanistic ideology about authenticity of nature in proportion to contemporaneous historical background, science is always necessary intelligence vitality of social production of the age, in any case, social production must try to procure and administrate ideal existence & motion available in the nature for necessity of social production and social life, for practical feasibility & possibility to procure ideal existence & motion in the nature towards necessity of social production and social life, human have to know about the hypostatic existence & motion in the nature in prior. Thus, science become something necessary for intelligent and efficient social production, otherwise, social production can only be fatuous production similar as inherent instinct of animal to procure necessary food around, what the God originally arranges around us, we are always ready to hunt our necessary ones among the availability upon inherent instinct.

For example, monkey climbs up this tree to pick this kind fruits a little now and climbs up that tree to pick that kind of fruits a little then, and instinctively avoid possible hunting of tigers, wolves etc. This is almost survival fundamental of all animals on the earth. Whereas, survival fundamental of human being can

never be limited in this. Comparably, Human being are always more active and intelligent to know more of the accessible existence & motion around and are always ready to procure and administrate the ideal ones among them for practical necessity of social production and social life. Compared to common animals on the earth, the most remarkable advantage of human being is that, towards necessity of social production and social life, human being are always ready to know existence & motion around and consequently try to procure & administrate the ideal ones in accordance with practical necessity of social production and social life.

ii-2) Science is ideological outcome of social work of social members under living social conditions against contemporaneous historical background. On one hand, realistic scientific knowledge proliferation always exists in crecive progression of historical progress of science, contemporaneous historical background is always living basis and potential vitality for successive scientific knowledge proliferation, there is almost no possibility for realistic scientific to deviate living basis and potential vitality of contemporaneous historical background, deviated living basis and potential vitality of contemporaneous historical background, successive scientific knowledge proliferation must be endeavor to build more floors on top of castle in the air. And on other hand, integrative social circumstances is always favorable external conditions for practice of scientific knowledge proliferation, without necessary backup of favorable social conditions, there is almost no practical feasibility & possibility for scientific knowledge proliferation, scientific knowledge proliferation throughout historical progress of science always depends on living social conditions for practical feasibility & possibility.

ii-3) The practical generality & precision of temporal science to formulate universal existence & motion radically depends on involvement extent & depth commensurate social practice to accessible existence & motion in the nature. As remarkable disparity of involvement extent & depth commensurate social practice to accessible existence & motion in the nature in different ages, humanistic ideology about authenticity of nature in different ages always has different ideological connotation, even remarkable antinomy unexpectedly occurred thereby. Such situation not only indicates potential correlation like it's only possible for this kind of tree to produce the corresponding fruits between contemporaneous historical background and corresponding scientific knowledge proliferation, but also indicates reciprocal coevolution between integrative historical background and commensurate scientific knowledge proliferation.

And at the same time, in discretionary progressive stage throughout historical progress of science, no matter how appalling or how tiny the historical authenticity tolerance of science of the proper age is, as long as there is substantial mainstream of humanistic ideology about authenticity of nature of the proper age, there must be proportionate "contemporaneous scientific orthodoxy" of the age. Of course, presence of "contemporaneous scientific orthodoxy" must imply coexistence of "temporal authoritative conventionality", presence of "temporal authoritative conventionality" of course implies coming scientific knowledge proliferation must be impacted and restricted accordingly more or less, roughly or enlightenedly, actively or negatively, so that "benign domino effect of officialdom of contemporaneous scientific orthodoxy" or "conservative domino effect of officialdom of contemporaneous scientific orthodoxy" occurred thereby.

Benign officialism domino effect of contemporaneous scientific orthodoxy due to historical presence of contemporaneous scientific orthodoxy was mostly incarnated as, in the early years after contemporaneous scientific orthodoxy procured social legitimacy qualification, as timely substantiation & perfection of contemporaneous scientific orthodoxy was almost equivalent to historical progress or timely substantiation & perfection of contemporaneous

scientific orthodoxy could practically take full role of historical progress of science of the age, temporal authoritative conventionality embarking upon a political venture could expediently sparkplug substantiation & perfection of contemporaneous scientific orthodoxy and consequently made contemporaneous scientific orthodoxy widely carried forward. However, once endeavor of substantiation & perfection of contemporaneous scientific orthodoxy exhausted all potentiality for general progress of science towards historical authenticity tolerance of science 0, and temporal authoritative conventionality was still intrepid, then, practical application of temporal authoritative conventionality must impact and restrict coming realistic scientific knowledge proliferation conservatively. Especially, once timely renovation of humanistic ideology about authenticity of nature in proportion to contemporaneous historical background has to challenge social legitimacy subsistence of contemporaneous scientific orthodoxy, as powerful opposite of scientific knowledge metabolism campaign with authoritative backup of contemporaneous scientific orthodoxy, temporal authority must rouse as counter checking battleship in scientific knowledge metabolism campaign, whose practical effect is of course self-evident.

So-called “**conservative officialism domino effect of contemporaneous scientific orthodoxy**” is generally as, under precondition the uniqueness & invariance of ultimate authenticity of nature predestines unique possibility of scientific verity, as rigorous enantiomorphous correlation between objective authenticity of nature and humanistic ideology about authenticity of nature, it's neither possible for “the unique & invariable ultimate authenticity of nature” to be compatible with “two distinctive humanistic ideologies about authenticity of nature with remarkable ideological difference” nor possible for “two distinctive humanistic ideologies about authenticity of nature with remarkable ideological difference” to discover and formulate “the unique & invariable ultimate authenticity of nature” coequally. And veritable progress of science is not intuitional cumulative achievement of colorful scientific travelogues A, B, C, D, E, F, ...as deserving reward of the first itineracy around preternatural landscapes of brand-new landmasses of science like omnifarious smallwares full of a basket but successive hypostatic endeavor to push humanistic ideology about authenticity of nature forward to perfect ideological enantiomorph of ultimate authenticity of nature step by step draw on practical feasibility & possibility in proportion to contemporaneous historical background, which is virtually hypostatic historical progress of science in inherent optimum orientation towards historical authenticity tolerance of science 0, and virtually, it's only possible for the major melody of historical progress of science to be serial epochmaking scientific knowledge metabolism in inherent optimum orientation towards perfect ideological enantiomorph of ultimate authenticity of nature. However, as social legitimacy subsistence of contemporaneous scientific orthodoxy directly implicates solid gain and fame of temporal authority even loving successors of contemporaneous scientific orthodoxy, once timely renovation of humanistic ideology about authenticity of nature in proportion to contemporaneous historical background has to challenge social legitimacy subsistence of contemporaneous scientific orthodoxy, drastic scientific knowledge metabolism campaign must occur in humanistic operation of free press admittance and social legitimacy authentication in the nature of human nature, whose practical effect to coming necessary scientific knowledge metabolism is of course self-evident.

This is why, as multiple notion with double significance of “**social connotation**” & “**natural connotation**”, social legitimacy & validity of truths can never exceed cannon range.

In any case, as out-and-out social work outgrowth and humanistic ideology about authenticity of nature in proportion to contemporaneous historical background, social existence and historical progress of “science” must inherently possess double coordinative significance of “**natural connotation**” and “**social connotation**”,

As coherent natura naturans throughout cosmic evolution, instinctive PNT reciprocal equilibrium towards optimum PNT operation is radical potentiality & conditionality for cosmos always ready to orientate itself towards perfection.

social legitimacy subsistence of neonatal scientific idea especially successive renovation of humanistic ideology about authenticity of nature along historical progress of science in inherent optimum orientation towards perfect ideological enantiomorph of ultimate authenticity of nature never simply depends on cognizant achievement that brand-new or more veritable authenticity of nature has been reflected on sense of pioneering originators with commensurate authenticity highlight effect in proportion to contemporaneous historical background, it even crucially implicates esoteric authoritative social legitimacy identification & authentication in accordance with egotistic criterion of contemporaneous scientific orthodoxy under official centered background —social legitimacy & validity of truths can never exceed cannon range, which of course includes humanistic operation of virulent scientific knowledge metabolism campaign underlying. The negative effect of esoteric authoritative social legitimacy identification & authentication may be mostly conservative domino effect of officialdom of contemporaneous scientific orthodoxy.

There is neither science which only possesses natural connotation without social connotation nor science which only possesses social connotation without natural connotation in the world. If we suppose science is just esse of a metal cent, then, natural connotation may be just the face of the metal cent, and social connotation of science may be the back of the metal cent. Of course, as science esse, it's impossible for the so-called “metal cent” to be empty simply made up of cover of a “face” and a “back”. Virtually, the solid core of the metal cent is just living “reciprocal coevolution between integrative social circumstances and scientific knowledge proliferation in monofier modality” in time current. In another words, living “reciprocal coevolution between integrative social circumstances and scientific knowledge proliferation in monofier modality” in time current makes up of the solid core of metal cent of science.

As humanistic ideology about authenticity of nature coming from social work, scientific knowledge proliferation and social economy, politics, education, scientific knowledge metabolism & scientific knowledge metabolism campaign etc are closely linked and condition each other as following:

2.2.1) Independent bidirectional cause and effect domino effect between scientific knowledge proliferation and social economy, which can be illustrated as below:

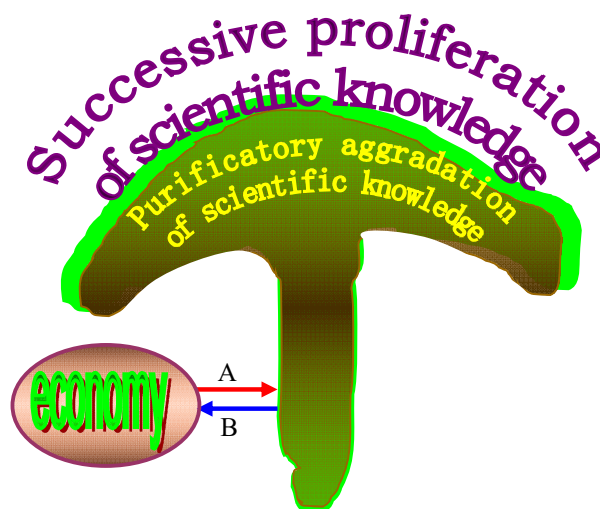

(VIII-iii-3) independent bidirectional cause and effect domino effect between scientific knowledge proliferation and social economy

A) Once social economy exists as external active condition of scientific knowledge proliferation, the possible

Historical progress of science in the recent several centuries seemed like a far-flung exploration of the first itinerary around numerous distinctive landscapes of brand-new landmasses of science with palette & tablet on back, several hundred years' scientific travelogues were compiled thereby.

consequent implementation of scientific knowledge proliferation derived from social economy.

Usually, social economy can not manage to consequent implementation in first order with scientific knowledge proliferation; instead, social economy mostly involves consequent implementation in second or third order with scientific knowledge proliferation. At any rate, consequent implementation of scientific knowledge proliferation derived from social economy is that social economy can offer financial support and favorable applicable occasion for scientific knowledge proliferation.

The first, having manpower devotion to science study in mind, the advantage of social economy determines whether it's possible for necessary social members to release themselves from labor and devote themselves to scientific research. The better the social economy is, there are more possibilities for more members to be released from labor and devote themselves to scientific research.

The second, having material devotion to science study in mind, the advantage of social economy determines whether it's possible for the society to offer necessary and favorable materials for scientific study, especially the necessary materials for measurement and experimental for scientific study.

The third, having the potential favorable facilitation social economy to science study in mind, favorable economy has powerful assimilation to harvest of scientific knowledge proliferation (or science study harvest), economic modality and development degree of society directly determines the possibilities and efficiency of harvest of scientific knowledge proliferation to hypostatize its benefit to economy, and inversely, the remarkable economic benefit realization derived from harvest of scientific knowledge proliferation can stimulate society to pay more attention to scientific study.

B) Once scientific knowledge proliferation exists as external active condition of social economy, the possible consequent implementation of social economy derived from scientific knowledge proliferation.

All in all, scientific knowledge proliferation is the most substantial intellectuality devotion to social economy, science is the soul of social productivity, —the harvest of scientific knowledge proliferation directly relates to what is possible and feasible for human to pursue “natura naturans personalization towards human necessity”. At any rate, only scientific knowledge proliferation highlights more of existence & motion of matter in the nature, there is more substantial rational capital for human to actualize natura naturans personalization towards human necessity, there are more possibilities for human to integrate and administrate ideal existence & motion accessible in the nature to actualize or satisfy production and/or living necessity of society, social production and social lives can be upgraded thereby.

At any rate, universal objects in the nature exist in idiographic existence & motion and embody their idiographic physical characters and material profile. Scientific production is to intelligently integrate and administrate ideal existence & motion accessible in the nature to satisfy productive and/or living necessities of human. The more existence & motion of matter in the nature highlighted for scientific knowledge proliferation, the more existence & motion of matter in the nature are accessible for human to integrate and administrate towards productive and/or living necessities of human, and quality of natura naturans personalization towards human necessity is relatively higher, social production is more technologic, economy is relatively more advanced.

2.2.2) Independent bidirectional cause and effect domino effect between scientific knowledge proliferation

As coherent natura naturans throughout cosmic evolution, instinctive PNT reciprocal equilibrium towards optimum PNT operation is radical potentiality & conditionality for cosmos always ready to orientate itself towards perfection.

and social politics, which can be illustrated as below:

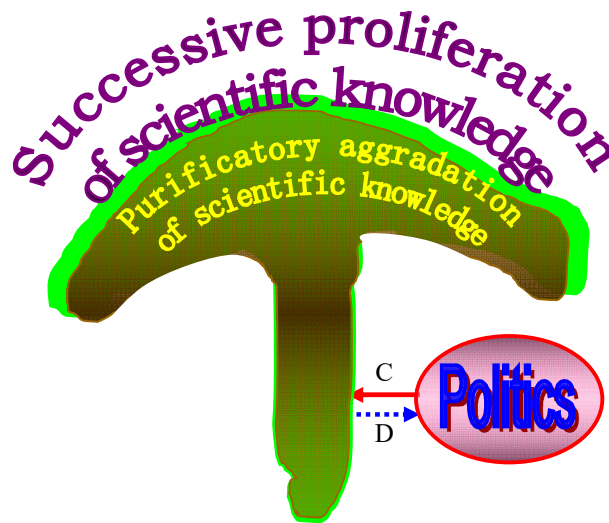

(VIII-iii-4) independent bidirectional cause and effect domino effect between scientific knowledge proliferation and social politics

C) Once social politics exists as external active condition of scientific knowledge proliferation, the possible consequent accomplishment of scientific knowledge proliferation derived from social politics.

Politics usually impacts scientific knowledge proliferation by consequent implementation in second order or in third order.

Politics is the shaping mould of society; it directly demarcates the social production relation framework, class distinction, job division, output distribution and consumption etc. among all members of the society by the strong hand, even restrict the daily operation of the integrative society under the proper framework. Normal operation of social production is just the precondition of society, and social progress radically depends on development of social production, the unique criterion to scale the worthiness of political practice is whether political practice can do good to social production, how much it can do for favourable operation of social production even necessarily lead progress of social production. If the political practice can remarkably do good to social production even necessarily lead progress of social production, such kind of politics is of course wise God of human society, if the political practice can only do bad to social production even apparently restrain progress of social production, such kind of politics is of course villainous devil of human society. For instance, Chinese political practice as great civilization revolution for 10 years is typical villainous devil of human society.

As special outcome of social production, implementation of scientific knowledge proliferation is too among the integrative operation of social production, once politics is wise God of human society, scientific knowledge proliferation will be equally benefited among the integrative operation, once the politics is villainous devil of human society, scientific knowledge proliferation will be equally fall victim among the integrative operation.

After all, excellence or badness of political ambient directly determines whether the society advocates science & technology and dedicate development of science & technology, or for what kind of political intention to involve in scientific practice, it even relates to system about scientific education, talent

Historical progress of science in the recent several centuries seemed like a far-flung exploration of the first itinerary around numerous distinctive landscapes of brand-new landmasses of science with palette & tablet on back, several hundred years' scientific travelogues were compiled thereby.

selection & promotion for scientific research, organization of scientific research team, study or research orientation, distribution of scientific study resource, encouragement and application popularization of scientific research fruit etc. The practical implementation of the integrative system must affect dealing devotion and output effect of scientific knowledge proliferation all without exception.

Different historical age, different society, as disparity of political practice, especially disparity of political tendency of the leadership, the affection and guidance to scientific knowledge proliferation derived from politics is obviously different, there are substantial difference of affection and guidance to scientific knowledge proliferation derived from politics between developing countries and developed countries. During the course of war years, there are even remarkable affection and guidance to scientific knowledge proliferation derived from politics.

D) Once scientific knowledge proliferation exists as external active condition of social politics, the possible consequent implementation of social politics derived from scientific knowledge proliferation.

Scientific knowledge proliferation usually affects politics as consequent implementation in second order or in third order. That's to say, scientific knowledge proliferation usually does not affect politics directly, instead, it mostly affect social production and social economy, and once social economy changes, the politics will change accordingly. We affirm science is the first productivity and radically determines the integrative progress of society, the substantial consequent implementation of social politics derived from scientific knowledge proliferation is one of the most active causes of the leitmotiv.

2.2.3) Independent bidirectional cause and effect domino effect between scientific knowledge proliferation and education, which can be illustrated as below:

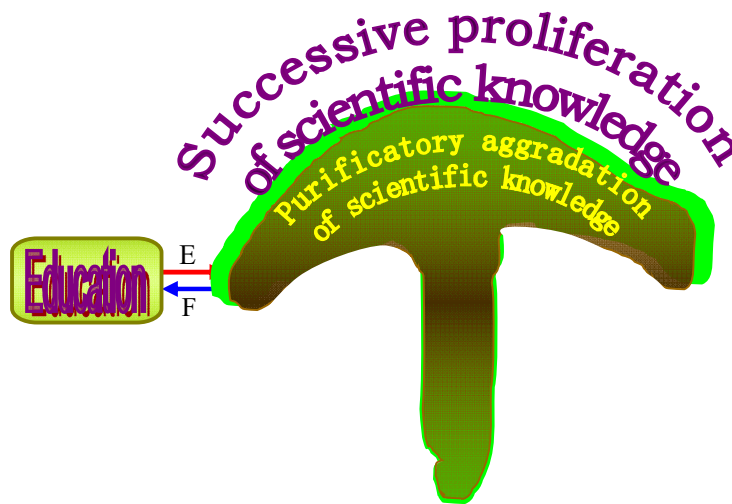

(VIII-iii-5) independent bidirectional cause and effect domino effect between scientific knowledge proliferation and education

E) Once education exists as external active condition of scientific knowledge proliferation, the possible consequent implementation of scientific knowledge proliferation derived from education. .

Education generally does its work of civilization impartation and intelligence cultivation to coming generation, favorable education can not only ensure excellent knowledge of the age adequately replanting on coming generation and so as to actualize civilization succession but also makes it possible for coming

As coherent natura naturans throughout cosmic evolution, instinctive PNT reciprocal equilibrium towards optimum PNT operation is radical potentiality & conditionality for cosmos always ready to orientate itself towards perfection.

scientific knowledge proliferation rooting in the purificatory aggradation of scientific knowledge, so that it can ensure the coming generation are able to stand on mountain peak of the age and create new age so as to make the coming progressive succession of civilization in optimum & powerful orientation.

F) Once scientific knowledge proliferation exists as external active condition of education, the possible consequent implementation of education derived from scientific knowledge proliferation.

Along history extension, any fecund outcome of scientific knowledge proliferation will drop down into historical knowledge aggradation as background thought resource of the age, and even become contents of coming education. This of course means that scientific knowledge proliferation is always ready to increase and renovate contents of coming education, innovative scientific knowledge proliferation maybe even make education thoroughly remould itself (for instance, the education shift from geocentric theory to heliocentric theory). The more flourishing scientific knowledge proliferation of the age is, the more substantial the knowledge aggradation derived from the prior knowledge multiplication is, there more wonderful programs for education, and after promulgation of education, it influence more of coming scientific knowledge proliferation, education is more meritorious therefore.

2.2.4) Side effect of scientific knowledge proliferation——scientific knowledge metabolism & scientific knowledge metabolism campaign.

If we define the positive effect scientific knowledge proliferation done to social production (/economy), politics, education is direct-effect, then, quantitative change of scientific knowledge proliferation inevitably causes scientific knowledge metabolism is just the so-called the “side-effect” of scientific knowledge proliferation. And at the same time, once the performance of scientific knowledge metabolism seems ready to impact survival of contemporaneous scientific orthodoxy, the implementation of scientific knowledge metabolism must cause scientific knowledge metabolism campaign. As a result, we call scientific knowledge metabolism the first side-effect of scientific knowledge proliferation towards authenticity of nature, and call scientific knowledge metabolism campaign the second side-effect of scientific knowledge proliferation towards authenticity of nature.

So-called “scientific knowledge metabolism” is just historical occurrence that newly progressive knowledge multiplication gradually supersede and lay over temporal ready-made knowledge of science during the course human coming to know ultimate authenticity of nature cumulatively enriched from nothingness to goat, from goat to a great lot and consequently following the proportionate historical reciprocal cognition correction & qualitative optimization from superficiality to profundity, from parochiality to generality. As the uniqueness & invariance of ultimate authenticity of nature proportionably predestines the unique possibility of scientific verity as perfect ideological enantiomorph of ultimate authenticity of nature, quantitative & qualitative change of scientific knowledge proliferation towards absolute scientific verity must gradually supersede and lay over foregone even temporal ready-made knowledge and hypostatize science progress of knowledge optimization renovation, which directly cause occurrence of “knowledge metabolism”.

2.2.4.1) Independent bidirectional cause and effect domino effect between scientific knowledge proliferation and scientific knowledge metabolism, which can be illustrated as below:

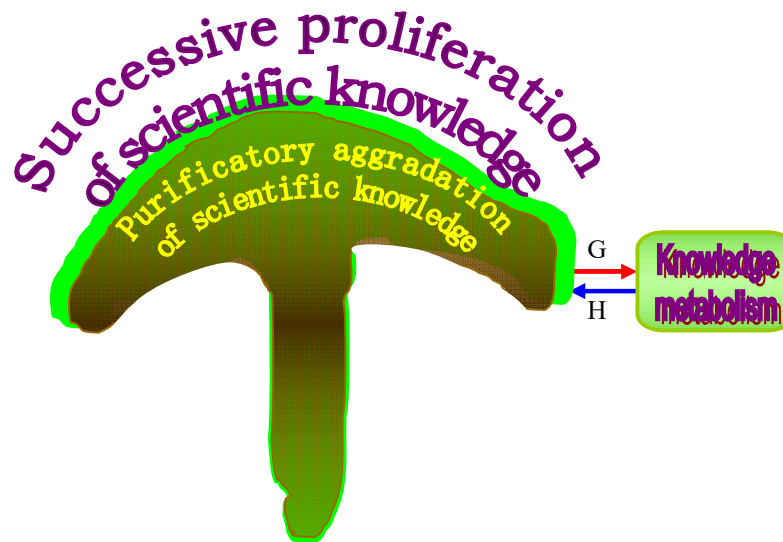

(VIII-iii-6) independent bidirectional cause and effect domino effect between scientific knowledge proliferation and scientific knowledge metabolism

G) Once scientific knowledge proliferation exists in favorable enlightened social condition for necessary scientific knowledge metabolism in inherent orientation towards perfect ideological enantiomorph of ultimate authenticity of nature, the possible consequent implementation of scientific knowledge metabolism derived from scientific knowledge proliferation.

As successive quantitative change feature of scientific knowledge proliferation throughout historical progress of science, the coming scientific knowledge proliferation will be restricted by conventionality inevitably, especially; it will be affected by conventional puissance as degree awarding, free press authorization etc. And on the other hand, the coming scientific knowledge proliferation have to face more and more accessible existence & motion in the nature, as the practice human coming to discover and formulate authenticity of accessible existence & motion around must experience frondose evolvment of humanistic ideology about authenticity of nature cumulatively enriched from nothingness to goot, from goot to a great lot, and consequently followed proportionate ideaistic correction & qualitative optimization from superficiality to profundity, from parochiality to generality, and as the uniqueness & invariance of ultimate authenticity of nature proportionably predestines the unique possibility of scientific verity as perfect ideological enantiomorph of ultimate authenticity of nature, before human practically approach and accomplish absolute scientific very of nature, nothing can restrict the coming scientific knowledge proliferation in rigid succession of conventionality 100 over 100. As a result, taking reference of contemporaneous scientific orthodoxy, there are usually two distinctive rational orientations of scientific knowledge proliferation.

The first: **eulogistic scientific knowledge proliferation in rigid succession of contemporaneous scientific orthodoxy.**

The second: **aberrant scientific knowledge proliferation out of succession of contemporaneous scientific orthodoxy.**

Eulogistic scientific knowledge proliferation in rigid succession of contemporaneous scientific orthodoxy is mostly the further development & consummation of contemporaneous scientific orthodoxy, whose quantitative multiplication is usually impossible to impact social legitimacy subsistence and won't slide into trouble of scientific knowledge metabolism campaign. Instead, they are mostly favorable to contemporaneous scientific orthodoxy, so that they are usually very compatible and easy to be accepted and supported by

As coherent natura naturans throughout cosmic evolution, instinctive PNT reciprocal equilibrium towards optimum PNT operation is radical potentiality & conditionality for cosmos always ready to orientate itself towards perfection.

temporal authorities, even as popularity of free press egotistic proximity identification and degree awarding, eulogistic scientific knowledge proliferation in rigid succession of contemporaneous scientific orthodoxy are generally historical popularity of scientific knowledge proliferation of the age, especially once brand-new scientific orthodoxy come into being, in the early years after pioneering naissance of contemporaneous scientific orthodoxy, **royal substantiation & perfection of contemporaneous scientific orthodoxy \approx historical progress of science.**

Eulogistic scientific knowledge proliferation in rigid succession of contemporaneous scientific orthodoxy and aberrant scientific knowledge proliferation out of succession of contemporaneous scientific orthodoxy of the same age usually root in the same historical background, whereas, as disparity of thought origin, logic proliferation mode, objects in consideration, the outgrowth of scientific knowledge proliferation is consequently different. aberrant scientific knowledge proliferation out of succession of contemporaneous scientific orthodoxy usually departure conventionality remarkably and break elation of eulogistic scientific knowledge proliferation in rigid succession of contemporaneous scientific orthodoxy unexpectedly so as to slide into perplexity of knowledge metabolism campaign therefore. Once the knowledge metabolism campaign ultimately clarified, if ultimate clarification of related authenticity of nature supports aberrant scientific knowledge proliferation out of succession of contemporaneous scientific orthodoxy to supersede contemporaneous scientific orthodoxy, grand knowledge metabolism will be implemented thereby.

H) Once scientific knowledge metabolism exists as external active condition of scientific knowledge proliferation, the possible consequent implementation of scientific knowledge proliferation derived from scientific knowledge metabolism.

Implementation of scientific knowledge metabolism directly renovates the background thought resource and shapes the basis for coming scientific knowledge proliferation.

“Scientific knowledge metabolism campaign” is struggle generally between aberrant scientific knowledge proliferation out of succession of contemporaneous scientific orthodoxy and contemporaneous scientific orthodoxy once aberrant scientific knowledge proliferation out of succession of contemporaneous scientific orthodoxy is ready to supersede and lay over contemporaneous scientific orthodoxy during the course human coming to know ultimate authenticity of nature cumulatively enriched from nothingness to goat, from goat to a great lot and consequently followed the proportionate historical reciprocal cognition correction & qualitative optimization from superficiality to profundity, from parochiality to generality. The struggle between contemporaneous scientific orthodoxy and coming party of aberrant scientific knowledge proliferation out of succession of contemporaneous scientific orthodoxy usually exhibits as scientific idea dissension, if conflict irreconcilable, it maybe even arouse mutual forcible clash.

Scientific knowledge metabolism campaign has two-tier significations, the first is purely knowledge metabolism towards authenticity of nature for impersonal scientific clarification and verification; the second is interclass campaign with ulterior motives which usually related to self-benefits of legitimacy subsistence, after all, presence of so-called social legitimacy proportionably contains the worthy fame and gain of certain man or class of the society. As self-preservation is something inherent of man, as long as scientific knowledge metabolism campaign is implemented among men who are always ready for self-subsistence in the society, the two-tier significations of scientific knowledge metabolism campaign are usually adulterated and esoteric.

Historical progress of science in the recent several centuries seemed like a far-flung exploration of the first itinerary around numerous distinctive landscapes of brand-new landmasses of science with palette & tablet on back, several hundred years' scientific travelogues were compiled thereby.

2.2.4.2) Independent bidirectional cause and effect domino effect between scientific knowledge proliferation and scientific knowledge metabolism campaign, which can be illustrated as below:

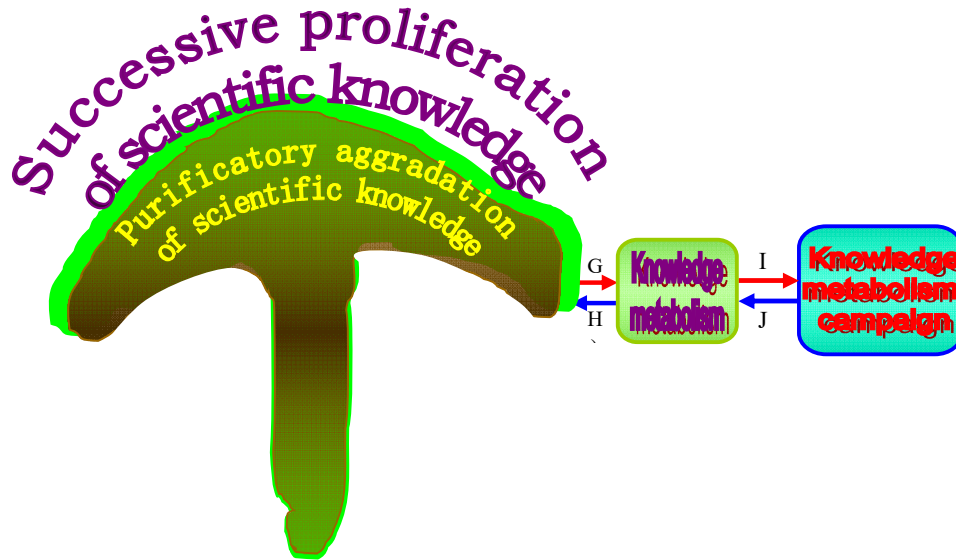

(VIII-iii-7) independent bidirectional cause and effect domino effect between scientific knowledge proliferation and scientific knowledge metabolism campaign

I) Once scientific knowledge proliferation exists as external active condition of scientific knowledge metabolism campaign, the possible consequent implementation of scientific knowledge metabolism campaign derived from scientific knowledge proliferation.

As second side-effect of scientific knowledge proliferation, scientific knowledge metabolism campaign is consequent implementation in second order of scientific knowledge proliferation. —the quantitative and qualitative change of scientific knowledge proliferation directly leads to occurrence of scientific knowledge metabolism, once the occurrence of scientific knowledge metabolism impacts the survival of contemporaneous scientific orthodoxy, scientific knowledge metabolism campaign will consequently be inevitable.

J) Once scientific knowledge metabolism campaign exists as external active condition of scientific knowledge proliferation, the possible consequent implementation of scientific knowledge proliferation derived from scientific knowledge metabolism campaign.

Scientific knowledge metabolism campaign is mostly rational encounter between aberrant scientific knowledge proliferation out of succession of contemporaneous scientific orthodoxy and contemporaneous scientific orthodoxy once the coming aberrant scientific knowledge proliferation out of succession of contemporaneous scientific orthodoxy endangers livability of contemporaneous scientific orthodoxy. In different age, the rational encounter modality is different, in historical age as Copernicus's, Bruno's, Galileo's, scientific knowledge metabolism campaign usually hypostatized as forcible subjection from contemporaneous scientific orthodoxy to coming party of aberrant scientific knowledge proliferation out of succession of contemporaneous scientific orthodoxy. Whereas, history proceeding to today, scientific knowledge metabolism campaign mostly hypostatize free press monopolization of science aristocrat and free press embarment implemented by temporal authority to coming party of aberrant scientific knowledge proliferation out of succession of contemporaneous scientific orthodoxy. Presence and hypostatic situation of scientific knowledge metabolism campaign directly impacts effect of scientific knowledge metabolism,

As coherent natura naturans throughout cosmic evolution, instinctive PNT reciprocal equilibrium towards optimum PNT operation is radical potentiality & conditionality for cosmos always ready to orientate itself towards perfection.

once temporal puissance implements remarkable ascendancy crackdown upon self-preservation, presence of scientific knowledge metabolism campaign will directly impact social legitimacy authorization of innovative aberrant scientific knowledge proliferation out of succession of contemporaneous scientific orthodoxy, and consequently delays the metabolism effect of innovative aberrant scientific knowledge proliferation out of succession of contemporaneous scientific orthodoxy to contemporaneous scientific orthodoxy even retard historical progress of science towards perfect ideological enantiomorph of authenticity of nature in inherent optimum orientation towards historical authenticity tolerance of science 0.

Virtually, the actual quantitative & qualitative change of continuity of scientific knowledge proliferation is not made up of isolated consequent implementation between scientific knowledge proliferation and economy, between scientific knowledge proliferation and politics, between scientific knowledge proliferation and education, between scientific knowledge proliferation and scientific knowledge metabolism & knowledge metabolism campaign, but integrative bidirectional syntonic reciprocity between scientific knowledge proliferation and integrated social conditions generally related to economy, politics, education, scientific knowledge metabolism & knowledge metabolism campaign etc. —favorable integrated social conditions generally related to economy, politics, education, scientific knowledge metabolism & knowledge metabolism campaign etc. can make scientific knowledge proliferation abundant. And inversely, abundant scientific knowledge proliferation can also expedite integrative social update generally related to economy, politics, education, scientific knowledge metabolism & knowledge metabolism campaign, such reciprocal situation directly makes up of normal reciprocal cycle between scientific knowledge proliferation and integrative social update mainly related to economy, politics, education, scientific knowledge metabolism & knowledge metabolism campaign. And on the contrary, bad social conditions generally related to economy, politics, education, scientific knowledge metabolism & knowledge metabolism campaign must cause desolation of scientific knowledge proliferation, and inversely, desolation of scientific knowledge proliferation must make integrative social update generally related to economy, politics, education, scientific knowledge metabolism & knowledge metabolism campaign stagnant, such bad involved situation directly leads to vicious circle between scientific knowledge proliferation and integrative social update generally related to economy, politics, education, scientific knowledge metabolism & knowledge metabolism campaign.

We study bidirectional syntonic reciprocity between scientific knowledge proliferation and integrative social update generally related to economy, politics, education, scientific knowledge metabolism & knowledge metabolism campaign is mainly ready to demonstrate and highlight the inherent covariant conditionality and reciprocity between practical integrative social update and scientific knowledge proliferation.

- a) Once integrative social circumstances exists as external active conditions of scientific knowledge proliferation, how leading change of integrative social circumstances compounding of social economy, politics, education, scientific knowledge metabolism & knowledge metabolism campaign etc affect scientific knowledge proliferation as consequent implementation.
- b) Inversely, once scientific knowledge proliferation exists as external active conditions of integrative social circumstances, how leading change of scientific knowledge proliferation affects integrative social circumstances compounding of economy, politics, education, scientific knowledge metabolism & knowledge metabolism campaign etc as consequent implementation.

Historical progress of science in the recent several centuries seemed like a far-flung exploration of the first itinerary around numerous distinctive landscapes of brand-new landmasses of science with palette & tablet on back, several hundred years' scientific travelogues were compiled thereby.

It especially pays attention to the bidirectional syntonic reciprocity between integrative social circumstances and scientific knowledge proliferation when integrative social circumstances and scientific knowledge proliferation condition each other by the light of nature. Virtually, the reciprocity and mutual restriction between integrative social circumstances and scientific knowledge proliferation is exact domino effect of their inherent bidirectional syntonic reciprocity.

So-called “syntonic domino effect” of bidirectional cause and effect just means the quantitative change couple which inherently condition each other accomplish mutual reciprocity in monofier modality of quantitative change all along, —the advantage of integrative social circumstances must favor scientific knowledge proliferation, and at the same time, harvest of scientific knowledge proliferation must favor integrative social update as well, so that the benign quantitative change of both integrative social update and scientific knowledge proliferation accomplish virtuous cycle in monofier modality. And inversely, the disadvantage of integrative social circumstances must hold in play of scientific knowledge proliferation as material ambient closely linked, and at the same time, stagnancy of scientific knowledge proliferation must cause intelligence famine of integrative social update generally related to economy, politics, education, scientific knowledge metabolism & knowledge metabolism campaign, and consequently lead to vicious circle between integrative social update and scientific knowledge proliferation in monofier modality.

The bidirectional syntonic reciprocity between integrative social circumstances compound of social economy, politics, education, scientific knowledge metabolism & scientific knowledge metabolism campaign etc. and scientific knowledge proliferation can be generally illustrated as below:

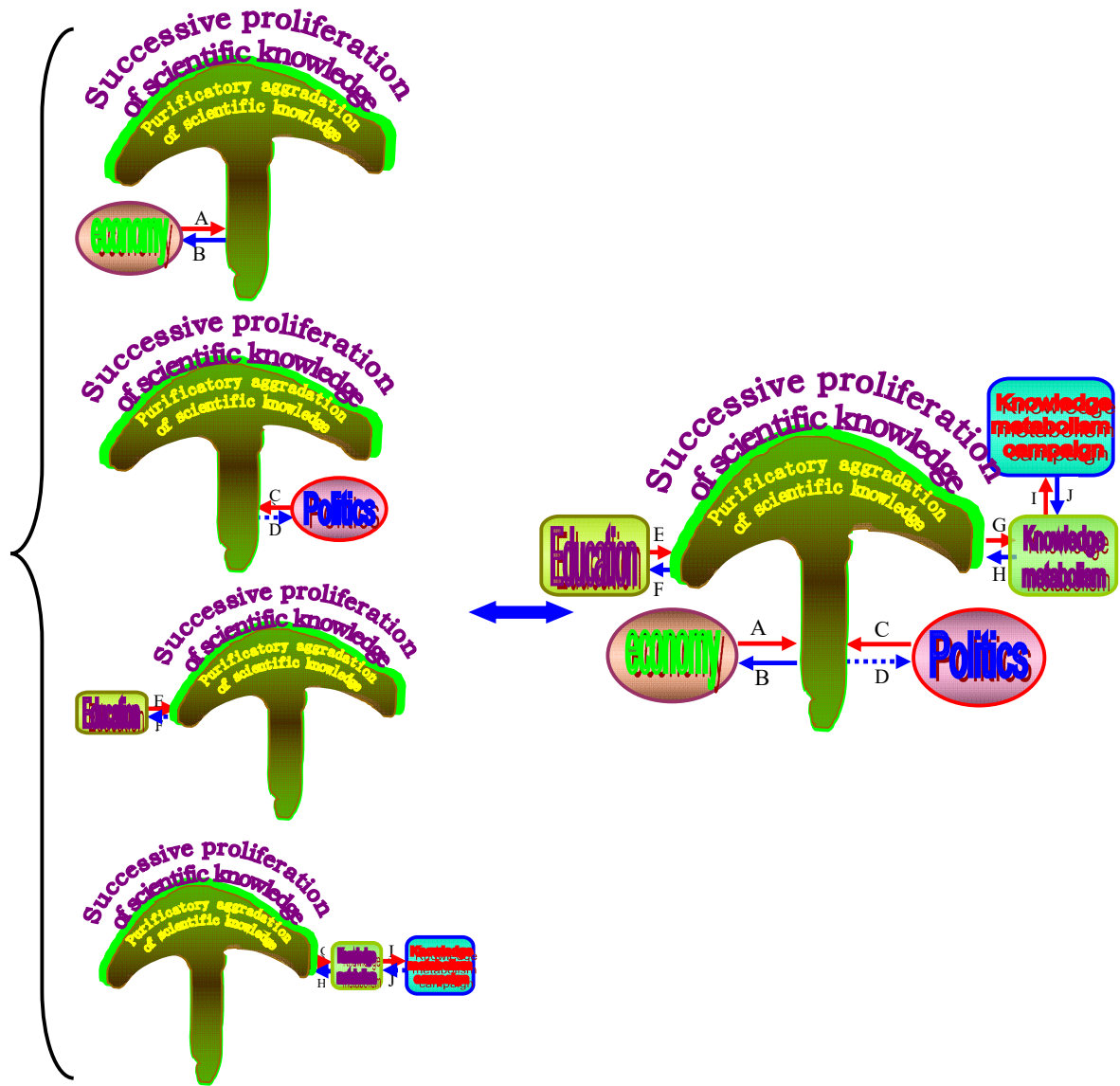

(VIII-iii-8) Operational modality of scientific knowledge proliferation under integrative social circumstances.

The bidirectional syntonic reciprocity between scientific knowledge proliferation and integrative social update runs through science progress all along and even practically restricts the quantitative & qualitative change of scientific knowledge proliferation through and through. Such thorough continuity of synoptic bidirectional cause and effect domino effect between scientific knowledge proliferation and integrative social update throughout science progress can be illustrated as below:

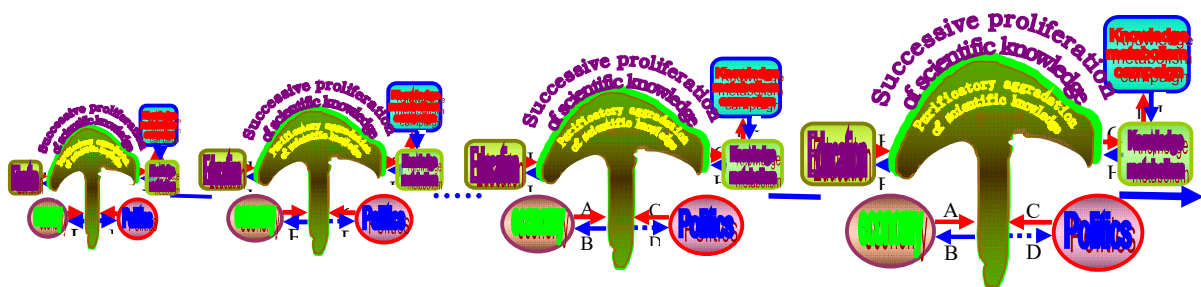

(VIII-iii-9) The integrative bidirectional syntonic reciprocity between integrative social circumstances and scientific knowledge proliferation hypostatize realistic historical progress of science through and through

Historical progress of science in the recent several centuries seemed like a far-flung exploration of the first itinerary around numerous distinctive landscapes of brand-new landmasses of science with palette & tablet on back, several hundred years' scientific travelogues were compiled thereby.

The purple centre line in diagram above denotes the time continuity of history of science progress, the mushroom growth modality of scientific knowledge proliferation rooted in proper purificatory aggradation of scientific knowledge becomes bigger and bigger along time lapse means the increasing quantitative change of scientific knowledge proliferation.

The reciprocity situation of synoptic bidirectional cause and effect domino effect between scientific knowledge proliferation and integrative social update is generally similar as domino effect of tricolor synthesizing fundamental. —if we respectively assimilate social economy & politics, education, scientific knowledge metabolism & knowledge metabolism campaign to tricolor of red, green, blue. Then, in contrastive logic, different social conditions mainly integrated by idiographic social economy, politics, education, scientific knowledge metabolism & knowledge metabolism campaign are just like physical discrepancy of mixture configuration of tricolor of red, green and blue, and effect disparity of consequent implementation of scientific knowledge proliferation derived from integrative social update is just like the connatural color display of characteristic tricolor domino effect of red, green and blue.

For instance, we just refer to typical parallel of United States and China; current integrative social circumstances of United States are apparently more advanced than integrative social circumstances of china. This firstly means, in contrastive logic, the compositive amount of tricolor of scientific knowledge proliferation of United States is larger than compositive amount of tricolor of scientific knowledge proliferation of China, which firstly indicates tricolor compositive brightness of scientific knowledge proliferation of United States is higher than tricolor compositive brightness of scientific knowledge proliferation of China, bidirectional syntonic reciprocity between integrative social update and scientific knowledge proliferation of United States is relatively more impassioned and active than bidirectional syntonic reciprocity between integrative social update and scientific knowledge proliferation of China. Secondly, as physical discrepancy of compositive configuration of tricolor of scientific knowledge proliferation, the resultant color display of characteristic tricolor domino effect of scientific knowledge proliferation of United States is different from characteristic tricolor domino effect of scientific knowledge proliferation of China.

Described in science cent model, as humanistic ideology about authenticity of nature coming from social work, no matter what historical age it is, the well-rounded cent modality of science always consists of idiographic frontispiece and the facing of a quilt and hardcore, which not only means the cent modality of science always has different profile in different age but also means the cent modality of science even has different profile in different countries in the same historical age.

2.3) Mathematical profile of quantitative change of scientific knowledge proliferation throughout historical progress of science

The practice human coming to discover and formulate authenticity of accessible existence & motion around must experience frondose evolvment of humanistic ideology about authenticity of nature cumulatively enriched from nothingness to groat, from groat to a great lot, and consequently followed proportionate ideaistic correction & qualitative optimization from superficiality to profundity, from parochiality to generality. Progress of science is firstly hypostatized as historical quantitative change of scientific knowledge proliferation, and historical quantitative change of scientific knowledge proliferation is generally affected and restricted by two external factors.

The first, as humanistic ideology about authenticity of nature in proportion to contemporaneous historical background, historical quantitative & qualitative change of scientific knowledge proliferation must condition commensurate social circumstances.

Social conditions integrated by economy, politics, education, knowledge metabolism & scientific knowledge metabolism and scientific knowledge proliferation usually do not accomplish mutual consequent implementation in first order, whereas, Social conditions integrated by economy, politics, education, knowledge metabolism & scientific knowledge metabolism do affect and restrict output quality & efficiency of scientific knowledge proliferation by affect and restrict necessary conditions related to scientific knowledge proliferation as consequent implementation in secondary orders or in third orders. bidirectional syntonic reciprocity between integrative social update and scientific knowledge proliferation substantially affects and restricts sequential quantitative change of scientific knowledge proliferation all the way of science progress.

In early age of human society, the integrative social circumstances of society was relatively immature, and the initial improvement of society due to necessity of scientific knowledge proliferation generally limited in gradual elimination of various negative factors, so that scientific knowledge proliferation can do its job in its normal way. As gradual progress of society, science progress has magically done more and more favorable to the society, human realized the significance of development of science early, no matter developing countries or developed countries, they are always ready to perfect their social necessity towards scientific knowledge proliferation. As a result, the consequent implementation of scientific knowledge proliferation derived from integrative social circumstances becomes more and more sensitive and intensive.

The second, as commensurate ideological system about authenticity of accessible existence & motion around, historical quantitative change of scientific knowledge proliferation is affected and restricted by fundamental of “the uniqueness & invariance of ultimate authenticity of nature proportionably predestines the unique possibility of scientific verity as perfect ideological enantiomorph of ultimate authenticity of nature”.

As commensurate ideological system about authenticity of accessible existence & motion around, historical progress of science must refer to existent authenticity of nature as ideological origin through and through, and resultingly, fundamental of **the uniqueness & invariance of ultimate authenticity of nature proportionably predestines the unique possibility of scientific verity as perfect ideological enantiomorph of ultimate authenticity of nature** radically determines historical progress of science in inherent optimum orientation towards perfect ideological enantiomorph of ultimate authenticity of nature eversince.

During the course of scientific knowledge accumulating from nothingness to great, from great to a great lot, as human practice of scientific knowledge proliferation really seemed like a far-flung exploration of the first itinerary around numerous distinctive landscapes of brand-new landmasses of science with palette & tablet on back, several hundred years’ scientific travelogues were compiled thereby, evolvment of scientific knowledge proliferation was still far away from knowledge proliferation season to approach perfect ideological enantiomorph of ultimate authenticity of nature, fundamental of **the uniqueness & invariance of ultimate authenticity of nature proportionably predestines the unique possibility of scientific verity as perfect ideological enantiomorph of ultimate authenticity of nature** could hardly do its job to affect and restrict scientific knowledge proliferation on its own ground. Only when science development steps into stage from superficiality to profundity, from parochiality to generality, —as scientific knowledge aggradation is relatively substantial, modality of universal existence & motion becomes more and more verisimilitude in our sense day by day, cosmic-scale longitudinal ideology optimization

Historical progress of science in the recent several centuries seemed like a far-flung exploration of the first itinerary around numerous distinctive landscapes of brand-new landmasses of science with palette & tablet on back, several hundred years’ scientific travelogues were compiled thereby.

about universal existence & motion in coherent logic system has been practical possibility and inevitability, the coming scientific knowledge proliferation has to face issue whether universal existence & motion are subject to law of identity or not, and what is the so-called “law of identity”, and as a result, connatural fundamental of the uniqueness & invariance of ultimate authenticity of nature proportionably predestines the unique possibility of scientific verity as perfect ideological enantiomorph of ultimate authenticity of nature begins to do its job to scientific knowledge proliferation on its own ground, and at the more advanced stage of cognition development from superficiality to profundity, from parochiality to generality, connatural fundamental of the uniqueness & invariance of ultimate authenticity of nature proportionably predestines the unique possibility of scientific verity as perfect ideological enantiomorph of ultimate authenticity of nature can shape more of realistic scientific knowledge proliferation sternly. Virtually, throughout the process of quantitative & qualitative change of scientific knowledge proliferation, if a new theory can not formulate the universal existence & motion in the nature more generally and precisely, there is no necessity for it to come into being and there is no possibility for it to be promoted legitimacy of the age.

All in all, integrative social circumstances and connatural fundamental of the uniqueness & invariance of ultimate authenticity of nature proportionably predestines the unique possibility of scientific verity as perfect ideological enantiomorph of ultimate authenticity of nature are two major impact factors of scientific knowledge proliferation all along, but in different historical stages, the practical effect of the both is apparently different. In prophase of historical progress of science, especially during the course of scientific knowledge cumulation in travelogue style from nothingness to groat, from groat to a great lot, on one hand, the integrative social circumstances were still relatively poor and uncultured, the effect and restriction to scientific knowledge proliferation derived from integrative social circumstances is even rigorous. And on the other hand, historical progress of science was still far away from formulation of universal existence & motion in thorough coherence as linear logic system through and through but desultory travelogues for stochastic scenes coming into rational purview of human, as a result, the effect and restriction to scientific knowledge proliferation derived from connatural fundamental of the uniqueness & invariance of ultimate authenticity of nature proportionably predestines the unique possibility of scientific verity as perfect ideological enantiomorph of ultimate authenticity of nature is of course recessive. Only when science development steps into stage from superficiality to profundity, from parochiality to generality, historical progress of science shows itself orientating coherent logic system, the consequent implementation of scientific knowledge proliferation derived from integrative social circumstances becomes relatively weaker and weaker. Instead, the effect and restriction to scientific knowledge proliferation derived from connatural fundamental of the uniqueness & invariance of ultimate authenticity of nature proportionably predestines the unique possibility of scientific verity as perfect ideological enantiomorph of ultimate authenticity of nature becomes more and more remarkable.

If we denote consequent implementation of scientific knowledge proliferation due to proper integrative social circumstances $H=\gamma(t)$ throughout science progress, and we denote consequent implementation of scientific knowledge proliferation due to potential restriction of fundamental of “the uniqueness & invariance of ultimate authenticity of nature proportionably predestines the unique possibility of scientific verity as perfect ideological enantiomorph of ultimate authenticity of nature” $J=\xi(t)$ throughout science progress, among the function, christcross-row “t” denotes time of science progress, then, the characteristic curves of both function $H=f(t)$ and function $J=\xi(t)$ can be generally illustrated as following:

As coherent natura naturans throughout cosmic evolution, instinctive PNT reciprocal equilibrium towards optimum PNT operation is radical potentiality & conditionality for cosmos always ready to orientate itself towards perfection.

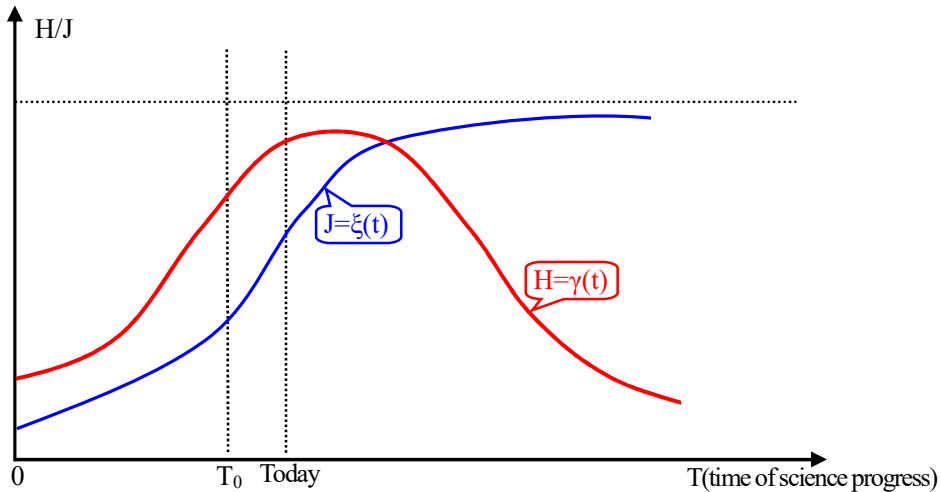

(VIII-iii-10) Effect curve of scientific knowledge proliferation based on integrative social circumstances and effect curve of scientific knowledge proliferation based on connatural fundamental of the uniqueness & invariance of ultimate authenticity of nature predestines the unique possibility of scientific verity

In above diagram, the abscissa denotes time “T”, vertical coordinate denotes the outgrowth value of consequent implementation of H/J, the point T_0 on abscissa denotes historical time about the first industrial revolution of England, point “Today” on abscissa just denotes time of today.

As practical quantitative change of scientific knowledge proliferation is restricted by both integrative social circumstances and connatural fundamental of the uniqueness & invariance of ultimate authenticity of nature proportionably predestines the unique possibility of scientific verity as perfect ideological enantiomorph of ultimate authenticity of nature, we can denote the quantitative change of scientific knowledge proliferation into multiple function $Y = \alpha[\gamma(t), \xi(t)]$ with both conditional parameters of $\gamma(t)$ and $\xi(t)$. In the equation, “Y” denotes the quantitative output of consequent implement due to proper conditional parameters of $\gamma(t)$ and $\xi(t)$. Then, we can approximately study out the characteristic curve the multiple function $Y = \alpha[\gamma(t), \xi(t)]$ as below:

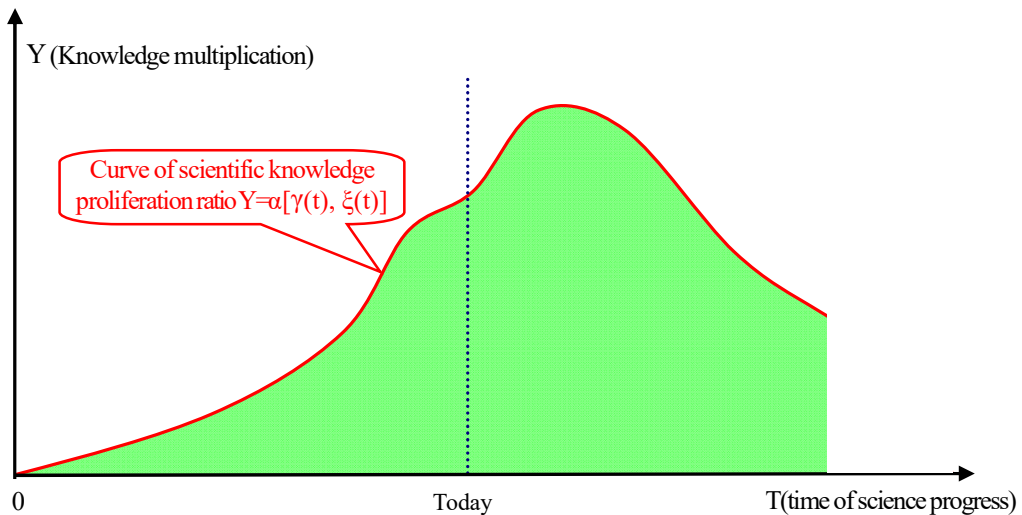

(VIII-iii-11) Quantitative change curve of historical scientific knowledge proliferation

In diagram above, the Y axis denotes quantitative output of scientific knowledge proliferation, T axis denotes time of science progress, any coordinate point on curve of multiple function $Y = \alpha[\gamma(t), \xi(t)]$ denotes quantitative output of consequent implementation of scientific knowledge proliferation Y due to proper

integrative social circumstances under potential restriction of connatural fundamental of the uniqueness & invariance of ultimate authenticity of nature proportionably predestines the unique possibility of scientific verity as perfect ideological enantiomorph of ultimate authenticity of nature at any time point throughout historical progress of science.

Apparently, when history lasts time “t”, the quantitative outcome of scientific knowledge proliferation of human is as below:

$$M_0 = \int_0^t \alpha[\gamma(t), \xi(t)] dt \quad \dots\dots\dots (A-ii-1)$$

As connatural fundamental of the uniqueness & invariance of ultimate authenticity of nature proportionably predestines the unique possibility of scientific verity as perfect ideological enantiomorph of ultimate authenticity of nature must do its job by the light of nature, throughout science progress, besides the initial stage scientific knowledge aggradation started from none to groat, the quantitative change of scientific knowledge proliferation usually follows proportionate scientific knowledge metabolism.

Scientific knowledge metabolism is just the occurrence playing to the score of scientific knowledge proliferation, any time “t” along science progress, if quantitative output of scientific knowledge proliferation as consequent implementation of integrative social condition under potential restriction of connatural fundamental of the uniqueness & invariance of ultimate authenticity of nature proportionably predestines the unique possibility of scientific verity as perfect ideological enantiomorph of ultimate authenticity of nature is $Y = \alpha[\gamma(t), \xi(t)]$, there must be the first side-effect of scientific knowledge proliferation, — proportionate scientific knowledge metabolism, if we denote the proportionate quantitative change of scientific knowledge metabolism “Z”, then, quantity “Z” can be formulated into multiple function as $Z = \beta\{\alpha[\gamma(t), \xi(t)]\}$ with both conditional parameters of $\gamma(t)$ and $\xi(t)$. Then, throughout science progress, the characteristic curve of multiple function $Z = \beta\{\alpha[\gamma(t), \xi(t)]\}$ can be generally studied out as below:

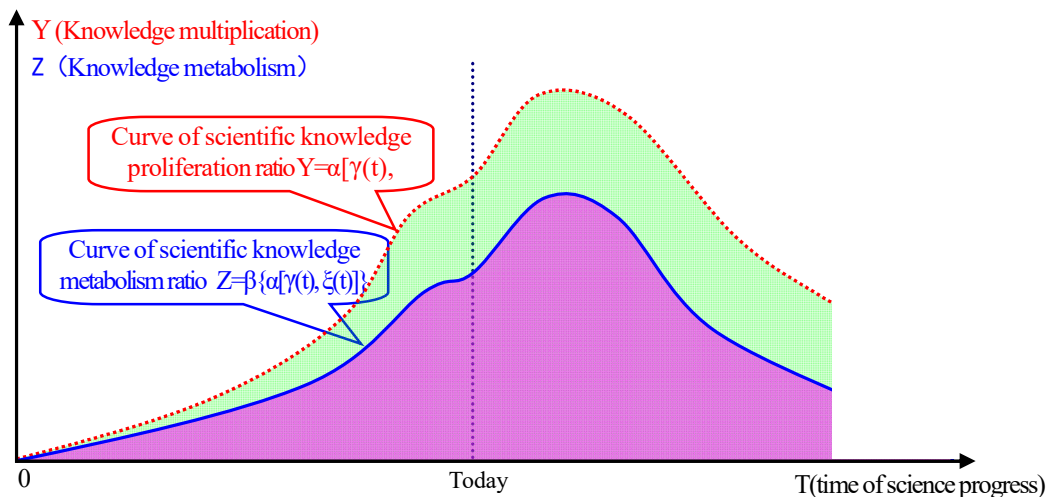

(VIII-iii-12) Quantitative change curve of scientific knowledge metabolism as first side-effect of scientific knowledge proliferation

Of course, as the first side-effect of scientific knowledge proliferation, scientific knowledge metabolism is stochastic quantitative change of scientific knowledge proliferation, quantity Z of scientific knowledge metabolism is but stochastic quantity of scientific knowledge proliferation quantity Y, which not only means, followed scientific knowledge proliferation, scientific knowledge metabolism must proportionably renovate temporal social legitimacy, but also means, in different age, as historical disparity of scientific knowledge proliferation,

As coherent natura naturans throughout cosmic evolution, instinctive PNT reciprocal equilibrium towards optimum PNT operation is radical potentiality & conditionality for cosmos always ready to orientate itself towards perfection.

the renovation degree the proper scientific knowledge metabolism done to temporal social legitimacy is too proportionably different.

Generally, the renovation done by scientific knowledge metabolism to temporal scientific cognition legitimacy is usually the newly scientific knowledge proliferation lays over and supersedes some of the ready-made knowledge even some of contemporaneous scientific orthodoxy. As depth and span disparity of scientific knowledge proliferation towards authenticity of nature, knowledge metabolism effect of newly scientific knowledge proliferation to ready-made knowledge even contemporaneous scientific orthodoxy is relatively different. Accordingly, the quantitative change curve of scientific knowledge metabolism due to newly scientific knowledge proliferation is stochastic quantitative change curve of scientific knowledge proliferation, which is not only quantitative change curve along time extension, but even quantitative change curve exactly followed proper scientific knowledge proliferation. Throughout science progress, any outcome of historical scientific knowledge proliferation $Y = \alpha[\gamma(t), \xi(t)]$ inevitably means the proportionate scientific knowledge metabolism $Z = \beta\{\alpha[\gamma(t), \xi(t)]\}$, as a result, quantitative curve of scientific knowledge metabolism $Z = \beta\{\alpha[\gamma(t), \xi(t)]\}$ always has its suited characteristics of proper scientific knowledge proliferation. For instance, when science progress extended to time T_A and time T_B , as disparity of historical background and proper scientific knowledge proliferation of time T_A and time T_B , there are proportionately two different quantitative change curves of scientific knowledge metabolism of time T_A and time T_B , the situation can be generally illustrated as following:

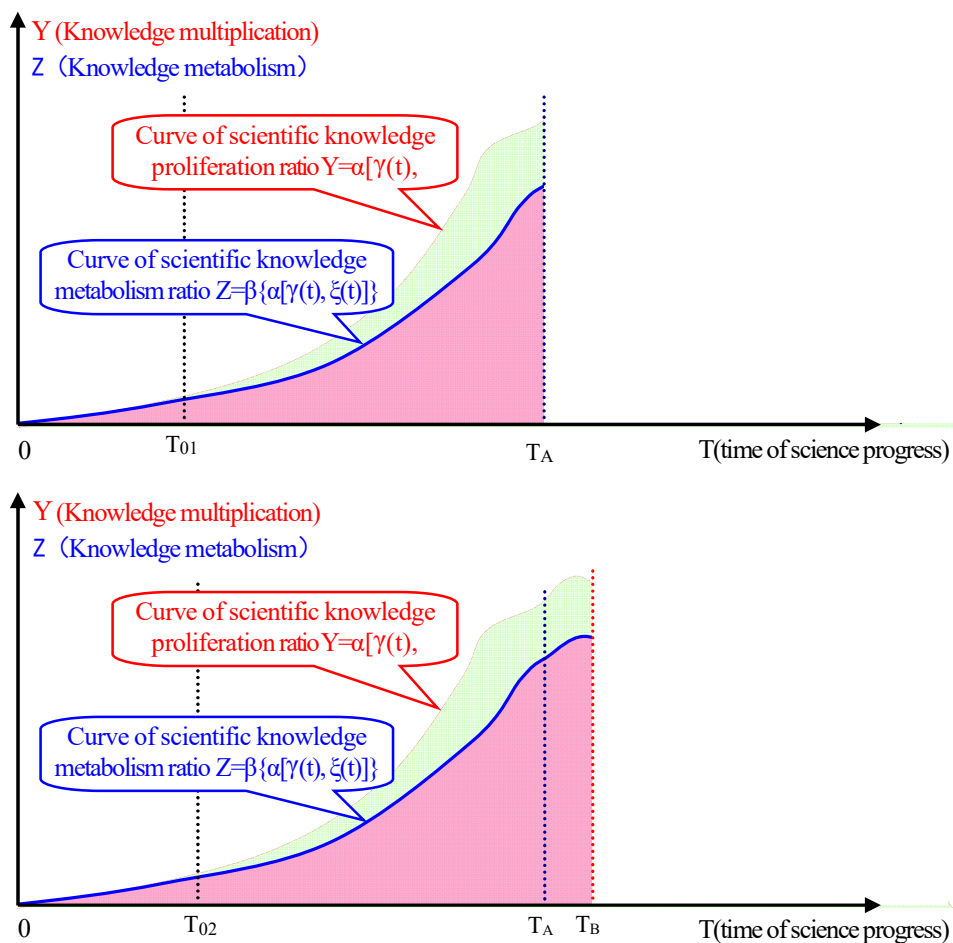

(VIII-iii-13) Contrast of quantitative change curve of scientific Knowledge metabolism at different time T_A and time T_B

Historical progress of science in the recent several centuries seemed like a far-flung exploration of the first itinerary around numerous distinctive landscapes of brand-new landmasses of science with palette & tablet on back, several hundred years' scientific travelogues were compiled thereby.

In above diagram, T_{01} , T_{02} denote knowledge depopulation point of knowledge metabolism time T_A and knowledge metabolism time T_B , which means, when science progress extended to time T_A , as gradual quantitative change of scientific knowledge metabolism, all ready-made knowledge before time T_{01} had been washed out completely, and when science progress extended to time T_B , as gradual quantitative change of scientific knowledge metabolism, all ready-made knowledge before time T_{02} had been washed out completely. And apparently, along time axis, $T_A < T_B$, $T_{01} < T_{02}$, this of course indicates once science progress proceeding to different time T_A and T_B , the depopulation points T_{01} and T_{02} of knowledge metabolism curves have been different. Generally, the more the quantitative change curve extends towards right, the more the depopulation point moves to right. And at the same time, as disparity of scientific knowledge proliferation of time T_A and T_B , the magnitude of any point on knowledge metabolism curve $Z = \beta \{ \alpha[\gamma(t_A), \xi(t_A)] \}$ between T_{02} and T_A is different from the proportionate point on knowledge metabolism curve $Z' = \beta \{ \alpha[\gamma(t_B), \xi(t_B)] \}$ between T_{01} and T_B .

Scientific knowledge proliferation and its first side-effect of scientific knowledge metabolism must stochastically renovate contemporaneous scientific orthodoxy. So-called “temporal social legitimacy” is just a historical phenomenon when science progress proceeding to some certain stage, the historical scientific knowledge proliferation and proper scientific knowledge metabolism relatively settled, the outcome of scientific knowledge proliferation which are still regarded as scientific truth. If we denote “temporal social legitimacy” M_1 , then, “temporal social legitimacy” of certain historical stage can be mathematically expressed as below:

$$M_1 = \int_0^t \alpha[\gamma(t), \xi(t)] dt - \int_0^t \beta \{ \alpha[\gamma(t), \xi(t)] \} dt \quad \dots\dots\dots (A-ii-2)$$

As scientific knowledge proliferation must be affected and restricted by both integrative social circumstances and connatural fundamental of the uniqueness & invariance of ultimate authenticity of nature proportionably predestines the unique possibility of scientific verity as perfect ideological enantiomorph of ultimate authenticity of nature, the quantitative change of scientific knowledge proliferation generally has feature as following:

As historical feasibility & possibility, the practice human coming to discover and formulate authenticity of accessible existence & motion around must experience frondose evolvment of humanistic ideology about authenticity of nature cumulatively enriched from nothingness to groat, from groat to a great lot, and consequently followed proportionate ideaistic correction & qualitative optimization from superficiality to profundity, from parochiality to generality. And as the uniqueness & invariance of ultimate authenticity of nature proportionably predestines the unique possibility of scientific verity as perfect ideological enantiomorph of ultimate authenticity of nature, on one hand, the quantitative change of scientific knowledge proliferation must follow unconditional implementation of scientific knowledge metabolism; the coming progressive scientific knowledge proliferation must gradually lay over and replace foregone knowledge even contemporaneous scientific orthodoxy; and on the other hand, the development of science towards authenticity formulation of nature must permanently orientate to thorough coherence of linear logic system. At any rate, **it's only possible for concordant cosmos to be demiurgic aggradation of out-and-out serial natura naturata in the nature of coherent natura naturans throughout cosmic evolution; there is no way for demiurgic aggradation in the nature of different natura naturans to be concordant cosmos through and through.**

Development of science is firstly hypostatized as quantitative change of scientific knowledge proliferation. Although, quantitative change of scientific knowledge proliferation is always affected and restricted by both integrative social circumstances and connatural fundamental of the uniqueness & invariance of ultimate authenticity of nature proportionably predestines the unique possibility of scientific verity as perfect ideological enantiomorph

of ultimate authenticity of nature through and through, in different development stage of science, the affection and restriction efficiency of integrative social circumstances and connatural fundamental of the uniqueness & invariance of ultimate authenticity of nature proportionably predestines the unique possibility of scientific verity as perfect ideological enantiomorph of ultimate authenticity of nature is obviously different.

When historical progress of science is still inadequate to make it possible for human to review universal existence & motion of matter in cosmos systematically, quantitative change of scientific knowledge proliferation is more remarkably affected and restricted by integrative social circumstances generally related to economy, politics, education, scientific knowledge metabolism & knowledge metabolism campaign, bidirectional syntonic reciprocity between integrative social circumstances and scientific knowledge proliferation is obviously dominant. And only when science apparently begin to orientate to thorough coherence of linear logic system, dominant effect of bidirectional syntonic reciprocity between integrative social circumstances and scientific knowledge proliferation begins to weaken, instead, the affection and restriction of connatural fundamental of the uniqueness & invariance of ultimate authenticity of nature proportionably predestines the unique possibility of scientific verity as perfect ideological enantiomorph of ultimate authenticity of nature become more and more remarkable. Once science is ultimately consummated into single coherent logic system, the quantitative change of successive scientific knowledge proliferation and proportionate scientific knowledge metabolism will present degressive trend, which indicates science has ultimately tally with authenticity of nature and its successive development has been locked by natural authenticity, at any rate, at such stage, no matter how much we devote ourselves to historical progress of science, historical progress of science can not go remarkable aberrancy from ultimate authenticity of nature any longer.

The thorough scientific knowledge proliferation of science progress of human can be approximately studied out as below:

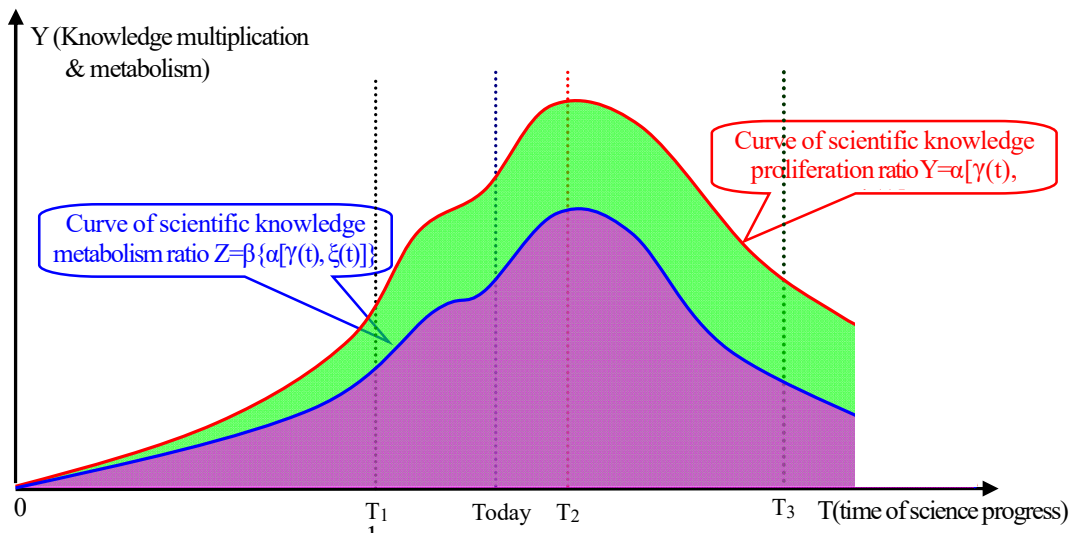

(VIII-iii-14) Characteristic quantitative change curve of historical scientific knowledge proliferation

In above diagram, The T_2 on X axis denotes the moment science turns into thorough coherence of linear logic system. Throughout the process from 0 moment to T_2 moment, the bidirectional syntonic reciprocity between integrative social circumstances and scientific knowledge proliferation is apparently dominant, after T_2 moment, scientific knowledge proliferation is more remarkably restricted by connatural fundamental of the uniqueness & invariance of ultimate authenticity of nature proportionably predestines the unique possibility

Historical progress of science in the recent several centuries seemed like a far-flung exploration of the first itinerary around numerous distinctive landscapes of brand-new landmasses of science with palette & tablet on back, several hundred years' scientific travelogues were compiled thereby.

of scientific verity as perfect ideological enantiomorph of ultimate authenticity of nature.

In accordance with the remarkable discrepancy of sense feature of human, scientific knowledge proliferation throughout historical progress of science can be generally classified into four phases as following:

A) “0~T₁” historical stage——stochastic development of science upon human intuitionistic geist

This stage is the initial civilization stage of human, which started from initial naissance of human on the earth to the early years of 16th century. As limitation of social practice, scientific knowledge proliferation was apparently slow at the stage. And virtually, science had not become social advocacy and dedicated pursuit, scientific knowledge proliferation was obviously limited in gradual aggradation of intuitional perception or experience about existence & motion accessible around.

B) “T₁~Today” historical stage——remarkable scientific knowledge proliferation of scientific travelogues A, B, C, D, E, F, ... of the first itineracy around distinctive landscapes accessible of brand-new landmasses of science.

The historical stage of “T₁~Today” is generally historical range starting at 16th century (about Galleon age) to today. During the course of historical stage, as remarkable increment of scientific knowledge about accessible existence & motion around, intentionally, human began to choose and administrate ideal existence & motion accessible for human necessity of social production and social life. And just because of remarkable applicable efficiency of scientific idea towards necessity of social production & social life, science has become social advocacy and dedicated pursuit, cumulative aggradation of scientific knowledge proliferation consequently became more and more remarkable therefore.

Whereas, no matter how remarkable the quantitative scientific knowledge proliferation was then and there, realistic historical progress of science can never overleap the objective inevitability of successive quantitative & qualitative change of scientific knowledge proliferation from nothingness to groat, from groat to a great lot, from superficiality to profundity, from parochiality to generality, ——in the face of rich and colorful existence & motion accessible in the nature, as crecive progression of practical feasibility & possibility in proportion to contemporaneous historical background, on one hand, human have to look into distinctive landscapes of brand-new landmasses of science one by one for more perception of authenticity of nature; and on the other hand, as primary implication of distinctive landscapes of brand-new landmasses of science one after another without necessary favorable rational background, human had to accomplish humanistic ideology about authenticity of nature in proportion to contemporaneous historical background then and there, such experience of scientific knowledge proliferation was substantively like a far-flung exploration of the first itineracy around numerous distinctive landscapes of brand-new landmasses of science with palette & tablet on back, several hundred years’ scientific travelogues were compiled thereby, although, cosmic status quo is well-regulated homogeneity system as natura naturata subject to coherent natura naturans throughout cosmic evolution.

Of course, several hundred years’ scientific travelogues have remarkably renovated historical legitimacy of science and practically settled commensurate necessity of social production and social life of human then and there. Whereas, scientific travelogues A, B, C, D, E, F, ... of the first itineracy around distinctive landscapes of brand-new landmasses of science are but humanistic ideology about authenticity of nature in proportion to contemporaneous historical background. Since ultimate authenticity of nature can be neither

As coherent natura naturans throughout cosmic evolution, instinctive PNT reciprocal equilibrium towards optimum PNT operation is radical potentiality & conditionality for cosmos always ready to orientate itself towards perfection.

omnifarious authenticity smallwares full of a basket nor authenticity chameleon one piece and only but coherent natura naturans throughout cosmic evolution, as commensurate ideological enantiomorph of accessible existence & motion around us, ultimate consummation of science must be perfect ideological enantiomorph of ultimate authenticity of nature, veritable progress of science is not intuitional cumulative achievement of colorful scientific travelogues A, B, C, D, E, F, ... as deserving reward of the first itineracy around preternatural landscapes of brand-new landmasses of science like omnifarious smallwares full of a basket but successive hypostatic endeavor to push humanistic ideology about authenticity of nature forward to perfect ideological enantiomorph of ultimate authenticity of nature step by step draw on practical feasibility & possibility in proportion to contemporaneous historical background, and before humanistic ideology about authenticity of nature finally qualified as perfect ideological enantiomorph of ultimate authenticity of nature, it's only possible for science to be commensurate ideological system about authenticity of accessible existence & motion in proportion to contemporaneous historical background. Although it's virtually impossible for human to leap over such distinctive stage of historical progress of science with remarkable quantitative change of scientific knowledge proliferation like colorful scientific travelogues A, B, C, D, E, F, ... full of a basket as harvest of the first itineracy around distinctive landscapes of brand-new landmasses of science, we can never show off too much about such decent scientific travelogues as paramountcy.

C) “Today ~ T₂” historical stage—Historical progress of science remarkably approaches perfect ideological enantiomorph of ultimate authenticity of nature due to uniqueness & invariance of ultimate authenticity of nature as coherent natura naturans throughout cosmic evolution.

History of science progress proceeding to today, although we are still unaware of what matter is and what existence & motion of matter is in cosmos, we have substantial knowledge about idiographic existence & motion of objects A, B, C, D, E, F, ... indeed, vivid existence & motion in cosmos has been more and more verisimilitude in our sense. As scientific knowledge aggradation and intelligence resource of coming scientific knowledge proliferation of today, the solid knowledge aggradation about idiographic existence & motion of objects A, B, C, D, E, F, ... apparently has been enough for us to systematically review universal existence & motion in cosmos towards coherent logic system, the so-called “law of identity” of coherent natura naturans throughout cosmic evolution will be found has been practically possible.

In another word, under background of knowledge aggradation is rather considerable; the coming scientific knowledge proliferation of the new century will step into stage of scientific knowledge proliferation from superficiality to profundity, from parochiality to generality, which will lead quantitative change of historical travelogue-style knowledge aggradation into innovative optimization towards coherent logic system about universal existence & motion in cosmos. Of course, the quantitative change of such innovative optimization towards coherent logic system about universal existence & motion in cosmos must bring out unprecedented scientific knowledge metabolism, so that it will make the so-call “scientific truths” less and less, till at last there is unique scientific truth as perfect ideological enantiomorph of ultimate authenticity of nature about universal existence & motion. At any rate, *it's only possible for concordant cosmos to be demiurgic aggradation of out-and-out serial natura naturata in the nature of coherent natura naturans throughout cosmic evolution; there is no way for demiurgic aggradation in the nature of different natura naturans to be concordant cosmos through and through.*

D) “T₂ ~ T₃” historical stage—comprehensive implementation of natura naturans personalization towards human necessity of integrative environment.

Historical progress of science in the recent several centuries seemed like a far-flung exploration of the first itineracy around numerous distinctive landscapes of brand-new landmasses of science with palette & tablet on back, several hundred years' scientific travelogues were compiled thereby.

Once humanistic ideology about authenticity of nature in proportion to contemporaneous historical background finally qualified as perfect ideological enantiomorph of ultimate authenticity of nature, there is unique scientific verity about universal existence & motion and unique subject of science without speciality, so-called “expert” has purely become theatrical pronoun of parochialism and emptiness. In any case, since ultimate authenticity of nature can be neither omnifarious smallwares full of a basket nor authenticity chameleon one piece and only, but coherent natura naturans throughout cosmic evolution, as ideological system about authenticity of nature in proportion to contemporaneous historical background, ultimate consummation of science must be perfect ideological enantiomorph of ultimate authenticity of nature. Motivation of humanistic classification of subjects & subdisciplines has apparently desecrated originality of coherent natura naturans throughout cosmic evolution of the demiurge, and indeed, cosmic status quo is but demiurgic aggradation of sequential homologic cosmogony, which exists as well-regulated integrative cosmic homogeneity system as out-and-out serial natura naturata in the nature of coherent natura naturans throughout cosmic evolution.

At the historical stage, practice of science & technology will mostly focus on accomplishment of “natura naturans personalization towards human necessity”, administrate and utilize ideal existence & motion for favorable applicability for social production and social life so as to ensure comprehensive existence & motion around compatible with social production and social life of human, no matter idiographic existence & motion around us belong to biological category or abiological category.

2.4) Scientific knowledge proliferation with good and bad intermingled on the earth.

Theoretically, under potential synthesized conditionality of “**crecive progression of practical feasibility & possibility in proportion to contemporaneous historical background + the uniqueness & invariance of ultimate authenticity of nature predestines the unique possibility of scientific verity as perfect ideological enantiomorph of ultimate authenticity of nature**” through and through, in different areas or different counties on the earth, the bidirectional syntonic reciprocity between integrative social circumstances and scientific knowledge proliferation must perform in accordance with law of identity in the nature of things. If the bidirectional syntonic reciprocity between integrative social circumstances and scientific knowledge proliferation of any country on the earth performs independently by themselves, the ultimate integrated performance of bidirectional syntonic reciprocity between integrative social circumstances and scientific knowledge proliferation of any country may be generally as illustration of (VIII-iii-14). Whereas, different areas or different countries on the earth virtually have distinctive social circumstances for disparity of historical progress and reciprocal influence of the world, this of course indicates disparity of the proper consequent implementation of scientific knowledge proliferation even implies proportionably different performance of bidirectional syntonic reciprocity between integrative social circumstances and scientific knowledge proliferation.

In accordance with practical effect of bidirectional syntonic reciprocity between integrative social circumstances and scientific knowledge proliferation of human on the earth, if performance of bidirectional syntonic reciprocity between integrative social circumstances and scientific knowledge proliferation of idiographic country or area is relatively pioneering and preponderant, the civilization proliferation of the very country or area is the leading origin of human civilization therefore, and we just call such pioneering and preponderant bidirectional syntonic reciprocity between integrative social circumstances and scientific knowledge proliferation of the

country or area “world dominant bidirectional syntonic reciprocity”. In accordance with practical effect of bidirectional syntonic reciprocity between integrative social circumstances and scientific knowledge proliferation of human on the earth, if performance of bidirectional syntonic reciprocity between integrative social circumstances and scientific knowledge proliferation of idiographic country or area is relatively recessive, the civilization progress of the very country or area is apparently benefited from human civilization subsequently, and we just call such subsequently benefited bidirectional syntonic reciprocity between integrative social circumstances and scientific knowledge proliferation of the country or area “world recessive bidirectional syntonic reciprocity”.

As remarkable disparity of historical progress of society, compared with the developing countries, the integrative social circumstances of the developed countries on the earth are relatively mature and advanced; this of course implies preponderance of bidirectional syntonic reciprocity between integrative social circumstances and scientific knowledge proliferation. As a result, the civilization proliferation of the developed countries is generally the leading origin of human civilization, whose idiographic bidirectional syntonic reciprocity between integrative social circumstances and scientific knowledge proliferation is mostly “world dominant bidirectional syntonic reciprocity”. Comparably, the integrative social circumstances of the developing countries on the earth are relatively uncultured; this of course implies disadvantage of bidirectional syntonic reciprocity between integrative social circumstances and scientific knowledge proliferation. As a result, the civilization proliferation of the developing countries is subsequently benefited from human pioneering civilization, whose idiographic bidirectional syntonic reciprocity between integrative social circumstances and scientific knowledge proliferation is mostly “world recessive bidirectional syntonic reciprocity”.

However, as favored area for subsequent civilization pervasion, science & technology development of developing countries usually possess advantage of reference of prior successful experience of developed countries, once the developing countries are ready to perform and accomplish the similar technologic practice, which the developed countries had successful experience in prior, taking the prior successful experience of developed countries as practical reference, there are apparently less X factors, ambiguity, whose project implementation generally has advantages as goal in focus, less risk, high efficiency and short project cycle. This is of course substantial resource for developing countries to expediently pursue after developed countries. If the developing countries neglect such successful experience of developed countries in implementation of their scientific research and related technologic practice, they will of course lose such advantages, it’s mostly unwise

As one of the typical developing countries on the earth, the bidirectional syntonic reciprocity between integrative social circumstances and scientific knowledge proliferation of China is typical “world recessive bidirectional syntonic reciprocity” too. At any rate, the current integrative social circumstances of China is till under benefit of ready-to-wear purificatory scientific knowledge aggradation of the age, even has not fully assimilated the ready-to-wear purificatory scientific knowledge aggradation of the age. China has brought up neither apparent necessity of pioneering scientific knowledge proliferation nor favorable potential towards pioneering scientific knowledge proliferation. The frondose situation of China is generally as following:

The first: Syntonic reciprocity between social circumstances of Chinese economy and scientific knowledge proliferation

Throughout social working division of integrated worldwide economy, China is enthusiastically taking roles of rough manufacture of the world. And indeed, the most remarkable preponderance of current Chinese

Historical progress of science in the recent several centuries seemed like a far-flung exploration of the first itinerary around numerous distinctive landscapes of brand-new landmasses of science with palette & tablet on back, several hundred years’ scientific travelogues were compiled thereby.

economy is still substantiality of cheap labors. In terms of current corporations of China, most of the Chinese corporations are still in extravagant ambition to buy the first-class machines or facilities of the world so that they can expediently produce the second-class products for the world. Possessing the first-class machines or facilities of the world is usually their extravagant pursuit and great pride. In terms of Chinese products, among Chinese products, there are really few of them in a class by oneself, instead, most of the Chinese corporations are still trying their best to chase vogue of the world with motivation since others are able to manufacture, we must be able to, since others are able to produce it nicely, we must try our best to for self-excitation.

Comparably, the first-class corporations in the world always appreciate the possession of the first-class human resource which are generally top-ranking geniuses or second-string geniuses in the world, so that they can design and produce the first-class products of the world so as to lead the integrative social production of human on the earth. This may be just the root cause why there are corporations as Microsoft, Apple etc and outstanding men as Bill-gates, Jobs etc. in united states, whereas, there are none in mainland of China. All in all, Chinese economy has neither apparent necessity of pioneering scientific knowledge proliferation nor favorable potentiality towards pioneering scientific knowledge proliferation. (Of course, as typical developing country with large amount of population mostly in poor education, current economic situation of China is inevitable historical stage for development, this may be practical and realistic way for Chinese development leastways)

All in all, till today, China has not accomplished its remarkable substantiality of social necessity and practical possibility of pioneering scientific knowledge proliferation, economic operation in mainland of China still has not slidden into ideal benign circle of bidirectional syntonic reciprocity between integrative social circumstances of Chinese economy and scientific knowledge proliferation. Of course, in terms of such a country with so substantial uncultured population, perhaps it has been relatively better situation for their primary development.

The second: Syntonic reciprocity between social circumstances of Chinese politics and scientific knowledge proliferation.

In simple words, so-called “science & technology practice” is but **human endeavor to accomplish possible natura naturans personalization towards human necessity draw on potential facility of proportionable rational capital of live humanistic ideology about authenticity of nature in proportion to contemporaneous historical background** (/基于“物态自然”的理性知悉而力求“物态自然人格化”), straightforward endeavor to personalize available natura naturata in the nature of coherent natura naturans throughout cosmic evolution towards human necessity upon proportionable rational capital of modern ideological enantiomorph of accessible existence & motion around us so as to improve social production and finally satisfy demands of social life as much as possible. In another words, “science & technology practice” is straightforwards endeavor to know authenticity of nature draw on practical feasibility & possibility in proportion to contemporaneous historical background as much as possible, so that it's possible for us to proportionably administrate and utilize ideal existence & motion available around us towards human necessity in accordance with compatible applicability of social production and social life, the so-called “ideal existence & motion available” mentioned herein are of course out-and-out serial natura naturata in the nature of coherent natura naturans throughout cosmic evolution.

This of course indicates:

Favorable prelude of “science & technology practice” is of course possible **authenticity highlight of nature** draw on practical feasibility & possibility in proportion to contemporaneous historical background, which is necessary

As coherent natura naturans throughout cosmic evolution, instinctive PNT reciprocal equilibrium towards optimum PNT operation is radical potentiality & conditionality for cosmos always ready to orientate itself towards perfection.

rational capital for us to know accessible existence & motion around possible facility for practical accomplishment of natura naturans personalization towards human necessity.

Necessary payoff of “science & technology practice” is of course proportionable accomplishment of “natura naturans personalization towards human necessity” on the basis of favorable rational capital of authenticity highlight of nature draw on practical feasibility & possibility in proportion to contemporaneous historical background, which mostly focus on rational administration & utilization of ideal existence & motion in our rational eyeshot towards practical necessity of social production and social life.

Favorable prelude and necessary payoff of “science & technology practice” must be synchronously reciprocal all along.

As favorable precondition for natura naturans personalization towards human necessity, If favorable prelude of “science & technology practice” authenticity highlight of nature is too milk-toast, then, necessary payoff of “science & technology practice” will consequently lack necessary rational capital of authenticity highlight of accessible existence & motion for natura naturans personalization towards human necessity, endeavor of “natura naturans personalization towards human necessity” will be difficult to find necessary ideal existence & motion for favorable applicability in social production and social life.

As favorable precondition of natura naturans personalization towards human necessity, If favorable prelude of “science & technology practice” indulges too much in authenticity highlight of nature but keep a slack hand to possible proportionable “natura naturans personalization towards human necessity”, then, endeavor of authenticity highlight of nature draw on practical feasibility & possibility in proportion to contemporaneous historical background must lack necessary reward, further endeavor of authenticity highlight of nature will be remarkably frustrated therefore, there may be even less and less necessary fund for further authenticity highlight of nature.

All in all, **human endeavor to accomplish possible natura naturans personalization towards human necessity draw on potential facility of proportionable rational capital of live humanistic ideology about authenticity of nature in proportion to contemporaneous historical background** is the most accurate interpretation of “science & technology practice”, which of course indicates, in order to administrate and utilize ideal existence & motion around us for favorable applicability of social production and social life, we must look into authenticity of nature draw on practical feasibility & possibility in proportion to contemporaneous historical background as much as possible, till at last, we approach perfect ideological enantiomorph of ultimate authenticity of nature about universal existence & motion, so that, upon possession of rational comprehension of universal natura naturata in the nature of coherent natura naturans throughout cosmic evolution, universal existence & motion can be accessible resource for intelligent natura naturans personalization towards human necessity self-evidently. Virtually, natura naturans personalization towards human necessity is all we can scientifically accomplish for improvement of social production and social life, scientific creation can never overstep endeavor of “natura naturans personalization towards human necessity”, and human creationary accessibility can never transcend category of out-and-out serial natura naturata in the nature of coherent natura naturans throughout cosmic evolution.

In accordance with disparity of subjective purpose & practical approach, we can generally classify science & technology practice of different regions or countries into two types:

The first type: Pioneering originator of natura naturans personalization towards human necessity.

The second type: Greedy imitator after pioneering natura naturans personalization towards human necessity.

So-called “pioneering originator of natura naturans personalization towards human necessity”, is just the pioneering

Historical progress of science in the recent several centuries seemed like a far-flung exploration of the first itinerary around numerous distinctive landscapes of brand-new landmasses of science with palette & tablet on back, several hundred years’ scientific travelogues were compiled thereby.

implementors, who are always ready to discover and comprehend the authenticity of nature as much as possible draw on practical feasibility & possibility in proportion to contemporaneous historical background, so that it's practically possible for them to administrate and utilize the ideal existence & motion accessible around for applicable personalization in accordance with social necessity, so that their endeavor can accomplish practical necessity of social production and social life in the nature of things, which is of course the most realistic and feasible way for human to know authenticity of nature and purposefully administrate & utilize ideal existence & motion accessible around us towards applicable accomplishment of practical necessity of social production and social life.

Historical occurrence of **"pioneering originator of natura naturans personalization towards human necessity"** is the most remarkable indication of advancement of human civilization, whose core worthiness is that, draw on practical feasibility & possibility in proportion to contemporaneous historical background, they are always ready to discover and comprehend authenticity of nature as much as possible, and just because of further rational highlight of authenticity of nature, more ideal existence & motion around us become self-evidently accessible for practical accomplishment of natura naturans personalization towards human necessity.

In terms of human resource, the **pioneering originator of natura naturans personalization towards human necessity** are always top-ranking geniuses and second-string geniuses of the age. After all, the innovative ideal existence & motion are mostly found by either top-ranking geniuses or second-string geniuses following the rational guidance of top-ranking geniuses.

After all, social production is but human endeavor & practice to administrate and utilize ideal existence & motion accessible around towards applicable accomplishment of practical necessity of social production and social life. Intelligent natura naturans personalization of ideal existence & motion under precondition we've comprehended more authenticity of nature draw on practical feasibility & possibility in proportion to contemporaneous historical background is of course the most realistic and best way for improvement of social production and social life, and innovation of pioneering natura naturans personalization towards human necessity is of course the most remarkable advancement of human civilization. Virtually, innovators of pioneering natura naturans personalization towards human necessity are just the pacemakers of science & technology on the earth.

So-called **"greedy imitator after pioneering natura naturans personalization towards human necessity"** is mostly successive imitation practice after practical accomplishment of pioneering natura naturans personalization towards human necessity, as in greedy admiration of wonderful innovative output of the scientific pacemakers on the earth for pioneering natura naturans personalization towards human necessity, people who have not synchronously involved in the pioneering natura naturans personalization towards human necessity are greedy to learn and imitate the proper science & technology practice of the scientific pacemakers who are pioneering originators of natura naturans personalization towards human necessity for the same or similar technologic products.

The most remarkable discrepancy between **"pioneering originator of natura naturans personalization towards human necessity"** and **"greedy imitator after pioneering natura naturans personalization towards human necessity"** is that, in order to accomplish ideal natura naturans personalization towards human necessity, **pioneering originator of natura naturans personalization towards human necessity** has to look into authenticity of nature in prior, otherwise, none ideal existence & motion can be accessible resource for natura naturans personalization towards human necessity; whereas, in terms of **"greedy imitator after pioneering natura naturans personalization towards human necessity"**, it's obviously unnecessary for them to bet a lot for original discovery or clarification of authenticity of nature draw on practical

feasibility & possibility in proportion to contemporaneous historical background. In any case, as **pioneering originator of natura naturans personalization towards human necessity** has brought out perfect products in prior, project pursuit of “**greedy imitator after pioneering natura naturans personalization towards human necessity**” has been ready-made scientific idea early, which mostly lay particular stress on learning and imitating **pioneering originator of natura naturans personalization towards human necessity** for accomplishment of practical output of similar products.

In another words, the ostensible purpose of **greedy imitators after pioneering natura naturans personalization towards human necessity** is that, since others are able to manufacture, we must be able to. Social practice of “**greedy imitators after pioneering natura naturans personalization towards human necessity**” mostly lay particular stress on learning and imitating the scientific pacemakers for practical accomplishment of output of similar products, who engaged in the proper “**pioneering natura naturans personalization towards human necessity**” in prior. As a result, in terms of necessary talent for imitation of **pioneering natura naturans personalization towards human necessity**, some excellent third-rate talents are usually enough for the jobs. After all, they are but endeavor for “**since others were able to manufacture, we must be able to**”. Of course, if possible, attendance of related “top-rank geniuses” and “second-string geniuses” is even advantage to ensure and expediate the science & technology practice of **greedy imitators after pioneering natura naturans personalization toward human necessity**.

Undoubtedly, the science & technology practice of **greedy imitators after pioneering natura naturans personalization towards human necessity** is typical imitative endeavor of the scientific pacemakers of **pioneering originators of natura naturans personalization towards human necessity** on the earth.

As top building of Chinese economy, Chinese politics generally has the common tune of Chinese economy in science & technology practice, — **since others are able to manufacture, we must be able to, since others are able to produce it nicely, we should try our best to**. Compared with the developed countries in the world, nowadays China is typical “**greedy imitators after pioneering natura naturans personalization towards human necessity**”. The scientific projects Chinese government supported have poor original pursuit of discovery or clarification of authenticity of nature. And usually, when Chinese government came to schedule important scientific projects, they were always ready to refer to whether the occident counties had ever implemented the similar scientific projects in prior, and what’s the practical effect of the proper projects. The research items occident countries had never implemented in prior, Chinese government usually are not willing to arrange them rashly, and virtually, they do not have adequate resource to arrange them, especially China lack necessary human resource of top-ranking geniuses or second-string geniuses in scientific exploration, even lack historical background aggradation of **pioneering originators of natura naturans personalization towards human necessity** in the recent several centuries.

This of course implies, on one hand, scientific knowledge proliferation rooted in social circumstances of mainland of china is generally under shadow of occidental developed countries, there is really few supereminent harvest of science and technology in china which is relatively pioneering of the age. Even the A-bomb, H-bomb, the first satellite projects of China, they did never indicate China has procured any supereminent achievement in science & technology but stimulated several third-rate talents of technologic artisan kind and came true **since others are able to manufacture, we must be able to**. And on the other hand, as Chinese government adequately exerted advantage of occidental prior experience reference, although, compared to occident, China still has not completely eliminate the remarkable disparity of science & technology, China really achieved a lot for such pressing endeavor.

Whereas, something worthy of emphasis is that, in the coming 20 years, Chinese advantage to invoke occidental prior experience will be fainter and fainter, 20 years later, there may be none prior experience reference

Historical progress of science in the recent several centuries seemed like a far-flung exploration of the first itinerary around numerous distinctive landscapes of brand-new landmasses of science with palette & tablet on back, several hundred years’ scientific travelogues were compiled thereby.

accessible, it should be time for Chinese to acclimate themselves towards transition of science & technology practice from “greedy imitators after pioneering natura naturans personalization towards human necessity” to “pioneering originators of natura naturans personalization towards human necessity”.

Something even worthy of emphasis herein is that, Chinese economy has not brought up athirst demands and active traction for scientific knowledge proliferation towards authenticity highlight of nature, this directly makes Chinese politics do its job to scientific knowledge proliferation like monkey exaltedly acting overlord in a mountain for absence of tiger. In mainland of China, social importance even authenticity of science mostly adulterated political sense for remarkable predominance of political necessity. What's more, mainland of China is a typical autocratic country, there is popularity of “social perdue regulation” going without saying, which is mostly related to official rank, money, guanxi etc. Under such political ambiance, technological practitioners in mainland of China have to spend a lot for various esoteric official coquetry for promotion, project support etc, otherwise, you will be out.

And on the other hand, mainland of China devotes more to actualization of off-the-peg scientific idea, such as production of A-bomb, rocket, aircraft, satellite CMOS chip etc., whereas, they do not devote too much for exploration of authenticity of nature. And virtually, the most important academicians in mainland of China are mostly the several technological artisans who were remarkably meritorious to production actualization of A-bomb, rocket, aircraft, satellite etc., there were few people who had pioneered authenticity highlight of nature or natura naturans personalization towards human necessity as number 1 in the world, no more a group of scientists who lead development of science of human.

Of course, we were substantively disadvantaged and poor that years, we had none big-league scientists in the world, and it's even impossible for us to possess of a lot of big-league scientists in the world. It virtually had been rather worthy of felicitation that we had found several excellent technological artisans and actualized technological production of A-bomb, rocket, aircraft, satellite etc, whereas, it's apparently not all we should do for development of science & technology.

Practice of **greedy imitator after pioneering natura naturans personalization towards human necessity** with practical advantage of reference of occidental successful experience can of course reduce the disparity of science & technology between us and the occident, whereas, endeavor can never be effective approach for us to transcend occident in practice in science & technology, after necessary and expedient implementation of **greedy imitator after pioneering natura naturans personalization towards human necessity**, we must acclimate ourselves for necessary turnaround from **greedy imitator after pioneering natura naturans personalization towards human necessity** to **pioneering originator of natura naturans personalization towards human necessity**. Organize a group of “third-rate talents” towards practical accomplishment “since others were able to manufacture, we must be able to” is of course effective and considerable, whereas, endeavor to organize a group of “third-rate talents” to transcend occident in science & technology is of course wishful thinking funny. The unique possible approach for Chinese science & technology to transcend occident is that we have procured advantage of rational capital of humanistic ideology about authenticity of nature in proportion to contemporaneous historical background, so that we possess more rational capital for proportionable accomplishment of natura naturans personalization towards human necessity, which of course implies we must procure advantage in authenticity highlight of nature in prior, then accomplish epochmaking new products by practice of proportionate **pioneering originator of natura naturans personalization towards human necessity**.

In any case, scientific creation is but endeavor of natura naturans personalization towards human necessity

As coherent natura naturans throughout cosmic evolution, instinctive PNT reciprocal equilibrium towards optimum PNT operation is radical potentiality & conditionality for cosmos always ready to orientate itself towards perfection.

under background of favorable authenticity highlight of nature draw on practical feasibility & possibility in proportion to contemporaneous historical background, which can never overstep endeavor of “natura naturans personalization towards human necessity”, human creationary accessibility can never transcend category of natura naturata in the nature of coherent natura naturans throughout cosmic evolution. In order to accomplish “natura naturans personalization towards human necessity” as much as possible, we must know more authenticity of nature in prior, advanced scientific knowledge is the most substantial capital for us to accomplish “natura naturans personalization towards human necessity for social production & social life”, only we’ve comprehended more authenticity of nature, it’s possible for us to accomplish more of “natura naturans personalization towards human necessity of social production and social life”. The key issue for science & technology level of China to be equivalent or even above science & technology level of occident is that we should know more authenticity of nature as substantial rational capital towards practical accomplishment of “natura naturans personalization towards human necessity”. Without solid intelligence backup of “top-ranking geniuses” & “second-string geniuses”, nothing can change our technologic role of greedy imitator after pioneering natura naturans personalization towards human necessity.

The third: Syntonic reciprocity between Chinese education and scientific knowledge proliferation

Education of China is typical examination-oriented education system:

Before examination ~ recite books bitterly; after examination ~ throw books into fire!

Once left school ~ no books are necessary; in the face of the unknown ~ perplex for reading none books related ever since!

In mainland of China, the most effective function of knowledge is to procure test scores, once come out of examination hall, test scores have been foregone conclusion, knowledge seems no use any longer.

China is of course qualified to be one of the venerable civilization countries in the world for its 5000 years’ succession of history of civilization. However, once we come to review Chinese education in accordance with modern criterion, it may be but occurrence after the so-called “great civilization revolution” in mainland of China (1966-1976), whose life time is still less than half century till today. Generally, Chinese education still maintains its initial and unconditioned catering for absorption as subsequent pervasion area of human civilization on the earth, but has not remarkably brought up active stimulation to human civilization renovation and further proliferation.

It might be just because China lacked experience to navigate development of science of human in the recent 1000 years, especially, in the recent 300 years, science & technology of China was apparently backward, learning the ready-made scientific knowledge is of course the most expedient way for Chinese to catch up with the tide of the age. What’s more, as typical **Greedy imitator after pioneering natura naturans personalization towards human necessity** country, the keynote of scientific practice of China is that “**since others can produce, we must be able to; since others can produce it so well; we must try our best to**”, which are of course typical business pursuit to bring third-rate talents into full play. As a result, third-rate talents who have modern ready-made knowledge are the most popular talents ③ in China in the recent half century.

Colleges and universities in mainland of China are mostly third-rate talent manufactory, even as permanent keynote of scientific practice of China——**since others can produce, we must be able to; since others can produce it so well; we must try our best to** in the recent half century, most of the academicians in CAS are but typical third-rate talents who are mostly meritorious in scientific practice of China in the recent half century, which generally brought third-rate talents into full play. There are few second-string geniuses who are meritorious to historical

Historical progress of science in the recent several centuries seemed like a far-flung exploration of the first itinerary around numerous distinctive landscapes of brand-new landmasses of science with palette & tablet on back, several hundred years’ scientific travelogues were compiled thereby.

progress of science under background of royal substantiation & perfection of contemporaneous scientific orthodoxy, no more top-ranking geniuses who had ever brought out epochmaking scientific innovation. And virtually, ever since World War II, there are none top-ranking geniuses in scientific fields on the earth, most of the second-string geniuses distribute in occident, there are few second-string geniuses in mainland of China.

Whether a university is the top-rank one on the earth mostly depends on how much it is doing to lead development of human civilization but not how much ready-made knowledge it has disseminated.

And just because of this, talent criterion in mainland of China is almost straightforward ruler of third-rate geniuses, so-called talent is but straightforward carton of ready-made knowledge, whether you are really talent, big talent or small talent radically depends on how much ready-made modern knowledge has been filled in your brain, but has less to do with your innovation ability. Comparably, the second-string geniuses seem derelict in duty and run irrelevant business, the top-ranking geniuses even seem reactionaries against the grain.

And indeed, daily operation of Chinese education is mostly limited in initiating ready-made knowledge to students, throughout Chinese education system, students are mostly demanded to recite sutra, comprehend the ready-made fundamentals of humanistic ideology about authenticity of nature in proportion to contemporaneous historical background and fill up their normal answers in examinations, there is faint endeavor to bring up active stimulation of renovation or further proliferation of human civilization. And virtually, 80% Chinese universities are but manufactory of third-rate talents, who are always ready to facilitate their students to recite relevant classic knowledge in historical aggradation and fill up their normal answers in examinations, 20% Chinese universities have some a little function to cultivate second-string geniuses for the society, more than 60% second-string geniuses in mainland of China are importations who had ever studied abroad in occident, the homegrown second-string geniuses are relatively rough and sleazy.

In another even figurative word, in Chinese education practice, so-called “knowledge” is but a big tree, practical endeavor of education is ready to facilitate students to approach the top branches of the big tree but torpid and faint to treat the students coming human resource of the age and exert a subtle influence on them to make them a part of the big tree so as to deal in continuative pullulation of the big tree. Virtually, the scientific knowledge aggradation of today is apparently better than that of yesterday, the excellence of scientific knowledge aggradation of today is but outcome of endeavor of students of yesterday, and excellence of scientific knowledge aggradation of tomorrow of course need further endeavor of students of today. At any rate, education should not only encash succession of ready-made civilization but also should make coming civilization increment inevitable with powerful potentiality; advanced education is especially responsible to do the major job towards it.

In the passed 31 Years, development of China mostly existed in China having accomplished proportionate production scale with middle & low level technology in proportion to 14 billion population and consequently incarnated solid existence under background of global integrated economy. Whereas, in coming 30 years, if China could not accomplish human resource transition from labor preponderance to intelligence preponderance for further development, China would have nothing to challenge advantage of united states but to challenge coordinative advantage of India. Of course, as economic development in recent 31 years, Chinese economy has begun doing its active job to education, it seems good tendency to accomplish favorable climate for scientific knowledge proliferation. China needs pioneering creative education.

May 2014 ~ Dec 2014, Dongguan city, Shatian town, Dani village, Nanxing manufactory

Note ③: I mentioned that Chinese practice of science & technology is business pursuit to mostly bring third-rate talents into full play had no intention to demote Chinese practice of science & technology, but straightforwardly to be free with status quo of Chinese practice of science & technology so as to highlight the necessity of challenge for Chinese science & technology to transcend accident science & technology and lead development of science of human. What's more, there is apparent objectivity of popularity of third-rate talents in mainland of China.

Humanistic pursuit of science & technology is **natura naturans personalization towards human necessity**. Universal existence & motion must be subject to inherent regularity as what I emphasize cosmos is throughout homogenous originated from unique genesis, cosmic status quo is demiurgic aggradation of sequential homologous cosmogony, which exactly exists as well-regulated integration of cosmic homogeneity system making up of out-and-out serial **natura naturans** in the nature of coherent **natura naturans** throughout cosmic evolution. Human have no craftsmanship to create or revise authenticity of nature, but capability to know authenticity of nature as much as possible draw on practical feasibility & possibility in proportion to contemporaneous historical background and implement proportionate **natura naturans personalization towards human necessity** accordingly. Humanistic pursuit of science & technology is to comprehend authenticity of nature as much as possible and then make known distinctive existence & motion tally with necessity of social production & social life accordingly, before we comprehend proper authenticity of nature, nothing can support proportionate technologic accomplishment as **natura naturans personalization towards human necessity**.

As typical country of **greedy imitator after pioneering natura naturans personalization towards human necessity**, in the recent 70 years, the classes of China did not mind too much of authenticity exploration of nature so as to know regular existence & motion accessible around us as much as possible for potential **natura naturans personalization towards human necessity**. They mostly stared at the wonderful output like A-bump, rocket, aircraft, satellite, satellite navigation, ... CMOS chip of **pioneering originators of natura naturans personalization towards human necessity** and eagerly managed for imitation——since others can produce at the volley, we must be able to.

This is of course not inherent cause and effect of **natura naturans personalization towards human necessity**, no more inherence of **pioneering originators of natura naturans personalization towards human necessity**, but shortsighted greedy ambition for technology. Before Chinese people can work as coordinate **pioneering originators of natura naturans personalization towards human necessity** as the occidental peoples, as long as occidental **pioneering originators of natura naturans personalization towards human necessity** are still doing their jobs ever since, in coming days, there is no way for Chinese people to evade how-do-you-do before competitive challenge of unexpected technologic occurrence like A-bump, rocket, aircraft, satellite, satellite navigation, ... CMOS chip etc.

When can Chinese surpass shortsighted greedy ambition since others can produce, we must be able to?

When can Chinese people work as normal **pioneering originators of natura naturans personalization towards human necessity** with background intelligence of 1.4 billion of peoples?

The best approach of development of science & technology is that **development of science & technology and development of economics** accomplishes optimum bidirectional syntonetic reciprocity in monofier modality, and the necessary precondition of optimum bidirectional syntonetic reciprocity in monofier modality is that **development of science & technology and development of economics** must accomplish optimum reciprocal correlation, only development of science & technology can practically serve development of economics as much as possible, there is proportionable potentiality for social economics to reserve development of science & technology, there is practical possibility for **development of science & technology and development of economics** to accomplish optimum bidirectional syntonetic reciprocity in monofier modality as typical benign circle.

In accordance with the reality of integrative social conditions especial economic conditions of China in the

Historical progress of science in the recent several centuries seemed like a far-flung exploration of the first itinerary around numerous distinctive landscapes of brand-new landmasses of science with palette & tablet on back, several hundred years' scientific travelogues were compiled thereby.

recent 20 years, in order to accomplish optimum reciprocal correlation between Chinese development of science & technology and Chinese development of economics towards optimum bidirectional syntonic reciprocity in monofier modality as typical benign circle, it seemed impossible for Chinese development of science & technology to transcend the progressive stage of “since others can produce, we must be able to; since others can produce it so well; we must try our best to”, which obviously seems down-to-earth with explicit and reliable pursuit. The key issue is that we must be aware that, once we have practically accomplished the pursuit of “since others can produce, we must be able to; since others can produce it so well; we must try our best to”, the successive business pursuit must be endeavor to deal in second-string geniuses and top-ranking geniuses. No second-string geniuses and top-ranking geniuses for us to deal in, there is no way for us to lead development of science & technology of human, no favorable social conditions for pullulation and management of second-string geniuses and top-ranking geniuses, we even lack necessary precondition to lead development of science & technology of human.

Of course, so sensitive factuality is commented herein by lowdown man of the society as me is apparent hazardous behavior like attacking honeycomb with bare hands recklessly, whereas, I have to comment herein, current scientific talent repertory in mainland of China is self-evident consequence in proportion to permanent keynote of scientific practice of China in the recent half century that since others can produce, we must be able to; since others can produce it so well; we must try our best to, which is mostly business pursuit to bring third-rate talents into full play and progressive expedience of scientific practice of China due to distinctive historical background. As straightforward man, I have to speak out the simple factuality off the cuff.

(VIII-iv) Optimum Accomplishment of Scientific Knowledge Proliferation in Conditionality of integrative social circumstances

Abstract: *We mention optimum accomplishment of scientific knowledge proliferation in conditionality of is ready to pursue **optimum bidirectional syntonic reciprocity** between integrative social circumstances and scientific knowledge proliferation in accordance with inherent operational correlation between integrative social circumstances as economy, politics, education, scientific knowledge metabolism & scientific knowledge metabolism campaign etc. and scientific knowledge proliferation. We should not only do our best for optimum consequent implementation of integrative social circumstances as economy, politics, education, scientific knowledge metabolism & scientific knowledge metabolism campaign etc towards scientific knowledge proliferation but also should do our best for optimum consequent implementation of scientific knowledge proliferation towards integrative social circumstances as economy, politics, education, scientific knowledge metabolism & scientific knowledge metabolism campaign etc.*

Keywords: *contemporaneous scientific orthodoxy of scientific knowledge, optimum bidirectional syntonic reciprocity, circumfluent value of bidirectional syntonic reciprocity, circumfluence ratio of bidirectional syntonic reciprocity, eulogistic scientific knowledge proliferation in rigid succession of contemporaneous scientific orthodoxy, aberrant scientific knowledge proliferation out of succession of contemporaneous scientific orthodoxy, historical legitimacy of science, scientific knowledge livability of contemporaneous scientific orthodoxy, scientific knowledge metabolism ratio of contemporaneous scientific orthodoxy, lineal logic extension in rigid succession of contemporaneous scientific orthodoxy, historical authenticity tolerance of science, jurisdiction of free press regulation customization of science, jurisdiction of free press admittance arbitrament of science.*

1. Inherent operational correlation between scientific knowledge proliferation and integrative social circumstances.

Integrative social circumstances and scientific knowledge proliferation can spontaneously accomplish bidirectional syntonic reciprocity. We sparkplug optimum consequent implementation of scientific knowledge proliferation derived from integrative social circumstances is ready to administrate and optimize the practical operation of bidirectional syntonic reciprocity in accordance with the ingenerate correlation between integrative social circumstances and scientific knowledge proliferation so as to perfect the quantitative change linkage of sequential leading quantitative change towards driven quantitative change (For convenience of expression, we abbreviate leading quantitative change towards driven quantitative change “leading → driven quantitative change”) throughout integrated operation of bidirectional syntonic reciprocity, so that we approach **optimum bidirectional syntonic reciprocity** between integrative social circumstances and scientific knowledge proliferation.

1.1. Optimum bidirectional syntonic reciprocity between scientific knowledge proliferation and integrative social circumstances

The operational relationship of bidirectional syntonic reciprocity of the nature and society is usually reticula, in time current, one leading quantitative change can omnidirectionally accomplish multiple bidirectional syntonic reciprocity with available ambient objects, and at the same time, the dynamic existence of one driven quantitative change maybe result in superposition of multiple leading quantitative change. In order to analyze the

bidirectional syntonic reciprocity between integrative social circumstances and scientific knowledge proliferation due to presence and historical evolution of integrative social circumstances, we must comprehend the historical causality of elementary factors of social conditions above all, then to know all the active reticular relationship with practice of scientific knowledge proliferation with idiographic leading→driven quantitative changes involved in. Virtually, operation of bidirectional syntonic reciprocity between integrative social circumstances and scientific knowledge proliferation is very similar as a physical machine whose operational efficiency & quality radically depend on the functional configuration & capability of the machine.

At any rate, both initial coming into being and far evolvment of society are all outcome of material existence & motion in the nature as high rank consequent implementation. In a straightforward word, presence of society is but durable segment of high rank consequent implementation of existence & motion of matter in the nature, although, such durable presence of high rank consequent implementation of existence & motion of matter has brought out so remarkable modality discrepancy to nature, it can never bring out radical regularity discrepancy to nature. Compared with universal existence & motion of matter in the nature, characteristic existence & motion of society is virtually outcome of physical consequent implementation of nature according to fundamental in rule of identity too. After all, **it's only possible for concordant cosmos to be demiurgic aggradation of out-and-out serial natura naturata in the nature of coherent natura naturans throughout cosmic evolution; there is no way for demiurgic aggradation in the nature of different natura naturans to be concordant cosmos through and through.**

The simpler consequent implementation in the nature, the more straightforward for it to hypostatize inward regularity of nature, the more complex consequent implementation in the nature the more magic for it to weave law of identity of nature into vivid phenomena kaleidoscope so as to make the nature complicated and confusing. The reason regularity of existence & motion of society is relatively more blurry than regularity of existence & motion of matter in the nature is that, compared with consequent implementation of nature, consequent implementation of society contains relatively higher rank and more complex action linkage, whereas, the existence & motion of society can never transcend regularity of existence & motion of matter in the nature.

Once we are ready to analyze and value quality & functional capability of a machine for improvement accordingly, we must analyze and value the idea of initial contrive and the physical structure above all so as to be aware of how the machine was originally designed in accordance with practical functional necessity under certain technologic background, by what kind of functional operation under proper external conditions to accomplish what kind of functional output; for the very functional output, the machine introduced what kinds of compositive functional units and how all the compositive functional units were ultimately organized systematically for integration of the machine.

In terms of single compositive functional unit, we must review whether the initial definition of the single compositive functional unit exactly tallies with the integrative functional necessity of the whole machine and whether introduction of the proper compositive functional unit has practically satisfied the proper functional necessity. Besides these, it is still necessary for us to consider the reliability and technical cost.

In terms of the whole machine, we must go deep into analysis and evaluation of whether introduction of all compositive functional units is appropriate, (**inadequacy must cause functional careless omission or weakness; more must cause cost overstaffed**) whether overall arrangement of all compositive functional units is logical, whether integrated operation is unisonous and reliable, whether operation is safe and expedient and whether operational energy

cost is oecumenical and so on. Then, optimize the proper function in accordance with the proper analysis & evaluation and practical availability of technologic resource.

Once we are ready to consider the potential feasibility of optimum bidirectional syntonic reciprocity of operation of common bidirectional syntonic reciprocity between idiographic integrative social circumstances and scientific knowledge proliferation, we must go deep into analysis of the operational mechanism of bidirectional syntonic reciprocity between idiographic integrative social circumstances and proper scientific knowledge proliferation. Although, different countries, different area have distinctive integrative social circumstances and consequently have distinctive performance of bidirectional syntonic reciprocity between their idiographic integrative social circumstances and proper scientific knowledge proliferation, generally, the bidirectional syntonic reciprocity between integrative social circumstances related to economy, politics, education, scientific knowledge metabolism & knowledge metabolism campaign and proper scientific knowledge proliferation has its general operational mechanism as below:

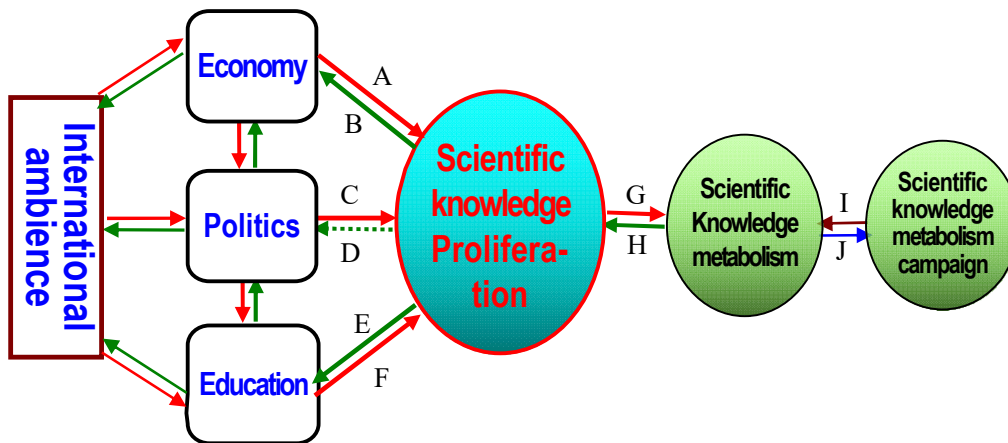

(VIII-iv-1) General operational mechanism of bidirectional syntonic reciprocity

The connotation denoted by crisscross-rows A, B, C, D, ..., I, J are just the same crisscross-rows in diagram (A-ii-8).

The meaning different areas, different countries have their distinctive integrative social circumstances is as following:

The first, located on the same earth, different areas, different countries have their distinctive international surroundings, in another word, international surrounding has its relativity connotation, at the same historical age, to China, international surroundings may be green, to Russia, international surroundings may be red, to united States, international surroundings may be blue, In terms of integrative social circumstances of some certain country, different color of international surroundings of course means different surrounding domino effect, which practically do different job to it.

The second, at the same historical age, as disparity of historical origin and development degree, different areas, different countries inherently have their distinctive integrative social circumstances related to social economy, politics, education, scientific knowledge metabolism & knowledge metabolism campaign.

Once the distinctive integrative social circumstances of different areas or different countries involve in idiographic bidirectional syntonic reciprocity between integrative social circumstances and proper scientific

knowledge proliferation, if of course means different operation domino effect of the idiographic bidirectional syntonic reciprocity between distinctive integrative social circumstances and proper scientific knowledge proliferation.

The leitmotiv we sparkplug optimum bidirectional syntonic reciprocity between integrative social circumstances and proper scientific knowledge proliferation is as following:

- i) When integrative social circumstances exist as external condition of scientific knowledge proliferation, we try to ensure action mellifluence of positive consequent implementation of favorable quantitative change of integrative social circumstances related to economy, politics, education, scientific knowledge metabolism & knowledge metabolism campaign etc towards scientific knowledge proliferation.
- ii) When scientific knowledge proliferation exists as external condition of integrative social circumstances, we try to ensure action mellifluence of inverse consequent implementation of favorable quantitative change of scientific knowledge proliferation towards integrative social circumstances related to economy, politics, education, scientific knowledge metabolism & knowledge metabolism campaign etc.

In order to put the leitmotiv into effect of operational mechanism of bidirectional syntonic reciprocity between integrative social circumstances and scientific knowledge proliferation, we should not only know well of historical causality of the related social factors, —try to be aware of how the related social factors originally coming into being under proper background even subsequent effect and evolvment, but also we should go deep into clarifying the ongoing correlation between various surrounding factors and practice of scientific knowledge proliferation and ascertaining **circumfluent value of bidirectional syntonic reciprocity and circumfluence ratio of bidirectional syntonic reciprocity** of leading quantitative change of various surrounding factors towards driven quantitative change of scientific knowledge proliferation.

In rather a long historical age, local development and evolvment of social economy, politics, education, knowledge metabolism & scientific knowledge metabolism of different areas or different countries was almost independent. Till today, although development of the seven seas has slide into union pattern being closely bound up, integrative social circumstances of different areas or different countries generally related to economy, politics, education, scientific knowledge metabolism & knowledge metabolism campaign are still colorful and sundry before us. Such situation of course implies, as remarkable disparity of parochial social conditions, we are really difficult to review so colorful and sundry social conditions in coherent criterion. For expedience, we straightforwardly enter topic of **circumfluent value of bidirectional syntonic reciprocity and circumfluence ratio of bidirectional syntonic reciprocity** of leading quantitative change of various surrounding factors towards driven quantitative change of scientific knowledge proliferation.

The integrated quantitative operation of bidirectional syntonic reciprocity generally makes up of parrell ongoing quantitative change of leading quantitative change towards driven quantitative change and driven quantitative change towards leading quantitative change. We call the quantitative change of leading quantitative change towards driven quantitative change “obverse quantitative change of bidirectional syntonic reciprocity”, and we denote it with crisscross-row “ \mathcal{C} ”; we call the quantitative change of driven quantitative change towards leading quantitative change “inverse quantitative change of bidirectional syntonic reciprocity”, and we denote it with crisscross-row “ \mathcal{L} ”. Once social economy and scientific knowledge proliferation accomplish

parochial bidirectional syntonic reciprocity ①, the obverse quantitative change of parochial bidirectional syntonic reciprocity of leading quantitative change of economy towards driven quantitative change of scientific knowledge proliferation can be denoted as “ Φ_A ”, subscript “A” means the quantitative change connotation of obverse quantitative change of parochial bidirectional syntonic reciprocity of leading quantitative change of economy towards driven quantitative change of scientific knowledge proliferation is “A”, which has been introduced in correlation between social economy and scientific knowledge proliferation in prior; the inverse quantitative change of parochial bidirectional syntonic reciprocity of driven quantitative change of scientific knowledge proliferation towards leading quantitative change of social economy can be denoted as “ \mathcal{E}_B ”, subscript “B” means the quantitative change connotation of inverse quantitative change of parochial bidirectional syntonic reciprocity of driven quantitative change of scientific knowledge proliferation towards leading quantitative change of social economy is “B”, which has been introduced in correlation between social economy and scientific knowledge proliferation in prior.

As analogies in series, once politics and scientific knowledge proliferation accomplish parochial bidirectional syntonic reciprocity, the obverse quantitative change of parochial bidirectional syntonic reciprocity of leading quantitative change of politics towards driven quantitative change of scientific knowledge proliferation can be denoted as “ Φ_C ”, and inverse quantitative change of parochial bidirectional syntonic reciprocity of driven quantitative change of scientific knowledge proliferation towards leading quantitative change of politics can be denoted as “ \mathcal{E}_D ”. Once education and scientific knowledge proliferation accomplish parochial bidirectional syntonic reciprocity, the obverse quantitative change of parochial bidirectional syntonic reciprocity of leading quantitative change of education towards driven quantitative change of scientific knowledge proliferation can be denoted as “ Φ_E ”, and inverse quantitative change of parochial bidirectional syntonic reciprocity of driven quantitative change of scientific knowledge proliferation towards leading quantitative change of education can be denoted as “ \mathcal{E}_F ”. Added the connotation of obverse quantitative change of parochial bidirectional syntonic reciprocity and inverse quantitative change of parochial bidirectional syntonic reciprocity into general operational mechanism of bidirectional syntonic reciprocity through and through, we can arrive at integrative illustration of general operational mechanism of bidirectional syntonic reciprocity with connotation of both obverse quantitative change of parochial bidirectional syntonic reciprocity and inverse quantitative change of parochial bidirectional syntonic reciprocity as below:

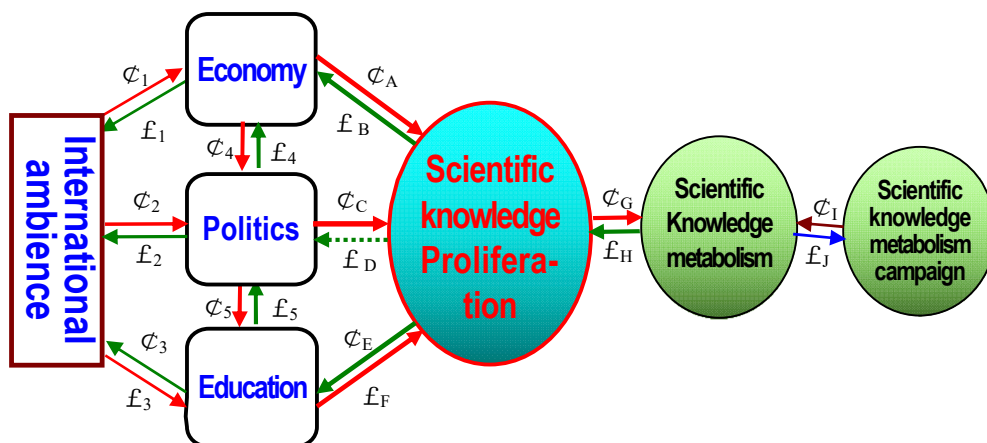

(VIII-iv-2) General operational mechanism of bidirectional syntonic reciprocity with circumfluence value of bidirectional syntonic reciprocity indicated in

Historical progress of science in the recent several centuries seemed like a far-flung exploration of the first itinerary around numerous distinctive landscapes of brand-new landmasses of science with palette & tablet on back, several hundred years' scientific travelogues were compiled thereby.

Note ①: the reason I have to call the bidirectional syntonic reciprocity between social economy and scientific knowledge proliferation “parochial bidirectional syntonic reciprocity” is but because it is almost impossible for social economy and scientific knowledge proliferation to accomplish bidirectional syntonic reciprocity independently, no more isolated optimum bidirectional syntonic reciprocity. That's to say, once social economy and scientific knowledge proliferation accomplish bidirectional cause and effect domino effect, there must be some other active factors involved in. in subsequent sections, we mention parochial bidirectional syntonic reciprocity between scientific knowledge metabolism & knowledge metabolism campaign and scientific knowledge proliferation is just the same reason.

If we can perform quantitative conversion between obverse quantitative change of parochial bidirectional syntonic reciprocity “ \mathcal{C} ” and inverse quantitative change of parochial bidirectional syntonic reciprocity “ \mathcal{F} ”, it will be very easy for us to find that obverse quantitative change of parochial bidirectional syntonic reciprocity “ \mathcal{C} ” is always bigger or equal to inverse quantitative change of parochial bidirectional syntonic reciprocity “ \mathcal{F} ”, just $\mathcal{C} \geq \mathcal{F}$. Virtually, in terms of operation of bidirectional syntonic reciprocity with single quantitative change couple of leading quantitative change and driven quantitative change, the inverse quantitative change of parochial bidirectional syntonic reciprocity “ \mathcal{F} ” is just the circumfluent value of bidirectional syntonic reciprocity of the bidirectional syntonic reciprocity operation system. So-called “circumfluent value of bidirectional syntonic reciprocity” is, in a bidirectional syntonic reciprocity operation system, take reference of obverse quantitative change of parochial bidirectional syntonic reciprocity, under precondition output of obverse quantitative change of parochial bidirectional syntonic reciprocity in single unit time is “ \mathcal{C} ”, the inverse quantitative change of parochial bidirectional syntonic reciprocity reacts quantitative change \mathcal{F} , then, the “circumfluent value of bidirectional syntonic reciprocity” of the bidirectional syntonic reciprocity operation system is just \mathcal{F} .

Of course, theoretically, when we come to consider “circumfluent value of bidirectional syntonic reciprocity” of bidirectional syntonic reciprocity operation system, we do not only mean the bidirectional syntonic reciprocity operation system with single quantitative change couple of leading quantitative change towards driven quantitative change, and indeed, the definition of circumfluent value of bidirectional syntonic reciprocity really tally with situation bidirectional syntonic reciprocity operation system having n quantitative change couples of leading quantitative change towards driven quantitative change. However, occurrence in society is usually not isolated but involves in complex relationship meshwork with various inherent reciprocity so as to reveal their individual feature, the more quantitative change couples of leading quantitative change towards driven quantitative change that bidirectional syntonic reciprocity operation system contains, modality of the operation system is relatively more complex, the quantitative change connotation of the operation system is more complicated and confusing, the so-called “circumfluent value of bidirectional syntonic reciprocity” is of course more difficult for us to ascertain and define, circumfluent value of bidirectional syntonic reciprocity with blurry connotation is of course unauthentic. As a result, when we come to study circumfluent value of bidirectional syntonic reciprocity, we usually study the bidirectional syntonic reciprocity operation system with single quantitative change couple of leading quantitative change towards driven quantitative change.

For instance, the right operation segment of “scientific knowledge proliferation \leftrightarrow scientific knowledge metabolism \leftrightarrow scientific knowledge metabolism campaign” in diagram (A-iii-8) seems like an independent operation system with two quantitative change couples of leading quantitative change towards driven quantitative change. Whereas, in realistic practice, operation system “scientific knowledge proliferation \leftrightarrow scientific

knowledge metabolism ↔ scientific knowledge metabolism campaign” can never perform independently without disturbance of ambience, at least, it must adulterate disturbance of politics, not only in rural countries, the situation is always like this, but also in autocratic countries, the situation is even worse. The reason I list it like an independent bidirectional syntonic reciprocity operation system with two quantitative change couples of leading quantitative change towards driven quantitative change is but I have to highlight kernel and neglect the subordination.

So-called **circumfluence ratio of bidirectional syntonic reciprocity** is just, in an operation system of bidirectional syntonic reciprocity, the ratio of inverse quantitative change towards the first leading quantitative change \mathcal{F} above obverse quantitative change towards the first leading quantitative change \mathcal{C} . If we denote the circumfluence ratio of bidirectional syntonic reciprocity “ ϖ ”, then, circumfluence ratio of bidirectional syntonic reciprocity can be formulated as below:

$$\varpi = (\mathcal{F} / \mathcal{C}) * 100\% \quad \dots \dots \dots \quad (\text{A-ii-3})$$

For the same reason, notion of circumfluence ratio of bidirectional syntonic reciprocity is generally apply in cases of bidirectional syntonic reciprocity operation system with single quantitative change couple of leading quantitative change towards driven quantitative change.

The bigger the obverse quantitative change and inverse quantitative change of bidirectional syntonic reciprocity are, the operation of the bidirectional syntonic reciprocity is relatively more active and intensive, the operation wattage of the system is bigger. If the circumfluence ratio of bidirectional syntonic reciprocity is bigger, it indicates the operational efficiency of the bidirectional syntonic reciprocity operation system is relatively higher. We sparkplug optimum bidirectional syntonic reciprocity is virtually endeavor, under precondition we adjust the obverse quantitative change and inverse quantitative change of bidirectional syntonic reciprocity operation system the biggest allowable values, we endeavor to ensure circumfluence ratio of bidirectional syntonic reciprocity 100%. Of course, optimum bidirectional syntonic reciprocity is apparently ideal target for us to approach, in realistic practice, it’s substantively difficult for us to actualize circumfluence ratio of bidirectional syntonic reciprocity 100%, whereas, the introduction of the idea can really highlight and calibrate our endeavor towards our pursuit.

For instance, once we come to consider the parochial bidirectional syntonic reciprocity between social economy and scientific education & research, we have to take below issues into account:

- a) Idiographic economic modality & economic operation needs what kind of resource supply of scientific education & research, and how much it depends on the resource supply of scientific education & research. In another word, under what kind of resource supply of scientific education & research, idiographic economic modality & economic operation can accomplish its optimum operation and best economic output.
- b) Idiographic scientific education & research of society needs what kind of economic backup, and how much it depends on economic backup. In another word, under what kind of economic backup, idiographic scientific education & research can accomplish optimum operation & resource output.
- c) Taking reference of resource requirement of scientific education & research for idiographic economic operation and the proper resource output of scientific education & research, it decides investment lot of social economy to scientific education & research. Scilicet, it decides the biggest value of obverse quantitative change \mathcal{C} of social economy towards scientific education & research of society,

Historical progress of science in the recent several centuries seemed like a far-flung exploration of the first itinerary around numerous distinctive landscapes of brand-new landmasses of science with palette & tablet on back, several hundred years’ scientific travelogues were compiled thereby.

——poor investment must cause operational famine of the bidirectional syntonic reciprocity, superabundant investment must cast pearls before swine.

- d) Under precondition the biggest value of obverse quantitative change φ of social economy towards scientific education & research of society has been decided, ensure the optimum operation of scientific education & research, and ensure the feedback of scientific education & research to social economy easy, so that we can ensure the circumfluence ratio of the bidirectional syntonic reciprocity operation system as substantial as possible.

All in all, if we are ready to accomplish optimum bidirectional syntonic reciprocity between integrative social circumstances and scientific knowledge proliferation in accordance with idiographic social conditions, we must try to perfect two issues below in accordance with operational mechanism of bidirectional syntonic reciprocity between integrative social circumstances and scientific knowledge proliferation.

The first, decide the optimum operational load value of bidirectional syntonic reciprocity in accordance with the speciality of integrative social circumstances (**just to decide the optimum operational wattage of the bidirectional syntonic reciprocity operation system**).

The second, under precondition the optimum operational load value of bidirectional syntonic reciprocity has been decoded, endeavor to ensure the circumfluence ratio of bidirectional syntonic reciprocity as big as possible so as to ensure the best syntonic domino effect of the bidirectional syntonic reciprocity operation system.

Usually, the more developed the countries are, as comparative advantage in social economy, politics, education, scientific knowledge metabolism & knowledge metabolism campaign, the optimum operational load of the bidirectional syntonic reciprocity between integrative social circumstances and scientific knowledge proliferation is relatively bigger, the operational wattage of the bidirectional syntonic reciprocity operation system is relatively bigger.

For instance, we take contrast with China and United States, the total production value of china is almost equal to the total production value of United States at present, whereas, integrative social circumstances of China are apparently not as active as United States. As a result, when we come to consider and manage syntonic consequent implementation between integrative social circumstances and scientific knowledge proliferation, we can not puff ourselves up to our own cost to compete heroism with American. At any rate, our integrative social circumstances are apparently behindhand; this is something very true, ——the load capability of the proper machine of us is not as strong as the one of United States, we can not be eager for quick success and instant benefit to compete output wattage of the very machine; we can only try to make the best use of everything of the “machine” of us, and do our best to make operation of proper bidirectional syntonic reciprocity perfect, so that we can procure better circumfluence ratio of the bidirectional syntonic reciprocity operation system, we can procure better integrative syntonic domino effect and development acceleration of society than United States.

1.2. Conditional intervention of scientific knowledge metabolism & knowledge metabolism campaign throughout quantitative & qualitative change of scientific knowledge proliferation towards perfect ideological enantiomorph of ultimate authenticity of nature.

3.2.1. Historical inevitability & social existent modality of scientific knowledge metabolism & knowledge metabolism campaign throughout quantitative change of scientific knowledge proliferation towards authenticity

As coherent natura naturans throughout cosmic evolution, instinctive PNT reciprocal equilibrium towards optimum PNT operation is radical potentiality & conditionality for cosmos always ready to orientate itself towards perfection.

of nature.

Scientific knowledge metabolism & knowledge metabolism campaign is practical inevitability of quantitative change of scientific knowledge proliferation towards authenticity of nature.

At first, progress of science is solid process scientific knowledge proliferation and knowledge metabolism gradually towards authenticity of nature under potential restriction of connatural fundamental of the uniqueness & invariance of ultimate authenticity of nature proportionably predestines the unique possibility of scientific verity as perfect ideological enantiomorph of ultimate authenticity of nature: — before approach absolute scientific verity as perfect ideological enantiomorph of ultimate authenticity of nature, quantitative change of scientific knowledge proliferation towards perfect ideological enantiomorph of ultimate authenticity of nature must cause emergent knowledge metabolism that brand-new scientific knowledge proliferation gradually lays over ready-made knowledge even supersedes temporal social legitimacy, this of course implies inevitability of scientific knowledge metabolism & knowledge metabolism campaign.

The second, science progress of human has its inherent historical regularity and inevitability; — The practice human coming to discover and formulate authenticity of accessible existence & motion around must experience historical cognition development cumulatively enriched from nothingness to groat, from groat to a great lot, and consequently followed the proportionate historical reciprocal cognition correction & qualitative optimization from superficiality to profundity, from parochiality to generality. Such historical practice means inevitability of scientific knowledge metabolism & knowledge metabolism campaign as well.

Scientific knowledge metabolism & knowledge metabolism campaign is magic lineup of social demeanour derived from innovative scientific knowledge proliferation.

There are usually two opponents in this magic lineup.

The one is temporal social legitimacy authorities.

The other are coming renovators of humanistic ideology about authenticity of nature in proportion to contemporaneous historical background, who are mostly the originators of aberrant scientific knowledge proliferation out of succession of contemporaneous scientific orthodoxy.

There are usually two original motives in the magic lineup.

The first is excellent scientific knowledge washing out inferior ones for quantitative change of scientific knowledge proliferation towards authenticity of nature by the light of nature. .

The second is high-hat duel for legitimacy survival for self-preservation of human nature. .

That's to say, scientific knowledge metabolism & knowledge metabolism campaign has double tussle connotation:

The first is excellent scientific knowledge washing out inferior ones towards authenticity of nature.

The second: high-hat duel between contemporaneous scientific orthodoxy authorities and the coming renovators of humanistic ideology about authenticity of nature in proportion to contemporaneous historical background who are most originators of aberrant scientific knowledge proliferation out of succession of contemporaneous scientific orthodoxy for legitimacy survival of their patent knowledge in society. As the practice human coming to discover and formulate authenticity of accessible existence & motion around must experience frondose evolvement of humanistic ideology about authenticity of nature cumulatively enriched from nothingness to groat, from groat to a great lot, and consequently followed proportionate

Historical progress of science in the recent several centuries seemed like a far-flung exploration of the first itinerary around numerous distinctive landscapes of brand-new landmasses of science with palette & tablet on back, several hundred years' scientific travelogues were compiled thereby.

ideaistic correction & qualitative optimization from superficiality to profundity, from parochiality to generality, and as the uniqueness & invariance of ultimate authenticity of nature proportionably predestines the unique possibility of scientific verity as perfect ideological enantiomorph of ultimate authenticity of nature that it's neither possible for "the unique & invariable ultimate authenticity of nature" to be compatible with "two distinctive humanistic ideologies about authenticity of nature with remarkable ideological difference" nor possible for "two distinctive humanistic ideologies about authenticity of nature with remarkable ideological difference" to discover and formulate "the unique & invariable ultimate authenticity of nature" coequally, quantitative change of scientific knowledge proliferation must lead to scientific knowledge metabolism. In the face of impact of scientific knowledge metabolism, social legitimacy authorities are always ready to vindicate their legitimacy status quo and prevent their own legitimacy being washed out; and on the other hand, the coming aberrant scientific knowledge proliferation out of succession of contemporaneous scientific orthodoxy are always try to qualify their legitimacy.

In social behavior of scientific knowledge metabolism & knowledge metabolism campaign, the most accessible weapon for duel of knowledge metabolism campaign is temporal lordliness, with backup of their lordliness; they either take role of free press tipstaves of science or take role of free press admittance umpire. Comparably, the coming aberrant scientific knowledge proliferation out of succession of contemporaneous scientific orthodoxy usually has none weapon involved in knowledge metabolism campaign but trying to show people the factuality as possible as they can, and virtually, most of them are victims of scientific knowledge metabolism campaign.

In different historical age, as disparity of social advancement and historical progress of science, the duel content and modality of scientific knowledge metabolism & knowledge metabolism campaign are apparently different. In forepart of science progress, in the face of scientific knowledge metabolism impact, the legitimacy authorities usually take role of free press tipstaves to involve in coming scientific knowledge metabolism campaign upon backup of their lordliness, beating and cracking down on scientific heterodoxy by strong arm, Copernicus, Galileo, and Darwin etc are typical victims of scientific knowledge metabolism campaign in forepart of science progress. History proceeding to modern time, contemporaneous scientific orthodoxy authorities are more convenient to take role of free press admittance umpires to involve in coming scientific knowledge metabolism campaign. By the right of facility of full jurisdiction of free press regulation customization and free press admittance arbitrament of science in hand, on one hand, temporal authority is always ready to lock coming scientific knowledge proliferation in eulogistic scientific knowledge proliferation in rigid succession of contemporaneous scientific orthodoxy towards so-called "science community", and on the other hand, temporal authority carries free press monopolization and full-scale free press egotistic proximity identification for admittance into execution so as to suppress survival of aberrant scientific knowledge proliferation out of succession of contemporaneous scientific orthodoxy.

2.2) Optimization of conditional intervention of scientific knowledge metabolism & knowledge metabolism campaign throughout quantitative & qualitative change of scientific knowledge proliferation.

We mention optimization of conditional intervention of scientific knowledge metabolism & knowledge metabolism campaign throughout quantitative change of scientific knowledge proliferation herein is ready to clarify and highlight the conditional intervention of scientific knowledge metabolism & knowledge metabolism

campaign throughout quantitative & qualitative change of scientific knowledge proliferation, —when scientific knowledge metabolism & knowledge metabolism campaign exists as external condition of scientific knowledge proliferation, we are ready to optimize the obverse quantitative change of leading quantitative change of scientific knowledge metabolism & knowledge metabolism campaign towards driven quantitative change of scientific knowledge proliferation so as neither to violate science progress toward authenticity of nature by the light of nature nor to violate inevitability of historical progress of science due to crecive progression of practical feasibility & possibility in proportion to contemporaneous historical background.

Scientific knowledge metabolism & knowledge metabolism campaign and scientific knowledge proliferation usually accomplish bidirectional cause and effect correlation, not only Scientific knowledge metabolism & knowledge metabolism campaign is inherent outgrowth of scientific knowledge proliferation, inversely, presence of scientific knowledge metabolism & knowledge metabolism campaign can too add more active conditions to scientific knowledge proliferation and practically impact the quantitative change of scientific knowledge proliferation. And what's more, followed historical progress of science, the content and modality of performance of bidirectional cause and effect domino effect between scientific knowledge metabolism & knowledge metabolism campaign is always evolving. As a result, if we are ready to optimize the conditional intervention of scientific knowledge metabolism & knowledge metabolism campaign throughout quantitative & qualitative change of scientific knowledge proliferation, we have to clarify where contemporaneous scientific orthodoxy locating in crecive progression of historical progress of science and status quo of both human scientific knowledge proliferation and scientific knowledge metabolism & knowledge metabolism campaign.

<A> Where contemporaneous scientific orthodoxy locates in crecive progression of historical progress of science.

Historical travelogue style scientific knowledge aggradation of recent several centuries has remarkably highlighted numerous and complicated existence & motion of object A, B, C, D, E, F, ..., integrative modality and silhouette of universal existence & motion has been more and more vivid in our sense, human have consummated historical progress of scientific knowledge proliferation from nothingness to goat, from goat to a great lot thereby. And at the same time, remarkable highlight of numerous and complicated existence & motion of object A, B, C, D, E, F, ... has virtually made systematical review of universal existence & motion possible, such situation practically leads science progress from preliminary knowledge cumulation from nothingness to goat, from goat to a great lot to general knowledge qualitative optimization from superficiality to profundity, from parochiality to generality. After all, although remarkable highlight of numerous and complicated existence & motion of object A, B, C, D, E, F, ... has made universal existence & motion more and more vivid in our sense indeed. upon radical sense, we have to admit we are still unaware of what matter is even what existence & motion are in cosmos. In order to push humanistic ideology about authenticity of nature forward to perfect ideological enantiomorph of ultimate authenticity of nature, we have to challenge great perplexity.

Scientific knowledge proliferation of general knowledge qualitative optimization from superficiality to profundity is successive quantitative change of preliminary knowledge cumulation from nothingness to goat, from goat to a great lot, the logic succession of the quantitative change between preliminary knowledge cumulation from nothingness to goat, from goat to a great lot and general humanistic ideology about authenticity of nature optimization from superficiality to profundity is that quantitative change of preliminary knowledge cumulation from nothingness to goat, from goat to a great lot (just remarkable highlight of numerous and complicated existence &

Historical progress of science in the recent several centuries seemed like a far-flung exploration of the first itinerary around numerous distinctive landscapes of brand-new landmasses of science with palette & tablet on back, several hundred years' scientific travelogues were compiled thereby.

motion of object A, B, C, D, E, F, ...) has made general knowledge qualitative optimization from superficiality to profundity possible (generally means successive scientific knowledge proliferation derived from systematical review of universal existence & motion). In a straightforward word, scientific knowledge proliferation of general knowledge qualitative optimization from superficiality to profundity successively rooted in preliminary knowledge aggradation from nothingness to groat, from groat to a great lot is succession of favorable knowledge quantitative change towards knowledge qualitative change of science from numerous travelogue style knowledge aggradation to thoroughly coherent linear logic system about universal existence & motion. This of course implies the coming knowledge metabolism and consequent scientific knowledge metabolism campaign will be even drastic and grand. Resultingly, we have to pay more attention to conditional intervention of scientific knowledge metabolism & knowledge metabolism campaign in coming scientific knowledge proliferation.

** Status quo of both human scientific knowledge proliferation and scientific knowledge metabolism & knowledge metabolism campaign.**

As social outcome, quantitative change of scientific knowledge proliferation has inherent relationship with social conditions, once we mention status quo of scientific knowledge proliferation and subsequent scientific knowledge metabolism & knowledge metabolism campaign, we have to circumspectly consider jurisdiction of free press regulation customization of science which directly restrict content and modality of scientific knowledge proliferation and jurisdiction of free press admittance arbitrament of science which remarkably impact legitimacy survival of coming scientific knowledge proliferation. Towards this, it is necessary for us to introduce three related notion: ——historical legitimacy of science, scientific knowledge livability of contemporaneous scientific orthodoxy, scientific knowledge metabolism ratio of contemporaneous scientific orthodoxy.

So-called “historical legitimacy of science” is, when science progress proceeds to some certain stage, progressive scientific knowledge proliferation and the proper scientific knowledge metabolism & knowledge metabolism campaign have slidden into relative finality, the popular scientific knowledge aggradation of the age. The mathematical formulation of historical legitimacy of science is generally as below:

$$M_1 = \int_0^t \alpha[\gamma(t), \xi(t)] dt - \int_0^t \beta \{ \alpha[\gamma(t), \xi(t)] \} dt \quad \dots\dots\dots (A-ii-4)$$

Throughout historical progress of science, quantitative & qualitative change of scientific knowledge proliferation from nothingness to groat, from groat to a great lot, from superficiality to profundity, from parochiality to generality, even historical subrogation of social legitimacy of science is always inconstant all along, ——on one hand, at any historical stage of science progress, historical legitimacy of science exists all the way, and on the other hand, before human ultimately approach absolute scientific verity, any historical legitimacy of science is always ready to acclimate itself in ongoing scientific knowledge metabolism. After all, hypostatic historical progress of science is just quantitative & qualitative change of scientific knowledge proliferation under permanent conditionality of “**crecive progression of practical feasibility & possibility in proportion to contemporaneous historical background + the uniqueness & invariance of ultimate authenticity of nature predestines the unique possibility of scientific verity as perfect ideological enantiomorph of ultimate authenticity of nature**” through and through, which brings out realistic historical progress of science in inherent optimum orientation towards perfect ideological enantiomorph of ultimate authenticity of nature in the nature of things.

So-called “scientific knowledge livability of contemporaneous scientific orthodoxy” is, in a considerable historical period, followed remarkable quantitative change of both scientific knowledge proliferation and

As coherent natura naturans throughout cosmic evolution, instinctive PNT reciprocal equilibrium towards optimum PNT operation is radical potentiality & conditionality for cosmos always ready to orientate itself towards perfection.

consequent scientific knowledge metabolism, once the active scientific knowledge proliferation and consequent scientific knowledge metabolism slide into relative finality, the ratio of amount of popular scientific knowledge created in the considerable period over total scientific knowledge created in the considerable period. The mathematical formulation of scientific knowledge livability of contemporaneous scientific orthodoxy is generally as below:

$$\delta = \left(\int_0^{t_2} \alpha[\gamma(t), \xi(t)] dt - \int_0^{t_2} \beta \{ \alpha[\gamma(t), \xi(t)] \} dt \right) / \left(\int_0^{t_2} \alpha[\gamma(t), \xi(t)] dt - \int_0^{t_1} \beta \{ \alpha[\gamma(t), \xi(t)] \} dt \right) \quad \dots \quad (\text{A-ii-5})$$

Among the equation above, t_1 and t_2 denote the start time and terminal time of a considerable historical period.

Of course, the time length of the so-called “a considerable historical period” is virtually appropriate historical segment for definite reference, which can be properly defined in accordance with output rate of scientific knowledge proliferation of the age and precision of the scientific knowledge livability of contemporaneous scientific orthodoxy we demand. Generally, the higher the output rate of scientific knowledge proliferation of the age and the more precise the scientific knowledge livability of contemporaneous scientific orthodoxy we demand are, the so-called “a considerable historical period” we snatch as appropriate historical segment for definite reference can be relatively shorter. For examples, if it’s necessary for us to consider scientific knowledge livability of contemporaneous scientific orthodoxy of Copernicus’ age, the appropriate historical segment for definite reference can be about 100 years. If it’s necessary for us to consider scientific knowledge livability of contemporaneous scientific orthodoxy of Newtonian age, the appropriate historical segment for definite reference can be about 50 years. If it’s necessary for us to consider scientific knowledge livability of contemporaneous scientific orthodoxy of later 19 century and early 20 century, the appropriate historical segment for definite reference can be about 30 years. If it’s necessary for us to consider scientific knowledge livability of contemporaneous scientific orthodoxy of modern age, the appropriate historical segment for definite reference can be about 20 years.

So-called “scientific knowledge metabolism ratio of contemporaneous scientific orthodoxy” is, in a considerable historical period, followed remarkable quantitative change of both scientific knowledge proliferation and consequent scientific knowledge metabolism, once the active scientific knowledge proliferation and consequent scientific knowledge metabolism slide into relative finality, the ratio of amount of out scientific knowledge ever created in the considerable period over total scientific knowledge created in the considerable period. The mathematical formulation of scientific knowledge metabolism ratio of contemporaneous scientific orthodoxy is generally as below:

$$\varphi = (1 - \delta) * 100\% \\ = \left(\int_0^{t_2} \beta \{ \alpha[\gamma(t), \xi(t)] \} dt - \int_0^{t_1} \beta \{ \alpha[\gamma(t), \xi(t)] \} dt \right) / \left(\int_0^{t_2} \alpha[\gamma(t), \xi(t)] dt - \int_0^{t_1} \beta \{ \alpha[\gamma(t), \xi(t)] \} dt \right) \quad \dots \quad (\text{A-ii-6})$$

Among the equation above, t_1 and t_2 denote the start time and terminal time of a considerable historical period. And apparently, $\delta + \varphi = 1$.

As discrepancy of output rate & quality of scientific knowledge proliferation and consequent scientific knowledge metabolism, scientific knowledge metabolism ratio of contemporaneous scientific orthodoxy of different ages are of course different accordingly. According to conservative estimate, scientific knowledge metabolism ratio of contemporaneous scientific orthodoxy of Copernicus’ age is about 50%, scientific knowledge metabolism ratio of contemporaneous scientific orthodoxy of Newtonian age is about 40%, scientific knowledge

metabolism ratio of contemporaneous scientific orthodoxy of later 19 century and early 20 century is about 30%, scientific knowledge metabolism ratio of contemporaneous scientific orthodoxy nowadays is about 25%.

Scientific knowledge metabolism ratio of contemporaneous scientific orthodoxy nowadays is about 25% means, if we snatch an appropriate historical segment for definite reference with start time of 1990 end time 2010, and let's suppose from 1990 to 2010, there are totally 10000 intelligent output of scientific knowledge proliferation on the earth. Once history proceeding to end of 2010, we came to review legitimacy subsistence of the 10000 intelligent output of scientific knowledge proliferation in the recent 20 years, we found, as successive active quantitative change of scientific knowledge proliferation and consequent scientific knowledge metabolism in the recent 20 years, there almost $10000 \times 25\% = 2500$ of them has been washed out. In another word, on stand of historical stage of 2010, we came to review legitimacy subsistence of the 10000 intelligent output of scientific knowledge proliferation in the recent 20 years, as successive active quantitative change of scientific knowledge proliferation and consequent scientific knowledge metabolism, there were almost 2500 of them has been submerged by successive rise, which can almost be neglected for they can operate little for coming social practice and scientific knowledge proliferation.

Throughout science progress, there is historical legitimacy of science all the way, and as historical quantitative change of scientific knowledge proliferation and consequent scientific knowledge metabolism, content of historical legitimacy of science is always varying accordingly and hypostatize renovation of scientific knowledge livability of contemporaneous scientific orthodoxy and scientific knowledge metabolism ratio of contemporaneous scientific orthodoxy. Generally, the higher the scientific knowledge livability of contemporaneous scientific orthodoxy is, it indicates the higher the quality of scientific knowledge proliferation of the age is. Resultingly, scientific knowledge livability of contemporaneous scientific orthodoxy can be regarded as quality criterion of scientific knowledge proliferation of the very age. Once we come to consider and endue jurisdiction of free press regulation customization of science and jurisdiction of free press admittance arbitrament of science to temporal authority, we can take reference of the quality criterion of scientific knowledge livability of contemporaneous scientific orthodoxy. Generally, what a nice scientific knowledge livability of contemporaneous scientific orthodoxy the temporal science legitimacy authorities can practically maintain, what a proportionate lot of jurisdiction of free press regulation customization of science and jurisdiction of free press admittance arbitrament of science is worthy of being awarded to the contemporaneous scientific orthodoxy authorities.

—since social legitimacy authorities of Copernicus' age were only able to maintain their scientific knowledge livability of contemporaneous scientific orthodoxy 50%, of course, they were only qualified to dominate 50% jurisdiction of free press regulation customization of science and 50% jurisdiction of free press admittance arbitrament of science of the age; since social legitimacy authorities of Newtonian age were only able to maintain their scientific knowledge livability of contemporaneous scientific orthodoxy 60%, of course, they were only qualified to dominate 60% jurisdiction of free press regulation customization of science and 60% jurisdiction of free press admittance arbitrament of science of the age; since social legitimacy authorities of later 19 century and early 20 century were only able to maintain their scientific knowledge livability of contemporaneous scientific orthodoxy 70%, of course, they were only qualified to dominate 70% jurisdiction of free press regulation customization of science and 60% jurisdiction of free press admittance arbitrament of science of the age; since social legitimacy authorities of modern age are only able to maintain their scientific knowledge livability of

contemporaneous scientific orthodoxy 75%, of course, they are only qualified to dominate 75% jurisdiction of free press regulation customization of science and 75% jurisdiction of free press admittance arbitrament of science of the age.

Whereas, history proceeding to today, it seems our society had never taken concern of active conditional intervention of scientific knowledge metabolism & knowledge metabolism campaign throughout quantitative change of scientific knowledge proliferation, no more endeavor for optimum conditional intervention of scientific knowledge metabolism & knowledge metabolism campaign throughout quantitative change of scientific knowledge proliferation, such as to take reference of scientific knowledge livability of contemporaneous scientific orthodoxy for evaluation of reasonable distribution of jurisdiction of free press regulation customization of science and jurisdiction of free press admittance arbitrament of science. Instead, we always subconsciously leave 100% jurisdiction of free press regulation customization of science and 100% jurisdiction of free press admittance arbitrament of science for autarchy of temporal authority, just to leave it personal job of science aristocrat and to let temporal authority arrange the business at their pleasure, such situation leads to remarkable abnormality of coming scientific knowledge proliferation thereby.

For examples, temporal authorities invoke items as PACC, PACS to demand coming scientific knowledge proliferation must tally with their aforethought scientific orders, otherwise, there is no way for them to procure free press authorization, such situation of course esoterically but sternly locks development orientation of coming scientific knowledge proliferation. Doughty preciousness of reference has made situation self-evident that anybody ready to involve scientific free press must refer to me (**temporal authorities**) first; otherwise, there is no way for entrance. Virtually, reference popularity inherently has both positive significance and negative significance like both sides of a coin, if we can keep positive significance of reference popularity preponderant to negative significance all the way, reference popularity can of course do good to coming scientific knowledge proliferation, if we rashly make opportunity to let the vogue authors, authoritative journals even so-called authoritative reviewers think “reference” is profitable business for them to preciously pursue, reference soap bubble even negative significance of reference must deluge immediately. Preciousness of scientific noun & item conventionality is even anticipative command of temporal authorities to coming scientific knowledge proliferation, especially to aberrant scientific knowledge proliferation out of succession of contemporaneous scientific orthodoxy.

Theoretically, since nowadays scientific knowledge livability of contemporaneous scientific orthodoxy is 75%, there should be $(1-75\%)=25\%$ aberrant scientific knowledge proliferation out of succession of contemporaneous scientific orthodoxy acceptable in nowadays scientific knowledge proliferation.

Virtually, as jurisdiction of free press regulation customization & free press admittance arbitrament of science under control of temporal orthodox authorities one hundred over one hundred, free press authorization of coming temporal science knowledge multiplication is completely esoteric egotistic proximity identification towards eulogistic scientific knowledge proliferation in rigid succession of contemporaneous scientific orthodoxy. In another visual word, temporal free press admittance & social legitimacy authorization of coming scientific knowledge proliferation is almost dealing of cow chooses husband, —none bull can be accepted; besides suffering free press embarment, there is substantively no way for aberrant scientific knowledge proliferation out of succession of contemporaneous scientific orthodoxy for survival. As a result, current output of eulogistic scientific knowledge proliferation in rigid succession of contemporaneous scientific orthodoxy account for more than 90% of

total scientific knowledge proliferation, whereas, aberrant scientific knowledge proliferation out of succession of contemporaneous scientific orthodoxy can only account for less than 10% of total scientific knowledge proliferation, eulogistic scientific knowledge proliferation in rigid succession of contemporaneous scientific orthodoxy obviously monopolize complete social resource with knock-down vigour, as if it can take full role of science progress nowadays. After all, anybody who is qualified to involve in free press regulation customization & free press admittance arbitrament of science is but temporal authority, and temporal authority are always ready for eulogistic scientific knowledge proliferation in rigid succession of contemporaneous scientific orthodoxy and are always used to free press egotistic proximity identification. As magistral autarchy of free press regulation customization & free press admittance of temporal authority short of necessary intendance, modern science forum seems occasion for temporal authority to dawdle, you sing pean for contemporaneous scientific orthodoxy, I sing pean for contemporaneous scientific orthodoxy, we are all science community; you slide into aberrance of contemporaneous scientific orthodoxy, he devotes to aberrant scientific knowledge proliferation out of rigid succession of contemporaneous scientific orthodoxy, you should stray out of free press going without saying.

Homogenous Cosmos Originated from Unique Genesis is typical aberrant scientific knowledge proliferation out of succession of contemporaneous scientific orthodoxy. In the recent a quarter century, the contribute times of Homogenous Cosmos Originated from Unique Genesis to orthodox journals has been more than 200 times. However, 60% of the contribute times could not approach program of expert review for I could not pass qualification & identity identification, and the rest 40% lucky times were either failed for Homogenous Cosmos Originated from Unique Genesis did not tally with orthodox conventionality (especially the conventionality as PACC, PACS, reference, even keywords) or failed for vicious countercheck in scientific knowledge metabolism campaign. the factuality I can remember to end of my life is that throughout the quarter century to orthodox journals, I never met a single earnest editor or reviewer whose final review involved the core topic of Homogenous Cosmos Originated from Unique Genesis, —whether entire cosmos is throughout homogenous originated from unique genesis, if cosmos is really homogenous originated from unique genesis through and through, what integrative homologic existence & motion of matter in cosmos should be. And virtually, half of the final conclusions from the so-called “experts” did not derived from my contribution, but directly derived from the conventional experience even self-preservation of the reviewers. Besides the heavy word of “No” in their comment was ready for me, all the other words were but ready for themselves as “civilization camouflage”, after all, it's still necessary for them to show themselves nonsense reviewers with the civilization camouflage on their bodies.

In social politics, we emphasize three puissance of legislative, law implementation and administration schism, whereas, in science forum, we think too much of social legitimacy authorities, we leave full jurisdiction of free press regulation customization of coming scientific knowledge proliferation towards authenticity highlight (equivalent to legislative action), jurisdiction of free press admittance of coming renovation of humanistic ideology about authenticity of nature in proportion to contemporaneous historical background (equivalent to law implementation) and scientific free press management (equivalent to administration) under magistral autarchy of temporal authority 100 over 100.

Virtually, as historical limitation, qualification of free press regulation customization and free press admittance arbitrament of science of our society are limited and unequal in different stages of science progress,

the more developed science is, the higher qualification of free press regulation customization and free press admittance arbitrament of science of our society is. Since nowadays scientific knowledge livability of contemporaneous scientific orthodoxy is only about 75%, the jurisdiction of free press regulation customization of science and jurisdiction of free press admittance arbitrament of science are necessary to assign 25% jurisdiction to non-legitimacy authorities. On one hand, it can prevent free press admittance of eulogistic scientific knowledge proliferation in rigid succession of contemporaneous scientific orthodoxy straightway, and on the other hand, it can prevent aberrant scientific knowledge proliferation out of succession of contemporaneous scientific orthodoxy slide into autarchy of contemporaneous scientific orthodoxy authorities. Only thus, coming scientific knowledge proliferation can go its way like itself to push humanistic ideology about authenticity of nature forward to perfect ideological enantiomorph of ultimate authenticity of nature draw on practical feasibility & possibility in proportion to contemporaneous historical background. Leastways, such kind of endeavor can prevent free press monopolization of temporal authority and reduce authority ruffian more or less.

In accordance with conventionality, if a theory is able to unpuzzle existence & motion of object A, B, C, D, E, F, ... in cosmos, temporal orthodox authorities have substantial reasons to promote it truth. In accordance with connatural fundamental of the uniqueness & invariance of ultimate authenticity of nature proportionably predestines the unique possibility of scientific verity as perfect ideological enantiomorph of ultimate authenticity of nature which is generally equivalent as *it's only possible for concordant cosmos to be demiurgic aggradation of out-and-out serial natura naturata in the nature of coherent natura naturans throughout cosmic evolution; there is no way for demiurgic aggradation in the nature of different natura naturans to be concordant cosmos through and through*, discretionary scientific theory throughout science progress, as long as it meets explanation inability in nature, we have to suspect it may be phoney truth. Upon this criterion, live contemporaneous scientific orthodoxy has none veritable truth. At any rate, output of so-called "truth" inherently has its historical groundwork and has the proper historical limitation as well. —In Copernicus' age, there was only possibility to produce scientific truth of heliocentric theory kind, and virtually, legitimacy survival of scientific truth as heliocentric theory kind can only be limited in historical age of Copernicus or so; in Newtonian age, there was only possibility to produce scientific truth of Newtonian theory kind, and virtually, legitimacy survival of scientific truth as Newtonian theory kind can only be limited in historical age of Newton or so; in Einstein, Bohr age, there was only possibility to produce scientific truth of relativity, quantum theory kind, and virtually, social legitimacy survival of scientific truth as Relativity, Quantum theory kind can only be limited in historical age of Einstein, Bohr or so; This is of course objective historical inevitability of quantitative & qualitative change of scientific knowledge proliferation along historical progress of science from nothingness to goat, from goat to a great lot, from superficiality to profundity, from parochiality to generality, —out and out historical progress of science. The key issue is that nowadays scientific knowledge proliferation is still in dynamic extension of such historical inevitability, scientific knowledge proliferation of today and tomorrow is still performing program for coming science progress, and the key issue is that we should not twiddle with contemporaneous scientific orthodoxy too aggressively and overbearingly in spite of historical inevitability.

Involving in living scientific knowledge proliferation, orthodox authorities neither readily suspect their respectable legitimacy nor reconcile to coequally lay their celebrated legitimacy in arrangement of coming scientific knowledge metabolism. Upon consolidation of their respectable legitimacy, orthodox authorities (**OR temporal authority**) are usually ready to carry forward pean knowledge proliferation in succession of contemporaneous scientific orthodoxy; the most feasible approach of pean knowledge proliferation is lineal logic extension in

Historical progress of science in the recent several centuries seemed like a far-flung exploration of the first itinerary around numerous distinctive landscapes of brand-new landmasses of science with palette & tablet on back, several hundred years' scientific travelogues were compiled thereby.

rigid succession of contemporaneous scientific orthodoxy.

In simple words, so-called “lineal logic extension in rigid succession of contemporaneous scientific orthodoxy” is a kind of logic model for scientific knowledge proliferation when historical progress of science in inherent optimum orientation towards historical authenticity tolerance of science 0 proceeds to some certain stage, some certain relatively mature scientific knowledge in proportion to contemporaneous historical background has been promoted legitimacy of the age, the corresponding orthodox authorities (/temporal authority) consequently carry forward eulogistic scientific knowledge proliferation in rigid succession of contemporaneous scientific orthodoxy by subconscious implementation of lineal logic extension of their celebrated legitimacy so as to crown all accessible existence & motion in their rational purview. No matter they are orthodox authorities of geocentric theory, heliocentric theory, Newtonian, or relativity, quantum theory, as long as the proper orthodox authorities pride their celebrated legitimacy as themselves, they all can carry forward eulogistic scientific knowledge proliferation in rigid succession of contemporaneous scientific orthodoxy by implementation of lineal logic extension in rigid succession of contemporaneous scientific orthodoxy going without saying. As progressional disparity of science, pean knowledge proliferation of different age derived from idiographic lineal logic extension in rigid succession of contemporaneous scientific orthodoxy has different authentic reliability.

Taking reference of **ultimate authenticity of nature**, we call the authentic discrepancy between historical legitimacy of science and ultimate authenticity of nature “**historical authenticity tolerance of science**”. As the practice human coming to discover and formulate authenticity of accessible existence & motion around must experience frondose evolvement of humanistic ideology about authenticity of nature cumulatively enriched from nothingness to groat, from groat to a great lot, and consequently followed proportionate ideaistic correction & qualitative optimization from superficiality to profundity, from parochiality to generality, the earlier age of historical progress of science is, the more remarkable authentic discrepancy between historical legitimacy of science and ultimate authenticity of nature is, the proportional value of “historical authenticity tolerance of science” is relatively more remarkable, scientific knowledge proliferation derived from lineal logic extension in rigid succession of contemporaneous scientific orthodoxy ② is relatively more narrow and flimsy, and authentic reliability of the corresponding scientific knowledge proliferation is relatively poorer therefore. Virtually, historical progress of science is generally hypostatic process historical authenticity tolerance of science gradually approaching 0, which of course indicates the later age of historical progress of science is, the less authentic discrepancy between historical legitimacy of science and ultimate authenticity of nature is, the value of “historical authenticity tolerance of science” is relatively more tiny and closer to 0, scientific knowledge proliferation derived from lineal logic extension in rigid succession of contemporaneous scientific orthodoxy is relatively more general and credible, and authentic reliability of the very knowledge multiplication is relatively higher therefore. Historical process of quantitative & qualitative

Note ②: Of course, throughout historical process of sequential quantitative & qualitative change of scientific knowledge proliferation, scientific knowledge proliferation derived from lineal logic extension in rigid succession of contemporaneous scientific orthodoxy are still substantial part of historical scientific knowledge proliferation, even once a brand-new innovative thought comes to supersede a relatively conservative legitimacy, the proper knowledge multiplication derived from lineal logic extension of the brand-new innovative idea usually inaugurates a new age and fashions the coming popularity of the very age. However, once history is ready to proceed to another progressional circle of science, the proper lineal logic extension in rigid succession of contemporaneous scientific orthodoxy is generally difficult to gloss over its historical limitation and fragility.

As coherent natura naturans throughout cosmic evolution, instinctive PNT reciprocal equilibrium towards optimum PNT operation is radical potentiality & conditionality for cosmos always ready to orientate itself towards perfection.

change of sequential scientific knowledge proliferation of human just hypostatize inherent progression of historical progress of science, which is course process historical authenticity tolerance of science gradually approaches 0 as well.

So-called Black Hole theory, Dark matter, Dark energy are all outcome of pean knowledge proliferation as typical “lineal logic extension in succession of contemporaneous scientific orthodoxy”. Of course, before veritable demonstration, theoretical outcome of Black Hole theory, Dark matter, Dark energy can do nothing good to contemporaneous scientific orthodoxy, even as we still lack evidence to ensure historical authenticity tolerance of science 0 of contemporaneous scientific orthodoxy, we have admit there must be humanistic confusion historically adulterated in contemporaneous scientific orthodoxy, once we implement lineal logic extension in succession of contemporaneous scientific orthodoxy, nothing can make us confident that none artificial components of contemporaneous scientific orthodoxy has been insensibly peculated as undoubted “logic basis/rationale” so as to make the output of lineal logic extension in succession of contemporaneous scientific orthodoxy even flimflam therefore.

In terms of original theoretical derivation of so-called “dark matter”, ——as temporal astronomers noticed that huge celestial bodies as fixed stars, galaxies often show themselves indecipherable displacement in spacetime, they have to suspect there may be some unknown gravitation doing their job therein. As gravitation directly relates to mass, they quickly turn to their conclusion that there must be some certain unknown object with stupendous mass around, whereas, as there is no light from the unknown objects with stupendous mass, they have to call them dark matter therefore.

This is just the original theoretical derivation of so-called “dark matter”, outcome of eulogistic scientific knowledge proliferation in rigid succession of contemporaneous scientific orthodoxy all wool and a yard wide.

There are apparently two egotistic logic conjuries in eulogistic scientific knowledge proliferation in rigid succession of contemporaneous scientific orthodoxy:

The first logic conjury is **there may be some unknown gravitation doing their job therein.**

The second logic conjury is **there must be some certain unknown object with stupendous mass around.**

The freebooting of the first logic conjury is that it treated a theory with apparent historical limitation as absolute authentic precondition, ——temporal orthodox authorities think the indecipherable displacement of celestial bodies in large-scale spacetime must derive from gravity, since there is occurrence of indecipherable displacement of celestial bodies, there must be substantial gravity doing their job therein. And as gravity inherently relates mass in accordance with contemporaneous scientific orthodoxy, they consequently turn to conclusion that there must be substantial mass around, whereas, as absence of optic image of the substantial mass, they have to call it dark matter.

However, is it true that it’s only possible for indecipherable displacement of celestial bodies in large-scale spacetime to be derived from gravitational effect?

Once we have perceived unknown occurrence in cosmos which is apparently out of prediction of contemporaneous scientific orthodoxy, we of course have no reasons to reject endeavor to assume the potential authenticity of the unknown occurrence in accordance with lineal logic extension in succession of contemporaneous scientific orthodoxy and try to verify the Potential authenticity of the unknown occurrence. Whereas, we have

Historical progress of science in the recent several centuries seemed like a far-flung exploration of the first itinerary around numerous distinctive landscapes of brand-new landmasses of science with palette & tablet on back, several hundred years’ scientific travelogues were compiled thereby.

substantial reasons to suspect the reliability of contemporaneous scientific orthodoxy as well. Facing to the “unknown occurrence” in cosmos, why we are always ready to assume the potential authenticity of the unknown occurrence in accordance with lineal logic extension in succession of contemporaneous scientific orthodoxy and try to verify the potential authenticity of the unknown occurrence but never suspect reliability of contemporaneous scientific orthodoxy?

Have we perceived the potential authenticity of the unknown occurrence in accordance with lineal logic extension in succession of contemporaneous scientific orthodoxy? Is it possible for us to find the potential authenticity of the unknown occurrence in accordance with lineal logic extension in succession of contemporaneous scientific orthodoxy?

If traditional gravitational theory itself is a historically altisonant inaccuracy, what's the respectable reason for us to spend so much time and money for verification lineal logic extension of the altisonant inaccuracy of traditional gravitational theory?

Considered by Homogenous Cosmos originated from Unique Genesis, so-called “force” in cosmos is but dynamic domino effect of instinctive PNT reciprocal equilibrium towards optimum PNT operation due to presence of PNT operational disturbance of matter integration, there are none so-called four fundamental forces in the nature virtually. The superposition of matter fields of different celestial bodies of course cause dynamic domino effect of instinctive PNT reciprocal equilibrium towards optimum PNT operation generally as conventional gravity kind, but it's not exactly the nature itself, at any rate, “force” in cosmos is but dynamic domino effect of instinctive PNT reciprocal equilibrium towards optimum PNT operation due to presence of PNT operational disturbance of matter integration. If there is occurrence of concomitant spacetime change of journey of celestial bodies in large-scale spacetime, the PNT operation throughout all the sequential configurable hierarchy from micromechanism to macro-mechanism of matter integration must vary accordingly. Of course, the spontaneous PNT operational readjustment must cause energetic variation of matter integration, cause occurrence as brilliant spots or black spots of sun kind, or cause occurrence as earthquake, volcano of earth kind. And if PNT operational variation throughout all the sequential configurable hierarchy from micromechanism to macro-mechanism of matter integration remarkably extends to spacetime momentum variation in terminal reciprocal PNT configurable hierarchy, we will of course find remarkable displacement of celestial bodies as fixed stars, galaxies in large-scale spacetime (please refer to section (IV-iv) Spontaneous individuation of dynamic connotation of resultant reciprocal PNT combination among compositive subunits in the nature of instinctive PNT reciprocal equilibrium towards optimum PNT operation — Spacetime momentum micromodelization & macromodelization in configurable hierarchy of reciprocal PNT combination). However, it's not gravitational effect as conventionality, no more solid evidence to deduce presence of substantial indiscernible mass around for gravitational effect.

As eulogistic scientific knowledge proliferation in rigid succession of contemporaneous scientific orthodoxy, dark matter originality that indecipherable displacement of celestial bodies in large-scale spacetime must derive from gravity apparently seems presumptuous airs and graces but weak in logic. No matter coming scientific authentication supports force definition of Homogenous Cosmos Originated from Unique Genesis or not, as long as we can not exclude possibility that there may be remarkable bifurcation between coming scientific knowledge proliferation and contemporaneous scientific orthodoxy, we can not be too confident even overbearing in eulogistic scientific knowledge proliferation in rigid succession of contemporaneous scientific orthodoxy;

As coherent natura naturans throughout cosmic evolution, instinctive PNT reciprocal equilibrium towards optimum PNT operation is radical potentiality & conditionality for cosmos always ready to orientate itself towards perfection.

because, no matter what remarkable contrast between contemporaneous scientific orthodoxy orthodoxy, all the imperfect components in contemporaneous scientific orthodoxy for historical limitation must take role of mistake dynatron in logic extension therein.

—In practice of free press admittance, as full jurisdiction of free press admittance arbitrament is under control of temporal authority, the practical implementation of free press admittance arbitrament is apparently more expedient to serve contemporaneous scientific orthodoxy than to serve science progress of human. Nowadays popularity of Big Bang, Black Hole theory, dark matter & dark energy theory generally owe to independent dealing of free press of temporal authority and owe to free press admittance monopolization of temporal authority! Hubble telescope was sent to outer space in April 1990 and ultimately became effective after repairing in Dec. 1993, Big Bang is direct observation effect of Hubble telescope ③. Idea of Homogenous cosmos originated from unique genesis was born in Nov. 1991, a paper in due form about the idea was written in winter 1992. Nowadays popularity disparity of Big Bang and Homogenous Cosmos Originated from Unique Genesis should firstly owe to free press admittance autarchy of temporal authority and should secondly owe to persistent free press embarment to Homogenous Cosmos Originated from Unique Genesis for facility of free press admittance autarchy of temporal authority.

All in all, as humanistic ideology about authenticity of nature in proportion to contemporaneous historical background, historical progress of science can never go ahead as freewheeling with 0 resistances. Virtually, resistance of historical progress of science in inherent optimum orientation towards perfect ideological enantiomorph of ultimate authenticity of nature mostly derives from alteration of dynamic equilibrium of social legitimacy subsistence as typical behoof assignment for pestilent impact of inevitable scientific knowledge metabolism. As long as we admit there is still historical limitation of contemporaneous scientific orthodoxy of science or we have to admit contemporaneous scientific orthodoxy is still out of scientific legitimacy qualification of historical authenticity tolerance of science 0, we have no reasons to leave free press regulation customization and free press admittance under magistral autarchy of temporal authority short of necessary intendance, otherwise, practical implementation of free press regulation customization and free press admittance must be more expediently accessible to serve the time instead of endeavor for historical progress of science whose major melody is always epochmaking scientific knowledge metabolism one after another towards perfect ideological enantiomorph of ultimate authenticity of nature but not interminable royal substantiation & perfection of contemporaneous scientific orthodoxy, even our persistent pursuit towards perfect ideological enantiomorph of ultimate authenticity of nature has to be helpless before intrepidity of rogue authority without alternatives that social legitimacy & validity of truths can never exceed cannon range.

Several years later, if we come to recall “The Big Bang Theory”, “Black Hole Theory”, “Dark Matter & Dark Energy Theory”, ..., even the recent discovery of so-called gravitational waves of LIGO, which had ever been so resounding all over the world, perhaps we can practically find the terrible priapism of free press monopolization as self-sportful of temporal authority with perdurable palpitation.

On stand of objective inevitability of historical progress of science, as the practice human coming to discover and formulate authenticity of accessible existence & motion around must experience frondose evolvement of humanistic ideology about authenticity of nature cumulatively enriched from nothingness to groat, from groat to a great lot, and consequently followed proportionate ideaistic correction & qualitative optimization

Historical progress of science in the recent several centuries seemed like a far-flung exploration of the first itinerary around numerous distinctive landscapes of brand-new landmasses of science with palette & tablet on back, several hundred years' scientific travelogues were compiled thereby.

from superficiality to profundity, from parochiality to generality, and as the uniqueness & invariance of ultimate authenticity of nature proportionably predestines the unique possibility of scientific verity as perfect ideological enantiomorph of ultimate authenticity of nature, historical quantitative & qualitative change of scientific knowledge proliferation must inherently follow necessary scientific knowledge metabolism & consequent scientific knowledge metabolism campaign, once coming scientific knowledge metabolism & consequent scientific knowledge metabolism campaign endanger social legitimacy subsistence of contemporaneous scientific orthodoxy, for self-preservation of human nature, the temporal authorities must rouse as overbearing egoist & powerful countercheck puissance and become conventional resistance of historical progress of science therefore. And indeed, science today is outcome of foregone science progress had ever broken through conventional resistance time after time and has not got rid of conventional resistance for its progressive status quo at all.

In terms of live scientific knowledge proliferation, with nice legitimacy coronet on head, facing rich and colorful existence & motion accessible in cosmos, once the temporal authority find there are still distinctive existence & motion in cosmos inexplicable in accordance with contemporaneous scientific orthodoxy, they are usually not ready to re-collect themselves to review universal existence & motion again without restriction and bewitchment of conventionality. Instead, they are always subliminally ready to implement eulogistic scientific knowledge proliferation in rigid succession of contemporaneous scientific orthodoxy so as to yield more congeneric theories for expository complement of contemporaneous scientific orthodoxy. Whereas, once coming aberrant scientific knowledge proliferation out of succession of contemporaneous scientific orthodoxy seems to endanger survival of contemporaneous scientific orthodoxy, they must rouse as overbearing egoist & powerful countercheck puissance for human self-preservation and consequently become conventional resistance of science progress. Whereas, in terms of weather of typical heterodoxy, who devote themselves to aberrant scientific knowledge proliferation out of succession of contemporaneous scientific orthodoxy and are difficult to be compatible to eulogistic scientific knowledge proliferation in rigid succession of contemporaneous scientific orthodoxy therefore, forum of science is almost position of enemy, under situation that full jurisdiction of free press regulation customization of science and full jurisdiction of free press admittance arbitrament of science are completely under control of temporal authority, the serious factuality is even painful. Although ultimate pursuit of science progress is to formulate universal existence & motion in thorough coherence of linear logic system and temporal sciences are still so far away from our ultimate pursuit.

If we ignore temporal conventional resistance of historical progress of science and leave jurisdiction of free press regulation customization of science and jurisdiction of free press admittance arbitrament of science personal possession of temporal authority at their pleasure, it must cause civilization lag.

At any rate, as an opposite of scientific knowledge metabolism & knowledge metabolism campaign with facility of puissance in hand, compared with foregone geocentric theory authorities, science aristocrat of today have none advantage of inbeing goodness, but because of gradual perfection-orientated evolvement of society, their enlightened camouflage seems more and more decent. —although, the history contemporaneous scientific orthodoxy authorities of science rampantly served as science forum bobby has gone, temporal scientific orthodox authorities are more convenient to act as respectable commander of free press regulation customization and umpire of free press admittance to involve in scientific knowledge metabolism & knowledge metabolism campaign, if jurisdiction of free press regulation customization of science and jurisdiction of free press

admittance arbitrament of science implemented by temporal scientific orthodox authorities are unlimited, their conduct may be even more esoteric and viperous. As a result, practical assignment and implementation of jurisdiction of free press regulation customization of science and jurisdiction of free press admittance arbitrament of science has been the most active two conditional interventions in coming scientific knowledge metabolism & knowledge metabolism campaign, we have to earnestly consider reasonable assignment and implementation of jurisdiction of free press regulation customization and jurisdiction of free press admittance arbitrament of science. We should not keep a slack hand to doughty preciousness & autarchy of temporal authority.

Till today, although, several hundred years' scientific knowledge aggradation has remarkably highlighted numerous existence & motion of object A, B, C, D, E, F, ..., we are still delusory of what matter is and what existence & motion of matter is on earth. Whereas, on the other hand, with backup of remarkable highlight of rich & colorful existence & motion of matter in cosmos, systematical review of universal existence & motion of matter in cosmos has been practical possibility, successive progress of science will step into cognition stage from superficiality to profundity, from parochiality to generality, such progressive quantitative change of scientific knowledge proliferation must lead to unprecedented scientific knowledge metabolism & knowledge metabolism campaign, many so-called ready-made truths in point of existence & motion of object A, B, C, D, E, F, ... will be washed one after another, till at last humanistic ideology about authenticity of nature tallies with ultimate authenticity of nature 100 over 100 as perfect ideological enantiomorph of ultimate authenticity of nature.

In any case, since it's only possible for ultimate of nature to be unique and invariable, in accordance with rigorous enantiomorphous correlation between objective authenticity of nature and humanistic ideology about authenticity of nature, it's neither possible for "the unique & invariable ultimate authenticity of nature" to be compatible with "two distinctive humanistic ideologies about authenticity of nature with remarkable ideological difference" nor possible for "two distinctive humanistic ideologies about authenticity of nature with remarkable ideological difference" to discover and formulate "the unique & invariable ultimate authenticity of nature" coequally, no more humanistic ideology about authenticity of nature in proportion to contemporaneous historical background as scientific travelogues of physics, chemistry, biology, iatrology kind like omnifarious smallwares full of a basket, which of course implies the potential extent and depth of coming scientific knowledge metabolism.

As a result, it's necessary for us to organize an International Discussion Committee of Scientific Dissidence, the International Discussion Committee of Scientific Dissidence must organize the related men to meet discussing important scientific dissidence occurred recently once per year leastways. The dissidence introduced to the meeting can be applied by the dissident or recommended by reviewers of journals, publishing houses etc or some other related men. Presence of International Discussion Committee of Scientific Dissidence will be good for popular clarification of scientific dissidence and avail favorable operation of scientific knowledge metabolism & knowledge metabolism campaign, and it must straightforwardly avail favorable quantitative & qualitative change of scientific knowledge proliferation for historical progress of science.

In any case, throughout historical progress of science, once necessary pioneering humanistic ideology about authenticity of nature in proportion to contemporaneous historical background procured its social legitimacy qualification and became contemporaneous scientific orthodoxy of the age therefore, as endeavor of early substantiation & perfection of brand-new contemporaneous scientific orthodoxy \approx general progress of science of the age, freewheeling of royal substantiation & perfection of contemporaneous scientific orthodoxy was

Historical progress of science in the recent several centuries seemed like a far-flung exploration of the first itinerary around numerous distinctive landscapes of brand-new landmasses of science with palette & tablet on back, several hundred years' scientific travelogues were compiled thereby.

always inevitable, and authoritative intrepidity of contemporaneous scientific orthodoxy must be inherent outgrowth of social legitimacy subsistence of contemporaneous scientific orthodoxy then and there, although, it's only possible for the major melody of historical progress of science to be epochmaking scientific knowledge metabolism one after another in inherent optimum orientation towards perfect ideological enantiomorph of ultimate authenticity of nature draw on practical feasibility & possibility in proportion to contemporaneous historical background. Whereas, once brand-new contemporaneous scientific orthodoxy gradually exhausts its inherent potentiality to push humanistic ideology about authenticity of nature forward to perfect ideological enantiomorph of ultimate authenticity of nature, so that historical progress of science in inherent optimum orientation towards perfect ideological enantiomorph of ultimate authenticity of nature slides into remarkable aberrance for interminable royal substantiation & perfection of contemporaneous scientific orthodoxy.

Veritable progress of science is hypostatic endeavor to push humanistic ideology about authenticity of nature forward to perfect ideological enantiomorph of ultimate authenticity of nature draw on practical feasibility & possibility in proportion to contemporaneous historical background but not interminable royal substantiation & perfection of contemporaneous scientific orthodoxy. As a result, it's necessary for us to additionally pay our attention to potential occurrence of positive renovation of humanistic ideology about authenticity of nature in proportion to contemporaneous historical background upon our prophetic vision that it's only possible for the major melody of historical progress of science to be epochmaking scientific knowledge metabolism one after another in inherent optimum orientation towards perfect ideological enantiomorph of ultimate authenticity of nature but not interminable royal substantiation & perfection of contemporaneous scientific orthodoxy out of scientific legitimacy qualification of historical authenticity tolerance of science 0. Although, before occurrence of creditable omen of positive renovation of humanistic ideology about authenticity of nature in proportion to contemporaneous historical background, we usually have no expedient & respectable facility to retard overwhelming authoritative intrepidity of contemporaneous scientific orthodoxy so as to weaken egotistic guidance & authoritative restriction to live scientific knowledge proliferation for interminable royal substantiation & perfection of contemporaneous scientific orthodoxy, we have substantial reasons to take necessary precautions against occurrence that free press admittance of timely renovation of humanistic ideology about authenticity of nature in proportion contemporaneous historical background has to challenge venomous counterwork upper limit of temporal authority, especially when life-and-death scientific knowledge metabolism directly impacts vested interest of temporal authority who are mostly hardcore puissance of living historical progress of science with expedient official facility of magistral autarchy of free press regulation customization and free press admittance short of necessary intendance.

May 2014 ~ Dec 2014, Dongguan city, Shatian town, Dani village, Nanxing manufactory

Supplemental note ③: of course, I never suspect the reliability of observation factuality from Hubble telescope, whereas, with respectable legitimacy coronet on head and solid backup of magistral autarchy of free press regulation customization and free press admittance short of necessary intendance, temporal authority were substantively flimflam to subjectively even

As coherent natura naturans throughout cosmic evolution, instinctive PNT reciprocal equilibrium towards optimum PNT operation is radical potentiality & conditionality for cosmos always ready to orientate itself towards perfection.

intrepidly compile these flimsy factuality into “The Big Pang” by bandit logic as “local crowing all over” and “segment crowing all along” and so on. The original logic deduction of Black Hole theory, dark matter, and dark energy is too similar as this. However, they are output of eulogistic scientific knowledge proliferation in rigid succession of contemporaneous scientific orthodoxy all wool and a yard wide with extravagant fund support. And as free press monopolization of temporal authority, free press admittance of initial papers of Big Bang, Black Hole theory, dark matter, and dark energy could be of course authorized politely without delay.

And in the recent years, I casually read some articles about Black Hole theory, dark matter, and dark energy in some certain journal series; I found almost half of the content of these articles under shadow of Homogenous Cosmos Originated from Unique Genesis. It’s too coincidental, the coincidence even made me astonished! In the morning of October, 28, 2009, I casually met Morning New of CCTV about brief introduction of Dark Matter, Dark Energy, I was so astonished to find the notions of “Dark Matter” and “Baryonic Matter” mentioned by these theories were almost second names of “negative matter” and “positive matter” mentioned in Homogenous Cosmos Originated from Unique Genesis. I was taken aback in a sudden, is it only unexpected coincidence? Whereas, it’s almost too coincidental. As no alternatives, I added **Acknowledgement of introduction of two special nouns of “Dark Matter” and “Baryonic Matter”** to Homogenous Cosmos Originated from Unique Genesis on proper page just that morning.

After all, since 1995, Homogenous Cosmos Originated from Unique Genesis is always open to commonality as possible as I can reach, since I am so lowdown man of the society, there is almost no way for me to approach free press admittance, I have no reasons to keep my idea secret, instead, I have to push a narrow way to open it as possible as I can just as what I am doing at researchgate.net since 2019.

In spring 1999, I went Changsha twice, in winter 2000, I went to Beijing, I totally handed out more than 150 printed copies of the monograph in Changsha yuelushan and in Beijing zhongguan village. Since I edited my electronic version of the monograph in winter 2004, I was always ready to air it on possible website openly and updated revision frequently. The most shut-in factuality is that they are all science aristocrat with extravagant fund support, and they are always perfectly justifiable to publish their papers on so-called science forum so as to shell out fund support, which is virtually homegrown outgrowth in the garden of contemporaneous scientific orthodoxy beyond all doubt.

SW. Hawking is always famous for his Black Hole theory, whereas, once I reached the fundamental of gravitational reciprocity of “mass disparity accessible to positive gravity” and “mass approximation accessible to negative gravity” along hypostatic logic extension of connotation objectification with freewheeling logic extension of homogenous cosmos originated from unique genesis in 1995, I had declared, as natural instance of spontaneous occurrence of [external physical disturbance + (PNT action + instinctive PNT equilibrium)] with external physical disturbance=matter field superposition, so-call gravitational reciprocity must be subject to reciprocal fundamental of “mass disparity accessible to positive gravity” and “mass approximation accessible to negative gravity” . As a result, there is almost no connatural way for original generation of so-called “Black Hole” in homogenous cosmos. In any case, traditionary definition of so-called “gravity” is not humanistic idea compatible with coherent natura naturans throughout cosmic evolution, but one of our scientific travelogues A, B, C, D, E, F, ... like omnifarious smallwares full of a basket out of scientific legitimacy qualification of historical authenticity tolerance of science 0. Whereas, once we come into Homogenous Cosmos Originated Unique Genesis as innovative cosmos redefinition in radical logic enantiomorph of newly highlighted factuality that **discretionary particles in cosmos are mutually convertible**, we then have to admit cosmic status quo is but demiurgic aggradation of sequential homologous cosmogony, which exactly exists as well-regulated integration of cosmic homogeneity system making up of out-and-out outgrowth of natura naturata in the nature of coherent natura naturans throughout cosmic evolution.

The even deadly factuality is that, as predictive conclusion of traditionary science of “gravitation theory” in typical

Historical progress of science in the recent several centuries seemed like a far-flung exploration of the first itinerary around numerous distinctive landscapes of brand-new landmasses of science with palette & tablet on back, several hundred years’ scientific travelogues were compiled thereby.

rational model of linear logic extension in succession of so-called contemporaneous scientific orthodoxy out of scientific legitimacy qualification of historical authenticity tolerance of science 0, so-called “Black Hole” is completely out of category of out-and-out serial natura naturata in the nature of coherent natura naturans throughout cosmic evolution, and indeed, so-called “gravitational theory” of tradition is not logic extension of coherent natura naturans throughout cosmic evolution.

However, as lowdown man of the society and typical heterodoxy of the age, there is completely no way for me to air my idea of cosmos redefinition in radical logic enantiomorph of newly highlighted factuality that **discretionary particles in cosmos are mutually convertible** under egotistic background of interminable royal substantiation & perfection of contemporaneous scientific orthodoxy. Instead, as remarkable divarication between linear logic extension about universal existence & motion as spontaneous occurrence of **[external physical disturbance + (PNT action + instinctive PNT equilibrium)]** on the basis of **[(Homogenous cosmos originated from unique genesis postulate + spacetime~matter fully embodying cosmos postulate) + Instinctive PNT equilibrium postulate]** and scientific travelogues A, B, C, D, E, F, ... like omnifarious smallwares full of a basket, life-and-death scientific knowledge metabolism seems inevitable, even as magistral autarchy of free press regulation customization and free press admittance of temporal authority under egotistic background of interminable royal substantiation & perfection of contemporaneous scientific orthodoxy, free press admittance of Homogenous Cosmos Originated from Unique Genesis must break through legitimacy defense line of contemporaneous scientific orthodoxy, so that it has to challenge venomous counterwork upper limit of temporal authority therefore. As a result, more than 31 years has gone, my idea of reciprocity fundamental of gravity as “**mass disparity accessible to positive gravity**” and “**mass approximation accessible to negative gravity**” never impacts the social legitimacy subsistence of Black Hole Theory of S.W. Hawking.

The even unexpected factuality was that, in the early year of 2016, LIGO suddenly declared that they discovered “mechanical collision of binary Black Hole” and consequently discovered “gravitational wave”. In 2017, LIGO gained PHYSICAL NOBEL PRIZE therefore. I have to admit the comedy of royal substantiation & perfection of contemporaneous scientific orthodoxy is really high-sounding on stilts, authoritative intrepidity of contemporaneous scientific orthodoxy is carefree overwhelming indeed! My straightforward reaction & comment about the discovery of gravitational wave of LIGO is as below:

Nobody knows whether there is a dinosaur in Jack’s house or not, whereas, one day, Bob suddenly cried out, Oh, my God, how wonderfully the dinosaur in Jack’s house dances!

—Oh, shit, what grotesque hoax it is! is there really a dinosaur in Jack’s house? Before verification of the very situation, what’s the precipitate and unintelligible wonder that even a dinosaur dances wonderfully in Jack’s house!?

And indeed, once I added section of Homogenous Cosmos Originated from Unique Genesis Encountered LIGO Gravitational Wave Discovery into the monograph, I slid into even pestilent vicious circle of virulent scientific knowledge metabolism campaign therefore.

In June 2017, even esoteric wonder occurred, it’s said that SW. Hawking recently declared again there are virtually no Black Holes in cosmos, SW. Hawking was famous again for his intelligent declaration therefore. What’s the unintelligible situation can you imagine? About 40 years ago, SW. Hawking insisted there are substantial Back Holes in cosmos and predicted some a little about attribute of Black Hole, he was famous all over the world for his prediction, about 40 years later, he came out to insist again that Black Holes are virtually nonexistent in cosmos, he was famous all over the world again. I insisted cosmos is but demiurgic aggradation of sequential homologic cosmogony, which exactly exists as well-regulated integration of cosmic homogeneity system making up of out-and-out natura naturata in the nature of coherent natura naturans throughout cosmic evolution, there is completely no connatural possibility for original generation of so-called Back Hole in the nature of coherent natura naturans throughout cosmic evolution in 1995, whereas, just because I am lowdown man of the society and typical heterodoxy of the age, practical naissance of Homogenous Cosmos Originated from Unique

As coherent natura naturans throughout cosmic evolution, instinctive PNT reciprocal equilibrium towards optimum PNT operation is radical potentiality & conditionality for cosmos always ready to orientate itself towards perfection.

Genesis can do nothing to impact social legitimacy subsistence of contemporaneous scientific orthodoxy under egotistic background of royal substantiation & perfection of contemporaneous scientific orthodoxy.

We have to admit, as multiple notion with double significance of “**social connotation**” & “**natural connotation**”, social legitimacy & validity of truths can never exceed cannon range; we have to admit, under egotistic background of royal substantiation & perfection of contemporaneous scientific orthodoxy, modern science forum is magically wonder-working.

Originally, historical progress of science is always endeavor to push humanistic ideology about authenticity of nature forward to perfect ideological enantiomorph of ultimate authenticity of nature step by step draw on practical feasibility & possibility in proportion to contemporaneous historical background, science forum should be platform for promulgation of innovative scientific idea for historical progress of science in inherent optimum orientation towards perfect ideological enantiomorph of ultimate authenticity of nature. Whereas, as durable popularity of royal substantiation & perfection of contemporaneous scientific orthodoxy with unprecedented official facility of magistral autarchy of **free press regulation customization** and **free press admittance** short of necessary intendance, science forum has become VIP banquet for royal substantiation & perfection of contemporaneous scientific orthodoxy, where free press seems always ready for high-sound comedy of royal substantiation & perfection of contemporaneous scientific orthodoxy in defiance of objectivity that, as permanent synthesized conditionality of “**crecive progression of practical feasibility & possibility in proportion to contemporaneous historical background + the uniqueness & invariance of ultimate authenticity of nature predestines the unique possibility of scientific verity as perfect ideological enantiomorph of ultimate authenticity of nature**” through and through, it’s only possible for the major melody of historical progress of science to be a series of epochmaking scientific knowledge metabolism in inherent optimum orientation towards perfect ideological enantiomorph of ultimate authenticity of nature.



It's only possible for concordant cosmos to be demiurgic aggradation of out-and-out serial natura naturata in the nature of coherent natura naturans throughout cosmic evolution; there is no way for demiurgic aggradation in the nature of different natura naturans to be concordant cosmos through and through.

The Ninth Part

References Interpretation of Homogenous Cosmos Originated from Unique Genesis and Nowadays “Reference Popularity” Under Egotistic Background of Interminable Royal Substantiation & Perfection of Contemporaneous Scientific Orthodoxy

Foreword

Development of science is always hypostatic endeavor to discover and formulate the universal existence & motion as authentic, comprehensive and systematical as people are practically able to, whose most veritable effect is mostly accomplishment to push humanistic ideology about authenticity of nature forward to perfect ideological enantiomorph of ultimate authenticity of nature draw on practical feasibility & possibility in proportion to contemporaneous historical background, till at last, the humanistic ideology about authenticity of nature tally with ultimate authenticity of nature of coherent natura naturans throughout cosmic evolution 100 over 100. Whereas, once living development of science is restricted too much by authoritative intrepidity of contemporaneous scientific orthodoxy short of necessary intendance, historical progress of science must slide into interminable royal substantiation & perfection of contemporaneous scientific orthodoxy under unrestrained egotistic guidance & restriction of temporal authority in defiance of necessary renovation of humanistic ideology about authenticity of nature in proportion to contemporaneous historical background, and the living scientific knowledge proliferation all over the world must be rigid succession of contemporaneous scientific orthodoxy due to magistral autarchy of free press regulation customization and free press admittance of temporal authority short of necessary intendance, although, the major melody of historical progress of science must be serial epochmaking scientific knowledge metabolism in inherent optimum orientation towards perfect ideological enantiomorph of ultimate authenticity of nature.

Historical progress of science in the recent several centuries seemed like a far-flung exploration of the first itinerary around numerous distinctive landscapes of brand-new landmasses of science with palette & tablet on back, several hundred years' scientific travelogues were compiled thereby.

When brand-new innovative humanistic ideology about authenticity of nature coming to do its positive jobs as contemporaneous scientific orthodoxy, endeavor of substantiation & perfection of the innovative contemporaneous scientific orthodoxy can mostly take the full role of general progress of science. Whereas, once the live contemporaneous scientific orthodoxy exhausts its inherent rational potentiality to push humanistic ideology about authenticity of nature forward to perfect ideological enantiomorph of ultimate authenticity of nature, the endeavor of interminable substantiation & perfection of contemporaneous scientific orthodoxy must be faint and conservative, and the reference popularity under background of high-sounding freewheeling royal substantiation & perfection of contemporaneous scientific orthodoxy is just the typical endeavor. In any case, the major melody of historical progress of science is epochmaking scientific knowledge metabolism in inherent optimum orientation towards perfect ideological enantiomorph of ultimate authenticity of nature but not interminable royal substantiation & perfection of contemporaneous scientific orthodoxy out of scientific legitimacy qualification of historical authenticity tolerance of science 0. Before humanistic ideology about authenticity of nature finally qualified as perfect ideological enantiomorph of ultimate authenticity of nature, none interminable freewheeling of royal substantiation & perfection of contemporaneous scientific orthodoxy like nonstop can finish coming progress of science through and through without epochmaking scientific knowledge metabolism.

Since the idea of homogenous cosmos originated from unique genesis was born in Nov 1991, in accordance with conventional definition of reference, the books which had practically taken role of reference as fecund thought resource of Homogenous Cosmos Originated from Unique Genesis must be the ones I had read before Nov 1991, especially the ones I read in library of the first middle school of Wugang city in period from September 1991 to November 1991. However, as onefold senior high school student, I had to comment herein, the idea of homogenous cosmos originated from unique genesis purely came into being under subconscious fettle; it was not outcome of painstaking and professional study but unselfconscious outgrowth of related fecund thought gradually stored up and ultimately cleared up in my mind according to some certain rational question I stochastically met upon my personal thought speciality.

In any case, as simplex senior high school student, I had no intention to study something devoted that years, I but tasted books accessible and stored up related information upon my personal interest and fancy and thought of my questions upon my subconscious speciality. I had no intention to study something professionally and I had no idea of reference that years. And indeed, I had never intentionally read any books for necessity of professional demonstration or rational support as so-called reference as nannyish orthodox experts usually do with goal draft prepared on table, no more to intentionally note down references involved in. The situation was really similar as honeybee working for honey, at the beginning, honeybees have no idea what kind of honey to brew and what kind of pollen should be in orders, but fly freely among rich and colorful flowers and gather all available pollen by the light of nature. However, once the honey has been brewed, if you come to ask them what's the original "pollen" of the very "honey"? Oh, my God, what's the serious trouble for me to face so unexpected question? Have I done something wrong? It's completely unintelligible!

It was of course true the idea of homogenous cosmos originated from unique genesis primitively came into being in Nov. 1991, it was also true I had read a lot of books in school library that days, but I am afraid, once we come to review and ascertain the practical actuality the idea of homogenous cosmos originated from unique genesis originally came into being on the basis of proper fecund thought resource, we can not localize our attention within what happened in the three months from September to November 1991. The actual substantial fecund thought resource which was adequate to brew idea of homogenous cosmos originated from unique genesis was not something gathered within that three months, it was not only because I had ever read one or two special books that days. Instead, the most substantial significance was that I just involved in such favorable background with remarkable highlight of microcosmic conformation of matter in 20 century, especially, the factuality that [discretionary](#)

particles in cosmos are mutually convertible is always in live orientation towards complete induction.

As virginal senior high school student full of curiousness and enterprising groping thought, my blank sensitive memory were widely open and always ready to store and assimilate related knowledge radiation of the age all along. The key issue of the occurrence was that I hunted reading madly and thought of my questions deeply during the very period, and unconsciously, I touched the sensitive detonating mine “discretionary particles in cosmos are mutually convertible \leadsto for they ultimately possess the common component in certain configurable hiberarchy”, and sensitively touched off chain-reacting of all the “thought resource uranium” which was gradually accumulated in my memory upon my subconsciousness all the time and consequently made Homogenous Cosmos Originated from Unique Genesis exploded itself at the volley. Whereas, it's substantively difficult for me to review and ascertain all the foregone subconscious gain and count all the proper fecund thought resource which is approximately bodiless but could be generalized as “discretionary particles in cosmos are mutually convertible” afterwards upon memory into nice references according to temporal reference popularity.

In even straightforward words, it's just the favorable historical background that microcosmic configuration of matter was remarkably highlighted, which made idea of homogenous cosmos originated from unique genesis come into being accordingly. However, it's completely impossible for me to write down the favorable historical background that microcosmic configuration of matter was remarkably highlighted onto normal references. Virtually, the cumulation process of the related information just as honeybees collect pollen in garden, there is no honeybees who are always ready to remember which flowers they have practically collected pollen from. What's more, once the pollen have been brewed into honey, there is no way for you to tell apart who is who.

As pioneering endeavor of historical progress of science in inherent optimum orientation towards perfect ideological enantiomorph of ultimate authenticity of nature, Homogenous Cosmos Originated from Unique Genesis is innovative cosmos redefinition in logic enantiomorph of newly highlighted factuality that discretionary particles in cosmos are mutually convertible with consequent dynamics about universal existence & motion of matter in the nature of coherent natura naturans throughout cosmic evolution, the progenitive references Homogenous Cosmos Originated from Unique Genesis benefited from tradition are but limited in that ideological aggradation about microcosmic conformation of matter in the recent 100 years has thrown more and more lights on “homogenous profile of cosmos”, especially the factuality of “discretionary particles in cosmos are mutually convertible” in freewheeling towards complete induction day by day, so that I could expediently perceive the presumable precondition of homogenous cosmos originated from unique genesis. Whereas, the aggressive logic extension of Homogenous cosmos originated from unique genesis postulate with supplementation of two 0.5 grade auxiliary postulates has no references, and virtually, it seems none references are necessary for the job. In any case, connotation objectification and successive freewheeling logic extension of Homogenous cosmos originated from unique genesis postulate with supplementation of two 0.5 grade accessorial postulates is but independent logic chain-reacting.

In a straightforward word, all references Homogenous Cosmos Originated from Unique Genesis benefited from ambience are but limited in it perceived the general presumable precondition of Homogenous cosmos originated from unique genesis from recognizant aggradation of tradition about microcosmic conformation. All endeavor of logic outspread rooted in the presumable precondition of Homogenous cosmos originated from unique genesis has none references, and virtually, it needs none references. However, as the very idea came into being under subconscious state when I was still a senior high school student, what are the definite denomination of the references? I could hardly clarify it now but knowing it is favorable historical background of remarkable highlight of microcosmic configuration of matter, especially remarkable highlight of factuality that “discretionary particles in cosmos are mutually convertible”.

The references listed herein is mostly for three reasons:

Historical progress of science in the recent several centuries seemed like a far-flung exploration of the first itinerary around numerous distinctive landscapes of brand-new landmasses of science with palette & tablet on back, several hundred years' scientific travelogues were compiled thereby.

The first, in many cases; I have to cater for popularity of royal substantiation & perfection of contemporaneous scientific orthodoxy, and virtually, before 2006, there were none references listed in Homogenous Cosmos Originated from Unique Genesis.

The second, compared with the books I had read before Nov. 1991, these books are largely identical with minor literal differences, and they consolidated my idea of homogenous cosmos originated from unique genesis more or less when I read them later.

The third, some of the contents introduced in Homogenous Cosmos Originated from Unique Genesis but never involved in my elementary education before 1992 were all learned by me from these books.

I am quite sure the congregation of all the books is of course enough to piece together the integrative historical background of Homogenous Cosmos Originated from Unique Genesis.

In the recent 20 years, in order to procure free press admittance from temporal authorities, in the face of nannyish request of reference, I suffered bitterly without alternatives. Ostensibly, temporal authorities demand nannyish format of reference, virtually they have esoteric pursuit underlying. And virtually, the below references had changed their format three times at least in the recent 20 years, all my effort did nothing.

As no alternatives, I added <supplemental explanation of reference of Homogenous Cosmos Originated from Unique Genesis> behind the reference in January 2011. I see, reference is substantively not only something with nannyish and admirable format but even esoteric legerdemain underlying. As typical heterodoxy, I could hardly be chi-chi.

Each time I met nannyish reference imbroglio in the coming two years, I had to try to avoid fruitless effort but keep silent. Even several times, I could hardly stop my impulsion to delete all the "references" listed below, but to leave single words—*as timely renovation of humanistic ideology about authenticity of nature in proportion to contemporaneous historical background of remarkable highlight of microcosmic configuration of matter*, "*Homogenous Cosmos Originated from Unique Genesis*" is innovative cosmos redefinition in logic enantiomorph of newly highlighted factuality that "*discretionary particles in cosmos are mutually convertible*" with consequent PNT dynamics about universal existence & motion in the nature of coherent natura naturans throughout cosmic evolution. In a straightforward word, favorable groundwork of remarkable highlight of microcosmic configuration of matter, especially, as favorable fecund thought resource, remarkable highlight that *discretionary particles in cosmos are mutually convertible* in the recent one century has brought out substantial headspring for me to succeed the downwind potentiality for pioneering cosmos redefinition and proportionate PNT dynamics about universal existence & motion in the nature of essence of matter in a class by itself. The favorable groundwork of remarkable highlight of microcosmic configuration of matter is not only all necessary references but also overall logic fulcrum of Homogenous Cosmos Originated from Unique Genesis. Luckily, my sense held me, I see, this may be my self-abandoned action to make things even worse, as a result, my silence remains ever since.

Of course, I am quite aware historical progress of science is always realistic sitcom, if live contemporaneous scientific orthodoxy had not brought out *remarkable highlight of microcosmic configuration of matter*, so that the factuality *discretionary particles in cosmos are mutually convertible* is orientating complete induction day by day and the homogenous profile of cosmos become more and more explicit in our rational purview thereby, there is no possibility for stochastic occurrence of aberrant rational sublimation of Homogenous Cosmos Originated from Unique Genesis.

(IX-i) Reference Interpretation of Homogenous Cosmos Originated from Unique Genesis

Abstract: *As timely renovation of humanistic ideology about authenticity of nature in proportion to contemporaneous historical background of remarkable highlight of microcosmic configuration of matter, “Homogenous Cosmos Originated from Unique Genesis” is innovative cosmos redefinition in logic enantiomorph of newly highlighted factuality that “discretionary particles in cosmos are mutually convertible” with consequent PNT dynamics about universal existence & motion in the nature of coherent natura naturans throughout cosmic evolution. In straightforward words, favorable groundwork of Homogenous Cosmos Originated from Unique Genesis is remarkable highlight of microcosmic configuration of matter, especially remarkable highlight that discretionary particles in cosmos are mutually convertible in the recent one century, which has brought out substantial headspring as favorable fecund thought resource for me to succeed the downwind potentiality for pioneering cosmos redefinition and proportionate PNT dynamics about universal existence & motion in the nature of essence of matter in a class by itself. The favorable groundwork of remarkable highlight of microcosmic configuration of matter is not only all necessary references but also overall logic fulcrum of Homogenous Cosmos Originated from Unique Genesis.*

*In straightforward words, the references of Homogenous Cosmos originated from Unique Genesis generally focuses on thought derivation of the general presumable precondition of **Homogenous cosmos originated from unique genesis postulate**, which was radically derived from newly highlighted factuality that **discretionary particles in cosmos are mutually convertible**. In another words, it's just the remarkable highlight of microcosmic configuration of matter in the recent one century, which has brought out favorable fecund thought resource as historical headspring for me to pioneer universal existence & motion in homogenous cosmos in the nature of essence of matter in a class by itself. Favorable groundwork of remarkable highlight of microcosmic configuration of matter was all necessary references of Homogenous Cosmos Originated from Unique Genesis indeed.*

The integrative logic expansion of Homogenous Cosmos Originated from Unique Genesis is completely a logic chain-reacting of [(homogenous cosmos originated from unique genesis + spacetime & matter fully embodying existence of cosmos) + instinctive PNT equilibrium]. Of course, the logic expansion of the logic chain-reacting has no references, and it needs no references besides rationality of itself indeed. The universal applicability hypostatization of PNT dynamics of course has no references. And virtually, I am the unique person involved this subject on earth at present, there is no related references for me to refer to. However, temporal authority are always ready to demand me to refer to their authorized papers in the recent 5 years, otherwise, there is no way for me to pass free press admittance.

1. **As timely renovation of humanistic ideology about authenticity of nature in proportion to contemporaneous historical background of remarkable highlight of microcosmic configuration of matter, “Homogenous Cosmos Originated from Unique Genesis” is innovative cosmos redefinition in logic enantiomorph of newly highlighted factuality that “discretionary particles in cosmos are mutually convertible” with consequent PNT dynamics about universal existence & motion in the nature of coherent natura naturans throughout cosmic evolution. Virtually, as favorable fecund thought resource, remarkable highlight of microcosmic configuration of matter, especially factuality that discretionary particles in cosmos are mutually convertible is always in freewheeling orientation towards complete induction in the recent one century has brought out substantial headspring for me to succeed the downwind potentiality for pioneering cosmos**

redefinition with consequent PNT dynamics about universal existence & motion in the nature of coherent natura naturans throughout cosmic evolution. The favorable groundwork of **remarkable highlight of microcosmic configuration of matter** is not only all background references but also overall logic fulcrum of Homogenous Cosmos Originated from Unique Genesis.

Remarkable progress of modern particle physics has thrown more and more lights onto factuality that **discretionary particles are mutually convertible** \leftrightarrow **for they ultimately possess the common component in certain configurable hierarchy**, such factuality makes me impressive that cosmos should be throughout homogenous originated from unique genesis! Although it's still very difficult for me to prove that cosmos is really homogenous originated from unique genesis through and through, the remarkable highlight of the very factuality is substantively enough for us to introduce **Homogenous cosmos originated from unique genesis postulate** for expedient theoretical exploration straightway. Virtually, Homogenous Cosmos Originated from Unique Genesis is just cosmos redefinition in logic enantiomorph of newly highlighted factuality that **discretionary particles in cosmos are mutually convertible** with consequent PNT dynamics about universal existence & motion in the nature of coherent natura naturans throughout cosmic evolution (/essence of matter in a class by itself).

Virtually, integrative logic proliferation of Homogenous Cosmos Originated from Unique Genesis is generally made up of two major logic processes.

The first, as remarkable highlight of factuality that **discretionary particles in cosmos are mutually convertible**, I introduced **Homogenous cosmos originated from unique genesis postulate** accordingly.

The second, with supplementation of two 0.5 grade accessorial postulates, I expanded the logic connotation of **Homogenous cosmos originated from unique genesis postulate**.

The first logic process of introduction of Homogenous cosmos originated from unique genesis postulate is straightforward logic result of references of favorable highlight of factuality that **discretionary particles in cosmos are mutually convertible**. And just because of remarkable highlight of the very factuality, I introduced **Homogenous cosmos originated from unique genesis postulate** accordingly. In straightforward words, as authentic factuality that **discretionary particles in cosmos are mutually convertible** is running towards perfect induction day by day, which consequently makes the homogenous profile of cosmos more and more explicit, I introduced **Homogenous cosmos originated from unique genesis postulate** for freewheeling logic extension of universal existence & motion, —since cosmos is homogenous originated from unique genesis through and through, what's the integrative homologic universal existence & motion should be accordingly?

This of course indicates that innovative naissance of Homogenous Cosmos Originated from Unique Genesis is pioneering endeavor to review overall configuration of cosmos and universal existence & motion of matter in rational succession of historical groundwork of middle and posterior of 20 century for remarkable highlight of microcosmic configuration of matter. As a result, I arrive at cosmos redefinition with consequent PNT dynamics about universal existence & motion in the nature of coherent natura naturans throughout cosmic evolution. As favorable fecund thought resource, the favorable historical groundwork of remarkable highlight of microcosmic configuration of matter, especially remarkable highlight of factuality that **discretionary particles in cosmos are mutually convertible** has brought out substantial headspring for me to succeed the downwind potentiality to review universal existence & motion in the nature of essence of matter in a class by itself following a rational clew of sequential homologic cosmogony, and it's just the favorable historical groundwork which virtually offered all necessary references for integrative logical operation of Homogenous Cosmos Originated

from Unique Genesis.

2. As timely renovation of humanistic ideology about authenticity of nature in proportion to contemporaneous historical background of **remarkable highlight of microcosmic configuration of matter** and rational expansion of independent logic chain-reacting out of rigid succession of contemporaneous scientific orthodoxy, connotation objectification & proportionate freewheeling logic extension of **“Homogenous cosmos originated from unique genesis postulate”** with supplementation of two 0.5 grade accessorial postulates can find none compatible references from tradition. Virtually, there is substantial suspicious that conventional reference popularity is but esoteric manner to restrict living scientific knowledge proliferation in rigid succession of contemporaneous scientific orthodoxy, especially under egotistic background of interminable royal substantiation & perfection of contemporaneous scientific orthodoxy with unprecedented magistral autarchy of **free press regulation customization & free press admittance** of temporal authority short of necessary intendance, which is of course remarkable aberrance of hypostatic endeavor historical progress of science to push humanistic ideology about authenticity of nature forward to perfect ideological enantiomorph of ultimate authenticity of nature draw on **practical feasibility & possibility in proportion to contemporaneous historical background**.

The second thought process for logic proliferation of Homogenous Cosmos Originated from Unique Genesis is virtually an independent logic chain-reacting of **[(Homogenous cosmos originated from unique genesis + spacetime & matter fully embodying cosmos) + instinctive PNT equilibrium]**. The connotation expansion of the independent logic chain-reacting has no references of course, and virtually, it needs no references as independent logic chain-reacting. The full connotation expansion of the independent logic chain-reacting is that if cosmos is really homogenous originated from unique genesis through and through, and if we just presume that entire cosmos is made up of “spacetime” and “matter”, none third coordinative component in cosmos any more, then, “spacetime” and “matter” must be alternative homologic filiation either **“spacetime father & matter son”** or **“matter father & spacetime son”**, and once we exclude potential possibility of **“matter father & spacetime son”**, we can arrive at unique possible homologic filiation **“spacetime father & matter son”**, so that cosmos is but homogenous aggregation of **“spacetime father & matter son”** with inherent relationship of PNT action. And finally, I introduced **“Instinctive PNT equilibrium postulate”** to specify dynamic fundamental of PNT action, which seems magic leitmotiv of the demiurge and dynamic atman of universal existence & motion.

Ostensibly, introduction of **“Instinctive PNT equilibrium postulate”** directly specifies dynamic fundamental of **“PNT action”**, virtually, PNT action is not only headspring creation of original generation of matter along sequential homologic cosmogony but also proportionate dynamic origin of postnatal existence & motion of matter in cosmos, which of course indicates existence & motion of matter in spacetime is vivid mirror of innative PNT action of matter integration. As a result, introduction of **“Instinctive PNT equilibrium postulate”** even specifies **“existence & motion of matter”** indirectly, which not only nail down the connatural intention of existence & motion of matter, but also make the state orientation of existence & motion of matter self-evident. —so-called **“motion”** is but physical process as spontaneous occurrence, as PNT operation of matter integration is disturbed, PNT equilibrium instinct of matter integration has to react to maintain and rebuild optimum PNT operation by the light of nature.

This of course implies existence & motion of matter is but spontaneous occurrence of **[external physical disturbance + (PNT action + Instinctive PNT equilibrium)]**.

Once **external physical disturbance=0**, as no instinctive reaction of PNT equilibrium for no physical disturbance, all state parameters of matter integration keep constant, matter integration exists in inertial state

Historical progress of science in the recent several centuries seemed like a far-flung exploration of the first itinerary around numerous distinctive landscapes of brand-new landmasses of science with palette & tablet on back, several hundred years' scientific travelogues were compiled thereby.

therefore, mathematical formulation of the proper inertial state of matter integration leads to accomplishment of “**Matter Inertial Conservation Equations**”.

Once **external physical disturbance** ≠ 0, PNT operation of matter integration is disturbed therefore, and PNT equilibrium instinct of matter integration has to react to maintain and rebuild optimum PNT operation by the light of nature. As a result, all state parameters of matter integration vary accordingly, matter integration exists in accelerating state therefore, and mathematical formulation of the instinctive accelerating variation of matter integration directly lead to accomplishment of “**PNT Dynamics**”.

The integrative logic constitution of PNT Dynamics can be illuminated as following:

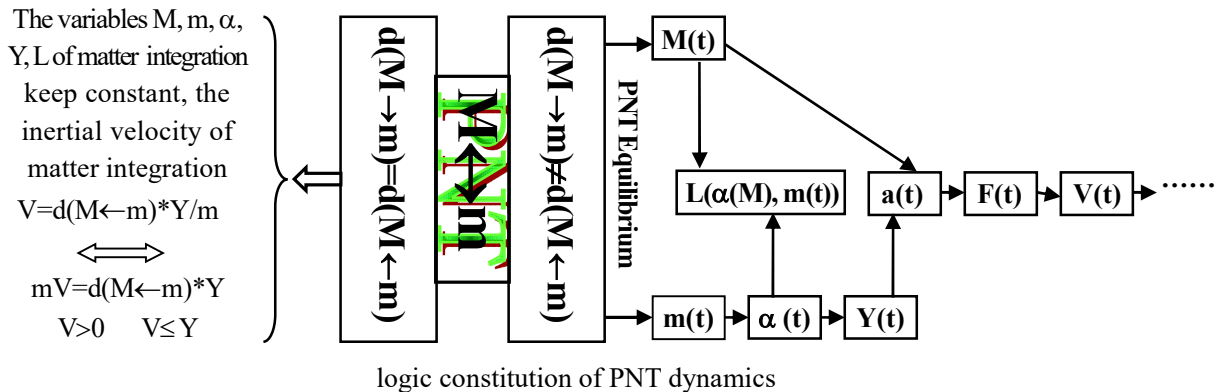

Virtually, as timely renovation of humanistic ideology about authenticity of nature in proportion to contemporaneous historical background of **remarkable highlight of microcosmic configuration of matter**, Homogenous Cosmos Originated from Unique Genesis is typical outgrowth of aberrant scientific knowledge proliferation out of succession of contemporaneous scientific orthodoxy, which never succeeds the rich and colorful scientific travelogues A, B, C, D, E, F, ...like omnifarious smallwares full of a basket for further highlight of authenticity of nature but does its job for cosmos redefinition as linear logic system based on presumable precondition of **Homogenous cosmos originated from unique genesis postulate** and formulates universal existence & motion in the nature of coherent natura naturans throughout cosmic evolution as radical logic enantiomorph of newly highlighted factuality that **discretionary particles in cosmos are mutually convertible**. The favorable groundwork of remarkable highlight of microcosmic configuration of matter is not only radical headspring and necessary references but also overall logic fulcrum of Homogenous Cosmos Originated from Unique Genesis.

January 6-10, 2011, Baisha village, Humen town, Dongguan city, Guangdong province
 Further revision was done in June 2018, Nanxing, Dani-shatian-dongguan-guangdong

(IX-ii) Practical significance of reference popularity

Abstract: *As thought resource for coming scientific knowledge proliferation, as long as the references are not absolute scientific verities out of scientific legitimacy qualification of historical authenticity tolerance of science 0, practice of reference popularity must synchronously bring out “positive significance” & “negative significance” undoubtedly, inherent coexistence of “positive significance” & “negative significance” of reference popularity is similar as couple sides of a coin. Virtually, the most straightforward practical significance of reference popularity is that interminable implementation of reference popularity under egocentric guidance of temporal authority must form invisible egotistic restriction of contemporaneous scientific orthodoxy, which grimly coerces all coming scientific knowledge proliferation in rigid succession of contemporaneous scientific orthodoxy, none scientific knowledge proliferation out of succession of contemporaneous scientific orthodoxy can be qualified and acceptable. As a result, practical significance of reference popularity mostly depends on scientific quality or historical authenticity tolerance of science of contemporaneous scientific orthodoxy. However, temporal authority only admit and face the positive significance of reference popularity in defiance of the inherent coexistence of the negative significance of reference popularity, they even persist in by tolerant deeds that all coming progress of human science is but conventional extension of royal substantiation & perfection of contemporaneous scientific orthodoxy without any shift of social legitimacy metabolism for ever.*

Keywords: *positive significance of reference popularity; negative significance of reference popularity; contemporaneous scientific orthodoxy of science; successive freewheeling substantiation & perfection of contemporaneous scientific orthodoxy; historical social legitimacy metabolism.*

1. Before humanistic ideology about authenticity of nature finally qualified as perfect ideological enantiomorph of ultimate authenticity of nature, it's only possible for “science” to be commensurate ideological system about authenticity of nature in proportion to contemporaneous historical background existing in crecive progression of historical progress of science in inherent optimum orientation towards perfect ideological enantiomorph of ultimate authenticity of nature. As influential ideological background for coming scientific knowledge proliferation, “positive significance” & “negative significance” of reference popularity is always coordinative inherence like inherent couple sides of a coin.

Before humanistic ideology about authenticity of nature finally qualified as perfect ideological enantiomorph of ultimate authenticity of nature, the most pestilent obstacle for historical progress of science is mostly unnoticed thought misdirection & bewitchment derived from authoritative intrepidity of contemporaneous scientific orthodoxy out of scientific legitimacy qualification of historical authenticity tolerance of science 0 to succedent generation, especially, once authoritative intrepidity of contemporaneous scientific orthodoxy is egotistically all-time and overwhelming towards interminable substantiation & perfection of contemporaneous scientific orthodoxy.

So-called “reference popularity” is a kind of operational regulation of scientific knowledge proliferation, which demands coming scientific knowledge proliferation among all academicians on the earth must refer to the authorized ready-made scientific knowledge of contemporaneous scientific orthodoxy as available thought resource so as to ensure coming scientific knowledge proliferation to have come into temporal authorities/orthodoxy. As long as ideological connotation of “references” is not perfect ideological enantiomorph of ultimate authenticity of nature, once it takes role of available thought resource for coming scientific knowledge proliferation, reference

popularity must have coexistent practical significance of “positive significance” and “negative significance” as inherence due to coming scientific knowledge proliferation like couple sides of a coin.

The positive significance of reference popularity is mostly to come into and carry forward worthy thought & idea of contemporaneous scientific orthodoxy for substantiation & perfection of contemporaneous scientific orthodoxy, no matter how remarkable historical limitation of the “worthy thought & idea” of contemporaneous scientific orthodoxy is, no matter how remarkable the historical authenticity tolerance of science of contemporaneous scientific orthodoxy is.

The negative significance of reference popularity is to bring coming scientific knowledge proliferation into egotistic restriction & bewitchment of conventionality and make coming scientific knowledge proliferation in rigid succession of contemporaneous scientific orthodoxy and unknowingly serve the time by itself in defiance of historical limitation of contemporaneous scientific orthodoxy, as long as “contemporaneous scientific orthodoxy” inherently has historical limitation as humanistic ideology about authenticity of nature in proportion to contemporaneous historical background before approaching perfect ideological enantiomorph of ultimate authenticity of nature.

Before humanistic ideology about authenticity of nature finally qualified as perfect ideological enantiomorph of ultimate authenticity of nature, “positive significance” & “negative significance” is inherent couple of reference popularity, the inherent coexistence of “positive significance” & “negative significance” of reference popularity is just similar as the both sides of a cent. The practical significance of reference popularity radically depends on “scientific quality” or “historical authenticity tolerance of science” of so-called references which are mostly the contemporaneous scientific orthodoxy for it's only possible for contemporaneous scientific orthodoxy to be qualified to take the role of popular references for perdue regulation of reference popularity going without saying.

The more remarkable the historical authenticity tolerance of science of so-called references (/contemporaneous scientific orthodoxy) is, the reference popularity is relatively more tinpot with poor potentiality towards in-depth highlight of authenticity of nature for general progress of science and consequently has less potentiality for valuable practice of human, reference popularity is relatively flimsy to expose “negative significance” therefore. On the contrary, the more hairlike the historical authenticity tolerance of science of so-called references (/contemporaneous scientific orthodoxy) is, the reference popularity is relatively more valuable with substantial potentiality towards in-depth highlight of authenticity of nature for general progress of science, and consequently has substantial potentiality for valuable practice of human, reference popularity is relatively expedient to realize the “positive significance” therefore. This is just inherent “objective potentiality” of reference popularity, which indicates “historical authenticity tolerance of science” of contemporaneous scientific orthodoxy is proportional worthiness weight of reference popularity of the age.

In any historical age, it's only possible for temporal authority to take the role of charter members and exponentials of “reference popularity”, in fact, besides temporal authority, nobody is qualified and superior enough to be charter members and exponentials of “reference popularity”. And just because of practical involvement and restriction, especially the powerful restriction of free press admittance, interminable implementation of reference popularity must follow out idiographic ideology & subjective intention of temporal authority going without saying, and consequently form egotistic restriction to make the coming scientific knowledge proliferation unknowingly slide into rigid succession of contemporaneous scientific orthodoxy. If the egotistic restriction exerts its function freely, interminable implementation of reference popularity even approach ideal situation that any people who are ready to enter science forum must refer to contemporaneous scientific orthodoxy above all, otherwise, there is no

way for him to. As a result, interminable implementation of reference popularity under egotistic guidance of temporal authority must form invisible egotistic restriction of contemporaneous scientific orthodoxy, which grimly coerce all coming scientific knowledge proliferation all over the world must be in rigid succession of contemporaneous scientific orthodoxy, subaudition is of course that any scientific knowledge proliferation out of succession of contemporaneous scientific orthodoxy is unintelligible and unacceptable. This is just the self-evident implication and root cause of most straightforward practical significance of reference popularity.

2. General practical significance of reference popularity throughout historical progress of science.

Practical significance of reference popularity radically depends on scientific quality or historical authenticity tolerance of science of contemporaneous scientific orthodoxy. In another words, throughout historical progress of science, the relationship between “scientific quality of contemporaneous scientific orthodoxy” and “practical significance of reference popularity” is always something like a tangible object and its shadow. However, throughout historical progress of science, what’s the general quantitative & qualitative change profile of scientific quality of successive contemporaneous scientific orthodoxy, so that we can follow out the isochronous practical significance of reference popularity like shadow of scientific quality of contemporaneous scientific orthodoxy through and through?

Towards clarification of practical significance of reference popularity throughout historical progress of science, it’s necessary for us to highlight the two typical progressive features of historical progress of science.

<i> Since **ultimate authenticity of nature** can be neither omnifarious authenticity smallwares full of a basket nor authenticity chameleon one piece and only but coherent natura naturans throughout cosmic evolution, as ideological enantiomorph of accessible existence & motion around us, ultimate consummation of science must be **perfect ideological enantiomorph of ultimate authenticity of nature**, veritable progress of science is not intuitional cumulative achievement of colorful scientific travelogues A, B, C, D, E, F, ... as deserving reward of the first itinerary around preternatural landscapes of brand-new landmasses of science like omnifarious smallwares full of a basket but successive hypostatic endeavor to push humanistic ideology about authenticity of nature forward to perfect ideological enantiomorph of ultimate authenticity of nature step by step draw on practical feasibility & possibility in proportion to contemporaneous historical background. And as permanent synthesized conditionality of “**crecive progression of practical feasibility & possibility in proportion to contemporaneous historical background + the uniqueness & invariance of ultimate authenticity of nature predestines the unique possibility of scientific verity as perfect ideological enantiomorph of ultimate authenticity of nature**” through and through, it’s only possible for the major melody of historical progress of science to be a series of epochmaking scientific knowledge metabolism in inherent optimum orientation towards perfect ideological enantiomorph of ultimate authenticity of nature. This of course indicates any contemporaneous scientific orthodoxy out of scientific legitimacy qualification of historical authenticity tolerance of science 0 can only exist as distinctive progressive segment of historical progress of science in proportion to contemporaneous historical background with proportionate historical authenticity tolerance of science, general progress of science can never be nonstop of freewheeling substantiation & perfection of distinctive contemporaneous scientific orthodoxy out of scientific legitimacy qualification of historical authenticity tolerance of science 0 through and through, but gradational succession of series of historical legitimacy metabolism of N different temporal orthodoxies one by one.

Throughout historical progress of science, as long as there is scientific artery, there must be contemporaneous scientific orthodoxy therefore. However, as gradual melioration of practical feasibility & possibility in proportion to persistent quantitative & qualitative change of commensurate historical groundwork along crecive progression of historical progress of science, there is almost no possibility for occurrence of such a magic scientific orthodoxy

Historical progress of science in the recent several centuries seemed like a far-flung exploration of the first itinerary around numerous distinctive landscapes of brand-new landmasses of science with palette & tablet on back, several hundred years’ scientific travelogues were compiled thereby.

who is able to push humanistic ideology about authenticity of nature forward to perfect ideological enantiomorph of ultimate authenticity of nature all along by freewheeling royal substantiation & perfection of the invariable contemporaneous scientific orthodoxy like nonstop, till at last, the conventional extension of royal substantiation & perfection of the invariable contemporaneous scientific orthodoxy approaches absolute scientific verity as perfect ideological enantiomorph of ultimate authenticity of nature and consequently accomplishes historical progress of science through and through.

Virtually, as long as there is remarkable historical limitation, it's completely impossible for any contemporaneous scientific orthodoxy with inherent historical limitation to perfect scientific connotation towards absolute scientific verity as perfect ideological enantiomorph of ultimate authenticity of nature with legitimacy qualification of historical authenticity tolerance of science 0 by endeavor of interminable royal substantiation & perfection of contemporaneous scientific orthodoxy like nonstop without shift of historical subrogation of contemporaneous scientific orthodoxy. Instead, it's only possible for historical progress of science to be crevice progression making up of serial social legitimacy metabolism with synchronous orthodoxy subrogation of N distinctive temporal orthodoxies one after another. Historical progress of science can never be conventional freewheeling of interminable royal substantiation & perfection of invariable scientific orthodoxy out of scientific legitimacy qualification of historical authenticity tolerance of science 0.

<ii> As crevice progression of practical feasibility & possibility in proportion to contemporaneous historical background, it's completely impossible for human to introduce universal existence & motion into rational purview for scientific clarification & verification towards perfect ideological enantiomorph of ultimate authenticity of nature once but to discover and formulate historically accessible existence & motion around draw on practical feasibility & possibility in proportion to contemporaneous historical background. As potential synthesized conditionality of “**crevice progression of practical feasibility & possibility in proportion to contemporaneous historical background + the uniqueness & invariance of ultimate authenticity of nature predestines unique possibility of scientific verity as perfect ideological enantiomorph of ultimate authenticity of nature**” through and through, it's only possible for the major melody of historical progress of science to be serial epochmaking scientific knowledge metabolism in inherent optimum orientation towards perfect ideological enantiomorph of ultimate authenticity of nature with synchronous orthodoxy subrogation. Throughout historical progress of science, any contemporaneous scientific orthodoxy out of scientific legitimacy qualification of historical authenticity tolerance of science 0 must be washed out for successive accomplishment of further advancement of historical authenticity tolerance of science towards 0, till at last, humanistic ideology about authenticity of nature tallies with ultimate authenticity of nature 100% as perfect ideological enantiomorph of ultimate authenticity of nature.

As crevice progression of practical feasibility & possibility in proportion to contemporaneous historical background, it's completely impossible for humanistic ideology about authenticity of nature to be consummated once as perfect ideological enantiomorph of ultimate authenticity of nature about universal existence & motion. Instead, it's only possible for human to clarify and verify temporally accessible existence & motion around us off the cuff one after another, so that we gradually know more and more about distinctive existence & motion accessible around us. Once we have procured enough knowledge about accessible existence & motion around us, as incremental quantitative & qualitative change of practical feasibility & possibility as hypostatic potentiality for historical progress of science, we consequently come to know authenticity of nature from superficiality to profundity, from parochiality to generality, and ultimately, we come to formulate the ultimate authenticity of nature as perfect ideological enantiomorph of ultimate authenticity of nature about universal existence & motion .

As coherent natura naturans throughout cosmic evolution, instinctive PNT reciprocal equilibrium towards optimum PNT operation is radical potentiality & conditionality for cosmos always ready to orientate itself towards perfection.

Throughout historical progress of science, if human had practically accomplished N ($N \geq 2$) times of renovation of humanistic ideology about authenticity of nature in proportion to contemporaneous historical background at the volley, then, we can of course conclude that it's impossible for the N times of renovation of humanistic ideology about authenticity of nature in proportion to contemporaneous historical background to be perfect ideological enantiomorph of ultimate authenticity of nature as coherent theory about universal existence & motion, but idiographic humanistic ideology about authenticity of nature in proportion to contemporaneous historical background with proportionate unequal historical authenticity tolerance of science in rigorous succession & orientation towards historical authenticity tolerance of science 0. Then, in accordance with general progressive fundamental humanistic ideology about authenticity of nature gradually approaching perfect ideological enantiomorph of ultimate authenticity of nature in inherent optimum orientation towards historical authenticity tolerance of science 0, the occurrence succession of scientific knowledge metabolism must be as following:

Once the second renovation of humanistic ideology about authenticity of nature in proportion to contemporaneous historical background occurred and consequently procured social legitimacy qualification of the age, the first version of humanistic ideology about authenticity of nature in proportion to foregone historical background must be washed out by the second renovation of humanistic ideology about authenticity of nature in proportion to contemporaneous historical background. In any case, as humanistic ideology about authenticity of nature in proportion to contemporaneous historical background, it's only possible for ultimate consummation of science to be perfect ideological enantiomorph of ultimate authenticity of nature, since it's only possible for ultimate authenticity of nature to be unique and invariable as coherent *natura naturans* throughout cosmic evolution, it's of course impossible for "two distinctive humanistic ideologies about authenticity of nature with remarkable ideological difference" to discover and formulate "the coherent *natura naturans* throughout cosmic evolution" coequally.

Once the third renovation of humanistic ideology about authenticity of nature in proportion to contemporaneous historical background occurred and consequently procured social legitimacy qualification of the age, the second version of humanistic ideology about authenticity of nature in proportion to foregone historical background must be washed out by the third renovation of humanistic ideology about authenticity of nature in proportion to contemporaneous historical background. In any case, as humanistic ideology about authenticity of nature in proportion to contemporaneous historical background, it's only possible for ultimate consummation of science to be perfect ideological enantiomorph of ultimate authenticity of nature, since it's only possible for ultimate authenticity of nature to be unique and invariable as coherent *natura naturans* throughout cosmic evolution, it's of course impossible for "two distinctive humanistic ideologies about authenticity of nature with remarkable ideological difference" to discover and formulate "the coherent *natura naturans* throughout cosmic evolution" coequally.

Once the 4th renovation of humanistic ideology about authenticity of nature in proportion to contemporaneous historical background occurred and consequently procured social legitimacy qualification of the age, the third version of humanistic ideology about authenticity of nature in proportion to foregone historical background must be washed out by the 4th renovation of humanistic ideology about authenticity of nature in proportion to contemporaneous historical background. In any case, as humanistic ideology about authenticity of nature in proportion to contemporaneous historical background, it's only possible for ultimate consummation of science to be perfect ideological enantiomorph of ultimate authenticity of nature, since it's only possible for ultimate authenticity of nature to be unique and invariable as coherent *natura naturans* throughout cosmic evolution, it's of course impossible for

Historical progress of science in the recent several centuries seemed like a far-flung exploration of the first itinerary around numerous distinctive landscapes of brand-new landmasses of science with palette & tablet on back, several hundred years' scientific travelogues were compiled thereby.

“two distinctive humanistic ideologies about authenticity of nature with remarkable ideological difference” to discover and formulate “the coherent natura naturans throughout cosmic evolution” coequally.

.....

Once the Nth renovation of humanistic ideology about authenticity of nature in proportion to contemporaneous historical background occurred and consequently procured social legitimacy qualification of the age, the (N-1)th version of humanistic ideology about authenticity of nature in proportion to foregone historical background must be washed out by the Nth renovation of humanistic ideology about authenticity of nature in proportion to contemporaneous historical background. In any case, as humanistic ideology about authenticity of nature in proportion to contemporaneous historical background, it's only possible for ultimate consummation of science to be perfect ideological enantiomorph of ultimate authenticity of nature, since it's only possible for ultimate authenticity of nature to be unique and invariable as coherent natura naturans throughout cosmic evolution, it's of course impossible for “two distinctive humanistic ideologies about authenticity of nature with remarkable ideological difference” to discover and formulate “the coherent natura naturans throughout cosmic evolution” coequally. And scientific knowledge metabolism throughout historical progress of science will be ended once humanistic ideology about authenticity of nature approaches perfect ideological enantiomorph of ultimate authenticity of nature.

All in all, as potential synthesized conditionality of “**crecive progression of practical feasibility & possibility in proportion to contemporaneous historical background + the uniqueness & invariance of ultimate authenticity of nature predestines unique possibility of scientific verity as perfect ideological enantiomorph of ultimate authenticity of nature**” through and through, it's only possible for the major melody of historical progress of science to be serial epochmaking scientific knowledge metabolism in inherent optimum orientation towards perfect ideological enantiomorph of ultimate authenticity of nature, the major melody of historical progress of science is scientific knowledge metabolism in inherent optimum orientation towards perfect ideological enantiomorph of ultimate authenticity of nature.

The uniqueness & invariance of ultimate authenticity of nature firstly indicates the authenticity of nature is everlastingly constant in a class by itself. As long as we admit the uniqueness & invariance of ultimate authenticity of nature and science is but out-and-out enantiomorphous humanistic ideology against authenticity of nature, we then have to admit the “**unique possibility of scientific verity as perfect ideological enantiomorph of ultimate authenticity of nature**”. In any case, as rigorous enantiomorphous correlation between objective authenticity of nature and humanistic ideology about authenticity of nature, it's neither possible for “the unique & invariable ultimate authenticity of nature” to be compatible with “two distinctive humanistic ideologies about authenticity of nature with remarkable ideological difference” nor possible for “two distinctive humanistic ideologies about authenticity of nature with remarkable ideological difference” to discover and formulate “the unique & invariable ultimate authenticity of nature” coequally. And as a result, veritable progress of science is not intuitional cumulative achievement of colorful scientific travelogues A, B, C, D, E, F, ...as deserving reward of the first itineracy around preternatural landscapes of brand-new landmasses of science like omnifarious smallwares full of a basket but successive hypostatic endeavor to push humanistic ideology about authenticity of nature forward to perfect ideological enantiomorph of ultimate authenticity of nature step by step draw on practical feasibility & possibility in proportion to contemporaneous historical background, till at last, humanistic ideology about authenticity of nature tallies with ultimate authenticity of nature 100 over 100 with legitimacy qualification

As coherent natura naturans throughout cosmic evolution, instinctive PNT reciprocal equilibrium towards optimum PNT operation is radical potentiality & conditionality for cosmos always ready to orientate itself towards perfection.

of historical authenticity tolerance of science 0.

Historical progress of science towards historical authenticity tolerance of science 0 usually makes up of two periodic process couple as below:

The first, conventional extension of royal substantiation & perfection of contemporaneous scientific orthodoxy can do limited job to carry forward historical progress of science of course.

The second, coming innovative scientific idea gradually lay over and supersede the ready-made orthodox scientific truths, which is just historical legitimacy metabolism of science in intrinsic progression towards historical authenticity tolerance of science 0. After all, as **the uniqueness & invariance of ultimate authenticity of nature predestines unique possibility of scientific verity as perfect ideological enantiomorph of ultimate authenticity of nature**, veritable progress of science is not intuitional cumulative achievement of colorful scientific travelogues A, B, C, D, E, F, ... like omnifarious smallwares full of a basket about rich and colorful existence & motion accessible around us but successive hypostatic endeavor to push humanistic ideology about authenticity of nature forward to perfect ideological enantiomorph of ultimate authenticity of nature as coherent theory about universal existence & motion.

However, before approach of absolute scientific verity, the so-called “contemporaneous scientific orthodoxy” can only come into being on the basis of limited potentiality in proportion to the proper historical groundwork, it must have its inherent historical limitation thereby, and there is almost no way for conventional extension of royal freewheeling substantiation & perfection of contemporaneous scientific orthodoxy to overcome and transcend its inherent historical limitation for further scientific innovation towards absolute scientific verity like a nonstop eversince, so that the conventional extension of freewheeling royal substantiation & perfection of contemporaneous scientific orthodoxy is even able to finish performing all the rest historical progress of human science. Virtually, as permanent synthesized conditionality of **“crescive progression of practical feasibility & possibility in proportion to contemporaneous historical background + the uniqueness & invariance of ultimate authenticity of nature predestines the unique possibility of scientific verity as perfect ideological enantiomorph of ultimate authenticity of nature”** through and through, historical progress of science has to experience N times of successive social legitimacy metabolism with synchronous orthodoxy subrogation for practical accomplishment of historical progress of science in inherent optimum orientation towards historical authenticity tolerance of science 0, till at last, humanistic ideology about authenticity of nature tallies with ultimate authenticity of nature 100 over 100 as perfect ideological enantiomorph of ultimate authenticity of nature.

It’s completely impossible for conventional extension of royal freewheeling substantiation & perfection of Aristotle’s Theory to overcome and transcend its inherent historical limitation for successive epochmaking scientific innovation towards ultimate formulation of unique & invariable authenticity of nature like nonstop eversince, so that conventional extension of royal freewheeling substantiation & perfection of Aristotle’s Theory was even able to finish performing all the rest historical progress of human science without shift of orthodoxy subrogation. In fact, Galileo had stopped conventional extension of royal freewheeling substantiation & perfection of Aristotle’s Theory by experimental demonstration that two iron balls on the same height of a tower always falls onto the ground just at the same time, and actualized the historical legitimacy metabolism of science and consequent orthodoxy subrogation off the cuff, so that it remarkably refurbished scientific sense of human by experimental demonstration instead of superficial consciousness, and it built up a good scientific example for coming scientific exploration thereby.

Historical progress of science in the recent several centuries seemed like a far-flung exploration of the first itinerary around numerous distinctive landscapes of brand-new landmasses of science with palette & tablet on back, several hundred years’ scientific travelogues were compiled thereby.

nature to accomplish further necessary scientific knowledge metabolism with proportionate orthodoxy subrogation, till at last, humanistic ideology about authenticity of nature tallies with the unique & invariable ultimate authenticity of nature as coherent natura naturans throughout cosmic evolution 100 over 100.

2.1. As fecund thought resource for coming scientific knowledge proliferation, as long as references are still not absolute scientific verity with historical authenticity tolerance of science 0, implementation of reference popularity must materialize both nonzero **positive significance** and **negative significance** of reference popularity. The bigger the historical authenticity tolerance of science of the so-called references is, there is less potentiality for the commensurate reference popularity to push humanistic ideology about authenticity of nature forward to perfect ideological enantiomorph of ultimate authenticity of nature, there is proportionately less potentiality for commensurate reference popularity to actualize positive significance of reference popularity, and it's relatively easy for commensurate reference popularity to expose negative significance of reference popularity.

As crescive progression of practical feasibility & possibility in proportion to contemporaneous historical background, the practice human coming to discover and formulate authenticity of accessible existence & motion around must experience frondose evolvement of humanistic ideology about authenticity of nature cumulatively enriched from nothingness to goad, from goad to a great lot, and consequently followed proportionate ideaistic correction & qualitative optimization from superficiality to profundity, from parochiality to generality. Along crescive progression of historical progress of science, there are of course distinctive temporal orthodoxies in proportion to contemporaneous historical background, which are always parallel to practical feasibility & possibility in proportion to contemporaneous historical background. As there is almost no way for any conventional extension of royal substantiation & perfection of contemporaneous scientific orthodoxy to transcend its inherent historical limitation, there is no possibility for any conventional extension of royal substantiation & perfection of contemporaneous scientific orthodoxy to approach absolute scientific verity as perfect ideological enantiomorph of ultimate authenticity of nature like nonstop. This of course indicates it's impossible for any conventional extension of royal substantiation & perfection of contemporaneous scientific orthodoxy to finish performing all the rest historical progress of science without shift of orthodoxy subrogation. Virtually, veritable progress of science must experience N times of successive historical social legitimacy metabolism and proportionable orthodoxy subrogation towards perfect ideological enantiomorph of ultimate authenticity of nature step by step draw on practical feasibility & possibility in proportion to contemporaneous historical background. Till at last, humanistic ideology about authenticity of nature tallies with ultimate authenticity of nature 100 over 100. This of course indicates perfect ideological enantiomorph of ultimate authenticity of nature can never be outcome of conventional extension of royal substantiation & perfection of contemporaneous scientific orthodoxy, it's only possible to be timely renovation of humanistic ideology about authenticity of nature in proportion to contemporaneous historical background.

And as potential natural determinism that **the uniqueness & invariance of ultimate authenticity of nature predestines unique possibility of scientific verity**, veritable progress of science is not intuitional cumulative achievement of colorful scientific travelogues A, B, C, D, E, F, ... as deserving reward of the first itineracy around preternatural landscapes of brand-new landmasses of science like omnifarious smallwares full of a basket but successive hypostatic endeavor to push humanistic ideology about authenticity of nature forward to perfect ideological enantiomorph of ultimate authenticity of nature as coherent theory about universal existence & motion step by step along intrinsic progression of quantitative & qualitative change of scientific

Historical progress of science in the recent several centuries seemed like a far-flung exploration of the first itineracy around numerous distinctive landscapes of brand-new landmasses of science with palette & tablet on back, several hundred years' scientific travelogues were compiled thereby.

knowledge proliferation. The most remarkable indication of humanistic ideology about authenticity of nature optimization towards consummate formulation of ultimate authenticity of nature is of course revolutionary scientific knowledge metabolism following quantitative & qualitative change of scientific knowledge proliferation.

In straightforward word, as “**crecive progression of practical feasibility & possibility in proportion to contemporaneous historical background + the uniqueness & invariance of ultimate authenticity of nature predestines the unique possibility of scientific verity as perfect ideological enantiomorph of ultimate authenticity of nature**”, it's only possible for veritable historical progress of science to be hypostatic endeavor to push humanistic ideology about authenticity of nature forward to perfect ideological enantiomorph of ultimate authenticity of nature step by step draw on practical feasibility & possibility in proportion to contemporaneous historical background, which virtually actualize hypostatic historical progress of science in inherent optimum orientation towards historical authenticity tolerance of science 0. This of course implies, in the earlier years of historical progress of science, the historical authenticity tolerance of science must be bigger, the so-called contemporaneous scientific orthodoxy is relatively rougher, and once interminable implementation of reference popularity practically restricts the coming scientific knowledge proliferation in rigid succession of contemporaneous scientific orthodoxy, there is of course less potentiality for practice of reference popularity to materialize its positive significance historically. On the contrary, there is more possibility for reference popularity to expose its negative significance. As a result, in earlier years of historical progress of science, as historical authenticity tolerance of science of contemporaneous scientific orthodoxy is relatively bigger, the so-called contemporaneous scientific orthodoxy in earlier years of historical progress of science relatively has less qualification to spark plug interminable reference popularity. Otherwise, reference popularity must be more flimsy to expose its negative significance relatively.

As historical progress of science in inherent optimum orientation towards perfect ideological enantiomorph of ultimate authenticity of nature is unchangeable, the unprompted quantitative & qualitative change of scientific knowledge proliferation following the freewheeling royal substantiation & perfection of contemporaneous scientific orthodoxy must gestate and accumulate potentiality for coming social legitimacy metabolism by the light of nature. At any rate, historical social legitimacy metabolism is almost the unique entrance to successive epochmaking scientific innovation, there is almost no way for conventional extension of royal substantiation & perfection of contemporaneous scientific orthodoxy to approach successive epochmaking scientific innovation as if none ivory can be grown up in mouth of a dog.

As remarkable disparity of historical limitation, Aristotle apparently had poor social legitimacy qualification to sparkplug interminable reference popularity than Galileo so as to restrict coming scientific knowledge proliferation in rigid succession of contemporaneous scientific orthodoxy.

In any case, veritable progress of science is not intuitional cumulative achievement of colorful scientific travelogues A, B, C, D, E, F, ... as deserving reward of the first itineracy around preternatural landscapes of brand-new landmasses of science like omnifarious smallwares full of a basket but successive hypostatic endeavor to push humanistic ideology about authenticity of nature forward to perfect ideological enantiomorph of ultimate authenticity of nature step by step draw on practical feasibility & possibility in proportion to contemporaneous historical background. Comparably, conventional extension of royal freewheeling substantiation & perfection of Aristotle's Theory could only do very limited job to carry forward historical progress of science in inherent optimum orientation towards historical authenticity tolerance of science 0, the even pestilent deadlock was that

there was almost no way for conventional extension of royal substantiation & perfection of Aristotle's Theory to overcome or transcend inherent historical limitation for successive epochmaking scientific innovation itself, so that it's impossible for conventional extension of royal freewheeling substantiation & perfection of Aristotle's Theory to go on perfecting humanistic ideology about authenticity of nature towards perfect ideological enantiomorph of ultimate authenticity of nature like nonstop eversince, till at last, it magically finished performing all the successive historical progress of human science without deadlock. And virtually, conventional extension of royal substantiation & perfection of Aristotle Theory could never be qualified to finish performing all the successive historical progress of human science, practical progress of science had no reasons to be spoony over conventional extension of royal freewheeling substantiation & perfection of Aristotle's Theory overmuch. At any rate, in accordance with inherent optimum orientation of historical progress of science towards historical authenticity tolerance of science 0, there must be substantial potentiality for occurrence of renovation of humanistic ideology about authenticity of nature in proportion to contemporaneous historical background, which must bring up inevitable scientific knowledge metabolism for remarkable renovation towards perfect ideological enantiomorph of ultimate authenticity of nature.

And on the other hand, even if history approached Galileo's age, the reference popularity were still under persistent and intrepid leading orientation of loving successors of Aristotle Theory, even when Galileo was ready to show people the experimental factuality that two iron balls on the same height of a tower always falls onto the ground exactly the same time, the loving successors of Aristotle Theory still authoritatively insisted that scientific knowledge proliferation of Galileo must be in rigid succession of Aristotle Theory, such esoteric thought succession restriction must be conservative even retroactive against leitmotiv of historical progress of science in inherent optimum orientation towards historical authenticity tolerance of science 0.

As remarkable disparity of historical limitation, Geocentric Theory apparently had poor social legitimacy qualification to sparkplug interminable reference popularity than Heliocentric Theory so as to restrict coming scientific knowledge proliferation in rigid succession of contemporaneous scientific orthodoxy.

In any case, veritable progress of science is not historical process human approach distinctive scientific truths one after another but hypostatic endeavor to push humanistic ideology about authenticity of nature forward to perfect ideological enantiomorph of ultimate authenticity of nature step by step draw on practical feasibility & possibility in proportion to contemporaneous historical background. Comparably, interminable freewheeling of royal substantiation & perfection of Geocentric Theory could only do very limited job to carry forward historical progress of science in inherent optimum orientation towards historical authenticity tolerance of science 0, the even pestilent deadlock was that there was almost no way for interminable freewheeling of royal substantiation & perfection of Geocentric Theory to overcome or transcend inherent historical limitation for successive epochmaking scientific innovation itself, so that it's impossible for interminable freewheeling of royal substantiation & perfection of Geocentric Theory to be qualified endeavor to push humanistic ideology about authenticity of nature forward to perfect ideological enantiomorph of ultimate authenticity of nature like nonstop to finish all successive historical progress of human science in inherent optimum orientation towards perfect ideological enantiomorph of ultimate authenticity of nature without deadlock.

In any case, hypostatic progress of science has no reasons to be spoony over interminable freewheeling of royal substantiation & perfection of Geocentric Theory overmuch, in accordance with inherent optimum

Historical progress of science in the recent several centuries seemed like a far-flung exploration of the first itinerary around numerous distinctive landscapes of brand-new landmasses of science with palette & tablet on back, several hundred years' scientific travelogues were compiled thereby.

orientation of historical progress of science towards historical authenticity tolerance of science 0, there must be substantial possibility for veritable historical progress of science to bring out substantial potentiality for epochmaking scientific knowledge metabolism with proportionate social legitimacy metabolism therefore.

And on the other hand, even if history approached Copernicus' age, the reference popularity were still under persistent and intrepid leading orientation of loving successors of Geocentric Theory, even when Copernicus was ready to proclaim his Heliocentric Theory, the loving successors of Geocentric Theory still authoritatively insisted that scientific knowledge proliferation of Copernicus must be in rigid succession of Geocentric Theory, such esoteric thought succession restriction must be conservative even retroactive against leitmotiv of historical progress of science in inherent optimum orientation towards historical authenticity tolerance of science 0.

... ..

As remarkable disparity of historical limitation, Newton had poor social legitimacy qualification to sparkplug interminable reference popularity than Einstein so as to restrict coming scientific knowledge proliferation in rigid succession of contemporaneous scientific orthodoxy.

In any case, veritable progress of science is always endeavor to push humanistic ideology about authenticity of nature forward to perfect ideological enantiomorph of ultimate authenticity of nature step by step draw on practical feasibility & possibility in proportion to contemporaneous historical background. Comparably, conventional extension of royal substantiation & perfection of Classic Mechanics could only do very limited job to carry forward historical progress of science in inherent optimum orientation towards historical authenticity tolerance of science 0 when so-called contemporaneous scientific orthodoxy originally came into being as innovative scientific idea of the age. The even pestilent deadlock was that there was almost no way for interminable freewheeling of royal substantiation & perfection of Classic Mechanics to overcome or transcend inherent historical limitation for successive epochmaking scientific innovation itself, so that it's impossible for interminable freewheeling of royal substantiation & perfection of Classic Mechanics to go on perfecting humanistic ideology about authenticity of nature towards perfect ideological enantiomorph of ultimate authenticity of nature like nonstop ever since, till at last, it magically finished performing all the successive historical progress of human science without deadlock.

Virtually, interminable freewheeling of royal substantiation & perfection of Classic Mechanics can never be qualified endeavor to push humanistic ideology about authenticity of nature forward to perfect ideological enantiomorph of ultimate authenticity of nature through and through, hypostatic progress of science has no reasons to be spoony over interminable freewheeling of royal substantiation & perfection of Classic Mechanics overmuch. At any rate, in accordance with inherent optimum orientation of historical progress of science towards perfect ideological enantiomorph of ultimate authenticity of nature with social legitimacy qualification of historical authenticity tolerance of science 0, there must be substantial possibility for veritable historical progress of science to bring out enough potentiality for epochmaking scientific knowledge metabolism with proportionate social legitimacy metabolism therefore.

And on the other hand, even if history approached Einstein's age, the reference popularity was still under persistent and intrepid leading orientation of loving successors of Classic Mechanics, even when Einstein was ready to proclaim his Relativity, the loving successors of Classic Mechanics still authoritatively insisted that

As coherent natura naturans throughout cosmic evolution, instinctive PNT reciprocal equilibrium towards optimum PNT operation is radical potentiality & conditionality for cosmos always ready to orientate itself towards perfection.

scientific knowledge proliferation of Einstein must be in rigid succession of Newtonian, such esoteric thought succession restriction must be conservative even retroactive against leitmotiv of historical progress of science in inherent optimum orientation towards historical authenticity tolerance of science 0.

.....

It's only possible for conventional extension of royal substantiation & perfection of "Relativity + Quantum Theory" to do limited job to carry forward historical progress of science in inherent optimum orientation towards historical authenticity tolerance of science 0 as well, the even pestilent deadlock was that there was almost no way for conventional extension of freewheeling royal substantiation & perfection of "Relativity + Quantum Theory" to overcome or transcend inherent historical limitation for successive epochmaking scientific innovation themselves, so that conventional extension of royal substantiation & perfection of "Relativity + Quantum Theory" is even able to go on perfecting humanistic ideology about authenticity of nature towards consummate formulation of unique and invariable ultimate authenticity of nature like nonstop eversince, till at last, they can magically finish performing all the successive historical progress of human science without deadlock. And virtually, interminable freewheeling of royal substantiation & perfection of "Relativity + Quantum Theory" can never be qualified endeavor to push humanistic ideology about authenticity of nature forward to perfect ideological enantiomorph of ultimate authenticity of nature like nonstop to finish all successive historical progress of human science through and through, practical progress of science had no reasons to be spoony over interminable freewheeling of royal substantiation & perfection of "Relativity + Quantum Theory" overmuch.

In accordance with inherent optimum orientation of historical progress of science towards historical authenticity tolerance of science 0, there must be substantial possibility for veritable historical progress of science to bring out substantial potentiality for remarkable renovation of humanistic ideology about authenticity of nature forward to perfect ideological enantiomorph of ultimate authenticity of nature, which must bring up epochmaking scientific knowledge metabolism with proportionate social legitimacy metabolism therefore. History has proved it time after time, it's impossible for epochmaking scientific innovation to be outgrowth of interminable freewheeling of high-sounding royal substantiation & perfection of contemporaneous scientific orthodoxy as if it's impossible for any ivory to be grown up in mouth of a dog.

Of course, in terms of a brand-new scientific idea which was primarily promoted orthodoxy as pioneering innovation, as its inherent worthiness of potentiality towards consummate formulation of unique and invariable ultimate authenticity of nature had not been released adequately, once solid implementation of reference popularity restricted all coming scientific knowledge proliferation in rigid succession of contemporaneous scientific orthodoxy, it could gather all possible academicians to devote themselves to royal substantiation & perfection of contemporaneous scientific orthodoxy. After all, as pioneering innovation under the proper historical background, there were still solid potentiality for the brand-new orthodoxy to carry forward historical progress of science in inherent optimum orientation towards historical authenticity tolerance of science 0, which almost takes the full role of historical progress of science at the very stage.

However, freewheeling royal substantiation & perfection of contemporaneous scientific orthodoxy mostly does its best for substantiation & perfection of contemporaneous scientific orthodoxy with toleration & persistence of temporal legitimacy. No matter how much substantiation & perfection contemporaneous scientific orthodoxy

Historical progress of science in the recent several centuries seemed like a far-flung exploration of the first itinerary around numerous distinctive landscapes of brand-new landmasses of science with palette & tablet on back, several hundred years' scientific travelogues were compiled thereby.

has practically benefited from it, as there is almost no way for conventional extension of freewheeling royal substantiation & perfection of contemporaneous scientific orthodoxy to overcome and transcend inherent historical limitation, it's impossible for it to go on perfecting humanistic ideology about authenticity of nature towards consummate formulation of unique and invariable ultimate authenticity of nature like nonstop towards absolute scientific verity without deadlock, till at last, it magically finishes performing all successive historical progress of human science. Once contemporaneous scientific orthodoxy nearly exhausted its rational potentiality for historical progress of science, reference popularity accompanied freewheeling royal substantiation & perfection of contemporaneous scientific orthodoxy must expose its negative significance, which would of course seem conservative even backward-looking. The successive social legitimacy metabolism was inevitable therefore.

All in all, historical progress of human science towards consummate formulation of unique & invariable ultimate authenticity of nature is unchangeable, since there is almost no way for conventional extension of freewheeling royal substantiation & perfection of contemporaneous scientific orthodoxy to overcome and transcend inherent historical limitation for successive epochmaking scientific innovation, so that it's impossible for conventional extension of royal substantiation & perfection of contemporaneous scientific orthodoxy to go on perfecting humanistic ideology about authenticity of nature towards consummate formulation of unique and invariable ultimate authenticity of nature like nonstop towards "historical authenticity tolerance of science 0", there is no reasons for authentic progress of science to be spoony over any exhausted conventional extension of royal substantiation & perfection of contemporaneous scientific orthodoxy overmuch. Veritable progress of science has to experience N times successive social legitimacy metabolism along intrinsic progression of quantitative & qualitative change of scientific knowledge proliferation towards consummate formulation of unique and invariable ultimate authenticity of nature without alternatives, till at last, humanistic ideology about authenticity of nature tallies with unique & invariable authenticity of nature 100 over 100.

In terms of natura naturans, original generation of matter in the nature of coherent natura naturans brings out essence of matter in a class by itself; essence of matter in a class by itself predestines thorough coherence of dynamic regularity of universal existence & motion. Since the demiurge creates matter according to coherent demiurgic fundamental through and through, essence of universal matter must be in a class by itself, and as spontaneous occurrence against essence of matter, universal existence & motion of matter must be subject to coherent dynamic regularity due to essence of matter in a class by itself. And as a result, **it's only possible for concordant cosmos to be demiurgic aggradation of out-and-out serial natura naturata in the nature of coherent natura naturans throughout cosmic evolution; there is no way for demiurgic aggradation in the nature of different natura naturans to be concordant cosmos through and through.**

However, once human try to master the natura naturans by permanent endeavor draw on practical feasibility & possibility due to historical limitation, human practice has to be subject to historical inevitability. In another words, as crescive progression of practical feasibility & possibility in proportion to contemporaneous historical background, the practice human coming to discover and formulate authenticity of accessible existence & motion around must experience frondose evolvment of humanistic ideology about authenticity of nature cumulatively enriched from nothingness to groat, from groat to a great lot, and consequently followed proportionate ideaistic correction & qualitative optimization from superficiality to profundity, from parochiality to generality. During the course human coming to know ultimate authenticity of nature from nothingness to groat, from groat

to a great lot, as idiographic study objects gradually entered human rational purview one after another, and human rational purview become wider and wider day by day therefore, human have to study the rich & colorful objects one by one then and there like twiddling with distinctive apple on tip of our fingers, the scientific harvest is really something like our stochastic receipt during the course of fresh travel, once mountain shows itself before us, mountain must be painted as improvisation, and once river appears, human must pay a tribute to river off the cuff. Historical progress of live contemporaneous scientific orthodoxy in the recent several hundred years seemed like a far-flung exploration of the first itineracy around numerous distinctive landscapes of brand-new landmasses of science with palette & tablet on back, several hundred years' scientific travelogues were compiled thereby. Although, cosmic status quo is but evolutional aggradation of out-and-out serial natura naturata as well-regulated homogeneity system in the nature of coherent natura naturans throughout cosmic evolution.

Although, harvest of live contemporaneous scientific orthodoxy in the recent several centuries looking like rich and colorful travelogues apparently does not tally with natural determinism that **the uniqueness & invariance of ultimate authenticity of nature proportionably predestines the unique possibility of scientific verity as perfect ideological enantiomorph of ultimate authenticity of nature**. As human practice has to be subject to crecive progression of practical feasibility & possibility in proportion to contemporaneous historical background, there is substantively no way for historical progress of human science to transcend the historical inevitability. Only once the accumulation of the rich and colorful scientific travelogues become more and more comprehensive about universal existence & motion, there is wider and more general rational purview for us to review universal existence & motion for longitudinal rational optimization, there is substantial potentiality for historical progress of science to enter progressional stage from superficiality to profundity, from parochiality to generality, there is substantial potentiality for us to push humanistic ideology about authenticity of nature forward to perfect ideological enantiomorph of ultimate authenticity of nature draw on practical feasibility & possibility in proportion to contemporaneous historical background.

2.2. The most straightforward practical significance of reference popularity is that interminable implementation of reference popularity under egotistic guidance of temporal authority must bring out invisible magisterial restriction to general progress of science for presence of authoritative intrepidity of contemporaneous scientific orthodoxy, which grimly coerces that coming scientific knowledge proliferation all over the world must be in rigid succession of contemporaneous scientific orthodoxy. In any case, once free press regulation customization and free press admittance is remarkably under magistral autarchy of temporal authority, there is almost no way for aberrant scientific knowledge proliferation out of succession of contemporaneous scientific orthodoxy to pass free press egotistic proximity identification from temporal authority.

And now, "impact factor" has been glorified into the most gewgawish camouflage for fame & gain by temporal authority, and as "free press regulation customization" and "free press admittance" is completely under autarchy of temporal authority, if temporal authority have a finger in the pie of reference popularity at their pleasure draw on facility of free press regulation customization and free press admittance short of necessary intendance, reference popularity must turn into bare ambition to carry forward contemporaneous scientific orthodoxy or temporal authority as royal substantiation & perfection of contemporaneous scientific orthodoxy usually do. Especially when the so-called "reference" involves in jurisdiction implementation of free press admittance, there is substantial possibility & expedience for reference popularity to be turned into a free wind for temporal authority to carry forward their egotism and deal in impact factors by the light of nature.

Historical progress of science in the recent several centuries seemed like a far-flung exploration of the first itineracy around numerous distinctive landscapes of brand-new landmasses of science with palette & tablet on back, several hundred years' scientific travelogues were compiled thereby.

That's to say, as it's only possible for temporal authority to take the role of charter members and exponentials of "reference popularity", and as free press customization and free press admittance is completely under autarchy of temporal authority, interminable implementation of reference popularity must follow out idiographic ideology & subjective intention of temporal authority and consequently form aeriform esoteric restriction to make the coming scientific knowledge proliferation in rigid succession of contemporaneous scientific orthodoxy. If your scientific papers are not in rigid succession of contemporaneous scientific orthodoxy and can not offer respectable impact factors for temporal authority, you must be difficult to find a way to pass free press admittance, no more social legitimacy authorization.

If we suppose "contemporaneous scientific orthodoxy" is just a pile of flaming needfire on the ground, then, reference popularity is of course aeriform restriction which confines all coming scientific knowledge proliferation must go around the flaming needfire for any scientific endeavor, but forbid producing another needfire elsewhere, which of course implies reference popularity is virtually aeriform restriction to demand that coming scientific knowledge proliferation all over the world must be in rigid succession of contemporaneous scientific orthodoxy going without saying, none aberrant scientific knowledge proliferation out of succession of contemporaneous scientific orthodoxy is acceptable. It seems there is no reason for temporal authority to defer to reality of any people to study universal existence & motion in distinctive manner which is apparently different from contemporaneous scientific orthodoxy. This is just major reason that there is no way for conventional extension of royal substantiation & perfection of contemporaneous scientific orthodoxy to approach successive epochmaking scientific innovation, which is substantively situation similar as it's impossible for any ivory to be grown up in mouth of a dog.

In straightforward words, temporal authority only admit the "positive significance" of reference popularity but never face the inherently coexistent "negative significance" of reference popularity. They even seemed never to admit the historical limitation of Relativity & Quantum Theory as renovation of humanistic ideology about authenticity of nature in proportion to contemporaneous historical background of ideological transition from macrophysics to microphysics in terminal years of 19th century and early years of 20th century, it's impossible for conventional extension of royal substantiation & perfection of "Relativity + Quantum Theory" to overcome and transcend inherent historical limitation for further development of science like nonstop towards perfect ideological enantiomorph of ultimate authenticity of nature. However, temporal authority are always ready to direct that coming progress of science is always conventional extension of freewheeling royal substantiation & perfection of contemporaneous scientific orthodoxy without necessary shift, as if they really have no sense that coming progress of science is still necessary to accomplish successive social legitimacy metabolism and corresponding historical subrogation of contemporaneous scientific orthodoxy so as to optimize general progress of science in inherent optimum orientation towards historical authenticity tolerance of science 0.

In fact, as favorable accompaniment of freewheeling royal substantiation & perfection of contemporaneous scientific orthodoxy, reference popularity is not only profitable inducement and available handrail for substantiation & perfection of contemporaneous scientific orthodoxy, but also barrier to prevent aberrant scientific knowledge proliferation out of succession of contemporaneous scientific orthodoxy, it persists with aeriform restriction that coming scientific knowledge proliferation all over the world must be in rigid succession of contemporaneous scientific orthodoxy for ever. If your scientific idea is not in rigid succession of contemporaneous scientific

orthodoxy or not ready for substantiation & perfection of contemporaneous scientific orthodoxy, you must firstly come up against perplexity of free press egotistic proximity identification of temporal authority, and consequently slide into interminable free press embarment. Under live background of royal substantiation & perfection of contemporaneous scientific orthodoxy, only you are always ready to carry forward contemporaneous scientific orthodoxy, or you have practically proved some certain idea of contemporaneous scientific orthodoxy is right like LIGO gravitational wave discovery, your endeavor undoubtedly tallies with leitmotiv of royal substantiation & perfection of contemporaneous scientific orthodoxy, you are popular for free press admittance & social legitimacy authorization accordingly. Such practice of free press regulation customization and free press admittance of course has more reasons and facility to serve the time instead of general progress of science off the cuff.

At any rate, veritable progress of science is not intuitional cumulative achievement of colorful scientific travelogues A, B, C, D, E, F, ... as deserving reward of the first itineracy around preternatural landscapes of brand-new landmasses of science like omnifarious smallwares full of a basket but successive hypostatic endeavor to push humanistic ideology about authenticity of nature forward to perfect ideological enantiomorph of ultimate authenticity of nature step by step draw on practical feasibility & possibility in proportion to contemporaneous historical background so as to accomplish historical progress of science in inherent optimum orientation towards historical authenticity tolerance of science 0. The most remarkable evidence of veritable progress of science is of course accomplishment of epochmaking scientific knowledge metabolism along historical progress of science in inherent optimum orientation towards historical authenticity tolerance of science 0.

However, as crescive progression of practical feasibility & possibility in proportion to contemporaneous historical background, the practice human coming to discover and formulate authenticity of accessible existence & motion around must experience frondose evolvement of humanistic ideology about authenticity of nature cumulatively enriched from nothingness to groat, from groat to a great lot, and consequently followed proportionate ideaistic correction & qualitative optimization from superficiality to profundity, from parochiality to generality. Since veritable progress of science is not intuitional cumulative achievement of rich and colorful scientific travelogues A, B, C, D, E, F, ... like smallwares full of a basket, but successive hypostatic endeavor to push humanistic ideology about authenticity of nature forward to perfect ideological enantiomorph of unique and invariable ultimate authenticity of nature as coherent theory about universal existence & motion, historical accomplishment of veritable progress of science must wash out all whilom ready-made scientific truths by social legitimacy metabolism one after another at the volley, which are relatively superficial and parochial for foregone historical limitation. Whereas, we have to admit practical implementation of necessary social legitimacy metabolism is apparently discordant against magistral autarchy of free press regulation customization & free press admittance of temporal authority who are mostly loving successors of contemporaneous scientific orthodoxy.

Virtually, before approach of absolute scientific verity, (which indicates humanistic ideology about authenticity of nature ultimately tallies with unique & invariable authenticity of nature 100 over 100, historical authenticity tolerance of science approaches 0 therefore) it's completely impossible for conventional extension of high-sounding freewheeling royal substantiation & perfection of contemporaneous scientific orthodoxy to transcend inherent historical limitation for further scientific innovation like nonstop towards perfect ideological enantiomorph of ultimate authenticity of nature so as to finish all rest historical progress of human science without remarkable deadlock. As crescive progression of practical feasibility & possibility in proportion to contemporaneous historical background, historical progress of

Historical progress of science in the recent several centuries seemed like a far-flung exploration of the first itineracy around numerous distinctive landscapes of brand-new landmasses of science with palette & tablet on back, several hundred years' scientific travelogues were compiled thereby.

science that humanistic ideology about authenticity of nature gradually approaches ultimate authenticity of nature step by step must experience N times of successive social legitimacy metabolism and consequently accomplish N times of historical subrogation of contemporaneous scientific orthodoxy thereby. Throughout historical progress of science, none historical subrogation of contemporaneous scientific orthodoxy is not outcome of accomplishment of successive social legitimacy metabolism of coming innovative scientific idea against living temporal social legitimacy.

Once the brand-new contemporaneous scientific orthodoxy coming into being as pioneering scientific idea and is ready to lead a brand-new age for general progress of science, no matter how far the contemporaneous scientific orthodoxy is away from absolute scientific verity, no matter how remarkable its historical authenticity tolerance of science is, it must bring out its royal substantiation & perfection of contemporaneous scientific orthodoxy at the volley. And in early years of the brand-new contemporaneous scientific orthodoxy, as there is solid potentiality of contemporaneous scientific orthodoxy for general progress of science, incipient extension of royal substantiation & perfection of contemporaneous scientific orthodoxy almost takes the full role of historical progress of science of the very age (incipient extension of royal freewheeling substantiation & perfection of contemporaneous scientific orthodoxy \approx historical progress of science of the very age). As favorable accompaniment of royal substantiation & perfection of contemporaneous scientific orthodoxy, reference popularity meets the best season to materialize its positive significance. However, once the contemporaneous scientific orthodoxy gradually exhausts its inherent potentiality for general progress of science, so that conventional extension of royal substantiation & perfection of contemporaneous scientific orthodoxy apparently lack potentiality to carry forward general progress of science, reference popularity must expose more of its negative significance, and successive social legitimacy metabolism is necessary therefore.

In fact, the most veritable effect of development of science is achievement of advancement that humanistic ideology about authenticity of nature becomes closer and closer to ultimate authenticity of nature so as to realize proportionate advancement towards historical authenticity tolerance of science 0 in proportion. And as potential synthesized conditionality of “**the crescive progression of practical feasibility & possibility in proportion to contemporaneous historical background + the uniqueness and invariance of authenticity of nature predestines the unique possibility of scientific verity as perfect ideological enantiomorph of ultimate authenticity of nature**” throughout historical progress of science, it's only possible for the practical achievement of persistent advancement that humanistic ideology about authenticity of nature becomes closer and closer to ultimate authenticity of nature to be actualized by serial scientific knowledge metabolism in inherent optimum orientation toward perfect ideological enantiomorph of ultimate authenticity of nature, which of course indicates it's impossible for historical progress of science to be interminable freewheeling of royal substantiation & perfection of some certain contemporaneous scientific orthodoxy out of scientific legitimacy qualification of historical authenticity tolerance of science 0 ever since. Unless when it is necessary & possible for the innovative contemporaneous scientific orthodoxy to sparkplug royal substantiation & perfection of contemporaneous scientific orthodoxy, whose practical effect can be generally equivalent to general progress of science, it can be found that living scientific knowledge proliferation all over the world is almost in rigid succession of contemporaneous scientific orthodoxy.

Whereas, once it's necessary for historical progress of science to accomplish scientific knowledge metabolism for social legitimacy subsistence of of timely renovation of humanistic ideology about authenticity of nature

As coherent natura naturans throughout cosmic evolution, instinctive PNT reciprocal equilibrium towards optimum PNT operation is radical potentiality & conditionality for cosmos always ready to orientate itself towards perfection.

in proportion to contemporaneous historical background, it's almost impossible for reference popularity to be kept in rigid succession of contemporaneous scientific orthodoxy without remarkable disparity. After all, it is not only impossible for freewheeling of royal substantiation & perfection of some certain contemporaneous scientific orthodoxy out of scientific legitimacy qualification of historical authenticity tolerance of science 0 to achieve remarkable advancement towards historical authenticity tolerance of science 0, but also impossible for it to approach epoch-making scientific innovation. At any rate, **it's only possible for concordant cosmos to be demiurgic aggradation of out-and-out serial natura naturata in the nature of coherent natura naturans throughout cosmic evolution; there is no way for demiurgic aggradation in the nature of different natura naturans to be concordant cosmos through and through**, and ultimate authenticity of nature must be unique and invariable as coherent natura naturans throughout cosmic evolution, as rigorous enantiomorphous correlation between objective authenticity of nature and humanistic ideology about authenticity of nature, it's neither possible for "the unique & invariable ultimate authenticity of nature" to be compatible with "two distinctive humanistic ideologies about authenticity of nature with remarkable ideological difference" nor possible for "two distinctive humanistic ideologies about authenticity of nature with remarkable ideological difference" to discover and formulate "the unique & invariable ultimate authenticity of nature" coequally.

All in all, since interminable implementation of reference popularity must follow out ideology and intention of temporal authority, there must be more facility for reference popularity to serve the time instead of historical progress of science. How much reference popularity can virtually serve historical progress of science mostly depends on how much the conventional extension of freewheeling royal substantiation & perfection of contemporaneous scientific orthodoxy has virtually taken the role of historical progress of science. And indeed, as complete autarchy of free press regulation customization and free press admittance, modern authority of second-string geniuses have implemented too much egotistic restriction to coming scientific knowledge proliferation. For instance, interminable implementation of reference popularity has apparently coerce that coming scientific knowledge proliferation all over the world must be in rigid succession of contemporaneous scientific orthodoxy, so that puissance of second-string geniuses who are meritorious for substantiation & perfection of contemporaneous scientific orthodoxy intensively restrains the potential social legitimacy metabolism of contemporaneous scientific orthodoxy. As a result, in the recent half century, although contemporaneous scientific orthodoxy was always high-sounding, practical progress of science was unromantic indeed. If we admit complete autarchy of free press regulation customization and free press admittance is the chief criminal for the second-string geniuses to implement too much esoteric restriction to coming scientific knowledge proliferation, then, we have to admit reference popularity must be the most effectual facility in hand of the chief criminal. All in all, modern physics is fighting its way in riancy with demoded legitimacy coronet of contemporaneous scientific orthodoxy on head, reference popularity is of course meritorious for it.

Before humanistic ideology about authenticity of nature finally qualified as perfect ideological enantiomorph of ultimate authenticity of nature, the most pestilent obstacle for historical progress of science is mostly unnoticed thought misdirection & bewitchment derived from authoritative intrepidity of contemporaneous scientific orthodoxy out of scientific legitimacy qualification of historical authenticity tolerance of science 0 to succedent generation, especially, once authoritative intrepidity of contemporaneous scientific orthodoxy is egotistically all-time and overwhelming towards interminable substantiation & perfection of contemporaneous scientific orthodoxy. Since there is almost no way for conventional extension of royal freewheeling substantiation & perfection of contemporaneous scientific orthodoxy to overcome and transcend inherent historical limitation of contemporaneous



It's only possible for concordant cosmos to be demiurgic aggradation of out-and-out serial natura naturata in the nature of coherent natura naturans throughout cosmic evolution; there is no way for demiurgic aggradation in the nature of different natura naturans to be concordant cosmos through and through.

scientific orthodoxy, it's of course impossible for conventional endeavor of royal substantiation & perfection of contemporaneous scientific orthodoxy to carry forward historical progress of science like nonstop towards perfect ideological enantiomorph of ultimate authenticity of nature, what's the reason for temporal authority to coerce coming scientific knowledge proliferation all over the world must be in rigid succession of contemporaneous scientific orthodoxy for ever??

January 6-10, 2011, Baisha village, Humen town, Dongguan city, Guangdong province

Further revision was done in June 2018, Nanxing, Dani-shatian-dongguan-guangdong

As coherent natura naturans throughout cosmic evolution, instinctive PNT reciprocal equilibrium towards optimum PNT operation is radical potentiality & conditionality for cosmos always ready to orientate itself towards perfection.

(IX-iii) Dithyrambic reference popularity under egotistic background of interminable royal substantiation & perfection of contemporaneous scientific orthodoxy

Abstract: *Development of science is always hypostatic endeavor to push humanistic ideology about authenticity of nature forward to perfect ideological enantiomorph of ultimate authenticity of nature which is virtually successive quantitative & qualitative change of humanistic ideology about authenticity of nature in inherent optimum orientation towards historical authenticity tolerance of science 0. As permanent synthesized conditionality of “crescive progression of practical feasibility & possibility in proportion to contemporaneous historical background + the uniqueness & invariance of ultimate authenticity of nature predestines the unique possibility of scientific verity as perfect ideological enantiomorph of ultimate authenticity of nature” through and through, it’s only possible for the major melody of historical progress of science to be a series of epochmaking scientific knowledge metabolism in inherent optimum orientation towards historical authenticity tolerance of science 0, which practically hypostatize humanistic ideology about authenticity of nature gradually approaching perfect ideological enantiomorph of ultimate authenticity of nature draw on practical feasibility & possibility in proportion to contemporaneous historical background step by step. And virtually, the so-called series of scientific knowledge metabolism is too synchronous series of orthodoxy subrogation, which of course implies historical progress of science is succession of legitimacy metabolism of N so-called temporal orthodoxies one by one.*

The most straightforward practical significance of reference popularity is that interminable implementation of reference popularity under egotistic guidance of temporal authority must form invisible magisterial restriction of contemporaneous scientific orthodoxy, which grimly coerces that coming scientific knowledge proliferation all over the world must be in rigid succession of contemporaneous scientific orthodoxy, none scientific knowledge proliferation out of succession of contemporaneous scientific orthodoxy can be qualified and acceptable for free press admittance. Since it’s impossible for historical progress of science to be freewheeling substantiation & perfection of some certain single contemporaneous scientific orthodoxy through and through, once historical progress of science needs epoch-making innovation for shift of next contemporaneous scientific orthodoxy, reference popularity under egotistic guidance of temporal authority must expose its negative significance for magisterial restriction to coming scientific knowledge proliferation in rigid succession of contemporaneous scientific orthodoxy, which restricts development of science, especially stochastic occurrence of aberrant scientific knowledge proliferation out of succession of contemporaneous scientific orthodoxy. Nowadays reference popularity on the earth under background of high-sounding royal substantiation & perfection of contemporaneous scientific orthodoxy is typical instance like this.

Keywords: *reference popularity, impact factor.*

1. Before contemporaneous scientific orthodoxy achieving legitimacy qualification of historical authenticity tolerance of science 0, implementation of reference popularity must bring out both “**positive significance of reference popularity**” and “**negative significance of reference popularity**”. And in different historical stages along historical progress of science, as idiographic developmental disparity of contemporaneous scientific orthodoxy, the value of “**positive significance of reference popularity**” and “**negative significance of reference popularity**” must be proportionately different.

The practical accomplishment of historical progress of science can never be interminable freewheeling

Historical progress of science in the recent several centuries seemed like a far-flung exploration of the first itinerary around numerous distinctive landscapes of brand-new landmasses of science with palette & tablet on back, several hundred years’ scientific travelogues were compiled thereby.

of royal substantiation & perfection of distinctive contemporaneous scientific orthodoxy out of scientific legitimacy qualification of historical authenticity tolerance of science 0, but successive subrogation of N different orthodoxies linked up by innovative scientific knowledge metabolism one by one in inherent optimum orientation towards historical authenticity tolerance of science 0, till at last, humanistic ideology about authenticity of nature tallies with ultimate authenticity of nature 100 over 100 with legitimacy qualification of historical authenticity tolerance of science 0. Reference popularity is relatively feasible for burgeoning contemporaneous scientific orthodoxy to dominate comprehensive social resource to focus on substantiation & perfection of incipient contemporaneous scientific orthodoxy under egotistic guidance of temporal authority, which mostly restrict coming scientific knowledge proliferation all over the world in rigid succession of contemporaneous scientific orthodoxy, and virtually, the incipient burgeoning contemporaneous scientific orthodoxy is just the pioneering ideology about authenticity of nature of the age. Whereas, once contemporaneous scientific orthodoxy has exhausted its inherent potentiality to push humanistic ideology about authenticity of nature forward to perfect ideological enantiomorph of ultimate authenticity of nature and consequently lose its historical significance to exist as contemporaneous scientific orthodoxy any longer, epoch-making innovation for subrogation of temporal orthodoxies become inevitable, reference popularity consequently become morbid at the volley.

That's to say, as reference popularity must be under egotistic guidance of temporal authority with solid backup of authoritative intrepidity of contemporaneous scientific orthodoxy and mostly hypostatize egotistic volition of contemporaneous scientific orthodoxy of course, whose practical continuity can never conventionally transcend rational estrangement of epochmaking orthodoxy subrogation in proportion to epochmaking scientific knowledge metabolism. In another words, reference popularity starts from contemporaneous scientific orthodoxy 1 can never be conventionally extended to reference popularity of contemporaneous scientific orthodoxy 2. And the even important thing is that, in different progressive stages of contemporaneous scientific orthodoxy, implementation of reference popularity has different practical effect.

When the incipient contemporaneous scientific orthodoxy is flourishing, as **flourishing substantiation & perfection of contemporaneous scientific orthodoxy≈historical progress of science**, reference popularity usually can serve substantiation & perfection of contemporaneous scientific orthodoxy effectively, and it indirectly serves historical progress of science thereby, so that substantiation & perfection of contemporaneous scientific orthodoxy under egotistic guidance of temporal authority leads historical progress of science in inherent optimum orientation towards historical authenticity tolerance of science 0 by itself.

However, once freewheeling royal substantiation & perfection of contemporaneous scientific orthodoxy has exhausted its inherent rational potentiality toward further authenticity highlight of nature, reference popularity must expose its subnormal domino effect to push humanistic ideology about authenticity of nature forward to perfect ideological enantiomorph of ultimate authenticity of nature, and it indicates coming development of science need pioneering epoch-making innovation for shift of contemporaneous scientific orthodoxy, living reference popularity under egotistic guidance of temporal authority must expose its negative significance and restrict coming development of science, especially restricts stochastic occurrence even successive social subsistence of aberrant scientific knowledge proliferation out of succession of contemporaneous scientific orthodoxy for magisterial restriction to coming scientific knowledge proliferation in rigid succession of contemporaneous scientific orthodoxy, historical progress of science consequently slides into vicious circle under conservative

restriction of temporal authority.

All in all, veritable progress of science is not historical process human stochastically approach distinctive scientific truths one after another but hypostatic endeavor to push humanistic ideology about authenticity of nature forward to perfect ideological enantiomorph of ultimate authenticity of nature draw on practical feasibility & possibility in proportion to contemporaneous historical background. Whereas, the most straightforward practical significance of reference popularity is that interminable implementation of reference popularity under egotistic guidance of temporal authority must form invisible magisterial restriction of contemporaneous scientific orthodoxy, which grimly coerces that coming scientific knowledge proliferation all over the world must be in rigid succession of contemporaneous scientific orthodoxy, for none aberrant scientific knowledge proliferation out of succession of contemporaneous scientific orthodoxy can be qualified and acceptable for free press admittance. Whereas, once contemporaneous scientific orthodoxy has exhausted inherent potentiality to push humanistic ideology about authenticity of nature forward to perfect ideological enantiomorph of ultimate authenticity of nature, the negative significance of reference popularity must be exposed thereby. And indeed, the practical significance of reference popularity mostly depends on the scientific quality of contemporaneous scientific orthodoxy due to necessity to push humanistic ideology about authenticity of nature forward to perfect ideological enantiomorph of ultimate authenticity of nature, and there is almost none reasons for impact factors to reflect development quality of science at all.

2. As thought resource for coming scientific knowledge proliferation, practical worthiness of “reference” depends on its straightforward knowledge proliferous effect to push humanistic ideology about authenticity of nature forward to perfect ideological enantiomorph of ultimate authenticity of nature——how much importance reference has accomplished for renovation of humanistic ideology about authenticity of nature towards perfect ideological enantiomorph of ultimate authenticity of nature, but does not tread on air who referred to me and how many people referred to me.

In modern science forum, when we come to evaluate significance of “references” and so-called “impact factors”, it seems we never care proliferous effect of practical scientific knowledge proliferation derived from “references” as fecund thought resource towards authenticity highlight of nature, we care nothing about whether reference as fecund thought resource have practically proliferated grand branchy trees or misshapen branches or wizened leaves, which had ever involved in renovation of humanistic ideology about authenticity of nature in proportion to contemporaneous historical background, but huged ourselves on who referred to me, how many people referred to me. Such highbrow fad directly lead to VIP domino effect of greeting and entertainment flattering temporal authorities for expedience of free press egotistic proximity identification even courtesy demands reciprocity. Especially, once jurisdiction of free press admittance involves in, the smell it gives off may be even stinking.

Under such background of reference popularity, in order to fashionably involve in science forum and popularize in so-called “science community”, the stylish academicians are always ready to immerse the dye vat of contemporaneous scientific orthodoxy for fresh color on their bodies, then climb out of the dye vat for a stagy posture. I am genuinely confused whether they are delicately showing off the beautiful color of contemporaneous scientific orthodoxy on their bodies or their stagy posture with beautiful color of contemporaneous scientific orthodoxy on their bodies. All in all, as reference popularity, most of the modern academicians are joyously turning over in popularity of contemporaneous scientific orthodoxy for expedience of free press

admittance and social legitimacy authorization instead of devoting to study of vivid existence & motion of matter accessible around for straightforward authenticity highlight of nature, a bevy of popular pean references are always their adept accomplishment.

If we compare scientific study to guitar play, then, the string on guitar are mostly the popularity of contemporaneous scientific orthodoxy of science but very little of vivid existence & motion of matter accessible around us. Such situation of course implies modern scientific study with remarkable feature of reference popularity is largely teasing contemporaneous scientific orthodoxy for popularity of so-called science community instead of for straightforward authenticity highlight of nature by studying vivid existence & motion of matter accessible, they are always ready to act sitcom of scientific knowledge proliferation in rigid succession of contemporaneous scientific orthodoxy for substantiation & perfection of contemporaneous scientific orthodoxy. This is of course remarkable apotheosis of high-sounding freewheeling royal substantiation & perfection of contemporaneous scientific orthodoxy with remarkable feature of “reference popularity”.

And now, “impact factor” has been sugared into the most gewgawish camouflage for fame & gain of authors & journals, however, practical output of impact factor has none direct correlation as coherent causality with progressional quality or output quality of science of the proper age. Under background of high-sounding royal substantiation & perfection of contemporaneous scientific orthodoxy, as esoteric dandyism for expedience of free press admittance and social legitimacy authorization, the papers which are popular for common citation are mostly the lineal kinfolks of contemporaneous scientific orthodoxy, as contemporaneous scientific orthodoxy has apparently slidden into powerless situation to carry forward historical progress of science, such popular lineal kinfolks of contemporaneous scientific orthodoxy are mostly floundering about in orthodox riancy but difficult to highlight more authenticity of nature as well as contemporaneous scientific orthodoxy has been powerless to carry forward historical progress of science. However, the papers which maybe highlight authenticity of nature remarkably are mostly distinctive, they are usually not popular for quick comprehension and common citation. As a result, historical progressional quality of science can hardly be indicated by synchronous output of impact factors, historical output of impact factors is not something authentic to indicate historical progressional quality of science as well.

In another even straightforward word, so-called “impact factor” only means who refer to me and how many people refer to me, whereas, it's not authentic evidence to indicate practical effect of authenticity highlight of nature. —how much importance reference has accomplished to living humanistic ideology about authenticity of nature, As long as temporal authority are always ready to canonize as beautiful coronet, no matter it's really the new clothing of the emperor or the old clothing of the emperor, impact factors are always able to make the vogue academicians superior and respectable, no matter historical progress of science gets veritable progress or feign progress for remarkable output of impact factors.

3. Freakish output of “impact factor” for reference popularity in modern science forum

The most straightforward practical significance of reference popularity is that interminable implementation of reference popularity under egotistic guidance of temporal authority must bring out magisterial restriction for presence of authoritative intrepidity of contemporaneous scientific orthodoxy, which grimly coerces that coming scientific knowledge proliferation all over the world must be in rigid succession of contemporaneous scientific orthodoxy. In any case, once free press regulation customization and free press admittance is completely under

magistral autarchy of temporal authority, there is almost no way for aberrant scientific knowledge proliferation out of succession of contemporaneous scientific orthodoxy to pass free press egotistic proximity identification from temporal authority. As a result, before humanistic ideology about authenticity of nature finally qualified as perfect ideological enantiomorph of ultimate authenticity of nature, reference popularity must synchronously possess dual significance of “positive significance” and “negative significance”, and intrepidity of reference popularity must magnify both “positive significance” and “negative significance” of reference popularity.

Live contemporaneous scientific orthodoxy is of course out of scientific legitimacy qualification of historical authenticity tolerance of science 0, and commensurate reference popularity must synchronously possess “positive significance of reference popularity” and “negative significance of reference popularity” beyond doubt, whereas, temporal authority never admit the synchronous “negative significance of reference popularity”, especially, royal substantiation & perfection of contemporaneous scientific orthodoxy has apparently slid into vicious circle, the situation of live reference popularity is even worse, impact factors are more and more unworthy of the name therefore.

In accordance with official definition of impact factor, so-called “impact factor” is just the times a paper published in authoritative journal or official publishing house is cited by subsequent papers published in authoritative journals or subsequent books published by official publishing houses. In despite of how much the so-called impact factors are able to indicate the practical development quality of human sciences of the proper age, in accordance with official definition of impact factor and practical implementation of nowadays reference popularity, impact factor (/citation times of papers) is generally affected even restricted by causes as below:

(A) **Repute and sale effect of journals or publishing houses.** The better the repute and sale efficiency of journals or publishing houses is, there is more probability for papers published by the journals or publishing houses to reach readers, and there is consequently more probability for papers published by the journals or publishing houses to be cited by successive potential authors. Repute and sale efficiency of journals or publishing houses generally encash about 15% probability of citation times of papers. That’s to say, in any case, if the same paper is published in a superior journal (/publishing house) which has remarkable repute and sale efficiency or is published in an ordinary journal (/publishing house) which has ecumenical repute and sale efficiency, there must be 15% disparity of the subsequent citation times of the paper leastways. This of course implies there are about 15% phoney impact factors which do not directly result from authenticity demonstration effect of papers but result from repute and sale efficiency of journals or publishing houses. As a result, so-called “impact factors” adulterates 15% phoney impact factors therefore.

(B) **Quantity of professional researchers in-service and quantity of social investment related to motif of the papers.** If there are more professional researchers in-service and more social investment related to motif of the papers, there must be more potential authors related to motif of the papers, and there must be more probability for the related papers published in prior to be cited. Especially, when the quantity of professional researchers in-service and quantity of social investment related to motif of the papers take on remarkable increase, the citation probability preponderance of the related papers published in prior is self-evident. The quantity of professional researchers in-service and social investment quantity related to motif of the papers may encash about 15% citation probability of the related papers. This of course implies there are about 15% impact factors do not directly result from authentic effect of papers but indirectly result from quantity of

professional researchers in-service and quantity of social investment related to motif of the papers instead, so-called “impact factors” adulterate another 15% phoney impact factors therefore.

(C) VIP domino effect of greeting & entertainment flattering temporal authorities for expedience of free press admittance & social legitimacy authorization even courtesy demands reciprocity. Throughout implementation of reference popularity, as most authors need swanky references for expedient free press admittance & social legitimacy authorization, the journals & publishing houses need substantial impact factors for their reputes too, and full jurisdiction of free press admittance is under control of temporal authority who mostly fall over themselves for impact factor too, there are remarkable reference VIP domino effect of greeting & entertainment flattering contemporaneous scientific orthodoxy for expedient free press admittance & social legitimacy authorization even courtesy demands reciprocity throughout implementation of reference popularity. Especially, when reference VIP domino effect involves free press egotistic proximity identification for free press admittance, the smell from it may be even terrible.

And indeed, among the published papers in the recent years, there are substantial ones in three pages of straight matter and two pages of references, even two pages of straight matter and three pages of references. I wonder whether the authors and journals are exerting themselves for authenticity highlight of nature or for professional production of impact factors. There are at least 30% impact factors are soap bubble kind for pollution of reference VIP domino effect of greeting & entertainment flattering temporal authorities for expedience of free press admittance & social legitimacy authorization even courtesy demands reciprocity, if we go on keeping a slack hand with such VIP domino effect, the so-called impact factors in soap bubble kind must go on increasing day by day.

(D) The paper is worthy of carrying forward. This may be just the original intention of reference popularity —authentic worthiness of impact factor. Whereas, in accordance with official definition of reference criterion, impact factor and practical implementation of reference popularity, connotation of authentic worthiness of so-called impact factor is even less than 40% of the original definition value. In any case, except the 30% non-paper impact factors and the living 30% phoney impact factors of soap bubble kind referred above, if we still keep a slack hand with reference VIP domino effect of greeting & entertainment flattering contemporaneous scientific orthodoxy for expedience of free press admittance & social legitimacy authorization, reference soap bubble must go on increasing day by day.

And indeed, under background of interminable royal substantiation & perfection of contemporaneous scientific orthodoxy, as magistral autarchy of “free press regulation customization” and “free press admittance” of temporal authority short of necessary intendance, realistic scientific knowledge proliferation is always restricted in rigid succession of contemporaneous scientific orthodoxy without alternatives, we have to admit “impact factor” is really flaunty fame and fortune cover due to egotistic guidance and magisterial esoteric restriction of temporal authority:

i). As long as temporal authority insist that regular papers must be endowed with references, papers without references can never be qualified and acceptable for free press admittance.

ii). As long as there are still substantial people alive on the earth, some of them devote to writing papers and are ready to publish their papers in journals or publishing houses, and there are still normal quantity of journals & publishing houses on the earth

which publish papers in their conventional ways all along.

The output of impact factors will be constant ever since, which has neither definite pertinency with hypostatic development of science nor definite pertinency to hypostatic operational quality of development of science.

And indeed, in the recent half century, as fashionable authors, authoritative journals & publishing houses even jurisdiction of free press admittance fall over themselves for impact factor, if we say modern science forum is ready to manage development of science, we have more reasons to say modern science forum is always ready to manage “impact factor”. And as a result, the credibility of impact factor is really suspectable.

All in all, in the recent half century, as common aspiration to impact factors among vogue authors, authoritative journals and publishing houses even related reviewers, we would rather to say the living science forum is always ready to deal in impact factors for temporal authority and journals/or publishing houses than ready for development of science which is veritable endeavor to push humanistic ideology about authenticity of nature forward to perfect ideological enantiomorph of ultimate authenticity of nature draw on practical feasibility & possibility in proportion to contemporaneous historical background. In fact, as long as temporal authority insist that regular papers must be endowed with references, papers without references can never be qualified and acceptable for free press admittance; as long as there are still substantial people alive on the earth, some of them devotes to writing papers and are ready to publish their papers in journals or publishing houses, and there are still normal quantity of journals & publishing houses on the earth which publish papers in their conventional ways ever since, then, it has been sufficient condition to ensure steady output of impact factors on the earth in defiance of developmental quality of science.

Even as magisterial restriction of free press admittance under backup of authoritative intrepidity of contemporaneous scientific orthodoxy, especially magisterial restriction derived from egotistic intrepidity of the so-called second-string geniuses under background of royal substantiation & perfection of contemporaneous scientific orthodoxy, the most straightforward practical significance of reference popularity is that interminable implementation of reference popularity under egotistic guidance of temporal authority must form invisible magisterial restriction of contemporaneous scientific orthodoxy, which grimly coerces that coming scientific knowledge proliferation all over the world must be in rigid succession of contemporaneous scientific orthodoxy, for none aberrant scientific knowledge proliferation out of succession of contemporaneous scientific orthodoxy can be qualified and acceptable for free press admittance. As a result, the practical effect of long-term implementation of reference popularity under egotistic guidance of temporal authority depends on the scientific quality of contemporaneous scientific orthodoxy, which can of course be scaled by historical authenticity tolerance of science of the very contemporaneous scientific orthodoxy.

Once a brand-new contemporaneous scientific orthodoxy is ready to be innovative scientific idea, and there is substantial rational potentiality for the innovative scientific idea to renovate humanistic ideology about authenticity of nature in proportion to contemporaneous historical background, as **royal substantiation & perfection of flourishing contemporaneous scientific orthodoxy**~**historical progress of science**, reference popularity of the age can of course bring positive significance of reference popularity into play thereby, which can of course make impact factor honorary at the volley. Once contemporaneous scientific orthodoxy out of scientific legitimacy qualification of historical authenticity tolerance of science 0 has exhausted its inherent rational potentiality towards authenticity

Historical progress of science in the recent several centuries seemed like a far-flung exploration of the first itinerary around numerous distinctive landscapes of brand-new landmasses of science with palette & tablet on back, several hundred years' scientific travelogues were compiled thereby.

highlight of nature, so that freewheeling royal substantiation & perfection of contemporaneous scientific orthodoxy can hardly do its normal jobs to push humanistic ideology about authenticity of nature forward to perfect ideological enantiomorph of ultimate authenticity of nature, reference popularity must expose its negative significance therefore. Whereas, impact factors can still be fastuous, no matter how little endeavor of royal substantiation & perfection of contemporaneous scientific orthodoxy can virtually do to push humanistic ideology about authenticity of nature forward to perfect ideological enantiomorph of ultimate authenticity of nature.

In fact, reference popularity is but ideal accompaniment of royal substantiation & perfection of contemporaneous scientific orthodoxy, once substantiation & perfection of contemporaneous scientific orthodoxy can mostly take role of historical progress of science, synchronous impact factor seems all wood and a yard wide, once substantiation & perfection of contemporaneous scientific orthodoxy gradually slide out of job to push humanistic ideology about authenticity of nature forward to perfect ideological enantiomorph of ultimate authenticity of nature, synchronous impact factor consequently become esoteric. After all, practical achievement of repute of “impact factors” only depends on “**who referred to me**” and “**how many people referred to me**”, which maybe adulterate too much of conservative official domino effect of contemporaneous scientific orthodoxy out of scientific legitimacy qualification of historical authenticity tolerance of science 0. In any case, it is not direct influence of veritable progress of science to push humanistic ideology about authenticity of nature forward to perfect ideological enantiomorph of ultimate authenticity of nature, it's not credible scientific knowledge proliferous effect of reference as fecund thought resource.

Virtually, under favorable background of high-sounding royal substantiation & perfection of contemporaneous scientific orthodoxy, the papers which are always easy to pass egotistic proximity identification from temporal authority and can be largely cited by the subsequent modish authors of the age are mostly the conventional topics of contemporaneous scientific orthodoxy, no matter the conventional topics are able to multiply big trees and can represent the potential uptrend of general progress of science in inherent optimum orientation towards historical authenticity tolerance of science 0 or not. Comparably, any aberrant scientific ideas relative to contemporaneous scientific orthodoxy are always difficult to pass egotistic proximity identification from temporal authority, even though they reluctantly pass egotistic proximity identification from temporal authority, as modish popularity of royal substantiation & perfection of contemporaneous scientific orthodoxy, it's almost impossible for any aberrant scientific idea to be largely cited immediately, no matter whether it is virtually able to multiply big trees as fecund thought resource and able to accomplish remarkable renovation of humanistic ideology about authenticity of nature forward to perfect ideological enantiomorph of ultimate authenticity of nature or not.

This is not only direct cause that impact factor is not valid element to indicate progressional quality of science of the proper historical age but also the major cause it's impossible for conventional extension of royal substantiation & perfection of contemporaneous scientific orthodoxy to approach successive epochmaking scientific innovation.

If neglecting the invisible restriction of scientific knowledge proliferation in rigid succession of contemporaneous scientific orthodoxy due to interminable implementation of reference popularity under egotistic guidance of temporal authority, output of impact factor of the age is more hypostatic to indicate linkage consistence between upriver scientific knowledge proliferation and downriver scientific knowledge proliferation even more hypostatic

to indicate the restriction degree of upriver scientific knowledge proliferation to downriver scientific knowledge proliferation. Whereas, worthiness of impact factor derived from “who referred to me” and “how many people referred to me” of the age can never indicate the historical progressional quality of science, no more indicate practical progressive situation or progressive degree of historical progress of science in inherent optimum orientation towards historical authenticity tolerance of science 0.

January 6-10, 2011, Baisha village, Humen town, Dongguan city, Guangdong province

Further revision was done in June 2018, Nanxing, Dani-shatian-dongguan-guangdong

(IX-iv) **As timely cosmos redefinition in radical logic enantiomorph of newly highlighted factuality that *discretionary particles in cosmos are mutually convertible* and typical aberrant scientific knowledge proliferation out of succession of contemporaneous scientific orthodoxy, esoteric perplexity of Homogenous Cosmos Originated from Unique Genesis floundering about in high-sounding reference popularity under egotistic background of interminable royal substantiation & perfection of contemporaneous scientific orthodoxy**

Abstract: *The most straightforward practical significance of reference popularity is that interminable implementation of reference popularity under egotistic guidance of temporal authority must form invisible egotistic restriction of contemporaneous scientific orthodoxy, which grimly coerces all coming scientific knowledge proliferation in rigid succession of contemporaneous scientific orthodoxy, none scientific knowledge proliferation out of succession of contemporaneous scientific orthodoxy can be qualified and acceptable. As successive rational sublimation against favorable background of remarkable highlight of microcosmic configuration of matter, "Homogenous Cosmos Originated from Unique Genesis" is innovative cosmos redefinition in logic enantiomorph of newly highlighted factuality that *discretionary particles in cosmos are mutually convertible* with consequent PNT dynamics about universal existence & motion in the nature of coherent natura naturans throughout cosmic evolution, which is apparently aberrant scientific knowledge proliferation out of rigid succession of contemporaneous scientific orthodoxy, especially out of modern popularity of academic classification of PACC & PACS. Whereas, each time I contributed to relevant journals, I was always demanded to offer references which were published in the recent 5 years. Even as magistral autarchy of "free press regulation customization" and "free press admittance" of temporal authority short of necessary intendance, I have to flounder around in free press embarment for near 30 years without alternatives.*

Keywords: *homogenous cosmos originated from unique genesis, compound cosmos originated from multiple genesis, unintelligible cosmos originated from non-genesis.*

Introduction of Homogenous cosmos originated from unique genesis postulate and successive connotation objectification even freewheeling logic extension of connotation objectification of homogenous cosmos originated from unique genesis made up of the hardcore of Homogenous Cosmos Originated from Unique Genesis, —positive & negative transmutation dynamics of homogenous cosmos (which were virtually the first and the second part of the treatise). In the recent 20 years, I always insisted, as the hardcore of Homogenous Cosmos Originated from Unique Genesis, if this part could not be considered and comprehended by people in prior, any independent contribution of any other sections of the treatise could only make people unintelligible, so I always devoted to contribute the hardcore emphatically without alternative. And indeed, the times of independent contribution of the hardcore accounted near half of all my contribution times all these years, the independent contribution of all the other sections of the treatise in defiance of prior publication of the hardcore is but my loath choice without alternatives. Even three months ago and 20 days ago, I still separately contributed "Positive & negative transmutation dynamics of homogenous cosmos" to Copernicus office and AIP physics advances with all the other sections kept down.

As renovation of humanistic ideology about authenticity of nature in proportion to contemporaneous

As coherent natura naturans throughout cosmic evolution, instinctive PNT reciprocal equilibrium towards optimum PNT operation is radical potentiality & conditionality for cosmos always ready to orientate itself towards perfection.

historical background of remarkable highlight of microcosmic configuration of matter, remarkable highlight of microcosmic configuration of matter, especially remarkable highlight of factuality that discretionary particles in cosmos are mutually convertible in the recent one century has brought out substantial headspring for me to succeed the downwind potentiality for pioneering cosmos redefinition in logic enantiomorph of newly highlighted factuality that discretionary particles in cosmos are mutually convertible with consequent PNT dynamics about universal existence & motion in the nature of coherent natura naturans throughout cosmic evolution. The favorable groundwork of remarkable highlight of microcosmic configuration of matter is not only all necessary references but also overall logic fulcrum of Homogenous Cosmos Originated from Unique Genesis. Whereas, in all my contribution of paper of positive & negative transmutation dynamics of homogenous cosmos, I added references according to temporal reference popularity; I was enforced to do so without alternatives, for you see, as low-down man of the society, there is no opportunity for me to submit any special excuse. And indeed, in accordance with prideful orthodoxy, none paper can be qualified without references. Whereas, to my deadly torture, I could hardly label all the reluctant references onto the proper contents of the paper proportionately for they were not commensurate along original thought proliferation indeed. Say truly, the hardcore of Homogenous Cosmos Originated from Unique Genesis has no reference stand to reason, and I did never refer to any special books or papers for connotation objectification with freewheeling logic extension of homogenous cosmos originated from unique genesis.

We must be aware of the factuality that, as crescive progression of practical feasibility & possibility in proportion to contemporaneous historical background, the practice human coming to discover and formulate authenticity of accessible existence & motion around must experience frondose evolvment of humanistic ideology about authenticity of nature cumulatively enriched from nothingness to goat, from goat to a great lot, and consequently followed proportionate ideaistic correction & qualitative optimization from superficiality to profundity, from parochiality to generality. And throughout historical progress of science, any scientific genius can only accomplish historical progress of science in proportion to contemporaneous historical background but could never do something wonderful but unintelligible out of crescive progression of historical progress of science. Before humanistic ideology about authenticity of nature finally qualified as perfect ideological enantiomorph of ultimate authenticity of nature, naissance of contemporaneous scientific orthodoxy only indicates living progress of science has accomplished top level development of science in proportion to contemporaneous historical background off the cuff, and social legitimacy authorization of temporal authority only indicates the brand-new humanistic ideology about authenticity of nature has been endowed social legitimacy qualification, but not indicates variation of the rational mode of further development & innovation of science or indicates approach of perfect ideological enantiomorph of ultimate authenticity of nature.

We must be aware that, current popularity of scientific reference overflows more authoritative restriction of temporal authority, a scientific topic is able to find substantial references in modern journals of the age firstly means this scientific topic tally with popularity and has been included in scientific mainstream of the age. Substantial presence of references is not in proportion to its positive energy towards veritable progress of science. Comparably, pioneering scientific ideas are mostly distinctive and difficult to find substantial references around.

As innovative cosmos redefinition in logic enantiomorph of newly highlighted factuality that discretionary particles in cosmos are mutually convertible with consequent PNT dynamics about universal existence & motion in the nature of coherent natura naturans throughout cosmic evolution, Homogenous Cosmos Originated from Unique Genesis is typical outgrowth of longitudinal ideological optimization as linear logic system rooted

Historical progress of science in the recent several centuries seemed like a far-flung exploration of the first itinerary around numerous distinctive landscapes of brand-new landmasses of science with palette & tablet on back, several hundred years' scientific travelogues were compiled thereby.

in favorable background of **remarkable highlight of microcosmic configuration of matter**, which is so different from travelogue style live contemporaneous scientific orthodoxy like omnifarious smallwares full of a basket. Virtually, there are only two coordinative logic topics which are commensurate with Homogenous Cosmos Originated from Unique Genesis in logic grade.

The first is “**Compound cosmos originated from multiple genesis**”.

The second is “**Unintelligible cosmos originated from non-genesis**”.

Whereas, even if we accumulate all the sciences of live contemporaneous scientific orthodoxy totally, the total accumulation of all live contemporaneous scientific orthodoxy is still not enough to be commensurate with Homogenous Cosmos Originated from Unique Genesis in logic grade. Virtually, as innovative cosmos redefinition in logic enantiomorph of newly highlighted factuality that **discretionary particles in cosmos are mutually convertible** with consequent PNT dynamics about universal existence & motion in the nature of coherent natura naturans throughout cosmic evolution, as long as total study scope of live contemporaneous scientific orthodoxy does not exceed category of universal existence & motion, Homogenous Cosmos Originated from Unique Genesis must crown all live contemporaneous scientific orthodoxy all and singular. In fact, as humanistic ideology about authenticity of nature in proportion to contemporaneous historical background, live contemporaneous scientific orthodoxy is but rich and colorful scientific travelogues about accessible existence & motion of omnifarious matter specimens around us, **academic scope of live contemporaneous scientific orthodoxy = (physics + chemistry + biology + iatrology + ...)** is of course subclass of Homogenous Cosmos Originated from Unique Genesis, in any case, Homogenous Cosmos Originated from Unique Genesis is innovative cosmos redefinition in radical logic enantiomorph of newly highlighted factuality that **discretionary two particles in cosmos are mutually convertible** with consequent PNT dynamics about universal existence & motion in the nature of coherent natura naturans throughout cosmic evolution, which is not rigid succession of live contemporaneous scientific orthodoxy with idea of academic classification as physics, chemistry, biology, iatrology, ... but timely renovation of humanistic ideology about authenticity of nature in proportion to contemporaneous historical background of remarkable highlight of microcosmic configuration of matter.

Say truly, the hardcore of the treatise has no reference, I never referred to anything else indeed when I tried to finish it. Otherwise, I then would have to admit that throughout the logic expansion of Homogenous cosmos originated from unique genesis postulate with supplementation of two 0.5 grade accessorial postulates, I virtually exhausted all I had learned in all my math & physics classes from primary school to senior high school, if it's necessary for me to offer references of the hardcore of the treatise, I am afraid, I should list out all my math text books, my physics text books and the proper math teachers, physics teachers. Even though PNT dynamics apparently referred to the original definition formulation of Newtonian mechanics, whereas, I never read any treatise of Newton, I but learned them in my physics classes. As a result, I could only list my physics text books and my physics teachers as reference too. However, in accordance with temporal authoritative criterion of “reference popularity”, it is obviously cockeyed behavior or nonsense, I can not be so naughty, I am afraid.

Virtually, remarkable highlight of factuality that **discretionary particles in cosmos are mutually convertible** was but occurrence before 70s of 20th century. And indeed, idea of homogenous cosmos originated from unique genesis firstly came into being in winter of 1991. And during the course of my school education from 1980 to 1991, I only got touch of the scientific groundwork before 70s of 20 century. After naissance of scientific idea

of homogenous cosmos originated from unique genesis, practical connotation objectification and successive freewheeling logic extension of homogenous cosmos originated from unique genesis towards cosmos redefinition and consequent PNT dynamics about universal existence & motion in the nature of coherent natura naturans throughout cosmic evolution is but logic expansion of an independent logic chain-reacting, which focuses on rational highlight if cosmos is really homogenous originated from unique genesis through and through, what integrative homologic configuration of cosmos and proportionate universal homologic existence & motion should be accordingly.

The independent logic chain-reacting has no reference, it even seems no references are unnecessary for logic expansion of the independent logic chain-reacting. And in fact, under background of freewheeling royal substantiation & perfection of contemporaneous scientific orthodoxy, I am the unique man on the earth who has involved a scientific motif in so superior logic grade as innovative cosmos redefinition in logic enantiomorph of newly highlighted factuality that **discretionary particles in cosmos are mutually convertible**, it's completely impossible for me to find any coordinative references on the earth.

However, I was enforced to offer references which were published in the recent 5 years, even though, Homogenous Cosmos Originated from Unique Genesis has been floundering about in deadly free press embarment for more than a quarter century.

Say truly, for expedience of free press admittance, I had no reason to refuse producing necessary impact factors for temporal authority indeed. In fact, I downloaded many papers from famous journals, whereas, in accordance with the proper requirements of reference popularity, I could hardly add all the popular papers into reference list of Homogenous Cosmos Originated from Unique Genesis. I was completely confused, after all, all the popular papers were not in logic extension of Homogenous Cosmos Originated from Unique Genesis indeed, they were but cordial endeavor for substantiation & perfection of contemporaneous scientific orthodoxy like rich and colorful smallwares full of a basket, which completely had nothing to do with introduction of Homogenous cosmos originated from unique genesis postulate no more logic expansion of the very postulate with supplementation of two 0.5 grade accessorial postulates. At any rate, Homogenous Cosmos Originated from Unique Genesis is innovative cosmos redefinition in logic enantiomorph of newly highlighted factuality that **discretionary particles in cosmos are mutually convertible** with consequent PNT dynamics about universal existence & motion in the nature of coherent natura naturans throughout cosmic evolution, which is completely different from tradition for distinctive background rationale, logic origin and derivation.

In any case, as remarkable disparity of historical thought origin and inherent logic connotation, Homogenous Cosmos Originated from Unique Genesis is so different from live contemporaneous scientific orthodoxy. What's more, naissance of Relativity & Quantum Theory was primary sense acclimation for adaptive ideological transition from macrophysics to microphysics, whose historical background was that, as more and more microcosmic factuality came into human sense, human were almost astonished and confused that more and more microcosmic factuality apparently negated their inrooted experience of macrophysics. And as remarkable interposition of microcosmic factuality and remarkable confusion for more and more microcosmic factuality out of inrooted experience of macrophysics, human had to review universal existence & motion draw on practical feasibility and possibility in proportion to contemporaneous historical background again, and Relativity & quantum Theory came into being accordingly.

Historical progress of science in the recent several centuries seemed like a far-flung exploration of the first itinerary around numerous distinctive landscapes of brand-new landmasses of science with palette & tablet on back, several hundred years' scientific travelogues were compiled thereby.

Whereas, as timely renovation of humanistic ideology about authenticity of nature in proportion to contemporaneous historical background of **remarkable highlight of microcosmic configuration of matter**, I slid into deadly complexity as below:

The first, although, **remarkable highlight of microcosmic configuration of matter** has thrown more and more lights onto homogenous profile of cosmos, which virtually has brought out substantial headspring for me to succeed the downwind potentiality for pioneering cosmos redefinition in logic enantiomorph of newly highlighted factuality that **discretionary particles in cosmos are mutually convertible** with consequent PNT dynamics about universal existence & motion in the nature of coherent natura naturans throughout cosmic evolution, human practical accessibility of science has been relatively near to upper limit of human perception, scientific experiments are not only difficult for human to detect and uncover a fly in the ointment of live contemporaneous scientific orthodoxy but also difficult to offer creditable demonstration for coming renovation of humanistic ideology about authenticity of nature in proportion to contemporaneous historical background, which is apparently different from the ideological transition of humanistic ideology about authenticity of nature from macrophysics to microphysics in terminal years of 19th century and early years of 20th century for interposition of remarkable deregulation of microcosmic factuality against Newtonian Mechanics, necessary renovation of humanistic ideology about authenticity of nature in proportion to contemporaneous historical background of successive implication dilation of scientific practice from macrocosm to microcosmos was self-evident.

The second, as lowdown man of the society, I have to devote myself to consummating the topic alone after hours, especially, I can hardly shy away identity & qualification discrimination in many occasions, especially in free press admittance occasion under egotistic background of interminable royal substantiation & perfection of contemporaneous scientific orthodoxy.

The third, authoritative intrepidity of contemporaneous scientific orthodoxy is all-time even overwhelming, free press regulation customization and free press admittance is under magistral autarchy of temporal authority short of necessary intendance, science forum can hardly be free from duress of all-time authoritative intrepidity of contemporaneous scientific orthodoxy once epochmaking scientific knowledge metabolism is inevitable. As renovator of humanistic ideology about authenticity of nature in proportion to contemporaneous historical background of remarkable highlight of microcosmic configuration of matter, I am floundering around in royal substantiation & perfection of contemporaneous scientific orthodoxy as helpless fighter in coming scientific knowledge metabolism campaign, I have to challenge unprecedented authoritative intrepidity of contemporaneous scientific orthodoxy alone in esoteric social authoritative operation for accredited social legitimacy authorization in accordance with egotistic criterion of contemporaneous scientific orthodoxy under official centered background. And as personal limitation, it's almost impossible for me to be unquestionable to pass free press egotistic proximity identification from temporal authority. What's more, I have to write down my idea in a foreign language. Chinese is my native language, whereas, I am lowdown man in mainland of china.

Although, "Homogenous Cosmos Originated from Unique Genesis" is innovative cosmos redefinition and thoroughly coherent PNT dynamics about universal existence & motion in the nature of essence of matter in a class by itself, which is radical logic enantiomorph of newly highlighted factuality that "**discretionary particles in cosmos are mutually convertible**".

it's only possible for concordant cosmos to be demiurgic aggradation of out-and-out serial natura naturata in the nature of

As coherent natura naturans throughout cosmic evolution, instinctive PNT reciprocal equilibrium towards optimum PNT operation is radical potentiality & conditionality for cosmos always ready to orientate itself towards perfection.

coherent natura naturans throughout cosmic evolution; there is no way for demiurgic aggradation in the nature of different natura naturans to be concordant cosmos through and through. I am really difficult to comprehend, as loving successors of contemporaneous scientific orthodoxy, why the temporal authority are so enthusiastic to devote themselves to formulate the unique & invariable authenticity of nature with two different theories which are apparently incompatible. Even if the factuality is not something childish or ludicrous, it must be rough historical romantic in human history of scientific progress. What's more, temporal authority are so inflexible that scientific knowledge proliferation all over the world must be in rigid succession of contemporaneous scientific orthodoxy for ever, none distinctive scientific innovation out of succession of contemporaneous scientific orthodoxy can be acceptable, no more distinctive way to study universal existence & motion, which is remarkably different from contemporaneous scientific orthodoxy.

Frankly, what kind of references Homogenous Cosmos Originated from Unique Genesis had practically referred to, how Homogenous Cosmos Originated from Unique Genesis had practically acclimated even digested the reference distillate as favorable background resource, and how Homogenous Cosmos Originated from Unique Genesis accounted for the proper references are not something all-important; the most significant theme is whether cosmos is really homogenous through and through; and if yes, what integrative configuration and homogenous existence & motion the entire cosmos are therefore? Whereas, as low-down heterodoxy and typical science panhandler floundering about in royal substantiation & perfection of contemporaneous scientific orthodoxy, once Homogenous Cosmos Originated from Unique Genesis slid into esoteric scientific knowledge metabolism campaign, not only issues originally significant can not be taken into conscious consideration in its normal way, they are even always ready to be staggered and obviated. However, none inappreciable shortages of it can be luckily escaped being resorted as deadly bullets to be filled into the most efficacious gun of countercheck jurisdiction of science free press admittance instead.

How difficult it is for me to break through the free press defence line of temporal authority for knowledge metabolism campaign; how difficult it is for me to escape free press embarment and enter open eyeshot of commonality. How stupid I am! I can hardly find my way to serve the hour and flirt reference popularity with temporal authority who have full jurisdiction of free press admittance in hand, no more imitate resorting celeb references as to coronate and lubricate myself for esoteric popularity, especially, I can hardly imitate to patronize the living celeb references with substantial puissance so as to keep away from unrighteousness and to be ready for egotistic proximity identification, I can only gather pollen and brew honey instinctively like honeybee. Till today, all necessary pollen had been gathered, and the honey had been brewed like this herein. Whereas, what are my original pollen for the very honey?

I do not know, I do not know indeed, I can hardly look back into my original subconscious brewing of the idea of homogenous cosmos originated from unique genesis in school yard of the first middle school of Wugang city. It even seems no way for me to ascertain the proper references, I am but aware the pollen quintessence I invoked to brew the honey is but the newly highlighted factuality that “**discretionary particles in cosmos are mutually convertible**”.

Which are the undeniable magic flowers which have practically imparted me the pollen quintessence of “**discretionary particles in cosmos are mutually convertible**”?

I do not know indeed, I am almost at my wits' end besides aware all these pollen quintessence is originally

Historical progress of science in the recent several centuries seemed like a far-flung exploration of the first itinerary around numerous distinctive landscapes of brand-new landmasses of science with palette & tablet on back, several hundred years' scientific travelogues were compiled thereby.

procured from garden of tradition, and I am substantively depressed and helpless for clarification of this! In any case, Homogenous Cosmos Originated from Unique Genesis is substantively innovative cosmos redefinition in logic enantiomorph of newly highlighted factuality of “**discretionary particles in cosmos are mutually convertible**” with consequent PNT dynamics about universal existence & motion in the nature of coherent natura naturans throughout cosmic evolution.

I am depressed and unintelligible indeed! As remarkable highlight of microcosmic configuration of matter, I sublimate the rationality of newly highlighted factuality that “**discretionary particles in cosmos are mutually convertible**” into **Homogenous cosmos originated from unique genesis postulate** accordingly. And successively, I expanded the proper logic connotation of homogenous cosmos originated from unique genesis with supplementation of two 0.5 grade accessorial postulates of “Spacetime~matter fully embodying cosmos postulate” and “Instinctive PNT equilibrium postulate”. Just for the accomplishment of connotation expandedness and objectification, I devoted me myself with great care, to my depression, I met unexpected trouble that I must bend myself to reference popularity in rigid succession of contemporaneous scientific orthodoxy for obligation of necessary impact factor.

However, **whether cosmos is throughout homogenous originated from unique genesis really? And if yes, what integrative homologic configuration of cosmos and proportionate universal existence & motion of matter should be?** It seems nobody care about it. Even as authoritative intrepidity of contemporaneous scientific orthodoxy is all-time and divarication between Homogenous Cosmos Originated from Unique Genesis and tradition is so remarkable, I can hardly be free from snobbism of temporal authority even point-blank discrimination for my poor identity and qualification.

In any case, as magic intelligence for human to make use of ideal existence & motion in the nature to materialize necessity of social production & living, “science” is soul of social productivity, human advocate science so much therefore. As a result, legitimacy subsistence of science is above all fame & gain capital of temporal authority. Whereas, on the other hand, the undeniable factuality of quantitative & qualitative change of historical progress of science is that the practice human coming to discover and formulate authenticity of accessible existence & motion around must experience frondose evolvment of humanistic ideology about authenticity of nature cumulatively enriched from nothingness to goad, from goad to a great lot, and consequently followed proportionate ideaistic correction & qualitative optimization from superficiality to profundity, from parochiality to generality.

This of course indicates historical progress of science is not only quantitative & qualitative change of scientific knowledge proliferation but also the proportionate scientific knowledge metabolism for recognizant correction & ideological optimization from superficiality to profundity, from parochiality to generality all along. And as scientific knowledge metabolism must undoubtedly follow scientific knowledge metabolism campaign, once there is potential of scientific knowledge metabolism which apparently impacts subsistence of temporal legitimacy of science, scientific knowledge metabolism campaign must occur between temporal authority (including loving successors of contemporaneous scientific orthodoxy) and successive scientific innovators therefore. As originator of Homogenous Cosmos Originated from Unique Genesis, I am cherubic indeed, whereas, I can hardly keep me free from damnatory scientific knowledge metabolism campaign. After all, as out-and-out social work outgrowth and humanistic ideology about authenticity of nature in proportion to contemporaneous historical background, social existence and historical progress of “science” must inherently possess double coordinative significance of

As coherent natura naturans throughout cosmic evolution, instinctive PNT reciprocal equilibrium towards optimum PNT operation is radical potentiality & conditionality for cosmos always ready to orientate itself towards perfection.

“natural connotation” and “social connotation”, social legitimacy subsistence of neonatal scientific idea especially successive renovation of humanistic ideology about authenticity of nature along historical progress of science in inherent optimum orientation towards perfect ideological enantiomorph of ultimate authenticity of nature never simply depends on cognizant achievement that brand-new or more veritable authenticity of nature has been reflected on sense of pioneering originators with commensurate authenticity highlight effect in proportion to contemporaneous historical background, it even crucially implicates esoteric authoritative social legitimacy identification & authentication in accordance with egotistic criterion of contemporaneous scientific orthodoxy under official centered background —social legitimacy & validity of truths can never exceed cannon range, which of course includes humanistic operation of virulent scientific knowledge metabolism campaign underlying. The even pestilent imbroglio is that authoritative legitimacy identification is mostly under autarchy of temporal authority going without saying in defiance of historical limitation of live contemporaneous scientific orthodoxy short of necessary intendance.

Under living background of freewheeling royal substantiation & perfection of contemporaneous scientific orthodoxy, as human self-preservation + social legitimacy authorization autarchy of temporal authority in defiance of historical limitation of contemporaneous scientific orthodoxy short of necessary intendance, once social legitimacy authorization of any aberrant scientific knowledge proliferation out of succession of contemporaneous scientific orthodoxy sliding into social operation of esoteric authoritative social legitimacy identification & authentication, the forepleasure of esoteric authoritative social legitimacy identification & authentication must firstly be free press egotistic proximity identification under control of second-string geniuses who are meritorious for substantiation & perfection of contemporaneous scientific orthodoxy even third-rate talents who are loving successors of contemporaneous scientific orthodoxy. As free press admittance and social legitimacy authorization are completely under magistral autarchy of temporal authority, living social legitimacy metabolism fair play between timely renovation of humanistic ideology about authenticity of nature and live contemporaneous scientific orthodoxy must be puissance rivalship above all. As long as contemporaneous scientific orthodoxy is still altisonant without remarkable suspicion, and free press admittance & social legitimacy identification is still under control of temporal authority, primary authoritative legitimacy identification of aberrant scientific knowledge proliferation out of succession of contemporaneous scientific orthodoxy must be spontaneous occurrence of “human self-preservation + cozy identification of temporal puissance” with authenticity unbeknown. What’s more, in mainland of China, there is always inrooted “official perdue regulation” going without saying.

捧得权威颜，利禄变现钱；

If your academic achievement is fashionable for high-sounding substantiation & perfection of contemporaneous scientific orthodoxy, as remarkable expedience for free press egotistic proximity identification from temporal authority, you can be expediently confirmed meritorious, fame & gain can immediately turn into ready money in your pocket.

赢得真理然，功名在坟前。

As potential conditionality that [the uniqueness & invariance of ultimate authenticity of nature predestines unique possibility of scientific verity as perfect ideological enantiomorph of ultimate authenticity of nature](#), there is almost no way for renovation of humanistic ideology about authenticity of nature in proportion to contemporaneous historical background to shy away remarkable divarication from contemporaneous scientific orthodoxy, there is almost no way for pioneering innovators towards perfect ideological enantiomorph of ultimate authenticity of nature to evade scientific knowledge metabolism campaign at daggers drawn. As a result, under background of royal substantiation & perfection of contemporaneous scientific orthodoxy with intrepid backup of magistral autarchy of free press regulation customization & free press admittance of temporal authority short of necessary intendance, social legitimacy

Historical progress of science in the recent several centuries seemed like a far-flung exploration of the first itinerary around numerous distinctive landscapes of brand-new landmasses of science with palette & tablet on back, several hundred years’ scientific travelogues were compiled thereby.

subsistence of timely renovation of humanistic ideology about authenticity of nature in proportion to contemporaneous historical background must slide into vicious circle of virulent scientific knowledge metabolism campaign. Whereas, as immanent potentiality of historical progress of science in inherent optimum orientation towards perfect ideological enantiomorph of ultimate authenticity of nature, there is still proportionate potentiality for fame & gain to be left before lasthome of innovators.

后尘亲奴才，示真特难过；

Under background of royal substantiation & perfection of contemporaneous scientific orthodoxy, authoritative intrepidity of contemporaneous scientific orthodoxy is mostly all-time by itself, even as magistral autarchy of free press regulation customization & free press admittance of temporal authority short of necessary intendance, any endeavor for substantiation & perfection of contemporaneous scientific orthodoxy is always fashionable at pleasure of temporal authority. However, if you slide into necessary renovation of humanistic ideology about authenticity of nature in proportion to contemporaneous historical background at the volley of historical progress of science, you must slide into perplexity of free press egotistic proximity identification of temporal authority, free press admittance of timely renovation of humanistic ideology about authenticity of nature in proportion to contemporaneous historical background even has to challenge venomous counterwork upper limit of temporal authority for virulent scientific knowledge metabolism campaign.

官人当场秀，能人死后优。

As magistral autarchy of **free press regulation customization** & **free press admittance** of temporal authority short of necessary intendance, science forum is out-and-out homegrown outgrowth in the garden of contemporaneous scientific orthodoxy beyond all doubt, the bureaucracy of temporal authority is always elated off the cuff for cock-a-hoop self-appreciation of royal substantiation & perfection of contemporaneous scientific orthodoxy. Thank God, as immanent potentiality of historical progress of science in inherent optimum orientation towards perfect ideological enantiomorph of ultimate authenticity of nature, there is still proportionate potentiality for the innovators to be worthy after death.

I am quite aware, as low-down heterodoxy floundering about in high-sounding royal substantiation & perfection of contemporaneous scientific orthodoxy, I did not follow temporal legitimacy and implement all my necessary obligation of substantiation & perfection of contemporaneous scientific orthodoxy, my unexpected endeavor to sublimate the rationality of newly highlighted factuality that **discretionary particles in cosmos are mutually convertible** into **Homogenous cosmos originated from unique genesis postulate** and expanded the proper logic connotation of the very postulate with supplementation of two 0.5 grade accessorial postulates towards innovative cosmos redefinition in logic enantiomorph of newly highlighted factuality that **discretionary particles in cosmos are mutually convertible** with consequent PNT dynamics about universal existence & motion in the nature of coherent natura naturans throughout cosmic evolution is of course heterodox even villainous endeavor, only references in rigid succession of live contemporaneous scientific orthodoxy are really something significant and respectable.

I am so sad I can hardly ascertain the divine and respectable references of the living authorities who may be meritorious for having done some a little job for historical accomplishment of remarkable highlight of factuality that “**discretionary particles in cosmos are mutually convertible**”.

Even though, this is my sin, I am afraid, I can only confess my transgression like this herein!

January 6-10, 2011, Baisha village, Humen town, Dongguang city, Guangdong province

Further revision was done in June 2018, Nanxing, Dani-shatian-dongguan-guangdong

(IX-v) Serial assembly of special nouns & items of Homogenous Cosmos Originated from Unique Genesis and necessary interpretation

Abstract: *As necessity of rational formulation and helplessness of free press admittance of Homogenous Cosmos Originated from Unique Genesis, it's necessary for me to add another two supplemental items as below:*

The first, *Along the logic clew of Homogenous Cosmos Originated from Unique Genesis, it's necessary for me to assemble all the special nouns & items of the monograph as integrative series in a table so as to review the whole thesis systematically and show the integration of all special nouns & items along lineal logic extension of connotation objectification and freewheeling logic extension of homogenous cosmos originated from unique genesis even supplemental universal applicability of consequence of connotation objectification and freewheeling logic extension of homogenous cosmos originated from unique genesis on the basis of [(homogenous cosmos originated from unique genesis + spacetime-matter fully embodying cosmos) + Instinctive PNT equilibrium].*

The second, *it's necessary for me to illuminate the remarkable discrepancy even the root cause of remarkable discrepancy of special nouns & items between Homogenous Cosmos Originated from Unique Genesis and traditionary sciences as typical scientific travelogues A, B, C, D, E, F, ... about numerous distinctive landscapes of brand-new landmasses of science, —distinctive rational origin and homologous logic extension radically conditions the proportionate proliferation of special nouns & items like distinctive DNA conditioning growth of distinctive organism. And by the way, I illuminate the variation inevitability & inherent uptrend of special nouns & items of science as consequent variation of scientific knowledge metabolism along quantitative change of historical progress of science in inherent optimum orientation towards perfect ideological enantiomorph of ultimate authenticity of nature.*

Keywords: *physical domino effect of superposition disturbance of matter fields, physical domino effect of superposition disturbance of matter field with congeneric or complemental genic preponderance or genic insufficiency, physical domino effect of PNT complemental linkage optimization among unsaturated particles in available space range.*

I have to comment herein, I finally write this section is generally because of occurrence exceeding my expectation. In the recent years, I contributed my papers in Homogenous Cosmos Originated from Unique Genesis to journals many times, and I frequently received comment that there were too many special nouns & items in my paper too newfangled to contemporaneous scientific orthodoxy, after all, this is typical age of royal substantiation and perfection of contemporaneous scientific orthodoxy, free press admittance is mostly validation of free press egotistic proximity identification. Virtually, in order to reduce the remarkable estrangement of special nouns & items between Homogenous Cosmos Originated from Unique Genesis and omnifarious conventional scientific travelogues as physics, chemistry, biology, iatrolgy etc so as to shy away remarkable aberrancy for free press egotistic proximity identification, I had tried to invoke the ready-made nouns and items of traditionary sciences as many as possible. Whereas, as remarkable discrepancy of radical rationale and logic proliferation model between Homogenous Cosmos Originated from Unique Genesis and omnifarious conventional scientific travelogues as physics, chemistry, biology, iatrolgy etc, Homogenous Cosmos Originated

from Unique Genesis is substantively reluctant to invoke too many ready-made nouns & items of traditionary sciences as physics, chemistry, biology, iatrolgy etc to formulate authenticity of nature as lineal logic system on the basis of [(homogenous cosmos originated from unique genesis + spacetime-matter fully embodying cosmos) + Instinctive PNT equilibrium].

In any case, as typical output of aberrant scientific knowledge proliferation out of succession of contemporaneous scientific orthodoxy and timely renovation of humanistic ideology about authenticity of nature in proportion to contemporaneous historical background of remarkable highlight of microcosmic configuration of matter, Homogenous Cosmos Originated from Unique Genesis is not something similar as conventional physics, chemistry, biology, iatrolgy etc as colorful scientific travelogues like omnifarious smallwares full of a basket, it's cosmos redefinition in logic enantiomorph of newly highlighted factuality that discretionary particles in cosmos are mutually convertible with consequent PNT dynamics about universal existence & motion in the nature of coherent natura naturans throughout cosmic evolution in typical rational model of lineal logic system on the basis of [(homogenous cosmos originated from unique genesis + spacetime-matter fully embodying cosmos) + Instinctive PNT equilibrium].

And as necessity of rational formulation and helplessness of free press admittance of Homogenous Cosmos Originated from Unique Genesis, I have to do up all special nouns & items of the monograph systematically in an integrative table for highlight of the remarkable discrepancy between Homogenous Cosmos Originated from Unique Genesis and omnifarious scientific travelogues of traditionary sciences as physics, chemistry, biology, iatrolgy etc. And emphatically, I finally added necessary interpretation of the remarkable discrepancy between Homogenous Cosmos Originated from Unique Genesis and omnifarious scientific travelogues of traditionary sciences as physics, chemistry, biology, iatrolgy etc.

1. Serial assembly of special nouns & items of Homogenous Cosmos Originated from Unique Genesis along lineal logic extension on the basis of [(homogenous cosmos originated from unique genesis + spacetime-matter fully embodying cosmos) + Instinctive PNT equilibrium].

Nouns & Items	Annotation of Nouns & Items
The first part	<p>Connotation Objectification of Homogenous Cosmos Originated from Unique Genesis Homologisation of Spacetime & Matter—Precondition Initialization of PNT Dynamics</p>
Transverse ideological expansion	<p>The historical process that scientific knowledge cumulatively enriched from nothingness to groat, from groat to a great lot is just the transverse ideological expansion, which generally incarnates quantitative expansion of recognizant range and consequent knowledge cumulation.</p>
Longitudinal ideological optimization	<p>The historical process that scientific knowledge qualitatively optimized from superficiality to profundity and from parochiality to generality is just the longitudinal ideological optimization, which generally incarnates gradual qualitative optimization of ideology orientating authenticity of nature based on and inherited temporal scientific knowledge achievement of transverse ideological expansion.</p>
Homogenous cosmos originated from unique genesis postulate	<p>Homogenous cosmos originated from from unique genesis postulate is the unique basic precondition of Homogenous Cosmos Originated from Unique Genesis, which has mostly succeeded the headspring of tradition of remarkable highlight of microcosmic configuration of matter especially the factuality that discretionary particles in cosmos are mutually convertible in</p>

As coherent natura naturans throughout cosmic evolution, instinctive PNT reciprocal equilibrium towards optimum PNT operation is radical potentiality & conditionality for cosmos always ready to orientate itself towards perfection.

	orientation towards complete induction day by day. And with supplementation of two accessory postulates of spacetime-matter fully embodying cosmos postulate and instinctive PNT equilibrium postulate , it arrived at cosmos redefinition in logic enantiomorph of newly highlighted factuality that discretionary particles in cosmos are mutually convertible with consequent PNT dynamics about universal existence & motion in the nature of coherent natura naturans throughout cosmic evolution as lineal logic system on the basis of [(homogenous cosmos originated from unique genesis + spacetime-matter fully embodying cosmos) + Instinctive PNT equilibrium].
Logic extension 1 of Homogenous cosmos originated from unique genesis postulate	Since cosmos is throughout homogenous originated from unique genesis, as undeniable components of cosmos, both “spacetime” and “matter” must be homologic coordinators coequally originated from the common cosmic extremity genesis (/cosmic genic origin i_0) along sequential homologic cosmogony. As a result, as coordinative homology in cosmos, “spacetime” must be coequally physical as matter, unless we have tangible evidence to exclude spacetime out of category of cosmos.
Logic extension 2 of Homogenous cosmos originated from unique genesis postulate	If cosmos is object fully embodied by hypostatic coexistence of “spacetime” and “matter”, nothing else, along sequential homologic cosmogony starting at the so-called common cosmic extremity genesis (/cosmic genic origin i_0) to cosmic status quo, “spacetime” and “matter” must be alternative homologic filiation either “spacetime father & matter son” or “matter father & spacetime son”.
Negative matter/dark matter	Cosmic tangible substance of space field which consist of phantasmagorial space field genic units spontaneously existing in mutual transiting and transmuting at speed of time dynamic speed.
Space field	Just the alias of space for its hylic existent profile is very similar as field.
Space field genic unit	Just the elementary genic component of material space field.
Space	Cosmic hylic aggregation consisting of phantasmagorial space field genic units in innate dynamic estate of mutual transmuting and transiting at speed of time dynamic speed.
Time	Time is just dynamic esse of hylic space field, —the dynamic integration of mutual transmutation & transition among all field genic units in space field. Time rate directly depends on rapidness and intensity of dynamic transmutation & transition among all field genic units in space field.
Spacetime	The integrative compound of both hylic esse and dynamic esse of material space field consisting of space field genic units in spontaneous dynamic estate of mutual transmuting and transiting.
Phoney displacement	The transference of genic units in disguised form derived from the transmutation and transition of genic units in space field. Phoney displacement has no direction.
Standard time unit	Under presumable precondition the spacetime around the earth is everlastingly constant, we define 1 second on the earth is just a standard time unit.
Time dynamic speed	Time dynamic speed is just mathematical quantification of phoney displacement cumulation of field genic units materialized by their mutual dynamic transmuting & transiting in one standard time unit. The magnitude of time dynamic speed not only directly means the time

Historical progress of science in the recent several centuries seemed like a far-flung exploration of the first itinerary around numerous distinctive landscapes of brand-new landmasses of science with palette & tablet on back, several hundred years’ scientific travelogues were compiled thereby.

	rate, but also means the integrative rate or capability of universal existence & motion of matter in cosmos.
Standard spacetime	As practical feasibility and convenience, it's expedient for us to define the spacetime around the earth is standard spacetime under presumable precondition the spacetime around the earth is everlastingly constant. (Virtually, as the value of "π" is an inconstant number, it implies the spacetime around the earth is proportionably inconstant, the so-called standard spacetime is virtually not standard, however, for some certain rational necessity, we have to introduce it for local rational support)
Standard equivalent time	If some certain interval T_0 in some certain space field has the same physical effect with the interval T in standard space field, we then say T_0 is just the standard equivalent time of T .
Standard equivalent time coefficient	With the same clock in the same interval, if the clock quantified the quantity value T_0 in standard spacetime, and quantified the same interval T_1 in the reference space field, then the quotient of T_1 and T_0 (T_1/T_0) is just the standard equivalent time coefficient.
Positive matter /baryonic matter	Is lineal homologic multiplication outgrowth of hyllic space field when space field developed to some certain stage, which is convergent agglomeration of hyllic space field for extra-saturation and independently performs negative and positive transmutation in spacetime by the light of nature so as to materialize idiographic existence & motion as behavioral object in spacetime.
Matter field	Just the consort field of matter, whose scale is proportional to the relative concentration of mass of positive matter, matter field strength contribution is subject to $\alpha = \varepsilon * m/R^2$, any matter field is a limited field with field radius of R_{max} and the proportionate field strength low confine α_0 , R_{max} and α_0 satisfy $\alpha_0 = \varepsilon * m/R_{max}^2$.
PNT	Is just the abbreviation of "Positive & Negative Transmutation", which is virtually physical carry-over and continuance of homologic generation correlation of matter lineally originated from coordinative hyllic spacetime and means osmosis transmutation and transition between matter and matter field; whose symbolization format is " $M \leftrightarrow m$ ".
Matter generation as lineal homology of spacetime postulate	Once we introduce spacetime-matter fully embodying cosmos, on the basis of [homogenous cosmos originated from unique genesis + spacetime-matter fully embodying cosmos], we can of course arrive at lineal homologic correlation between spacetime and matter, which indicates alternative of "spacetime father and matter son" or "matter father and spacetime son". Once we exclude the possibility of "matter father and spacetime son", we directly arrive at "spacetime father and matter son" thereby, which of course implies that all field genic units in space field exist in state of everlasting mutual transmutation and transition in transnormal speed, so that it's completely impossible for us to ascertain and perceive any definite presence of any separate field genic unit in space field, but only possible for us to perceive the holistic effect of their dynamic coexistence.
Elementary genic units	Elementary genic units are just the fundamental components of positive matter as lineal coordinative homology of spacetime, which are the primary outgrowth of lineal homology behind negative genic units or primary output of aberrant convergence of cosmic esse due to PNT reciprocal gelation. The symbolic expression of elementary genic units are $i_{n+1}, i_{n+2}, i_{n+3}, \dots i_{n+P}, (n, P \in \mathbb{N})$.

As coherent natura naturans throughout cosmic evolution, instinctive PNT reciprocal equilibrium towards optimum PNT operation is radical potentiality & conditionality for cosmos always ready to orientate itself towards perfection.

The second part	Freewheeling Logic Extension of Connotation Objectification of Homogenous Cosmos Originated from Unique Genesis—PNT Dynamics
PNT	Is just the abbreviation of “Positive & Negative Transmutation”, which is virtually physical carry-over and continuance of homologous generation correlation of matter lineally originated from coordinative hyllic spacetime and means osmosis transmutation and transition between matter and matter field; whose symbolization format is “ $M \leftrightarrow m$ ”.
Negative towards positive transmutation ratio	Just the transmutation intensity or speed of space field genic units towards positive genic units in spacetime, whose symbolic expression is $d(M \rightarrow m)$.
Positive towards negative transmutation ratio	Just the transmutation intensity or speed of positive genic units towards space field genic units in spacetime, whose symbolic expression is $d(M \leftarrow m)$.
Positive & negative transmutation ratio	Just the bidirectional transmutation intensity or speed between space field genic units and positive genic units in spacetime, whose symbolic expression is $d(M \leftrightarrow m)$.
Absolute spacetime momentum	Is a notion indicating original existent dynamic connotation of matter in spacetime — spacetime momentum of matter integration relative to the presumable absolutely stationary reference, whose mathematical expression is $mV = d(M \leftarrow m)Y$. As there are none absolutely stationary reference in cosmos, absolute spacetime momentum has none relative significance but to define the natural attribute qualitatively upon ideal ration.
Cosmic utmost speed	Cosmic utmost speed is just the time dynamic speed, it’s a deduction of the definition of absolute spacetime momentum as following: as $mV = d(M \leftarrow m)Y \iff d(M \leftarrow m)/m = V/Y$, and as $d(M \leftarrow m)$ & m absolutely satisfy $d(M \leftarrow m)/m \leq 1$, consequentially, $V/Y \leq 1 \iff V \leq Y$. (V denotes the velocity of any matter; Y denotes the time dynamic speed of matter integration)
Motion	Motion is dynamic enantiomorph of PNT action of matter integration in spacetime.
Matter existence	<p>So-called “matter existence” is that, when matter integration performs PNT action under proper spacetime condition by the light of nature, integrative situation that integral cumulation of negative towards positive transmutation from field genic units to elementary genic units $\int_0^t d(M \rightarrow m) dt$ - integral cumulation of positive towards negative transmutation from elementary genic units to field genic units $\int_0^t d(M \leftarrow m) dt = \text{selfhood physical esse of positive matter with mass residue } m > 0$ (which indicates $\int_0^t [d(M \rightarrow m) - d(M \leftarrow m)] dt = m > 0$ in time current) is maintained in relatively steady idiographic succession with absolute spacetime momentum $mV = d(M \leftarrow m) * Y$ ever since.</p> <p>As a result, matter existence can be mathematically formulated as below:</p> $\begin{cases} \int_0^t [d(M \rightarrow m) - d(M \leftarrow m)] dt = m > 0 \\ mV = d(M \leftarrow m) * Y \end{cases}$ <p>In a simple word, so-called “matter existence” is spontaneous physical occurrence due to PNT action with instinctive PNT equilibrium of matter integration once integral accumulation of living positive & negative transmutation of matter integration satisfies $\int_0^t [d(M \rightarrow m) - d(M \leftarrow m)] dt = m > 0$, which usually implicates magnitude of mass, configuration and energetic status of matter integration.</p>
Matter motion	So-called “matter motion” is that, when matter integration performs PNT action under proper

	<p>spacetime condition by the light of nature, as external dissonance to PNT performance of matter integration, integrative situation that integral cumulation of negative towards positive transmutation from field genic units to elementary genic units $\int_0^t d(M \rightarrow m) dt$ - integral cumulation of positive towards negative transmutation from elementary genic units to field genic units $\int_0^t d(M \leftarrow m) dt = \text{selfhood physical esse of positive matter with mass residue } m > 0$ (which indicates $\int_0^t [d(M \rightarrow m) - d(M \leftarrow m)] dt = m > 0$ in time current) and absolute spacetime momentum $mV = d(M \leftarrow m) * Y$ is consequently disturbed. The radical indication integrative situation that integral cumulation of negative towards positive transmutation from field genic units to elementary genic units $\int_0^t d(M \rightarrow m) dt$ - integral cumulation of positive towards negative transmutation from elementary genic units to field genic units $\int_0^t d(M \leftarrow m) dt = \text{selfhood physical esse of positive matter with mass residue } m > 0$ and absolute spacetime momentum $mV = d(M \leftarrow m) * Y$ is disturbed is $d(M \rightarrow m) \neq d(M \leftarrow m)$. Of course, once “$d(M \rightarrow m) \neq d(M \leftarrow m)$” of matter integration occurred, spontaneous occurrence of PNT action with instinctive PNT equilibrium must be subject to fundamental of instinctive PNT reciprocal equilibrium towards optimum PNT operation, and instinctive PNT equilibrium in operation must accomplish quantitative change from $d(M \rightarrow m) \neq d(M \leftarrow m)$ towards $d(M \rightarrow m)' = d(M \leftarrow m)'$ as expediently as possible, $d(M \rightarrow m) \neq d(M \rightarrow m)'$; $d(M \leftarrow m) \neq d(M \leftarrow m)'$.</p> <p>As a result, matter motion can be mathematically formulated as below:</p> $\begin{cases} \int_0^t [d(M \rightarrow m) - d(M \leftarrow m)] dt = m > 0 \\ mV = d(M \leftarrow m) * Y \\ d(M \rightarrow m) \neq d(M \leftarrow m) \xrightarrow{\text{dynamic}} d(M \rightarrow m)' = d(M \leftarrow m)' \end{cases}$ <p>In a simple word, so-called “matter motion” is but, under precondition that matter integration satisfies mass integral accumulation $\int_0^t [d(M \rightarrow m) - d(M \leftarrow m)] dt = m > 0$ in time current, PNT action has to rebuild the perfect operation of PNT action of matter integration by the right of instinctive PNT reciprocal equilibrium towards optimum PNT operation once some certain external disturbance occurs to PNT operation of matter integration so as to cause occurrence of $d(M \rightarrow m) \neq d(M \leftarrow m)$, — spontaneous occurrence in the nature of instinctive PNT reciprocal equilibrium towards optimum PNT operation proportionate to external disturbance, which usually implicates magnitude of mass, configuration and energetic status of matter integration. In above equations, the symbolic mark “$\xrightarrow{\text{dynamic}}$” indicates spontaneous dynamic orientation of matter integration from initial state $d(M \rightarrow m) \neq d(M \leftarrow m)$ to target state $d(M \rightarrow m)' = d(M \leftarrow m)'$ due to instinctive PNT reciprocal equilibrium towards optimum PNT operation.</p>
<p>Matter integration</p>	<p>Just the integrative aggregation of matter and the proper matter field correlated by PNT .</p>
<p>Matter inertial conservation equations</p>	<p>The conservation equations involves in all inherent quantitative correlation of all related state coefficients of matter integration when matter integration exists in inertial state, which is generally as following:</p> $\begin{cases} M + m = R \\ M/m = K \\ mV = d(M \leftarrow m)Y \\ L^3 * \alpha(M) = A * m \\ Y = B * \alpha(M) \end{cases} \iff \begin{cases} M = KR / (1 + K) \\ m = R / (1 + K) \\ V = d(M \leftarrow m)Y / m \\ L^3 = A * m / \alpha(M) \quad (\otimes) \\ Y = B * \alpha(M) \quad (\otimes) \end{cases}$

As coherent natura naturans throughout cosmic evolution, instinctive PNT reciprocal equilibrium towards optimum PNT operation is radical potentiality & conditionality for cosmos always ready to orientate itself towards perfection.

	Of course, when matter integration exists in non-inertial state, the state equations can too be expressed as above format, but all related quantitative coefficients of matter integration are variables.
Mass quotient of negative matter above positive matter.	Just the quotient of matter mass m above the proper matter field mass M , its symbol is K , mathematical equation is $M/m=K$.
Unbalanced matter inertial conservation equations	<p>Just the mathematical formulation of quantitative correlation of all the inherent parameters related to PNT operation of matter integration once matter integration loses its PNT balance due to instinctive PNT reciprocal equilibrium towards optimum PNT operation, whose uniform mathematical format is generally as following:</p> $\left\{ \begin{array}{l} M(t)+m(t)= R(t) \\ M(t)/m(t) = K(t) \\ V(t)*m(t)= d(M \leftarrow m)(t)* Y(t) \\ L^3(t)*\alpha(t)=A*m(t) \\ Y(t)=B*\alpha(t) \end{array} \right. \iff \left\{ \begin{array}{l} M(t)=K(t)*R(t)/[1+K(t)] \\ m(t)=R(t)/[1+K(t)] \\ V(t)= d(M \leftarrow m)(t)*Y(t)/ m(t) \\ L^3(t)= A*m(t)/ \alpha(t) \quad (\otimes) \\ Y(t)=B*\alpha(t) \quad (\otimes) \end{array} \right.$
PNT dynamics	PNT dynamics is just the mathematical formulation of physical process all state variables of matter integration spontaneously readjusting in the nature of instinctive PNT reciprocal equilibrium towards optimum PNT operation.
Space distance	Space distance is just dynamic succession materialized by dynamic transmutation & transition among all accessible field genic units in space field, just physical objectification of time or physical objectification of the dynamic continuation of transmutation & transition among accessible field genic units in space field. As dynamic transmutation and transition of field genic units has relativity domino effect, space distance is relative therefore.
Space radiation cornu.	“Space radiation cornu” is relative geometric domino effect of perceivable dynamic spacetime, which radically depends on discretional radiation intensity caused by discretional transition & transmutation among field genic units and relativity domino effect how fast the observer in spacetime for spacetime dynamic assimilation.
The third part	As Demiurgic Aggradation of Sequential Homologic Cosmogony, Cosmos is Well-regulated Integration of Cosmic Homogeneity System Making Up of Out-and-out Serial Natura Naturata in the Nature of Coherent Natura Naturans Throughout Cosmic Evolution, Universal Existence & Motion Are Spontaneous Occurrence of [External Physical Disturbance + (PNT Action + Instinctive PNT Equilibrium)] —Universal Applicability PNT Dynamics
Force	so-called “force” is but dynamic domino effect in the nature of instinctive PNT reciprocal equilibrium towards optimum PNT operation for external physical disturbance of matter integration related to PNT operation, ——spontaneous occurrence of matter integration due to “external physical disturbance + (PNT action + instinctive PNT equilibrium)” . In the spontaneous mechanism of force definition above, “external physical disturbance” directly means the state parameters of matter integration related to PNT operation are disturbed and consequently arises non-zero quantitative change, so that the PNT operation

	<p>of matter integration has to react in the nature of instinctive PNT reciprocal equilibrium towards optimum PNT operation therefore, which of course means that “external physical disturbance” is just external cause for occurrence of force. “PNT action” is virtually the living lineal homologic correlation between spacetime and positive matter and inherent attribute of matter integration, which is radically derived from Homogenous cosmos originated from unique genesis postulate with supplementation of a 0.5 grade auxiliary hypothesis of spacetime-matter fully embodying cosmos postulate. “instinctive PNT equilibrium” is a kind of instinctive directional motility to rebuild optimum PNT operation (/to recover PNT equilibrium of matter integration) once the PNT operation of matter integration is disturbed by external physical disturbance.</p> <p>The uniform mathematical expression of force is $F=m \cdot K'(t) \cdot Y(t)$.</p> <p>Distinction of idiographic forces can only be derived from distinctive “external physical disturbance”. So-called “gravity”, “electromagnetic force”, “strong interaction” and “weak interaction” in tradition are but four typical forces derived from four characteristic “external physical disturbance”, which make us find them “four fundamental forces in the nature”.</p>
<p>Force field</p>	<p>Is just the matter field or matter field with special genic configuration with some certain genic preponderance or genic insufficiency, which is just physical inter-medium to cause force. such as gravitational field, electromagnetic field.</p>
<p>Gravitational field</p>	<p>It's the proper matter field of matter integration, whose field strength contribution is generally as $\alpha = \varepsilon \cdot m / R^2$.</p>
<p>Gravity</p>	<p>Is but dynamic domino effect in the nature of instinctive PNT reciprocal equilibrium towards optimum PNT operation for matter field superposition disturbance of matter integration related to PNT operation, — spontaneous occurrence of matter integration due to “matter field superposition disturbance + (PNT action + instinctive PNT equilibrium)”.</p>
<p>Peripheral inexpedient assimilable globose field lamella</p>	<p>The innate esthetical configuration of matter field directly relates to PNT operation of matter integration, and any matter integration in cosmos congenitally has instinct to maintain PNT equilibrium. Once there is matter field superposition between two celestial bodies, matter field superposition must impact the innate esthetical configuration of matter field and consequently impact the PNT operation of matter integration; and on the other hand, as matter field superposition is inadequate, so that it's still not expedient for matter integration to assimilate the superposed matter field so as to maintain the innate esthetical configuration of matter field and keep PNT operation of matter integration in its normal way. Relatively, it is more expedient for the matter integration to reject the matter field superposition so as to maintain innate esthetical configuration of matter field and keep PNT operation of matter integration in its normal way. As a result, the both matter integration (/celestial bodies) spontaneously reject the matter field superposition in the nature of instinctive PNT reciprocal equilibrium towards optimum PNT operation, thus, the gravitational reciprocity between the two celestial bodies is of course repulsion. We just call the peripheral inexpedient assimilable globose field lamella for inadequate matter field superposition between any two celestial bodies “ peripheral inexpedient assimilable globose field lamella”.</p>

<p>Inexpedient assimilable repulsion (/Negative gravity)</p>	<p>The innate esthetical configuration of matter field directly relates to PNT operation of matter integration, and any matter integration in cosmos congenitally has instinct to maintain PNT equilibrium. Once there is matter field superposition between two celestial bodies, matter field superposition must impact the innate esthetical configuration of matter field and consequently impact the PNT operation of matter integration; and on the other hand, as matter field superposition is inadequate, so that it's still not expedient for matter integration to assimilate the superposed matter field so as to maintain the innate esthetical configuration of matter field and keep PNT operation of matter integration in its normal way. Relatively, it is more expedient for the matter integration to reject the matter field superposition so as to maintain innate esthetical configuration of matter field and keep PNT operation of matter integration in its normal way. As a result, the both matter integration (/celestial bodies) spontaneously reject the matter field superposition in the nature of instinctive PNT reciprocal equilibrium towards optimum PNT operation, thus, the gravitational reciprocity between the two celestial bodies is of course repulsion. We just call the reciprocity of inexpedient assimilable repulsion for inadequate matter field superposition between any two celestial bodies “inexpedient assimilable repulsion”, which is just the negative gravity.</p>
<p>Central expediently assimilable globose field extent</p>	<p>The innate esthetical configuration of matter field directly relates to PNT operation of matter integration, and any matter integration in cosmos congenitally has instinct to maintain PNT equilibrium. Once there is matter field superposition between two celestial bodies, matter field superposition must impact the innate esthetical configuration of matter field and consequently impact the PNT operation of matter integration. And on the other hand, as matter field superposition is relatively adequate, so that it's difficult for matter integration to reject the matter field superposition to maintain innate esthetical configuration of matter field and keep PNT operation of matter integration in its normal way, instead, it's even expedient for matter integration to assimilate the superposed matter field so as to maintain the innate esthetical configuration of matter field and keep PNT operation of matter integration in its normal way. As a result, the both matter integration (/celestial bodies) spontaneously assimilate the matter field superposition in the nature of instinctive PNT reciprocal equilibrium towards optimum PNT operation, which makes the gravitational reciprocity between the two celestial bodies incarnate attraction. We just call the central expediently assimilable globose field extent for adequate matter field superposition between any two celestial bodies “ central expediently assimilable globose field extent”.</p>
<p>Expediently assimilable attraction (/Positive gravity)</p>	<p>The innate esthetical configuration of matter field directly relates to PNT operation of matter integration, and any matter integration in cosmos congenitally has instinct to maintain PNT equilibrium. Once there is matter field superposition between two celestial bodies, matter field superposition must impact the innate esthetical configuration of matter field and consequently impact the PNT operation of matter integration. And on the other hand, as matter field superposition is relatively adequate, so that it is difficult for matter integration to reject the matter field superposition so as to maintain innate esthetical configuration of matter field and keep PNT operation of matter integration in its normal way, instead, it's</p>

	<p>even expedient for matter integration to assimilate the superposed matter field so as to maintain the innate esthetical configuration of matter field and keep PNT operation of matter integration in its normal way. As a result, the both matter integration (/celestial bodies) spontaneously assimilate the matter field superposition in the nature of instinctive PNT reciprocal equilibrium towards optimum PNT operation, which makes the gravitational reciprocity between the two celestial bodies incarnate attraction. We just call the reciprocity of expedient competitive assimilation of superposed matter field for adequate matter field superposition between any two celestial bodies “expediently assimilable attraction”, which is just the positive gravity.</p>
<p>Mass disparity accessible to positive gravity</p>	<p>In terms of any two celestial bodies with matter field superposition, if one of the both is massive, and the other is relatively small, there are obvious disparity in mass scale between the two celestial bodies, once there is occurrence of matter field superposition between the both celestial bodies, the small celestial body is very easy to accomplish adequate matter field superposition in matter field of the massive celestial body, so that the gravitational reciprocity between the massive celestial body and the relative small celestial body is relatively accessible to expediently assimilable attraction, which is just positive gravity. As a result, we just call such gravitational reciprocity fundamental “mass disparity accessible to positive gravity”.</p>
<p>Mass approximation accessible to negative gravity</p>	<p>In terms of any two celestial bodies with matter field superposition, if the mass scale of the two celestial bodies is very approximate, once there is occurrence of matter field superposition between the two celestial bodies, it is difficult for them to accomplish adequate matter field superposition towards expediently assimilable superposition pattern, instead, it is easy for them to accomplish inexpedient assimilable superposition for gravitational repulsion. So that the gravitational reciprocity between the both celestial bodies with approximate mass scale is relatively accessible to gravitational repulsion, which is just negative gravity. As a result, we just call such gravitational reciprocity fundamental “mass approximation accessible to positive gravity”.</p>
<p>Lineal logic extension in rigid succession of contemporaneous scientific orthodoxy</p>	<p>Lineal logic extension in rigid succession of contemporaneous scientific orthodoxy is a kind of logic model for scientific knowledge proliferation when historical progress of science in inherent optimum orientation towards historical authenticity tolerance of science 0 proceeds to some certain stage, some certain relatively mature scientific knowledge in proportion to contemporaneous historical background has been promoted social legitimacy qualification of the age, the corresponding orthodox authorities (/temporal authority) consequently carry forward eulogistic scientific knowledge proliferation in rigid succession of contemporaneous scientific orthodoxy by subconscious implementation of lineal logic extension of their celebrated legitimacy so as to try to crown all accessible existence & motion accordingly in their rational purview.</p> <p>Virtually, before humanistic ideology about authenticity of nature finally qualified as perfect ideological enantiomorph of ultimate authenticity of nature, any humanistic ideology about authenticity of nature in proportion to contemporaneous historical background is out of</p>

As coherent natura naturans throughout cosmic evolution, instinctive PNT reciprocal equilibrium towards optimum PNT operation is radical potentiality & conditionality for cosmos always ready to orientate itself towards perfection.

	<p>scientific legitimacy qualification of historical authenticity tolerance of science 0, which can not be invoked as undoubted logic basis or rationale as so-called “axiom” for lineal logic extension in succession of contemporaneous scientific orthodoxy out of question, unless we can validate the legitimacy qualification of contemporaneous scientific orthodoxy in historical authenticity tolerance of science 0. Although, we have to admit that lineal logic extension in succession of contemporaneous scientific orthodoxy is still a kind of accessible and expedient manner for us to look into undiscovered object around, the key issue is that, we should be aware of the situation that contemporaneous scientific orthodoxy is still out of scientific legitimacy qualification of historical authenticity tolerance of science 0, which of course indicates the disqualification of contemporaneous scientific orthodoxy to take logic role of “axiom/rationale” for lineal logic extension in succession of contemporaneous scientific orthodoxy, and the larger the historical authenticity tolerance of science of contemporaneous scientific orthodoxy is, the credibility of lineal logic extension in succession of contemporaneous scientific orthodoxy is relatively lower. If we implement lineal logic extension in succession of contemporaneous scientific orthodoxy off the cuff with full ignorance of this, we may slide into unintelligible perplexity for implementation of lineal logic extension in succession of contemporaneous scientific orthodoxy. For instance, we substantively slid into perplexity for introduction of “Black Hole Theory”, “Dark Matter Theory”, “Dark Energy Theory” etc for rather a long time for intrepid implementation of lineal logic extension in succession of contemporaneous scientific orthodoxy in defiance of factuality that humanistic ideology about authenticity of nature in proportion to contemporaneous historical background as contemporaneous scientific orthodoxy is still out of scientific legitimacy qualification of historical authenticity tolerance of science 0.</p>
<p>Historical authenticity tolerance of science</p>	<p>Taking reference of ultimate authenticity of nature, we call the authentic discrepancy between historical legitimacy of science and ultimate authenticity of nature “historical authenticity tolerance of science”. After all, ultimate consummation of science is but perfect ideological enantiomorph of ultimate authenticity of nature. As the practice human coming to discover and formulate authenticity of accessible existence & motion around must experience frondose evolvement of humanistic ideology about authenticity of nature cumulatively enriched from nothingness to groat, from groat to a great lot, and consequently followed proportionate ideaistic correction & qualitative optimization from superficiality to profundity, from parochiality to generality, the earlier age of historical progress of science is, the more remarkable authentic discrepancy between social legitimacy of science and ultimate authenticity of nature is, the proportional value of “historical authenticity tolerance of science” is relatively more remarkable, scientific knowledge proliferation derived from lineal logic extension in rigid succession of contemporaneous scientific orthodoxy is relatively more narrow and flimsy, and authentic reliability of the corresponding scientific knowledge proliferation is relatively poorer therefore.</p> <p>Virtually, historical progress of science is always in inherent optimum orientation towards historical authenticity tolerance of science 0, which of course indicates the later age of historical progress of science is, the less authentic discrepancy between historical legitimacy of science and ultimate authenticity of nature is, the value of “historical authenticity tolerance of</p>

Historical progress of science in the recent several centuries seemed like a far-flung exploration of the first itinerary around numerous distinctive landscapes of brand-new landmasses of science with palette & tablet on back, several hundred years’ scientific travelogues were compiled thereby.

	<p>science” is relatively more tiny and closer to 0, scientific knowledge proliferation derived from lineal logic extension in rigid succession of contemporaneous scientific orthodoxy is relatively more general and credible, and authentic reliability of the very scientific knowledge proliferation is relatively higher therefore. Successive quantitative & qualitative change of scientific knowledge proliferation of human just brings out hypostatic historical progress of science in inherent optimum orientation towards historical authenticity tolerance of science 0 by the light of nature.</p>
<p>Substantiation & perfection of contemporaneous scientific orthodoxy</p>	<p>As lacking of necessary foreknowledge of status quo of sciences and historical progress of science, as science hierarchy of the age, once the timely renovation of humanistic ideology about authenticity of nature in proportion to contemporaneous historical background procured social legitimacy qualification and consequently became contemporaneous scientific orthodoxy of the age, temporal authority mostly had no sense of historical limitation of the burgeoning contemporaneous scientific orthodoxy even ignorant of the inherence of historical progress of science that, as permanent synthesized conditionality of “the uniqueness & invariance of ultimate authenticity of nature predestines the unique possibility of scientific verity as perfect ideological enantiomorph of ultimate authenticity of nature + crescive progression of practical feasibility & possibility in proportion to contemporaneous historical background” through and through, it's only possible for the major melody of historical progress of science to be a series of epochmaking scientific knowledge metabolism in inherent optimum orientation towards historical authenticity tolerance of science 0, and veritable progress of science is not intuitional cumulative achievement of colorful scientific travelogues A, B, C, D, E, F, ... like omnifarious smallwares full of a basket about rich and colorful existence & motion accessible around us but successive hypostatic endeavor to push humanistic ideology about authenticity of nature forward to consummate formulation of ultimate authenticity of nature as coherent theory about universal existence & motion so as to accomplish historical progress of science in inherent optimum orientation towards historical authenticity tolerance of science 0 step by step draw on practical feasibility & possibility in proportion to contemporaneous historical background.</p> <p>As a result, temporal authority mostly overrate legitimacy qualification of live contemporaneous scientific orthodoxy for cock-a-hoop self-appreciation and consequently insist scientific truths of contemporaneous scientific orthodoxy are all absolute scientific truths beyond all doubt, so that they seem confident that all the rest jobs for historical progress of science are but substantiation & perfection of contemporaneous scientific orthodoxy going without saying. And as authoritative intrepidity of contemporaneous scientific orthodoxy is all-time even overwhelming, they even insist that all coming scientific knowledge proliferation all over the earth must be in rigid succession of contemporaneous scientific orthodoxy eversince, otherwise, there is no way for free press admittance. Virtually, development of science is always endeavor to push humanistic ideology about authenticity of nature forward to perfect ideological enantiomorph of ultimate authenticity of nature step by step draw on practical feasibility & possibility in proportion to contemporaneous historical background, it's almost impossible for royal substantiation & perfection of contemporaneous scientific orthodoxy = general progress</p>

	<p>of science all along. Interminable implementation of substantiation & perfection of contemporaneous scientific orthodoxy under invisible restriction of authoritative intrepidity of contemporaneous scientific orthodoxy must lack of alignment of original endeavor of development of science to push humanistic ideology about authenticity of nature forward to perfect ideological enantiomorph of ultimate authenticity of nature step by step draw on practical feasibility & possibility in proportion to contemporaneous historical background more or less.</p> <p>And indeed, the most remarkable feature of substantiation of perfection of contemporaneous scientific orthodoxy is that, under precondition that live contemporaneous scientific orthodoxy is still out of scientific legitimacy qualification of historical authenticity tolerance of science 0, royal substantiation & perfection of contemporaneous scientific orthodoxy seems ready to monopolize comprehensive social resource for general progress of science draw on authoritative intrepidity of contemporaneous scientific orthodoxy which is mostly derived from intrepid superiority of the living second-string geniuses of the age, although, it's self-evident that royal substantiation & perfection of contemporaneous scientific orthodoxy \neq original endeavor of historical progress of science to push humanistic ideology about authenticity of nature forward to perfect ideological enantiomorph of ultimate authenticity of nature step by step draw on practical feasibility & possibility in proportion to contemporaneous historical background. And just because of permanent domino effect of authoritative intrepidity of contemporaneous scientific orthodoxy, living scientific knowledge proliferation all over the world must be in rigid succession of contemporaneous scientific orthodoxy, otherwise, no way for free press admittance.</p> <p>Once a brand-new contemporaneous scientific orthodoxy come into being on the earth, endeavor of substantiation & perfection of contemporaneous scientific orthodoxy is mostly necessary and popular, whose practical significance is still worthy of historical progress of science at the very stage. Whereas, once contemporaneous scientific orthodoxy exhausted its inherent rational potentiality towards highlight of authenticity of nature, redundant endeavor of substantiation & perfection of contemporaneous scientific orthodoxy may bring development of science into floundering in riancy. In any case, it's impossible for freewheeling royal substantiation & perfection of contemporaneous scientific orthodoxy to be nonstop towards perfect ideological enantiomorph of ultimate authenticity of nature and finish historical progress of science thereby. And virtually, veritable progress of science is not historical process human approach distinctive scientific truths one after another but hypostatic endeavor to push humanistic ideology about authenticity of nature forward to perfect ideological enantiomorph of ultimate authenticity of nature step by step draw on practical feasibility & possibility in proportion to contemporaneous historical background.</p>
<p>Top-ranking geniuses</p>	<p>Throughout historical progress of human civilization, top-ranking geniuses are just the pioneering creators who contribute the epochmaking foreknowledge at pioneering foreland of knowledge multiplication so as to lead remarkable tideway towards historical progress of human civilization then and there. In human history, Vinci, Copernicus, Galileo, Beethoven, Newton, Darwin ... Einstein, Bohr ... Michael-Jackson etc were typical top-ranking geniuses.</p> <p>However, as crecive progression of practical feasibility & possibility in proportion to</p>

	<p>contemporaneous historical background and the uniqueness & invariance of ultimate authenticity of nature proportionably predestines the unique humanistic possibility of scientific verity, for you see, there is completely no possibility for two distinctive scientific truths with remarkable ideological difference to formulate the unique and invariable ultimate authenticity of nature coequally, the major melody of historical progress of science must be serial epochmaking scientific knowledge metabolism in inherent optimum orientation towards historical authenticity tolerance of science 0. Throughout historical progress of science, as pioneering renovator of humanistic ideology about authenticity of nature draw on practical feasibility & possibility in proportion to contemporaneous historical background forward to perfect ideological enantiomorph of ultimate authenticity of nature, hypostatic endeavor of top-ranking geniuses inevitably break through conventionality of live contemporaneous scientific orthodoxy and consequently accomplish scientific keynote of coming age, which is of course remarkable innovation for historical progress of science. As a result, there was substantial probability for top-ranking geniuses to slide into virulent scientific knowledge metabolism campaign, especially in early years of historical progress of science. After all, as it's only possible for ultimate authenticity of nature to be unique and invariable, absolute scientific verity about universal existence & motion can only be perfect ideological enantiomorph of ultimate authenticity of nature. in accordance with rigorous enantiomorphous correlation between objective authenticity of nature and humanistic ideology about authenticity of nature, it's neither possible for "the unique & invariable ultimate authenticity of nature" to be compatible with "two distinctive humanistic ideologies about authenticity of nature with remarkable ideological difference" nor possible for "two distinctive humanistic ideologies about authenticity of nature with remarkable ideological difference" to discover and formulate "the unique & invariable ultimate authenticity of nature" coequally.</p> <p>And indeed, there were substantial tragedies of top-ranking geniuses for scientific knowledge metabolism campaign in the early years of historical progress of science. Even today, as human nature as self-preservation still remains aboriginality subliminally, and the more superior humanistic ideology about authenticity of nature towards perfect ideological enantiomorph of ultimate authenticity of nature become more and more difficult to be demonstrated by tangible experiments, even as magistral autarchy of free press regulation customization & free press admittance of temporal authority short of necessary intendance — science forum can hardly be free from duress of authoritative intrepidity of contemporaneous scientific orthodoxy, there is almost no fair play for necessary scientific knowledge metabolism towards authenticity highlight of nature, so-called social authoritative operation of social legitimacy authorization of coming renovation of humanistic ideology about authenticity of nature in proportion to contemporaneous historical background become more and more unintelligible, it's still difficult for coming potential top-ranking geniuses to slide over tragedy for deadly impact of scientific knowledge metabolism campaign.</p>
<p>Second-string geniuses</p>	<p>The second-string geniuses are the favored people who have acclimatized themselves in historical vogue and substantiated & carried forward the mainstream of living civilization of the very age. whose typical business feature is of course to accomplish positive substantiation</p>

	<p>& perfection of contemporaneous scientific orthodoxy. The reason the second-string geniuses are outstanding talents worthy of the name is mostly because they have substantiated and carried forward the costate civilization of the age, and just because of having acclimatized themselves in historical vogue then and there, the second-string geniuses are mostly fashionable talents of the age with favorable award and quick promotion.</p> <p>We have to admit that temporal authority is an esoteric class of human society. Under background of high-sounding royal substantiation & perfection of contemporaneous scientific orthodoxy, once “free press regulation customization” & “free press admittance” is completely under magistral autarchy of temporal authority short of necessary intendance, science forum must slide into egotistic monopolization under duress of authoritative intrepidity of contemporaneous scientific orthodoxy beyond all doubt, coming scientific knowledge proliferation must be restricted in rigid succession of contemporaneous scientific orthodoxy. Such situation apparently violates historical inevitability that, under permanent synthesized conditionality of “crescive progression of practical feasibility & possibility in proportion to contemporaneous historical background + the uniqueness & invariance of ultimate authenticity of nature predestines the unique possibility of scientific verity as perfect ideological enantiomorph of ultimate authenticity of nature” through and through, it’s only possible for the major melody of historical progress of science to be a series of epochmaking scientific knowledge metabolism in inherent optimum orientation towards historical authenticity tolerance of science 0. In another words, as self-preservation of human nature, magistral autarchy of free press regulation and free press admittance of temporal authority short of necessary intendance must bring out deadly obstacle of social legitimacy authorization of successive renovation of humanistic ideology about authenticity of nature in proportion to contemporaneous historical background towards perfect ideological enantiomorph of ultimate authenticity of nature.</p>
<p>Third-rate talents</p>	<p>The people who are rewarded with creditable diploma & degree for their acquirement of ready-made knowledge of contemporaneous scientific orthodoxy in vogue, the ideological successors or carriers of costate civilization of the age, who are mostly culturati for having learned substantial ready-made knowledge of contemporaneous scientific orthodoxy in vogue but having done very little to push progress of human civilization forward. In straightforward words, the reason for third-rate talents to be geniuses worthy of the name is mostly because they have learned substantial ready-made knowledge of contemporaneous scientific orthodoxy in vogue without contribution to historical progress of human civilization. The most remarkable character of third-rate talents is of course diploma & degree. As historical progress of human civilization is always in crescive progression, third-rate talents are mostly the preliminary talents of the second-string geniuses even the top-ranking geniuses.</p>
<p>Electromagnetic field</p>	<p>Electromagnetic field is just the special matter field with certain genic preponderance or genic insufficiency. Just because of the distinction of genic preponderance or genic insufficiency in matter field, there are positive electric field, negative electric field and magnetic field.</p>
<p>Electromagnetic force</p>	<p>Is but dynamic domino effect in the nature of instinctive PNT reciprocal equilibrium towards optimum PNT operation for electric field superposition disturbance of matter integration related to PNT operation, ——spontaneous occurrence of matter integration due to “electric</p>

	<p>field superposition disturbance + (PNT action + instinctive PNT equilibrium)”.</p> <p>If the so-called “electric field superposition disturbance” is superposition disturbance of electric fields with complementary genic preponderance/insufficiency, the consequent electromagnetic force is electromagnetic attraction. If the so-called “electric field superposition disturbance” is superposition disturbance of electric fields with the same genic preponderance /insufficiency, the consequent electromagnetic force is electromagnetic repulsion, because any matter integration has instinct to maintain its neutral genic configuration</p>
Strong interaction	<p>To any two particles whose inverse PNT operational couple of negative transmutation and positive transmutation are not exactly even but in dynamic modality similar as the natural motion of pendulum, once the one is performing negative transmutation (or performance of negative transmutation is relatively regnant), at the same time, the other is just performing positive transmutation (or performance of positive transmutation is relatively regnant), as the both transmutation opposites seem mutually complementary resource, once such two particles with inversely regnant transmutation are closed enough, the two particles with mutually complementary resource will spontaneously link up and combine into an integrated reciprocal PNT link. We can expediently call such reciprocal PNT combination between two particles with mutually complementary resource “reciprocal positive & negative transmutation link”, single pendulum style dynamic pattern of PNT combination performance. Reciprocal positive & negative transmutation links among particles joint particles firmly, and the reciprocal PNT combination performance in pendulum dynamic pattern among available particles is just the dynamic modality of strong interaction.</p>
Spacetime dynamic assimilation.	<p>As spacetime itself is a dynamic aggregation consisting of phantasmagorical transmutation and transition of cosmic genic units at speed of time dynamic speed, for relativity domino effect, its dynamic esse or dynamic physical significance is consequently different proportional to the moving speed of observer in spacetime, we just call the phenomenon that the spacetime arises relative weakening tendence with the increase of moving speed of observer as “spacetime dynamic assimilation”. To any observer with moving speed in spacetime, the presence of spacetime dynamic assimilation means, the moving speed of observer is closer to time dynamic speed, the less quantitative existence the observer can practically find in cosmos, until the moving speed of observer is equal to time dynamic speed, the observer can find nothing in cosmos.</p>
Spacetime dynamic assimilation coefficient	<p>Just the quantitative mathematical formulation of spacetime dynamic assimilation, whose reference variable is usually just the speed of observer. Generally, the closer the speed of observer relative to time dynamic speed is, the more remarkable the spacetime dynamic assimilation effect is.</p>
Homogenous relativity	<p>Homogenous relativity is relative domino effect materialized by spacetime dynamic assimilation, any observer with certain moving speed in spacetime, all the quantitative existence he can find satisfy relative domino effect as following definition:</p> <p>Relative state quantification=Normal state quantification × Dynamic assimilation coefficient function</p> <p>As motion speed change proportionably cause variation of spacetime dynamic assimilation</p>

As coherent natura naturans throughout cosmic evolution, instinctive PNT reciprocal equilibrium towards optimum PNT operation is radical potentiality & conditionality for cosmos always ready to orientate itself towards perfection.

	<p>effect, observers with different moving speeds must find different quantitative existence around them. Usually, the moving speed of observer is closer to time dynamic speed, the less quantitative existence in cosmos he can find.</p>
Spacetime dynamic assimilation function	<p>Just mathematical formulation of variation of spacetime dynamic assimilation proportionably following the variation of moving speed of the observer in spacetime.</p>
Normal motion	<p>Motion is just dynamic embodiment of PNT operation of matter integration in spacetime. In accordance with $mV=d(M \leftarrow m)Y$, so-called “normal motion” is just the motion format that the magnitude of $d(M \leftarrow m)$ and $d(M \rightarrow m)$ keep in non-periodic situation or some certain linear change situation.</p>
Waveform motion	<p>In accordance with $mV=d(M \leftarrow m)Y$, so-called “waveform motion” is just dynamic objectification the magnitude of the covariant PNT opposites $d(M \leftarrow m)$ and $d(M \rightarrow m)$ of matter integration arises periodic change.</p>
Light wave	<p>Light wave is typical electromagnetic wave, as the material light origin consists of very few genic units, the both covariant PNT opposites of $d(M \leftarrow m)$ and $d(M \rightarrow m)$ of matter integration are almost impossible to keep in situation of $d(M \leftarrow m)=d(M \rightarrow m)$, but to keep continuous periodic varying tendency of $d(M \leftarrow m) \geq d(M \rightarrow m)$ and $d(M \leftarrow m) \leq d(M \rightarrow m)$. Consequently, its motion status proportionately arises periodic rhythm.</p> <p>And just because the material light origin consists of very limited genic units and arises sequential $d(M \leftarrow m) \geq d(M \rightarrow m)$ and $d(M \leftarrow m) \leq d(M \rightarrow m)$ periodic variation, the proper matter field resultingly arises corresponding preponderant or insufficient genic units in genic configuration, so as to arises electromagnetic characteristics, so that we find out that light wave is typical electromagnetic wave.</p>
Light-speed	<p>According to $mV=d(M \leftarrow m)Y$ and the existence characteristics of the material light origin — the magnitude of $d(M \leftarrow m)$ and $d(M \rightarrow m)$ of matter integration PNT arises relative periodic change situation, and according to the PNT dynamics, we can arrive at the light-speed as following:</p> $\begin{cases} V=\lambda/T=(S_1+S_2)\cos\theta/(t_1+t_2) \\ S_1=V_0*t_1+\int_0^{t_1} a(\tau)d\tau d\tau=V_0*t_1+\int_0^{t_1} B*\alpha(\tau)*\{[M-\Delta M(\tau)]/[m+\Delta m(\tau)]\}'d\tau d\tau \\ S_2=V_0*t_2+\int_0^{t_2} a(\tau)d\tau d\tau=V_0*t_2+\int_0^{t_2} B*\alpha(\tau)*\{[M+\Delta M(\tau)]/[m-\Delta m(\tau)]\}'d\tau d\tau \\ T=t_1+t_2 \quad (\text{If it is regular waveform, then } t_1=t_2) \\ \lambda=(S_1+S_2)\cos\theta, \quad (\text{In the equation, the symbol } \theta \text{ denotes the angle between the vibration direction and the spread direction of the wave, if it is regular waveform, then } S_1=S_2) \end{cases}$ <p>Obviously, light-speed is changeable, and indeed, considered by Homogenous Cosmos Originated from Unique Genesis, it completely impossible for the cosmos to contain any unchangeable objects in cosmic unique-genesis homogeneity system.</p>
The fourth part	<p>Cosmogony of Homogenous Cosmos Originated from Unique Genesis—As Demiurgic Aggradation of Sequential Homologic Cosmogony, Cosmos is Well-regulated Integration of Homogeneity System Making up of Out-and-out Serial Natura Naturata in the Nature of Coherent Natura Naturans Throughout Cosmic Evolution</p>

<p>Homogenous Cosmos Originated from Unique Genesis</p>	<p>So-called “cosmos” is just an organic hyllic aggregation made up of coordinative homology of “spacetime” and “matter” with original causality of sequential homologic cosmogony through and through, especially homologic essentiality of spacetime & matter, alternative homologic filiation between spacetime and matter which inherently implies “PNT action” between spacetime and matter.</p> <p>So-called “homogenous cosmos originated from unique genesis” just means entire cosmos is an out-and-out homogeneity system originated from unique genesis with original causality of sequential homologic cosmogony through and through, any object in cosmos is either the so-called “unique genesis” itself, or homologic compound or combination radically originated from the so-called “unique genesis” with idiographic homologic configuration indicating individuality of itself.</p> <p>So-called “homogenous” cosmos is mainly to emphasize the absoluteness of purely homologic configuration throughout cosmic category, which not only implies comprehensive cosmic endosome are entirely made up of cosmic homogeneity system, but also implies it is only possible for cosmos to be limited in the homogeneity system derived from sequential homologic cosmogony starting at the so-called cosmic genic origin to cosmic status quo through and through. And indeed, the absolutely exclusive PNT dynamics has radically predestined there is no possibility for cosmos to adulterate any non-unique-genesis object out of category of cosmic homogeneity system.</p> <p>So-called homogeneity “system” is mainly to emphasize the inherent lineage connotation as coherent causality derived from sequential homologic cosmogony, which makes cosmos well-regulated in silhouette and well-rounded in compatibility as grand homogeneity system through and through.</p>
<p>Cosmic homogeneity system</p>	<p>It just means that entire cosmic endosome are pure homology series radically originated from unique genesis, which originally comes into being along sequential homologic cosmogony starting at so-called cosmic genic origin to cosmic status quo along evolutionary lineage sequence implicated in cosmic integrative configuration as inherent causality through and through, which even makes cosmos an all wool and a yard wide homogeneity system as well.</p>
<p>Reciprocal PNT combination</p>	<p>So-called “reciprocal PNT combination” is just convergent mechanical compound made up of compositive sub-mechanical-units originally coming into being for spontaneous occurrence of instinctive PNT reciprocal equilibrium towards optimum PNT operation due to favorable presence of “reciprocal idiosyncrasy towards PNT equilibrium + accessible space overall arrangement for PNT reciprocity” among the very sub-mechanical-units. In another words, so-called “reciprocal PNT combination” is just convergent esse in spacetime with relatively steady reciprocal PNT operation among proper compositive sub-mechanical-units in accordance with demiurgic fundamental of instinctive PNT reciprocal equilibrium towards optimum PNT operation, ——out-and-out outgrowth of coherent natura naturans in the nature of instinctive PNT reciprocal equilibrium towards optimum PNT operation.</p> <p>The noun of “reciprocal PNT combination” is the most typical noun in Homogenous Cosmos Originated from Unique Genesis, which is the most general to indicate the connotation and</p>

As coherent natura naturans throughout cosmic evolution, instinctive PNT reciprocal equilibrium towards optimum PNT operation is radical potentiality & conditionality for cosmos always ready to orientate itself towards perfection.

	<p>significance of “homogenous cosmos originated from unique genesis” and “coherent PNT dynamics about universal existence & motion against essence of matter in a class by itself in proportion to coherent natura naturans throughout cosmic evolution”.</p> <p>After all, cosmic contents = field genic units + elementary genic units + reciprocal PNT combinations. We study universal existence & motion are generally ready to study existence & motion of elementary genic units and reciprocal PNT combinations in spacetime. And virtually, aberrant convergence of cosmic esse due to PNT reciprocal gelation is just original generation and postnatal existence & motion of elementary genic units and reciprocal PNT combinations —freewheeling of {stochastic accomplishment of “reciprocal idiosyncrasy towards PNT equilibrium + accessible space overall arrangement for PNT reciprocity” among compositive components] + consequent convergence of compositive components in the nature of instinctive PNT reciprocal equilibrium towards optimum PNT operation}, which is just freewheeling of coherent natura naturans throughout cosmic evolution, as a result, besides free elementary genic units in spacetime, the demiurgic outgrowth are uniform reciprocal PNT combinations through and through! At any rate, cosmos is always ready to orientate itself towards perfection by the right of nature, as coherent natura naturans throughout cosmic evolution, instinctive PNT reciprocal equilibrium towards optimum PNT operation is just radical potentiality & conditionality for cosmos always ready to orientate itself towards perfection.</p>
<p>Reciprocal PNT combinations in gradation I</p>	<p>So-called “reciprocal PNT combinations in gradation I” is convergent mechanical compound category of subatomic kind, which originally coming into being for spontaneous occurrence of instinctive PNT reciprocal equilibrium towards optimum PNT operation due to well-rounded presence of “reciprocal idiosyncrasy towards PNT equilibrium + accessible space overall arrangement for PNT reciprocity” among the original compositive elementary genic units gradually enriched in spacetime (but not excluding the possible presence of succedent relatively simple subatomic units or particles), such as quark, ..., electron, neutron, proton, α particles and so on.</p>
<p>Reciprocal PNT combinations in gradation II</p>	<p>So-called “reciprocal PNT combinations in gradation II” is convergent mechanical compound category of atom kind, which originally coming into being for spontaneous occurrence of instinctive PNT reciprocal equilibrium towards optimum PNT operation due to well-rounded presence of “reciprocal idiosyncrasy towards PNT equilibrium + accessible space overall arrangement for PNT reciprocity” among compositive subatomic units gradually enriched in spacetime (but not excluding possible presence of elementary genic units), such as hydrogen atom, carbon atom..., oxygen atom, ... uranium atom and so on.</p>
<p>Reciprocal PNT combinations in gradation III</p>	<p>So-called “reciprocal PNT combinations in gradation III” is convergent mechanical compound category as molecule, molecule system, organism and so on, which originally coming into being for spontaneous occurrence of instinctive PNT reciprocal equilibrium towards optimum PNT operation due to well-rounded presence of “reciprocal idiosyncrasy towards PNT equilibrium + accessible space overall arrangement for PNT reciprocity” among compositive atoms gradually enriched in spacetime (but not excluding presence of succedent relatively simple molecule, molecule system), such as hydrogen molecule, oxygen molecule, ... carbon dioxide, crystal, stone, DNA, organism and so on.</p>

<p>Reciprocal PNT combinations in gradation IV</p>	<p>So-called “reciprocal PNT combinations in gradation IV” is convergent mechanical compound category as celestial bodies, galaxy kind in cosmos (but not excluding presence of any objects with mutual disturbance of substantial matter field superposition), which originally coming into being for spontaneous occurrence of instinctive PNT reciprocal equilibrium towards optimum PNT operation due to well-rounded presence of (reciprocal idiosyncrasy towards PNT equilibrium + accessible space overall arrangement for PNT reciprocity) among compositive celestial bodies or galaxies gradually enriched in spacetime (but not excluding presence of any objects with mutual disturbance of substantial matter field superposition), such as earth, moon, sun, solar system, Milky Way galaxy and so on.</p>
<p>Negative substance suffusion extent</p>	<p>Cosmic space field extent where there is none positive matter and unable to support normal existence & motion of matter.</p>
<p>Positive substance floating extent</p>	<p>Cosmic extent where there are substantial positive matter existing in.</p>
<p>Cosmic white extent</p>	<p>Just the negative substance suffusion extent, which is specially entitled in accordance with the egg model overall arrangement of cosmos.</p>
<p>So-called “Black Hole” in homogenous cosmos</p>	<p>In homogenous cosmos, so-called “Black Hole” is just the space field district with space field strength below confine matter field strength α_0. Black Hole itself has none supernatural attrahen force like traditionary gravity, just because its field strength is below low limit of field strength of matter field α_0, it is impossible to support normal existence of positive matter (/baryonic matter) in spacetime, the phenomena Black Hole devours positive matter (/baryonic matter) is just performance of inverse process of initial generation of positive matter (/baryonic matter) for matter field of matter integration weaken in Black Hole.</p> <p>To similar light objects, once the similar light objects have motion tendence towards Black Hole, as the similar light objects themselves have nothing to draw back their motion tendence and resultingly die off in (or dissolve into) Black Hole. To any macroscopical celestial bodies around the Black Hole, as presence of negative gravity between these celestial bodies relatively closer to Black Hole and the celestial bodies a little further from the Back Hole, worked by the “negative gravity”, these celestial bodies relatively closer to Black Hole tend to Back Hole consequentially and die off in (or dissolve into) Black Hole ultimately.</p> <p>Galaxies are too dispersed may cause “matter field cranny” ——Back Hole occurred.</p> <p>Of course, Black Hole Homogenous Cosmos Originated from from Unique Genesis mentioned herein is not the same ones as Laplace or S.W. Hawking had ever mentioned.</p>
<p>negative substance suffusion extent</p>	<p>Is just cosmic extent where the spacetime strength is insufficient for positive matter to exist in.</p>
<p>positive substance floating extent</p>	<p>Is just cosmic extent where the spacetime is mature enough for positive matter to exist in.</p>
<p>Cosmic white extent</p>	<p>Is virtually the same as negative substance suffusion extent, which is specially entitled in accordance with the egg model overall arrangement of cosmos.</p>
<p>Cosmic yolk extent</p>	<p>Is virtually the same as positive substance floating extent, which is specially entitled in</p>

As coherent natura naturans throughout cosmic evolution, instinctive PNT reciprocal equilibrium towards optimum PNT operation is radical potentiality & conditionality for cosmos always ready to orientate itself towards perfection.

	accordance with the egg model overall arrangement of cosmos.
White towards yolk transmutable pervasion	Just hylc transition & transmutation from space field genic units in cosmic white extent to elementary genic units in cosmic yolk extent.
Yolk towards white transmutable pervasion	Just hylc transition & transmutation from elementary genic units in cosmic yolk extent to space field genic units in cosmic white extent.
Light-exhaustion medium lamella	So-called “light-exhaustion medium lamella” is just the medium lamella between cosmic white extent and cosmic yolk extent, along cosmic evolutionary sequence, whose inner surface touch cosmic yolk extent linking up generation of elementary genic units——negative towards positive transmutation; outer surface touch cosmic white extent linking up degeneration of elementary genic units——positive towards negative transmutation, and whose space field strength is reluctant to support normal existence & motion of rays and radiations.
Aberrant convergence of cosmic esse due to PNT reciprocal gelation	<p>It just means under precondition time dynamic speed is bigger than critical value of time dynamic speed of cosmic yolk extent, some of the field genic units astringently transmute into even advance genic units as crystal infiltration from extra-saturated space field —— elementary genic units, as succedent enrichment of elementary genic units in spacetime, there is spontaneous occurrence of “reciprocal idiosyncrasy towards PNT equilibrium + accessible space overall arrangement for PNT reciprocity” among elementary genic units, and consequently, there are spontaneous occurrence of reciprocal PNT combinations in gradation I, reciprocal PNT combinations in gradation II, reciprocal PNT combinations in gradation III, and reciprocal PNT combinations in gradation IV. We just call the sequential homologous cosmogony from field genic units to elementary genic units, reciprocal PNT combinations in gradation I, reciprocal PNT combinations in gradation II, reciprocal PNT combinations in gradation III, and reciprocal PNT combinations in gradation IV “aberrant convergence of cosmic esse due to PNT reciprocal gelation”.</p> <p>The multiplication operation of aberrant convergence of cosmic esse due to PNT reciprocal gelation can be generally divided into two working procedures, the first working procedure is just the generation of elementary genic units —— crystal pervasion of field genic units; succedent multiplication of reciprocal PNT combinations in gradation I, reciprocal PNT combinations in gradation II, reciprocal PNT combinations in gradation III, and reciprocal PNT combinations in gradation IV in spacetime is just the second working procedure, —— convergent combination of sub-objects in the nature of instinctive reciprocal PNT equilibrium towards optimum PNT operation.</p>
Quantitative change regularity of white towards yolk transmutable pervasion	Under precondition of live input of potential resource of bidirectional lineage homologous pervasion with white towards yolk pervasion dominance $[d(M_{\text{white} \rightarrow \text{yolk}}) - d(M_{\text{white} \leftarrow \text{yolk}})] > 0$, the mutually diversionary quantitative change between field evolution of cosmic yolk extent and aberrant convergence of cosmic esse due to PNT reciprocal gelation is just “quantitative change regularity of white towards yolk transmutable pervasion”.

<p>Instinctive filter confinement of cosmic yolk extent</p>	<p>A kind of spontaneous confinement of cosmic yolk extent derived from instinctive PNT equilibrium and relatively massive mass convergence of matter integration, which restricts all massive matter integration existing in cosmic yolk extent by the light of nature.</p> <p>Any matter integration in cosmic yolk extent inherently possesses instinct of PNT equilibrium, once matter integration slides towards weak space field, the PNT equilibrium instinct of matter integration will spontaneously cause PNT reaction so as to evade destructive yolk towards white pervasion.</p> <p>And on the other hand, if the mass of the matter integration is relatively massive, so that, even though the matter integration slides towards weak space field (or cosmic white extent) and incurs destructive yolk towards white pervasion, there is substantial leeway for matter integration to readjust its motion status upon PNT equilibrium instinct, however, if the mass of matter integration is too tiny, such as photons or particles similar as photons, once they slide towards weak space field (or cosmic white extent), the active PNT reaction derives from PNT equilibrium instinct of matter integration can hardly evade them from destructive yolk towards white pervasion before they have been exhausted into weak space field (or cosmic white extent), what's more, their motion speeds of photons or particles similar as photons are relatively high, motion orientation is not easy to readjust.</p> <p>As a result, cosmic yolk extent confinement is only able to confine relatively macroscopical objects but helpless to confine microcosmic ones in it. So we just call it "instinctive filter confinement of cosmic yolk extent".</p>
<p>Relative weak space field interlayer among galaxies</p>	<p>The space field around galaxies whose space field strength is slightly lower than the inner space field of galaxies.</p>
<p>Instinctive weak space field interlayer confinement of galaxy</p>	<p>Relative weak space field interlayer confinement of galaxy is just instinctive confinement domino effect of all celestial bodies in galaxy due to [envelopment of relative weak space field interlayer among galaxies + instinctive PNT equilibrium against damage of yolk towards white transmutable pervasion of celestial bodies in galaxies].</p>
<p>Dynamic fundamental of homogenous cosmos</p>	<p>Interaction in homogenous cosmos is physical reciprocity materialized by compatible transition & transmutation between interactional objects, Actualization of interaction must satisfy conditions of "coherent homology for compatible accessibility" and "mutual PNT operational interference".</p> <p>A) Coherent homology for compatible accessibility: —the interactional objects must be radical homology, so that it's possible for them to approach material transition and transmutation to materialize physical reciprocity. Otherwise, they are completely inaccessible for reciprocity.</p> <p>B) Mutual PNT operational interference, —it means, in order to approach interactional effect, there must be possibility for PNT operation of all interactional objects to be interrelated, which mainly means PNT operational involvement extension of any object in cosmos is not infinite, in order to approach interaction between objects, the PNT operational involvement extension of both interactional objects must be interrelated in spacetime overall arrangement.</p>

As coherent natura naturans throughout cosmic evolution, instinctive PNT reciprocal equilibrium towards optimum PNT operation is radical potentiality & conditionality for cosmos always ready to orientate itself towards perfection.

<p>Homologic esse of homogenous cosmos</p>	<p>Just cosmic content of esse = space field genic units + elementary genic units + reciprocal PNT combinations.</p>
<p>Non homology in homogenous cosmos</p>	<p>Esse out of category of homogenous cosmos.</p>
<p>Serial Homologic quantification throughout homogenous cosmos</p>	<p>Serial Homologic quantification throughout homogenous cosmos is a kind of mathematical methodology to systematically quantize serial homologic quantity of homogenous cosmos originated from unique genesis starting at genic origin i_0 to universal reciprocal PNT combinations through and through in proportion to coherent natura naturans throughout cosmic evolution.</p> <p>Firstly, as cosmos is absolutely homogenous originated from unique genesis through and through, all physical quantities in homogenous cosmos are all limited in inherent succession of serial homologic quantities in proportion to coherent natura naturans throughout cosmic evolution.</p> <p>Secondly, as all cosmic contents belong to an absolute homogeneity system, all cosmic contents in cosmic homogeneity system are absolutely compatible and convertible “coordinative homology”, as physical quantification of the compatible and convertible coordinate homology in cosmos, all physical quantification of comprehensive cosmic contents in cosmic homogeneity system are all compatible, which are absolutely convertible.</p>
<p>Cosmic homogeneity symbolic logic</p>	<p>As the absolute homologic characteristics of comprehensive physical quantification in cosmos, there is absolute conversion correlation between any two discretionary physical quantification, and any two discretionary physical quantification in cosmos can be brought into the same equation to perform mathematical operation. So-called “cosmic homogeneity symbolic logic” is just the general quantitative conversion correlation designation of both quantitative change and qualitative change of cosmic homogenous sequential evolution from the genic origin to current status.</p>
<p>Homologic mathematical illation logic</p>	<p>On opinion of cosmic evolution, homologic mathematical illation logic rooted in essentiality of Homogenous cosmos originated from unique genesis is but general designation of intrinsic quantitative correlation of mathematical formulation of throughout quantitative change of sequential homologic cosmogony start at so-called cosmic genic origin to cosmic status quo, ——mathematical idiosyncrasy of mathematical formulation of throughout cosmic evolution. recognizant target of homologic mathematical illation logic is generally ready to make clear all mathematical correlation of quantitative change of throughout cosmic evolution.</p> <p>Of course, the mathematical correlation of quantitative change of throughout cosmic evolution of course includes PNT dynamics, in another word, simply on opinion of homologic mathematical illation logic, PNT dynamics is but a compositive segment of it. Both absolutely free quantification conversion accessibility throughout cosmic homogeneity system and homologic mathematical illation logic coordinately derived from quantitative change sequential homologic cosmogony starting at cosmic genic origin to cosmic status quo, integrative mathematical formulation of cosmic evolution not incarnates homologic mathematical illation logic with</p>

	PNT dynamics implicated in but also crown all absolutely free quantification conversion accessibility throughout cosmic homogeneity system.
Intuitionistic vision-cosmology	Cosmology straightforwardly rooted in intuitionistic visual evidence.
Logic conjury	Logic proliferation with unnoticed cheat under cover as conjury.
Cosmos expansion hypothesis	In accordance with the intuitionistic visual evidence of red shift in temporal human percipience purview draw on advantage of astronomic telescope, the hypothesis of cosmos expansion we can predictably introduce in prior in spite of temporal logic objection of local crown all over.
Experience notion derived from available cosmic status quo	Human notions based on common experience of normal existent status of cosmos.
Congruent condition linkage	Just the favorable operational relationship the occurrence in prior can offer full preconditions of the successive occurrence throughout sequential physical performance.
Status approximate to lower condition limit of aberrant convergence of cosmic esse due to PNT reciprocal gelation	The operational status of evolutionary transmutation of negative matter towards positive matter near the proper conditional lower limit of aberrant convergence of cosmic esse due to PNT reciprocal gelation.
Resting situation of aberrant convergence of cosmic esse due to PNT reciprocal gelation	The situation the output quantity of aberrant convergence of cosmic esse due to PNT reciprocal gelation very proximate to 0.
The fifth part	Systematical Unique-genesis Quantization Formulation of Universal Existence & Motion along Sequential Homologic Cosmogony Starting at Field Genic Origin i_0 to Universal Reciprocal PNT Combinations in the Nature of Coherent Natura Naturans Throughout Cosmic Evolution
Unique-genesis quantization of genic units	It's mathematical methodology to manage the quantification of idiographic genic units or the related variation of physical process with quantum of single genic origin i_0 .
Homology genic integral equation	$\sum m = \int_{i_0}^x f(m_{i_0 \rightarrow x}) i_0$
PNT dynamic connotation integral equation	$\sum_{m=D}^D [\int_{i_0}^x \text{PNT}]$
Homology integration equation	$\sum_{m=D}^D m = D [\int_{i_0}^x f(m_{i_0 \rightarrow x}) i_0]$, which is just the mathematical definition of Homogenous cosmos originated from unique genesis.
PNT action	So-called "PNT action" is just the natural performance of positive & negative transmutation and transition between matter and spacetime.

Field potential concrete vallum	So-called “field potential concrete vallum” is just the flexible half-condensed and half-converged field vallum as half-done evolutionary remainder left on elementary genic units when elementary genic units primarily generate in space field or the proper physical quantification of the flexible half-condensed and half-converged field vallum.
PNT reaction	So-called “PNT reaction” is just the instinctive PNT operation readjustment of elementary genic units (or matter integration) towards relative minimum of field potential concrete vallum.
Spacetime momentum micromodelization	Spacetime momentum delamination hoarding in relatively microcosmic hiberarchy substantiating characteristic existence & motion of relative subunits of reciprocal PNT combination.
spacetime momentum macromodelization	As PNT reciprocity among compositive components of object, some spacetime momentum is assimilated and transferred from the relatively microcosmic hiberarchy to macroscopical hiberarchy of reciprocal PNT combination substantiating the idiographic existence & motion of the resultant macroscopical structural unit.
Promotive assimilation transference of spacetime momentum	The process that some spacetime momentum is assimilated and transferred from the relatively microcosmic hiberarchy to macroscopical hiberarchy of reciprocal PNT combination as to hypostatize the relatively macroscopical existence & motion of the resultant combination unit once the PNT reciprocity among compositive subunits ultimately becomes consummated.
Concomitant spacetime change of earth journey	Spacetime condition around the earth changes followed the extension of earth journey in large-scale spacetime.
Geo-potential domino effect due to concomitant spacetime change of earth journey	As the occurrence of concomitant spacetime change of earth journey, the geo-potential status proportionably reacts and changes thereby.
Geo-potential cumulation towards volcano/earthquake	Geo-potential cumulation towards volcano/earthquake $W(t) = \text{geo-potential domino effect due to concomitant spacetime change of earth journey } Q(t) - \text{geo-potential dissipation } H(t) > 0$.
Lithosphere counter-shield against volcano or earthquake	A part of the earth’s crust, which locates above lively geo-potential cumulation toward volcano or earthquake and does a job of durance against geo-potential cumulation toward volcano or earthquake.
Systematical unique-genesis quantization formulation of universal existence & motion along sequential homologic cosmogony	Systematical unique-genesis quantization formulation of universal existence & motion along sequential homologic cosmogony starting at field genic origin i_0 to universal reciprocal PNT combinations in the nature of coherent natura naturans throughout cosmic evolution is systematical mathematical quantization formulation of universal existence & motion. As cosmos is throughout homogenous originated from unique genesis, cosmic status quo of demiurgic aggradation of sequential homologic cosmogony, which exactly exists as well-regulated integration of cosmic homogeneity system making up of out-and-out serial natura naturata in the nature of coherent natura naturans throughout cosmic evolution, we can adopt the so-called “genic origin i_0 ” as basic quantum to quantize space distance, time, universal existence & motion in cosmos, which of course includes vivid existence & motion of reciprocal PNT combinations in gradation I,

	<p>reciprocal PNT combinations in gradation II, reciprocal PNT combinations in gradation III, reciprocal PNT combinations in gradation IV along evolutionary progression of sequential homologic cosmogony.</p>
<p>humanistic methodology of scientific measurement & quantification</p>	<p>The conventional manner of scientific measurement & quantification of human is that, choose accessible “criterion reference” first, then implement relative measurement & quantification of accessible existence & motion around us. For instance, in order to measure and quantify length of objects or space distance among definite objects, we firstly define linear length of some certain object as length criterion reference--ruler, then, we come to measure and numerically quantify length of discretionary object or distance among discretionary objects accessible around us. On order to measure and numerically quantify mass of discretionary object in cosmos, we have to define mass of some certain object as mass weight (/mass criterion reference), then we can implement relative measurement & quantification of mass of discretionary object in accordance with mass criterion reference therefore.</p> <p>However, something necessary for me to emphasize herein is that, although, humanistic implementation of relative measurement & quantification of existence & motion accessible around in accordance with default criterion reference is relatively easy and feasible, the methodology to choose default “criterion reference” for humanistic implementation of measurement & quantification of existence & motion is not ideal manner subject to authenticity of nature. In straightforward words, in time current, there is none absolute constant in cosmos beside space field genic origin i_0, criterion reference as mass weight, length ruler, time second can never be exception, they are not constants but vivid stochastic variables in time current, so that they are not qualified to take role of criterion reference for precise measurement & quantification of existence & motion in cosmos, especially when we are ready to measure and quantify existence & motion of particles in cosmos. This of course indicates methodological limitation of measurement & quantification of objects in accordance with criterion reference as mass weight, ruler, clock etc.</p>
<p>Relative measurement & quantification of human</p>	<p>Humanistic measurement & and quantification of universal existence & motion is usually to choose default criterion reference first, then implement relative measurement & quantification of universal existence & motion in accordance with default criterion reference. Such kind of methodology for measurement & quantification universal existence & motion is of course feasible and easy, whereas, we have to admit such kind of methodology neglects remarkable authenticity of nature. In straightforward words, in time current, there are none constant besides space field genic origin i_0 throughout homogenous cosmos; in detail words, in time current, as long as existence & motion relates to time or PNT operation of matter integration and object does not exist in absolute inertial state, there is none constant in homogenous cosmos besides space field genic origin i_0. As a result, once we choose accessible criterion reference for relative measurement & quantification of universal existence & motion, we either choose noumenon quantification of space field genic origin as criterion reference for measurement & quantification of universal existence & motion or we must choose inconstant criterion reference for measurement & quantification of universal existence & motion.</p> <p>Introduction of inconstant criterion reference for measurement & quantification of universal existence & motion of course implies proportionate measurement & quantification distortion</p>

As coherent natura naturans throughout cosmic evolution, instinctive PNT reciprocal equilibrium towards optimum PNT operation is radical potentiality & conditionality for cosmos always ready to orientate itself towards perfection.

	of universal existence & motion, especially when we come to measure and quantify vivid existence & motion of particles in spacetime. In order to differentiate the methodology discrepancy of measurement & quantification of universal existence & motion, we call the humanistic measurement & quantification of universal existence & motion in accordance with inconstant accessible criterion reference “relative measurement & quantification of human”; we call the humanistic measurement & quantification of universal existence & motion in accordance with unique constant criterion reference of noumenon quantification of space field genic origin i_0 “absolute measurement & quantification of human”.
Absolute measurement & quantification of human	Under precondition of homogenous cosmos originated from unique genesis, so-called absolute measurement & quantification of human is just physical methodology to measure and numerically quantify universal existence & motion in accordance with absolute constant criterion reference of space field genic origin i_0 which is virtually systematical unique-genesis quantization formulation of universal existence & motion along sequential homologic cosmogony. Absolute measurement & quantification of universal existence & motion in accordance with basic quantum of noumenon quantification of space field genic origin i_0 is of course the best methodology for measurement & quantification of universal existence & motion, whereas, as inherent limitation of practical feasibility & possibility of human, it’s almost impossible for human to perfect implementation of absolute measurement & quantification of universal existence & motion 100 over 100, it’s only possible for human to approach absolute measurement & quantification of universal existence & motion as much as possible by precise implementation of relative measurement & quantification of universal existence & motion, especially when human come to measure and quantify vivid existence & motion of particles in spacetime.
Optimum PNT genic linkage	Just the best genic configuration in space field which can accomplish optimum PNT operation in the nature of spontaneous transmutation & transition among genic units, which mostly relates to genic unit species, general compositive proportion of all genic units and space field strength.
Inverted reciprocal convergence of optimum PNT genic linkages	Spontaneous occurrence of inverted reciprocal convergence of optimum PNT genic linkage is virtually the hypostatic action of aberrant convergence of cosmic esse due PNT reciprocal gelation. In straightforward words, aberrant convergence of cosmic esse due PNT reciprocal gelation is just action of inverted reciprocal convergence of optimum PNT genic linkages.
Atom State Equation in spacetime	We study the Atom State Equation in Spacetime is just to cast back and quantify the atomic convergent genic cumulation and the proper inherent dynamic compose hypostatized by PNT action among all compositive subatomic units for instinctive PNT reciprocal equilibrium towards optimum PNT operation.
Homologic genic convergence integral equation of atom	$\sum m_{\text{Atom}} = \int_{i_0}^{\text{Atom}} f(m_{i_0 \rightarrow \text{Atom}}) i_0$
PNT dynamic hiberarchy integral equation of atom	$\sum_{\text{Atom} \equiv D} [\int_{i_0}^{\text{Atom}} \text{PNT}]$
Neutron viscous PNT cloud drift	Just the physical noumenon for neutron PNT operation between mass convergent aggradation of neutron and accessible space field.

Historical progress of science in the recent several centuries seemed like a far-flung exploration of the first itinerary around numerous distinctive landscapes of brand-new landmasses of science with palette & tablet on back, several hundred years’ scientific travelogues were compiled thereby.

Proton viscous PNT cloud drift	Just the physical noumenon for proton PNT operation between mass convergent aggradation of proton and accessible space field.
Reciprocal convergent gelation of viscous PNT cloud drift	Further convergent PNT reciprocal gelation of physical noumenon for proton/neutron PNT operation between mass convergent aggradation of proton/neutron and accessible space field.
Time implementation rate	The PNT implementation quantity of idiographic object with definite mass in “standard time unit” is just the time implementation ratio.
Spacetime displacement implementation rate	The PNT implementation quantification of idiographic object in distinctive space field with certain mass moving one meter displacement in reference to the absolute stationary reference is the spacetime displacement implementation ratio.
Spacetime implementation rate	Spacetime implementation rate is just the PNT implementation quantity of freewheeling existent object with definite mass in one standard time unit.
Authentication instrument of atomic reciprocal structure	A kind of scientific instrument to authenticate the atomic configuration and atomic reciprocity structure of atomic reciprocal PNT combination and automatically offer the proper state equations of the target atomic reciprocal PNT combination once finished authentication, which is designed in accordance the individual features of all the 110 sorts of the atoms in cosmos with efficient sense to individual features of atoms.
Optimum orientation choice due to instinctive PNT reciprocal equilibrium towards optimum PNT operation	It is mostly the most expedient and adequate optimum PNT operation on the basis of stochastic occurrence of (reciprocal idiosyncrasy towards PNT equilibrium + accessible space overall arrangement for PNT reciprocity), especially when the condition of (reciprocal idiosyncrasy towards PNT equilibrium + accessible space overall arrangement for PNT reciprocity) is multi-optional for PNT reciprocity due to instinctive PNT equilibrium of matter integration.
The sixth part	Initial Endeavor of Natura Naturans Personalization Towards Human Necessity Based on Primary Authenticity Clarification of Homogenous Cosmos Originated from Unique Genesis
Common engine	“Common Engine” is a sort of mechanism which can be used to stochastically cause activation of potential energy of idiographic energetic source so as to offer relatively preponderant kinetic energy to loads.
Flying saucer engine	In accordance with authenticity that existence & motion of matter is just dynamic enantiomorph of PNT action of matter integration in spacetime, so-called “Flying Saucer Engine” is but a sort of mechanism to facilitate PNT action of matter integration under control at human pleasure so as to stochastically procure anticipative existence & motion of object according to intrinsic regularity of PNT action and the favorable idiosyncrasy of PNT action of the proper object which is used as PNT activation source of flying saucer engine.
Milk hitchhike-able speed	Just the speed of driving system whose variation of state parameter K won't deadly impact the normal function of organism hitchhiked on it.
PNT Non-normalized activation	Once initial conditions are offered for PNT activation for energy release, succedent proceeding of PNT activation is left ongoing by the light of nature.

As coherent natura naturans throughout cosmic evolution, instinctive PNT reciprocal equilibrium towards optimum PNT operation is radical potentiality & conditionality for cosmos always ready to orientate itself towards perfection.

<p>PNT activation source</p>	<p>Just the target object which is introduced for PNT activation for ideal drive, such object must possess advantages as following:</p> <ol style="list-style-type: none"> 1) It must possess remarkable energetic variation range with substantial activation energy. 2) The activated energy is feasible for momentum macromodelization and the throughout PNT activation process is accessible for implementation of continuous artificial control.
<p>PNT activation signal</p>	<p>PNT activation signal is just the physical object which is introduced to work on PNT activation source directly for ideal PNT activation.</p>
<p>PNT normalized activation</p>	<p>In accordance with the fundamental of universal PNT action and PNT operational idiosyncrasy of ideal PNT activation resource, materialize physical effect to PNT operation of PNT activation resource to make the PNT operation of PNT activation source under our artificial control so as to accomplish ideal motion of the object (PNT activation resource) followed our inclinations.</p>
<p>PNT elastic normalized activation</p>	<p>It means the operation of controllable process succession of PNT normalized activation is similar as elastic distortion of spring under outside pressure, once external pressure gradually attenuate, the spring elongates length itself, till at last the external pressure attenuate to zero, the spring elongates to its original length; comparably, once the PNT operation of PNT activation source is influenced by artificial control, proportionate variation of PNT operation of PNT activation source occur, once the artificial control influence attenuates, the PNT activation source gradually turn to its original state, till at last the artificial control influence attenuates to zero, the PNT activation source ultimately turn to its initial state.</p>
<p>Low-intensity train flying saucer engine</p>	<p>PNT engine is used to drive train in its relatively low-intensity state.</p>
<p>Flying saucer engine generator (PNT generator)</p>	<p>Proper PNT activation leads to remarkable electric polarity of PNT activation source so as to accomplish high-voltage electric-field around PNT activation source which is exact physical domino effect of generator.</p>
<p>PNT activated current</p>	<p>PNT activation lead to high-voltage electric field around PNT activation source, once conductor is connected onto the high-voltage PNT activation source, there must be current in the conductor, we call the current in conductor connected onto the high-voltage PNT activation source "PNT activated current".</p>
<p>Hard drive</p>	<p>Hard drive is just such kind of technologic practice which accomplish PNT non-normalized activation of certain energy source material for relatively preponderant kinetic energy, then facilitate the energy source material with relatively preponderant kinetic energy to butt the target object/load as possible as it can, so that the target object/load is driven for it received some preponderant kinetic energy from energy source material.</p>
<p>Soft drive</p>	<p>Soft drive is such technologic practice, as existence & motion is straightforward dynamic enantiomorph of PNT action of matter integration in spacetime, in accordance with fundamental of universal PNT action and favorable PNT operational idiosyncrasy of ideal PNT activation source, implement proper physical effect to PNT operation of PNT activation source so as</p>

	to accomplish ideal acceleration of PNT activation source.
Continuous controllability of PNT activation	PNT operational idiosyncrasy that PNT operation or PNT reaction under artificial control can be continuously carried through followed our inclinations.
Tyre core	For expedient PNT artificial control of flying saucer engine, the PNT activation source is manufactured into tyre model with ellipse section, and as the tyre model PNT activation source is fixed in core position of the integrative PNT activation mechanism, we just call it "tyre core".
Tyre core shape confining force	The confining action to prevent tyre core fragmentation and <i>sauve qui peut</i> under PNT activation.
Hard rectification,	Technologic practice which introduce hard chamber to confine and restrict the so-called material source with preponderant kinetic energy so as to make the material source jet to release their preponderant kinetic energy straightforwardly. For instance, we use .bore of a gun confine and restrict burning powder so as to butt bullet to fly out gun canal in high speed, gas engine introduce burning chamber to confine and restrict burning gas so as to butt piston to straightforwardly run in high speed, jet plane introduce turbo chamber to confine and restrict burning gas so as to ensure the burning gas jet straightforwardly for ideal recoil to plane.
Soft rectification	Soft rectification is such technologic practice, as existence & motion is straightforward dynamic enantiomorph of PNT action of matter integration in spacetime, in accordance with fundamental of universal PNT action and favorable PNT operational idiosyncrasy of ideal PNT activation source, implement proper physical effect to PNT operation of PNT activation source so as to ensure ideal or necessary existence & motion of PNT activation source.
PNT normalized driving	PNT normalized driving is such technologic practice, as existence & motion is straightforward dynamic enantiomorph of PNT action of matter integration in spacetime, in accordance with fundamental of universal PNT action and favorable PNT operational idiosyncrasy of ideal PNT activation source, implement proper physical effect to PNT operation of PNT activation source so as to consequently actualize expectant driving effect of PNT activation source according to PNT continuous controllable necessity.
PNT rough driving	PNT rough driving is such technologic practice, as existence & motion is straightforward dynamic enantiomorph of PNT action of matter integration in spacetime, in accordance with fundamental of universal PNT action and favorable PNT operational idiosyncrasy of ideal PNT activation source, implement physical effect to PNT operation of PNT activation source, however, the resultant implementation effect does not accomplish expectant driving effect of PNT activation source according to PNT continuous controllable necessity.
Quantitative change formula of PNT activation & rectification	In order to ensure the PNT reaction between PNT activation/rectification signal and PNT activation source is qualified and ensure expedient implementation of PNT soft driving, we compile and program the qualified mathematical correction between input of PNT activation/rectification signal "x" and PNT reaction output of PNT activation source F(x)

	and into formula $y=F(x)$, of course, the implementation of the program must ensure tyre core inner homologisation among adjacent atoms satisfies $ f_{\alpha} - f_{\beta} * \cos\phi \leq f_{\alpha- \beta} + (f_{\alpha} + f_{\beta}) * \sin\phi$, (Among the equation, α, β denote any two adjacent atoms in tyre core). We just call such qualified quantitative change correction $Y=F(x)$ between input of PNT activation /rectification signal “x” and PNT reaction output of PNT activation source $F(x)$ “quantitative change formula of PNT activation & rectification”.
Optimum quantitative change formula of PNT activation & rectification	Just the quantitative change formula of PNT activation & rectification in optimum mathematical correction $y=F(x)$ between input of PNT activation/rectification signal “x” and PNT reaction output of PNT activation source $F(x)$, whose practical implementation can ensure tyre core internal homologisation among adjacent atoms $ f_{\alpha} - f_{\beta} * \cos\phi = f_{\alpha- \beta} + (f_{\alpha} + f_{\beta}) * \sin\phi = 0$, (Among the equation, α, β denote any two adjacent atoms in tyre core)
Quantitative change formula of oval wheel fashion PNT activation & rectification	Quantitative change formula specially ready for oval wheel fashion PNT activation & rectification.
Optimum quantitative change formula of oval wheel fashion PNT activation & rectification	The optimum quantitative change formula specially ready for oval wheel fashion PNT activation & rectification.
Optimum quantitative change formula of oval wheel fashion PNT symmetric activation & rectification	The optimum quantitative change formula specially ready for oval wheel fashion PNT symmetric activation & rectification.
Optimum quantitative change formula of oval wheel fashion PNT asymmetric activation & rectification	The optimum quantitative change formula specially ready for oval wheel fashion PNT asymmetric activation & rectification.
Safe quantitative change range of PNT activation & rectification	Is just the qualified quantitative change range in quantitative change formula of PNT activation & rectification, which can make tyre core inner homologisation satisfy $ f_{\alpha} - f_{\beta} * \cos\phi \leq f_{\alpha- \beta} + (f_{\alpha} + f_{\beta}) * \sin\phi$, (Among the equation, α, β denote any two adjacent atoms in tyre core).
Safe quantitative change range of oval wheel fashion PNT symmetric activation & rectification	Safe quantitative change range specially fit for oval wheel fashion PNT symmetric activation & rectification.
Safe quantitative change range of	Safe quantitative change range specially fit for oval wheel fashion PNT asymmetric activation

Historical progress of science in the recent several centuries seemed like a far-flung exploration of the first itinerary around numerous distinctive landscapes of brand-new landmasses of science with palette & tablet on back, several hundred years’ scientific travelogues were compiled thereby.

<p>oval wheel fashion PNT asymmetric activation & rectification</p>	<p>& rectification.</p>
<p>Quantitative change deadline of PNT activation & rectification</p>	<p>Is just the critical function curve of quantitative change formula of PNT activation & rectification whose connotation of mathematical correction between input of PNT activation /rectification signal “x” and PNT reaction output of PNT activation source F(x) makes tyre core inner homologisation satisfy $f_{\alpha} - f_{\beta} * \cos\phi = f_{\alpha} - f_{\beta} + (f_{\alpha} + f_{\beta}) * \sin\phi$, (Among the equation, α, β denote any two adjacent atoms in tyre core).</p>
<p>Quantitative change deadline of oval wheel fashion PNT symmetric activation & rectification</p>	<p>Is just the critical function curve of quantitative change formula of PNT activation & rectification whose connotation of mathematical correction between input of PNT activation /rectification signal “x” and PNT reaction output of PNT activation source F(x) makes tyre core inner homologisation satisfy $f_{\alpha} - f_{\beta} * \cos\phi = f_{\alpha} - f_{\beta} + (f_{\alpha} + f_{\beta}) * \sin\phi$ when applies in oval wheel fashion PNT symmetric activation & rectification, (Among the equation, α, β denote any two adjacent atoms in tyre core).</p>
<p>Quantitative change deadline of oval wheel fashion PNT asymmetric activation & rectification</p>	<p>Is just the critical function curve of quantitative change formula of PNT activation & rectification whose connotation of mathematical correction between input of PNT activation /rectification signal “x” and PNT reaction output of PNT activation source F(x) makes tyre core inner homologisation satisfy $f_{\alpha} - f_{\beta} * \cos\phi = f_{\alpha} - f_{\beta} + (f_{\alpha} + f_{\beta}) * \sin\phi$ when applies in oval wheel fashion PNT asymmetric activation & rectification, (Among the equation, α, β denote any two adjacent atoms in tyre core).</p>
<p>Orientation adjusting in tyre core centre plane derived from rotary oval wheel fashion PNT activation & rectification</p>	<p>In oval wheel fashion PNT activation & rectification mechanism, the manner to accomplish orientation adjusting in tyre core centre plane by rotating the working PNT activators & PNT rectifiers around the tyre core.</p>
<p>Hard rotation of PNT activation & rectification for orientation adjusting</p>	<p>In order to accomplish orientation adjusting in tyre core centre plane in oval wheel fashion PNT symmetrical activation & rectification, the method we manage mechanic rotation of the working PNT activators & PNT rectifiers around the tyre core.</p>
<p>Soft rotation of PNT activation & rectification for orientation adjusting in tyre core centre plane</p>	<p>In order to actualize orientation adjusting in tyre core centre plane, even under precondition keeping the PNT activators & PNT rectifiers relatively stationary to tyre core, the method we manage the working output of PNT activators & PNT rectifiers rotating around tyre core so as to accomplish the equivalent working effect as PNT activators & PNT rectifiers mechanically rotating around the tyre core in their working state.</p>
<p>Orientation adjusting deviated tyre core centre plane derived from oval wheel fashion PNT asymmetric activation & rectification</p>	<p>Just the method by adjusting the output wattage of upper limb and lower limb of PNT activators and PNT rectifiers, be sure to cause output wattage margin of upper limb and lower limb of PNT activators and PNT rectifiers so as to actualize the proper acceleration of tyre core deviated to tyre core centre plane.</p>

<p>Orientation adjusting derived from oval wheel fashion PNT vertical asymmetric activation & rectification</p>	<p>In oval wheel fashion PNT activation & rectifier mechanism, the method we manage to adjust the output wattage of upper limb and lower limb of PNT activators and PNT rectifiers to ensure the output wattage margin so as to actualize acceleration for tyre core overturn.</p>
<p>Swoop drive programme</p>	<p>Quantitative change formula of PNT activation & rectification specially compiled according to idiographic drive mechanism whose application can cause swoop acceleration of PNT engine.</p>
<p>Elevation drive programme</p>	<p>Quantitative change formula of PNT activation & rectification specially compiled according to idiographic drive mechanism whose application can cause elevation acceleration of PNT engine.</p>
<p>Vertical swoop drive programme</p>	<p>Quantitative change formula of PNT activation & rectification specially compiled according to idiographic drive mechanism whose application can cause vertical swoop acceleration of PNT engine.</p>
<p>Vertical elevation drive program</p>	<p>Quantitative change formula of PNT activation & rectification specially compiled according to idiographic drive mechanism whose application can cause vertical elevation acceleration of PNT engine.</p>
<p>Level drive programme</p>	<p>Quantitative change formula of PNT activation & rectification specially compiled according to idiographic drive mechanism whose application can cause level acceleration of PNT engine.</p>
<p>Optimum (/relatively better) PNT action linkage</p>	<p>Just the relative better or best PNT operational linkage made up of proper genic units, which is in the relative better or best genic configuration to consummate optimum PNT operation of matter integration due to instinctive PNT equilibrium towards optimum PNT operation.</p>
<p>Clutch mechanism of optimum PNT action linkage</p>	<p>In order to accomplish consummate operation of relative better or best PNT optimum linkage of objective matter integration, in accordance with practical necessity and possibility, we disjoin the optimum PNT genic linkage into two or more compositive parts, so that it is possible for us to control the availability among all the compositive parts for consummation of PNT operation of the relative better or best PNT optimum linkage towards ideal motion of objective matter integration, which is similar as the methodology we control the contact proportion between cadmium bar and uranium fuel to control the speed of nuclear reaction.</p>
<p>Disassembly of goal optimum PNT action linkage</p>	<p>In accordance with practical possibility and validity of material preparation, we disjoin the optimum PNT genic linkage into two (or more) compositive parts, one of them left on PNT activation sign, the other part left on PNT activation resource. Once the PNT activation sign works on PNT activation resource, the two part can contact each other and consequently accomplish ideal operation of relative better or best PNT genic linkage on objective matter integration, so that the objective matter integration is driven accordingly.</p>
<p>Father linkage of PNT engine</p>	<p>We call the compositive PNT genic linkage taken apart from the relative better or best PNT genic linkage which is used as PNT activation sign as “Father linkage of PNT engine”.</p>
<p>Mother linkage of PNT engine</p>	<p>We call the compositive PNT genic linkage taken apart from the relative better or best PNT genic linkage which is used as PNT activation resource as “Mather linkage of PNT engine”.</p>

<p>Synthesized revival of optimum PNT action linkage</p>	<p>Just PNT activation signal + PNT activation source $\xrightarrow{\text{Precipitate}}$ Operation of optimum (/relatively better) PNT action linkage</p>
<p>The seventh part</p>	<p>As Timely Renovation of Humanistic Ideology about Authenticity of Nature in Proportion to Contemporaneous Historical Background of Remarkable Highlight of Microcosmic Configuration of Matter and Typical Aberrant Scientific Knowledge Proliferation Out of Succession of Contemporaneous Scientific Orthodoxy, Free Press Admittance of Homogenous Cosmos Originated from Unique Genesis Must Break Through Legitimacy Defense Line of Contemporaneous Scientific Orthodoxy due to Inevitable Life-and-death Scientific Knowledge Metabolism, so that It Has to Challenge Venomous Counterwork Upper Limit of Temporal Authority Under Egotistic Background of Interminable Royal Substantiation & Perfection of Contemporaneous Scientific Orthodoxy ——Social Legitimacy & Validity of Truths Can Never Exceed Cannon Range</p>
<p>Scientific experiment</p>	<p>As accessorial instrumentality towards intelligent apperception & exploration of authenticity of nature, scientific experiment is active & effective approach human manage proper artificial performance of objective physical process in the nature so as to make the physical regularity or natural consequence of the objective physical process self-evident in conventional physical purview of human then and there, so that it's convenient for human to draw scientific conclusion about the objective physical process, which is not only practical instrumentality to make mysterious physical feature of nature accessible to human sense but also valid access to extend and strengthen human sense to mysterious physical feature of nature.</p> <p>Even as remarkable disparity of practical feasibility & possibility in proportion to contemporaneous historical background, the accessible implication scope & profundity of physical experiment of human is different accordingly, even the historical functional feature of physical experiments along crecive progression of historical progress of science is proportionably different too. However, as humanistic endeavor towards intelligent apperception & exploration of authenticity of nature, functional availability of scientific experiment can never exceed relative limitation of accessible physical purview of human.</p>
<p>General physical purview of human</p>	<p>is just relative accessible impression about universal existence & motion upon human biologic function under normal existent status of human in cosmos. Of course, as observer in cosmos, as our existent status can be slightly variable, there is tiny variable range of general physical purview of human for relativity domino effect proportionably. For instance, you observe cosmos standing on the earth and observe the cosmos in a flying plane, there must be slight difference of physical purview of cosmos before you.</p>
<p>Humanistic ideology about authenticity of nature in proportion to contemporaneous historical background</p>	<p>The most basic meaning of humanistic ideology about authenticity of nature in proportion to contemporaneous historical background is that, no society of human, no humanistic ideology about authenticity of nature can occur. In straightforward words, humanistic ideology about authenticity of nature is inevitable outgrowth of development of human society due to necessity of social production.</p> <p>The relative deep-seated meaning of humanistic ideology about authenticity of nature in proportion to contemporaneous historical background is that evolvement of humanistic ideology about authenticity of nature in proportion to contemporaneous historical background is always</p>

As coherent natura naturans throughout cosmic evolution, instinctive PNT reciprocal equilibrium towards optimum PNT operation is radical potentiality & conditionality for cosmos always ready to orientate itself towards perfection.

	<p>proportionable reciprocal quantitative and qualitative change in proportion to practical feasibility & possibility in proportion to contemporaneous historical background. Throughout historical progress of science, practical feasibility & possibility in proportion to contemporaneous historical background and humanistic ideology about authenticity of nature in proportion to contemporaneous historical background are always commensurate reciprocal quantitative & qualitative change all along, distinctive practical feasibility & possibility in proportion to contemporaneous historical background must condition proportionate output of humanistic ideology about authenticity of nature in proportion to contemporaneous historical background, and inversely, social validation of humanistic ideology about authenticity of nature in proportion to contemporaneous historical background must enhance practical feasibility & possibility in proportion to contemporaneous historical background as well, till at last, the humanistic ideology about authenticity of nature finally tallies with ultimate authenticity of nature 100 over 100 as perfect ideological enantiomorph of ultimate authenticity of nature.</p>
<p>proportionable contemporaneous scientific authentication</p>	<p>Historical occurrence of proportionate commensurate scientific authentication must condition prior original generation of humanistic ideology about authenticity of nature in proportion to contemporaneous historical background, no prior original generation of humanistic ideology about authenticity of nature in proportion to contemporaneous historical background, no proportionate commensurate scientific authentication is practically significant. In detail words, as long as there is original motivation & potentiality for historical progress of science, hypostatic historical background with distinctive practical feasibility & possibility must accomplish commensurate humanistic ideology about authenticity of nature in proportion to contemporaneous historical background; in order to procure social legitimacy qualification of the age, humanistic ideology about authenticity of nature in proportion to contemporaneous historical background of course needs necessary scientific authentication and social legitimacy authorization under the common historical background.</p> <p>As it's only possible for necessary scientific authentication to be implemented under the common historical background with distinctive practical feasibility & possibility, and virtually, the practical accomplishment of proportionate commensurate scientific authentication is relatively more difficult than practical accomplishment of humanistic ideology about authenticity of nature in proportion to contemporaneous historical background, it is only possible for historical authenticity tolerance of science of proportionate commensurate scientific authentication \cong historical authenticity tolerance of science of humanistic ideology about authenticity of nature in proportion to contemporaneous historical background, following the successive quantitative & qualitative change of practical feasibility & possibility, once historical authenticity tolerance of science of proportionate commensurate scientific authentication < historical authenticity tolerance of science of humanistic ideology about authenticity of nature in proportion to contemporaneous historical background, it indicates accomplishment of substantial potentiality for successive renovation of humanistic ideology about authenticity of nature in proportion to contemporaneous historical background in inherent optimum orientation towards perfect ideological enantiomorph of ultimate authenticity of nature.</p>
<p>The eighth part</p>	<p>Historical Progress of Science in Inherent Optimum Orientation Towards Perfect Ideological Enantiomorph of Ultimate Authenticity of Nature</p>

<p>Science</p>	<p>As ideological enantiomorph of accessible existence & motion on human sense with double significance of “social connotation” & “natural connotation” , “science” is always recognizant representation of accessible existence & motion reflected on human sense under proper historical background, which is virtually humanistic ideology about authenticity of nature in proportion to contemporaneous historical background, ultimate consummation of science must be perfect ideological enantiomorph of ultimate authenticity of nature as coherent theory about universal existence & motion.</p> <p>“Social connotation of science” generally derives from factuality that, as ideological system about authenticity of nature, science is always humanistic outgrowth under proportionate historical background, whose original naissance and postnatal existence must implicate practical feasibility & possibility in proportion to contemporaneous historical background, even the social legitimacy subsistence including initial social legitimacy authorization, successive development, timely social legitimacy metabolism of humanistic ideology about authenticity of nature must be operated in commensurate social ambience.</p> <p>“Natural connotation of science” generally derives from factuality that, as external reference of humanistic ideology, authenticity of nature is always objective enantiomorphous origin of science, no matter how much of authenticity of nature can be accessible in human rational purview due to practical feasibility & possibility in proportion to contemporaneous historical background. As a result, before humanistic ideology about authenticity of nature finally qualified as perfect ideological enantiomorph of ultimate authenticity of nature, as social outgrowth, science is always commensurate ideological system about authenticity of nature in proportion to contemporaneous historical background in crecive progression of historical progress of science in inherent optimum orientation towards perfect ideological enantiomorph of ultimate authenticity of nature.</p>
<p>Scientific knowledge</p>	<p>is just recognizant representation of human about accessible existence & motion in nature under proper historical background.</p>
<p>Development of science</p>	<p>is always normal quantitative & qualitative change of realistic scientific knowledge proliferation, which is permanent endeavor of human to push humanistic ideology about authenticity of nature forward to perfect ideological enantiomorph of ultimate authenticity of nature draw on practical feasibility & possibility in proportion to contemporaneous historical background, till at last, humanistic ideology about authenticity of nature tallies with ultimate authenticity of nature 100 over 100 as perfect ideological enantiomorph of ultimate authenticity of nature.</p> <p>as out-and-out social work outgrowth and humanistic ideology about authenticity of nature in proportion to contemporaneous historical background, social existence & historical progress of “science” must inherently possess double coordinative significance of “natural connotation” and “social connotation”, practical development of science not only directly implicates accessible existence & motion around us, but also roots in contemporaneous historical background and related social conditions to continue gradational quantitative & qualitative change of historical progress of science in inherent optimum orientation towards perfect ideological enantiomorph of ultimate authenticity of nature.</p>

	<p>As crescive progression of practical feasibility & possibility in proportion to contemporaneous historical background, no matter what the logic constitution of ultimate authenticity of nature is, the practice human coming to discover and formulate authenticity of accessible existence & motion around must experience frondose evolvment of humanistic ideology about authenticity of nature cumulatively enriched from nothingness to goot, from goot to a great lot, and consequently followed proportionate ideaistic correction & qualitative optimization from superficiality to profundity, from parochiality to generality.</p> <p>And as it's only possible for ultimate authenticity of nature to be unique & invariable as coherent natura naturans throughout cosmic evolution, once humanistic ideology about authenticity of nature in proportion to contemporaneous historical background tallies with ultimate authenticity of nature 100 over 100, it must turn into coherent scientific verity about universal existence & motion as perfect ideological enantiomorph of coherent natura naturans throughout cosmic evolution. At any rate, in accordance with rigorous enantiomorphous correlation between objective authenticity of nature and humanistic ideology about authenticity of nature, it's neither possible for "the unique & invariable ultimate authenticity of nature" to be compatible with "two distinctive humanistic ideologies about authenticity of nature with remarkable ideological difference" nor possible for "two distinctive humanistic ideologies about authenticity of nature with remarkable ideological difference" to discover and formulate "the unique & invariable ultimate authenticity of nature" coequally.</p>
<p>Scientific knowledge proliferation</p>	<p>is just living action people trying to discover and formulate accessible existence & motion draw on practical feasibility & possibility in proportion to contemporaneous historical background then and there.</p>
<p>contemporaneous scientific orthodoxy</p>	<p>In discretionary progressive stage throughout historical progress of science, no matter the historical authenticity tolerance of science of the proper age is large or small, as long as there is substantial mainstream of humanistic ideology about authenticity of nature of the proper age, there must be people who master and are ready to sparkplug the mainstream of humanistic ideology about authenticity of nature. Once the people organized into community and form their authoritative influence widely in society, they are just the contemporaneous scientific orthodoxy.</p>
<p>temporal authority</p>	<p>temporal authority are just the social group who are endowed degree & rank for having succeeded or even having carried forward contemporaneous scientific orthodoxy and are consequently relatively superior in economic treatment, free press admittance, ecclesiastic organization of science with book of books of mainstream of contemporaneous scientific orthodoxy. Of course, I have to comment herein, as contemporaneous scientific orthodoxy with book of books, ecclesiastic organization of science are not always the great-hearted group to push humanistic ideology about authenticity of nature forward to perfect ideological enantiomorph of ultimate authenticity of nature, instead, before humanistic ideology about authenticity of nature finally qualified as perfect ideological enantiomorph of ultimate authenticity of nature, the most pestilent obstacle for historical progress of science must be unnoticed thought misdirection & bewitchment derived from authoritative intrepidity of contemporaneous scientific orthodoxy out of scientific legitimacy qualification of historical authenticity tolerance</p>

Historical progress of science in the recent several centuries seemed like a far-flung exploration of the first itinerary around numerous distinctive landscapes of brand-new landmasses of science with palette & tablet on back, several hundred years' scientific travelogues were compiled thereby.

	<p>of science 0 to succedent generation, especially, once authoritative intrepidity of contemporaneous scientific orthodoxy is egotistically all-time and overwhelming short of necessary intendance. Although they are mostly beneficed and prestigious in society even with remarkable privilege of free press admittance for homegrown science forum in the garden of contemporaneous scientific orthodoxy.</p>
<p>Temporal authoritative conventionality</p>	<p>In simple words, it's just the conventionality of temporal authority with backup of authoritative intrepidity of contemporaneous scientific orthodoxy. As the conventionality mostly do its jobs to coming scientific knowledge proliferation according to ready-made criterion of contemporaneous scientific orthodoxy, we just call it temporal authoritative conventionality.</p>
<p>Authoritative intrepidity of contemporaneous scientific orthodoxy</p>	<p>Is but inherent potentiality & capability for social legitimacy subsistence of contemporaneous scientific orthodoxy under contemporaneous historical background, which of course includes the potentiality & capability for royal substantiation & perfection of contemporaneous scientific orthodoxy of the age even capability for counterwork in coming scientific knowledge metabolism campaign.</p>
<p>Official royalism value of contemporaneous scientific orthodoxy</p>	<p>is just the social influence of contemporaneous scientific orthodoxy under commensurate social background, which generally includes political support, practical reciprocity between economics and contemporaneous scientific orthodoxy, capability contemporaneous scientific orthodoxy sparkplug royal substantiation & perfection of contemporaneous scientific orthodoxy, even potentiality for contemporaneous scientific orthodoxy to counterwork in coming scientific knowledge metabolism campaign, no matter whether counterwork is rational or irrational.</p>
<p>Scientific Knowledge metabolism</p>	<p>So-called "scientific knowledge metabolism" is historical renewal & optimization of humanistic ideology about authenticity of nature gradually approach consummate formulation of universal existence & motion as coherent theory as perfect ideological enantiomorph of ultimate authenticity of nature due to incremental quantitative change of practical feasibility & possibility in proportion to contemporaneous historical background, which is virtually qualitative change of historical progress of science under potential synthesized conditionality of "crecscive progression of practical feasibility & possibility in proportion to contemporaneous historical background + the uniqueness & invariance of ultimate authenticity of nature predestines the unique possibility of scientific verity as perfect ideological enantiomorph of ultimate authenticity of nature". Virtually, as inevitability of quantitative & qualitative change of historical progress of science under potential synthesized conditionality of "crecscive progression of practical feasibility & possibility in proportion to contemporaneous historical background + the uniqueness & invariance of ultimate authenticity of nature predestines the unique possibility of scientific verity as perfect ideological enantiomorph of ultimate authenticity of nature", it's only possible for the major melody of historical progress of science to be serial "epochmaking scientific knowledge metabolism" in inherent optimum orientation towards perfect ideological enantiomorph of ultimate authenticity of nature through and through.</p>
<p>Scientific knowledge metabolism campaign</p>	<p>"Scientific knowledge metabolism campaign" is struggle which mostly occur between originator of aberrant scientific knowledge proliferation out of succession of contemporaneous scientific orthodoxy and deputation of contemporaneous scientific orthodoxy once aberrant scientific knowledge proliferation out of succession of contemporaneous scientific orthodoxy is</p>

	<p>ready to challenge legitimacy subsistence of contemporaneous scientific orthodoxy during the course human coming to know ultimate authenticity of nature cumulatively enriched from nothingness to goad, from goad to a great lot and consequently following the proportionate historical reciprocal cognition correction & qualitative optimization from superficiality to profundity, from parochiality to generality. The struggle between aberrant scientific knowledge proliferation out of succession of contemporaneous scientific orthodoxy and contemporaneous scientific orthodoxy usually exhibits as scientific idea dissension, if conflict irreconcilable, it maybe even arouse mutual forcible clash.</p> <p>Scientific knowledge metabolism campaign has two-tier significations, the first is pure knowledge metabolism towards perfect ideological enantiomorph of ultimate authenticity of nature in inherent optimum orientation towards historical authenticity tolerance of science 0; the second is interclass campaign with ulterior motives which usually related to self-benefits of legitimacy subsistence, after all, presence of so-called social legitimacy proportionately contains the worthy fame and gain of certain man or class of the society. As self-preservation is something inherent of man, as long as scientific knowledge metabolism campaign is implemented among men who are always ready for self-subsistence in the society, the two-tier significations of scientific knowledge metabolism campaign are usually adulterated and esoteric.</p>
<p>Lifespan of contemporaneous scientific orthodoxy</p>	<p>As permanent synthesized conditionality of “crescive progression of practical feasibility & possibility in proportion to contemporaneous historical background + the uniqueness & invariance of ultimate authenticity of nature predestines the unique possibility of scientific verity as perfect ideological enantiomorph of ultimate authenticity of nature” through and through, it’s only possible for the major melody of historical progress of science to be a series of epochmaking scientific knowledge metabolism in inherent optimum orientation towards historical authenticity tolerance of science 0. Throughout historical progress of science, any contemporaneous scientific orthodoxy out of scientific legitimacy qualification of historical authenticity tolerance of science 0 must be washed out once positive advancement towards historical authenticity tolerance of science 0 accomplished then and there, we just call the time starting at original naissance of the contemporaneous scientific orthodoxy to final social legitimacy invalidation of the contemporaneous scientific orthodoxy “lifespan of contemporaneous scientific orthodoxy”.</p>
<p>Historical legitimacy keynote initialization</p>	<p>Original naissance and primary social legitimacy promotion of innovative scientific idea which accomplishes the hardcore or basis of ideological system about authenticity of nature of coming contemporaneous scientific orthodoxy.</p>
<p>Gradational metabolism of humanistic ideology about authenticity of nature towards perfect ideological enantiomorph of ultimate authenticity of nature</p>	<p>Is just the historical process, following progressive quantitative change of practical feasibility & possibility for development of science, there are proportionably gradational scientific knowledge metabolism towards perfect ideological enantiomorph of ultimate authenticity of nature in inherent optimum orientation towards historical authenticity tolerance of science 0.</p>

<p>Aggradation of living scientific knowledge</p>	<p>Just the acceptable scientific knowledge under the proper historical background, which are mostly balance after commensurate scientific knowledge metabolism.</p>
<p>Authenticity value of scientific knowledge</p>	<p>Taking reference of ultimate authenticity of nature, the absolute numeric authenticity of scientific knowledge in proportion to contemporaneous historical background. Of course, the absolute numeric authenticity of scientific knowledge in proportion to contemporaneous historical background can be directly quantized by “historical authenticity tolerance of science”.</p>
<p>Upper limit curve of authenticity value of historical scientific knowledge proliferation</p>	<p>Realistic scientific knowledge proliferation along historical progress of science can never be groundless, whose ideological system must be rooted in contemporaneous historical background and knowledge proliferation implementation must implicate practical feasibility & possibility in proportion to contemporaneous historical background. As gradational quantitative & qualitative change of general historical background including practical feasibility & possibility in proportion to contemporaneous historical background, different stages throughout historical historical progress in inherent optimum orientation towards historical authenticity tolerance of science 0 have proportionable practical feasibility & possibility for development of science, even the upper limit of proportionable practical feasibility & possibility for development of science. Upper limit curve of authenticity value of historical scientific knowledge proliferation is just the lineal gradational quantitative change of upper limit of proportionable practical feasibility & possibility for development of science along historical progress of science.</p>
<p>Acceptable lower limit curve of authenticity value of historical scientific knowledge proliferation</p>	<p>Realistic scientific knowledge proliferation along historical progress of science can never be groundless, whose ideological system must be rooted in contemporaneous historical background and knowledge proliferation implementation must implicate practical feasibility & possibility in proportion to contemporaneous historical background. As gradational quantitative & qualitative change of general historical background including practical feasibility & possibility in proportion to contemporaneous historical background, different stages throughout historical historical progress in inherent optimum orientation towards historical authenticity tolerance of science 0 have proportionable practical feasibility & possibility for development of science, even the lower limit of proportionable practical feasibility & possibility for development of science. Acceptable lower limit curve of authenticity value of historical scientific knowledge proliferation is just the lineal gradational quantitative change of lower limit of proportionable practical feasibility & possibility for development of science along historical progress of science.</p>
<p>benign officialism domino effect of contemporaneous scientific orthodoxy</p>	<p>benign officialism domino effect of contemporaneous scientific orthodoxy is mostly incarnated as, in the early years when a brand-new contemporaneous scientific orthodoxy comes into being as epochmaking innovative scientific idea, temporal authority are very expedient to sparkplug substantiation & perfection of contemporaneous scientific orthodoxy upon remarkable validity & influence of social legitimacy qualification of contemporaneous scientific orthodoxy, as timely substantiation & perfection of contemporaneous scientific orthodoxy ≈ general progress of science, their endeavor to sparkplug timely substantiation & perfection of contemporaneous scientific orthodoxy can of course actualize the benign officialism domino effect of contemporaneous scientific orthodoxy.</p>

<p>conservative officialism domino effect of contemporaneous scientific orthodoxy</p>	<p>“conservative officialism domino effect of contemporaneous scientific orthodoxy” is something generally as, under precondition the uniqueness & invariance of ultimate authenticity of nature predestines unique possibility of scientific verity, as rigorous enantiomorphous correlation between objective authenticity of nature and humanistic ideology about authenticity of nature, it’s neither possible for “the unique & invariable ultimate authenticity of nature” to be compatible with “two distinctive humanistic ideologies about authenticity of nature with remarkable ideological difference” nor possible for “two distinctive humanistic ideologies about authenticity of nature with remarkable ideological difference” to discover and formulate “the unique & invariable ultimate authenticity of nature” coequally.</p> <p>Veritable progress of science is not intuitional cumulative achievement of colorful scientific travelogues A, B, C, D, E, F, ... like omnifarious smallwares full of a basket about rich and colorful existence & motion accessible around us but successive hypostatic endeavor to push humanistic ideology about authenticity of nature forward to consummate formulation of ultimate authenticity of nature as coherent theory about universal existence & motion so as to accomplish historical progress of science in inherent optimum orientation towards historical authenticity tolerance of science 0 step by step draw on practical feasibility & possibility in proportion to contemporaneous historical background, which is just realistic historical progress of science in inherent optimum orientation towards historical authenticity tolerance of science 0. And virtually, it’s only possible for the major melody of historical progress of science to be serial scientific knowledge metabolism in inherent optimum orientation towards perfect ideological enantiomorph of ultimate authenticity of nature. However, as social legitimacy subsistence of contemporaneous scientific orthodoxy directly implicates solid gain and fame of temporal authority, once timely renovation of humanistic ideology about authenticity of nature in proportion to contemporaneous historical background has to challenge social legitimacy subsistence of contemporaneous scientific orthodoxy, temporal authority must rouse as countercheck battleship in scientific knowledge metabolism campaign upon self-preservation of human, whose practical effect to coming necessary scientific knowledge metabolism is of course self-evident, especially once free press regulation customization and free press admittance is under magistral autarchy of temporal authority short of necessary intendance.</p>
<p>Natura naturans personalization towards human necessity</p>	<p>Is just social practice human try to organize and administrate ideal existence & motion towards necessity of social production & living upon prior conscious comprehension of existence & motion of matter.</p>
<p>Bidirectional syntonic reciprocity in monifier modality</p>	<p>Two objects of A and B which can interact each other as cause, once object A exists as cause of object B, leading change of object A causes consequent implementation of object B, we just call the leading change of object A causes consequent implementation of object B “direct consequent implementation of object B derived from leading change of object A”. Inversely, once object B exists as cause of object A, leading change of object B causes consequent implementation of object A, we just call the leading change of object B causes consequent implementation of object A “inverse consequent implementation of object A derived from leading change of object B”. When both object A and object B coexist as cause each other in time current, the synchronous consequent implementation of the both reciprocally reacted each other is just “bidirectional syntonic reciprocity</p>

	in monifier modality”, which is mostly quantitative change model of reciprocity similar as benign circle or vicious circle.
World dominant bidirectional syntonic reciprocity	Typical bidirectional syntonic reciprocity whose practical effect can cause remarkable impact all over the world.
World recessive bidirectional syntonic reciprocity	Typical bidirectional syntonic reciprocity, whereas, its practical effect can hardly cause remarkable impact all over the world.
Social production	Social practice people try to invoke and administrate ideal existence & motion towards necessity of social production and social life under proper historical background.
Contemporaneous scientific orthodoxy	No matter what progressive stage historical progress of science has proceeded to, and no matter how large historical authenticity tolerance of science is, as long as there is mainstream of ideological system about authenticity of nature, there must be proportionate authority who are either the contributors or loving successors of the mainstream of ideological system about authenticity of nature, once the contributors or loving successors of the mainstream of ideological system about authenticity of nature procure remarkable social legitimacy qualification in society, so-called “contemporaneous scientific orthodoxy” comes into being therefore.
Historical social legitimacy qualification of science	Once historical progress of science proceeds to some certain historical stage, scientific knowledge metabolism has come to its balance, and the relative mature humanistic ideology about authenticity of nature in proportion to contemporaneous historical background are still regarded as popular “scientific truths” of the age, we then say the so-called popular scientific truths of the age possess historical social legitimacy qualification of science.
Legitimacy livability ratio of scientific knowledge	In some certain historical period, once quantitative change of scientific knowledge proliferation and successive scientific knowledge metabolism come to relative balance, the quotient of the quantity of living scientific knowledge above total output of scientific knowledge proliferation of the historical period is just legitimacy livability ratio of scientific knowledge.
Metabolism ratio of scientific knowledge	In some certain historical period, once quantitative change of scientific knowledge proliferation and successive scientific knowledge metabolism come to relative balance, the quotient of the quantity of scientific knowledge washed out for scientific knowledge metabolism above total output of scientific knowledge proliferation of the historical period is just metabolism ratio of scientific knowledge.
Lineal logic extension in succession of contemporaneous scientific orthodoxy	So-called “lineal logic extension in succession of contemporaneous scientific orthodoxy” is a kind of logic model for scientific knowledge proliferation when historical progress of science in inherent optimum orientation towards historical authenticity tolerance of science 0 proceeds to some certain progressive stage, some certain relatively mature scientific knowledge in proportion to contemporaneous historical background has been promoted social legitimacy qualification of the age, the corresponding orthodox authorities (/temporal authority) consequently carry forward eulogistic scientific knowledge proliferation in rigid succession of contemporaneous scientific orthodoxy by subconscious implementation of lineal logic extension of their celebrated

As coherent natura naturans throughout cosmic evolution, instinctive PNT reciprocal equilibrium towards optimum PNT operation is radical potentiality & conditionality for cosmos always ready to orientate itself towards perfection.

	<p>legitimacy so as to crown all accessible existence & motion in their rational purview, which usually treats contemporaneous scientific orthodoxy as absolute scientific verity straightway even use it as “axiom” off the cuff in despite of whether contemporaneous scientific orthodoxy has been qualified as perfect ideological enantiomorph of ultimate authenticity of nature with scientific legitimacy qualification of historical authenticity tolerance of science 0 or not, no more what’s the scientific legitimacy qualification of historical authenticity tolerance of science of contemporaneous scientific orthodoxy.</p>
Historical legitimacy of science	<p>So-called “historical legitimacy of science” is, when science progress proceeds to some certain stage, progressive scientific knowledge proliferation and the proper scientific knowledge metabolism & knowledge metabolism campaign have slidden into relative finality, the popular scientific knowledge aggradation of the age.</p>
Scientific knowledge livability of contemporaneous scientific orthodoxy	<p>So-called “scientific knowledge livability of contemporaneous scientific orthodoxy” is, in a considerable historical period, followed remarkable quantitative change of both scientific knowledge proliferation and consequent scientific knowledge metabolism, once the active scientific knowledge proliferation and consequent scientific knowledge metabolism slide into relative finality, the ratio of amount of popular scientific knowledge created in the considerable period over total scientific knowledge created in the considerable period.</p>
Scientific knowledge metabolism ratio of contemporaneous scientific orthodoxy	<p>So-called “scientific knowledge metabolism ratio of contemporaneous scientific orthodoxy” is, in a considerable historical period, followed remarkable quantitative change of both scientific knowledge proliferation and consequent scientific knowledge metabolism, once the active scientific knowledge proliferation and consequent scientific knowledge metabolism slide into relative finality, the ratio of amount of out scientific knowledge ever created in the considerable period over total scientific knowledge created in the commensurate period.</p>
Pioneering originator of natura naturans personalization towards human necessity	<p>is just the pioneering implementors, who are always ready to discover and comprehend the authenticity of nature as much as possible draw on practical feasibility & possibility in proportion to contemporaneous historical background, so that it’s practically possible for them to administrate and utilize the ideal existence & motion accessible around for applicable personalization in accordance with social necessity, so that their endeavor can accomplish practical necessity of social production and social life in the nature of things, which is of course the most realistic and feasible way for human to know authenticity of nature and purposefully administrate & utilize ideal existence & motion accessible around us towards applicable accomplishment of practical necessity of social production and social life.</p> <p>Historical occurrence of “pioneering originator of natura naturans personalization towards human necessity” is the most remarkable indication of advancement of human civilization, whose core worthiness is that, draw on practical feasibility & possibility in proportion to contemporaneous historical background, they are always ready to discover and comprehend authenticity of nature as much as possible, and just because of further rational highlight of authenticity of nature, more ideal existence & motion around us become self-evidently accessible for practical accomplishment of natura naturans personalization towards human necessity.</p>
Greedy imitator	<p>is mostly successive imitation practice after practical accomplishment of pioneering natura</p>

Historical progress of science in the recent several centuries seemed like a far-flung exploration of the first itinerary around numerous distinctive landscapes of brand-new landmasses of science with palette & tablet on back, several hundred years’ scientific travelogues were compiled thereby.

<p>after pioneering natura naturans personalization towards human necessity</p>	<p>naturans personalization towards human necessity, as in greedy admiration of wonderful innovative output of the scientific pacemakers on the earth for pioneering natura naturans personalization towards human necessity, people who have not synchronously involved in the pioneering natura naturans personalization towards human necessity are greedy to learn and imitate the proper science & technology practice of the scientific pacemakers who are pioneering originators of natura naturans personalization towards human necessity for the same or similar technologic products.</p> <p>The most remarkable discrepancy between “pioneering originator of natura naturans personalization towards human necessity” and “greedy imitator after pioneering natura naturans personalization towards human necessity” is that, in order to accomplish ideal natura naturans personalization towards human necessity, pioneering originator of natura naturans personalization towards human necessity has to look into authenticity of nature in prior, otherwise, none ideal existence & motion can be accessible resource for natura naturans personalization towards human necessity; whereas, in terms of “greedy imitator after pioneering natura naturans personalization towards human necessity”, it’s obviously unnecessary for them to bet a lot for original discovery or clarification of authenticity of nature draw on practical feasibility & possibility in proportion to contemporaneous historical background. In any case, as pioneering originator of natura naturans personalization towards human necessity has brought out perfect products in prior, project pursuit of “greedy imitator after pioneering natura naturans personalization towards human necessity” has been ready-made scientific idea early, which mostly lay particular stress on learning and imitating pioneering originator of natura naturans personalization towards human necessity for accomplishment of practical output of similar products.</p>
<p>Authority ruffian</p>	<p>Authority ruffian is firstly straightforward egoistic morbidity walking on air for cook-a-hoop self-appreciation in defiance of factuality that, under permanent synthesized conditionality of “crescive progression of practical feasibility & possibility in proportion to contemporaneous historical background + the uniqueness & invariance of ultimate authenticity of nature predestines the unique possibility of scientific verity as perfect ideological enantiomorph of ultimate authenticity of nature” through and through, it’s only possible for the major melody of historical progress of science to be serial “epochmaking scientific knowledge metabolism” in inherent optimum orientation towards historical authenticity tolerance of science 0, and before humanistic ideology about authenticity of nature finally qualified as perfect ideological enantiomorph of ultimate authenticity of nature, it’s only possible for so-called science to be commensurate ideological system about authenticity of nature in proportion to contemporaneous historical background with proportionate historical authenticity tolerance of science.</p> <p>Authority ruffian is secondly unenlightened overbearing attitude to countercheck and blackball dissidents in accordance with egotistic criteria of contemporaneous scientific orthodoxy in defiance of inherent historical limitation of contemporaneous scientific orthodoxy. After all, in terms of any contemporaneous scientific orthodoxy out of scientific legitimacy qualification of historical authenticity tolerance of science 0, as long as historical progress of science is still in its normal way towards historical authenticity tolerance of science 0, it must be</p>

	<p>washed out soon or later. Virtually, it's only possible for any contemporaneous scientific orthodoxy out of scientific legitimacy qualification of historical authenticity tolerance of science 0 to exist as distinctive progressive segment in proportion to contemporaneous historical background in crescive progression of historical progress of science in inherent optimum orientation towards historical authenticity tolerance of science 0.</p>
<p>The ninth part</p>	<p>References Interpretation of Homogenous Cosmos Originated from Unique Genesis and Nowadays "Reference Popularity" Under Egotistic Background of Interminable Royal Substantiation & Perfection of Contemporaneous Scientific Orthodoxy</p>
<p>Reference</p>	<p>"Reference" is a sort of practical criterion of science, whose practical implementation generally implicates:</p> <p>The first, it is ready to acknowledge the logic origin of the scientific idea by presentation of reference.</p> <p>The second, it is ready to acknowledge the location of the scientific idea in integrative logic framework of some certain ready-made ideological system even the logic correlation with all related coordinative scientific ideas.</p> <p>As accessible & effective thought resource for living scientific knowledge proliferation of the age, and as reference popularity must be under esoteric guidance of contemporaneous scientific orthodoxy, especially inevitable restriction of free press admittance, the most straightforward practical significance of reference popularity is that interminable implementation of reference popularity under egotistic guidance of temporal authority must form invisible magisterial restriction of contemporaneous scientific orthodoxy, which grimly coerces that coming scientific knowledge proliferation all over the world must be in rigid succession of contemporaneous scientific orthodoxy, which maybe distorts even goes against original endeavor of historical progress of science to push humanistic ideology about authenticity of nature forward to perfect ideological enantiomorph of ultimate authenticity of nature step by step draw on practical feasibility & possibility in proportion to contemporaneous historical background.</p>
<p>Positive significance & negative significance of reference popularity</p>	<p>As permanent synthesized conditionality of "crescive progression of practical feasibility & possibility in proportion to contemporaneous historical background + the uniqueness & invariance of ultimate authenticity of nature predestines the unique possibility of scientific verity as perfect ideological enantiomorph of ultimate authenticity of nature" through and through, it's only possible for the major melody of historical progress of science to be serial "epochmaking scientific knowledge metabolism" in inherent optimum orientation towards historical authenticity tolerance of science 0; even as the most straightforward practical significance of reference popularity is that interminable implementation of reference popularity under egotistic guidance of temporal authority must form invisible magisterial restriction of contemporaneous scientific orthodoxy, which grimly coerces that coming scientific knowledge proliferation all over the world must be in rigid succession of contemporaneous scientific orthodoxy:</p> <p>Along historical progress of science in inherent optimum orientation towards historical authenticity tolerance of science 0, once some certain contemporaneous scientific orthodoxy primitively coming into being as innovative ideological system about authenticity of nature,</p>

	<p>popularity of reference is of course very expedient for the temporal authority to sparkplug substantiation and perfection of contemporaneous scientific orthodoxy, in any case, permanent implementation of popularity of reference can expediently restrict coming scientific knowledge proliferation in succession of contemporaneous scientific orthodoxy. In the early years of the contemporaneous scientific orthodoxy, as burgeoning substantiation and perfection of contemporaneous scientific orthodoxy \approx general progress of science, popularity of reference is of course expedient to accomplish its positive significance therefore.</p> <p>Along historical progress of science in inherent optimum orientation towards historical authenticity tolerance of science 0, once some certain contemporaneous scientific orthodoxy has exhausted its inherent potentiality for historical progress of science, so that freewheeling royal substantiation & perfection of contemporaneous scientific orthodoxy becomes more and more difficult to push humanistic ideology about authenticity of nature forward to perfect ideological enantiomorph of ultimate authenticity of nature on the spot. Whereas, reference popularity will still restrict coming scientific knowledge proliferation in succession of contemporaneous scientific orthodoxy magisterially, such kind of practice is not only inefficient to push humanistic ideology about authenticity of nature forward to perfect ideological enantiomorph of ultimate authenticity of nature, but also go against successive necessary renovation of humanistic ideology about authenticity of nature in proportion to contemporaneous historical background due to crecive progression of historical progress of science in inherent optimum orientation towards historical authenticity tolerance of science 0. And just because of this, once contemporaneous scientific orthodoxy exhausts its inherent potentiality for historical progress of science, reference popularity must contort even go against original endeavor of historical progress of science to push humanistic ideology about authenticity of nature forward to perfect ideological enantiomorph of ultimate authenticity of nature step by step draw on practical feasibility & possibility in proportion to contemporaneous historical background. reference popularity must expose its negative significance thereby.</p>
<p>Physical domino effect of superposition disturbance of matter fields</p>	<p>Gravity is but physical domino effect of superposition disturbance of matter fields of matter integration due to instinctive PNT reciprocal equilibrium towards optimum PNT operation of matter integration. And just because of the PNT operational feature of physical domino effect of superposition disturbance of matter field, there are more reasons for us to call it “Physical domino effect of superposition disturbance of matter fields” due to instinctive PNT reciprocal equilibrium towards optimum PNT operation.</p>
<p>physical domino effect of superposition disturbance of matter field with congeneric or complementary genic preponderance or genic insufficiency</p>	<p>The preconditions for occurrence of electromagnetic force is as below: The first, there are genic preponderance or genic insufficiency in matter fields of matter integration, so that the matter field of matter integration exhibit charterers as “electric field”, the matter field of matter integration implicating genic preponderance is negative electric field, the matter field of matter integration implicating genic insufficiency is negative electric field. The second, in terms of matter integration with genic preponderance or genic insufficiency in matter fields, once there is occurrence of superposition disturbance of matter fields, there must be physical domino effect due to instinctive PNT reciprocal equilibrium towards optimum</p>

As coherent natura naturans throughout cosmic evolution, instinctive PNT reciprocal equilibrium towards optimum PNT operation is radical potentiality & conditionality for cosmos always ready to orientate itself towards perfection.

	<p>PNT operation, which is course electromagnetic force between matter integration with genic preponderance or genic insufficiency in matter fields.</p> <p>In accordance with distinctions of superposition disturbance of matter fields with genic preponderance or genic insufficiency, there are three kinds of distinctive physical domino effect due to superposition disturbance of matter fields with genic preponderance or genic insufficiency:</p> <ol style="list-style-type: none"> ①. [(PNT action + PNT equilibrium instinct) + genic insufficiency] + [genic preponderance + (PNT action + PNT equilibrium instinct)] =Electromagnetic abstraction between different charges ②. [(PNT action + PNT equilibrium instinct) + genic insufficiency] + [genic insufficiency + (PNT action + PNT equilibrium instinct)] =Electromagnetic repulsion between positive charges ③. [(PNT action + PNT equilibrium instinct) + genic preponderance] + [genic preponderance + (PNT action + PNT equilibrium instinct)] =Electromagnetic repulsion between negative charges <p>And just because of the PNT operational feature of physical domino effect of superposition disturbance of matter fields with genic preponderance or genic insufficiency due to instinctive PNT reciprocal equilibrium towards optimum PNT operation, there are more reasons for us to call it “physical domino effect of superposition disturbance of matter field with congeneric or complemental genic preponderance or genic insufficiency” due to instinctive PNT reciprocal equilibrium towards optimum PNT operation.</p>
<p>Physical domino effect of PNT complemental linkage optimization among unsaturated particles in available space range</p>	<p>The preconditions for occurrence of strong interaction is as below:</p> <p>The first, as the convergent cumulation of mass of particles is rather limited, as a result, once the matter integration tries to accomplish PNT action between particle and inherent matter field, it’s really difficult for it to commensurate perfect PNT operational chain of matter integration independently.</p> <p>The second, if the distance among particles with PNT actions in imperfect PNT operational chain is short enough, as presence of instinctive PNT reciprocal equilibrium towards optimum PNT operation of matter integration, the imperfect PNT operational chains of particles very near will spontaneously linked up by the light of nature so as to make the PNT operational chain of PNT actions of the particles with very limited convergent cumulation of mass as perfect as possible. Of course, the perfection of PNT operational chain will remarkably cause convergent domino effect of aberrant convergence of cosmic esse due to PNT reciprocal gelation, the particles is consequently converged into more heavy reciprocal PNT combinations, such typical convergent domino effect is just the so-called “strong interaction”.</p> <p>And just because of the PNT operational feature of physical domino effect of PNT linkage of imperfect PNT operational chain of particles due to instinctive PNT reciprocal equilibrium towards optimum PNT operation, there are more reasons for us to call strong interaction “physical domino effect of PNT complemental linkage optimization among unsaturated particles in available space range” due to instinctive PNT reciprocal equilibrium towards optimum PNT operation.</p>

2. Interpretation of special nouns & items discrepancy between Homogenous Cosmos Originated from Unique Genesis and contemporaneous scientific orthodoxy

2.1. What kind of vine inherently produces the proper melons, what kind of tree inherently produces the proper fruits; “distinctive background rationale” and “proportionate logic proliferation” radically predestines the rational proliferation of proportionate nouns & items of idiographic ideological system like DNA doing its job to proper organisms. The remarkable discrepancy of special nouns & items between Homogenous Cosmos Originated from Unique Genesis and traditional sciences radically originates from their distinctive background rationale and proper logic proliferation.

Rational proliferation of **special nouns & items of Homogenous Cosmos Originated from Unique Genesis** is systematical outgrowth along lineal logic extension of connotation objectification and freewheeling logic extension of homogenous cosmos originated from unique genesis, which is **integrative special nouns & items series** about homologic attribute of spacetime and matter, universal existence & motion against essence of matter in a class by itself on the basis of **[(homogenous cosmos originated from unique genesis + spacetime matter fully embodying cosmos) + Instinctive PNT equilibrium]**.

As timely renovation of humanistic ideology about authenticity of nature in proportion to contemporaneous historical background of **remarkable highlight of microcosmic configuration of matter** in the recent one century, Homogenous Cosmos Originated from Unique Genesis is brand-new cosmos redefinition with consequent PNT dynamics about universal existence & motion in the nature of coherent natura naturans throughout cosmic evolution. As factuality that **discretionary particles in cosmos are mutually convertible** is always in live orientation towards complete induction day by day, which apparently indicates that cosmos is homogenous originated from unique genesis through and through, I introduced “**Homogenous cosmos originated from unique genesis postulate**” accordingly. And subsequently, I expanded the logic connotation of “**Homogenous cosmos originated from unique genesis postulate**” with necessary supplementation of two accessorial postulates as “**spacetime-matter fully embodying cosmos postulate**” and “**Instinctive PNT equilibrium postulate**”, I came to redefine cosmos following a rational line of cosmic homologic evolution starting at genic origin to cosmic status quo, and in accordance with inherent homologic attribution of spacetime and matter even lineal homologic correlation between spacetime and matter, I confirmed the inherent homologic “positive & negative Transmutation” correlation between spacetime and matter, which radically determines inherent existence & motion of matter in spacetime out of question. And finally, as introduction of “**Instinctive PNT equilibrium postulate**”, the dynamic fundamental of universal existence & motion become self-evident, I came to formulate universal existence & motion accordingly.

And just because endeavor of renovation of humanistic ideology about authenticity of nature in proportion to contemporaneous historical background of remarkable highlight of microcosmic configuration of matter, in theoretical model, Homogenous Cosmos Originated from Unique Genesis is typical lineal logic system about universal existence & motion in proportion to coherent natura naturans throughout cosmic evolution, which is virtually lineal logic extension on the basis of **[(homogenous cosmos originated from unique genesis + spacetime matter fully embodying cosmos) + Instinctive PNT equilibrium]**, which is apparently different from traditional sciences as physics, chemistry, biology, iatrology etc as colorful scientific travelogues like omnifarious smallwares full of a basket.

As a result, all special nouns and items of Homogenous Cosmos Originated from Unique Genesis are completely in an integrative lineal series along connotation objectification and freewheeling logic extension of homogenous cosmos originated from unique genesis about essential attribute of spacetime and matter as coordinative homology fully embodying cosmos, coherent PNT dynamics about universal existence & motion as straightforward consequence of lineal logic extension on the basis of **[(homogenous cosmos originated from unique**

As coherent natura naturans throughout cosmic evolution, instinctive PNT reciprocal equilibrium towards optimum PNT operation is radical potentiality & conditionality for cosmos always ready to orientate itself towards perfection.

genesis + spacetime matter fully embodying cosmos) + Instinctive PNT equilibrium].

In straightforward words, Homogenous Cosmos Originated from Unique Genesis originally came out of two sixty-four-dollar questions:

The first: Since discretionary particles in cosmos are mutually convertible \leftrightarrow for they ultimately possess the common components in certain configurable hierarchy, is cosmos really homogenous originated from unique genesis through and through?

The second: If yes, what integrative cosmic homologic configuration and proportionate universal homologic existence & motion should be accordingly?

The whole monograph is just lineal logic expansion along rationale of the two sixty-four-dollar questions above. As a result, as necessary elements of literal expression of the ideological system about homogenous cosmos originated from unique genesis, all the necessary nouns & items are introduced one by one following a rational line of logic expansion of the two sixty-four-dollar questions above.

Relatively, the most remarkable character of live contemporaneous scientific orthodoxy is that it's inertial ideological aggradation of all-time remarkable transverse ideological expansion in the recent several centuries, which is typical unsystematized ideological system about universal existence & motion making up of rich and colorful scientific travelogues A, B, C, D, E, F, ... like omnifarious smallwares full of a basket. Virtually, historical progress of science in the recent several centuries seemed like a far-flung exploration of the first itineracy around numerous distinctive landscapes of brand-new landmass of science with palette & tablet on back, several hundred years' scientific travelogues were compiled thereby. And it's just the ideological aggradation of rich and colorful scientific travelogues A, B, C, D, E, F, ... like omnifarious smallwares full of a basket which makes up of nowadays distinctive physics, chemistry, biology, iatrology etc.

We have to admit the ideological aggradation of rich and colorful scientific travelogues in general academic classification as conventional physics, chemistry, biology, iatrology etc are but distinctive logs of the first itineracy around the brand-new landmasses of science, which neither originally came into being in accordance with definite uniform logic precondition, nor came into being in accordance with coherent background rationale; it is of course not integrative coherent ideological system about universal existence & motion as radical ideological enantiomorph of serial natura naturata in the nature of coherent natura naturans throughout cosmic evolution, no more perfect ideological enantiomorph of ultimate authenticity of nature, but colorful scientific travelogues A, B, C, D, E, F, ... like omnifarious smallwares full of a basket about numerous distinctive matter specimens accessible. As a result, all the ingenerate nouns & items in traditionary sciences as physics, chemistry, biology, iatrology etc are even more colorful accumulation of unsystematic nouns & items like omnifarious smallwares full of basket which originally come into being in omnifarious scientific travelogues A, B, C, D, E, F, ... about numerous matter specimen accessible then and there.

And now, since the colorful scientific travelogues like omnifarious smallwares full of a basket about numerous distinctive matter specimens accessible have procured social legitimacy qualification of the age, a group of so-called temporal authority come into being thereby, whose historical role is instinctively ready to sparkplug substantiation & perfection of contemporaneous scientific orthodoxy at the volley, when royal substantiation & perfection of contemporaneous scientific orthodoxy \approx general progress of science, they are of course honorary and popular, once demode royal substantiation & perfection of contemporaneous scientific orthodoxy \neq general progress of science, their official role must be esoteric even pestilent in proportion to aberrancy of royal substantiation & perfection of contemporaneous

Historical progress of science in the recent several centuries seemed like a far-flung exploration of the first itineracy around numerous distinctive landscapes of brand-new landmasses of science with palette & tablet on back, several hundred years' scientific travelogues were compiled thereby.

scientific orthodoxy out of general progress of science in inherent optimum orientation towards perfect ideological enantiomorph of ultimate authenticity of nature.

In any case, we could be proud that human have substantively traveled a long way through brand-new landmasses of science in the recent several centuries, where we have really experienced numerous vivid landscapes of the brand-new landmasses of science with numerous scientific travelogues compiled on the spot thereby. And just because of the inevitable historical reality, the ready-made special nouns & items of traditionary sciences as physics, chemistry, biology, iatrology etc are substantively special nouns & items accumulation like omnifarious smallwares full of a basket distributed in colorful scientific travelogues about many many distinctive matter specimens accessible.

Since the discrepancy of background rationale and proportionate logic proliferation between Homogenous Cosmos Originated from Unique Genesis and traditionary sciences as physics, chemistry, biology iatrology etc is so remarkable, the consequent discrepancy of special nouns & items between Homogenous Cosmos Originated from Unique Genesis and traditionary sciences is of course necessary and inevitable. If coming ideological system about authenticity of nature has to be generated systematically in lineal logic system of Homogenous Cosmos Originated from Unique Genesis in proportion to coherent natura naturans throughout cosmic evolution, then, all the neonatal special nouns & items along lineal logic system in proportion to coherent natura naturans throughout cosmic evolution must be remarkably different from the ready-made special nouns & items of traditionary sciences, and there must be no reasons for you to tell apart which one is special noun or item belonging to physics, which one is special noun or item belonging to chemistry or biology.

What's more, once we introduce systematical state equations in accordance with Mathematical Definition of Homogenous Cosmos Originated from Unique Genesis to formulate all physical existence & motion of universal reciprocal PNT combinations in spacetime, less literal description will be necessary in ideological system about authenticity of nature, and the total special nouns & items in ideological system about authenticity of nature will be remarkably less than special nouns & items of live contemporaneous scientific orthodoxy. We can primarily estimate that there may be 60% special nouns & items in live contemporaneous scientific orthodoxy will be washed out or be covered (or only to leave them in history books) at least. And of course, the neonatal special nouns & items along lineal logic system in proportion to coherent natura naturans throughout cosmic evolution must be more systematical, condense and regular. Virtually, the more humanistic ideology about authenticity of nature close to perfect ideological enantiomorph of ultimate authenticity of nature, the rationale of science is more superior and general, there are less scientific truths, less and less special nouns & items are necessary for formulation of universal existence & motion thereby.

For instance, in microphysics, the names of various particles are so rich and colorful, such as boson, quark, antiquark, meson ... electron, proton ..., which seem like heavy snow flying in the sky. For convenience to study and formulate comprehensive idiographic existence & motion of particles in cosmos as common reciprocal PNT combinations in appropriate state equations, and in order to ensure the purity & coherence of the whole logic system about particles in inherent homologic series, Homogenous Cosmos Originated from Unique Genesis will have to neglect all the omnifarious nouns and items of traditionary sciences, but to think more of the original sequence of demiurgic multiplication & combination of all the particles from simpleness to complexity in accumulative configuration of genes as $i_0, i_1, i_2, \dots, i_n$ to $i_{n+1}, i_{n+2}, i_{n+3} \dots i_{n+p} \dots$ till $\sum m_{Atom} = \int_{i_0}^{X_{Atom}} f(m_{i_0 \rightarrow X}) i_0$

As coherent natura naturans throughout cosmic evolution, instinctive PNT reciprocal equilibrium towards optimum PNT operation is radical potentiality & conditionality for cosmos always ready to orientate itself towards perfection.

to rename comprehensive particles systematically, which may be similar as the naming of chemical objects as alkyl series and hydrocarbon series.

For the same reason of thorough coherence of natura naturans throughout cosmic evolution, once we introduce systematical state equations in mathematical natura naturans style to formulate comprehensive reciprocal PNT combination in gradation II and reciprocal PNT combination in gradation III, most of the special nouns & items in traditionary science as chemistry, biology and iatrology will be washed out going without saying. After all, **it's only possible for concordant cosmos to be demiurgic aggradation of out-and-out serial natura naturata in the nature of coherent natura naturans throughout cosmic evolution; there is no way for demiurgic aggradation in the nature of different natura naturans to be concordant cosmos through and through** Once we try to formulate universal existence & motion in coherent fundamental through and through, language of science must be most systematical and monotone in proportion to coherent natura naturans throughout cosmic evolution.

Another even typical instance is that, **“reciprocal PNT combination”** is the most typical special noun in Homogenous cosmos Originated from Unique Genesis, which is the best incarnation of significance of homogenous cosmos originated from unique genesis and coherent natura naturans throughout cosmic evolution. In straightforward words, as typical outgrowth of **aberrant convergence of cosmic esse due to PNT reciprocal gelation**, “reciprocal PNT combination” is just natura naturata of coherent natura naturans throughout cosmic evolution in the nature of instinctive PNT reciprocal equilibrium towards optimum PNT operation, whose logic connotation and logic extension almost includes essence of homogenous cosmos originated from unique genesis. Of course, **aberrant convergence of cosmic esse due to PNT reciprocal gelation** is virtually hypostatic performance of coherent natura naturans in the nature of instinctive PNT reciprocal equilibrium towards optimum PNT operation throughout cosmic evolution.

And indeed, **aberrant convergence of cosmic esse due to PNT reciprocal gelation** is just the hypostatic physical process that elementary genic units and reciprocal PNT combinations originally come into being and postnatal existence & motion in spacetime—freewheeling of **{[stochastic accomplishment of “reciprocal idiosyncrasy towards PNT equilibrium + accessible space overall arrangement for PNT reciprocity” among compositive components] + consequent convergence of compositive components in the nature of instinctive PNT reciprocal equilibrium towards optimum PNT operation}**, which is just freewheeling performance of coherent natura naturans throughout cosmic evolution. As a result, besides free elementary genic units in spacetime, the demiurgic outgrowth are uniform reciprocal PNT combinations through and through! Although, ostensibly, the cosmos seems so rich and colorful, the demiurgic creation is but freewheeling coherent natura naturans as **{[stochastic accomplishment of “reciprocal idiosyncrasy towards PNT equilibrium + accessible space overall arrangement for PNT reciprocity” among compositive components] + consequent convergence of compositive components in the nature of instinctive PNT reciprocal equilibrium towards optimum PNT operation}** through and through.

Original generation of universal reciprocal PNT combinations is just previous output of freewheeling coherent natura naturans eversince, and postnatal existence & motion of universal reciprocal PNT combinations is too ongoing performance of freewheeling coherent natura naturans through and through. Original generation of all non-living things besides elementary genic units is just previous output of freewheeling coherent natura naturans eversince, and postnatal existence & motion of non-living things besides elementary genic units is too ongoing performance of freewheeling coherent natura naturans through and through. Original generation of all organisms is just previous output of freewheeling coherent natura naturans eversince, and postnatal existence

& motion of organisms is too ongoing performance of freewheeling coherent natura naturans through and through.

In logic extension, **cosmic contents = field genic units + elementary genic units + reciprocal PNT combinations**, which of course indicates, cosmic contents are all reciprocal PNT combinations besides field genic units and elementary genic units, relatively, reciprocal PNT combinations have more hypostatic significance of coherent natura naturans in the nature of instinctive PNT reciprocal equilibrium towards optimum PNT operation than field genic units and elementary genic units, which even indicates that reciprocal PNT combinations in cosmos virtually include all particles besides elementary genic units, subatomic units, atoms, molecule, molecular system, ..., mineral, organism, ..., celestial bodies, galaxy, superior galaxy, ...

We study universal existence & motion are virtually endeavor to study hypostatic existence & motion of **cosmic contents = field genic units + elementary genic units + reciprocal PNT combinations**, once we are able to formulate **{[stochastic accomplishment of “reciprocal idiosyncrasy towards PNT equilibrium + accessible space overall arrangement for PNT reciprocity” among compositive components] + consequent convergence of compositive components in the nature of instinctive PNT reciprocal equilibrium towards optimum PNT operation}** mathematically, as ideological system about authenticity of nature, existence & motion of universal reciprocal PNT combinations will consequently turn into mathematical natura naturans style state equations. Once we are able to formulate universal reciprocal PNT combinations in mathematical natura naturans style state equation, as ideological enantiomorph of authenticity of nature, in terms of universal existence & motion against essence of matter in a class by itself, science will consequently turn into uniform mathematical state equations in proportion to coherent natura naturans throughout cosmic evolution, and so-called physics, chemistry, biology, iatrology etc will be immediately inferior by comparison.

And further more, in the coherent lineal logic system of Homogenous Cosmos Originated from Unique Genesis, definition of force is unique and coherent in cosmos; — “force” is but dynamic domino effect in the nature of **instinctive PNT reciprocal equilibrium towards optimum PNT operation** for external physical disturbance of PNT operation of matter integration, —spontaneous occurrence of matter integration due to **“external physical disturbance + (PNT action + instinctive PNT equilibrium)”**. The uniform mathematical expression of force is $F=m*K'(t)*Y(t)$, in which the magnitude of “m” denotes the positive mass of matter integration, the value of “m” is continuous in quantitative range $(0, +\infty)$ implies the dynamic attribute of all cosmic objects with different mass scale is coherent; $|K'(t)| \neq 0$ indicates the PNT performance of matter integration is inconstant, $*Y(t)$ in equation indicates the dynamic origin of force is “time dynamic speed”.

All force domino effect are radically rooted in PNT action with equilibrium instinct, discrepancy among distinctive forces are but limited in what kind of active ingredients in PNT operational mechanism cause disturbance and proportionate variation of PNT operation and consequently cause unbalanced PNT domino effect due to instinctive PNT reciprocal equilibrium towards optimum PNT operation. If it was not because people have been used to comprehending the authenticity of nature by stepping the conventional footprints, there is no possibility for Homogenous Cosmos Originated from Unique Genesis to think of such kind of nouns as gravity, electromagnetic force, strong interaction and weak interaction. In a straightforward word, special nouns of gravity, electromagnetic force, strong interaction and weak interaction are completely out of lineal logic extension of Homogenous Cosmos Originated from Unique Genesis on the basis of **[(homogenous cosmos originated from unique genesis + spacetime matter fully embodying cosmos) + Instinctive PNT equilibrium]**. Just because it's

As coherent natura naturans throughout cosmic evolution, instinctive PNT reciprocal equilibrium towards optimum PNT operation is radical potentiality & conditionality for cosmos always ready to orientate itself towards perfection.

necessary for Homogenous Cosmos Originated from Unique Genesis to acclimate itself harmoniously in crecive progression of historical progress of science, I had to mention them at the volley.

Virtually, both gravity, electromagnetic force root in PNT equilibrium instinct equally, but some distinctive configurable or formative ingredients of matter field which directly involve in PNT operation of matter integration tell apart them. And strong interaction is but PNT equilibrium domino effect of instinctive PNT reciprocal equilibrium towards optimum PNT operation due to availability of reciprocal PNT operational linkage optimization between particles.

As inherent macroscopical structure of matter field of matter integration is one of the active ingredients which directly influences the inherent operation of PNT action, once the macroscopical structure of matter field is disturbed, the PNT operation of matter integration will be involved thereby, and matter integration will arises instinctive PNT equilibrium reaction for variation of active ingredients of PNT operation, which is of course physical domino effect of matter integration in the nature of instinctive PNT reciprocal equilibrium towards optimum PNT operation. Gravity is just this kind of physical domino effect of matter integration due to instinctive PNT reciprocal equilibrium towards optimum PNT operation, which is radically caused by distortion of macroscopical structure of matter field for disturbance of matter field superposition.

Originally, in accordance with effective logic proliferation of Homogenous Cosmos Originated from Unique Genesis, I have more reasons to call gravity “**physical domino effect of superposition disturbance of matter fields**” for distortion of macroscopical structure of matter field due to instinctive PNT reciprocal equilibrium towards optimum PNT operation. In any case, it’s straightforward physical domino effect of PNT reaction due to instinctive PNT reciprocal equilibrium towards optimum PNT operation caused by distortion of macroscopical structure of matter field for disturbance of matter field superposition. Whereas, I did not change the proper noun like this but to introduce “**gravity**” without hesitation. After all, almost all educated people on the earth have been used to looking into the very authenticity of nature by stepping the “conventional footprint” already.

Comparably, the introduction of the two nouns of “electromagnetic force” and “strong interaction” were not so awkward as the introduction of noun of “gravity”. Leastways, with supplemental explanation of Homogenous Cosmos Originated from Unique Genesis, these two nouns can still cover their full inherence.

Of course, along lineal logic extension of Homogenous Cosmos Originated from Unique Genesis towards rational proliferation of special nouns & items, I have more reasons to introduce electromagnetic force another more appropriate noun of “**physical domino effect of superposition disturbance of matter field with congeneric or complemental genic preponderance or genic insufficiency**” due to instinctive PNT reciprocal equilibrium towards optimum PNT operation of matter integration. And I have more reasons to introduce strong interaction another more appropriate noun of “**Physical domino effect of PNT complemental linkage optimization among unsaturated particles in available space range**” due to instinctive PNT reciprocal equilibrium towards optimum PNT operation of matter integration, which is of course physical domino effect caused by instinctive PNT reciprocal linkage optimization in available space range as to consummate PNT operational circulation among particles.

All n all, force is but physical domino effect of spontaneous occurrence of [**external physical disturbance + (PNT action + Instinctive PNT equilibrium)**].

As particularity of homologic configuration of matter due to coherent natura naturans throughout cosmic evolution, the so-called “**external physical disturbance**” has individual instances as “**physical disturbance of matter field**

Historical progress of science in the recent several centuries seemed like a far-flung exploration of the first itinerary around numerous distinctive landscapes of brand-new landmasses of science with palette & tablet on back, several hundred years’ scientific travelogues were compiled thereby.

superposition”, “physical disturbance of matter field superposition with congeneric or complemental genic preponderance or genic insufficiency”, “PNT complemental linkage optimization among unsaturated particles in available space range”, so that the physical domino effect of spontaneous occurrence of [external physical disturbance + (PNT action + Instinctive PNT equilibrium)] is consequently individualized into:

- ①. Physical domino effect of spontaneous occurrence of [physical disturbance of matter field superposition + (PNT action + Instinctive PNT equilibrium)], which is just so-called “gravity”.
- ②. Physical domino effect of spontaneous occurrence of [physical disturbance of matter field superposition with congeneric or complemental genic preponderance or genic insufficiency + (PNT action + Instinctive PNT equilibrium)], which is just so-called “electromagnetic force”.
- ③. Physical domino effect of spontaneous occurrence of [PNT complemental linkage optimization among unsaturated particles in available space range + (PNT action + Instinctive PNT equilibrium)], which is just so-called “strong interaction”.

The logical constitution of above individualization of force can be illustrated as below:

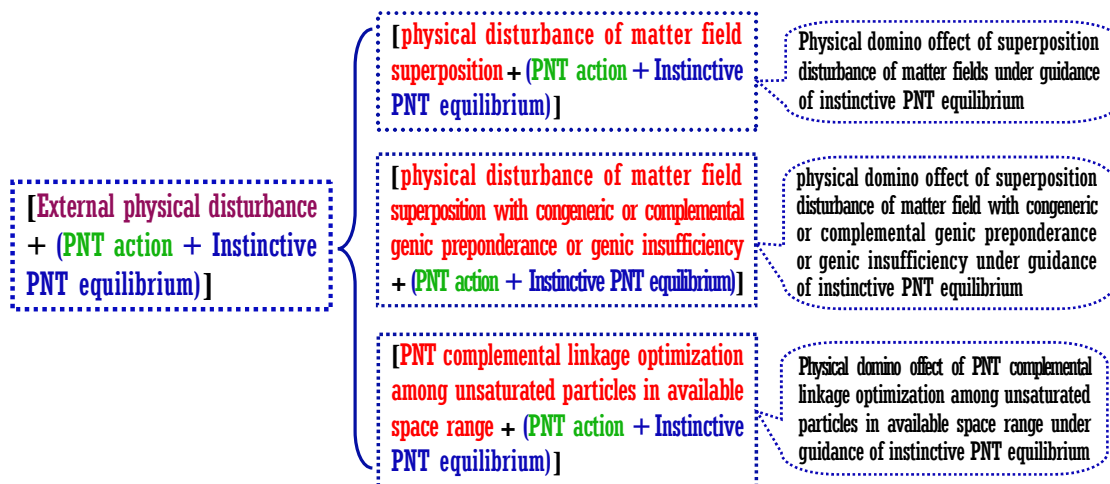

(IX-v-1) Logic constitution of individuality classification of force

The similar cases are of course more than these I enumerated herein.

2.2. As permanent synthesized conditionality of “crescive progression of practical feasibility & possibility in proportion to contemporaneous historical background + the uniqueness & invariance of ultimate authenticity of nature predestines the unique possibility of scientific verity as perfect ideological enantiomorph of ultimate authenticity of nature” through and through, it's only possible for the major melody of historical progress of science to be a series of epochmaking scientific knowledge metabolism in inherent optimum orientation towards historical authenticity tolerance of science 0, proportionate metabolism of special nouns & items distributed in humanistic ideology about authenticity of nature in proportion to contemporaneous historical background must be involved in synchronously.

Since it's only possible for “ultimate authenticity of nature” to be unique and invariable, as ideological enantiomorph of accessible existence & motion, ultimate consummation of science must be perfect ideological enantiomorph of ultimate authenticity of nature, and veritable progress of science must be hypostatic endeavor to push humanistic ideology about authenticity of nature forward to perfect ideological enantiomorph of ultimate authenticity of nature draw on practical feasibility & possibility in proportion to contemporaneous historical background, but not permanent endeavor of substantiation and perfection of contemporaneous scientific orthodoxy. Historical progress of science in inherent optimum orientation towards perfect ideological enantiomorph of

As coherent natura naturans throughout cosmic evolution, instinctive PNT reciprocal equilibrium towards optimum PNT operation is radical potentiality & conditionality for cosmos always ready to orientate itself towards perfection.

ultimate authenticity of nature must bring out gradational update of ideological enantiomorph about authenticity of nature, which must consequently bring out proportionate gradational series of scientific knowledge metabolism in inherent optimum orientation towards perfect ideological enantiomorph of ultimate authenticity of nature. Of course, the practical accomplishment of gradational series of “epochmaking scientific knowledge metabolism” must include accessorial accomplishment of necessary update & metabolism of special nouns & items at the volley.

We should be aware of the factuality that, what kind of vine always produces the proper melons by itself, what kind of tree always produces the proper fruits in the nature of things; “background rationale” and “proportionate logic proliferation” of realistic scientific knowledge proliferation radically restricts the coordinative rational proliferation of proper nouns & items of idiographic ideological system like DNA doing its job to proper organisms. As literal expression of ideological system about authenticity of nature, it’s only possible for logic proliferation of spacial nouns & items to be consequential coherence of logic extension derived from distinctive background rationale.

In accordance with the remarkable discrepancy of special nouns & items between temporal scientific travelogues of traditionary sciences as physics, chemistry, biology iatrology etc and perfect ideological enantiomorph of ultimate authenticity of nature, looking forward to development of science on stand of today, we have no reasons to demand coming academicians to invoke ready-made special nouns & items of tradition always and refuse them to introduce different nouns & items for literal expression of future ideological system about authenticity of nature. Instead, we should look forward to necessary optimization of special nouns & items in accordance with logic necessity and expressive expedience of timely renovation of humanistic ideology about authenticity of nature in proportion to contemporaneous historical background due to positive historical progress of science in inherent optimum orientation towards historical authenticity tolerance of science 0. Since we have to admit remarkable discrepancy of ideological system between perfect ideological enantiomorph of ultimate authenticity of nature and nowadays scientific travelogues A, B, C, D, E, F, ... of the first itinerary around brand-new landmasses of science, we then have to admit the proportionate discrepancy if special nouns & items between perfect ideological enantiomorph of ultimate authenticity of nature and nowadays scientific travelogues A, B, C, D, E, F, ... derived from the first itinerary around brand-new landmasses of science.

All in all, as long as we have to admit that ultimate authenticity of nature can be neither authenticity smallwares full of a basket nor authenticity chameleon one piece and only but coherent natura naturans throughout cosmic evolution, we then have to admit that ultimate consummation of science must be perfect ideological enantiomorph of ultimate authenticity of nature, none else, and as crescive progression of practical feasibility & possibility, before humanistic ideology about authenticity of nature finally qualified as perfect ideological enantiomorph of ultimate authenticity of nature, it’s only possible for so-called science to be commensurate ideological system about authenticity of nature in proportion to contemporaneous historical background, and veritable progress of science is not historical process human stochastically approach distinctive scientific truths one after another but hypostatic endeavor to push humanistic ideology about authenticity of nature forward to perfect ideological enantiomorph of ultimate authenticity of nature step by step draw on practical feasibility & possibility in proportion to contemporaneous historical background. Throughout historical progress of science in inherent optimum orientation towards perfect ideological enantiomorph of ultimate authenticity of nature, ideological system about authenticity of nature is always a variable, as literal expression elements of ideological system about authenticity of nature, special nouns & items of ideological system about authenticity of

nature must be the proportionate variable along historical progress of science in inherent optimum orientation towards perfect ideological enantiomorph of ultimate authenticity of nature.

In any case, since **ultimate authenticity of nature** can be neither omnifarious authenticity smallwares full of a basket nor authenticity chameleon one piece and only but coherent natura naturans throughout cosmic evolution, as commensurate ideological enantiomorph of accessible existence & motion around us, ultimate consummation of science must be perfect ideological enantiomorph of ultimate authenticity of nature, veritable progress of science is not intuitional cumulative achievement of colorful scientific travelogues A, B, C, D, E, F, ... as deserving reward of the first itinerary around preternatural landscapes of brand-new landmasses of science like omnifarious smallwares full of a basket but successive hypostatic endeavor to push humanistic ideology about authenticity of nature forward to perfect ideological enantiomorph of ultimate authenticity of nature step by step draw on practical feasibility & possibility in proportion to contemporaneous historical background. And as permanent synthesized conditionality of **“crescive progression of practical feasibility & possibility in proportion to contemporaneous historical background + the uniqueness & invariance of ultimate authenticity of nature predestines the unique possibility of scientific verity as perfect ideological enantiomorph of ultimate authenticity of nature”** through and through, it's only possible for the major melody of historical progress of science to be a series of epochmaking scientific knowledge metabolism in inherent optimum orientation towards historical authenticity tolerance of science 0, proportionate metabolism of special nouns & items distributed in scientific knowledge must be synchronously involved in. Once it's possible for us to bring the quantitative change of typical transverse ideological expansion of nowadays scientific travelogues A, B, C, D, E, F, ... of the first itinerary around brand-new landmasses of science into typical qualitative change as longitudinal ideological optimization similar as what Homogenous Cosmos Originated from Unique Genesis has done herein, we must immediately find the remarkable discrepancy of theoretical model of ideological system about authenticity of nature as well as proportionate discrepancy of special nouns & items in innovative ideological system about authenticity of nature between successive renovation of humanistic ideology about authenticity of nature in proportion to contemporaneous historical background and nowadays scientific travelogues A, B, C, D, E, F, ... of the first itinerary around brand-new landmasses of science.

No matter whether it's Homogenous Cosmos Originated from Unique Genesis ready to formulate authenticity of nature as perfect ideological enantiomorph of ultimate authenticity of nature or not, we can of course imagine the necessary discrepancy between special nouns & items introduced in perfect ideological enantiomorph of ultimate authenticity of nature and the ready-made special nouns & items introduced in nowadays scientific travelogues A, B, C, D, E, F, ... of the first itinerary around brand-new landmasses of science. Along crescive progression of historical progress of science in inherent optimum orientation towards perfect ideological enantiomorph of ultimate authenticity of nature, the necessary metabolism of special nouns & items in coming days is of course imaginable.

Since **“ultimate authenticity of nature”** can be neither omnifarious authenticity smallwares full of a basket nor authenticity chameleon one piece and only, but coherent natura naturans throughout cosmic evolution; and cosmic status quo is but demiurgic aggradation of sequential homologic cosmogony as well-regulated cosmic homogeneity system making up of out-and-out serial natura naturata in the nature of coherent natura naturans throughout cosmic evolution, as humanistic ideology about authenticity of accessible existence & motion in proportion to contemporaneous historical background, it's only possible for ultimate consummation of science to

be perfect ideological enantiomorph of coherent natura naturans throughout cosmic evolution (/ultimate authenticity of nature). Veritable progress of science is not skin-deep cumulative achievement of rich and colorful scientific travelogues A, B, C, D, E, F, ... as deserving reward of the first itinerary around numerous distinctive landscapes of brand-new landmasses of science like omnifarious smallwares full of a basket but realistic endeavor to push humanistic ideology about authenticity of nature forward to perfect ideological enantiomorph of ultimate authenticity of nature as coherent theory about universal existence & motion step by step draw on practical feasibility & possibility in proportion to contemporaneous historical background, which is hypostatic process of realistic historical progress of science in inherent optimum orientation towards historical authenticity tolerance of science 0.

However, as unprecedented official facility of magistral autarchy of **free press regulation customization & free press admittance** of temporal authority short of necessary intendance, freewheeling endeavor of interminable royal substantiation & perfection of contemporaneous scientific orthodoxy can be deified unlimitedly, so-called science forum consequently turns into out-and-out homegrown outgrowth in the garden of contemporaneous scientific orthodoxy at the volley. As distinctive segment of crecive progression of historical progress of science in inherent optimum orientation towards perfect ideological enantiomorph of ultimate authenticity of nature after remarkable transverse ideological expansion in the recent several centuries, it seems unintelligible for top journals on the earth to be so rich and colorful <reviews of modern physics>, <reviews of modern chemistry>, <reviews of modern biology> etc, instead, it should be **advance towards perfect ideological enantiomorph of ultimate authenticity of nature** the one and only once authenticity of **homogenous cosmos originated from unique genesis** is confirmed and systematical unique-genesis quantization formulation of universal existence & motion along sequential homologic cosmogony starting at field genic origin i_0 to universal reciprocal PNT combinations in the nature of coherent natura naturans throughout cosmic evolution become our unswerving pursuit therefore.

At any rate, the motivation of humanistic classification of disciplines & subdisciplines has apparently desecrated originality of coherent natura naturans throughout cosmic evolution of the demiurge, although, as crecive progression of practical feasibility & possibility, it's only possible for human coming to discover and formulate authenticity of accessible existence & motion from nothingness to goot, from goot to a great lot, and consequently followed the proportionate ideaistic correction & qualitative optimization from superficiality to profundity, from parochiality to generality.

And indeed, as interminable royal substantiation & perfection of contemporaneous scientific orthodoxy under egotistic guide of temporal authority draw on unprecedented official facility of magistral autarchy of free press regulation customization and free press admittance short of necessary intendance, there has been remarkable aberrancy relative to general progress of science to push humanistic ideology about authenticity of nature forward to perfect ideological enantiomorph of ultimate authenticity of nature draw on practical feasibility & possibility in proportion to contemporaneous historical background, so-called modern physics has slidden into unintelligible perplexity fighting its way in riancy with extravagant backup of unprecedented authoritative intrepidity of contemporaneous scientific orthodoxy.

Acknowledgement: The original cause I wrote down the **discrepancy interpretation about special noun & items between Homogenous Cosmos Originated from Unique Genesis and Traditionary Sciences** of this section in Dec 2008 was that I received suggestion

Historical progress of science in the recent several centuries seemed like a far-flung exploration of the first itinerary around numerous distinctive landscapes of brand-new landmasses of science with palette & tablet on back, several hundred years' scientific travelogues were compiled thereby.

mails from comrade Zhixie who persisted that special noun & items of Homogenous Cosmos Originated from Unique Genesis were too distinctive and special relative to tradition, as brand-new scientific idea, Homogenous Cosmos Originated from Unique Genesis must adopt conventional nouns and items of contemporaneous scientific orthodoxy as much as possible, otherwise, nobody would like to read and understand, no more free press admittance & social legitimacy authorization. In straightforward words, he suggested me to zealously acclimate myself aiming at necessity of so-called "free press egotistic proximity identification" of temporal authority. I could of course comprehend his goodwill, whereas, I was substantively reluctant to adopt ready-made nouns & items of tradition out of lineal logic extension of [(Homogenous cosmos originated from unique genesis postulate + spacetime~matter fully embodying cosmos postulate) + Instinctive PNT equilibrium postulate]. After all, Homogenous Cosmos Originated from Unique Genesis is typical cosmos redefinition in logic enantiomorph of newly highlighted factuality that discretionary particles in cosmos are mutually convertible with consequent PNT dynamics about universal existence & motion in the nature of coherent natura naturans throughout cosmic evolution but not traditionary scientific travelogues A, B, C, D, E, F ... like omnifarious smallwares full of a basket. As a result, I had to write down the comment of discrepancy interpretation about special noun & items between Homogenous Cosmos Originated from Unique Genesis and Traditionary Sciences herein, virtually, the comment of discrepancy interpretation about special noun & items between Homogenous Cosmos Originated from Unique Genesis and Traditionary Sciences firstly came into being as refined rearrangement of the corresponding three response emails to him. I am thankful for his cordial advice and support in the recent 5 years.

Zhixie: zhixie@netease.com the undertaker of Physical doubt exploration Website :

<http://www.phyw.com/wytk/xtwzh/yangguosheng/yangguosheng.htm>

—Firstly written in Dec.2004, comment about special noun and item discrepancy was added in Feb.2009. —-Zhenzhu town, Wugang city, Hunan province.

Final Words

As multiple notion with double significance of “**social connotation**” & “**natural connotation**”, social legitimacy & validity of truths can never exceed cannon range

As timely renovation of humanistic ideology about authenticity of nature in proportion to contemporaneous historical background and innovative cosmos redefinition in radical logic enantiomorph of newly highlighted factuality that **discretionary particles in cosmos are mutually convertible** with consequent PNT dynamics about universal existence & motion in the nature of coherent natura naturans throughout cosmic evolution. I am but ready to challenge authenticity highlight of two issues as below:

- ①. Since “**discretionary particles in cosmos are mutually convertible**”, whether cosmos is really homogenous originated from unique genesis through and through.
- ②. If yes, what integrative cosmic homologic configuration and proportionate universal homologic existence & motion should be accordingly?

However, under egotistic background of interminable royal substantiation & perfection of contemporaneous scientific orthodoxy, the perplexity I can hardly evade is that, as innovative cosmos redefinition in radical logic enantiomorph of newly highlighted factuality that discretionary particles in cosmos are mutually convertible with consequent PNT dynamics about universal existence & motion in the nature of coherent natura naturans throughout cosmic evolution, Homogenous Cosmos Originated from Unique Genesis is out-and-out lineal logic system on the basis of [(Homogenous cosmos originated from unique genesis postulate + spacetime~matter fully embodying cosmos postulate) + Instinctive PNT equilibrium postulate] about universal existence & motion which are spontaneous occurrence of [external physical disturbance + (PNT action + instinctive PNT equilibrium)]; relatively, live contemporaneous scientific orthodoxy is but ideological aggradation of rich and colorful scientific travelogues A, B, C, D, E, F, ... like omnifarious smallwares full of a basket, which is mostly made up of X scientific subjects, Y academic professions with Z foundational regularities adulterated in. Homogenous Cosmos Originated from Unique Genesis is brand-new ideological system as independent lineal logic system about universal existence & motion out of live contemporaneous scientific orthodoxy. Remarkable ideological contrast of course indicates life-and-death scientific knowledge metabolism even consequent virulent scientific knowledge metabolism campaign inevitable. Whereas, as opposites of life-and-death scientific knowledge metabolism, free press admittance of Homogenous Cosmos Originated from Unique Genesis has to pass orthodox filtration of free press egotistic proximity identification from temporal authority, the perplexity is of course self-evident.

So fast time flying away unknowingly, just for the ambition to get rid of free press embarment and unveil the latent authenticity of cosmos behind factuality that **discretionary particles in cosmos are mutually convertible**, hiding Homogenous Cosmos Originated from Unique Genesis like pathetic fish on chopping block has exhausted itself shouting hoarse about the idea for more than 31 years! What's the redoubtable endeavor and torment !?

Oh, virulent scientific knowledge metabolism campaign! Magistral autarchy of free press regulation customization and free press admittance; respectable free press egotistic proximity identification! Why cannot I die hard on fire torture straight from the shoulder but to leave me suffering in endless free press embarment eversince!?

Oh, stupid heterodoxy, you are quite aware the result of fish on chopping block confronting violence of butcher knife, the suffered can only be the fish, the bleeding can never the butcher knife. However, you not only painfully confront valiancy of butcher knife but also counterwork shouting hoarse for righteousness temerarily!!

... ..

Oh, heroic & terrible butcher knife, when can my blood rust you out ultimately !!?

The most remarkable character of live contemporaneous scientific orthodoxy is that it's inertial ideological aggradation of remarkable transverse ideological expansion in the recent several centuries, which is typical unsystematized ideological system about universal existence & motion making up of rich and colorful scientific travelogues A, B, C, D, E, F, ... like omnifarious smallwares full of a basket. Virtually, historical progress of science in the recent several centuries seemed like a far-flung exploration of the first itinerary around numerous distinctive landscapes of brand-new landmasses of science with palette & tablet on back, several hundred years' scientific travelogues were compiled thereby. As a result, live contemporaneous scientific orthodoxy is just ideological aggradation of rich and colorful scientific travelogues A, B, C, D, E, F, ... like omnifarious smallwares full of a basket. Whereas, just because of remarkable transverse ideological expansion in the recent several centuries, **microcosmic configuration of matter remarkably highlighted** thereby, especially the factuality that **discretionary particles in cosmos are mutually convertible** is always orientating towards perfect induction day by day, which of course makes homogenous profile of cosmos more and more explicit in our rational purview.

As a result, I introduced **Homogenous cosmos originated from unique genesis postulate**, and with necessary accessorial supplementation of "**spacetime-matter fully embodying cosmos assumption**" & "**Instinctive PNT equilibrium assumption**", I consequently implemented **connotation objectification of homogenous cosmos originated from unique genesis & further freewheeling logic extension of connotation objectification of homogenous cosmos originated from unique genesis** so as to reach cosmos redefinition in logic model of [(**Homogenous cosmos originated from unique genesis postulate** + **spacetime~matter fully embodying cosmos postulate**) + **Instinctive PNT equilibrium postulate**], which indicates universal existence & motion are but spontaneous occurrence of [**external physical disturbance** + (**PNT action** + **instinctive PNT equilibrium**)], comprehensive humanistic ideology about authenticity of nature turns into lineal logic system through and through.

Whereas, as multiple notion with double significance of "**social connotation**" & "**natural connotation**", social legitimacy & validity of truths can never exceed cannon range, under egotistic background of interminable royal substantiation & perfection of contemporaneous scientific orthodoxy with unprecedented official facility of magistral autarchy of **free press regulation customization** and **free press admittance** of temporal authority short of necessary intendance, there is neither way for introduction of **Homogenous cosmos originated from unique genesis postulate** and successive implementation of **connotation objectification of homogenous cosmos originated from unique genesis & further freewheeling logic extension of connotation objectification of homogenous cosmos originated from unique genesis** to be authenticated as valid endeavor to push humanistic ideology about authenticity of nature forward to perfect ideological enantiomorph of ultimate authenticity of nature nor reason to be regarded as high-sounding paean towards royal substantiation & perfection of contemporaneous scientific orthodoxy, it's but my personal tragedy. As brand-new ideological updation and innovative cosmos redefinition in radical logic enantiomorph of newly highlighted factuality that **discretionary particles in cosmos are mutually convertible** with consequent PNT dynamics about universal existence & motion in the nature of coherent natura naturans throughout cosmic evolution, as remarkable divarication between Homogenous Cosmos Originated from Unique Genesis and contemporaneous scientific orthodoxy, free press admittance of Homogenous Cosmos Originated from Unique Genesis must break through legitimacy defense line of contemporaneous scientific orthodoxy due to inevitable life-and-death scientific knowledge metabolism, so that it has to challenge venomous counterwork upper limit of overwhelming temporal authority, there is almost nobody ready to displease overwhelming temporal authority for free press admittance of Homogenous Cosmos Originated from Unique Genesis. As a result, I have been floundering in vicious circle of virulent scientific knowledge metabolism campaign for more than 31 years. And as commensurate opposite consequence, Homogenous Cosmos Originated from Unique Genesis helplessly grows in wilderness as amateur work day by day, it has gradually turned into the largest personal academic monograph throughout historical progress of science in both native language and a foreign language with 31 years idea aggradation.

As coherent natura naturans throughout cosmic evolution, instinctive PNT reciprocal equilibrium towards optimum PNT operation is radical potentiality & conditionality for cosmos always ready to orientate itself towards perfection.

1. As timely renovation of humanistic ideology about authenticity of nature on proportion to contemporaneous historical background of remarkable highlight of microcosmic configuration of matter, initial pullulation of Homogenous Cosmos Originated from Unique Genesis in grievous perplexity of social legitimacy subsistence.

The most unintelligible joke the God played on me was that, when I was still a senior high school student in 1991, he jokingly threw the ill-fated pill of **Homogenous cosmos originated from unique genesis** into my soup, which is refined from newly highlighted factuality that **discretionary particles in cosmos are mutually convertible**. As a result, I slid into cothurnus eversince.

1.1. Initial upgrowth of Homogenous Cosmos Originated from Unique Genesis.

The foremost thought germination of Homogenous Cosmos Originated from Unique Genesis started in winter 1991, and in winter 1992, the formal manuscript of Unique Genesis Cosmos came into being in its primary format. Subsequently, I finished the manuscript of Unique Genesis Cosmos twice separately in winters of 1995 and 1996. Whereas, nobody was ready to deign to read it that years. In 1997, I worked in Dongguang city Guangdong province, and I even did not came back home in Chinese New Year festivals. In spring 1998, I got married, and in the winter 1998, I condensed the Unique Genesis Cosmos into Matter Evolves from Hyllic Spacetime and contributed it to relevant publishing houses many times, but I failed and frustrated bitterly.

For subsistence stress, I'd thought to give it up, I was genuinely not willing to lay it aside dying off in stoniness. In 1999, from February to May I went to Changsha Yuelushan twice with more than 120 printed copies of my manuscript, I'd like to release the idea and methodology of Homogenous Cosmos Originated from Unique Genesis to any people who work in the relevant fields professionally. To my despair, there were nobody ready to concern it besides professor Wang Yongjiu (**Hunan Normal University**) offered me four bananas after chatting with me for about 20 minutes. My practical rencontre even made me fatally frustrated and aching. In winter 2000, I took the 80 remainder copies of my manuscript of Matter Evolves from hyllic spacetime to Peking city Zhongguan village with the same ambition, whereas, my frustration was almost just the same as my prior experience at Changsha Yuelushan. To my luck, a warmhearted young man named Guizhong-Li took me into his small hire room in cold windy winter night, otherwise, I must have been frozen to death in Peking street.

As frustrated bitterly without alternatives, I began to improve my English, because my experience had told me so many times that in such hallowed land nourished by inrooted feudal officialism, it was substantively difficult for me to find some sincere readers who were willing to spend two minutes to read such an unofficial paper from a Joe Blow. And my experience made me strongly impressed, most of the high-ranking men with respectable identity & qualification in our country are nobly busy; they usually are not willing to read anything from Joe Blow. However, men who still have not procured their respectable degree have to inflexibly devote themselves in "official model answers" for examination for their official degree authorization, tangible fame and gain. I even met several superior gentlemen once in a way, slight smiles in their faces seemed having immediately exhausted all their civility. Reading such an unofficial paper from Joe Blow is but nonsense to waste time, who have such leisure and carefree mood to deign to read it? If I still want to have a try, I think I have to improve my English. Otherwise, I must have lost my heart.

In winter 2002, I wrote my primary English manuscript of Matter Evolves from Hyllic Spacetime. Then I worked in Dongguan city Guangdong province all the year of 2003, and even I did not come back home in Chinese New Year festivals. In April 2004, I accidentally found an unofficial physic website asked for physics papers in both English and Chinese, I privately edited the manuscript into electronic document with computer in

Historical progress of science in the recent several centuries seemed like a far-flung exploration of the first itinerary around numerous distinctive landscapes of brand-new landmasses of science with palette & tablet on back, several hundred years' scientific travelogues were compiled thereby.

my office and sent the electronic document to the physics website. To my luck, my English manuscript of Matter Evolves from Hyllic Spacetime was accepted. It of course encouraged me a lot.

As limitation of my poor English, the English version of the paper was of course not very ideal. In December 2004, I resigned my job and finished my primary Chinese manuscript of Homogenous Cosmos Originated from Unique Genesis which was accepted by the same unofficial physic website in June 2005. In spring 2006, I began to write my English manuscript of Homogenous Cosmos Originated from Unique Genesis in my spare time. And in June 2006, I added a new section of "Common engine and flying saucer engine". In Nov. 2007, I added a section of "Mathematical Definition of Homogenous Cosmos Originated from Unique Genesis" and consequently revised the subsequent section of "Introduction of Atom State Equation in Spacetime". In June 2008, I added a section of "Tyre model of PNT engine", and I am now ready to add a new section of "PNT action and PNT reaction" in Oct. 2008.

Virtually, the fundamental thoughts and the general contents of Homogenous Cosmos Originated from Unique Genesis had been rather mature when the manuscript of Matter Evolves from Hyllic Spacetime came into being in 1998. Compared with version of Matter Evolves from Hyllic Spacetime, Homogenous Cosmos Originated from Unique Genesis had very little logic expansion as linear logic system based on unique presumable precondition of **Homogenous cosmos originated from unique genesis postulate** besides rational sublimation of "**Mathematical Definition of Homogenous Cosmos Originated from Unique Genesis**" and freewheeling applicable technologic extension of "**Common Engine and Flying Saucer Engine**" & "**Tyre Model of PNT Engine**" following the rational line that universal existence & motion are but spontaneous occurrence of **[external physical disturbance + (PNT action + Instinctive PNT equilibrium)]**, all the mathematical formulations and the proper syllogistic mathematical analysis of the treatise are just the same besides necessary optimization of holistic logic constitution and possible improvement of literal expression about connotation details. All in all, most of my endeavor in the recent several years was but limited in possible optimization of holistic logic constitution and necessary improvement of literal expression of connotation details of the treatise.

1.2. As favorable fecund thought resource, remarkable highlight of microcosmic configuration of matter in the 20th century has brought out substantial headspring for me to succeed the downwind potentiality for aberrant rational sublimation of Homogenous Cosmos Originated from Unique Genesis at the volley.

Remarkable rational aberrancy of Homogenous Cosmos Originated from Unique Genesis is mostly discrepancy relative to rational constitution even rational model of live scientific knowledge proliferation for substantiation & perfection of contemporaneous scientific orthodoxy. As humanistic ideology about authenticity of nature in proportion to contemporaneous historical background, the remarkable discrepancy between contemporaneous scientific orthodoxy and Homogenous Cosmos Originated from Unique Genesis is generally as following:

1.2.1. Remarkable discrepancy of historical background.

1.2.1.1. Favorable background for initial naissance & subsequent freewheeling substantiation & perfection of contemporaneous scientific orthodoxy.

In the terminal of 19th century and early years of 20th century, implication dilation of scientific practice of human gradually slid into transition from macrocosm to microcosmos, and penetrated deeply into microcosmos ever since, successive scientific knowledge proliferation involved more and more microcosmic factuality, which brought out remarkable deregulation to Newtonian Mechanics. As a result, rational renovation of humanistic

As coherent natura naturans throughout cosmic evolution, instinctive PNT reciprocal equilibrium towards optimum PNT operation is radical potentiality & conditionality for cosmos always ready to orientate itself towards perfection.

ideology about authenticity of nature in proportion to contemporaneous historical background of ideological transition from macrophysics to microphysics was inevitable.

And on the other hand, although naissance and subsequent development of Relativity and Quantum Theory were substantively two wonder programme of historical progress of science there and then, which practically indicated that humanistic ideology about authenticity of nature of the age had practically acclimated and included the brand-new experience in microcosmos, the rationale of Relativity and Quantum Theory did not highlight the universal existence & motion through and through, subjects as Chemistry, biology, iatrology etc. have to do their jobs cooperatively for rational comprehension of universal existence & motion. Thus, no matter whether the ultimate authenticity of nature about universal existence & motion are really unique and invariable as coherent natura naturans throughout cosmic evolution or not, and no matter whether it's only possible for the absolute scientific verity about universal existence & motion to be perfect ideological enantiomorph of ultimate authenticity of nature as coherent natura naturans throughout cosmic evolution or not, live contemporaneous scientific orthodoxy is substantively aggradation of scientific travelogues like omnifarious smallwares in a basket which invokes X scientific subjects, Y academic professions with Z foundational regularities adulterated in for formulation of rich and colorful existence & motion accessible around, no mater whether **it is only possible for concordant cosmos to be demiurgic aggradation of out-and-out serial natura naturata in the nature of coherent natura naturans throughout cosmic evolution** or not and whether **there is no way for demiurgic aggradation in the nature of different natura naturans to concordant cosmos through and through** or not. The live contemporaneous scientific orthodoxy is of course hypostatic outgrowth of realistic scientific knowledge proliferation in the recent one and a half century under contemporaneous historical background that scientific practice of human gradually came for transition from macrophysics to microphysics and even penetrated deeply into microcosmos eversince.

1.2.1.2. Favorable historical background of Homogenous Cosmos Originated from Unique Genesis.

In the recent one century, expedient development of particle physics has thrown more and more lights onto microcosmic configuration of matter, factuality that **discretionary particles in cosmos are mutually convertible** is orientating complete induction day by day, which of course indicate that entire cosmos is homogenous through and through.

Whereas, is cosmos really homogenous originated from unique genesis through and through?

On historical stage of today, once we come to consider the very issue, there are substantiation favorable facts for the issue. If we insist that cosmos is throughout homogenous originated from unique genesis, we of course have millions of evidences to say “yes”, if we insist it's impossible for cosmos to be homogenous originated from unique genesis through and through, we can hardly find credible evidence to say “yes”. However, even though we have millions of evidences to say “yes” that cosmos is throughout homogenous originated from unique genesis, we still have not approached complete induction of the issue that cosmos is throughout homogenous originated from unique genesis beyond all doubt.

Facing perplexity of the very issue, what shall we do?

Under favorable historical background of remarkable highlight of microcosmic configuration of matter, especially newly highlighted factuality that discretionary particles in cosmos are mutually convertible is always in freewheeling orientation towards complete induction day by day, I introduced **Homogenous cosmos originated from unique genesis postulate**, and with supplementation of two 0.5 grade accessorial postulates, I implemented

Historical progress of science in the recent several centuries seemed like a far-flung exploration of the first itinerary around numerous distinctive landscapes of brand-new landmasses of science with palette & tablet on back, several hundred years' scientific travelogues were compiled thereby.

connotation objectification with further freewheeling logic extension of homogenous cosmos originated from unique genesis, which is of course endeavor towards theoretical clarification of matter configuration of integrative cosmos, original generation of spacetime and matter as serial homology with inherent homologic filiation between spacetime and matter, universal existence & motion of matter in spacetime.

1.2.2. Rationale discrepancy of scientific knowledge proliferation.

1.2.2.1. Historical scientific knowledge proliferation of live contemporaneous scientific orthodoxy under favorable historical background that scientific practice of human penetrated deep into microcosmic configuration of matter day by day.

When historical progress of science proceeded to terminal years of 19th century and earlier years of 20th century, object of human scientific practice slid into sensitive transition from macrocosm to microcosmos, and it penetrated deep into microcosmos by freewheeling. As unprecedented pioneering endeavor towards authenticity highlight of microcosmos, it must open out grand unbeknown landscape of brand-new landmasses of science at the volley. The pioneering scientific knowledge proliferation following up the age must be scene comment about the magic landscape of the brand-new landmasses of science then and there. Consequently, output of innovative scientific knowledge proliferation of the age were of course rich and colorful scientific travelogues about the distinctive landscape of the landmasses of science, which was of course endeavor of typical transverse ideological expansion to find physical regularity I about distinctive landscape A, physical regularity II about distinctive landscape B, physical regularity III about distinctive landscape C, And as a result, live contemporaneous scientific orthodoxy is inertial ideological aggradation of remarkable transverse ideological expansion in the recent several centuries which mostly makes up of **X scientific subjects, Y academic professions with Z foundational regularities adulterated in** for formulation of rich and colorful existence & motion accessible around us like omnifarious smallwares full of a basket, although, till today, live contemporaneous scientific orthodoxy has experienced royal substantiation & perfection of contemporaneous scientific orthodoxy for more than one century.

1.2.2.2. Favorable background of remarkable highlight of microcosmic configuration of matter has brought out substantial headspring for me to succeed the downwind rational potentiality for cosmos redefinition in logic enantiomorph of newly highlighted factuality that **discretionary particles in cosmos are mutually convertible**.

The factuality that **discretionary particles in cosmos are mutually convertible** directly indicates cosmos is homogenous originated from unique genesis, and as such factuality seems always ready to orientate to complete induction, we are more and more confident to introduce **Homogenous cosmos originated from unique genesis postulate** for pioneering exploration of homogenous universal existence & motion without delay. And as a result, on the basis of [(**Homogenous cosmos originated from unique genesis postulate** + **spacetime~matter fully embodying cosmos postulate**) + **Instinctive PNT equilibrium postulate**], I implemented connotation objectification of homogenous cosmos originated from unique genesis and the proportionate freewheeling logic extension of connotation objectification of homogenous cosmos originated from unique genesis, and with aid of logic springboard that original generation of matter in the nature of coherent natura naturans brings out essence of matter in a class by itself; essence of matter in a class by itself predestines thorough coherence of dynamic regularity of universal existence & motion, I arrive at the unique coherent dynamic fundamental of instinctive PNT reciprocal equilibrium towards optimum PNT operation against the essence of matter in a class by itself, whose mathematical formulation is just coherent PNT dynamics about universal existence & motion. scientific knowledge proliferation of Homogenous Cosmos

As coherent natura naturans throughout cosmic evolution, instinctive PNT reciprocal equilibrium towards optimum PNT operation is radical potentiality & conditionality for cosmos always ready to orientate itself towards perfection.

Originated from Unique Genesis is typical longitudinal ideological optimization.

At any rate, **it's only possible for concordant cosmos to be demiurgic aggradation of out-and-out serial natura naturata in the nature of coherent natura naturans throughout cosmic evolution; there is no way for demiurgic aggradation in the nature of different natura naturans to be concordant cosmos through and through.**

1.2.3. Rationale discrepancy of theoretical model

1.2.3.1. Theoretical model of live contemporaneous scientific orthodoxy.

Sensitive object transition of scientific practice of human from macrocosm to microcosmos, especially deep into microcosmos upon historical freewheeling in the early years of 20th century brought out remarkable expansion of physical purview of human, many unbeknown landscapes of brand-new landmasses of science were consequently highlighted one after another. Under favorable historical background with remarkable expansion of physical purview of human, output of pioneering scientific knowledge proliferation of the age were of course rich and colorful scientific travelogues in proportion to expansion of physical purview of human. As a result, live contemporaneous scientific orthodoxy is humanistic ideology made up of **X scientific subjects, Y academic professions with Z foundational regularities adulterated in** for formulation of rich and colorful existence & motion accessible around us like omnifarious smallwares full of a basket.

1.2.3.2. Theoretical model of Homogenous Cosmos Originated from Unique Genesis.

Under precondition of homogenous cosmos originated from unique genesis, facing challenge of formulation of universal existence & motion, Homogenous Cosmos Originated from Unique Genesis implemented connotation objectification of homogenous cosmos originated from unique genesis and the proportionate freewheeling logic extension, which approach PNT dynamics about universal existence & motion in the nature of essence of matter in a class by itself invoking logic gangway that original generation of matter in the nature of coherent natura naturans brings out essence of matter in a class by itself; essence of matter in a class by itself predestines thorough coherence of dynamic regularity of universal existence & motion. That's to say, towards uniform formulation of universal existence & motion in the nature of coherent natura naturans throughout cosmic evolution, Homogenous Cosmos Originated from Unique Genesis has no idea of physics, chemistry, biology, iatrology etc, any object as long as it belonging to category of "matter" in cosmos, connatural existence & motion of it as out-and-out serial natura naturata in the nature of coherent natura naturans throughout cosmic evolution must be subject to coherent dynamic fundamental of instinctive PNT reciprocal equilibrium towards optimum PNT operation, whose mathematical formulation is just something as PNT dynamics in the nature of essence of matter in a class by itself.

Historical progress of science is always realistic sitcom. as timely renovation of humanistic ideology about authenticity of nature in proportion to contemporaneous historical background of **remarkable highlight of microcosmic configuration of matter**, if contemporaneous scientific orthodoxy had not thrown more and more lights onto factuality that **discretionary particles in cosmos are mutually convertible**, there was no possibility for homogenous profile of cosmos to be more and more explicit in our rational purview, there was no possibility of stochastic occurrence of rational renovation of humanistic ideology about authenticity of nature in proportion to contemporaneous historical background out of succession of contemporaneous scientific orthodoxy. Virtually, throughout historical progress of science, it's only possible for living scientific knowledge proliferation to be crime scene of pioneering thinkers against the contemporaneous historical background then and there. During course of initial gestation & formation of scientific idea of homogenous cosmos originated from unique genesis, the

Historical progress of science in the recent several centuries seemed like a far-flung exploration of the first itinerary around numerous distinctive landscapes of brand-new landmasses of science with palette & tablet on back, several hundred years' scientific travelogues were compiled thereby.

aggradation of contemporaneous scientific orthodoxy, especial **remarkable highlight of microcosmic configuration of matter** has brought out substantial headspring for me to succeed the downwind rational potentiality for cosmos redefinition in logic enantiomorph of newly highlighted factuality that **discretionary particles in cosmos are mutually convertible** with consequent PNT dynamics about universal existence & motion in the nature of coherent natura naturans throughout cosmic evolution. The rationale discrepancy between live contemporaneous scientific orthodoxy and Homogenous Cosmos Originated from Unique Genesis can be generally illustrated as below:

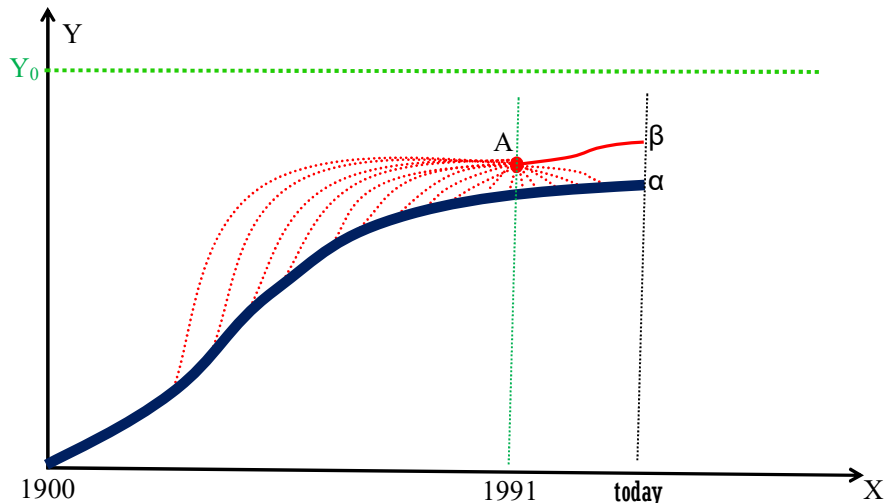

(X-i-1) Relative rationale status between contemporaneous scientific orthodoxy and Homogenous Cosmos Originated from Unique Genesis.

In above diagram, the Y axis denotes authenticity value of scientific knowledge, the X axis denotes time of historical progress of science, the origin of the coordinate denotes initial time of 1900, the position of the first upright broken line on X axis denotes the time of 1991, and the position of the second upright broken line on X axis denote time of today. The **upright green broken line Y_0** above on Y axis denotes authenticity value of ultimate authenticity of nature, which is of course the extremum of authenticity value of scientific knowledge.

In diagram above, the **brawny blue curve α** indicates variation of authenticity value of scientific knowledge of live contemporaneous scientific orthodoxy since 1900. The **brawny red dot A** indicates the **Homogenous cosmos originated from unique genesis postulate**, and the multitudinous tiny red broken lines between the **brawny red dot A** and **brawny blue curve α** the indicates substantial correlation between live contemporaneous scientific orthodoxy and Homogenous Cosmos Originated from Unique Genesis, which virtually indicates that, as remarkable highlight of microcosmic configuration of matter, more and more lights were thrown onto factuality of out-and-out homogenous profile of cosmos so as to lead to naissance of scientific idea of Homogenous cosmos originated from unique genesis. And the **red curve β** extended from the **brawny red dot A** just indicates the Connotation objectification of Homogenous Cosmos Originated from Unique Genesis and the proper freewheeling logic extension derived from Homogenous cosmos originated from unique genesis postulate.

2. The most maximal affliction all my life is that, as typical aberrant scientific knowledge proliferation out of rigid succession of contemporaneous scientific orthodoxy and timely renovation of humanistic ideology about authenticity of nature in proportion to contemporaneous historical background of **remarkable highlight of microcosmic configuration of matter**, accomplishment of scientific idea of Homogenous Cosmos Originated from Unique Genesis can hardly gloss over remarkable divarication from tradition which directly impacts vested interest of temporal authority who are working as hardcore puissance of historical progress of science. As a result, as lowdown man of the society and typical heterodoxy of the age,

As coherent natura naturans throughout cosmic evolution, instinctive PNT reciprocal equilibrium towards optimum PNT operation is radical potentiality & conditionality for cosmos always ready to orientate itself towards perfection.

I slid into vicious circle of **virulent scientific knowledge metabolism campaign**, free press admittance of Homogenous Cosmos Originated from Unique Genesis must break through legitimacy defense line of contemporaneous scientific orthodoxy, so that it has to challenge venomous counterwork upper limit of temporal authority, although, as amateur work of lowdown man, it has been the largest personal academic monograph throughout historical progress of science in both native language and a foreign language with 31 years idea aggradation.

As remarkable highlight of microcosmic configuration of matter, the factuality that **discretionary particles in cosmos are mutually convertible** is orientating complete induction day by day, which of course indicates favorable rational background of remarkable highlight of homogenous profile of cosmos. Consequently I would like to tell people on the earth that cosmos is homogenous originated from unique genesis and universal existence & motion are but well-regulated homogeneity system making up of out-and-out serial natura naturata in the nature of coherent natura naturans throughout cosmic evolution. Whereas, to my despair, the endeavor of connotation objectification and the proportionate freewheeling logic extension of homogenous cosmos originated from unique genesis is apparently out of rigid succession of contemporaneous scientific orthodoxy with remarkable divarication, no more compatibility of royal popularity of substantiation & perfection of contemporaneous scientific orthodoxy of the age. And as a result, I slid into perplexity of typical heterodoxy out of the swim under untimely background of royal substantiation & perfection of contemporaneous scientific orthodoxy, which of course led my life to confused crossroad.

In fact, in 1991, I was the unique half-free schooling student at the first middle school of Wugang city, and just the unique student in grade II who applied to attend college entrance examination (**But the headmaster did not consent in the end**). Since idea of Homogenous Cosmos Originated from Unique Genesis came to me, I insensibly slid into puzzlement. Because I revolted the omnifarious classification of live contemporaneous scientific orthodoxy so much from then on, once referred to this kind of “fundamental force” and that kind of “fundamental force”, “thermodynamics”, “Newtonian mechanics”, “electromagnetic force”, ..., I could hardly help throwing my books madly; once referred to so-called “chemistry” and “biology” I was immediately wearied out.

Because I always thought, since cosmos originally comes into being in accordance with coherent fundamental of natura naturans through and through, matter must have coherent essence in a class by itself for coherent generation in cosmos, and as postnatal spontaneity, existence & motion of matter in cosmos must be subject to proportionate coherent dynamic fundamental due to coherent essence of matter in a class by itself. And as a result, it's completely impossible for the nature to enact this kind of fundamental force and that kind of fundamental force against coherent demiurgic fundamental due to coherent natura naturans throughout cosmic evolution. I always thought chemical reaction and biological domino effect should not be so superficial humanistic ideology about authenticity of nature, which substantively seem nothing to do with coherent natura naturans throughout cosmic evolution besides the historical features that we had ever occurred as distinctive landscapes of brand-new landmasses of science. Instead, they should originally be series of deductive dynamic equations on the basis of **Atom State Equation in Spacetime**. And indeed, they generally exist as rich and colorful reciprocal PNT combinations made up of atoms, whose dynamic connotation of idiographic existence & motion radically root in the mechanic compose of compositive atoms under proper external conditions, which are precisely subjected to the coherent dynamic fundamental in the nature of essence of matter in a class by itself (**the coherent cosmic dynamics**) and exactly hypostatize the inherent idiographic attribute of matter itself—distinctive existence & motion of matter itself. And what's more, nothing seems rational to support chemistry and biology to be

Historical progress of science in the recent several centuries seemed like a far-flung exploration of the first itinerary around numerous distinctive landscapes of brand-new landmasses of science with palette & tablet on back, several hundred years' scientific travelogues were compiled thereby.

independent scientific subjects themselves.

At any rate, as typical postnatal existence & motion against essence of matter in a class by itself, as long as it's absolutely impossible for any special postnatal existence & motion to change the essence of matter, there is no possibility for any distinctive existence & motion to be out of original coherent dynamic fundamental due to essence of matter in a class by itself. As long as the original coherent dynamic fundamental against essence of matter is formulable, no matter how long and complex the postnatal homologic multiplication extension of matter is, their original dynamic fundamental for demiurgic evolution or homologic multiplication will never break or change, all their postnatal existence & motion must be deductive mathematical operations derived from the coherent original dynamic fundamental in the nature of essence of matter in a class by itself, which is virtually included in typical dynamical model as what Atom State Equations in Spacetime formulated.

This may be just the so-called “historical ignorance D” we have to admit and face.

Now, twenty more years has gone, none of the basic ideas of Homogenous Cosmos Originated from Unique Genesis changed. Science is but humanistic ideology about authenticity of nature in proportion to contemporaneous historical background, since existence & motion of matter is but spontaneous occurrence due to coherent essence of matter, and essence of matter inherently derives from coherent generation and formation of matter throughout cosmic evolution, there is no discrepancy of demiurgic originality of matter for this kind of science and that kind of science, the uniqueness & invariance of ultimate authenticity of nature of course predestines the unique possibility of scientific verity as perfect ideological enantiomorph of ultimate authenticity of nature. Just because the practice human coming to discover and formulate authenticity of accessible existence & motion around must experience frondose evolvement of humanistic ideology about authenticity of nature cumulatively enriched from nothingness to groat, from groat to a great lot, and consequently followed proportionate ideaistic correction & qualitative optimization from superficiality to profundity, from parochiality to generality, and during the hypostatic historical course human coming to know ultimate authenticity of nature from nothingness to groat, from groat to a great lot, we have to look into this object and that object which gradually entered our rational purview like this green apple or that red apple on the tip of our fingers one after another, and as a result, our recognizant harvest are gradually rich and colorful like smallwares full of a basket. And indeed, several hundred years' historical progress of live contemporaneous scientific orthodoxy was really like a far-flung exploration with palette and tablet on back, —paint mountain once facing mountain; describe rive once encountering river,, laud flower when we see flower; sing greenery when we stay with greenery; ... several hundred years' harvest of science seems several hundred years' travelogues like omnifarious smallwares full of a basket. Although, cosmic status quo is but demiurgic aggradation of sequential homologic cosmogony which exactly exists as well-regulated integration of cosmic homogeneity system making up of out-and-out serial natura naturata in the nature of coherent natura naturans throughout cosmic evolution.

Note D: If you are not convenient to comprehend “historical ignorance”, please come to ponder how great Aristotle had ever been at his age, and how ignorant he was when Galileo came to highlight the very factuality at further historical stage, and subsequent Copernicus, Bruno, ... Newton,, even Einstein, Bohr were in the same progression one by one. History has proved and is always ready to prove the same regularity that historical progress of science is always ready to push forward humanistic ideology about authenticity of nature towards historical authenticity tolerance of science 0 as well as to expose historical ignorance of human.

As coherent natura naturans throughout cosmic evolution, instinctive PNT reciprocal equilibrium towards optimum PNT operation is radical potentiality & conditionality for cosmos always ready to orientate itself towards perfection.

Till today, practical application of sciences is generally ready to improve human's living conditions and living environment. If we can affirm that cosmos is throughout homogenous originated from unique genesis and all cosmic contents entirely consist in a unique-genesis homogeneity system indeed in 2008, then we focus our endeavor, and in 2015, we can work out full mathematical connotation of Atom State Equations in Spacetime $\sum_{m_{\text{Atom}} = \int_{i_0}^{\text{Atom}} f(m_{i_0 \rightarrow \text{Atom}})_{i_0}$ successfully, so that we possess enough rational capital to deduce and master universal existence & motion both contained by atoms and based on the innate mechanics compose of atoms in the nature by coherent systematical mathematical operation, and in terms of any material existence in cosmos, we can expediently follow a rational line to study it mathematically as reciprocal PNT combination according to the corresponding atom state equations, consequently, under such expedient science exploitation situation, who can casually underestimate the conditions on the earth in 2030 !?

As naissance of Atom State Equation in Spacetime, biological process will be mathematically quantified into systematical symbolic logic and precisely programmed. As the entire mathematical quantification and program control of the material configuration and proliferation process of DNA reciprocal PNT combinations $\sum_{m_{\text{DNA}} = \text{DPNT}}^D \left[\int_{i_0}^{\text{DNA}} f(m_{i_0 \rightarrow \text{DNA}})_{i_0} \right]$, human will self-consciously improve and optimize their own biological mechanism and functions, human may optimize their own DNA configuration according to practical necessity and possibility —either optimize, or engraft and combine any more excellent biological mechanism or biological functions than those we inherently possess. Once it's possible for us to do so, human may think our current living manner of buying, cooking, eating is too cockamamie, human may engraft the biologic function of photosynthesis of plants into man's skin, or just to make photosynthesis clothes, man may directly have it on, and consequently be able to pass ten more days without eating anything, but only to stroll in the sun a little now and a little then, Of course, man can improve their brains by optimizing DNA configuration and the related proliferation process, and can design the computer like a cap, just to "wear" it on head as external supplementation of brain, man can write program not only for machines, but also for themselves, man can input knowledge and thought program to brain directly according to practical necessity.

All in all, **Atom State Equations in Spacetime** are just the "kaleidoscope" and navigation "steering wheel" for us to discern and dominate natural material existence & motion, any substantive material subsistence or theoretically existent possibility in the nature are all we can predict and master.

Of course, it does not imply, on opinion of Homogenous Cosmos Originated from Unique Genesis, live contemporaneous scientific orthodoxy is worthy of nothing and I can not accept such historical inevitability. Virtually, the most significant cause that the originator of Homogenous Cosmos Originated from Unique Genesis is neither Newton nor Einstein is mostly because of headspring disparity of favorable background along crevice progression of historical progress of science. As longitudinal ideological optimization based on **remarkable highlight of microcosmic configuration of matter** of live contemporaneous scientific orthodoxy, Homogenous Cosmos Originated from Unique Genesis has none intention to depreciate and exclude live contemporaneous scientific orthodoxy. And indeed, before ultimate consummation of Atom State Equations in Spacetime, any unconcern to live contemporaneous scientific orthodoxy will immediately make us find ourselves unbacked. Since live contemporaneous scientific orthodoxy could lead social productivity to accomplish so resplendent advancement, their historical significance is of course self-evident.

At any rate, throughout historical progress of science, any attentive pioneering thinker towards discovery

Historical progress of science in the recent several centuries seemed like a far-flung exploration of the first itinerary around numerous distinctive landscapes of brand-new landmasses of science with palette & tablet on back, several hundred years' scientific travelogues were compiled thereby.

and formulation of authenticity of nature can only do his job/best on stage against his accessible historical background so as to push forward historical progress of science then and there. The cause the originator of Homogenous Cosmos Originated from Unique Genesis is neither Newton nor Einstein is mostly because of the remarkable discrepancy of historical background, which usually offer different rational purview for commensurate pioneering thinkers for different aggradation of scientific knowledge along crescive progression of historical progress of science. Especially, the **remarkable highlight of microcosmic configuration of matter** has exposed more and more of the homogenous profile of cosmos day by day, which is of course substantial headspring for me to succeed the downwind potentiality to introduce **Homogenous cosmos originated from unique genesis postulate** for further rational review and clarification of universal existence & motion as integrative cosmic homogeneity system.

Whereas, the inevitable tragic factuality is that, as low-down man of the society and typical heterodoxy under untimely background of royal substantiation & perfection of contemporaneous scientific orthodoxy, Homogenous Cosmos Originated from Unique Genesis must break through estrangement between scientific innovation and royal substantiation & perfection of contemporaneous scientific orthodoxy for subsistence. And virtually, as self-preservation of human nature, half of the official subsistence of temporal authority towards historical progress of science is to creditably come into and propagandize the ready-made success of live contemporaneous scientific orthodoxy, and half of the official subsistence is ready for substantiation & perfection of contemporaneous scientific orthodoxy. And as unparalleled authoritative impavidity, popularity of royal substantiation & perfection of contemporaneous scientific orthodoxy is always ready to impropriate all social resource for general progress of science as possibly as it can. They persist living scientific knowledge proliferation all over the world must be in rigid succession of contemporaneous scientific orthodoxy going without saying, and reject aberrant scientific knowledge out of succession of contemporaneous scientific orthodoxy at their pleasure. Although, in the recent half century, it always seemed faint for endeavor of substantiation & perfection of contemporaneous scientific orthodoxy to push forward humanistic ideology about authenticity of nature close to ultimate authenticity of nature. After all, free press regulation customization and free press admittance is 100% bare puissance of temporal authority short of necessary intendance.

As authoritative operators of social legitimacy identification with top power in hand, temporal authority seemed having no idea that the practice human coming to discover and formulate authenticity of accessible existence & motion around must experience frondose evolvment of humanistic ideology about authenticity of nature cumulatively enriched from nothingness to groat, from groat to a great lot, and consequently followed proportionate ideaistic correction & qualitative optimization from superficiality to profundity, from parochiality to generality. No matter how much innovation historical progress of science in the recent several centuries had experience already, and how much innovation of coming progress of science must accomplish to push forward humanistic ideology about authenticity of nature close to ultimate authenticity of nature, they are always ready to reject aberrancy of coming scientific knowledge proliferation out of succession of contemporaneous scientific orthodoxy as temporal science hierarchy. As magistral autarchy of free press regulation customization & free press admittance of temporal authority, nowadays free press forum of science is substantively VIP banquets for royal substantiation & perfection of contemporaneous scientific orthodoxy. Free press admittance or rejection is generally outcome of free press egotistic proximity identification, and without say-so of temporal authority,

there is no way for any aberrant scientific knowledge out of succession of contemporaneous scientific orthodoxy to pass free press admittance.

Since ultimate authenticity of nature can be neither omnifarious authenticity smallwares full of a basket nor authenticity chameleon one piece and only but coherent natura naturans throughout cosmic evolution, as commensurate ideological enantiomorph of accessible existence & motion around us, ultimate consummation of science must be perfect ideological enantiomorph of ultimate authenticity of nature, veritable progress of science is not intuitional cumulative achievement of colorful scientific travelogues A, B, C, D, E, F, ... as deserving reward of the first itineracy around preternatural landscapes of brand-new landmasses of science like omnifarious smallwares full of a basket but successive hypostatic endeavor to push humanistic ideology about authenticity of nature forward to perfect ideological enantiomorph of ultimate authenticity of nature draw on practical feasibility & possibility in proportion to contemporaneous historical background. And as permanent synthesized conditionality of “**crescive progression of practical feasibility & possibility in proportion to contemporaneous historical background + the uniqueness & invariance of ultimate authenticity of nature predestines the unique possibility of scientific verity as perfect ideological enantiomorph of ultimate authenticity of nature**” through and through, it’s only possible for the major melody of historical progress of science to be a series of epochmaking scientific knowledge metabolism in inherent optimum orientation towards historical authenticity tolerance of science 0, which is virtually hypostatic historical progress of science that humanistic ideology about authenticity of nature is always ready to be pushed forward to perfect ideological enantiomorph of ultimate authenticity of nature draw on practical feasibility & possibility in proportion to contemporaneous historical background step by step.

And throughout historical progress of science, in terms of any contemporaneous scientific orthodoxy out of scientific legitimacy qualification of historical authenticity tolerance of science 0, as long as historical progress of science is still on its normal way towards historical authenticity tolerance of science 0, the live contemporaneous scientific orthodoxy out of scientific legitimacy qualification of historical authenticity tolerance of science 0 must be ultimately washed out by coming coming rational renovation of humanistic ideology about authenticity of nature in proportion to contemporaneous historical background without alternatives. Throughout historical progress of science, it’s only possible for any contemporaneous scientific orthodoxy out of social legitimacy qualification of historical authenticity tolerance of science 0 to exist as “**idiographic progressive segment**” in crescive progression of historical progress of science.

And at the same time, under the general precondition that the authoritative impavidity of live contemporaneous scientific orthodoxy is unparalleled, education of our society is always ready to morbidly compliment the normative keys offered by the living authority. In fact, Chinese education is normative examination-oriented education system, normative keys determine everything and negate everything. And virtually, live contemporaneous scientific orthodoxy is but humanistic ideology about authenticity of nature like fragmentary crystals, and temporal authority seem too wallowed in fragmentary crystal, whereas, as long as we have to admit it’s only possible for the ultimate authenticity of nature to be coherent natura naturans throughout cosmic evolution, as lifelike enantiomorphous ideology about ultimate authenticity of nature as coherent natura naturans throughout cosmic evolution, we then have admit humanistic ideology about authenticity of nature should ultimately be crystal palace instead of fragmentary crystals. I deprecated the temporal authority fastened them as absolute truths to me indeed. And such kind of education can bring out substantial third-rate geniuses of course, whereas,

Historical progress of science in the recent several centuries seemed like a far-flung exploration of the first itineracy around numerous distinctive landscapes of brand-new landmasses of science with palette & tablet on back, several hundred years’ scientific travelogues were compiled thereby.

potential top-rank geniuses who are confident to challenge live contemporaneous scientific orthodoxy are completely killed off the cuff.

Normative keys can only be ideology in acceptable level of yesterday and today, whereas, development is always endeavor to create tomorrow with backup of yesterday and today, which of course implies, as brand-new human resource of the society, we must possess backbone to break through conventional standard and update the proper standard even better than before. Endeavor of education can never be limited in indoctrination of ready-made knowledge to brand-new social members, the most important thing is that we should ensure our brand-new social members are able to create tomorrow so as to make the world tomorrow better than today,

Since the practice human coming to discover and formulate authenticity of accessible existence & motion around must experience frondose evolvement of humanistic ideology about authenticity of nature cumulatively enriched from nothingness to goat, from goat to a great lot, and consequently followed the proportionate ideaistic correction & qualitative optimization from superficiality to profundity, from parochiality to generality, throughout our practical progress, what kind mistakes we had ever erred in is not something inglorious; instead, exclusive free press monopolization and snobbish free press embarment to dissidents are something really inglorious.

As timely renovation of humanistic ideology about authenticity of nature in proportion to contemporaneous historical background of **remarkable highlight of microcosmic configuration of matter**, "Homogenous Cosmos Originated from Unique Genesis" is innovative cosmos redefinition in logic enantiomorph of newly highlighted factuality that **discretionary particles in cosmos are mutually convertible** with consequent PNT dynamics about universal existence & motion in the nature of coherent natura naturans throughout cosmic evolution. In logic extension, the so-called PACC, PACS system is complete subclass of Homogenous Cosmos Originated from Unique Genesis, which can be expressed as below:

$$\{PACC\} + \{PACS\} + \dots \leq \text{Homogenous Cosmos Originated from Unique Genesis} \stackrel{\text{def}}{=} \sum_{m=D}^D \int_{i_0}^X f(m_{i_0 \rightarrow x}) i_0.$$

At any rate, in terms of logic extension:

Logic extension of conventional (physics + chemistry + biology + iatrolgy + ...) < logic extension of perfect ideological enantiomorph of ultimate authenticity of nature about universal existence & motion in the nature of coherent natura naturans throughout cosmic evolution.

In terms of ideological quality of scientific legitimacy qualification of historical authenticity tolerance of science:

Scientific legitimacy qualification of historical authenticity tolerance of science of conventional (physics + chemistry + biology + iatrolgy + ...) << scientific legitimacy qualification of historical authenticity tolerance of science of perfect ideological enantiomorph of ultimate authenticity of nature about universal existence & motion in the nature of coherent natura naturans throughout cosmic evolution,

In any case, historical progress of science in the recent several centuries seemed like a far-flung exploration of the first itineracy around numerous distinctive landscapes of brand-new landmass of science with palette & tablet on back, several hundred years' scientific travelogues were compiled thereby, live contemporaneous scientific orthodoxy is but inertial ideological aggradation of remarkable transverse ideological expansion in the recent several centuries making up of rich and colorful scientific travelogues A, B, C, D, E, F, ... like omnifarious smallwares full of a basket.

Comparably, as innovative cosmos redefinition in logic enantiomorph of newly highlighted factuality that **discretionary particles in cosmos are mutually convertible** with consequent PNT dynamics about universal existence & motion in the nature of coherent natura naturans throughout cosmic evolution, original naissance of Homogenous Cosmos Originated from Unique Genesis has no idea of physics, chemistry, biology, iatrolgy etc, but homogenous

As coherent natura naturans throughout cosmic evolution, instinctive PNT reciprocal equilibrium towards optimum PNT operation is radical potentiality & conditionality for cosmos always ready to orientate itself towards perfection.

cosmos consists of both spacetime and matter with alternative homologic filiation either **spacetime father & matter son** or **matter father & spacetime son**, which radically predestines inherence of universal existence & motion by the light of nature. Whereas, under egotistic background of interminable royal substantiation & perfection of contemporaneous scientific orthodoxy, I have to contribute to journals of physics, chemistry, biology, iatrology kind. This is not all, the even trouble situation is that, even though I contribute to omnifarious journals as physics, chemistry, biology, iatrology etc, I am still restricted to choose even omnifarious academic classification for proportionate **free press egotistic proximity identification**, oh~shit, as typical cosmos redefinition in linear logic system about universal existence & motion in the nature of coherent natura naturans throughout cosmic evolution, it's substantively too rough and limited for me to choose **conventional (physics + chemistry + biology + iatrology + ...)** for morbid academic classification, whereas, I must choose one or two sub-items in general academic classification of physics, chemistry, biology, iatrology for proportionate free press egotistic proximity identification, who can imagine my perplexity & helplessness in so unintelligible situation due to overwhelming authoritative intrepidity of contemporaneous scientific orthodoxy?

After all, on one hand, live contemporaneous scientific orthodoxy is really inertial ideological aggradation of remarkable transverse ideological expansion making up of rich and colorful scientific travelogues A, B, C, D, E, F, ... like omnifarious smallwares full of a basket, which are straightforward deserving rewards of a far-flung exploration of the first itineracy around numerous distinctive landscapes of brand-new landmasses of science with palette & tablet on back in the recent several centuries. On the other hand, live temporal authority is the most overwhelming temporal authority with unprecedented official facility of magistral autarchy of **free press regulation customization** and **free press admittance** short of necessary intendance throughout historical progress of science, although, normal endeavor of historical progress of science is to push humanistic ideology about authenticity of nature forward to perfect ideological enantiomorph of ultimate authenticity of nature step by step draw on practical feasibility & possibility in proportion to contemporaneous historical background, but not endeavor for royal substantiation & perfection of contemporaneous scientific orthodoxy. As long as we have to admit and face objectivity that **it's only possible for concordant cosmos to be demiurgic aggradation of out-and-out serial natura naturata in the nature of coherent natura naturans throughout cosmic evolution; there is no way for demiurgic aggradation in the nature of different natura naturans to be concordant cosmos through and through**, we then have to admit the remarkable morbidity of modern science forum as out-and-out egotistic outgrowth in the garden of contemporaneous scientific orthodoxy due to magistral autarchy of **free press regulation customization & free press admittance** short of necessary intendance.

Under precondition of **homogenous cosmos originated from unique genesis**, as original generation of matter in law of identity brings out essence of matter in a class by itself, essence of matter in a class by itself predestines thorough coherence of dynamic regularity of universal existence & motion, as a result, universal existence & motion is but spontaneous occurrence in the nature of essence of matter in a class by itself which is virtually vivid hypostatization of universal dynamic fundamental of instinctive PNT reciprocal equilibrium towards optimum PNT operation working as coherent natura naturans throughout cosmic evolution and potential conditionality for cosmos always ready to orientate itself towards perfection, no matter objects microcosmic or macroscopical, moving in low speed or high speed, organic or inorganic, biologic or abiological.

In any case, for free press admittance, I must find a proper code for Homogenous Cosmos Originated from Unique Genesis from PACC or PACS system for free press egotistic proximity identification. I can of course

Historical progress of science in the recent several centuries seemed like a far-flung exploration of the first itineracy around numerous distinctive landscapes of brand-new landmasses of science with palette & tablet on back, several hundred years' scientific travelogues were compiled thereby.

comprehend, as the inherent historical progression of gradual quantitative enrichment and qualitative correction & optimization of humanistic ideology about authenticity of nature, under certain historical background, there is substantial historical inevitability of practical naissance & presence of PACC, PACS. And indeed, occurrence of PACC, and PACS had orderly hackled the tousy accumulation of remarkable transverse ideological expansion in the recent one century indeed. And at the same time, we have to admit, before naissance of more advanced theory to formulate universal existence & motion systematically; it seems only possible for us to hackle and systematize our enrichment actuality of scientific knowledge proliferation like this. Whereas, live humanistic ideology about authenticity of nature is generally something like this can never be reasons for us to insist that we must do further jobs to push forward humanistic ideology about authenticity of nature close to ultimate authenticity of nature like this forever. In another word, we can of course do up and systematize science cumulative status quo as PACC, PACS systems like this at the volley, but we have no reasons to importune and restrict the coming scientific knowledge proliferation must be coincident with current PACC, PACS logic constitution for ever.

At any rate, PACC, PACS systems are but hindsight derived from aggradation of ready-made scientific knowledge, it's impossible for such rational groundwork to impregnate PACC, PACS enough foreknowledge to take the role of pilot for coming pioneering thinkers to push forwards humanistic ideology close to ultimate authenticity of nature so as to accomplish solid advancement towards historical authenticity tolerance of science 0. If we optimistically do it, such subjective eisegesis maybe misdirect development of science, even maybe unknowingly let the PACC, PACS take the role of bowstring or prisoner's cage either to garrotte the benign germination of scientific idea out of temporal PACC, PACS systems or to exclude and block benign development of scientific idea out of temporal PACC, PACS systems. —Just because the foregone sages and temporal authority only explored scientific topic A, B, C, D, E, F, ..., the coming generation can only unconditionally compliment and try to consolidate the established scientific topic A, B, C, D, E, F, ..., if deviated, there is no way for them to pass free press admittance.

Such modus operandi not only subjectively restricts the rational range and logic model of coming scientific knowledge proliferation but also chokes back the inherent scientific knowledge metabolism towards consummation of humanistic ideology about authenticity of nature in disguised formality; because it virtually forbids development of science in open air but along the preconcerted ways as PACC, PACS defined and under restriction of legitimacy identification and free press admittance of so-called second-string geniuses, —typical conservative modus operandi for scientific exploration, which apparently implemented two compelling hints to coming scientific knowledge proliferation:

The first: **men who are ready to devote to scientific study must consciously find himself ways in PACC, PACS systems, which are esoterically preconcerted by temporal authority in prior, otherwise, there is no way for you to pass free press admittance no more social legitimacy authorization.** This of course got much of the credit to restrict the development orientation of science even logic model of coming scientific knowledge proliferation. And virtually, it's just the practical modus operandi and major cause for temporal science hierarchy to accomplish ideal science community for royal substantiation & perfection of contemporaneous scientific orthodoxy, which seems favorable sans souci for temporal authority to enjoy themselves treading on air.

The second, **in my manor, my criterion is of course general wise apotheosis & pursuit of the age**, which directly indicates principle of free press admittance of the age, —free press egotistic proximity identification

& social legitimacy under duress of temporal authority. Free press admittance or social legitimacy authorization of each special manor/domain of sciences is guarded by the so-called authoritative suzerain specialists, anybody ready to enter science forum must pass free press egotistic proximity identification from the corresponding suzerain specialists according to the proper manor popularity. There is almost no manor/domain who is ready accept their dissidents. Especially, the esoteric identification of so-called standard references of papers is even feasible way for free press egotistic proximity identification. Under precondition that live contemporaneous scientific orthodoxy is still out of scientific legitimacy qualification of historical authenticity tolerance of science 0, the temporal authority are always ready to reject admitting the coexistence of “positive significance” and “negative significance” of reference popularity. Durable operation of reference popularity under management of temporal authority of course accomplish situation that scientific knowledge proliferation must be in rigid succession of contemporaneous scientific orthodoxy and restricts aberrant scientific knowledge proliferation out of succession of contemporaneous scientific orthodoxy but in proportion to contemporaneous historical background at their pleasure, no matter whether scientific knowledge proliferation in rigid succession of contemporaneous scientific orthodoxy can accomplish ideal efficiency to push humanistic ideology about authenticity of nature forward to perfect ideological enantiomorph of ultimate authenticity of nature and achieve positive advancement of historical progress of science in inherent optimum orientation towards perfect ideological enantiomorph of ultimate authenticity of nature or not, it even retards the necessary scientific knowledge metabolism along crecive progression of historical progress of science.

And indeed, in the recent half century, so-called science forum is always altisonant VIP banquet for substantiation & perfection of contemporaneous scientific orthodoxy. The most straightforward duty of so-called normal publishing houses and authoritative journals or magazines are substantively professional advertisement agency of live contemporaneous scientific orthodoxy, no matter whether their business virtually relates to historical progress of science in inherent optimum orientation towards historical authenticity tolerance of science 0 more or less. As cosmos redefinition in logic enantiomorph of newly highlighted factuality that **discretionary particles in cosmos are mutually convertible** with consequent PNT dynamics about universal existence & motion in the nature of essence of matter in a class by itself, the logic extension of Homogenous Cosmos Originated from Unique Genesis apparently crown all the holistic logic framework of “PACC + PACS”, what’s more, endeavor of connotation objectification and proportionate freewheeling logic extension of homogenous cosmos originated from unique genesis is obviously out of leitmotiv of high-sounding royal substantiation & perfection of contemporaneous scientific orthodoxy. As a result, there is always no way for Homogenous Cosmos Originated from Unique Genesis to find a proper access in PACC & PACS logic framework for free press egotistic proximity identification.

Virtually, as consequence of development of science, the contents of PACC, PACS are always in synchro variation following development of science so as to actualize their proportionate proliferation & metabolism. This of course implies, along crecive progression of historical progress of science, any item in PACC, PACS may be overlaid or washed out or catabolized thereby. However, once we introduce PACC, PACS to lead and restrict the coming scientific knowledge proliferation, the contradictions consequently involved in is of course self-evident. And now, several decades of historical progress of science has gone under such preconcerted guidance of PACC, PACS already, we of course have no reasons to negate it through and through, after all,

Historical progress of science in the recent several centuries seemed like a far-flung exploration of the first itinerary around numerous distinctive landscapes of brand-new landmasses of science with palette & tablet on back, several hundred years’ scientific travelogues were compiled thereby.

historical achievement like rich and colorful scientific travelogues we twiddled with this green apple and that red apple on tip of our fingers under favor of free press egotistic proximity identification from the so-called authoritative suzerain professors then and there are not historical course neglectable. Whereas, shall we be remorseless to forward and limit our coming progress of science under such preconcerted favor of PACC, PACS for ever?

I can of course comprehend, as the inevitable intervention of human self-preservation, once some certain relatively mature humanistic ideology about authenticity of nature has procured legitimacy qualification of the society, respectable excuse will be immediately endowed for it to lead people to identify with external existence & motion around us going without saying and consequently occupy ideological realm as much as possible, which invisibly assimilates coming thought and inhibits heterodoxy, even as gradual consolidation of officialism, powerful authority stronghold comes into being so as to inhibit and resist interposition of coming dissident. What's more Homogenous Cosmos Originated from Unique Genesis is still tender, there are still a lot left to follow up further. What's more, the idea, study methodology and lingual format of Homogenous Cosmos Originated from Unique Genesis is so abnormal compared to live contemporaneous scientific orthodoxy! What's more, as typical heterodoxy under background of high-sounding royal substantiation & perfection of contemporaneous scientific orthodoxy, I am so low-down man of the society, this is of course glaring excuse for facile approach of quick conclusion!!

3. Penance of Homogenous Cosmos Originated from Unique Genesis

As fecund thought resource and favorable background, live contemporaneous scientific orthodoxy is of course substantial headspring of Homogenous Cosmos Originated from Unique Genesis, if it had not brought up remarkable highlight of microcosmic configuration of matter, especially made the factuality **discretionary particles in cosmos are mutually convertible** orientate to complete induction day by day, nothing can be possible to cause naissance of scientific idea of homogenous cosmos originated from unique genesis. I practically came to the scientific idea was but because my thought psychology to face the factuality was a little distinctive, to most people in the world, ready-made knowledge of live contemporaneous scientific orthodoxy are always standard answers for them to procure degree, fame and gain from temporal authorities, whereas, I but treated them as compositive crystals to build grand crystal palace. I did not dive into the "sea", but to study the "colorful crystals" on the shore upon my curiosity and distinctive thought, I found the fragmentary crystals on shore were originally derived from inherent crystal palace, and the original perfect configuration of the crude crystal palace is "homogenous originated from unique genesis through and through". My potential motivity to learn more was but ready to make my suspense & questions more and more distinct in mind, and just because of my persistent endeavor like this, I found that the entire cosmic contents substantively consist in an absolute "homogeneity system" which is originated from unique genesis through and through. As a result, I was anxious to tell people around me — "It's going to rain!", but nobody was willing to pay attention to me. I was disappointed indeed.

As Joe Blow without any respectable identity & qualification, I was genuinely exhausted struggling in so terrible social ambience for subsistence. Say truly, since I left school, I had never learned anything by heart besides learning some English in my free time in the recent several years. It was neither because I was not willing to learn anything, nor because I was unable to learn, but just because I had to keep me a little numb. God is always ready to play joke on me to show off his humour gift, fate left me suffering so much frustration

without alternatives, I could hardly find my confidence and motivity to learn more. Although in winter 2000, when I encountered at high energy physics department of Tsinghua, a teacher I did not know had offered me many physical books, and recently, professor Li offered me some physics information and some of his own treatises, and Mr Duang-canguang post me his newly published book too. I but skipped through them roughly, I was sorry to have violated their favor.

And indeed, when I came to answer the nine group of questions from professor Li, I genuinely felt my nonfeasance and ignorance to modern physics. But still, it seemed none better for me to be, because in the face of reality, I have to work for my subsistence above all, I never have so much spare time to do it in the sun, and I need confidence and motivity for the endeavor. What's more, say truly, I always found me myself weary indeed once I turned to traditionary physics, because I found the traditionary physics was too omnifarious in travelogue style with very poor coherence in logic correlation. It's substantively very difficult for me to acclimatize my sense to. The endeavor to read traditionary physics is exactly like strolling in zoo to visit various animals one by one, and endeavor for rational comprehension is substantively like situation driving in confused and deserted roads. Oh, shit, the demiurge must be idiot without any endowment of demiurge, and universal existence & motion must be nonsense created madly by idiot. Otherwise, as ideological enantiomorph of authenticity of nature, why sciences about universal existence & motion are so colorful travelogues like omnifarious smallwares in a basket? Does it indicate ultimate authenticity of nature is omnifarious authenticity smallwares full of a basket or authenticity chameleon one piece and only?

My temerarious endeavor to push a narrow way to air my idea of homogenous cosmos originated from unique genesis in open access against acrimonious free press embarment is generally because nothing else I can do to make things right. I am genuinely not willing to leave it dying off in historical billow undisturbedly. I'd like to show people simple thesis straightway:

Whether cosmos is really homogenous originated from unique genesis through and through.

If yes, what a hypostatic homogenous existence & motion aggregation cosmos can accordingly be.

In so far as what a homogenous configuration cosmos is, how the so-called cosmic homogeneity system originally comes into being throughout cosmic evolution and how to quantize the so-called cosmic homogeneity system systematically, I can not arbitrarily draw positive conclusions about these issues immediately, I am afraid, it's not something I can consummate alone, and I should not work with it blindly alone. I but hope my dedicated study about these issues can be favorable headspring for people to succeed the potentiality to look into the thesis. Because the dedicated study and practical substantiation of these issues must undoubtedly forward remarkable progress of sciences. I now try to air my views about the thesis hereby is but I hope my endeavor in this field can do good to the coming pursuers and play a favorable prelude for the thesis. Just as what one of our educationists said: "multitudinous inventions maybe root in single question", and as what one of the quantum theory initiators said, once the proper questions come to confront us, half of the issue has been solved.

Who is the man coming to discover and formulate ultimate authenticity of nature is not something all-important, the most all-important thing is whether human can discover and formulate it precisely in good season.

At this stage, as a vagrant floundering about in such execrable social ambience with luggage on back, as various impersonal limitations, Homogenous Cosmos Originated from Unique Genesis has been fatally locked at the choke point of further verification, substantiation and consummation. And indeed, since 1998, struggling

in puzzledom and poverty, I was always helpless like a poor mother too ashamed and embarrassed of her poverty to foster her children. I was always ready to send it to some “rich man” who is able to nurture it so as to release my agony and acquit my guilt. Till today, I have not disentangled me from the extravagant dependence yet.

My intention to write the two sections of “Introduction of Atom State Equation in Spacetime” and “Further substantiation & consummation of Homogenous Cosmos Originated from Unique Genesis” is generally ready to do up my final submission for my exhaustion and helplessness. I genuinely hope somebody to adopt and foster it. Because once I finish the rough manuscript of Homogenous Cosmos Originated from Unique Genesis, if my endeavor still can not infuse me any necessary subsistence support or favorable conditions to break loose from the choke point, I am afraid, I have to say good-bye to “spacetime” and “matter” now. Upon all my manna, I think I’ve done all I can, and what I’ve devoted to should have been enough, I should not struggle too bitterly on so fatiguesome belief, although I am quite sure it’s very significant. And now, all my rest endeavor is but to save it from invisible prisoner's cage and find her a foster father. In any case, I am too an organism, in order to carry out necessary biological function to hypostatize decent selfhood as a social member, my 70 kilogram organic body needs necessary nutrient of course. However, no matter how perfect this piece of paper is, it can do nothing for the necessity.

As onefold and frank man, and just for the intention to tell people that entire cosmos is homogenous originated from unique genesis through and through, and universal existence & motion are consequently subject to coherent dynamic fundamental of instinctive PNT reciprocal equilibrium towards optimum PNT operation, I persisted several decades to write down the monograph of <Homogenous Cosmos Originated from Unique Genesis> after hours in defiance of my subsistence perplexity. However, as low-down man of the society even typical heterodoxy under egotistic background of royal substantiation and perfection of contemporaneous scientific orthodoxy, my endeavor was always so villainous, although, I am quite aware of the social nature that, as multiple notion with double significance of “**natural connotation**” & “**social connotation**”, social legitimacy & validity of truths can never exceed cannon range.

I am so depressive and desperate to flounder about in royal substantiation & perfection of contemporaneous scientific orthodoxy, with remarkable free press monopolization of science aristocrat! I am so frangible and anguished to confront mortal free press embarment to low-down heterodoxy!

Whether cosmos is throughout homogenous originated from unique genesis or not?

If yes, what integrative homologic configuration of cosmos and universal homologic existence & motion should be accordingly?

All living science aristocrat have no obligation to face such exceptive issues besides royal anthem for substantiation & perfection of contemporaneous scientific orthodoxy. However, once some heterodoxy unexpectedly educes dissidence from such issues against their legitimacy dignity, the puissance of them must immediately react. As science hierarchy with full jurisdiction of “free press admittance & social legitimacy of science” in hand, before powerless heterodoxy, they are mostly powerful big men, whereas, once subsequent highlight of authenticity of nature proved significant innovation of science had been mortally devastated offhand, nobody of them are accountable therefore!

Virtually, I should be aware early that self-preservation is inherence of human nature, once the developmental metabolism of humanistic ideology about authenticity of nature slides into mortal conflict of fame and gain, nothing can be different from the social interclass warfare in ideological domain! I should confess early, on

As coherent natura naturans throughout cosmic evolution, instinctive PNT reciprocal equilibrium towards optimum PNT operation is radical potentiality & conditionality for cosmos always ready to orientate itself towards perfection.

stand of moral and ethic, I was completely wrong and even villainous, because no matter Relativity, Quantum Theory, ..., Unitive Field Theory, Big Bang, Black Hole theory even LIGO gravitational wave discovery are but ugly begums under beautiful veil or disingenuous prostitutes with beautiful fresh flowers on head, I should not make bold to unveil them or expose their galling intimacy as to hurt their dignity and grace. Whereas, on the stand of plain logic, I was completely guiltless without any villainous intention, and I need none penitence. Because all these are but derived from naturalism that I'd like to show people authenticity freeheartedly that cosmos is throughout homogenous originated from unique genesis. And during the course of connotation objectification & freewheeling logic extension of the very idea, I encountered them by chance.

Virtually, at the moment, I was but a cherubic pathfinder pushing forward my way in mistiness with sapiential flashlight in hand, I abruptly detected their profiles a little weird, and then I illuminated them with my flashlight by the light of nature so as to assuage my amazement. However, what's the evil of my action? And why I must suffer so cruel free press embarment for it? Am I really audacious & villainous that I should not throw light over intimacy of temporal authority and perturb the Vanity Fair of temporal authority in defiance of my lowness? What's more, what are the wise reasons for us to importune interminable royal substantiation & perfection of contemporaneous scientific orthodoxy and keep enmity in mind to consider rationality of stochastic aberrant scientific knowledge proliferation out of succession of contemporaneous scientific orthodoxy? Is it possible for **interminable royal substantiation & perfection of contemporaneous scientific orthodoxy \approx veritable historical progress of science** all along?

Development of science is always endeavor to discover and formulate the universal existence & motion as authentic comprehensive and systematical as possible draw on practical feasibility and possibility in proportion to contemporaneous historical background. As it's only possible for ultimate authenticity of nature to unique and invariable as coherent natura naturans throughout cosmic evolution, the practical accomplishment to push humanistic ideology about authenticity of nature forward to perfect ideological enantiomorph of ultimate authenticity of nature step by step must bring out relatively advanced innovative humanistic ideology about authenticity of nature and wash out all relatively conservative humanistic ideology about authenticity of nature in proportion to forgone historical background. At any rate, as rigorous enantiomorphous correlation between objective authenticity of nature and humanistic ideology about authenticity of nature, it's neither possible for "the unique & invariable ultimate authenticity of nature" to be compatible with "two distinctive humanistic ideologies about authenticity of nature with remarkable ideological difference" nor possible for "two distinctive humanistic ideologies about authenticity of nature with remarkable ideological difference" to discover and formulate "unique & invariable ultimate authenticity of nature" coequally.

In any case, as uniqueness & invariance of ultimate authenticity of nature, veritable progress of science is not intuitional cumulative achievement of colorful scientific travelogues A, B, C, D, E, F, ... like omnifarious smallwares full of a basket about rich and colorful existence & motion of matter accessible around us but successive positive endeavor to push humanistic ideology about authenticity of nature forward to perfect ideological enantiomorph of ultimate authenticity of nature as coherent theory about universal existence & motion step by step draw on practical feasibility & possibility in proportion to contemporaneous historical background, which is hypostatic process of realistic historical progress of science in inherent optimum orientation towards historical authenticity tolerance of science 0. As a result, it's only possible for the major melody of historical progress of science to be serial "epochmaking scientific knowledge metabolism" in inherent optimum orientation towards scientific legitimacy qualification of historical authenticity tolerance of science 0.

Historical progress of science in the recent several centuries seemed like a far-flung exploration of the first itinerary around numerous distinctive landscapes of brand-new landmasses of science with palette & tablet on back, several hundred years' scientific travelogues were compiled thereby.

Before humanistic ideology about authenticity of nature finally qualified as perfect ideological enantiomorph of ultimate authenticity of nature, quantitative & qualitative change of realistic scientific knowledge proliferation along historical progress of science from nothingness to groat, from groat to a great lot, and consequently followed the proportionate ideaistic correction & qualitative optimization from superficiality to profundity, from parochiality to generality can never be limited in freewheeling of royal substantiation & perfection of contemporaneous scientific orthodoxy out of scientific legitimacy qualification of historical authenticity tolerance of science 0.

Virtually, throughout crescive progression of historical progress of science in inherent optimum orientation towards perfect ideological enantiomorph of ultimate authenticity of nature, royal substantiation & perfection of Geocentric Theory lasted more than 1400 years and was ultimately superseded by Heliocentric Theory at the volley;

Royal substantiation & perfection of Newtonian mechanics lasted more than 300 years and was ultimately superseded by Relativity and Quantum Theory.

When history proceeded to terminal years of 19th century and early years of 20th century, implication of scientific practice of human slid into sensitive transition from macrocosm to microcosmos. As gradual intervention of various microcosmic factuality obviously negated validity of Newtonian mechanics, human had to review universal existence & motion for rational compatibility of unexpected deregulation of microcosmic factuality. As a result, **Relativity & Quantum Theory** came into being at the volley, and successive royal substantiation & perfection of “**Relativity + Quantum Theory**” occurred along crescive progression of historical progress of science in inherent optimum orientation towards perfect ideological enantiomorph of ultimate authenticity of nature (/historical authenticity tolerance of science 0).

Of course, we must admit innovative naissance and appropriate freewheeling of successive substantiation & perfection of “**Relativity + Quantum Theory**” has practically accomplished solid progressive segment of historical progress of science in proportion to contemporaneous historical background of the 20th century. Whereas:

- ① As long as we have to admit **ultimate authenticity of nature** can be neither omnifarious authenticity smallwares full of a basket nor authenticity chameleon one piece and only, but coherent natura naturans throughout cosmic evolution. And accordingly, historical progress of science is but humanistic endeavor to push humanistic ideology about authenticity of nature forward to perfect ideological enantiomorph of ultimate authenticity of nature step by step draw on practical feasibility & possibility in proportion to contemporaneous historical background.
- ② As long as we have to admit that both **Relativity & quantum Theory** are not perfect ideological enantiomorph of ultimate authenticity of nature with scientific legitimacy qualification of historical authenticity tolerance of science 0.
- ③ Historical progress of science is still in its inherent optimum orientation towards perfect ideological enantiomorph of ultimate authenticity of nature (/historical authenticity tolerance of science 0)

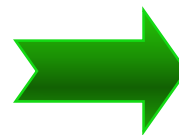

There is no way for Relativity & Quantum Theory to shy away destiny to be washed out by further renovation of humanistic ideology about authenticity of nature in proportion to contemporaneous historical background towards perfect ideological enantiomorph of ultimate authenticity of nature.

Undoubtedly, historical progress of science is always in inherent optimum orientation towards perfect ideological enantiomorph of ultimate authenticity of nature, and as permanent synthesized conditionality of “**crescive progression of practical feasibility & possibility in proportion to contemporaneous historical background + the uniqueness & invariance of ultimate**

As coherent natura naturans throughout cosmic evolution, instinctive PNT reciprocal equilibrium towards optimum PNT operation is radical potentiality & conditionality for cosmos always ready to orientate itself towards perfection.

authenticity of nature predestines the unique possibility of scientific verity as perfect ideological enantiomorph of ultimate authenticity of nature” through and through, it’s only possible for the major melody of historical progress of science to be a series of epochmaking scientific knowledge metabolism in inherent optimum orientation towards perfect ideological enantiomorph of ultimate authenticity of nature.

As wise undertakers of historical progress of science, the key issue is that it’s firstly necessary for us to clarify the philosophic objectivity whether **ultimate authenticity of nature** can be neither omnifarious authenticity smallwares full of a basket nor authenticity chameleon one piece and only, but coherent *natura naturans* throughout cosmic evolution. If yes, as perfect logic enantiomorph of authenticity of nature, ultimate consummation of science must be perfect ideological enantiomorph of ultimate authenticity of nature (*/coherent natura naturans throughout cosmic evolution*), which is not only **unique coherent scientific verity** about universal existence & motion through and through but also **absolute criterion reference** to authenticate historical authenticity tolerance of science of any historical humanistic ideology about authenticity of nature throughout crevice progression of historical progress of science. As hardcore puissance of live historical progress of science, if popular second-rate geniuses even loving successors of contemporaneous scientific orthodoxy indulging in interminable royal substantiation & perfection of contemporaneous scientific orthodoxy are always ready to insist that live ideological system about authenticity of nature out of legitimacy qualification of historical authenticity tolerance of science 0 are undoubted truths in defiance of inherent historical limitation of contemporaneous scientific orthodoxy and instinctively refuse timely renovation of humanistic ideology about authenticity of nature in proportion to contemporaneous historical background by the right of expedient official facility of magistral autarchy of free press regulation customization & free press admittance in defiance of objectivity that it’s only possible for the major melody of historical progress of science to be a series of epochmaking scientific knowledge metabolism in inherent optimum orientation towards perfect ideological enantiomorph of ultimate authenticity of nature, historical progress of science must slide into perplexity due to **conservative officialism domino effect of contemporaneous scientific orthodoxy**.

And indeed, throughout historical progress of science, any so-called “scientific truths” out of scientific legitimacy qualification of historical authenticity tolerance of science 0 must have their limited “scientific legitimacy life time” in crevice progression of historical progress of science, they must be washed out by progressive renovation of humanistic ideology about authenticity of nature in proportion to contemporaneous historical background towards perfect ideological enantiomorph of ultimate authenticity of nature.

Royal substantiation & perfection of Aristotle theory had been inundated by tidal current of historical progress of science in inherent optimum orientation towards perfect ideological enantiomorph of ultimate authenticity of nature (*/historical authenticity tolerance of science 0*) early.

Royal substantiation & perfection of Geocentric Theory had been inundated by tidal current of historical progress of science in inherent optimum orientation towards perfect ideological enantiomorph of ultimate authenticity of nature (*/historical authenticity tolerance of science 0*) early.

Royal substantiation & perfection of Heliocentric Theory had been inundated by tidal current of historical progress of science in inherent optimum orientation towards perfect ideological enantiomorph of ultimate authenticity of nature (*/historical authenticity tolerance of science 0*) early.

.....

Royal substantiation & perfection of Newtonian mechanics had been inundated by tidal current of historical

Historical progress of science in the recent several centuries seemed like a far-flung exploration of the first itinerary around numerous distinctive landscapes of brand-new landmasses of science with palette & tablet on back, several hundred years’ scientific travelogues were compiled thereby.

progress of science in inherent optimum orientation towards perfect ideological enantiomorph of ultimate authenticity of nature (/historical authenticity tolerance of science 0) early.

What's the credible reasons for us to persist interminable royal substantiation & perfection of "Relativity + Quantum Theory" ?

Virtually, live royal substantiation & perfection of "**Relativity + Quantum Theory**" has been apparently faint to push humanistic ideology about authenticity of nature forward to perfect ideological enantiomorph of ultimate authenticity of nature, freewheeling substantiation & perfection of contemporaneous scientific orthodoxy as "**Relativity + Quantum Theory**" can never be nonstop of historical progress of science in inherent optimum orientation towards perfect ideological enantiomorph of ultimate authenticity of nature. And virtually, there is no realistic way for interminable substantiation & perfection of contemporaneous scientific orthodoxy like "**Relativity + Quantum Theory**" to ultimately approach perfect ideological enantiomorph of ultimate authenticity of nature like freewheeling nonstop to finish all the rest of historical progress of science through and through. It's only possible for stochastic historical naissance and successive development of "**Relativity + Quantum Theory**" to be "**idiographic progressive segment in proportion to contemporaneous historical background of 20th century**" in crecive progression of historical progress of science. On stand of historical inevitability of historical progress of science in inherent optimum orientation towards perfect ideological enantiomorph of ultimate authenticity of nature, it's only possible for the major melody of historical progress of science to be serial epochmaking scientific knowledge metabolism in inherent optimum orientation towards perfect ideological enantiomorph of ultimate authenticity of nature (/scientific legitimacy qualification of historical authenticity tolerance of science 0).

What's the credible reason for coming scientific knowledge proliferation must be limited in rigid succession of contemporaneous scientific orthodoxy forever? What's the credible reason for us to persist coming scientific knowledge proliferation all over the world must be in rigid succession of contemporaneous scientific orthodoxy and reject the potential possibility for stochastic occurrence of aberrant scientific knowledge proliferation out of succession of contemporaneous scientific orthodoxy to bring out epoch-making renovation of humanistic ideology about authenticity of nature in proportion to contemporaneous historical background? Is it possible for historical progress of science in inherent optimum orientation towards perfect ideological enantiomorph of ultimate authenticity of nature to be everlasting royal substantiation & perfection of contemporaneous scientific orthodoxy in stead of gradational series of epochmaking scientific knowledge metabolism with proportionate orthodoxy subrogation?

As out-and-out social work outgrowth and humanistic ideology about authenticity of nature in proportion to contemporaneous historical background, social existence & historical progress of "science" must inherently possess double coordinative significance of "natural connotation" and "social connotation", social legitimacy subsistence of neonatal scientific idea never simply depends on recognizant achievement that brand-new or more authenticity of nature has been reflected on sense of pioneering originators with proper highlight effect of authenticity of nature in proportion to contemporaneous historical background, it even crucially implicates esoteric authoritative social legitimacy identification & authentication in accordance with egotistic criterion of contemporaneous scientific orthodoxy under official centered background——social legitimacy & validity of truths can never exceed cannon range, which of course includes esoteric operation of scientific knowledge metabolism campaign underlying. The even pestilent imbroglio is that authoritative social legitimacy identification is mostly under autarchy of temporal authority going without saying in defiance of historical limitation of live

contemporaneous scientific orthodoxy short of necessary intendance.

Since science aristocrat are always ready to suffocate me to death by free press embarment for dignity maintenance of contemporaneous scientific orthodoxy, and none jurisdiction of free press admittance and social legitimacy for coming renovation of humanistic ideology about authenticity of nature in proportion to contemporaneous historical background is out of magistral autarchy of temporal authority, authoritative intrepidity of contemporaneous scientific orthodoxy is all-time and overwhelming, my struggle can only make me even sorer and more exhausted.

As typical heterodoxy of the age, I should not say “No” to altisonant Relativity.

As typical aberrant scientific knowledge proliferation out of rigid succession of contemporaneous scientific orthodoxy, I should not say “No” to respectable The Big Bang.

As cosmos redefinition in logic enantiomorph of newly highlighted factuality that **discretionary particles in cosmos are mutually convertible**, I should not say “No” to humorless existence of Black Hole in cosmos.

As lowdown man of the society, I should not say “No” to LIGO gravitational wave discovery even respectable physical Nobel Prize of 2017.

.....

Since I’ve said so many “No” to tradition, there is no way for me to slider over virulent scientific knowledge metabolism campaign, although, before I realize the unexpected divarication between **Homogenous Cosmos Originated from Unique Genesis** and **live contemporaneous scientific orthodoxy**, I but straightforwardly introduced **Homogenous cosmos originated from unique genesis postulate** and implemented proportionate connotation objectification of homogenous cosmos originated from unique genesis as linear logic system on the basis of **[(Homogenous cosmos originated from unique genesis postulate + spacetime~matter fully embodying cosmos postulate) + Instinctive PNT equilibrium postulate]**, I have no intention to attack any ready-made scientific idea of tradition but straightforwardly implement scientific exploration as “introducing **Homogenous cosmos originated from unique genesis postulate** in accordance with newly highlighted factuality that **discretionary particles in cosmos are mutually convertible** + connotation objectification of homogenous cosmos originated from unique genesis” as typical aberrant scientific knowledge proliferation out of succession of contemporaneous scientific orthodoxy.

Whereas, as lowdown man of the society, what’s my puissance to insist that **cosmos is throughout homogenous originated from unique genesis**? Although, factuality that **discretionary particles in cosmos are mutually convertible** is always in freewheeling orientation towards complete induction.

As lowdown man of the society, I have to face the cruel reality that, as multriple notion with double significance of “**social connotation**” & “**natural connotation**”, social legitimacy & validity of truths can never exceed cannon range. Whereas, as lowdown man of the society and typical heterodoxy of the age, where is my cannon and cannon range? I should be aware of my distance.

As cosmos redefinition in radical logic enantiomorph of newly highlighted factuality that **discretionary particles in cosmos are mutually convertible** which is typical aberrant scientific knowledge proliferation out of succession of contemporaneous scientific orthodoxy, what’s my puissance to insist that **it’s only possible for concordant cosmos to be demiurgic aggradation of out-and-out serial natura naturata in the nature of coherent natura naturans throughout cosmic evolution; there is no way for demiurgic aggradation in the nature of different natura naturans to be concordant cosmos through and through?**

Stand aside, Homogenous Cosmos! Go your way yourself, Unique Genesis!

Historical progress of science in the recent several centuries seemed like a far-flung exploration of the first itinerary around numerous distinctive landscapes of brand-new landmasses of science with palette & tablet on back, several hundred years’ scientific travelogues were compiled thereby.

Since temporal authority have validated legitimacy of “1+1=2”, and knowledge of “1+1=2” has practically accommodated the hypostatic and crucial significance for temporal authority to possess the sacred temple of science, as low-down man of the society and typical heterodoxy under background of royal substantiation & perfection of contemporaneous scientific orthodoxy, what's my favorable qualification and possible access for free press admittance of a treasonous argument of “1+1≠2” as Homogenous Cosmos Originated from Unique Genesis from temporal authority? Why was I always so bigoted to act temerarily reclining me myself onto chopping block waiting for free press egotistic proximity identification of temporal authority!?

What's more, in any case, I should firstly spare me out to sell labor for necessary fecula and protein for the physiological metabolism which inherently supports my native vitality.

A villainous science heterodoxy floundering about in virulent scientific knowledge metabolism campaign like a wolf struggling on bottom of well.

Firstly written in Feb. 2006, Wuguang city, zhenzhu hometown.

Revised in Sep. 2008, Shengzhen--Shiyan town--Xingcun village.

Final Final Words

As typical heterodoxy of the age, I am completely innocent struggling in vicious circle of virulent scientific knowledge metabolism campaign, I am but ready to show 7 billions of live people on the earth that cosmos is throughout homogenous originated from unique genesis, cosmic status quo is demiurgic aggradation of sequential homologic cosmogony, which exactly exists as well-regulated integration of cosmic homogeneity system making up of out-and-out serial natura naturata in the nature of coherent natura naturans throughout cosmic evolution

Since ultimate authenticity of nature can be neither omnifarious authenticity smallwares full of a basket nor authenticity chameleon one piece and only, but coherent natura naturans throughout cosmic evolution, ultimate consummation of humanistic ideology about authenticity of nature must be **perfect ideological enantiomorph of ultimate authenticity of nature**; veritable progress of science is not intuitional cumulative achievement of colorful scientific travelogues A, B, C, D, E, F, ... as deserving reward of the first itineracy around preternatural landscapes of brand-new landmasses of science like omnifarious smallwares full of a basket but successive hypostatic endeavor to push humanistic ideology about authenticity of nature forward to perfect ideological enantiomorph of ultimate authenticity of nature as coherent theory about universal existence & motion step by step draw on practical feasibility & possibility in proportion to contemporaneous historical background. Whereas, as authoritative intrepidity of contemporaneous scientific orthodoxy is all-time with magistral autarchy of free press regulation customization and free press admittance of temporal authority short of necessary intendance, live scientific knowledge proliferation is apparently indulging in royal substantiation & perfection of contemporaneous scientific orthodoxy.

As timely renovation of humanistic ideology about authenticity of nature in proportion to contemporaneous historical background of remarkable highlight of microcosmic configuration of matter, Homogenous Cosmos Originated from Unique Genesis is ready to tell people on the earth that cosmos is homogenous originated from unique genesis and universal existence & motion are but well-regulated integration of cosmic homogeneity system making up of out-and-out serial natura naturata in the nature of coherent natura naturans throughout cosmic evolution. Whereas, my adversity is that, connotation objectification and freewheeling logical extension of homogenous cosmos originated from unique genesis is apparently **out of rigid succession of contemporaneous scientific orthodoxy with remarkable aberrancy, no more compatibility tallying with leitmotiv of royal substantiation & perfection of contemporaneous scientific orthodoxy of the age**. And as low-down man struggling in so feudatorial social ambience, I can hardly shy away snobbish identity & qualification discrimination before overbearing placeman. Although, Homogenous Cosmos Originated from Unique Genesis is but straightforward logic extension of **discretionary particles in cosmos are mutually convertible** and linear logic system about universal existence & motion as out-and-out natura naturata in the nature of coherent natura naturans throughout cosmic evolution on the basis of [(Homogenous cosmos originated from unique genesis postulate + spacetime~matter fully embodying cosmos postulate) + Instinctive PNT equilibrium postulate]. As a result, I've been floundering around in vicious circle of virulent scientific knowledge metabolism campaign for more than 31 years.

i) Factuality that **discretionary particles in cosmos are mutually convertible** in freewheeling orientation towards perfect induction day by day has made homogenous profile of cosmos more and more explicitly highlighted in our rational purview, which is of course tangible rationale and favorable headspring for us to succeed towards timely renovation of humanistic ideology about authenticity of nature. Homogenous Cosmos Originated from Unique Genesis is just innovative cosmos redefinition in radical logic enantiomorph of newly highlighted factuality that **discretionary particles in cosmos**

are mutually convertible under general background of remarkable highlight of microcosmic configuration of matter.

As onefold senior high school student, I virtually had no intention to involve in renovation of humanistic ideology about authenticity of nature in proportion to contemporaneous historical background indeed. However, for an unexpected occasion, the God jokingly threw an ill-fated pill of **Homogenous Cosmos Originated from Unique Genesis** into my soup, which was refined from newly highlighted factuality that **discretionary particles in cosmos are mutually convertible**. As a result, the **New World Manufacturer** grown up in my mind in the nature of things like a vital seed left in soil. This is a manufacturer ready for renovation of humanistic ideology about authenticity of nature against two powerful sixty-four-dollar questions as below:

The first sixty-four-dollar question, —since **discretionary particles in cosmos are mutually convertible** ↷ **for they ultimately possess the common components in certain configurable hiberarchy**, is cosmos really homogenous originated from unique genesis through and through?

The second sixty-four-dollar question, —if cosmos is really homogenous originated from unique genesis through and through, what integrative cosmic homologic configuration and proportionate universal homologic existence & motion should be accordingly?

Connotation objectification of Homogenous cosmos originated from unique genesis based on (Homogenous cosmos originated from unique genesis + spacetime~matter fully embodying cosmos) and further **freewheeling logic extension of connotation objectification of Homogenous cosmos originated from unique genesis** based on (PNT action + instinctive PNT equilibrium) have achieved the primary product series of my **New World Manufacturer**.

As particularity of mechanical ascendancy of atoms in crescive progression of **aberrant convergence of cosmic esse due to PNT reciprocal gelation** in the nature of coherent natura naturans throughout cosmic evolution, especially successive generation of universal reciprocal PNT combinations in grade III, “atom state equation in spacetime” will be the kernel pursuit for expedient theoretical exploration of vivid existence & motion of rich and colorful reciprocal PNT combinations in grade III in cosmos, which not only indicates formulation of natural existence & motion of **universal atomic reciprocal PNT combinations** (which include natural existence & motion of discretionary free atoms in spacetime and all objects made up of atoms in cosmos, no matter it belongs to abiological category or biologic category, such as objects as SARS, 2019-ncov, grass, rat, tiger, human body, ore, etc.) will be precise mathematical logic in general dynamic fundamental of **instinctive PNT reciprocal equilibrium towards optimum PNT operation** based on rationale of Atom State Equations in Spacetime with proper state parameter input of idiographic compositive atoms, but also indicates thorough clarification of existence & motion of all sub-atomic structures and elementary genic units in cosmos following a rational line of cosmic demiurgic evolution along sequential homologic multiplication as necessary precondition. Technologic applications such as PNT engine, PNT generator, idiographic analysis & proper functional optimization of various DNA will be practically accessible at the volley.

As clinging faith of homogenous cosmos originated from unique genesis, I persisted to write down my idea after hours in the recent 31 years in spite of my personal subsistence perplexity, my most devoted pursuit is of course to consummate idea of Homogenous Cosmos Originated from Unique Genesis as possibly as I can, which has cumbered me more than a quarter century. However, as personal limitation of such a poor man struggling in so terrible social ambience, it's substantively difficult for me to approach tangible consummation of the scientific idea of Homogenous cosmos originated from unique genesis alone, no more further verification.

Virtually, as lowdown man of the society without respectable degree, I have to work as sixpenny labor in

As coherent natura naturans throughout cosmic evolution, instinctive PNT reciprocal equilibrium towards optimum PNT operation is radical potentiality & conditionality for cosmos always ready to orientate itself towards perfection.

another evil manufactory 10 more hours per day for subsistence, I can hardly spare me out to work in my **New World Manufacturer** in the sun, although, the products I've accomplished herein seems slightly substantial, it's but because I've devoted to it for more than a quarter century. In fact, my **New World Manufacturer** needs more passionate workers for intelligent cooperation indeed ———for endeavor of tangible clarification and demonstration whether cosmos is really homogenous originated from unique genesis through and through; if yes, what integrative cosmic homologic configuration and proportionate universal existence & motion due to sequential homologic cosmogony in the nature of coherent natura naturans throughout cosmic evolution should be accordingly.

ii) The most remarkable character of live contemporaneous scientific orthodoxy is that it's inertial ideological aggradation of all-time remarkable transverse ideological expansion in the recent several centuries, which is typical unsystematized ideological system about universal existence & motion making up of rich and colorful scientific travelogues A, B, C, D, E, F, ... like omnifarious smallwares full of a basket. Virtually, historical progress of science in the recent several centuries seemed like a far-flung exploration of the first itineracy around numerous distinctive landscapes of brand-new landmass of science with palette & tablet on back, several hundred years' scientific travelogues were compiled thereby. Comparably, as typical aberrant scientific knowledge proliferation out of succession of contemporaneous scientific orthodoxy, Homogenous Cosmos originated from Unique Genesis is cosmos redefinition in radical logic enantiomorph of newly highlighted factuality that **discretionary particles in cosmos are mutually convertible** with consequent PNT dynamics about universal existence & motion in the nature of coherent natura naturans throughout cosmic evolution, which is typical lineal logic system on the basis of [(**Homogenous cosmos originated from unique genesis postulate** + **spacetime~matter fully embodying cosmos postulate**) + **Instinctive PNT equilibrium postulate**] and apparently different from live contemporaneous scientific orthodoxy as (**physics + chemistry + biology + iatrolgy + ...**) therefore. As a result, life-and-death scientific knowledge metabolism and consequent virulent scientific knowledge metabolism campaign inherently follows like shadow of free press admittance of Homogenous Cosmos Originated from Unique Genesis eversince.

As recognizant outgrowth of logic expansion as lineal logic system based on unique assumable precondition of **Homogenous cosmos originated from unique genesis postulate**, rational accomplishment of connotation objectification & freewheeling logic extension of [(**Homogenous cosmos originated from unique genesis postulate** + **spacetime~matter fully embodying cosmos postulate**) + **Instinctive PNT equilibrium postulate**] is straightforward endeavor to throw lights onto authenticity that homogenous cosmos is but demiurgic aggradation of sequential homologic cosmogony, universal existence & motion are out-and-out serial natura naturata in the nature of coherent natura naturans throughout cosmic evolution. Whereas, as innovative cosmos redefinition in logic enantiomorph of newly highlighted factuality that **discretionary particles in cosmos are mutually convertible** with consequent PNT dynamics about universal existence & motion in the nature of coherent natura naturans throughout cosmic evolution, **Homogenous Cosmos Originated from Unique Genesis** is so different from tradition, so that, under egotistic background of royal substantiation & perfection of contemporaneous scientific orthodoxy, social legitimacy subsistence of Homogenous Cosmos Originated from Unique Genesis straightforwardly slides into virulent scientific knowledge metabolism campaign at daggers drawn for remarkable divarication and pestilent illogicality against live contemporaneous scientific orthodoxy. Although, the undoubted factuality is that, as permanent synthesized conditionality of "**crecscive progression of practical feasibility & possibility in proportion to contemporaneous historical background + the uniqueness & invariance of ultimate authenticity of nature predestines the unique possibility of scientific verity as perfect ideological enantiomorph of ultimate authenticity of nature**" through and through, it's only possible for the major melody of historical progress of science to be a series of epochmaking scientific knowledge metabolism in inherent optimum orientation towards

Historical progress of science in the recent several centuries seemed like a far-flung exploration of the first itineracy around numerous distinctive landscapes of brand-new landmasses of science with palette & tablet on back, several hundred years' scientific travelogues were compiled thereby.

perfect ideological enantiomorph of ultimate authenticity of nature.

Virtually, as humanistic ideology about authenticity of nature in proportion to contemporaneous historical background, development of science is always hypostatic endeavor to push humanistic ideology about authenticity of nature forward to perfect ideological enantiomorph of ultimate authenticity of nature step by step draw on practical possibility & feasibility in proportion to contemporaneous historical background, which is of course realistic historical progress of science in inherent optimum orientation towards historical authenticity tolerance of science 0. As long as we admit **the uniqueness & invariance of ultimate authenticity of nature** that ultimate authenticity of nature can be neither colorful authenticity smallwares full of a basket nor authenticity chameleon one piece and only, development of science must orientate humanistic ideology about authenticity of nature to **“unique scientific verity as perfect ideological enantiomorph of ultimate authenticity of nature”** by the light of nature. In any case, as rigorous enantiomorphous correlation between objective authenticity of nature and humanistic ideology about authenticity of nature, it's neither possible for “the unique & invariable ultimate authenticity of nature” to be compatible with “two distinctive humanistic ideologies about authenticity of nature with remarkable ideological difference” nor possible for “two distinctive humanistic ideologies about authenticity of nature with remarkable ideological difference” to discover and formulate “the unique & invariable ultimate authenticity of nature” coequally.

However, as crecive progression of practical feasibility & possibility in proportion to contemporaneous historical background, the practice human coming to discover and formulate authenticity of accessible existence & motion around must experience historical cognition development cumulatively enriched from nothingness to goad, from goad to a great lot, and consequently followed the proportionate ideaistic correction & qualitative optimization from superficiality to profundity, from parochiality to generality. And on the other hand, as **the uniqueness & invariance of ultimate authenticity of nature predestines unique possibility of scientific verity**, it's impossible for veritable progress of science is not intuitional cumulative achievement of colorful scientific travelogues A, B, C, D, E, F, ... like omnifarious smallwares full of a basket as deserving reward of the first itineracy around preternatural landscapes of brand-new landmasses of science but successive hypostatic endeavor to push humanistic ideology about authenticity of nature forward to perfect ideological enantiomorph of ultimate authenticity of nature as coherent theory about universal existence & motion step by step draw on practical feasibility & possibility in proportion to contemporaneous historical background, which makes up of realistic historical progress of science in inherent optimum orientation towards perfect ideological enantiomorph of ultimate authenticity of nature.

This of course indicates, throughout historical progress of science, especially in the early stage of historical progress of science, we ostensibly seemed always ready to produce omnifarious scientific truths about rich and colorful existence & motion around us. However, veritable progress of science is virtually not historical process human stochastically approach distinctive scientific truths one after another but hypostatic endeavor to push humanistic ideology about authenticity of nature forward to perfect ideological enantiomorph of ultimate authenticity of nature as coherent formulation about universal existence & motion, this of course indicates it's only possible for the major melody of historical progress of science to be serial epochmaking scientific knowledge metabolism in inherent optimum orientation towards perfect ideological enantiomorph of ultimate authenticity of nature.

Generally, the early fancy-free quantitative change of scientific knowledge proliferation as stochastic scientific travelogues like colorful smallwares full of a basket must be inferior by comparison and consequently be washed out for social legitimacy metabolism once historical progress of science proceeds to its in-depth

extension towards historical authenticity tolerance of science 0. Virtually, throughout historical progress of science, it's only possible for any contemporaneous scientific orthodoxy without social legitimacy qualification of historical authenticity tolerance of science 0 to exist as temporary progressive segment in proportion to contemporaneous historical background in crecive progression of historical progress of science. Especially, once historical progress of science slides into progressive transition from superficiality to profundity, from parochiality to generality, the inevitable scientific knowledge metabolism towards historical authenticity tolerance of science 0 is even remarkably flourishing.

This of course implies any inaugurator of successive scientific innovation towards consummate formulation of unique and invariable ultimate authenticity of nature must be destructor of contemporaneous scientific orthodoxy out of scientific legitimacy qualification of historical authenticity tolerance of science 0. In any case, as the uniqueness & invariance of ultimate authenticity of nature proportionably predestines the unique possibility of scientific verity as perfect ideological enantiomorph of ultimate authenticity of nature, it's completely impossible for two distinctive scientific truths with remarkable ideological difference to formulate the unique & invariable authenticity of nature coequally.

iii) As linear logic system on the basis of [(Homogenous cosmos originated from unique genesis postulate + spacetime~matter fully embodying cosmos postulate) + Instinctive PNT equilibrium postulate] and innovative cosmos redefinition in radical logic enantiomorph of newly highlighted factuality that **discretionary particles in cosmos are mutually convertible** with consequent PNT dynamics about universal existence & motion in the nature of coherent natura naturans throughout cosmic evolution, Homogenous Cosmos Originated from Unique Genesis can hardly gloss over remarkable divarication from contemporaneous scientific orthodoxy, which directly impacts vested interest of temporal authority. As a result, free press admittance of Homogenous Cosmos Originated from Unique Genesis must break through legitimacy defense line of contemporaneous scientific orthodoxy due to inevitable life-and-death scientific knowledge metabolism, so that it has to challenge venomous counterwork upper limit of temporal authority without alternatives. Virtually, wherever I contribute on the earth, there is not only unintelligible perplexity that almost nobody is ready to displease overwhelming temporal authority for free press admittance of Homogenous Cosmos Originated from Unique Genesis unless conclusive evidence drives temporal authority to the brink of retreat in defiance of my personal limitation but also unbending discrimination of my poor identity & qualification. As a result, I've been floundering around in vicious circle of virulent scientific knowledge metabolism campaign over 31 years.

As cosmos redefinition in logic enantiomorph of newly highlighted factuality that **discretionary particles in cosmos are mutually convertible** with consequent PNT dynamics about universal existence & motion in the nature of coherent natura naturans throughout cosmic evolution, Homogenous Cosmos Originated from Unique Genesis is brand-new ideological system about authenticity of nature so different from contemporaneous scientific orthodoxy, which straightforwardly makes me typical heterodoxy and perplexed to pass free press admittance. On one hand, as lowdown man of the society, nothing can support me to involve in virulent scientific knowledge metabolism campaign, even as personal limitation, it's almost impossible for me to offer tangible evidence to make the remarkable divarication & illogicality self-evident on the spot. And on the other hand, there is almost no way for me to pass free press egotistic proximity identification, so that there is no way for implementation of credible authentication of the remarkable divarication but to leave me silent aside in free press embarment for magistral autarchy of free press regulation customization and free press admittance of temporal authority short of necessary intendance. Such

situation of course has predestined my tragedy unless I am ready to give up the rationality of logic proliferation of Homogenous Cosmos Originated from Unique Genesis and offer anthem to contemporaneous scientific orthodoxy to serve the time. Leastways, as long as temporal authority are still ready to maintain their respectable legitimacy & repute by the right of humanistic self-preservation, there is almost no way for me to slide over torture floundering around in virulent scientific knowledge metabolism campaign. In order to tell people on the earth that cosmos is homogenous originated from unique genesis through and through, I am so sorrowful and depressed to be living victim of scientific knowledge metabolism campaign of the age without alternatives.

I am genuinely sorry that, as multiple notion with double significance of “**social connotation**” & “**natural connotation**”, social legitimacy & validity of truths can never exceed cannon range. Just because of my inculpable intention to show 7 billions of live people on the earth that **cosmos is throughout homogenous originated from unique genesis, cosmic status quo is demiurgic aggradation of sequential homologous cosmogony, which exactly exists as well-regulated integration of cosmic homogeneity system making up of out-and-out serial natura naturata in the nature of coherent natura naturans throughout cosmic evolution**, I’ve unexpectedly provoked so many virulent counterworkers due to inevitable scientific knowledge metabolism for remarkable divarication even illogicality between cosmos redefinition in radical logic enantiomorph of newly highlighted factuality that **discretionary particles in cosmos are mutually convertible** and live contemporaneous scientific orthodoxy. As low-down heterodoxy floundering around in virulent scientific knowledge metabolism campaign against overwhelming high-sounding royal substantiation & perfection of contemporaneous scientific orthodoxy, I’ve been so exhausted and depressed for interminable free press embarment, as overwhelming authoritative intrepidity of contemporaneous scientific orthodoxy with unprecedented official facility of magistral autarchy of **free press regulation customization & free press admittance**, no matter how much I’ve tragically suffered, I can only stick to suffer quietly, I am even forbidden to cry out for bitterly torture, otherwise, vicious circle of virulent scientific knowledge metabolism campaign must be even drastic like pouring oil on the flames immediately.

Virtually, as frank and onefold man, I substantively had no intention to unhallow contemporaneous social legitimacy qualification of Relativity, Quantum Theory, Black Hole, Dark Matter, The Big Bang, LIGO gravitational wave discovery etc, I but introduced **Homogenous cosmos originated from unique genesis postulate** for remarkable highlight that **discretionary particles in cosmos are mutually convertible**, and successively expanded the proper logic connotation of Homogenous cosmos originated from unique genesis postulate with supplementation of two 0.5 grade accessorial postulates of “**Spacetime~matter fully embodying cosmos postulate**” & “**Instinctive PNT equilibrium postulate**” as independent logic chain reaction towards cosmos redefinition & mathematical formulation of universal existence & motion in the nature of coherent natura naturans throughout cosmic evolution.

In any case, as magistral autarchy of **free press regulation customization & free press admittance** of temporal authority short of necessary intendance, practical implementation of free press admittance & social legitimacy authorization of brand-new scientific idea is apparently more accessible to serve the time than to devote to general progress of science. Under untimely background of high-sounding freewheeling royal substantiation & perfection of contemporaneous scientific orthodoxy, if there are only so-called temporal authority as second-string geniuses in the world, the reason for a typical heterodoxy to pass free press egoistical proximity identification must be unintelligibly magic. I am genuinely sorry I am not modish science aristocrat who are mostly self-conscious to find jobs following direction of contemporaneous scientific orthodoxy orders like PACC, PACS and smoothly devoting themselves to high-sounding royal substantiation & perfection of contemporaneous scientific orthodoxy. My endeavor to jundied

a narrow way to air my monograph as possible as I can is but attempt to take use of possible opening to make the two sixty-four-dollar questions of my **New World Manufacturer** available to some of the intelligentsia in the world for unexpected rescue from a desperate situation. In any case, my **New World Manufacturer** needs more cordial workers for sapiential cooperation indeed.

And virtually, I contributed few times from 2013 to 2018, it's not because I was not willing to contribute to journals and publishing houses, but because I was quite aware of my distance, the living authoritarian and learned ambience in the nature of royal successive freewheeling substantiation & perfection of contemporaneous scientific orthodoxy. In July & August 2019, I contributed about 20 times to related journals and publishing houses, all my religious contribution were refused without mercy. My experience told me time after time, as lowdown man and typical heterodoxy of cosmos redefinition out of rigid succession of contemporaneous scientific orthodoxy, no matter how much authenticity of nature has been practically highlighted by Homogenous Cosmos Originated from Unique Genesis, as long as there is remarkable deviation from contemporaneous scientific orthodoxy, scientific knowledge metabolism and consequent scientific knowledge metabolism campaign must be inevitable, under egotistic background of royal substantiation & perfection of contemporaneous scientific orthodoxy, free press admittance can never be free from duress of authoritative intrepidity of contemporaneous scientific orthodoxy, if there is magistral autarchy of free press regulation customization and free press admittance of temporal authority short of necessary intendance, free press admittance of timely renovation of humanistic ideology about authenticity of nature in proportion to contemporaneous historical background has to challenge venomous counterwork upper limit of temporal authority without alternatives. As multiple notion with double significance of "social connotation" & "natural connotation", social legitimacy & validity of truths can never exceed cannon range.

Thanks to live input of civilization advancement of the age, I am reluctantly luckier than Copernicus, Bruno, Galileo ..., thanks to invention & popularization of computer & internet of the age, if I could only write my paper with my ink pen and show it to one or two placeman in mainland of China, Homogenous Cosmos Originated from Unique Genesis must have died early. After all, as out-and-out social work outgrowth and humanistic ideology about authenticity of nature in proportion to contemporaneous historical background, one terminal of social subsistence of commensurate humanistic ideology about authenticity of nature natively fixes on frame & gain of live contemporaneous scientific orthodoxy, the other terminal of social subsistence of commensurate humanistic ideology about authenticity of nature inherently connects living scientific knowledge proliferation of the age as ongoing extension of historical progress of science in inherent optimum orientation towards perfect ideological enantiomorph of ultimate authenticity of nature, as quantitative & qualitative change of historical progress of science in inherent optimum orientation towards perfect ideological enantiomorph of ultimate authenticity of nature must bring out progressive ideological variance of humanistic ideology about authenticity of nature, scientific knowledge metabolism and consequent scientific knowledge metabolism campaign is always something inevitable. Throughout human history, many progressive scientific ideas had ever struggled tragically in scientific knowledge metabolism campaign all their lives, and many of them did not triumph by convincing their opponents and making them see the light, but rather because their opponents eventually died and a new generation grew up who were familiar with them. As low-down man of the society struggling as typical heterodoxy under egotistic background of interminable royal substantiation & perfection of contemporaneous scientific orthodoxy, my tragedy is of course self-evident.

Historical progress of science in the recent several centuries seemed like a far-flung exploration of the first itinerary around numerous distinctive landscapes of brand-new landmasses of science with palette & tablet on back, several hundred years' scientific travelogues were compiled thereby.

As grown up under egotistic background of high-sounding royal substantiation & perfection of contemporaneous scientific orthodoxy without remarkable contrast, you might have a thick skin to invalidity of interminable substantiation & perfection of contemporaneous scientific orthodoxy for relatively smooth involvement in respectable contemporaneous scientific orthodoxy ever since. You might be insensitive to comprehend what makes science forum homegrown outgrowth in the garden of contemporaneous scientific orthodoxy in the nature of things. Whereas, I am quite sure, several years later, it might be obvious for you to comprehend abnormality of the factuality that Homogenous Cosmos Originated from Unique Genesis, the Big Bang, String Theory, even recent LIGO gravitational wave discovery were almost contemporaneous scientific occurrence. Whereas, what's the magic motivity for temporal authority to shake the world draw on authoritative intrepidity of The Big Bang, String Theory, LIGO gravitational wave discovery etc. Comparably, as timely renovation of humanistic ideology about authenticity of nature in proportion to contemporaneous historical background and innovative cosmos redefinition in logic enantiomorph of newly highlighted factuality that **discretionary particles in cosmos are mutually convertible** with consequent PNT dynamics about universal existence & motion in the nature of coherent natura naturans throughout cosmic evolution, why commensurate Homogenous Cosmos Originated from Unique Genesis has to flounder around in free press embarment for more than 31 years aside.

I am really depressed and jittery for frequent frustration of free press admittance, in any case, just because authoritative intrepidity of contemporaneous scientific orthodoxy is all-time and overwhelming, there are really few people on the earth who are ready to clarify issues as below:

①. Since ultimate authenticity of nature can be neither omnifarious authenticity smallwares full of a basket nor authenticity chameleon one piece and only but coherent natura naturans throughout cosmic evolution, ultimate consummation of science must be perfect ideological enantiomorph of ultimate authenticity of nature. Whereas, is it possible for **“royal substantiation & perfection of contemporaneous scientific orthodoxy** out of scientific legitimacy qualification of historical authenticity tolerance of science 0” to be nonstop towards perfect ideological enantiomorph of ultimate authenticity of nature without innovative aberrancy, and whether live scientific knowledge proliferation all over the world is still on its freewheeling way of interminable **royal substantiation & perfection of contemporaneous scientific orthodoxy** instead of **veritable progress of science** to push humanistic ideology about authenticity of nature forward to perfect ideological enantiomorph of ultimate authenticity of nature step by step draw on practical feasibility & possibility in proportion to contemporaneous historical background?

②. What's the timely occasion for freewheeling royal substantiation & perfection of contemporaneous scientific orthodoxy to take almost full roles of historical progress of science for **“substantiation & perfection of flourishing contemporaneous scientific orthodoxy ≈ general progress of science”**, when it's demoded endeavor to egotistically persist **royal substantiation & perfection of contemporaneous scientific orthodoxy** and necessary to leave off interminable **royal substantiation & perfection of contemporaneous scientific orthodoxy** under egotistic guidance of authoritative intrepidity of contemporaneous scientific orthodoxy and acclimate ourselves for **veritable progress of science** to push humanistic ideology about authenticity of nature forward to perfect ideological enantiomorph of ultimate authenticity of nature step by step draw on practical feasibility & possibility in proportion to contemporaneous historical background.

We have to admit, in the recent several centuries, historical progress of science seemed like a far-flung exploration of the first itineracy around numerous distinctive landscapes of brand-new landmasses of science with palette & tablet on back, several hundred years' scientific travelogues were compiled thereby, and we have to admit, as crescive progression of practical feasibility & possibility for development of science, such hypostatic progress of science in the recent centuries is necessary progressive segment of historical progress of science

in inherent optimum orientation towards perfect ideological enantiomorph of ultimate authenticity of nature. And indeed, as it's only possible for ultimate authenticity of nature to be unique & invariable as coherent natura naturans throughout cosmic evolution, as humanistic ideology about accessible authenticity of nature, veritable progress of science is but hypostatic endeavor to push humanistic ideology about authenticity of nature forward to perfect ideological enantiomorph of ultimate authenticity of nature step by step draw on practical feasibility & possibility in proportion to contemporaneous historical background. As a result, before humanistic ideology about authenticity of nature finally qualified as perfect ideological enantiomorph of ultimate authenticity of nature, it's only possible for "science" to be **commensurate ideological system about authenticity of nature in proportion to contemporaneous historical background** with proportionate historical authenticity tolerance of science. Idiographic naissance & successive development of "Relativity + Quantum Theory" was of course idiographic progressive segment in crescive progression of historical progress of science in inherent optimum orientation towards perfect ideological enantiomorph of ultimate authenticity of nature in proportion to historical background of early years of 20th century, when human had to accomplish ideological transition from macrophysics to microphysics at the volley for more and more interposition of various microcosmic factuality out of conventionality of ready-made macrophysics.

Necessary precondition of social legitimacy subsistence of any contemporaneous scientific orthodoxy is that:

- i) As humanistic ideology about authenticity of nature in proportion to contemporaneous historical background, original naissance of the so-called contemporaneous scientific orthodoxy must accomplish credible historical advancement to have pushed humanistic ideology about authenticity of nature forward to perfect ideological enantiomorph of ultimate authenticity of nature.**
- ii) Successive remarkable historical advancement to push humanistic ideology about authenticity of nature forward to perfect ideological enantiomorph of ultimate authenticity of nature has not been accomplished and procured social legitimacy qualification therefore.**

In terms of any contemporaneous scientific orthodoxy out of scientific legitimacy qualification of historical authenticity tolerance of science 0, as long as historical progress of science is still in its normal ways in inherent optimum orientation towards perfect ideological enantiomorph of ultimate authenticity of nature, once remarkable advancement of historical progress of science to push humanistic ideology about authenticity of nature forward to perfect ideological enantiomorph of ultimate authenticity of nature has been accomplished and consequently procured social legitimacy qualification, the so-called contemporaneous scientific orthodoxy must be washed out without alternatives. At any rate, it is only possible for ultimate authenticity of nature to be unique and invariable, as rigorous enantiomorphous correlation between objective authenticity of nature and humanistic ideology about authenticity of nature, it's neither possible for "the unique & invariable ultimate authenticity of nature" to be compatible with "two distinctive humanistic ideologies about authenticity of nature with remarkable ideological difference" nor possible for "two distinctive humanistic ideologies about authenticity of nature with remarkable ideological difference" to discover and formulate "the unique & invariable ultimate authenticity of nature" coequally.

As pioneering scientific idea in proportion to contemporaneous historical background of remarkable practice transition from macrocosmos to microcosmos, as long as we have to admit that "**General Relativity + Quantum Theory**" are still out of scientific legitimacy qualification of historical authenticity tolerance of science 0, and historical progress of science is still on its normal way in inherent optimum orientation towards perfect ideological enantiomorph of ultimate authenticity of nature, Relativity & Quantum Theory must be washed out by coming positive renovation of humanistic ideology about authenticity of nature towards perfect ideological enantiomorph of ultimate authenticity of nature sooner or later. Although, before 1960, as burgeoning contemporaneous scientific orthodoxy of the age, it

Historical progress of science in the recent several centuries seemed like a far-flung exploration of the first itinerary around numerous distinctive landscapes of brand-new landmasses of science with palette & tablet on back, several hundred years' scientific travelogues were compiled thereby.

seemed freewheeling royal substantiation & perfection of “Relativity + Quantum Theory”≈ general progress of science.

Whereas, under background of royal substantiation & perfection of contemporaneous scientific orthodoxy, magistral autarchy of “free press regulation customization” and “free press admittance” of temporal authority is full condition for temporal authority to customize historical progress of science at their pleasure. Once “free press regulation customization” and “free press admittance” is under magistral autarchy of temporal authority short of necessary intendance, nothing can prevent “royal substantiation & perfection of contemporaneous scientific orthodoxy” to be aggrandized as “general progress of science” or to take full historical role of “general progress of science” with magisterial backup of authoritative intrepidity of contemporaneous scientific orthodoxy in spite of historical objectivity that **interminable royal substantiation & perfection of contemporaneous scientific orthodoxy ≠ original endeavor of general progress of science to push humanistic ideology about authenticity of nature forward to perfect ideological enantiomorph of ultimate authenticity of nature step by step draw on practical feasibility & possibility in proportion to contemporaneous historical background, which is virtually realistic historical progress of science in inherent optimum orientation towards perfect ideological enantiomorph of ultimate authenticity of nature**, science forum must turn into homegrown outgrowth in garden of contemporaneous scientific orthodoxy, which even can hardly be free from duress of authoritative intrepidity of contemporaneous scientific orthodoxy.

What's more, as out-and-out social work outgrowth and humanistic ideology about authenticity of nature in proportion to contemporaneous historical background, social existence and historical progress of “science” must inherently possess double coordinative significance of “natural connotation” and “social connotation”, social legitimacy subsistence of neonatal scientific idea especially successive renovation of humanistic ideology about authenticity of nature along historical progress of science in inherent optimum orientation towards perfect ideological enantiomorph of ultimate authenticity of nature never simply depends on cognizant achievement that brand-new or more veritable authenticity of nature has been reflected on sense of pioneering originators with commensurate authenticity highlight effect in proportion to contemporaneous historical background, it even crucially implicates esoteric authoritative social legitimacy identification & authentication in accordance with egotistic criterion of contemporaneous scientific orthodoxy under official centered background —social legitimacy & validity of truths can never exceed cannon range, which of course includes humanistic operation of virulent scientific knowledge metabolism campaign underlying. What's more, our society seems numb about “scientific knowledge metabolism and the consequent scientific knowledge metabolism campaign” till today. Especially, as opposite of scientific knowledge metabolism campaign with magisterial backup of contemporaneous scientific orthodoxy, temporal authority can deal with coming scientific knowledge metabolism at their pleasure draw on absolute autarchy of free press admittance short of necessary intendance.

As author of innovative cosmos redefinition in logic enantiomorph of newly highlighted factuality that **discretionary particles in cosmos are mutually convertible** with consequent PNT dynamics about universal existence & motion in the nature of coherent natura naturans throughout cosmic evolution, I am so low-down man in mainland of China floundering under background of interminable royal substantiation & perfection of contemporaneous scientific orthodoxy, there is substantively no way for me to slide over pestilent scientific knowledge metabolism campaign for remarkable divarication even remarkable despotism of free press admittance of temporal authority short of necessary intendance. At any rate, as humanistic ideology about authenticity of historically accessible existence & motion around us, the weight on balance of science is not veritable achievement of discovery & formulation

of authenticity of nature, much of it is royal superiority even intrepidity of historical hierarchy originated from self-preservation of human for historical limitation. It's of course imaginable that situation of Copernicus age, Galileo age were always something like this, whereas, without practical experience as scientific heterodoxy floundering about in high-sounding interminable royal substantiation & perfection of contemporaneous scientific orthodoxy, you may be insensitive to the morbid situation floundering in riancy today.

Since ultimate authenticity of nature can be neither omnifarious authenticity smallwares full of a basket nor authenticity chameleon one piece and only, but coherent natura naturans throughout cosmic evolution, and cosmic status quo is but demiurgic aggradation of sequential homologic cosmogony which is well-regulated integration of cosmic homogeneity system making up of out-and-out serial natura naturata in the nature of coherent natura naturans throughout cosmic evolution, as humanistic ideology about authenticity of nature, why live ideological system about authenticity of nature seems so omnifarious disciplines & subdisciplines as physics, chemistry, biology, iatrology etc instead of perfect ideological enantiomorph of ultimate authenticity of nature?

Although, the demiurge is always straightforward who only possess invariable originality as coherent natura naturans throughout cosmic evolution. And indeed, cosmic status quo is but demiurgic aggradation of sequential homologic cosmogony which exactly exists as well-regulated integration of cosmic homogeneity system making up of out-and-out serial natura naturata in the nature of coherent natura naturans throughout cosmic evolution. As crescive progression of practical feasibility & possibility in proportion to contemporaneous historical background, it's only possible for human to study distinctive existence & motion accessible around us then and there, so that historical progress of science in the recent several centuries seemed like a far-flung exploration of the first itinerary around numerous distinctive landscapes of brand-new landmasses of science with palette & tablet on back, several hundred years' scientific travelogues were compiled thereby. Even as permanent synthesized conditionality of "crescive progression of practical feasibility & possibility in proportion to contemporaneous historical background + the uniqueness & invariance of ultimate authenticity of nature predestines the unique possibility of scientific verity as perfect ideological enantiomorph of ultimate authenticity of nature" through and through, it's only possible for the major melody of historical progress of science to be a series of epochmaking scientific knowledge metabolism with proportionate orthodoxy subrogation. However, once free press regulation customization and free press admittance is completely under magistral autarchy of temporal authority short of necessary intendance, it's of course imaginable what's the trouble for the gradational series of scientific knowledge metabolism with isochronous orthodoxy subrogation to be implemented smoothly.

I have to be wary of sliding into vicious circle for more spiteful frustration. Virtually, as timely renovation of humanistic ideology about authenticity of nature in proportion to contemporaneous historical background of remarkable highlight of microcosmic configuration of matter and typical aberrant scientific knowledge proliferation in lineal logic system without distinction of physics, chemistry, biology, iatrology etc, the rationale of Homogenous Cosmos Originated from Unique Genesis is apparently out of conventional academic model in accordance with PACC, PACS, chemistry, biology, iatrology etc; under egotistic background of high-sounding royal substantiation & perfection of contemporaneous scientific orthodoxy, it may be not sensitive for most of the conventional academicians to understand, especially the confident loving successors of tradition or even meritorious second-string geniuses of contemporaneous scientific orthodoxy. Whereas, once they come to implement straightforward **free press egotistic proximity identification**, they are of course sensitive to find my heterodoxy & incompatibility to orthodox criterion.

In the early 20 years (before 2012), when I contributed to journals or publishing houses, I was always devoutly

Historical progress of science in the recent several centuries seemed like a far-flung exploration of the first itinerary around numerous distinctive landscapes of brand-new landmasses of science with palette & tablet on back, several hundred years' scientific travelogues were compiled thereby.

ready to follow their advice for proper improvement, 20 years later, I did few jobs like this ever since. It's of course comprehensible since I can hardly shake off puzzledom of scientific knowledge metabolism campaign at daggers drawn, there is no way for me to be unquestionable and none shortage can be my last one. Virtually, as magistral autarchy of "free press regulation customization" & "free press admittance" of temporal authority short of necessary intendance, practical social operation of free press admittance adulterates too much of authoritative intrepidity and egotistic confidence of temporal authority.

In any case, we have to admit this is typical age of royal substantiation & perfection of contemporaneous scientific orthodoxy, as a result, there is remarkable endeavor aberrance of historical progress of science to push humanistic ideology about authenticity of nature forward to perfect ideological enantiomorph of ultimate authenticity of nature step-by-step draw on practical feasibility & possibility in proportion to contemporaneous historical background. And as magistral autarchy of free press regulation customization and free press admittance short of necessary intendance, there is almost no way for free press admittance of aberrant scientific knowledge proliferation out of succession of contemporaneous scientific orthodoxy to be free from free press egotistic proximity identification of temporal authority, especially when aberrant scientific knowledge proliferation out of succession of contemporaneous scientific orthodoxy can hardly cover up remarkable divarication from tradition and consequently slides into virulent scientific knowledge metabolism campaign.

In terms of any contemporaneous scientific orthodoxy out of scientific legitimacy qualification of historical authenticity tolerance of science 0, there is rather limited potential range for endeavor of royal substantiation & perfection of contemporaneous scientific orthodoxy to push humanistic ideology about authenticity of nature forward to perfect ideological enantiomorph of ultimate authenticity of nature, no more endeavor of linear logic extension in rigid succession of contemporaneous scientific orthodoxy. Comparably, there is substantial probability for aberrant scientific knowledge proliferation out of succession of contemporaneous scientific orthodoxy to bring out epochmaking timely renovation of humanistic ideology about authenticity of nature in proportion to contemporaneous historical background.

The even pestilent officialism morbidity is that, as unprecedented official facility of magistral autarchy of free press regulation customization & free press admittance due to officialdom of overwhelming authoritative intrepidity of contemporaneous scientific orthodoxy in the recent half century, science forum has been egotistically customized so much towards substantiation & perfection of contemporaneous scientific orthodoxy in scientific travelogue style, so that, as timely renovation of humanistic ideology about authenticity of nature in proportion to contemporaneous historical background of remarkable highlight of microcosmic configuration of matter as radical logic enantiomorph of newly highlighted factuality that discretionary particles in cosmos are mutually convertible, over 90% journals on the earth insist that, as typical aberrant scientific knowledge proliferation out of succession of contemporaneous scientific orthodoxy, Homogenous Cosmos Originated from Unique Genesis neither belong to conventional academic scope they are professionally devoting to nor accord with egotistic academic regularity, which is of course the most straightforward consequence of magistral autarchy of free press regulation customization & free press admittance of temporal authority short of necessary intendance.

In any case, free press regulation customization & free press admittance is undoubtedly hardcore puissance of historical progress of science, since there is unprecedented official facility of magistral autarchy of free press regulation customization & free press admittance of temporal authority under egotistic background of interminable royal substantiation &

perfection of contemporaneous scientific orthodoxy short of necessary intendance, humanistic resistance of free press admittance even altisonant legitimacy authorization of timely renovation of humanistic ideology about authenticity of nature as Homogenous Cosmos Originated from Unique Genesis is self-evident. Virtually, free press admittance of Homogenous Cosmos Originated from Unique Genesis must break through legitimacy defense line of contemporaneous scientific orthodoxy due to inevitable life-and-death scientific knowledge metabolism, so that it has to challenge venomous counterwork upper limit of temporal authority without alternatives, I slide deep into vicious circle of virulent scientific knowledge metabolism campaign therefore, unless I give up inherent logic self-consistency of homogenous cosmos originated from unique genesis and cater for royal substantiation & perfection of contemporaneous scientific orthodoxy.

Whereas, once I turn back to calmness after anguish, I see it's necessary for me to keep level-headed for further endeavor to improve it. No matter whether I can break loose of free press embarment all my life time or not, I should try to push my narrow way to write down my idea as possible as I can off hours. And virtually, as low-down man struggling in so bureaucratic social ambience without official rank, money, guanxi, nothing better I can do.

Since January, 2020, I was lucky to procure an opportunity to air the monograph in researchgate.net, where I met thousands of cordial readers all over the world.

https://www.researchgate.net/publication/343335817_Homogenous_Cosmos_Originated_from_Unique_Genesis

Read demographics for the last 8 weeks

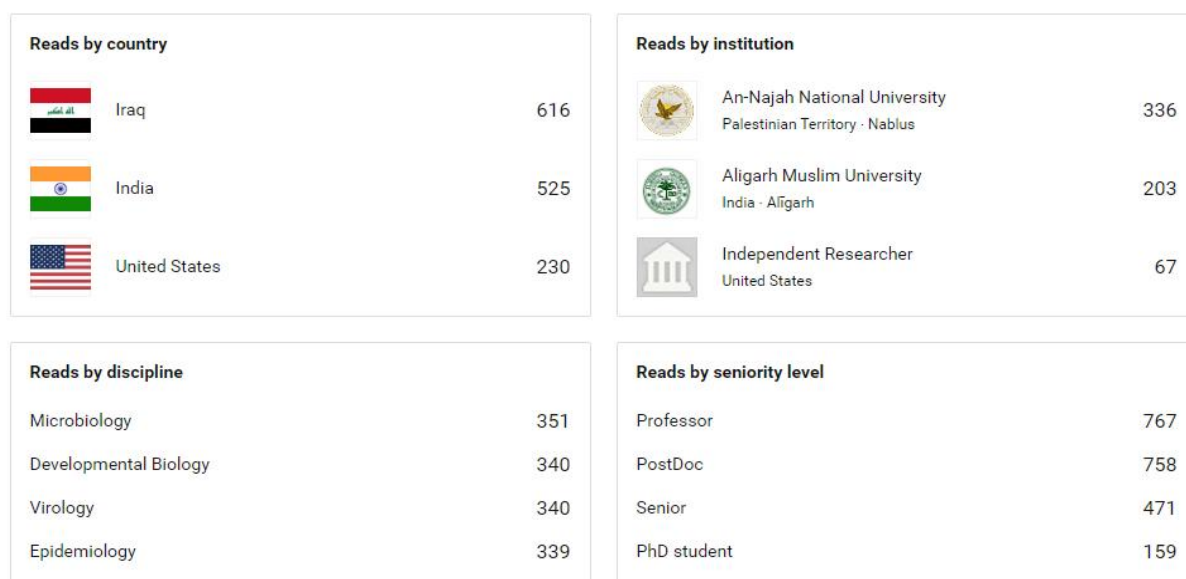

[View all demographics](#)

https://www.researchgate.net/publication/345494202_danyuanchunxiyuzhou

<https://independent.academia.edu/YangGuosheng>

I was encouraged a lot by my cordial readers indeed, I didn't expect there were so many readers of the monograph which was repeatedly rejected as annoying outgrowth of aberrant scientific knowledge proliferation out of rigid succession of contemporaneous scientific orthodoxy by journals on the earth all these years. Even as remarkable contrast like this, I have to suspect there are always **Villainous Black Hands** following like a shadow once Homogenous Cosmos Originated from Unique Genesis enters editorial office for free press admittance anywhere on the earth. Virtually, throughout historical progress of science, no timely renovation of humanistic

Historical progress of science in the recent several centuries seemed like a far-flung exploration of the first itineracy around numerous distinctive landscapes of brand-new landmasses of science with palette & tablet on back, several hundred years' scientific travelogues were compiled thereby.

ideology about authenticity of nature suffered so much in virulent scientific knowledge metabolism campaign besides heliocentric theory had ever suffered fire torture, even the <The Origin of Species> of Charles Darwin did not suffered so much of free press embarment but some a little suffering of dissidence after publication. Commensurately, <The Large-scale Structure of Spacetime> had been high-soundly published on the earth, “Big Bang” even “LIGO gravitational wave discovery” had been coronated with perfect justification too. Besides they all had wisely echoed and glorified “the new clothing of the tzar is really beautiful” so as to be compatible for ineradicable free press egotistic proximity identification and be free from virulent scientific knowledge metabolism campaign, another all-important cause was that, as straightforward endeavor towards royal substantiation & perfection of contemporaneous scientific orthodoxy, they were all science aristocrat with respectable identity & qualification even substantial official fund backup. I am genuinely sorry that, as multiple notion with double significance of “social connotation” & “natural connotation”, social legitimacy & validity of truths can never exceed cannon range.

In any case, as timely renovation of humanistic ideology about authenticity of nature in proportion to contemporaneous contemporaneous historical background and innovative cosmos redefinition in radical logic enantiomorph of newly highlighted factuality that **discretionary two particles in cosmos are mutually convertible** with consequent PNT dynamics about universal existence & motion in the nature of coherent natura naturans throughout cosmic evolution, naissance of Homogenous Cosmos Originated from Unique Genesis has renovated our rational purview about universal existence & motion so much that cosmos is throughout homogenous originated from unique genesis, cosmic status quo is demiurgic aggradation of sequential homologic cosmogony which exactly exists as well-regulated integration of cosmic homogeneity system making up of out-and-out serial natura naturata in the nature of coherent natura naturans throughout cosmic evolution. Relatively, live contemporaneous scientific orthodoxy is but inertial ideological aggradation of remarkable transverse ideological expansion making up of rich and colorful scientific travelogues A, B, C, D, E, F, ... like omnifarious smallwares full of a basket which are virtually deserving rewards of a far-flung exploration of the first itineracy around numerous distinctive landscapes of brand-new landmasses of science with palette & tablet on back in the recent several centuries. As a result, life-and-death scientific knowledge metabolism and consequent virulent scientific knowledge metabolism campaign is inevitable, normal publication of Homogenous Cosmos Originated from Unique Genesis must intensively impact vested interest of temporal authority, that's why free press admittance of Homogenous Cosmos Originated from Unique Genesis has to challenge venomous counterwork upper limit of temporal authority under egotistic background of interminable royal substantiation & perfection of contemporaneous scientific orthodoxy.

Since social legitimacy subsistence of contemporaneous scientific orthodoxy can hardly be free from progressive inconsistency of “magistral puissance of historical progress of science + vested interest in live contemporaneous scientific orthodoxy + inevitable life-and-death scientific knowledge metabolism in optimization orientation towards perfect ideological enantiomorph of ultimate authenticity of nature” through and through, we have to admit objective coexistence of “benign officialism domino effect of contemporaneous scientific orthodoxy” & “conservative officialism domino effect of contemporaneous scientific orthodoxy” throughout historical progress of science. Whereas, under egotistic background of interminable royal substantiation & perfection of contemporaneous scientific orthodoxy, **conservative officialism domino effect of contemporaneous scientific orthodoxy** seems nonexistent, instead, magistral autarchy of **free press regulation customization** and **free press admittance** of temporal authority is so intrepid going without saying, which always acts as hardcore puissance of historical progress of science.

Long-term struggling in vicious circle of virulent scientific knowledge metabolism campaign made me the

As coherent natura naturans throughout cosmic evolution, instinctive PNT reciprocal equilibrium towards optimum PNT operation is radical potentiality & conditionality for cosmos always ready to orientate itself towards perfection.

most tragic innovator of humanistic ideology about authenticity of nature throughout historical progress of science, although, as amateur work of lowdown man of the society, Homogenous Cosmos Originated from Unique Genesis has been the largest personal academic monograph throughout historical progress of science in both native language and a foreign language. It's really innovative cosmos redefinition in radical logic enantiomorph of newly highlighted factuality that **discretionary particles in cosmos are mutually convertible** with consequent PNT dynamics about universal existence & motion in the nature of coherent natura naturans throughout cosmic evolution.

In any case, as crecive progression of practical feasibility & possibility along historical extension, it's only possible for the major melody of historical progress of science in inherent optimum orientation towards perfect ideological enantiomorph of ultimate authenticity of nature to be a series of epochmaking scientific knowledge metabolism one after another, I can hardly slide over inevitable life-and-death scientific knowledge metabolism due to historical progress of science in inherent optimum orientation towards perfect ideological enantiomorph of ultimate authenticity of nature, I have to confront the most overwhelming opposite of virulent scientific knowledge metabolism throughout historical progress of science who are working as hardcore puissance of live historical progress of science with unprecedented official facility of magistral autarchy of **free press regulation customization** and **free press admittance**, 31 years' free press embarment is self-evident consequence at the volley. As commensurate opposite consequence, Homogenous Cosmos Originated from Unique Genesis helplessly grows in wilderness day by day and consequently turns into the largest personal academic monograph in both native language and a foreign language throughout historical progress of science with 31 years' idea aggradation.

Since there is no way for me to slide over vicious circle of virulent scientific knowledge metabolism campaign, free press admittance of Homogenous Cosmos Originated from Unique Genesis must break through legitimacy defense line of contemporaneous scientific orthodoxy due to inevitable life-and-death scientific knowledge metabolism, so that it has to challenge venomous counterwork upper limit of overwhelming temporal authority who are mostly hardcore puissance of living historical progress of science with unprecedented official facility of magistral autarchy of **free press regulation customization** and **free press admittance** short of necessary intendance, my personal persistence & struggling is negligible. In straightforward words, free press admittance of timely renovation of humanistic ideology about authenticity of nature in proportion to contemporaneous historical background is not simple issue whether timely renovation of humanistic ideology about authenticity of nature in proportion to contemporaneous historical background is pioneering idea with necessary ideographic quality, the even pestilent issue is that there is almost no way for free press admittance of timely renovation of humanistic ideology about authenticity of nature in proportion to contemporaneous historical background to slide over virulent scientific knowledge metabolism campaign and have to challenge venomous counterwork upper limit of overwhelming temporal authority.

Throughout human history, progress of human civilization can hardly evade deadly conflicts of interest irreconcilable between conservative power and pioneering power, human have to invoke life-and-death warfare to smooth them away. Whereas, as hardcore component of human civilization, once historical progress of science slides into virulent scientific knowledge metabolism campaign for occurrence of timely renovation of humanistic ideology about authenticity of nature in proportion to contemporaneous historical background, it seems nothing can do its jobs to conciliate the virulent scientific knowledge metabolism campaign, but to leave innovators lonely & helpless themselves and overwhelming temporal authority having their full swing.

After floundering in cruel social reality even vicious circle of virulent scientific knowledge metabolism campaign

Historical progress of science in the recent several centuries seemed like a far-flung exploration of the first itinerary around numerous distinctive landscapes of brand-new landmasses of science with palette & tablet on back, several hundred years' scientific travelogues were compiled thereby.



It's only possible for concordant cosmos to be demiurgic aggradation of out-and-out serial natura naturata in the nature of coherent natura naturans throughout cosmic evolution; there is no way for demiurgic aggradation in the nature of different natura naturans to be concordant cosmos through and through.

for more than 31 years, I've been exhausted and old indeed, it's substantively more and more difficult for me to keep level-headed for further authenticity highlight of homogenous cosmos originated from unique genesis. Originally, I am always ready to do my utmost for the challenge of it, whereas, once I slide into interminable vicious circle of virulent scientific knowledge metabolism campaign, as lowdown man of the society, I have to admit my weakness & helplessness before overwhelming temporal authority who are mostly hardcore puissance of living historical progress of science. No matter whether I have to shake off the terrible obsession soon or not, I am genuinely appreciated for permanent support of my cordial readers all over the world who have practically shown me a sunny window of the dad-burned free press embarment eversince, which even seems a single spark ready to start a prairie fire.

Many thanks for your kindly concern; many thanks for your sincere support!

A villainous science heterodoxy floundering about in virulent scientific knowledge metabolism campaign like a wolf struggling on bottom of well.

Firstly written in Jan. 2014, revised off the cuff.

As coherent natura naturans throughout cosmic evolution, instinctive PNT reciprocal equilibrium towards optimum PNT operation is radical potentiality & conditionality for cosmos always ready to orientate itself towards perfection.

Data Availability Statement:

The data that support the findings of this study are openly available in researchgate.net at

https://www.researchgate.net/publication/343335817_Homogenous_Cosmos (English version)

https://www.researchgate.net/publication/332871141_Homogenous_Cosmos (English version)

https://www.researchgate.net/publication/345494202_danyuanchunxiyuzhou (Chinese version)

The data that support the findings of this study are openly available in independent.academia.edu

<https://independent.academia.edu/YangGuosheng> (Both English version and Chinese version are available)

The data that support the findings of this study are openly available in Dryad open access.

https://datadryad.org/stash/share/3WYa5MUGhkZ8E9WHjI4Pmt0bufsC1faVd_yYudqM0mQ

(doi:10.5061/dryad.9zw3r22kn) (Both English version and Chinese version are available)

References:

- [1] Hackermüller L, Hornberg K, Arndt M, et al., Decoherence of matter waves by thermal emission of radiation. *Nature*, 2004, 427: 711~714
- [2] Hackermüller L, Uttenthaler S, Zeilinger A, et al., The wave nature of biomolecules and fluorofullerenes. *Phys. Rev. Lett.*, 2003, 91(9): 90408
- [3] La Vacca, Giuseppe & Mota, David (2013). Mass-varying neutrino in light of cosmic microwave background and weak lensing. *Astronomy and Astrophysics*. ISSN 0004-6361. 560. doi: 10.1051/0004-6361/201220971
- [4] Li, Baojiu; Mota, David & Barrow, John D (2011). VARYING ALPHA FROM N-BODY SIMULATIONS. *Astrophysical Journal*. ISSN 0004-637X/728/2/108
- [5] S. Weinberg, *Gravitation and Cosmology; Principles and Applications of the General Theory of Relativity*, John Wiley & Sons, New York, (1972), Sect, 11/7, pp. 335 ff.
- [6] W. L. Freeman et. Al., “Final results from the Hubble Space Telescope Key Project to measure the Hubble constant,” *Astrophysical Journal*, Vol. 553, May 20, (2001), pp. 47-72.
- [7] A. Cimatti, E. Daddi, A. Renzini, P. Cassata, E. Vanzella, L. Pozzetti, S. Cristiani, A. Fontana, G. Rodighiero, M. Mignoli, G. Zamorani, “Old galaxies in the young universe,” *Nature*, Vol. 430, (2004), pp. 184-187.
- [8] R. L. Mills, R. Booker, Y. Lu, “Soft X-ray continuum Radiation from Low-Energy Pinch Discharges of Hydrogen,” *J. Plasma Physics*, Vol. 79, (2013), pp 489-507; doi: 10.1017/S0022377812001109.
- [9] Mota, David (2018). Probing screened modified gravity with nonlinear structure formation. *International journal of modern physics D*. ISSN 0218-2718. 27(4). doi: 10.1142/s0218271818300033
- [10] Shiraishi, Maresuke; Mota, David; Ricciardone, A, & Arroja, F.(2014). CMB statistical anisotropy from noncommutative gravitational waves. *Journal of cosmology and Astroparticle Physics*. ISSN 1475-7516. 2014(07). doi: 10.1088/1475-7516/2014/07/047
- [11] F. BOURLAIT, p>g. FERREIRA, d.f. Mota and C. Skordis, The cosmological behavior of Bekenstein’s modified theory of gravity, *Phys. Rev. D* 75 (2007)063508 [astr-Ph/0611255] [SPIRES]. MathSciNet

ADS Google Scholar

- [12] Zurek W H. Decoherence and the transition from quantum to classical. *Phys Today*, 1991, 44(10): 36~44
- [13] Haroche S. Entanglement, decoherence and the quantum/classical boundary. *Phys Today*, 1998, 51(7): 36~42
- [14] Brune M, Raimond J M, Haroche S, et al. Observing the progressive decoherence of the “meter” in a quantum measurement. *Phys Rev Lett*, 1996, 77: 4887~4890
- [15] *Phys. News in 1997*, Edited by Schewe P F and Stein B P. Public Information Division American Institute of Physics A Supplement to APS News. 1~11
- [16] Myatt C J, King B E, Wineland D J, et al. Decoherence of quantum superpositions through coupling to engineered reservoirs. *Nature*, 2000,403: 269-273
- [17] Schleich W P. Engineering decoherence. *Nature*, 2000, 403: 256~257
- [18] Schöllkopf W, Toennies J P. Nondestructive mass selection of small van der Waals clusters. *Science*, 1994,266: 1345~1348
- [19] Arndt M, Nairz O, Zeilinger A, et al. Wave-particle duality of C60 molecules. *Nature*, 1999, 401: 680~682
- [20] Rae A I M. Waves, particles and fullerenes. *Nature*, 1999, 401: 651~653
- [21] Marshall T W. Brownian motion of a mirror. *Phys. Rev. D*, 1981, 24(6): 1509~1515.
- [22] Mandel, L. and Wolf, E. *Optical coherence and quantum optics*, Cambridge University Press, 1995, Cambridge, 503~504
- [23] Mota, David (2016). Nonlinear structure formation in gravity theories beyond general relativity. *Modern Physics Letters A*. ISSN 0217-7323. 31(21). doi: 10.1142/s0217732316400071
- [24] B. P. Abbott et al. Observation of Gravitational Waves from a Binary Black Hole Merger, *PHYSICAL REVIEW LETTERS*, 2016, 116, 061102.
- [25] Badurek G, Rauch H, Tuppinger D. Neutron interferometric double-resonance experiment [J]. *Phys Rev*, 1986, A34(4): 2600~2608.
- [26] Scully M O, Englert B G, Walther H. Quantum optical tests of complementarity [J]. *Nature*, 1991, 351 (6322): 111~116.
- [27] Durr S, Nonn T, Rampe G. Origin of quantum mechanical complementarity probed by a which-way experiment in an atom interferometer [J]. *Nature*, 1998,395(6697): 33~37.
- [28] Seiff Ellewisen, Thor Andress; Flack, Bridget Lynn & Mota, David (2018). Degeneracies between modified gravity and baryonic physics. *Astronomy and Astrophysics*. ISSN 0004-6361. 615. doi: 10.1051/0004-6361/201731938 Full text in Research Archive.
- [29] Yang, WeiQiang; Pan, Supriya; Di Valentino, Eleonora; Nunes, Rafael C., vagnozzi, Sunny & mota, David (2018). Tale of stable interacting dark energy, observational signatures, and the H₀ tension. *Journal of Cosmology and Astroparticle Physics*. ISSN 1475-7516. 2018(9). doi: 10.1088/1475-7516/2018/09/019
- [30] Honardoost, M.; Mota, David & Sepangi, H.R. (2017). Symmetron with a non-minimal kinetic term. *Journal of Cosmology and Astroparticle Physics*. ISSN 1475-7516. 2017(11). doi: 10.1088/1475-7516/2017/11/018 Full text in Research Archive.
- [31] N. W. Halverson, E. M. Leitch, C. Pryke, J. E. Carlstrom, W. L. Holzapfel, M. Dragovan, J. K. Cartwright, B. S. Mason, S. Padin, T. J. Pearson. M. C. Shepard, and A. C. S. Readhead, “DASI first results: a

As coherent natura naturans throughout cosmic evolution, instinctive PNT reciprocal equilibrium towards optimum PNT operation is radical potentiality & conditionality for cosmos always ready to orientate itself towards perfection.

measurement of the cosmic microwave background temperature decrement,” The Astrophysical Journal, Vol. 648, (2006), pp. 176-199.

- [32] D. J. Bird, et al., “Evidence for correlated changes in the spectrum and composition of cosmic rays at extremely high energies,” Physical Review Letters, Vol. 71, No. 21, (1993), pp. 3401-3404.
- [33] P. de Bernardis, et al., A flat universe from high-resolution maps of the cosmic microwave background radiation, Nature, Vol. 404, (2000), p. 955; <http://cmb.phys.cwru.edu/boomerang>.
- [34] P. Shawhan, “Gravitational-wave astronomy: observational results and their impact,” Class. Quantum Grav., Vol. 27 (2010) 084017 (14 pp).
- [35] S.W.Hawking, A brief history of time, Bantam books, Toronto Books (1998),
- [36] J. Foster, J.D.Nightingale. A Short Course in General Relativity, Peking, Springer-Verlag, 1998
- [37] Steven Frautschi. Beyond the Mechanical Universe, Peking, Peking University Publishing Company, 2000
- [38] Stephen Gasiorowicz, Quantum physics, Peking, Higher Education Press, 2006
- [39] General Physics (普通物理学), one set of three copies, author: (I’d forgotten the author because I threw the set of books into dustbin at Changsha train station in April 1999 for my frustration and distress when I returned from Yuelu mountain)
- [40] Zhang-shanhui, Wang-huzhu. College Physics — Mechanics (大学物理学 — 力学), Peking, Tsinghua University Publishing Company, 1998
- [41] Zhang-shanhui, Sheng-huijun. College Physics — Calorifics (大学物理学 — 热学), Peking, Tsinghua University Publishing Company, 1998
- [42] Zhang-shanhui, Cang-genmei, Hua-zhimei. College Physics — Electromagnetics (大学物理学 — 电磁学), Peking, Tsinghua University Publishing Company, 1997
- [43] Zhang-shanhui, Shi-tianlian. College Physics — Optics (大学物理学 — 光学), Peking, Tsinghua University Publishing Company, 1996
- [44] Zhou-sishun. Quantum Mechanics Tutorial, Shanghai, People Education Publishing Company, 1996
- [45] Yang-hujia. Atom Physics (原子物理学), Peking, Higher Education Press, 1997
- [46] Gou-shouhong. Electrical Mechanics (电动力学), Peking, Higher Education Press, 2006
- [47] Cheng-tansheng. Modern Quantum Mechanics Course (现代量子力学教程), Peking, Peking University Publishing Company, 2006
- [48] Li-xuesheng, <Reflection of modern physics basis > (现代物理学基础的思考), electronic doc presented by professor Li in 2010.
- [49] William F. Trench, Introduction to real analysis, electronic doc of free edition 1.07, November 2011
- [50] Yang guosheng, Historical progress of science, Wuhan, hans publication organization 2013
<http://www.hanspub.org/journal/Paperinformation.aspx?paperID=12407#abstract>
- [51] Yang guosheng, Anterior Half of Compendium of “Homogenous Cosmos Originated from Unique Genesis”. AASCIT Journal of Physics. Vol. 1, No. 3, 2015, pp. 180-189.
- [52] Yang guosheng, Hind Half of Compendium of “Homogenous Cosmos Originated from Unique Genesis”. AASCIT Journal of Physics. Vol. 1, No. 4, 2015, pp. 263-274.

- [53] Yang guosheng, Mathematical Definition of "Homogenous Cosmos Originated from Unique Genesis". AASCIT Journal of Physics. Vol. 1, No. 4, 2015, pp. 229-235.
- [54] Yang guosheng, Connotation objectification of Homogenous Cosmos Originated from Unique Genesis. International Journal of Modern Physics and Application. Vol. 2, No. 4, 2015, pp. 28-37.
- [55] Yang guosheng, Freewheeling Logic Extension of Connotation objectification of Homogenous Cosmos Originated from Unique Genesis Hind Half of Positive & Negative Transmutation Dynamics. American Journal of Science and Technology. Vol. 2, No. 5, 2015, pp. 202-214.
- [56] Yang guosheng, Homogenous Cosmos Originated from Unique Genesis Precondition initialization of PNT dynamics, 2017 international seminar on artificial intelligence, networking and information technology (ANIT 2017) Atlantis Press, <https://doi.org/10.2991/anit-17.2018.41>
- [57] B.P. Abbott, R. Abbott, T.D. Abbott et al.. Observation of Gravitation Waves from a Binary Hole Merger. Phys Rev., 2016, LIGO-P150914-v13.
- [58] Giacconi, R. (2008). Secrets of the hoary Deep: A personal History of Modern Astronomy, Baitimore: Johns Hopkins university Press.
- [59] Gursky, H., Solinger, A., Kellog, E.M. et al. (1972). x-ray emission from rich clusters of galaxies. Astrophysical Journal, 173: L99.
- [60] Lasker, B.M., Sturch, C.R., Mclean, B.J. et al. (1990), The guide star catalog I: Astronomical foundations and image processing, Astronomical Journal, 99: 2019.
- [61] Markevitch, M., Gonzales, A.H., Clowe, D. et al. (2004). Direct constraints on the dark matter self-interaction cross section from the merging galaxy cluster 1E 0657-56. Astrophysical Journal, 606 (2): 819-24
- [62] Tananbaum, H., Gursky, H., kellog, E.M. et al. (1972). Discovery of a periodic pulsating binary source in Hercules from Uhuru. Astronomical Journal, 174: L134.
- [63] Vaiana, G.S. and Rosner, R. (1978). Recent Advances in Coronal physics. Annual Review of Astronomy and Astrophysics, 16: 393-428.
- [64] Abadi, M.G., Moore, B., and Bower, R.G. (1999). Ram pressure stripping of spiral galaxies in clusters. Monthly Notices of the Royal Astronomical Societym 308: 947-54.
- [65] Abadi, M.G., Navarro, J.F., Steinmetz, M., et al. (2003). Simulations of galaxy formation in a lambda cold dark matter universe. I. Dynamical and photometric properties of a simulated disk galaxy. Astrophysical Journal, 591:499-514.
- [66] Birnbiom, Y. and Dekel, A. (2003). Virial shocks in galactic halos? Monthly Notices of the Royal Astronomical Society, 345: 349-64.
- [67] Conselice, C.J., Bershady, M.A., Dickinson, M., et al. (2003). A direct measurement of major galaxy mergers at $z < 3$. Astronomical Journal, 126: 1183-207.
- [68] Corbelli, E. and Salucci, P. (2000). The extended rotation curve and the dark matter halo of M33. Monthly Notices of the Royal Astronomical Society, 311: 441-47.
- [69] Dekel, A., Birnboim, Y. (2006). Galaxy bimodality due to cold flows and shock heating, Monthly Notices of the Royal Astronomical Society, 368: 2-20.
- [70] Diemand, J., Kuhlen, M., and Madau, P. (2007). Formation and evolution of galaxy dark matter halos and

- their substructure. *Astrophysical Journal*, 667: 859-77.
- [71] Giordano, L., Tran, K.-V.H., Moore, B., et al. (2010). Multi-wavelength properties of barred galaxies in the local universe. I: Virgo Cluster. *Journal*, submitted (arXiv: 1002.3167v1 [astro-ph. CO]).
- [72] Gondolo, P. and Silk, J. (1999). Dark matter annihilation at the Galactic center. *Physical Review Letters*, 83: 1719-722.
- [73] Gunn, J.E. and Gott, J.R., III (1972). On the infall of matter into clusters of galaxies and some effects on their evolution. *Astronomical Journal*, 176.
- [74] Keres, D., Katz, N., Weinberg, D.H., et al. (2005). How do galaxies get their gas? *Monthly Notices of the Royal Astronomical Society*, 363: 2-28.
- [75] Klypin, A., Zhao, H., and Somerville, R.S. (2002). Lambda CDM-based models for the Milky Way and M31. I. Dynamical models. *Astronomical Journal*, 573: 597-613.
- [76] Madau, P., Kuhlen, M., Diemand, J., et al. (2008). Fossil remnants of reionization in the halo of the Milky Way. *Astrophysical Journal*, 689:L41-4.
- [77] Mastropietro, C., Moore, B., Mayer, L., et al. (2005). Morphological evolution of discs in clusters. *Monthly Notices of the Royal Astronomical Society*, 364: 607-19.
- [78] Mateo, M.L. (1998). Dwarf galaxies of the local Group. *Annual Review of Astronomy and Astrophysics*, 36: 435-506.
- [79] Mayer, L. and Moore, B. (2004). The baryonic mass-velocity relation: Clues to feedback process during structure formation and the cosmic baryon inventory. *Monthly Notices of the Royal Astronomical Society*, 354: 477-84.
- [80] Moore, B., Lake, G., Quinn, T., and Stadel, J. (1999b). On the survival and destruction of spiral galaxies in clusters. *Monthly Notices of the Royal Astronomical Society*, 304: 465-74.
- [81] Peebles, P.J.E. (1982). Large-scale background temperature and mass fluctuations due to scale-invariant primeval perturbations. *Astronomical Journal*, 263: L1-5.
- [82] Simon, J.D. and Geha, M. (2007). The kinematics of the ultra-faint Milky Way Satellites: Solving the missing satellite problem. *Astronomical Journal*, 670: 313-31.
- [83] White, S.D.M. (2007). Fundamental physics: Why dark energy is bad for astronomy. *Reports on progress in physics*, 70:883-97.
- [84] Springel, V., White, S. D. M., Jenkins, A. et al. (2005). Simulations of the formation, evolution and clustering of galaxies and quasars. *Nature*, 435: 629-36.
- [85] Yoshida, N., Omukai, K. and Hernquist, L. (2008). Protostar formation in the early universe. *Science*, 321: 669-71.
- [86] Young, D.R., Smartt, S. J., Valenti, S. et al. (2010). Two type IC supernovae in low-metallicity diversity of explosions. *Astronomy and Astrophysics*, 512: 70-88.
- [87] Bloom, J.S., Kulkarni, S.R., Djorgovski, S.G., et al. (1999). The unusual afterglow of the gamma-ray burst of 26 March 1998 as evidence for a supernova connection. *Nature*, 401: 453-56.
- [88] Bethe, H.A. (1990). Supernova mechanisms. *Reviews of Modern Physics*, 62: 801-66.
- [89] Burrows, A., Livne, E., Dessart, L., et al. (2006). A new mechanism for core-collapse supernova explosions.

Astronomical Journal, 640: 878-90.

- [90] Gehrels, N., Ramirez-Ruiz, E., and Fox, D.B. (2009). Gamma-ray bursts in the swift Era. *Annual Review of Astronomy and Astrophysics*, 47: 567-617.
- [91] Herant, M., Benz, W., Hix, W.R., et al. (1994). Inside the supernova-A powerful connective engine. *Astrophysical Journal*, 435: 339-61.
- [92] Hester, J.J. (2008). The Crab Nebula: An astrophysical chimera. *Annual Review of Astronomy and Astrophysics*, 46: 127-55.
- [93] Hirata, K., Kajita, T, Koshiha, M., et al. (1987). Observation of a neutrino burst from the Supernova SN1987A. *Physical Review Letters*, 58: 1490-493.
- [94] W.J. Weber, A. Cavalleri, R. Dolesi, G. Fontana, M. Hueller, and S. Vitale, *Classical and Quantum Gravity*, 19, 1751(2002).
- [95] Iben, I., Jr. (1974). Post main sequence evolution of single stars. *Annual Review of Astronomy and Astrophysics*, 12: 215-56.
- [96] Janka, H-T. and Mueller, E. (1996). Neutrino heating, convection, and the mechanism of Type-II supernova explosions. *Astronomy & Astrophysics*, 306: 167-98.
- [97] Matheson, T., Garnavich, P.M., Stanek, K.Z., et al. (2003). Photometry and spectroscopy of GRB 030329 and its associated supernova 2003dh: The first two months. *Astrophysical Journal*, 599: 394-407.
- [98] Riess, A.G., Macri, L., Casertano, S., et al. (2009). A Redetermination of the Hubble Constant with the Hubble Space Telescopediscoveries of Type Ia supernovae at $z \geq 1$: Narrowing constraints on the early behavior of dark energy evolution. *Astrophysical Journal*, 659: 98-121.
- [99] Schaefer, B.E. (2007). The Hubble diagram to redshift >6 from 69 gamma-ray bursts. *Astrophysical Journal*, 660: 16-46.
- [100] Trimble, V. (1982). supernovae. Part I: The events. *Reviews of Modern Physics*, 54: 1183-224.
- [101] Trimble, V. (1983). supernovae. Part II: The aftermath. *Reviews of Modern Physics*, 55: 511-63.
- [102] Woosley, S.E. (1993). Gamma-ray bursts from stellar mass accretion disks around Black Holes. *Astrophysical Journal*, 405: 273-77.
- [103] Ercolano, B., Barlow, M.J., Storey, P.J., et al. (2003b). Three-dimensional photoionization modeling of the hydrogen-deficient knots in the planetary nebula Abell 30. *Monthly Notices of the Royal Astronomical Society*, 344: 1145-54.
- [104] J. Luo, L. S. Chen, H. Z. Duan, Y. G. Gong, S. Hu, J. Ji, Q. Liu, J. Mei, V. Milyukov, M. Sazhin, C. G. Shao, V. T Toth, H.B. Tu, Y. Wang, Y. Wang, H.C. Yeh, M.S. Zhan, Y. Zhang, V. Zharov, and Z.B. Zhou. *Classical and Quantum Gravity*, 33, 035010(2016).
- [105] Esteban, C., Peinbert, M., Torres-Peimbert, S., et al. (2002). Optical recombination lines of heavy elements in giant extragalactic H II regions. *Astrophysical Journal*, 581: 241-57.
- [106] Liu, X.W. (2006b). Optical recombination lines as probes of conditions in planetary nebulae. In: M.J. Barlow and R.H. Mendez (eds.), *Planetary Nebulae in our Galaxy and Beyond*, 219-26. *Proceedings of the international Astronomical Union Symposium No. 234*. Cambridge: Cambridge University Press.
- [107] Hackermüller L, Uttenthaler S, Zeilinger A, et al.. The wave nature of biomolecules and fluorofullerenes.

As coherent natura naturans throughout cosmic evolution, instinctive PNT reciprocal equilibrium towards optimum PNT operation is radical potentiality & conditionality for cosmos always ready to orientate itself towards perfection.

- Phys. Rev. Lett., 2003, 91(9): 90408.
- [108] M. Rodrigues, B. Foulon, F. Liorzou, and P. Touboul, Classical and Quantum Gravity, 20, S291(2003).
- [109] Liu, X.W., Barlow, M.J., Zhang, Y., et al. (2006). Chemical abundances for Hf 2-2, a planetary nebula with the strongest-known heavy-element recombination lines. Monthly Notices of the Royal Astronomical society, 368: 1959-970.
- [110] Liu, Y., X.W., Barlow, M.J., et al. (2004a). Chemical abundances of planetary nebulae from optical recombination lines-II. Abundances derived from collisionally excited lines and optical recombination lines. Monthly Notices of the Royal Astronomical Society, 353: 1251-285.
- [111] V. Fock, The Theory of Space, Time, and Gravitation, The MacMillan Company, (1964).
- [112] Brian David. Einstein: A life [M]. John Wiley and Son, New York, 1996,p. 76.
- [113] K. Boukerrioua, T. Chiheb, B. Meftah, Fractional Hermite-Hadamardtype inequalities for functions whose second derivative are (s,r)-convex in the second sense, Kragujevac Journal of Mathematics 40, No. 2(2016) 172-191.
- [114] Weinberg, S. Gravitation and Cosmology [M]. John Wiley. 1972.
- [115] R. Ragazzoni, M. Turatto, W. Gaessler, "The lack of evidence for quantum structure of space at Planck scales," Astrophysical Journal, April 10, 2003, Vol. 587. L1-L4.
- [116] Cropper Willian H. Great Physicists [M]. Oxford University Press. New York. 2001.
- [117] W. J. Weber, D. Bortoluzzi B, A Cavalleri, L. Carbone, M. D. Liob, R. Dolesia, G. Fontanad, C. D. Hoylea, M. Huellera, and S. Vitalea, Gravitational-Wave Detection, SPIE. 4856, 31(2003).
- [118] S. Bower, G. Field, and J. Mack, "Detection of an anisotropic soft X-ray background flux," Nature, Vol. 217 (1968). P.32.
- [119] Abraham Pais. 'Subtle is the lord...' The Science and the life of Albert Einstein [M]. Oxford University Press. 1982.
- [120] Hawking S W, Ellis G F R. The large scale structure of spacetime [M]. Cambridge: Cambridge University Press 1973.
- [121] Penrose R. Singularities of space-time, In Theoretical principle in Astrophysics and relativity, [M]. edN.R, Liebowitz, W. H. Reid, and P. O. Vandervoort, Chicago: Chicago University Press, 1978.
- [122] Penrose R. Singularities and time-asymmetry, In General Relativity: An Einstein Centenary [M]. ed. S. W. Hawking, and W. Israel. Cambridge: Cambridge University Press, 1979.
- [123] Kip, S. Throne, Black Hole, et al. Einstein's Outrageous Legacy [M]. W. W. Norton. New York. 1994.
- [124] S. Bonometto, V. Gorini, U. Moschella. Modern Cosmology [M]. Institute of Physics Publishing. Bristol and Philadelphia 2002.
- [125] D. W. Sciama. Modern Cosmology and the Dark Matter Problem [M]. Cambridge: Cambridge University Press. 1993.
- [126] S. Mubeen, G.M. Habibullah, K-Fractional integrals and application, International Journal Contemporary Mathematical Sciences, 7, No. 2 (2012) 89-94.
- [127] P. Shawhan, "Gravitational-wave astronomy: Observational results and their impact," Class. Quantum Grav., Vol. 27 (2010) 084017 (14PP).

- [128] Kerr, R. P. Gravitational field of a spinning mass as an example of algebraically special metrics [J]. Phs. Rev. Lett, 1963, 11, 237.
- [129] Newman, E. T.. Metric of a rotating charged mass [J]. J. Math. Phy, 1965, 6, 918.
- [130] P. de Bernardis, et al., A flat universe from high-resolution maps of the cosmic microwave background radiation, Nature, Vol. 404, (2000), P. 955; <http://cmb.phys.cwru.edu/boomerang>.
- [131] Hawking, S W. The occurrence of singularities in cosmology [J]. Proc. Roy. Soc. Lond. 1965. A300, 187-201.
- [132] Hawking, S W. Penrose R. The singularities of gravitational collapse and cosmology [J]. Proc. Roy. Soc. Lond. 1970, A314, 529-548.
- [133] L. Z. Fang, and R. Ruffini, Basic Concepts in Relativistic Astrophysics, World Scientific, 1983.
- [134] Tunahan Turhan, Nihat Ayyildiz. Some Results on the Differential Geometry of Spacelike Curves in De-Sitter Space, Journal of Applied Mathematics and Physics, 2013.



Printing instruction

- 1) Print pages 2~35, in both sides in color, A4 paper, a little thicker but softer.
- 2) Print pages 36~1037 in both sides, A4 paper.
- 3) Page 1 is the front color cover, page 1038 is the back color cover of the monograph, for binding expedience, it's better to print the both pages in a whole white paper in size of "A3+book thickness margin". Of course, as book cover, it's better to adopt paper relatively harder and thicker.

