



VIRTUAL

REALITY:

CONSCIOUSNESS

REALLY

EXPLAINED!

(THIRD EDITION)

JEROME IGLOWITZ

PHI015000

“I think you have proposed an original theory of cognition.”

(Arnold Leiman, professor of Psychology and Cognitive science, U.C. Berkeley. Author of “Biological Psychology: An Introduction to Behavioural, Cognitive, and Clinical Neuroscience”)

“Your arguments are indeed compelling and should persuade some of the proponents of representational AI of the feasibility of alternatively based models...”

(W.J. Freeman, Director, The Freeman Laboratory for Nonlinear Neurodynamics, U.C. Berkeley. author of “How Brains Make up their Minds”)

The author spent over 50 years of intense work on this problem. This volume represents his finished answer. Is it hard? It may be the hardest read you have ever undertaken, but it actually answers the questions it asks, (for the first time he claims)!

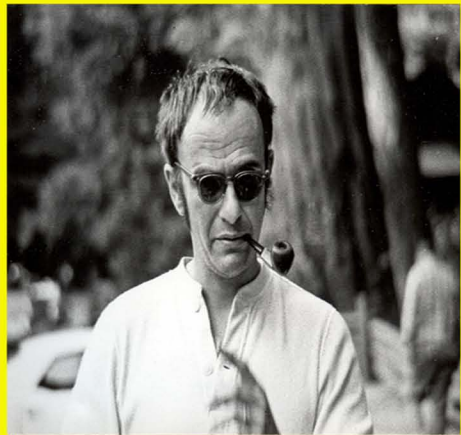

Richard Jung

If your actually *want* an answer, then you must do the work!

JERRYSPLACE
Granite Bay, Ca.



ISBN: 978-0-9845285-0-9



9 780984 528509

Virtual Reality: Consciousness *Really*

Explained!

(Third Edition)

Jerome Iglowitz

Copyright

July, 2010

Jerome Iglowitz

ISBN 978-0-9845285-0-9

Library of Congress Control Number:

2010908362

JERRYSPLACE Publishing

Granite Bay, California



Dedication

For Chen

Who has taught me more about courage
than I had ever known.

Chenin-Blanc Yic-Mun-Fuung Iglowitz
(Gentle Phoenix)

March 18, 1974 – May 2, 2010

I love you kid.

Baba

Table of Contents

A NOTE FOR IMPATIENT OR SKEPTICAL MINDS.....	13
PREFACE:	17
PREAMBLE:	21
CHAPTER 1. INTRODUCTION AND NEW PRÉCIS: “IN A NUTSHELL”.....	25
A CURRENT NOTE: JANUARY, 2010	25
EMERGENCE	26
A VERY BASIC ARGUMENT –AN ARGUMENT FROM FUNDAMENTALS.....	28
THE “HARD CORE”.....	33
<i>David Hilbert:</i>	33
<i>Maturana and Freeman:</i>	36
<i>Kant</i>	39
END CURRENT NOTE. JANUARY, 2010.....	39
OLD PRECIS FOLLOWS:.....	39
<i>The Brain: A Materialist Perspective:</i>	39
<i>The “Mental” Perspective:</i>	44
<i>The Concordance:</i>	45
“ <i>Symbolic Forms</i> ”	45
“ <i>The Interface</i> ”	47
CONCLUSION:	47
CHAPTER 2: EXOTIC MATHEMATICS: WHAT IS IT, AND HOW IS IT RELEVANT TO THE MIND-BRAIN PROBLEM?.....	53
(A DEEPER LOOK AT HILBERT.)	53
MATHEMATICAL STRUCTURALISM AND CATEGORY THEORY:	64
BACK TO THE MATHEMATICAL PROBLEM:	84

BACK TO THE SOURCES OF CATEGORY THEORY AND STRUCTURALISM:	85
SHAPIRO PART ONE.....	85
CHAPTER 3: ADVENTURES OF THE MIND: A CRITICAL TURNING POINT AND THE ORIGINS OF MY CONCEPTION	97
CASSIRER AND LOGIC:	98
ON CANTOR’S DIAGONAL ARGUMENT –WRITTEN 50 YEARS AGO!.....	111
A REITERATION OF MY LATER REFLECTIONS ON CANTOR’S ARGUMENT ...	114
A POWERFUL ARGUMENT FOR THE STRUCTURALIST PERSPECTIVE.....	118
MY CONCLUSION:	119
THE CONCEPT OF IMPLICIT DEFINITION	124
BUT HOW CAN WE CONCEIVE OF PURELY OPERATIONAL OBJECTS AS CORRELATING WITH THE REAL WORLD?	127
THE ANTHROPIC PRINCIPLE	130
BACK TO MAC LANE AGAIN:	130
A FINAL COMMENT BY CASSIRER RELEVANT TO THIS CURRENT PROBLEM	132
<i>Mac Lane category theory</i>	135
BACK TO SHAPIRO:.....	140
THE ROSEN LETTER: (A REFLECTION ON SHAPIRO’S POSITION).....	142
MODERN PTOLEMEAN PHYSICS.....	145
ANOTHER LOOK AT HILBERT	148
LOGIC AS BIOLOGY:	153
RAICHLER:.....	155
ADDRESSING SHAPIRO AGAIN:	160
THE REMAINDER OF THIS BOOK CONSTITUTES MY PROPOSED	161
SPECIFIC SOLUTION TO THE MIND-BRAIN PROBLEM.....	161
THE INITIAL PART WAS TO ENABLE YOU TO UNDERSTAND IT.	161
CHAPTER 4: MY FIRST HYPOTHESIS IN DETAIL: (BIOLOGY PART ONE)	163

1. REPRESENTATION: THE PERSPECTIVE FROM BIOLOGY.....	163
2. “THE SCHEMATIC MODEL”: DEFINITION AND EXAMPLES.....	165
2.1 <i>The Simplest Case: A Definition by Example</i>	165
2.1.1 Reversing our perspective:.....	171
2.2 <i>A Case for Schematism More Specific to Our Special Problem: Narrowing the Focus.</i>	173
(<i>The Engineering Argument</i>).....	173
2.3 <i>The “G.U.I.”, the Most Pertinent and Sophisticated Example of a Schematic Model: the Special Case)</i>	175
A Graphic Rendering of Edelman’s Epistemology: Figure 12:	178
2.4 <i>Towards a Better Biological Model.</i>	181
2.4.1 Biology, The Real Thing: Freeman’s Model.....	181
Walter J. Freeman.....	181
The Peripheral Code:.....	186
Cortical Mapping is Very Different, However:.....	187
2.4.2 An Explicit Model of the Mind:.....	194
GOD’S EYE?.....	197
ON P.S.CHURCHLAND:.....	198
3. THE FORMAL AND ABSTRACT PROBLEM:.....	198
3.1 <i>The formal argument</i>	198
3.2 <i>The Specific Case of Biology</i>	201
Turning our Perspective Around.....	201
3.3 <i>Retrodictive Confirmation</i>	204
A Profound Teleological Consequence.....	205
3.4 <i>Conclusion, (section 3)</i>	205
4. THE CONCORDANCE: BIOLOGY’S PROPER CONCLUSION.....	206
5. PLAIN TALK:.....	210
BOUNDS AND LIMITS.....	215
APPENDIX, (FREEMAN & AUTOMORPHISM).....	217
FIGURE 19: GOD’S EYE?.....	221

EDELMAN TO FREEMAN TO EDELMAN	221
CHAPTER CONCLUSIONS:	224
CHAPTER 5: MY SECOND HYPOTHESIS –A SHORT SKETCH	227
AN ASIDE FOR CLARIFICATION:	228
THE CONCEPT OF IMPLICIT DEFINITION	234
FROM APPENDIX C: CASSIRER AGAIN.....	237
HOW? THE LOGICAL PROBLEM OF CONSCIOUSNESS	238
CASSIRER AND CLASSICAL LOGIC:.....	240
CONCEPT VS. PRESENTATION:.....	241
CONTRA THE THEORY OF ATTENTION:.....	242
MAJOR CONSEQUENCES:	244
RE PRESENTATION:	245
THE CONCEPT OF IMPLICIT DEFINITION:	248
IMPLICIT DEFINITION VIS A VIS PRESENTATION:.....	253
WHY IS THIS RELEVANT TO MIND?.....	256
CONTRA CASSIRER:.....	259
THE CRUX OF THE ISSUE: PRESENTATION	262
CHAPTER 6: MATURANA & VARELA & KANT BIOLOGY-PART II	265
TOWARDS THE WHERE AND THE WHAT?	265
BIOLOGY & EPISTEMOLOGY, (MATURANA AND VARELA AND KANT)	265
CLOSURE:.....	269
MATURANA AND VARELA:.....	275
“TRIGGERING” VS “CAUSATION”:	281
THE CONSERVATION OF AUTOPOIESIS:	283
BEHAVIOR AS AN ASPECT OF STRUCTURAL COUPLING:	284

OPERATIONAL CLOSURE:	286
THE STRUCTURAL PRESENT:	288
MATURANA’S PARADOX	291
THE AXIOM OF EXTERNALITY	300
RELATIVIZED MATERIALISM	313
AN ANSWER TO THE NEW DILEMMA:	313
KANT’S CRITICAL IDEALISM:	314
A NEW AND MORE RECENT PERSPECTIVE ON MATURANA:	319
THE PARALLEL POSTULATE.....	324
CHAPTER 7: COGNITION AND EXPERIENCE	329
QUINE AND CASSIRER	329
A FANTASY:	332
THE AXIOM OF EXPERIENCE:.....	337
THE EPISTEMOLOGICAL PROBLEM:	337
CASSIRER REVISITED:.....	343
THE AXIOM OF EXPERIENCE.....	347
CASSIRER’S THEORY OF SYMBOLIC FORMS, AN ANALYSIS:.....	348
CHAPTER 8: CASSIRER’S “SYMBOLIC FORMS”	363
(THE SOLUTION TO MY OWN EPISTEMOLOGICAL DILEMMA –AND A <i>PROFOUND</i> CHANGE IN PERSPECTIVE!)	363
WHENCE CASSIRER’S THESIS:.....	367
CONTRA CASSIRER: (WHAT ARE THE REAL PARAMETERS?)	371
THE POWER OF NATURALISM:	387
CHAPTER CONCLUSIONS:	397
CHAPTER 9: A SIMPLER ALTERNATIVE APPROACH TO CASSIRER’S SYMBOLIC FORMS: “MATHEMATICAL IDEALS”:	401
AN ALTERNATIVE APPROACH TO CASSIRER’S AND MY IDEAS: “MATHEMATICAL IDEALS”:	402

CASSIRER’S THEORY OF SYMBOLIC FORMS:	409
THE SUBSTANCE OF MIND:.....	411
CHAPTER 10: “THE INTERFACE”	415
HERE FOLLOWS MY PERSONAL METAPHYSICAL ASSERTION!.....	416
CHAPTER 11: THE LAST HURDLE.....	419
THE THIRD HYPOTHESIS: A FORMAL STATEMENT:.....	420
A FORMAL STATEMENT OF MY THIRD HYPOTHESIS:	422
CHAPTER 12: TWO (RELATIVELY) CONTEMPORARY REALIST CRITICISMS OF MY CONCLUSIONS	425
DURANT ON KANT:	426
DURANT CRITIQUES KANT:	436
THE JCS REVIEW	440
WHERE CASSIRER AND I FUNDAMENTALLY DIFFER:.....	451
THE ANTHROPIC PRINCIPLE	455
CASSIRER AND GOD’S EYE:	456
IN DEFENSE OF KANT:.....	461
CHAPTER 13: CONCLUSIONS & OPINIONS	465
SCIENTIFIC CONCLUSIONS:.....	465
SO WHERE DO WE GO FROM HERE?	466
DEVIL’S ADVOCATE:	466
SO WHY BOTHER?.....	469
HOW DO WE LIVE?.....	472
MY "ACT OF FAITH":.....	472
CHAPTER 14: EPILOGUE	475
CHAPTER 15: BOOK CONCLUSION.....	483
APPENDIX A: THE DENNETT APPENDIX AND THE COLOR PHI, (FROM IGLOWITZ 1995)	491

TOWARDS A WORKING MODEL OF <i>REAL</i> MINDS: DENNETT, HELMHOLTZ AND CASSIRER.....	492
CASSIRER ON THE COLOR PHI:	501
AN EXTENSION OF THE SCHEMATIC MODEL: A BRIEF SKETCH	504
A THOUGHT EXPERIMENT	505
APPENDIX B: LAKOFF, EDELMAN, AND “HIERARCHY”.....	513
LAKOFF:	514
<i>The Classical Concept</i>	515
<i>Cassirer and Lakoff’s Logic</i>	523
<i>Putnam’s Requirements</i>	534
<i>Lakoff’s ICM’s</i>	541
<i>Maturana:</i>	542
EDELMAN:	545
<i>God’s and Edelman’s Eye</i>	551
<i>On “Presentation”</i>	551
<i>Re-entrant Maps</i>	553
<i>What Edelman has not solved: the problem of the Cartesian Theatre</i>	557
<i>On Epistemology:</i>	562
<i>Conclusion</i>	570
BIBLIOGRAPHY	573
ENDNOTES	579

A Note for Impatient or Skeptical Minds

Impatient or skeptical minds should probably begin the New Précis, (“In a Nutshell”) –at the very beginning of Chapter 1 and then skip to Chapter 12 which show two relatively contemporaneous criticisms of my ideas and my answers to them.

1 1

This should resolve many difficulties before they start. This is a very difficult subject to present with any perspective other than the standard ones: i.e. the very ones that have already clearly failed! Give me some space and I’ll try to make a revolutionary out of you! I think the answer is important.

On the other hand, let me insert an apology at this point. I am currently 71 years old, and have had several strokes which have impaired my abilities. And yet, I consider the new content of this book important. What it is lacking is an overall stylistic form of sufficient refinement to do it justice as my concentration has been narrowed to specific problems which I have responded

1 (Note: This is the third edition of “Virtual Reality: Consciousness really Explained” which was completed in 1995, (revised 1998). Though it lacks some of the detail of the former, it incorporates a later and richer perspective with much new material and elucidates my second thesis far better than the original. I do not think it changes, but rather enriches the substance and sense of the earlier edition and clarifies its rationale. This version uses a mix of footnotes and endnotes. The footnotes, (in ordinary numerals), are necessary for immediate clarity, but I felt the material included in the endnotes, (in Roman numerals), interrupted the flow of thought. Hence it was relegated to its endnote status.)

to and which I think make my perspective clearer.² Some of the citation references might need “tweaking”, but that should be achievable with minimal effort given sufficient interest. There is also a certain amount of redundancy –partly from a lack of sustainable concentration, and partly because this MS may perhaps be read in parts wherein certain citations must be explicit and considered in context. This is the “hard problem” and you’d better begin by expecting it to be so.

Jerome Iglowitz, 2010

P.S. If you need a C.V. to cause you to evaluate even the very plausibility of these ideas, then you had probably best go elsewhere as you will not do well here. I abandoned academia long ago as I felt it was not possible to fully explore this huge problem within its rigid confines. I think my completed answer validates this presupposition. Is it complete and final? Of course not. This is the very beginning of a dialogue and I have repeatedly asked for help, but it will take more courage than I have found in academia to go beyond trivial answers, risk

² Purely from the standpoint of organization, my first edition is clearly superior to this one. From the standpoint of understanding however, I feel this edition is a marked improvement.

association with a maverick mind, and face up to the real problem like a man, (woman)! No sexism intended.

Preface:

There is a wonderful though longish passage by the famous logician W.V.O.Quine¹ which I will quote in its entirety to serve as an introduction:

"The totality of our so-called knowledge or beliefs, from the most casual matters of geography and history to the profoundest laws of atomic physics or even of pure mathematics and logic, is a man-made fabric which impinges on experience only along the edges. Or, to change the figure, total science is like a field of force whose boundary conditions are experience. A conflict with experience at the periphery occasions readjustments in the interior of the field. Truth values have to be redistributed over some of our statements. Reevaluation of some statements entails reevaluation of others, because of their logical interconnections- the logical laws being in turn simply certain further statements of the system, certain further elements of the field. Having reevaluated one statement we must reevaluate some others, which may be statements logically connected with the first or may be the statements of logical connections themselves.

¹ (recently deceased)

But the total field is so underdetermined by its boundary conditions, experience, that there is much latitude of choice as to what statements to reevaluate in the light of any single contrary experience. No particular experiences are linked with any particular statements in the interior of the field, except indirectly through considerations of equilibrium affecting the field as a whole.....

Furthermore it becomes folly to see a boundary between synthetic statements... and analytic statements...Any statement can be held true come what may, if we make drastic enough adjustments elsewhere in the system... Conversely... no statement is immune to revision... even the logical law of the excluded middle... and what difference is there in principle between such a shift and the shift whereby Kepler superseded Ptolemy, or Einstein Newton, or Darwin Aristotle?"¹

And another much shorter quote from another of his writings which displays the full extent of his horizons:

"One could even end up, though we ourselves shall not, by finding that the smoothest and most adequate overall account of the world *does not after all accord existence to ordinary physical things.....Such eventual departures from Johnsonian usage*", (Samuel Johnson is said to have

demonstrated the reality of a rock by kicking it!), “could partake of the spirit of science and even of the evolutionary spirit of ordinary language itself.”¹¹

This has always been my personal goal – i.e. of “finding *the smoothest and most adequate overall account of the world*” –but to include *my own mind* as well! But it will involve a conceptual framework as large as Quine’s.

Piaget had a relevant comment which I think is applicable. The famous child psychologist was interested in the foundations of mathematics as a secondary interest. He evaluated mathematical Platonism, and concluded, (paraphrasing):

“if a mathematician (thinker), were to arrive at some conclusions that neither he nor his readers were able to fully understand, and if he were to write these conclusions down, (that is, to date stamp them), and if, furthermore, they were found to be correct at some future time –then the conclusive case for Platonism would be made.”

I think the argument is applicable to ideas in general. If I am right in my conclusions, (and I do not dogmatically claim that I am), then the future of science will come to my perspective asymptotically. When and if that happens, hear me again! I will probably be gone, but my cause will not be.

Finally, let me cite Kepler regarding his profound revelations in astronomy:

“Now, since the dawn eight months ago, and since a few days ago, when the full sun illuminated my wonderful

speculations, nothing holds me back. I yield freely to the sacred frenzy; I dare frankly to confess that I have stolen the golden vessels of the Egyptians to build a tabernacle for my god far from the bounds of Egypt. If you pardon me, I shall rejoice; if you reproach me, I shall endure. The die is cast, and I am writing the book –to be read either now or by posterity, it matters not. It can wait a century for a reader, as god himself has waited six thousand years for a witness.”^{III}

Take care, and good luck, Jerry Iglowitz 2010

Preamble:

Let me state at the outset that I am as much a realist as any one of you –maybe more so. I enjoy, and fear as well, my naïve reality at least as much as anyone¹. It is the *foundations* of realism I question. But so does realism itself. Science continually changes the rules of the game. The world is no longer truly made up of the simple atoms of Democritus, nor is it made up of the subatomic particles of Bohr and Heisenberg. It is made up of whatever it is that was most recently proposed –and seems to work, (quarks, bosons, superstrings,...)- as “substance” or “material”. Supposedly hierarchy and emergence resolve the difficulty, but is this, in fact, true?² (See footnote –it is a total misuse of legitimate concepts drawn from other disciplines!)

¹ I have lived more on the “rough side” of life probably more than most of my expected readers, though less so than many others who have been forced to deal with unimaginable horrors.

² “Emergence” supposedly solves the problem of hierarchy in materialist explanations of the mind-brain problem. It purportedly explains how new phenomena “emerge” from more fundamental explanations. These new emergent phenomena are said to embed themselves hierarchically in ontic material -taken at the deepest level. The conception seems to derive from, or at least be analogous to the embedding of mathematical explanations –or of computer languages, (high vs low level languages). In point of fact, however, we are allowed to embed some higher level axiom system, (or computer language), in some more fundamental or different axiom system or language *if and only if* we can prove/derive each of the axioms, (or new computer language

It is the *phenomenology* of realism –those relations that work -and the “naïve realistic world” itself –that hard, cold, violent, passionate and very concrete reality we all must live in and survive in that must be preserved. But the ever changing substance of the “objects” *per se* of realism is at constant peril. I wish to severely question realism’s ultimate “objects” themselves to resolve the deepest dilemma of mankind: i.e. the mind-body relationship.

But I must do so in a way that preserves the realism of science, the realism of the naïve world, and the reality of the mind which perceives them both. This is the core and the center of my conception. I think that all of us, deep down, accept these

terms), of the higher system from the lower one. But that implicit level of proof is always there. No new “phenomena” are allowed to exist in the former that cannot be reduced to perhaps more complicated implications of the grounding system. (One need only replace any usage of the axioms, (terms), of the higher system with its proof system in the lower to derive the same result.) Nothing radically new comes from such an approach. The rationale for instituting the higher system derives from operational simplicity. Nothing emerges –hierarchy will not allow it. In the computer language example, all the computer itself ever sees is machine language!

Materialist explanations of consciousness of the usual sort all have this flaw. As I will state the problem later: “how can a (biological) machine/mechanism whose parts are discrete in time and space ever know anything *whatsoever*? But I mean “knowing” in a different sense than simple mechanical, “zombie-like” performance, and I think you wish it to be taken so too. “Consciousness” could never arise in any normal sense of the word! It would constitute too great a divide from the current, and specifically (*meta*)physical models of brain function.

perspectives as our most fundamental realist presuppositions. It is in the attempt at their mutual resolution that this pervasive paradox endures.

It has been said of my work³ that I am simply repeating Kant. This is fair in one perspective –I am very much like Kant insofar as the “What” of reality is concerned, though we differ about the categories and ethics, and fundamentally about epistemology. My particular thesis consists in supplying the actual “How” and the “Why” –and the “Where”- of Kant’s profound insight however, and which he never even attempted to explain. I think I have accomplished that goal. If you would argue with me, argue with me here.

³ By an anonymous JCS reviewer who questioned my claim of the novelty and the “outrageousness” of my proposal.

Chapter 1. Introduction and New Précis: “In a Nutshell”

A Current Note: January, 2010

I feel I must try to restart this dialogue yet again as I have been so grossly misunderstood. Reviewers just don't seem to get it.

In my conclusion I will argue that you will have to come to the same conclusions about the mind and the brain, (but not necessarily my own), no matter what perspective you start with initially –whether from materialism, from dualism, from idealism... provided that you do it rigorously enough. Provisionally accepting that conclusion then, let me start again from the easiest perspective therefore. Let me approach the problem as a strict materialist would see it.

First though, a codicil: all materialist explanations of science and in this instance of the mind-brain relationship must necessarily start with mechanics.

To quote Maturana:

"The key to understanding all this is indeed simple: as scientists, we can deal only with unities that are structurally determined. That is, we can deal only with systems in which all their changes are determined by their structure, whatever it may be, and in which those structural changes are a result of their own dynamics or

triggered by their interactions."¹ Maturana & Varela:
Tree of Knowledge, [96]

In this case we must start with the structure of the brain per se, and ultimately reduce it to mechanics –in this instance to the biological and physical mechanics of brain process at some fundamental level.

Computer people do essentially the same thing in their quest for artificial intelligence. (I took a half dozen computer classes long ago to try to see if the “brain-is-a- computer” people had anything important to say at this fundamental level. When I came to the “systems” course, I concluded that they didn’t. It all came down to microcoding of the CPU which entailed essentially nothing other than “nots” and “ands” chasing each other around the CPU at unimaginable speeds, but adding nothing new to content and no new insight to the essential problem.)

Emergence

Let me start by promoting the footnote made early in the Preamble of this book which has something to say on this subject:

¹ Maturana & Varela: tree of knowledge, [96]

“Emergence” supposedly solves the problem of hierarchy in materialist explanations of the mind-brain problem, (e.g. P.S. Churchland’s). It purportedly explains how new phenomena “emerge” from more fundamental explanations. These new emergent phenomena are said to embed themselves hierarchically in ontic material –taken at the deepest level. The conception seems to derive from, or at least be analogous to the embedding of mathematical explanations –or of computer languages, (high vs low level languages).

In point of fact we are allowed to embed some higher level axiom system, (or computer language), in some more fundamental or different axiom system or language but *if and only if* we can prove/derive each of the axioms, (or new computer language terms), of the higher system from the lower one. But that implicit level of proof is always there.

No new “phenomena” are allowed to exist in the former that cannot be reduced to perhaps more complicated implications of the grounding system. (One need only replace any usage of the axioms, (or terms), of the higher system with its proof system in the lower to derive the same result.) Nothing radically new comes from such an approach. The rationale for instituting the higher system derives from *operational* simplicity. Nothing “emerges” –hierarchy will not allow it. In the computer language example, all the computer itself ever sees is machine language: i.e. ones and zeros!

Materialist explanations of consciousness of the usual sort all have this flaw. As I will state the problem later: “how can a (biological) machine/mechanism whose parts are discrete in time and space ever know anything whatsoever? But I mean “knowing” in a different sense than simple mechanical, “zombie-like” performance, and I think you wish it to be taken so too. “Consciousness” could never arise in any normal sense of the word! It would constitute too great a divide from the current, and specifically (*meta*)physical models of brain function.

A Very Basic Argument –An Argument from Fundamentals

In light of my opening comments, (i.e. my assertion of the ultimate irrelevancy of the particular choice of beginning perspective), let us therefore begin our dialogue at the materialist level of mechanism. Let us begin at the level of the machine we call the brain.

Consider your opinions and your objections well –as I will expect you to follow them to the limits of reason.

1. First of all I assert that no machine can ever “know where it is”! Now this may seem silly, but a machine only processes inputs on route to outputs. This is Nagel’s “brain in a vat” argument. If we could simulate any input with a high

enough level of sophistication, the machine could not tell the difference, (reversing the sense of the “Turing test”).

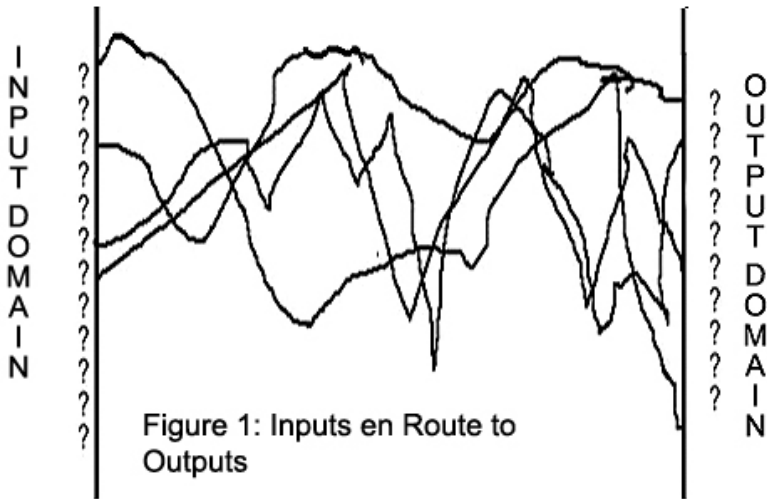

The machine therefore lives in a space of what I will call “ontic indeterminacy”. It cannot know where or what it is! (See fig.1) It is a complicated linear sequence from start to back consisting of pure mechanics –“gears and levers”, chips ... It does not cognate the space which supplies its input nor does it cognate the space wherein its output is received. And it doesn’t “care”! There is nobody home!

2. But for higher order, better functioning machines, we would want some form of feedback to allow it to “learn”. That “learning”, however, must be understood solely in the sense of a progressive optimization of the initial process, (see figure 2) But again there is nobody home!

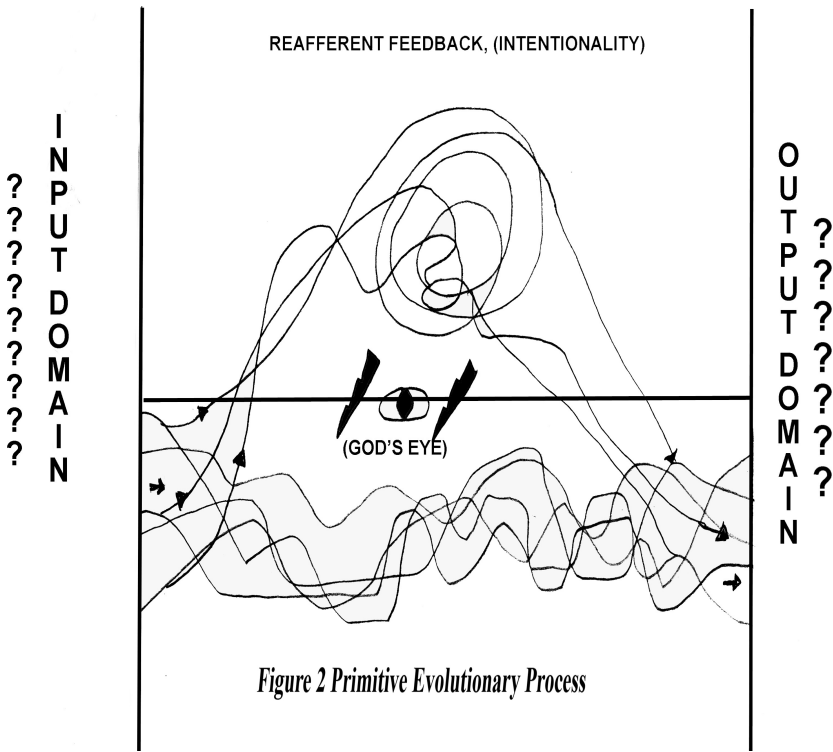

3. A significant point occurs at this stage however. The “learning” in the step just above leads us to bend the linear diagram into a circle. (See Fig. 3.) What good would feedback do if it were not imprinted right back onto the very output which then again re-affects its input? It implies *some connection* between its input and its output domains. This is the one good thing I found in Merleau-Ponty.

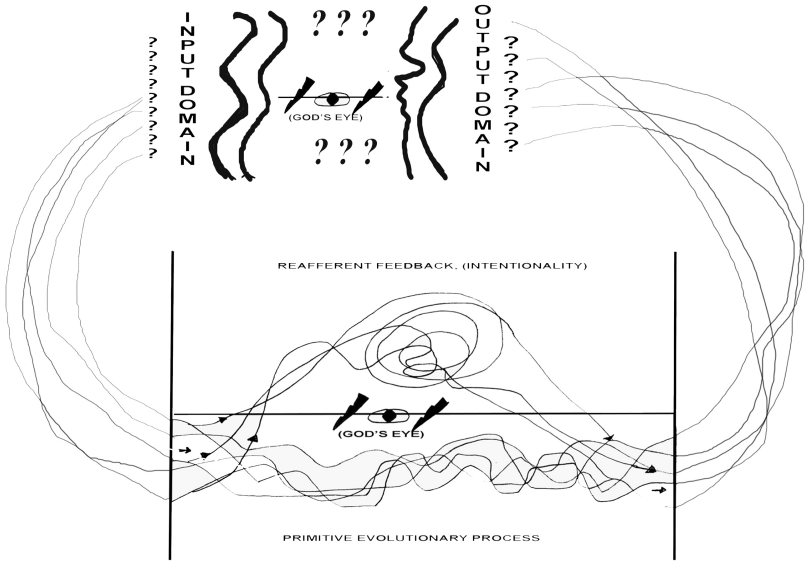
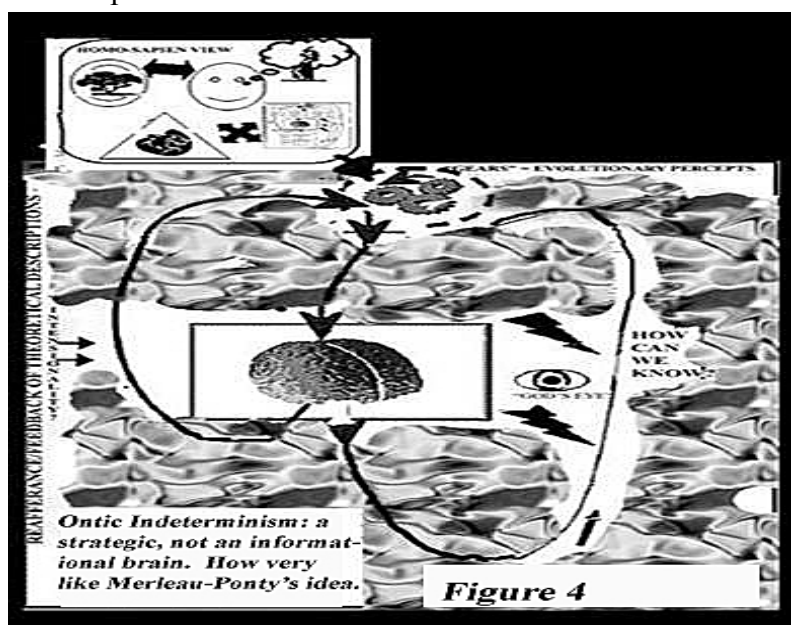

Figure 3: Connecting Input to Output to Input ...

To quote W.J. Freeman:

“In particular, Maurice Merleau-Ponty in "The Phenomenology of Perception" [2] *conceived of perception*" [itself] "as the outcome of the "intentional

arc", by which experience derives from the intentional actions of individuals that control sensory input and perception. Action into the world with reaction that changes the self is indivisible in reality, and must be analyzed in terms of "circular causality" as distinct from the linear causality of events as commonly perceived and analyzed in the physical world." W.J. Freeman, 1997, my emphasis.



But this is essentially the same conclusion I derived in the first version of my paper “Mind-Brain: the Argument from Evolutionary Biology”. (See Fig. 4.)

4. But the “where” and the “what”—the “what and which” of the input/output domain remains just as indeterminate at this

step, (Figs. 3 and 4), as it was in steps one, and two. There is *still* nobody home!

5. This, however, is precisely *the particular model* I propose as the initial stage in beginning to understand the brain mechanism! If you are a materialist, I think you must accept it.

On the face of it, this result seems profoundly damning to even the very possibility of “mind” in all the normal senses of the word. But I assert that this model is fully rigorous and fully legitimate within the confines of materialism. How then could there even exist a “mind” within such a picture? Where is there even the *possibility* of such a thing? Mechanisms just do, by definition they cannot “know” in the sense we all mean the word and in the sense of the materialist picture sketched above. So it seems I have just disproved the possibility of “mind” in all our intuitive conceptions of it.

The “Hard Core”:

This is the hard point around which my conception centers and becomes meaningful! However I should emphasize here that this is a problem for *all* materialists. Their best answers to date are vague and ambiguous at best and duplicitous at worst.

David Hilbert:

6. Early on when studying mathematics, I had a revelation pertinent to this issue. There was precisely one sense I

concluded, (and I challenge you to suggest some other), wherein an actual possibility consistent with science –and with the materialist picture above -arose. There was one case, I found, wherein a purely operative system, “a machine” *can* know something!. It can know its *own* “objects”! I discovered it in David Hilbert’s profound, but purely mathematical “concept of implicit definition”. Was it a vague correlation, did it need deepening and reorientation to this specific problem? Of course it did. (See Chapters 2 and 3 for a full discussion of the idea and an explanation of my interaction with it.)

Though solely mathematical entities of course, Hilbert’s “axiom systems” actually *define* their specific mathematical “things”, (their “objects”) –and they actually know them! What in fact is a line? What is a point? These concepts arise from the *whole* of an axiom system, (see citation below), and it is only *as a whole* that they can know them –and they actually do!

Here is a quote from Hilbert answering an objection to his conception by Gottlob Frege:

“It is impossible to give a definition of point, for example, since only the whole structure of axioms yields a complete definition. A concept can be fixed logically only by its relations to other concepts. These relations [are] formulated in certain statements (which) I call axioms, thus arriving at the view that axioms are the definitions of the concepts.” (Hilbert via Shapiro¹)

And another:

“I do not want to assume anything as known in advance. I regard my explanation ...as the definition of the concepts point, line, plane ... If one is looking for other definitions of a ‘point’, e.g. through paraphrase in terms of extensionless, etc., then I must indeed oppose such attempts in the most decisive way; one is looking for something one can never find because there is nothing there; and everything gets lost and becomes vague and tangled and degenerates into a game of hide and seek.”
(ibid)

Here was Moritz Schlick’s early characterization of Hilbert’s brilliant original conception:

"[Hilbert's] revolution lay in the stipulation that the basic or primitive concepts are to be defined just by the fact that they satisfy the axioms.... [They] acquire meaning only by virtue of the axiom system, and possess only the content that it bestows upon them. They stand for entities *whose whole being* is to be bearers of the relations laid down by the system."

Otherwise stated: its “objects” are a function of the system itself; the system is *not* a function of its objects! These

latter are, in fact, clearly and specifically *virtual* objects!² They “acquire *both* meaning *and* content “only by virtue of the axiom system”! The discovery of this conceptual possibility opened the keyway to the solution of my particular “hard problem”, (defined above), that I had sought!

Maturana and Freeman:

If the mechanics of the brain were biologically analogous to such an “axiom system”, (think of nerve nets –W.J. Freeman’s “equivalence classes” perhaps, as “axioms” as I will later suggest), and if the “we”, (“my mind”), were taken to be the *whole* of that system of the brain, (see Hilbert’s reference to the “whole of the axiom system” above), then it would indeed be possible for “us”, (the “me”), to *actually know* something, (sans any necessity of a homunculus), in something like our usual meaning of the word.

We, (I), could know our objects in the profoundest sense of “knowing”! The bad part of this, however, is that the only thing we, (I), would be *capable* of knowing would be the implicitly defined objects of the biological “axiom system” itself

² See Resnick’s discussion of mathematical structuralism in Chapter 2 which essentially reaffirms this interpretation.

–i.e. its virtual objects/artifacts –themselves relevant *only* to the mechanism itself.

7. This latter was the huge problem I addressed in my first hypothesis wherein I argued that the brain is *organizationally* rather than referentially defined. I argued that our very “objects” of perception themselves, (our “gears and levers”), are organizational and virtual –that they are the evolutionarily derived metaphorical and virtual reflections of process. Taking “axioms” in a biological/mechanical sense then, seeing them as the fundamental operative units of brain biology, we are allowed for the very first time to *legitimately* conceive, (i.e. as materialists), of an *actual* physical mind!

8. (Some of you, I am sure, have some limited knowledge of Hilbert and his concept of implicit definition. I had a reviewer totally mischaracterize it in his response as solely a formalistic theory of mathematical proof, but it was profoundly larger and different from that, (see chapters 1- 3). True, Hilbert later went astray, but the young Hilbert saw something that I think he later forgot. I think he was, in the language of Chapter 2, clearly the first “mathematical structuralist”!



This is the model I propose for human reality, but it is lived through the “gears and levers” of our evolutionary artifacts, the latter being understood from the perspective of biology, itself just one of Cassirer’s multitudinous “Symbolic Forms”. This, I believe, is the homo sapien cognitive reality

Figure 5

therefore agree neither surprises nor impeaches me, (contrary to Durant’s similar negative commentary on Kant. See Chapter 12 re: Durant). I believe we *all* see with the same indeterminacy that Figure 5 shows, but through the *same* parameters, i.e. through the same “gears and levers”!¹¹ (Please note how closely Figure 5 resembles the picture of philosophical idealism! But the “black space” is *not* non-existence; it is ontic *unknowability*.)

9. One last point here and it is highly relevant to our base problem: I believe in “other minds”, (and I think you do too) –which, I think defines much of the rest of our problem.

These minds, I believe, see through the exactly same evolutionarily derived “gears and levers” that I do). That our conclusions about reality should ,

This, I assert, is the reality of our human linguistic and cognitive world: we all speak the same language, but we are all equally ontologically blind! Therefore the totality of our dialogue must be interpreted heterophenomenologically, (using Dennett's word).

Kant

I guess I could quote Kant ad nauseum at this point, but I will not. I consider my ideas an extension and a completion of much of his conception. I feel that Kant was, and still remains the deepest thinker on the mind-brain problem.

End current note. January, 2010

A more explicit Nutshell summary extracted from an early webpage rendition below:

Old Precis Follows:

The Brain: A Materialist Perspective:

1. From the physicalist perspective, what I propose is that "mind" is specifically a function of the organization of behavior itself, not a function of knowledge. Loosely stated, I propose that the brain/mind is the evolutionary result (by a multicellular organism) of an optimization of process. It is the result of the *self-organized* evolutionary optimization –but an optimization of *blind* behavior per se and not one of knowledge!

In that process, I maintain that our naive perceptual "objects" are non-representative, purely behavioral,

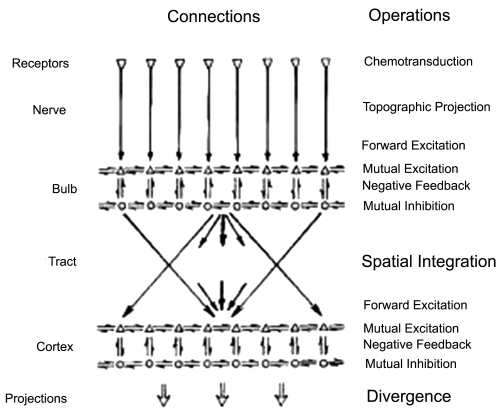

Figure 6, (Freeman's Figure 2)

(i.e. organizational and virtual), artifacts, but stable ones.

(This, though biologically plausible, is a very radical hypothesis,

but I believe it is the only viable scientific

pathway to the solution of the *other* leg of the problem –i.e. my second hypothesis.)

I propose that these artifacts/"objects" are *re-used* in the "intentional arc", (re: Merleau-Ponty), to test our (behavioral) hypotheses -i.e. both scientific and non-scientific. They are the ground for the whole of cognition.

But these artifacts, (our naive objects), need not correlate hierarchically to absolute reality, (see W.J. Freeman for instance, -Freeman's fig. 2—my Figure 6- above wherein he reveals a specifically *non-hierarchical* mapping into, (not *onto*), the cortex).

It is necessary only that these “objects” be locked into the re-entrant loop between action and perception which passes we know not where.

(Note how closely this perspective of “circular causality” fits with modern quantum theory -i.e. in the Schrödinger equation vis a vis "measurement"!³)

“But there is something very odd about the relation between the time-evolved quantum state’, (the Schroedinger equation), “and the actual behaviour of the physical world that is observed to take place. From time to time –whenever we consider that a ‘measurement’ has occurred – we must discard the quantum state that we have been laboriously evolving, and use it only to compute the various probabilities that the state will ‘jump’ to one or another of a set of new possible states.” (Penrose, 1989, pps. 226-227)

But each new instance of a measurement causes yet another “loop”! The mind, I assert, is a similar looping and circular probability machine -in this case utilizing the feedback/intentional aspects of the brain. It must countenance each “measurement” against our biologically innate, (and stable), evolutionary objects/artifacts and then recompute its overall picture and strategies. This is what cognition is.

³ You might also consider it in the light of the Raichle discussion of Chapter 3.

I maintain that our mental “objects” are the evolutionary yardstick we carry. They function to crystallize and organize our input, and to crystallize and organize our output. But they must be *rigidly* maintained as the “working gears”, (alternatively the

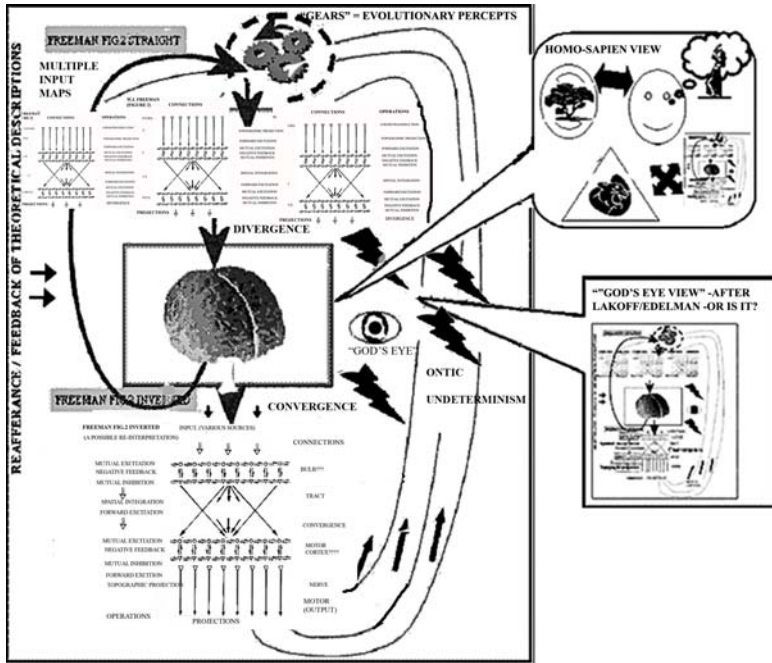

Figure 7 “A/D converters”, or, better still, as the hierarchical/non-hierarchical converters), of perception. I argue that they are organizational artifacts only!

This is the answer to the question of how a non-hierarchical mapping, (e.g. Walter Freeman's chaotic dispersive mapping, or Edelman's non-topological "global mapping"), could specifically function in cognition. I think it also gives a very pointed clue to Penrose’s problem.

"In particular, Maurice Merleau-Ponty in "The Phenomenology of Perception" [2] conceived of perception" [itself] "as the outcome of the "intentional arc", by which experience derives from the intentional actions of individuals that control sensory input and perception. Action into the world with reaction that changes the self is indivisible in reality, and must be analyzed in terms of "circular causality" as distinct from the linear causality of events as commonly perceived and analyzed in the physical world." W.J. Freeman, 1997 {22} (as cited previously)

This particular thesis, (my first of three hypotheses), supplies the necessary perspective of biology and the brain. It is our very own "cave of shadows", (Plato), -but it need not even be projective, (as a "shadow")! I propose that it is the evolutionary result of a self-organized and virtual optimization of pure response. It is instead as a GUI, (graphic user interface), rather than as a "shadow" or a "projection" that it functions. And GUI's actually have the potential for this.

This potential *per se* was a specific target of my argument in my paper: "Why: Mind- the Argument from Evolutionary Biology, (Virtual Reality -A Working Model)". It culminated in my discovery and interpretation of the experimental neurological researches of the noted neurophysiologist Walter J. Freeman which validate exactly that possibility. I argue that our "objects"

are deep metaphors of process, and virtual; they are not objects, (even indirectly), of representation

The “Mental” Perspective:

(2) Mind as the functional organization of behavior, (as proposed above), gives us the first viable answers to the other profound questions of mind. It gives answers to the "homunculus" problem, to the "Cartesian theatre" problem, to the problem of "meaning", and to Leibniz's pentultimately profound question: how can the one know the many, (That is, how is it possible that a unity, (e.g. a unified mind), could somehow actually know the (localized) “objects” it contained –i.e. “the many”)?

These answers are found in the specifically *operative* interpretation and application of David Hilbert's mathematical thesis of "implicit definition" as applied to the working “axioms” of the brain. Implicit definition allows an operative knowledge specifically of functioning itself, (sans a homunculus); it does not allow "representative knowledge".

But this is "knowing" in all the crucial aspects we require as mechanisms! This perspective is that of "mind" itself, (rather than of “brain”), and constitutes my second and central hypothesis. We can know our "objects" if (and *only* if), they are specifically (and purely) operative objects! This is the whole sense of Hilbert's sally as interpreted within the context of materialism. Mathematics has already solved this problem!

The Concordance:

(3) At this point I argued what I called “the concordance” between my first and second hypotheses above. I argued that hypotheses one and two are fundamentally *isomorphic*. It is proved by reconstruing *and embedding* logic, (*-per se!*), as a purely biological and evolutionary faculty -which I argue is the *necessary* interpretation for any strict materialist. This reconception forces the identification of my first two theses. It is just such correspondences that are the most valuable clues to science.

(4) From there, my thesis gets harder, but justifiably so, I think. It is very “sophisticated”, (in the mathematical usage of the term), and relativistic, most of it lying outside the bounds of a short précis such as this, so I will merely sketch its outline. (See Chapters five through ten for a full explanation). It will take a very sophisticated mind to comprehend it adequately, but I think it actually does complete the project I initially set myself. I think it actually does answer the question: “What and where is the mind?”

“Symbolic Forms”

Employing Ernst Cassirer's "Theory of Symbolic Forms", I argue a case of ontic indeterminism, (likened and clearly similar to the Input/Output Domain question discussed initially in this précis). I argue that it is a legitimate extension of Kant's beginnings. I propose that a modification of Cassirer's thesis is

the only plausible answer for what it is that we must finally consider ourselves, (that is, scientifically –from the materialist perspective again) -*as purely biological organisms*. Organisms, (aka Mechanisms), do not know, organisms do -organisms are "triggered", (after Maturana). Or rather, the only "knowing" of which we are capable is an operative knowing –following Hilbert- of the artifacts of our very own process! Ontology is, and must always be, an indeterminate. It is the Input / Output Domain problem characterized initially.

5. But Cassirer's "Symbolic Forms" provides much broader and deeper insights as well. It provides the means for the mutual reconciliation of the many perspectives on the mind-body problem promised above. Cassirer argued that each of the perspectives of thought asks its own legitimate questions, "each from its own standpoint", but each employs an implicit logical context specific to itself as well.

Without, *or in the act of relativizing*, that specific logical context, the "object" itself becomes "a mere X". (Cassirer)

How close his conclusions are to our beginning materialist perspective –to the brain/machine's total inability to know its input/output domain and to the purely intentional, (i.e. feedback) functioning of that mechanism! The further implications I have drawn from Cassirer's "Symbolic Forms" reconcile these multitudinous perspectives and the broader perspectives of epistemology as well and makes them whole.

“The Interface”

6. In Chapters nine and ten, I suggest “interface”, defined abstractly and *by necessity* heterophenomenologically⁴, (as the invariant commonality, the “mathematical ideal”, of all materialistic interpretations of the sensory boundary), as a necessary and legitimate realist ontological *existence* postulate in itself. Of those realist ontological existence postulates, I assert there are exactly three –largely parallel to Putnam’s postulates of realist belief.

I then propose “interface” as being essentially equivalent to the concept of the GUI presented earlier. (This is my third and final hypothesis.) Each is “implicitly defined”, and I argue that they are isomorphic! (See Chapter 9). Granting the actual ontological *existence* of this interface, then, it in itself supplies the ontological reality of an *actual* mind. All the “hard problems” have been solved en route to this point.

Conclusion:

Mine is admittedly a very long and a very complicated solution, but it is the nature of the problem and not my inclination which has made it so. I think you probably expected a 10,000

⁴ Using Dennett’s word

word answer to a 60,000 word problem. The normal size of scientific papers is about that word length, and I guess that most ordinary ideas could be covered in such a scope –at least in summary. But I think any even reasonably comprehensive, *mere statement* of this particular problem will require at least 60,000 words -and with a conceptual depth to match.

Kant made a highly relevant comment on this point:

[The problem of the mind] "is a sphere so separate and self-contained that we cannot touch a part without affecting all the rest. We can do nothing without first determining the position of each part and its relation to the rest ... It may, then, be said of such [an argument] that it is never trustworthy except it be perfectly complete, down to the minute elements [of pure reason]. In the sphere of this faculty you can determine and define either everything or nothing." ("Prolegomena", P. 11)

Now finally, hear Cassirer:

"A glance at the history of physics shows that precisely its most weighty and fundamental achievements stand in closest connection *with considerations of a general epistemological nature*. Galileo's 'Dialogues on the Two Systems of the World' are filled with such considerations and his Aristotelian opponents could urge against Gallilei that he had devoted more years to the study of philosophy

than months to the study of physics. Kepler lays the foundation for his work on the motion of Mars and for his chief work on the harmony of the world in his 'Apology for Tycho', in which he gives a complete methodological account of hypotheses and their various fundamental forms; an account by which he really created the modern concept of physical *theory* and gave it a definite concrete content. Newton also, in the midst of his considerations on the structure of the world, comes back to the most general norms of physical knowledge, to the *regulae philosophandi*

... But all these great historical examples of the real inner connection between epistemological problems and physical problems are almost outdone by the way in which this connection has been verified in the foundations of the theory of relativity.... Einstein...appeals *primarily* to an epistemological motive, to which he grants...a decisive significance." (Cassirer: "Einstein's Theory of Relativity",P.353-354, my emphasis.)

How could you think that our particular problem –the self-referentiality of the brain- would not require such epistemological considerations *more than any other*? Our conclusions must turn upon themselves to validate our very beginnings. They are progenitors and antecedents of theories. But these would have to be an integral *part* of the new science,

not mere reflections upon it –as, in fact, were the epistemological presuppositions of the entire history of our greatest thinkers on our hardest problems. Philosophy, i.e. *constructive* philosophy in the service of science and integrated *within* the science must be our focus.

It is a current buzzword amongst neurophilosophers that the solution to this problem will be “multidisciplinary”, but most of this is merely talk, supporting and applying mainly to the assumed “obvious truths” of naïve realism. My argument is that this is *truly* a multidisciplinary problem, involving radical departures across the whole spectrum of human thought. My thesis actually fulfills this core requirement within a plausible perspective. In some ways, surprisingly, my conclusions are very similar to our current deepest scientific worldview except that they substitute the idea of a non-hierarchical GUI for the notions of hierarchical embedding and emergence. Our world is not a “shadow”, it is an algorithm. My thesis will require an intellectual sophistication that we are not normally required to maintain however. But whatever made you think that a solution to this millennia-old problem would be simple? If you read it, I will answer.

I believe the very act of the presentation of any adequate solution to this problem is probably the hardest (technical) writing problem that has ever existed. There are so many preconceptions and prejudices, so many "prior certainties", so

much confusion over even the basic beginnings, that it is almost impossible -and the resulting reactions often strongly hostile.

There is also, I feel on the other hand, a built-in biological prejudice against a real answer. (Absolute dedication to the innate algorithm is clearly biologically essential.) I need, (and anyone with a similar case needs), active participation from my, (his), reader -and the realization of the necessity for a bravery to believe differently. The problem demands it.

My original book stated my basic case, but there were crucial later advancements in my online papers, “A Very Different Kind of Model: Mind, The Argument from Evolutionary Biology”, and “A Shortcut to the Problem: Consciousness per se!” This third edition of my original book gives the best overall rendition of my conception as it attempts to outline the origins of my own very different beginning perspective on the basic problem. That perspective is very unlike any you have ever seen before.

I will ask that you examine my whole case before rendering a judgment. I start out with an extremely abstract approach, but reach very concrete and specific answers. I think this is the shortest and easiest path between this profound problem and its solution.

Chapter 2: Exotic Mathematics: What is it, and how is it relevant to the Mind-Brain Problem?

(A deeper look at Hilbert.)

I have been very careful in my choice of words in the chapter heading because I do not wish to be misunderstood. By “exotic mathematics” I do not refer to arithmetic, ordinary algebra or the slight but profound extension of the latter which is called “the calculus”.

Nor do I refer to the manifestations of formal logic, ordinary set theory, statistics or ordinary topology. Instead I wish to refer to new developments in the very core of mathematics itself. I refer specifically to Mathematical Structuralism and to Category Theory which have been proposed as new and radical foundations for the whole of mathematics.

It is an old saying that reality is written in the language of mathematics. The question I propose to address is whether that language is only descriptive and pragmatic or is it fundamental to the problem –and to reality itself. And why would the *philosophy* of the foundations be relevant? It is relevant just in case the latter is true –i.e. it is relevant if the foundations of our reality are just the foundations of mathematics itself!

I believe there remains just one truly significant question in the mind-brain problem. It is a simple question, but it is as crucial as it is blatant, i.e. how can a (biological)

machine/mechanism whose parts are discrete in time and space ever know anything *whatsoever*? That it can mechanically function is no longer in question, but mechanical functionality is not the same as “knowing”. (Dennett addressed this problem quite well, but, he concludes, we are necessarily mechanical “zombies”!)^{I)}

This was the question that overpowered me over fifty years ago, and the one I still must reevaluate each day and every day -even today. I think it is the relentless, recurring and irrepressible question underlying all objections to any proposed solution of the mind-brain problem.

Long ago when I was very young I was extremely lucky in that I stumbled across what I saw as the beginnings of an answer.^{II} In the summer of my nineteenth birthday I read Saunders MacClane’s “A Survey of Modern Algebra”.^{III} This book, very little concerned with ordinary “algebra” per se, was significant not because it dealt specifically with Mathematical Structuralism or Category Theory as such, but because I believe the book’s very own structure and content was framed within that context.

The very layout of its content inherently defined its origins –and I perceived them intuitively. (MacLane, of course, was the actual co-discoverer/inventor of mathematical Category Theory which he conceived long before writing this particular book.) I think the book proselytized its origins -*sotto voce*!

In my autodidactic digestion of this book in that summer fifty years ago, it became apparent to me that its subject matter had more to do with structures themselves and very little to do with the content of the “objects” of those structures. I understood it furthermore as an exploration and extension of the mathematical possibilities of all abstract “orderings” rather than about ontology.

But I understood that “ordering” itself largely from the perspective of Ernst Cassirer’s “Substance and Function” which I had read earlier and whose relevance to this specific mathematical and logical problem we will examine later.

The strong implication I derived from MacClane’s book was that the “objects” of mathematics were in fact only virtually defined “positions”, defined implicitly within the structures of their axiom systems.^{IV}

Resnik, one of the leading contemporary proponents of mathematical structuralism and recently discovered by me, says it this way:

“The view’s [Mathematical Structuralism’s] leading ideas are that mathematics studies structures or patterns and that reference to mathematical objects figures in this study only as a means for depicting structures.

Mathematical languages do not refer to determinate elements of fixed domains, as, to use Hellman’s term, “objects-Platonists” hold, but rather, in so far as they refer at all, they refer to positions whose identities are fixed

only through their relationships to other positions in the structure under discussion.”^v

Here is a relevant quote from my original manuscript, (Iglowitz 1998), on the subtleties of the mind-brain problem which proposed an equivalent view:

“The mere existence of a multiplicity of alternately viable calculuses, (sic), and the allowable incommensurability of their objects suggests an interpretation of the objects of those models contrary to representation or denotation however. It suggests the converse possibility that the function and the motivation of the “objects” of those models, specifically *as entities* per se, (in what I will call these “schematic models”), is *instead* to illustrate, to enable, -to crystallize and simplify *the very calculus of relation proposed between them!*

They are a byproduct of deep ordering!¹ The “objects” of these schematic models, I propose, are manifestations of the structure; the structure is *not* a resolution of the objects. It is the structure which is ~~predictive~~, [or better, “operative”]; its objects merely ~~enable~~ [reflect] it!

I continued: “The rationale for this move comes from Hilbert’s profound mathematical notion of ‘implicit

definition' ...” [Note September, 2008: Hilbert is the focus of much of the current debate over mathematical structuralism and Category theory -see Shapiro section to follow.]²

Quoting Stefanik re: Resnik's structuralism:

“These objects [for Resnik] serve as only positions within these structures, with their identity determined only by their relationships with other positions within that

¹ See Chapter 3 for a detailed analysis of Cassirer's conception of the innate ordering of Concepts themselves.

² I continued: “(Under this conception, the ‘objects’ of a mathematical system are not given beforehand, but are, in fact, a resolution of the operative rules of the system itself. [See prior Schlick quote.] They exist solely as focuses, nexuses (sic), [i.e. *virtual expressions*] of the interaction of those rules. Now let us consider applying this notion of ‘objects’ to the ‘objects’ of the mind. If this shocks you –and I hope its implications will at least interest you- consider this: it presents the very first, truly scientific pathway around the problems of the homunculus, of knowing, and enables the first possibility of an actual scientific existence of an *actual* mind! If ‘the (biological) system’ were to know, and ‘we’ *were* the system itself, then it would indeed be possible for us to know our objects. But *only*, however, if those objects were like the ‘objects’ of implicit definition.” This is the revelation I had 40 years ago.) There are many profound difficulties in it, I know, e.g. in regard to what I have referred to as “the static problem” which I addressed in the “Dennett Appendix” in my book, [Iglowitz, 1995], and in the “Freeman Appendix” to [Iglowitz, 2005]. The latter comments deal with the biological viability of such evolutionarily determined objects in a changing environment. See the reference in the latter to “A/D converters” [ibid]. (My conception raises deep logical problems as well. I will address these presently.) Contrarily, it seems to be the *only* possible pathway to “knowing” *per se* within the context of modern science.

structure. His basic underlying metaphor³ is that of geometric points, and he claims that we do not have knowledge of mathematical objects given in isolation but rather as ‘pieces of structures.’”^{VI}

Here is a much older viewpoint on Hilbert’s related conception of “implicit definition” that I was aware of almost from the beginning and which helped form my initial conception. (From Moritz Schlick, physicist/philosopher and founder of the famous "Vienna Circle", and, according to Cassirer, the actual inventor of the phrase “implicit definition”). He grasped the deep implications of Hilbert's innovation early on:

"[Hilbert's] revolution lay in the stipulation that the basic or primitive concepts are to be defined *just by the fact that they satisfy the axioms....* [They] *acquire meaning* only by virtue of the axiom system, *and possess only the content* that it bestows upon them. They stand for entities *whose whole being* is to be bearers of the relations laid down by the system."^{VII}

I do not claim to be a mathematician, or even a philosopher of mathematics, but the perspective Mac Lane’s

³ Please note that the usage of geometry is a “metaphor” only. The objects of mathematics may be more complexly ordered than is possible for geometry.

book engendered was the one I held from the very beginning of my quest for an answer to the mind-brain problem. I saw the blinding possibility of the first truly viable answer to the core question cited above.

My purpose here is to solicit the help of real mathematicians and philosophers of mathematics in the completion of a formal and rigorous resolution of this problem capable of empiric verification.^{VIII} I think this is the ground where neuroscience must go. My own thrust for most of my intellectual life has been to pursue the profound further consequences of this idea –and they are huge and difficult.

In my mistaken youthful naivety and humility, (which I renounce in this my old age), I had assumed that all minds bright enough to approach the deepest problems of our species, (the brightest minds of my elders and of my contemporaries), had long since understood and internalized these lucent, sophisticated ideas.⁴ These ideas seemed to be an absolutely essential part of the working tools of the intellect.

⁴ This was the second of my naive youthful intellectual assumptions. The first was that such minds –which I had idealized- had realized and adopted the profundity of Cassirer’s redefinition of the formal, technical “concept” of logic itself –which he had reformulated in terms of “ordering” rather than of “extensionality”- and which had struck me with a profound force at about the same time.

It seems I was wrong. It seems clear from their writings that most neurophilosophers have very limited conceptions of the dimensions and scope of modern mathematics.

Mac Clane's book suggested to me what I still believe is the only genuine possibility for an answer to the question posed above, viz: "How can a (biological) machine/mechanism, whose parts are discrete in time and space, ever know anything *whatsoever*?" It also suggested an answer to Leibniz' earlier and more purely philosophical question as well, i.e. "How is it possible for 'the one' to know 'the many'?" That is, how is it possible that a unity, (e.g. a unified mind), could somehow actually know the (localized) "objects" it contained –i.e. "the many"?

Equivalently, how is it possible that a "Cartesian theatre" could exist without a homunculus?

What Mac Clane's book spoke to me under my prior perspective of Cassirer's "Concept" in which I saw it,⁵ was that a system of mathematical "axioms"^{IX} *when taken as a whole*, (see the relevant Hilbert quotes following shortly), could actually *create* its "objects", (albeit virtually). It could actually "know them" moreover, rather than the other way around. Tentatively taking a system of "axioms" in a specifically *operative* sense,

[Note: 2010: (think of nerve nets –W.J. Freeman’s “equivalence classes” perhaps, as “axioms”), –in a biological sense then –as the fundamental units of brain process⁶ - it suggested that as a system, (i.e. *as a whole*), it could create and actually *know* its “objects”.

Here is some very recent material I have found and which buttresses my early interpretation: Quoting Hilbert’s response to Frege, (David Hilbert, of course, was one of the most famous mathematicians in history and the actual father of “implicit definition”). Please note his emphasis on the “*whole structure*”:

“It is impossible to give a definition of *point*, for example, since *only the whole structure of axioms yields a complete definition*. A concept can be fixed logically only by its relations to other concepts. These relations [are] formulated in certain statements [which] I call axioms, thus arriving at the view *that axioms are the definitions of the concepts*.”^X

⁵ –see later Cassirer sections –especially Chapter 3.

⁶ Please do not be put off in considerations of size. Mathematics has no problem with axiom systems of even infinite size. I do not propose that they are that large, (sic), but a few hundred billion, (probably too large), probably wouldn’t raise many mathematical eyebrows.

Here is Hilbert's expansion of his perspective:

“I do not want to assume anything as known in advance. I regard my explanation ...as the definition of the concepts point, line, plane ... If one is looking for other definitions of a ‘point’, e.g. through paraphrase in terms of extensionless, *etc.*, then I must indeed oppose such attempts in the most decisive way; one is looking for something one can never find because there is nothing there; and everything gets lost and becomes vague and tangled and degenerates into a game of hide and seek.”^{XI}

From my early intuitive interpretation of MacClane's book, I proceeded at that early stage in my life to tentatively assume “axioms”⁷ as the fundamental operative units of the brain to see where the assumption led. (The repercussions are enormous, I realize, but please bear with me.) This was the perspective I started with fifty years ago and have pursued it ever since. I believe it has been fruitful.

I concluded early on that the (virtual) “objects” of this particular system, (i.e. of the brain conceived in this way), could actually function as the perceptual and conceptual objects of the “mind” and that the problems which I later came to know as “the

⁷ i.e. “atomic processes”

homunculus” and “the Cartesian Theatre” would be solved.⁸

This was the *one* case in which a mechanism could *actually know* its “objects” –but *only* in precisely the case where those “objects” were, in fact, a manifestation of the ordering, (structure), of the mechanism itself.⁹

The problem I then faced, and it was not a simple one, was that they would have to be mathematical objects *per se*! And how could this be?^{XII}

I spent many decades investigating and developing the biological and philosophical implications of my early insight with some success I think, though communication of them has been almost impossible for the reasons stated previously, I think.

After long consideration, (too long!), I have recently concluded that the difficulty has always been a direct result of my original naïve assumption. These tools are not in the workchests of neuroscientists or neurophilosophers!

As a whole I think these ideas make sense. Their ramifications are huge but admittedly raise substantial and profound doubts which are extremely difficult.

⁸ These problems are implicit in the core problem stated at the outset of course. I always saw the problems, but their naming came much later. See Chapter 3 :“Cassirer” for a rationale.

⁹ It also clearly seemed to resolve the deepest problems of “meaning” as well.

I will not minimize this fact. But I feel the latter objections are themselves essential to the problem however as they must constantly be clashed against the core problem raised at the outset. This was the hammer and the anvil on which my ideas were forged. Only recently did I discover the actual formal mathematics which elucidate my beginning insight and seem to validate it.^{XIII}

Mathematical Structuralism and Category Theory:

Let me begin by quoting pieces of the modern dialogue. I will not be able to truly elaborate this discussion, but my purpose here is to give you a flavor and to establish the legitimacy and the “legality” of my perspective.^{XIV} ¹⁰ (See Footnote)

First let me repeat the short quote of Resnik defining Mathematical Structuralism as a place for us to start:

“The view’s leading ideas are that mathematics studies structures or patterns and that reference to mathematical objects figures in this study only as a means for depicting structures.

¹⁰ I claim no expertise in Category Theory whatsoever save through these references, but I have a greater confidence in my understanding of Mathematical Structuralism as I came to the same conclusions myself over

Mathematical languages do not refer to determinate elements of fixed domains, as, to use Hellman's term, "objects-platonists" hold,; but rather, in so far as they refer at all, they refer to positions whose identities are fixed only through their relationships to other positions in the structure under discussion."»^{XV}

There is so much to present here, so many misunderstandings, so many presuppositions that it is almost impossible to even begin to communicate fluently on this subject. One aspect lies in the foundations of logic itself. Almost everybody, it seems, assumes set theory as the logical primitive of thought, (which assumption lies at the basis of some of the deepest problems here):

Benacerraf counters however:

“Very often philosophical logicians are really logicians who are promoting the program of reducing mathematical objects to logic and set theory. This is clearly distinct from the activities of mathematicians who are not interested in a reductionist program...”

fifty years ago. See my youthful arguments in the next chapter on Cantor's Diagonal Argument.

....We will see that category theory has been proposed as an alternative to set theory as a foundation of mathematics. “The search for urelements, fundamental objects of the mathematical universe, is a mistaken enterprise that underlies an absolute theory of identity and the platonic philosophy of mathematics. ...”.^{XVI XVII}

Here is another perspective:

“Mac Lane^{XVIII} correctly states that many interesting questions cannot be settled on the basis of the Zermelo-Fraenkel axioms of set theory.

‘Various additional axioms have been proposed, including axioms which ensure the existence of some very large cardinal numbers and an axiom of determinacy (for certain games) which in its full form contradicts the axiom of choice.

This variety and the undecideability results indicate that set theory is indeterminate in principle: There is no unique and definitive list of axioms for sets; the intuitive idea of a set as a collection can lead to wildly different and mutually inconsistent formulations.

On the elementary level, there are options such as ZFC, ZC, ZBQC or intuitionistic set theory; on the higher level, the method of forcing provides many alternative models with divergent properties. *The platonic notion that there*

is somewhere the ideal realm of sets, not yet fully described, is a glorious illusion.’ ” XIX

Stefanik continues:

“MacLane believes that this situation is similar to that of geometry after the proof of consistency for non-Euclidean geometry demonstrated that there are many geometries, and not just one. In a similar manner, *the intuitive idea of a collection leads to different versions of set theory*. For Mac Lane, this is sufficient reason to consider alternatives to set theory as a foundation for mathematics. The alternative that he proposes is category theory.”^{XX}

And a few more:

“Category theory is essentially anti-platonistic, for it undermines the received idea that the meaning of any mathematical concept is fixed by referring it to the context of a unique absolute universe of sets.”^{XXI}

“...it becomes natural, indeed mandatory, to seek for the set concept a formulation that takes account of its *underdetermined* character, that is, one that does not bind

it so tightly *to the absolute universe of sets with its rigid hierarchical structure.*”^{11 12}

I studied the Zermelo-Frankel set-theoretic foundation for numbers -a well-accepted and pretty much standard interpretation briefly, (long ago). Surprisingly, I found that there is precisely *one* thing that actually, (i.e. ontologically), exists for mathematics under this set-theoretical interpretation: “the empty set”! Everything else –*all else*- is grounded in sets and sets of sets and sets of sets of sets of...that selfsame “empty set” –i.e. the set which has no members!

The actual (ontological) existence of that empty set –that empty basket in the real world- is proved moreover solely on the basis of a logical contradiction.¹³ Assume it does *not* exist and a logical contradiction arises! Therefore it, *our most crucial ontological logical building block* is “proved” thereby to *actually* exist! I think this is not a viable beginning for anything; much less as the very foundation for the logic we apply to the very core

¹¹ Note: W.J. Freeman and I both specifically argued against hierarchy in the compositing of the brain. He has supplied a physical model. See Chapter 4 and Iglowitz, 2005

¹² Bell, 238,my emphasis

¹³ The proof is grounded in “material implication”.

of our world.^{XXII} It is a self-serving and circular argument.¹⁴
The solution I have evolved is harder, but I think it works.

Back to the sources of mathematical structuralism and
category theory:

Resnick:

“... As positions in structures, they have no identity
outside of a structure. Furthermore, the various results of
mathematics which seem to show that mathematical
objects such as the numbers do have internal structures,
e.g. their identification with sets, are in fact interstructural
relationships.”^{XXIII}

Repeating Stefanik:

“These objects [for Resnik] serve as only positions within
these structures, with their identity determined only by
their relationships with other positions within that
structure.”

¹⁴ I say it is circular because the logicians stand on the foundations of
mathematical logic, and the mathematical logicians stand on the foundations of
philosophical logic. I had a well known philosophy professor who used to sit in
on my beginning mathematical logic classes and take ferocious and copious
notes even at that level. So an appeal to philosophical logic to support
mathematical logic seems very strange to me.

But how could “a structure” serve a biological mechanism without the further inclusion of actual “objects”¹⁵ within that structure?¹⁶ On the other hand, how could “a structure” serve a biological mechanism *at all*?

Either it is conceived to exist externally in the unknown input/output domain in which case it is merely *manipulated*, (and still unknown), or it is conceived internally to that mechanism itself, in which case it is a part of the intentional feedback loop of the mechanism described early on, but here, as argued in the very beginning, there is *still* nobody home!

The better answer is that *virtual* “objects”, (and I think it is pretty clear that the objects of structuralist mathematics are truly virtual), could serve the organism as a highly effective and optimizing *organization* of response¹⁷, alternatively as a cohesive operative metaphor^{XXIV} of its primitive structural units, (serving as a “higher level language” for intentionality perhaps),^{XXV} and this is just what I propose for the human brain.^{XXVI}

I will argue in Chapter 4 that our “perceptual objects” are a byproduct of the deep evolutionary self-organization (ordering)

¹⁵ How about a structure of neural connections, for instance?

¹⁶ Considering it as a *connectionist* structure –as we will do- will make more sense.

of our primitives! Our “objects”, I will propose, are manifestations of the structure; the structure is *not* a resolution of the objects. It is the structure which is predictive and operative; its objects merely enable or “reflect” it!^{xxvii} There is considerably more to the solution of this problem than I have discussed so far,¹⁸ but, surprisingly many of these further deep ramifications are actually mirrored in the current (mathematical Categorical^{xxviii}) dialogue as well!

This is our deepest and ultimate problem and we must expect the implications to be vast on all fronts.

One of these implications, and it is very real, relates to my investment long ago in Ernst Cassirer’s “Symbolic Forms” which incorporates an *absolute relativism* of epistemology.¹⁹ (This is clearly consistent with our present, albeit conditional, materialistic perspective!)

¹⁷ See Iglowitz, 2005, for a precise biological elaboration of this possibility, and the later citation of my letter to Rosen in Chapter 3 as an expansion of my ideas on this subject.

¹⁸ Briefly, I have argued for evolutionary “objects” as primitives, but I also strongly suggest the inclusion of intentional axioms as well -as an answer to the “static problem” –see Freeman Appendix of Iglowitz 2005, and the “Dennett Appendix” in Iglowitz, 1995

¹⁹ Which fits very nicely with my base ideas, of course –i.e. with the necessities of the brain as “machine”.

The absolute ontological object for Cassirer becomes “a mere X”.²⁰

“Even in ‘nature’, the physical object will not coincide absolutely with the chemical object, nor the chemical with the biological –because physical, chemical, biological knowledge *frame their questions* each from its own particular standpoint and, in accordance with this standpoint, subject the phenomena to a special interpretation and formation²¹

The end of this development [“critical idealism”^{XXIX}] seems to negate its beginning –the unity of [ontological] being, for which it strove....The One Being, to which thought holds fast and which it seems unable to relinquish without destroying its own for, eludes *cognition*. The more its metaphysical unity as a ‘thing in itself’ is asserted, the more it evades all possibility of knowledge, until at last it is relegated entirely to the sphere of the unknowable and becomes a mere ‘X’”.^{XXX}

²⁰ Ontology is clearly relevant to the mind-body problem which occurs as a self-referential question within it.

²¹ i.e. each discipline incorporates its own specialized logical structure –without that particular structure the “object” becomes faceless

Simply put, Cassirer argued that each of the forms of science incorporates its own specialized logical perspective, (“each *frame(s)* *their questions* each from its own particular standpoint”), and, if that unique, purely logical, and specialized framework were removed *-or relativized*, all that would remain of the ontological “object” would be “a mere X”! ^{XXXI}

But note how closely Cassirer’s conception of reality matches the materialist perspective I sketched in the *Precis*! There is no way that a machine, (and this is the precise characterization of the brain implicit in materialism), could have knowledge of the space which constitutes its input or its output domains!

Cassirer’s conception seems to be precisely mirrored mathematically in Bell’s “Category Theory and the Foundations of Mathematics”,²² [J.L. Bell]. (Citation shortly)

²² If these, (structuralism and category theory), are, in fact, the foundations of our mathematics, then they are also the foundations of our logic. This should be confirmed with even a casual glance at the present mathematical state of logic. As such they strongly imply that Cassirer’s conclusions are relevant to logical thought at the very bottom level. This seems to be confirmed from Bell’s perspective.

But first, in close parallel to my comments above, Stefanik cites Benacerraf:

“[Hilbert] argues that what constitutes an object varies from theory to theory, category to category, and that Frege failed to realize this fact. It is a thesis that is supported by the activity of mathematicians, and is essential to the philosophical perspective underlying category theory, as we shall discuss later.

The search for urelements, fundamental objects of the mathematical universe, is a mistaken enterprise that underlies an absolute theory of identity and the platonic philosophy of mathematics.’ “[and of neuroscience as well I propose],” ... ‘It [logic]^{xxxii} remains the tool applicable to all disciplines and theories, the difference being only *that it is left to the discipline or theory to determine what shall count as an 'object' or 'individual.'* [Benacerraf, 288]

Quoting Stefanik, (solely for definitional purposes here):

“Any topos²³ may be regarded as a mathematical domain of discourse or ‘world’ in which mathematical concepts can be interpreted and mathematical constructions performed. Bell develops an analogy between mathematical frameworks and local coordinate systems of relativity theory. Each serves as the appropriate reference frame for fixing the meaning of mathematical or physical concepts respectively.” [Stefanik, 1994]

Here are the promised relevant citations from Bell:

“The topos-theoretical viewpoint suggests that the absolute universe of sets be replaced by a plurality of ‘toposes of discourse’, each of which may be regarded as a possible ‘world’ in which mathematical activity may (figuratively) take place. The mathematical activity that takes place within such ‘worlds’ is codified within local set theories; it seems appropriate, therefore, to call this codification local mathematics, to contrast it with the absolute (i.e., classical) mathematics associated with the absolute universe of sets.

Constructive provability of a mathematical assertion *now means that it is invariant*, i.e., valid in every local mathematics.”^{XXXIII}

“There is an evident *analogy* between mathematical frameworks and the local coordinate systems of relativity: each serve as the appropriate *reference frames* for fixing the meaning of mathematical or physical concepts respectively. Pursuing this analogy suggests certain further parallels.

For example, consider the concept of *invariance*. In relativistic physics, *invariant physical laws* are statements of mathematical physics (e.g. Maxwell’s equations^{XXXIV}) that, suitably formulated, hold universally, i.e. in every local coordinate system. Analogously, *invariant mathematical laws* are mathematical assertions that again hold universally, i.e. in every mathematical framework.”
[Bell, 241]

The trick is to understand that Cassirer’s epistemological relativism is based, like Bell’s and Einstein’s, in the *absolute*

²³ “Topos”: In mathematics, a **topos** (plural "topoi" or "toposes") is a type of category that behaves like the category of sheaves of sets on a topological space. (Wiki)

preservation of connective –i.e. *translatory* invariants.²⁴ I came to these conclusions by an independent route –by a continual reexamination of the original core question, (matched against Cassirer’s ideas and those structuralist implications I inferred from my early exposure to MacClane’s book), which I feel lead inexorably to Cassirer’s ultimate perspective.

How is it possible for a pure mechanism to actually know, (in the sense of ontology), anything whatsoever?” As I argued in the *Precis*, the ultimate answer is that, other than the “objects” of its own operability, it *cannot!* But it is possible for a mechanism to have “beliefs” –i.e. operative strategies/organizations each of which addresses the invariant core, (transformed through our evolutionary artifacts), of raw experience instead!²⁵

I believe that invariant core, (of experience), its primitive objects are, in fact, evolutionary artifacts implicitly defined by the structure of brain process!^{xxxv} These artifacts, I think, are our primitive “percepts”.^{xxxvi}

They function, as I said in one of my papers, as fixed “A/D” converters,^{xxxvii} (or, better: hierarchical/chaotic

²⁴ For Cassirer, these invariants are preserved in “the phenomena”.

²⁵ The “invariants” for Cassirer’s “Symbolic Forms” are our raw percepts themselves sans an interpretation.

converters), so to speak, mediating between input²⁶ and central brain process²⁷. (These are the “schematic artifacts” of the “GUI”, (graphic user interface), that I argue in Chapter 4.) I believe this was how evolution organized and optimized the behavior of the seventy trillion celled megacollosus called man!

Here is a bit from my original manuscript on the subject of “objects: (note: where I have used the term “implicit definition” you may substitute the terms “mathematical structuralism” or “category theory” if you like. I don’t automatically agree, (that is, I do not automatically agree in a “knee-jerk” sense. I don’t know enough.) It should work however.

“I propose that the boundaries -the demarcations and delimitations of these schematic objects, (their “contiguity” if you will) -are formed specifically to meet the needs of the operations themselves. I propose that they exist to serve the structure, (the rules of the “calculus”) - not the converse.^{XXXVIII}

I propose that the ‘objects’ of these schematic models – specifically as objects *qua objects* - serve to organize process, (i.e. analysis or response). They are not representations of *actual*

²⁶ “Triggering” to use Maturana’s more profound perspective

²⁷ which, I propose in agreement with W.J. Freeman and consistent with the categorical perspective as well, is not organized hierarchically

objects or *actual* entities in reality.^{XXXIX} This, I propose, is why they are taken [utilized] as “things” in the first place.

They functionally bridge reality in a way that physical, (i.e. ontological), objects do not and I suggest that they are, in fact, materialized metaphors of analysis or response. The rationale for using them, (as any good “seminarian”²⁸ would tell you), is clarity, organization and efficiency.^{XL}

As a side issue, remember that axiom systems may embody “space” itself. Hilbert’s original axioms in the “Grundlagen”, (itself only a small part of the beginning of his massive revelation), also deal with “between”, “dimension”, “point”, “motion”, etc –i.e. his conception includes spatiality itself. So I think do the axioms of the brain! Is spatiality then external? Or is it just an extremely useful part of the reactive and pragmatic organization of brain process?²⁹ ^{XLI}

I believe we will never know as I concur with Cassirer that ontology *in its entirety* “is a mere X”. Maturana’s perspective is absolutely relevant here. Briefly Maturana proposes that we do not pass or receive *information* from

²⁸ The intended humor will become apparent in the discussion at the early stages of Chapter 4 –it applies to “the training seminar”.

²⁹ The self-referential aspect of this viewpoint is addressed in my adoption of a modification of Cassirer’s epistemological relativism –again based in invariants– as my third hypothesis.

externality, we are simply “triggered” by that externality to preserve our “Autopoietic entity”, -just as externality in its turn is merely “triggered” by us.³⁰

But isn’t this just the conclusion that we might have expected from our opening discussion regarding a mechanism?³¹

And another.³²

“Even idealism and dualism do not resolve the underlying logical problem however -the *how* of Leibniz’s “expression of the many in the one”, for even then how could *this* part of even a *mental* “substance” know *that* part?^{XLII} These are [precisely and profoundly] logical problems [*per se*] -the problem of the “homunculus” and the problem of the “Cartesian theatre”. Where does there exist even the possibility of a solution?

Implicit definition, virtual existence -and logic as biology³³ - this triad is the *only* example within our intellectual horizons that seems to hold even *any* promise for sentience in this our ordinary sense of it. It suggests the only scientifically

³⁰ See Chapter 6. Maturana 1987.

³¹ I addressed this issue as “the (intentional) axiom of externality” in my MS. (Iglowitz, 1995 and in the current MS in Chapter 6.)

³² Since this is just me quoting me, I don’t think I have to apologize for the length of my citations.

plausible solution to “the mind’s eye” and the “Cartesian theatre” and the only non-eliminativist, (for “mind”), [biological] answer to the homunculus problem.

These are answers which *must* exist if mind in our ordinary sense is, in fact, to be real. Implicit definition, taken operatively, permits knowing as a whole what are, in some real sense, our distinct and separate parts. This is precisely because those parts, (objects), are in fact non-localized and virtual (logical) expressions specifically *of* the whole. It opens the first genuine possibility, therefore, for a resolution of this essential requirement of “naive” consciousness.

But that pathway, (implicit definition), *does not make sense from the standpoint of representation!* For implicit definition solves the problem *logically* -from the standpoint of constitutive logic -and speaks to nothing other than its own internal structure. Repeating myself: “objects”, (under implicit definition), are known *to* a system, (i.e. universally/globally), *only* because they are specifically expressions *of* the system.

It becomes a viable and natural solution to the problem of awareness, therefore, only when the objects of consciousness

³³ See Iglowitz, 1995 and the heading to follow shortly in Chapter 3: “Logic as Biology”.

themselves are conceived operationally and schematically, (and specifically, *logically*³⁴), rather than representatively.³⁵

When our objects are taken specifically as schematic representations of process itself however, (as per my first thesis [Chapter 4 of current MS]), the solution becomes both natural and plausible -the specifically logical problem of sentiency is resolved.³⁶ I assert that no other actual solution, (other than a denial of the problem itself), has ever been suggested. This is the argument from the second to the first hypothesis -and different from the argument from the first to the second presented earlier [in the original MS, Chapter 4 here].

But this conclusion is greatly strengthened by the arguments I will propound in Chapter 4 ...and by the conclusions of several eminent contemporary biologists.^{XLIII}

My biological thesis, *considered biologically*, (i.e. aside from its admittedly profound, but purely epistemological difficulties -which I will make good in Chapters 5 through 10 in

³⁴ and “bio-logically”

³⁵ That the objects of this constitutive logic would further “*represent*”, however, would be a genuine assumption of the miraculous -possible but difficult. See P.S. Churchland: “and then a miracle happened....” [Churchland, 1988] Representative objects are not the right *sort* of mathematical objects to be applicable here. Representative objects are based in reference, denotation and not in connectivity. At the very beginning they resurrect the homunculus.

³⁶ Though not the *substance* problem. That is a separate epistemological and metaphysical issue addressed by my third thesis.

an extrapolation of Cassirer’s “Symbolic Forms”), is exceedingly strong. How could evolution organize *-as it had to organize-* the reactive function of this colossus of seventy trillion cells?

Even this formulation of the question disregards the yet more profound complexity of the reactivity of the individual cells -also organisms- themselves! It was the overwhelmingly crucial issue in the evolution of complex metacellulars. My thesis of schematism is both viable and plausible in this context. But what does this evolutionary development and organization of the reactive process of complex metacellulars have to do with [actual] ‘*information*’ “?³⁷ There is still, again, “nobody home”!

As an aside: I dealt with this “information” problem from the perspective of Humberto Maturana in Chapter 3 of my MS, (Chapter 6 of the current writing). I believe this brilliant, if slightly flawed work^{XLIV} is the modern equivalent of Kant’s “Prolegomena” and is clearly relevant to the problem at hand.

³⁷ “Information” is a subject that must be discussed, obviously. Both the materialists and myself see the function of the brain in the light of optimized efficiency. From their standpoint, this is accomplished by the incorporation of a realistic model of externality within it. From my standpoint this is an impossibility –it goes against the whole grain of the evolutionary perspective. Evolution works by the selection of processes. But the subsequent extension into “information processes” invokes a miracle. How did, and how could it start? Maturana attempted it in his “structural parallelism”, but I find that this aspect of his arguments is faulty. [See Iglowitz, 1995]

Back to the mathematical problem:

Presently I will introduce Shapiro's critique of the structuralist claims. I think it is important because I think it seriously challenges my position and causes me to deepen and clarify it. It will lead me to a discussion of the other main thrust of my conception, starting with Ernst Cassirer's reinterpretation of the deepest problem of all –of the fundamental technical logical "concept" itself. This in turn will lead to a reconsideration of even the fundamental concept of the "class" which grounds modern set theory.

Remember, I asserted previously that our problem here is a profound problem of logical *possibility per se!* This is the ground in which Shapiro's discussion, (and most of mathematics' preconceptions), must necessarily be evaluated.

But first hear Goldblatt:

"Now, since category theory, through the notion of topos, has succeeded in axiomatising set-theory, the outcome is an entirely new *categorical foundation of mathematics!* The category theorists attitude that "function"³⁸ rather than "set membership:

³⁸ "One of the primary perspectives offered by category theory is that the concept of *arrow*, abstracted from that of *function* or *mapping*, may be used instead of the set membership relation as the basic building block for developing

can be seen as the fundamental mathematical concept has been entirely vindicated.”^{XLV} (Do you hear a distant echo of Cassirer’s “mathematical concept of function” here? I think you will when we enter Chapter 3!)

Back to the Sources of Category Theory and Structuralism:

Shapiro Part One

I will cite just one more perspective from mathematical structuralism^{XLVI}, and then go on to present my own solution to the Mind-Brain problem. Shapiro’s perspective on mathematical structuralism exposes what I think is a critical defect in our thinking about mathematics and “reality” generally -and about the mind-brain problem specifically. I think it derives from the presumed foundations of the classical logical “concept” itself.

Shapiro dealt fairly deeply with Hilbert’s original conception of “implicit definition”. But he argued that the issue of consistency/coherence is the more critical. He distinguished

mathematical constructions, and expressing properties of mathematical entities. Instead of defining properties of a collection by reference to its members, i.e. *internal* structure, one can proceed by reference to its *external* relationships, with the other collections. The links between collections are provided by functions, and the axioms for a category derive from the properties of functions under composition.” Goldblatt, Robert, Dover 1984, p.1 Yes, I do see the problem!

strongly between the “young Hilbert” and the “older Hilbert”.
(And, most definitely, *so do I!*)

The former was the father of “implicit definition” who proved consistency only algebraically and relativistically. The latter sought an answer in Formalism with its “finitary arithmetic”, “tokens” and “assertatory statements” and Shapiro seems to have approved.

My own perspective based on fifty years of contemplation in a much broader and very different context is that the young Hilbert was closer to the truth than the older Hilbert. This was the young man who was called “the king of invariants” and I think his breeding showed in his apotheosis as embodied in his concept of “implicit definition”.³⁹

“In this note, I hope to shed a little light on the question, or questions, by relating the present debate to a clash that took place over a hundred years ago, between two intellectual giants, Gottlob Frege and David Hilbert. I propose to focus on the role and function of meta-

³⁹ I think he was later seduced by Cantor’s easier, but highly alluring perspective. “No one will drive us from the paradise which Cantor created for us” [Hilbert]

mathematics⁴⁰, which, I suggest, does not fit smoothly into Hilbert's algebraic perspective at the time.

The problem was directly remedied in the subsequent development of the Hilbert program some decades later, where it is explicit that the proper meta-mathematics is finitary arithmetic. But, the story goes, this resolution was undermined with the incompleteness theorems, thanks to Gödel. So there is some unfinished business in the original debate, at least from Hilbert's side of it.”^{XLVII}

“A crucial aspect of the axiomatization is that the system is what I call ‘free-standing’. Anything at all can play the role of the undefined primitives of points, lines, planes, *etc.*, so long as the axioms are satisfied. Hilbert was not out to capture the essence of a specific chunk of reality, be it space, the forms of intuition, or anything else.

Otto Blumenthal reports that in a discussion in a Berlin train station in 1891, Hilbert said that in a proper

⁴⁰ Please note and remember that it is metamathematics *per se* which is Shapiro's focus throughout this paper. But, as he later states: “For one thing, *the meta-theory is not axiomatized in the Grundlagen*, and so there is no implicit” [or explicit] “definition of the meta-theoretic notions.” I think they originated in Hilbert's native but superb, mathematical and logical perspective, (as the “king of invariants”), and not from his later (Cantorian) perspective. I think his conversion was one of the greatest mistakes in intellectual history.

axiomatization of geometry, ‘one must always be able to say, instead of “points, straight lines, and planes”, “tables, chairs, and beer mugs”.⁴¹ [ibid 64]^{XLVIII}

To further quote Shapiro:

“the early pages of Hilbert [1899] contain phrases like “the axioms of this group define the idea expressed by the word ‘between...’ and “the axioms of this group define the notion of congruence or motion....we think of ...points, straight lines and planes as having certain mutual relations, which we indicate by means of such words as ‘are situated’, ‘between’, ‘parallel’, ‘congruent’, ‘continuous’, etc. The complete and exact description of these relations follows *as a consequence of the axioms of geometry*”. [ibid]

But “*Anything at all* can play the role of the undefined primitives”! He quotes Hilbert:

“... it is surely obvious that every theory is only a scaffolding or schema of concepts together with their necessary relations to one another, and that the basic

⁴¹ This is pretty nearly equivalent to Wilder’s “permissive”. See Wilder 1952

elements can be thought of in any way one likes. If in speaking of my points, I think of some system of things, *e.g.*, the system love, law, chimney-sweep ...and then assume all my axioms as relations between these things, then my propositions, *e.g.*, Pythagoras' theorem, are also valid for these things ... [Any] theory can always be applied to infinitely many systems of basic elements.

One only needs to apply a reversible one-one transformation and lay it down that the axioms shall be correspondingly the same for the transformed things. This circumstance is in fact frequently made use of, *e.g.*, in the principle of duality ... [This] ...can never be a defect in a theory, and it is in any case unavoidable." [Hilbert via Shapiro]

But what precisely *could* the Pythagorean Theorem mean for "beer mugs", "love", "chimney sweeps" for example? These terms are proposed as *co-equal* to "line", "between" ... as *primitive* terms, not as derivational from *other* primitive terms! If we were to translate the question into one of the *positions* of beer mugs for instance, we would only have come back to the very "points", "lines", etc. that we started out with and begged the question, as we would not have done an actual substitution of the basic terms. It would have been a circular argument and a completely trivial conclusion. Hilbert was certainly brighter than that!

In my earlier papers, I had adopted Wilder's interpretation –i.e. in “Consciousness: a Simpler Approach to the Mind-Brain Problem.”^{XLIX} This was a completely workable answer I believe for the purposes of my central thesis, but in Chapter 3 I will explore a different and deeper interpretation of Hilbert's remarks which will broaden our context considerably.

In those earlier papers I had interpreted Hilbert's comments in the most minimal sense -that these “objects” were, using Wilder's terminology, “permissive and presumptive only”, that is, semantically neutral.

These objects, (of its domain -and "existence" terms generally), are assumed *only*, (as Wilder points out) "presumptive(ly)" and "permissive(ly)" however. We are told *nothing* about them in an objective sense.”^L

I began with an interpretation of Hilbert where the “objects” of a system are taken in a purely *impartial* sense.

“... it is surely obvious that every theory is only a scaffolding or schema of concepts together with their necessary relations to one another, and that the basic elements can be thought of in any way one likes. If in

speaking of my points, I think of some system of things, e.g., the system love, law, chimney-sweep ...and then assume all my axioms as relations⁴² between these things”.

Shapiro continues:

“It is hard to be definitive on what his view was, or should have been, but I suggest that the meta-theory—the mathematical theory in which the consistency of an axiomatization is established” [ontologically established – *but where?*] “—is not to be understood algebraically, not as another theory of whatever satisfies its axioms.

Instead, the statement that a given theory, such as Euclidean geometry, is consistent⁴³ *is itself assertory*.

[My emphasis] The notion of consistency is a contentful^{LI}

⁴² But *what kind* of relations? What is the conception of relation itself that Hilbert had in mind?

⁴³ I have no idea whether Euclidean Geometry is indeed consistent. All I know of it is that it works exceedingly well –and that is the most we can demand of an evolutionary artifact. See my illustration: “Bounds and Limits” in Iglowitz, 1995. Relative consistency is all we can demand -but this is the actual meaning of “invariance”!

property of theories^{LII}, and is not to be understood as defined implicitly by the axioms of the meta-theory.

For one thing, *the meta-theory is not axiomatized in the Grundlagen, and so there is no implicit definition of the meta-theoretic notions.*⁴⁴ [my emphasis] This, of course, is not decisive. It would be a routine exercise for a graduate student in mathematical logic to axiomatize the meta-theory of the Grundlagen.

Given the structural analogy between natural numbers and strings, [See footnote⁴⁵], the meta-theory would resemble elementary arithmetic. However, if a Hilbertian algebraist did think of the axiomatized meta-theory as algebraic, then she would have to worry about its

⁴⁴ But why would there have to be? I don't think that Hilbert, at this stage, intended one. I think, in Quine's words, he meant to "kick away the [Fregean] ladder".

⁴⁵ This claim assumes the adequacy of current formal (set-theoretic-based) logic to Hilbert's (then) perspective. I think it is suspect. It is not string representations, but *meanings* –which may differ– which are significant here. Within a rigidly abstractive and hierarchical worldview, these are essentially the same. But within a non-hierarchical conception of the mind and brain, they are most definitely not. See the W.J. Freeman quote to follow (~p.53). It is "Alice down the hole", i.e. the non-parallel distributive mapping and a non-hierarchical meaning for each individual recipient brain, but these can be quite different. This is a wholly new perspective on this mathematical problem.

Or, to quote Edelman: "*certain symbols do not match categories in the world* . . . Individuals understand events and categories in more than one way and sometimes the ways are inconsistent."

consistency. How would we establish that? The ensuing regress is vicious to the epistemological goals of the *Grundlagen*.^{LIII}

It is quite clear that Shapiro and I have *quite different* ideas of the meaning and the goals of “epistemology! As a brief excerpt from the footnote immediately above: “Or, to quote Edelman: “*certain symbols do not match categories in the world* . . . Individuals understand events and categories in more than one way and sometimes the ways are inconsistent.”

“In the later Hilbert program (e.g., [1925]) relative consistency gives way to absolute consistency. There, the meta-theory is finitary proof theory, focused directly on formal languages themselves. It is explicit that finitary proof theory is not just the study of another structure, on a par with geometry and real analysis.

Finitary proof theory has its own unique subject matter, related to natural numbers and formal syntax, and it is ultimately founded on something in the neighborhood of Kantian intuition. [The older] Hilbert said that finitary

proof theory is contentful. In present terms, the theorems of finitary proof theory are *assertory*,^{LIV} not algebraic.”^{LV}

I think that Shapiro falls into the trap of his own philosophical prejudices in failing to understand and accept the *thoroughgoing* relativism of Hilbert’s original idea. In Quine’s words, “we must kick away the ladder” in order to appreciate the full brilliance of Hilbert’s insight. “Relative proofs only”? How could they be anything but?⁴⁶ I think the young Hilbert understood that, but lost his insight in his new passion.

“Hilbert’s claim that a concept can be fixed only by its relations to other concepts is a standard motivation for structuralism.” [ibid]

Shapiro now exhibits a viewpoint, (fundamental for him), which I will oppose through the rest of this book!

“Nowadays we have a rough and ready distinction which we can apply here. The algebraist says that a group is anything that satisfies the axioms of group theory; a ring is anything that satisfies the ring axioms, *etc.*” [but]

“*there is no such thing as ‘the group’ or ‘the ring’*”.^{LVI}

“Hilbert says”, [Shapiro says –but *which Hilbert?* *Young*

⁴⁶ To tie in with the early pages of the present book, how could a mechanism, (brain), ever know –i.e. assert absolute truth to features of its environment. This is the “assertatory” that Shapiro demands!

or Old?], “the same thing *about* geometry, and, by extension, arithmetic, real analysis, and so forth.”

If “the concept” –and “the class” below and within it- is truly all about extensionality, then I think Shapiro stands on solid ground. If it is about something more, (as Cassirer’s ideas, and my own thesis of the “schematic object” will suggest), then I think his ground becomes far less secure.

Chapter 3: Adventures of the Mind: A Critical Turning Point and the Origins of my Conception

At this point I feel I must interpose another necessary but somewhat lengthy tangential discussion of fundamentals so that you may have some understanding of my very different and unique beginnings from which I approached these problems.

Hopefully it will help you to better understand my conclusions. Then I will return to and try to answer Shapiro's objections, (and even Mac Lane's similar ones to which I will come presently).¹ Since I have structured this paper on my own intellectual history, let me continue to do so here as well. I think it is the most efficient way to pursue this new logical perspective on the problem.

I said very early in this paper that even before my exposure to Hilbert's "implicit definition", I had encountered Ernst Cassirer's radical reformulation of the very *definition* of the "concept" of logic itself.¹ It was through this filter that I interpreted the mathematics and modern algebra, (which I saw as an extension and fulfillment of the profound possibilities of

Cassirer's notion of ordering *within* concepts² and which we will come to very soon) -and through which I interpreted Hilbert's conception of "implicit definition" that I was exposed to shortly thereafter as well.

Cassirer and Logic:

"... Every attempt to transform logic must concentrate above all upon this one point: all criticism of formal logic is comprised in criticism of the general doctrine of the construction of concepts."^{II} (Ernst Cassirer)^{III}

When I went as a beginning freshman to the University of Chicago, I rode the train from the north side of the city of Chicago -about an hour's commute in all. In the very beginning, I visited the campus bookstore, and acquired a copy of Cassirer's doubly bound volume: "Substance and Function" and "Einstein's Theory of Relativity".

¹ This reformulation of the logical "concept" by Cassirer's is different and distinct from his "Theory of Symbolic Forms", another powerful insight which I will go into presently.

² I conceived mathematics then as the study of Concepts, not of Classes, (of objects), nor of Sets, (of objects) -I think this is a relevant and defensible perspective in light of the discussion to follow. It enables, for instance, the concept of "*the* (general) class" -or the concept of a particular class. Also, obviously, it enables the concept of "*the* (general) 'set'" and the concept of a particular 'set' as a subspecies! I think, shortly, that this will become clearly relevant to the Shapiro discussion begun above.

I won't say I read it all at that point, but I started at the beginning while on my daily commute and discovered Cassirer's radical re-assessment of the very *meaning* of the word "concept" as used in logic, (and in everyday thought as well), in the opening chapter. It shaped my understanding of everything that followed.

He reinterpreted the formal logical "concept" quite differently from the classical Aristotelian understanding of the idea. He did not interpret it hierarchically –by the abstraction and inclusion of properties of objects, but reformulated it instead as "the mathematical concept of function".^{IV}

Please forgive the longish quotes, but please try to follow his argument. It was my actual starting point and understanding it is crucial to your understanding my ultimate perspective. I think, in conjunction with just a few other steps, it lays the groundwork required for a scientific understanding of Consciousness itself!

He characterized the traditional, Aristotelian concept this way:

"A series of presentations", ["things" with characteristics=properties], "with characteristics: (a,b,c,d), (a,c,d), (a,c,e), for instance, is held to bring forth the

classical concept: {a,c}.³ From *mere abstraction*, (via attention), the whole of the doctrine of the classical Concept follows from these simplistic origins.”⁴ It is a concept based on and fully resolved in the extensionality of its properties. It is a concept based on the properties of real things, i.e. of “objects”.

Under that classical Concept it follows that "every series of comparable objects has an ultimate generic concept, which comprehends within itself all the determinations in which these objects agree, while on the other hand, within this supreme genus, the sub-species at various levels are defined by properties belonging only to a part of the elements."^v

The end result of this process is horrific to normal thought however. Hear him carefully!

“But the successive broadening of a concept necessarily correlates to a progressive lessening of its *content*; so that finally, the most general concepts we can reach no longer

³ The specific order within a class is not relevant, of course.

⁴ But are not the quantifiers of more modern logic an exception? “Set membership” $\rightarrow f(a,b)$, (a rule), but membership here is not *primitively* defined by *abstraction* as it is in the Aristotelian concept; it is defined by a rule instead. What is $\{x: x \text{ memb } s\}$ where “s” defines a rule? Where does the rule come from? It certainly does not come from abstraction. See later Lakoff and Cassirer references on “cue validity”.

possess any definite content.", [*at all!*]. The ultimate genus -"something"- is totally (and logically) devoid of specific content!

The Concept in this classical form, however, is clearly not adequate or consistent with scientific, or even with *ordinary* usage however:

"When we form the concept of *metal* by connecting gold, silver, copper and lead, we cannot indeed ascribe to the abstract object that comes into being the particular color of gold, or the particular luster of silver, or the weight of copper, or the density of lead; however, *it would be no less inadmissible* if we simply attempted to *deny* all these particular determinations of it."

It would not be sufficient to characterize "metal", for instance, "that it is neither red nor yellow, neither of this or that specific weight, neither of this or that hardness or resisting power"; but we have to add that "it is colored in *some* way in every case, that it is of *some* degree of hardness, density and luster." Similarly, we could not maintain the general concept of "animal", "if we abandoned in it all thought of the aspects of procreation, of movement and of respiration, *because there is no form of procreation, of breathing, etc., which can be pointed out as common to all animals.*" (My emphasis)

These few paragraphs sum up what I considered, and still do consider to be *Mirabile dictu*, (i.e. I don't think it could be

said better or more convincingly). I think it exposes the critical flaw at the ultimate foundations of logic. I believe his reformulation of that concept is more appropriate to both ordinary and to formal logical thought than is the classical concept.

Cassirer's new "Concept"^{VI} was reformulated instead as a *functional* rule, a complex rule of series but that rule *per se*, he concluded, was necessarily generated *internally* to the mind, (/brain), and not from the percepts themselves ! That is to say: it is *not* primitively defined (specifically as a rule) *in the presentation* itself.⁵ It comes from elsewhere! It is not, he argued moreover, abstractive.

⁵ There is an uncanny parallelism of argument throughout between Lakoff's and Cassirer's treatment of logic. Consider, as an example, the following: "Category cue validity defined for such psychological (or interactional) attributes might *correlate*", (his emphasis), "with basic-level categorization, but it would not *pick out* basic-level categories; *they would already have to have been picked out* in order to apply the definition of category cue validity so that there was such a correlation." (Lakoff: P.54, my emphasis) This is almost an exact parallel to one aspect of Cassirer's argument against the classical concept, and the "theory of attention", (see Chapters 2 and 5), –and for a "new form of consciousness". Discussing Erdman, Cassirer writes: "...instead of the community of 'marks,' the unification of elements in a concept is decided by their 'connection by implication.' And this criterion, here only introduced by way of supplement and as a secondary aspect, proves on closer analysis to be the real logical *prius*", (his emphasis), "for we have already seen that 'abstraction' remains aimless and unmeaning if it does not consider the elements from which it takes the concept to be *from the first* arranged and connected by a certain relation." Cassirer, "Substance and Function", p.24

He characterized his reformulated Concept as “a new form of consciousness” as I will discuss presently. He proposed instead an alternative and considerably more plausible basis for a *different* technical logical Concept -borrowed from mathematics. He called it "the *Functional* Concept of Mathematics":

"Lambert pointed out that it was the exclusive merit of mathematical 'general concepts' not to cancel the determinations of the special cases, but in all strictness fully to retain them. When a mathematician makes his formula more general, this means not only that he is *to retain* all the more special cases, but also be able *to deduce* them from the universal formula."

But this possibility of deduction does not exist in the case of the scholastic, (Aristotelian), Concepts, "since these, according to the traditional formula, are formed by *neglecting* the particular, and hence the reproduction of the particular moments of the concept seems excluded."

"The ideal of a *scientific* concept here appears in opposition to the schematic^{VII} general presentation which is expressed by a mere *word*. The genuine concept does not disregard the peculiarities and particularities, which it holds under it, but seeks to show the *necessity* of the occurrence and connection of just these particularities. What it gives is a universal *rule* for the connection of the particulars themselves.... Fixed properties are replaced by

universal rules that permit us to survey a total series of possible determinations at a single glance."

Of critical importance is the fact that Cassirer's new formal Concept *is no longer logically derivable from its extension*, (its membership), however:

"The meaning of the *law* that connects the individual members is not to be exhausted by the enumeration of any number of instances of the law; for such enumeration lacks the generating *principle* that enables us to connect the individual members into a functional whole."

"If we know the relation according to which a b c . . . are ordered, we can deduce them by reflection and isolate them as objects of thought. "It is *impossible*, on the other hand, to discover the special character of the connecting relation from the mere juxtaposition of a,b,c *in presentation*."

And again:

"That which binds the elements of the series a,b,c, ... together is not itself a new element that was factually blended with them, *but it is the rule of progression*, which remains the same, no matter in which member it is represented. The function $F(a,b)$, $F(b,c)$, ..., which determines the sort of dependence between the successive members, *is obviously not to be pointed out as itself a*

member of the series, which exists and develops according to it." ⁶ (My emphasis) See footnote.

This is the *definitive* argument against "abstraction" as the *general* case and against "presentation", ["things"], as an ultimate foundation for logic. ^{VIII}

He continued:

"We do not go therefore from a series: $a\text{-}\alpha_1\text{-}\beta_1$, $a\text{-}\alpha_2\text{-}\beta_2$, $a\text{-}\alpha_3\text{-}\beta_3$... directly to their common element a , (Cassirer argues), but replace the alphas *by a variable* x , and the betas *by a variable* y . Therein we unify the totality in the expression 'a-x-y' ", (actually $w\text{-}x\text{-}y$, where "w" is the constant function $w(p) = a$, for all "p" of the "generic concept"). This expression can be changed into the "concrete totality" of the members of the series by a continuous transformation, and therefore "perfectly represents the structure and logical divisions of the concept"! ^{IX}

⁶ cf. Stewart, 1995, "Fibonacci Forgeries". Stewart's article illustrates the case. The "insufficiency of small numbers" leads to an indeterminability of any finite series.

Cassirer's "series" may be ordered by *radically variant* principles however: "according to equality", (which is the special case of the "generic concept"), "or inequality, number and magnitude, spatial and temporal relations, or causal dependence"^X -so long as the principle is definite and consistent.

But where does this principle, *this rule*, come from? Any finite series of presentations, *no matter how long*, is not definitive to establish a general case.^{XI} I could, for instance expand the series 1,3,5, ... to the googleplexth element, (GP,- i.e. 10 to the 100th power), and then insert any arbitrary series behind it. 1,3,5,7,E_{GP-1}, E_{GP}, 99, 47, 20075, The rule itself is never inherent in the *presentation* of the series. To a mathematician moreover, any finite number is pretty much as relatively small as any other –that is what it means to say that it is *finite!*

Googleplex is not significantly different in its fundamental nature from “34”, for instance –i.e. they are both finite, each could be raised to the GPth power, and for each and every such resultant, it could itself be treated likewise ad infinitum! If rules *per se* are not inherent in *presentation*, then, where do they come from? I will propose that they come from the billions of years of biological self-organization which is itself based in pragmatism –i.e. in an optimization of the functioning of its neural primitives, and, of course, in their subsequent survival!

Cassirer continues: “The distinction between the concept and its extension, therefore, *is categorical* and belongs to the 'form of consciousness'". It is "a new expression of the

characteristic contrast *between the member of the series and the form of the series*".^{XII} But the rule itself is now internal to the mind(/brain) itself! It is "a new form of consciousness"!^{XIII}

Thus he fundamentally reconceived the formal Concept, *this our ultimate logical building block*, as "the "Functional Concept of Mathematics". It is the *functional* rule, $F(x,y,z, \dots)$, which organizes and embodies the totality of its extension.

For Cassirer the association of the members of a series by the possession of a common "property" is only a *special case* of logically possible connections in general, but it is the *sole* possibility allowed by abstraction alone. I believe it encompasses what I will term "Diophantine logic" which I believe constitutes the essence and the focus of contemporary logic.^{XIV} But the connection of the members "*is in every case* produced by some general law of arrangement through which a thorough-going rule of succession is established." This is the general and comprehensive case. He argued that it is "a new form of consciousness".

He posited it –*his* "Concept"- at the very bottom of our mental world. I saw, I understood, and I agreed. This was my starting point.⁷

⁷ (Note: this is a very truncated version of my earlier analysis of Cassirer's ideas. There is a much fuller analysis of Cassirer's conception which I have

Cassirer’s “concept” was so natural and so real that it affected my thinking forever after. I believe his Concept is the “concept” we actually use in our thinking. It still sits at the bottom of my understanding and it colored my understanding of the mathematics which followed it.

My next mark was my beginning calculus course. I was very fortunate in that I was exposed, (even at that level), to three very famous mathematicians: Saunders MacLane, (cited earlier), Paul Halmos, and lastly, but most importantly for me, to Isaac Wirczup who was my primary instructor. I was concurrently and exhaustively reading three texts on the calculus. I spent a minimal of six to eight hours a night on calculus alone -but *trying to understand it within Cassirer’s conceptual framework* –my other classes were essentially neglected. It was so beautiful that I changed my major to mathematics. I was in love!

Wirczup was a kind and marvelous teacher who taught me rigor. But most of all, (from my current perspective), he was important to me because I think he was a “closet intuitionist”. He defined the word “infinity” for me strictly in terms of the delta / epsilon relation, (the precisely defined relations of limits), and

presented in Chapter 5. I think it is important for a better understanding of his ideas, and of my subsequent expansion of them, but I also thought it would have interrupted the flow of my argument here.)

not in terms of “size” or “magnitude”. It made great sense to me, I think, because of my newly acquired Cassirerian perspective.

For Wirczup, (at least as I understood him), “infinity” meant simply and solely that we could not bound the epsilon, no matter how small the delta –and that was the totality of the *meaning* of the word “Infinity”! Any sentence using the word “infinity” became a statement purely and strictly about the relationships between limits, (defined logically, relationally and conceptually); it was not a statement about objects or sizes!

I was able to interpret the whole of the Calculus I encountered at that level from my newfound Cassirerian/Wirzcupian perspective and it made total sense to me in those conceptual terms⁸ -whether that was ultimately to be the correct perspective or not. During the following summer, I finished Mac Clane’s “Modern Algebra” by myself.^{XV} I saw the latter with the help of my prior acquaintance with Wilder’s characterization of the objects of axiom systems as “presumptive and permissive” only^{XVI}. That is, I saw it in purely conceptual terms.

I saw MacClane’s book specifically and solely as a comprehensive exploration of all the possible forms of abstract

⁸ Thinking it over, I guess I always saw mathematics in terms of concepts rather than in terms of sets –see later.

mathematical ordering, (in Cassirer's sense of the ordering of the concept discussed earlier), and that was certainly consistent with the perspective of modern structuralism which I discovered (*by name*) only recently.

For me, Mac Lane's book had nothing to do with actual objects at all⁹ –it had to do with the possibilities of “ordering” specifically. It had to do with the possibilities of ordering, (taken in Cassirer's sense), *within a concept itself*.

Benacerraf's characterization of structuralist mathematical objects as “positions in a structure”, (cited earlier), is certainly corroborative to such an interpretation.

Mac Lane's book also exposed me for the first time to Cantor's famous proof showing the indenumerability of the reals: i.e. that the real numbers cannot be set in one-to one correspondence with the natural numbers -or even to the rational numbers for that matter. Cantor's proof was obviously profound, (and ingenious), but the specific conclusion that he drew from it was not acceptable from my (Wirzupian?) perspective –and led to another critical revelation which is absolutely pertinent to my

⁹ This latter perspective seems to be the only way that the subject could be approached via the classical, generic concept. Upon reflection, this seems to be the cusp of our difference and seems to refer directly to Shapiro's and MacClane's demand for the non-existence of “the group”, etc. mentioned earlier.

ultimate perspective on the problem of the mind/brain whose examination we, together, have undertaken to understand here..

I conceived a fundamental objection at that point in time to Cantor's "diagonal proof" which had argued against the commensurability of the rational numbers and the reals wherein he purported to show that the reals are of a *larger order* of infinity, (size), than the rationals.

My interpretation was based specifically in my prior conception of Modern Algebra as being fundamentally about "ordering" within concepts –from what would now be called a structuralist perspective. Even though it was the objection of a very young man, I think it has held up well over time.

On Cantor's Diagonal Argument –written 50 years ago!

(Copied pretty much verbatim from my notes 50 years ago –this is just me quoting my own very old writing)

“The uncountability of the real numbers would not seem to be derived from ‘size’ or ‘magnitude’ discrepancies between the rationals / integers –and the reals, but rather, would seem to boil down to a fundamental question of *order* – i.e. of the impossibility, (even in theory), of setting up a procedure, a continuing intellectual (ordering) procedure which would present each and every real number. They cannot all be presented serially, (even in theory), in spite of the fact that we can (in theory) present in a serial list *any* given real, and any *list* of reals.

Cantor's proof displays a (specific but variable) real number (via his diagonal/slash procedure), appropriate to any serial list, (and continuing intellectual procedure) which is not, and cannot be contained in that list. Its construction is derived from the specific serial nature of the particular list itself. It is also, of course, related to the serial (decimal) presentation of any given real number itself.

Consider this *alternative* visualization: (I will claim exactly the same kind of freedoms that Cantor was allowed in his diagonal proof here.) It seems I could set up a serial presentation of all reals in this manner: set up a hypothetical line segment of unit length one, (which, of course, is fully sufficient as this segment can be shown to be in one to one correspondence with the whole real line).¹⁰

Select a hypothetical dart with a zero magnitude point, (equivalent in principal to Cantor's hypothetical ability to write out the whole of a real as an infinite decimal –i.e. exactly, precisely). Throw the dart at the line, (axiom of choice?), and the point hit is then r_1 . Continue throwing the dart for r_2 , r_3 , etc. If the dart hits a previously speared point, throw again for that

¹⁰ Simply consider the semi-circle based at the origin whose length equals 1, and then radiate the lines from the origin through the semi-circle to some horizontal line. This yields the necessary correspondence.

member of the list. No point is privileged or exempt *a priori!* If I were infinitely lucky –which is *theoretically* possible, (but infinitely improbable), it seems that I might derive such a list in an infinite time. (Cantor gave himself an equivalent time in the writing of his list!)

Certainly, though, this shows that the difficulty is not as usually thought and that such a sequence would be possible except, I believe, for one *fundamental* reason, not to do with ‘size’ or ‘magnitude’.

Rather, I believe it derives from the inherent *impossibility* of setting up such a procedure in the first place. Here, -of setting up an intellectual procedure which will assure that *every* point on the line would *definitely* be accounted for –even assuming infinite luck and time, (because the *number of the throw* is always an integer value and submits itself to the diagonal/slash procedure.)¹¹ Thus, the difficulty would seem to derive from fundamental differences *in structure* of the reals and the integers/rationals –i.e. of the real and the rational fields.

You could not predetermine the placing or even if there actually exists a definite placing –given a particular real in the line –and this seems to be inherently so. This is contrary to the situation of the rationals, (wherein a denumerable correspondence

is easily demonstrable using the “zig-zag technique”¹²), and, I think, is the essence of the difference.

A reiteration of my later reflections on Cantor’s argument

(A much more recent return to the subject):

“Infinite sets are unique in that it is possible that they *can* be put into 1 to 1 correspondence with (some) subsets of themselves. (This is not to say that some given subset may *not* qualify –e.g. the classic case of the rationals inside of the reals with which we are concerned here –or to the trivial subset {1,2,5,11,3}.) We may even leave out huge – *even infinite subsets*. (e.g.: 1->2, 2->4, 3->6, ... -all the odd integers are left out of the second set of integers), but each of these sets is still infinite! “Largeness” is not the issue.

¹¹ i.e. You can’t *sequence* the correspondence between the two manifolds!

¹² Lay out the integers in two dimensions a and b, then consider the intersections as the ratio of a / b. Come back and start at the origin 1/1, (which is the first element of the sequence), traverse in one of the two dimensions to the second element, then traverse the diagonal, then sideways or down, repeat the diagonal, etc. This gives a unique ordering to the rationals and a one to one correspondence with the integers.

Consider Cantor's definition: Two infinite sets "are of equivalent size" precisely if and only if they *can* be put into 1 to 1 correspondence with each other.

(Within the reals themselves this would correspond, for instance, to the possibility of the 1 to 1 correspondence between the unit interval into the whole of the real line. O.K. so far- but suppose they *cannot* be, (*rejecting* the "precisely" in the definition). Suppose we are not talking about "size".

Now consider Cantor's 'diagonal slash' argument. Suppose this reveals the fact that the rationals and the reals cannot be put into 1 to 1 correspondence *not* because they are of different *sizes*, but because the reals cannot be *ordered* like the rationals.

Suppose this is an argument about *possible ordering* rather than about *size*, - *i.e. that the reals are incapable of a natural ordering!* ("Ordering" had become a big word to me by that time as it became the focus of my orientation of modern algebra which I saw as the progressive development of all the possible orderings of ideal and abstract mathematical objects.)

It is certainly amazing that the whole of the rationals –and not just the integers- can be ordered countably as is clearly known and easily demonstrable, but it is an amazing fact nonetheless! But consider: between any two rationals there exists another rational. Between any two rationals there exists a real. But *between any two reals –no matter how close- there exists a rational as well!*

Consider the open interval from x to $x + \Delta$, (Δ ¹³), for any non-rational real x , and consider the limit in that interval as Δ , (Δ), approaches 0 of the truth value of the statement: “There exists a rational number in the interval.” The limit is the *constant*: “true”! It is not viable *at* the limit however, i.e. it is discontinuous, approaching from either side of x .

Are we talking then about “size” or about something else? If this is, in fact, not a discussion of “size”, then there need exist only *one* “infinity” – one unbounded “quantity”-reflecting a statement about the Δ/ϵ relationship; it is not a statement about magnitude! But then ordering and structure become the crucial issues!

Nowhere does Cantor’s diagonal argument have anything at all to do with “size” *per se* save in his conclusion. *Everywhere* it does have to do with order and ordering –even in his specification of the problem itself. So why take the dubious, more complicated conclusion over the leaner and clearly justifiable one? Why not invoke Occam’s razor right here? Why not recharacterize Cantor’s argument specifically as an argument against imposing a natural ordering on the reals and stop right there?

¹³ Delta spelled out for mp3 conversion

That two *finite* sets are equal “in size” just in case they may be (“may be” = “can be”) put in one to one correspondence with each other is clearly justifiable. But to make the *same* assertion for infinite sets does not seem to be anywhere near as plausible.

It is trivial, (and definitional) that any infinite set may be set in one to one correspondence with some, (but not *any arbitrary*), proper subset of itself, (by definition). Are they then of “the same size”? Under Cantor’s definition, of course, they are because of the correspondence. And yet the original set contains elements, (perhaps even an infinite “number” of elements), not in its proper subset.

It seems to be an equivocal assertion, then, to assert the converse -that just because two (infinite) sets *cannot* be set in one to one correspondence that they are therefore of “*different sizes*”. The simpler, (leaner –invoking Occam’s Razor), though more abstract conclusion would seem to be the better one: simply to assert the raw result itself: i.e. that *they cannot be set in one to one correspondence!*

This directly converts my claim about the possibility of imposing an order. It seems to me that Cantor’s proof is a profound revelation about “ordering” and about “correspondences”, not about size. It elucidates the impossibility of a natural ordering of the reals. (But whence then his transfinite sets? Where have the “alephs” gone? DNE? ^{XVII})

A Powerful Argument for the Structuralist Perspective

Consider this: Cantor could not fulfill even the very first natural and anticipated step after his initial conclusion –i.e. the proof, (or disproof), of the Continuum Hypothesis¹⁴! Indeed Gödel proved it is impossible within the standard axiomatizations of set theory. And yet it is accomplished *merely in the addition of a single axiom* to the axioms of the rationals: i.e. the “Least Upper Bound” axiom!

This is a very powerful argument for “ordering” vs. “size” in our conception of numbers¹⁵ and for the actual root of that ordering as being in the logical connectivity, (the structure), of the very axioms themselves, (think “nerve connectivity”), rather than in the “objects” of the system. I think it is a powerful argument specifically for the structuralist perspective itself and one of the reasons I became enmeshed in my own version of it 50 years ago! I had figured it out for myself.

You see, I think the young Hilbert¹⁶ had it right in the first place. The “properties”, the *ordering* of his “things” comes *from the whole of the axiom system* (itself), not from just a part.

¹⁴ i.e. that the Reals are the “next larger size” beyond the Rationals!

¹⁵ Or of *any other* abstract mathematical object

¹⁶ Contrary to his “older brother” who was seduced by Cantor and lost his virginity thereby!

Without the Least Upper Bound Axiom or its equivalent, we cannot attain the Real Continuum, though we may attain the Rationals. To reiterate Schlick's comments:

These elements "acquire meaning only by virtue of the axiom system, and possess only the content that it bestows upon them. They stand for entities *whose whole being* is to be bearers of the relations laid down by the system." This is not about size, this is about ordering, about structure, about the connectivity of the axioms themselves!

My Conclusion:

"Ordering", I concluded, is a function of all the *axioms* of an abstract axiom system – of the complex rather than the simplistic logical connectivity of the axioms themselves; it is about the connectivity of *meaning!* There may be "a natural analogy between natural numbers and strings", (requoting Shapiro), but there is no natural analogy between natural numbers and meanings! (Edelman's quote is worth repeating here: "certain symbols do not match categories in the world ... Individuals understand events and categories in more than one way and sometimes the ways are inconsistent! ")

Ordering is not a function of the properties of its "objects" which are specifically *virtual* reflections of its underlying structure. "Ordering" is not a function of these "positions in a

structure, it is not a function of these solely “permissive” and “presumptive” virtual “objects” from which it supposedly “arises”!

The “rule” of the continuum, (in the sense of Cassirer’s usage of the “rule” of a concept), here lies in the logical interplay of the meanings, the mechanics and the connectivity of the axioms themselves. It is a conceptual, (in Cassirer’s sense), rather than a reductive set-theoretical one. It refers instead to its own axiomatic structure in Benacerraf’s sense which generates its objects as (virtual) “positions in that structure”

(On the level of biology, its components may be understood analogously to the intentional functions in the sense of figure 3 early in the first chapter,. These are strategic rather than informational functions. But then again, what *else* could we demand from a “machine”?) ¹⁷

This is a new conception of “order” itself! (This perspective will find validation in both Quine’s remarks and in the structuralist perspective of the very concept of “class” itself!)

¹⁷ Consider W.J.Freeman: “The only knowledge that the rabbit could have of the world outside itself was what it had made in its own brain!” (W.J Freeman, 1995)

To quote a prior paper of mine: “the ‘objects’ of these schematic models, I propose, are manifestations of the structure; the structure is *not* a resolution of the objects.”¹⁸

To give a bit more credence –and to dissuade you from the tempting conclusion that the foregoing was just an instance of the arrogance and ignorance of youth, let me insert a couple of citations from some famous contemporaries of Cantor, (I discovered these citations much later). They argue the same case I made!

Poincaré, a famous contemporary of Hilbert and certainly Hilbert’s equivalent as one of history’s most significant mathematicians said:

"Actual infinity does not exist. What we call infinite is only the endless possibility of creating new objects no matter how many exist already"

Poincaré again: “set theory is a disease from which I hope future generations will recover.”

¹⁸ See Chapter 4 where that argument is presented.

Hermann Weyl, another famous name:

"...classical logic" [itself!] "was abstracted from the mathematics of finite sets and their subsets...Forgetful of this limited origin, one afterwards mistook that logic for something above and prior to all mathematics, and finally applied it, without justification, to the mathematics of infinite sets. This is the Fall and original sin of [Cantor's] set theory ...".

And a more current quote: (William P. Thurston):

"Set theory is based on polite lies, things we agree on even though we know they're not true. In some ways, the foundations of mathematics has an air of unreality."

Morris Kline:

"[The pure mathematicians] have followed a gleam that has led them out of this world...the work of the idealist who ignores reality will not survive."

Cantor's set theory, it is true, has come to lie at the core of contemporary mathematics –largely, I think, because of its easier conceptualization and fruitfulness, but it probably will not remain so.

To repeat Thurston, it is based on things we agree on even though we know they're not true. Consider just the Banach/Tarski theorem embedded in this perspective, for instance. If one were *really smart*, it would be possible to

dissect the moon to fit it into one's pocket! Think about that!
Does this correspond in *any* sense to our reality?

For science generally, progress goes in “fads”, (not to be taken in a mean sense). Calculus was the predominant (and most successful), mathematical fad from Newton till about 1900 when it was determined to be not rigorous enough.

It was regrounded in set theory which was able to supply that logical rigor. The problem, I feel, is that it supplied too much, both for mathematics and for logic –leading to the stalemate and the paradoxes that mathematics finds itself in currently. There is a new “fad”, mathematical structuralism and category theory, which is taking mathematics back to function over set membership.

“One of the primary perspectives offered by category theory is that the concept of *arrow*, abstracted from that of *function* or *mapping*, may be used instead of the set membership relation as the basic building block for developing mathematical constructions, and expressing properties of mathematical entities. ^{XVIII}

(Now can you hear the distant echo of Cassirer I foreshadowed in Chapter 2?)

The Concept of Implicit Definition¹⁹

When I was exposed to Hilbert's "implicit definition"²⁰, either at this point or in Cassirer's "Einstein's Theory of Relativity"^{XIX}, I had a final and completing insight –I hope you will find it relevant.

If mathematics was fundamentally all about ordering as I had concluded that it was, (and if the root of that ordering resided in the infrastructure of the axioms themselves rather than as a consequence of the (permissive) "objects" they generated), then the profound plethora and the richness –and the depth- of such orderings already extant in mathematical axiomatic systems conversely suggested a radical extension of Cassirer's rule-based "Functional Concept of Mathematics". It suggested an expansion to a new and larger notion and rule of "concept". It suggested the expansion to what I have called "the concept of implicit definition", (C.I.D.).

This latter is based at the deepest level in the axioms themselves and represents what I believe to be the broadest

¹⁹ See Chapters 2 and 5 for an earlier presentation of this idea.

²⁰ Let me repeat the quote from Schlick, (cited in Cassirer): "[Hilbert's] revolution lay in the stipulation that the basic or primitive concepts are to be defined *just by the fact that they satisfy the axioms...* [They] *acquire meaning* only by virtue of the axiom system, *and possess only the content* that it bestows upon them. They stand for entities *whose whole being* is to be bearers of the relations laid down by the system."

possibility of the formal logical Concept. Cassirer's "functional concept" is based in a set of denumerable and essentially dimensional functional rules²¹ –in rules of series. But axiom systems, as systems per se, have rules too –more complex, more profound constitutive rules of ordering deriving from their profound structural connectivity as just discussed in my conclusions regarding Cantor's argument.

They have comprehensive overall *unary* rules, (of the whole of the system of axioms itself –see Hilbert's comments earlier –"*since only the whole structure of axioms yields a complete definition.*" – and my just finished discussion above),

The logical infrastructure of such axiom systems is not, in fact, itself dimensional, (in Cassirer's sense -about properties of percepts or objects – $f(x,y,z)$) -but profoundly and interconnectedly *logical* instead to the structure of the axioms in the system itself.²² This is the import of my Cantor argument expressed above, and how I originally conceived the notion.

The "rule" of the continuum, (in the sense of Cassirer's usage of the "rule" of a concept), here lies in the logical interplay, the mechanics of the axioms themselves. It is a new conception of "order" itself!

²¹ i.e. $f(a,x,y,\dots)$

²² which is the way I interpreted the Cantor diagonal proof

I propose to interpret logic in the same manner that I think the “young Hilbert” intuitively did, and to which I have referred before. I propose to interpret it within the context of “the concept of implicit definition”!

This “Concept of Implicit Definition” suggested an extension of Cassirer’s “functional concept of mathematics” into a conceptual rule, (an ordering) grounded in the unary rule²³ of an overall axiom system.²⁴ I ultimately related this, under Hilbert’s “implicit definition”, (and Cassirer’s “new form of consciousness” perspective -to which I assert it is a legitimate heir), to a constitutive and specifically operative ordering totally internal to the brain.

This new form of consciousness could specifically reflect the structure and the operability of that brain –its own rules and connectedness^{XX}, its “triggering” to use Maturana’s more pregnant conceptualization,^{XXI} as well as its (virtual) objects.

But within such a system the elements, (the perceptual “objects” themselves –as well as the conceptual “objects”), could be “implicitly defined” after Hilbert’s conception. This, then,

²³ Recall Hilbert’s remarks that it is the *whole* of the axiom system which defines its objects!

was how I was able to conceive even our “percepts” themselves as internal to such a model. I conceived them solely as “positions in a structure”, as specifically *virtual* objects!

I conceived them as purely conceptual objects, implicitly defined by the “axioms” which embody the physical operability of the brain.^{XXII} I conceived “percepts” themselves as *metaphors* of the brain’s own process! I conceived them as virtual and operational objects! (See Chapter 4)

But How can we conceive of purely operational objects as correlating with the real world?

But how can we possibly conceive the objects of our ordinary but very concrete naïve world as solely operational objects? Certainly, if you call yourself a materialist, you must admit that “percepts” do not actually, (physically), exist as they seem; science *already* sees them quite differently. Do we perceive mathematical magnitudes, (wavelengths), of light waves or "colors"? Do we perceive molecular density or "hardness"? Do we perceive mean molecular energy or "heat"?

Consider moreover the best of our current physical theories. Consider the parallel between Penrose’s comments on

²⁴ I ultimately identified “mind” with the operative, unary rule of the brain –i.e.

the Schroedinger equation and the functioning I propose between the re-afferent brain and action into the world.

Repeating an earlier section of this paper, quite pertinent here,²⁵ consider the parallel between the *most* SUPERB¹, (according to Roger Penrose- his CAPS), of modern physical theories, and my own conclusions:

"There is a very precise equation, the *Schroedinger equation*, which provides a completely deterministic time-evolution for this [quantum] state. But there is something very odd about the relation between the time-evolved quantum state and the actual behavior of the physical world that is observed to take place.

From time to time -whenever we consider that a 'measurement' has occurred -we must discard the quantum state that we have been laboriously evolving, and use it only to compute various probabilities that the state will 'jump' to one or another of a set of *new* possible states." (ibid, P.226, his emphases)

with its overall rule of "structural coupling". See Maturana in Chapter 6.

²⁵ I will come back to this passage again later. I think it is highly pertinent and a strong argument for my conceptions.

In this “more optimistic” view, it is only "*in relation to the results of 'measurements'*" that concrete reality emerges -i.e. that a specific rendition of space-time is enabled.

Now compare this to the re-afferent model I have already sketched and which I will formally present in the Freeman Appendix of Chapter 4, (alternatively my Figure 3 of Chapter 1 is a reasonable referent). wherein it finds a striking parallel. Each evolves a “state” equation and then performs a “measurement”, (action into the world), which then causes a *new* state equation, (Schroedinger/Merleau-Ponty) ,to be formed until the next “measurement” is performed. How close these conceptions are!

I think my perspective is legitimate and answers the basic *biological* question. The biggest remaining problem that I have is the one from organism to externality and I think that Maturana and Varela, (see Chapter 6), have framed the essential problem very, very well.

There remains one fundamental objection to my thesis which I have long considered, do not consider trivial, and which is exposed throughout this dialogue however: why then, does our model work *so well*? I have thought this over deeply, and perhaps the best answer that I can make is the analogy to a “hive of bees” completing their hive, (cited in Chapter 12). That is, I think good science is a self-fulfilling prophecy. The trick, however, is to understand it entirely relativistically –ie. to understand it in its *entirety* heterophenomenologically!

The Anthropic Principle

Or, to put it in a more respectable setting, I think it may be the ultimate fulfillment of the concept that I first saw in Penrose's book: i.e. of the "anthropic principle".

But the usage I imply here is a deeper sense and meaning of the words. It is not that "if the world were not as it is, then we would not be here to see it", (Penrose, paraphrase), but rather in a sense where "our seeing it that way" allows an algorithmic interaction with a nameless reality. Put more simply, we can only see what –and in the precise manner that we are "designed" = "configured" to see.

We are, however, allowed to extend and expand that vision. But our current perspective must be understood as a specifically biological perspective under Cassirer's "Symbolic Forms" to attain the full vision. (See Chapters 8 & 9).

We are clearly *already* dealing with a model even within rigorous science itself, and my hypothesis seems to fit very well with what we know so far. I propose that the mind/brain is even more of a model than we suspect however -to include *our "objects"* themselves in the sense of Quine's earlier comment!

Back to Mac Lane Again:

Here was a brief (though negative) comment that Saunders Mac Lane was gracious enough to make about my conception: "the idea that axiomatics amounts to an 'implicit'

definition is no longer generally accepted. It fits well with class axiomatics (e.g. for geometry) where there is just one intended model. It doesn't fit for axioms for groups or space, where there (sic) are many models." That may be precisely the point. If there were, in Mac Lane's words, "just one intended model" – then the intended model would be the physical brain itself.

The problem arises, however as to just what sort of an axiom system might enable the kind of complexity found in the human brain.

In reading Gerald Edelman a possibility suggested itself drawn from his theory of immune response, (for which he won the Nobel Prize). He treats the whole subject of immune response as "an information system". Antibodies are originally and autonomously made, (i.e. before the fact), for all possible antigens.

Combining this broadness of spectrum with his discussion of the phenomenon of "neural pruning", (the massive destruction of the early connectivity of the fetal brain which he pursues in "Bright Air ..." ^{XXIII}), it opens a useful line of thought regarding the "a/d converters", (or better "hierarchical/non-hierarchical converters"), mentioned earlier and in Chapter 4, which I believe constitute our actual perceptual "objects".

Despite the obvious differences in conceptualization, the "objects" of the mind are treated somewhat similarly by me – perhaps as the massively enabled and massively pruned a/d

converters of the pure process, the connectedness of the brain!
Perhaps they follow a similar developmental path.

This problem is huge, and I don't claim to have fully solved it, but let me remind you of the raw neuronal "size" of the brain. If we are dealing with axioms, or Freeman's "equivalence classes", then we may have billions of them, and that opens new possibilities.

A final comment by Cassirer relevant to this Current Problem

Consider Cassirer's commentary on the fundamental nature of the percept:

"For example, if we conceive the different perceptual images, which we receive from one and the same 'object' according to our distance from it and according to changing illumination, as comprehended in a series of perceptual images, then from the standpoint of immediate psychological experience, no property can be indicated at first by which any of these varying images should have preeminence over any other.

Only the *totality* of these data of perception constitutes what we call empirical knowledge of the object; ... No one of the successive perspective aspects can claim to be the only valid, absolute expression of the 'object itself; rather all the cognitive value of any particular perception

belongs to it only in connection with other contents, with which it combines into an empirical whole.”

“...In this sense, the presentation of the stereometric form *plays ‘the role of a concept’*”, (my emphasis),

“compounded from a great series of sense perceptions...”

This ordering *by a concept* means, however, that the various elements do not lie alongside of each other like the parts of an aggregate, but that we estimate each of them according to its *systematic* significance....”^{XXIV}

Please note Cassirer’s focus specifically on “the concept” –his *reformulated* “functional concept of mathematics”–at the very center of his percept. My extension of Cassirer’s functional concept of mathematics into the concept of implicit definition will be the final step into an understanding of my ultimate perspective.

Cassirer’s “functional concept of mathematics” and my newfound deeper anti-Cantorian conception of ordering, (seeing the latter as residing in the infrastructure of the axioms themselves rather than in the properties of their “permissive” objects), *when combined with Hilbert’s “implicit definition”* enabled a profound “logical leap” to “the concept of implicit definition”^{XXV} which is a new thing. It enabled for the first time an *explicit* conception of a “constitutive concept” in the sense of Kant.

It supplied a totally new rule of “ordering” beyond Cassirer’s beginning extension of the meaning of “concept”. It goes from Cassirer’s internalized ordering of the series, (“the new form of consciousness”), to a more complex^{XXVI} ordering: the Concept of Implicit Definition, itself *also* a “new form of consciousness” and consistent with the former - imposed by the structure of an axiomatic system under implicit definition, (and probably to the foundations of structuralism).²⁶ In fact, I will go further –I believe it is the only *possible* form of consciousness!

My conclusions from my “Cantor diagonal” paper, along with my (“ordering”) conclusions from my study of modern algebra, (all seen through the filter of Cassirer’s reformulated concept), supplied the genesis of this notion.

The question remains only whether such a leap is justifiable or necessary. The thrust of my overall thesis argues that it is. It suggests the first actual non-eliminative resolution of the mind-body problem!

It suggested the first possibility of a solution to the problem I stated at the opening of this paper: “How can a biological mechanism ever know anything at all? Answer: it could if its “objects” were *purely operative*^{XXVII} –*and virtual-*

²⁶ I would be open to input on the latter as I claim no expertise therein.

objects like the objects of implicit definition, (or of structuralist mathematics).

These “objects” could be defined internally and *known* to the organism/mechanism itself, (which would be its model) – likened to and extending “the new form of consciousness” claimed by Cassirer for his “mathematical concept of function” but obviating his necessary external referent. (My third and final thesis of “ontic indeterminism”, coupled with Maturana’s “structural coupling” explains and answers the obvious materialist epistemological objections.)

Mac Lane category theory

Perhaps I misunderstood Mac Lane’s book, but I believe it did preach the doctrine of structuralism implicitly. Structuralism was “implicitly defined” by the import of the whole of the book. Mac Lane was still working within the confines of “objects” and referents however, and this is where I think he went wrong.

Listen to Quine once more:

"One could even end up, though we ourselves shall not, by finding that the smoothest and most adequate overall account of the world *does not after all accord existence to ordinary physical things.....Such* eventual departures from Johnsonian usage”, (Samuel Johnson, again, is said to have demonstrated the reality of a rock by kicking it!),

“could partake of the spirit of science and even of the evolutionary spirit of ordinary language itself.”^{XXVIII}

Quine, generally acknowledged as one of the leading logicians of the 20th century, was able to conceive of an account of the world that “*does not after all accord existence to ordinary physical things*”. But how *could* we account for the world without “accord(ing) existence to ordinary physical things”, - without “accord(ing) existence to some- “*thing*” –i.e. without objects?

I think the mind is about concepts –intentional concepts; it is not about referents. It is not about classes or sets, (necessarily of “things” abstracted from dogmatically accepted “sense impressions”), except within a conceptual framework. (See Benacerraf comment shortly)

Cassirer’s reformulated “Functional Concept of Mathematics” is wholly based in rules, (contrary to the case in Aristotelian –or in Cantor’s logic which is derived from it), so there does not even exist for Cassirer a “concept of all concepts” -as some rules would clearly contravene other rules!

Therefore it follows immediately that there does not exist even the very concept of “the class of all classes” or the very concept of “the set of all sets” as there are inbuilt conflicts in the *rules* of these concepts from the very beginning as the antinomies clearly show. An analog of Russell’s initial disjunction into proper classes is made at the very beginning of Cassirer’s Concept -by definition.

If the possibility of the non-existence of “objects” themselves that Quine asserted is, in fact, a *real* possibility, if it is truly plausible, then what could classes and sets refer to? And why would we, in fact, need them at all? I think we do need them, but as *specialized* concepts. I think these specialized concepts, (i.e. classes, sets), are generated to fulfill specialized perspectives, (see my first hypothesis of “schematic artifacts” to follow in Chapter 4.²⁷). You might also revisit the early part of this paper to note Benacerraf’s and Bell’s comments. But consider each within the context of Cassirer’s “Symbolic Forms” cited earlier.

Cassirer:

“...because physical, chemical, biological knowledge *frame their questions* each from its own particular standpoint and, in accordance with this standpoint, subject the phenomena to a special interpretation and formation”

–i.e. “each discipline asks its questions from its own perspective.”:

“[Hilbert] argues that what constitutes an object *varies from theory to theory*, category to category, and that Frege failed to realize this fact... It [logic] remains the

²⁷ See Chapter 4, this book

tool applicable to all disciplines and theories, the difference being only *that it is left to the discipline or theory to determine what shall count as an 'object' or 'individual.'* [Benacerraf, 288, my emphasis.]

And Bell, (my emphasis):

“The topos-theoretical viewpoint suggests that the absolute universe of sets be replaced by a plurality of ‘toposes of discourse’, *each of which may be regarded as a possible ‘world’ in which mathematical*” [and logical] *“activity may (figuratively) take place.”*

But the concepts of the mind are strategic concepts, I believe, not referential ones, (of “objects”).

Walter J. Freeman contributes a relevant perspective here:

“This book had its origin ... in an experimental finding....I was tracing the path taken by neural activity that accompanied and followed a sensory stimulus in brains of rabbits. I traced it from the sensory receptors into the cerebral cortex and there found that the activity vanished, just like the rabbit down the rabbit hole in ‘Alice in Wonderland’. What appeared in place of the stimulus-evoked activity was a *new* pattern of cortical activity that was *created* by the rabbit brain... My students and I first noticed this anomaly in the olfactory system... and in looking elsewhere we found it in the visual, auditory, and somatic cortices too... the only knowledge that the rabbit

could have of the world outside itself was what it had made in its own brain.”^{XXIX}

What makes sense of this perspective, (i.e. its seeming self-contradiction) is Maturana’s stark and beautiful conception of “structural coupling”, itself combined with Cassirer’s other brilliancy: “Symbolic Forms”^{XXX}, but the former must be taken in its broadest sense. Equivalently, I have called it “ontic indeterminism”. It allows us to *act*, (pragmatically), without *knowing*.²⁸

Reconsider Schlick’s characterization and interpret it through the *young* Hilbert’s eyes:

"[Hilbert's] revolution lay in the stipulation that the basic or primitive concepts are to be defined *just by the fact that they satisfy the axioms*.... [They] *acquire meaning* only by virtue of the axiom system, *and possess only the content* that it bestows upon them. They stand for entities *whose whole being* is to be bearers of the relations laid down by the system." This is what I propose the “A/D converters”, the “objects” of the cortex do.

²⁸ It also allows an entirely new reassessment of the problem of “consciousness”.

Back to Shapiro:

“Frege insisted that arithmetic and geometry each have a *specific* subject matter, space in the one case and the realm of natural numbers in the other. And the axioms express (presumably self-evident) truths about this subject matter.

Following a suggestion of Hellman’s, let us say that for Frege, the axioms of arithmetic and geometry are *assertory*; and for Hilbert, they are *algebraic*. Sentences that are assertory are meant to express propositions with fixed truth values. Algebraic sentences are schematic, applying to any system of objects defined by them -that meets certain given conditions”²⁹ [ibid, my emphasis]

“[Young] Hilbert’s *Grundlagen* provided consistency and independence proofs by finding interpretations that satisfy various sets of axioms. Typically, he would interpret the axioms of a theory in terms of constructions on real numbers. This approach, now as common as anything in mathematics, runs roughshod over Euclid’s definition of a

²⁹ My disagreement with this characterization onto “systems of objects” should no longer need any elaboration. Think once again about Wilder’s characterization of the “objects” of axiom systems “as presumptive and permissive only”.

‘point’ as ‘that which has no parts’. When we interpret a ‘point’ as an ordered pair of real numbers, we see that points can indeed have parts.

This free reinterpretation of axioms is a main strength of contemporary mathematical logic and a mainstay of mathematics generally. It drives the structuralist, algebraic, perspective on mathematics. And it runs counter to the Fregean perspective.”

[*But*]“...It seems clear that for Hilbert and just about anyone else, consistency is itself a mathematical matter. His methodology indicates that in order for us to be assured that certain mathematical objects exist; we have to establish the consistency of an axiomatization.”

I differ with both parts of this sentence –both proof of existence and of consistency. The ultimate question is “how would it even be possible”! I think Hilbert was speaking a different language –of invariants and of relativity.

“In the *Grundlagen*, Hilbert discharged this burden, *at least in part*, by providing relative consistency *proofs*.”

[*ibid*, my emphasis]

But not necessarily “in part” only. The system need only *be* consistent. Shapiro's comment confuses human logical certainty with reality. Hilbert's relative consistency proofs are of a different order entirely. They elaborate the notion of invariants themselves and are consistent with such. (I think relative consistency proofs are the only ones possible for the machine we call the brain!)

Those invariants must go across the board however -i.e. the whole of one system must be mirrored in the other -as in the principle of duality. As far as our assurance that “certain mathematical objects [must] exist” goes, however, this is a limitation in Shapiro’s own epistemology. From Cassirer’s perspective, this is something we will never know.

The Rosen Letter: (a Reflection on Shapiro’s Position)

But what of the "beer mugs" conception? Must the organization of one system be mirrored *simply* in the other? Or may the translation be complex? Here is an extract from my (fairly recent) letter to Robert Rosen’s daughter Judith Rosen^{XXXI}. I had just learned that he had died, (sadly before I even “discovered” him), and I wanted to express my sympathy to her as well as my excitement in newly discovering his views.

As part of my letter I discussed a theme her father had addressed to approach an understanding of “invariance”, (which I think was Hilbert’s focus). It so happened that it was a

significant theme in my own work as you should be able to recognize by now, (and of Thomas Kuhn's as well). I talked of the mathematical equivalence of *mechanical models* of the Ptolemean and the Copernican universes, easily seen by the arbitrary choice of our anchor point for the respective models. (The following is just me quoting me!)

“...The motions of the planets and the wildly gyrating stars of the one translate into the picture of the stable universe we are ordinarily used to! Mathematically, I hope you can appreciate the beauty and the inherent *mechanical necessity* of the absolute mathematical translation between these models. The version I had been thinking about used our own, (modern), view of the universe vis a vis the Ptolemaic system. (Kuhn used the Tychoean Model). Conceive again of a rigid mechanical model of our solar system revolving about our linearly moving sun, embedded in the field of stars -just as we normally conceive of it and sitting on your (large) desktop.

But let us reach down from some other dimension, (just to stay out of the way), and grasp the now moving and spinning earth firmly pinching it tight so that it becomes motionless, lifting the model off its prior base, and establishing a new "center" in the now unmoving earth, (with its now wildly gyrating extraterrestrial adjuncts).

The point is that the two perspectives must necessarily be *absolutely* mathematically and observationally equivalent – established by the *purely mechanical*, [“gear driven”] nature of

the model itself! All of their *relative motion* is absolutely invariant! From the standpoint of an observer anywhere in that universe, all observations and measurements would necessarily be the same^{XXXII}, [though the language expressing them would be radically different!]

These, then, are *purely mathematical translations*, (albeit complex ones), confirmed by the *purely mechanical* nature of the model. From this standpoint no observable data whatsoever is gained from adopting one viewpoint over the other.^{XXXIII}

I think this translation of perspective, (this invariance), illustrates a deeper interpretation of Hilbert's "beer mugs" assertion.³⁰

"The problem, however, lies in the 'laws of nature'. All laws, (gravity, inertia, the speed of light, et al), would have to be rewritten to be *place specific* under the (Ptolemaic or, as I later saw from Kuhn –who used a very similar construction- using the Tychonean transformation instead^{XXXIV}).

³⁰ It gives a hint to the "how" of Hilbert's statement quoted earlier: "If in speaking of my points, I think of some system of things, e.g., the system love, law, chimney-sweep ...and then assume all my axioms as relations between these things,³⁰ then my propositions, e.g., Pythagoras' theorem, are also valid for these things ... [Any] theory can always be applied to infinitely many systems of basic elements. One only needs to apply a reversible one-one transformation and lay it down that the axioms shall be *correspondingly the same* for the transformed things." The current discussion is precisely about the translation of invariants, but more complex ones than normally considered.

Laws of motion that hold on the earth would not necessarily hold in such simple form on the moon, (in fact, as seen through an all powerful, earth-based telescope, they would not under these non-Copernican [and pre-Galilean] perspectives!)”^{XXXV}

This situation is relevant to my suggestion made in reference to the lack of preconceived necessity for a preservation of hierarchy in Hilbert’s “Pythagorean theorem” assertion. Think about the purely mathematical and necessarily *definitive*³¹ nature of the translations involved between our models.

Modern Ptolemean Physics

Suppose, purely hypothetically of course, that some brilliant but esoteric mathematician of the Ptolemaic school had discovered the dualistic translatory laws for these (new, i.e. “Copernican”) laws of nature - but who conceived those translatory laws *as mathematics only*, (like Heisenberg’s matrices perhaps –and, in fact, as the Pope supposedly advised Copernicus himself to do). Mathematically this discovery would have involved the implicit (though not necessarily a conscious and

³¹ because they are “gear-driven”

explicit) reorientation of the universe back to its "original" (Copernican) state, (a la Schrödinger?)

He would have implicitly reformulated and discovered new [more easily accessible] laws and implications in that context, (which would have been his mathematical “scratch pad”), and subsequently retranslated them, (and the new laws directly evolving from them -perhaps in a single combined, but possibly “blind” compositional act), back to the original, fixed earth formulation, skewing but precisely reflecting even the new laws.

But, (following our story just a bit further), this could very well have been a "blind", purely mathematical and compositional discovery -involving only purely mathematical translations *and without a necessary cosmology or insight.*”^{XXXVI} [Heisenberg’s concept of “Matrices” supplies a reasonable parallel.]

I continued: “The point is that these are solely and precisely mathematical translations! All laws would be absolutely preserved and correct, (all motions would be exactly the same, of course). I think this is a very pretty idea with profound consequences. The biggest problem, however, would be in the discovery of new laws –i.e. the *fecundity* of the model! But, again, these might well be implicit in the transformations.

What does this mean for our problem? It means that our central problem is not one of data, (that is a distinct problem), but of organization! The observational data *per se* holds constant, (by

mechanical necessity), in this example. Rather, it becomes a problem of organization for current understanding and for the organization needed *for future scientific progress*. It is not a problem of data or the necessary consistency of data as my example demonstrates. This data is obviously absolutely consistent.

(But mine -this present discussion -is a *relative proof* in the very form for which Shapiro so roundly criticized Hilbert!)

As such, it relates to some of the issues raised by Penrose in his criteria for theories,^{xxxvii} but in a deeper context. It relates to what I will call "centrality" and "shape" [theoretical "beauty" if you like], which are surely intentional attributes. Rules and principles are normally more "central" to theories than the language of their data. Galilean Relativity, gravity, the speed of light, Kepler's laws... are preferentially stated in their simplest and most intelligible mathematical form, not in skewed transformations.

This is Occam's razor, but more finely honed. We centralize principles, (and, I argue along with Cassirer), intentional principles specifically as well for *organization!* We then organize the data to fit!

Theories have "shape" in the same sense that great music has "shape" -not only in its individual themes, but as an overall composition. Occam's razor, (least assumptions), is only the tip of the iceberg.

What does this "interlude" mean specifically for the problem of the brain? Does the mind do this? Is its organization based on aesthetic and intentional grounds as well? I propose that the problem of the organization of the mind is fundamentally like the problem of the organization of theories. I propose that this was how the megacellular colossus organized its process. (But what then, are the "objects" of ordinary consciousness?)

By this discussion I have tried to introduce the kind of complexity that I think we are dealing with, and the profundity of Hilbert's approach. This, I think, is the kind of thing that Hilbert was thinking about with his remark about "beer mugs" and "points". It is *all* about invariants.

Another Look at Hilbert

In my discussion of Chapter 2, I noted that I had incorporated Wilder's interpretation of Hilbert's "objects" in my earlier writings, and promised a further perspective on the issue in this chapter.

In those earlier papers I had interpreted Hilbert's comments in the most minimal sense -that these "objects" were, using Wilder's terminology, "permissive and presumptive only", that is, semantically neutral.

"These objects, (of its domain -and "existence" terms generally), are assumed *only*, (as Wilder points out)

"presumptive(ly)" and "permissive(ly)" however. We are told *nothing* about them in an objective sense.”^{XXXVIII}

I began with an interpretation of Hilbert where the “objects” of a system are taken in a purely *impartial* sense.

“... it is surely obvious that every theory is only a scaffolding or schema of concepts together with their necessary relations to one another, and that the basic elements can be thought of in any way one likes. If in speaking of my points, I think of some system of things, e.g., the system love, law, chimney-sweep ...and then assume all my axioms as relations³² between these things”.

In thinking it over, I have come to the conclusion that Hilbert had something much deeper in his mind. Hilbert himself did not interpret “these things” as semantically neutral in this specific instance but gave them names and meanings! (This is not the blatant contradiction it would appear to be. It depends, as I have said in another of my writings “on which end of the telescope you look through.”)

³² But *what kind* of relations? What is the conception of relation itself that Hilbert had in mind?

Here he first assumes some “system of objects” but then he assumes “all my axioms as relations” [are] “correspondingly the same for the transformed things” –i.e. “*between* these [prior] things”! Here he does not begin with the axioms as the logical prius but rather begins with his “things”, and he then *transforms his axioms to fit!* His axioms *themselves* are transformed to fit his “things”.

“..and then assume all my axioms as relations between these things.”

This is not a *simplistic* conceptualization of “relation”. I think his perspective here corresponds to that of Quine wherein the latter noted that “total science is like a field of force whose boundary conditions are experience. A conflict with experience at the periphery occasions readjustments in the interior of the field. Truth values have to be redistributed over some of our statements. Reevaluation of some statements entails reevaluation of others, because of their logical interconnections- the logical laws being in turn simply certain further statements of the system, certain further elements of the field. Having reevaluated one statement we must reevaluate some others, which may be statements logically connected with the first or may be the statements of logical connections themselves. But the total field is so underdetermined by its boundary conditions, experience, that there is much latitude of choice as to what statements to reevaluate in the light of any single contrary experience. No

particular experiences are linked with any particular statements in the interior of the field, except indirectly through considerations of equilibrium affecting the field as a whole..... Furthermore it becomes folly to see a boundary between synthetic statements... and analytic statements...Any statement can be held true come what may, if we make drastic enough adjustments elsewhere in the system... Conversely... no statement is immune to revision... even the logical law of the excluded middle... and what difference is there in principle between such a shift and the shift whereby Kepler superseded Ptolemy, or Einstein Newton, or Darwin Aristotle?"^{XXXIX}

Consider Hilbert's "one only needs to apply a reversible one-one transformation and lay it down that the axioms shall be correspondingly the same for the transformed things." It is his "correspondingly the same" which grabs my attention.

Remember this was the "king of invariants" speaking and I think his meaning was much deeper. "*Correspondingly the same*" would have a very different significance to someone with that background involving complex transformations and invariance in the sense of my "Rosen" and "Kuhn" discussions above. (You might want to think of the Lorenzian transformations here.)

I believe it is the *invariant core*, the context-free sense of the relationality of his axioms that he wanted preserved in the sense of Kuhn's translations of cosmologies or of Quine's

relativistic perspective with which we began this journey. This is a much deeper and more radical interpretation of Hilbert's conception than usual, but I think it is justified. I think this is the actual concept of implicit definition of the "young Hilbert".

I believe that Hilbert's was a deeper conception than Shapiro acknowledges, relating to invariance in complex transformations^{XL} and to Hilbert's non-simplistic and mathematically nurtured intuitive conception, rather than from his perspectives drawn from of formalistic logic.

I think this was the actual subject of his initial debate with Frege. Hilbert's conception of implicit definition is *reinterpretation* in its deepest sense, deriving from the larger scope of the principle of duality³³ and complex transformations, and from Hilbert's native, rather than from his formal logic. I believe it has an affinity to Cassirer's perspective in his "Symbolic Forms", (and to Bell's "local mathematics"?). I believe that it is *invariance itself* that was Hilbert's subject.³⁴ His was, I think, the very first *structuralist* perspective!

³³ The algebraic "Principle of Duality" says that if we merely change the reference of each instance of any non-explicitly defined term in an axiom system, that the conclusions drawn from that system apply to and actually define the latter. It is a very deep and profound idea and is the genesis of Hilbert's "implicit definition"

³⁴ See "Rosen" discussion above

Hilbert's original conception was not grounded, as it later came to be, in the formalistic "Byzantine" implementations of logicism and Cantor's set theory.

Shapiro, Mac Lane, and even Hilbert himself became trapped in the abstractive context^{XL1} implicit in classical logic - e.g. in Shapiro's definition of "an algebraist" and their joint conception of structures as being necessarily "about" some ontological things.

As I read it, Hilbert's original conception, (of the "young Hilbert"), was not about ontology: it was not about proof theory; it was about invariance itself. Hilbert's is a world of mathematical conditionality^{XLII} *per se*, and it "floats"! It is neither a world of philosophical idealism nor one of Fregean pragmatism. These are the "ladders"^{XLIII} we must kick away!

Logic as Biology:

Now let us take a radical but, I think, decisive turn, and consider this mathematics from the standpoint of biology. From a purely physicalist and evolutionary standpoint, logic must *itself* be considered as a highly sophisticated but *purely reactive*^{XLIV} system for the survival of the entity. (Maturana is surely relevant here.)

As such logic becomes pure biology³⁵, and the “concepts” and “percepts” within that logic, (*even those of human mathematics*), become biological objects. Hence logic becomes “bio-logic”! I suggest that this insight might solve many of the deepest issues in the underlying mathematics.

George Lakoff’s ICMs, (to be examined later –See Appendix B), are biologically based –on the human organism. Human cognition and human reason consists, for Lakoff, in the application of the best fit of these inbuilt ICM’s, (and their respective categories), to a given problem or situation. They constitute an “embodied logic” deriving from the nature of the human organism itself. There is an obvious parallel between Lakoff’s “embodied logic” and the more general case I have argued. I have argued that logic is indeed embodied, *but at the primitive level of cellular process!* (See Chapter 4 -“The Specific Case of Biology”). This more general characterization allows the crucial epistemological move,³⁶ (which Lakoff’s does not), beyond the “God’s eye view” he disclaims.

The distinction is important because at the cellular level of phenomenology biology becomes a *pure form* very much in

³⁵ See my “embodied logic” comment in the Lakoff appendix.

³⁶ Through what Maturana and Varela call “structural coupling”

the sense that I will argue that Maturana's is in Cassirer's sense of a "Symbolic Form" and thus compatible with Cassirer's Hertzian premise. This is especially transparent in Maturana and Varela's book, for instance, (see chapter 6), i.e. in its explicit constructiveness and the subsequent purity of its phenomenology.

I think it is relevant to Hilbert's *relative consistency* proofs, Shapiro's problem with "necessarily *assertive statements*", MacClane's "existence problems", and the difficulties of Platonism, et al. If logic is actually bio-logic, then we have an actual model *in the human brain itself*,^{XLV} and as such, we can accept its reality and legitimacy in all these perspectives.

Here is another quote from a very recent contemporary source which might make you think.

Raichle:

Compare Raichle:

"Of the virtually unlimited information available in the world around us, the equivalent of 10 billion bits per second arrives on the retina at the back of the eye.

Because the optic nerve attached to the retina has only a million output connections, just six million bits per second can leave the retina, and only 10,000 bits per second make it to the visual cortex.

...After further processing, visual information feeds into the brain regions responsible for forming our conscious perception. Surprisingly, *the amount of information constituting that conscious perception is less than 100 bits per second*. Such a thin stream of data probably could not produce a perception if that were all the brain took into account; the intrinsic activity must play a role.

...Yet another indication of the brain's intrinsic processing power comes from counting the number of synapses, the contact points between neurons. In the visual cortex, the number of synapses devoted to incoming visual information is less than 10 percent of those present. Thus, the vast majority must represent internal connections among neurons in that brain region.” (This is very much in accord with both Maturana's and W.J. Freeman's conceptions.)

.... Although six million bits are transmitted through the optic nerve, for instance, only 10,000 bits make it to the brain's visual processing area, and only a few hundred are involved in formulating a conscious perception –too little to generate a meaningful perception on their own. *The finding suggested that the brain probably makes constant predictions about the outside environment in anticipation*

of paltry sensory inputs reaching it from the outside world.”³⁷ (My emphasis)

How very similar to Maturana’s, W.J.Freeman’s and mine is his perspective. But Raichle does not draw the obvious conclusions, as indeed, it seems nobody else seems to. His conclusions are confounded by the epistemological paradox of his own arguments –*his* is a brain also and subject to the same limitations. *His* picture of the world too is built on that same thin data stream of a few hundred bits per second, (DIV 8 ≈ bytes per second), imposed on the underlying structure for as many seconds as he has been alive. This stream that we would never allow for even the crudest dial-up connection on our computer modem, (which would normally be about 64 thousand bytes per second), consists, according to Raichle of a mere few *hundreds* of bits per second in which to download reality. And yet he seems to think he has a definite and explicit conception of the world. Whence, then, “the virtually unlimited information available in the world around us, the equivalent of 10 billion bits per second

³⁷ Scientific American March 2010 “The Brain’s Dark Energy” Marcus Raichle, Washington University School of Medicine in Saint Louis

[which] arrives on the retina at the back of the eye.” How did he arrive at this world picture?

How much closer is the fit to Maturana’s “triggering” of an underlying process than to Raichle’s own “informational model” which lies at the bottom of his worldview? His explicit answer has a definite and clear affinity to my own model of an optimization of underlying blind process –to an optimization of strategy rather than of information –or to William James’ pragmatism which we will look at in Chapter 12. His implicit and always underlying answer, however, is that of informational naïve realism!

His formal conclusion does it better:

The finding suggested that the brain probably makes constant predictions about the outside environment in anticipation of paltry sensory inputs reaching it from the outside world.” (My emphasis)

The ultimate answers he seeks lie, rather, in the relativism of epistemology I will propose in Chapter 8. Philosophy *does* have a role in science, and most especially in this particular problem –but in support of science, not in pontificating on it. It provides us with new conceptions of possibility! Repeating a relevant quote from Chapter 1 by Cassirer:

"A glance at the history of physics shows that precisely its most weighty and fundamental achievements stand in

closest connection with considerations of a general epistemological nature. Galileo's 'Dialogues on the Two Systems of the World' are filled with such considerations and his Aristotelian opponents could urge against Galilei that he had devoted more years to the study of philosophy than months to the study of physics. Kepler lays the foundation for his work on the motion of Mars and for his chief work on the harmony of the world in his 'Apology for Tycho', in which he gives a complete methodological account of hypotheses and their various fundamental forms; an account by which he really created the modern concept of physical *theory* and gave it a definite concrete content. Newton also, in the midst of his considerations on the structure of the world, comes back to the most general norms of physical knowledge, to the *regulae philosophandi*

... But all these great historical examples of the real inner connection between epistemological problems and physical problems are almost outdone by the way in which this connection has been verified in the foundations of the theory of relativity.... Einstein...appeals primarily to an epistemological motive, to which he grants...a decisive significance." (Cassirer: "Einstein's Theory of Relativity",P.353-354)

In short, Raichle's is a clear problem within a framework of epistemological relativity! Cassirer provided a definite picture of such.

Addressing Shapiro again:

Do we really need “assertatory metamathematical statements”, or is it only necessary to accept relative consistency proofs. Taking the brain as a machine, then within the bio-logic, I think the latter is the only option. These are strategies, not ontologies!

To answer Mac Lane's pointed question in his “Mathematics: Form and Function”, (paraphrasing): Why and how does mathematics then work for us? Why and how is it so useful in our pragmatic world?

My answer is that the foundations of mathematics are necessarily just the same as the organizational foundations of brain process. They work just to the best possible extent that the brains of these highly sophisticated organisms are capable of continuing their existence. They exist and they work, to use Maturana's pregnant terminology, just to the extent that these organisms are capable of preserving autopoiesis. But *no more!*^{XLVI}

**The Remainder of this Book Constitutes my proposed
Specific Solution to the Mind-Brain Problem.**

(Chapters 4 through 13)

The Initial Part was to Enable You to Understand It.

Chapter 4: My First Hypothesis in Detail: (Biology Part One)

1. Representation: the perspective from biology

Sometimes we tentatively adopt a seemingly absurd or even outrageous hypothesis in the attempt to solve an impossible problem -and see where it leads. Sometimes we discover that its consequences are not so outrageous after all. I agree with Chalmers that the problem of consciousness is, in fact, “the hard problem”. I think it is *considerably* harder than even he seems to think it is however.

I think its solution requires new heuristic principles as deep and as profound as, (though different from), the “uncertainty”, “complementarity” and (physical) “relativity” that were necessary for the successful advance of physics in the early part of the 20th century. From the preceding chapters, I think you will have some idea of my thoughts on the subject. I think it involves an extension of logic as well. Consideration of those deep cognitive principles: “cognitive closure”, (Kant and Maturana), “epistemological relativity”, (Cassirer and Quine), and of the extension of logic, (Cassirer, Lakoff, Iglowitz), must await other chapters however.

Sometimes it is necessary to walk around a mountain in order to climb the hill beyond. It is the mountain of “representation”, and the cliff, (notion), of “presentation”¹ embedded on its very face, which blocks the way to a solution of the problem of consciousness. This hypothesis points out the path around the mountain.

Maturana and Varela’s “Tree of Knowledge”¹ is a compelling argument based in the mechanics of physical science and biology against even the very possibility of a biological organism’s possession of a representative model of its environment. They and other respected biologists, (Freeman, Edelman), argue against even “information” itself. They maintain that information never passes between the environment and organisms; there is only the “triggering” of structurally determinate organic forms. I believe theirs is the inescapable conclusion of modern science.

I will now present a specific and constructive counterproposal for another kind of model however: i.e. what I will call the “Schematic Operative Model”. Contrary to the case of the representative model, it *does* remain viable within the critical context of modern science. I believe that we, as human

¹ For we would surely, then, require some homunculus for it to be presented to!

organisms, do in fact embody a model. I believe it is the stuff of mind!

2. “The Schematic Model”: Definition and Examples.

(Defining What It Means To Be “An Object”)

Normally, when we think of “models”, we mean reductive or at least parallel models. In the first we think of a structure that contains just some of the properties of what is to be mirrored. When we normally use the term “schematic model”, we talk about the preservation of the “schema”, or “sense” of what is mirrored. Again it is reductive, however- it is logically reductive. It is, as has been claimed, “just a level of abstraction”². There are other uses for models, however, -those that involve superior organizations! This is the new sense of “schematic model” that I propose to identify.

2.1 The Simplest Case: A Definition by Example

Even our most simplistic models, the models of even our most simplistic and mundane training seminars, suggest the possibility of another usage for models very different than as representative schemas. They demonstrate the possibility of a

² As a JCS reviewer once tried to characterize my conception

wholly different paradigm whose primary function is *organization* instead.

Look first at the very simplest of models. Consider the models of simplistic training seminars -seminars in a sales organization –even the primitive training seminars of AMWAY©!- for instance. “‘Motivation’ plus ‘technique’ yields ‘sales’.”, we might hear at their sales meeting. Or, (escalating and shifting our ground just a little bit), “‘Self-awareness of the masses’ informed by ‘Marxist-dialectic’ produces ‘revolution’!”, we might hear from our local revolutionary at a Saturday night cell meeting. Visual aids, (models), and diagrams are ubiquitous in these presentations.

A lecturer stands at his chalkboard and asks us to accept drawings of triangles, squares, cookies, horseshoes... as meaningful objects -with a “calculus” of relations, (*viz*: an “arithmetic” of signs),³ between them, (arrows, squiggles, et al). The icons, (objects), of those graphics are stand-ins for concepts or processes as diverse, (escalating and shifting ground just a bit more), as “motivation”, “the nuclear threat”, “sexuality”, “productivity”, and “evolution”.

³ Webster’s defines “calculus”: “(math) a method of calculation, any process of reasoning by use of symbols”. I am using it here in contradistinction to “the calculus”, i.e. differential and integral calculus.

Those icons need not stand in place of entities in objective reality, however. What is the object which is “*a productivity*” or “*a sexuality*”, for instance? What *things* are these?

Consider this: two different lecturers might invoke different symbols, (“objects”), and a different “calculus” to explicate the same topic. In analyzing the French Revolution in a history classroom,⁴ let us say, (a classroom is a *kind* of training seminar after all!) , a fascist, a royalist, a democrat might alternatively invoke “the Nietzschean superman”, “the divine right of kings”, “freedom”, ... as actual “objects” on his blackboard, (with appropriate symbols).

He will redistribute certain of the explanatory aspects, (and properties), of a Marxist’s entities, (figures) -or reject them as entities altogether.^{II} That which is unmistakably explanatory, (“wealth”, let us say), in the Marxist’s entities, (and so which must be accounted for by *all* of them), might be embodied instead solely within the fascist’s “calculus” or in an interaction between his “objects” and his “calculus”.

Thus and conversely the Marxist would, (and ordinarily does), reinterpret the royalist’s “God”-figure, (and his –the

⁴ I actually attended such a class which dealt with alternative explanations of the French Revolution at the University of Chicago. It was a good school.

Marxist's- admitted function of that "God" in social interaction⁵), as "a self-serving invention of the ruling class".

It becomes an expression solely of his "calculus" and is not embodied as a distinct symbol, (i.e. object). Their "objects" - *as objects* - need not be compatible! As Edelman noted: "*certain symbols do not match categories in the world. ... Individuals understand events and categories in more than one way and sometimes the ways are inconsistent.*"^{III}

⁵ Dennett's term "heterophenomenological" -i.e. with neutral ontological import -is apt here.

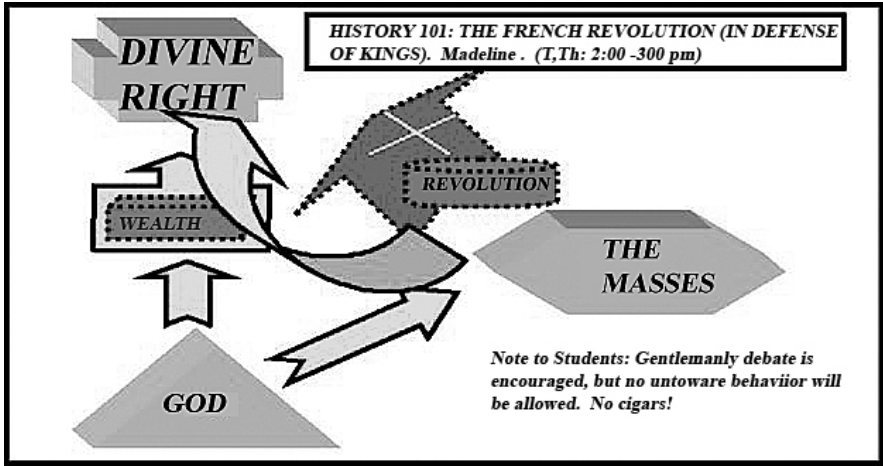

Figure 8, (Madeline's Chalkboard)

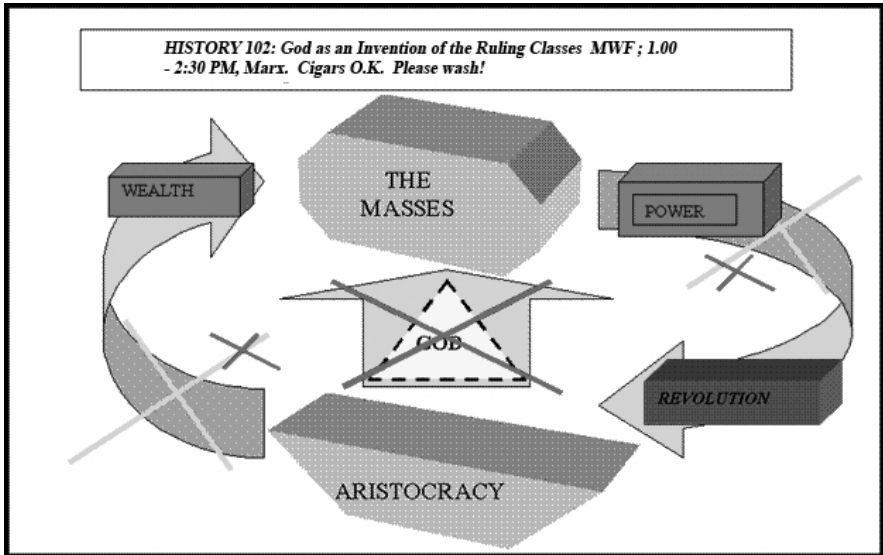

Figure 9, (Marx's Chalkboard)

What is important is that a viable calculus-plus-objects, (a given model), must explain or predict “history” -that is, it must be compatible with *the phenomena*, (in this particular example the historical phenomena). But the argument applies to a much broader scope. I have argued elsewhere,^{IV} (following the strong case of Hertz and Cassirer –see Chapter 7), that the same accounting may be given of competing scientific theories, philosophies, and, indeed, of *any* alternatively viable explanations.

Consider Heinrich Hertz:

“The [scientific] images of which we are speaking are our ideas of things; they have with things the one essential agreement which lies in the fulfillment of the stated requirement, [of successful consequences], but further agreement with things is not necessary to their purpose. Actually we do not know and have no means of finding out whether our ideas of things accord with them in any other respect than in this one fundamental relation.”
(Hertz, “Die Prinzipien der Mechanik”)

The existence of a multiplicity of alternately viable “calculuses”, (sic), and the allowable incommensurability of their “objects”^V suggests an interpretation of those objects contrary to representation or denotation however. It suggests the *converse*

possibility that the function and the motivation of the objects of those models, specifically as entities *per se*, (in what I will call these “schematic models”), is *instead* to illustrate, to enable, -to crystallize and simplify *the very calculus of relation* proposed between them!^{VI} The "objects" of these models, I propose, are manifestations of their structure; their structure is not a resolution of the objects.

2.1.1 Reversing our perspective:

I propose and will argue the actual possibility that the boundaries -the demarcations and definitions of these schematic objects, (their “contiguity” if you will) -are formed specifically to meet the needs of the operations. I propose that they exist to serve structure- not the converse.^{VII}

The objects of those structures –specifically *as objects per se* - serve to organize process, (i.e. analysis or response). They are not representations of actual objects or actual entities in reality.^{VIII} This, I propose, is *why* they are “things”.⁶ These

⁶ Compare the Benacerraf passage cited earlier: “[Hilbert] argues that what constitutes an object varies from theory to theory, category to category, and that Frege failed to realize this fact. . . .’It [logic]⁶ remains the tool applicable to all disciplines and theories, the difference being only *that it is left to the discipline or theory to determine what shall count as an 'object' or 'individual'.*” [Benacerraf, 288]

“objects” functionally bridge reality in a way that physical objects do not and I suggest that they are, in fact, metaphors of analysis or response. The rationale for using them, (as any good “seminarian” would tell you), is clarity, organization and efficiency.

Though set in a plebian context, the “training seminar”, (as minimally presented), illustrates and defines the most general and abstract case of schematic non-representative models in that it presumes *no particular agenda*. It is easily generalized: it might as well be a classroom in nuclear physics or mathematics, the boardroom of a multinational corporation, -or a student organizing his love life on a scratchpad!

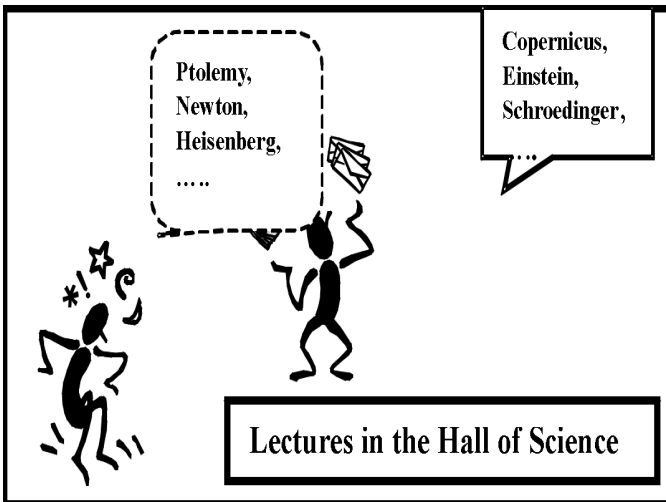

Figure 10



Figure 11

2.2 A Case for Schematism More Specific to Our Special Problem: Narrowing the Focus.

(The Engineering Argument)

Engineers' instrumentation and control systems provide an example of the organizational, non-representational use of models and "entities" in another setting. These entities, and the context in which they exist, provide another *kind* of "chalkboard".⁷ Their "objects" need not mirror objective reality either. A gauge, a readout display, a control device, (the "objects" designed for such systems), need not mimic a single parameter - or an actual physical entity. Indeed, in the monitoring of a

⁷ Their designers are the "lecturers", and the instruments they design are the "objects" of their schematic models

complex or dangerous process, it should not. Rather, the readout for instance should represent an efficacious synthesis of just those aspects of the process which are relevant *to effective response*, -and be crystallized *around* those relevant responses!

A warning light or a status indicator, for instance, need not refer to just one parameter. It may refer to electrical overload and/or excessive pressure and/or... Or it may refer to an optimal relationship, (perhaps a complexly functional relationship), between many parameters -to a relationship between temperature, volume, mass, etc. in a chemical process, for instance, or the urgency of immediate response by a battlefield commander.

The exactly parallel case holds for its control devices. A single control may orchestrate a multiplicity of (possibly disjoint) objective responses. The accelerator pedal in a modern automobile, as a simple example, may integrate fuel injection volumes; spark timing, transmission gearing...

Ideally, (given urgent constraints), instrumentation and control might unify in the *selfsame* “object”. We could then manipulate the very object of the display and it in itself could be the control device as well. Consider the advantages of manipulating a graphic or tactile object which is simultaneously both a readout and a control mechanism under urgent or dangerous circumstances.

Now think about this same possibility in relation to our ordinary objects of perception -in relation to the sensory-motor coordination of the brain and the objects of naive realism in the

real world! The brain is a control system, after all, so what should its “objects” be? The brain is an organ of control and its mechanics must be considered in that perspective. Its function is exceedingly complex and the very continuation of life itself is at stake.^{IX} It is indeed a complex and dangerous world. Might not our naïve world *itself* be such a combined schematic control system?

2.3 The “G.U.I.”, the Most Pertinent and Sophisticated Example of a Schematic Model: the Special Case)

The “object” in the graphic user interface, (G.U.I.), of a computer is perhaps the best example of a purely schematic usage currently available. In my simplistic manipulation of the schematic objects of my computer’s G.U.I., I am, in fact, effecting and coordinating quite diverse, disparate and unbelievably complex operations at the physical level of the computer. These are operations impossible, (in a practical sense), to accomplish directly.

What a computer object, (icon), represents and what its manipulation does, at the physical level, can be exceedingly

complex and disjoint.⁸ The disparate voltages and physical locations, (or operations), represented by a single “object”, and the (possibly different) ones effected by manipulating it, correlate to a metaphysical object only in this “schematic” sense. Its efficacy lies precisely in the simplicity of the “calculus” it enables! (It is specifically the *interface* that must be simple!)⁹

Contemporary usage is admittedly primitive. Software designers have limiting preconceptions of the “entities” to be manipulated, of a necessary preservation of hierarchy, and of the operations to be accomplished in the physical computer by their icons and interface. But I assert that G.U.I.’s and their “objects”, (icons), have a deeper potentiality of “free formation”. They have the potential to link to *any* selection across a substrate, i.e. they could “cross party lines”.¹⁰ They could cross categories of “things in the world”, (Lakoff’s “objectivist categories”^X), and acquire thereby the possibility of organizing on a different and the most pressing issue: i.e. urgency / risk. They need preserve neither parallelism nor hierarchy.

Biology supplies fortuitous examples of the sort of thing I am suggesting for G.U.I.’s –e.g. in the brain’s “global mapping”

⁸ In fact, it is totally arbitrary and at the will of the programmer(s) –and any, possibly conflicting, organizational schemes they may have in mind.

⁹ This is clearly related to intentionality, to the facility of implementation.

noted by Edelman^{XI}, (I will present Walter Freeman's more explicit case in detail shortly). The *non*-topological connectivity Edelman notes from the brain's "topobiological" maps,¹¹ and specifically the connectivity, (the "global mapping"), *from* the objects of those maps *to the non-mapped* areas of the brain supplies a concrete illustration the kind of potential I wish to urge for a G.U.I..

Ultimately I will urge it as the rationale for the brain itself. This global mapping allows "... selectional events", [and, I suggest, *their* "objects" as well], "occurring in its local maps ... to be connected to the animal's motor behavior, to new sensory samplings of the world, and to further successive reentry events." But this is explicitly a non-topological mapping. This particular mapping, (the global mapping), *does not preserve contiguity*. Nor need it preserve hierarchy.

Here is an actual biological model demonstrating the more abstract possibility of a connection of localized "objects"¹², (i.e. in a G.U.I.), to non-topological (distributed) process -to "non-objectivist categories", using Lakoff's terminology. As such, it illustrates the possibility of "schematism" in its broadest

¹⁰ See Freeman Figure 2 in section 2.4.1 for a physical demonstration.

¹¹ The multiple, topological maps in the cortex

¹² in the brain's spatial maps

sense. Edelman's fundamental rationale is "Neural Darwinism", the ex post facto adaptation of process, not "information", and is thus consistent with such an interpretation. It does not require "information". Nor does it require "representation".

Edelman, (unfortunately), correlates his topobiological maps, (as sensory maps), directly and representatively, (i.e. hierarchically), with "the world". This is a clear inconsistency in his epistemology. It is in direct conflict with his early and continual repudiation of "the God's eye view" upon which he grounds his biologic epistemology.

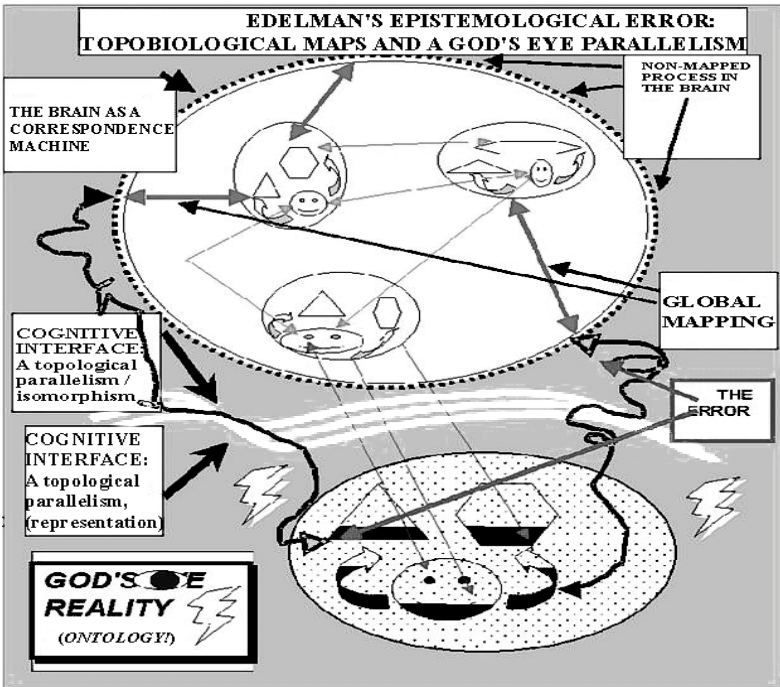

A Graphic Rendering of Edelman's Epistemology: **Figure 12:**

(Note: hierarchy and contiguity are implicit in his model!)

But what if we turn Edelman's perspective around however? What if we *blink* the "God's eye" he has himself so strongly and continually objected to, and step back from the prejudice of our human (animal) cognition. What if the maps and their objects both were taken as existing to serve blind primitive process instead of information? (Figure 13) What if they are organizational rather than representative?

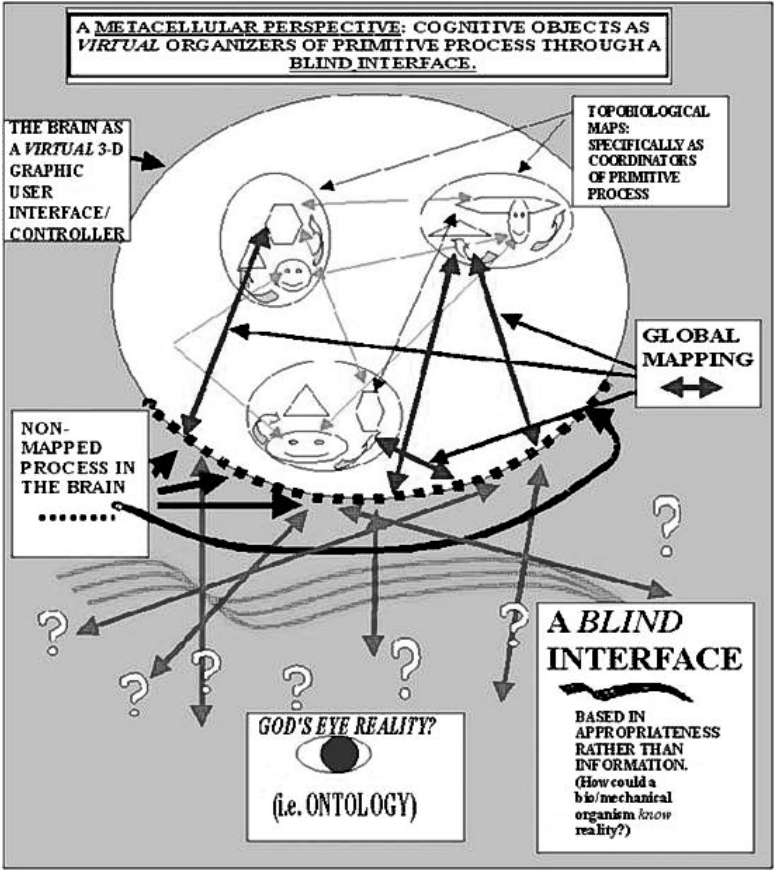

Figure 13:

A More Consistent Rendering of Edelman’s Epistemology Suggesting a New Paradigm for G.U.I.’s. (Note: Neither hierarchy nor contiguity are implicit in this model!)

This is the case I wish to suggest as an illustration of the most abstract sense of the G.U.I., (and which I will argue shortly) –i.e. a non-topological correlation! It opens a further fascinating possibility moreover. It suggests that evolution’s “good trick”, (after P.S. Churchland’s usage), was not representation, but was,

rather, the organization of primitive process in a topological context. It suggests that the “good trick” was evolution’s creation of *the cortex* itself!

2.4 Towards a Better Biological Model

Figure 14



2.4.1 Biology, The Real Thing: Freeman’s Model

What is needed now is a more explicit model, and a specific research problem to embody the proposal. Edelman’s “global mapping” is all very well and good, but it doesn’t really do what it has to. It is “too philosophical”, too vague, and as Popper would have predictably urged, not falsifiable. A more detailed and quite specific model comes from the work of the noted neurophysiologist, Walter J. Freeman.

Walter J. Freeman

Based on extensive experimental research first with the olfactory cortex, (arguably evolution’s first cortex), and then with

the visual and other cortices, Freeman argues that the brain does not process information at all –it does other things!

He has approached the problem directly and addressed the crux of the issue: what is the correlation between sensory input and resultant brain states? Is there one? This is explicitly empirical research clearly pertinent to the problems of parallelism and hierarchy and, if its conclusions are viable, is totally relevant to my argument. It *is* falsifiable! But, conversely, it is capable of falsifying the very premise of the standard paradigm -i.e. that of “representation” itself.

First, however, please look at Freeman’s model, and note the striking similarity to my own Figure 13 just above.¹³ Strikingly similar, that is, if we interpret his “topographic projections” as following behind Edelman’s “topobiological maps”. (Feature detectors?)

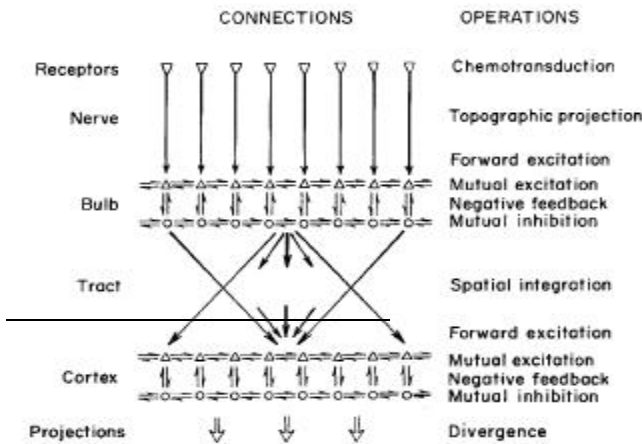

¹³ Please note that figure 13 and figure 15 were generated by myself and W.J.Freeman in total mutual ignorance of the other and in different contexts. It was only later that I discovered this paper –to me it was a blinding coincidence.

Figure 15, (Freeman’s Figure 2)

“Fig. 2. The input path from receptors to the bulb has some topographic specificity.” [but] “The output path to the prepyriform has broad axonal divergence, which provides a basis for spatial integration¹⁴, (please see important footnote below), of bulbar output and extraction of the “carrier” wave. (From Freeman 1983, reproduced by permission.)

“It is based on a striking difference between two types of central path, one that provides *topographic* mapping from an array of transmitting neurons to an array of receiving neurons, the other having *divergence* of axons that provides for *spatial*¹⁵ integration of the transmitted activity.” (Freeman, 1994, my emphasis).

Now compare Freeman’s Figure 2 with my Figure 13 shortly before it. This is an explicit case, truly drawn from biology, illustrating the non-topological potential of virtual

¹⁴ Understand that Freeman is talking within a context and here “spatial integration” relates to the geometry, (physical space), of the brain, and not about the structure of the data itself.

¹⁵ Again, see usage above.

systems and of models. It is not a topological mapping, does *not* preserve hierarchy, and it does not preserve information.

This is an actual case demonstrating the ultimate potential of schematic G.U.I.'s for distributing, (or conversely, for centralizing), function into operative “objects” which I had sought. Freeman’s model exposes a new paradigm for models. It demonstrates an organizational potential of models beyond representation. (See overview model in Freeman Appendix in this chapter.

Freeman begins:

“This book had its origin ... in an experimental finding...I was tracing the path taken by neural activity that accompanied and followed a sensory stimulus in brains of rabbits. I traced it from the sensory receptors into the cerebral cortex and there found that the activity vanished, just like the rabbit down the rabbit hole in ‘Alice in Wonderland’.

What appeared in place of the stimulus-evoked activity was a *new* pattern of cortical activity that was *created* by the rabbit brain... My students and I first noticed this anomaly in the olfactory system... and in looking elsewhere we found it in the visual, auditory, and somatic cortices too...

In all the systems the traces of stimuli seemed to be replaced by constructions of neural activity, which *lacked invariance with respect to the stimuli that triggered them*. The conclusion seemed compelling. *The only knowledge that the rabbit could have of the world outside itself was what it had made in its own brain.*" (Freeman, 1995, my emphasis.)

What does this mean? What does it mean that the new pattern "lacked invariance" in regard to the stimuli? The "invariance" demanded correlates precisely to the "passage of information" -and it could not be found! "The visual, auditory, somatic and olfactory cortices generate... waves [that] reveal macroscopic activity ... from millions of neurons. ... These spatial AM patterns are unique to each subject, are *not invariant* with respect to stimuli, and *cannot be derived* from the stimuli by logical operations!" (Freeman, 1994)

In this paper, ("Chaotic Oscillations..."), Freeman actually makes two cases –one structural and one functional. The structural case is purely physiological and, I think, very strong. It deals with the actual connectivity of nerve tissue and argues against the possibility of maintaining topological integrity, (of the "data"), within the cortex. (The other case is for "Chaos theory" as an explanation of function which I will refer to later.)

The former is the case I want to emphasize here as I think it supplies an exact and explicit example of my argument for the non-topological possibilities of schematic models. This model as

an ultimate possibility of GUI's is what I believe evolution did and how it did it.

The Peripheral Code:

1. Freeman divides nerve physiology into two categories: Those which preserve topological integrity: this is the case for the sensory nerves for instance.

“Sensory neurons exist in large arrays in the skin, inner ear, retina...so that a stimulus is expressed as a spatial¹⁶ pattern...carried in parallel along sensory nerves.

Typically only a small fraction of the axons in a nerve is activated...with the others remaining silent” [for isolation]

“...so that the ‘signal’ of the stimulus is said to be ‘encoded’ in the frequencies of firing of that subset of axons subserving ...the activated...receptors.”

“The code of sensory, motor and autonomic parts of the peripheral nervous system is the spatial”^{XII}, [topological], “pattern of temporal pulse rates. The same code appears to hold...for the ascending and descending pathways and relays in the brainstem and spinal cord. ...Serious efforts

¹⁶ i.e. in “real=informational space” –see my third thesis for a rationale for this seeming paradox.

have been made to extend this model to the cerebral cortex with considerable success in characterizing the receptive fields and ‘feature detector’ properties of cortical neurons in primary sensory areas.” (Freeman, 1994)

(But he argues that ‘feature detection’ occurs only early in cortical process.)

Points on the retina, for instance, are mapped onto the cortex in a way that preserves the topology of the source and, apparently, feeds the feature detectors which are just the very beginning of cortical input.

Cortical Mapping is Very Different, However:

(2) Within the cortex, however, it is a different story. Cortical neurons typically have short dendritic trees on the order of ½ millimeter. They are not, however, typically connected to the neurons physically adjacent to them!

“The main neurons in cortex ...intertwine at unimaginable density, so that each neuron makes contact with 5,000 to 10,000 other neurons within its dendritic and axonal arbors, but those neighbors so contacted are less than one percent of the neurons lying within the radius of contact. The chance of any one pair of cortical neurons being in mutual contact is less than one in a million.” (Freeman, 1995)

“Peripheral neurons”, [on the other hand], “seldom interact with other neurons, but offer each a private path from the receptor to the central nervous system. In contrast, each cortical neuron is embedded in a milieu of millions of neurons, and it continually transmits to a subset of several thousand other neurons sparsely distributed among those millions and receives from several thousand others in a different subset.” (Freeman, 1994)

This is reminiscent of Maturana’s comment:

“It is enough to contemplate this structure of the nervous system... to be convinced that the effect of projecting an image on the retina is not like an incoming telephone line. Rather, it is like a voice (perturbation) added to many voices during a hectic family discussion (relations of activity among all incoming convergent connections) in which the consensus of actions reached will not depend on what any particular member of the family says.”
Maturana, (1987), 163-4.

And Edelman’s:

“... To make matters even more complicated, neurons generally send branches of their axons out in diverging arbors that overlap with those of other neurons, and the same is true of processes called dendrites on recipient neurons To put it figuratively, if we ‘asked’ a neuron

which input came from which other neuron contributing to the overlapping set of its dendritic connections, it could not ‘know’.” (Edelman, 1992, p.27)

Peripheral neurons are relatively isolated, (“private”), within nerve bundles and support a topological case to the point of ‘feature detection’ at cortex. Within the cortices, however, we are dealing with a different sort of connective process. We are no longer dealing with parallel or hierarchical, (i.e. information preserving), mappings. Because each cortical neuron is embedded in a milieu of millions of neurons, it “continually transmits and receives from several thousand others” and therefore has “continual [non-topological] *background* activity owing to its synaptic interactions with its neighbors”. This is a characteristic property of cortical neural populations not shared by peripheral neuron arrays.¹⁷ Cortical process disburses

¹⁷ Compare Reichle: “Of the virtually unlimited information available in the world around us, the equivalent of 10 billion bits per second arrives on the retina at the back of the eye. Because the optic nerve attached to the retina has only a million output connections, just six million bits per second can leave the retina, and only 10,000 bits per second make it to the visual cortex.

...After further processing, visual information feeds into the brain regions responsible for forming our conscious perception. Surprisingly, the amount of information constituting that conscious perception is less than 100 bits per second. Such a thin stream of data probably could not produce a perception if that were all the brain took into account; the intrinsic activity must play a role.

function *spatially* through the physical space of the brain, (“with strong axonal divergence”), through intertwined nerve process - not topologically. It connects point-to-point fitfully within the volumetric space of the brain, not topologically. These cell assemblages act as units which “provide for spatial integration [projection] of the transmitted activity.” The cortices generate dendritic potentials... arising from synaptic interactions of *millions* of neurons. They share “a spatially coherent oscillation... by which spatial patterns of amplitude modulation

... Yet another indication of the brain’s intrinsic processing power comes from counting the number of synapses, the contact points between neurons. In the visual cortex, the number of synapses devoted to incoming visual information is less than 10 percent of those present. Thus, the vast majority must represent internal connections among neurons in that brain region.” (This is very much in accord with both Maturana’s and W.J. Freeman’s conceptions.)

... Although six million bits are transmitted through the optic nerve, for instance, only 10,000 bits make it to the brain’s visual processing area, and only a few hundred are involved in formulating a conscious perception –too little to generate a meaningful perception on their own. *The finding suggested that the brain probably makes constant predictions about the outside environment in anticipation of paltry sensory inputs reaching it from the outside world.*” (My emphasis)

From Scientific American March 2010 “The Brain’s Dark Energy”
Marcus Reichle, Washington University School of Medicine in Saint Louis

How very similar to Maturana’s, W.J.Freeman’s and mine is his perspective.

But Reichle does not draw the obvious conclusions, as indeed, nobody else does. His conclusions are confounded by the epistemological paradox of his own arguments –*his* is a brain also and subject to the same limitations. Those answers lie in the relativism of epistemology I propose. Philosophy *does* have a role in science, and especially in this particular problem –but in support of science, not in criticism of it.

are transmitted in distinctive configurations... The neurons sharing the macroscopic, aperiodic oscillations comprise a local neighborhood that can be viewed as an equivalence class.”

(Freeman, 1994, my emphasis)

These “equivalence classes” thereby provide a non-contiguous spatial distribution onto the physical space of the brain. These spatially extensive and intertwined complexes of cells throughout the cortex achieve the connectivity that mere parallelism, (or hierarchy), cannot. Freeman shows us how a topological mathematical space can be mapped onto the specifically physical space of the brain. But that particular physical space, I argue, is determined by its specific connectivity -by evolution and ontogeny, *not by* representation. Determined by genetics and learning, (ontogeny), it has the ability to connect specific process “ad hoc”. It has the ability to self-organize on principles other than topological ones.

“The local neighborhoods corresponding to cortical columns and hypercolumns seldom have anatomical boundaries of their internal synaptic connections, so that an area of cortex composed of hundreds and even thousands of neighborhoods can act as a coherent element of function in generating a spatially coherent carrier wave. These distributed neural populations are dynamically unstable and are capable of very rapid global state transitions [which can] easily fulfill the most

stringent timing requirements encountered in object recognition.” (ibid).

(Think of the possibility of these “equivalence classes” functioning as evolutionary “axioms” as I have suggested earlier!)

Freeman concludes:

“The transform effected by the output path defines the self-organized macroscopic activity as *the cortical ‘signal’*...In brief, the central code cannot be the same as the peripheral code.”(Freeman, 1994, my emphasis) He argues ultimately that the brain is a self-organizing entity, specifically obeying the laws of Chaos theory, (“Chaos can make as well as destroy information!”).

I am frankly unqualified to judge this aspect of his argument, nor do I think it is necessary. His physiological case is an actual physical demonstration of the full possibilities and an actual physiological example of my thesis of schematism and of G.U.I.’s that is the thesis of this chapter.

That physiological case: i.e. the connectivity of the CNS, is entirely sufficient in itself to demonstrate the kind of mapping, the broadest logical potential of “schematic G.U.I.’s” and their explicit relevance to cognition. This model actually does “cross party lines”!

That the brain is, in fact, “self-organized” is exactly the case I am making. I argue that it is self-organized specifically for

optimal efficiency, (i.e. urgency / risk), not for reference. Freeman's case, I believe, constitutes an actual instance demonstrating the deepest possibilities of the "schematic models" argued earlier. It demonstrates the possibility of a truly useful model organized on non-topological principles, and, as such, demonstrates the deepest capabilities-previously suggested- of a schematic G.U.I.. This is *not* just "a level of abstraction."

But where, accepting Freeman's description of the actual brain, do these cell assemblages, (these "equivalence classes"), come from, and what is their function? How do these particular entangled arrays of cells, interconnecting and overarching "the less than one percent of the neurons lying within the radius of contact" arise? I propose that they arise evolutionarily –as internal, organizations of *blind function*. This is exactly what we would expect the organizing principle of a "self-organizing" metacellular entity to be.^{XIII} It is also how a machine, in the sense of my figure 3 in Chapter one could arise!

Representation is neither required, nor, accepting Freeman, is it possible in cortex. This is what we would expect if neural organization were modeled on efficiency over "truth" -and how. Our "percepts", moreover, are what we would expect if we joined the loop of output to input! (See graphic immediately following.)

"In particular, Maurice Merleau-Ponty in "The Phenomenology of Perception" [2] conceived of

perception”, [*itself*], as the outcome of the "intentional arc", by which experience derives from the intentional actions of individuals that control sensory input and perception. Action into the world with reaction that changes the self is indivisible in reality, and must be analyzed in terms of ‘circular causality’ as distinct from the linear causality of events as commonly perceived and analyzed in the physical world." ^{XIV} W.J. Freeman, 1997

2.4.2 An Explicit Model of the Mind:

If we turn our perspective around and think of our (input) topographic maps as the looping, *re-entrant* extension of our output, then we can clearly see them, (and their “objects”), in their specific role as organizing artifacts of cortical function itself. Our “percepts” are just the *combined-in-one icons* previously described in the “engineering” argument! They are the “A-D”, (“analog/digital”, or, better yet, the hierarchical/chaotic), converters, so to speak, of the reentrant loop of process.¹⁸

This is what we would expect taking “percepts” as expressly schematic objects of process. That is, these are what we

¹⁸ This is, at best, a crude metaphor –but it crystallizes the idea nicely. A more apt characterization would be “topological / non-topological” converters.

would expect *to see*! (See Figure 16) I propose that our cognitive interface lays precisely in the topobiological models themselves, mediating between an unknowable externality and the optimized functionality of the cortex. I claim that this constitutes an explicit and non-representational model for the mind.^{xv} (See graphic model immediately following.)

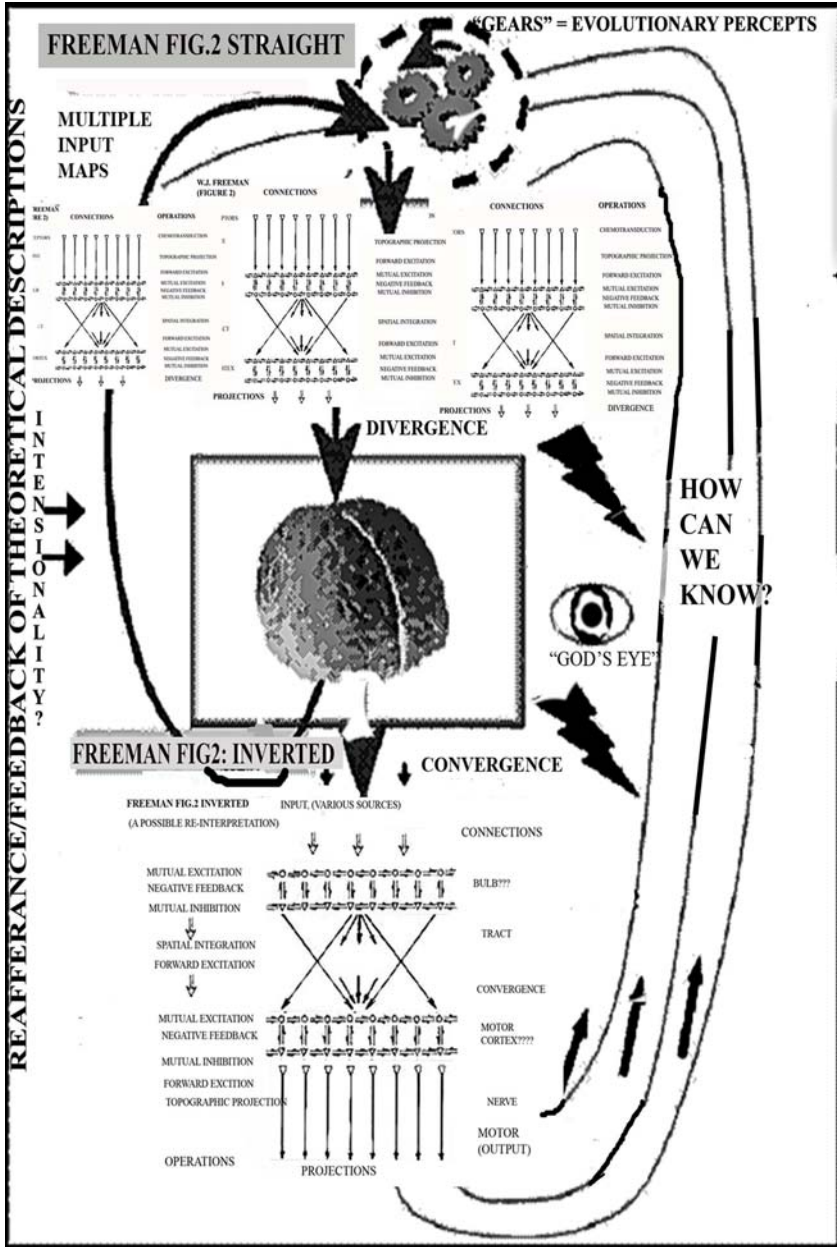

Figure 16

GOD’S EYE?

(Edelman -to Freeman -to Edelman!)

Freeman’s model exposes a new paradigm for models. It also exposes the possibility of a new correspondence with reality. We want to believe that our knowledge of reality is direct –or at least parallels that reality. How could it be otherwise? How could a model be other than “an abstraction” and still be useful? Moreover, what is the evolutionary rationale for all of this?

Modern science says that what truly is, absolute reality, (or “ontology” to use an old but precise word), consists of some ultimate particles: atoms or subatomic particles, quarks, etc.

We are allowed to retain our normal view of reality within this view however because we envision our ordinary objects, (baseballs, you, me, the sun, etc.), as spatial containers, (and logical, theoretical hierarchies), in the new absolute reality we are forced to believe in. We may still preserve the sense of our ordinary objects as physical and logical clusters, (hierarchies), of those deeper existences. I can think of myself as a cluster of atomic particles and fields shaped like me, doing all the things I do, and positioned in ontic reality next to other things and persons just as I ordinarily see myself.

There is a necessary belief in a continuity, and a contiguity, (“next-to-ness”), in this belief system. This is the “hierarchy” or “logical containment” implicit in the Newtonian

World and it is mirrored in the hierarchies of contemporary mathematics and of logic. Truly modern science says otherwise, however. Quantum theory and Relativity say that the world, (reality), is an even stranger place. Freeman's conclusions, moreover do not allow it at all. If we live anywhere, we live in cortex.

On P.S.Churchland:

“At some point in evolutionary history, nature performed a “good trick”. It allowed for an internal representation of environment.... and this allowed competence in the larger world.” (P.S. Churchland, paraphrase)

I suggest that the “good trick” was evolution's invention of the schematic model, and specifically in the GUI enabled in cortex!

Unless, of course, we were to posit a “pre-established harmony”. This, however, would be mysticism, not science. This is *our* world, not God's. We do not and cannot have a God's eye view.

3. The formal and abstract problem:

3.1 The formal argument

Consider, finally, the formal and abstract problem. Consider the actual problem that evolution was faced with. Consider the problem of designing instrumentation for the

efficient control of both especially complex *and* especially dangerous processes. In the general case, (imagining yourself the “evolutionary engineer”), what kind of information would you want to pass along and how would you best represent it? How would you design your display and control system?

It would be impossible, obviously, to represent all information about the objective physical reality of a, (any), process or its physical components, (objects). Where would you stop? Is the color of the building in which it is housed, the specific materials of which it is fabricated, that it is effected with gears rather than levers, -or its location in the galaxy- necessarily relevant information? (Contrarily, even its designer’s middle name might be relevant if it involved a computer program and you were considering the possibility of a hacker’s “back door”!) It would be counterproductive even if you could as relevant data would be overwhelmed and the consequent “calculus”, (having to process all that information),^{XVI} would become too complex and inefficient for rapid and effective response.

Even the use of realistic abstractions could produce enormous difficulties in that you might be interested in many differing, (and, typically, conflicting), significant abstractions and/or their interrelations.^{XVII} This would produce severe difficulties in generating an intuitive and efficient “calculus” geared towards optimal response.

For such a complex and dangerous process, the “entities” you create must, (1) necessarily, of course, be viable in relation to

both data and control -i.e. they must be adequate in their function.^{XVIII}

But they would also, (2) need to be constructed with a primary intent towards efficiency of response, (rather than realism), as well -the process is, by stipulation, dangerous! The entities you create would need to be specifically fashioned to optimize the “calculus” while still fulfilling their (perhaps consequently distributed) operative role!

Quoting from my arguments in Chapter 12: In the terminology of computer languages, “danger” may necessitate a “Go To” command which can absolutely violate the “structure”/hierarchy of a program to go elsewhere –even outside the program itself by reason of urgent necessity!

But your “entities” would need to be primarily fabricated in such a way as to intrinsically define a simplistic operative calculus of relationality between them -analogous to the situation in our generic training seminar. Maximal efficiency, (and safety), therefore, would demand crystallization into schematic *virtual* “entities” -a “G.U.I.”- which would resolve both demands at a single stroke. (This, I think, is the ultimate import of Freeman’s discoveries.)

Your objects could then distribute function, (in a “global / cortical mapping”), so as to *concentrate and simplify control*, (operation), via an elementary, intuitive calculus. I think they serve the intentional functions of the brain.

These virtual entities need not necessarily be in a simple (or hierarchical -i.e. via abstraction) correlation with the objects of physical reality however.^{XIX}

But they would most definitely need to allow rapid and effective control of a process which, considered objectively, might not be simple at all. It is clearly the optimization of the process of *response* itself -i.e. a simplistic “calculus”- that is crucial here, not literal representation. We, in fact, *do not care* that the operator *knows* what function(s) he is *actually* fulfilling, only that he does it (them) well!

3.2 The Specific Case of Biology

Biological survival is exactly such a problem! It is both especially complex *and* especially dangerous. It is the penultimate case of complexity and embodies a moment-by-moment confrontation with disaster. It is therefore a schematic model in just this sense that I argue evolution constructed, and I propose it is the basis for both the “percept” and the “mind”.

Turning our Perspective Around

But it is just the *converse* of the argument made above that I propose for evolution however. It is not the distribution of function, but rather the centralization of disparate atomic biological function into efficacious schematic -and virtual- objects that evolution effected while compositing the complex

metacellular organism. (These are clearly just the complementary perspectives on the same issue.)^{XX}

But let's talk about the "atomic" in the "atomic biological function" of the previous statement. There is another step in the argument to be taken at the level of biology. The "engineering" argument, (made above), deals specifically with the schematic manipulation of "data".

At the level of primitive evolution, however, it is modular (reactive) process that is significant to an organism, not data functions. A given genetic accident corresponds to the addition or modification of a given (behavioral/reactive) process which, for a primitive organism, is clearly and simply merely beneficial or not. The process itself is informationally indeterminate to the organism however -i.e. it is a modular whole.¹⁹

No one can presume that a particular, genetically determined response is informationally, (rather than reactively), significant to a Paramecium or an Escherichia coli, for example, (though *we* may consider it so). It is significant, rather, solely as a modular unit which either increases survivability or not.

Let me therefore extend the prior argument to deal with the schematic organization of atomic, (modular), process, rather than of primitive, (i.e. absolute), data. It is my contention that the

cognitive model, and cognition itself, is solely constituted as an organization of that atomic modular process, designed for computational and operational efficiency. The atomic processes themselves remain, and *will forever remain*, informationally indeterminate to the organism.

The evolutionary purpose of the model was *computational* simplicity itself! The calculational facility potentiated by a schematic and virtual object constitutes a clear and powerful evolutionary rationale for dealing with a multifarious environment. Such a model, (the “objects” and their “calculus”), allows rapid and efficient response to what cannot be assumed, a priori, to be a simplistic environment.

From the viewpoint of the seventy trillion or so individual cells that constitute the human cooperative enterprise, *that* assumption, (environmental simplicity), is implausible in the extreme!

But theirs, (i.e. that perspective), is the most natural perspective from which to consider the problem. For five-sixths of evolutionary history, (three billion years), it was the one-celled organism which ruled alone. As Stephen Gould puts it, metacellular organisms represent only occasional and unstable

¹⁹ See Maturana’s “structural coupling” in Chapter 6 for a rationale.

spikes from the stable “left wall”, (the unicellulars), of evolutionary history.

“Progress does not rule, (and is not even a primary thrust of) the evolutionary process. For reasons of chemistry and physics, life arises next to the ‘left wall’ of its simplest conceivable and preservable complexity. This style of life (bacterial) has remained most common and most successful. A few creatures occasionally move to the right... “

“Therefore, to understand the events and generalities of life’s pathway, we must go beyond principles of evolutionary theory to a paleontological examination of the contingent pattern of life’s history on our planet. ...Such a view of life’s history is highly contrary both to conventional deterministic models of Western science and to the deepest social traditions and psychological hopes of Western culture for a history culminating in humans as life’s highest expression and intended planetary steward.”(Gould, 1994)

3.3 Retrodictive Confirmation

Do you not find it strange that the fundamental laws of the sciences, (or of logic), are *so few*? Or that our (purportedly) accidentally and evolutionarily acquired logic works *so well* to manipulate the objects of our environment?

A Profound Teleological Consequence

From the standpoint of contemporary science, this is a subject of wonder -or at least it should be. (cf contra: Minsky, 1985) It is, in fact, a miracle!^{XXI} From the standpoint of the schematic model, however, it is a trivial, (obvious), and necessary consequence. It is precisely the purpose of the model itself! This is a *profound* teleological simplification!

3.4 Conclusion, (section 3)

Evolution, in constructing a profoundly complex metacellular organism such as ours, was confronted with the problem of coordinating the physical structure of its thousands of billions of individual cells. It also faced the problem of coordinating the response of this colossus, this “Aunt Hillary”, (Hofstadter’s “sentient” ant colony).²⁰ It had to coordinate their functional interaction with their environment, raising an organizational problem of profound proportions.

Evolution was forced to deal with exactly the problem detailed above. The brain, moreover, is universally accepted as an evolutionary organ of response, (taken broadly^{XXII}). I propose

²⁰ of Hofstadter, 1979. His is a very nice metaphor for picturing metacellular existence.

that a *schematic* entity, (and its corresponding *schematic model*), is by far the most credible possibility here.

It can efficiently orchestrate the coordination of the ten million sensory neurons with the one million motor neurons,^{XXIII} -and with the profound milieu beyond. A realistic, (i.e. representational /informational), “entity”, on the other hand, would demand a concomitant “calculus” embodying the very complexity of the objective reality in which the organism exists, and this, I argue, is overwhelmingly implausible.^{XXIV}

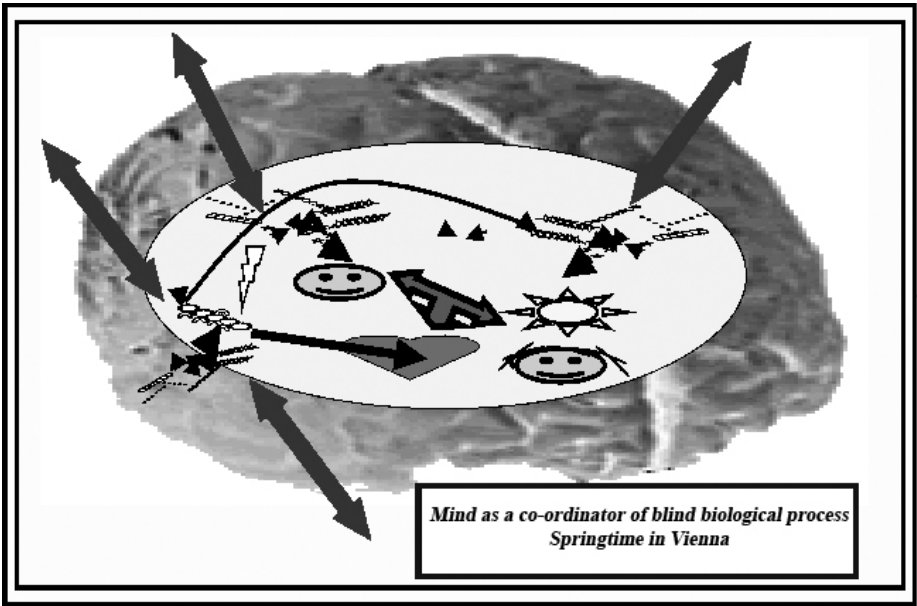

Figure 17: “Lovelife”?

4. The Concordance: Biology’s Proper Conclusion

Now I will move to what I think is the most important purely scientific implication of the combination of this and the

“implicit definition” briefly expounded in chapter 1, and treated again in Chapter 5, (to follow), where will I formally state it as my second hypothesis.²¹ I call it “the concordance”.

In those chapters I have argued that the objects of mind are solely virtual. I argued that they are logically and implicitly defined by the “axioms” of brain function. I believe this line is profoundly explanatory for the deepest dilemmas of mind as we normally conceive it.

In this chapter, I have argued another course -that the objects of mind are biological schematic artifacts. They are optimizing metaphors, artifacts integrating primitive brain process.

Now I propose the biological argument which *relates* the two themes. By identifying the “rule” of the brain, (which, accepting Cassirer’s conclusions of Chapters 3 and 5 specifies a distinct logical concept^{XXV}), with the rule of “structural coupling” of the human organism, (after Maturana and Varela’s profound characterization of biological response –see Chapter 6), then “mind” may now reasonably be defined as the “concept”, (/rule), of the brain. This is a highly significant conclusion!

²¹ I have always had a problem deciding which of these two hypotheses should be stated first. After long consideration, I think this is the way it should be.

Given that the rule is of the specific structure of my extended concept however, (i.e. the concept of implicit definition - my second hypothesis-see Chapters 3 and 5), then mind becomes the specifically *constitutive* concept of the brain in the sense of Immanuel Kant, and not an ordinary concept. It is a concept necessary to -inbuilt into- our cognition, (in the exact sense that Kant used the word), not one imposed upon it.

It is not something *with which* we conceive; it is, rather, the “we” *which conceives!* Following the arguments of the earlier chapters, it implicitly defines and therefore *knows* its “objects”.

Combining the results of the two perspectives, I now assert a concordance. I claim that their conclusions are commensurable. The earlier chapters made the case that it is only by considering our mental objects as operative *logical* objects, as objects *implicitly defined* by the system, that the wholeness and the logical autonomy of sentiency becomes possible. Referential objects do not convey the same possibility.

The present chapter has made the case that it is only as *virtual and metaphorical* objects, artifacts of the system of control, that the profound difficulties of the integration of megacellular response may be overcome. Again, referential objects do not convey the same possibility. The “objects” of each thesis are thus solely objects of their systems! The objects of the earlier, purely logical and cognitive thesis are thus commensurable with the objects of the second, purely biological

and operative thesis. The discovery of such correspondences has always been crucial in the history of science.

But biology affirms the correlation. Modern day biology necessarily must reduce logic *itself*! From an evolutionary perspective, human logic must *itself* be taken as a strictly biological, evolutionarily derived rule of response, (broadly conceived^{xxvi}).

So too must the “concepts” and “categories” embodied within it. Logic *per se* can no longer be taken as “God-given”, or “God-knowledgeable”. Such mysticism is not *compatible* with the perspective of modern science.

It is more than plausible, therefore, for biology to identify that human “logic”, (that *bio* -logic -and the “implicit definition” resident within it), with the rules governing the “objects” of the cognitive G.U.I. of this chapter. “Mind”, as the constitutive concept of that bio-logic, (in Kant’s and Cassirer’s sense), then, is the *biological interface*: the constitutive, holistic, and logical, (i.e. *bio* -logical), expression of the human organism’s organization of response.

This conclusion restores “mind” as we normally conceive it to biology and enables a science of mind. This, the biological perspective of the concordance, I maintain, is the logical and proper biological perspective on the whole of the mind-brain problem. It is where biology must ultimately come to stand.

The special significance of the “concordance” for neuroscience is that it finally enables a viable perspective within

which biological and specifically neural process might be scientifically correlated with the actual specifics of the mind under evolutionary and operational paradigms. The latter, however, remain the most productive heuristic principles in contemporary biology. It opens, moreover, the prospect of a physical description of mind itself!

Our perceptual objects are not objects in reality; they are the implicitly defined logical objects, (alternatively, clearly now, operative objects), of this constitutive logic. They are objects of process.

5. Plain Talk:

Let's talk loosely for a bit. We do not start with absolutes anywhere in our logical and scientific endeavors. Somewhere we start with beliefs. I, for one, believe that I have a mind and a consciousness in the naïve senses of those words. I think most of you believe that you do too.

By this we do not just mean that our bodies mechanically and robotically produce words and actions which “cover the territory” -which merely simulate, (substitute for), sentience in our naïve sense of it, but that there is some universal and unified existence which is aware. But how?

The solution I propose lies in the combination of the concepts of implicit definition, virtual existence -and logic as biology. This is the only model within our intellectual horizons that seems to hold even any promise for sentience in our ordinary

sense of it. It suggests the only scientifically plausible solution to “the mind’s eye” and the “Cartesian theatre” and the only non-eliminativist answer, (for “mind” as such), to the homunculus problem. But these are answers which must exist if mind in our ordinary sense is to be real. The “Implicit definition” of my second hypothesis permits knowing, (as a whole), what are, in some real sense, our distinct and separate parts precisely because those parts, (objects), are in fact non-localized and virtual (logical) expressions *of* the whole. It opens the first genuine possibility, therefore, for a resolution of this essential requirement of “naive” consciousness.

But that pathway, (implicit definition), does not make sense from the standpoint of representation! Implicit definition solves the problem *logically* -from the standpoint of constitutive logic -and speaks to nothing other than its own internal structure. “Objects”, (under this thesis), are known to a system, (i.e. universally/globally), only because they are specifically expressions *of* the system.

It becomes a viable and natural solution to the problem of awareness, therefore, only when the objects of consciousness themselves are conceived operationally and schematically, (and specifically, logically), rather than representatively. When our objects are taken as specifically schematic representations of process however, (as per the present chapter), the solution becomes both natural and plausible. The logical problem of sentience is resolved.

How could evolution organize -as it had to organize- the reactive function of this colossus of seventy trillion cells? Even this formulation of the question disregards the yet more profound complexity of the reactivity of the individual cells -also organisms- themselves! It was the overwhelmingly crucial issue in the evolution of complex metacellulars.

My thesis of schematism is both viable and plausible in this context. But what does this evolutionary development and organization of the reactive process of complex metacellulars have to do with “information”?

That the progressive evolutionary reactivity of this megacollosus occurred under the bounds of real necessity is, of course, a given. It is the basic axiom of Darwinian “survival”. But that it could *match* that possibility²² -i.e. that it could achieve a (reactive) parallelism to that bound -i.e. “information!” -is a hypothesis of quite another order and teleologically distinct. It is, I assert moreover, mathematically immature.

Objective reality is a *bound* to the evolutionary possibility of organisms, (in Quine’s words of my Preface: “the boundary condition”), but under that bound infinitely diverse possibilities remain. I may, as a crude metaphor for instance, posit an infinity

²² See Chapter 6: Maturana and the specific issue of “*congruent* structural coupling”.

of functions under the arbitrary bound $Y = 64,000,000$. I may cite semi-circles, many of the trigonometric functions, curves, lines ... ad infinitum. Only one of these matches the bound, and only a specific subset, (the horizontal lines $Y = a, a \leq 64,000,000$), parallels it. It is a question of the distinction between a bound and a limit. (See Figure 18 following shortly.)

The reactive evolutionary actuality of an organism certainly exists within, (and embodies), a lower bound of biological possibility. But that some such, (*any* such), organism, (-to include the human organism!), embodies a *greatest* lower bound -i.e. that it, (or its reactivity), matches and meets, (or parallels, i.e. knows!), the real world does not follow.

It is incommensurate with the fundamental premise of “natural selection” and stands as the “parallel postulate” of evolutionary theory. Organisms do not know; organisms do! Organisms survive!

How much more plausible, is it not, that the primary and crucial thrust of evolution was coordination, and specifically a coordination of allowable or appropriate, (rather than “informed”), reactive response? I submit that from a biological perspective the schematic object is far more plausible than the representative one. It involves no “magic”, and is totally consistent with our deepest conceptions of biology.

I submit that no other viable, (i.e. non-eliminative or non-dualistic), explanation, -an actual explanation rather than a prevarication, has ever even been offered for mind and

consciousness as understood in our ordinary sense. The argument, then, is one of demonstration. If no truly viable alternative can be offered, then this one must be considered seriously.

The operational process of brain, (and its evolutionarily determined structural optimization), I argue, implicitly defines its “objects”, its “entities” in the same sense and in the same manner that the “process” of an axiom system implicitly defines its “objects”. The “objects of perception” are “intellectual objects”. They are (constitutive) conceptual objects. But *those*, in turn, are schematic objects, (alternatively, “operational objects”), *only*, in no necessarily simple correspondence with objective reality. They are *metaphors* of response.

Bounds and Limits

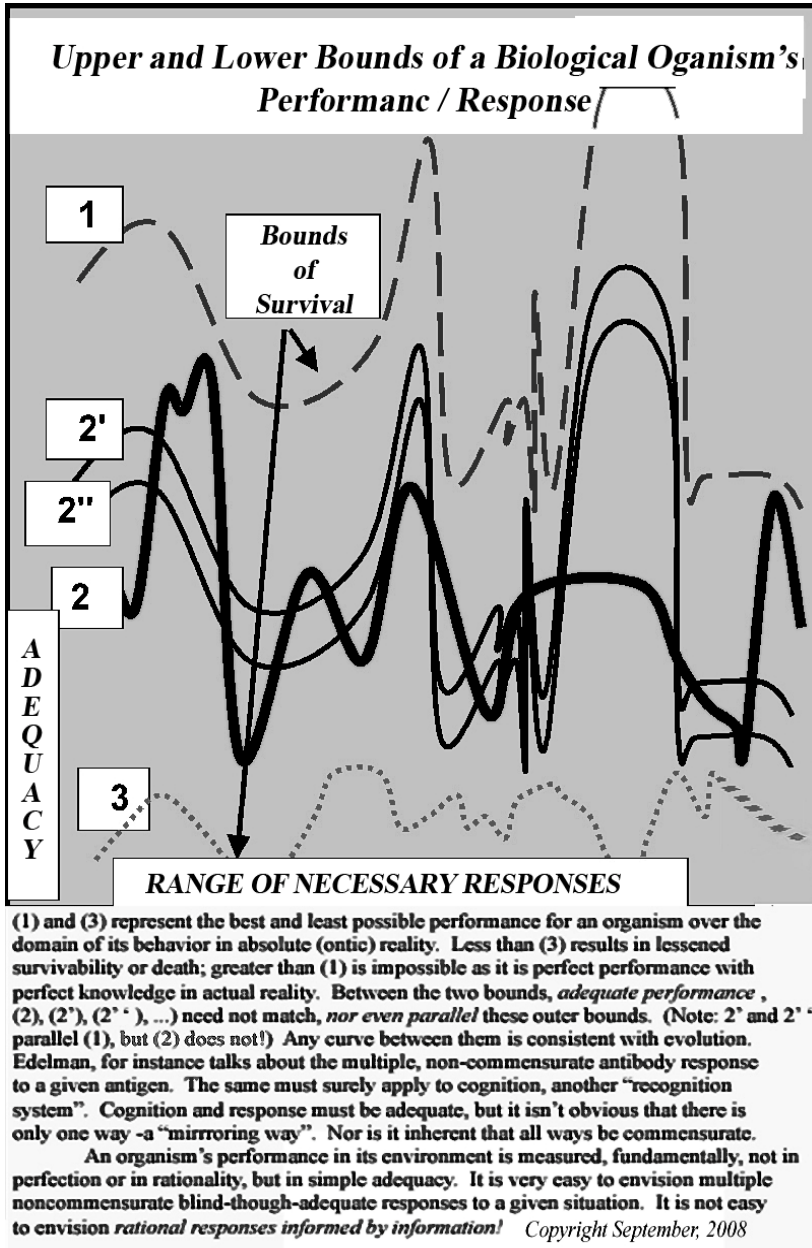

Figure 18 –an Illustration of Bounds and Limits:

(1) and (3) represent the best and the least possible performance for an organism over the domain of its behavior in absolute (ontic) reality. Less than (3) results in lessened survivability or death; greater than (1) is impossible as it is envisioned as perfect performance with perfect knowledge in actual reality. Between the two bounds, “adequate performance”, (... (2), (2’), (2’’) , ...) need not match, *nor even parallel* these outer bounds. [Note: 2’ and 2’’ parallel 1, but 2 does not!] Any curve within them is consistent with evolution.

Edelman, for instance, talks about the multiple, non-derivative antibody responses to a given antigen. The same must surely apply to cognition itself, another “recognition system”, (using Edelman’s terminology). Cognition and response must be adequate, but it is not obvious that there is only *one* way -a mirroring way. Nor is it inherent that all ways be commensurate! An organism’s performance in its environment is measured, fundamentally, not in perfection or in rationality, but in simple adequacy. It is very easy to envision multiple, noncommensurate, blind-though-adequate responses to a given situation. It is not easy to envision rational responses *informed* by information!

Appendix, (Freeman & Automorphism)

An aside: a fascinating quote from Freeman, (it rings strong “bells” in my head)!

“Some people turn to chemicals as a way to deepen the privacy within solipsistic chasms, and in order to retreat from social stress into inner space. A few have induced these states so as to peer through the solipsistic bars and dirty windows in order to see what is ‘really there’, although, as minds disintegrate, what comes are swirls and tinglings, and ultimately the points of receptor inputs like stars, flies or grains of sand.” (Freeman, 1995, my emphasis)

Freeman and I have the same problem -in our innate resistance to the consequences of our own nonrepresentationalism. I too have wrestled with the “points” of sensory input -“like stars, flies or grains of sand”. The conclusion I have reached however is that our “points” are, in fact, primitive, atomic, (unspecified) process, not information. From the simpler perspective of ordinary biology, this is more obvious. These processes, (i.e. pragmatic and adequate, but *not* informational processes), are the necessary basic building blocks of biological cognition. These are our “points’. The difficulty lies in the automorphism we presume in cognition itself, and this is not an easy problem.

How can science continue to make new, profound discoveries? How can the level of verifiable intricacy continue to multiply, seemingly without bounds within the legitimate confines of science? How can the various branches of science continue to integrate and resolve themselves within one comprehensive picture? How could, and why does statistics in fact work? These are the real and crucial questions that a non-representational conception of mind must address.

The fact that the overall picture is getting better –that it is completing itself- does not in itself invalidate the hypothesis that it is non-representational however. Nor does its overwhelming level of intricacy.

To answer the objection, let me reiterate a *counter* question: Is it not possible that we, like a swarm of bees, are merely building, (completing), a “hive”, (our worldview)?

We may be completing our interface with externality, but it does not follow at all that that interface is representational. What does follow is that it is the most efficient one possible within our context. This, I believe, is a system with (mathematical) closure –it never escapes itself.

We presume that our science maps back, (automorphically), onto the very model we visualize. But the *path* of the automorphism we seek, I propose, lies through the very “gears and levers” of the *original* evolutionarily derived topobiological cognitive model itself, (*re-using* its "objects") - through another iteration –in another re-entrant mapping which

supplies the mechanics and the transformation (back into Freeman's non-topological dispersive mapping into the overall brain) that we seek.

I propose that *reafferance* within the loop of brain function combines with input from outside the loop, (passing through the environment), to yield a consistent, compound map which either does, or does not confirm our theoretical constructs. Nowhere does this conception demand the absolute (ontic) reality of the objects of those constructs, however. It is a reuse of our evolutionarily pragmatic (cortical) objects, (like Rosch's prototypes??), saying nothing whatsoever about the real (external) world in which we live.

Why is this an important advance in our perspective? Because it allows the use of my second hypothesis of "implicit definition" in a legitimate scientific context. (See Chapter 5). That second thesis enables, for the very first time, legitimate scientific conceptions of the most fundamental aspects we demand for "mind" itself: i.e. a "Cartesian Theatre", the elimination of the problem of the "homunculus", and "knowing" per se. These are not trivial consequences.

Thus microscopy, anatomy, biology, physics ... is fed through the same interface to yield an image --of the body of another being or of our own, for instance, or the nature of our environment. But the "objects" are functions of the interface itself, not of an external ontology. This, I believe, is the mechanics of the automorphism we seek --i.e. the one processed

by the brain, using its own transformation and mapping back onto its own map *reusing* the "objects" of that map. It is Edelman plus Freeman plus Merleau-Ponty and back to Edelman. It already exists. (The automorphism can be skewed by the *intent* of the model however –i.e. it can be processed to a different purpose.)

(The whole of this discussion is nonsense, of course, in the absolute form within which it is stated.) Does our feedback really preserve parallelism in the absolute form I have proposed? It is a valid statement *within a context*, but in an absolute ontological sense these are things we can never truly know. A proper formulation must await the introduction of a completely new philosophical perspective -i.e. that of Cassirer's Philosophy of Symbolic Forms which I will detail in Chapter 7. This supplies the rigorous, (and biologically necessary), scientific epistemological relativism required by the parameters of the problem.

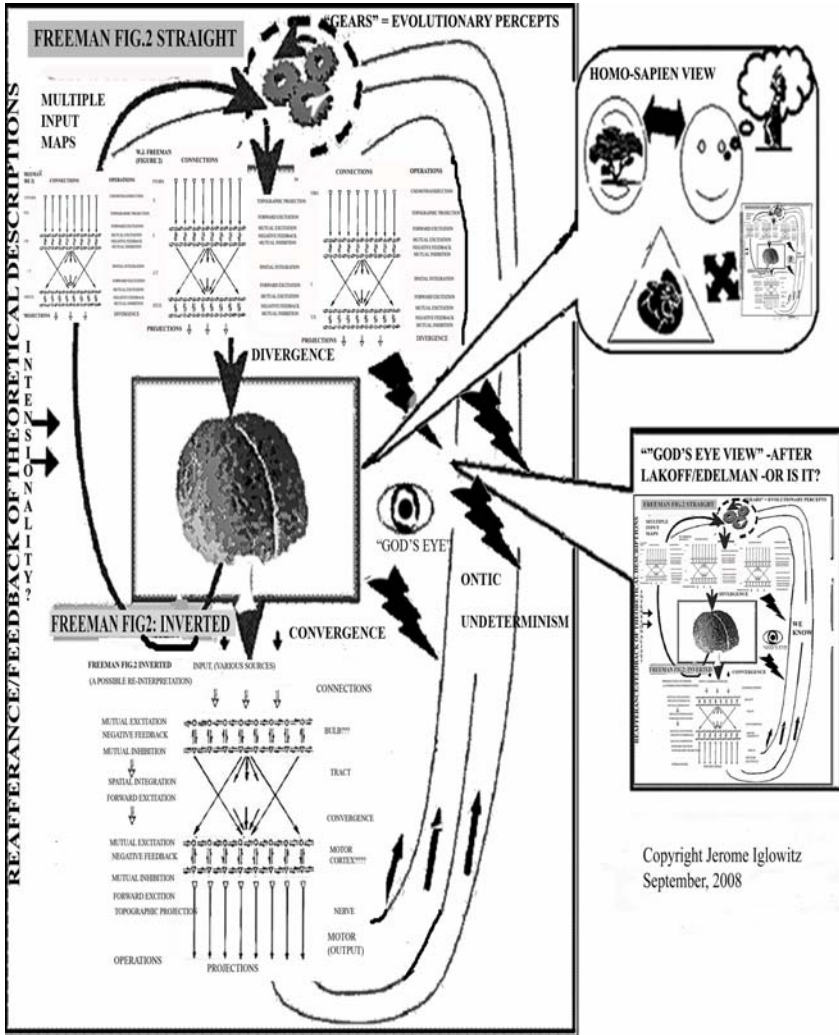

Copyright Jerome Iglowitz
September, 2008

Figure 19: GOD'S EYE?

Edelman to Freeman to Edelman^{XXVII}

-----DIV----- = Epistemological

Relativism!

(DIV Merleau-Ponty)

Quoting Freeman:

“To explain how stimuli cause consciousness, we have to explain causality. [But] We can’t trace linear causal chains from receptors after the first cortical synapse, so we use circular causality to explain neural pattern formation by self-organizing dynamics. But an aspect [a key aspect] of intentional action is causality, which we extrapolate to material objects in the world. Thus causality [as far as humans are concerned] is a property of mind, not matter.” (Freeman, 1999)

Where is the world outside? What is the world outside? Freeman describes his stance as “epistemological solipsism”. I understand his rationale, but let me suggest something else. As realists, we necessarily accept the actual existence of an external reality, (as does Freeman), but the fact is we can never know it. Instead of epistemological solipsism, (which is circular ontological language at best), let me suggest another characterization: i.e. ontic indeterminism. (I think Maturana came closest to a realization of this characterization: See Chapter 6).

We must accept the existence of externality, but, as biological organisms, there is not even a possibility that we may ever know it. We can never attain a “God’s eye view”.

There is a good side to this, however. If we accept the existence of other beings as well, (as I think both you and I do as

intentional *belief*), then we are not limited to enclosing them hierarchically. We are not obliged to limit them to their “properties”. Who is old or young? Who is white or black? Who is crippled or sound? Who is beautiful or ugly? What is the possibility and the “soul” of man?

I have made a point earlier that I think is worth repeating here. I argued that it is not important that the “operator” of such a complicated process knows what it is, (specifically), that he is doing. It is important *only that he does it well*. It is crucially important that he does it diligently, however. It is imperative that he be locked into the loop of his virtual reality -that he “pay attention”.

This introduces the necessity of an *inbuilt realistic imperative* -i.e. a mechanical guarantee of his dedication.^{XXVIII}. The universal and dogmatic belief in the simple reality of our natural world is thus itself a consequence of my thesis -and the greatest obstacle to its acceptance!

Speaking of falsifiability, consider Dennett’s “Color Phi” from our new perspective. Here is a case where the mental content *is* falsifiable under the standard interpretation. And yet it exists -*it has been confirmed repeatedly*. What *else* follows? Phantom limbs, blindsight? Are these not clear examples, falsifying the standard paradigm, (i.e. representationalism), and easily incorporated into the converse picture of a *virtual* mind?

Chapter Conclusions:

This (specific) chapter, by itself, does not answer the questions of consciousness. I do claim it as a valid, but specifically biological perspective and *part of* the solution however. It is important at this early stage because it enables my *other* crucial hypothesis: i.e. that of "implicit definition". That second hypothesis finally offers an explanation of the profoundest problems of mind, *per se*. It finally elucidates Leibniz' profound problem: "How is it possible for the one to know the many?" It answers it by finding that "the many" are, in fact, *part of* "the one". The logic of brain *implicitly defines* our objects because they are *operational objects* as seen under my previously presented "concept of implicit definition". This is how we are able to know them! *This* is the ground of the "Cartesian Theatre" and finally lays the "homunculus" to rest. But implicit definition as a solution to these problems makes sense only in an operational system, not an informational one.

But still we are not at the end of our quest. There still remain two more critical steps. The first is an examination of what *any* kind of knowledge *per se* could possibly be. Ernst Cassirer proposed that all knowledge is axiomatic. Otherwise stated, it is all hypothesis and organization, (commensurate, of course, with experience).

His brilliant conclusion was to realize that there could be many beginnings, many organizations, and that the comprehensiveness of a one given theory did not preclude the

comprehensiveness of another. What it leads to is a conclusion of the indeterminacy of our absolute understanding of the world around us, (ontic indeterminacy). But this is just what we would expect of the biological organisms we both understand ourselves to be.

This frustrating conclusion actually leads to the proper ground for an understanding of "mind" however. That ground lies in the realization of our basic realist posture itself – in our belief system itself. It is what we, as realists, absolutely refuse to give up and which is innately incorporated in *any* theory we will countenance.

Putnam, Lakoff and Edelman, (and Kant himself), propose three basic tenets of scientific realism. They are:

(1) “A commitment to the existence of a real world external to human beings

(2) a link between conceptual schemes and the world via real human experience; experience is not purely internal, but is constrained at every instant by the real world of which we are an inextricable part. A concept of truth that is based not only on internal coherence and “rational acceptability”, but, most important, on coherence with our constant real experience

(3) a commitment to the possibility of real human knowledge of the world.” (I differ with this last postulate for what should now be obvious reasons.)

(Note: Points 1 through 3 might almost be a restatement of my claims regarding and framing the “interface: in Chapters 9 and 10!)

But I propose a further postulate, (elaborating on the sense of postulate two above). I propose the *actual ontic existence* of an "interface" between the "real world" and "experience" however—consistent with Freeman’s conclusions, for instance.

It is the existence of the actual substance of this “interface” that I will propose is the substance of the mind. (Cassirer will place strong limitations on our description of this interface however –it will have to be a *context-free* description.)

My third hypothesis, (foreshadowing a bit), will be to assume that this “interface” is structured in the same way as I have postulated for the brain and experience, (my first and second hypotheses). All the other substantive problems are answered in my first and second hypotheses. Thus it will follow that we are, (this interface is), “live”, we are, (this interface is) “conscious”, and we, (as minds), *do exist!*

Chapter 5: my Second Hypothesis –a Short Sketch

Note: This second thesis is already better rendered at your level of preliminary understanding in the beginning stages: chapters 1, 2 & 3 of the present paper so here I will only sketch an overview and then proceed to an elaboration as a “snippet” drawn from the first edition of my book which corresponds to that opening material. That original chapter of the first edition elaborates further the philosophical argument regarding the “concept of implicit definition” and I have added to it a bit. It was mostly original with me, contrary to the case with Chapters 1 and 2 of this current writing, but with which it is totally consistent. It derived from my early understanding of mathematics.

I always hated High school mathematics and had an extremely difficult time with it. The reason lay in the fact that on days 1 and 2 of most of these courses, the beginnings were both plausible and highly interesting to me. But then on day 3 –and it was *universally* so- the instructors began their dialogue with the words “and therefore”, and jumped to conclusions which totally confounded me, and which, it turns out, were totally unwarranted.

It was only in my autodidactic digestion of MacClane’s book that I realized that there were months of intense work between days 2 and 3, and it made me furious for being so deceived. I never forgave them. Even the simplest of

mathematical operations involved laborious computations and intermediate theorems derived from the axioms and definitions, (which primed me for Hilbert's "Implicit Definition"), and had absolutely nothing to do with the "permissive" and totally blind, (and never specified), "objects" themselves.

2. Contrary to Dennett, Hofstadter, Churchland, et al, this, my second hypothesis, asserts that the problems of sentience –of consciousness: the "homunculus" problem, the "mind's eye", "the Cartesian theatre", ... actually *are* capable of solution within the physical world, (and I have proposed an explicit solution).¹ Indeed they *must* be solvable if mind in our ordinary sense of the term is to exist at all. (Dualism is a non-answer. It is a philosophical "cop-out"!) But these problems are not solvable within the confines of classical Aristotelian logic or its modern embodiments. Current logic, still based essentially in the Aristotelian, (i.e. "generic" and hierarchical, set-theoretic), formal concept, is inadequate, I maintain, for the *specifically logical* problems implicit in the mind-brain problem.

An Aside for Clarification:

Let me introduce two diagrams which I will replicate again in Chapter 12. These are fundamentally just input-output loops, (sensors/motor nerves), with feedback.

Figure 20:

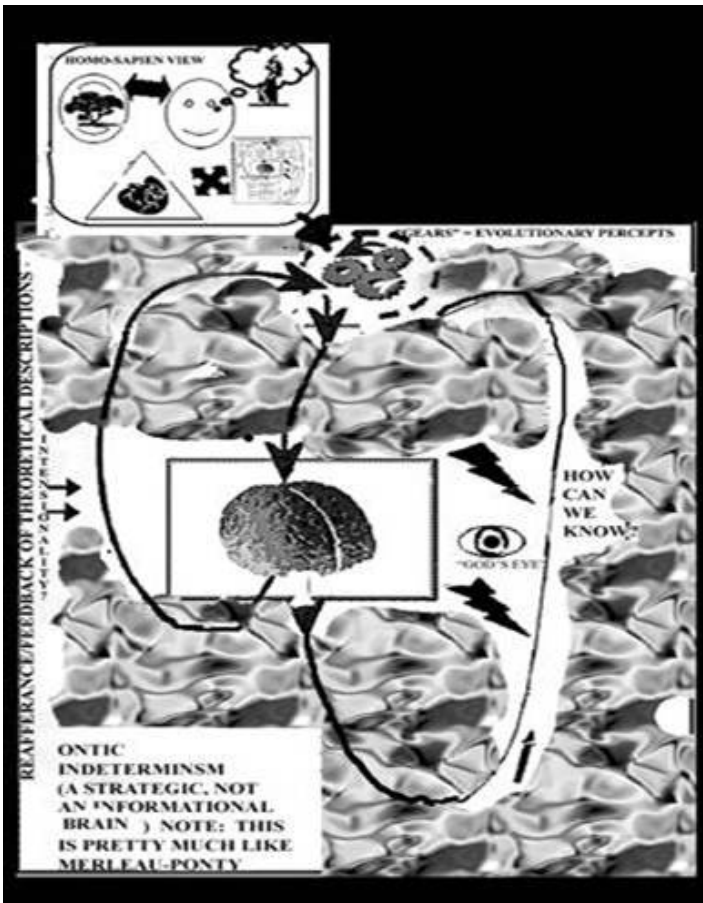

Any physical description of a mind, (or of a community of such minds), as mechanisms/organisms, must meet the minimal necessities of these diagrams. They must embody action

into the world and self-correcting feedback in the sense of Merleau-Ponty. Repeating the Freeman quote yet again:¹

“In particular, Maurice Merleau-Ponty in "The Phenomenology of Perception" [2] conceived of perception”, [*itself*], as the outcome of the "intentional arc", by which experience derives from the intentional actions of individuals that control sensory input and perception. Action into the world with reaction that changes the self is indivisible in reality, and must be analyzed in terms of ‘circular causality’ as distinct from the linear causality of events as commonly perceived and analyzed in the physical world.”¹¹ W.J. Freeman, 1997

¹ I cannot expect that every reader will read this book in context. I will therefore repeat the critical citations where I think it is necessary.

Figure 21.

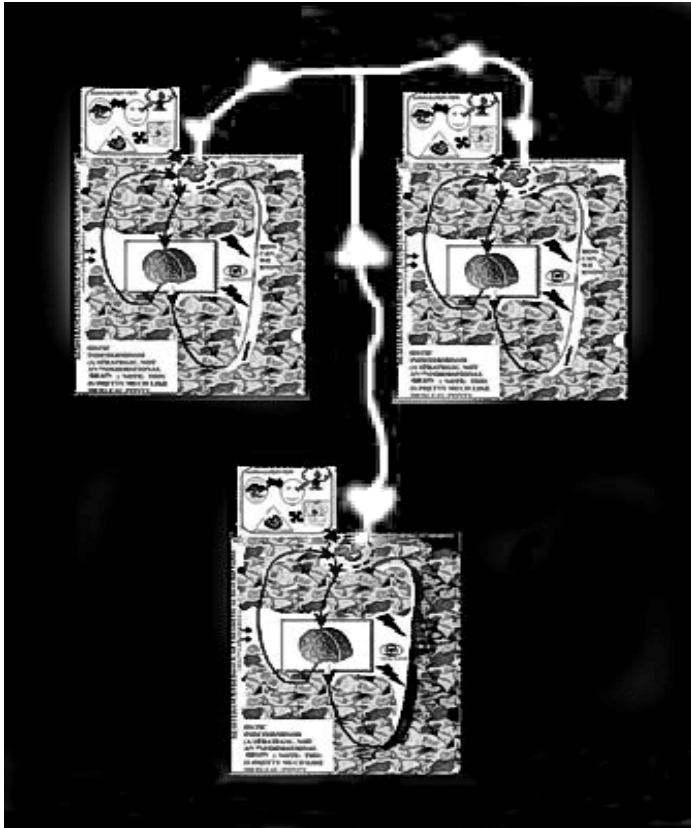

This is the model I propose for human reality, but it is lived through the “gears and levers” of our evolutionary artifacts, the latter being understood from the perspective of biology, itself just one of Cassirer’s multitudinous “Symbolic Forms”. This, I believe, is the homo sapien cognitive reality

What is the “space” that a *machine per se* must necessarily live in? It is a space of total unknowns. It is a space of ontic indeterminacy and the machine really doesn’t “care” or “know”. Machines only “do”. They do it on the surface of the

Moon, or in the Pope's living room. It is simply a question of whether or not it works and survives intact!

A machine/mechanism cannot "know"; it can only react. How then could there be "knowing" other than in its contemporaneous physically reductive sense, (Dennett), as mere pertinent mechanical reaction? How could there be a Cartesian theatre, and what of the homunculus? How could a whole know its parts in Leibniz's sense? These questions, moreover, embody pretty much the whole of the very essence of our demands for "mind" in our intuitive sense of the word.

This was the first formulation of the mind-brain problem I conceived about 50 years ago and I think it was precisely on target. The sole possibility of a solution I saw then, and still the only one I can see now lay in an adaptation and incorporation of something very strange. It was Hilbert's "concept of implicit definition" which seemed to offer the only conceivable answer to the dilemma other than a circumvention. Hilbert's conception, taken operatively, wherein the "axioms" are re-interpreted as the physical building blocks of the brain, allowed "live", (but specifically *virtual*), objects to physically exist even within the sense of a pure mechanism.

To repeat the quote by Schlick:

“The [Hilbert’s] revolution lay in the stipulation that the basic or primitive concepts are *to be defined*² just by the fact that they satisfy the axioms.

[They] "acquire meaning only by virtue of the axiom system, *and possess only the content that it bestows upon them*. They stand for entities *whose whole being* is to be bearers of the relations laid down by the system.", (my emphasis)³

The hard conclusion followed, however, that those “objects” would necessarily have to be “implicitly defined” within the very mechanics of the system itself –i.e. they would have to be operative, internal and logical objects and not referential ones except to the system itself. And how could this be?

² It is crucial to understand that "defined" is used in a very different sense in mathematics than in the sense of ordinary "dictionary definition". It specifies the *actual*, the whole and exclusive *existence* -for mathematics- of the entity defined. Mathematics students are ingrained in this as the very first step towards "mathematical maturity".

³ Please note the close parallel to the argument I made in the "training seminar" of Chapter 4

This route led me through the development of my first thesis, and eventually through my third thesis which answer these profound difficulties.

Building on Ernst Cassirer's innovative *rule-based*, (rather than property-based), reformulation of the classical concept itself, (his "functional concept of mathematics"), and a new application of David Hilbert's brilliant logical reorientation of mathematics onto purely axiomatic grounds: "implicit definition", [as strongly distinguished from his later "Formalism"⁴ –the current paper probably explains the foundations for this thesis best]. I propose a further extension of Cassirer's formal and technical "Concept", (and its subsequent logic), to a new and largest formal "Concept": i.e. "The Concept of Implicit Definition", (C.I.D.), which is largely equivalent to the *complex rule* of an axiom system.⁵

The Concept of Implicit Definition

Following and extending Cassirer's cogent arguments, (see Chapter 3 and especially the "snippet" to follow), dualism and opposition, (innate in classical logic and themselves the basis of the "homunculus", I argue), are then, (after Hilbert), no longer

⁴ Which some still persist in confusing –See Shapiro discussion of Chapter 3.

innate in this new Concept. Just as Cassirer argued for his own “Functional Concept of Mathematics”, I argue that CID no longer derives from presentation vs. attention and abstraction in cognition- which latter is generally accepted as the theoretical basis of the classical Concept, but rather is unary⁶ and *internally*, (i.e. *logically*), resolving of its objects in the sense of Hilbert and modern mathematics.

The extended Concept, (CID), is no longer confined to *intellectual* cognition, (i.e. logic and concepts), however, but is adequate to *perceptual cognition*, (i.e. "objects"), as well. (From the physical perspective⁷, I argue that our primitive perceptual “objects” are evolutionary optimizations of process.) CID is a *constitutive* logic in the sense envisaged by Kant –or it may itself *actually be* that constitutive logic that he envisioned! In concert with the first hypothesis, (non-*representation* = "not presentation"), it allows a solution of the logical problem by permitting cognition and "objects" *without* presentation and without the latter's implicit oppositional "cognator" -i.e. without a homunculus. Reconceiving brain function as *organization* rather

⁵ See Chapter 3 for a full elaboration of this whole concept.

⁶ In the sense of Hilbert's “from the *whole* of the axiom system” quoted earlier

⁷ Itself taken as a legitimate though relativized “symbolic form” in the sense of Chapter 8

than representation, (Chapter 4), allows mind and cognition in our ordinary, unified sense.

A significant corollary of this hypothesis is that it allows mind to be productively defined as the biologically logical, i.e. the *operative* "concept" of the brain. It allows it to be seen as an expression of the *behavioral rule* of the brain, (taken in Cassirer's sense of "the rule of the Concept"). (But here "logical" itself and "concept" itself are expressed in a reductively materialist sense. My third thesis, to be developed shortly in Chapters 7 through 9 will rectify this.) This present, however, is an important result since I have argued that it is only in taking our objects as *specifically logical* objects that the homunculus problem can be solved, and it shows the relevance of that conclusion to the specifically biological problem. But the "logic" just mentioned is *biological* logic in the sense of the first hypothesis. It is the "calculus" of our biological "schematic model".

From Appendix C: Cassirer Again

**(An extract from Iglowitz 1998: Chapter 2 to Expand the
Cassirer and Concept of Implicit Definition Dialogues
Incorporated Hertofore.)⁸**

⁸ Note: This is an excerpt from my original Chapter 2 from my initial MS. It is an expansion of my compacted versions rendered earlier in this book as I thought it might have interrupted the flow of the argument. I think it is a reasonably good overall presentation of Cassirer's perspective and of my expansion of it so I incorporate it here. I think it is worth reading for depth.) Please forgive the repetition of parts of this text, but I want to present it as a whole and completed body. You might want to examine the original book. Note: this was written prior to my acquaintance with the modern "structuralism" / "category theory" dialogue.

How? The Logical Problem of Consciousness

(Cassirer- Hilbert- Maturana: an Archimedean Fulcrum)

"... Every attempt to transform logic must concentrate above all upon this one point: all criticism of formal logic is comprised in criticism of the general doctrine of the construction of concepts."
(Ernst Cassirer)⁹ ¹⁰

⁹ Compare also Lakoff: 1987, p.353. "Most of the subject matter of classical logic is categorization."

¹⁰ Cassirer 1923 pps.3-4

He continues: "The Aristotelian logic, in its general principles, is a true expression and mirror of the Aristotelian metaphysics. Only in connection with the belief upon which the latter rests, can it be understood in its peculiar motives. The conception of the nature and divisions of being predetermines the conception of the fundamental forms of thought. In the further development of logic, however, its connections with the Aristotelian ontology in its special form begin to loosen; still its connection with the basic doctrine of the latter persists, and clearly reappears at definite turning points of historical evolution. Indeed, the basic significance, which is ascribed to the theory of the *concept* in the structure of logic, points to this connection. ..."

[But] "... The work of centuries in the formulation of fundamental doctrines seems more and more to crumble away; while on the other hand, great new groups of problems, resulting from the general mathematical theory of the manifold, now press to the foreground. This theory appears increasingly as the common goal toward which the various logical problems, that were formerly investigated separately, tend and through which they receive their ideal unity."

It is just this "general mathematical theory of the manifold" to which he refers at the end which, I will argue, forces an even further extension of Cassirer's own arguments.

The problem of "consciousness" and the profoundest paradoxes of the mind-body problem: the "Cartesian theater", the "mind's eye", and the "homunculus" are *logical* problems. They are problems of *logical possibility!*

How could cognition, *how* could mind, ordinarily taken, even *exist?* It is not so much a problem of what it is that they *actually are*, but rather a problem of how is it even possible that they *could be!*

How, as Leibniz framed it, *could* "the many be expressed in the one"? How could we *know?* In the context of realism, ordinary logic allows not even a possibility -other than an eliminative reduction, (a denial), of the problem -and of sentience itself.

The "schematic model" of my first hypothesis cuts to the core of these problems. Coupled with Ernst Cassirer's extension of traditional logic, (his "Functional Concept of Mathematics"), itself extended again in light of the expansion of logical possibility innate in David Hilbert's "implicit definition"¹¹ for the axiom systems of pure mathematics, it illuminates them and demonstrates a specific "how" for the first time.

¹¹ as strongly distinguished from his "Formalism" which is quite a different issue

The answer turns on an extension of the formal logical Concept¹² and with it, of logic itself. Surprisingly that answer will allow us to retain our normal, ("folk"), conception of mind as well.

Cassirer and Classical Logic:

2. Cassirer argued that “the object” of modern mathematics, and “the object of mathematical physics”¹³ as well, (their "ideal" objects), are *conceptual* objects (only). He maintained that the Concept they actually embody in modern science is not the classical (Aristotelian) "generic Concept" however, but is rather a new "Functional Concept of Mathematics", (Cassirer’s reformulated “*Concept*”). He argued that modern mathematics and modern physics have *already* reconceived the formal logical "Concept" itself, albeit tacitly.¹⁴

[Repeating just a bit:]

¹² I will be employing a convention of capitalizing the word “concept” when it denotes the formal, technical notion of the concept to avoid such verbiage as “the concept of the concept”, etc.

¹³ See the Heinrich Hertz citation in Chapter 8.

¹⁴ *ibid.* Also see his "Einstein's Theory of Relativity"

Concept vs. Presentation:

Cassirer's new formal Concept is no longer logically derivable *from its extension* however:

"The meaning of the *law* that connects the individual members is not to be exhausted by the enumeration of any number of instances of the law; for such enumeration lacks the generating *principle* that enables us to connect the individual members into a functional whole."¹⁵

If we know the relation by which a b c . . . are ordered, we can deduce them by reflection and isolate them as objects of thought. "It is impossible, on the other hand, to discover the special character *of the connecting relation* from the mere juxtaposition of a,b,c *in presentation*."^{16 17}

"That which binds the elements of the series a,b,c,... together is not itself a new element, that was factually blended with them, but it is the rule of progression, which remains the same, no matter in which member it is represented. The function F(a,b), F(b,c),..., which determines the sort of dependence between the successive

¹⁵ *ibid* P.26

¹⁶ *ibid* P.26, my emphasis

members, is obviously not to be pointed out as itself a member of the series, which exists and develops according to it."¹⁸

This latter is the *definitive* argument against “abstraction” as the *general* case and “presentation” as an ultimate foundation for logic. The association of the members of a series by the possession of a common "property" is only a *special case* of logically possible connections in general. But the connection of the members "*is in every case* produced by some general law of arrangement [order] through which a thorough-going rule of succession is established."¹⁹

Contra the Theory of Attention:

The "*theory of attention*"²⁰ therefore "loses all application in a deeper phenomenology of the pure thought processes", (i.e. cognition). The similarity of certain elements, (under the classical view), can only be (conceptually) meaningful when a

¹⁷ cf. Stewart, 1995, "Fibonacci Forgeries". Stewart's article illustrates the case. The "insufficiency of small numbers" leads to an indeterminability of any finite series.

¹⁸ *ibid* P.17

¹⁹ *ibid* P.17, my emphasis

certain point of view has *already* been established²¹ from which the elements can be distinguished as like or unlike. This identity of reference under which the comparison takes place is, however, "*something distinctive and new as regards the compared contents themselves.*"²²

The distinction between the concept and its extension, therefore, *is categorical*²³ and "belongs to the 'form of consciousness'".²⁴ It is "a new expression of the characteristic contrast between the member of the series and the form of the series".²⁵

Cassirer argued that it is the equivalent of his "Functional Concept of Mathematics", rather than the generic concept, that is the *actual* "Concept" which has been employed throughout the

²⁰ It is "presentation" vs. "attention" which is at the basis of the oppositional orientation of classical logic, and which is ultimately, I will argue, the origin of the problem of the homunculus.

²¹ Compare Lakoff: "Category cue validity defined for such psychological (or interactional) attributes might *correlate*", (his emphasis), "with basic-level categorization, but it would not *pick out* basic-level categories; *they would already have to have been picked out* in order to apply the definition of category of category cue validity so that there was such a correlation." (Lakoff: P.54, my emphasis) See Afterword: Lakoff / Edelman. This is surely directly relevant to the context problem as well, (i.e. "the frame problem), in Artificial Intelligence research. (cf. Dreyfus, 1992)

²² *ibid* p.25

²³ But see my discussion later.

²⁴ *op. cit* P.25

²⁵ *ibid* p.26

history of modern science.²⁶ He offered a convincing co-thesis, furthermore, that the objects of mathematics and science are "implicitly defined", (in Hilbert's sense), specifically.²⁷ The "functional concepts", (their primitive laws), implicitly define their conceptual "objects" -and these are the actual working objects of science.²⁸

Major Consequences:

Cassirer's "Functional Concept" marks a profound advance to understanding, (and our specific problem), in two respects:

(1) it redefines the formal Concept, *fundamentally*, as a "functional rule" and,

(2), it isolates the concept as (logically) separate from, -as from a "different world" than -the "objects" it "orders". The concept is no longer inherent in the elements it orders, (e.g. of "perception"), nor is it (logically) derived from them.

²⁶ "...the concept of function constitutes the general schema and model according to which the modern concept of nature has been molded in its progressive historical development." (ibid, P.21) See also especially: *Einstein's Theory of Relativity*, Cassirer 1923

²⁷ Discussing Hilbert, Cassirer says: "The procedure of mathematics here", (implicit definition), "points to the analogous procedure of theoretical natural science, for which it contains the key and justification." ibid p.94

²⁸ Heinrich Hertz is relevant here:

It is:

"a new 'object' ... whose *total content* is expressed in the relations established between the individual elements *by the act of unification*."²⁹

Re Presentation:

The Concept is a purely intellectual -and original- entity, a "peculiar form of consciousness, *such as cannot be reduced to the consciousness of sensation or perception*."³⁰ It is neither a copy of nor an abstraction from its extension. It is an *independent* and "mathematically" functional "ordering" –*an act of unification!* It is a rule not logically derivable³¹ from presentation. *That* rule, I will argue, is provided by biology, *not* by revelation.³²

Cassirer has removed logic, (in his critique of the formal Concept), from the simple abstraction of perceptual objects, (i.e. from presentation). It becomes instead an *internal* function of the mind, (and hence, I will argue, of biology) –he calls it “a new form of consciousness”.

²⁹ *ibid* P.24

³⁰ *ibid* p.25, my emphasis

³¹ i.e. under classical logic

³² i.e. it is not transcendent –nor does it provide a “God’s eye view”!

I will now proceed to argue a very natural extension (and, I think, a completion) of Cassirer's thesis: "the Concept of Implicit Definition". This Concept, part of that *same* "new form of consciousness" is also internal and logically independent from perceptual presentation as well. I will argue, in fact, that it *creates* its very "objects" – its "extension" -*within* the same free act of unification. Even our very "perceptual objects", (as well as our "intellectual objects"), I will argue, are resolved within the same internal (biological) act.

This will remove, (in agreement with Maturana, Walter Freeman, and Edelman), the need for "presentation", (*metaphysically taken*), altogether. It is the (presented) "perceptual object", I will argue in specific disagreement with Cassirer however, which has been hypostasized! This further reformulation of the Concept and its subsequent logic will allow the resolution of the logical paradoxes of sentiency.

Cassirer's Concept, (the Functional Concept of Mathematics), is unique in that its arguments show that the fundamental logical Concept is *not* derived from presentation or perception. It is a free and independent act (of unification). It is a "new form of consciousness" according to Cassirer and *not* dependent on them.

But if his arguments are believed, (and I think they are *very* strong), then there is a very *natural* extension of Cassirer's Concept wherein the rule, (which determines the concept), can be likened to the conjunction of the axioms in an axiom system and

its objects, therefore, to the objects of implicit definition. This is the import of my prior arguments in Chapter 3 regarding the Cantor diagonal argument and its implications for structuralism. Putting this conception within the framework of biology, it opens a new possibility –it potentiates the possibility *that objects as well*, (and not just intellectual concepts), can be free creations, acts of unification of that same new consciousness and not dependent on presentation or perception either!

It is clearly in “*presentation*” *itself* that the paradoxes of the homunculus and the Cartesian Theatre arise, after all, and these are specifically paradoxes of presentation. If our perceptions were *presented to us*,³³ -if mind, consciousness and perception were presentational and dualistic, (which is implicit in the presentation/attention → abstraction of classical logic) -then the paradoxes of sentiency would be innate and irresolvable.

But if those perceptions arose *within* us, and if consciousness arose as a whole, (as the unified rule of "ontogenic coupling", after Maturana, as I will argue), then sufficient grounds for a complete resolution of the problem would be established. This is not an answer from solipsism, dualism or idealism however, but from *realism* sans information and presentation.

The Concept of Implicit Definition:

(a natural extension of Cassirer's "Functional Concept of Mathematics")

3. Cassirer's "Functional Concept of Mathematics" does not exhaust the possibilities however -not even for mathematics. The "implicit definition" of axiomatic mathematics has specific and *converse* consequences for the formal Concept. Since, (following Cassirer), an actual concept is now defined by any (definite and consistent) conceptual rule, I propose that the rule of a mathematical axiom system, [in the sense of structuralism], itself generates a perfectly good Concept in Cassirer's sense. Axiom systems embody more profound rules than Cassirer considered however, and I propose that they define the *ultimate* concepts.

Here it is a logically complex, (and typically non-serial), rule which defines the concept, (i.e. the conjunction of the axioms³⁴), and conversely. Significantly, following Hilbert and modern mathematics, it is a definite, logically precise and consistent rule of generation of its "extension" -i.e., of its

³³ as is assumed under the classical view

³⁴ see chapter 3

implicitly defined “elements” as well.³⁵ But axiom systems are not logically "dimensional", (strictly implied in Cassirer's $F(x,y,z,\dots)$), nor do they normally define a "series"; they define the raw (broadest) manifold itself.”³⁶ [Note 2010: That is, they define the permissive and virtual “objects” implicitly defined by its axioms.]

There is no *a priori* presumption of dimensionality in the domain of an abstract axiom system. Nor can the elements of the mathematical manifold be characterized a priori, (dimensionally), *as functional values* of the individual axioms. Their "objects" are *not* "objects" of the sort: $(a_1(x), a_2(y), a_3(z), \dots)$.

Axioms do not interact *dimensionally*, they interact *operationally* [at the fundamental level of meaning!] The combination of axioms, and their rule of generation, (corresponding to Cassirer's "continuous transformation"), is purely, profoundly and complexly logical. A mathematical axiom system need not characterize a "series" or a "series of

³⁵ I am concerned here with the object of implicit definition *only insofar* as it is a logical object, *only insofar* as it is a mathematical object. This is the actual object of implicit definition. I am not concerned with the (different) objects of models with which it may be made to correspond, i.e. with the objects of its possible realizations. This is quite a different case and quite a different object. It is the logical object *per se*, I will argue, that solves the homonculus. This is the significance of my objection to Shapiro’s critique of Hilbert in Chapters 2 and 3.

³⁶ I.e. the abstract set taken in its broadest, most general mathematical sense

series" moreover.³⁷ Indeed, this is the exception rather than the rule. What it must and does embody, however, is the raw manifold itself, (its domain).³⁸ It embodies the "logical continuum" generated by its axioms [which is the lesson we learn from my Cantor argument and from modern structuralism.]. It embodies an "order" of a higher degree of freedom.

The instances of Cassirer's "Functional Concept", (the objects of its extension), are the continuous generation of its rule. The instances of the implicit definition of mathematical axiom systems, the implicitly defined "elements" of their manifolds, are logically continuous as well -they are the continuous generation

³⁷ Cassirer, like Kant before him, considered the "series", (or a series of series), as the ultimate possible mode of logical and conceptual organization. He saw it as the ultimate expression, and only possible principle, (rule), for a logical function, (i.e. a logical principle which specifies its extension), other than identity. He based his new formal concept, ("the Functional Concept of Mathematics"), upon that belief.

But that conception is inadequate and inaccurate for the case of modern mathematics which was forced to deal with the continuum. Axiom systems exactly describe, (specify), elements, (their extension), that are not generally, (i.e. not a priori), organizable on a series principle. Axiom systems embody a larger and broader logical principle, (a rule which specifies its instances), and a broader logical concept, (as demonstrated, I suspect, by Gödel). The elements of a mathematical domain are fully prescribed, ("functionally" in Cassirer's sense), by their axioms, (their rule), but this rule is not "series". It is a complex logical rule -not referring to, but internally generating its extension as a virtual expression of its own innate ordering. It is the rule of implicit definition. This rule, following Cassirer, (I will argue), defines a new concept, the "Concept of Implicit Definition".

³⁸ which is not, a priori, *implicitly* dimensional.

of a more profound rule which, *by definition*, exhausts, (and defines), its extension.

The "elements" of the mathematical domain are precisely *all and only* those "values" implicitly defined by, (logically generated by), a particular system of axioms -in a sense *precisely parallel* to Cassirer's.

They are the pure embodiment, (crystallization), of the "order" of its rule. Its elements are *virtual* elements expressing its innate order. The whole of their meaning and the whole of their being, (*mathematically*), is solely such." [Note 2010 –see Hilbert, Chapter 2] “The manifold, (domain), represents the functional and conceptual "values" of its system of "generating relations". Its elements are logical elements.

The "elements", (mathematically conceived), of axiom systems are not "objects" *upon which* a system of "generating relations" acts, however, or to which it relates. They are *products* of it. There is no a priori presumption of their distinct and separate existence. Wilder, pertinently, characterizes the "existence" terms of axiom systems as "presumptive" and "permissive" only.³⁹ Axiomatic "existence" is an operative term only.

³⁹ Wilder, 1967, P.18

The elements *-the objects-* of axiom systems are logical "invariants" of their generating relations and internal to the rule itself.⁴⁰ Neither "presentation", (nor reference), is implicit in them. They are "entities *whose whole being* is to be bearers of the relations laid down by the system."

I urge that this *-the Concept of Implicit Definition-* is the *ultimate* logical rule, and the ultimate "ordering". It captures the ultimate functionality, (in Cassirer's sense), of a logical system and generates its extension, (its abstract "domain"), as a virtual embodiment of its *own* (logical) "ordering" *-its rule*. An axiom system, (conceived mathematically), is a rule which *wholly specifies* its "elements" *-by definition*.⁴¹ [Note 2010 *-in Hilbert's sense.*]

I propose, therefore, a new and largest formal "Concept": the Concept of Implicit Definition. I propose it in strict analogy to the case of the mathematical axiom system and in strict extension of Cassirer's Concept. It is the natural extension of Cassirer's Functional Concept of Mathematics, and embodies, I propose, the ultimate rule, (in Cassirer's sense), of order.

⁴⁰ Contrary to this view, Resnik,(Resnik, 1992), criticized an example of such a "structuralist" conception of mathematics in terms of the theory of reference. Under my hypothesis, however, the theory of reference *itself* becomes highly problematic. (cf Quine, 1953, pps.139-159, "Reference and Modality") Also see Chapter 5.

But it is a generalization of Cassirer's formal concept, not an instance of it. Conceptual "dimensionality", (a "series of series"), implicit in Cassirer's linear function of functions: $F(x,y,z..)$, is a *special case* of the "rule" -and of the formal Concept.

The concept of an axiom system, its "rule" of implicit definition, embodies something absolutely new and unique amongst concepts however. Its extension is *precisely* its own analyticity. The "being", (and the "meaning"⁴²), of its elements are, by definition, *identical* with the purely logical "singularities" of the (complex) rule -and the concept- itself. They "are ... defined just by the fact that they satisfy the axioms."⁴³

Implicit Definition vis a vis Presentation:

Like Cassirer's Concept, (its conceptual progenitor), the Concept of Implicit Definition is not *oppositional*: i.e. it does not (logically) presuppose "abstraction" or "attention" either. It too is a "peculiar form of consciousness", an "act of unification ... not reducible to the consciousness of sensation or perception". But

⁴¹ See prior "Elaboration" discussion

⁴² see above --Schlick

this particular "act", (unlike Cassirer's), does not presuppose "presentation" either.

It does not just logically specify its extension; it logically encompasses it! The rule of "implicit definition" itself then, following Cassirer, is logical exhaustion and its "objects" are *purely logical* objects. They are "crystallizations" - i.e. logical "invariants"⁴⁴ of and internal to the rule itself.⁴⁵ This Concept, I suggest, does not entail "extension" at all -it is a (complex) unity.

Cassirer's Concept, (the Functional Concept of Mathematics), is unique in that its arguments show that the fundamental logical Concept is not derived from presentation or perception but is a free and independent act of unification. It is a "new form of consciousness" *not* dependent on them. The

⁴³ Wilder quotes Nagel: "Indeed, if geometry is to be deductive ... only the *relations* specified in the propositions and definitions employed may legitimately be taken into account." (Wilder, 1967, p.7)

⁴⁴ cf Cassirer, 1923 pps.36-41

⁴⁵ Implicit definition is important when something significant is *actually* defined. The "objects" of abstract mathematics, (integers, for instance), are, (in opposition to Mill),"concrete", viable and fruitful. Its element specifies a particular kind of object, and that object is specifically a "crystallization" of a peculiar kind of "*ordering*"! It *embodies* the logical and relational *essence* of that ordering -and that's all! Its "objects" are "crystallizations" of its rule -just like the objects of the training seminar. The rules here, (and there), I argue, define the object, not the converse. But here the actual mechanism of that "crystallization" is transparent. The "calculus" defines the object, and the definitional mechanism is implicit definition.

Concept of Implicit Definition, (an extension of Cassirer's thesis), opens a further possibility, however.

It potentiates the possibility *that objects as well* can be free creations, acts of unification of that same new consciousness, (and biological organism I argue), and not derived from presentation or perception either. This is a radical idea admittedly. Though somewhat repugnant and somewhat astounding to our preconceptions, it is certainly consistent with the biological conclusions of Maturana, Edelman, and Freeman wherein perception and consciousness, (whatever those may or may not be for these authors –more generally, the internal biological function), of an organism do *not* derive *information* from the world. But that is just what perceptual presentation would imply.

The positive and the immediate consequence of this new rendering of the Concept, (C.I.D.⁴⁶), is that we now have the tools to understand –completely resolve in fact- the problems of the “homunculus” and the Cartesian theatre.

The virtual objects of implicit definition are *known* to the system as a whole. For it is only *as implicitly defined resolutions of the system as a whole* that they exist at all!

This is a major advance on the problem and enables the only realist solution of the problem yet proposed other than a denial of the problem itself. It was in “presentation” *itself* that the irresolvable paradoxes arose after all. To repeat myself however, the denial of (metaphysical) “presentation” does not result in solipsism, but in *realism* sans information and presentation.

Why is this relevant to mind?

4. Why is this significant to the problem at hand? It is because *this* Concept, (C.I.D.), seems "tailor-made" to the logical problem of mind: It is capable of solving the homunculus problem and that of the Cartesian theatre. It can resolve objects without presentation, (without “the homunculus”), and in itself supplies the “theatre”! It supplies an autonomous theory of meaning as well!.

⁴⁶ my “Concept of Implicit Definition”

Cassirer has established the equivalence of "concept" and "rule".

If, (1) following the arguments of chapter 4,⁴⁷ we are no longer concerned with representation, (nor, with it, of "presentation"),⁴⁸

and (2) if, tentatively, mind were taken as the unified rule, (the "act of unification"), of brain response,⁴⁹ -if it were taken as the *unified rule* of the "structural coupling"⁵⁰ of the brain

-then (3), (following Cassirer), "mind" might reasonably be identified with the "concept", (in the larger constitutive sense), of the brain.

If that particular concept were analogous to the "Concept of Implicit Definition" in mathematical axiom systems furthermore,⁵¹ then it would not just "take account" of the elements of its "extension", it would *know* them!⁵² Their

⁴⁷ and of Chapter 4, and of Maturana and Varela, Edelman and Freeman

⁴⁸ See the Raichle citations in Chapter 3, for instance.

⁴⁹ I.E. As an organizational rather than a representative model as I argued in chapter 4

⁵⁰ See Chapter 4: Maturana and Varela

⁵¹ This is consistent, certainly, with the "schematic object" presented earlier. How *could* evolution crystallize its (schematic) objects? The implicit definition of process -of "rule"- provides an explicit mechanism and rationale!

⁵² If there is a tendency to characterize my thesis as a variation of functionalism, then it should be noted that it involves a totally different notion of "function", (and "relation").

"meaning" and their "being" would be logically manifest *internal* to that concept, (and rule), itself.

They would be resolved as *virtual* expressions of that very rule. They would "acquire meaning ... and possess only the content that it bestow[ed] upon them." They would be *logical* entities "whose whole being [was] to be bearers of the relations laid down by the system."

I argue that the "logic" just mentioned is a constitutive logic⁵³. I will argue presently that it is the schematic calculus of Chapter 4!

But these *particular* entities -as cognitive and perceptual entities- *no longer* (metaphysically) presuppose attention or abstraction -*nor do they presuppose presentation*. Therefore, they do not presuppose that which it would be presented *to* -i.e. a "seer"! The logical problems of "the object" -the problem of the homunculus, the problem of "the mind's eye", the "Cartesian theatre", (which are the principal enigmas of consciousness) -are thereby solved in principle.

The fundamental duality, implicit in classical logic, between "seer" and "seen", "thinker" and "object of thought", "perceiver" and "perceived", or, more fundamentally, *between cognition and presentation*, is bridged. The unity, and the very

possibility of cognition of "the object" -the global perspective of the many in the one- is explained in the unity of its existence as a virtual object of implicit definition. For it is only globally that such a virtual object even *exists* as an object.

In our rational universe, then, the Concept of Implicit Definition seems the most appropriate,⁵⁴ as a model, to the logical problem of "consciousness". There *is* no categorical disjunction between the "form of the series" -i.e. the "rule" of implicit definition- and its "elements". They are unified in the concept itself.

Contra Cassirer:

Cassirer "bent" the focus, however:

"there is no danger of hypostasizing the pure concept, of giving it an independent reality along with the particular things. ... Its 'being' consists exclusively in the logical determination by which it is clearly differentiated from other possible serial forms ... and this determination can

⁵³ after Kant's usage

⁵⁴ the *only* appropriate yet suggested!

only be expressed by a synthetic act of definition, and not by a simple sensuous intuition."⁵⁵

There are two crucial flaws in his argument, however:

(1): In the axiom systems of pure mathematics, the *elements* are also expressed by an "act of definition", (albeit an analytical one) -i.e. that of "implicit definition". They are themselves manifestations of that "peculiar form of consciousness, such as cannot be reduced to the consciousness of sensation or perception."

(2): While he states that the application of the Functional Concept is embodied in the concept itself,⁵⁶ he argues that concepts are different *in kind* from their extension. These are "objects" of a different world from that of the "particular things" - the objects of "simple sensuous intuition".

I argue, (in concert with my first thesis), that the "objects" of "simple sensuous intuition" are *themselves* ultimately objects of "implicit definition" and part of that *same* "peculiar form of consciousness".

It follows, then, (given my hypothesis), that there is, (in concert with W.J. Freeman, for instance), no *simple* sensuous

⁵⁵ Cassirer, 1923, P.26

intuition at all -it does not exist. It is the *perceptual object* which has been hypostasized! His dichotomy of the "being" of the pure concept and the "being" of the "particular things" need not stand on either leg.

Cassirer did not generalize the "Functional Concept of Mathematics" into "the Concept of Implicit Definition". The "new consciousness", furthermore, stopped short of "sensuous impressions" themselves. For him, the latter were absolute and unknowable. They were, in effect, the focal point upon which the various forms of knowledge, his "Symbolic Forms",⁵⁷ were oriented, but could never reach. They were the rock upon which he erected, in Swabey's characterization, his "epistemological theory of relativity".⁵⁸

His "object of knowledge" was a purely conceptual object, implicitly defined by the fundamental laws of the sciences, -their "generating relations". The "objects of perception", the "particular things", were of a different and untouchable world, the rock splitting the intellect in two.

⁵⁶ "if I know the relation according to which a b c ... are ordered, I can deduce them by reflection and isolate them as objects of thought" *ibid* p.26

⁵⁷ cf Cassirer 1953 and Chapter 5

⁵⁸ *Op. cit* P.v. I will have much more to say about "Symbolic Forms" in Chapter 5.

The Crux of the Issue: Presentation

Cassirer did Promethean work, however. He demonstrated the fundamental inadequacies of the classical Concept, both in its scope and specifically as regards "perception". He illuminated the profound and expressly logical chasm between the Concept and the perceptual realm, (the "material" with which it purportedly deals!), and hence the pervasive *duality* which "perception", i.e. "sensuous impressions", necessitates for mind and logic.

Even Cassirer's "Functional Concept of Mathematics" was insufficient to the fundamental problem, however, and he remained inside the "magic circle" of perception. The opposition of "Concept" and "percept", (e.g. "attention/abstraction" and "presentation" or still even the opposition of Cassirer's "Functional Concept" and presentation - "sensuous intuition"), and the dualism which is still implicit in it, is the essence of the issue. It is a genuine antinomy and the actual genesis of the problem.

Already contained in "abstraction", already implicit in "attention", already embodied in "presentation" is the dualistic homunculus: i.e. that *to which* "presentation" is offered. There was no way heretofore that we could even *conceive* of an answer to this problem because it was *the formal Concept itself* which generated it. *This* was the retort in which the "homunculus" was conjured!

"Implicit definition", however, belongs *totally* to the "new form of consciousness" -as do the "objects" which it "orders". But here, (beyond Cassirer), there is no longer the assumption of a *presentation* of "elements", (psychological impressions or otherwise), from one world to an intellectualizing, (cognitive), faculty in another. There remains, therefore, *no implicit need* for the dualistic homunculus in cognition. This explains why the two worlds are compatible. There are not two worlds, but one. This "peculiar form of consciousness", this "new consciousness" I maintain, is the *only* form of consciousness!"

[End snip]

The whole of that chapter is reasonably cohesive, but now you have seen most of it. I began it with a presentation of Hilbert's thesis, (not incorporated here), but I think I have done that better in this present book. There was always an indecision in me as to whether to start from Cassirer or from Hilbert, they are linked so tightly.

Chapter 6: Maturana & Varela & Kant Biology- Part II

Towards the Where and the What?

Biology & Epistemology, (Maturana and Varela and Kant)¹

"If in a new science which is wholly isolated and unique in its kind, we started with the prejudice that we can judge of things by means of alleged knowledge previously acquired -though this is precisely what has first to be called in question -we should only fancy we saw everywhere what we had already known, because the expressions have a similar sound.

But everything would appear utterly metamorphosed, senseless, and unintelligible, because we should have as a foundation our own thoughts, made by long habit a second nature, instead of the author's."¹

From our ordinary way of looking at things, my third and final thesis, (which will be formally stated in Chapter 11), will appear convoluted, esoteric and disturbing. When the inverting glasses of habit are removed and a proper perspective is attained,

however, it will become considerably simpler², more plausible and profoundly more compatible with modern science than any proposed alternative. To reach that perspective and before I can even begin to properly state this thesis however, I must deal with several seemingly divergent, (but actually closely related), issues. This chapter will discuss the first of them. I must begin to address the epistemological dilemma created by the conclusion of the first two theses.

Nobody writing meaningfully about the mind-body problem today appears to take Immanuel Kant as seriously and as literally as I do, and yet he seems to be the thinker most pertinent to it.³ (I think he must be informed and corrected by Maturana however.) The problem of mind-body is, in one profound respect, the problem of knowing, (epistemology), itself. The questions of what we, as organisms, do know, or even *can* know - and how!- reflect back on the very knowledge by which we judge the problem itself.

¹ I will begin this Chapter with my original version of it and then come back to make more recent comments. Original MS Numbered Chapter 3 in Iglowitz, 1995.

² in a mathematical sense of the term

³ "This is an advantage no other science", [than epistemology/metaphysics], "has or can have, because there is none so fully isolated and independent of others *and so exclusively concerned with the faculty of cognition pure and simple*". Kant, "Prolegomena", Lewis Beck translation, Bobs-Merrill, 1950, p.131, my emphasis

In an ancillary and important respect, moreover, the problem Kant faced in attempting to communicate his ideas is very similar to the one Maturana and I face as well. (I referred to this in the introduction.) Both theses totally contravene the common wisdom, and (therefore) make sense only as a whole and not in their parts.

Like Kant's problem "of pure reason", (which is clearly a part of my own problem), my problem:

"is a sphere so separate and self-contained that we cannot touch a part without affecting all the rest. We can do nothing without first determining the position of each part and its relation to the rest; for, as our judgment within this sphere cannot be corrected by anything without, the validity and use of every part depends upon the relation in which it stands to all the rest within the domain [of reason].

As in the structure of an organized body, the end of each member can only be deduced from the full conception of the whole. It may, then, be said of such [a critique] that it is never trustworthy except it be perfectly complete, down to the minute elements [of pure reason]. In the sphere of this faculty you can determine and define either everything or nothing."¹¹

The combination of my first two theses provides radical and powerful simplifications to the mind-body problem. But it

raises a new and seemingly overwhelming difficulty however. If it is true, then what do we know, and what *can* we know of the reality in which we exist? Since my very arguments depend, moreover, on *accepted knowledge*⁴ of that world, have I not reduced my own case to absurdity? The path to my third thesis will answer these questions and supply, (at its conclusion), the single remaining part of my promised *complete* solution to the mind-body problem. The latter is the answer to the problem of the "substance" of the mind. *What* is "mind" and *where* is it? How could it even *be*?

Before I can formally state my third thesis which will answer these questions, (in Chapters 10 and 11), however, we must look at the problem of knowing, (epistemology), and at the broader problem of cognition generally, to include perception. It *demarcates* the problem of "substance". It sets the bounds and defines the very context within which we must consider it. The pivotal issue will be "closure"!⁵

⁴ e.g. Darwinian evolution

⁵ This is, as an emotional issue, the most difficult of my theses and I must expect to lose my credibility with many of you here. It is a strange and esoteric idea, but, I believe, true. It must, on my part, be presented with the utmost delicacy. On your part, I must ask for a very careful reading as it may not be as it seems at first.

Closure:

A mathematical domain D is called "closed" under operations "*" and "#", (let us say), if for every x and y in D , " $x*y$ " and " $x\#y$ " are necessarily in D as well. The result of all such operations on the domain, *no matter how far concatenated*, will always remain again within the domain. It never "escapes" itself!

I will argue that our human cognitive domain is itself likewise closed, (though bounded),⁶ under its operations. This was Kant's, (and Maturana's), essential conclusion as well. Surprisingly it will *simplify* the problem of "substance" and resolve the intolerable dilemma I (so innocently) raised as well. It is not that the problem of substance is itself so difficult; it is the demands that we make on the answer.

Kant was the earliest scientific, (I might equally say "mathematical" –in the sense of modern mathematics), thinker on this problem, and he is confirmed more recently, from the logical side by Quine,^{III} and, from the side of biology, by Maturana and Varela. Though Kant's arguments belong to another era, his

⁶ A simple mathematical example of a closed and bounded domain would be the domain of the open interval $-1 < x,y < 1$ under the operation of multiplication. Another would be the open domain bounded by unit circle: for all (x,y) : $-1 < x,y < 1$ with the operation #: $(x,y)\#(u,v) = (x*u,y*v)$. The integers

fundamental conclusions and his rigorous identification of the basic and necessary assumptions remains intact.

Sanity and plausibility depend on just two, (*by definition* "metaphysical"), postulates of absolute existence: "externality" and "experience", ("intuition"). Without them, there is no reason for reason! But those postulates operate solely within the closed domain of reason: "our judgment within this sphere cannot be corrected by anything without."^{IV}

While fully affirming the *existence* of our external world, ("substantia phenomena"), as a necessary prerequisite to reason, Kant concluded that we are inherently incapable of knowing any of its independent properties, (to include time, space, extension, tactility, impenetrability ...), that is, we are incapable of knowing them *independently of* their revelation in, and in combination with, human cognitive forms.

Kant argued, (in quite a modern vein), that it is impossible to separate our "instrument", (the peculiarities of biological human cognition), from what it "measures", i.e. the world it cognates. His genuinely relativistic conclusion gains modern physical credence from the theories of relativity and quantum mechanics, and logical credence, (though it contravenes

are, of course, closed under addition and multiplication, the rationals under addition, multiplication, and division, ...

certain of his own, dated, arguments), from the axiomatic foundation of mathematics. He arrived at a position which I will rename as "ontic indeterminism"⁷, (i.e. an indeterminism as to properties, but not as to the *existence* of the "something" –or rather of the "somewhat"- we call "external reality".⁸

More recently, Quine⁹ has argued that our "system of knowledge and beliefs" is *logically* closed, and Maturana and Varela^V have argued that biological organisms are, (by definition!), *operationally and cognitively* closed.

I will argue that our knowledge and, even more broadly, *cognition generally*¹⁰, (to include perception!), is a closed, (i.e. self-referential), domain whose "boundary conditions"^{VI} are:

1. the most general, (i.e. the weakest and most abstract), possible assumption of "externality" itself, and

⁷ Kant himself was never satisfied with "critical idealism" but was forced to retain it for historical reasons. "This being the state of the case, I could wish, in order to avoid all misunderstanding, to have named this conception of mine otherwise, but to alter it altogether is probably impossible. It may be permitted me however, in future, as has been above intimated, to term it 'formal' or, better still, 'critical' idealism, to distinguish it from the dogmatic idealism of Berkeley and from the skeptical idealism of Descartes." -"Prolegomena", Pps.124-125

⁸ See a more thorough analysis of Kant's "Critical Idealism" later in this chapter.

⁹ W.V.O. Quine, 1960. I will elaborate Quine's position in Chapter 7.

¹⁰ Cognition has two aspects. Repeating the definition cited earlier, (Webster's: "cognition: the act or process of knowing, including both awareness and judgment". Also, "Perception: (4a) direct or intuitive cognition.")

2. "experience" as an *uninterpreted primitive*, i.e. not the interpretation or organization of that "experience" -not, for example, its interpretation as "sense impressions"¹¹.

The connection between these two assumptions is not necessarily simplistic. This chapter elaborates the first of them. In this chapter, I will examine Maturana and Varela's arguments as set forth in "*The Tree of Knowledge*".^{VII}

They consummate the viewpoint of modern biology on the issue of closure. This penetrating work, very much the biological complement of Kant's "Prolegomena" I feel, defines the secure biological context in which they develop a single heuristic principle, (i.e. "structural coupling"), crucial to the mind-body problem.

I will differ strongly with the conclusions they draw from it, however, as they were unwilling to accept the devastating consequences of their own arguments. I do.

Maturana and Varela characterize their book as an argument against a *representative model* of environment in the

¹¹ But if our perceptual objects *are* cognitions, then how can they be a *boundary condition* of cognition as well? How can our perceptual objects and the things they do be "experience" themselves? I will argue that they are not! "Experience" is their *invariant relationality* across all orientations including even those which might distribute the "objects" themselves! Does *perceptual cognition* equate with "experience"? No, it is a particular (evolutionarily derived

brain, against the existence of a current "map" which we use to compute behavior appropriate for survival in our contemporaneous world.

Their argument propounds, instead, a closed, (and evolutionarily determined), reactive parallelism to environment - i.e. "congruent structural coupling".¹² They argue that organisms do not behave as they do *because* of the nature of their current surroundings; they behave *alongside* of it!¹³

Organisms, as reactive physical systems, are "operationally closed". Their closed ontogenic state is only "triggered" by their environment. Environment is a "boundary condition" of survival, not a *motivation* for action. (See my illustration "Bounds and Limits" in Chapter 4 which illustrates the lack of need for a parallelism between environment and the organism.) Maturana and Varela conclude there is no *current model* because there is no flow of current "information".

They develop their fundamental thesis, "structural coupling", at the ground level of primitive evolution. It is a

and "pictorial") *orientation* of that relationality! See Chap.7 and the "King of Petrolia".

¹² Thinking it over, February, 2010, there is a way that their usage of "congruence" could be re-interpreted so as to correspond with my later criticism of their employment of it. It could be re-interpreted as "simple, non-destructive co-existence"!

¹³ Their argument is considerably subtler than this as I will detail below.

principle of purely mechanistic coexistence between "organism" and "environment" which preserves "autopoiesis", (reproduction). It is, I will argue however, weaker than the strict parallelism, ("congruence"), they demand of it.

Their argument, examined more deeply, is against "information" between an organism and its environment *at any stage* -to include that of natural selection! "Congruence"¹⁴, however, would clearly be *evolutionary* information!¹⁵ "Structural coupling" and the "conservation of autopoiesis", (and Darwin's principle of "natural selection" itself), are all quintessentially principles of raw *appropriateness* alone however.¹⁶ They are not informational.

These principles say: "This works!" They do not say: "This is what is!" (They do not exhaust or mirror the whole of possibility). Neither parallelism, ("congruence"), nor embodiment are legitimate consequences of these principles, I will argue, even at the evolutionary level.

There are correlations between domains other than "isomorphism" or "congruence" which preserve pertinency. The

¹⁴ as in "*congruent* structural coupling"

¹⁵ cf Edelman, 1992. He argues that the human genome is simply too small for the purposes of information

¹⁶ i.e. they are boundary conditions, not limits!

mappings and transformations of abstract algebra are obvious counterexamples disproving the inference.¹⁷

It is only necessary that (some) feature(s) *compatible* with the milieu of the domain be preserved. I will argue that the presumed necessity of "evolutionary congruence" is a *human* precept and part of the closed and specifically human cognitive model.

I will now attempt to summarize Maturana and Varela's thesis. Their arguments are profound, subtle, and more concise than any paraphrase. I believe they are, up to a certain point, conclusive.

Maturana and Varela:

Maturana and Varela,^{VIII} make a profound and phenomenologically pure¹⁸ argument proceeding from first principles. It leads to severe epistemological consequences. They begin by outlining *minimal and necessary* biological specifications for "living organisms". Those then become an entirely *sufficient* rationale for the *whole* of metacellular

¹⁷ Think about Hilbert's "beer mugs" in Chapter 2, for instance.

¹⁸ i.e. they do not mix their contexts or the origins of their presumptions

organisms and their (nervous) behavior.¹⁹ The argument is wholly operational and constructive.²⁰ Please forgive the length of the following quotes, but they make their case better than I could. Echoing my comment about one of Cassirer's arguments, I believe that it, too, is *Mirabile dictu*. It is not my purpose to make their case here, but rather to build upon it!

"Our intention, therefore, is to proceed scientifically: if we cannot provide a list that characterizes a living being, why not propose a system that generates all the phenomena proper to a living being?

The evidence that an *autopoietic unity* has exactly all these features becomes evident in the light of what we know about the interdependence between metabolism and cellular structure."^{IX}

¹⁹ "And how can we tell when we have reached a satisfactory explanation of the phenomenon of knowing? ...when we have set forth a conceptual system that can *generate* the cognitive phenomenon as a result of the action of a living being, and when we have shown that this process can produce living beings like ourselves, able to generate descriptions and reflect on them as a result of their fulfillment as living beings operating effectively in their fields of existence." Please note their use of the operative word "conceptual" in "conceptual system" –theirs indeed is a conceptual and a Hertzian "axiomatic" foundation. (op.cit P.30)

²⁰ Please come back and review Maturana's preamble when you have gotten through Chapter 7, particularly Hertz's reflections on the nature of science. I think the connection is important.

Plausibly, they characterize a "living organism" as an "autopoietic unity", i.e. a replicating (cellular) physical entity. In so doing, they clarify the inherent nature of biological *phenomenology* itself, (i.e. its innate categories and operative principles).

"the potential diversification and plasticity in the family of organic molecules has made possible the formation of networks of molecular reactions that produce the same types of molecules that they embody, while at the same time they set the boundaries of the space in which they are formed. These molecular networks and interactions that produce themselves and specify their own limits are ... living beings."^X

"Autopoietic unities specify biological phenomenology as the phenomenology proper of those unities", (my emphasis), "with features distinct from physical phenomenology... because the phenomena they generate in functioning as autopoietic unities depend on their organization and the way this organization comes about, and *not* on the physical nature of their components."^{XI}

The legitimate and minimal principles appropriate to biological process are operational closure and operational independence.

"Ontogeny is the history of structural changes in a particular living being. In this history each living being begins with an initial structure. This structure conditions the course of its interactions *and restricts the structural changes* that the interactions may trigger in it", (my emphasis). "At the same time, it is born in a particular place, in a medium that constitutes the ambience in which it emerges and in which it interacts.

This ambience appears to have a structural dynamics of its own, operationally distinct from the living being.

This is a crucial point. As observers, we have distinguished the living system as a unity from its background and have characterized it as a definite organization.

We have thus distinguished two structures that are going to be considered *operationally independent* of each other, "*living being and environment.*"^{XII} (my emphasis),

Physical science's primal principle of "mechanism", however, leads to a distinct point of view on the interactions of the "autopoietic unity" with its environment: "triggering", "perturbation", and "structural coupling". Organism and environment are *coincident*, not operationally dependent!

"Every ontogeny occurs within an environment; we, as observers, can describe both as having a particular structure such as diffusion, secretion, temperature. In

describing autopoietic unity as having a particular structure, it will become clear to us that the interactions (as long as they are recurrent) between unity and environment will consist of reciprocal perturbations. In these interactions, the structure of the environment only *triggers* structural changes in the autopoietic unities (*it does not specify or direct them*"), (my emphasis), "and vice versa for the environment. The result will be a history of mutual congruent structural changes as long as the autopoietic unity and its containing environment do not disintegrate: there will be a *structural coupling*."^{XIII}

(I argue that their phenomenology applies to genetic modification as well as ontogenic modification. A genetic change -randomly and not causally obtained- is retained simply if it is a benefit to the functioning of the organism -i.e. solely on the basis of *appropriateness*. It, and the summation of such genetic changes, therefore, do not actually imply "congruence", [in the sense of *parallelism*], but rather *some* pertinent, (beneficial or at least non-destructive), correlation between domains. "Structural coupling" and "conservation of autopoiesis" are not determinate. They are not "specified or directed" by the environment either; they are *bounded* by it. Structural coupling is therefore a weaker

and more abstract condition than they presume –at least under my understanding of their usage of “congruent”).²¹

Between the living being and the environment there is a "necessary structural congruence", [but see my comment above], "(or the unity disappears)." But organisms *must*, (in the innate phenomenology of biology), be considered as *independently reactive to*, rather than determinately, (i.e. informationally), *guided by* their environment. The conclusion is grounded in the structure of science itself:

"In the interactions between the living being and the environment within this structural congruence, the perturbations of the environment do not determine what happens to the living being; *rather, it is the structure of the living being that determines what change occurs in it.* This interaction is not *instructive*",²² (my emphasis), "for it does not determine what its effects are going to be.

²¹ Cognition as a coordination of atomic *primitives*, (as argued in Chapter 4), makes a great deal of sense in this context. The organization is not itself correlative to externality, but is an operative device working on ultimately indeterminate primitives.

²² i.e. informational

“Triggering” vs “Causation”:

Therefore, we have used the expression 'to trigger' an effect. In this way we refer to the fact that the changes that result from the environment are brought about by the disturbing agent but *determined by the structure of the disturbed system*. The same holds true for the environment: the living being is a source of perturbations and not of instructions."^{XIV}

"The key to understanding all this is indeed simple: as scientists, *we can deal only with unities that are structurally determined*. That is, we can deal only with systems in which all their changes are determined by their structure, whatever it may be, and in which those structural changes are a result of their own dynamics or triggered by their interactions."^{XV}

Organisms *react!* They react, moreover, in the operational closure of their *current (physical) structure*. The latter is determined by their "ontogeny", (i.e. on their summed history of structural change as individuals), which has modified the original phenotypic structure:

"This ongoing structural change occurs in the unity from moment to moment, either as a change triggered by interactions coming from the environment in which it exists or as a result of its internal dynamics. As regards

its continuous interactions with the environment, the cell unity classifies them and sees them in accordance with its structure at every instant.

That structure, in turn continuously changes because of its internal dynamics. The overall result is that the ontogenic transformation of a unity ceases only with its disintegration."^{XVI}

Maturana goes on to define "second order" and "third order structural coupling" as the structural coupling of the multicellular organism with its environment, and the coupling of intraspecies' behavioral interaction, (e.g. linguistic behavior), with environment respectively. But these are always dependent upon the necessary conservation of the autopoiesis of the *germ cell*.

The scope of the subsequent development, (the operational range), of the *metacellular* organism²³ is determinate from its unicellular stage, and subject to its phenomenology.

"The life of a multicellular individual as a unity goes on through the operation of its components, *but it is not determined by their properties*. Each one of these pluricellular individuals...results from the division and

²³ i.e. the phenotype

segregation of a lineage of cells that originate ... (from) a single cell or zygote. ...It is as simple as this: the logic of the constitution of each metacellular organism demands that it be part of a cycle in which there is a necessary unicellular stage."^{XVII}

The Conservation of Autopoiesis:

The conservation of the autopoiesis of that unicellular stage is the necessary boundary condition of the (independent and coincident) function of any organism, unicellular or multicellular.

"Living beings are not unique in their determination nor in their structural coupling. What is proper to them, however, is that structural determination and coupling in them take place within the framework of ongoing conservation of the autopoiesis that defines them, whether of the first or second order, *and that everything in them is subordinate to that conservation.*

Thus, even the autopoiesis of the cells that make up a metacellular system is subordinate to its autopoiesis as a second-order autopoietic system. *Therefore, every structural change occurs in a living being necessarily limited by the conservation of its autopoiesis; and those interactions that trigger in it structural changes*

compatible with that conservation are perturbations, whereas those that do not are destructive interactions.

Ongoing structural change of living beings with conservation of their autopoiesis is occurring at every moment, continuously, in many ways at the same time. It is the throbbing of all life."^{XVIII}

Behavior as an Aspect of Structural Coupling:

Behavior, from the biochemical behavior of the amoeba to the nervous behavior of man, is simply an aspect of primary structural coupling. It is the correlation of sensory surfaces with motor surfaces: "...the sequence of movements of the amoeba is therefore produced through the maintenance of an *internal correlation* between the degree of change of its membrane and those protoplasmic changes we see as pseudopods.

That is, a recurrent or invariable correlation is established between a perturbed or sensory surface of the organism and an area capable of producing movement (motor surface), which maintains unchanged a set of internal relations in the amoeba."^{XIX}

"This basic architecture of the nervous system is universal and valid not only for the hydra, but also for higher vertebrates, including human beings. ... the basic

organization of this immensely complicated human nervous system follows essentially the same logic as in the humble hydra ...the nervous tissue understood as a network of neurons has been separated like a compartment inside the animal, with nerves along which pass connections that come and go from the sensory surfaces and motor surfaces.

The sole difference lies not in the fundamental organization of the network that generates sensorimotor correlations, but in the form in which this network is embodied through neurons and connections that vary from one animal species to the other. ...

But we emphasize: ... this is the key mechanism whereby the nervous system expands the realm of interactions of an organism: *it couples the sensory and motor surfaces through a network of neurons whose pattern can be quite varied*. Once established, however, it permits many different realms of behavior in the phylogeny of metazoa. In fact, the nervous systems of varied species essentially differ only in the specific patterns of their interneuronal networks."^{XX}

Brain cells do not connect only to motor and receptor cells, however, most of them connect to *other brain cells*:

"in humans, some 10^{11} (one hundred billion) interneurons interconnect some 10^6 (one million) motoneurons that

activate a few thousand muscles, with some 10^7 (ten million) sensory cells^{XXI} distributed as receptor surfaces throughout the body. Between motor and sensory neurons lies the brain, like a gigantic mass of interneurons that interconnects them (at a ratio 10:100,000:1) in an ever changing dynamic."^{XXII}

The sensory surface includes, however, not only those cells that we see externally as receptors capable of being perturbed by the environment, "but also those cells capable of being perturbed by the organism itself, including the neuronal network."

"Thus the nervous system participates in the operation of a metacellular as a mechanism that maintains within certain limits the structural changes of the organism. This occurs through multiple circuits of neuronal activity structurally coupled to the medium.

Operational Closure:

In this sense, the nervous system can be characterized as having *operational closure*", (my emphasis). "In other words, the nervous system's organization is a network of active components in which every change of relations of activity leads to further changes of relations of activity. Some of these relationships remain invariant through continuous perturbation both due to the nervous system's own dynamics and due to the interactions of the organism

it integrates. In other words, the nervous system functions as a closed network of changes in relations of activity between its components."^{XXIII}

External perturbations only *modulate* the constant interplay of internal balances of sensorimotor correlations:

"It is enough to contemplate this structure of the nervous system... to be convinced that the effect of projecting an image on the retina is not like an incoming telephone line. Rather, it is like a voice (perturbation) added to many voices during a hectic family discussion (relations of activity among all incoming convergent connections) in which the consensus of actions reached will not depend on what any particular member of the family says."²⁴

"a nervous system...as part of an organism, will have to function in it by contributing to its structural determination from moment to moment. This contribution will be due both to its very structure and to the fact that the result of its operation (e.g., language)

²⁴ *ibid* Pps. 161-163. Also consider Edelman's comment on this same issue: "... To make matters even more complicated, neurons generally send branches of their axons out in diverging arbors that *overlap* with those of other neurons, and the same is true of processes called dendrites on recipient neurons To put it figuratively, if we 'asked' a neuron which input came from which other

forms part of the environment which, from instant to instant, will operate as a selector in the structural drift of the organism with conservation of adaptation.

The Structural Present:

Living beings (with or without a nervous system), therefore, function always in their structural present. The past as a reference to interactions gone by and the future as a reference to interactions yet to come are valuable dimensions for us to communicate...however, they do not operate in the structural determinism of the organism at every moment. *With or without a nervous system, all organisms (ourselves included) function as they function and are where they are at each instant, because of their structural coupling.*"^{XXIV}

Maturana presents a sufficient and scientifically necessary rationale for the whole of "living organisms" -to include their "behavior". It is convincing because of the *purity* and the *correctness* of his phenomenology *as biology*. At each step of evolution, on each fundamental aspect of the functioning of an

neuron contributing to the overlapping set of its dendritic connections, it could not 'know'." Edelman, 1992, p.27

"organism", on the reconciliation of the metacellular, (in all its functions), with the germ cell, these are the *biologically definitive* categories and principles proper to a "living being".

Its "purity" lies in the fact that he never, (and never *has* to), step outside this phenomenology -this particular context- to complete his thesis. It is necessary and sufficient, -and *legitimate*, (in the legal sense),- to the whole of "living beings". It is, therefore, completely plausible.²⁵

Nowhere does his mechanics involve "representation", however! Indeed, "representation" is inconsistent with the mechanics itself. He concludes as a necessary consequence of scientific principle that neither organisms, nor their brains, operate with *representations* of their surroundings.

"Representation" is inconsistent with the necessary phenomenology of organisms -and extrinsic, (and inessential), to the "mechanism" of science. The principle of parsimony, (i.e. least cause), dictates his conclusion. *Organisms are structurally closed systems*, only "perturbed" by their environment, *never* "in knowledge" of it.

"The most popular and current view of the nervous system considers it an instrument whereby the organism

²⁵ Compare this to Hertz's axiomatic characterization of "the object" of science.

gets information from the environment which it then uses to build a *representation* of the world that it uses to compute behavior adequate for its survival in the world.

This view requires that the environment imprint in the nervous system the characteristics proper to it and that the nervous system use them to generate behavior, much the same as we use a map to plot a route. We know, however, that the nervous system as part of an organism operates with structural determination. Therefore, the structure of the environment cannot specify its changes, but can only trigger them. ...

Our first tendency to describe what happens .." (is in) "... some form of the metaphor of 'getting information' from the environment represented 'within'. *Our course of reasoning, however, has made it clear that to use this type of metaphor contradicts everything we know about living beings.*"^{XXV}

His argument is not against models in general, however, but, rather, against *representative* models, and in this I think it is conclusive.²⁶ It leaves very little room for objection. It is

²⁶ I have proposed a very different, and plausible, alternative model in Chapter 4. I proposed that organisms *do* use models, but that those models are

consistent, convincing and in the mainstream of science. It leads, perplexingly, to a disastrous paradox:

Maturana's Paradox

"We are faced with a formidable snag because it seems that the only alternative to a view of the nervous system as operating with representations is to deny the surrounding reality"!

"Indeed, if the nervous system does not operate -and cannot operate -with a representation of the surrounding world, what brings about the extraordinary functional effectiveness of man and animal and their enormous capacity to learn and manipulate the world? If we deny the objectivity of a knowable world, are we not in the chaos of total arbitrariness because everything is possible?"

schematic; their "objects" schematic objects only, aspects of operationally closed process. The "objects" of that model are not "entities" in reality; they are optimizing loci of process itself.

I propose that models do, in fact, exist in the human brain, but they are *schematic* models. Their *virtual* "objects", (in no necessarily simple correlation with externality), are evolutionarily derived *schematic artifacts* of process like the "objects" of the training seminar of chapter 4. They effectively coordinate the sensory and motor faculties of the brain!

This is like walking on the razor's edge. On one side there is a trap: the impossibility of understanding cognitive phenomena if we assume a world of objects that informs us *because there is no mechanism that makes that 'information' possible*", (my emphasis). On the other side, there is another trap: the chaos and arbitrariness of nonobjectivity, where everything seems possible."^{XXVI}

"In fact, on the one hand there is the trap of assuming that the nervous system operates with representations of the world. And it *is* a trap, because it blinds us to the possibility of realizing how the nervous system functions from moment to moment as a definite system with operational closure. ... On the other hand, there is the other trap: denying the surrounding environment on the assumption that the nervous system functions completely in a vacuum, where everything is valid and everything is possible. This is the other extreme: absolute cognitive solitude or solipsism. ... And it is a trap because it does not allow us to explain how there is a due proportion or commensurability between the operation of the organism and its world."^{XXVII}

Maturana and Varela have honed their "razor's edge" with the same care and meticulous skill with which, as biologists, they would undoubtedly hone a microtome. I suggest they are

proposing that we stand, therefore, not on a razor's edge, but on a *microtome's*! That, as any biologist should surely know, is an invitation to suicide. It is likely to result, depending on the angle of fall, in decapitation or, as seems to have happened here, in a severing of the corpus callosum. [;-)]

They have created a full-blown antinomy. The usual method of dealing with antinomies is to examine the presuppositions.

Wait though, you must surely be thinking! Couldn't we just *deny* "mind" in its ordinary sense, then? Isn't this the simplest solution to the difficulty? Why not just abandon (organic) "cognition" entirely, and "experience" and "externality", (in our normal meanings of them), right along with it- and go back solely to parallel and congruent *behavior* itself - i.e. to parallel *reactivity*, predetermined by evolution? Why not just deal with the reactivity and the (reductionist) process of the brain *as part of* the world, (as most current Naturalists, in fact, actually do), accepting the arguments for the inadequacy and the inconsistency of organic cognition as a final *reductio ad absurdum* of "mental states" and deal only with organisms' (behavioral) function?

Maturana and Varela have, you might correctly continue, specified a phenomenology specific to organisms, but they have specified it *within* the context of an actual physical world. Couldn't we, therefore, just deny the "figment"^{XXVIII} of the mind, (the "consciousness", the "awareness" of the brain -or organism),

as "folk psychology" and myth?^{XXIX} Couldn't we consider "mind" as just a linguistic and behavioral phenomenon? Sure we could, and it is a necessary consequence of ordinary Naturalism. But then we are right back, (necessarily), in Maturana's dilemma, (and Quine's and Kant's which are themselves the children of an ancient line of legitimate skepticism), but invoked at a deeper level!

For how then does even the behavioral, and especially the linguistic²⁷ function, (our descriptive language), of (human) organisms, *as behavior*, come to be *specifically*, (i.e. informationally), relevant to the world? Is this not *linguistic idealism*?²⁸ Maturana's whole primary argument -and Darwin's as well - is instead one of simple appropriateness. It is "survival" and "structural coupling", not "information".

This Naturalist argument presumes that organisms' reactivity -third order coupling, (language), and behavior-determined from the beginning by evolution *for the phenotype* and operationally closed thereafter, *is categorical*²⁹! This is an astounding conclusion and more than the principles, (and

²⁷ for behavioral "knowledge"

²⁸ As I will suggest in Appendix A later it is also the case with Dennett's thesis

²⁹ i.e. any two models are isomorphic

Occam's razor), will bear! At best it is *petitio principii*, (assuming what you have to prove); at worst it is magic!

This, however, is the *only* plausible course left to ordinary³⁰ Naturalism after Maturana, but it is a difficult one. It assumes that *whatever* evolution determines, (whatever "parallelism" or "congruency" or "adaptability" that evolution gets for an organism), *is embodied in the genotype* -and subsequently in the phenotype. From that point on, the argument is necessarily entrapped in the operational closure of the organism. That closed system must determine its reactivity, (its supposed "parallel reactivity"), *forever after* throughout its subsequent ontogenic history.³¹

But if even the weather is not determinate from a fixed set of principles and starting point, then how are we to believe that evolution has embodied the complexity of day to day, week to week, or year to year physical reality in such a fixed beginning? What model does evolution, (as embodied in the genotype), *itself* have that it is trying to parallel? If a butterfly in Australia can cause a hurricane in Florida then how are we to believe that

³⁰ cf Chapter 7 for my distinction of "ordinary Naturalism" from "relativized Naturalism".

³¹ February, 2010. Another possibility occurs to me at this time. It is that genes for a *communicating* entity might serve. I.e. a "linguistic" entity in the

evolution has a model *at all*, much less that it can embody such in closed (behavioral or linguistic) principles and laws of reactivity *for the phenotype*.

The argument assumes that evolution launched a closed operational system, (the phenotype), out into the world. But evolution could not know what that phenotype must be functional *with* -i.e. evolution has no model *itself!*³² Evolution cannot predict the world -especially in its human-scale features. It cannot predict the weather, the pattern of rocks, foliage, water and heat -i.e. "*the facts*"- in an ecosystem, and, if not them, then it surely cannot predict the more complex reactivity of the organism's fellow biological creatures -pinching claws, a stalking tiger, or an infection by vibrio comma, (cholera).

"Chaos theory", (for instance), argues that while cyclical processes, (e.g. the large-scale motions of the planets and stars), produce regular and predictable results, non-linear processes do not. But physical process, (the ongoing world), especially at the human scale, *is*, in fact, dynamic and non-linear. Moreover it is, by and large, *not* cyclical. It is, therefore, not predictable in a determinate model.

broad sense of *any* passage of "memes" for instance -by *whatever* route. This does not invalidate my central thesis in any sense however.

³² February, 2010. Note: See "other minds" discussion and graphic in Chapter 1. It gives a clue to this problem, consistent with my just prior footnote.

To assume that such a correspondence to the physical world can be implemented throughout the lifespan of an organism in a fixed and determinate, and specifically *a parallel* operative model, (an informational model), is a difficult premise. For the specifically biological world, the biological ecosystem, it is *more* than difficult. More plausible is that evolution works by the creation of dynamic and operative local, (primitive) -and not *informational* -functions that are intimately and locally connected to changing process –[that affect it “at the system level”]³³

The creation of a multitude of these atomic functions that track, (i.e. trigger from), incremental change in the physical world is a more plausible evolutionary scenario than the representationist one. But this is exactly my first hypothesis: that evolution created local functions like this at the cellular level. The *organization* of these atomic processes then becomes the real problem for the "evolutionary engineer", and it is this organization which, I propose, was accomplished incrementally by the schematic model.

Our primitive (biological) "objects" are organizers, I argue, *organizing loci* of these atomic processes and not

³³ February 2010. It gives rise not to an “informational” model, but rather to an ongoing refinement of a *strategic* model which is perfectly consistent with my thesis.

informational representations. The schematic object is an organization of atomic processes, which latter track we-know-not-what.

For how could even evolution know what that "what" might be? Evolution produces the operationally closed structural coupling of the phenotype, but that structural coupling must be specifically dynamic rather than informational. What evolution *can* deal with are such processes, not information. It can deal with processes that *work* on the local, tactical level.

The representationalist schema, (of ordinary Naturalism), is not plausible. No, that is not quite true; it is plausible *inside* of our own human cognitive model. It is plausible *because it happens that way!* My argument is that it happens *that way* because it *is* inside of our model!

To quote Dennett, (a surprising passage for me):

"it is not the point of our sensory systems that they should detect 'basic' or 'natural' properties of the environment, but just that they should serve our 'narcissistic' purposes in staying alive; *nature doesn't build epistemic engines.*"

^{xxx} I find this a very curious statement –coming from Dennett.

This is an antinomy. No, more accurately, it is a specific and pointed *reductio ad absurdum* of the (ordinary) Naturalist premise!³⁴ What Bertrand Russell says of naive realism applies to ordinary Naturalism, its (natural) child:

"We all start from 'naive realism'. We think that grass is green, that stones are hard, and that snow is cold. But physics assures us that the greenness of grass, the hardness of stones, and the coldness of snow are not the greenness, hardness, and coldness that we know in our own experience, but something very different.

The observer, when he seems to himself to be observing a stone, is really, if physics is to be believed, observing the effects of the stone upon himself. Thus science seems to be at war with itself: when it most means to be objective, it finds itself plunged into subjectivity against its will.

Naive realism leads to physics, and physics, if true, shows that naive realism is false. Therefore naive realism, if true, is false; therefore it is false."^{XXXI}

To paraphrase Russell, if we *know*, then we *can't* know. Therefore we *do not* know.

³⁴ but not of relativized Naturalism! cf Chapter 7

Maturana and Varela characterized the dilemma incorrectly, however. They specified a necessary choice between solipsism on the one hand, and representationalism/realism on the other, and this is not the case.

The Axiom of Externality

We needn't deny *reality* based on their arguments, just our specific *knowledge* of it! Nor need we deny "mind". It is the acceptance of an "Axiom of Externality", in its *most abstract* form, *taken axiomatically*, that is demanded here,³⁵ and *that* is not denied by their arguments. It is the improper extension of that demand, and its confusion with the particulars of our specifically human organic process, (to include cognition), that generates the difficulty.

As realists we *must* grant the presumption of "externality": i.e. we must grant the simple *posit* of an ontic existence. It is fundamental to sanity and to plausibility. The *posit of our world*: men and baseballs and trees and planets as *necessary ontic entities*, however, is *not*! Even our perceptual world is a part of our closed cognitive process. I have argued, (in Chapter 4), that it is an operative, (and dynamic), artifact.

³⁵ both here and in the foundations of physics

But, you surely object once again, we *cannot* deny the "objects of our experience" and their apparent relationality! I agree, it is these objects which provide the stability of our life experience and ground the very essence of sanity, (my thesis is *not* solipsism). In the next chapter, I will show why we need not.

We all want our naive world to be real: trucks, men, planets and baseballs, and all our normal relations between them -i.e. all the things they do. It is a necessary component of "sanity", and distinguishes it from dreams, fantasies, and, baldly, insanity. If a rock hits me on the head, it *will* hurt! But, contrarily, our *best science* says that our naive world is *not* real! What is real for science are atoms, forces, photons, quarks,... all embedded in some mathematically esoteric spatial context.

For it, myself and the man in front of me are, in fact, biological pluralities, or, deeper still, atomic amalgams... down to the deepest levels of physical conception. Naturalism, (the scientifically extended³⁶ form of our naive conception and the verity Maturana is loathe to lose), allows this heresy only because it says that our natural world is hierarchically,³⁷ (and

³⁶ to *whatever* level of sophistication!

³⁷ See the discussion in the Preamble to this work for a detailed discussion of hierarchy. The reduction of scientific theories, (and theoretic reduction in

isomorphically), *embedded* in that primitive existence which science posits, and that those hierarchical entities, (our normal "objects"), act *as units*. It maintains that this reduction is

general), is subject to a fundamental logical limitation under the classical, (pre-Cassirerian), concept. In Chapter 3, I exhibited Cassirer's arguments that the whole root of the classical formal concept is set-theoretical. Concepts, or concepts of "things", (to include, for instance, our ordinary objects), were reducible only in a set-theoretic sense, i.e. by abstraction, (intersection), of common properties. They are, therefore, subject to Russell's "theory of types". At the bottom level, and there *must* be a bottom level according to the theory of types, there are atomic primitives. Each of the levels above that must be hierarchically oriented, each containing the one above it, (i.e. the "things" of the next higher level are abstractions -intersections- of the ones below). This theory of types was the logically necessary result of the antinomies discovered in the roots of set theory. The most famous is, of course, Russell's paradox. Cassirer's fundamental advance on the classical formal concept, "the mathematical concept of function" however, provides an escape. There is no "Cassirer's paradox" in the universal formation of concepts. There is no "concept of all concepts", because concepts are now constituted as an assemblage of (consistent) generative rules, not as a (set-theoretic) abstraction (intersection) of properties -which currently stands for the process of scientific reduction. There is clearly no "rule of all rules" as some rules obviously contravene others. At the level of my "concept of implicit definition", concepts are assemblages of rules, of "axioms", (i.e. fundamental and consistent generative rules), and the same situation obtains. But, just as is the well demonstrated case for mathematical axiom systems, it is possible to exchange an appropriate subset of theorems for the pre-existing axioms, (while still absolutely preserving the integrity -the interior relationality- of the mathematical subject), so is it possible to "cross-reduce" theories. We do not have one single preferred perspective.

This is the relativism of Cassirer's "symbolic forms". What remains is the "web" of relationality, the "invariants" of experience that must be preserved under *all* comprehensive perspectives. But that web, those invariants must be viewed, in Van Fraassen's term, in a "coordinate-free" sense, i.e. they must be viewed in their abstract relationality, not from any *particular* orientation. cf. Chapter 5 and Afterword: Lakoff / Edelman. See also the "mathematical ideals" discussion in Chapter 9.

specifically a *hierarchical*³⁸ one which maintains all the spatial and material relationships down through each and all of the depths of scale -*hence their reality!*

Modern science has not confirmed, but rather has seriously questioned, that assertion. What are we to embed them *in*? At the bottom level of physics, "matter", "space", even "existence", in the sense in which naive realism uses them, are anomalous terms. Even "cardinality" *as such* -the "how many of it"- is dubious!³⁹

Even *ordinary* Naturalism⁴⁰ does not, therefore, maintain the integrity of our naive objects! But is its insistence on the maintenance of the *hierarchical* integrity of those objects a necessary, or even a plausible presupposition at this juncture in our intellectual history?

My hypothesis of the schematic object, contrarily, says that our naive world -to include its relationality, (its laws and happenings),-is more probably *unhierarchically*, (but rather transformationally), correspondent with absolute externality, *whatever* and *however* the latter may be.

³⁸ Please consider Bell's comments in Chapter 3 on hierarchy

³⁹ Cf Penrose on the twin-slit experiment, for instance

⁴⁰ i.e. scientific naturalism = "scientific realism"

Ultimately it says that our naive world is in correspondence to "points" of *atomic biological process*,⁴¹ and not to "points" of ontology. It is a *metaphor of response*. It says that the further correspondence between those atomic processes themselves and ontology is *completely indeterminate* to us as biological and cognitive entities!

The acceptance of this, the bare, raw *existence*⁴² of such a correlation, however, constitutes a necessary requirement for any sane or plausible argument -to include my own. This is my assertion, the "Axiom of Externality" in its most abstract and precise form, and constitutes the first of the two necessary, (apodictic), premises for realist reason.⁴³ (The other is the "Axiom of Experience" which I will treat in the following chapter.)

The "realism" Maturana impeaches is, in fact, (ordinary) "Naturalism". Nor has he really made a case that solipsism is the only other alternative.⁴⁴ While his case against

⁴¹ It is an optimizing organization of primitive, organic *process* -i.e. of primitive *operational* process.

⁴² which assumes, therefore, both the axiom of existence and the reality of experience

⁴³ Is the "axiom of externality" the same as the "realistic imperative" of Hume? Is it an *emotional* imperative? It *orients* world-views.

⁴⁴ There is a *structured* isolation. It does not support the implication that "everything is valid and everything is possible"!

representationalism *does* destroy the claims of ordinary Naturalism,⁴⁵ a *realistic* case is still possible -but it must be a theoretically mature one. Einstein's realism⁴⁶ is more plausible.

That brand of realism involves simply that "theory be organized around a [some] conceptual model of an observer-independent realm".^{XXXII} My thesis takes this "some" in its most abstract form, as the (pure) limit of reason. *This* "realism" is certainly more credible in light of today's physics. Realism is more robust than Maturana assumes, and is capable of greater sophistication than a mere linear extension of the naive world-view. In Fine's words, it is an "attitude". In disagreement with Fine however, I believe it is a *robust* attitude.

Maturana came very close to the answer I propose however. His "object" of cognition⁴⁷ is an object of *process*: "cognition does not concern" [external] "objects, for cognition is effective action." He relapses, however, into [the language of]

⁴⁵ Since it assumes the premise of naturalism and ends in a contradiction, it is, in fact, a *reductio ad absurdum*.

⁴⁶ "It is existence and reality that one wishes to comprehend. ... When we strip the (this) statement of its mystical elements we mean that we are seeking for the simplest possible system of thought which will bind together the observed facts." (Einstein 1934, Pps. 112-113)

⁴⁷ In fact, they do not actually allow an "object" of cognition, as the following citation shows. I am referring here to that aspect of brain process -the effective action- which corresponds to their object of linguistic coupling -which latter is the only "object" they will explicitly allow.

the "objects" of the Naturalistic context in which he framed the problem:

"Thus, *human cognition as effective action* pertains to the biological domain, but it is always lived in a cultural tradition. The explanation of cognitive phenomena that we have presented in this book is based on the tradition of science and is valid insofar as it satisfies scientific criteria. It is singular within that tradition, however, in that it brings forth a basic conceptual change: *cognition does not concern objects, for cognition is effective action...*"⁴⁸

"At the same time, as a phenomenon of languaging in the network of social and linguistic coupling, *the mind is not something that is within my brain.*"⁴⁹

*Consciousness and mind belong to the realm of social coupling.*⁵⁰ That is the locus of their dynamics....Language was never invented by anyone only to take in an outside world. *Therefore, it cannot be used*

⁴⁸ How close this is to my suggestion that "objects" are the a/d converters of the brain.

⁴⁹ See prior reference to "other minds"

⁵⁰ To repeat a prior reference, they display here a problem that is ubiquitous amongst epistemologists, (to include even Kant himself), who *always* posit "a God's Eye View".

as a tool to reveal that world. Rather, it is by languaging that the act of knowing, in the behavioral coordination which is *language, brings forth a world.*”

No, I think it brings forth a common intentional strategy *towards* “a world”!

“...We find ourselves in this co-ontogenic coupling, not as a preexisting reference nor in reference to an origin, but as an ongoing transformation in the becoming of the linguistic world that we build with other human beings”, (metacellular organisms).^{xxxiii}

But “*language ... cannot be used as a tool to reveal [the] world.*” Hence, (accepting his own conclusion), *all* his primitives at the final telling are “entities” *solely* of linguistic (and ontogenic) coupling, and, *as such*, have no absolute referent! He maintains that we are *wrong* in characterizing the actual world “in reference to an origin”.

Yet he does exactly that himself. He frames his primitives: structural coupling, metacellular coupling, intraspecies' coupling, (“third order coupling”), and linguistic coupling as interactions of “*autopoietic [biological] unities*”!

What “autopoietic unities”? And *where*? Where do these linguistic domains exist -and between what and whom? Where does *his book* exist? *Does* it, and, if so, how is it relevant to anything at all? *What* “*history of evolution*”?

These linguistic terms supposedly do not "reveal the world"!

He *is*, in fact, committed to a Naturalist ground, and it contains real organisms, i.e. "objects". His "object" is ambiguous however. On the one hand it is solely a product of linguistic coupling, (the object of language), but, on the other hand, (in his presupposition of objects/biological unities which are coupled), it is also the basis of his ontology. This is an explicit and fatal self-contradiction.

Either the object, i.e. the organism, actually *exists* - providing the *ground* of this linguistic coupling, -or it *does not* - in which case "linguistic coupling" is vacuous!

Does my own thesis make our objects *not real*, then?⁵¹ Does it mean that there is no connection between them and the "externality" we must assume? The answer is emphatically "No!" The connection is in *the interface itself*, ("structural coupling") and "experience". But the latter must be understood in terms of the former. We are not justified in assigning a *particular* ontic interpretation to "experience".⁵²

⁵¹ I will make this case in greater detail in the next chapter.

⁵² Naturalism's mistake is in trying to assign an ontic reference to our *whole* cognitive domain. As I have argued, we are justified in making only two primitive ontic, (metaphysical), assertions: "externality" and "experience". These are the minimal and the maximal legitimate ontic posits. Maturana will

In my next chapter I will "slice" this problem from another side, (citing Quine and Cassirer), and argue that "experience", as an ontic posit -and a cognitive primitive -while absolutely justified as such, can be legitimately described only as that which *remains invariant* under all possible (viable) interpretations, (and I will argue there is always more than one interpretation). But "invariants" are in themselves a very concrete form: they stand, for instance, as the foundation of the Theory of Relativity.

Our human cognitive world, and specifically our perceptual world: people and baseballs and the things they do, *are real*, but they are real in the most general interpretation of their relationality, (them and the things they do). This is not so strange a conception -it is implicit in the reductions of science already. But the latter's requirements of hierarchy and isomorphism are *not* inherent; they constitute the *crux* of the problem. It is those requirements which lead to the disastrous end of Maturana's noble and profound enterprise.

Beneficial connection, *pertinent* connection between domains, (i.e. "structural coupling"), does *not* require "parallelism", it does not imply "congruence", it does not require

contribute a third: i.e. "structural coupling" which I will identify with "interface"! See Chapters 9 and 10.

"hierarchy".⁵³ Virtual embodiment demonstrates another, non-hierarchical yet exhaustive possibility of compatibility, and it is this that I have argued in my first thesis.

Maturana's thesis of "structural coupling" is of profound importance. It is an epistemological principle of the highest significance.⁵⁴ It is a necessary consequence of his Naturalist beginnings -and impeaches them! It precedes and supersedes even its biological origin in its relation to the fundamental problem of knowledge.

Biology, therefore, must integrate into a new and *larger* frame, a new orientation of the whole context of our world and our reality. But the Copernican center of that frame must be structural coupling *itself*. (Think of the connection between "structural coupling" and Kant's brilliant vision!) It is "structural coupling" which must ground biology; it is not biology which must ground "structural coupling"!⁵⁵ (This

⁵³ *Could* there be a congruent correspondence, (though admittedly not apodictic), however? Sure, but would be "magic" of a high order- "and then a miracle occurs"! Churchland, 1986)

⁵⁴ It is, in fact, a biological and epistemological principle of relativity. This does not imply that it is a *frivolous* relativity, (i.e. solipsism), however, no more than did Einstein's Relativity imply a lawlessness in physics!

⁵⁵ It is not an unusual, (nor inconsistent), practice in mathematics to begin by constructing a new mathematical discipline from one set of premises, and then to start all over with what were originally derivative consequences as the new, (and more appropriate), primitives.

possibility will be argued in the next chapter within the context of Cassirer's "Symbolic Forms".)

I propose to accept *absolutely* the consequences of "structural coupling": that the "object" of biological cognition is a function of brain process itself—it is “an object of effective action”! It is not an embodiment of its environment.⁵⁶ But this must *necessarily* translate into a Copernican revolution in our very *world-view*: if *we* are biological organisms, then the objects of *our own* human world-view are objects of process, of response as well. They are "objects" of "effective action"!

Maturana and Varela's profound heuristic principle reduces their premise to absurdity -i.e. the metaphysical certitude of the ordinary Naturalist world-view from which they started. The naive-realistic world, (the represented "naturalist" world), can have no internal relevance to the organism, *as* organism. But this does *not* impeach the science, (evolution and biology), which is their ground -no more than did Einstein's Relativity impeach the physics which was *his* ground! The *viable relationality*, (the viable system of predictivity), of biology and evolution, (and of science generally), can be, (*must be!*), preserved, (as was the observed relationality of Ptolemean astronomy -times and angles

⁵⁶ Though this might still seem self-contradictory, please bear with me. I will explain myself fully in the next chapter.

and relative positions- in the Copernican system which replaced it), but they must be interpreted as transformations rather than as reductions.

Are we to throw away the whole of our human enterprise then -to include its science? Of course not -that would be preposterous! But the most profound and most radical advances in human thought, its "Copernican revolutions" and "SUPERB^{xxxiv} theories", have always, (by necessity), subsumed the viable parts of pre-existing knowledge. In the present case, the subsumption of the *preponderance* of naive realism and the *preponderance* of naturalist science stand as necessities. They *work*, after all, with a power and effectiveness which is awesome.

My proposal does not suggest or imply that they be considered any less important. It subsumes the whole of those vistas, but it subsumes them in their viable *relationality*,⁵⁷ and not in their specific ontic (*metaphysical*) reference! Their connection to externality is operational, and not referential. In their whole, they constitute a profoundly effective and complex *algorithm* of unparalleled significance whose link to externality is "structural coupling".

⁵⁷ i.e. their *predictivity*! I will clarify this point in my next chapter.

Relativized Materialism

The latter, however, is *referentially* indeterminate, (i.e. metaphysically so) Science turns recursively back on itself in biology and finds that there is a limitation to knowledge itself. Structural coupling is the antinomy which forces the absolute relativization of all knowing -to include "biology" and "evolution" -and even "perception" - themselves. These are "creatures" of *human* knowledge, of cognition. They are *organizers*, not primitives.⁵⁸

Our true primitive is "*experience*", (under the necessary premise of "externality"), not any particular interpretation -or organization of it. My hypothesis implies, then, a relativization of epistemology precisely equivalent to Einstein's relativization of physics. This is what Cassirer concluded as well.^{xxxv}

An Answer to the New Dilemma:

At last I can give a preliminary answer, (which I will complete in the next chapter), to the disturbing question raised at the beginning of the chapter. How can I presume the naturalistic

⁵⁸ It is explicit in Maturana's argument, (as we have seen), that "structural coupling" and "the conservation of autopoiesis", (and "congruence" itself), are specifically part of the closed, human (biological) cognitive process.

world -with its "evolution"- to prove a hypothesis which severely questions them?^{XXXVI} How can I use a (Darwinian) biological argument, (which *presumes* a simple correspondence between our cognitions and the real physical world), *against* that very simplicity -and embodiment- itself?

If my thesis is true, then our ultimate external reality, (ontology), is *not* necessarily, (nor even probably), like the reality of our cognitive model! The answer is that "evolution" is as much an organizing principle as is "causation". It, (and the objects it treats), is part of the (closed) model itself. It is not a necessary, (or proper!), *metaphysical* presumption, but is, in Kant's words, a "synthetic a priori" proposition. It is not a necessary part of reality; it is a necessary (plausible), part of our *cognition* of reality. As such, I can use it with perfect legitimacy within that closed domain. But I use it, (modifying but keeping the sense of Dennett's word), "*heterophenomenologically*", i.e. with a neutral ontic reference!

My epistemological and metaphysical position, therefore, corresponds very much to Kant's, and ultimately, to Cassirer's. It is neither idealism nor solipsism, but a genuine, (*and realistic*), ontic indeterminism.

Kant's Critical Idealism:

"Idealism consists in the assertion that there are none but thinking beings, all other things which we think are perceived in intuition, being nothing but representations

in the thinking beings, to which no object external to them in fact corresponds. I, on the contrary, say that things as objects of our senses existing outside us *are*", (my emphasis), "given, but we know nothing of what they may be in themselves, knowing only their appearances, that is, the representations which they cause in us by affecting our senses.

Consequently I grant by all means that there are bodies without us, that is, things which, though quite unknown to us as to what they are in themselves, we yet know by the representations which their influence on our sensibility procures us. These representations we call 'bodies', a term signifying merely the appearance of the thing which is unknown to us, but not therefore less actual. Can this be termed idealism?"

Is he an idealist, then? I think his recharacterization of himself as a "critical idealist" was a profound and misleading mistake –probably his greatest!

“Long before Locke's time, but assuredly since him, it has generally assumed and granted without detriment to the actual existence of external things that many of their predicates may be said to belong, not to the things in themselves, but to their appearances, and to have no proper existence outside of our representation.

Heat, color and taste, for instance, are of this kind. *Now, if I go farther and, for weighty reasons, rank as mere appearances the remaining qualities of bodies also, which are called primary -such as extension, place, and, in general, space... with all that which belongs to it (impenetrability or materiality, shape, etc.)*", (my emphasis), "-no one in the least can adduce the reason of its being inadmissible.

As little as the man who admits colors not to be properties of the object in itself, but only as modifications of the sense of sight, should on that account be called an idealist, so little can my thesis be named idealistic merely because I find that more, nay, *all the properties which constitute the intuition of a body belong merely to its appearance.*" [His emphasis].

It is on such points that I claim that Kant is in no way an "idealist", but was rather, in my own terminology, an "ontic indeterminist" which I think is a more accurate description..

"The existence of the thing that appears is thereby not destroyed as in genuine idealism, but it is only shown that we cannot possibly know it by the senses as it is in itself."^{XXXVII}

The "world" as ontic reality certainly *does* exist for Kant, and he acknowledges it as "substantia phenomenon". My *knowledge* of the world however is necessarily indeterminate.

His is a world of ontic indeterminism, but not a denial of the ontic existence of “the world” itself. The ontic world, for Kant, is most certainly *not* “his idea”.

The term "indeterminism" refers to the impossibility of knowing the nature of that ontic reality *independent of* our cognition. It does not, however, assert a doubt as to, but rather affirms, its *existence*.

"Matter is *substantia phaenomenon*. Whatever is intrinsic to it I seek in all parts of the space that it occupies and in all effects that it exerts, which, after all, can never be anything but phenomena of the outer sense.

Thus I have nothing absolute but merely something comparatively internal which, in its turn consists only of external relationships. But what appears to the mere understanding as the absolute essence of matter is again simply a fancy, for matter is never an object of pure understanding; but the transcendental object that may be the ground of this appearance called matter is a bare Something," [Note: I would use the term ‘*somewhat*’ instead!], “whose nature we should never be able to understand even though someone could tell us about it. ...

The observation and analysis of phenomena press toward a knowledge of the secrets of nature and there is no knowing how far they may penetrate in time. But for all that we shall never succeed in answering those

transcendental questions that reach out beyond nature, though all nature were to be revealed to our gaze."^{XXXVIII}

I will, (in chapters 6 through 10), however, make the limiting step that Kant did not. I will posit our cognitive interface, (whatever that may ontically be"⁵⁹), as *itself* a metaphysical entity. It is a part of the minimal (realistic) ontic posit. It is the synthesis of "externality" and "experience".^{XXXIX} It is the generalization of "structural coupling"!

Knowledge is cognitively closed. It is an organizational system that *works*. It is Quine's "body of statements and beliefs", (see Preface or Chapter 5), constrained only by its "boundary conditions", ("experience"). But it exists always within the human (biological) cognitive frame. It can never achieve a "God's eye view"!

"It is by languaging that the act of knowing, in the behavioral coordination which is language, brings forth a world. ...We find ourselves in this co-ontogenic coupling, not as a preexisting reference nor in reference to an origin, but as an ongoing transformation in the becoming of the linguistic world that we build with other human beings."^{XL}

⁵⁹ i.e. "heterophenomenologically"

A New and More Recent Perspective on Maturana:

I said at the beginning of this chapter that though I have not changed my conclusions on its original essence, I had a significant and clarifying insight on it as seen within the context of this current writing. What is it that is substantially new in Maturana's perspective that is different from Kant's? And what was wrong with Kant's?

To review: I think there was a lot still wrong with Kant's vision. For instance, he still maintained that there was a logical necessity of ontological "things" -of "objects" *per se* "out there", ("substantia phenomenon"). This conception was inherited, though modified by Cassirer -and I think they were *both* wrong. Maturana and Varela^{XLI} exposed the crucial factor in dealing with this part of the problem, i.e. "structural coupling".

Hear Kant:

"...though we cannot know these objects as things in themselves, we must yet be in a position at least to think them as things in themselves", ["ding an sich"],
"otherwise we should be landed in the absurd conclusion that there can be appearance without anything that appears."^{XLII}

[Note: And why not? My thesis argues that this is precisely the case, -that "appearance" is an organizational

property rather than a referential one, which is no way inherently “absurd”.]

This passage distinguishes Kant’s position from my own: -from Maturana’s “structural coupling”⁶⁰, from my “concept of implicit definition”, and from my “schematic GUI”. Maturana’s “structural coupling” connects two absolutely distinct operative domains in the most abstract conceptual manner. My “concept of implicit definition” as combined with the “schematic GUI” shows how there can be appearance “without anything”, (ontological interpreted, e.g. –“ding an sich”), “that appears”, and how that “appearance” can, in fact, be efficacious and pragmatic without requiring representation in whatever guise.⁶¹

I don’t think Maturana and Varela finished their task however. They made mistakes,⁶² but they actually did the essential work, and it is profoundly brilliant and important. They showed that the basic (conceptual) operational domains: “environment” and “organism” are distinct and separate, lacking any possible transfer of “information”!

⁶⁰ *sans* “congruent”

⁶¹ We might correct Kant’s citation above by substituting “anything” for “anything”.

⁶² in their progression to “congruent” structural coupling which I argue is unnecessary to their perspective.

"The key to understanding all this is indeed simple: *as scientists, we can deal only with unities that are structurally determined.* That is, we can deal only with systems in which all their changes are determined by their structure, whatever it may be, and in which those structural changes are a result of their own dynamics or triggered by their interactions."^{XLIII}

But then comes the crucial point:

This is a crucial point. As observers, we have distinguished the living system as a unity from its background and have characterized it as a definite organization. *We have thus distinguished two structures that are going to be considered operationally independent of each other,* (my emphasis): "living being and environment...

Therefore, we have used the expression 'to trigger' an effect. In this way we refer to the fact that the changes that result from the environment are brought about by the disturbing agent *but determined by the structure of the disturbed system.* The same holds true for the environment: the living being is a source of perturbations and not of instructions."^{XLIV}

They describe the structural coupling of two domains, two *absolutely isolated* operative domains, and this allows a total disassociation of the brain's, (organism's), "things", -of its

“objects” from what was thought to be the *bare logical necessities* of “externality”.

"In the interactions between the living being and the environment within this structural congruence⁶³, the perturbations of the environment do not determine what happens to the living being; *rather, it is the structure of the living being that determines what change occurs in it.*

I consider Maturana’s writing to be as profound as Kant’s. I consider it to be an extension and a logical consequence of Kant’s profound biological insight.

Maturana’s absolute primitives, “living being”, (“autopoietic entity”) and “environment” are defined as pure concepts, not as classes, (or “objects”), however. Nowhere in his development has Maturana been forced to specify referents *across* these domains. He deals, at least as far as the interaction goes, always with the pure concepts, *as concepts*, themselves.

But Cassirer has forced us to a new understanding of “concepts”!. Even Cassirer’s concept, his “functional concept of mathematics” is defined, at bottom however, referentially like Kant’s. It is the “concept of implicit definition” which makes sense of this situation. It allows a non-referential view of the

⁶³ See my comment on “congruence”

concept itself by incorporating Hilbert's perspective. It allows the notion of a purely *operational* concept!

It is not logically required, (after Maturana), that we have ontological "things", nor do we need to have "something". What we do require, (as realists), is a *somewhat*, some unknown, input and output domains⁶⁴ –i.e. a *concept* of "externality" in Maturana's sense! This is my assertion of an "axiom of externality", which stands as the first of three axioms that I argue constitute the minimal and necessary requirements of realist reason.

We require a domain of "externality" that is somehow related to the domain of the brain. My concept of implicit definition does not require a functional, set-theoretic correlation but instead allows *any* beneficial correlation of domains.⁶⁵ Chaos theory, complexity theory, Freeman's dispersive mapping, Bell's "local mathematics" ... suggest just some of the possibilities.

But Maturana did not accept the consequences of his own profound paradigm shift, and he proceeded to develop his conception of "*congruent* structural coupling". I have argued that

⁶⁴ and, I argue from our beginning pages, that it is inherently *unknowable at all* from the materialistic perspective of "brain as machine"!

he went too far. Structural coupling alone, but not “congruent structural coupling” is the actual consequence of his arguments, as “congruence” presumes, but does not justify, an out and out parallelism. I think that “structural coupling” and “triggering” contradict the conception of “parallel structural coupling” as the latter assumes that we, as metacellular entities can have knowledge of what is on “the other side”!

The Parallel Postulate

I have called “parallel structural coupling” the “parallel postulate” of biology in analogy to the famous mathematical problem. Evolutionary theory teaches us otherwise. What we require is mere *appropriateness* pure and simple –i.e. anything that works pragmatically. We too must “kick away the ladder”. (See Figure 22)

⁶⁵ Consider category theory’s “morphisms” for instance –see footnote in Chapter 7.

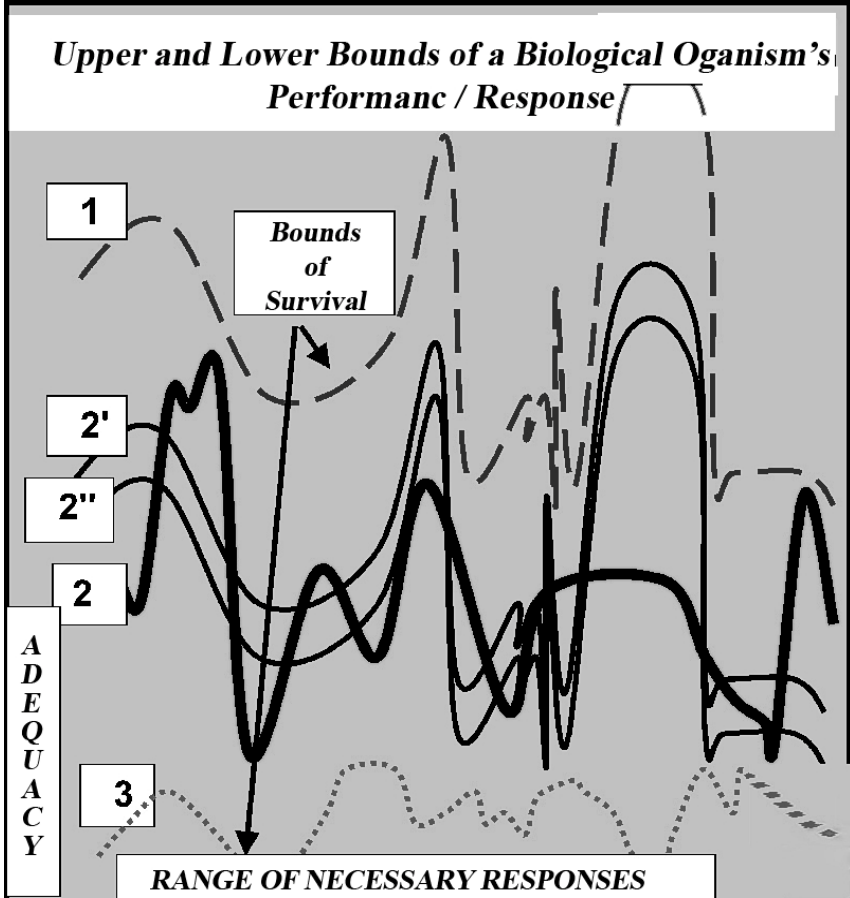

(1) and (3) represent the best and least possible performance for an organism over the domain of its behavior in absolute (ontic) reality. Less than (3) results in lessened survivability or death; greater than (1) is impossible as it is perfect performance with perfect knowledge in actual reality. Between the two bounds, *adequate performance*, (2), (2'), (2''), ... need not match, *nor even parallel* these outer bounds. (Note: 2' and 2'' parallel (1), but (2) does not!) Any curve between them is consistent with evolution. Edelman, for instance talks about the multiple, non-commensurate antibody response to a given antigen. The same must surely apply to cognition, another "recognition system". Cognition and response must be adequate, but it isn't obvious that there is only one way - a "mirroring way". Nor is it inherent that all ways be commensurate.

An organism's performance in its environment is measured, fundamentally, not in perfection or in rationality, but in simple adequacy. It is very easy to envision multiple noncommensurate blind-though-adequate responses to a given situation. It is not easy to envision *rational responses informed by information!* Copyright September, 2008

Figure 22

To repeat myself, this is a fault with just about *all* of the epistemological philosophers, (to include even Kant himself –and Edelman, and W.J. Freeman, the Churchlands, et al...). They *always* posit “a God’s eye view” and accept their own basic terms *as referential* in some real sense.

The only plausible –and *truly scientific* alternative to it that I can see is a relativism, (albeit a *rigid* relativism), of epistemology itself. Cassirer supplied just such a relativism in his “Theory of Symbolic Forms”, and mathematics, in its conception of “mathematical ideals” confirms its essence. But Cassirer’s thesis at its bottom is conceptual as well⁶⁶; it is not based in classes or “objects”. It deals with perspectives. It is a conceptual scheme. Consider Hertz:

"The images of which we are speaking are our ideas of things; they have with things the one essential agreement which lies in the fulfillment of the stated requirement, [of successful consequences], but further agreement with things is not necessary to their purpose. *Actually we do not know and have no means of finding out whether our ideas of things accord with them in any other respect than in this one fundamental relation.*"^{XLV}

⁶⁶ As is Maturana’s

It is just Cassirer's theme⁶⁷ –*as modified with Maturana's*– which I pursued en route to my third hypothesis. It is the only philosophical perspective that allows us to use ordinary descriptive language “heterophenomenologically”, (using Dennett's term), i.e. without an absolute ontic commitment. This is the conception that allowed my idea of a “relativized naturalism”, (equivalently “relativized matter”), stated earlier.

The trick here is to understand Cassirer's “Theory of Symbolic Forms” in terms of Swabey's characterization of him as having created an honest-to-god epistemological theory of relativity. The key words here are “epistemological” and “relativity”.

“Relativity” in a *scientific* sense means a rigid translation of invariants. “Epistemological” means how we describe the world. The key to understanding Cassirer is that he asserts that we have some kind of a constant set of invariants across *all* viable epistemological descriptions of reality. This is where we are coming to and it is the crucial point.

This is the theme that we will revisit in the summation at the end of the chapters 9 and 10: -in the characterization of “the

⁶⁷ The passage above from Hertz is cited in Cassirer's “Symbolic Forms” as part of its rationale.

interface” and the “contemplate your navel” sections of it. It leads into Swabey’s characterization. Cassirer asserts that there is, in fact, a set of invariants, but those invariants cannot be definitively described from any *particular* perspective. That is, they cannot be exclusively described from any single particular *epistemological* perspective –not even from mathematical physics! This is the “contemplate your navel” part of my answer. (See also the “Where Cassirer and I Fundamentally Differ” heading in Chapter 12).

In the next chapter I will explore the other axiom of reason, the Axiom of Experience, and conclude my answer to the epistemological problem I have raised. Quine and Cassirer show the way. This will then allow a brief and succinct statement of my third and final thesis in Chapter 11.

Chapter 7: Cognition and Experience

Quine and Cassirer

(The Epistemological Problem: *What* do we know?)

Let me begin this crucial chapter by repeating my quote from W.V.O. Quine in the preface in its entirety:

"The totality of our so-called knowledge or beliefs, from the most casual matters of geography and history to the profoundest laws of atomic physics or even of pure mathematics and logic, is a man-made fabric which impinges on experience only along the edges. Or, to change the figure, total science is like a field of force whose boundary conditions are experience.

A conflict with experience at the periphery occasions readjustments in the interior of the field. Truth values have to be redistributed over some of our statements. Reevaluation of some statements entails reevaluation of others, because of their logical interconnections- the logical laws being in turn simply certain further statements of the system, certain further elements of the field. Having reevaluated one statement we must reevaluate some others, which may be statements logically connected with the first or may be the statements of logical connections themselves.

But the total field is so underdetermined by its boundary conditions, experience, that there is much latitude of choice as to what statements to reevaluate in the light of any single contrary experience. No particular experiences are linked with any particular statements in the interior of the field, except indirectly through considerations of equilibrium affecting the field as a whole.....

Furthermore it becomes folly to see a boundary between synthetic statements.. and analytic statements...Any statement can be held true come what may, if we make drastic enough adjustments elsewhere in the system... Conversely... no statement is immune to revision... even the logical law of the excluded middle... and what difference is there in principle between such a shift and the shift whereby Kepler superseded Ptolemy, or Einstein Newton, or Darwin Aristotle?"¹

"Experience"! I have argued it as an axiom of sanity, and a minimal realist assumption. But *what* is it and what does it mean? Is it the same as "sensuous impressions"? Does the posit of absolute experience demand an immediate further commitment to reference?

In this chapter I will examine these questions in the light of Quine's and Cassirer's ideas, (and, of course, of Maturana's), and conclude that the answer to each is "no". I will propose an answer of rigorous and scientific epistemological relativism, (an

extension of Cassirer's), which preserves both the phenomena *and the validity of the whole dialogue of Naturalism*, (including, therefore, that of my first two theses), -but *as organization!*

It will preserve them without a commitment to metaphysical reference however. "Experience", I will argue, is identifiable with *exactly that* which remains (relativistically) invariant under all consistent and comprehensive worldviews.¹

Experience is the *phenomena* we must preserve and account for, but it is not the specific *organization* by which we do so. The primitives of a given organization are not legitimized, therefore, on the basis of reference, but on a (relativistic) basis of empirical adequacy.

In the previous chapter, I began a discussion of cognitive closure and asserted an "Axiom of Externality". In this chapter I will continue with the issue of closure and confirm the other necessary, (apodictic), realist prerequisite of cognition, i.e. the "Axiom of Experience". Quine's epigram illuminates both. It validates an absolute and ineradicable *multiplicity* of interpretations for both scientific experiment and experience.

To start, let me propose a fantasy which I think, clarifies the relationship between knowledge, cognition generally, and

¹ Which is essentially a restatement of Quine's position in the preface

"experience". It will suggest a viable working definition of the latter.

A Fantasy:

The remote and newly discovered atoll of Petrolia, deep in the south pacific islands and never before touched by modern civilization, was visited by a geological survey party. It was found to lie above enormous undersea oil reserves. Its king and high priest, a primitive but highly intelligent man, asked to see *our* "magic".² Seeking to humor him, (and, I am ashamed to tell, selfishly induce him to assign drilling rights to an American company at a ridiculously low price), he was given a "red carpet" tour of the Supercollider Accelerator, our greatest scientific marvel.¹¹

The king was mightily impressed. He saw "magical worms", (traces on oscilloscopes), "dancing arrows", (pointers on analog gauges), and tiny "animal tracks", (particle tracks under a microscope), in this "cavern of the gods". He was convinced that the whim of *our* gods provided the "magic", (the "physical laws"), of his experience there, as it, (they), seemed quite different from his own!

He subsequently engaged in a long and heated debate with one of the technicians over the *significance* of it all, ending, sad to say, with his casting a set of boar's knuckles and a shrunken head, (hidden in a bag under his robe), onto the cable-strewn floor with *disastrous* consequences!

Though whimsical, this little fable helps to clarify the purest, (weakest), and the minimum, (necessary), assumption of "experience". There are clearly aspects of the situation that the king may have considered significant, (i.e. explanatory), that the scientist did not, (and conversely). The color or shape of an instrument, or the particular way the technician cleaned his glasses before initiating the experiment, for instance, are things that the king might have considered as ritual, (or physical), necessities, essential to the result.

Even the number of floors of the facility, the time of day, or the route by which he entered might actually be relevant. The technician, of course, considered the king's multicolored ritual headdress, and his pouch of magic bones totally irrelevant, (the king was doing *his* best to be of help).

What I will call the "abstract frame" of the experiment he witnessed, however, was absolutely the same for him as for the

² He was awed when watching reruns of "Gilligan's Island" on the exploratory party's television.

scientist conducting it. The abstract frame, (the total data and the "boundary condition"), for both the scientist and for the King of Petrolia was identical with the *abstract*, (from interpretation),³ of the *whole* of the actual experiment itself, (i.e. the whole of the experimental situation). "Experiment" is clearly an extension, albeit a refined and defined one, of "experience" itself.

The "abstract frame" *must include* the "background situation" however, i.e. *all* the details -to include the observers! We do not know, a priori, *which* of these or *what* of these is relevant. This is one reason why, (other than the issues of personal integrity or error), experiments must be reproducible.

It is to eliminate unique factors deriving from the particular experimental context, (e.g. a magnetic field from the coffee-maker, a power surge from the factory down the block, the crumb from an assistant's lunch contaminating a culture), and to isolate the essentials through a multiplicitous duplication, hopefully random regarding what is (unknowably) extraneous.

We are never on certain ground in that process however. We are never sure that our historically dictated -and contextually limited- design of an experiment does not implicitly incorporate such factors, or that there are not *broader*, (or different), frames, isolating, (or incorporating), *other* factors as incidental and

³ alternatively, the *experiential invariant*

irrelevant, (or pertinent and important), in which it could be implemented.^{4 5}

Following Quine, we are in a process of dynamic reorientation only *bounded* by the abstract frame! *Any* theoretical description really compatible with the overall experimental situation⁶, however, is clearly a *legitimate*, (i.e. logical), interpretation in Quine's broad sense!

Consider: was the King of Petrolia's interpretation of the data of the experiment into *his* theoretical scheme, (worldview), *patently* false? Not necessarily, according to Quine. Was the scientist's translation into "laws of physics", "particles of matter" -or as an expression of the "primitive building blocks of reality" *inherently*, (i.e. logically), better? *Also* not necessarily!

Each could use the data to integrate, reinforce or modify his theoretical basis -his world-view. Even the cumulative body of scientific experiment can be accounted for by the King. Given an unending stream of counterexamples, he can, via Quine, incrementally account for each. The presumption that this

⁴ The lack of free ferrous iron in ordinary differential bacteriology plates when looking for Legionnaire's Disease was an example of a too limited context and was the reason for its long mystery.

⁵ Penrose's "Anthropic Principle" cites the extreme case.

⁶ including one which might dissolve -i.e. redistribute- but exhaustively account for- the apparent relationality of our primitives. Virtual systems clearly suggest a new logical possibility.

cumulative body rules out any other consistent world-view, that eventually he will be backed into a contradiction is not justified.

This is *not* to say that any consistent theory is just as good as any other consistent theory. The king's theory, spirits and witchcraft, let us say, while it may very well be consistent and capable of accounting for any given fact, clearly falls far short in many aspects, perhaps the most important of which is predictability.

The scientist will make strong and definite projections into the future which, by and large, will be clearly and precisely confirmed. He will be able to predict wide ranges of phenomena correctly and efficiently. There are other criteria of good theories as well. Roger Penrose, in his "Emperor's New Mind" has outlined a reasonable standard very concisely.^{III}

The issue, which I will postpone for a little, is whether there cannot be, under the thesis of epistemological relativism which I will assert shortly, multiple, *equipotent and comprehensive* "SUPERB" theories of reality, (using Penrose's classification). The proven equivalence, for example, between Heisenberg's and Schrödinger's (widely divergent) theories of quantum mechanics seems to imply that this may be the case.

The fable, (in concert with Quine I maintain), helps us to see that "experience" *as such* is not, (a priori *or* a posteriori), identifiable with any of its organizations or orientations. (Hilbert claimed as much!) Rather, it must be identified with the

invariant relationality -i.e. with that which remains fixed- under *all* global, comprehensive and consistent orientations.

The Axiom of Experience:

"Experience", (*tentative working definition*), is "that", (elephants, atomic bombs,...), for which both the king and the technician *must account* in some manner!⁷ It is not *itself* an orientation, however. It is, rather, *that* ("thing") *which must remain fixed*, and I argue that it is a *primitive* of reason.

Scientific experiment extends, (generates), experience and thereby bounds (and shapes) the scope of consistent theories. It adds new invariant relationality to the abstract frame, (and the history of abstract frames). Following Quine however, it never *determines* them.

The Epistemological Problem:

At the conclusion of Chapter 4, I asserted the definition: The mind is the "bio-logical", (i.e. materially reduced), "concept" of the brain. (Alternatively, mind is the rule⁸ of the brain.) This scientific conclusion, (and the schematic model), of my first

⁷ This identifies, I propose, a viable and legitimate -and theory independent- working definition of experience.

⁸ -following Cassirer's reformulation of the formal "concept" -see Chapter 3

chapters, however, raises profound philosophical and epistemological difficulties, seemingly contradicting itself.

It raises questions, moreover, which offend the very foundations of our rational sensibilities. This, however, is not so unusual a circumstance but has *always* been the case, historically, at the major turning points of science. Deep progress has *always* necessitated radical, (and often distasteful), reorientations, (rather than mere polishings), of our fundamental worldview -often with the loss of our cherished convictions.⁹

⁹ Here was a negative reaction from a 16th century non-astronomer to Copernicus' revelation cited by Kuhn:

“Those clerks who think (think how absurd a jest)
That neither heav’ns nor stars do turn at all,
Nor dance about this great round earthly ball;
But th’earth itself, this massy globe of ours,
Turns round-about once every twice-twelve hours;
... So should the fowls that take their nimble flight
From western marches towards morning’s light, ...
And bullets thundered from the cannon’s throat
(Whose roaring drowns the heav’nly thunder’s note)
Should seem recoil; since the quick career,
That our round earth should daily gallop here,
Must needs exceed a hundred-fold, for swift,
Birds, bullets, winds; their wings, their force, their drift,
Arm’d with these reasons, ‘twere superfluous
T’assail the reasons of Copernicus;
Who, to save better of the stars th’appearance,
Unto the earth a three-fold motion warrants”

Kuhn, Thomas “The Copernican Revolution” Harvard Press, 1957

Most recently, this is seen very clearly at the invocations of Relativity and Quantum Mechanics in modern physics which, incidentally, raise much the same sorts of questions as does my thesis, i.e. "realism vs. empiricism/algorithmic" questions. I urge that the problems raised by my thesis are not inherently more difficult -or of a radically new and different type- than have been raised, (and answered), before in the cause of science.

The real issue is *productivity* -to whose ultimate judgment I hereby submit my thesis. It is to legitimize and justify my conclusions, however, that I am forced to philosophy and a study of the metaphysical and epistemological presumptions of science *itself* -and there *are* such!

Though admittedly painful, how are the epistemological implications of my thesis so much more difficult than those of modern physics, for instance? At the scale of the very small and at the scale of the very large, physics says that our physical world is *profoundly* strange and, at the small scale at least, that the picture of science is essentially algorithmic.

My thesis proposes *that our human scale world is very much the same* -but that it is itself a *biological* and organic algorithm. It is an internally (and virtually "tactile" algorithm

wherein the "data" we receive and the instrument we manipulate to control it are one and the same.^{IV} Its elements, however, are purely and abstractly *logical*, (alternatively "operational"), elements!

This is a very different and radical way to look at our "objects", (to include perceptual objects), to be sure. It is, I believe however, far more compatible with the outlook of modern physics than is ordinary Naturalism. I maintain that our "tactile", "spatial", "extensive" et al. "objects" are *logical*, (alternatively "operational"), rather than *representative*. But the "logical" here is that of a (Kantian) "constitutive logic" via the "concept of implicit definition" rather than one of ordinary classical abstractive logic, (i.e. one of an "associationist logic" – following Dreyfus' term).

There are really two problems involved with the mind-brain problem. There is a scientific and empirical one, and there is a philosophical and metaphysical one. The combination of my first two theses actually solves the scientific problem I argue, and my third thesis will explicate the metaphysical and philosophical problems. This chapter will resolve just the apparent paradox

created by the first two hypotheses, i.e. the epistemological problem.

I shall now propose a specific answer to the problems which I have raised. My philosophic answer will lead, (in Chapters 8 through 10), to a plausible and pointed answer to the question of the actual substance of mind.

Let me emphasize, however, that my real and central claim remains the scientific one, i.e. the result of the combination of my first two theses; -my philosophic answer is solely its rationale.

Suppose that my scientific conclusion were true, (and I believe the concordance of my first two theses, amongst numerous other reasons, strongly suggests it is), then there seems to be an inherent paradox in knowledge itself, -and in my (Naturalist) premises themselves! If both our perceptual and intellectual objects are solely artifacts of *biological coordination*, then on what ground can knowledge, (and *my own* argument itself), stand? If the *very language*, (to include the very "biological coordination" and "evolution" of my argument),¹⁰ in

¹⁰ I will repeat a footnote I inserted much earlier in book: I think it would be wise to explicitly state that in any discussion such as this, where the very meanings of *all* the common terms are questioned, that you must assume just about every term as being in quotes. In Dennett's terminology, every term must be interpreted heterophenomenologically.

which I describe the problem, (being *part* of that self-same human reality), is only internally organizational and not referential, -then *what* is it that am I describing. How can I even discuss the problem itself?

Doesn't my theory actually eat itself? *How, then, could there be science at all?* Notwithstanding the apparent paradox, (which is not unique to my thesis¹¹ and to which I will here propose a solution), I maintain that mine is a very strong and a very pure Naturalist argument and that its conclusion, *as such*, is valid.¹²

Chapters 1 through 5 might be considered as a constructive *reductio ad absurdum* of the absolutist Naturalist premise, (though not of its relativized equivalent). Chapter 6 is a direct argument to the same effect, building on Kant and Maturana. Less kindly, they might be considered as constituting a "straw man". Combined, however, they are much more

¹¹ This problem is inherent in pretty much the same terms in the whole of Kantian and Neo-Kantian philosophy of science, and in the philosophical dilemmas of modern physics as well. I urge that my solution, in a form very close to that offered by Cassirer, fits with the whole of modern science in a way that none other does. Dogmatic materialism, on the other hand, leads to a linguistic idealism, I believe –that somehow our automaton-generated language leads to truth. But then *what* is truth? Is it then transformed to the automaton pragmatic truth of William James? (See Chapter 12) Is it only the "cash value of an idea"?

¹² See the Anthropic Principle discussion in of Chapter 12!

powerful than that as they actually do resolve the whole of the Naturalist dilemma, (other than the epistemological one I just raised), and explicate the actual mind-brain problem in absolutely legitimate, (and empirically promising), Naturalist terms. Clearly, there might be something wrong with the Naturalist program, but need it be *fatal*?

My argument turns now then, not to argue against the whole sense of Naturalism, but against the *part* of it I believe is flawed. I base those arguments in an extension of Kant's,¹³ and, ultimately, of Cassirer's Neo-Kantian position, i.e. his "Theory of Symbolic Forms". The thrust is to split Naturalism from its over-strong metaphysical presumptions.

Cassirer Revisited:

My prior arguments do not, however, reduce the system of Naturalist *organization*, (i.e. its predictive schema), to absurdity, (nor, therefore, the corresponding organizational, i.e. Naturalist, validity of my own first two theses which are framed within it), but only its claim of absolute, (i.e. metaphysical),

¹³ Kant's work was concerned *primarily* with the problem of cognition and therefore has a special relevance here.

"This is an advantage no other science", [than epistemology], "has or can have, because there is none so fully isolated and independent of others *and so*

reference.¹⁴ Nor do they question the profound *effectiveness* of Naturalist science.¹⁵

Cassirer suggests a way to preserve that overwhelmingly successful relationality, (i.e. the predictive efficacy), of Naturalism in a *relativized* sense, not as reference, but *as organization*, i.e. in his thesis of rigorous and scientific epistemological relativism.¹⁶ He proposes Naturalism, (and materialism),¹⁷ as just one (among several) of the possible -and equipotent- "Symbolic Forms" comprehensively *organizing* the whole of experience.

exclusively concerned with the faculty of cognition pure and simple."
Prolegomena, P.131

¹⁴ again, at *whatever* level of sophistication the latter is postulated

¹⁵ The Naturalist *organization* can be taken *within* contemporary anti-realism, (i.e. anti "scientific-realism" -the position that scientific theories do not directly describe ultimate, metaphysical reality). I am making a distinction between *naturalist organization* and *naturalist metaphysics*. Cassirer I believe, like Van Fraassen, is essentially an antirealist. This is not so surprising, given the fact that they both have Kantian roots, (cf., for instance, Van Fraassen's "Laws and Symmetry".) I will most definitely *not* argue in favor of Naturalism, (i.e. metaphysical naturalism ==scientific realism), but will argue for the (relativized and equipotent) naturalist organization. I will argue, therefore, for the structure, but not the reference of that organization. I call it my conclusion a "*relativized naturalism*". But isn't this just "structuralism" again?

¹⁶ Cassirer's is clearly a mathematical perspective, with its roots in modern algebra.

¹⁷ as embodied in mathematical physics

It is only *experience itself*,¹⁸ (the phenomena), that is preserved as a known metaphysical absolute and to which (relativized) reference can be made. Under Cassirer's "Symbolic Forms", "experience", (Naturalist connotations notwithstanding), must not be confused and identified with its characterization under any *particular* one of the possible symbolic forms however.

It is the confusion of a *particular* "frame of reference", i.e. form, (and the assumption that there is only one comprehensive frame possible¹⁹), with the *invariant relationality of experience* in the abstract, (i.e. under all consistent frames), that is the heart of the issue. It results in a confusion of a *specific organization* (of experience) with the experience itself, (to include scientific experiment as an extension of ordinary experience), which is organized.

It results in an improper assignment of unique metaphysical reference rather than a legitimate judgment of empirical, (i.e. experiential), adequacy for the primitives of the theory. Cassirer's reformulation of the formal logical concept, (and the "new form of consciousness" based in ordering within

¹⁸ Experience is not necessarily, therefore, the same as its ordinary organizational Naturalist interpretation, as "sense impressions". Nor, under my thesis, does experience *refer to* externality. It is an expression of process.

it), allows a new logical possibility and an escape from the dilemma.

Just as Einstein relativized measurement and disembodied the ether, so did Cassirer argue for a relativization of knowledge itself, and a disembodiment of direct reference.

But Cassirer's is not a frivolous, laissez-faire relativism, (nor is it solipsism); it is an explicit and technical *epistemological* relativity rigorously grounded in the phenomenology of science.²⁰ What, exactly, is the length of a rod to a physicist? It depends on the measurements, the frames of reference and the (absolute) equations of the theory of relativity relating them.

What is the relevance of a theory, (including a scientific one)? It depends on the experience, the "form", (e.g. physics/Naturalist science), and the (absolute/invariant) relations, ("equations" -i.e. the web of implication), which must be preserved in it. (See the Rosen letter of Chapter 3, or the notion of "mathematical ideals" elaborated in Chapter 9 for examples.)

¹⁹ i.e. Naturalism = scientific realism

²⁰ Why is Einstein not saying that *any* measurements, (at all!), are valid? Why is Einstein's *itself* not a laissez-faire *physical* relativism? It is because there is a rigid structure at the core of his assertion -i.e. the specific, (and precise), invariant equations of relativity. It is the rigid and invariant "equations", (alternatively "the topology"), of experience that structure valid theories. These "equations", this "topology", must be retained as invariant(s) under all viable theories. This is why neither mine, nor Cassirer's, is an irenic relativism.

The Axiom of Experience

What is constant, under all frames, are the invariants, (in a mathematical sense), which must be preserved in them, i.e. "experience" –which I have identified with that “*somewhat*” which must remain fixed. I argue that it is a *primitive* of reason.

"Experience", I claim, is that for which both the king and the technician *must account* in some manner! It is not *itself* an orientation per se, however. Scientific experiment extends, (generates), experience and thereby bounds and shapes the scope of consistent theories. It adds new invariant relationality to the abstract frame, (and the history of abstract frames). Following Quine however, it never *determines* them.

I argue therefore for a working (and non-referential) definition of "experience": as *that* which must be maintained under *all* comprehensive worldviews.²¹

But what exactly could a materialist's relativized “*substance*” be then? What could Naturalism's “*material*” be under such a conception? It would be an implicitly defined *term*, (alternatively a "symbol"), under a particular interpretation -i.e. it

²¹ Though this is clearly somewhat circular, it is perfectly consistent with my assertion that "experience" is, in fact, an epistemic primitive. Afterthought: look again at Bell's “local mathematics” and “invariants”.

would itself be an "object" implicitly defined by the "generating relations" of the science which specifies it.

Even materialism need not, therefore, *necessarily* carry a metaphysical commitment. It is, rather, an organization of experience using the (implicitly defined) terms of "substance".

Cassirer's Theory of Symbolic Forms, an Analysis:

Cassirer suggests a new way to look at the relation between theory and experience. He proposes a rigorous *epistemological relativism* innate in the phenomenology of modern science.

"Mathematicians and physicists were first to gain a clear awareness of this [the] symbolic character of their basic implements. The new ideal of knowledge, to which this whole development points, was brilliantly formulated by Heinrich Hertz in the introduction to his 'Principles of Mechanics'. He declares that the most pressing and important function of our natural science is" [simply] "to enable us to foresee future experience"^v

It is the *method* by which it derives the future from the past which is significant, however. We make "inner fictions or symbols" of outward objects, and these symbols are "so constituted that the necessary *logical consequences*, [my emphasis], of the images are always images of the necessary

natural consequences of the imaged objects".^{VI} But this analysis -and "image"- must be interpreted carefully:

“... [though] still couched in the *language* of the copy theory of knowledge -... the concept of the 'image' [itself] had undergone an inner change. In place of the vague demand for a similarity of content between image and thing, we now find expressed a highly complex *logical* relation, [my emphasis], a general intellectual *condition*, which the basic concepts of physical knowledge must satisfy.”^{VII}

Its value lies "*not in the reflection of a given existence, but in what it accomplishes as an instrument of knowledge,*"^{VIII} [my emphasis], "in a unity of phenomena, which the phenomena must produce out of themselves."

Heinrich Hertz formulated the distinction very succinctly:

"The images of which we are speaking are our ideas of things; they have with things the one essential agreement which lies in the fulfillment of the stated requirement, [of successful consequences], but further agreement with things is not necessary to their purpose. *Actually we do not know and have no means of finding out whether our ideas of things accord with them in any other respect than in this one fundamental relation.*"^{IX}

A system of physical concepts must reflect the relations between objective things and their mutual dependency, but, Cassirer argues, this is only possible "in so far as these concepts pertain *from the very outset* to a definite, homogeneous intellectual orientation",^X "[my emphasis]. "It is only within a distinct logical framework that these "images" are significant at all."²² The object cannot be regarded as a "naked thing in itself", *independent* of the essential categories, (and framework), of natural science: "for only within these categories which are required to constitute its form can it be described at all."

This change of perspective, (and it is a *genuine* "Copernican Revolution" in Kant's sense), necessitates and validates Cassirer's conclusion of the innate symmetry and *a relativity of interpretations* for phenomena. "With this critical insight ... *science renounces its aspiration and its claim to an 'immediate' grasp and communication of reality.*"^{XI}

"It realizes that the only objectivization of which it is capable is, and must remain, *mediation*," [my emphasis].

"And in this insight, another highly significant" [critical]

²² Please note the similarity of this situation, as formulated by Hertz and Cassirer, with that I laid out in Chapter 4 for the training seminar. The objects, ("images"), in a very real sense, are a function of the calculus. Insofar as they are justified, it is on the conjoint basis of utility.

“idealistic²³ consequence is implicit. If the object of knowledge can be defined only through the medium of a particular logical and conceptual structure, we are forced to conclude that a *variety of media*”, [my emphasis], “will correspond to various structures of the object, to various meanings for 'objective' relations.”^{XII 24}

This is the assertion of symmetry and the foundation for his thesis of "Symbolic Forms".

“... *Even in 'nature'*,²⁵” [my emphasis], “the physical object will not coincide absolutely with the chemical object, nor the chemical with the biological -because physical, chemical, biological knowledge *frame their questions* each from its own particular standpoint and, in accordance with this standpoint, subject the phenomena to a special interpretation and formation.²⁶ It might also

²³ *Everywhere*, where Cassirer uses "idealism", it must be understood as "critical idealism" in the sense that Kant used it. This is very different from ordinary idealism, and, as I discussed in Chapter 4, is a real misnomer. I have suggested "ontic indeterminism" as a more appropriate alternative, and one I think both Kant and Cassirer would have been happy with. Also compare the "mere X", (below), with my discussion earlier.

²⁴ Think about Hilbert's "beer mugs" and the "Pythagorean Theorem" discussion in the opening chapters!

²⁵ i.e., "science" as opposed to the "cultural forms" -see discussion later.

²⁶ But even within Cassirer's primary "natural forms" -in physics, for instance, I argue -beyond Cassirer- that the exact parallel obtains. There are arguably alternative Hertzian formulations of the problem. Alternative objects and

seem that this consequence in the development of”
[critical] “idealistic thought²⁷ had conclusively frustrated
the expectation in which it began. The end of this
development seems to negate its beginning -the unity of
being, for which it strove, threatens once more to
disintegrate into a mere diversity of existing things. The
One Being, to which thought holds fast and which it
seems unable to relinquish without destroying its own
form, eludes *cognition*.”^{XIII}

It is the *phenomena*, (experience), *not reference*, however,
that is the fulcrum of, (and reunifies), this relativity of
perspectives. The forms do not *refer to* (metaphysical) reality,
(their objects are not “*images*” of reality), instead they *organize*
experience.

Metaphysical reality becomes "a mere X"! "The more its
metaphysical unity as a 'thing in itself' is asserted, the more it
evades all possibility of knowledge, until at last it is relegated
entirely to the sphere of the *unknowable and becomes a²⁸ mere*
'X'", [my emphasis].^{XIV} “It is the realm of *phenomena*, "the true

alternative calculi are possible. Fine suggests that Relativity and Quantum
Mechanics may represent such alternatives, and certainly Schroedinger's and
Heisenberg's conceptions of quantum theory illustrate the plausibility.

²⁷ See prior definitional footnote re: “critical idealism”

²⁸ (Kantian)

sphere of the knowable with its enduring multiplicity, finiteness and relativity", on which we stand.

It is the (multiplicitous and relativized) *organizations* of the phenomena, *not reference* to a metaphysical origin, which lies at the basis of knowledge.

"And to this rigid metaphysical absolute is juxtaposed the realm of phenomena, the true sphere of the knowable^{XV} with its enduring multiplicity, finiteness and relativity."^{XVI}

But this reorientation does not destroy either the unity or the coherence of knowledge.

"But upon closer scrutiny the fundamental postulate of unity is not discredited by this *irreducible diversity*", [my emphasis], "of the methods and objects of knowledge; it merely assumes a new form. True, the unity of knowledge can no longer be made certain and secure by referring knowledge in all its forms to a 'simple' *common* object which is related to all these forms as the transcendent prototype to the empirical copies." [my emphasis]^{XVII}

(This latter demand is, of course, the rationale of the dogmatic Naturalist claim of reference.)

"But instead, a *new* task arises: to gather the various branches of science with their diverse methodologies -

with all their recognized specificity and independence - into one system, whose separate parts precisely through their necessary diversity will complement and further one another. This postulate of a purely functional unity *replaces the postulate of a unity of substance and origin, which lay at the core of the ancient concept of being.* ^{xviii}

This is an expansion of the concept of relativization far beyond any other ever proposed! I will shortly propose yet another expansion to a still wider conception.

Cassirer conceives his "symbolic forms" *functionally*, (and serially), i.e. in terms of the "mathematical concept of function".

"And this creates a new task for the philosophical critique of knowledge. It must follow the special sciences and survey them as a whole. It must ask whether the intellectual symbols by means of which the specialized disciplines reflect on and describe reality exist merely side by side *or whether they are not diverse manifestations of the same basic human function.* And if the latter hypothesis should be confirmed, a philosophical

critique must formulate the universal conditions of this function and define *the principle* underlying it.^{XIX} ²⁹

Instead of dogmatic metaphysics, "*which seeks absolute unity in a substance to which all the particulars of existence are reducible*", he seeks after "*a rule governing the concrete diversity of the functions of cognition, a rule which, without negating and destroying them, will gather them into a unity of deed, the unity of a self-contained human endeavor.*"^{XX} [my emphasis]³⁰

Perhaps the most succinct overall statement of Cassirer's thesis is found in his "Einstein's Theory of Relativity".^{XXI} Each of the perspectives of scientific knowledge: physics, chemistry, biology, ... (the "cognitive forms"), - and ultimately myth, religion and art, ... (the "cultural forms" which I may perhaps question),³¹ are taken as alternative and equipotent (organizational) perspectives on the phenomena. They are in a way like the Hilbertian "beer mugs" and "pythagorean theorems", or like the alternative models of the universe of the Rosen letter discussed much earlier.

²⁹ This is one of the explicit purposes of the present book.

³⁰ Cassirer extends his theory of symbolic forms *beyond "nature"*, (i.e. beyond the sciences), into the "cultural forms": art, myth, religion, etc. -i.e. beyond cognition itself. I will deal with this aspect of his thesis presently, taking a neutral perspective, but first I would like to extend and modify this, his core and scientifically grounded position somewhat.

"Each of the original directions of knowledge, each interpretation, which it makes of phenomena to combine them into the unity of a theoretical connection or into a definite unity of meaning, *involves a special understanding and formulation of the concept of reality.*"^{XXII}

Ordinary Naturalism confuses a *particular* organization, (mathematical physics), with the phenomena themselves which are organized. That is the basis of its assertion of reference -and its "scientific realism"³². "The "objects", (the organizational primitives -i.e. "images"), of one *particular* form are assumed, (incorrectly), to *reference* ontology -to relate to "an ultimate metaphysical unity".

"Where there exist such diversities in fundamental *direction* of consideration, the *results* of consideration cannot be directly compared and measured with each other. The naive realism of the ordinary view of the world, like the realism of dogmatic metaphysics, falls into this error, ever again. It separates out of the totality of possible concepts of reality a single one and sets it up as a norm and pattern for all the others. *Thus certain*

³¹ I will question the eventual scope of his vision presently

necessary formal points of view, from which we seek to judge and understand the world of phenomena, are made into things, into absolute beings".[my emphasis]^{XXIII} 33

What these "formal points of view" do, *instead*, he argues is organize phenomena. What is consistent under *all* forms, however, are the phenomena themselves.

Naturalism confuses a *particular* "frame of reference", i.e. "form",³⁴ with the *invariant relationality of experience* in the abstract -i.e. under *all consistent frames*.³⁵ It confuses a specific organization, (and a specific characterization), of experience with the experience itself³⁶ which is organized. It results, (and I repeat myself), in an improper assignment of unique metaphysical reference rather than a legitimate judgment of empirical, (i.e. experiential), adequacy for the primitives of its theories.

"Only when we resist the temptation to compress the totality of forms, which here result, into an ultimate metaphysical unity, into the unity and simplicity of an

³² another misnomer

³³ Naturalism, at *whatever* level of sophistication, clearly falls under this injunction.

³⁴ and assumes that there is only one comprehensive frame *possible* -i.e. that of Naturalism

³⁵ compare Van Fraassen's "co-ordinate-free descriptions". "Quantum Mechanics: an Empiricist's View"

³⁶ to include scientific experiment as an extension of ordinary experience

absolute 'world ground' and to deduce it from the latter, do we grasp its true concrete import and fullness. No individual form can indeed claim to grasp absolute 'reality' as such and to give it complete and adequate expression.[my emphasis]"^{XXIV 37}

This is his claim of epistemological relativism! Cassirer's denial of "completeness", and "adequacy", (i.e. *epistemological* completeness and *epistemological* adequacy), however, is not the same as denying that any individual form can grasp the whole of the phenomena *comprehensively* for a form can be both comprehensive and adequate without being unique! This is one of the lessons we got from Hilbert. Nor does Cassirer speak definitively on the issue of reduction! I will address both of these issues shortly.³⁸

"It is the task of systematic philosophy, which extends far beyond the theory of knowledge, to free the idea of the world from this one-sidedness. It has to grasp the *whole*

³⁷ Please see my mathematical ideals discussion of Chapter 9 for a petty lucid explanation of this idea.

³⁸ If a given form were, in fact, capable of reducing all other theories, and no other could, it would obviously cut against equipotency and "relativization" -i.e. against the whole sense of his thesis! This is the current rationale for dogmatic Naturalism as grounded, (problematically, I believe), in mathematical physics. A likely candidate would be the biologist Maturana's alternative perspective.

system of symbolic forms, the application of which produces for us the concept of an ordered reality, and by virtue of which subject and object, ego and world are separated and opposed to each other in definite form, and it must refer each individual in this totality to its fixed place.

If we assume this problem solved, then the rights would be assured, and the limits fixed, of each of the particular forms of the concept and of knowledge as well of the general forms of the theoretical, ethical, aesthetic and religious understanding of the world. Each particular form would be 'relativized' with regard to the others, *but since this 'relativization' is throughout reciprocal and since no single form but only the systematic totality can serve as the expression of 'truth' and 'reality'³⁹*, [my emphasis], "the limit that results appears as a thoroughly immanent limit, as one that is removed as soon as we again relate the individual to the system of the whole."

XXV

³⁹ This is the rationale for my later claim that no single form may adequately describe "the interface".

(At this point I would definitely refer you once again to my discussion of “mathematical ideals” which is a much simpler way of understanding this idea!)

Cassirer's “Symbolic Forms” is not a *capricious* relativism however; it is a relativism as rigorous in concept as is Einstein's –or as is Hilbert's. Just as Einstein characterized his theory as having removed "the last remainder of physical objectivity from space and time", Cassirer's conclusion removes the last remainder of metaphysical, (i.e. absolute), *reference* from knowledge.

It is based in the essential methodology of science: in its (Hertzian) theorizing *function*! It is the nature of science to construct a form, complete and interdependent between symbols, ("images"), and a “calculus” which acts as a whole.⁴⁰

Under all the forms, (of "nature", at least), Cassirer maintains that what must be maintained are the "invariants" -i.e. that which must be preserved under any consistent form. These are not "things" or "images", but rather, (mathematically), that which remains constant under all epistemologically legitimate forms. In the sense which I will expand the notion, I argue that it corresponds to my prior (relativized) definition of "experience".

⁴⁰ cf. the "training seminar" of Chapter 4

"But above all it is the general form of natural law which we have to recognize as the real invariant and thus as the real logical framework of nature in general.....No sort of *things* are truly invariant, but always only certain fundamental relations and functional dependencies retained in the symbolic language of our mathematics and physics, in certain equations." ^{XXVI} (I will qualify this assertion slightly in Chapter 12.)

I will postpone my critique of Cassirer's thesis for a little. Though I think there are problems and questions which need to be resolved, I would like to make the connection to my own thesis before going into those. In its essence, i.e. the essential relativism of knowledge, and his case against reference, I think his argument is very strong and very fundamental. There are very strong questions and delimitations that I will raise when I return to Cassirer's broader thesis later. They will not, however, question this, his core position.

Chapter 8: Cassirer's "Symbolic Forms"

(The Solution to My OWN epistemological Dilemma –and a *Profound Change in Perspective!*)

Nowhere does Cassirer question the profound *effectiveness* of modern science, however. His orientation is wholly and profoundly scientific. Rather, he preserves the various sciences as *perspectives*, as organizations of phenomena. He has, moreover, provided the very tools necessary to resolve the epistemological dilemma created by the combination of my first and second theses.

I therefore propose a fundamental, (and final), "Copernican Revolution" -a profound change in perspective-contrary to that of the Naturalist perspective which I conditionally adopted at the end of Chapter 6¹, (but with perfect legitimacy, I now maintain -as a *relative* stance), and *to* the stance I now ultimately proclaim.

This stance "reduces" the materialist position itself to organization and *not* to reference. I argue against ordinary Naturalism, and *for* a more sophisticated realism, (essentially a

¹ And in the very first chapter of the present MS –in the "Nutshell précis "

biologically Kantian-Cassirerian-Maturanian-Freemanian one), consistent with the results of the first two theses.¹ By this, (once again), I do not mean to say that the *relationality* of Naturalism, (or of Naturalist science), is faulty, (on the contrary it is superb), but that its metaphysical reference *as reference per se* is faulty.

My thesis, though built with Naturalist "bricks", does *not* therefore entail the further and unnecessary Naturalist "foundation" of reference. Though it assumes the validity of the Naturalist organization, (at least on the human scale), it does not assume the metaphysical reality of Naturalism's primitive "material", ie. of its "substance". (I have called this "relativized Naturalism").

In questioning our actual, (referential), cognition of metaphysical reality, it is not, therefore, innately self-contradictory! Though stated in Naturalist terms, my thesis can legitimately question the actual (metaphysical) existence, (or

¹ Kant's thesis is profoundly difficult to accept admittedly, both intellectually and intuitively -but so was Einstein's. Where Einstein relativized the physical world, Kant sought to relativize the epistemological one. His lapses can be assigned to his deprivation of the examples of modern mathematics and modern science -which subjects were always his primary focus -and which could have corrected him. That he was two hundred years before his time is surely not an argument against his credibility.

even the *possibility of knowledge*), of the referents of those terms!

Ordinary Naturalism, though it will not say so, is through and through grounded in a specifically metaphysical dogma, i.e. absolute reference, (however sophisticated), to absolute, (rather than relativized), "material" which it equates with "substance". This is the "material" in "materialism",¹ and was the specific target of Kant's and Cassirer's profound arguments.

As realists, on the other hand, (and I speak to no one else), we *must* posit the existence of an absolute, external reality. It is, I have argued, an axiom of realist reason. But, I further argue based on Kant, on Cassirer, on the advances of modern physics, on Maturana's penetrating analysis and on the results, (and natural concordance), of my first two theses, that human cognition does not know, and *can never know* that absolute reality! (There is still "nobody home" in the materialist sense.) I argue we cannot know that *metaphysical* world in itself, even in "sophisticated" reference!

I propose that we stand, *even at the human scale*,² in the same relation to ontology that current physics does, (at least as I

¹ as usually conceived -i.e. not in a Cassirerian sense

² more properly "domain" than "scale", as I do not think this is a *size* issue. I will expand this momentarily.

understand, let's say, Bohr's or Heisenberg's position to be.) I propose that our human scale cognitive world is as much -and *as solely*- a pure algorithm as is the worldview of quantum physics. I argue that it is utilitarian and not referential. But it is an organic, "tactile" algorithm, (a "GUI"), that evolution constructed.¹ This sentence, however, is no longer paradoxical. It must itself now be understood in my larger context, as the very "evolution" in it is *itself* relativized, (i.e. it is a relative assertion *within* the particular and *relativized* Naturalist form).

The results of my first two theses are therefore consistent under this epistemological rationale. The resolution lies in the scientifically and mathematically, (but most certainly *not arbitrarily*), conceived relativization of knowledge itself!

Relational implications, predictive systems, (to include scientific theories), are not, (with Quine), epistemologically determinate. Rather, their essence, (which is their predictivity), can be isolated, (following Cassirer), as relational invariants, (in a mathematical sense), over the field of consistent hypotheses in a sense parallel to that in which Einstein's equations of special

¹ This is the implication of my remark in Iglowitz 1995. Let me repeat it here: Ideally instrumentation and control would unify in the *same* "object". We would manipulate "the object" of the display itself and *it* would be the control device. Think about this in relation to our ordinary "objects of perception" -in relation to

relativity were isolated as invariants from the "ether" in which they were originally grounded by Lorentz.

Or, rather, relational implications are invariant, but predictive organizations, (i.e. theories and epistemologies), even comprehensive ones, are not! They are the (better or worse), "SUPERB" or "MISGUIDED"¹ "forms" which organize those implications.

Whence Cassirer's Thesis:

There is, interestingly, a very real similarity of intent at least, (if not in scope or rationale), between Bas Van Fraassen's "co-ordinate free" and "semantic" approach to modern physics and Cassirer's "symbolic forms".

"To formulate a view on the aim of science, I gave a partial answer to the question of what a scientific theory is. ... It does not follow that a theory is something essentially linguistic.

That we cannot convey information, or say what a theory entails, without using language does not imply that -after all, we cannot say what anything is without using

the sensory-motor coordination of the brain and the problem of naive realism!
We do not *use* our biological algorithm, we *live* in it!

¹ cf Penrose "The Emperor's New Mind" (his CAPS!).

language. We are here at another parting of the ways in philosophy of science. Again I shall advocate one particular view, the *semantic view* of theories. Despite its name, it is the view which de-emphasizes language."^I

"Words are like coordinates. If I present a theory in English, there is a transformation which produces an equivalent description in German. There are also transformations which produce distinct but equivalent English descriptions. This would be easiest to see if I were so conscientious as to present the theory in axiomatic form; for then it could be rewritten so that the body of theorems remains the same, but a different subset of those theorems is designated as the axioms, from which all the rest follow.

Translation is thus analogous to coordinate transformation -is there a *coordinate-free*", [*invariant?*], "*format as well?*" [my emphasis] "The answer is *yes* (though the banal point that I can describe it only in words obviously remains)."^{II}

Though Van Fraassen ultimately rejects axiomatics, and confines himself to the domain of physical science, his position

has a very definite resemblance to that of Cassirer, at least insofar as the latter is confined to "nature". Each is epistemologically relativistic,¹ and each is grounded in invariants. Van Fraassen rejects axiomatics, (which I believe is the most cogent formulation of the problem), however, on the basis of a *need for meaning and interpretation*, i.e. reference.²

He goes on:

¹ "There are a number of reasons why I advocate an alternative to scientific realism ... One concerns the difference between acceptance and belief; reasons for acceptance include many which *ceteris paribus*, detract from the likelihood of truth. This point was made very graphically by William James; it is part of the legacy of pragmatism. The reason is that, in constructing and evaluating theories, we follow our desires for information as well as our desire for truth. We want theories with great powers of empirical prediction. For belief itself, however, all but the desire for truth must be 'ulterior motives'." (ibid p.3) Please note the connection to the essential Hertzian perspective. "Information" is concerned with predicting future events; "truth" is something else altogether.

² Hilbert's "concept of implicit definition", combined with Cassirer's "Symbolic Forms" is my answer to his objection. See the Schlick quote re: "meanings".

"To show this, we should look back a little for contrast. Around the turn of the century, foundations of mathematics progressed by increased formalization. Hilbert found many gaps in Euclid's axiomatization of geometry because he rewrote the proofs in a way that did not rely at all on the *meaning* of the terms (point, line, plane,...). This presented philosophers with the ideal: a pure theory is written in a language devoid of meaning (a pure *syntax*) *plus* something that imparts meaning and so connects it with our real concerns."^{III}

My thesis of the "schematic object" and the first three chapters of this book are directed *precisely* to that point and deny it. It is precisely my point, (and Hilbert's as well), that "meaning" be taken in its *mathematical* sense for such a system. A mathematician understands the meaning of a term to be *precisely* that which is implied by the syntax, i.e. it is a virtual term "ordering" the *whole* of the system in which it is defined.

If the mind and perception specifically, (the phenomena), is taken in this sense, as ordering process- if it is taken as an organization, and its terms as metaphors of its own organizational process then there is no longer the *metaphysical* question of meaning or of reference –“structural coupling” does not allow it. The terms, instead, mean precisely what the syntax implies -i.e. they are virtual terms *only!* I maintain *these* are our actual “real concerns”!

The deeper problem is the one that Cassirer defined: that of "experience" itself and how theoretical science relates to it,¹ - and *that* involves a total reevaluation of the problem of reference. Cassirer's epistemology, of course, is firmly grounded in axiomatics. Discussing Hilbert, Cassirer says:

"The procedure of mathematics here", (implicit definition), "points to the analogous procedure of theoretical natural science, for which it contains the key and justification."^{IV}

Contra Cassirer: (What are the real parameters?)

Though I accept, (and argue), Cassirer's core position of epistemological relativism, (I believe it is absolutely warranted on the very pure and very strong phenomenological grounds

¹ Theory, (seen as a Hertzian, free construct -as developed in the last chapter), must match, (in *some* sense), the "topology", so to speak, of temporal and spatial consequence in experience. As stated thus far, this idea is, of course, Kantian. Russell however, (in his "Foundations of Geometry"), argued to extend the Kantian frame to projective geometry. I feel it must be broadened again past that -past even topology and into the mathematics of abstract transformations. What is required is that the predicted results of the theoretical system (*through some transformation!*) must match the results of naive (?) experience, -*and conversely!* That is, the results of naive experience -through *some* (mathematical) transformation - should match the retrodictive predictions of the theory. But this transformation, (since it is *past* topology), need not preserve objects, and therefore, *not reference!* What its Hertzian premise demands that it *must* preserve is the web of relationality in its most abstract sense. It must preserve the "abstract frame".

wherein he evolved it), I will now question his extension of its scope and its applicability. What *are* the legitimate forms?

Cassirer's thesis goes beyond "cognition" and science, ("nature") into a symmetry of cultural forms, (to include science as a special case), as well. Van Fraassen does not, nor did Kant, (who remained entirely within "nature" in his core thesis), but this is a question of scope. There is also a question of the identification of the legitimate (primitive) forms -even within "nature" itself.

Before addressing these questions, however, let me first complete my examination of the broadest formulation of Cassirer's thesis.

Going beyond the "natural forms", (physics, biology, chemistry, etc), he extends his thesis into ground which I must at least question. He proposes that the forms of "nature", of "cognition", are only part of the innate symmetry of perspectives across the phenomena. They, (the natural forms), represent those forms which relate phenomena directly to a metaphysical, (cognitive), framework. Phenomena can however, (he asserts), be organized on *other* grounds: art, myth, religion, etc., "*but they achieve this universal validity by methods entirely different from the logical concept and logical law*". (Note: it is his "entirely different" that I will question.)

"But again our perspectives widen," [i.e. beyond "nature" and into the purely cultural forms], "if we consider that *cognition,*" [itself], "however universally and

comprehensively we may define it, *is only one of the many forms* in which the mind can apprehend and interpret being. In giving form to multiplicity it is governed by a specific, hence sharply delimited principle.

All cognition, much as it may vary in method and orientation, aims ultimately to subject the multiplicity of phenomena *to the unity of a 'fundamental proposition.'*

The particular must not be left to stand alone, but must be made to take its place in a context, where it appears as part of a *logical structure*, whether of a teleological, logical, or causal character. ¹Essentially cognition is always oriented toward this essential aim, the articulation of the particular into a universal law and order.”^V

(I disagree with his distinction -so too do the "cultural forms" embody law. The difference, I believe, is in the *orientation* -i.e. to *cognition* -to "externality" as world-ground. Any form, even the "cultural forms", will have, (by definition), its own sense of law and logical structure. It is a question of the meaning of "logical structure".)

¹ Note: this is a reiteration of his “mathematical concept of function and a reference to its necessary “rule”.

"But beside this intellectual synthesis, which operates and expresses itself within a system of scientific concepts, the life of the human spirit as a *whole knows other forms*.

They too can be designated as modes of 'objectivization': i.e., as means of raising the particular to the level of the universally valid; but they achieve this universal validity by methods entirely different from the logical concept and logical law.

Every authentic function of the human spirit has this decisive characteristic in common with cognition: it does not merely copy but rather embodies an original, formative power. It does not express passively the mere fact that something is present but contains an independent energy of the human spirit through which the simple presence of the phenomenon assumes a definite 'meaning', a particular ideational content."^{VI}

But please note carefully that *all* of Cassirer's "functions of the human spirit" -even his "cultural forms" specifically articulate *phenomena* -i.e. they are not free, "idealistic" constructs, (i.e. of philosophical idealism)! ("...an independent energy of the human spirit through which the simple presence of the phenomenon assumes a definite 'meaning', a particular ideational content"), but rather are objects of the mind!)

"This is as true of art as it is of cognition; it is as true of myth as of religion. All live in particular image-worlds,

which do not merely reflect the empirically given, but which rather produce it *in accordance with an independent principle.*” [Note: That is, in accordance with “a rule”.]

Each of these functions creates its own symbolic forms which, if not similar to the intellectual symbols, enjoy equal rank as products of the human spirit.

None of these forms can simply be reduced to, or derived from, the others; each of them designates a particular approach, in which and through which it constitutes its own aspect of 'reality'. They are not different modes in which an independent reality manifests itself to the human spirit, but roads by which the spirit proceeds towards its objectivization, i.e. its self-revelation."^{VII}

I will repeat a paragraph from the previous chapter here. The paragraphs above are his claim of epistemological relativism! But Cassirer's denial of "completeness", and "adequacy" are correctly to be understood as denials of *epistemological* completeness and of *epistemological* adequacy. To deny epistemological completeness or epistemological adequacy for any given form is not the same as denying that any individual form can grasp the whole of the phenomena *comprehensively* for a form can be both comprehensive and adequate without being unique! This is one of the lessons we got from Hilbert, from complex transformations, and which comes

from the cross-reductions ubiquitous in modern mathematics. Nor does Cassirer speak definitively on the issue of reduction! I will address both of these issues shortly.¹

That he claims that "none of these epistemological forms can simply be reduced to, or derived from, the others" seems to provide an essential argument to dogmatic Naturalism.²

Conversely, I will argue that it suggests and delimits a more correct extension of Cassirer's solution to the overall problem. I will address these very large problems shortly.

His meaning must be examined very closely”:

"If we consider art and language, myth and cognition in this light, they present a common problem which opens up new access to a universal philosophy of the cultural sciences.^{VIII}

"The 'revolution in method' which Kant brought to theoretical philosophy rests on the fundamental idea that

¹ If a given form were, in fact, capable of reducing all other theories, and no other could, it would obviously cut against equipotency and "relativization" -i.e. against the whole sense of his thesis! This is the current rationale for dogmatic Naturalism as grounded, (problematically, I believe), in mathematical physics. A likely candidate would be the biologist Maturana's alternative perspective.

² But you must understand that he is talking about the epistemological forms *themselves* here, not their content.

the relation between cognition and its object, generally accepted until then, must be radically modified.

Instead of starting from *the object*", [my emphasis]," as the known and given, we must begin with the law of cognition, which alone is truly accessible and certain in a primary sense; instead of defining the universal qualities of *being*, like ontological metaphysics, we must, by an analysis of reason, ascertain the fundamental form of *judgment* and define it in all its numerous ramifications; only if this is done, can objectivity become conceivable.

According to Kant, only such an analysis can disclose the conditions on which all *knowledge* of being and the pure concept of being depend. But the object which transcendental analytics thus places before us is the correlate of the synthetic unity of the understanding, an object determined by purely logical attributes.

Hence it does not characterize all objectivity as such, but only that form of objective necessity which can be apprehended by the basic concepts of science, particularly the concepts and principles of mathematical physics. ..."^{IX}

Cassirer asserts, beyond this, an absolute "*spiritual*" relativism, (but *always* articulating the phenomena), -i.e. an absolute symmetry across the whole of the "cultural forms", (the "spirit"), of man.

"There result here not only the characteristic differences of meaning in the objects of science, the distinction of the 'mathematical' object from the 'physical' object, the 'physical' from the 'chemical', the 'chemical' from the 'biological', but there occur also, over against the whole of *theoretical* scientific knowledge, other forms and meanings of independent type and laws, such as the ethical, the aesthetic 'form'.

It appears as the task of a truly universal criticism of knowledge not to level this manifold, this wealth and variety of forms of knowledge and understanding of the world and compress them into a purely abstract unity, but to leave them standing as such."^x

Though starting from very stable ground, I think that Cassirer ended up in a somewhat ambiguous position. He, like Kant, used words with great precision,¹ so he must be read very carefully -even technically. "Nature", and "the forms of nature", for Cassirer, are *technical words*.

He defines the "forms of nature" for us -e.g. physics, biology, chemistry. These are some of the "values" of his specific *function*, (his "purely functional unity"), of the human

¹ I think it is a necessary concomitant of the very abstract nature of their ideas

spirit, (here specifically the cognitive forms). A philosophical critique "must formulate the universal conditions of this function and define the principle underlying it."

We must place this passage in the context of Cassirer's *redefinition* of the formal concept however. We must see it in the context of "the mathematical concept of function" to understand it. The various forms are functional "values" -in a technical mathematical sense -of a definite, and, for Cassirer, *serial* ordering, (and principle). They are the alternative orderings of the phenomena, (defined by a serial function), -and constitute a series of series.

The phenomena, however, remain always the orientation -the focus -of *all* the forms, (even the "cultural forms"). There is in this no assertion of comprehensiveness, (and even a seeming denial of it), for any given form however. He seems to argue against reduction,¹ (and therefore comprehensiveness), as well -but against "reduction" and "comprehensiveness" in *what senses?*

It is against *epistemological reduction* and *epistemological comprehensiveness*, but it is not against the comprehensive adequacy of a given perspective as regards the phenomena.

Compare:

(1) "none of these" [epistemological] "forms can simply be reduced to, or derived from, the others",^{XI}

(2) "no individual", [epistemological], "form can indeed claim to grasp absolute 'reality' as such and to give it complete and adequate expression."^{XII}, and

(3) "each particular form would be 'relativized' with regard to the others, but since this 'relativization' is throughout reciprocal and since no single form but only the systematic totality can serve as the expression of 'truth' and 'reality', the limit that results appears as a thoroughly immanent limit, as one that is removed as soon as we again relate the individual to the system of the whole."^{XIII}

What is the sense of Cassirer's "*cannot be simply reduced to or derived from*"? That no individual form can give "complete and adequate expression to reality" and that no form can be "simply reduced" does not necessarily imply that reduction, (i.e. translation / transformation), in a *non-simple* sense, or that *comprehensiveness*, (as a complete accounting for phenomena), is impossible *within any given form*. (3), moreover, seems to contradict (1) and (2).

¹ "None of these forms can simply be reduced to, or derived from, the others"

Consider, moreover, his "*invariants of nature*": though "no sort of *things* [his emphasis] are truly invariant, but [it is the]...fundamental relations and functional dependencies retained ... in certain equations... [which are truly invariant]".

He proposes these, (the functional invariants of these forms), as "the real logical framework of nature *in general*" [my emphasis]. But "nature" is a *pluralistic* word for Cassirer -the "natural forms" are *all the forms of science*!

We have, therefore, an assertion of invariance¹ across *all* the forms of science -and cross-reduction, (i.e. morphisms), across the invariants.² Indeed, this is the only sense in which "invariance" makes any sense at all, (i.e. it is a "coordinate-free" perspective).

"Invariance", therefore, means invariance across different, (*all the different*), perspectives of nature -and epistemologic relativity. For what *other* interpretation of the "relativization" of (3) is there except as alternative orientations of the same phenomena?

Consider also his seeming denial of comprehensiveness. "The 'relativization' [of forms] is throughout reciprocal". "No single form but only the systematic totality can serve as the

¹ of functional dependency but not of "things"

² See my "Rosen letter" of Chapter 3 for a beginning on this perspective

expression of 'truth' and 'reality'." What he is actually asserting, I argue, is that although multiple forms are legitimate, no single one of them can describe the structure *as abstracted from an orientation!*¹ What Cassirer is portraying here is exactly a "*coordinate free*" perspective! It is not, therefore, a denial of *comprehensiveness*² that he is arguing, but a denial of the

¹ This corresponds to the concept of a "mathematical ideal" which I will present shortly.

² Comprehensiveness is, of course, a highly pertinent issue because of the very definite, (and very powerful), claim by ordinary Naturalism for just such an ultimate comprehensiveness for mathematical physics . (I will address this issue presently). This is a very strong claim, and one I think we all actually do accept -at least in principle.

However, if one particular form, (e.g. Naturalism), *is* actually capable of such comprehensiveness, (even in principle), *and no other were*, then this would constitute a very definite objection to his thesis. The question lies in the "no other were" part of the premise. Certainly Quine would argue otherwise. Cassirer believed that the only salvation for the symmetry and relativism he envisaged lay in his extension across the cultural forms:

"As long as philosophical thought limits itself to analysis of *pure cognition*, [his emphasis], the naive-realistic view of the world cannot be wholly discredited, [I will disagree with this],. The object of cognition is no doubt determined and formed in some way by cognition and through its original law -but it must nevertheless, so it would seem, also be present and given as something independent outside of this relation to the fundamental categories of knowledge.** If, however, we take as our starting point not the general concept of the world, but rather the general concept of culture, the question assumes a different form. For the content of the concept of culture cannot be detached from the fundamental forms and directions of human activity: here 'being can be apprehended only in 'action'."

I believe the *actual* salvation of his thesis and the guide to its extension lies in the idea of *converse* -i.e. mutual reduction. If his basic conception is right, and I think it is, (on phenomenological grounds), then multiple *cross-reductions* and a true relativism will be possible. The possibility is founded in the conception of alternative axiom systems, (and orientations), in formal mathematics, in the

(metaphysical) adequacy and the sole truth of any *particular epistemological orientation*, [symbolic form].

It is only in their multiplicity that he believes that they express "'truth' and 'reality'". "The limit that results appears as a thoroughly immanent limit, as one that is removed as soon as we again relate the individual [form] to the system of the whole."^{XIV} (Again, see my discussion of “mathematical ideals” in Chapter 9.)

If these are "the real logical framework of *nature*", i.e. of the natural sciences and they are invariant across *all* the forms of nature, then all the forms of nature are, by implication, *cross reductive and comprehensive*! That these forms themselves cannot be “*simply*.”, (epistemologically), “reduced to, or derived from the others”, does *not* mean, therefore, that their “objects” cannot be reduced or derived *at all!*¹ This is what “invariants” are all about.

It is *cross-reduction* and relativistic invariance which tie the forms together and it is only in their totality that they express reality -and experience. The mathematical axiom system will

developments in the foundations of mathematics presented at the outset of this paper, and in my extension of Cassirer's reformulation of the formal logical concept.

¹ Think about Hilbert's “beer mugs” and “Pythagorean theorem” comments of Chapter one.

serve to illustrate the case again. That any (adequate) axiom system for a given discipline will be comprehensive is, of course, clear by definition. But to confuse the discipline itself with any one of the particular, (of many possible), adequate axiom systems, is incorrect. Peano's system *per se* is not the same as the positive integers.¹ (A more specific and perhaps a more elegant tool for illustrating Cassirer's conception, lies the mathematical notion of "ideals" in abstract algebra, (when properly considered in this light). (I have referred to this a couple of times and will present it shortly, with illustrations, in Chapter 9.)

Cassirer is asserting alternative functional orientations across the phenomena in his thesis of "Symbolic Forms". Each draws different functional, (and serial), perspectives, "diverse manifestations of the same basic human function".² This is an explicit invocation of his "mathematical concept of function".

I suggest, instead, an extension of it: that the objects of knowledge are constituted in different, (and alternative), "axiom systems"¹ which "crystallize" the phenomena as virtual, but probably here as virtual *intentional* objects, (of the feedback loop), under the "concept of implicit definition". (This is

¹ See the prior quote from Van Fraassen

² Also: "A philosophical critique must formulate the universal conditions of *this function* and define the principle underlying it."

certainly consistent with the Hertzian perspective, more so, I believe, than even Cassirer's interpretation.)

But I suggest that it is the phenomena *themselves* which are the actual invariants!² It is a solution based, not in the mathematics of functions but, as Cassirer suggested often as the true focus of modern thought, -in that of the manifold itself. What results is a *true* epistemological relativity, (in a mathematical sense), and the possibility of multiple, each-truly-comprehensive and cross-reductive independent perspectives.³

I will leave the problem of the definition of the *actual* (valid) forms without reaching a definite conclusion. Cassirer's solution is seductive, to be sure -and may very well be correct, but it is outside of the needs for my thesis. What is unquestionable, I think, is his "coordinate-free" orientation to phenomena. Such a perspective on Cassirer's Hertzian stance, narrowed to Van Fraassen's smaller physical perspective, and his case for the "forms of nature" in general, (biology, chemistry, ...),

¹ Alternatively, "generators of an Ideal"

² Are the phenomena themselves, then, invariant *equations*? No, they are what the equations embody.

³ See the discussion of mathematical "ideals" shortly for a further elaboration of these ideas.

will adequately serve my case. But, as Cassirer himself explicitly states, beyond that we leave the arena of "cognition" altogether.

But cognition is precisely our area *of interest* here. Our context here is precisely that of cognition and metaphysics!

If my area of *interest* were to change -if I chose to look at "the phenomena" artistically, let's say, then this would *no longer* be my orientation, and his broader case might be argued. But then, conversely, I would *no longer* be able to express it in a cognitive context!¹

Cassirer's is a profoundly beautiful and elegant conception, to be sure. I am not sure that I can accept the broadest symmetry that Cassirer asserts however, a symmetry, (and a still further Copernican Revolution), that extends beyond cognition and science itself into the cultural forms: language, religion, myth. But I believe the symmetry within cognition and science itself is wholly justified.

¹ An interesting and important point comes up here, however. If his broader thesis is correct, and my extension of it as well -i.e. mutual cross-reductions and comprehensiveness - then the "invariants", (if there should be such), of *those other forms* will be (reductively) retained as invariants even in the sciences! Thus, if there be absolutes, (invariants), in art, in music, in religion, then they will be *retained* as invariants even in the sciences, (in psychology, for instance). I consider this a very significant scientific conclusion, and running contrary to current social relativism. There *may be* an ultimate scientific decision possible between, let's say, John Cage and Beethoven! -Or between Zoroaster and Jesus!

The Power of Naturalism:

Naturalism, however, is a profoundly *comprehensive* theory! Not only mathematical physics, but its reductive incorporation of the *other* disciplines, from biology and chemistry through (purportedly) psychology, philosophy, ethics, religion,¹ presents a purportedly complete (comprehensive) theory of *all* the phenomena. Quine demonstrates, however, that there are *always* other interpretations of the phenomena, *no matter the level of detail*. Can there be *other* comprehensive forms then? I think the answer is necessarily yes! Need they be *physical* forms?

The possibility of alternative, *and comprehensive*, physical forms, certainly seems quite believable. Heisenberg vs. Schroedinger illustrates the plausibility. Based on the sense of this current writing, I believe that Cassirer's *other* "natural forms": biology, chemistry, etc. are capable of such a legitimate extension to comprehensiveness² as well. I believe it is absolutely sound as demonstrated in Chapters 1 through 5 of this book.

¹ The primitives of some of these forms are distributed and derivative under the reduction, however. Think about "beer mugs" and Rosen again.

² with equivalent distributions and derivativeness of primitives

Cassirer wrote in another era,¹ but this does not, in itself, invalidate his conclusions or their possible extension to a broader relativism. On the subject of biology, for instance, he dealt with the issues of vitalism. In modern times, however, there is a much stronger case made on much more rigorous grounds which supports the same, independent case for biology. It is that of Maturana and Varela as presented in Chapter 6. To appreciate it, it is necessary, of course, to effect the same "Copernican Revolution" which Cassirer suggested.

Maturana and Varela's case is made on very pure phenomenological grounds. The biology they propound is not grounded *upon* mathematical physics. Its primitives are not those of the latter, but rather, physics, (and human knowledge) is derived as a function of linguistic coupling, (third order structural coupling) -i.e. it is contained as a (non-centralized) theoretical derivative of biology's own epistemological primitives:

"It is by languaging that the act of knowing, in the behavioral coordination which is language, brings forth a world. ...We find ourselves in this co-ontogenic coupling, *not as a preexisting reference nor in reference to an origin*, [my emphasis], but as an ongoing transformation

¹ though not *that* long ago!

in the becoming of the linguistic world that we build with other human beings."^{XV}

Maturana and Varela's thesis does not find its epistemological roots in substance, but drives past its materialist beginnings to find its new epistemological center in "autopoietic unities" and "structural coupling". It ends up questioning the very physical ground from which it began.

In many ways it represents the "Heisenberg" case of biology. It represents an alternative theoretical perspective on experience and on science. It *works* because of the purity of its phenomenology. Can other "natural forms" be asserted in this same sense?¹ Could chemistry, for instance, be stated with the phenomenological purity with which Maturana and Varela stated biology? That is the only real issue. This is Hertz' problem, after all, pure and simple. It is also the case I made for the training seminar in Chapter 4.

¹ Maturana and Varela reveal such an alternative orientation in "structural coupling" and "autopoietic unities". That these other "symbolic forms" *must* encompass the whole of experience, (i.e. the whole of past and future experience -to include scientific experiment), I think is incontrovertible. But they need not encompass it *in the same way* as does physics, for example. They need not encompass it as the primitive and hierarchical ground of their science, (think of Bell's perspective in Chapter 2), but may weave and distribute its relationality into a much less central, (i.e. that particular relationality removed from "axiomatic" status), much less concentrated position in its theoretical structure a

I will not profess an absolute conclusion on these questions other than in the case of the “natural forms”, (physics, biology, chemistry ...), where I conclude, (on Quinean grounds), that there must be, indeed, multiple possible comprehensive forms. But my conclusion in its essence, and beyond Cassirer's, is a *fully* relativistic one.

The truly fundamental forms are (necessarily) *comprehensive* forms -i.e. they are fully functional "axiom systems"¹ capable of exhausting the phenomena. (Alternatively, "the phenomena" is that which remains constant -i.e. invariant- under all such exhaustive perspectives.) These forms "slice" the phenomena, (*all* the phenomena), from different perspectives. To be fully relativistic, *each* form must be complete. Though Cassirer seemed to drive towards this complete relativism, I don't think he ever completed it.²

But must not a comprehensive organization *be* *categorical*, i.e. must there not be *only one*? (If we could achieve

la Quine. They need not adopt the primitives of another orientation as their own primitives as the latter may become "theorems"!

¹ again see later discussion of mathematical "ideals"

² I believe because of the limitation in his formal concept

the Laplacean ideal, would it not be unique?)¹ Or, rather, might there not be alternative yet still comprehensive predictive organizations with *different* perspectives and *different* utilities²? Under the Aristotelian logic, and assuming comprehensiveness, (i.e. assuming the possibility of a single and complete accounting

¹ The Laplacean ideal is not realist by definition.

"In the introduction to his "Theorie analytique des probabilites" Laplace envisages an all-embracing spirit possessing complete knowledge of the state of the universe at a given moment, for whom the whole universe in every detail of its existence and development would thus be completely determined. Such a spirit, knowing all forces operative in nature and exact positions of all the particles that make up the universe, would only have to subject these data to mathematical analysis in order to arrive at a cosmic formula that would incorporate the movements both of the largest bodies and of the lightest atoms. Nothing would be uncertain for it; future and past would lie before its gaze with the same clarity. ...Du Bois-Reymond elevated scientific knowledge far above all accidental, merely empirical bounds...If it were possible for human understanding to raise itself to the ideal of the Laplacean spirit, the universe in every single detail past and future would be completely transparent. 'For such a spirit the hairs on our head would be numbered and no sparrow would fall to the ground without his knowledge. He would be a prophet facing forward and backward for whom the universe would be a single fact, one great truth'."

Cassirer, "Determinism and Indeterminism in Modern Physics", pps.3-4

Under a functional logic, (i.e. one not based in the generic concept), there is the possibility of alternative "axiom systems", (organizational perspectives), exposing alternative utilities, (e.g. biology, psychology, etc. -or alternative physical theories). The Laplacean ideal does not, therefore, presuppose a unique theory, (Newtonian, for instance), and reference.

If we were, in fact, to achieve a science, (theory), such that "the hairs on our head would be numbered and no sparrow would fall to the ground without his [our] knowledge", i.e., comprehensiveness, I maintain that it still not need be unique. The Laplacean ideal is not tied necessarily to Newtonian or any other particular theory, but constitutes the basis of determinism and could apply generally. (ibid)

² I.e satisfying different intentional goals

of all phenomena), there would have to be a linear reduction of all true theories to a single substratum of primitives.¹

Hierarchy, (set-theoretic, type ordered inclusion), is an essential component of the existing Naturalist perspective: i.e. that there is a necessary hierarchy of spatial scale. It argues that that hierarchy is mirrored in the process of the reduction of scientific theories: e.g. biology is a subset of chemistry, and chemistry of physics. (Thus psychology and all the phenomena of experience, of knowledge, and of the "spirit" as well, are embedded in that hierarchical ordering -as biological subsets.)

It presumes that our *naive world*, (or at least most of it), is hierarchically mirrored in the primitives of any true theory, (i.e. that the objects of naive realism are objects of that true theory as well). It presumes that they can be represented as legitimate and necessary groupings of those primitives. Thus our ordinary objects and the ordinary things they do are, in fact, real and necessary *metaphysical* objects and happenings. This argument is crucial to the strength of Naturalism and its metaphysical claim!

But scale is not a priori inherent or the only way to preserve the phenomena, i.e. it *need not* necessarily "cut reality at

¹ See Appendix B: Lakoff and Edelman for a further discussion of classical logic and science

the joints". If *other* organizations, more effective, (i.e. other schematic organizations), are found, then they are legitimate as well. Our naive objects, *as objects*, are not necessarily *metaphysical* objects.

Science, until very recently has supported such a spatial, (and theoretical), hierarchy -from the macroscopic to the human scale to the microscopic to the atomic, (which, of course, theoretical reduction generally supports -i.e. biology -> chemistry -> physics), -or from cosmology right down through the human scale to the atomic.

At the smallest level of scale, of course, (and at the largest scale as well -EPR), the case for hierarchy has broken down in this twentieth century. As an example, let me once more cite Penrose's "most optimistic" view of quantum mechanics, (most optimistic for scientific realism, that is):

"I shall follow the more positive line which attributes *objective physical reality* to the quantum description: the *quantum state*. ."

"I have been taking the view that the 'objectively real' state of an individual particle is indeed described by its wave function ψ . It seems that many people find this a difficult position to adhere to in a serious way. One reason for this appears to be that it involves our regarding individual particles being spread out spatially, rather than always being concentrated at single points. For a momentum state, this spread is at its most extreme, *since*

psi is distributed equally all over the whole of space, (my emphasis),...It would seem that we must indeed come to terms with this picture of a particle which can be spread out over large regions of space, and which is likely to remain spread out until the next position measurement is carried out...."

The particle -this *smallest part of our "object"*- is not included, (spatially, reductively), *within* the spatiality of the atom or within the molecule -or even within the *human scale* object of which it is the theoretical (and supposed material) foundation. Naturalism can no longer support, therefore, a consistent hierarchy of scale!

At the human level, of course, it is a very useful tool, and that is just what I propose it is -constructed by evolution! Schematism, (and "Symbolic Forms" as well), suggests *other*, non-scaled and non-hierarchical organizations -i.e. they support *any* other truly efficacious organization. It is a simple matter of utility.

Naturalism's primitive substratum, (the primitives of mathematical physics), is deemed unique and "true of" == "refers (isomorphically) to" ontology. It is Naturalism's epistemological basis for a claim of reference. But under a functional logic, (i.e. a logic not based in the generic concept), there is the possibility of *alternative* "axiom systems", (different functional logical concepts/theories, -*not* as class abstractions from phenomena or as hierarchical spatial perspectives into the phenomena, but as

lines drawn *across* phenomena -as connective functional rules), and a different sort of "reduction", or, rather instead, *translation*, exposing alternative utilities, (e.g. biology, psychology, etc. -or even alternative purely physical conceptions).

So may we consider the new possibility that the relationality of experience, (and experiment), can be entirely preserved under varying (comprehensive) functional perspectives, no one of which stands as the canonical revelation of ontology/experience. The assertion of comprehensiveness for a given reducing theory would not then imply that it would necessarily, therefore, be *the sole and unique* organizational primitive -i.e. that would be the only one.

This is the sense of my extension of Cassirer's "symbolic forms". I argue, with Cassirer, for a relativism of forms which organize the phenomena, but, (disagreeing with him), against reference. I do not argue for his particular specification, (choices), of these forms, nor do I assert my own specific alternatives to these forms, but I do argue for his *overall* conclusion.

It is in Cassirer's sense of the organizational, rather than the referential relevance of theories that I propose that the relations of ordinary Naturalism -and my own thesis as well- can be, (must be), retained in a deeper realism. "Experience", our true primitive, (and, I have argued, the other axiom of reason), is not the same as any particular organization of it. It is not identical with its (legitimate but particular) characterization as

"sense impressions" under the Naturalist form, for instance. I have argued a broader -and truly relativistic definition of "experience" as that which remains invariant under all consistent and comprehensive worldviews.¹

What must be preserved is the web of implication of experience in our world, but *hierarchy as such*² need not be maintained. A comprehensive theory, ("form"), e.g. Naturalism, stands as an "axiom system" to generate the field of experience. But if *other* theories, (forms), and other "axiom systems" are found, (and Quine definitely implies their existence), also comprehensive, then the preference is no longer epistemological but utilitarian. Each, however, must fully preserve "experience" - to include the whole body of past (and future) scientific experiment.³

¹ But does "experience" itself absolutely, (i.e. metaphysically), refer to *something else*? My thesis proposes that it does not. I propose, rather, that it is an organization of atomic, (and indeterminate), process. It is, therefore, real and ontic, but irreducible and non-referential.

² Remember the work of W.J. Freeman in Chapter 4

³ This is the point on which I question, (but do not necessarily deny), Cassirer's suggestions of the *particular* comprehensive "symbolic forms" -i.e. in that I believe that they must each embody the whole as past and future scientific experiment. In defense of his choice, however, that relationality of experiment need not necessarily be maintained as "central" to the organization of a particular form. That is, it need not lie close to its "axiomatic" base, but need only be maintained somewhere and somehow within the form as a whole. Thus biology could stand as such a "form" in Maturana's conception, for instance, wherein the experimental results of science would be maintained within third order structural

Chapter Conclusions:

I have proposed that our ordinary perceptual world -our innate and functional organic naive realism- is such an organization itself, constructed by evolution for efficient viability, (as stated in *relative* -but legitimate- Naturalist terms, i.e. within a “relativized Naturalism). At the human scale, Naturalism is an extension of that existing organization -i.e. of that which evolution has given us. But there is clearly no paradox remaining in these statements in light of the prior discussion. My thesis is, therefore, self-consistent and non-contradictory. The epistemological dilemma is resolved!

My thesis is, I believe however, *more* than consistent. Even from a purely Naturalistic perspective, I maintain that it is the only complete and consistent explanation yet offered of what it is we have set out to understand -i.e. the whole of cognition! This is *how* “a machine” could know its “objects”. This is *how* a

coupling, for example. But how would science be retained in a *mythical* form, for instance? Or *language*? And yet he has touched something very powerful in both of these. That I am, as yet, unable to see the specific relevance of these suggestions does not convince me that they are, therefore, wrong! In the specific case of religion, for instance, however, I believe that Cassirer has misconstrued the problem. Let me make a counter suggestion: that religion, identified not with its ordinary practice, but with its incarnations in the religious mystics - exhibits an alternative *biological* form corresponding to the rational form suggested by Quine, i.e., one in which "ordinary objects" are no longer the organizing rationale. (cf. William James "Varieties of Religious Experience").

“Cartesian theatre” could exist. This is *how* there could be “meaning”!

The problem of the "Cartesian theatre", (sentiency), for instance, has heretofore either been trivialized and eliminated by ordinary Naturalism, (leading to a sort of linguistic or materialistic "idealism"), or it has been referred, for instance, to epiphenomenalism or emergence. But the latter are little more than an invocation of magic, (they do not *vivify* the ghosts they summon).

On its own grounds, I believe my *scientific* thesis stands well vis a vis its competition -it is biologically, psychologically, logically and teleologically cogent. It is, moreover, far more compatible with the epistemology of modern physics than is any other alternative -it speaks the same language. It "covers the territory", (of mind and mind-brain), for the first time and assumes no "magic", (*also* for the first time).

But our "ordinary objects", (the objects of naive realism), *need not* be, (and in fact, *are not*), preserved as *metaphysical* primitives -i.e. as necessary unities. Quine acknowledged the possibility:

"One could even end up, though we ourselves shall not, by finding that the smoothest and most adequate overall

account of the world does not after all accord existence to ordinary physical things.....*Such* eventual departures from Johnsonian usage¹ could partake of the spirit of science and even of the evolutionary spirit of ordinary language itself."^{XVI}

This is exactly the case I have made. I argue that the "smoothest and most adequate overall account of the world" does not, indeed, accord existence to ordinary physical things. My departure from Johnsonian usage does "partake of the spirit of science and the evolutionary spirit of ordinary language itself".

¹ Johnson, once again, demonstrated the reality of a stone by kicking it!

Chapter 9: A Simpler Alternative Approach to Cassirer's Symbolic Forms: "Mathematical Ideals":

There is an easier and more intuitive approach to Cassirer's ideas and to my own, especially concerning my characterization of "the interface", (which I will define soon explicitly in a dedicated short chapter). That route is by employing the purely mathematical notion of an "ideal". The example given in Birkhoff and Mac Lane's, ("A Survey of Modern Algebra"), is clearly directly applicable, (by its substance), to the immediate problem and should make Cassirer's ideas much clearer and more immediate.

The subject of mathematical ideals illustrates a very different and very concrete notion of "relativism". While actually encompassing a scope much wider than simple geometry, this simple example provides a very clear illustration of what it means to be a truly scientifically relativistic concept.

The point is that the very same object, (in this particular example "the mathematical circle", (taken as an illustrative token for the just about any mathematical "thing"), and, in general, for I want you to consider it as a standin for phenomena themselves - baseballs, elephants (and all the things these things do). It will show how these phenomena can be preserved in a *context-free* setting. Try to envision "the circle C" itself throughout the following discussion as though it were an *actual object of perception* –an "elephant" perhaps -and consider the profound

philosophical *consequences* of this conception!

**An Alternative Approach to Cassirer's and My Ideas:
“Mathematical Ideals”:**

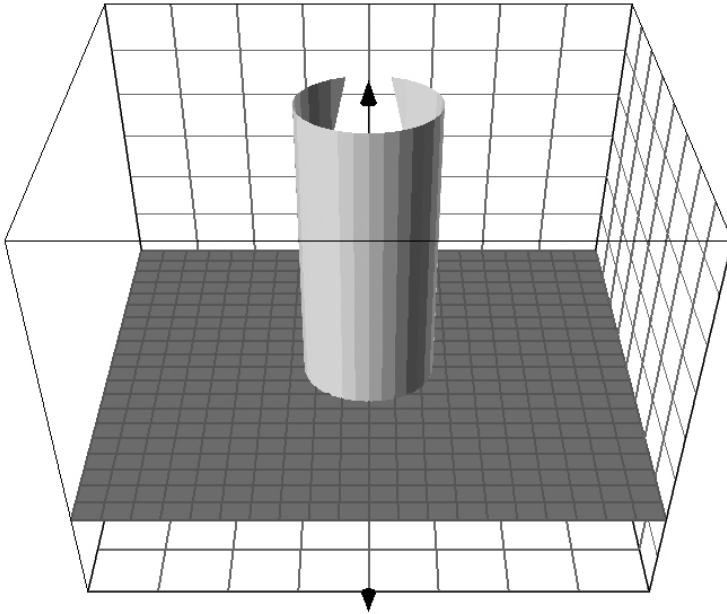

Figure 23

“*The circle C of radius 2*”, [standing in place of our “object” –my italics], “lying in the plane parallel to the (x,y) plane and two units above it in space is usually described analytically as the set of points (x,y,z) in space satisfying the simultaneous equations:

$$(16) \quad x^2 + y^2 - 4 = 0, \quad z - 2 = 0.$$

These describe the curve C as the intersection of a circular cylinder and a plane.

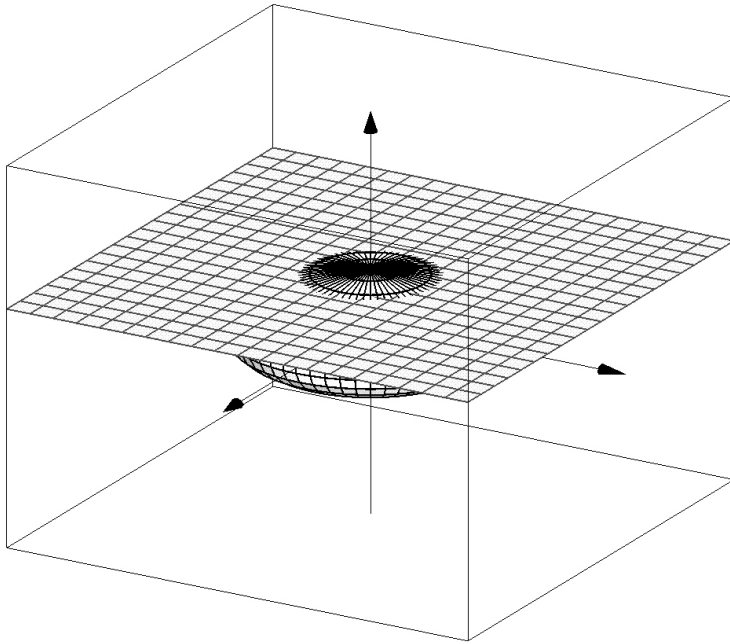

Figure 24

But C can be described with equal accuracy”, (as well),
“as the intersection of a *sphere*”, (my emphasis), “with
the plane $z = 2$, by the equivalent simultaneous equations:

$$(17) \quad x^2 + y^2 + z^2 - 8 = 0, \quad z - 2 = 0.$$

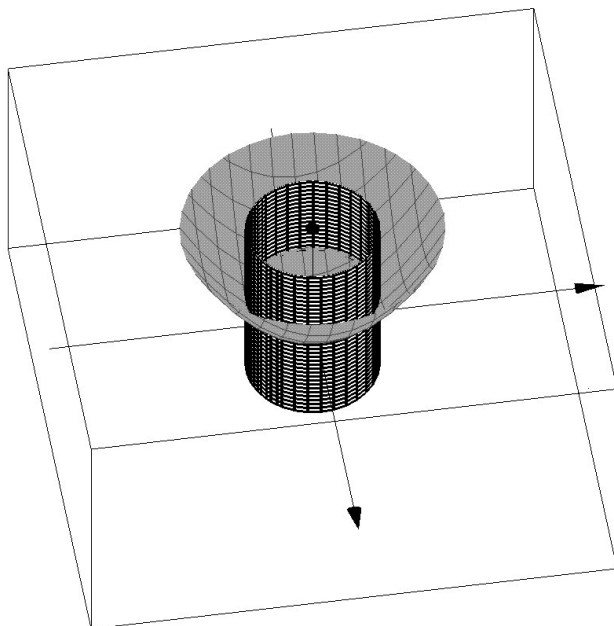

Figure 25

Still another description", (my emphasis), "is possible, by the equations

$$(18) \quad x^2 + y^2 - 4 = 0, \quad x^2 + y^2 - 2z = 0.$$

These describe C as the intersection of a circular cylinder with the paraboloid of rotation:

$$x^2 + y^2 = 2z.$$

Therefore the only *impartial* way to describe C ", (my emphasis), "is in terms of *all* the polynomial equations which its points satisfy."

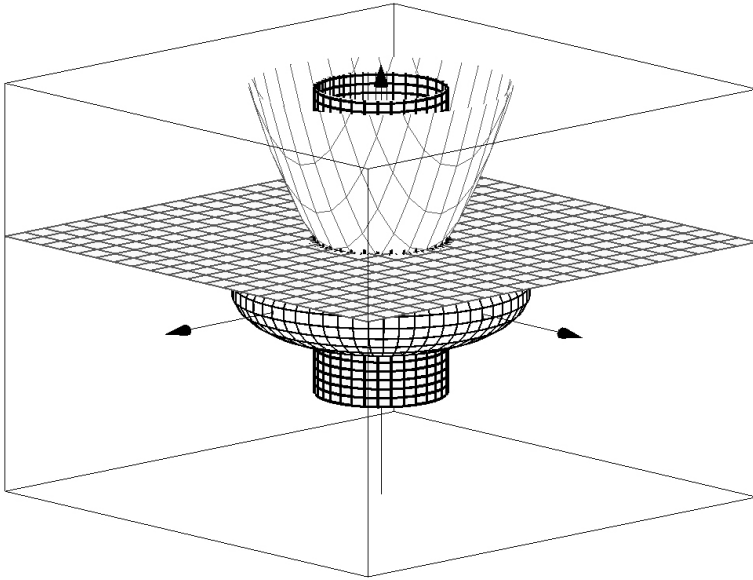

Figure 26

The descriptions above represent just a few of the ways to represent "the circle C " however. But in fact there are an *infinity* of ways to do so!

"But if $f(x,y,z)$ and $g(x,y,z)$ are any two polynomials whose values are identically zero on C , then their sum and difference also vanish identically on C . So, likewise, does any multiple $a(x,y,z)f(x,y,z)$ of $f(x,y,z)$ by *any polynomial* $a(x,y,z)$ whatsoever.", (my emphasis). "This means that

the set of all polynomials whose values are identically zero on C *is an ideal*.¹ This ideal then, and not any special pair of its elements, *is the ultimate description of C* . In the light of this observation the special pairs of polynomials occurring in equations (16)-(18) appear *simply as generators* of the ideal of all polynomials which vanish identically on C”, (my emphases).

"The polynomial ideal determined by this curve thus has various", [actually an infinity of²], "bases,

$$(20) (x^2 + y^2 - 4, z - 2) = (x^2 + y^2 + z^2 - 8, z - 2) = (x^2 + y^2 - 2z, z - 2) \dots, \dots, \dots, \dots, \dots, \dots$$

An understanding of this concept of mathematical “ideals” opens a door to a better understanding of Cassirer’s arguments, and a simpler understanding of my third thesis. It illustrates the conception of a *rigid* invariance –and not a mere, unstructured or trivial relativism! (In no respect is it anything like the conception of “cultural relativism”, for instance). *None* of these generators

¹ My emphasis

² Simply concatenate the operations!

stands prior to any other, nor does it *create* the figure comprehended, but each is comprehensive and exhaustive!

Each stands, rather, as an *equipotent* and relativistic “logical”, (i.e. explanatory), basis fully exhausting the actuality of the figure: “*The circle C of radius 2*” which we may consider as a stand-in for a phenomenon –e.g. the elephant. No one of these *organizations* replaces the reality, the “ideal” of the figure itself!

What this says is that the *particular* perspective we begin with in our explanation is not the ultimate determining factor. To quote Cassirer in his “Symbolic Forms”: “each asks its own questions” and constitutes a *different* perspective, but the “object” which is described is the invariant “ideal”. Descriptions, explanations are not the same thing as the actual “object” described. Ultimately it remains “a mere X”! This will relate later to my Chapters 9 and 10 and my conception of “interface”!

We *start* with the phenomena themselves, not with theories and explanations, (orientations, organizations). Theories must *validate* the phenomena, not the converse. (But we must incorporate Merleau-Ponty's input-output loop -his "intentional arc"- to truly understand the relationship).

"The circle" cited here would stand in place of Cassirer's "phenomena", (sic), for my "percept" or for *the perceptual elephant!* It is the *invariant* component of perception that we must needs preserve. It is focused as an invariant under varying perspectives relativistically but rigidly. This is *how* we can

preserve the actuality of our phenomena, (evolutionarily fixed, I argue), as relativistic invariants of our symbolic forms and gain an understanding of the rationale of those forms themselves! Percepts are not created by, nor are they dependent upon any particular frame of reference. If they reference ontology, then they do it as a composite ideal, and not in their particular frames. This was the sense of Galileo's profound insight long, long ago.

But we must consider the "ideal" within the larger context of mathematics. Not only can such descriptions be relativized in relation to a fixed coordinate system, but the very coordinate systems themselves stand in like case. Axes need not be orthogonal, nor need they be rectilinear, (e.g. polar coordinates are possible). Nor need they be fixed.

They may be in translation –e.g. relative motion, (which correlates to conditions of special relativity for instance), and they need not be Euclidean, (nor Hyperbolic nor Spherical). Bertrand Russell, for instance, argued that our descriptions of phenomena might even be based in projective geometry.

But need they be *even spatial*? Can we not conceive of such explanations being framed as abstract transformations,³ which latter are *not* defined on spaces, but on raw and unstructured abstract domains as suggested in my illustration for

brain function in my first hypothesis, and the “externality” of Maturana’s “structural coupling.”⁴ Abstract domains, however, fall naturally within the scope of axiomatics which ground Cassirer’s “Symbolic Forms” and Hilbert’s “Implicit Definition”.

Cassirer’s Theory of Symbolic Forms:

Cassirer’s “symbolic forms” is the broadest, and, I think, the deepest conception of truly scientific relativism yet expounded as it is grounded in invariants themselves. Cassirer concludes that the actual metaphysical “object” is a mere “x”, which can be interpreted from a myriad of perspectives, but always preserving the relations of phenomenology. This is a perspective analogous and similar to the effect of combining my prior citations from Benacerraf and Bell:

’It [logic] remains the tool applicable to all disciplines and theories, the difference being only *that it is left to the discipline or theory to determine what shall count as an ‘object’ or ‘individual.’* [Benacerraf, 288]

³ Morphisms?

⁴ Let me repeat Bell’s comment from our Structuralism discussion –it is very pertinent here: “...it becomes natural, indeed mandatory, to seek for the set concept a formulation that takes account of its *underdetermined* character, *that is, one that does not bind it so tightly to the absolute universe of sets with its rigid hierarchical structure.*”

“There is an evident *analogy* between mathematical frameworks and the local coordinate systems of relativity: each serve as the appropriate *reference frames* for fixing the meaning of mathematical or physical concepts respectively. [Bell]

But Cassirer’s conception confirms that there is no *canonical* context in which to view reality. Repeating myself once again, it is the confusion of (the "objects" of) a *particular* form, (e.g. mathematical physics), with the invariant relationality of the phenomena which it organizes, he argued, which leads to an unwarranted assertion of metaphysical reference for its objects. His genuine "epistemological theory of relativity" is, I argue, “coordinate free”, (and non-referential), in Van Fraassen's and Bell’s sense as well.

My third and final hypothesis, (in Chapter 12), will be epistemological, an extension of Kant's, and ultimately of Cassirer's epistemology. Its purpose will be to supply a plausible answer to the "what" of mind.

I have argued an essentially Kantian position –greatly deepened by Maturana’s insights and consistent with Cassirer's to reduce the de facto *metaphysical* presumptions of naturalism to their legitimate and necessary minimum.

This, surprisingly, leaves room for the *actual* existence of a "substance" of mind for which I propose a specific and plausible answer. Ultimately I argue that our mental reality

comes down to intentional strategies that work, and not to certain knowledge. But this is all we will ever need!

There remain, of course, significant problems -the most obvious of which still remains "reference". But I argue that there is a categorical difference between *metaphysical* reference and the internal, *model/model* automorphisms, (transformations), of what I maintain is our logically closed human cognitive world. (cf Quine). It is the latter which constitute the problem of science, and I have suggested a particular kind of automorphism between the brain and the world.⁵

The Substance of Mind:

Here is another excerpt from my earlier book. Hopefully you can now understand it in the mathematical context of the current paper.⁶

“Though I have argued against the "material" and the "substance" of *Naturalism* as metaphysical existences, there is a deeper -and truly metaphysical sense of substance that I *do* wish to maintain. It is embodied in our's, (and Kant's), minimal *realist* assumptions -in the axioms of externality and of experience, [stated formally in Chapters 3,4 and 6]

⁵ See Iglowitz, 2005

⁶ from Iglowitz, 1995, Chapter 5 on “the substance of mind”

Though Cassirer argues for a broad range of symbolic forms, there is *another form* implicit in his thesis, (roughly equivalent to the whole of the natural forms), -and innate in Kant's as well. It is the *metaphysical form*, i.e. the whole of the metaphysical context of the problem itself. (It was as a "Prolegomena to any Future Metaphysics" that Kant himself characterized his work, after all.)

This metaphysical form is the proper context for any conception of cognition, (and realism), but, precisely because of Kant, Cassirer and Maturana, it is necessarily severely restricted and analytic.

Inside of the *form* of metaphysics, (wherein we are now framing the problem), we are constrained by Kantian parameters -i.e. the fundamental, (rather than the historically limited), parameters discussed earlier. These *abstract* limits, the axioms of externality, and of experience, and the relativity of perception to the (human) instrument whereby it is effected, dictate a necessarily general, relativized and abstract solution to the problem.

Always implicit in Kant, however, was the assumption of *some connection* between our cognition, and the reality which is perceived, (metaphysical reality), -and that connection was assumed to be reflected in experience, ("intuition").

Always implicit in Kant is the relationship between the absolute external existence which he affirms and the modifying, coupling relationship of cognition itself. Kant's is very much a

modern mathematical conception. He argues that we cannot separate the facts of our "instrument", (our cognition), from that which it "measures", (cognates).

The *relationship* between that cognating entity and its object, however, is understood in a very profound and sophisticated sense –very much in the sense of modern algebra. [e.g. “structuralism”] His concept of intuition, (experience), is a relativistic one. The connection is seen as a limit concept -as the most abstract possibility- conceived relativistically to the complete “X” of metaphysical reality.

Alternatively, we might today characterize this connection as the most abstract reinterpretation of Maturana and Varela's "structural coupling", (which I addressed in Chapter 6), but removed from its strict Naturalistic (metaphysical) formulation. I think the most natural characterization of it is, simply and abstractly, "interface"!

This concludes the epistemological argument. In the next chapter, I will complete my solution of the mind-body problem with a statement of my third thesis which will supply the "what", the "matter of mind". All the hard work has already been done, however, so the chapter will be brief. The *problem* is not so hard; it was our presuppositions which made it seem so!

Chapter 10: “The Interface”

This “interface”, this connectivity, (or, rather, the mathematically conceived “ideal” of the same - I think Dennett would use the words “heterophenomenologically conceived”¹), between cognator and that which is cognated, is assumed in *any* realist conception of reality, (most definitely to include Kant's itself).

It is implicit in materialism, in dualism ...; it is implicit in behaviorism, and identicism ..., in "memes" and in neural process. I mean it to be the minimum intersection, (the limit, i.e. *the most abstract mathematical conception*), of all of these realist, (i.e. non-idealistic –taking that word in its historic philosophical meaning here), possibilities. It is the invariant commonality, the “mathematical ideal” of all materialistic interpretations of the sensory boundary, and it is therefore a necessary and legitimate realist ontological *existence* postulate in itself!

I mean it to be taken in the sense of a “mathematical ideal”, (see Chapter 9) -in the sense of a mathematical relativism- as in the sense we take the equations of Special Relativity. This minimum conception of interface is then, (by definition),

necessary and apodictic to any realist position –to mine, and to yours as well. *Realistically*, (i.e. -therefore Realists *must* so believe), it does *metaphysically* exist, (-whatever it “is”!)

Here follows my Personal Metaphysical Assertion!

This “interface” is the metaphysical reality that Kant does not name, but which is implicit in his and any other realist position. *As a realist*, I claim it therefore to truly *metaphysically* exist, and I call it "substance".

This is not the "substance" of materialism however, but an *analytic* conception -i.e. it is the metaphysically and mathematically minimal logical necessity of realist cognition. It is a *some-what*; not a *some-thing*!

That there is something more, some *other* "substance", some externality other than the interface, is also apodictic to realism -it is presumed in the “axiom of externality”¹ -and I confirm it as well. Kant and Maturana have stripped the latter of all knowable determinate form, (but not of existence), but it is the former, (“interface”), with which I wish to concern myself here.

[Note: I also believe in “other minds”. My problem, however, is that I have no idea what they might “look like”! If

¹ Or “co-ordinate-free” as I understand Van Fraassen

my perspective is valid, then it opens a whole new perspective on my fellow man. One may have the attribute, (under some viewpoint), of blackness, or whiteness or beauty or oldness, or ugliness, or “crippled-ness”, without *being that!* What I am left with is humanity, not bigotry or zealotry. “Is” is the trap of limited minds.]

Chapter 11: The Last Hurdle

There remains one last difficulty with my (Naturalist) hypothesis of Chapter 4. From the standpoint of my original claim of a *complete* solution to the mind-body problem, "mind", (at the stage of Chapter 6 -and even at the stage of Chapter 9), remained conceivable only in a reductively materialist, (alternatively: an *organizational*), sense. It remained only process and without "awareness" except as the latter was itself considered reductively.

What is "mind" and where is it? How could it be? The answer is that it is! It must "be"!

For it is the apodictic metaphysical realist "*substance*"¹ of the interface *itself*, (as just affirmed *as an innate realist posit* in the previous brief chapter), that I propose is the substance of mind. The reality, the metaphysical presence of this interface is the immediate and necessary consequence of the synthesis of our two realist intentional fundamentals: externality and experience. It is the *relativistic* equation between a cognitive entity and externality, (and you may correctly interpret this from Maturana's perspective). This necessary presumption of the *actual existence* of connective "substance" supplies the last

remaining element for the complete solution of the mind-body problem.

The Third Hypothesis: a formal statement:

Please spend the time to truly *contemplate* the import and meaning of this very brief section. It is a very deep idea, though you may not think so at first. It is like “the sound of one hand clapping”, and to understand it you must contemplate your navel for a reasonable amount of time for a true understanding of Cassirer’s and of my perspective. This, I believe, is the deepest possible conception of a scientific relativism, and it needs some “quiet time” to enable comprehension.

Swabey described Cassirer’s “Theory of Symbolic Forms” as a genuine epistemological theory of relativity. Take awhile to digest this characterization. It characterizes a *relativism* of epistemologies *themselves* and proposes that there is more than one totally legitimate way of viewing the world.

But to describe it as “a *genuine* epistemological theory of relativity”, says something more. I am forced to interpret it, (and I think the nature of Cassirer’s own history of thought forces this conclusion), as a truly *scientific relativism* in the sense of

¹ Taken “heterophenomenologically”

Einstein, rather than in the trivial senses of social relativism, ..., et al. The “genuine relativism” of Swabey’s characterization reflects the necessary incorporation of invariants, (in the sense of *mathematical* invariants),² across all the viable epistemological forms, and it is these invariants themselves, (as distinct from any particular -necessarily “localized”³- description of them), which allows us to define the “interface”, (a la Maturana’s “structural coupling”), *in an abstract sense*, but which prohibit us, in that very same sense, from definitively grounding it within any single one of the particular forms of knowledge.

To repeat an earlier reflection: With Cassirer, I argue that the essential flaw in the referential conception of knowledge, (“scientific realism”), lies in its confusion of a *particular* “frame of reference”, i.e. “symbolic form”, (and its assumption that there is only one comprehensive frame possible). It is confused with the *invariant relationality of experience in the abstract*, (i.e. under all consistent frames).

This, Cassirer and I both argue, is the heart of the issue. It results in scientific realism’s confusion of a specific

² See my Rosen discussion Chapter 3 for a partial idea of the kind of perspective I intend.

³ Please review Bell’s perspectives on “local mathematics” in Chapter 2.

organization of experience⁴ with the experience itself, which is organized.

A formal statement of my third hypothesis:

Given that the interface, (as just defined –*whatever-it-is*), (1) *metaphysically exists*, (“heterophenomenologically”, to use Dennett’s term again), and given further (2) *that it is structured as postulated in my first and second hypotheses*, (and *this* is the formal statement of my third hypothesis), then (3) it internally and necessarily defines our objects and what they do -and they *too* exist! And, as demonstrated by my arguments in Chapters one through eight, it *knows* them!

All the problems of structure, all the problems of logic have been dealt with in the previous hypotheses, and a plausible Naturalist rationale is in place. All that remained was *existence*. It is the sole further assumption of the *metaphysical existence* of the interface *itself* which supplies the reality and the existence of sentiency!

Mind is the “unified concept”, (the rule), of this interface, (and of the brain) –seeing it from Cassirer’s⁵, (via Hilbert’s), and

⁴ I.e. mathematical physics

⁵ as a “rule” in the sense of Cassirer’s reformulated “concept”, and further, in the sense of the “ordering” of my “concept of implicit definition”

Maturana's perspective. Under the combination of my three hypotheses, then, mind becomes quickened, becomes "aware", becomes "live".

We *do* know, we *are* aware, we *are* real. What we are sentient and aware *about* however, is *not* metaphysical externality. Rather, it is the metaphorical organization of primitive process with which we deal with the latter. But that is quite good enough. It works! And it is a *genuine* miracle in all its glory!

In the next chapter, I will answer two relatively modern critiques of my conception. Hopefully it will answer some of your questions and objections as well.

A (crude) Graphic Overview follow: (see technical footnote! ⁶)

⁶ Note: Freeman's use of the words "spatial integration" is somewhat confusing and misleading. His use of "spatial integration" refers to integration over the *physical* space of the brain but which actually accomplishes a *divergence* in the mapping of the "data" itself. (Please note the diagram itself which illustrates the mapping of parallel data distributively!) An afterthought: Both sides of the feedback loops pictured here, considered together, seem to furnish a fairly lucid rendition of Merleau-Ponty's "intentional arc" – "by which experience derives from the intentional actions of individuals that control sensory input and perception". [W.J. Freeman 1994]

A (crude) Graphic Overview:¹

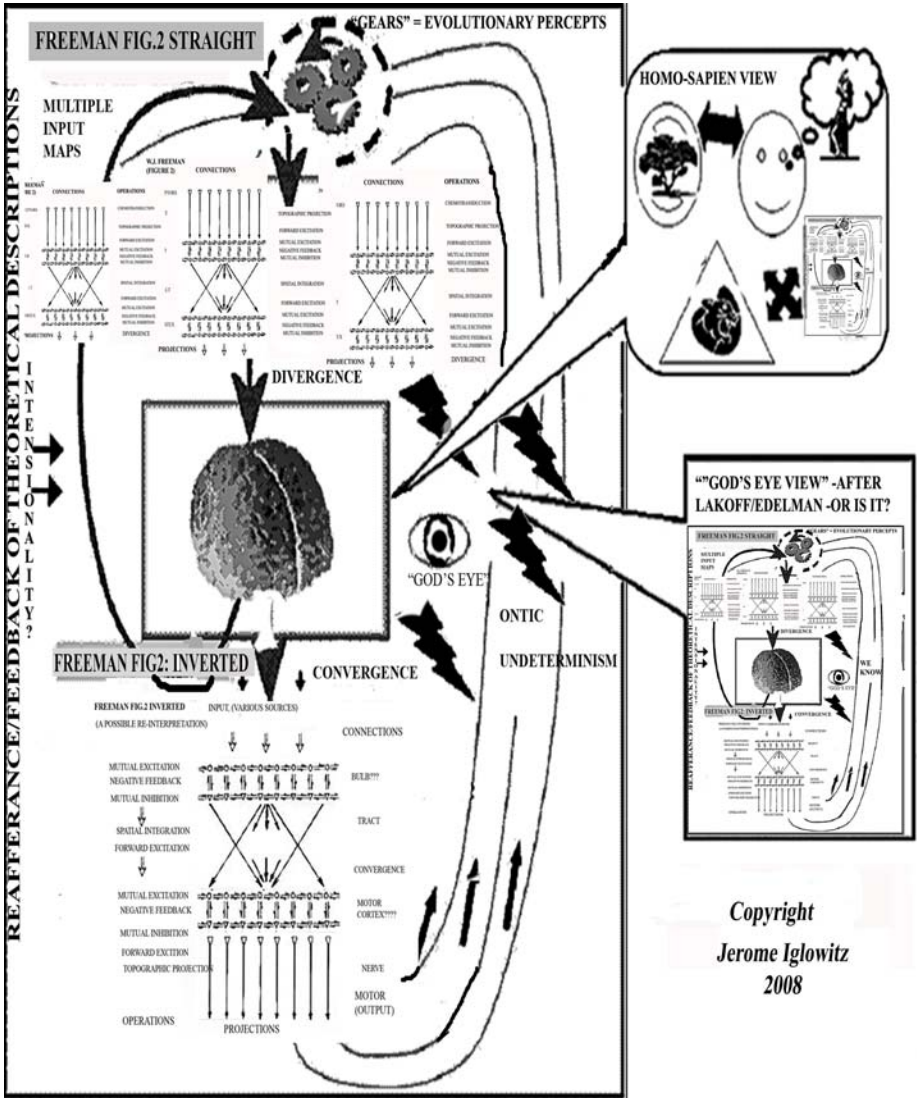

Figure 27 (See technical footnote)

Chapter 12: Two (Relatively) Contemporary Realist Criticisms of My Conclusions

In this chapter, I am just going to present two different (negative) viewpoints on my perspective. One of them is Will Durant's –who was actually criticizing Kant's huge idea, but, by implication, my own as well as they are quite similar in the aspects he addresses. The other one is from a "Journal of Consciousness Studies" anonymous reviewer commenting on a submission of a piece of my own work some years ago. Hopefully they will raise and answer some of your own problems with this very radical interpretation of reality.

I'll start with Durant. He does a pretty nice description of Kant's conception but he doesn't "buy" it however, (in the sense of William James' "cash value of an idea"). He prefers to accept James' very specialized perspective (which is a psychologist's perspective, and which, in fact, makes a great deal of sense as such –purely as a psychologist's perspective). I frankly don't think any biologist would ever accept it however¹. But then Durant inherits James' problem: i.e. of conversely legitimizing his own perspective to a biologist.

¹ (In Durant's words, conversely, it would have no "cash value" to a biologist!)

Durant instead adopted James' specifically psychological perspective: i.e. that we get relations right along with our objects as epistemological *primitives*. I think any biologist would ask the question "how?" But Durant never answers that and neither does James. They just assume it exists as a primitive and build their worlds from there.

Durant on Kant:

“[Kant’s] *Critique becomes a detailed biology of thought*, an examination of the origin and evolution of concepts, an analysis of the inherited structure of the mind. This, as Kant believes, *is the entire problem of metaphysics*”, (my emphasis)....”¹

This is *my* “take” on Kant as well –I think Kant saw the problem just as a biologist would see it, and as I still see it myself as well! When I was a very young man, I was a student in a biology laboratory. An idea had occurred to me from my own ruminations and I wanted to run it by the lab supervisor, (a Ph.D candidate, I think). I asked the question: “Is it possible to view a multicellular organism merely as an *assemblage* of unicellulars?” Without a moment’s hesitation, (and I have had the highest respect for the philosophical abilities of biologists ever since), he

replied: “Sure. There are sponges which can be forced through a sieve and dispersed into individual cells, but which then come back together to become a metacellular once again all by themselves.”²

This has always been my perspective on multicellulars, and you and I *both*, (you must surely admit), fit that characterization –we are metacellular organisms. Mine is a *biological* perspective, and I think it is clear that it is Kant’s perspective as well.

“... it [the brain] is an active organ which moulds and *coordinates* sensations into ideas, an organ which transforms the chaotic multiplicity of experience into the ordered unit of thought.¹¹ But let these various sensations group themselves about an object in space and time –say this apple; let the odor in the nostrils, and the taste on the tongue, the light on the retina...unite and group themselves about this ‘thing’; and there is now an

² He asked me my major and when I replied “philosophy, he said he thought I would be good at it.

awareness not so much of a stimulus *as of a specific object...*”^{III 3}

“But again, was this passage, this grouping, automatic? Did the sensations of themselves, spontaneously and naturally, fall into a cluster and an order, and so become perception?

Yes, said Locke and Hume; not at all, says Kant.”

“For these varied sensations come to us through varied channels of sense, through a thousand ‘afferent nerves’ that pass from skin and eye and ear and tongue into the brain; what a medley of messengers they must be as they crowd into the chambers of the mind, calling for attention!”

This is very reminiscent of Maturana’s comment⁴ that the input to the brain is “like an animated family discussion with all the members talking at once!”^{IV}

³ My emphasis. Note: this is my interpretation of the function of the cortex, and its “a/d converters”

⁴ cited in Chapter 6

“And left to themselves, they remain rabble, a chaotic ‘manifold’, pitifully impotent, waiting to be ordered into meaning and purpose and power...”

“Observe, first, that not all of the messages are accepted... a storm of stimuli beats down upon the nerve-endings which, amoebalike,⁵ you put forth to experience the external world: but not all that call are chosen; only those sensations are selected that can be molded into perceptions *suitied to your present purpose*, or that bring those imperious *messages of danger* which are *always* relevant.”^v

Please note the connection of this passage with the issue of the intentionality of the brain –and to its organizational prioritization of *danger* explicitly. This was my focus also in my first thesis –it lies at the roots of my “schematic model”, “interface”, and at the root of my argument for a necessary violation of “hierarchy” to preserve urgent priorities in reaction as well.

In the terminology of computer languages, “danger” may necessitate a “Go To” command which can absolutely violate the

⁵ This is relevant to my conception of the multicellular as an assemblage, a “society” of unicellular organisms.

“structure”/hierarchy of a program to go elsewhere –even outside the program itself by reason of urgent necessity! ^{VI}

And finally, one last quote:

“Consider a system of thought like Aristotle’s; is it conceivable that this almost cosmic ordering of data should have come by the automatic, anarchistic spontaneity of the data themselves? See this magnificent card-catalogue in the library, intelligently ordered into sequence by human purpose.

Then picture all these card-cases thrown upon the floor, all these cards scattered pell-mell into riotous disorder. Can you now conceive these scattered cards pulling themselves up, Munchausen-like, from their disarray, passing quietly into their alphabetical and topical places in their proper boxes, and each box into its fit place in the rack, -until all should be order and sense and purpose again? What a miracle-story these skeptics have given us after all!”

What a wonderful metaphor. It represents beautifully the most succinct argument for Kant’s thesis. Durant thinks that

William James supplies the answer to Kant's objections in his "Radical Empiricism" however.⁶

Durant's brief coverage of James' perspective is quite different. James' is a psychologist's viewpoint, and, lacking Cassirer's insight of "Symbolic Forms", James rejected Kant's fundamental conclusions out of hand. (I think Kant would have rejected his as well.)

First of all, let me say that I have a harder time in dealing with William James' philosophy than I do with Durant's criticism of Kant because I think, under a certain perspective, it makes some sense. I think that James proposed an almost pure epistemology, (form), grounded in a *psychological* perspective and very much equivalent to the sense in which Maturana, (as we saw in Chapter 6), proposed a *biological* epistemological form. As such, James' is a real candidate for incorporation within Cassirer's "Symbolic Forms."⁷

The relationship of these alternative worldviews is again roughly equivalent to Hilbert's "beer mugs and Pythagorean theorem" interpretation of the mathematics we examined earlier. This is what Cassirer's "Symbolic Forms" is all about!

⁶ It will take Cassirer's "Symbolic Forms" to mediate between their conceptions, and which will eventually reconcile them.

Now let us turn to Durant's brief summary of William James's ideas. He sees James' as a more rational alternative in the modern world and as providing an escape from Kant's fundamental "error":

"... and if he", (James), "begins with psychology it is not as a metaphysician who loves to lose himself in ethereal obscurities, *but as a realist* to whom thought, however distinct it may be from matter, is essentially a mirror of *external and physical reality*."^{VII}

...And it is a better mirror than some have believed; it perceives and reflects not merely separate things... but their relations too; it sees everything in a context; *and the context is as immediately given in perception as the shape and touch and odor of the thing*. Hence the meaninglessness of Kant's 'problem of knowledge', (how do we put sense and order into our sensations?) –the sense and the order, in outline at least, are already there."^{VIII}

⁷ Paraphrasing Cassirer: "each asks its *questions* each from a particular perspective..."

I think that Kant, as a biologist, would ask the legitimate question “*How* is it ‘already there’? Give me a biological rationale!” Within my own (biological) perspective, “things” and “relations” would be specifically “already accounted for” under the rationale of the “schematic model” whose facile relations, “the calculus”, I have proposed, was the very purpose of the model itself.

James’ assumed his personal perspective, I believe, under the “realist imperative” mentioned earlier⁸, and, since we *all* possess it, we are inclined to agree from the beginning. This inclination in itself guarantees nothing logically however.

“Consciousness is not an entity, not a thing, but a flux and system of relations; it is a point at which the sequence and relationship of thoughts coincide illuminatingly with the sequence of events and the relationship of things. *In such moments it is reality itself, and no mere ‘phenomenon’ that flashes into thought; for beyond phenomena and ‘appearances’ there is nothing. ... the ‘noumenon’ is simply the total of all phenomena, and the ‘Absolute’ [is] the web of relationships of the world.*”

⁸ see Chapter 4

(It would have been interesting to have asked James for his own *specific* meaning of the word “relationships”.)

Shifting perspective somewhat, Durant now goes on to develop James’ notion of “radical empiricism”:

“To find the meaning of an idea, said Peirce, we must examine the consequences to which it leads in action; otherwise dispute about it may be without end and will surely be without fruit.

[James] tried the problems and ideas of the old metaphysics by this test, and they fell to pieces at its touch...” [Pierce’s] “simple...test led James on to a new definition of truth. Truth had been conceived as an objective relation, ... now what if truth” [itself] “ ... were ... relative to human judgment and *human needs*, (i.e. productivity)?”

“ ... ‘Natural laws’ had been taken as ‘objective’ truths, eternal and unchangeable ...and yet what were these truths but formulations of experience, convenient and successful in practice; not copies of an object, but correct calculations of specific consequences? Truth is the ‘cash-value’ of an idea.”

(This might almost be a paraphrase of my arguments for my “schematic model”, but lacking its implicit biological rationale.)

“...The true ... is only the *expedient* in the way of our thinking ... The true is the name of whatever proves itself to be good in the way of belief”, (productivity, consequences). “...Truth is a process and ‘happens to an idea’; verity is verification.

Instead of asking whence an idea is derived, or what are its premises, pragmatism examines its results; it ‘shifts the emphasis and looks forward’; it is the ‘attitude of looking away from first things, principles, ‘categories’, supposed necessities, and of looking towards last things, fruits, consequences, facts’.”

“Scholasticism asked, What *is* the the thing, -and lost itself in ‘quiddities’; Darwinism asked, What is its origin? –and lost itself in nebulas; pragmatism asks *What are its consequences?* –and turns the face of thought *to action and the future.*”

“...Men accept or reject philosophies, then, according to their needs and their temperaments, not according to ‘objective truth’; they do not ask, Is this logical? –they ask, What will the actual practice of this philosophy mean for our lives and our interests? Arguments for and against may serve to illuminate, but they never prove.”

As an independent symbolic form I think James’ perspective makes sense. And it’s a perfectly legitimate form, I believe. I think it’s capable of being just as rigorous for

psychology as Maturana's was for biology, for instance, (see Chapter 6), but it's a totally different worldview. It does not, however, fill the needs of a biological perspective.

Durant ends up accepting James' generalist rejection of Kant and then basically falls down to an argument "ad populum" which is fundamentally just an appeal to *everybody else's* prejudices. It's not a very good refutation.

Durant Critiques Kant:

Cutting to the chase, here is what I believe constitutes the core and the essence of Durant's criticism of Kant's conception. It is a (naïve) realist's simplistic and absolute dismissal!

"the annual elliptical circuit of sun by earth [is] independent of any perception whatever; the deep and dark blue ocean rolled on before Byron told it to, and after he had ceased to be...[or] when we see an insect moving across a still background..." "a tree will age, wither and decay, whether or not the lapse of time is measured or perceived." IX

The problem, as I see it, is that Durant was unwilling to consider the deepest implications of the existence and of the possibility of the mutual agreement of "other minds", "other brains", (which I think both he and I accept), and which has deep implications to this problem.

If another mind, another brain sees and acknowledges the same “facts of reality” that I do, could it not merely mean that it too has processed these in the same way that I would, that our naïve worlds are similar precisely because our *brains*⁹ are so – irrespective of the character of the underlying “substantia phenomena”?¹⁰ Durant’s argument, a simple appeal to popular agreement¹¹ does not really address the substance of the issue. That “a tree will age, wither and decay, whether or not the lapse of time is measured or perceived” is a certainty within our worlds, but the very substance of the assertion must be taken heterophenomenologically!

⁹ But what then are “brains”? I will repeat my very early injunction that in any theory of deep metaphysics *all* terms should be assumed to be in quotes –i.e. they should be taken heterophenomenologically – at least until the final conclusions. This allows a “context-free” discussion in the sense of Van Fraassen. I have supplied an actual answer to this problem in my third thesis.

¹⁰ Think about the possibility of two minds with alternate primitive conceptions of physical reality, (just as, for instance, Benacerraf conceives of two minds with alternate conceptions of set theory). Each might see “the deep and dark blue ocean [that] rolled on before Byron told it to”.

¹¹ an example of an “argumentum ad populum”

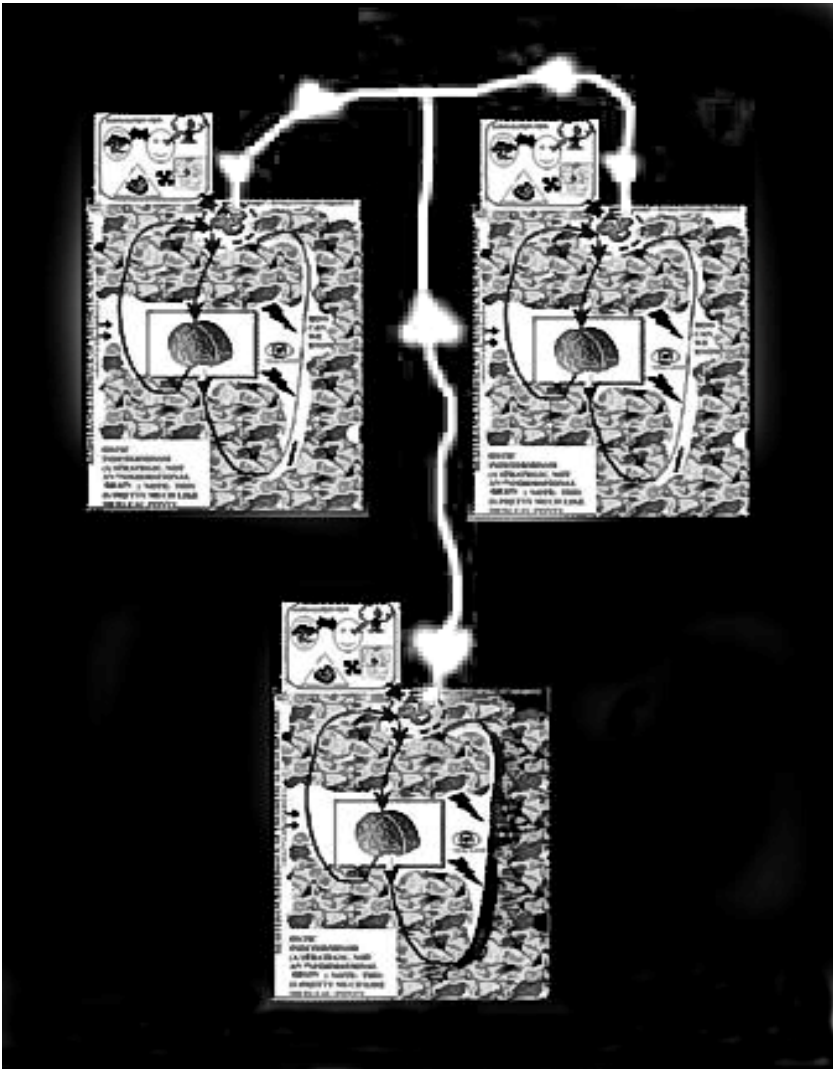

This is the model I propose for human reality, but it is lived through the “gears and levers” of our evolutionary artifacts, the latter being understood from the perspective of biology, itself just one of Cassirer’s multitudinous “Symbolic Forms”. This, I believe, is the homo sapien cognitive reality

Figure 28

The viewpoint embodied in Figure 28 is the picture I suggest as an alternative and whose substance will be clarified shortly. I believe in other minds, (I get to have beliefs too), but these minds, I believe, see through the exact same “gears and levers” that I do.

That our conclusions about reality should agree does not surprise me. We all see with the same indeterminacy that my later figure of chap 11, (reproduced above), shows *but through the same parameters!* This is our human linguistic and cognitive world: we speak the same language!

That there is something more, (i.e. *somewhat*), that is real is Kant’s assertion of “substantia phenomena”, but the “what” of it is precisely at issue, and Durant did not debate the substance of Kant’s claim against knowledge other than in a casual reference to James’ “Radical Empiricism”^X which I think is a poor answer. He went on against Kant’s categories, ethics, et al. I have definite problems with these latter as well, but I think that Kant had the basic problem precisely right.

The JCS Review ¹²

The JCS reviewer did a much better job of critiquing my own conceptions, I think, than Durant did of Kant's. He raises some fairly substantial issues, but I think they're answerable. But to repeat once again, mine, like Kant's, is a *biologist's* perspective.

The JCS reviewer raises two questions. There are two fundamental problems that he's looking at -but he mixes them together. One of them is his "my world". He provisionally accepts my viewpoint and then he asks the question "what is my world?" Well what does that mean?

"No dent has yet been made, however, on the problems of consciousness as they are likely to be perceived by the readers of JCS (including myself). The adoption of a non-representational position shifts the locus of these problems. Given that I have a world consisting of perceptual and conceptual objects (i.e. operational constructs) which I denote by terms such as 'trees', 'despair', 'redness', 'brains' etc, is it possible to envisage how [the] last mentioned of these constructs", [the brain],

¹² This is an anonymous reviewer's commentary on a submission to JCS which encompassed essentially just my first hypothesis as presented in Chapter 4 of the current writing.

"could itself embody a world analogous to that of my own?" (Please note that his primary problem is that of envisioning even the *possibility* of an answer:

"how...*could*... 'the brain' ...embody a world analogous to my own?"

My answer lies in Cassirer's "Symbolic Forms" –i.e. it lies in the conception of an epistemological automorphism.)

"If, however, it is admitted that what I call a 'brain' might itself form operational constructs and this might thereby explain what I am myself doing all the time, then are we not back in almost exactly the same place as we started?"

"Namely, we have to explain how it is that a pattern of neuronal firing can have the attributes that I designate by the word 'tree'."

(The attributes would be "implicitly defined" in just Hilbert's sense of chapters 1 and 2 by the operative process of the brain. This again is a problem of envisioning possibility.)

"The only gain is that we no longer have the additional problem of hooking it onto a postulated external "real" tree, and this gain may in fact be a loss for those who hold that the real tree may play a role in establishing the qualia of our percepts."

Before answering his objections more fully, let me note emphatically that something very new has slipped apparently unnoticed into his equation, (*besides* his "only gain"): i.e. *an*

explicit and constructive biological rationale for

“consciousness” itself! And this is *not* a small thing. It was the very purpose of the dialogue.

His first question, (stated last): the reviewer’s “real world” and the possibility of the “real tree’s supplying qualia. That part of it I think is addressed in Maturana and Varela’s “structural coupling” which is a coupling between the autopoietic organism and externality. It’s a very general thing, defined conceptually at the outset and I think it is best understood within the context of the “mappings” or “morphisms” as I understand they are conceived within category theory - between the unspecified realms “domain” and “codomain”.

I think this is about as far as a Darwinian analysis can go. It’s very, very general. What we’re talking about here is some kind of a mapping that only preserves “adequacy”.¹³ We are not talking about (James’) “goodness” or “truth” but *just* adequacy, *mere* adequacy. (See my illustration *Bounds and Limits* in Chapter 4.)

To get a broader picture however, let’s look first of all at my God’s Eye explanatory diagram from the “Freeman Appendix” of Chapter 4 again. Let me reference and try to explain more fully what this model signifies.

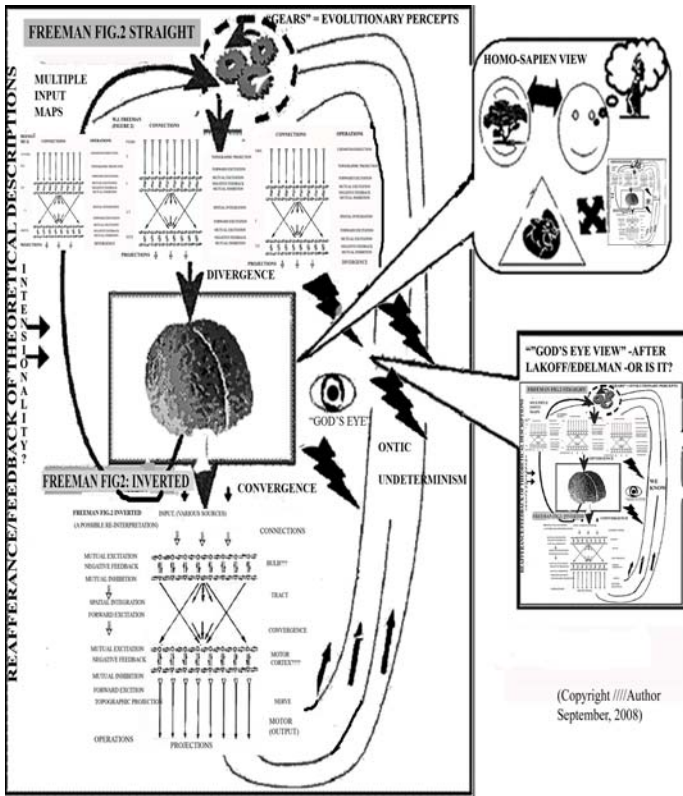

Figure 29

First we have to define our fundamentals and refine our characterizations. The fact is that even this very model, (above), exists *inside* of the closed and bounded cognitive framework of man, (as discussed in Chapter 6) – of me, and of you. We must start from there and we can never really get outside of it no matter how far we concatenate our reasoning.

¹³ See also the Gleick reference shortly

The question of the “embodiment”, the “analogy”¹⁴, (automorphism), of my reviewer’s dilemma exists *within* our closed, (but very effective), cognitive model, but the question of possibility *per se*, i.e. what *kind* of possibility results from his limited appreciation of the scope of transformations! Consider, for instance, the mappings from the domain to the range of the logistic difference equation of chaos theory, or Mandelbrot sets. James Gleick gives a pretty good introduction to the whole of the possibility. (Gleick, 1988) These mappings explicitly break hierarchy.

(In my early work, I had always understood sets as “unstructured manifolds” inside of my interpretation of Cassirer’s ideas.)

Ours must be an automorphism” in the *general* sense rather than the specialized sense that is invoked here as the fact is that we are truly “*blinded*”, (ontologically incompetent, to state it baldly -in the “real” ontological sense), at the periphery of my previous “GOD’S EYE!” map.

¹⁴ "How could ['the brain'] itself embody a world analogous to that of my own?"

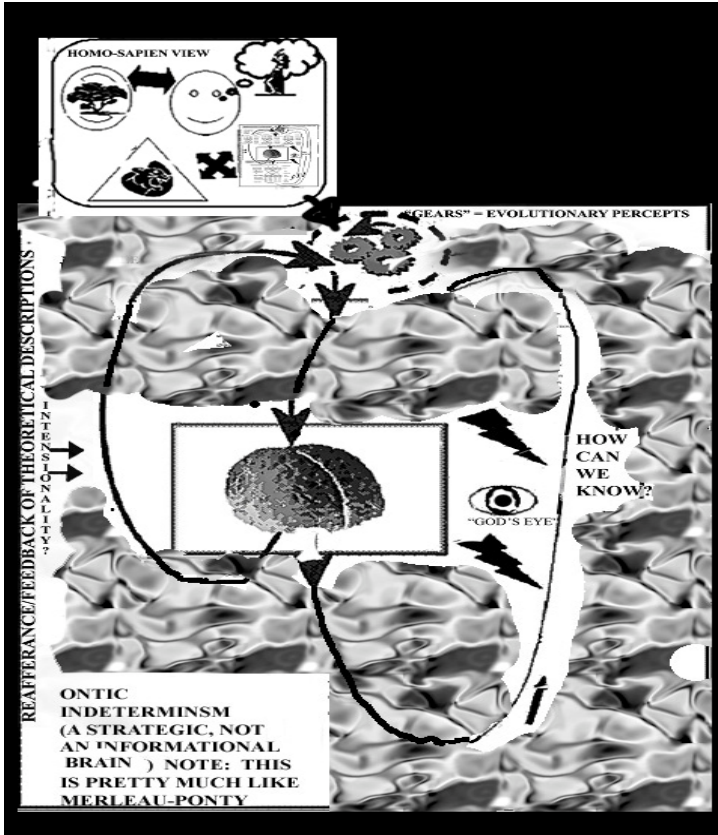

Figure 30

The diagram above is the ontic model I ultimately propose for cognition and it corresponds pretty well with Merleau-Ponty's. For even the previous conception itself, (my Freeman's God's eye conception), exists *within* the cognitively closed human world! The answer I was attempting to propose to JCS was just too big to fit into that limited journal format.

But *within* the biological symbolic form implicit in the previous model, (i.e. in terms of that model –call it the “Freeman

Model”), we receive input¹⁵ into the brain. (Remember that this “brain” is still within our closed cognitive framework.)

This input is passed through into the “objects”/percepts, “the gears and levers”, (i.e. the implicitly defined objects), of the brain –through these organizational nexuses which I propose are the “a/d converters”, (hierarchical/nonhierarchical converters), of the cortex and distributed¹⁶ as per Freeman’s diagram, (Freeman’s Figure 2, Chapter 4). (There may be other, deeper interpretations of that conversion on the level of metacellular chemistry for instance, -I don’t pretend to certainty or completeness nor, I think, did Kant, -just conceptual legitimacy).

This input travels downward through the diagram and we ultimately “act into the world”¹⁷ at the very bottom end of this loop. We send output into the world, and it, (something or somewhat), comes back. What it does and how is absolutely, that is, ontically hidden from us until the next re-entry loop.

But within that loop reafferent feedback, (which I believe embodies the particular symbolic form we are employing –and intentionality?), our specialized and particular

¹⁵ I could, I am sure you realize, employ “scare quotes” almost everywhere in this discussion

¹⁶ or “centralized” depending upon perspective- see the “telescope” reference in Chapter 4.

¹⁷ Using Merleau-Ponty’s phrase

viewpoint/worldview is “measured” against that transformed input. It is our theoretical hypotheses that *modulate* and are modulated by our actions –by what we’re promulgating “into the world”.

Every time you or I do something, every time we “act into the world”, we are implementing a theoretic hypothesis which may, in fact, turn out to be wrong! It is corrected or at least linearized when it “triggers” input right back through those very same a/d converters employed in the first place I believe. But we’re still dealing here with the implicitly defined and evolutionary “objects” -the “gears and levers” of the mind/brain. It’s a continual loop. This cycle goes on forever and ever and ever.

What is really and truly “out there” I don’t know, you don’t know, and nobody *can* know. But inside of, interior to our model itself, this conception is legitimate. This is “*ontic indeterminism*”. It is *not* strategic indeterminism!

You might object to this concept of cognition on the grounds of an infinite regress. Sure it’s an infinite regress. It exists within the *closed* cognitive framework of the human mind/brain and there’s no way it could be anything else. But I think it works there. It works in much the same manner within the presumptions of naïve realism or within any of the scientific theories, so it is really not such a new idea.

“The brain” *per se* can, in fact, be the focus and a starting point of a different but legitimate symbolic form. And why not?

Maturana began his conception from much the same grounds, and I think it is legitimate. But again, this is just the sort of thing that transformations do.

Within this context, we can now address my reviewer's "automorphism requirement": i.e. "Namely, we have to explain how it is that a pattern of neuronal firing can have the attributes that I designate by the word 'tree'."

If we take Cassirer's "phenomena", or James' web of relationships of the world¹⁸ in the sense of my axiom of experience; if we identify them with "that which remains invariant under all consistent worldviews" as I proposed in Chapter 7, then *epistemological* automorphisms in the sense of Cassirer's "symbolic forms" make sense and "the brain" can form the focus and origin of one specific independent symbolic form.

¹⁸ "Consciousness is not an entity, not a thing, but a flux and system of relations; it is a point at which the sequence and relationship of thoughts coincide illuminatingly with the sequence of events and the relationship of things. *In such moments it is reality itself, and no mere 'phenomenon' that flashes into thought*; for beyond phenomena and 'appearances' there is nothing. ... *the 'noumenon' is simply the total of all phenomena, and the 'Absolute' [is] the web of relationships of the world.*"

Quoting from Chapter 7:

The fable, (in concert with Quine I maintain), helps us to see that "experience" *as such* is not, (a priori *or* a posteriori), identifiable with any of its organizations or orientations. Rather, it must be identified with the *invariant relationality* -i.e. with that which remains fixed- under *all* global, comprehensive and consistent orientations.

"Experience", (tentative working definition), is that for which both the king and the technician *must account* in some manner!¹⁹ It is not *itself* an orientation, however. It is, rather, *that* ("thing") *which must remain fixed*, and I argue that it is a *primitive* of reason. [It is a logically primitive invariant!]

Scientific experiment extends, (generates), experience and thereby bounds (and shapes) the scope of consistent theories. It adds new invariant relationality to the abstract frame, (and the history of abstract frames). Following Quine however, it never *determines* them."

But our "objects" and "the things they do" are exactly what I propose as being the implicitly defined "objects" -i.e. the primitive, implicitly defined invariants of the brain and the schematic (naïve) model which embodies them. If this were true,

if these were, in fact, the invariants of the various symbolic forms, if these constituted the basis of the phenomena themselves, then the conception of mutually valid automorphisms *over* these “objects” is not problematic. This is exactly the sort of thing that automorphisms do.²⁰

These automorphisms are alternative and equipotent Cassirerian symbolic forms. In fact, automorphisms are probably the easiest way to understand Cassirer’s “symbolic forms” –i.e. as *epistemological* automorphisms! (See Chapter 9). From Cassirer’s standpoint, (and within the “naturalist forms”), we always maintain the equations; we always maintain the invariants of experience.

“The naive realism of the ordinary view of the world, like the realism of dogmatic metaphysics, falls into this error, ever again. It separates out of the totality of possible concepts of reality a single one and sets it up as a norm and pattern for all the others. *Thus certain necessary formal points of view, from which we seek to judge and*

¹⁹ This identifies, I propose, a viable and legitimate -and theory independent- working definition of experience.

²⁰ (FOOTNOTE HERE → Automorphisms need not preserve operations – i.e. addition could go to multiplication, etc →MacClane quote.?)

understand the world of phenomena, are made into things, into absolute beings.[my emphasis]"^{XI}

"But above all it is the general form of natural law which we have to recognize as the real invariant and thus as the real logical framework of nature in general.....No sort of *things* are truly invariant, but always only certain fundamental relations and functional dependencies retained in the symbolic language of our mathematics and physics, in certain equations." ^{XII}

Where Cassirer and I Fundamentally Differ:

At this point, I think I must differ with Cassirer. I agree that "it is the general form of natural law which we have to recognize as the real invariant and thus as the real logical framework of nature in general." But I differ with his assertion that "no sort of *things* are truly invariant".

I agree with Cassirer that our specifically *theoretical* "objects" are not fixed, -that they are no more invariant than our theoretical *hypotheses* are invariant, ("No sort of *things* are truly invariant"). Cassirer is saying that "the laws of nature" *per se* are invariant –and I agree with that.

The part I differ with is his assertion that "no sort of *things*" [*per se* –i.e. *whatever*] "are truly invariant". I believe that our naïve "things", meaning specifically our perceptual,

naïve realistic things, are evolutionarily created, (as seen within the Naturalist form), as an organization of process and that this picture, (form), “objects” and “calculus” *combined* is, in fact, invariant. This is the “realist imperative” that I discussed in Chapter 4.

The composite of a *theoretical hypothesis* plus its concomitant plastic, (i.e. non-invariant) “objects” which it can conceivably distribute differently²¹ than directly to our naïve “objects” must match against the sum total of our perceptual objects -the evolutionary “objects and the things they do” of the naïve realistic form. They are what hold the different symbolic forms together and constitute the source and the target of these automorphisms.

This is my hypothesis. If they do match, then we have a successful theory to whatever level it has been tested to. And I think, as biological/mechanical entities that that is all we can ever have. I think, moreover, that it is all we will ever *need to have!*

The strong parallel of quantum physics reasserts itself once again here. Within its model we have a “state equation” which is some solution we’ve made to the whole, (or the applicable part), of reality. It lasts until we do the next

²¹ This goes directly back to the schematic models of Chapter 4.

experiment, (“action into the world”), in which case the whole of the model is recast.

This is a very similar situation that I postulate within my model. We act into the world but what’s going to come back, we can’t know. The new input has to be reintegrated into a new “state equation” which generates new hypotheses. I think the parallel is very, very strong, and I think it works.

This parallel is interesting because it makes the functioning of the brain very much like the functioning of quantum physics. It establishes that we’re adopting the same strategy that physics did at the very small and the very large scale. But this is at the middle, biological scale and it deals with algorithms fundamentally.

As I stated much earlier, I think that “the mind” is the brain’s *rule* of structural coupling. But this “rule” must be understood in Cassirer’s sense of the logical rule of a concept – and in its extended sense of the rule of the concept of implicit definition.

It has been argued that Cassirer’s “symbolic forms” departed from the tradition of Kant, specifically in the issue of innate categories.^{XIII} I don’t think this criticism would have bothered Cassirer particularly no more than I believe it would have bothered Kant. Cassirer quoted Kant, (paraphrasing), as acknowledging that his ideas were a beginning, not an end, and that change and development were inevitable.

The reviewer's second question challenges the existence of any possibility of an answer to the dilemma he proposes. In terms of the reviewer's "'objects' that we construct -including the 'brain' which mirrors everything he, (I), do", it's a different issue than discussed above.

We're talking here specifically about the possibility of an *automorphism* that maps from the worldview that the reviewer has, (essentially that of naïve realism), into a specific worldview that orients the whole thing in a different way. (This is Cassirer's "Symbolic Forms" of Chapter 7.) It's a specifically *epistemological* automorphism, another symbolic form. This symbolic form starts from the brain as its central organizing point, ("asks its questions" from that beginning), and builds outward to include all of the things he does. I think it's perfectly legitimate as an automorphism. (Maturana began much the same way.)

In the "Freeman diagram", you see output into the world and coming back through our primitive "gears and levers" and with a concomitant reafferent feedback besides which latter embodies, (and corrects), our (intentional) theoretical hypotheses. In these terms I think it makes a great deal of sense.

I think it works for what we need it to do. I think the perspective of "the brain" as such can be oriented that way and that it is a legitimate biological and cognitive symbolic form.

It's superior to the reviewer's own naive realistic worldview that he starts with and which he is advocating

essentially unchanged in the end. It supplies a specific rationale for “consciousness” as well which for him is innately impossible!²² I think my perspective is legitimate and answers the basic *biological* question, and I don’t have any deep problems in his critique. The biggest remaining problem that I have is the one from organism to externality and I think that Maturana and Varela have framed the essential problem very, very well.

There remains one last fundamental objection to my thesis which I have long considered and which is exposed throughout this dialogue: why then, does it work so well? I have thought this over deeply, and perhaps the best answer that I can make is of a “hive of bees” completing their hive. That is, I think good science is a self-fulfilling prophecy.

The Anthropic Principle

Or, to put it in a more respectable setting, I think it may be the ultimate fulfillment of the concept that I first saw in Penrose’s book: of the “anthropic principle”.

But the usage I imply here is a deeper sense and meaning of the word. It is not that “if the world were not as it is, then we would not be here to see it”, (Penrose, paraphrase), but rather in a

²² Save in the “quiddities” of dualism, for instance.

sense where “our seeing it that way” allows an algorithmic interaction with a nameless reality. Put more simply, we can only see what we are “designed” = “configured” to see. It is not a matter of external existence, but rather one of “structural coupling”!

We are, however, allowed to extend and expand that vision. But this must be combined with a biological perspective under Cassirer’s “Symbolic Forms” to attain the full vision.

Cassirer and God’s Eye:

Durant²³, as well as my JCS reviewer exhibit a fault common with just about all the epistemological philosophers, (to include even Kant²⁴ himself). They always posit “a God’s eye view”²⁵.

The only plausible scientific alternative to this, the traditional, absolutist approach to epistemology, that I can

²³ For instance, when Durant says: “The tree will wither and die whether or not anyone sees it or not.” This is a statement that says we really, (ontologically), know! This is an ontological assertion.

²⁴ E.g. where do the “mind” and the “brain”, i.e. cognition actually exist? This was Kant’s and Maturana’s flaw as well.

²⁵ They always make statements such as “This” is “a brain”, or “The mind does such and so”, for instance. These are statements with purportedly absolute ontological meanings.

conceive, (to repeat a section of Chapter 6), is in a relativism, (albeit a *rigid* relativism), of epistemology itself.

Cassirer supplied just such a relativism in his “theory of symbolic forms”, and mathematics, in its conception of “mathematical ideals” confirms its essence. But Cassirer’s thesis, at its bottom is conceptual; it is not based in classes or “objects”. It deals instead with perspectives. It deals with abstract “domains”. It deals with the (unstructured) “manifold”. It is a conceptual, (rather than a set-theoretic), scheme.

Repeating Hertz:

"The images of which we are speaking are our ideas of things; they have with things the one essential agreement which lies in the fulfillment of the stated requirement, [of successful consequences], but further agreement with things is not necessary to their purpose. *Actually we do not know and have no means of finding out whether our ideas of things accord with them in any other respect than in this one fundamental relation.*"[Hertz]^{XIV} ²⁶ (Note: there is an echo of James in this.)

It is just Cassirer's theme –as modified with Maturana's and within my structuralist perspective of the "schematic model" of Chapter 4 that I pursued en route to my third thesis.

It is the only philosophical perspective that allows us to use ordinary descriptive, i.e. naïve realistic language "heterophenomenologically" using Dennett's term. It allows us to use such language without an absolute ontic commitment and allows the employment of a "relativized naturalism"²⁷ as well – i.e. one that allows us to describe reality in our normal, "natural" terms.

²⁶ but there can even be no "things" at all –they may even be "whats".

²⁷ As developed in Chapter 7

"Each of the original directions of knowledge, each interpretation, which it makes of phenomena to combine them into the unity of a theoretical connection or into a definite unity of meaning, *involves a special understanding and formulation of the concept of reality.*"^{XV} [Cassirer]

Repeating myself yet again, ordinary naturalism confuses a *particular* organization, (mathematical physics), with the phenomena which are organized. That is the basis of its assertion of reference -and "scientific realism"²⁸. "The "objects", (the organizational primitives -i.e. Hertz's "images"), of one *particular* form are assumed, (incorrectly), to *reference* ontology -to relate to "an ultimate metaphysical unity". "Scientific realism thinks it can salvage its strange entities with "hierarchy" and "emergence", but my objections as stated in the very preface to this book, as well as the whole current effort to reground mathematics beyond set theory effectively counters that claim, I believe. (See my discussion in the Précis: In a Nutshell which I think is conclusive).

"Where there exist such diversities in fundamental *direction* of consideration, the *results* of consideration

²⁸ another misnomer

cannot be directly compared and measured with each other. The naïve realism of the ordinary view of the world,²⁹ like the realism of dogmatic metaphysics, falls into this error, ever again. It separates out of the totality of possible concepts of reality a single one and sets it up as a norm and pattern for all the others. *Thus certain necessary formal points of view, from which we seek to judge and understand the world of phenomena, are made into things, into absolute beings.* [Cassirer, my emphasis]"^{XVI} ³⁰

What these "formal points of view" do, instead, is *organize* phenomena. What is consistent under *all* forms, however, are the phenomena themselves.

It results, (and I repeat myself again), in an (improper) assignment of (unique) metaphysical reference rather than a (legitimate) judgment of empirical, (i.e. experiential), adequacy for the primitives of its theories.

"Only when we resist the temptation to compress the totality of forms, which here result, into an ultimate metaphysical unity, into the unity and simplicity of an

²⁹ but see the prior discussion of naïve realism as a biological algorithm

³⁰ Naturalism, at *whatever* level of sophistication, clearly falls under this injunction.

absolute 'world ground' and to deduce it from the latter, do we grasp its true concrete import and fullness. No individual form can indeed claim to grasp absolute 'reality' as such and to give it complete and adequate expression.[my emphasis]"^{XVII} ^{XVIII}

In Defense of Kant:

I have said it elsewhere, but I think that Immanuel Kant may be the most misunderstood, misconstrued, and unfairly trivialized thinker in the history of the mind-brain problem. This is quite understandable from the perspective of my earlier comment about the necessity of an inbuilt realist imperative in the human brain.

I argued^{XIX} that from a biological perspective it is not important that the “operator” of such a complicated process knows what it is, (specifically), that he is doing. It is important *only that he does it well*. It is crucially important that he does it *diligently*, however. It is imperative that he be locked into the loop of his virtual reality -that he “pay attention”. This introduces the necessity of an *inbuilt realistic imperative* -i.e. a mechanical guarantee of his dedication, (see P.S. Churchland / Hume).

The universal and dogmatic belief in the simple reality of our natural world is thus itself a consequence of my thesis -and the greatest obstacle to its acceptance!

Durant ultimately dismissed Kant for his “subjectivism” – in Durant’s words “‘the world is my idea’ *as Schopenhauer honestly*³¹ *put it*”. Bertrand Russell,^{xx} though initially a Kantian, expressed his absolute joy at getting his “objects” back once he had renounced those ideas. Scientists and philosophers have spent two centuries trivializing Kant’s brilliant insight. I think it’s time to turn our perspective around. Science will demand it! *The science of Mind* will demand it.

Kant, by his own words characterized himself as a “critical idealist”, and I think that may be the biggest mistake he ever made! As I noted in Chapter 6, there is a footnote to this however. Kant himself was never satisfied with "critical idealism" but was forced to retain it for historical reasons.

Kant, I think, was not an “idealist” in *any* sense at all - not even a “critical” idealist as the references to his own words above clearly proves. He was rather what I have termed an “ontic indeterminist” which I think is more descriptive of his actual perspective.

But this is still a “realist” in the most essential sense of the word! Kant was very much a realist about the *existence* of externality. His question instead was what it, i.e. externality, in

³¹ Durant’s characterization

fact actually *was*.³² But this is the question that physical science continually asks.³³ Kant's work has severe historical limitations to be sure, but he never claimed his program was completed. This was his implicit sanction for the subsequent evolution of the neo-Kantians, of whom Cassirer was perhaps the most outstanding.

I have moved beyond Kant, I believe, but I accept him for the genius he was.

³² Kant reduced externality to a "something". Maturana reduced it to a "somewhat". I have reduced it to the "axiom of externality". It is an *intentional* axiom of realist reason.

³³ There is a great similarity between the relationship of Schrödinger's equations and the act of measurement and the reafferent aspect of "acting into the world" and the feedback generated by it as noted in my Freeman Appendix. Neither really has presumptive "objects" before the fact.

Chapter 13: Conclusions & Opinions

Scientific Conclusions:

I consider my most important result, (though you may think this strange), the *Naturalist* one: i.e. that "mind" is the (reduced) "concept" of the brain!¹ I hold that it is both legitimate and important within the (reinterpreted and relativized) Naturalist framework and leads to definite and practical empiric lines of research.

That Naturalism is itself thereby relativized detracts neither from its utility *nor* from its importance -no more than did the introduction of relativity or indeterminacy into modern physics lessen *its* viability or importance. Rather, it produced profound and immediate practical results.

Naive realism is a biological and behavioral algorithm superb for normal life, and Naturalism, its natural extrapolation, is valuable beyond measure -as well it should be under my hypotheses. It is to the ultimate empirical results, (or not), of my thesis, however and finally, that I will equate its ultimate value.

So where do we go from here?

The biggest problem still remaining for the science of man is the physical brain itself. Physical science thinks it has solved the essential problem of everything else, (almost), but how large is the scope of its knowledge? A few billion pieces of knowledge, I think. Minsky thinks it is just a few pieces.¹

But, conversely, how big is the physical brain in itself? It is 100 billion cells alone, and its synapses are of the order of 10 trillion. Think of the combinations and the complexity of our original and foundational mechanism which is, furthermore, *self-referential by definition*.

Which is the larger, more difficult problem? I think the answer is pretty clear. The focus on the brain will become the primary focus of any future science.

Devil's Advocate:

Though I have argued against our knowledge of externality, and for a schematic organization of process, *could*

¹ Dreyfus cites Minsky's attempt to specify the magnitude of the mass of knowledge necessary for humanoid intelligence. Minsky estimates the number of facts required as on the order of one hundred thousand for reasonable behavior in ordinary situations, a million for a very great intelligence. If this doesn't satisfy us, we are to multiply this figure by ten! Dreyfus 1992. Minsky apparently thinks that ten million is a huge number! I don't think it is.

not our external, metaphysical world *still* be like the objects of our cognition. Of course it could! The possibility is suggested in my conception of interface.

Since implicit definition defines *our* objects within, conceivably it might, as well, define the "objects" of external reality without! But this is a profession of extreme faith, and not of science.²

"If anyone adopts such a belief, he or she does it as a leap of faith. To make such a leap does not make us *ipso facto* irrational; but we should be able to live in the light of day, where our decisions are acknowledged and avowed as our own, and not disguised as the compulsion of reason."^{II}

I, however, do not choose to, (nor do I have to), make such a leap of faith. I propose that what we have is a viable, (and truly real!), working model that simply "does the job", i.e. it is at least compatible, and probably beneficial^{III} vis a vis absolute externality.

² It is a question of bounds and limits again. Or, more simply, of the distinction between an upper bound and a *least* upper bound. Reality clearly sets definite upper bounds to (evolutionary) development, but does it convey to the organism a *least* upper bound, (which would be defining)? The former encompasses (raw) "structural coupling", but the latter would be necessary for "*congruent* structural coupling". It is an assumption equivalent to the "parallel postulate", you see!

Come, isn't it the height of arrogance to presume, (under the Naturalist presumption), that this race of apes, barely able to scribble for a mere few thousand years, has been able to divine the nature of absolute reality? How much more probable is it not, (changing the metaphor), that we are merely constructing "*a hive*"?

Why do we think we know even the *boundaries* of all the possible solutions to all of the problems of reality? Whence comes our arrogance that we feel we have solved the ultimate problems of the universe and of our existence in it?

Is it not more believable, (under the very Naturalist assumption), that we have merely expressed our own particular mode of existence, -that human civilization, (incorporating human minds), like a swarm of bees, has simply built a hive?

What is this logic we are so sure of? Ultimately, biologically, it is an expression of the "structural coupling" of the race with its environment. But the invariants of that coupling are derived from the structure of the uniquely human brain.

Other brains, other modes of coupling almost certainly would embody another protologic. Ordinary logic, (i.e. "associationist" logic -after Dreyfus' term), denies its biological roots. It believes it has touched eternity and verity. How? Why? What teleological mystery does it hide?

When we thought that man was created by God in his image and that God gave us this open channel to truth, then there was a meaningful rationale for such a view. But when man

became, purely and simply, a material animal, derived mechanistically and randomly by material combination, then this mechanistic process lost all justification as correlating with anything other than its own mechanical necessities.

But it works! How and why? Perhaps that is itself the answer. It is an operative process that works in the world in which it lives! This provides no guarantee of its ontological posits at all however -it is an operative process that works -and that's all!

So Why Bother?

But if this is the ultimate answer, if this "ontic indeterminism" is the conclusion we must reach, what is the point of it all?

Throughout I have admitted the (intuitive) difficulties of my thesis. But modern physics has much the same difficulty -its picture of reality, though intensely beautiful and exotic, offends those same normal sensibilities.

The (why bother) answer for physics is that that very picture produces desirable, powerful, and practical results right at the human, (naive), scale, and which we cannot deny. The transistor, nuclear power, working telephones and radios, ... are necessary and practical consequences of that *very* theory -and they would be impossible without it.

I propose that this will be very much the case for my conception. Though admittedly offensive to our (naive) realist sensibilities, *if it is correct*^{IV} it will lay the scientific and mathematical theoretical ground necessary for the quantum advances in neuroscience, for instance, which will finally and specifically, (rather than non-specifically and destructively), cure the terrible aberrations of mental illness.

But the mind-brain puzzle has far larger implications than that. It deals with the *problem of man* in all its aspects. It deals with all his social, ethical and artistic parts.³ The final implications must not be underestimated.

This is the "why bother". Even offensive theories can yield useful and powerful results, necessary to man! The final test, the final judgment therefore, must be made on results. But, before results can be obtained, it is necessary, first, to entertain *the possibility!*

My reconception of fundamentals, though radical, is absolutely consistent with the historical progress of science -of physics, biology, mathematics and logic. It solves the biological

³ I think it would be a real mistake to discount the possibility of real, purely physical implications from my thesis. In the transition beyond "objects", wholly new degrees of freedom may be possible for physics itself.

and the philosophical problems inherent in the mind-body problem, and exorcises the "homunculus" once and for all.

It provides an Archimedean fulcrum to overturn our naive realistic presuppositions, (inherited by "scientific realism"), and let us get on to the serious business of creating a science of mind and brain. It provides a viable context in which I believe workable theories are now, finally, possible.

No substantial progress will ever be made in dealing with "mind", or in the treatment of its terrible, destructive aberrations, (both individual and societal), -until the mind-body problem itself is solved and *workable tools* are developed.

To deal with the mind, we must deal with its "objects" and the relations between them. To deal with the brain, we must deal with its process. To constructively and *specifically*^V affect the processes of mind^{VI} *via* the brain, the relationship between the two *must* be understood!

The simplistic orientations of naive realism, ("though grown up and sporting a beard" -to coin a phrase), just will not stand any longer. Great issues, to include the most profound social, ethical and spiritual aspirations of the race, depend upon the resolution of this problem -and upon its consequent, the establishment of a mature and viable neuroscience.

There is too much pain in our world, and too much *need*, - dependant upon real solutions to these problems, to cling to the playgrounds of our intellectual youth.

How do we live?

So, (given my thesis), *what is the point?* Do we exist, therefore merely contemplating our navels, lost in the "ontic indeterminism" of metaphysics? No.

I, for one, rarely even *think* about metaphysics, but love and feel pain, pay attention to passing cars, and generally live my life as you, (or any dogmatic Naturalist), would. I practice Descartes' interim life strategy of normalcy, (by necessity), and pretty much live my life as I always have. I speak the language of Naturalism because it is good and fecund language and because it is, well ..."natural"!

When I *choose* to consider the connection however, I know that by following my inbuilt model, (and extending it through the discovery of new science, let's say), I am in harmony with that nameless externality. I do not *use* my model, you see, I *live in* it!

My "Act of Faith":

But what do *I*, personally and as *my* act of faith, believe? (I, after all, get to have beliefs as well!) Though I do not believe in the necessity of spatially and temporally separate *metaphysical* objects, (consistent, certainly, with the views of modern physics), nor in the metaphysical "aether" in which they are *still* conceived(!), I, (personally), believe in the metaphysical

existence of *other minds!*⁴ (That there is *still* more, -an absolute externality, "phenomena substantia"- I also believe.)

But as per those other minds, specifically *as minds*, (as per my second thesis), I believe they are all precisely products of implicit definition, variations on, (values of), a single universal function. They are, I believe therefore, *continuous variations of me*. We are all, I believe consequently, *more than brothers*, but "states" of the same being.

"You" are "me" in a different "place", (state) -there is no necessary spatial or temporal separation between us, i.e. there is no necessary *metaphysical "aether"* between us!
But somebody already *said* all that, didn't they?

⁴ I also believe in a *continuity of sentiency*, at least with the higher animals -for reasons which should be perfectly obvious by now. Just where the "cutoff point" may be, I would not be presumptuous enough to speculate. Might not these be the "extra-terrestrial"/ alien intelligences we have so long desired to meet?

"I tell you the truth, whatever you did for one of the least of these brothers of mine, you did for me. ... whatever you did not do for one of the least of these, you did not do for me." (Mat. 25:40-45)

Chapter 14: Epilogue

How do you convince a bird, living in a dying tree, to leave its accustomed perch, its familiar nest, and go to inhabit another? You may praise the new view, and describe fantastic horizons invisible to the old. You may catalogue the prospects of juicy worms, temperate climes, and soaring flights through inestimable thermals.

But the bird, clutching stubbornly to its tattered branch, may only envision the loss of its well-defined routines. The path to an easy patch of straw for its nest or a worm-rich meadow might become convoluted or even impossible because of distance or predators! It cannot even envision the possibilities of the new place unless it is willing to chance an exploratory flight.

Its world is simple and uncomplicated -or at least the complications are well known. This has been my problem here. I believe the mind-body problem is the most difficult in the history of the human intellect. It hinges on the problem of cognition -and *that* is the problem of everything! Its solution, I feel, involves a brand new "roost" -a new intellectual perspective with horizons different but incomparably broader than before.

Admittedly however, though it proffers "sunsets of unmatched vividness", and "new and fertile meadows", it involves a definite risk as well. It may turn out, after all, that the "nest" I propose lies over *fallow* fields and iron-hard soil where no "worms" might survive!

You are right, therefore, to be conservative and cautious in the selection of your ultimate habitat, but you are *wrong* if you are timid in your *survey* -your future may depend on it. I invite you to conquer your fear of vertigo and try your wings in an exploratory flight to this very different tree of knowledge.

"Safe (that is, probable) hypotheses are a dime a dozen, and the safest are logical truths. If what science is seeking is primarily a body of certain truths, it should stick to spinning out logical theorems. The trouble with such safety, however, is that it doesn't get us anywhere."
(P.S. Churchland)¹

There are really just two schools of thought on the mind-body problem. One holds that the relationship between the mind and the brain is inherently unsolvable. It holds that the natures of mind and brain are (1) either absolutely incommensurate, (are of different kinds), or (2) the problem is beyond intrinsic limitations on human understanding.

The other school holds that the relationship is perfectly direct and unproblematic, albeit totally one-sided and exceedingly complex. The first offers no practical hope

whatsoever for the dysfunctions of the human mind, but the latter destroys the reason for caring in the first place.

Its solution is that we are all automatons, "zombies"! Mind, in its ordinary sense, is a fantasy, a "figment" of the imagination! What, then, does it matter whether *another* automaton makes "pain" noises rather than "happy" noises?

Less delicately, what possible objection could there be to the Dachau "fetus series" or to the atrocities in Bosnia? The solutions offered by both schools, moreover, are counterintuitive, limit the scope of empirical investigation and involve significant logical difficulties. I have offered a new alternative capable of resolving the whole of the problem and commensurate with the whole of the human spirit.

My thesis opens the further and distinct possibility of an actual "physics", i.e. a mathematical and scientific mechanics of mind and brain, as it defines, for the first time, an appropriate context in which it could be formulated. Just as the SUPERB^{II} theories of Newton, Maxwell, and Einstein were literally *unthinkable* in the cosmological context of Ptolemy or in the physical (and gravitational) context of Aristotle, neither can the SUPERB theories which must eventually encompass the mind

and the brain arise without the context -and the continuum -which will make them possible.

I believe the mind-body problem is the most important problem in the history of our (human) species. Subsuming both science and ethics, it will ultimately determine our future as a civilization.

Though this sounds overly dramatic and even downright pompous, reflection shows that it is not. Answers to what we are, and *why* we are will determine what we can do and what we *will* do.^{III} Profound belief determines actual practice!

The bounds of future civilization will be set by our ultimate understanding of our own being. This problem demands, therefore, the greatest latitude and the greatest tolerance to radical ideas. It is too important to be treated otherwise.

It has been said of scientists, (and it certainly applies to philosophers of mind as well), that they live, alternately, in two disjoint worlds. They do not take their reality home with them. The reality they believe as professionals is not the reality they believe when they dodge cars on the freeway or make love. *None* will put out a saucer of milk for Schrödinger's cat.

Is Dennett prepared during his self-stimulating monologue, (whilst sitting in his rocker and listening to Vivaldi), to accept himself solely as a "center of narrative gravity", solely as the cumulative product of temporally and spatially separate and discrete processes, (the "Final Edition" published on his "Demonic Press"), lacking "figment" or "qualia"? I, personally, am perhaps willing to accept *him* as such, but I am certainly not willing to accept *me* as such.

Like Dennett, I have been wrestling with this problem for over 50 years. I came to it not from philosophical curiosity or "epistemic hunger", but as a result of personal tragedy -the loss of a loved one, (my mother), to the maw of mental illness. Frustration -and anger- at the inability of science to help her and a survey of the dismal "mythological",¹ (Freudian and quasi-Freudian), state of then-current thinking on the subject^{IV} caused me to begin a personal and private search, of necessity based in

¹ echoing Einstein's characterization of Freudianism

logical and abstract theoretical criteria -but aimed at an empiric goal.²

Emerging from my "cave", (of contemplation), just a few years ago, I was surprised and fascinated by the illuminating and brilliant bonfires which had been lit on the plains of biology and philosophy. Since then, with more than a little trepidation, I have been scouting each of the major encampments so lit.

I have concluded that I have something still new and novel to say. I think that my torch, crafted as much by art as by science, carries a unique Promethean flame. I think I have solved the essence of the problem of mind-brain. Now I, like Benjamin Franklin, Rousseau's "backwoods philosopher", stand before the sophisticates of Paris in my bearskin cap.^v

² Since then, my perspectives have widened. I have come to believe that the tragedies of mental illness are echoed in the tragedies of the human social condition -the wars, the hatred, the arrogance, the exploitation of man by his fellow man, these are other aspects of the same basic problem. Under the perspective of dogmatic Naturalism, these are plausible and normal, and therefore necessary. I do not believe they are.

Though my thesis admittedly opens new and fundamental problems -more, perhaps, even than it solves, that very fact unlocks whole new worlds of possibility for scientific advance and in itself constitutes an argument for serious consideration.

If, in fact, we have already "arrived", if you are satisfied that we do, in fact, already possess in rough form a valid picture of the whole of our reality, then the very *poverty* of that reality as regards the human condition must make you very sad -and kindle the hope that something more is possible. I think it is!

Science has provided the tools for an enlarged and more sophisticated physical life, but taken away the reasons for living it!

Chapter 15: Book Conclusion

Is this a truly “outrageous”¹ proposal? It certainly is! However totally "antirealistic" it may sound however, I argue that my thesis is more compatible with contemporary science than any alternative currently proposed. It preserves science and ordinary experience as well. [It is not far removed from the spirit of modern physics either.]

I will insert the whole of the opening quote from W.V.O. Quine again here, as I think it must be considered as a whole.

"The totality of our so-called knowledge or beliefs, from the most casual matters of geography and history to the profoundest laws of atomic physics or even of pure mathematics and logic, is a man-made fabric which impinges on experience only along the edges. Or, to change the figure, total science is like a field of force whose boundary conditions are experience. A conflict with experience at the periphery occasions readjustments in the interior of the field. Truth values have to be redistributed over some of our statements. Reevaluation of some statements entails reevaluation of others, because of their logical interconnections- the logical laws being in turn simply certain further statements of the system, certain further elements of the field. Having reevaluated one statement we must reevaluate some others, which may be statements logically connected with the first or

may be the statements of logical connections themselves. But the total field is so underdetermined by its boundary conditions, experience, that there is much latitude of choice as to what statements to reevaluate in the light of any single contrary experience. No particular experiences are linked with any particular statements in the interior of the field, except indirectly through considerations of equilibrium affecting the field as a whole.....

Furthermore it becomes folly to see a boundary between synthetic statements... and analytic statements...Any statement can be held true come what may, if we make drastic enough adjustments elsewhere in the system... Conversely... no statement is immune to revision... even the logical law of the excluded middle... and what difference is there in principle between such a shift and the shift whereby Kepler superseded Ptolemy, or Einstein Newton, or Darwin Aristotle?"¹¹

We have *already seen* deep contradictions “at the periphery” -eg Raichle, W.J. Freeman, Edelman, Maturana....which force us to profound changes “in the interior

of the field” comparable to Quine’s “even the law of the excluded middle”. In fact, they force us beyond even “objects”.

"One could even end up, though we ourselves shall not, by finding that the smoothest and most adequate overall account of the world *does not after all accord existence to ordinary physical things.....Such* eventual departures from Johnsonian usage”, (Samuel Johnson is said to have demonstrated the reality of a rock by kicking it!), “could partake of the spirit of science and even of the evolutionary spirit of ordinary language itself.”^{III}

My book supplies such a perspective. How could “the color phi”, “chinese rooms”, “cats on mats”, ... tenuous purely philosophical arguments at best, be more important than these deep biological and physical facts?

This is *such* a theory, but, at the same time, it also allows us “to have a life!”

Consider once again the parallel between the *most* SUPERB¹, (according to Roger Penrose), of modern physical theories,² and my own conclusions:

"There is a very precise equation, the *Schroedinger equation*, which provides a completely deterministic time-evolution for this [quantum] state. But there is something very odd about the relation between the time-evolved quantum state and the actual behavior of the physical world that is observed to take place. From time to time - whenever we consider that a 'measurement' has occurred - we must discard the quantum state that we have been laboriously evolving, and use it only to compute various probabilities that the state will 'jump' to one or another of a set of *new* possible states." (ibid, P.226, his emphases)

¹ His "CAPS"

² F. Quantum mechanics: Explains "hitherto inexplicable phenomena...The laws of chemistry, the stability of atoms, the sharpness of spectral lines...the curious phenomenon of superconductivity.. and the behavior of lasers are just a few amongst these." (P.153) "No observational discrepancies" (*at all*) "with that theory are known."

In this “more optimistic” view, it is only "*in relation to the results of 'measurements'*" that concrete reality emerges -i.e. that a specific rendition of space-time is enabled.

Now compare this one last time to the re-afferent model I presented in the Freeman Appendix of Chapter 4. Each evolves a “state” equation and then performs a “measurement”, (action into the world), which then causes a *new* state equation, (Schrödinger/W.J. Freeman) to be formed until the next “measurement” is performed.

Quoting Penrose once again:

“What kind of a picture of ‘physical reality’ does”
[quantum physics] “provide us with? ...Many physicists
find themselves despairing of *ever* finding such a picture.
They claim instead to be happy with the view that
quantum theory provides merely a calculational
procedure”, [an algorithm], “for computing probabilities

and not an objective picture of the real world. *Some, indeed, assert that quantum theory proclaims no objective picture to be possible –at least none which is consistent with physical facts.*”^{IV}

Neils Bohr, the recognized "father" of quantum theory said that a realistic picture of ontology was unattainable! He characterized his new science as a pure algorithm, (i.e.: a rote, purely pragmatic but *profoundly* and overwhelmingly useful procedure), instead. What the actual reality beneath it is, he said, we cannot know and cannot picture. His theoretical world could not, (cannot), fit any normal sense of the real world. And yet it works and leads to the production of new things -transistors, nuclear power plants, etc.

How close these conceptions are! But quantum physics, according to Penrose is considered the *most* “SUPERB” theory in our current repertoire. It gives you something to think about, doesn't it?

I invite comments and would welcome constructive help in my lifelong quest for a pragmatic answer to this, our deepest and most urgent problem. I sincerely believe it will determine

the future of our species as it lies at the bottom of our deepest and most destructive dilemmas.³

³ Note: I will not expose my humanistic or ethical views, (and they are quite broad and fiercely important to me), as it is vitally important that this problem be solved scientifically and soon, and advancing my personal beliefs would only hinder the process. I will only say that I think this is the most urgent and the most important problem that humankind has ever faced. Without its input, I think we will exterminate ourselves very shortly –I agree with Stephen Hawking on this matter.

(Note: I will respond to any decently proposed questions at jiglowitz@rcsis.com .

Please put some verbiage corresponding to “In Response to your Theories” in the subject line as, else, I will probably delete it as “spam” unread.)

Appendix A: The Dennett Appendix and the Color Phi, (from Iglowitz 1995)

Perhaps the hardest hurdle for my conception is what I call "the static problem". The axiom systems of current mathematics tend to create uniform, "static" fields of objects: the integers, for instance, or the real numbers.

True, there are special, unique objects within them, pi, or e, or 1 for instance, but these are not promising for the kind of usage we will need to see for viable mental objects.

To this point, the model I have proposed stands more in the sense of a Platonic "form", and lacks the viability of Aristotle's conjunction of "form and matter" for the existence of *actual, special* objects.

Let me try to suggest the beginnings of a solution for the existence of such objects within such a system. Let me try to suggest a rationale for actual perceptual objects!

Daniel Dennett, (though he is a confirmed anti-mentalistic), has provided an inspiration. It derives from his treatment of the "color phi" phenomenon, -though his conclusion must be stood on its head. I suggest that the answer to the "static problem" and the ground of viable perceptual objects lies in recognizing intentionality as a primary component of brain process. It is a necessary and complementary (system of) "axiom(s)".

Towards a Working Model of *Real* Minds: Dennett, Helmholtz and Cassirer

I really *liked* Daniel Dennett's "Consciousness Explained"¹. It is not because I could agree with his conclusions, (except in a *certain sense*), that I liked it, but because it is a *brutally* candid and forthright exposition of the Naturalist position, proceeding with compelling logic, and without hedging.

I respect that! It is, moreover, a phenomenologically *pure* position. I think it is, (agreeing with his own parenthetical question), really "Consciousness Explained *Away*" however, rather than "Consciousness Explained" because, at the end, "we are all zombies".¹

¹ I know, I know! I must, in threat of disingenuousness, quote his footnote to this comment: "it would be an act of the utmost intellectual dishonesty to quote this statement out of context."

But the context he demands is 470 pages of careful redefinition and argument against all the normal senses of mental function and existence - qualia, figment, the "substance of mind". The upshot is that it is O.K., (i.e. socially correct), to be a zombie! But the sense in which his statement would normally be understood *out* of context is essentially what it *still* means within

There is one crucial argument he makes against the existence of mental states, (i.e. "figment"), however, in which I think he has correctly identified a profound antinomy -and, I believe, a necessary and major modification to our ordinary conception of mind. He has argued it from "the color phi".

"The color phi" names an actual experiment, suggested by Nelson Goodman, wherein two spots of light are projected in succession, (at different locations), on a darkened screen for 150 msec intervals with a 50 msec interval between them. The first spot, however, is of a different color, (red, say), than the second, (green). Just as in the case of motion pictures, (the "phi phenomenon"), subjects report seeing the continuous motion of a *single* spot, but interestingly, they report that it changes color, (from red to green), midway *between* the two termini!²

it. He attempts to make any objection, (or any comment on its own prima facie unintuitiveness), unraisable. There is *another* cult, (besides the Feenomanists!), in the jungle, you see! :-)

² and not, for instance, that it is red all the way till its terminus, with a final and sudden change-to-green.

Dennett bases a very interesting, (and, I feel a very important), argument against the very possibility of a "Cartesian Theatre", against a unity, (and "figment" = substance), of consciousness on this well documented and reproducible experiment. Dennett's argument, in brief, is this:

Mental states, the "Cartesian Theatre", if they exist, are subject to the laws of causality, of time precedence. For one event to affect another, it must occur *before* it. Let me, for discussion's sake, label the events described. Let E1 be the ("heterophenomenological"³), perception, (hereinafter to be called by me "h-perception"), of the first, (red), spot. Let E2 be the h-perception of the red-changing-to-green, and let E3 be the h-perception of the final green spot.

Dennett argues, based on the principle of causality that E2 cannot occur until after E3. Since there were only two actual,

³ Dennett introduces the criterion "heterophenomenological" to describe "mental events", which he does *not* believe in, to describe whatever-it-is that is named by them, i.e. to talk about them as they are (linguistically) used by real bodies and brains, (which he does believe in), but with a neutral metaphysical commitment.

(physical), events, (the first and second projected spots), he argues that the h-perceived midpoint, (the "mental event", i.e. red-changing-to-green), cannot occur until *after* the reception of the second actual event, (green projection), as it was that which provided the very sensory data *necessary* to the h-perception of change.

Other than a (mystical) hypothesis of "projection backward in time", there remain for Dennett just two possibilities for an internal, "Cartesian Theatre" consistent with the experiment: the "Stalinesque" and the "Orwellian" hypotheses.

The first involves the creation of a "show trial" staged by a subterranean "central committee", (after the fact of both real events, of course, and involving a "delay loop"), wherein the complete, (and partially fabricated), sequence, (red ->red-changing-to-green -> green), is "projected", (i.e. achieves sentience).

Under this hypothesis, the whole of our sentience, our consciousness, occurs "after the fact". The second possibility, the "Orwellian" hypothesis, is that the actual events are received by our sentient faculty *as is*, but that our memory then rewrites history, (just as the thought police of Orwell's "1984" did), so that we *remember* not two disjoint and separate events, but the connected, and pragmatically more probable sequence red -> red-changing-to-green -> green.

Dennett argues that ultimately *neither* theory is decidable -that either is consistent with *whatever* level and kind of experimental detail science may ultimately supply, and that, therefore, the only pragmatic distinction between them is purely linguistic, and therefore trivial.

He argues that there *is* no "great divide", no actual moment, (nor existence), of sentience, but only the underlying brain process, (which *all* theories must countenance), itself. Based on the "spatial and temporal smearing of the observer's point of view", he expounds his thesis of "multiple drafts" wherein there *is* no "theatre", only brain process -and its various "speaking", (drafts).

And yet the observer *himself* has absolutely no problem with these events! *His* perspective is very clear: E1 -> E2 -> E3. It is our interpretation, (and rationale), for this sequence that causes the problem.

I think Dennett has a very strong argument, but I want to refocus it. Nondecidability is all very well and good, but it is a much weaker line than the one he started out with- on the possibility of *synchronization*! In a very real sense, I feel it is very similar in intent and consequence to Einstein's famous "train" argument against simultaneity.

Consider, (with Einstein), an imaginary train moving (very fast)⁴ down a track, with an observer standing midway on top of the moving train and observing two (hypothetically instantaneous) flashbulbs going off at either end of the train.

The train goes by another (stationary) observer standing (hypothetically infinitely) close by the track as the bulbs go off. Suppose that the moving observer, (OT), reports both flashes as

⁴ nearing the speed of light

simultaneous. He argues that since both photon pulses reach him simultaneously, (granted for all frames on the local, infinitesimal scale, and thus agreed on (?) by *both* observers who are assumed infinitely close -i.e. side by side), that therefore the pulse from the rear of the train, having to "catch" him, must have left its source sooner than the pulse from the front which added his velocity to its own and so must have left later.

Relative to OS, (stationary observer), however, the two sources travel the same distance to a *stationary* target, (himself). Since OT and OS are momentarily adjacent to each other, (i.e. within a local frame), they should be able to agree that the two pulses *arrive* there simultaneously.

What they *cannot* agree on, however, (in that instance), is whether the events, (the flashes), *occurred* simultaneously -*nor that the other could have thought, (i.e. could have observed), them so!* Time, in Dennett's words, is "smeared"!⁵ We could, of

⁵ Are the observers, (and the experimental apparatus), then "heterophenomenological"?

course and significantly¹¹, *vary the parameters* of the stated problem to make *either* event "earlier" and the other "later".⁶

The argument⁷ is that from the standpoint of one observer, he must maintain that the *other* cannot see them as simultaneous, and vice versa! Thus from OS's standpoint, if he sees them as simultaneous, then, since he is stationary, they *occurred* simultaneously. But if they occurred simultaneously, and since OT is moving, then *OT cannot*, (OS argues), see them as simultaneous, (and conversely). And yet both observers pass through an infinitesimal local frame of reference, (side-by-side). Time is "smeared"!

Just as Einstein's two observers, near the limits of physical possibility, cannot agree whether the two lights were *simultaneously* flashed at the ends of the train or not, (i.e. cannot

⁶ i.e. if the front pulse arrived at the correct interval before the rear pulse, OT could argue that they were, in fact, simultaneous, but OS would obviously argue to the contrary. This would be a better match to Dennett's specific problem.

⁷ assuming the legitimacy of "simultaneity" itself

establish a common temporal frame of reference), nor that the other could observe them locally as such, neither, given Dennett's pointed argument, can we establish a common temporal frame of reference for "the world" and "the mind" at the limits of cognition.⁸

I agree with Dennett that "the color phi" identifies a legitimate and critical aspect of the mind-body problem. The spatial and temporal "smearing" of the percept and the non-explicit reference of qualia that he demonstrates forces a profound extension to our traditional conception of the "theatre".

But his dimensional "smearing" actually fits very well⁹ with the model I am proposing. I submit that it is *more plausible* in terms of the "focus" and "function" of an operational object

⁸ For macroscopic science, these limits are at the scale of the speed of light. For atomic physics, they are at the scale of Planck's constant. And for the brain, I suggest, they are at the scale of minimal biological response times, i.e. in the 100 msec. range.

⁹ when taken "heterophenomenologically" -i.e. with a neutral ontic commitment. Heterophenomenology works both ways!

than in terms of his "multiple drafts", "demons" and "memes" in the "real world".

Cassirer on the Color Phi:

His objections to the ordinary "Cartesian theatre" are admittedly valid, but so were those of Cassirer and Helmholtz long before him:

"For example, if we conceive the different perceptual images, which we receive from one and the same 'object' according to our distance from it and according to changing illumination, as comprehended in a series of perceptual images, then from the standpoint of immediate psychological experience, no property can be indicated at first by which any of these varying images should have preeminence over any other. Only the *totality* of these data of perception constitutes what we call empirical knowledge of the object; and in this totality no single element is absolutely superfluous. No one of the successive perspective aspects can claim to be the only valid, absolute expression of the 'object itself;' rather all the cognitive value of any particular perception belongs to

it only in connection with other contents, with which it combines into an empirical whole.”

“...In this sense, the presentation of the stereometric form *plays 'the role of a concept'*”, (my emphasis),
“compounded from a great series of sense perceptions, which, however, could not necessarily be construed in verbally expressible definitions, such as the geometrician uses, but only through the living presentation of the law, according to which the perspective images follow each other.’ This ordering by a concept means, however, that the various elements do not lie alongside of each other like the parts of an aggregate, but that we estimate each of them according to its *systematic* significance....”
(Cassirer, 1923, pp. 288-289, citing Helmholtz)

But Cassirer's own drastic reformulation of the formal [technical] “concept” itself must be considered for an understanding of his meaning here. The “concept”, for Cassirer as we have spent a lot of time understanding, *is a function*. It is like "the form of a series", independent and distinct from what it orders.^{III} This is the "systematic significance" which he purports.

I urge, extending Cassirer's insight and in the sense of my conclusions of Chapter 3, [Iglowitz, 1995] that the stereometric form itself, the actual percept,¹⁰ then plays the role of, (is), a function.

From the standpoint of (relativized) Naturalism,¹¹ if we take the mind to be schematic, but specifically a "*predictive*" and "*intentional*" schematic model, (which extension I will suggest shortly), rather than a static and "representative" one^{IV}, then the temporal and spatial "smearing" of the percept do not have the implications against the "theatre" *per se* that Dennett attributes to them.

I have argued that the percept itself is conceptual, (albeit specialized, invariant and constitutive), and therefore, following Cassirer, functional. It is an entity of order and process -and it *is*

¹⁰ This, *the percept as concept*, is clearly at odds with, but, (I have argued), a legitimate extension of, Cassirer's ideas. He did not have the perspective of the schematic object.

¹¹ cf. Chapter 5

"smeared". That is the normal nature of *functions* -functions *are* smeared! [Note June, 2010: Reconsider the continuum itself!]

What Dennett explains by "multiple drafts", (and the "demonic" process he envisions beneath them), I explain by "focus". We focus the percept, (via implicit definition) according to operational need.

An Extension of the Schematic Model: A Brief Sketch

Let me frame the following in the language of ordinary Naturalism, (this *will* be a short appendix). I want to sketch a very large canvas very quickly.¹² In "the color phi", I think that Dennett has identified a very important difficulty in our ordinary conception of mind. It suggests an enlargement and a more

¹² I could, of course, try to footnote every misconception and every possible claim of inconsistency, but I already did that in my original MS. I think I have paid my dues. "Predictivity", "intentionality", et al are, under my thesis, perfectly valid conceptions *within* the Naturalist "form" - and I may consistently use them *as such* without self-contradiction! Within the context of my larger perspective, they are model-model correlations, synthetic a priori "slices" across the phenomena. [Iglowitz, 1995]

sophisticated perspective on the schematism I have argued heretofore. Though I think I have successfully laid the solid foundation, let me now briefly sketch the design of the cathedral itself, i.e. the design of *real minds*!

I have dealt, previously, with the schematic object. I argued that the object of perception is a schematic artifact of reactive brain process, specifically "designed" to optimize a simple and efficient "calculus" of response.

But the converse side to that argument is that a calculus was actually enabled! What are the (Naturalistic) implications of that calculus, and of the schematic model?^V

A Thought Experiment

Follow me in a thought experiment! Keeping your eyes fixed to the front, you perceive, (in your perceptual model), this paper in front of you, the wall behind it, and, perhaps, the pictures of your family. There may be pens and pencils, books. You may hear music from the stereo next to you, (and perhaps still in peripheral vision). There may be a window, and the lights of the neighbor's house beyond it.

But there is no wall behind you! There is no car in the driveway outside of your house -indeed, there is no "house" at all.

There is no city, no taxes, no friends. The sun does not exist in this model. There is no government, no "universe", -no tomorrow! The (purely) perceptual model is incomplete as a model of "reality" and it is, (Naturally!), inadequate even to keep you alive!

There is something else necessary for completeness of the model detailed in this book, i.e. a new perspective on it. It is an *intentional* aspect. It is necessary to supply the object behind your back and the reality "over the hill"! It supplies the connection to "tomorrow" and "yesterday". It supplies "causality". It is necessary for the completeness of a model of "*the world*". It is necessary, (specifically following Dennett!), even for the individual "objects" of perception itself, (E1 and E3 for instance).

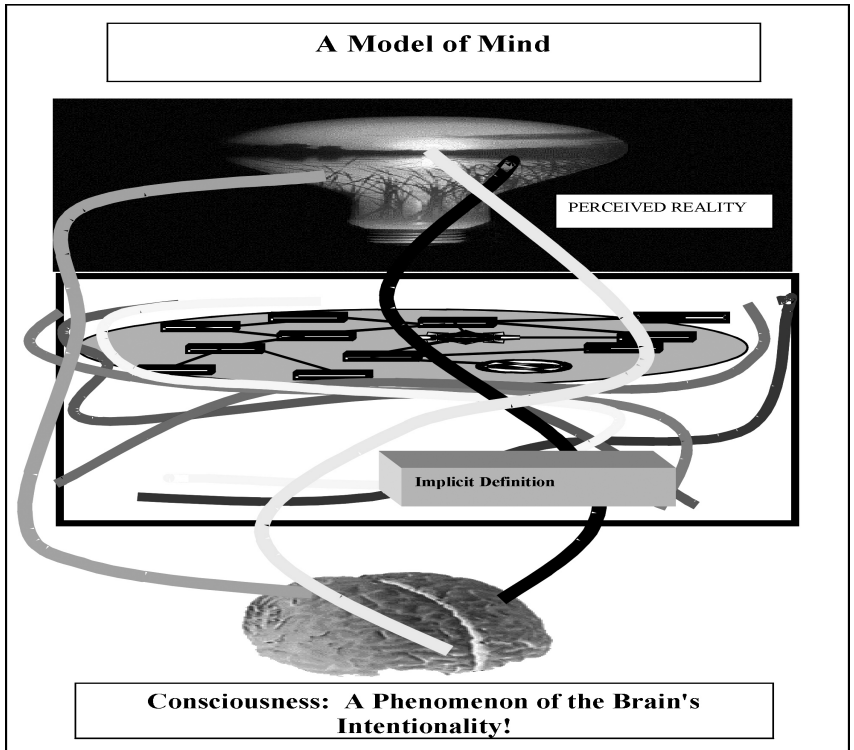

Figure 31

This model, I suggest, is where E2, (the object of Dennett's perplexity), lives. It cohabits there very comfortably

with E1 and E3 which, I argue, are *also* predictive and schematic objects. There is a seamless integration, (above the scale of 100 ms, let us say), of what we normally think of as our pure percepts and the intentional fabric within which they are woven.¹³

This model, I believe, is the actual "home" of mind, and the legitimate purview of a truly scientific psychiatry.^{VI}

¹³ Let us turn Dennett's argument around. Dennett argues strongly and convincingly that "figment", (mental states), are logically inconsistent with our, (his), ordinary (naïve) views of cognition and reality. If, instead of accepting his conclusion however, we choose to accept the *reality* of that figment -E1, E3, and E2, -if we believe that E2 is *actually* perceived, (whatever it may be), then his argument takes on a different import and works against the very ground in which it was framed: i.e. his ordinary view of cognition and the Naturalism, ("objectivism"), in which he embedded it. The "color phi", he says himself, embodies a precise and *reproducible* experiment –both you and I would expect to *see* E2!

I consider the "phi phenomenon" *itself* more interesting than the "color phi", however. The credibility and intentional depth of a series of oversized, rapidly sequenced still pictures, (a movie), is quite suggestive. Its potential for an uncanny parallelism with our ordinary experience suggests that the latter, (i.e. ordinary experience), is *itself* a predictive and integrative phenomenon grounded in a schematic, intentional model in precisely the same manner as I propose the "color phi" to be.

"Now what is a phenomenal space? Is it a physical space inside the brain? Is it the onstage space in a theater of consciousness located in the brain? Not literally. But metaphorically? In the previous chapter we saw a way of making sense of such metaphorical spaces, in the example of the 'mental images' that Shakey, [a robot], manipulated. In a strict but metaphorical sense, Shakey drew shapes in space, paid attention to particular points in that space, based conclusions on what he found at those points in space. But the space was only a *logical* space.

It was like the space of Sherlock Holmes's London, a space of a fictional world, but a fictional world systematically anchored to actual physical events going on in the ordinary space in Shakey's 'brain'. If we took Shakey's utterances as expressions of his 'beliefs', then we could say that it was a space Shakey *believed in*, but that did not make it real, any more than someone's belief in

Feenoman would make Feenoman real. Both are merely intentional objects.... *So we do have a way of making sense of the ideas of phenomenal space -as a logical space.*"¹⁴

But this is my exact conclusion of Chapter 3. [Iglowitz, 1995] Dennett and I are not so very far apart after all -save in our metaphysics, (wherein we are *very* different). Mind is a *logical* entity -i.e. its "space" is a *logical* space.

But Dennett's "mind" is based in abstractive, associationist logic (after Dreyfus' usage^{VII}), and *dead*, and mine is based in a functional logic, (the constitutive logic of Kant and of biology), and *live*. We are *not* zombies!

On the issue of metaphysics, on the other hand, surprisingly Dennett specifically argues that "nature does not build epistemic engines."^{VIII} Why, then, does he think that *he*,

¹⁴ Dennett, 1991, pps.130-131, my emphasis.

either as a physical engine of process, (and the "demons" of process), *or* as a linguistic engine of "memes", *-is epistemic*, (i.e. metaphysically so)? Or that *his book* is so?

I don't think that he, or I, are. This was my exact conclusion of Chapter 5.

Appendix B: Lakoff, Edelman, and “Hierarchy”¹

As I mentioned in the Introduction, (Iglowitz, 1995), I had not seen George Lakoff’s “Women, Fire, and Dangerous Things” nor Gerald Edelman’s “Bright Air, Brilliant Fire” until very recently. It was remarkable to me, therefore, to see how closely Lakoff’s logical and epistemological conclusions resembled those of Cassirer², (considered as the combination of Cassirer’s dual theses: his logical thesis of “the functional Concept of mathematics” and his epistemological thesis of “Symbolic Forms”), and how closely Edelman’s biological and philosophical answers, based in Lakoff’s and his own original work, resembled my own conclusions.

There is an uncanny parallelism of structure, (though not of consequence), between the paths we have followed to arrive at our conclusions. Our structural differences are differences of degree –but important differences. I believe that Lakoff, (and Edelman), have gone too far in the case of logic, and not far enough in the case of epistemology.

¹ [Note: This is the original Lakoff/Edelman appendix from Iglowitz 1998 sans the discussion of mathematical “ideals” which latter is presented elsewhere in this book. Pretty much everything else is reproduced.]

² Of which Lakoff, apparently, was unaware

They fail³, crucially thereby, to provide the grounds for an answer to the ultimate problem: i.e. how can “mind” or “consciousness”, (normally taken) coexist with the existence of the brain?

Lakoff:

Lakoff grounds his work in logical reflections of Wittgenstein⁴ which questioned the adequacy of the classical logical Concept and in the work of Rosch and a host of modern empirical researchers which further challenged that classical Concept by demonstrating exceptions in actual human usage of language and concepts across cultures and even within our own legitimate contemporary usage. From these grounds and his own

³ -innocently for Lakoff who never promised such an answer, but more pointedly for Edelman who did

⁴ E.g. Wittgenstein’s “family resemblances”

original work, Lakoff drew strong conclusions about the nature of logic⁵ –and the human mind- itself.

The Classical Concept

The classical concept⁶ is defined “by necessary and sufficient conditions” -that is, by set theoretic definitions on properties. It is an elementary theorem of logic that the whole of the operations of sentential logic, for instance, may be grounded solely in the primitive operations of intersection and complement.⁷ More generally, logical sets and categories, (concepts⁸), are defined on presumed “atomic properties” and are

⁵ compare Cassirer: "... Every attempt to transform logic must concentrate above all upon this one point: *all criticism of formal logic is comprised in criticism of the general doctrine of the construction of concepts.*" –cited at the beginning of my Chapter 3.

⁶ Lakoff is concerned with primarily with categories, but the distinction is technical and not necessary to this discussion. Cassirer dealt specifically with concepts, but he covered essentially the same ground.

⁷ Or on other subsets of set operations as well

⁸ See prior footnote: categories vs. concepts

commensurable wholly based on the set-theoretic possibilities of those sets –i.e. union, intersection, complement, etc.

Concept-sets, (within this classical perspective), express a hierarchical “container schema” moreover, (using Lakoff’s language). Though Lakoff frames his discussion to the same end slightly differently, by this I mean that whenever we classically specify a genus, we do so by eliminating one or more of these atomic properties, (by intersection of the properties of species), at the same time thereby specifying an expanded extension, (union) –i.e. the set of “objects” which the genus concept encompasses.

The delimitation, (by property containment), of the genus category is contained within, (is a subset - an intersection of), that of the species category while the *extension* of the species category, conversely, is contained within, (is a subset of), the extension of the genus category.

In specifying a species on the other hand, we do so by adding one or more properties –ultimately “atomic properties” to the properties of the genus and this species concept encompasses

a diminished, (intersectional), extension of the extension of the genus.⁹ This classical categorization therefore expresses an absolute, rigid and *nested* hierarchy of levels and containment. In Lakoff's terms it expresses a hierarchical "container schema".¹⁰

Ultimately, (because they *are* nested), at the limits these processes specify

(1) a largest concept: "something", (defined by *no* atomic properties), whose extension is "everything", and

(2) a smallest concept: a particular "object" in reality, (or possible reality), defined by *all* its atomic properties¹¹.

Given the classical paradigm then, reason necessarily begins with "something", (the most general concept), and points, inexorably, to some particular "thing", i.e. a specific object.¹²

⁹ "Cross categorization", the "other . . . classical . . . principle of organization for categories" refers to the various possibilities at any stage of genus or species categorization – on the particular choices of which "atomic properties" are to be eliminated or added. Cf Lakoff pps. 166-167

¹⁰ *ibid*

¹¹ to include spatio-temporal properties

But Lakoff plausibly argues that concepts¹³ in legitimate human usage are actually determined by *any* rule, (to include the classical rules of set operations on properties as just one *special case* of a rule), or even *by no rule at all* !

Thus metaphorically based categories, such as the Japanese concept of “hon” are generated, (determined by), a metaphoric rule of extension and metonymically based categories are generated by a rule of metonymy. (Metonymy is the case where one particular instance of a category is made to stand for the category.) “Don’t let El Salvador” become another Vietnam” is an example Lakoff uses of a metonymically based category.¹⁴ Here “Vietnam” stands for the concept of all hopeless, unending wars.

¹² or *the exact converse* –i.e. beginning with some specific object or objects in reality or possible reality and ending with everything!

¹³ he would say “categories”

¹⁴ P. 77. Actually I like his “ham sandwich” better, but it was pre-empted by Edelman!

In the case of “radial categories” on the other hand, such as the concept of “mother”, (to include birth mother, adoptive mother, foster mother, surrogate mother, etc.), or of “Balam”¹⁵ in the Dyirbal aboriginal language in Australia, they are determined by simple historical accident –they are not generated from the central model by general rules

[but] .. must be learned one by one.”¹⁶ (Extensions from the central model are not “random” however, but are “*motivated*”, his emphasis, “by the central model plus certain general principles of extension.”)¹⁷

¹⁵ The category which is the source of his title and includes, among other things, women, fire, and dangerous things.

¹⁶ Lakoff, P.91

¹⁷ As I will repeat later, this discussion of Lakoff’s thesis is woefully inadequate, but it will have to do for the purposes of this appendix. He states as the “main thesis of [his] book .. that we organize our knowledge by means of structures called *idealized cognitive models*, or ICMs, and that category structures and prototype effects are by-products of that organization.” Ibid, p.68

He argues his case rigorously and scientifically by exhibiting myriad examples that are *not* compliant with the classical Concept and analytically by demonstrating the degradation of concepts in actual bi-cultural environments –i.e. where a culture and language is being overrun by another, (“language death”), as is the case with the Dyirbal aboriginal language in modern Australia.¹⁸ The degradation is characterized by the loss of blocks of suborganizations, not of random individual elements.

Lakoff’s logic is not trivialized by this “free formation” of concepts however, (as it might seem it *would be*¹⁹- logic being [paraphrase] “mostly concerned with categories”), as he bases

¹⁸ See Lakoff, pps. 96-102

¹⁹ If, according to Lakoff, (1) legitimate concepts may be formed on any principle or no principle, and if, also according to Lakoff, (2), most of the business of logic is concepts, (categories), then it would appear, (at first glance), that (3) logic could prove *any* conclusion. But if logic can prove anything, then it can prove nothing! Thus it would appear, on the face of it, that his purported impossibility of a rigorous, comprehensive structure for categories in general would imply the invalidation of logic in general.

logic and the relevance of concepts ultimately in a *preconceptual context* rather than in the concepts themselves. Concepts, (categories), he argues, are not created in a vacuum, but within preconceptual schemas: “idealized cognitive models”, (ICMs). The latter are ultimately determined, (he argues), by the function of the body in the external world—all describable from “body in the world”.

“There are at least two kinds of structure in our preconceptual experiences:

A. Basic-Level structure: Basic-level categories are defined by the convergence of our gestalt perception, our capacity for bodily movement, and our ability to form rich mental images.

B. Kinesthetic image-schematic structure: Image schemas are relatively simple structures that constantly recur in our everyday bodily experience: CONTAINERS, PATHS, LINKS, FORCES, BALANCE, and in various

orientations and relations: UP-DOWN, FRONT-BACK, PART-WHOLE, CENTER-PERIPHERY, etc.”²⁰

These schemas, however, being at the *basis* of our reasoning²¹, are necessarily mutually relativistic and equipotent and we utilize them on a “best fit” rationale. The concepts that arise within them need not be commensurate *across* them. Thus he arrives at a relativism of logic and concepts.

Lakoff’s Concept/category in many ways resembles Cassirer’s²² and he rejects, (as does Cassirer), the classical

²⁰ Lakoff, p.267.

²¹ rather than categories

²² There is an uncanny parallelism of argument throughout between Lakoff’s and Cassirer’s treatment of logic. Consider, as an example, the following:

“Category cue validity defined for such psychological (or interactional) attributes might *correlate*“, (his emphasis), “with basic-level categorization, but it would not *pick out* basic-level categories; *they would already have to have been picked out* in order to apply the definition of category of category cue validity so that there was such a correlation.” (Lakoff: P.54, my emphasis) This is almost an exact parallel to one aspect of Cassirer’s argument against the classical concept, and the “theory of attention”, (see my Chapter 3), –and for a “new form of consciousness”.

“necessary and sufficient conditions”, (as he phrases it), which ground set theoretic abstraction and the Aristotelian generic Concept. His logical and ultimately epistemological relativism, (in his “idealized cognitive models”), is also very similar to, (though it is not as abstract and comprehensive as), Cassirer's “Symbolic Forms” which is described in my Chapter 5. (Chapters 7 & 8 in the current writing.)

Cassirer and Lakoff's Logic

Cassirer rejected the logical sufficiency of classical categorization as does Lakoff, but he did *not* reject the possibility of the possible existence of an absolute, comprehensive structure for categories, (which Lakoff does). Instead Cassirer retained *an*

Discussing Erdman, Cassirer writes: “. . .instead of the community of ‘marks,’ the unification of elements in a concept is decided by their ‘connection by implication.’ And this criterion, here only introduced by way of supplement and as a secondary aspect, proves on closer analysis to be the real logical *prius*; “ (his emphasis), “for we have already seen that ‘abstraction’ remains aimless and unmeaning if it does not consider the elements from which it takes the concept to be *from the first* arranged and connected by a certain relation.” Cassirer, “Substance and Function”, p.24

overall formal structure for categorization in the notion of a mathematically functional rule or series.

Cassirer did not question the *legitimacy* of the classical schema, but he did question its *necessity* and *sufficiency*. (Which is pretty much where Lakoff and myself stand as well.) He argued that the latter is, in fact, a special and *limit case* of the Concept and of the possibilities of logic. Cassirer maintained that many concepts –and *specifically* the very concepts of mathematical and physical science²³ –demonstrate another mode of concept formation and specification than the classical scheme, (this is the subject of my [old] Chapter 2). Both concept formation upward, (genera), and downward, (speciation), can obey *another* rule-based law, i.e. the properties of their extensions can embody a series other than the *specific series* of identity.

²³ Cf Cassirer, “Substance and Function”, “Einstein’s Theory of Relativity”. Incidentally, the original title for “Substance and Function” was

As a crude example, one member of the extension of a concept, (using an example drawn from numeric sets), might contain the numeral “2”, another the numeral “4”, another “8”, “16”... rather than the numeral “2” being in all of them. Thus the concept would express, (and be formed on the principle of), the series 2,4,8,16,... across its extension rather than being based in the series of identity: 2, 2, 2,..., (the classical schema). The extension of a category, therefore, may be defined based upon the possession of some property belonging to a series or function *on* properties rather than on the possession of some identical property(ies). Concepts can be specified by a function *other than* identity.²⁴

“Substanzbegriff und Funktionsbegriff”, i.e. Substance Concepts and Function Concepts!

²⁴ Cassirer's "series" could be ordered by *radically variant* principles, however: "according to equality", (which is the special case of the "generic concept"), "or inequality, number and magnitude, spatial and temporal relations, or causal dependence"²⁴ -so long as the principle is definite and consistent. But please remember that these are *principles of category construction* rather than *properties* of categories. see my Chapter 3

Cassirer has supplied a clear counterexample and an alternative to the classical schema, (which I explained at length and further extended as the subject of [the old]Chapter 3).

Simplistically, (and as crude illustration), we may have three pieces of “metal” in front of us for instance, wherein *none* of their properties are the same!

The first is a one pound piece of gold, (color: yellow, specific gravity: a.aaaa...., conductivity: b.bbbb...., etc.), the second a two pound piece of lead, (color: gray, specific gravity: l.lll..., conductivity: m.mmm...., etc), and the third a three pound piece of tin: (... , ..., ..., etc.) None of these properties need be *identical* however. They are related as “metal”, (and are specified as “metal objects”), because the color of each, (for instance), *is a value of the function*: $COL(x) \in \{\text{yellow, gray, silver, ...}\}$, the specific gravity of each is a value of the function $SG(x) \in \{\text{lll..., ggg..., ...}\}$, and so on.

These objects, (the objects called “metal objects”), can “cross party lines”, so to speak –i.e. they are not the product of strict set-theoretic intersection of atomic properties. In the illustration their intersection across these properties is null! The extension of scientific and mathematical concepts, (*specifically*,

Cassirer argues), need have *no* atomic properties in common²⁵ .

Repeating a short citation from my Chapter 3:

"Lambert pointed out that it was the exclusive merit of mathematical 'general concepts' not to cancel the determinations of the special cases, but in all strictness fully to retain them. When a mathematician makes his formula more general, this means not only that he is *to retain* all the more special cases, but also be able *to deduce* them from the universal formula."²⁶

But this possibility of deduction does not exist in the case of the scholastic, (Aristotelian), concepts, "since these, according to the traditional formula, are formed by *neglecting* the particular, and hence the reproduction of the particular moments of the concept seems excluded."²⁷

²⁵ Compare Wittgenstein's "family resemblances".

²⁶ Cassirer, "Substance and Function", P.20-23

²⁷ *ibid* P.20-23, my emphasis

"The ideal of a *scientific* concept here appears in opposition to the schematic general presentation which is expressed by a mere *word*. The genuine concept does not disregard the peculiarities and particularities which it holds under it, but seeks to show the *necessity* of the occurrence and connection of just these particularities. What it gives is a universal *rule* for the connection of the particulars themselves.... Fixed properties are replaced by universal rules that permit us to survey a total series of possible determinations at a single glance."²⁸

Consider "the ellipse as a simple mathematical example of a genus" for instance. Its species are functionally related –and fully recoverable- in the defining equation of ellipses in general.

Conversely in the specification of species and subspecies, ("downward"), the process does not necessarily lie in the addition of (identical) atomic properties either, (the members of the

²⁸ *ibid* P.20-23

extension of a subspecies, which is *also* a category, need not contain (any) identical atomic properties by the same reasoning), but can be accomplished instead in the identification of the value of a sub-function whose possibility is implicit within the genus.²⁹

Ultimately, (and recursively), the question proposes itself: *need there be* a lowest, “bottom” level concept *at all?*³⁰ Speciation is no longer necessarily intersection or containment,³¹ (it is no longer necessarily nested), so there is always the possibility of another, further rule of assembly for a subspecies

²⁹ Since we can build a genus without commonality, so can we build a super-genus. Turning our perspective around, then, we may speciate downward from that super-genus without the utilization of commonality!

³⁰ The other pole is clearly impossible. There is clearly no Concept, (category), of all concepts under Cassirer’s vision as it would necessarily be defined on “the rule of all rules”. But some, (most), rules are obviously inconsistent with other rules –disallowing the concept.

³¹ Since there is no longer a necessary presumption of nesting, the implication that there must be a “least member” is no longer justified.

of *any* species –at *any* level!³² There is thus no longer a *necessary* logical focus on an ultimate “thing”.

Cassirer argues that the ultimate “objects”, (the “theoretical objects”), of mathematics and physical science are “implicitly defined” by, (and express), the fundamental laws of the science itself. He argues that they are instances of complex speciation based in the general functional rules, (the laws), of the sciences themselves and not objects “in reality”.

Some of Lakoff’s categories, it is true, are also rule based, (other than the classical rule), but in the case of his “radial categories”, they may be formed by historical accident. Lakoff concluded that categories may be formed by classical rules, other rules or “*no rule at all*”! But this characterization divorces him from the possibility of any universally comprehensive categorical structure.³³

³² Remember that under Cassirer's Concept, we do not eliminate properties to speciate, but rather functions.

³³ Cf: the discussion of the crucial role of comprehensiveness vis a vis mathematical ideals near the end of this Afterword.

Cassirer includes this special latter case as an *ad hoc* rule, (series), however, rather than as an example of “no rule”. It would correspond to the special case in mathematical set theory wherein a set is defined by the explicit listing of its members.

Cassirer’s conception may be likened to a line segment bounded on one end by the classical criterion of identity of properties across members, (a “unity”), with the central section composed of any and all functional rules, (i.e. rules of series/regular functions on those properties), and bounded at the other end by the rule of explicit listing, i.e. no *other* rule, (a “zero”). This view reconciles the two conceptions, I think, and might be acceptable to Lakoff.³⁴ What it does besides, however,

³⁴ Compare Lakoff, p.146 : “in the classical theory, you have two choices for characterizing set membership: you can predict the members (by precise necessary and sufficient conditions, or by rule), or you can arbitrarily list them, if there is a finite list. The only choices are predictability (using rules or necessary and sufficient conditions) and arbitrariness (giving a list). But in a theory of natural categorization, the concept of *motivation*”, (his emphasis), “is available. Cases that are fully motivated are predictable and those that are totally unmotivated are arbitrary. But most cases fall in between—they are partly motivated.” [Note 2010: But Cassirer’s “Symbolic Forms” are *definitely* motivated—as *intentional perspectives!*]

is reveal a comprehensive structure across the *whole* of categories/concepts.

I have suggested a further extension beyond Cassirer's "Functional Concept" and sets of n-tuples however in my arguments of Chapter 3. Just why is the color of "gold-metal" *yellow* instead of gray? Why is "gold" a *particular* n-tuple rather than some *other* mix of possible place-values? Physical scientists will never agree with Lakoff, for instance, that it could be just an (accidental) property of a "radial category", nor, possibly even with Cassirer, that it is simply an element in a multi-place series.

Cassirer suggested another, (and more classical), "middle ground" wherein the principle of "necessary and sufficient" is not grounded in an identity of properties, but in a functional relationship between them. The relationship between their proposals is more complex than is possible to describe here, but as a thumbnail sketch of my opinion, the deficiencies in the classical category that Cassirer resolves in his "Functional Concept of Mathematics", Lakoff attributes to his Cognitive Models whereas the deficiencies in classical metaphysics are resolved by both of them very similarly in the epistemological relativity of "Symbolic Forms" by Cassirer and of "ICM's" by Lakoff. Cassirer's is the more general of the two solutions to the latter problem, however, as it is not framed within a specific image of the world, but within the constraints only of abstract epistemology as Kant definitively iterated them.

They will insist that it must be a *necessary* property determined by physical law. Cassirer apparently glimpsed this connection in his conception of the “ideal objects” of the sciences, but he never fully exploited it. (I have pursued it in my “Concept of Implicit Definition”.³⁵)

Both Lakoff and Cassirer followed the paths of their logical conclusions to see the essential flaw in “naïve realism”, (as Cassirer termed it), and “objectivism”, in Lakoff’s words, (I have used the term “naturalism”). If the classical logical schema of strict hierarchical containment were legitimate, and, more importantly, if it were necessary and sufficient, then the *only* possibility of science, as the resolution of experience and reality with logic, would lie in the absolute objective existence, (however reduced), of our ordinary objects.

If valid logic and conceptualization is broader than that, however, then the possibility of reality is considerably enriched. Valid conceptual, (or utilitarian cognitive), “objects” need not

³⁵ Cf my Chapter 3

then express “membranes” around spatio-temporally contiguous properties of *ontological*, (i.e. metaphysical), objects or groups of such objects!³⁶ They can “cross party lines”!

Cassirer had no problems with such an implication. It was implicit, of course, in his neo-Kantian origins. Lakoff did. In his laudable commitment to realism, he was forced to consider the minimal necessary requirements of such a (scientific) realism.³⁷

Putnam’s Requirements

He lists Putnam’s requirements of “internal realism”³⁸ as:

³⁶ This discussion constitutes my answer to one of the more difficult objections to my first thesis wherein it is objected that “schematism” is “just a level of abstraction”, (Richard Reiner, private communication). The discussion above shows why it need not be!

³⁷ The criteria of Putnam’s, Lakoff’s and Edelman’s basic realism are, I have argued in my chapters 3 and 4, essentially the same ones definitively identified by Kant. Kant is grossly mischaracterized as an “idealist”. He was, in fact, the penultimate modern realist in just the sense demanded by these thinkers. See chapters 3 and 4.

³⁸ Which he uses as the jumping off point for his own “experiential realism”. Edelman, incidentally, has adopted Putnam’s definition pretty much “as is”.

- (1) “A commitment to the existence of a real world external to human beings
- (2) a link between conceptual schemes and the world via real human experience; experience is not purely internal, but is constrained at every instant by the real world of which we are an inextricable part
- (3) a concept of truth that is based not only on internal coherence and “rational acceptability”, but, most important, on coherence with our constant real experience
- (4) a commitment to the possibility of real human knowledge of the world.”³⁹

He has extended and refined Putnam’s position somewhat from this basis, (his “basic realism”), to be able to answer certain further questions that arise, but this is a reasonably concise rendition of his stance vis a vis realism.

³⁹ P.263

I have discussed his position, (as reiterated by Edelman), briefly in the preface to my Chapter 2, [Chapter 6 here], wherein I agreed with (1) – (3), but strongly qualified (4). I had argued the equivalent of his essential conclusions as the subjects of my [old] chapters 3 and 4, [Chapters 4 and 6 in this MS respectively]: i.e. the bare and unstructured “axiom of externality”, and the bare and unstructured “axiom of experience” respectively. These are purely intentional postulates, foundational to Scientific Realism.

Because of his conclusions, Lakoff was further forced into a position of epistemological, (as well as logical), relativism –against what has been called a “God-eye view of reality”.⁴⁰

Lakoff’s relativism, necessary because of his logical conclusions but challenged in his own mind, (admirably, I maintain, as I consider myself a strong realist as well), by his fervent commitment to science and realism, is ill-defined

⁴⁰ cf my Chapter 5 for a discussion of Cassirer’s arguments on the same subject and of my extension of them.

however. Though he talks about relativism at length, he never clearly defines it. He begins by noting the anathema which “relativism” is considered by the scientific world, but argues that there are, in fact, many different forms of relativism. (Neither he, nor I, advocate a “relativism of everything”.) The most cogent interpretation I can give to his position, (Whorf aside), is that he advocates a cognitive and logical relativism based on bodily function, (in the world), which leads to a relativism of contexts, (ICM’s), which employ different categorical, (conceptual), schemas. Within each of these ICM’s, there *does* exist a structure consistent with rigor, however,⁴¹ but ultimately the ICM’s themselves are relativistic.

I like what Lakoff has done, (hugely!), but his ICMs, the relativism in which he has based them, and his epistemology are deficient insofar as they are all derived from, (grounded in the

⁴¹ “The main thesis of this book is that we organize our knowledge by means of structures called idealized cognitive models, or ICM’s, and that category structures and prototype effects are by-products of that organization..”
Lakoff, 1987, p.68, his emphasis.

concept of), the human body and the functions of that body in the world. This is his overview, and this is the context within which they are framed. That very body in the world is conceived *in the primary set theoretic sense*, (he would call it the “container schema” ICM), however!

But if they all may be *described* within the container schema, (the body in the world), then ultimately all of his ICMs and his epistemology are *theoretically reducible* to a container schema! [2010 Similarly to my critique of Maturana’s ultimate thesis, I maintain that] this is a contradiction of his own position against a “God’s eye” picture of the world.⁴² It is the *generality* of Cassirer’s solutions⁴³ and of my extensions of them, (founded ultimately in a neo-Kantian perspective), which allows the solution of the general logical and ultimately of the epistemological problems.

⁴² I.e. all his arguments against it are reducible within it. I will have more to say on this subject shortly and will suggest a way out of his dilemma.

⁴³ and their origins in science and mathematics

Though Lakoff rejects the view that “anything goes” –that any conceptual system is as good as any other, nowhere does he approach the possibility of a *scientific, mathematical* relativism which would give rigor to his conceptions –save within a tacit objectivist context. It is the possibility of a general and comprehensive structure of the Concept which allows the true relativity of the essential forms/ICMs.

I will argue shortly, (in the sense of mathematically conceived “ideals” –[2010 see Chapter 9]), that the various “generators” of such an ideal must each be capable of generating the *whole* of the “space” of that ideal –to include all possible alternative generators as well. Thus each (legitimate) structure must be *comprehensive* to be translatable, (i.e. capable of itself being generated by *another* set of generators). But its concepts/categories/objects may be *distributed* in the translation.⁴⁴

⁴⁴ cf my Chapter 5

This is intelligible only outside of the classical conception of logic, and is the essence of my conclusion of Chapter 5.

Lakoff's "Concept" is certainly broader than the classical concept, but he takes his arguments too far –against *any* rule of concept formation.

Please do not misunderstand me. I loved Lakoff's book. It is brilliant, far reaching, and, I believe, essentially valid. He develops and documents his arguments solidly, but I think his strongest point is in his clear and cogent examples from our own normal usage⁴⁵, (as well as from extensive empirical studies), which makes his essential case almost unanswerable.

His conception is considerably richer than it is possible to describe within the confines of an appendix, nor is it as simplistic as I have characterized it. We have huge areas of agreement and possible interaction, (his and Rosch's "basic level categories" have a natural correlate in my "schematic perceptual objects", for instance.)

⁴⁵ Cassirer's case was grounded primarily in scientific examples.

Lakoff's ICM's

Lakoff's ICMs are biologically based –on the human organism. Human cognition and human reason consists, for Lakoff, in the application of the best fit of these inbuilt ICM's, (and their respective categories), to a given problem or situation. They constitute an “embodied logic” deriving from the nature of the human organism itself. There is an obvious parallel between Lakoff's “embodied logic” and the more general case I have argued. I have argued that logic is indeed embodied, *but at the primitive level of cellular process!* This more general characterization allows the crucial epistemological move,⁴⁶ (which Lakoff's does not), beyond the “God's eye view” he disclaims.

The distinction is important because at the cellular level of phenomenology biology becomes a *pure form*, (in Cassirer's sense within his “Symbolic Forms” and compatible with

⁴⁶ Through what Maturana and Varela call “structural coupling”

Cassirer's Hertzian premise). This is especially transparent in Maturana and Varela's book, for instance, (see Chapter 6), i.e. in its explicit constructiveness and the subsequent purity of their phenomenology.

Citing a few pertinent examples quoted earlier in Chapter 6:

Maturana:

"Our intention, therefore, is to proceed scientifically: if we cannot provide a list that characterizes a living being, why not propose a system⁴⁷ that generates all the phenomena proper to a living being? The evidence that an *autopoietic unity* has exactly all these features becomes evident in the light of what we know about the interdependence between metabolism and cellular structure."

⁴⁷ i.e.: an "axiomatic system"!

"Autopoietic unities specify biological phenomenology as the phenomenology proper of those unities", (my emphasis), "with features distinct from physical phenomenology... because the phenomena they generate in functioning as autopoietic unities depend on their organization and the way this organization comes about, and not on the physical nature of their components."

"Ontogeny is the history of structural changes in a particular living being. In this history each living being begins with an initial structure. This structure conditions the course of its interactions and restricts the structural changes that the interactions may trigger in it", (my emphasis). "At the same time, it is born in a particular place, in a medium that constitutes the ambience in which it emerges and in which it interacts.

This ambience appears to have a structural dynamics of its own, operationally distinct from the living being. This is a crucial point. As observers, we have distinguished the living system as a unity from its background and have characterized it as a definite organization. We have thus distinguished two structures that are going to be

considered operationally independent of each other, (my emphasis), "living being and environment."

These are purely *constructive* and *operational* definitions, (or capable of being made so within "structural coupling"), in the precise sense of Hertz and Cassirer and clearly mesh with the substance of my Chapter 5. They are Hertzian "images" with a definite, predictive logical structure. They are clear examples of Cassirer's "each asks questions, each from its particular standpoint"!

At the level of cellular biology therefore, biology becomes a *pure form*, and, as such, it, (and the logic I posit within it), is capable of legitimate embodiment⁴⁸ within the now viable scientific epistemological relativism espoused by Cassirer and myself. It is this deeper placement, (and not as reductive physics), which allows an escape from the inconsistent "God's

⁴⁸ i.e. as a legitimate, fundamental "symbolic form"

eye view" implicit in Lakoff's and Edelman's theses, and enables a truly consistent and viable epistemological relativism.

It is because of Lakoff's Wittgensteinian origins, I think, that he has gone too far, (-and not far enough). Had he started from Cassirer instead, the case might have been different. I will return to Lakoff presently to suggest a "cleaner" solution to his problem consistent with his apparent needs –in the mathematical notion of "ideals". [again see Chapter 9] There is a way to save it, but I think it is too limited and inconsistent with the dictates of modern biology as espoused, for instance, by Edelman.

Edelman:

Gerald Edelman has adopted Lakoff's, (and Putnam's), logical and epistemological conclusions as the philosophical underpinning to his own theories of "Neuronal Group Selection", (TNGS), and "re-entrant topobiological maps". He proposed the combined result as an actual answer to the problem of mind-brain. Though Edelman's is a very plausible theory of brain development and function, it is limited to dealing with "mind" only *reductively* -i.e. as strictly biological and therefore physical

process and falls to the same objections that I, (and the preponderant Naturalist camp as well), have raised.

“Mind”, normally taken, is therefore *superfluous* therein! Edelman explicitly denies the “homunculus”, (as do I), but his “Cartesian theatre” is specifically a physical and spatial one. It is spatially and temporally distributed. Though he does not explicitly deny the existence of “mind” as ordinarily taken, he tacitly reinterprets it and reduces it to a description of process. He fits very comfortably, I feel therefore, within the naturalism, (and “objectivism”), which Dennett, Churchland, et al espouse.

I do not question the insightfulness or the importance of Edelman’s work –it is profoundly important and very solid –but, because of its limitations, (derived from Lakoff), it falls short of an answer to the problem of consciousness, retains internal inconsistencies, and does not resolve the mind-body dilemma.

Starting with the nature and limitations of embryology, Edelman makes a case for a very different concept of “recognition systems”. His exemplar “recognition system” is the immune system for whose investigation he won the Nobel Prize. The immune system, he argues, does not depend on information

about the world –i.e. we do not create new antibodies from informational templates resident in newly arrived antigens.

Rather, science finds that the body randomly generates a huge diversity of antibodies *before the fact* and reactively selects from this pre-existing diversity “ex post facto” as he phrases it. This, the immune system, is a system of process, not of information.

“A recognition system ... exists in one physical domain”, (for the immune system it is within an individual’s body), “ and responds to novelty arising independently in another domain, (for the immune system it is a foreign molecule among the millions upon millions of possible chemically different molecules) by a specific binding event and an adaptive cellular response. It does this *without* requiring that information about the shape that needs to be recognized be transferred to the recognizing system *at the time when it makes the recognizer molecules or antibodies*. Instead, the recognizing system *first* generates a diverse population of antibody molecules and then selects *ex post facto* those that fit or match. It does

this continually and, for the most part, adaptively.”

Edelman, P.78

Cognition, our *ultimate* “recognition system”, he argues, is a parallel case and must be reconceived accordingly. Because of the sheer size, and the place and time sensitivity of embryological neural development, the neural system, (he argues), is progressively “pruned” *ex post facto* from random preexisting variety over the stages of its development in like manner to the immune system.

“given the stochastic (or statistically varying) nature of the developmental driving forces provided by cellular processes such as cell division, movement, and death, in some regions of the developing nervous system up to 70 percent of the neurons die before the structure of that region is completed! In general, therefore, uniquely specified connections cannot exist.”

“the principles governing these changes are epigenetic – meaning that key events occur only if certain previous events have taken place. An important consequence is that the connections among the cells are therefore not

precisely prespecified in the genes of the animal.”

Edelman, pps. 23- 25

Of the great diversity of (preexisting) neural connections generated at any stage, particular connections are reinforced and kept, or pruned and deleted, in tune with place and time dependent events the scenario of which is too complex “by several orders of magnitude” to be embodied in the human genome. This pruning is achieved operationally, not informationally. Embryological development is too complex, too dependent on place and time to be prespecified. His argument in some ways parallels my own of [old] appendix A wherein I argued that there simply hasn’t been enough time in evolutionary history, (nor ever will be), to create such an information engine.

In his “ex post facto” adaptive “TNGS”, Edelman argues a criterion of *competence* , (as, indeed, did Darwin –and as did I in my first chapter), rather than one of information in the

evolution and development of organisms –and specifically of the *human* organism.

“The immune selective system has some intriguing properties. First, *there is more than one way to recognize successfully any particular shape.* (my emphasis) ⁴⁹

Second, no two individuals do it exactly the same way; that is, no two individuals have identical antibodies.

Third, the system has a kind of cellular memory.”

Edelman, P.78 (These comments are directly relevant to my discussion of bounds and limits and the “parallel postulate” of cognitive science.)

⁴⁹ You might want to look at my “Bounds and Limits” diagram here –Chapter 4, Figure 18

God's and Edelman's Eye

He too disclaims the possibility of a “God’s eye view” of reality by an organism.⁵⁰ But competence, as I have argued, does not imply *parallelism*. It is the question of bounds and limits that I have argued previously,⁵¹ and Edelman falls into the same epistemological trap as does Lakoff, (and Maturana and Varela as well). Other than this failing, however, I believe his overall position and arguments are very strong.

On “Presentation”

Edelman challenges ordinary logic and ordinary epistemology, (the classical, “objectivist”/“naturalist” views), for

⁵⁰ cf. my “Axiom of Externality” and “Axiom of Experience”, (Chapters 3 and 4).

⁵¹ Let me repeat a footnote of my Chapter 1: The question, of course, is whether "information" is necessary to competence. I will argue, (in Chapter 4), that it involves a distinction between "bounds" and "greatest lower bounds" of biologic survival. A given organism, (to include human beings), must reflect a *lower* bound of competence in the world. But "information" requires that it reflect a *greatest* lower bound, and this is inconsistent with the fundamental premises of evolution. It is the "parallel postulate" of cognitive science.

some of the same reasons that I do. In his TNGS, he has framed the same problem, and reached largely the same conclusion that I did under the issue of “presentation”.

“some of the reasons for considering brain science a science of recognition”, [under his special definition of "recognition systems" cited above]. " The first reason is almost too obvious: brain science and the study of behavior are concerned with the adaptive matching of animals to their environments. In considering brain science as a science of recognition I am implying that recognition is not an instructive process. No direct information transfer occurs, just as none occurs in evolutionary or immune processes. Instead recognition is selective.”

“a potent additional reason for adopting a selective rather than an instructive viewpoint has to do with the homunculus. ...the little man that one must postulate ‘at the top of the mind’, acting as an interpreter of signals and symbols in any instructive theory of mind.... But then another homunculus required in *his* head and so on, in an infinite regress... selectional systems, in which matching

occurs ex post facto on an *already existing* diverse repertoire, need no special creations, no homunculi, and no such regress.” Edelman pps. 81-82

Presentation in any sense other than an eliminative one *requires* a homunculus, and this is the problem that Edelman believes he has solved- in essentially the same way that I did. But, in doing so, he believed he had solved the whole of the mind-body problem.

Re-entrant Maps

To this point, (his theory of “TNGS”), his argument is very plausible and compatible with my own conclusions. His rationale from that point onward, however, bears examination.

His theory of re-entrant topobiological maps, (reactively linked cortical surfaces), is quite plausible and highly interesting, but, ultimately, it is tied to a truly topological correspondence of those maps with the “real” world, (contrary to his conclusions of the first part of his thesis –see Chapter 4, Figure 13 “Edelman’s

Epistemological Error”). “Maps... correlate happenings at one spatial location in *the world* without a higher-order supervisor...”⁵²

These maps themselves *do*, therefore, embody a “God’s eye view”, (contrary to the implications of TNGS). I have suggested a different orientation of Edelman’s schema in the discussion of my Chapter 4, wherein I suggested we step back from our human (animal) cognitive prejudice and consider the larger “global mapping” also described by Edelman, (which relates “*non-mapped*” areas of the brain to the topobiological maps), as the primary focus of biological process. (See illustration in Chapter 4: Figure 13 “A Metacellular Perspective). Under this perspective, the “objects” of our topobiological maps may be reconceived, not as God’s-eye renditions of ontology, but rather as *organizational foci*, (efficacious artifacts), of process.⁵³

⁵² Edelman, p.87, my emphasis

⁵³ An aside: While I hope it should be clear by now that I have no affinity for traditional idealism, I think it is worth quoting a short passage from Edelman as it talks about levels of “strangeness” in theories:

Edelman rationalizes his biological solution to the problem of the brain and the mind upon Lakoff's, (and

“and Berkeley's monistic idealism –suggesting that inasmuch as all knowledge is gained through the senses, the whole world *is* a mental matter –falters before the facts of evolution. It would be very strange indeed if we mentally created an environment that then subjected us (mentally) to natural selection.”
Edelman, p. 35

Berkeley aside, Edelman seems very put out with the very strangeness of the (recursive, re-entrant?) complication of such an idea. The complication, he implies, boggles the mind! But much of modern science is even more mind-boggling. My thesis proposes an even greater “boggle”, but results in an integration of epistemology and an actual solution to the mind-body problem.

Modern epistemology is radical at both the extremely small and at the extremely large (and fast) scales. It is *only as algorithms* they are comprehensible. And yet everyone, (read this as “most realists”), seems to accept that at the *middle scale* epistemology must be simple. Consider instead the *truly* mind boggling possibility I propose that the middle scale is algorithmic *as well!* Does this not explain “the prototype” which Rosch demonstrated and which ground Lakoff's and Edelman's very logical theses. Prototypes and the logical relations between them would, under this view, represent the “objects” and the “calculus” of algorithmic biology. If this thesis be accepted, then continuity, temporarily removed from epistemology by modern science, is restored across the board. This is a major epistemological and scientific result and worth the price we must pay for it. So was quantum mechanics!

Putnam's), answer. To him that answer is important because it allows a rationale for the brain which is *not* based in information as, in fact, he has concluded that it *is* not, (inconsistently with his theory of re-entrant maps, I maintain). He therefore reaches a conclusion very similar to my own. But again, like Lakoff's, his conception is too limited and incorporates an inherent contradiction. His concept of the world, like Lakoff's is based in a container schema. We, you and I and Lakoff and Edelman, *are organisms too after all*. But then "TNGS" requires that even *our* brains are not informational!⁵⁴ It is the *generality* of Cassirer's "Symbolic Forms" –and of my extension of it –the generality of the Concept and the generality of the *scientific* relativism which allows a consistent and meaningful solution⁵⁵ to the problems of the brain, mind and epistemology.

⁵⁴ I think that Edelman would comment here, as he did on another occasion, that this conclusion would "boggle the mind"! Maybe so, but I think we'd better get used to such a state. Modern physics? Edelman's own conclusions?
...

⁵⁵ by allowing a reorientation of the problem to a consideration of forms rather than of information

What Edelman has not solved: the problem of the Cartesian Theatre

What Edelman has not solved is the *other* problem, the problem of the “Cartesian theatre”⁵⁶, (i.e. “mind”, ordinarily taken), and this is the most important problem. It is that which we normally *mean* when we use the terms “consciousness”, “sentiency”, etc.

Its comprehensive solution is the subject of Chapters 1 through 5: the Concept of Implicit Definition and its integration with biology as the unified rule of ontogenic coupling. Edelman’s solution remains an essentially naturalist, (objectivist), one itself however and is, I argue moreover, epistemologically inconsistent. It is compatible with the rest of the eliminativist camp in that ultimately all his correspondences, (his stated epistemology to the contrary), are from topobiological maps, *themselves topologically corresponding to “the (real) world”!*

⁵⁶ after Dennett

His “mind” is purely process, spatially and temporally localized –and known! His *is* “a God’s eye view”.

Edelman is very derisive of Penrose’s “Emperor’s New Mind”,⁵⁷ but I think he has missed a major aspect of it. Penrose, (though he doesn’t say so explicitly), and the rest of the “quantum people” are trying, (Gödel aside), I think, to supply a “non-localization” –i.e. a spatial universality to the brain’s perceptual and cognitive objects- to make headway on the problem of knowing. They are trying to conceive an answer to Leibniz’ problem of the “one and the many” within a *physical* space.

The “chaos theory people” stand in a similar motivation I think, but attacking the logical problem of the object from a perspective of localized process, conceiving our objects as “attractors”. But even were such solutions meaningful, (and they *are* interesting), they would miss the requirement of a *self-*

⁵⁷ “Penrose’s account is a bit like that of a schoolboy who, not knowing the formula of sulfuric acid asked for on an exam, gives instead a beautiful account of his dog Spot.” Edelman, P.217

standing logical space in depth which the Concept of Implicit Definition, as combined with the schematic model of biology, supplies and which furnishes the foundation of “meaning” and “knowing”. Dennett glimpsed such a possibility⁵⁸ for a Cartesian theatre based in logic in Shakey the Robot’s program, (as I cited previously⁵⁹), but his naturalist/objectivist metaphysical prejudice enervated the concept before it could bear fruit.

But ordinary logic,⁶⁰ (Shakey’s program for instance), is inadequate to the problem. It is essentially dimensional: linear, planar, multi-dimensional, missing the integration in depth – missing the autonomy and (logical) self-sufficiency which is necessary to knowing and to meaning. ^{61 62}

⁵⁸ but using an inadequate logic

⁵⁹ of the "Dennett Appendix" - "the color phi"

⁶⁰ “associationist logic” in Dreyfus’ term

⁶¹ Wittgenstein’s objection is clearly pertinent here. He raised the question of the necessity for one to have *another* rule: i.e. another rule to apply any given rule. C.I.D./biology, however, supplies a consistent rationale. “One” *is* a rule, “one” doesn’t *apply* the rule. “One” is the single, “ex post facto” and unified rule of ontogenic coupling!

That aspect of ordinary mind we call the “Cartesian Theatre” does not work as a linear, a planar, or even as a multidimensional space¹ -even as a *logical space*. As I argued in chapters 2 and 5 each requires “presentation”, either physical or logical. Nor do such conceptions supply “knowing”, “meaning” or “motivation”, except as unnatural and gratuitous appendages.

C.I.D. and the schematic model focus logic and cognition in biology. Biology has *innate* depth and structure –derived from the single principle of efficacy as coupled with Darwinian survival –of ontogenic coupling, and these necessarily pass to the logic and the cognition which are embedded in it! The Concept of Implicit Definition as coupled with the schematic model⁶³ supplies an integration and a rationale in depth –*and an*

⁶² and which could provide the enrichment necessary to the possibility of future scientific development moreover. All the other proposals yet presented are essentially *just* explanatory –i.e. logically reductive- and hold little promise for further exploitation.

⁶³ i.e. the “*concordance*” mentioned in the Introduction

autonomy- implicit in its biological roots.⁶⁴ Edelman got very close to this answer, but his efforts were frustrated by his epistemological beginnings.

Cassirer, (“symbolic forms”), Rosch, (“prototypes” and “basic levels”), and Lakoff, (ICM’s), demonstrate that dimensional logic is not adequate to the realities of the human mind. Nor, even putting aside the problem of “information”, (Maturana and Varela, Freeman, Edelman), can such a logic supply meaning or motivation except in a very unnatural and perverted sense. It is biology itself which supplies this aspect –in the concept of a schematic model and an enlarged logic. This is my argument of as culminated in Chapter 11.

⁶⁴ It supplies “the rule which we need to apply the rule which we need to apply the rule ...” demanded by Wittgenstein. Ultimately it is a *constitutive* rule. But one doesn’t “apply” this rule. Rather, “one” *is* a rule –namely the constitutive rule of ontogenic coupling as the term is used by Maturana and Varela.

On Epistemology:

But let me be more generous to Lakoff and Edelman. In basing their conceptions on our ordinary world, or, to call a spade a spade, on our ordinary naïve realistic conception of the world, (people, baseballs, cars and all the things they do), they are *trying to preserve experience!* This they identify with realism. They seek to preserve their logical and biological conclusions with the *objects* of that ordinary realism,⁶⁵ and their relativism is a laudable and understandable attempt at a reconciliation.

I have explained my answer to the same problem in terms of the multiple possible axiomatic foundations of mathematical

⁶⁵ cf Lakoff's discussion, (p.262) of the "objects" of our experience –his chair, for instance. "It is important not to read Putnam out of context here, especially when he talks about objects. *An 'object' is a single bounded entity...* Putnam, being a realist, does not deny that objects exist. Take, for example, the chair I am sitting on. It exists. If it didn't, I would have fallen on the floor." (my emphasis). Compare this reference with my modification of Kant's position on "objects" which I advocated in the footnote in Chapter 5.

systems, but another line of understanding is possible. Consider the notion of “mathematical “ideals” as presented in Chapter 9.

Those mathematical “ideals” described there open a door to a better conclusion to Lakoff’s and Edelman’s arguments, and a simpler understanding of my own. *None* of these generators stands prior to any other, nor does it “create” the figure comprehended. Each stands, rather, as an equipotent and relativistic “logical”, (i.e. explanatory), basis fully exhausting the actuality of the figure.

But we must consider this example in the larger context of mathematics. Not only can such descriptions be relativized in relation to a fixed coordinate system, but the very coordinate systems themselves stand in like case. Axes need not be orthogonal, nor need they be rectilinear, (e.g. polar coordinates are possible). Nor need they be fixed. They may be in translation –e.g. relative motion, (which translates to special relativity), and they need not be Euclidean, (nor Hyperbolic nor

Spherical). Russell, for instance, further argued⁶⁶ that our descriptions of phenomena might even be based in projective geometry.

But need they be *even spatial*? Can we not conceive of such explanations being framed as abstract transformations, which latter are *not* defined on spaces, but on abstract sets! Abstract sets, however, fall naturally within the scope of axiomatics wherein I grounded C.I.D.

Such a relativism of descriptions, combined with a scientific relativism of logic and epistemology themselves as argued by Cassirer, Lakoff, and myself, (superseding the traditional “container schema” and broadening the very ideas of “set” and “object” themselves), points to the further possibility for such an “idealistic”, (in the mathematical sense), foundation of logic *itself*.

⁶⁶ Russell, “Foundations of Geometry”, 1956

Need mathematics, or logic, be *necessarily* grounded in objectivist sets, (ultimate “atomic” –i.e. *least* objects –and a *fixed* “Universe” of such objects), or could it not pick itself up by its own bootstraps, (following the cue of mathematical “ideals”⁶⁷ and the findings of Cassirer and Lakoff), and stand without them?⁶⁸ This is a question –not an easy one to be sure- for abstract mathematics and the future of logic.

If we think of “experience” in the abstract –i.e. as the “axiom” without interpretation, (i.e. “impartially” in the sense of “basic realism”), – then I think an “ideal” in this sense is a very reasonable way of understanding it – beyond any particular “generator”, beyond any particular interpretation.⁶⁹ But it is not necessarily a *spatial* interpretation either. Ideals are broader than this.

⁶⁷ though presently itself conceived in set-theoretic terms

⁶⁸ This would be the truly transcendental logic after which Kant sought.

⁶⁹ “context-free” in Van Fraassen’s term

On a narrower focus, the possible generators of a mathematical ideal rigorously parallel the explanatory possibilities which can absolutely preserve the objects of ordinary experience and naïve realism, (conserving shapes, boundaries, etc.). As such, the ideal they ground is entirely commensurate with Lakoff's and Edelman's conceptions and logically validates their (limited) relativism.

Within the perspective of that same "basic realism", the "experience" we deal with need not be taken as ultimately *informational* however,⁷⁰ but can be taken as specifically organizational and operative instead⁷¹ as I have argued in my Chapter 4 and consistently with Edelman's "TNGS".

Though *connected* with externality, (as representative of successful- .i.e. *adequate* process⁷²), it need not be further taken as conveying information about that externality. It need not be

⁷⁰ This my qualification on Putnam's 4th requirement of basic realism

⁷¹ contrary to Putnam's 4th requirement

⁷² "ex post facto", in Edelman's words

taken as *paralleling* externality. The latter presumption, I have argued, goes far beyond the needs and the implications of Darwinian biology.

The deeper issue is that of an adequate definition of “experience” itself. Need we identify it with the absolute and necessary preservation of ordinary objects? Or, might we not, consistent with the foundations of their own conceptions and the work of Rosch upon which it is grounded, consider even our ordinary perceptual objects as “*prototypes*” of a larger *experience*? Prototypes are objects of utility, of efficacy, after all, they are not foundational objects.⁷³ Could not our ordinary objects be considered, (as I have argued), as prototypes, (“schematic perceptual objects”), of a *biological* calculus?

“Experience” in a *modern* sense must be broadened to include the experience of the results of scientific experiment, and *that* experience, at least insofar as modern physics is concerned,

⁷³ see Lakoff for a discussion of Rosch, prototypes, and the logical significance of the latter. It is a very illuminating discussion.

is not commensurate with the preservation of objects, nor is it commensurate with ordinary spatiality.

Without even considering the deeper implications of QM or of Relativity, one need only consider results of the “twin slit” experiment or the implications of its multiple execution to see the point. Not even *cardinality* is preserved!⁷⁴ Similarly, consider Penrose’s “most optimistic” view of quantum mechanics, (most optimistic for objectivism/naturalism, that is):⁷⁵

⁷⁴ In answer to a question I asked on this point, a physicist correspondent of mine replied that “Yes, you can have many slits one after another, (it is better with Mach-Zehnder interferometers than slits, with the same result that one doesn’t know if the photon went through or was reflected by a mirror.... We can say that one photon may be in an arbitrary number of places at once.” (Wlodek Duch, private correspondence) My point was that even the *cardinality* of this basic object, (the photon), was *purely arbitrary* –it could be 1 or 2 or 3 or 1,000,001 or ..., depending on the branching structure of successive slits and the design of the experiment. But innate cardinality is perhaps the *most basic* “property” we ascribe to ordinary objects, so I think the conclusion is significant.

⁷⁵ Repeating a section of a prior appendix

"I shall follow the more positive line which attributes *objective physical reality* to the quantum description: the *quantum state*.

"I have been taking the view that the 'objectively real' state of an individual particle is indeed described by its wavefunction ψ . It seems that many people find this a difficult position to adhere to in a serious way. One reason for this appears to be that it involves our regarding individual particles being spread out spatially, rather than always being concentrated at single points. For a momentum state, this spread is at its most extreme, *since ψ is distributed equally all over the whole of space*, (my emphasis),...It would seem that we must indeed come to terms with this picture of a particle which can be spread out over large regions of space, and which is likely to remain spread out until the next position measurement is carried out...."

The particle -this *smallest part of our "object"*- is not included, (spatially, reductively, nested), *within* the spatiality of the atom or within the molecule -or even within the *human scale* object of which it is the theoretical (and supposed material)

foundation. Naturalism/objectivism can no longer support, therefore, even a consistent hierarchy of spatial scale!⁷⁶

At the human level, of course, it is a very useful tool, and that is just what I propose it is -constructed by evolution! Science and logic suggest *other*, non-scaled and non-hierarchical organizations -i.e. they support *any* other efficacious organization. It is a simple matter of utility.

Conclusion

To conclude this appendix, let me repeat that I truly admire Lakoff's and Edelman's work. It is both profound and crucial to the resolution of the ultimate problem. But then I really like the work of *all* the authors I have cited –even those

⁷⁶ Compare Lakoff, p.195: “In the case of biological categories, science is not on its [objectivist philosophy’s] side. Classical categories and natural kinds are remnants of pre-Darwinian philosophy. They fit the biology of the ancient Greeks very well....but they do not accord with phenomena that are central to evolution. ... Objectivist semantics and cognition and, to a large extent, even objectivist metaphysics are in conflict with post-Darwinian biology. I’d put my money on biology.”

most contrary to my own conclusions. (I would not cite or spend much time on anything of lesser quality –the problem is too huge and too difficult to be distracted.)

Dennett’s work, for example, is very beautiful to me in his honorable and perceptive pursuit of the hard implications of naturalism. P.S. Churchland, as another example, has a “clean” mind and frames the problem wonderfully from the perspectives of biology and philosophy. None of them has resolved the fundamental problem, however, though all have come very close in different aspects of it.

This is a *hard problem*, the hardest one, I maintain, that the human mind has ever dealt with. To solve it requires an intellectual ruthlessness, and specifically, a *ruthless realism!*

Bibliography

- Barrow, John D. . *Pi in the Sky: Counting, Thinking and Being*.
Little, Brown & Company 1992
- Bell, J.L. *Toposes and Local Set Theories, an Introduction*. Dover
Publications, 1988
- Benacerraf, P., and H. Putnam, eds. []: *Philosophy of
Mathematics*. 2nd Ed Cambridge University Press. 1983
- Birkhoff, Garrett and Mac Lane, Saunders *A Survey of Modern
Algebra* Macmillan Company 1955
- Cassidy, David. *Uncertainty: the Life and Science of Werner
Heisenberg*. New York. W.H. Freeman. 1992.
- Cassirer, Ernst. *The Theory of Symbolic Forms* Yale University
Press 1957
- Cassirer, Ernst. “*Substance and Function & Einstein’s Theory of
Relativity* (bound as one). Dover Publications 1953
- Cassirer, Ernst. *Spirit and Life* (An essay included in *The
Philosophy of Ernst Cassirer*). New York. Tudor 1949
- Cassirer, Ernst. *Kant’s Life and Thought* (Hayden translation)
Yale 1981
- Cassirer, Ernst. “*The Problem of Knowledge*” (Woglom and
Hendel translation) Yale 1950
- Churchland, Patricia. *Neurophilosophy* Bradford Books 1986

- Churchland, Paul. *Matter and Consciousness* MIT Press 1990
- Dennett, Daniel. *Consciousness Explained*. Little, Brown, and Company 1991
- Dreyfus, Hubert. *What Computers Still Can't Do* MIT Press. 1992
- Durant, Will. *The Story of Philosophy* Pocket Books 1926
- Edelman, G. M. "*Bright Air, Brilliant Fire.*" BasicBooks 1992
- Einstein, Albert. . *Essays in Science* Philosophical Library 1934
- Fine, Arthur. *The Shaky Game* University of Chicago Press 1986
- Freeman, W.J. *Chaotic oscillations and the Genesis of Meaning in Cerebral Cortex* Springer-Verlag 1994
- Freeman, Walter J. *How Brains Make Up Their Minds* Phoenix Press 1999, (also see his extensive repertoire of publications on his webpage: <http://sulcus.berkeley.edu/> (all free to download))
- Gleick, James. *Chaos Theory* Penguin 1988
- Goldblatt, Robert. *Topoi: The Categorical Analysis of Logic* Dover 1984

- Gould, Stephen Jay. 1994. *The Evolution of Life on the Earth*
Scientific American. October, 1994. Volume 271,
Number 4
- Hilbert, David. . *The Foundations of Geometry* (Translation by
E.J. Townsend) Open Court 1910
- Hofstadter, Douglas. *Gödel, Escher, Bach* Vintage 1979
- Iglowitz, Jerome. *Virtual Reality: Consciousness Really
Explained* <http://www.foothill.net/~jerryi/COMPILED9-2-00.pdf> 1995/1998
- Iglowitz, Jerome. *Mind: The Argument from Evolutionary
Biology, (A Working Model)* 2004
<http://www.foothill.net/~jerryi/BIOLOGY11.pdf>
- Iglowitz, Jerome. *Consciousness: a Simpler Approach to the
Mind-Brain Problem, (Implicit Definition, Virtual Reality
and the Mind)* 2005
<http://www.foothill.net/~jerryi/HILBERT1.pdf>
- Kant, Immanuel. *Prolegomena to Any Future Metaphysics*
(Muhaffy translation) Liberal Arts Press 1950

- Kant, Immanuel. *Critique of Pure Reason* (Norman Kemp Smith translation) St Martin's Press 1961
- Kuhn, Thomas. *The Copernican Revolution* Harvard College 1957
- Lakoff, G. *Women, Fire and Dangerous Things* Chicago-London. University of Chicago Press 1987
- Lara, Blaise. *Semantics and Factor Analysis: an approach to the interpretation of factors semantics and factor analysis: an approach to the interpretation of factors*
<http://www.hec.unil.ch/people/blara/lara/factors0.htm>
- MacLane, Saunders. *Mathematics: Form and Function* Springer-Verlag, New York, 1986
- Maturana, Humberto and Varela, Francisco *The Tree of Knowledge* Shambala Press, 1987
- Minsky, Marvin. *The Society of Mind* Touchstone 1985
- Penrose, Roger. *The Emperor's New Mind* Oxford University Press, 1989
- Quine, Willard Van Orman: *Word and Object* MIT Press, 1960

- Quine, Willard Van Orman "From a Logical Point of View"
Harper Torchbooks, 1953
- Reid, Constance. 1970. *Hilbert* Springer-Verlag.
- Resnick, Michael 1992. *Mind*, Vol. 101/401" January 1992
- Russell, Bertrand. The Autobiography of Bertrand Russell Little,
Brown, & Co. 1967
- Russell, Bertrand. *An Essay on the Foundations of
Geometry* Dover 1956
- Schlick, Moritz. *General Theory of Knowledge*" (Translation by
Albert E. Blumberg). New York: Springer-Verlag,
1974/1917
- Shapiro, Stewart *Categories, Structures, and the Frege-Hilbert
Controversy: The Status of Meta-mathematics*
Philosophia Mathematica (III) () **13**, 61–77.
doi:10.1093/phimat/nki007 2005
- Smart, H. *Cassirer's Theory of Mathematical Concepts in the
Philosophy of Ernst Cassirer* Tudor Publishing 1949

- Stefanik, Richard. *Structuralism, Category Theory and Philosophy of Mathematics* Washington: MSG Press 1994
- Stewart, Ian. *Fibonacci Forgeries* Scientific American, May, Volume 252, Number 5 1995
- Van Fraassen, Bas C.. *Laws and Symmetry* Clarendon Press 1989
- Van Fraassen, Bas C. *Quantum Mechanics, an Empiricist View* Clarendon Press. 1991
- Weyl, Hermann. . *David Hilbert and His Mathematical Work* Bulletin of the American Mathematical Society 50 1944
- Wilder, Raymond. . *Introduction to the Foundations of Mathematics* John Wiley & Sons 1952

ENDNOTES

A Note for Impatient or Skeptical Minds

^I (www.foothill.net/~jerryi/mp3_3RD_ED_FILES) is a link to my book mp3 versions of the chapters if you might be interested in listening to them on your iPod ©.

Preface

^I W.V.O. Quine, 1953, pps.42-43

^{II} W. V.O. Quine 1960, pps.3-4, my emphasis

^{III} Boorstin quoting Kepler in “The Discoverers”, Random House.

Chapter 1

^I see Chapter 2 for citation

^{II} Sometimes an image works better than an explanation. There was a wonderful episode on “The Outer Limits” television show, I think, that made the point graphically. Let me describe and summarize it:

A spaceship has been detected approaching Earth, and one of the earthly technicians has been assigned to stay in touch with one of its occupants over the years before it can actually land. It will take years because of its distance from the Earth. The Earth-based technician begins to fall in love with “her” and they develop a romance through their communication over this time. Finally the magic day arrives and he goes to the spaceport to finally meet and hold his new love. The spaceship door opens and she emerges. But “she” has the form of an Octopus! Think about that graphic image relative to my claim! Suppose we were all “blind”!

Chapter 2

^I [Dennett 1991]

^{II} The question was highly pertinent for me in that my mother had been recently diagnosed as paranoid schizophrenic.

^{III} Birkhoff & MacClane 1955

^{IV} -which, (via the axioms themselves), was solely and precisely the way I had been obliged to actually work with them.

^V Resnik 1992

^{VI} Stefanik, 1994

^{VII} Schlick, 1974 (translation)/1917 (original), my emphasis

^{VIII} I feel I have completed most of the ancillary and exploratory work already, but I definitely need help on the level of foundations and of mechanics. This book explores that level itself. Ultimately I hope to encourage some inspired mathematical genius to develop the actual mathematical “calculus” of the brain. He will stand with Newton in history.

^{IX} I will clarify this transition into “axioms” shortly. Mac Clane’s book dealt exclusively with axiom systems.

^X Hilbert -from Shapiro, 2005, my emphasis

^{XI} *ibid*

^{XII} This is one aspect of what I have termed “the static problem”. (Iglowitz, 1995, Dennett Appendix) I am not totally happy with that answer –I think the current paper addresses it more honestly.

^{XIII} I fell in love with mathematics way back then but was horrified when I glimpsed her concealed ugliness reflected in her “makeup mirror”, (of set theory) and, shocked, sadly abandoned her! I turned instead to pursue the biological and philosophical implications of my original insight –and this has been the driving force and focus of most of the rest of my life.

^{XIV} The question of the desired structure of these sections of the book arises immediately. Frankly I hope you will turn to the source material for a more-than-amateur exposition. I specifically recommend Richard Stefanik’s “Structuralism, Category Theory and Philosophy of Mathematics” for a very deep and lucid introduction to the subject and further references. But if you’re starting here you will at least hear an introduction to the subject, and a linkage with my own ideas –which linkage is quite deep.

^{XV} Resnik 1992

^{XVI} Benacerraf is considered the founder of mathematical structuralism

^{XVII} Benacerraf, 1983

^{XVIII} Saunders Mac Lane is widely regarded as one of the most significant mathematicians of the 20th century.

^{XIX} Mac Lane, 385, my emphasis

^{XX} Stefanik 1994, my emphasis

^{XXI} Stefanik 1994

^{XXII} I think this argument would not be viable under intuitionist logic for instance.

^{XXIII} Expanding Resnik, 530

^{XXIV} which is exactly the sense of “the objects” of mathematical structures

^{XXV} please refer back to the prior Hilbert quote –the objects are defined by the whole of the axiom system

^{XXVI} Iglowitz, 1995

^{XXVII} This does not necessarily lead to epiphenomenalism, at least not in its ordinary sense. My reflections in the Freeman appendix, [Iglowitz, 2005] suggest another usage. The feedback, incorporating intentional perspectives, (axioms), through the primitive, (and fixed), evolutionary objects opens a possibility. Of course, even this usage could be interpreted on the level of primitive axioms. It is a problem of prediction and organization. –see my letter to Rosen quoted later. I think they serve as operational metaphors.

^{XXVIII} See Bell 1988 for word usage

^{XXIX} Kant didn't particularly like this name himself either, but he was forced into it. See the later citations from Kant himself which explains his reasoning. I think it was his greatest mistake. I have termed it "ontic indeterminism" which I think expresses his conception far better.

^{XXX} Cassirer, 1957, p. 76

^{XXXI} I tried to synopsise Cassirer's "Symbolic Forms" in Chapter 5 of my MS. I truly love Cassirer's mind, but his writing style is oblique in the extreme.

^{XXXII} See my presentation of Cassirer's alternative logic to follow.

^{XXXIII} Bell, 1988, 245, my emphasis

^{XXXIV} but especially the Lorentzian transformations -or even Galileo's for that matter

^{XXXV} See Chapter 4 and Iglowitz, 2005 for a specific rationale and a close parallel in W.J. Freeman's non-hierarchical brain map.

^{XXXVI} Maturana is another crucial and brilliant source necessary to the problem at this point.

^{XXXVII} Iglowitz, 2005, and especially its Freeman Appendix

^{XXXVIII} See “Afterward: Lakoff/Edelman” [Iglowitz, 1995] for a discussion of mathematical “ideals” which bears on this discussion. Afterthought: I appended a graphical rendition of the discussion of “ideals” to Chapter 9 which might make it easier to follow my conclusions.

^{XXXIX} this relates to the issues of “hierarchy” which I will discuss in Chapter 3.

^{XL} Iglowitz, 1995

^{XLI} Which, of course, harks back to Kant

^{XLII} This is precisely the question that structuralism addresses.

^{XLIII} E.g. Maturana, Edelman, W.J. Freeman, etc.

^{XLIV} Maturana, 1987

^{XLV} Goldblatt: “Topoi: The Categorical Analysis of Logic”, Goldblatt, Robert, Dover 1984, p.3

^{XLVI} I once again strongly encourage you to turn to the sources themselves.

^{XLVII} Shapiro 2005

^{XLVIII} See my prior footnote on this subject

^{XLIX} Iglowitz, 2005

^L Iglowitz 2005

^{LI} Shapiro’s “contentful” seems to equate pretty much with “ontological”

^{LII} I disagree, and so, I think, would the “young Hilbert”.

^{LIII} This is precisely my point –I think it is precisely the issue. I think it is not vicious at all but is instead perfectly “consistent” (sic) with the whole of Hilbert’s *early* perspective!

^{LIV} “assertatory” = “contentful” = “ontological”????

^{LV} *ibid*] (my emphasis)

^{LVI} and why not, Platonism aside? Saunders Mac Lane, [Private correspondence], expressed a view equivalent to Shapiro’s to me which I will address presently.

Chapter 3

^I I would dearly love to hear input from real, (but open-minded), mathematicians of a philosophical bent on this phase of my argument. This is about as far as I can take it. I truly need and would sincerely value their input.

^{II} Compare also Lakoff: 1987, p.353. “Most of the subject matter of classical logic is categorization.”

^{III} Cassirer 1923 pps.3-4 He continues: "The Aristotelian logic, in its general principles, is a true expression and mirror of the Aristotelian metaphysics. Only in connection with the belief upon which the latter rests, can it be understood in its peculiar motives. The conception of the nature and divisions of being predetermines the conception of the fundamental forms of thought. In the further development of logic, however, its connections with the Aristotelian ontology in its special form begin to loosen; still its connection with the basic doctrine of the latter persists, and clearly reappears at definite turning points of historical evolution. Indeed, the basic significance, which is ascribed to the theory of the *concept* in the structure of logic, points to this connection. ..."

[But] "... The work of centuries in the formulation of fundamental doctrines seems more and more to crumble away; while on the other hand, great new

groups of problems, resulting from the general mathematical theory of the manifold, now press to the foreground. This theory appears increasingly as the common goal toward which the various logical problems, that were formerly investigated separately, tend and through which they receive their ideal unity."

It is just this "general mathematical theory of the manifold" to which he refers at the end which, I will argue, forces an even further extension of Cassirer's own arguments.

^{IV} See Iglowitz, 1995, Chapter 2 for a full discussion

^V This passage, (mirroring, incidentally, the mathematical "power set"), suggests also the absolute hierarchy of concepts, (and theories), already implicit in the classical conception. Cassirer's alternative, (which I will discuss shortly), reveals a new possibility, developing into his theory of "symbolic forms" which I have elaborated and tried to simplify in Chapter 7 of this book.

^{VI} Please forgive the Capital, but the problem lies in talking about "the concept of the concept" and the fact that this is not in any sense trivial to the issue.

^{VII} Note: This is a usage of the word entirely distinct from my later usage of the word!

^{VIII} Cassirer still saw perceptual objects as the basis of his functional rule, however.

^{IX} *ibid*, P.23. Rosch and Lakoff have argued in more recent times, (based in hard empirical data), that the categories of actual human beings, actual human cultures, actual human languages are not, in fact, grounded in the classical Aristotelian "Concept" but are based, instead, in prototype, metaphor, metonymy, association, radial categories, etc. But what are these, (in their

anthropological totality), but the *free posit* of rules of category formation? Cassirer has provided a more classical and rigorous conceptualization. It incorporates the possibility of *all* (consistent) rules in a classical formulation.

Clearly this *does* better correspond with ordinary and scientific usage than does the classical concept. It is the functionality of our definitions which specifies the concept. The mathematical "subset" is the limiting rather than the typical case.

^X *ibid* P.16

^{XI} See prior footnote: Stewart, "Fibonacci Forgeries"

^{XII} *ibid* p.26

^{XIII} *ibid*

^{XIV} In my opinion Cantor is a perfect illustration of the case.

^{XV} For the first time I understood the gaps between the conceptual lucidity of the opening few days of any given mathematics course to the "therefore..." it had so invariably falsely claimed.

^{XVI} See Wilder, 1952

^{XVII} Math-speak for "Does not exist"?

^{XVIII} Goldblatt, Robert, Dover 1984, p.1

^{XIX} Which I also read that summer.

^{XX} rather than its ontic references

^{XXI} This is related to W.J. Freeman 1994 which connection I will pursue shortly

^{XXII} W.J. Freeman’s “equivalence classes” might be a reasonable beginning here.

^{XXIII} Edelman, 1992

^{XXIV} Cassirer, 1923, pp. 288-289

^{XXV} See Iglowitz, 1995, Chapter 2

^{XXVI} I think it is *the most complex*

^{XXVII} and the brain is *surely* an operative organ

^{XXVIII} W. V.O. Quine 1960, pps.3-4, my emphasis

^{XXIX} Freeman, 1995, my emphasis. I will repeat this citation in reference to an argument by Shapiro as well shortly.

^{XXX} Alternatively, as combined with the mathematical conception of the “Ideal”.

^{XXXI} Which was never responded to

^{XXXII} identical

^{XXXIII} [Iglowitz, private correspondence]

^{XXXIV} [Kuhn, 1957]

^{XXXV} [ibid]

^{XXXVI} [ibid]

^{XXXVII} Penrose, 1989

^{XXXVIII} Iglowitz 2005

^{XXXIX} W.V.O. Quine, 1953, pps.42-43

^{XL} See my “Rosen” discussion later.

^{XL^I} Cassirer’s “Substance and Function” is an excellent reference to this “abstractive logic”. See especially the first few chapters.

^{XL^{II}} What *kind* of conditionality is another issue. Material implication, for instance, is not a direct gift from God. See Quine, 1953

^{XL^{III}} After Quine’s usage.

^{XL^{IV}} W.J. Freeman has objected to this usage, but I think if I qualify it to be: “the (*not necessarily hierarchically*) reactive”, I think he might approve.

^{XL^V} An idea discussed with a correspondent who suggested it. D.E., ~2005

^{XL^{VI}} See my illustration “Bounds and Limits”. [Iglowitz, 2005]

Chapter 4

^I Maturana and Varela, 1987

^{II} Is this not the *usual* case between conflicting theories and perspectives?

^{III} Edelman, 1992, pps.236-237, his emphasis.

^{IV} Iglowitz, 1995, especially Chapter 4

^V together: *all* the possible conceptual contexts

^{VI} c.f. the arguments of Chapters Two, the current paper, (Exotic Mathematics), and Chapter Four for a detailed rationale

^{VII} See the later discussion of mathematical “ideals” which bears on this discussion.

^{VIII} this relates to the issues of “hierarchy” which I will discuss shortly

^{IX} [A recent reference 2009: See Durant on Kant where the same kind of arguments are made.]

^X Cf Lakoff, 1987. Also see Iglowitz, 1995, “Afterward: Lakoff, Edelman...”

^{XI} Edelman, 1992, the problem is that he does not really explore this dimension, but W.J.Freeman –as presented shortly –does!

^{XII} See prior footnote about his ambivalent use of the word “spatial”.

^{XIII} See Maturana, 1987 and Edelman, 1992

^{XIV} My function, however, is to introduce a mechanics –which I have done. Merleau-Ponty is not “my philosopher”, but the concept seems pregnant.

^{XV} “Of the virtually unlimited information available in the world around us, the equivalent of 10 billion bits per second arrives on the retina at the back of the eye. Because the optic nerve attached to the retina has only a million output connections, just six million bits per second can leave the retina, and only 10,000 bits per second make it to the visual cortex.
...After further processing, visual information feeds into the brain regions responsible for forming our conscious perception. Surprisingly, the amount of information constituting that conscious perception is less than 100 bits per second. Such a thin stream of data probably could not produce a perception if that were all the brain took into account; the intrinsic activity must play a role.
...Yet another indication of the brain’s intrinsic processing power comes from counting the number of synapses, the contact points between neurons. In the visual cortex, the number of synapses devoted to incoming visual information is less than 10 percent of those present. Thus, the vast majority must represent internal connections among neurons in that brain region.” (This is very much in accord with both Maturana’s and W.J. Freeman’s conceptions.)

.... Although six million bits are transmitted through the optic nerve, for instance, only 10,000 bits make it to the brain's visual processing area, and only a few hundred are involved in formulating a conscious perception –too little to generate a meaningful perception on their own. *The finding suggested that the brain probably makes constant predictions about the outside environment in anticipation of paltry sensory inputs reaching it from the outside world.*” (My emphasis)

From Scientific American March 2010 “The Brain’s Dark Energy”
Marcus Reichle, Washington University School of Medicine in Saint Louis

But Reichle does not draw the obvious conclusions, as indeed, nobody else does.

His conclusions are confounded by the epistemological paradox of his own arguments –*his* is a brain also, and subject to the same limitations. Those answers lie in the relativism of epistemology I propose.

^{xvi} cf Dennett, Dreyfus on the “large database problem”

^{xvii} This is *typically* the case. A project manager, for instance, must deal with all, (and often conflicting), aspects of his task -from actual operation to acquisition, to personnel problems, to assuring even that there are meals and functional bathrooms! Any one of these factors, (or some combination of them), -even the most trivial- could cause failure of his project. A more poignant example might involve a U.N. military commander in Bosnia. He would necessarily need to correlate many conflicting imperatives -from the geopolitical to the humanitarian to the military to the purely mundane! Or, in a metaphor on the earlier discussion, he might need to take a “Marxist” perspective for one aspect of his task, and a “royalist” perspective for another!

^{xviii} Simple adequacy is quite distinct from information or parallelismhowever.

^{XIX} See Iglowitz, 1995: Lakoff/Edelman appendix for a discussion of abstraction and hierarchy

^{XX} See Birkhoff & Mac Lane, 1955, p.350, discussion of the “duality principle” which vindicates this move. More simply put, and using Edelman’s vision, it is a question of which end of the “global mapping” we look from!

^{XXI} The “anthropic principle” as usually interpreted, on the other hand, is clearly self-serving and tautological. There is another deeper sense of the principle I discussed in the section: The JCS Review which I think is more pertinent. (Chapter 11)

^{XXII} Freeman has objected to my characterization of the human brain as an “organ of response”. I understand his objection, as it seems to imply acceptance of “stimulus-response” causality” –which is clearly not my intention. At this level of discussion, I think the characterization is warranted however.

^{XXIII} Maturana and Varela, 1987

^{XXIV} See Dreyfus on the “large database problem”. Also see Appendix A of Iglowitz, 1995 for a “combinatory” counterargument.

^{XXV} See Cassirer, 1923

^{XXVI} See prior note about Freeman’s objection to “response”

^{XXVII} “HIKE” (:-) A *tiny* bit of humor.

^{XXVIII} see P.S. Churchland re: Hume

Chapter 5

^I This is the subject of the beginnings of this paper which is itself the best beginning reference.

^{II} My function, however, is to introduce a mechanics –which I have done. Merleau-Ponty is not “my philosopher”, but the concept seems pregnant.

Chapter 6

^I Kant, Prolegomena, p.10

^{II} "Prolegomena", P. 11

^{III} cf Chapter 7

^{IV} ibid

^V Maturana and Varela, 1987

^{VI} See Chapter 7 re: Quine

^{VII} Maturana and Varela, 1987

^{VIII} afterwards "Maturana"

^{IX} ibid P.48, my emphasis

^X ibid Pps. 39-40

^{XI} ibid P.51

^{XII} ibid P.63

^{XIII} ibid Pps.74-75

^{XIV} ibid Pps.63-64

^{XV} ibid P.96

-
- XVI *ibid* P.74
- XVII *ibid* Pps.80-81
- XVIII *ibid* Pps.95-102, (my emphasis)
- XIX *ibid* Pps.147-148
- XX *ibid* Pps.157-159
- XXI *cf* Appendix A
- XXII *ibid* p.159
- XXIII *ibid* Pps.163,164
- XXIV *ibid* P.124, my emphasis
- XXV *ibid* Pps.129-133, my emphasis
- XXVI *op.cit* p.133
- XXVII *ibid* Pps.133-134
- XXVIII *cf* Dennett, 1991
- XXIX *cf* P.S. Churchland, 1986, Dennett, 1991
- XXX *Dennett, 1991, P.382, my emphasis*
- XXXI "An Inquiry into Meaning and Truth", Bertrand Russell, Pp. 14-15
- XXXII *cf* Fine, 1986. p.97
- XXXIII *op.cit* Pps.234-244, my emphasis
- XXXIV *cf* Penrose
- XXXV *cf* Chapter 5
- XXXVI This is also, obviously, a reiteration of Maturana's "razor's edge".

xxxvii Kant, "Prolegomena" pps.36-37

xxxviii Kant, "Critique of Pure Reason", 2nd edition, 333, translated by Woglom and Hendel, and cited in Cassirer: "The Problem of Knowledge", 1950, Pps. 101-102 I prefer this to Smith's rendering.

xxxix cf Chapter 5

xl Maturana & Varela, 1987

xli Afterwards "Maturana"

xlII Kant, "Critique of Pure Reason"

xlIII ibid P.96

xlIV ibid Pps.63-64

xlV H. Hertz, "Die Prinzipien der Mechanik", p.1 ff, my emphasis

Chapter 7

ⁱ Quine, 1953, pps.42-43

ⁱⁱ cf heading above!

ⁱⁱⁱ Penrose 1989

^{iv} See Chapter 3

^v Cassirer, 1953, p. 75

^{vi} ibid, p.75

^{vii} ibid

^{viii} ibid

^{ix} H. Hertz, "Die Prinzipien der Mechanik", p.1 ff, my emphasis

^X Cassirer, op cit p.76

^{XI} ibid

^{XII} Cassirer, 1954, p.76

^{XIII} ibid

^{XIV} ibid

^{XV} see Chapter 3

^{XVI} ibid

^{XVII} ibid

^{XVIII} ibid

^{XIX} ibid p.77, my emphasis

^{XX} ibid

^{XXI} Cassirer 1953

^{XXII} ibid, P.446, my emphasis

^{XXIII} ibid, p.447

^{XXIV} ibid, p.446

^{XXV} ibid, p.447

Chapter 8

^{XXVI} Cassirer, 1923, pps.374-379, my emphasis

^I Van Fraassen, 1991, pps.4-5

^{II} ibid

^{III} *ibid*

^{IV} *ibid* p.94

^V Cassirer, 1953, p.77

^{VI} *ibid.* pps. 77-78, my emphasis

^{VII} *ibid*, my emphasis

^{VIII} *ibid*

^{IX} *ibid*

^X Cassirer, 1923, p.446

^{XI} *ibid*, my emphasis

^{XII} *ibid*, p.446

^{XIII} *ibid*, p.447

^{XIV} *ibid*, p.447

^{XV} *op.cit* Pps.234-244, my emphasis

^{XVI} W. V.O. Quine 1960, pps.3-4

Chapter 10

¹ cf Iglowitz, 1995

Chapter 11

¹ Note: the “.doc” version of this paper allows this figure to be adequately zoomed for legibility of all text. I have not been able to get this resolution in the PDF form.

Chapter 12

^I Durant, 1926

^{II} My emphasis

^{III} Durant, 1926

^{IV} See Iglowitz, 1995, Chapter 3

^V My emphasis

^{VI} See Chapter 3, this paper

^{VII} My emphasis

^{VIII} Durant, Will. 1926, my emphasis

^{IX} Here at this point, I am sad to say, he broaches his integrity by attributing a dishonest motive to Kant. “The truth is that Kant was too anxious to prove the subjectivity of space as a refuge from materialism; he feared the argument that if space is objective and universal, God must exist in space, and therefore be spatial and material. This is an *ad hominem* argument, pure and simple and does not do justice to Durant’s intrinsic integrity.

^X i.e. William James

^{XI} *ibid*, p.447

^{XII} Cassirer, 1923, pps.374-379, my emphasis

^{XIII} See Smart, 1949. Smart, though not in agreement, does an excellent job of elucidating the essential perspectives and is well worth reading.

^{XIV} H. Hertz, "Die Prinzipien der Mechanik", p.1 ff, my emphasis

^{XV} *ibid*, P.446, my emphasis

^{xvi} *ibid*, p.447

^{xvii} *ibid*, p.446

^{xviii} End repeat of Chapter 5 section.

^{xix} Iglowitz, 1995

^{xx} Russell, Bertrand. 1967

Chapter 13

ⁱ Alternatively, it is the brain's rule of ontogenic coupling

ⁱⁱ Bas Van Fraassen, *Quantum Mechanics*, p.17

ⁱⁱⁱ "beneficial" is itself a synthetic a priori perspective

^{iv} and I do not *dogmatically* assert that it is. The future of science must answer this question.

^v i.e. at the "fine-grained" level of mind

^{vi} or to gain reflective insights on them

Chapter 14

ⁱ P.S. Churchland, 1988, P.260

ⁱⁱ cf Appendix D, (Penrose)

ⁱⁱⁱ Consider Nazism, as just one recent example.

^{IV} And their damnable and blatant arrogance about it!

^V Van Doren, 1938

Chapter 15

^I E.g. Crick's usage of the term. I do not consider his thesis in any sense to be other than quite ordinary from a materialist standpoint.

^{II} W.V.O. Quine, 1953, pps.42-43

^{III} W. V.O. Quine 1960, pps.3-4, my emphasis

^{IV} Penrose, 1989. P. 243, my emphasis

Appendix A

^I Dennett, 1991

^{II} i.e. -relative to Dennett's problem

^{III} See Cassirer 1953, and Iglowitz, 1995

^{IV} i.e. vis-à-vis current process

^V See Iglowitz 2005

^{VI} Consider the world-views implicit in paranoia or schizophrenia, for instance, or in bipolar orientations

^{VII} Or "objectivist logic" after Lakoff's usage

^{VIII} Dennett, 1991, P.382

Appendix B

¹ cf Wlodek Duch for instance