

History of Western Philosophy from the quantum theoretical point of view; [Ver. 4]^{*1}

Shiro ISHIKAWA^{*2} (Mail: ishikawa@math.keio.ac.jp)

Preface: Toward post-analytic philosophy; Philosophy has made progress towards QL

Quantum language (i.e., QL (=MT = measurement theory), the linguistic Copenhagen interpretation of quantum mechanics, the quantum mechanical worldview) proposed by myself is a scientific language that is inspired by the Copenhagen interpretation of quantum mechanics, and moreover, it has a great power to describe classical systems as well as quantum systems. My lecture for graduate students in the faculty of science and technology in Keio university has been continued, with a gradual improvement, for about 20 years. The contents of my lecture are roughly as follows.

Assertion 0.1 (in Preface):

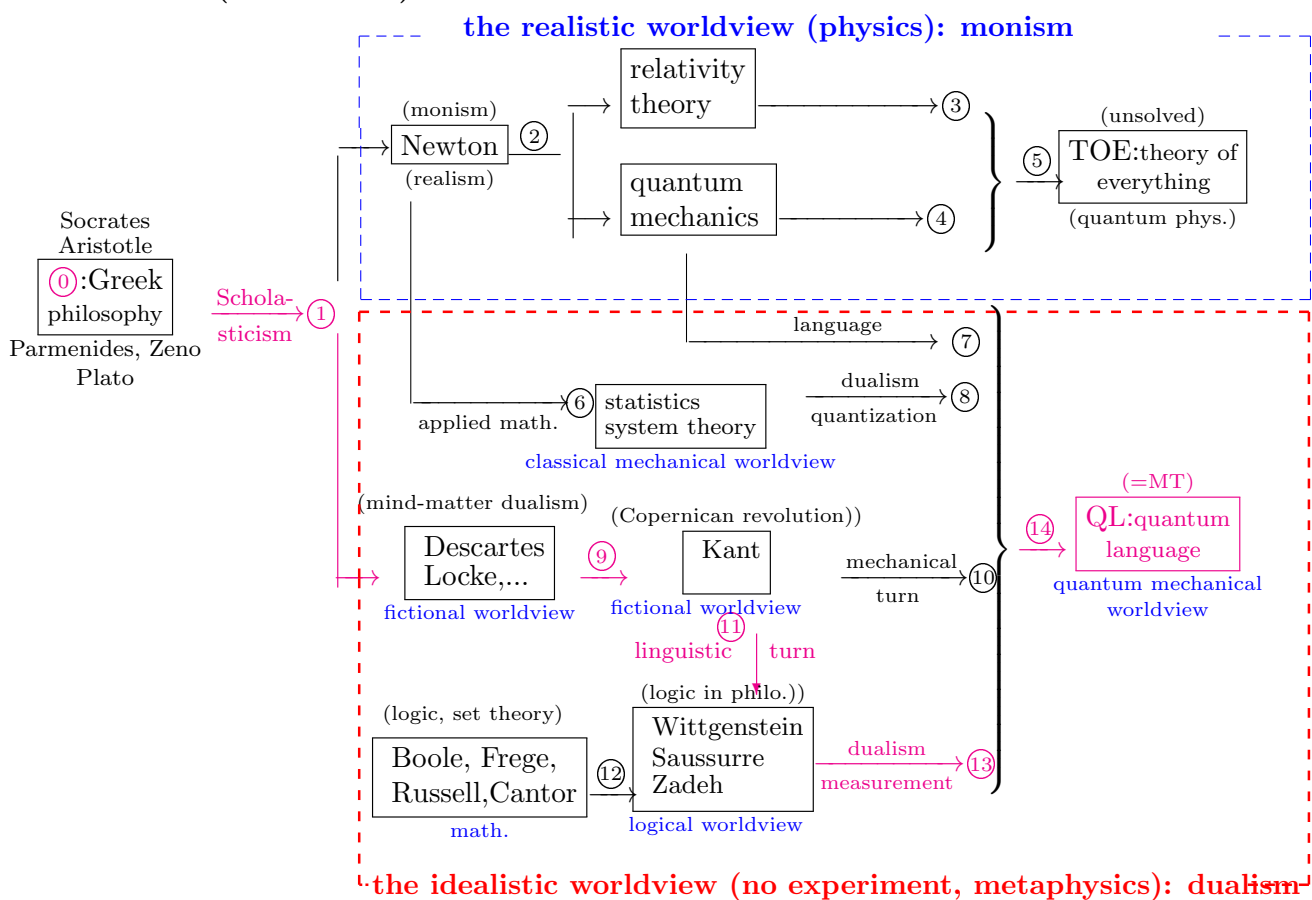

Figure 0: The history of the world-descriptions
Philosophy (≈ dualistic idealism) has progressed toward QL
 (i.e., 0 → 1 → 9 → 11 → 13 → 14)

The main part of quantum language [2 - 7 - 14] and statistics [6 - 8 - 14] in the above were already studied in the following:

^{*1} This paper was published in "Research Report KSTS/RR-21/001 (Dept. Math. Keio Univ.)" url: http://www.math.keio.ac.jp/academic/research_pdf/report/2021/21001.pdf

^{*2} Department of mathematics, Faculty of science and Technology, Keio University, 3-14-1, Hiyoshi, Kouhokoku, in Yokohama, 223-8522, Japan, HP: <http://www.math.keio.ac.jp/~ishikawa/indexe.html>

(A₁) ref. [71]: S. Ishikawa, "Linguistic Copenhagen interpretation of quantum mechanics: Quantum Language [Ver. 5]", Dept. Math. Keio University, 2019, KSTS/RR-19/003, 473 pages (http://www.math.keio.ac.jp/academic/research_pdf/report/2019/19003.pdf)

Therefore, in this text I devote myself to the part [① - ② - ③ - ④- ⑤- ⑥], which is almost equal to the history of western philosophy. This part [① - ② - ③ - ④- ⑤- ⑥] was not detailed in my lecture, but it will be a good preparation to read (A₁) (since (A₁) may be too hard). That is, this paper is written as the supplementary reader in my lecture, and thus it can be read without the mathematical preparation.

Thus, the above figure says that

(A₂) **statistics, quantum mechanics, Descartes=Kant philosophy and analytic philosophy are each one aspect of quantum language.**

Also, I think that the following is one of the most fundamental problems of western philosophy:

The progress problem (B) : Has philosophy made progress?

(B) Do the time series [① - ② - ③ - ④- ⑤- ⑥] mean the progress of philosophy?



In this paper I conclude that

(C): My answer; the progress of philosophy (≈ dualistic idealism)

(C₁) deep If "to make progress" is defined by "to come near quantum language" (i.e., "becoming more and more like quantum language" we can say that the time series [① - ② - ③ - ④- ⑤- ⑥] can be regarded as progress, that is,

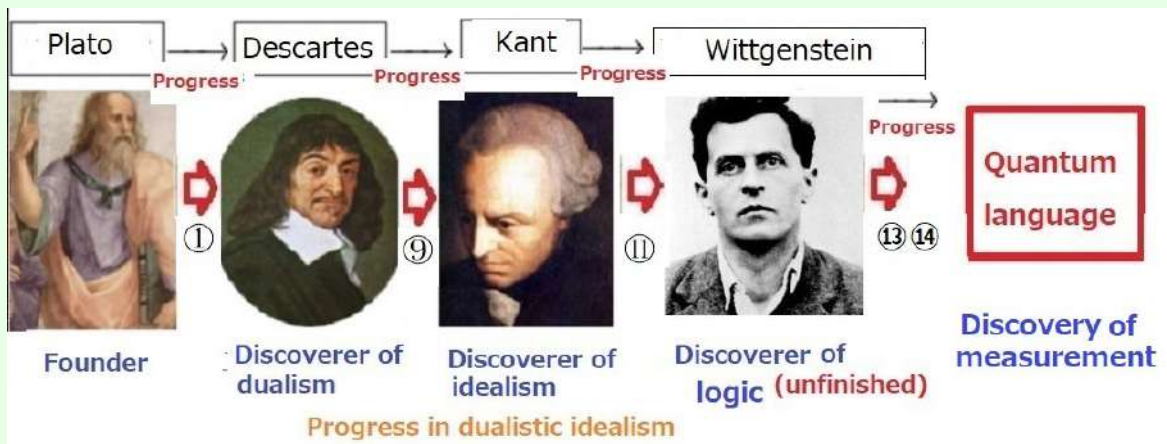

This will be proved throughout this text.

Note0.1:Wittgenstein could not discover "scientific logic", but I believe that he is the biggest

contributor.

Here, in this paper, it suffices to consider that "idealism" \approx "linguistic theory" \approx "metaphysics" (*cf.* Definition 1.8). Thus, we conclude that

(C₂) a scientific perfection of dualistic idealism is realized by quantum language

which is surely one of the most important assertions in western philosophy. Also recall that quantum language is intended as a language of science. Therefore,

(C₃) the **purpose** of philosophy concerning dualistic idealism was to make the language of science.

That is, I think that

(C₄) none of the philosophies of dualistic idealism (other than quantum language) has been successful.

It is sure:

- If anyone believes that he has found a theory that goes beyond ⑬, he will certainly want to talk about the landscape [① - ② - ③ - ④ - ⑤ - ⑥ - ⑦ - ⑧ - ⑨ - ⑩ - ⑪ - ⑫ - ⑬ - ⑭] seen from the theory.

Hence I wanted to do that too. This is my motive of writing this paper.

It should be noted that most unsolved problems in the history of western philosophy are caused by insufficient understanding of idealism and dualism. Thus,

- if the (C₂) is true (i.e., if **quantum language is overwhelmingly powerful compared to other immature philosophies**), I can expect that most unsolved problems in dualistic idealism can be solved in the framework of quantum language.

In this text, I will show that the following unsolved philosophical problems are easily solved as corollaries of the (C₂):

<p>It is said that</p> <ul style="list-style-type: none">• Wittgenstein carried out one of the most ambitious attempts in the history of philosophy to solve all the problems of philosophy at once in [117]: "Tractatus Logico-Philosophicus (abbreviated as TLP)". <p>However, 100 years later, we can't say that he succeeded in his challenge. However, as the following list shows, QL realized his dream.</p> <p>(D) Almost famous unsolved problems concerning dualistic idealism can be solved in QL</p> <ul style="list-style-type: none">• What is probability (or, measurement, causality) ? <i>cf.</i> Sec. 1.1.1)• Zeno paradox (Flying arrow, Achilles and a tortoise), (<i>cf.</i> ref. [45], or Sec. 2.4)



$$D = S \times T$$

distance speed time



("to solve Zeno paradox" = "to understand DST-formula" (cf. Sec. 2.4.3))ZenoDST

- the measurement theoretical understanding of Plato's allegory of the sum , (cf. Sec. 3.3.2)
- Plato's Idea theory≈Zadeh's fuzzy theory≈Sausuure's linguistic theory (cf. Sec. 3.5.3)
- Syllogism does not always holds in quantum systems (cf. Sec. 4.3.3)
- Syllogism always holds in classical and quantum systems (cf. Remark 12.9 in Sec. 12.1)
- Only the present exists (cf. Sec. 6.1.2)
- What is the problem of universals? (cf. Sec. 6.5.1)
- What is Geocentrism vs. Heliocentrism? After all, the worldviewism (cf. Sec. 7.4)

- Two (scientific or non-scientific) interpretations of I think, therefore I am .(cf. Sec. 8.2.2)
- Leibniz-Clark correspondence (i.e., what is space-time?), (cf. Sec. 9.3)
- The problem of qualia (cf. Sec. 9.5.1)
- Brain in a vat argument (cf. Sec. 9.5.2)
- The solution of Hume's problem of induction (cf. Sec. 9.7.1)
- grue paradox cannot be represented in quantum language (cf. Sec. 9.8)
- What is causality? (cf. Sec. 10.2)
- What is Peirce's abduction? (cf. Sec. 11.4.1)
- Five-minute hypothesis (cf. Sec. 11.5.2)
- McTaggart's paradox (cf. Sec. 11.5.3)
- quantitative representation of "Signifier" and "signified" (cf. Sec. 12.1)
- My scientific understanding of "Tractatus Logico-Philosophicus (=TLP)" and "Zadeh's fuzzy sets" (cf. ref. [78], or Sec. 12.1)

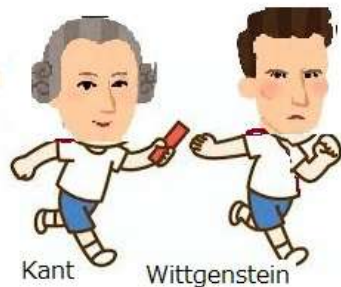

Kant

Wittgenstein



I'm a dualist!

That is, Wittgenstein took over the baton of "dualistic idealism (i.e., the mainstream of philosophy)" from Kant. This is essentially important, since Wittgenstein's picture theory must belong to dualistic idealism in order to assert (C) (or, Assertion 0.1)

- Lewis Carroll's paradox (cf. Sec. 12.4)
- Flagpole problem, (cf. Sec. 12.5)
- Hempel's raven paradox (cf. Sec. 12.6)
- the mind-body problem (i.e., How are mind and body connected?), (cf. Sec. 12.7)

Also, for the solutions of unsolved problems in quantum mechanics, statistical mechanics, statistics and probability theory, see ref. [71]), that is,

(A₁) ref. [71]: S. Ishikawa, "Linguistic Copenhagen interpretation of quantum mechanics: Quantum Language [Ver. 5]", Dept. Math. Keio University, 2019, KSTS/RR-19/003, 473 pages (http://www.math.keio.ac.jp/academic/research_pdf/report/2019/19003.pdf)

The list will be written is in (D₂) in Chap. 13: "Postscript."

After all, I will clarify that

(E) the strangeness of philosophy (i.e., dualistic idealism) is due to the strangeness of the Copenhagen interpretation of quantum mechanics



Lastly I should add the following:

- My specialty is not philosophy. Perhaps most readers are more familiar with the history of Western philosophy. The only advantage I have is that I am familiar with quantum language (which may be the scientific final goal of dualistic idealism). Thus,
my purpose of this text is to find the great power of quantum language (i.e., the quantum mechanical worldview) everywhere in the history of western philosophy.
- This text is written as the supplementary reader, and thus, it can be read without the knowledge of quantum theory. I used a lot of illustrations to explain things since I'm not confident in my English. The mathematical arguments were left to ref. [71] mentioned in (A): KSTS/RR-19/003 (2019); 473 p
(http://www.math.keio.ac.jp/academic/research_pdf/report/2019/19003.pdf)
- this text is the revised version of ref. [65]: *History of Western Philosophy from the quantum theoretical point of view* [Ver. 3], Research Report (Department of mathematics, Keio university, Yokohama), (KSTS-RR-20/001, 2020, 296 pages)
(http://www.math.keio.ac.jp/academic/research_pdf/report/2017/17004.pdf)
Roughly speaking, I say that
(*) this [Ver. 4] = "some corrections of [Ver. 3]" + ref. [78] + "illustrations"

I believe that philosophy, like literature, should be written for the general public. I think it should be mostly a playful part rather than an academic part. I hope many readers will enjoy it.*³.

August 2021
Shiro Ishikawa

*³ For the further information concerning quantum language, see my home page: <http://www.math.keio.ac.jp/~ishikawa/indexe.html>

Contents

	The sections containing solutions of famous unsolved problems are marked with the red *	xi
Chapter 1	The outline of quantum language (=measurement theory)	1
1.1	The overview of quantum language(=measurement theory)	2
1.1.1 *	Axiom 1 (What is probability (or, measurement) ?) and Axiom 2 (What is causality ?)	2
1.1.2	Linguistic Copenhagen interpretation (or in short, Linguistic interpretation)	5
1.2	The history of worldview and our purpose	13
1.2.1	Quantum language in the history of worldviews	13
1.2.2	Our purpose	14
1.3	Realistic worldview and idealistic worldview	17
1.3.1	The worldviewism	17
1.3.2	The realistic worldview(physics) (b_1)	21
1.3.3	The idealistic worldview (b_2)	21
1.4	Preview of the assertions in this paper	26
1.4.1	Realistic worldview?, (fictional, mechanical) worldview?	26
1.4.2	Keywords: Monism and dualism	27
1.5	Appendix: The mathematical foundations of quantum language	30
1.5.1	Mathematical preparations (the C^* -algebraic formulation of QL)	30
1.5.2	Axiom 1 [Measurement] and Axiom 2 [Causality]	31
1.5.3	Inference; Fisher's maximum likelihood method)	32
Chapter 2	Ancient Greek philosophy (before Socrates)	35
2.1	Thalēs (BC.640 - BC.546)	36
2.1.1	Thalēs: the first philosopher: " the arche (= the first thing of all things) is water"	36
2.1.2	Thalēs' ability at math	39
2.2	Pythagoras (BC.582 - BC.496)	41
2.2.1	The mathematical ability of Pythagorean religious organization	41
2.2.2	The arche (= the first principle of all things) is number	46
2.3	Hērakleitos and Parmenides	49
2.3.1	Hērakleitos(BC.540 - BC.480)	49
2.3.2	Parmenides; The ancestor of the Copenhagen interpretation	50
2.3.3	Motion function method as a worldview	52
2.4	Zeno(BC490 - BC430): The Motion Paradox	54
2.4.1	What is Zeno's paradoxes? Without a worldview, we cannot say anything	54
2.4.2 *	The solution* about Zeno's paradoxes (e.g., Flying arrow) in the motion function method	56
2.4.3	DST formula	57
2.4.4	Appendix: The discussion about Zeno's paradoxes (e.g., Achilles and a tortoise]) in the motion function method	59
Chapter 3	The Big Three in Greek Philosophy (Socrates, Plato)	61
3.1	Protagoras and Socrates	62
3.1.1	Ethics	62
3.1.2	Magic proposition: I know I know nothing	63
3.2	Plato(BC.427 - BC.347)	65
3.2.1	The theory of Ideas – Asserted fiction –	65
3.2.2	Allegory of the cave	69

3.2.3	The theory of anamnesis	70
3.3	The allegory of the sun: Measurement theoretical aspect of Idea theory	72
3.3.1	The allegory of the sun	72
3.3.2*	The measurement theoretical understanding of the allegory of the sun	74
3.4	Plato: The fictional worldview (=Plato's way of telling philosophy)	75
3.4.1	The necessity of idealism and dualism	75
3.5	Key words of dualism	78
3.5.1	Three key-words of dualism	78
3.5.2	Is Idea theory related to measurement (i.e., dualism) ?	78
3.5.3*	Plato's Idea theory \approx Locke's secondary quality \approx Sausuure's linguistic theory \approx Zadeh's fuzzy theory	81
3.6	Summary: Plato's way of telling philosophy	83
3.6.1	Summary	83
Chapter 4	The Big Three in Greek Philosophy (Aristotle)	87
4.1	Aristotle (BC.384 - BC.322)	88
4.1.1	Realistic worldview vs. idealistic worldview	88
4.1.2	Edios and Hyle	88
4.2	Why does the motion happen?	91
4.2.1	From purpose to causality: Modern science started from the discovery of "causality"	91
4.3	Practical logic	94
4.3.1	Practical logic; Aristotle's syllogism in ordinary language	94
4.3.2	Mathematical logic; due to Boole, Frege	96
4.3.3*	Syllogism does not always hold in quantum systems	97
Chapter 5	Around Alexndria; Hellenistic period	101
5.1	Around Alexandria; Hellenistic period	102
5.2	Euclid(BC.330 - BC.275)	103
5.2.1	Euclid geometry - Parallel postulate	103
5.2.2	non-Euclidean revolution	105
5.3	Aristarchus (BC.310 - BC.230)	107
5.3.1	the diameter of the moon : the diameter of the sun	107
5.3.2	Ancient Heliocentrism	108
5.4	Archimedes (BC.287 - BC.212)	109
5.4.1	Buoyancy (Archimedes' principle)	109
5.4.2	The tomb of Archimedes	111
5.4.3	Principle of leverage	112
5.5	Eratosthenes (BC.275 - BC.194)	114
5.5.1	The biggest ancient observer	114
5.6	Claudius Ptolemaeus (AD.83 - AD.168)	116
5.6.1	The ancient scientific collected studies	116
Chapter 6	The Middle Ages	119
6.1	Augustinus(AD. 354 - AD.430)	120
6.1.1	Philosophy is a maidservant of theology	120
6.1.2*	"Confessions" by Augustinus: Only the present exists	122
6.1.3	"Subjective time" is a magic word which excites our delusion	123
6.2	Scholasticism –Graft Bamboo (=Aristotle) to a tree (=Plato) –	126
6.2.1	Aristotle's philosophy spread to the Islamic world	126
6.2.2	Crusade expedition and Inflow of Islamic culture	126
6.3	The discovery of zero	128
6.3.1	Positional notation (= the discovery of zero): Arabic numerals	128
6.3.2	Arabic numerals and Roman numerals	128
6.3.3	The explosion of mathematics	128
6.4	The proof of the existence of God	130
6.4.1	Anselmus (1033 - 1109)	130
6.4.2	Review: the worldviewism	130

6.4.3	The inflow of Aristotle philosophy	131
6.5	Scholasticism; Problem of universals	133
6.5.1*	What is the problem of universals?	133
6.6	Thomas Aquinas (1225 - 1274); Scholasticism	136
6.6.1	Grafting Bamboo (Aristotlelian science) to a Tree (Plato's literature)	136
6.7	Ockham's razor and Plato's beard	138
Chapter 7	Early modern – Scientific revolution: From Geocentrism to Heliocentrism	141
7.1	Paradigm shift	142
7.2	Francis Bacon (1561 - 1626): The father of empiricism, Inductive reasoning	145
7.2.1	How to create science: The exclusion of idols (=prejudice, preconception)	145
7.3	From Geocentrism to Heliocentrism	148
7.3.1	What is "Geocentrism vs. Heliocentrism"?	148
7.3.2	Somehow "from Geocentrism to Heliocentrism"	149
7.3.3	"Geocentrism vs. Heliocentrism" is the problem of the worldview	150
7.3.4	The Galileo legend; Leaning Tower of Pisa, Trial of Galileo	150
7.4	Principia; Newtonian worldview	152
7.4.1	Principia (1687)	152
7.4.2*	What is "Geocentrism vs. Heliocentrism"? After all, the worldwivism	152
7.5	Appendix; About "Dialogues concerning two new sciences" by Galileo Galilei	155
Chapter 8	Modern philosophy (Dualism): Descartes	157
8.1	The theory of Ideas has expired	158
8.2	"I think, therefore I am" is meaningless from the scientific point of view	160
8.2.1	Discourse on the Method (1637)	160
8.2.2*	Two (scientific or non-scientific) interpretations of "I think, therefore I am"	161
8.3	Descartes' strategy	163
8.3.1	From cogito to dualistic idealism	163
8.4	The correspondence of key-words in Descartes philosophy and quantum language	166
Chapter 9	Modern philosophy(Locke, Leibnitz, Berkeley, Hume)	169
9.1	Locke (1632 - 1704): The father of British Empiricism	170
9.1.1	"An Essay Concerning Human Understanding" by Locke (1689)	170
9.1.2	"Tabula rasa", primary quality and secondary quality	171
9.2	Dramatic presentation of "British Empiricism vs. Continental Rationalism"	173
9.2.1	Would Leibniz be serious for this argument (i.e., nativism) ?	174
9.3	* Leibniz-Clarke Correspondence: What is space-time?	176
9.3.1	"What is space?" and "What is time?"	177
9.3.2	Leibniz-Clarke Correspondence	178
9.4	Subjective idealism: Berkeley, "To be is to be perceived"	181
9.4.1	Priest: Berkeley	181
9.4.2	(A ₃): To be is to be perceived	182
9.4.3	"Einstein-Tagore Meeting" and "Bohr-Einstein debates"	182
9.4.4	Bohr-Einstein debates: Do the laws of physics require measurement?	184
9.5	Qualia problem and Brain in a vat argument	185
9.5.1*	The problem of qualia	185
9.5.2*	Brain in a vat argument	187
9.6	Hume; skeptic who didn't measure, "A Treatise of Human Nature"	189
9.6.1	The review of Descartes	189
9.6.2	Hume's straying[Less than brain science]; Hume's wordplay	190
9.6.3	Hume; The causality problem	190
9.7	Hume's problem of induction in the quantum mechanical worldview	193
9.7.1*	The solution of Hume's problem of induction	193
9.8	* grue paradox cannot be represented in quantum language	197
Chapter 10	Kant: Copernican revolution	201
10.1	Critique of Pure Reason	202
10.1.1	Three Critiques	202

	10.1.2	The purpose of "Critique of Pure Reason" (1781)	203
	10.1.3	Thing-in-itself, Copernican revolution; from copy theory to constitution theory	204
10.2	*	Summary: What is causality?	208
	10.2.1	Four answers to "what is causality?"	208
10.3		Summary; Descartes=Kant philosophy	212
	10.3.1	Hume might be more scientific than Kant	212
	10.3.2	Why was Kant so successful?	212
10.4		Is Kant a progress from Descartes ?	215
	10.4.1	The inevitability of Kant's appearance	215
	10.4.2	Is Kant a progress from Descartes ?	216
Chapter 11		Linguistic philosophy (Before TLP)	221
	11.1	Elementary knowledge of symbolic logic in mathematics	223
	11.1.1	Propositional logic and predicate logic	223
	11.1.2	Which do you trust more, logic or statistics?	225
	11.2	Probabilistic symbolic logic in mathematics	226
	11.2.1	Easy example	226
	11.2.2	Quasi-product probability	227
	11.2.3	Logic symbols and logical operations	228
	11.3	George Boole (1815-1864), Gottlob Frege (1848-1925) and Bertrand Russell (1872-1970)	232
	11.4	Peirce (1839-1914): Abduction	235
	11.4.1	* What is Peirce's abduction?	237
	11.5	Bertrand Russell: five-minute hypothesis, McTaggart's paradox, Moore's paradox	241
	11.5.1	Russell's paradox in set theory	241
	11.5.2	* Five-minute hypothesis	243
	11.5.3	* McTaggart's paradox	245
	11.5.4	Moore's paradox: "It is raining, but I do not believe it is raining"	247
	11.6	Saussure: Copernican revolution in language	249
	11.6.1	Saussure's linguistics: What comes first, things or words?	249
	11.6.2	Several Copernican revolutions	250
	11.6.3	* The quantitative expressions of "signified"	252
Chapter 12		Linguistic philosophy (After TLP)	255
	12.1	* Fuzzy logic in QL; My scientific understanding of "Tractatus Logico-Philosophicus (=TLP)"	256
	12.1.1	Wittgenstein and Zadeh	256
	12.1.2	Easy example; classical system	257
	12.1.3	Fuzzy logic in QL	258
	12.1.4	General case	263
	12.2	Wittgenstein; the biggest star of analytic philosophy.	265
	12.2.1	What did he wanted to insist on in TLP?	265
	12.2.2	The power of Wittgenstein's word: Linguistic turn	268
	12.2.3	Philosophical Investigations (1953) and Wittgenstein's paradox	270
	12.3	Quine's analytic-synthetic distinction and Popper's falsifiability in QL;	272
	12.3.1	Quine's analytic-synthetic distinction in QL;	272
	12.3.2	Popper's falsifiability in QL	274
	12.4	Lewis Carroll's logical paradox in fuzzy logic	277
	12.5	Flagpole problem in the quantum mechanical worldview	279
	12.5.1	* The quantum linguistic solution of Flagpole problem	279
	12.6	* Hempel's raven problem	282
	12.6.1	Is "the set of all tyrannosaurus" meaningful? : the set theoretical worldview	282
	12.6.2	Hempel's raven problem in the set theoretical worldview	283
	12.6.3	Hempel's raven problem in the quantum mechanical worldview	283
	12.6.4	A priori proposition: "Any small black bird is black"	286
	12.6.5	A posteriori proposition: "Every raven is black"	287
	12.7	Three approaches to the mind-body problem	289
	12.7.1	The mind-body problem	289
	12.7.2	The first approach; Cognitive scientific approach	289

12.7.3	The second approach; Illusory problem?	290
12.7.4*	The third approach; Quantum linguistic solution to the mind-body problem	290
Chapter 13	Postscript: Can QL be post-analytic philosophy?	293
13.1	Philosophy (of worldviews) has progressed towards quantum language	293
13.2	If the above (A) and (B) are true, almost all unsolved problems concerning dualistic idealism have to be solved in QL	294
13.2.1	The list of my answers of unsolved problems	294
13.3	Can QL be post-analytic philosophy?	297
References		301

Chapter 1

The outline of quantum language (=measurement theory)

Abstract: Recently I proposed "quantum language" (or, "measurement theory", "the linguistic Copenhagen interpretation of quantum mechanics", "the quantum mechanical worldview"), which is not only characterized as the metaphysical and the linguistic turn of quantum mechanics but also as the linguistic turn of Descartes=Kant epistemology. And further, I believe that quantum language is the only scientifically successful theory in dualistic idealism. Hence, this turn encourages us to understand Western philosophies (Parmenides, Plato, Descartes, Locke, Berkeley, Hume, Kant, Wittgenstein, etc.) within the framework of quantum language. This is done in this paper. That is, I show that most unsolved philosophical problems in dualism are solved within the framework of quantum language.

Readers don't need any prior knowledge to read this paper. It is sufficient to read the overview of quantum language (and the linguistic Copenhagen interpretation) described in section 1.1 of this chapter. However, if you are a graduate student, I recommend you to read this paper and "quantum language (ref. [71])" together.

In Section 1.2, I remark that

(#₁) roughly speaking, western philosophy and the linguistic Copenhagen interpretation are similar. Further, in Section 1.3, I explain the worldview (= world description), which is classified by the following four,

- (#₂)
- the realistic worldview (\approx physics),
 - the fictional worldview (\approx western philosophy),
 - the logical worldview (=the logical spirit=the spirit of "Think logically!") (\approx analytic, linguistic, scientific philosophy),
 - the mechanical worldview (\approx statistics, quantum language).

(*cf.* Assertion 0.1 in Preface).

1.1 The overview of quantum language(=measurement theory)

1.1.1* Axiom 1 (What is probability (or, measurement) ?) and Axiom 2 (What is causality ?)

The idea of quantum language (also known as "measurement theory") is inspired and structured by quantum mechanics, in which microphenomena are analyzed. Quantum language is a language, by which we cannot only describe quantum mechanics but also most sciences (e.g., economics, psychology, engineering, etc.). However, it should be noted that quantum language is not almighty, for example, the theory of relativity is beyond the description of quantum language.

The framework of measurement theory(=quantum language) is simple, that is, it is composed with two axioms (Axiom 1 concerning measurement and Axiom 2 concerning causal relation) and the manual to use Axioms 1 and 2 (called the linguistic Copenhagen interpretation). That is, (*cf.* refs [46, 71]),

$$\begin{aligned} \boxed{\begin{array}{c} (=quantum language) \\ \text{measurement theory} \end{array}} &= \boxed{\begin{array}{c} [\text{Axiom 1}] \\ \text{measurement} \end{array}} + \boxed{\begin{array}{c} [\text{Axiom 2}] \\ \text{causal relation} \end{array}} \\ &+ \boxed{\begin{array}{c} \text{linguistic Copenhagen interpretation} \\ \text{[the manual to use Axioms 1 and 2]} \end{array}} \end{aligned} \quad (1.1)$$

That is,

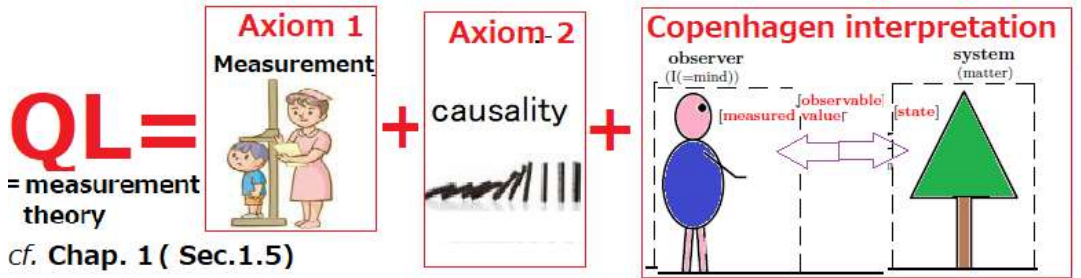

Although you do not need to fully understand Axiom 1 and Axiom 2 to read this text, I, for completeness, mention them as follows. (For the mathematical foundations of Axioms 1 and 2, see Section 1.5 (Appendix: the mathematical foundations of quantum language) later. The following axiom can be regarded as the mathematical generalization of the probabilistic interpretation of quantum mechanics (due to M. Born (*cf.* ref. [6])).

Axiom 1 [measurement] (in Section 1.1)

(This will be explained more precisely in Section 1.5)

With any system S , a basic structure $[\mathcal{A} \subseteq \mathcal{N} \subseteq B(H)]$ can be associated in which measurement theory of that system can be formulated. When the observer takes a measurement of an **observable** (or, by a **measuring instrument**) $O=(X, \mathcal{F}, F)$ for a system $S_{[\rho]}$ i.e., a **system** S with a **state** ρ , the **probability** that a **measured value** $x (\in X)$ obtained by the measurement belongs to $\Xi (\in \mathcal{F})$ is given by $\rho(F(\Xi))(\equiv \mathcal{A}^*(\rho, F(\Xi))_{\mathcal{N}})$.

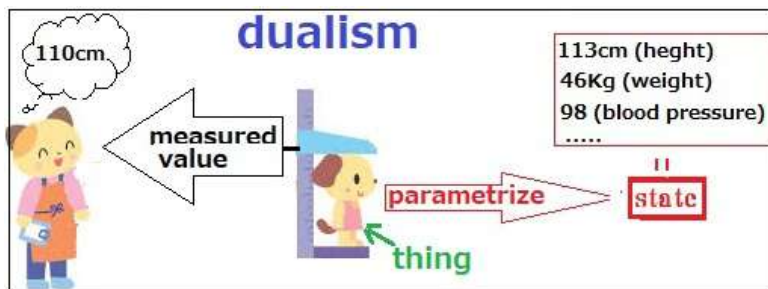

And, the following is a mathematical generalization of Heisenberg's kinetic equation (\approx Schrödinger equation).

Axiom 2 [causality] (in Section 1.1)

(This will be explained more precisely in Section 1.5)

Let T be a **tree** (i.e., semi-ordered tree structure). For each $t(\in T)$, a basic structure $[\mathcal{A}_t \subseteq \mathcal{N}_t \subseteq B(H_t)]$ is associated. Then, the **causal chain** is represented by a **sequential causal operator** $\{\Phi_{t_1, t_2} : \mathcal{N}_{t_2} \rightarrow \mathcal{N}_{t_1}\}_{(t_1, t_2) \in T_{\leq}^2}$.



Here, note that

- (A) the above two axioms are **kinds of spells** (i.e., incantation, magic words, metaphysical statements), and thus, it is impossible to verify them experimentally. **What we should do is not to understand the two, but to learn the spells (i.e., Axioms 1 and 2) by rote.**

In this sense, quantum language is a kind of metaphysics (\approx idealism). Therefore,

- (B) **The formation of quantum languages depends on human marvelous language ability**

♠**Note 1.1.** If metaphysics did something wrong in the history of science, it is because metaphysics

attempted to answer the following questions seriously in ordinary language:

(♣₁) What is ○○ (e.g., ○○ = measurement, probability, causality, space-time, etc.) ?

Although the question (♣₁) looks attractive, it is not productive. What is important is *to create a language* to deal with the keywords. So we replace (♣₁) by

(♣₂) How should ○○ (e.g., ○○ =measurement, probability, causality) be used ?

The problem (♣₁) will now be solved in the sense of (♣₂). If there are some failure in the history of philosophy, philosophers failed to propose a suitable language. It should be noted that Newton's success is due to the proposal of "the language called Newtonian mechanics". Recall that Newton mechanics does not answer the question "What are mass, force, acceleration?", but "How should they be used?" or equivalently, "How do they relate to each other?". That is, "[mass] · [acceleration] = [force]." Thus, I think that Newton's most important accomplishment is the following three (which are equivalent):

(b₁) making physics called Newtonian mechanics.

(b₂) proposing the worldview called Newtonian mechanics.

(b₃) making the language called Newtonian mechanics.

where these are equivalent: i.e., (b₁)≈(b₂)≈(b₃).

Similarly I think that the greatest task of philosophy is the following three: from the idealistic point of view,

(#₁) making a philosophy called □ □

(#₂) proposing a worldview called □ □

(#₃) making a language called □ □

where these are equivalent: i.e., (#₁)≈(#₂)≈(#₃). Our purpose is to show that □ □ = quantum language.

Thus we can answer the following problem from the quantum linguistic point of view:

Problem 1.1. Scientifically please answer to the problem:

- What is measurement, probability, causality?

[Answer]:

As mentioned in Note 1.1, the question: "What is measurement, probability, causality?" should be interpreted as the question: "How should the terms: measurement, probability, causality be used?". Since measurement, probability, causality are key-words of quantum language (i.e., Axioms 1 and 2), what is important is to use Axioms 1 and 2 appropriately. To this end, I recommend readers to read ref. [71] and this text carefully. □

♠**Note 1.2.** The above problem is the most difficult unsolved problem in the history of philosophy. The readers may be surprised at how easily this can be solved. I think many readers already know how powerful it is to create a proper language as the great success of Newtonian mechanics. Again, recall that Newtonian mechanics never answer to "What are forces, accelerations, and masses?". What Newtonian mechanics answers to is "How are used the terms: forces, accelerations, and masses?"

1.1.2 Linguistic Copenhagen interpretation (or in short, Linguistic interpretation)

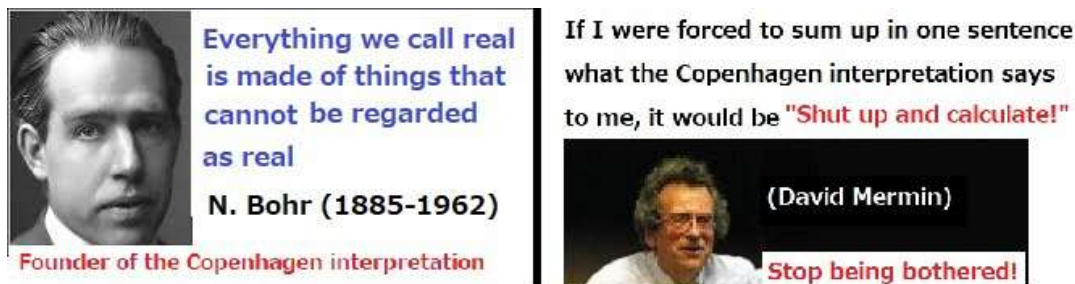

1.1.2.1 Descartes figure (the linguistic Copenhagen interpretation)

In the previous section, we introduced the outline of quantum language. Here, note that

(C₁) the axiom is a kind of spells (i.e., incantation, magic words, metaphysical statement), so that, it is impossible to verify it experimentally.

And thus, we say:

(C₂) Since quantum language is a language, it may be difficult to use it well at first. We need to make practice, and will master it only by trial and error.

♠**Note 1.3.** In Mermin's book [93], he said

- If I were forced to sum up in one sentence what the Copenhagen interpretation says to me, it would be **"Shut up and calculate"**
- Stop being bothered!

This means that "What is the Copenhagen interpretation? is unsolved problem. Thus, I assert that the linguistic Copenhagen interpretation is the true Copenhagen interpretation (cf. ref. [71]). That is, we assert that **the Copenhagen interpretation is justified in philosophy (i.e., language) and not in physics.**

However,

(C₃) if we want to master quantum language as quick as possible, we will need a good manual to use the axioms.

Here, we think that

**(C₄) the linguistic Copenhagen interpretation
= manual to use spells (Axioms 1 and 2)**

Since Axiom 1 includes the term "measurement", the concept of "measurement" should be, at first, understood in dualism (i.e., "observer" and "measuring object") as illustrated in Figure 1.2.

Figure 1.2. [Descartes Figure]: Image of "measurement(=Ⓐ+Ⓑ)" in dualism

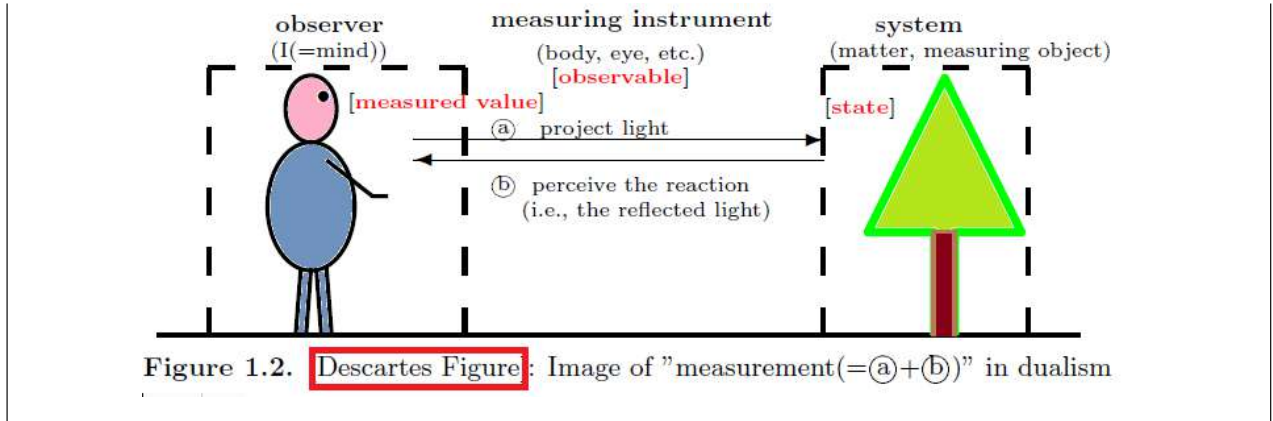

In the figure, "measurement" is characterized as interaction between "observer" and "system"(matter or object to be measured, measuring object), composed of

- (D₁) Ⓐ projection of light onto the object (i.e., someone, not necessarily an observer, shines the light.)
- Ⓑ perception of the reaction of the object (i.e., the observer receives the reaction.)

However, I want to emphasize that the interaction cannot be represented by kinetic equations. Therefore,

(D₂) in measurement theory (= quantum language), we use the term "measurement" instead of "interaction". Therefore, we won't say the above (D₁) outright.

After all, we think that:

(D₃) there is no measured value without observer, and that measurement theory is composed of three keywords:

measured value , observable (= measuring instrument) , state .
 (observer, brain, mind) (telescope, thermometer, eye, ear, body, polar star) (matter, measuring object)

In view of the above figure, it might be called "ternary relation (or, trialism)" instead of "dualism". But, following the convention, we use "dualism" throughout this paper.

♠**Note 1.4.** (i): The following argument, called the Bohr-Einstein debates, is extremely profound (*cf.* Sec.9.4.3 Bohr-Einstein debates).

- For example, if the voltmeter needle points to 5V, but the observer doesn't see it, it's just a physical phenomenon. Therefore, Axiom 1 (measurement) is not required. However, in the dualistic position of introducing measurement into science, Axiom 1 is essential.

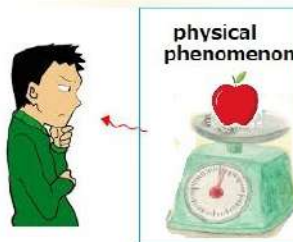

Einstein is the former position (i.e., monism) and Bohr is the latter (i.e., dualism). It's the biggest scientific debate of the 20th century, but it's not yet settled. My standing point is as follows.

- These two (monism and dualism) are not to be unified. As mentioned in Assertion 0.1 in Preface, they should be compatible.

(ii): The concept of "observable" (which can be identified with "measuring instrument") is not easy. For example, telescopes, glasses and eyes are a type of measuring instrument. A directional magnet is, of course, a measuring instrument. If so, then the polar star is also a type of measuring instrument.

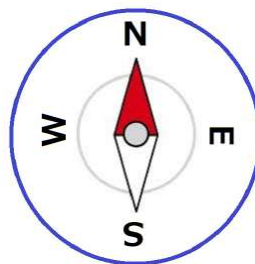
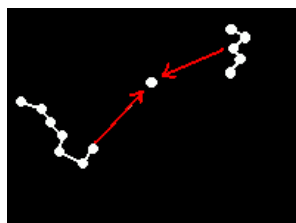

////

1.1.2.2 The linguistic Copenhagen interpretation [(E₀)-(E₇)]

The linguistic Copenhagen interpretation is "the manual to use Axiom 1 and 2". Thus, there are various explanations for the linguistic Copenhagen interpretations. However, it is usual to consider that the linguistic Copenhagen interpretation is characterized by statements in Panel (E), among which the most important is

(E₄) Only one measurement is permitted.

(E):The linguistic Copenhagen interpretation

With Descartes figure 1.2, i.e.,

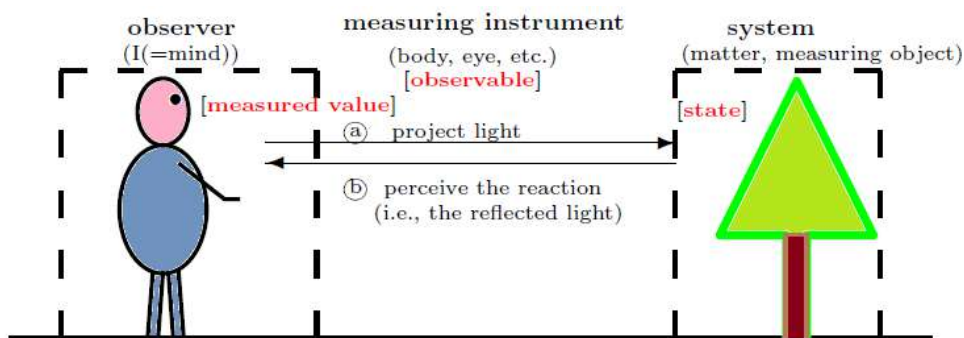
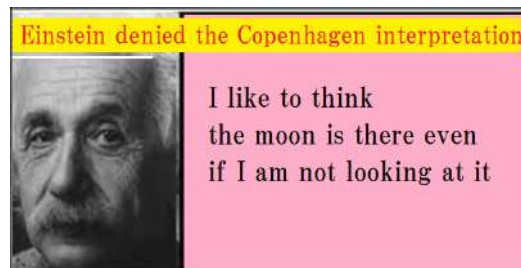
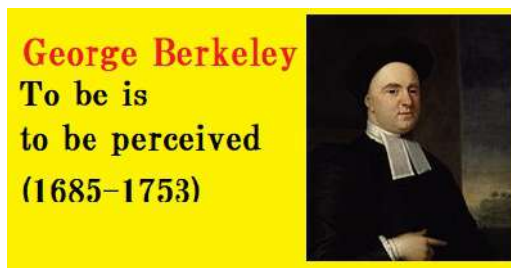

Figure 1.2. **Descartes Figure**: Image of "measurement(=(a)+(b))" in dualism

and the following (E₀)-(E₇) in mind, describe every phenomenon in terms of Axioms 1 and 2!

(E₀) (i); If you don't measure it, you don't know anything. Don't talk about things that cannot be measured. This seems to be Berkeley's saying "To be is to be perceived."



(ii); There in no scientific truth without experiment (= measurement). [Popper's Falsifiability; ref. [97]] In order to guarantee the objectivity of a scientific theory, there must be a possibility that the hypothesis will be disproved by experiment or observation. That is, truth must always be subjected to experiments that deny its truth. And if the denying experiment

is confirmed, then the truth must be rejected.

- (E₁) Consider the **dualism** composed of "observer" and "matter (= object to be measured)", where "observer" and "matter (= measuring object)" must be absolutely separated. Figuratively speaking, "Audience should not go on stage", or

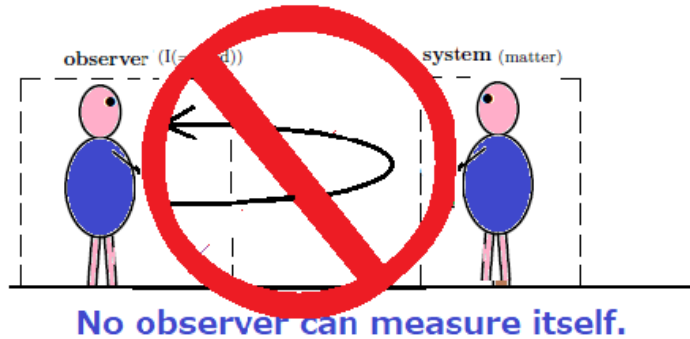

"the observer cannot measure the observer himself"

or

"The measurement is not dependent on the observer"

That is, the following qualia problem is non-sense.



To be more specific, the words "I", "Here", "Now" are forbidden. Hence, "I think, therefore I am" is non-sense.

♠**Note 1.5.** Consider the followings:

- (#₁) I measure my body temperature with a thermometer.
- (#₂) I feel my body feverish.

and

- (b₁) The doctor measures my body temperature with a thermometer.
- (b₂) The doctor feels my body feverish.

In terms of measurement, (#₁) and (b₁) are the same. On the other hand, (#₂) and (b₂) are different. Thus, in the strictest sense, we consider that (#₂) cannot be regarded as a measurement. However, the (b₂) seems to be a measurement. This example will help you understand that cogito proposition "I think, therefore I am" in Chapter 8.

- (E₂) While "matter" is in the space-time, the observer is not. That is, observer's space-time does not exist. Thus, the question: "When, where and by whom was the measured value obtained?" is out of the scope of measurement theory. Thus, words such as "now," "here," and "I" should not be used in a scientific proposition. If you are going to use it, you need to be very careful. That is, there is no tense either in measurement theory or in science. The "tense" is a treasure trove of word play (*cf.* McTaggart's paradox, Russell's five-minute hypothesis).

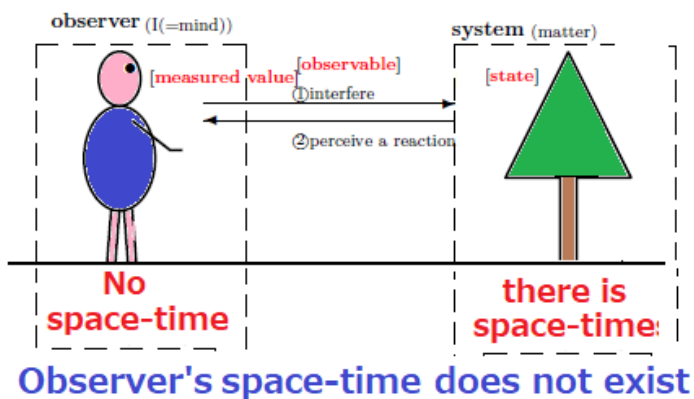

(E₃) In measurement theory, "observable(=measuring instrument≈body)" is the most important than "measured value(≈mind)" and "state(≈matter)" in (D₃).

(E₄) **Only one measurement is permitted.**

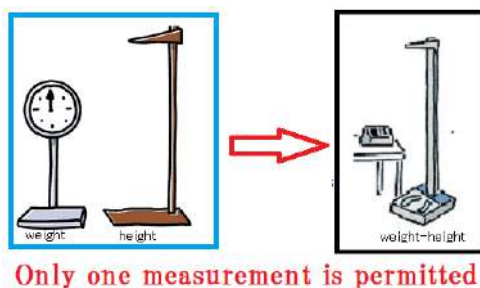

Thus, the state after measurement (or, wave function collapse, the influence of measurement) is meaningless.

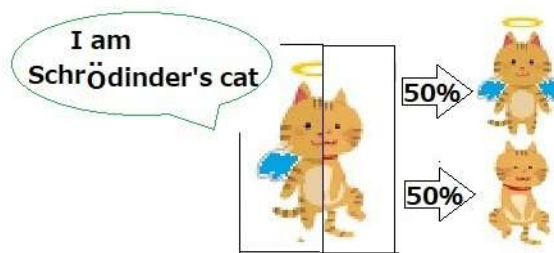

For the virtual wave function collapse, see:

ref. [63] S. Ishikawa, *Linguistic interpretation of quantum mechanics; Projection Postulate*, JQIS, Vol. 5, No.4 , 150-155, 2015, DOI: 10.4236/jqis.2015.54017
 (<http://www.scirp.org/Journal/PaperInformation.aspx?PaperID=62464>)

♠**Note 1.6.** The Schrödinger cat is the most famous paradox in quantum mechanics. However, we are not bothered by this paradox since the state after measurement is not described in quantum language.

(E₅) There is no probability without measurement. Also, the measurement cannot be measured.

There is no logic without measurement. See Assertion 0.1 in Preface such as

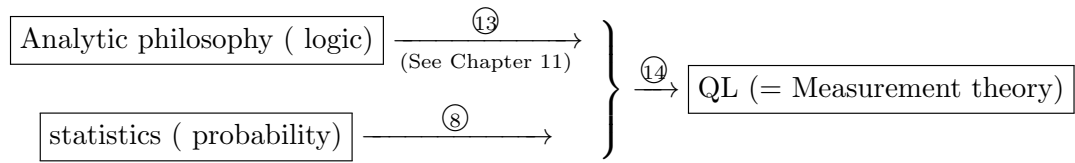

(E₆) State never moves. Thus, we always use the Heisenberg's picture (and not the Schrödinger picture)

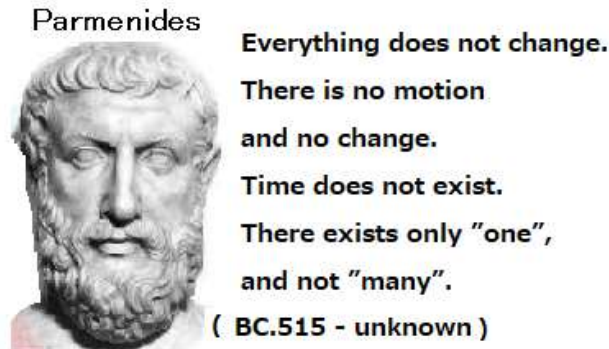

and so on.

Since it is believed that

quantum language is the final goal of dualistic idealism

(cf. ⑩ in Figure 0.1 in Assertion 0.1 (in Preface), it is deduced that

(E₇) most maxims of the philosophers (particularly, the dualistic idealism) can be regarded as expressions in linguistic Copenhagen interpretation.



For example, Locke's "Secondary quality", Berkeley's "To be is to be perceived", Kant's "Copernican revolution", Wittgenstein's "The limits of my language mean the limits of my world", "What we cannot speak about we must pass over in silence", etc. teach us the spirit of quantum language.

Some people may wonder (E₇). However, note

(F₁) Descartes=Kant philosophy and quantum language have the same purpose of pursuing dualistic idealism

Then, it is natural to consider

maxims of philosophers \approx the linguistic Copenhagen interpretation.

(F₂) : Now we can answer the following interesting question:

Why is philosophy (= dualistic idealism) preposterous?

Because

The linguistic Copenhagen interpretation is preposterous.

We assert the following.

Assertion 1.3. [descriptive power of quantum language](*cf.* ref. [71])

Roughly speaking,

- quantum language has a great descriptive power more than statistics.

Therefore, we assert that

(G₁) **quantum language is a language, by which most sciences (e.g., economics, psychology, engineering, etc.) are described**

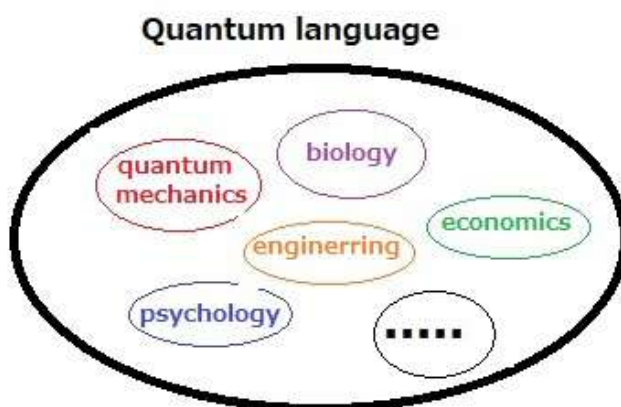

Quantum language is a language, by which we cannot only describe quantum mechanics but also most sciences (e.g., economics, psychology, engineering, etc.). Thus, as a modified version of "statistics is the language of science", we consider that

(G₂) **Quantum language is the language of science,**

or,

to do sciences is to describe phenomena by quantum language

However, it should be noted that quantum language is not almighty, for example, the theory of relativity is beyond the description of quantum language.

♠**Note 1.7.** It is one of the roles of the linguistic Copenhagen interpretation to exclude a scientifically nonsense propositions from quantum language. For example,

(‡₁) Cogito proposition "**I think, therefore I am**" is not the proposition within quantum language.

In cogito proposition, we see that "observer"="I" and "object to be measured"="I", which is inconsistent with that the above (E₁). Thus, cogito proposition is not a proposition in quantum language. This will be discussed again in Proposition 8.3.

Next,

(‡₂) The hypothesis that **the world was created five minutes ago** (due to B. Russell in Sec.11.4)

is not within quantum language.

That is because this hypothesis is considered under the premise such that the observer's time, which is prohibited by (E_2) .

1.2 The history of worldview and our purpose

1.2.1 Quantum language in the history of worldviews

We assert that, in the history of worldview, quantum language is located as follows.

Assertion 1.4. (= Assertion 0.1 in Preface) [The location of quantum language in the history of world-description (*cf.* ref.[47, 71])]

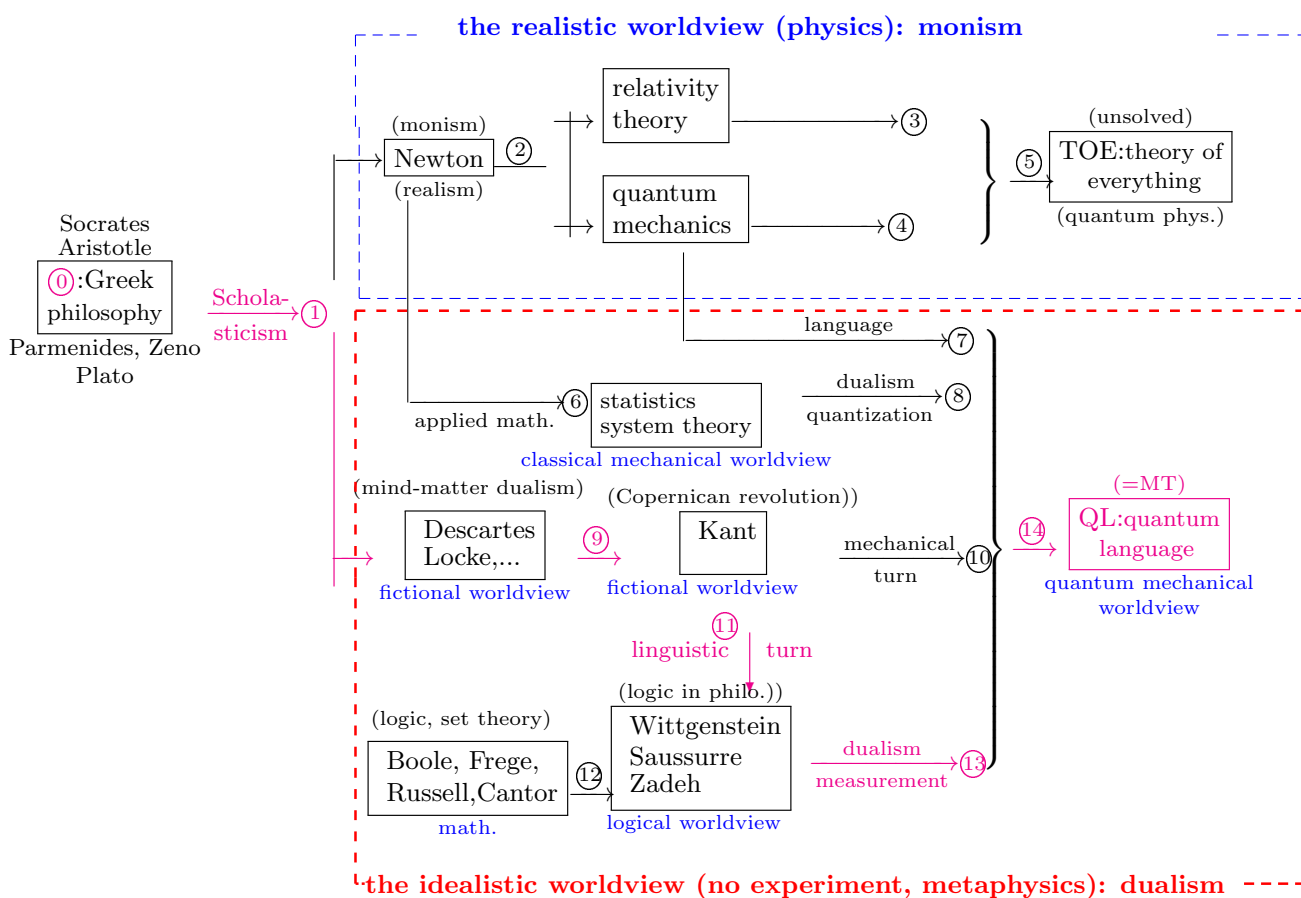

Figure 0: The history of the world-descriptions
Philosophy (\approx dualistic idealism) has progressed toward QL
 (i.e., ① \rightarrow ② \rightarrow ⑨ \rightarrow ⑪ \rightarrow ⑬ \rightarrow ⑭)

Therefore, quantum language has the following four aspects:

The four aspects of quantum language

$$= \left\{ \begin{array}{l} \textcircled{7}: \text{the linguistic turn of quantum mechanics} \\ \text{(i.e., the true color of the Copenhagen interpretation)} \\ \textcircled{8}: \text{the dualistic reconstruction of statistics} \\ \textcircled{10}: \text{the final goal of dualistic idealism} \\ \text{(i.e., the linguistic and mechanical turn of the Descartes=Kant epistemology)} \\ \textcircled{13}: \text{the measurement theoretical understanding of Wittgenstein's picture theory} \end{array} \right. \quad (1.2)$$

♠**Note 1.8.** I cannot answer the question: "What is quantum mechanics in physics?", since this is related to ⑤ in the above figure. However, I am convinced that our interpretation (i.e., the linguistic Copenhagen interpretation) is the true color of the Copenhagen interpretation.

1.2.2 Our purpose

Our purpose is to answer the problem "Has western philosophy made progress?", and to conclude the following Assertion 1.5.

In this paper I assert that

Has western philosophy (particularly, dualistic idealism) made progress?

Assertion 1.5. (A) If "to make progress" is defined by "to come near quantum language", we can say that the time series [① → ② → ③ → ④ → ⑤ - ⑥] can be regarded as progress, or more precisely,

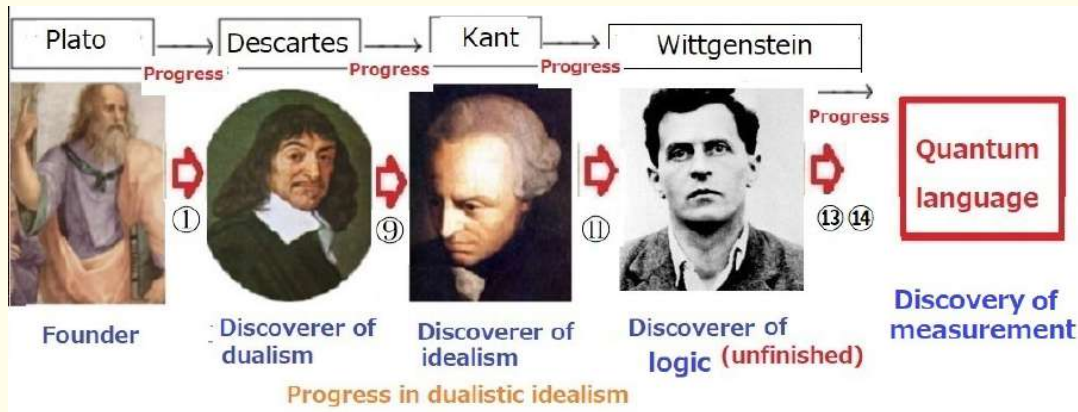
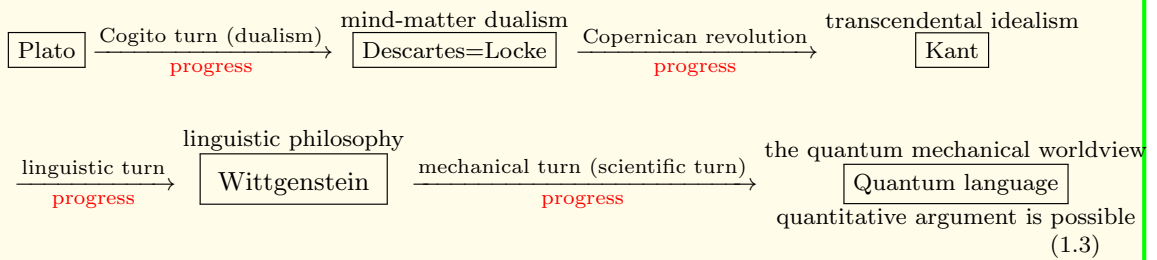

The name of "scientific turn" is due to the fact that quantitative argument is possible in quantum language and that it is only quantum language which scientists need in above-mentioned. Thus, we conclude that

(B) a scientific perfection of dualism and idealism^a is realized by quantum language.

^a Throughout this paper, it suffices to consider that "idealistic" ≈ "linguistic" ≈ "metaphysical" (cf. Definition 1.8)

It is sure:

(C) if someone believes that he/she finds the theory beyond ⑥, he/she certainly wants to talk about the landscape [① - ② - ③ - ④ - ⑤] seen from the theory.

This will be done in this paper.

It should be noted that most unsolved problems in the history of western philosophy are caused by insufficient understanding of idealism and dualism. Thus, if the (B)[a scientific perfection of dualism and idealism is realized by quantum language] is true, we can expect that most unsolved problems can be solved in the framework of quantum language (cf. (D) in Preface). In fact, in this paper we show the solutions of

the following problems

List 1.6. It is said that

- Wittgenstein carried out one of the most ambitious attempts in the history of philosophy to solve all the problems of philosophy at once in [117]: "Tractatus Logico-Philosophicus (abbreviated as TLP)".

However, 100 years later, we can't say that he succeeded in his challenge. However, as the following list shows, QL realized his dream.

(D₁) Almost famous unsolved problems concerning dualistic idealism can be solved in QL

- What is probability (or, measurement, causality) ? *cf.* Sec. 1.1.1)
- The solution of Zeno paradox (Flying arrow, Achilles and a tortoise), (*cf.* ref. [45], or, Sec. 2.4.2, Sec. 2.4.3)

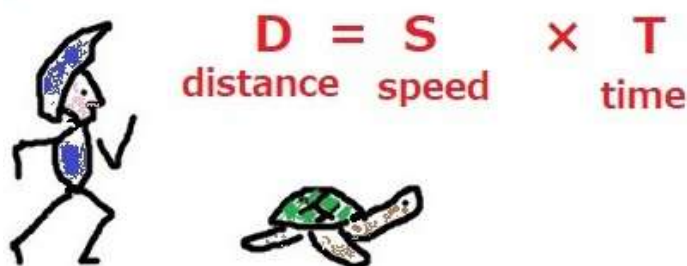

("to solve Zeno paradox" = "to understand DST-formula" (*cf.* Sec. 2.4.3)

- the measurement theoretical understanding of Plato's allegory of the sum , (*cf.* Sec. 3.3.2)
- Plato's Idea theory ≈ Zadeh's fuzzy theory ≈ Sausuure's linguistic theory (*cf.* Sec. 3.5.3)
- Syllogism does not always holds in quantum systems (*cf.* Sec. 4.3.3)
- Syllogism always holds in classical and quantum systems (*cf.* Remark 12.9 in Sec. 12.1)
- Only the present exists (*cf.* Sec. 6.1.2)
- What is the problem of universals? (*cf.* Sec. 6.5.1)
- What is Geocentrism vs. Heliocentrism? After all, the worldviewism (*cf.* Sec. 7.4)
- Two (scientific or non-scientific) interpretations of I think, therefore I am .(*cf.* Sec. 8.2.2)
- Leibniz-Clark correspondence (i.e., what is space-time?), (*cf.* Sec. 9.3)
- The problem of qualia (*cf.* Sec. 9.5.1)
- Brain in a vat argument (*cf.* Sec. 9.5.2)
- The solution of Hume's problem of induction (*cf.* Sec. 9.7.1)
- grue paradox cannot be represented in quantum language (*cf.* Sec. 9.8)
- What is causality? (*cf.* Sec. 10.2)
- What is Peirce's abduction? (*cf.* Sec. 11.4.1)
- Five-minute hypothesis (*cf.* Sec. 11.5.2)
- McTaggart's paradox (*cf.* Sec. 11.5.3)
- quantitative representation of "Signifier" and "signified" (*cf.* Sec. 12.1)
- My scientific understanding of "Tractatus Logico-Philosophicus (=TLP)" and "Zadeh's fuzzy sets" (*cf.* ref. [78], or Sec. 12.1)

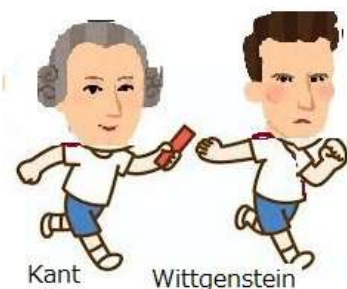

That is, Wittgenstein took over the baton of "dualistic idealism (i.e., the mainstream of philosophy)" from Kant. This is essentially important, since Wittgenstein's picture theory must belong to

dualistic idealism in order to assert 1.4 (= Assertion 1.5)

- Lewis Carroll's paradox (*cf.* Sec. 12.4)
- Flagpole problem, (*cf.* Sec. 12.5)
- Hempel's raven paradox (*cf.* Sec. 12.6)
- the mind-body problem (i.e., How are mind and body connected?), (*cf.* Sec. 12.7)

Also, for the solutions of unsolved problems in quantum mechanics, statistical mechanics, statistics and probability theory, see ref. [71]), that is,

(A₁) ref. [71]: S. Ishikawa, "Linguistic Copenhagen interpretation of quantum mechanics: Quantum Language [Ver. 5]", Dept. Math. Keio University, 2019, KSTS/RR-19/003, 473 pages
(http://www.math.keio.ac.jp/academic/research_pdf/report/2019/19003.pdf)

The list will be written is in (D₂) in Chap. 13: "Postscript."

Since most unsolved problems are easily solved in quantum language, we can be convinced that

quantum language is the final goal of the dualistic idealism[⑩ - ① - ⑨ - ⑩]

♠**Note 1.9.** It should be noted that Einstein's success is due to the proposal of "the language called the theory of relativity". On the other hand, I think that

(#₄) *philosophers failed because they did not propose a suitable language.*

Talking cynically, we say that

(#₅) Philosophers has investigated "linguistic Copenhagen interpretation" (= "how to use Axioms 1 and 2") without language (i.e., Axiom 1 (measurement) and Axiom 2 (causality)).

Therefore, in most cases many philosophers wander. However, great philosophers rarely miss the point. For example, Wittgenstein could only incompletely propose his language, but he left the maxim such that

(#₂) "The limits of my language mean the limits of my world"

which is just the spirit of quantum language (as mentioned in Chapters 11 and 12).

1.3 Realistic worldview and idealistic worldview

1.3.1 The worldviewism

The **worldviewism** is

the spirit that "Start from worldview!".

That is,

(A): The worldviewism

The worldviewism has the following form:

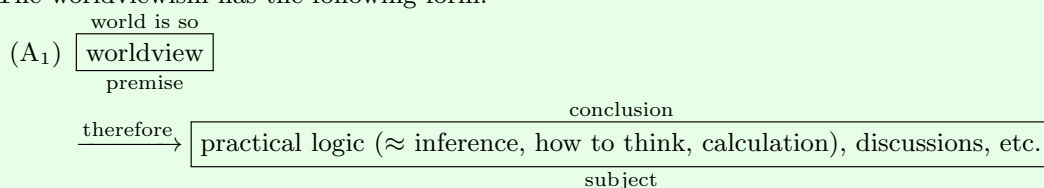

That is,

(A₂) **Since the world is like this, think like this!**

That is, the worldviewism is the spirit such that "Start from worldview!". I think that

(A₃) It's not an exaggeration to say **"philosophy = worldview"**.

[Remark] This is not trivial. That is because the above (A) says that the worldview is greater than logic. That is,

"logic" (precisely, "practical logic") is created by a worldview.

(*cf.* Section 2.4.1 [Zeno's paradoxes], Section 4.3.2 [Aristotle's syllogism] etc.).

Arguing repeatedly in this paper, we consider that the ignoring of the worldviewism (or, relying on a bad worldview) causes that philosophy falls into a blind alley. Slogan-wise, we say

(A₄) **Without a worldview, there is no logic (i.e., no calculation)**

(A₅) **Without a worldview, we can't have any discussion.**

(A₆) **Paradoxes arise from a lack of worldview.**

•

♠**Note 1.10.** Without a worldview, we have paradoxes as follows.

- Zeno's paradoxes (*cf.* Sec. 2.4.2)
- The solution of Hume's problem of induction (*cf.* Sec. 9.7.1)
- grue paradox cannot be represented in quantum language (*cf.* Sec. 9.8)
- Lewis Carroll's paradox (*cf.* Sec. 12.4)
- Wittgenstein's paradox (*cf.* Sec. 12.2.3)

As mentioned in Chapter 11 later, I think what makes analytic philosophy useless is that analytic philosophy does not follow worldviewism, but uses "logic".

////

The following questions often appear in philosophy:

Does time exist?	Does I exist?
Does position exist?	Does velocity exist?
Does beauty exist?	Does mathematics exist?
Does a particle exist?	Does motion exist?
Does God exist?	

However, these statements are ambiguous since the term "exist" (or "to be") is not determined. Thus I think as follows.

Definition 1.7. ["existence" (i.e., "to be")]

Fix a worldview. Then, we say "[X] exists", if [X] is a keyword in the worldview (or more generally, if [X]

is a thing that can be expressed using these keywords)

Remark: For example, in Newtonian mechanics, "velocity", "acceleration", "force", etc. exist. Also, if we see Christianity as a kind of worldview, we say that God exists. In the cases of QL, the followings are most essential:

measured value, observable, state, causal map

We begin with the following definition:

Definition 1.8.

["realism", "idealism"], ["monism", "dualism"]

- (B) realism := a worldview (or, theory) that requires experimental verification.
idealism := a worldview (or, theory) that does not necessarily require experimental verification.
("idealism" is also called "linguistic theory", "non-realism" or "metaphysics" in this paper)
- (C) monism := a worldview about objects
dualism := a worldview about humans and objects, (i.e., a theory with "observers" and "measuring objects")

Though the above is quite rough, it is sufficient to read this paper. I think that there is no strict definition in philosophy (not mathematics). And the more rigorous we try to say it, the more imprecise it becomes.

♠**Note 1.11.** The rule of philosophy (\approx idealism) is as follows:

- #1) Only discussion, no experimentation.
- #2) the winner will be determined by popularity vote of the general public.



As seen in Assertion 1.4, we have the following classification of philosophies:

Classification 1.9. [(D): Classification of worldviews]

- (b₁) : the realistic worldview : Aristotle, Archimedes, Galileo, Newton, Einstein
(monism)
- (b₂) : the idealistic worldview (dualism)
 - (b₂₁): the fictional worldview (\approx western philosophy)
Plato, Descartes, Locke, Kant
 - (b₂₂): the logical worldview (=the logical spirit =the spirit of "Think logically!") (\approx analytic, scientific phil.)
Frege, Saussure, Russell, Wittgenstein...
 - (b₂₃): the mechanical worldview
statistics, quantum language

Throughout this paper, we explain that

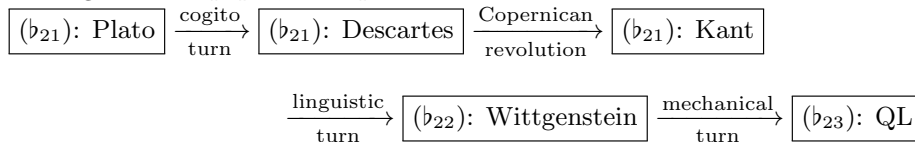

- (b₃)Others (Thinking Tip, etc.) : Darwin's theory of evolution, Hegel's dialectic, etc.
- (b₄)mathematics

Particularly, we devote ourselves to (b₂), i.e.,

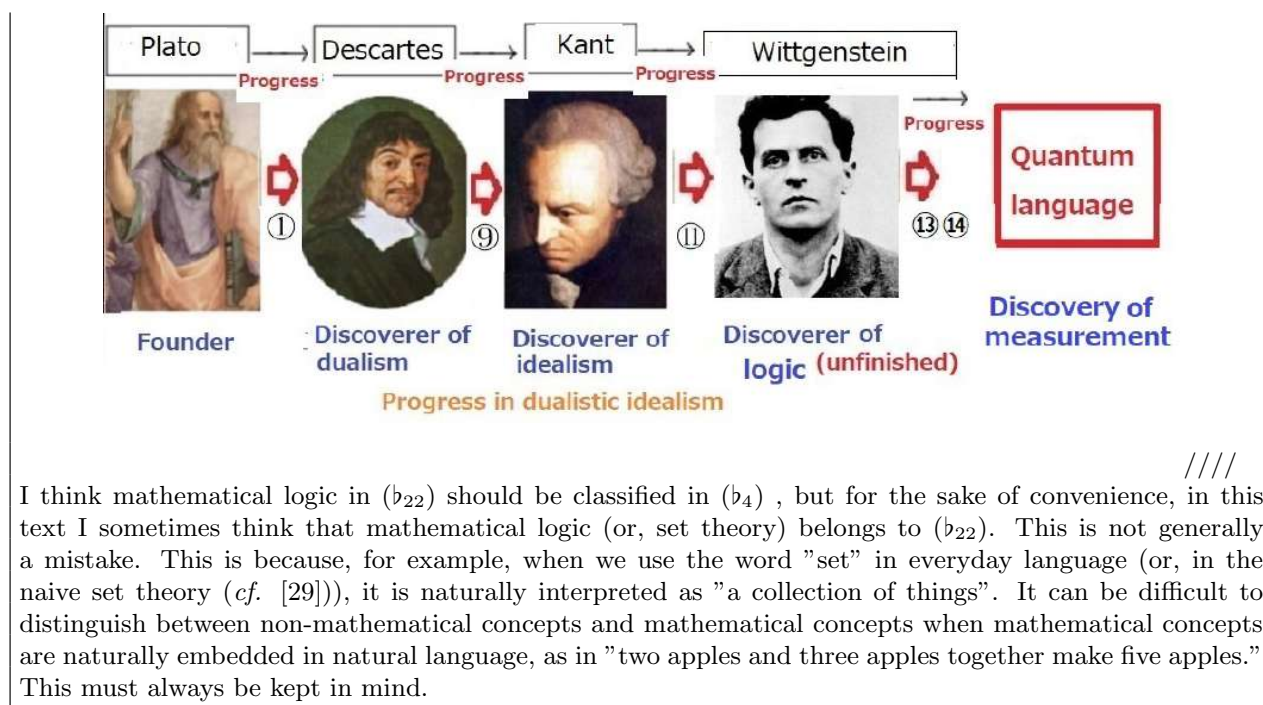

♠**Note 1.12.** Lord Kelvin (1824–1907) said

(#) Mathematics is the only good metaphysics.

The (b_2) , (b_3) and (b_4) are metaphysics, as they does not require experimental verification. For example, note that Darwin's theory of evolution has not been settled by experimental verification. Thus, if we believe the above (#), we must consider (b_2) , (b_3) and (b_4) as bad theories. However, I think that at least quantum language (which is not mathematics) is a good metaphysics. Hence, I think Kelvin is wrong.

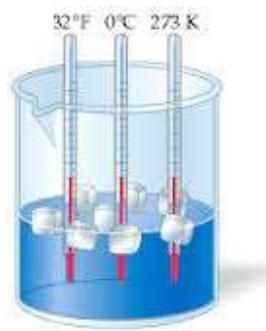
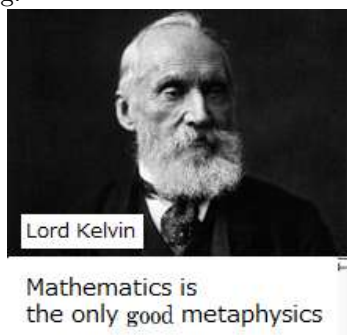

♠**Note 1.13.** For example, it is certain that

(#₁) there is no physics without the world

However,

(#₂) mathematics itself is not related to the world. In an extreme case, there may exist mathematics without the world

Therefore, it is natural to consider that mathematics is not a kind of worldview. Truth be told, I think

(#₃) mathematical theory (including logic, set theory, category theory) has nothing to do with worldview.

However, for example, consider the term: "set", which is the term in ordinary language as well as mathematics. Thus, some may comes up with the idea (which may be called the set theoretical worldview) of describing the world through the naive set theory (and not the axiomatic set theory). This set theoretical worldview is rather general in science. In Chap. 12, we will see that this worldview triggers the flagpole problem and Hempel's raven paradox.

I also think of symbolic logic as a tool for constructing mathematics, but some people may have the idea

(which may be called the logical worldview (=the logical spirit =the spirit of "Think logically!")) that modal logic can be used to describe the world. Thus, the relationship between logic and philosophy varies somewhat from researcher to researcher. Also, it is sure that some philosophers consider that logic is one of field of philosophy. Therefore, in spite that I believe in (#3), in this paper,

(#4) **logic (or, set theory) is regarded as a worldview called the logical worldview (=the logical spirit=the spirit of "Think logically!")**.

However, I think the chances of the logical worldview succeeding are very small. In fact, in Chapters 11 and 12. we will see that the logical worldview (=the logical spirit=the spirit of "Think logically!") was not very successful.

////

More precisely, let us examine the above (D):

(b₁) **the realistic worldview (= physics)**

The world is ruled by Newtonian mechanics
worldview
premise,law $\xrightarrow{\text{therefore}}$ Heliocentrism is true
discussions, calculation, practical logic, properties
discussion

where "therefore" is **reliable**

and

(b₂₁) **the fictional worldview (≈ western philosophy)**

invisible man exists
worldview (literary truth, pseudo- truth)
(fictional)premise $\xrightarrow{\text{therefore}}$ don't steal a glance
ethics, practical logic, discussions
main subject

where "therefore" is **not necessarily reliable**

and

(b₂₂) **the logical worldview (=the logical spirit=the spirit of "Think logically!") (≈ Analytic philosophy)**

Describe the world by symbolic logic, set theory
worldview (symbol logic, set theory)
Axiomatic logic $\xrightarrow{\text{therefore}}$ A → B, B → C, therefore, A → C
calculation, discussions, properties
theorem

where "therefore" is **not necessarily reliable**

and

(b₂₃) **the mechanical worldview (= the classical and quantum mechanical worldview)**

Describe the world by (mechanical) language
worldview
language inspired by mechanics $\xrightarrow{\text{therefore}}$ If an apple falls, it has a cause.
calculation, practical logic,properties
discussions

where "therefore" is **reliable**

1.3.2 The realistic worldview(physics) (b_1)

(E): The realistic worldview (physics) (b_1)

The realistic worldview has the following form:

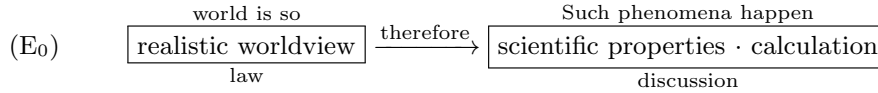

where "therefore" is **reliable**

Hence,

- (E₁) [world is so] is a law, truth, (which should be verified by experiment),
- (E₂) [such phenomena happen] is a consequence

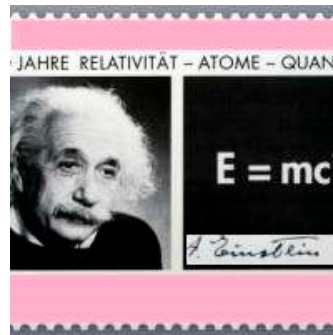
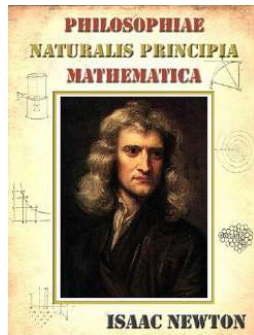

As examples of the realistic worldview, we see that

Newtonian mechanics, electromagnetism, theory of relativity, etc.

For example,

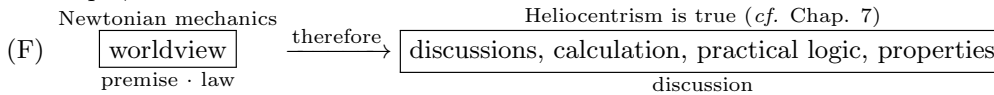

Note that the realistic worldview (=physics) is the most authorized.

1.3.3 The idealistic worldview (b_2)

In what follows, consider the idealistic worldview (b_2) in

1.3.3.1 The fictional worldview (Wester philosophy) (b_{21})

Our main theme of the preprint is the following fictional worldview:

(G): The fictional worldview (western philosophy) (b₂₁)

The fictional worldview (in Plato’s way of telling philosophy) is as follows.

(G₀) $\begin{matrix} \text{world is so} \\ \boxed{\text{fictional worldview (literary truth)}} \\ \text{preface, introduction, (fictional)premise, expedient} \end{matrix} \xrightarrow{\text{therefore}} \begin{matrix} \text{you should do so} \\ \boxed{\text{practical logic, ethics, morals}} \\ \text{main subject} \end{matrix}$

where "therefore," is **not necessarily reliable**

Therefore,

(G₁) [world is so] is secondary,
 (G₂) [you should do so] is main theme

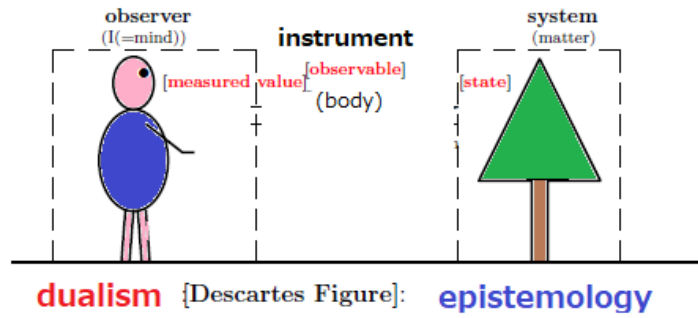

For example,

(H₁) $\begin{matrix} \text{invisible man exists} \\ \boxed{\text{fictional worldview (literary truth, pseudo- truth)}} \\ \text{(fictional)premise} \end{matrix} \xrightarrow{\text{therefore}} \begin{matrix} \text{don't steal a glance} \\ \boxed{\text{discussions, properties}} \\ \text{main subject} \end{matrix}$

and

(H₂) $\begin{matrix} \text{ultimate beauty exists} \\ \boxed{\text{fictional worldview (literary truth, pseudo- truth)}} \\ \text{premise, fiction} \end{matrix} \xrightarrow{\text{therefore}} \begin{matrix} \text{she is an embodiment of beauty.} \\ \boxed{\text{ethics, morals, aesthetic sense}} \\ \text{main assertion} \end{matrix}$

The fictional worldview forms the main current of western philosophy such as

Plato, Descartes, Locke, Hume, Kant,

etc.

□

1.3.3.2 the logical worldview (=the logical spirit=the spirit of "Think logically!") (analytic philosophy) (b₂₂)

(I₁): the logical worldview (=the spirit of "Think logically!") (axiomatic logic) (b₂₂)

As mentioned in Note 1.13, I think:

(I₁) **the logical worldview (=the logical spirit=the spirit of "Think logically!") (or, set theoretical worldview)**

Describe the world by symbolic logic, set theory $\xrightarrow{\text{therefore}}$ understandable propositions (cf. Remark 1.10)
 worldview (symbol logic, set theory) $\xrightarrow{\text{therefore}}$ scientific discussions
 Axiomatic logic science, science philosophy

where "therefore" is **not necessarily reliable**

Main philosophers (mentioned in this paper) are as follows.

Boole, Frege, Peirce, Russell, Wittgenstein, Hempel, Quine, Popper, Zadeh,...

However, concerning Boole, Frege, Russell, I can only understand their mathematics, but not their philosophy, since I think that the logical worldview (=the logical spirit=the spirit of "Think logically!") is not true worldview.

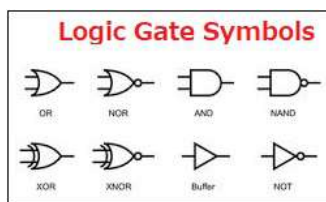

In ref. [117]: "Tractatus Logico-philosophicus", Wittgenstein opposed the straightforward introduction of mathematical logic into philosophy, but it was incomplete. It is my opinion that his spirit has come to fruition as fuzzy logic in QL (cf. Sec. 12.1).

Remark 1.10. The above (I₁) is motivated by the following:

Describe mathematics by logic, set theory
 (I₂) **axiomatic logic, set theory** $\xrightarrow{\text{therefore}}$ mathematics
 Axioms theorem

where "therefore" is **completely reliable**

This is the greatest achievement of mankind, which was completed by Cantor, Zermelo=Fraenkel, etc. Thus, many philosophers might consider that

(J) (I₂) is the greatest, hence, (I₁) is also promising.

This optimistic outlook, I believe, prompted the birth of analytic philosophy (Frege, Russell, etc.). To answer "Why does logic work in our world?", The proposal of fuzzy logic in QL was indispensable (cf. Sec. 12.1).

♠**Note 1.14.**

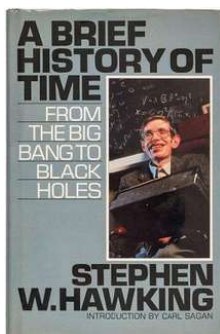

Dr. Hawking said in his best seller book [27]:

- However, in the nineteenth and twentieth centuries, science became too technical and mathemat-

ical for the philosophers, or anyone else except a few specialists. Philosophers reduced the scope of their inquiries so much that Wittgenstein the most famous philosopher this century, said "The sole remaining task for philosophy is the analysis of language." What a comedown from the great tradition of philosophy from Aristotle to Kant!

I agree to him. And thus, I may not appreciate analytic philosophy. In this paper, I think that one of the main purposes of western philosophy (from Plato to Kant) is to clarify dualistic idealism. To be honest, I have no clear answer on "What is the purpose of analytic philosophy?" However analytic philosophy (or, linguistic philosophy) is important since it bridges between the fictional worldview and the quantum mechanical worldview. That is,

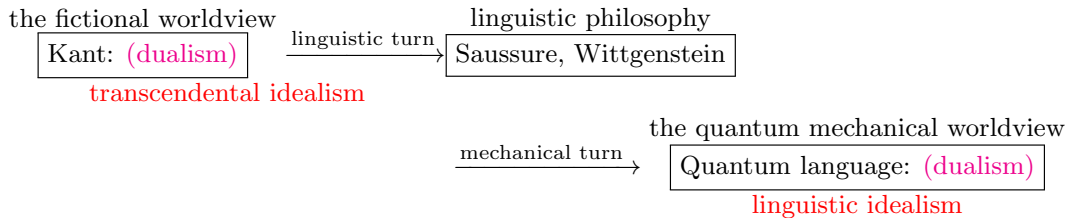

♠**Note 1.15.** Readers should not confuse two logics (i.e., axiomatic logic and practical logic) such that (1.4)

- (K) {
- (K₁): axiomatic logic (i.e., mathematical logic) in (I₁) or (J₁)
 - propositional logic, predicate logic, modal logic, temporal logic,
 - intuitionistic logic, quantum logic, etc.
 - (K₂): practical logic in (A) (i.e., logic generated from worldview, or, inference)
 - e.g., the logic of Newton mechanics, statistical inference in statistics, etc.

Recall the worldvism (A), i.e.,



That is, **"logic" (precisely, "practical logic") is created by a worldview.** As mentioned in (A), we see:

- Newtonian mechanics has the logic specific to Newtonian mechanics.
- Statistics has the logic specific to statistics (i.e., statistical inference).
- quantum language has the logic specific to quantum language.
-

Slogan-wise, we say

- **Without a worldview, there is no logic**
- **Without a worldview, there is no discussion**
-

I have an opinion that philosophers should be more interested in practical logic than in mathematical logic. Also,

(L) I don't think the mathematical achievements of the logical worldview (=the logical spirit=the spirit of "Think logically!") (e.g., modal logic, temporal logic, etc.) were very successful as philosophy.

That is because these were powerless in solving unsolved philosophical problems, compared to quantum language (*cf.* List 1.6).

1.3.3.3 The mechanical worldview (statistics, quantum language) (b₂₃)

In the era after Kant, disciplines (i.e., mathematics, physics, medicine, chemistry, biology, economics, psychology, etc.) were born one after another, and the weight of philosophy became smaller in the whole discipline. Therefore, philosophy is no longer regarded as the king of academia. But that doesn't mean that philosophy has run out of material. I think there is still a lot of work to be done on the scientification of "dualistic idealism."

(M): The mechanical worldview (Statistics, quantum language) (b₂₃)

The mechanical worldview is as follows.

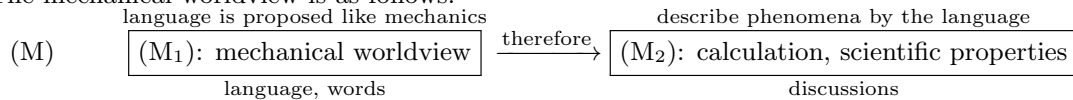

where "therefore" is **reliable**

Therefore,

(M₁) [language is proposed], that is, "establish the verbal system"

(M₂) [describe phenomena by the mechanical language]

The key words are "measurement" and "causality" as follows.

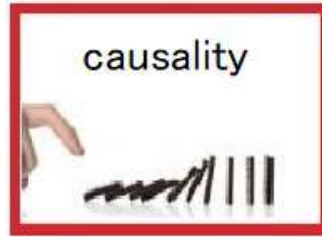

For example, it suffices to consider statistics (and moreover, quantum language). Also, recall that

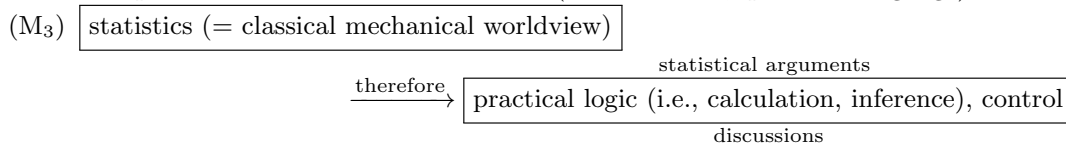

It was such a huge success that it has been said:

(M₄) **statistics is the language of science**

Also,

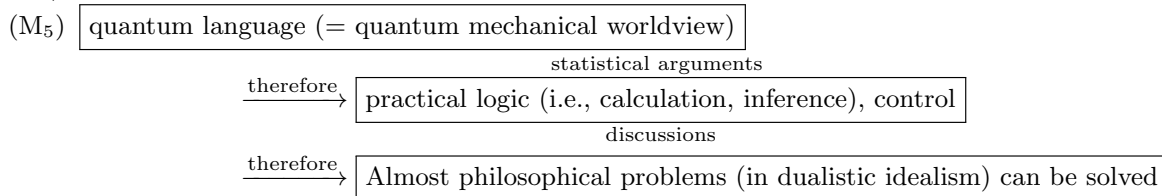

(M₆) **QL can explain "Why does logic work in our world?"** (cf. Sec. 12.1)

Assertion 1.3 says that, for example,

- Economics is to describe economical phenomena in terms of quantum language (or statistics)
- psychology is to describe psychological phenomena in terms of quantum language (or statistics)

1.4 Preview of the assertions in this paper

1.4.1 Realistic worldview?, (fictional, mechanical) worldview?

Classification 1.11. [= **Classification 1.9: the realistic worldview, the fictional worldview, the logical worldview (=the logical spirit=the spirit of "Think logically!"), the mechanical worldview**]

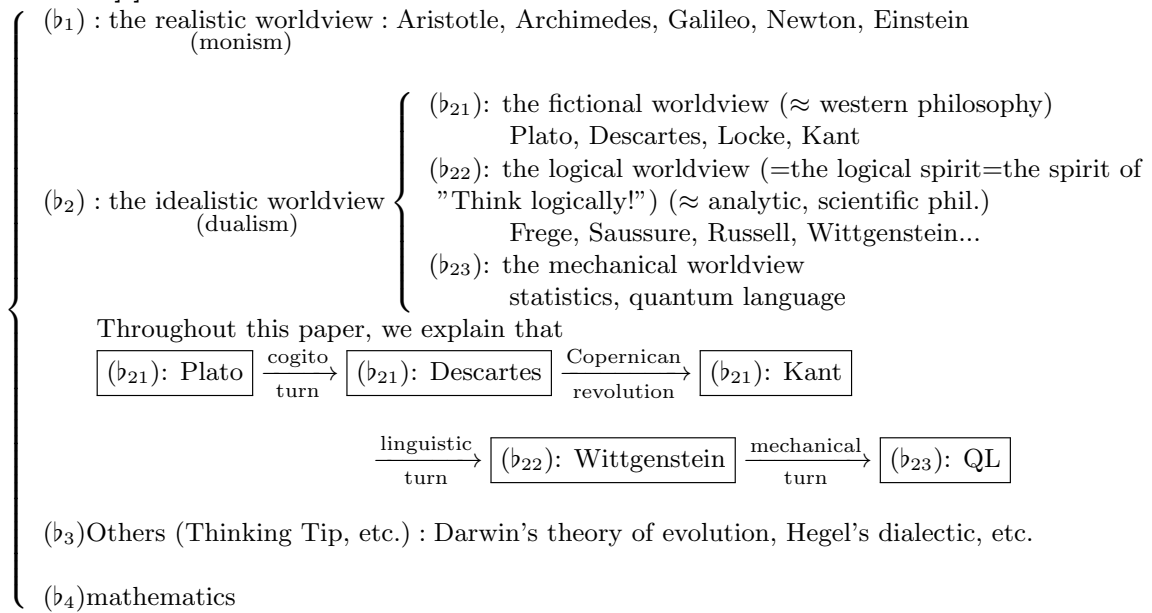

Particularly, we devote ourselves to (b₂), i.e.,

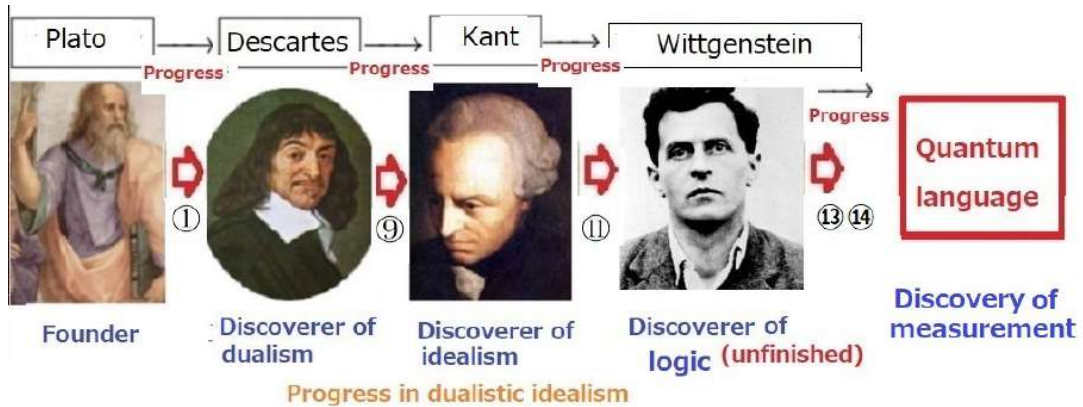

////
I think mathematical logic in (b₂₂) should be classified in (b₄) , but for the sake of convenience, in this text I may think of a field of mathematics as a kind of worldview. That is because, compared to people in science, philosophers like the word "logic".

Assertion 1.12. [Dispute: realistic worldview vs. idealistic worldview]

"realistic worldview? idealistic worldview?" is the biggest dispute in the history of philosophy. However, from our view-point, the two have to exist together as follows.

Table 1.1 : realistic worldview vs. idealistic worldview

dispute \ [R] vs. [L]	Realistic worldview (monism, realism, no measurement)	Idealistic worldview (dualism, idealism, measurement)
Ⓐ: motion	Hērakleitos	Parmenides
Ⓑ: Ancient Greece	Aristotle	Plato
Ⓒ: Problem of universals	"Nominalismus" (Ockham)	"Realismus" (Anselmus)
Ⓓ: space-time	Newton	Leibniz
Ⓔ: quantum theory	Einstein	Bohr
Ⓕ: philosophy of science	Carnap	Quine

Ⓐ is my fiction, Ⓒ is a confusion. Ⓓ is the Leibniz=Clarke correspondence (*cf.* Sec. 9.3.2), Ⓔ is Bohr-Einstein debates. Quantum language is proposed as one of answers to Bohr-Einstein debates (*cf.* ref. [71]). Ⓕ: Quine understood the spirit of the linguistic Copenhagen interpretation (i.e., "If you don't measure it, you don't know anything") in the Carnap=Quine debate (*cf.* Sec. 13.3).

1.4.2 Keywords: Monism and dualism

Recall Figure 1.2 (in Section 1.1.2: The linguistic Copenhagen interpretation) below:

Figure 1.13. (Figure 1.2 in Section 1.1.2) [Descartes Figure]: Image of "measurement(=Ⓐ+Ⓑ)" in dualism: **dualism** and **monism**

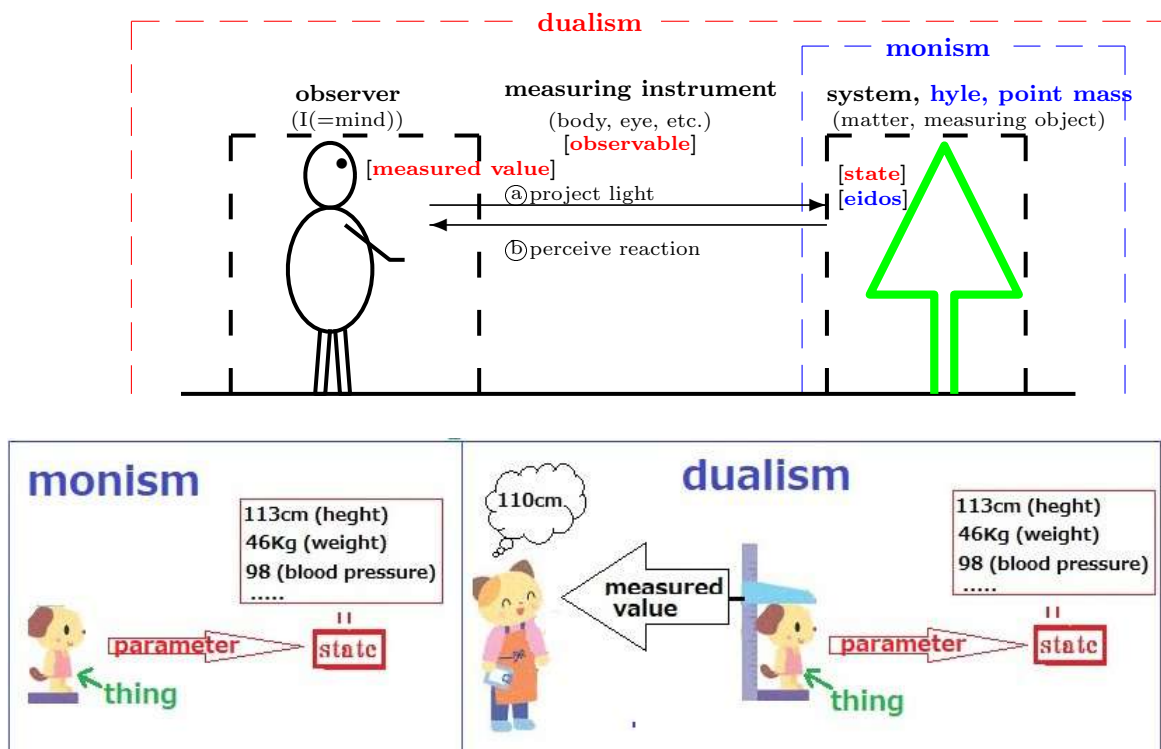

Assertion 1.14. [The correspondence of key-words]

It is a matter of course that each worldview has the corresponding key-words. If Western philosophy (i.e., worldview) makes progress, its key-words are naturally refined and clarified. The key-words' progress of the realistic worldview [resp. idealistic worldview] is written as follows.

[The key-words of the **dualism**] The idealistic worldview is the mind-matter dualism, which is composed of three key-words, that is, [A](= mind), [C](= matter) and [B](= body: something connecting [A:mind] and [C:matter]). Thus, we see that:

\	[A](= mind)	[B](Mediating of A and C)	[C](= matter)
Plato	actual world	Idea	/ [Idea world]
Thomas Aquinas	universale post rem	universale ante rem	/ [universale in re]
Descartes	I, mind, brain	body	/ [matter]
Locke	mind	secondary quality	primary quality [matter]
Berkeley	mind	secondary quality	/ [God]
Kant	phenomenon	cognition	/ [thing-in-itself]
Saussure Zadeh	/	signified [signifier] fuzzy set (= membership function)	/
Wittgenstein	truth value	[proposition]	logical space [object]
statistics	sample (space)	/ [trial]	parameter [population]
quantum mechanics	measured value	observable [measurement]	state [particle]
quantum language	measured value	observable [measurement]	state [system]

[The key-words of the **monism**] The realistic worldview is monism, and its completed version is realized as Newtonian mechanics, whose key-words are only "point mass" and "state". Thus, we see:

\	[A](= mind)	[B](Mediating of A and C)	[C](= matter)
Aristotle	nothing	nothing	eidos [hyle]
Newton	nothing	nothing	state [point mass]

That is, we consider the following progress:

$$[\text{eidos}] \xrightarrow[\text{progress}]{\text{quantification}} [\text{state}], \quad [\text{hyle}] \xrightarrow{\text{progress}} [\text{point mass}]$$

♠**Note 1.16.** (i): It is somewhat unreasonable to regard Plato's Idea theory as a type of measurement theory. Therefore, Plato and Aquinas above are doubtful, but I dare to write (*cf.* Sec. 3.3).

(ii): In mind-matter dualism, [B: medium] is the most important (*cf.* the linguistic Copenhagen interpretation (E₃) in Sec. 1.1.2). Thus, we consider that Plato's Idea theory is dualism. On the other hand, statistics lacks [B: medium]. Thus, statistics is not usually regarded as dualism but mathematical theory. However, in this paper, statistics is listed up as "incomplete dualism" in the above table.

(iii): The readers may wonder that "actual world ≈ mind(=human)" in Plato. However, it should be understood under the maxim: "Man is the measure of all things". Similarly, we think that "measured value ≈ mind(=human)" in quantum language. That is because there is no "measured value" without "mind(=brain)".

(iv): In [C: matter], the terms "state" and "system" in quantum language are always used as the form "the system with the state" (*cf.* Axiom 1 in Sec. 1.1). In the history of western philosophy, "state" and "system" were often confused, and in most cases, only one of the two has been found. Also, seeing statistics in the above table, the reader may find that understanding the difference between "parameter" and "population" is surprisingly difficult. And thus, in this paper, the difference is not

emphasized.

Corollary 1.15. Of the three (i.e., "measured value", "observable", "state"), the "observable" is the most difficult to understand. Thus, Let me summarize the history of "observable" as follows.

•

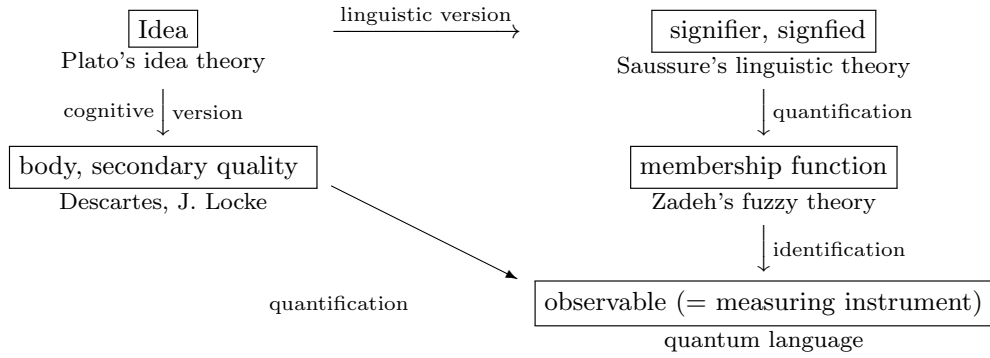

Of course, Plato's Idea can be interpreted in a variety of ways. Therefore, the above figure may be my desire.

1.5 Appendix: The mathematical foundations of quantum language

Although we will explain "quantum language (= measurement theory)" in this section, I may have omitted too much. This section alone may not be sufficient to read the mathematical part of this text. For the precise explanation, see [71]. If you want to read this book as literary as that refs. [23, 108], it might be recommended to skip this section. Literary enjoyment is also one of the charms of philosophy. Therefore, I have tried to write this book in such a way that you can enjoy it even if you skip this section (the mathematics part). We have two formulations of QL such that

$$(A) \text{ the formulation of QL } \begin{cases} (A_1): \text{ the } C^*\text{-algebraic formulation (see Sec. 1.5.1)} \\ (A_2): \text{ the } W^*\text{-algebraic formulation} \\ \quad \quad \quad \text{(see, for example, Section 2 in [76], or precisely [71])} \end{cases}$$

(A₁) is simple, On the other hand, (A₂) is rather mathematical. In this text, we usually use the C^* -algebraic formulation (A₁). But (A₂) will be used in the case that "exact measurement" is needed.

1.5.1 Mathematical preparations (the C^* -algebraic formulation of QL)

Following refs. [44, 46, 47, 71] (all our results until present are summarized in ref. [71]), we will review quantum language, which has the following form:

$$\boxed{\text{Quantum language}} = \boxed{\text{measurement}} + \boxed{\text{causality}} + \boxed{\text{linguistic (Copenhagen) interpretation}}$$

(= measurement theory) (Axiom 1) (Axiom 2) (how to use Axioms 1 and 2)

(1.5)

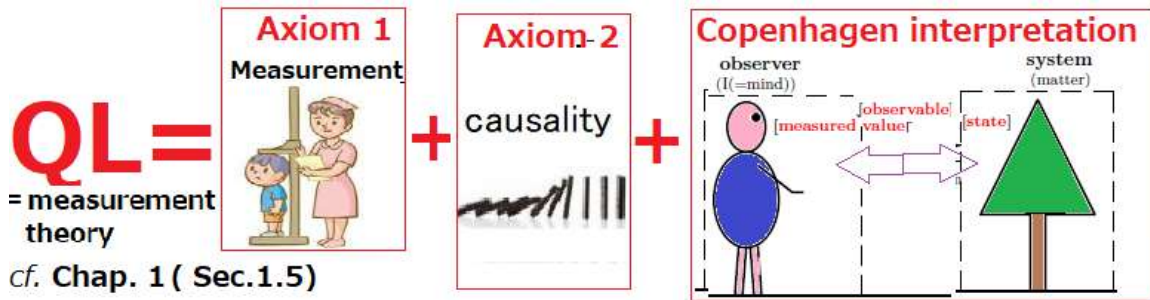

which asserts that "measurement" and "causality" are the most important concepts in science.

Consider an operator algebra $B(H)$ (i.e., an operator algebra composed of all bounded linear operators on a Hilbert space H with the norm $\|G\|_{B(H)} = \sup_{\|u\|_H=1} \|Gu\|_H$. Let $\mathcal{A}(\subseteq B(H))$ is a C^* -algebra, (i.e., norm-closed subalgebra of $B(H)$) (cf. refs. [113], [110], [120]). Our purpose of this section is not to explain QL in general situation but to explain QL in an understandable setting. Thus, from here, we devote ourselves to the following simple cases:

$$(B) \quad \text{QL} = \begin{cases} (B_1): \text{ quantum QL (when } \mathcal{A} = B(\mathbb{C}^n), \text{ where } H = \mathbb{C}^n) \\ \quad \quad \quad \text{i.e., the } C^*\text{-algebra composed of all } (n \times n) \text{ complex matrixes} \\ (B_2): \text{ classical QL (when } \mathcal{A} = C(\Omega)), \\ \quad \quad \quad \text{i.e., the space of all continuous functions on a compact space } \Omega \end{cases}$$

Let $\mathcal{A} \subseteq B(H)$ be a C^* -algebra, and let \mathcal{A}^* be the dual Banach space of \mathcal{A} . That is, $\mathcal{A}^* = \{\rho \mid \rho \text{ is a continuous linear functional on } \mathcal{A}\}$, and the norm $\|\rho\|_{\mathcal{A}^*}$ is defined by $\sup\{|\rho(G)| \mid G \in \mathcal{A} \text{ such that } \|G\|_{\mathcal{A}} (= \|G\|_{B(H)}) \leq 1\}$. Define the *mixed state* $\rho \in \mathcal{A}^*$ such that $\|\rho\|_{\mathcal{A}^*} = 1$ and $\rho(L) \geq 0$ for all $L \in \mathcal{A}$ such that $L \geq 0$. And define the mixed state space $\mathfrak{S}^m(\mathcal{A}^*)$ such that

$$\mathfrak{S}^m(\mathcal{A}^*) = \{\rho \in \mathcal{A}^* \mid \rho \text{ is a mixed state}\}.$$

A mixed state $\rho \in \mathfrak{S}^m(\mathcal{A}^*)$ is called a *pure state* if it satisfies that " $\rho = \theta\rho_1 + (1 - \theta)\rho_2$ for some $\rho_1, \rho_2 \in \mathfrak{S}^m(\mathcal{A}^*)$ "

$\mathfrak{S}^m(\mathcal{A}^*)$ and $0 < \theta < 1$ implies “ $\rho = \rho_1 = \rho_2$ ”. Put

$$\mathfrak{S}^p(\mathcal{A}^*) = \{\rho \in \mathfrak{S}^m(\mathcal{A}^*) \mid \rho \text{ is a pure state}\},$$

which is called a *state space*. It is well known (cf. ref. [110]) that

$$(C) \left\{ \begin{array}{l} \text{[Case (C}_1\text{)]}; \quad \mathfrak{S}^p(B(\mathbb{C}^n)^*) = \{\rho = |u\rangle\langle u| \text{ (i.e., the Dirac notation)} \mid \|u\|_{\mathbb{C}^n} = 1\} \\ \text{[Case (C}_2\text{)]}; \quad \mathfrak{S}^p(C(\Omega)^*) = \{\rho = \delta_{\omega_0} \mid \delta_{\omega_0} \text{ is a point measure at } \omega_0 \in \Omega\} \approx \Omega. \\ \text{Under the identification: } \mathfrak{S}^p(C(\Omega)^*) \in \delta_{\omega} \leftrightarrow \omega \in \Omega, \omega \text{ and } \Omega \text{ is also called a } \textit{state} \\ \text{and } \textit{state space} \text{ respectively.} \end{array} \right.$$

Definition 1.16. [Observable, Image observable] According to the noted idea (cf. refs. [14], [33]), an *observable* $\mathbf{O} = (X, \mathcal{P}(X), G)$ in \mathcal{A} is defined as follows:

- (i) X is a finite set, $\mathcal{P}(X) (= 2^X)$, the power set of X .
- (ii) [Additivity] G is a mapping from $\mathcal{P}(X)$ to \mathcal{A} satisfying: (a): for every $\Xi \in \mathcal{P}(X)$, $G(\Xi)$ is a non-negative element in \mathcal{A} such that $0 \leq G(\Xi) \leq I$, (b): $G(\emptyset) = 0$ and $G(X) = I$, where 0 and I is the 0-element and the identity in \mathcal{A} respectively. (c):[additivity]

$$G(\Xi_1) + G(\Xi_2) = G(\Xi_1 \cup \Xi_2)$$

for all $\Xi_1, \Xi_2 \in \mathcal{P}(X)$ such that $\Xi_1 \cap \Xi_2 = \emptyset$.

If $G(\Xi) = G(\Xi)^2$ ($\forall \Xi \in \mathcal{P}(X)$), then $\mathbf{O} = (X, \mathcal{P}(X), G)$ in \mathcal{A} is a projective observable (or, crisp observable). Also, $\mathbf{O} = (X, \mathcal{P}(X), G)$ in \mathcal{A} is also called an X -valued observable. I will devote myself to binary (i.e., $\{T, F\}$ -valued) observables in most of the cases in this paper. Let Y be a finite set, and let $\Theta : X \rightarrow Y$ be a map. Then, $\Theta(\mathbf{O}) = (Y, \mathcal{P}(Y), G(\Theta^{-1}(\cdot)))$ in \mathcal{A} is also an observable in \mathcal{A} (which is called an image observable).

1.5.2 Axiom 1 [Measurement] and Axiom 2 [Causality]

With any *system* S , a C^* -algebra $\mathcal{A} (\subseteq B(H))$ can be associated in which the measurement theory (2) of that system can be formulated. A *state* of the system S is represented by an element $\rho (\in \mathfrak{S}^p(\mathcal{A}^*))$ and an *observable* is represented by an observable $\mathbf{O} = (X, \mathcal{P}(X), G)$ in \mathcal{A} . Also, the *measurement of the observable* \mathbf{O} for the system S with the state ρ is denoted by $M_{\mathcal{A}}(\mathbf{O}, S_{[\rho]})$ (or more precisely, $M_{\mathcal{A}}(\mathbf{O} = (X, \mathcal{P}(X), G), S_{[\rho]})$). An observer can obtain a measured value $x (\in X)$ by the measurement $M(\mathbf{O}, S_{[\rho]})$.

The Axiom 1 presented below is a kind of mathematical generalization of Born’s probabilistic interpretation of quantum mechanics. And thus, it is a statement without reality.

Now we can present Axiom 1 as follows.

Axiom 1 [Measurement]

The probability that a measublack value $x (\in X)$ obtained by the measurement $M_{\mathcal{A}}(\mathbf{O} = (X, \mathcal{P}(X), G), S_{[\rho]})$ is given by $\rho(G(\{x\})) (\equiv {}_{\mathcal{A}^*} \langle \rho, G(\{x\}) \rangle_{\mathcal{A}})$.

Next let us explain Axiom 2 (which is not used in this paper). Let $\mathcal{A}_1 (\subseteq B(H_1))$ and $\mathcal{A}_2 (\subseteq B(H_2))$ be A continuous linear operator $\Phi_{1,2} : \mathcal{A}_2 \rightarrow \mathcal{A}_1$ is called a *Markov operator*, if $\Phi_{1,2}(L) \geq 0$ ($\forall L \in \mathcal{A}_2$ such that $L \geq 0$ and $\phi_{1,2}(I_2) = I_1$, where I_1 and I_2 is identity maps in \mathcal{A}_1 and \mathcal{A}_2 respectively.

Now we can propose Axiom 2 (i.e., causality). (For details, see ref. [71].)

Axiom 2 [Causality]

The causality is represented by a Markov operator $\Phi_{1,2} : \mathcal{A}_2 \rightarrow \mathcal{A}_1$.

Definition 1.17. [(i): Quasi-product observable, quasi-product measurement]: Let $O_i = (X_i, \mathcal{P}(X_i), G_i)$ ($i = 1, 2, \dots, N$) be commutative observables in \mathcal{A} . Define a quasi-product observable $\times_{i=1,2,\dots,n}^{qp} O_i = (\times_{i=1}^n X_i, \mathcal{P}(\times_{i=1}^n X_i), \times_{i=1,2,\dots,n}^{qp} G_i)$ such that

$$\left[\times_{i=1,2,\dots,n}^{qp} G_i \right] (X_1 \times X_2 \times \dots \times X_{j-1} \times \Xi_j \times X_{j+1} \times \dots \times X_n) = G_j(\Xi_j) \quad (\forall \Xi_j \in \mathcal{P}(X_j), j = 1, 2, \dots, n)$$

Also, $M_{\mathcal{A}}(\times_{i=1,2,\dots,n}^{qp} O_i = (\times_{i=1}^n X_i, \mathcal{P}(\times_{i=1}^n X_i), \times_{i=1,2,\dots,n}^{qp} G_i), S_{[\rho]})$ is called a quasi-product measurement of $M_{\mathcal{A}}(O_i = (X_i, \mathcal{P}(X_i), G_i), S_{[\rho]})$ ($i = 1, 2, \dots, n$).

[(ii): Tensor C^* -algebra, tensor quasi-product observable, tensor quasi-product measurement]: Let $O_i = (X_i, \mathcal{P}(X_i), G_i)$ be observables in \mathcal{A}_i , ($i = 1, 2, \dots, n$). Define a tensor quasi-product observable $\otimes_{i=1,2,\dots,n}^{qp} O_i = (\times_{i=1}^n X_i, \mathcal{P}(\times_{i=1}^n X_i), \otimes_{i=1,2,\dots,n}^{qp} G_i)$ in the tensor C^* -algebra $\otimes_{i=1}^n \mathcal{A}_i$ such that

$$\left[\otimes_{i=1,2,\dots,n}^{qp} G_i \right] (X_1 \times X_2 \times \dots \times X_{j-1} \times \Xi_j \times X_{j+1} \times \dots \times X_n) = \left(\otimes_{i=1}^{j-1} I \right) \otimes G_j(\Xi_j) \otimes \left(\otimes_{i=j+1}^n I \right) \\ (\forall \Xi_j \in \mathcal{P}(X_j), j = 1, 2, \dots, n)$$

Also, $M_{\otimes_{i=1}^n \mathcal{A}_i}(\otimes_{i=1,2,\dots,n}^{qp} O_i = (\times_{i=1}^n X_i, \mathcal{P}(\times_{i=1}^n X_i), \otimes_{i=1,2,\dots,n}^{qp} G_i), S_{[\otimes_{i=1}^n \rho_i]})$ is called a tensor quasi-product measurement of $M_{\mathcal{A}_i}(O_i = (X_i, \mathcal{P}(X_i), G_i), S_{[\rho_i]})$ ($i = 1, 2, \dots, n$).

1.5.3 Inference; Fisher's maximum likelihood method)

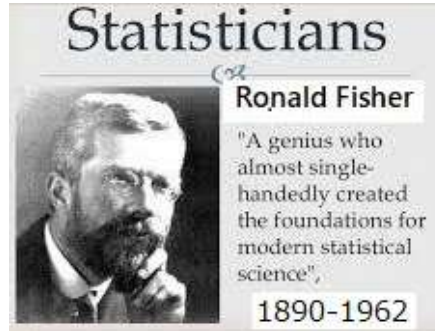

We begin with the following notation:

Notation 1.18. $[M_{L^\infty(\Omega, \nu)}(O, S_{[*]})]$: Consider a measurement $M_{L^\infty(\Omega, \nu)}(O := (X, \mathcal{F}, F), S_{[\omega_0]})$ formulated in the basic structure $[C(\Omega) \subseteq L^\infty(\Omega, \nu) \subseteq B(L^2(\Omega, \nu))]$. Here, note that

(E₁) in most cases that the measurement $M_{L^\infty(\Omega, \nu)}(O := (X, \mathcal{F}, F), S_{[\omega_0]})$ is taken, it is usual to think that the state $\omega_0(\in \Omega)$ is unknown.

That is because

(E₂) the measurement $M_{L^\infty(\Omega, \nu)}(O, S_{[\omega_0]})$ may be taken in order to know the state ω_0 .

Therefore, when we want to stress that we do not know the state ω_0 , the measurement $M_{L^\infty(\Omega, \nu)}(O := (X, \mathcal{F}, F), S_{[\omega_0]})$ is often denoted by $M_{L^\infty(\Omega, \nu)}(O := (X, \mathcal{F}, F), S_{[*]})$

Theorem 1.19. [Inference; Fisher's maximum likelihood method (cf. ref. [42] or §5.2 in ref. [71]) For simplicity, assume that X is finite set. Assume that the measured value $x(\in X)$ is obtained by the measurement $M_{L^\infty(\Omega, \nu)}(O := (X, 2^X, F), S_{[*]})$. Then, the unknown state $[*]$ can be inferred to be $\omega_0(\in \Omega)$ such that

$$[F(\{x\})](\omega_0) = \max_{\omega \in \Omega} [F(\{x\})](\omega)$$

Proof. It is an easy consequence of **Axiom 1** (cf. §5.2 in ref. [71]). \square

Remark 1.20. [Inference and Control cf. §5.2 in ref. [71]) The inference problem is characterized as the reverse problem of measurements.

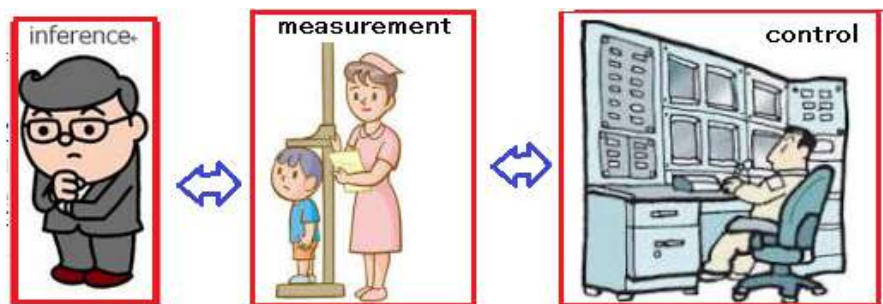

That is, we consider that

$$(E_1) \text{ (state } \omega_0, \text{ observable } O) \xrightarrow[\text{measurement (Axiom 1)}]{M_{L^\infty(\Omega, \nu)}(O := (X, 2^X, F), S_{[\omega_0]})} \text{measured value } x_0$$

On the other hand

$$(E_2) \text{ (measured value } x_0, \text{ observable } O) \xrightarrow[\text{inference (reverse Axiom 1)}]{M_{L^\infty(\Omega, \nu)}(O := (X, 2^X, F), S_{[*]})} \text{state } \omega_0$$

Thus, (E₁) and (E₂) are in reverse problem.

Also, we note, from the mathematical point of view, that inference problem (E₃) and control problem (E₄) are essentially the same as follows.

(E₃) [Inference problem; statistics]: when measured value x_0 is obtained, infer the unknown state ω_0 and

(E₄) [Control problem; dynamical system theory]: Settle the state ω_0 such that measured value x_0 will be obtained!

Thus, we think, from the theoretical point of view, that statistics and dynamical system theory are essentially the same. Thus, we consider that statistics (= dynamical system theory) is the mathematical representation of classical mechanical worldview. On the other hand, quantum language is regarded as the mathematical representation of quantum mechanical worldview.

1.5.3.1 Exercise: Fisher's maximum likelihood method

Problem 1.21. You can't tell if it's a man or a woman, but you can see someone in the distance. He/she is wearing a skirt. Estimate whether this person is a man or a woman.

Is it a man or a woman? [Fisher's maximum likelihood method]

$$\frac{\text{Number of men wearing skirts}}{\text{Number of men}} \stackrel{!}{=} 1\% < 50\% \stackrel{!}{=} \frac{\text{Number of women wearing skirts}}{\text{Number of women}}$$

Therefore, by Fisher's maximum likelihood method, we infer that

it is a woman.

Answer:

Consider the state space $\Omega = \{\omega_M, \omega_W\}$, where ω_M [resp. ω_W] is considered as the state of "man" [resp. "woman"]. Define the observable $O = (\{y, n\}, 2^{\{y, n\}}, F)$ in $C(\Omega)$ such that

$$\begin{aligned} [F(\{y\})](\omega_M) &= \frac{\text{Number of men wearing skirts}}{\text{Number of men}} < 0.01, & [F(\{n\})](\omega_M) &= 1 - [F(\{y\})](\omega_M) \\ [F(\{y\})](\omega_W) &= \frac{\text{Number of women wearing skirts}}{\text{Number of women}} > 0.4 & [F(\{n\})](\omega_W) &= 1 - [F(\{y\})](\omega_W) \end{aligned}$$

Fisher's maximum likelihood method says that

- find $\omega \in \Omega$ such that

$$[F(\{y\})](\omega) = \max\{[F(\{y\})](\omega_M), [F(\{y\})](\omega_W)\}$$

Thus, we see that $\omega = \omega_W$.

That is, we can infer that the person is a woman.

□

Chapter 2

Ancient Greek philosophy (before Socrates)

Readers can start reading from this chapter (i.e., you can skip Chapter 1).

In Ancient Greek philosophy (before Socrates), the phrase "the arche (= the first thing of all things) is $\bigcirc\bigcirc$ " is standard. Here " $\bigcirc\bigcirc$ " is, for example, as follows.

Thalēs ····· water

Pythagoras ····· Number is within all things

Parmenides ····· logic, motion

Democritus ····· atom

Hērakleitos ····· motion, fire

Zeno ····· logic, motion

Firstly we examine Pythagoras' saying "Number is within all things". But unfortunately, this golden rule has never been followed in the history of philosophy (\approx dualistic idealism).

- The reason that quantum language has a strong descriptive power is due to the fact that quantum language adhered to Pythagoras' saying.

Also, we note that Parmenides' claim is very similar to the Copenhagen interpretation of quantum mechanics. And thus,

- we treated Parmenides like the ancestor of the Copenhagen interpretation

Next we examine Zeno's paradoxes (the flying arrow, Achilles and the tortoise) from a quantum linguistic perspective and present a new view of Zeno's paradoxes. And we conclude that

- The confusion about Zeno's paradox lies in the lack of a world description method. This paradox can be easily solved under the worldview of the motion function method, which is a subclass of quantum language. It is not a mathematical problem about geometric series, as is often claimed.

This success has led us to worldviewism (i.e., the spirit that "Start from worldview!"). Throughout this text, we always argue that without worldview, there is no logic.

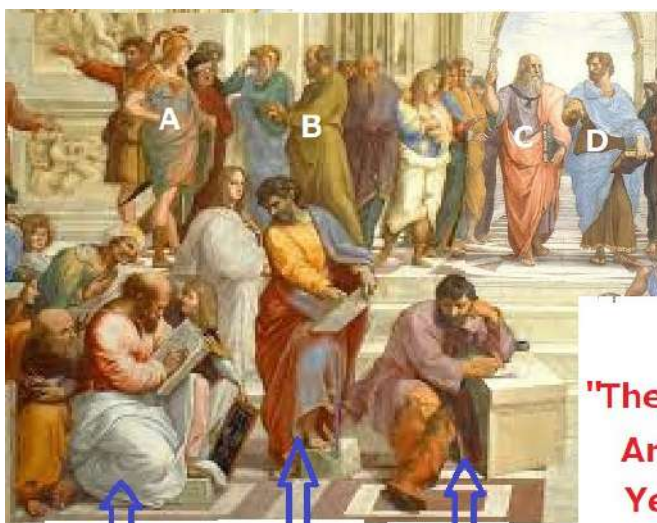

Pythagoras (BC.582 - BC.496) Parmenides (BC.515 - ?) Herakleitos (BC.540 - BC.480)

A: Alexander the Great

B: Socrates

C: Plato

D: Aristotle

**Part of
"The School of Athens"**

Artist Raphael

Year 1509–1511

2.1 Thalēs (BC.640 - BC.546)

2.1.1 Thalēs: the first philosopher: " the arche (= the first thing of all things) is water"

Every race had its own "mythology". Myths are the literature that explains the world by reason of God. Myths have been handed down from generation to generation from our ancestors by oral and written word. There is a great deal of maritime trade, and many ethnic groups come together to interact, but it is rare to find a region that is not united by force of arms because it is not a vast plain. This situation was realized on the eastern Mediterranean coast (now called Greece, Turkey, Syria, and Israel (Egypt)) around 1000 BC. In this region, various civilizations and cultures have merged to create a new culture. Particularly noteworthy was the realization of unification not by force of arms, but by culture. In other words, "philosophy as a synthesis of several myths" and "the alphabet as a synthesis of several letters" were born. That is,

$$(A) \left\{ \begin{array}{l} \text{integration of several myths} \\ \text{integration of the several characters} \end{array} \right. \begin{array}{l} \implies \text{philosophy} \\ \implies \text{Phoenician alphabet} \implies \text{alphabet} \end{array}$$

The alphabet is a phonetic alphabet because it was created with the intention of being a common letter between different ethnic groups. Egypt had an advanced civilization (such as the pyramids), but it was so unified in thought that philosophy did not develop.

In Aristotle's book "Metaphysics," Thales is called the "first philosopher". For example, to the question "why does an earthquake occur?" Most myths will say "because God is angry". Thalēs appeared in Miletus in ancient Greece and said:

(B) The arche (= the first principle of all things) is water. Therefore, the earthquake is caused by the vibration of the water

This may be childish, but is an explanation that does not brought out the "God" . This is the reason why Aristotle said Thalēs was "the first philosopher."

**Thales of
Miletus**

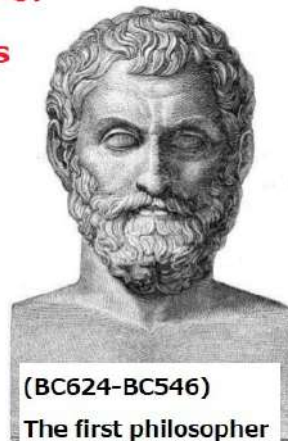

(BC624-BC546)

The first philosopher



♠**Note 2.1.** S. Weinberg (1933 -2021), An American physicist, won a Nobel Prize of physics in 1979, said in his book [115] "To explain the word; The discovery of modern science" as follows:

(#) *It seems to me that to understand these early Greeks, it is better to think of them not as physicists or scientists or even philosophers, but as poets.*

I agree with him. As mentioned earlier, I believe that the main purpose of the ancient Greek philosophers was not to pursue truth but to provide a common topic (i.e., a common myth, a universal myth) in order to avoid conflict between different peoples. This paper, however, may be a bit more radical. As far as to describing the world (not ethics), Plato, Descartes, Kant, etc. all should be regarded as poets or fiction writers. As we will discuss later, I believe that the purpose of Kant's Critique of Pure Reason is not the pursuit of truth, but a proposal for a symbiosis with science. That is because the rule of philosophy is as follows:

(#₁) Only discussion, no experimentation.

(#₂) the winner will be determined by popularity vote of the general public.



♠**Note 2.2.** Who is the first philosopher? Of course there may be a lot of opinions for this question. As mentioned above, Aristotle said Thalēs was "the first philosopher." Also, A.N.Whitehead (1861 - 1947) said that

(#) **Western philosophy is characterized as a series of footnotes to Plato**

Although I do not know Whitehead's intension, I want to think that this means "Plato is the first

philosopher”, which is the same as the spirit of this paper mentioned later.

2.1.2 Thalēs' ability at math

By the statement: "The first principle of all things is water", we cannot judge Thalēs' knowledge, However, the following is known as Thalēs' theorem, which shows his ability of math:

Theorem 2.1. [central angle = β , inscribed angle = α] $\implies \beta = 2\alpha$

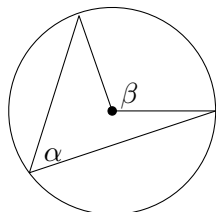

Proof. It suffices to draw the additional line through the center. □

Although it is a problem within the scope of junior high school mathematics, since training in elementary geometry is neglected in middle and high schools, only about 60

However, if the next theorem is the discovery of Thales, we can trust Thales' mathematical ability.

Theorem 2.2. • *The vertical angles are equal. That is, in the figure below, it holds that $a = c$, $b = d$*

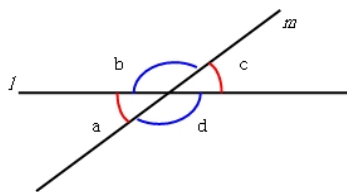

The model answer may be as follows.

$$a + b = 180^\circ \quad , \quad b + c = 180^\circ \tag{2.1}$$

thus,

$$a = 180^\circ - b = c$$

However, this proof has changed from "trivial" to "trivial", and I can't feel like proof. The fact that Thales said that "the vertical angles are equal" means that he was aware that "it is worth speaking." This fact makes us believe in Thales' (or at that time) mathematical ability. This tradition of ancient Greek philosophy may have given rise to Euclid's Elements. ////

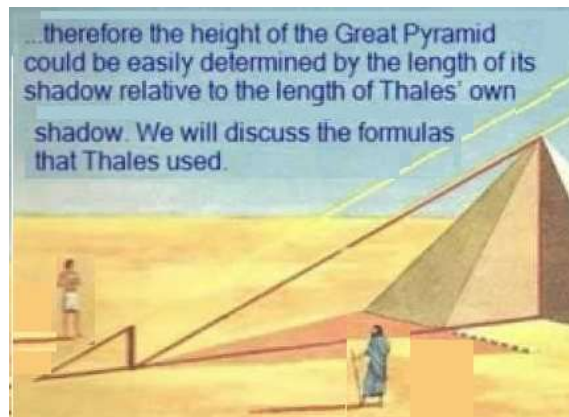

♠**Note 2.3.** (i): When Thales visited Egypt, there is a story that the king of Egypt was impressed by Thales' measuring the height of the pyramid in the way of measuring called triangulation. But, I think it is unreliable. Three great pyramids in the Egyptian Giza desert (deceased persons are Khufu, Khafre, Menkaure) erecting time of is the 2500 B.C. Thus I guess that the triangulation was known in those days (2000 years before Thalēs) in Egypt. If so, Thalēs' theorem should be doubt whether it is due to Thalēs. However, even as a true prover was unknown, the ability of mathematics at the time (i.e., the discovery of the concept of "proof") should be surprising. This led to Euclid's "Elements" (due to Euclid (275 BC - 330 BC)).

(ii): Anyone who is interested in the history of mathematics will be interested in the "origin of area". However, I don't know anything about this.

2.2 Pythagoras (BC.582 - BC.496)

2.2.1 The mathematical ability of Pythagorean religious organization



Celebrate the sunrise

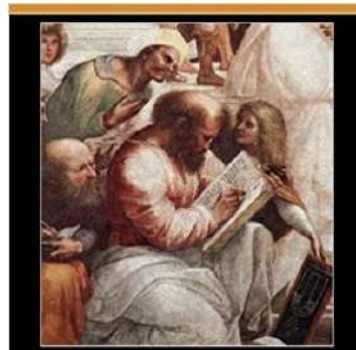

Pythagoras in the School of Athens by Raphael (AD.1511)

Pythagoras appears to have been the son of a gem-engraver on the island of Samos. Modern scholars disagree regarding Pythagoras's education and influences, but they do agree that, around 530 BC, he travelled to Croton in southern Italy, where he founded a school for mathematics. Pythagoras was a leader in the mathematics study group, which may be regarded as a kind of religious organization called Pythagorean religion.



As the mathematical achievements, the followings are known:

- the discovery of irrational numbers, the Pythagorean theorem, the construction of a regular pentagon

and so on.

Theorem 2.3. Finding of irrational members, e.g., $\sqrt{2}$ is an irrational number.

Theorem 2.4. (Pythagorean theorem): In $\triangle ABC$, the followings are equivalent:

- (#₁) $\angle A = 90^\circ$
- (#₂) $AB^2 + CA^2 = BC^2$

Proof. The proof of Pythagoras himself is unknown, but the next proof will be learned in junior high school.

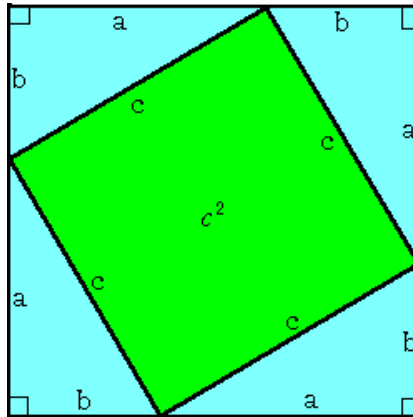

Thus,

$$4 \times \frac{ab}{2} + c^2 = (a + b)^2$$

And thus, $a^2 + b^2 = c^2$.

////

♠**Note 2.4.** However, this proof presupposes the additivity of the area. Therefore, there may be room for consideration.

Construction 2.5. the construction of a regular pentagon

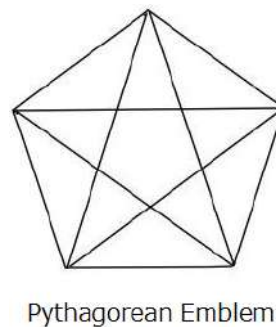

Explanation: In a regular pentagon as shown in the figure below (left), put $AB = BC = CD = DE = EA = 1$. Then, we see

$$AC = AD = \frac{1 + \sqrt{5}}{2}$$

Hence, it suffices to construct $\frac{1+\sqrt{5}}{2}$. By the Pythagorean theorem, $\sqrt{5}(= \sqrt{1^2 + 2^2})$ can be constructed as follows (the figure below (right)). Thus, we easily get $\frac{1+\sqrt{5}}{2}$.

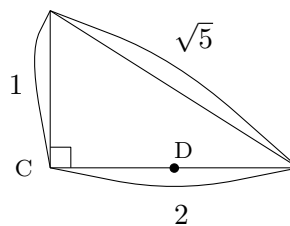
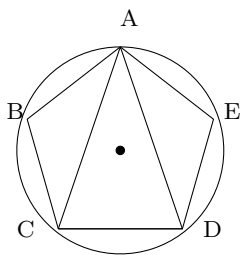

□

♠**Note 2.5.** (i): If you are a university student in mathematics, you must know at least three proofs (of Pythagorean theorem). Supplement the two proofs as follows:.

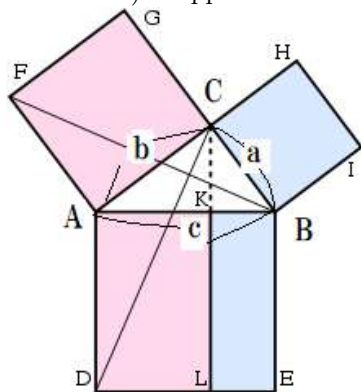

(a)

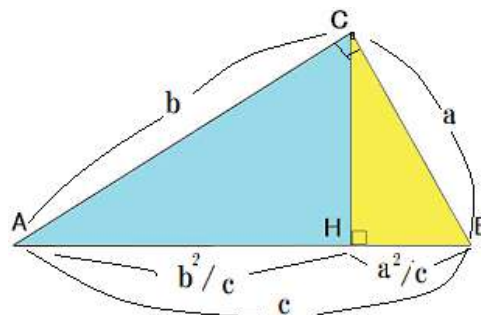

(b)

where (a) is due to Euclid ((b) is due to Einstein ?).

(ii): It could have been something extra, but I wrote the explanation of the construction of a regular pentagon for beginners. Even university students in the department of mathematics sometimes don't know this.

♠**Note 2.6.** The above two (the discovery of irrational numbers and the Pythagorean theorem) are one of the most important discoveries in mathematics. If the following episodes are true, we can trust his mathematical ability.

- (#1) Pythagoras was killing the disciple, who found the irrational number, in order to hide the existence of irrational numbers.
- (#2) When Pythagoras discovered the Pythagorean theorem, he celebrated it, offered the sacrifice of the bull.

The two theorems, about 2000 years from the originally discovered to the scientific revolution (Descartes' Analytical Geometry, etc.; 17th century), not been used even once with an essential meaning. Nevertheless, their importance had been recognized in Pythagorean organization. This suggests a very high mathematical level of Pythagorean organization. Even if I had been a member of the Pythagorean school, I don't think I could have recognized the importance of these two theorems to the extent that they deserve in (#1) and (#2) above.

♠**Note 2.7.** (i): Pythagoras is said to have known that the earth was round. And he consider the following astronomical system:

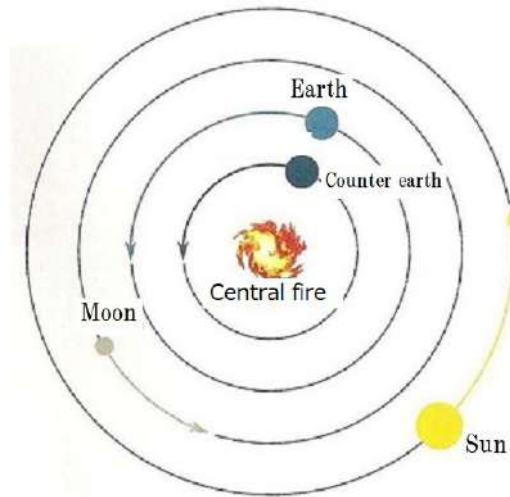

Pythagorean astronomical system

I love this astronomical system and could watch it for an hour and never get tired of it. At the time, astronomy might be believed to be a part of mathematics. Greek astronomy develops in the following way.

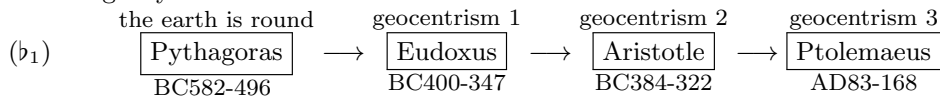

(Although there are several geocentrism k ($= 1, 2, 3$), the explanation is omitted.) where Eudoxus (BC.400 – BC.347) is a Greek astronomer and mathematician (called the greatest of ancient Greek mathematicians), a student of Plato. He proposed a kind of geocentrism and the method of exhaustion (as the quadrature). It is said that many of his theorems are written in Euclid's Elements.

Even in ancient China which had the great culture, the prevailing belief was that the Earth was flat and square, while the heavens were round, until the introduction of European astronomy in the 17th century

(ii): Also, ancient Greek mathematics should be praised. That is,

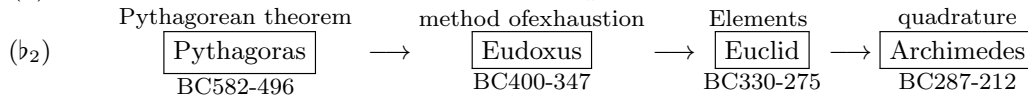

The above two (b_1) and (b_2) are the greatest achievements in ancient Greek philosophy.

Method of exhaustion

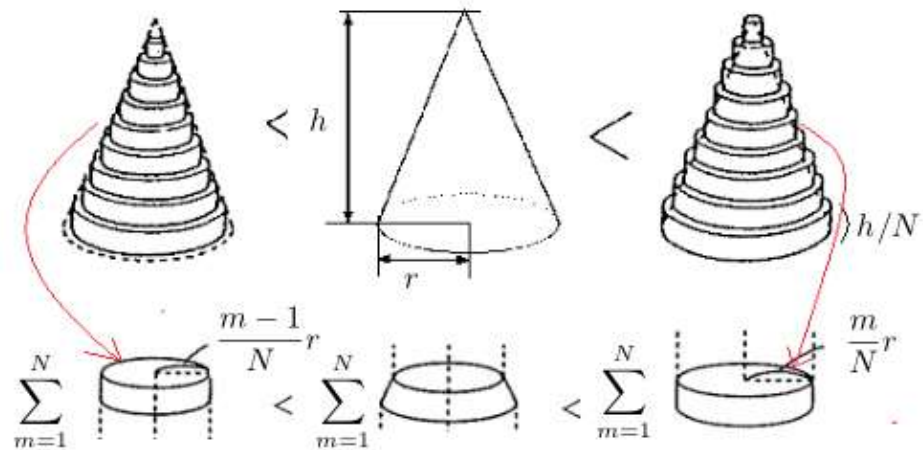

$$\frac{\pi(0^2 + \dots + (N-1)^2)r^2h}{N^3} < \text{Cone} < \frac{\pi(1^2 + \dots + N^2)r^2h}{N^3}$$

$$\frac{\pi r^2 h}{6} \left(1 - \frac{1}{N}\right) \left(2 - \frac{1}{N}\right) < \text{Cone} < \frac{\pi r^2 h}{6} \left(1 + \frac{1}{N}\right) \left(2 + \frac{1}{N}\right)$$

As $N \rightarrow \infty$, we see $\text{Cone} = \frac{\pi r^2 h}{3}$

2.2.2 The arche (= the first principle of all things) is number

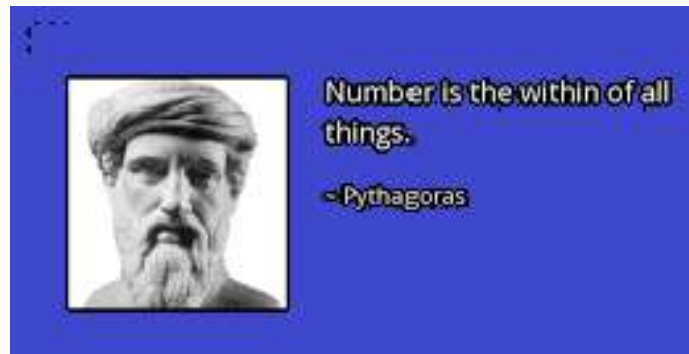
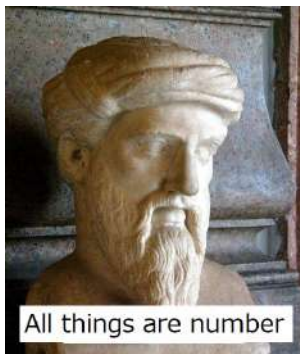

The main spirit of Pythagorean religious organization is "the first principle of all things is number". Now let us explain the following principle (called Pythagoreanism in this paper):

(A):Pythagoreanism

the first principle of all things) is number.

That is, "Describe the world using mathematics!", or

"Number is within of all things"

"To make a scientific theory is to parameterize things"

I believe that this is the most important claim throughout Western philosophy.

monism



parametrize

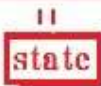

113cm (height)
46Kg (weight)
98 (blood pressure)
.....

The phrase: "The arche (= first principle) of all things is $\bigcirc\bigcirc$ " is a fashion in those days. Note that "water", "fire" etc. are visible, but "number" is not.

♠**Note 2.8.** (i): After about 2000 years from Pythagoras, Galileo was talking about a similar thing. That is, *the universe is written in the language of mathematics.*

In fact, Galileo wrote the universe in the language of mathematics.

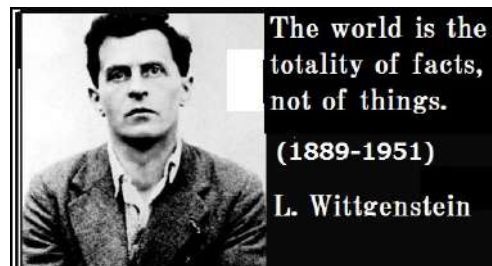
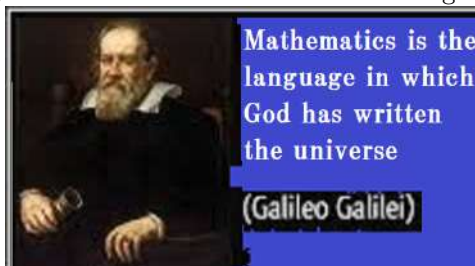

(ii): Descartes discovered that number is the within of all points of space as the Cartesian coordinates.

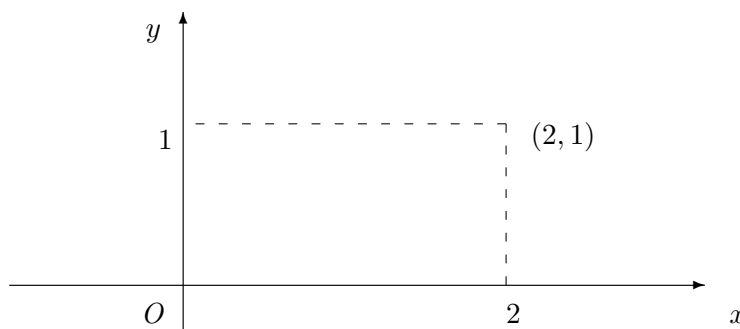

(iii): At the beginning of his book "ref. [117]: Tractatus Logico-philosophicus", Wittgenstein said

- (1.1): The world is the totality of facts, not of things.

Since "fact"="state" (or, precisely, "state"="quantification of fact"), he was merely emphasizing the orthodoxy of Pythagoreanism. But unfortunately he didn't perform parameterization. Thus, his work had become literature.

♠**Note 2.9.** As mentioned in Note 2.7, Pythagoras is said to have known that the earth was round. It may be a joke, but apparently he thought the earth was round because the most beautiful shape was a sphere. It is natural that the **pure Pythagoreanism** such as

(‡) The world is written in only the language of mathematics.

is not true. I believe that the world and mathematics are not directly related (though religious people might not think so). If it can be written in only the language of mathematics, it is just mathematics. However, this pure Pythagoreanism has carried over to the present day and is inhibiting the healthy development of our worldview (e.g., see "The theory of probability" in [71], or "Analytic philosophy" in Chap. 12).

Hence we have the following problem (i.e., the problem of worldview), which is the main problem in this paper:

Problem 2.6. The problem of worldview is as follows.

- A scientific worldview has the form: "scientific worldview= mathematics + α ". If so,

what is α ?

As mentioned later, let us say here conclusion now. For example, α is "motion", "causal relation", "probability", "measurement", etc. From the quantum theoretical point of view, that is, in this paper, we devote ourselves to "measurement (Axiom 1) and causality (Axiom 2) (*cf.* Sec.1.1).

♠**Note 2.10.** Possibly in this time, distinction of mathematics and science was not clear. What is mathematics? We had to wait for Cantor's set theory and axiomatic set theory (by Zermelo and Fraenkel) (circa 1900 A.D.) before we would know a definite answer to this question.

Pythagoreanism blossomed for the first time in the early modern times (i.e., the scientific revolution due to Galileo=Newton mechanics and Bernoulli's law of large numbers, etc. *cf.* Chapter 7 later). In this paper, we consider the following as a genealogy of dualism:

- Plato \rightarrow Descartes \rightarrow Kant \rightarrow Wittgenstein

However, it can be called only mysteriousness that Pythagoreanism has not blossomed in the main stream of western philosophy. As emphasized later, our assertion is

$$\boxed{\text{measurement, causality}} + \boxed{\text{mathematics}} \longrightarrow \boxed{\text{Quantum language}}$$

that is, we assert that

- **Pythagoreanism blossoms as quantum language in western philosophy**

if the following is accepted:

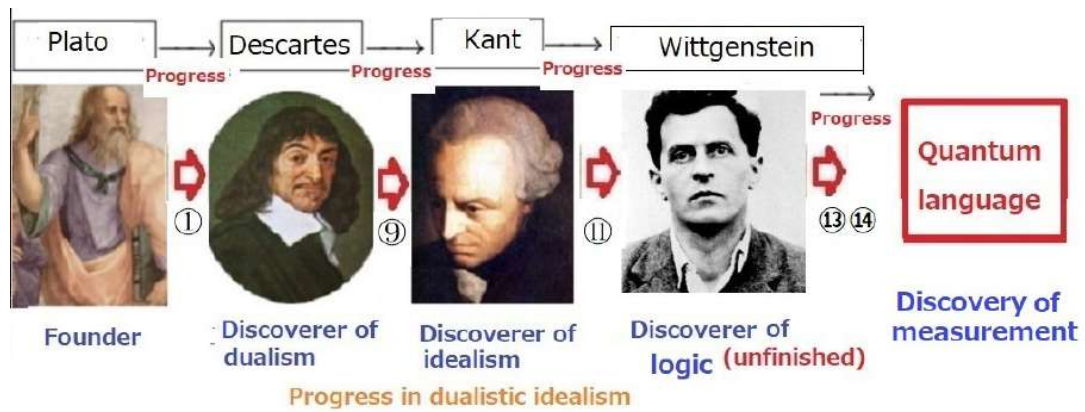

- $\boxed{\text{Plato}} \rightarrow \boxed{\text{Descartes}} \rightarrow \boxed{\text{Kant}} \rightarrow \boxed{\text{Wittgenstein}} \xrightarrow[\text{quantification}]{\text{Pythagoreanism}} \boxed{\text{Quantum language}}$

Note that, from Plato to Wittgenstein, Pythagoreanism was ignored. Finally, the dream of Pythagoras was realized in quantum language.

2.3 Hērakleitos and Parmenides

2.3.1 Hērakleitos(BC.540 - BC.480)



Hērakleitos said the following.

(A):Hērakleitos(BC.540 - BC.480) in Ephesus

The arche (= the first principle of all things) is fire

And, further,

Everything flows.

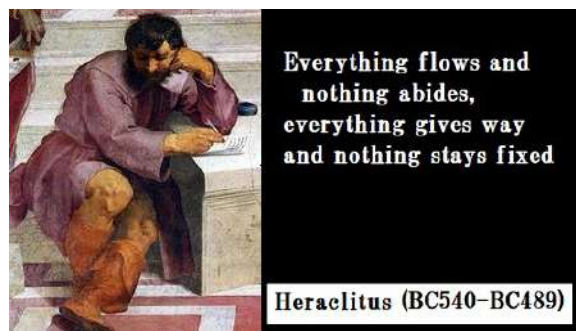

Although "Everything flows" and "You cannot step into the same river twice" are interesting, everyone may be able to say similar thing. Hence, in this paper, we interpret "Everything flows" as follows.

(B) "motion" is the most fundamental key-word in science.

If so, we can relate the (B) to Parmenides.

2.3.2 Parmenides; The ancestor of the Copenhagen interpretation

In the same period of Hērakleitos, Parmenides said the exact opposite of words of Hērakleitos. That is,

(C):Parmenides(BC.515 - unknown)

Parmenides said:

(C₁) Everything does not change. There is no motion and no change. Time does not exist. There exists only "one", and not "many".

Also,

(C₂) We should not rely on our senses to understand the world, but should think logically with reason. Even if it appears to be moving, it's just that the human being has the sense to see it. It does not guarantee the existence of the movement.

(Notice): Remark the similarity between (C₁) and the linguistic Copenhagen interpretation (*cf.* Sec. 1.1.2), i.e.,

"only one measurement is permitted", "State does not move", etc.

Also, in case of quantum mechanics, its object is too small, is not seen. Thus, we cannot rely on the sense, but only calculation. We can completely consent to Parmenides' assertion (C₂) in case of quantum mechanics.

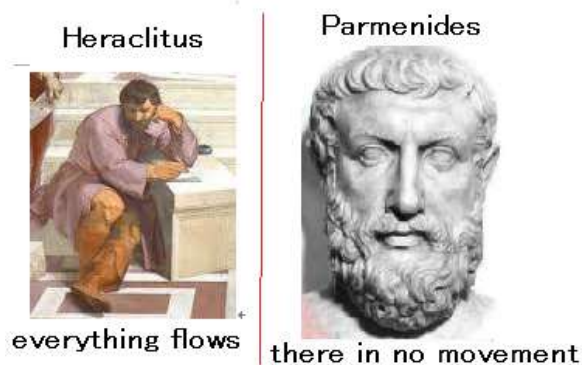

♠**Note 2.11.** It is certain that the Copenhagen interpretation of quantum mechanics was born in Niels Bohr institution of the university of Copenhagen.



However, I may have an opinion such that

(#) It is not too much to say that **Parmenides and Kolmogorov are the founders of the linguistic Copenhagen interpretation of quantum mechanics.**

(where Kolmogorov is the founder of the modern theory of probability (*cf.* ref. [83]). It is known that Kolmogorov’s extension theorem is the most fundamental in the theory of probability.) That is because

(b₁) Parmenides says that **there exists only "one", and not "many", there is no motion .**

(b₂) Linguistic Copenhagen interpretation says that **only one measurement is permitted .**

(b₃) Kolmogorov’s extension theorem says that **only one probability space is permitted .**

Roughly speaking, I think that (b₁)=(b₂)=(b₃).



If Parmenides didn’t think motion was important, there’s no way he could say "motion doesn’t exist". Thus, I consider that Parmenides believed in the importance of motion. Parmenides’ assertion is similar to Hērakleitos’, that is,

(D) "motion" is the most fundamental key-word in science.

The following (E₁) and (E₂) are my fiction about the difference between Hērakleitos and Parmenides:

(E₁) Since Hērakleitos said "The first principle of all things is fire", he seems to premise the realistic world. Thus, his motion is similar to the motion in physics.

(E₂) Parmenides might study the abstract motion in the linguistic worldview. For example, his motion is "vegetable growth", "increase of the population", "economic growth", "Achilles’ motion" and so on.

♠**Note 2.12.** Many would think the following.

(#₁) Hērakleitos is ordinary, and thus understandable, hence, scientific, therefore, realistic.

(#₂) Parmenides is ridiculous, and thus incomprehensible, hence, philosophical, therefore, idealistic (= linguistic).

Therefore, as mentioned in Assertion 1.12, I consider that

Realistic worldview vs. idealistic worldview

dispute \ [R] vs. [L]	Realistic worldview (monism, realism, no measurement)	Idealistic worldview (dualism, idealism, measurement)
Ⓐ: motion	Hērakleitos	Parmenides
Ⓑ: Ancient Greece	Aristotle	Plato
Ⓒ: Problem of universals	"Nominalismus" (Ockham)	"Realismus" (Anselmus)
Ⓓ: space-time	Newton	Leibniz
Ⓔ: quantum theory	Einstein	Bohr
Ⓕ: philosophy of science	Carnap	Quine

2.3.3 Motion function method as a worldview

As mentioned in the previous section, Pythagoras said "The arche (= the first principle of all things) is number", Hence,

- (F) Mathematics (or, parameterization) is indispensable to describe the world. However, we need words (or, concepts) to connect mathematics and the world.

And further, we want to consider the following fiction:

- (G) As an influential candidate of the key-words, Parmenides (and Hērakleitos) thought of "motion"

As one of the mechanical worldviews, we introduce the following "motion function method", which is assumed to be due to Parmenides in this paper though the true discoverer cannot be specified, (*cf.* Note 2.15).

(H): (Scientific linguistic) motion function method (due to Parmenides ?)

Principle 2.7. [The motion function method]

Let T be time axis, and let X be space axis. A function $f : T \rightarrow X$ is called a **motion function**.

Then, the motion function method (in the mechanical worldview) is proposed as follows:

- (H₁) "motion" should be described by the motion function $f : T \rightarrow X$.

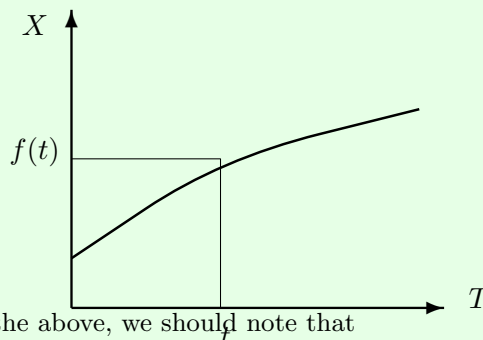

♠**Note 2.13.** In the above, we should note that

(#₁) "Moving feeling" is erased since the above graph is fixed.

If it is so, as Parmenides says, we think that

(#₂) if we devote ourselves to logic or mathematics without relying on the sense, then we cannot look at "motion".

Also, the motion function method belongs to the realistic worldview as well as the linguistic worldview. In fact, it is easy to see that the motion function method can be derived from Newton mechanics. However, motion functions are not limited to those derived from Newtonian mechanics. Thus, in this paper we usually consider that it belongs to the linguistic worldview.

(#₃) [For the derivation of motion function method from quantum language, see ref. \[45\], or Chap. 14 in ref.\[71\].](#)

The motion function method is easy, and it is usually studied in elementary school as follows.

Problem 2.8. An A spot and a B spot are 1400 meters away. Amy left the A spot for a B spot by 80 m per minute. Betty left the B spot for A spot at the same time by 60 m per minute. How many minutes later will Amy and Betty meet?

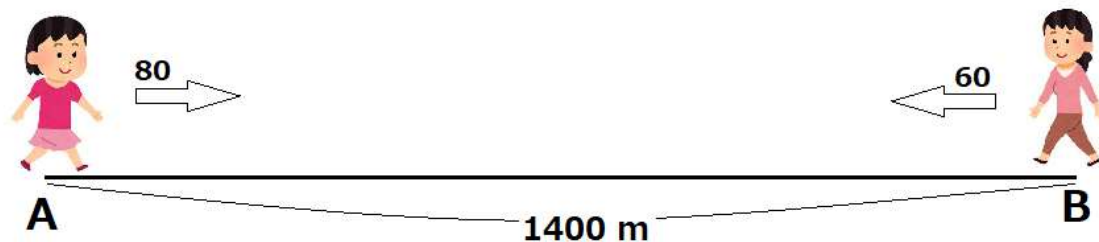

[Answer] Amy’s motion function $f_A : \mathbb{R}(\text{time axis}) \rightarrow \mathbb{R}(\text{one dimensional space axis})$ is defined by $f_A(t) = 60t$, Betty’s motion function $f_B : \mathbb{R}(\text{time axis}) \rightarrow \mathbb{R}(\text{one dimensional space axis})$ is defined by $f_B(t) = 1400 - 80t$, Thus, solving $f_A(t) = f_B(t)$, we see

$$60t = 1400 - 80t \quad \text{then, } t = 10$$

Hence, after 10 minutes later, the two meet. □

♠**Note 2.14.** Some may think that to consider two motion functions f_A and f_B is not consistent with Parmenides’ saying: *there exists only "one" and not "many"*(*cf.* Sec.1.1.2: linguistic Copenhagen interpretation). However, if so, it suffices to consider the following motion function:

(‡) $(f_A, f_B) : \mathbb{R}(\text{time axis}) \rightarrow \mathbb{R}^2(\text{two dimensional space axis})$.

This technique is common practice in quantum mechanics and analytical mechanics.

♠**Note 2.15.** (a): Note that the motion function method is derived from quantum language (*cf.* ref. [43, 44, 71]). Namely,

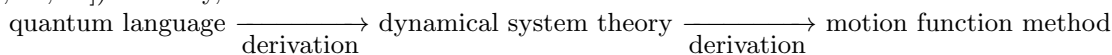

That is,

(‡) **the motion function method is one aspects of the quantum mechanical worldview (i.e., quantum language)**

Although I do not know, from the historical point of view, the discoverer of the motion function method, I want to assume that Parmenides is the main character, since he was a teacher of Zeno (*cf.* next section). Strictly speaking, the discovery might not be in Ancient Greece since the complete understanding of the concept of "function" is after Leibniz. However, we think that the spirit of the motion function method was understood by Pythagoras, Aristotle, Archimedes, etc.

(b): Of course, the above "motion function method" is incomplete and temporary. The motion function $f : T(\text{time}) \rightarrow X(\text{space})$ is not sufficient without the answers to the questions "What is time?" and "What is space?" (the Leibniz=Clarke correspondence (*cf.* Sec. 9.3.2). For the quantum linguistic answers to this questions, see ref. [71])

(c): The reader should want to ask the following questions.

- What is the motion function method ? Isn’t it in physics? Please answer briefly (without quantum language).

To put it simply, it is not in physics, but a kind of "habitual thinking" (\approx "worldview"). Such an idea may have come from D. Hume and I Kant (*cf.* Sec. 9.6, Chap.10).

♠**Note 2.16.** As the scientific worldviews before Newtonian mechanics, the most important is "the motion function method" and "Archimedes’ principle of leverage and buoyant force"

Some may have a question such as

- Why isn’t the importance of the motion function method emphasized?
Why can’t the discoverer of the motion function method be specified?

Although I have no clear answer, I consider as follows:

- The realistic worldview (i.e., physics) was usually discovered by one genius, for example, Archimedes, Newton, Maxwell, Einstein and so on. On the other hand, the mechanical worldview is discovered by plural persons. For example, the discoverer of the theory of probability (e.g., Pascal, J. Bernoulli, Laplace, Kolmogorov, etc.) cannot be specified. Probability theory was imperceptibly formed by a number of people. In this paper (*cf.* ref. [71]), we want to regard quantum theory, discovered by Heisenberg, Schrödinger and Born, as a kind of mechanical worldview (and not realistic worldview).

2.4 Zeno(BC490 - BC430): The Motion Paradox

In this section, from the quantum linguistic point of view, we study Zeno's paradoxes, the oldest paradox in science. Pay attention to the following.

- All the arguments in this section are my opinion, not the common.

Therefore, I invite readers to read this section from a critical perspective.

2.4.1 What is Zeno's paradoxes? Without a worldview, we cannot say anything

Zeno is a disciple of Parmenides. Thus, Zeno's Paradoxes may a collaboration between the two. Although Zeno's paradox has some types (i.e., "flying arrow", "Achilles and a tortoise", "dichotomy", "stadium", etc.), I think that these are essentially the same problem. And I think that the flying arrow expresses the essence of the problem exactly and is the best masterpiece in Zeno's paradoxes. As we will see in the next section, "Achilles and a tortoise" is a trick question.

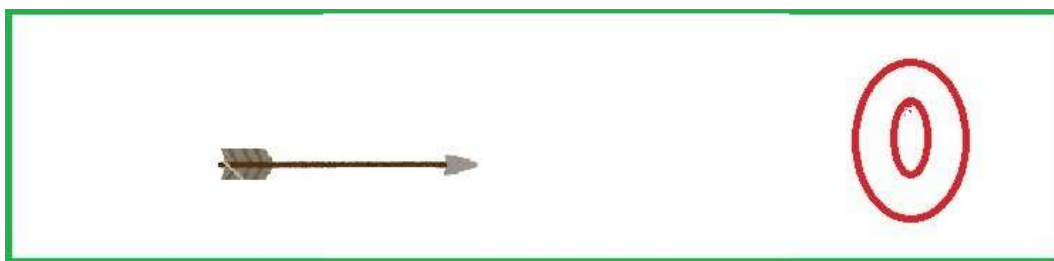

Now we present Zeno's paradoxes (i.e., flying arrow) as follows: Please taste the literary pleasure.

Paradox 2.9. [Zeno's paradoxes: The literature-like antinomy]

The literature-like proof of [Flying arrow is at rest]

- Consider a flying arrow. In any one instant of time, the arrow is not moving. Therefore, if the arrow is motionless at every instant, and time is entirely composed of instants, then motion is impossible. □

The literature-like proof of [Flying arrow is not at rest]

- We have to accept that an arrow passes there. However, "to pass there" is not equivalent "to exist there". What is "to pass there"? "To pass there" is both "to exit there" and "not to exist there". Therefore, flying arrow is not at rest. □

Therefore,

if we believe in such "logic" as above, we fall into a paradox.

Thus, our present problem is "How do we define 'logic'?"

Now we can answer the question "What is Zeno's paradoxes?". That is, we consider that

- (A) **Zeno's paradoxes say "Don't trust on 'logic' unconditionally", that is, "Start from a worldview and not logic".**

since Paradox 2.9 shows that "antinomy" happens in the logic in ordinary language. If so, we have to obey the worldviewism in Sec. 1.3.1. that is,

- First declare the worldview, and discuss the world in the worldview. Namely,

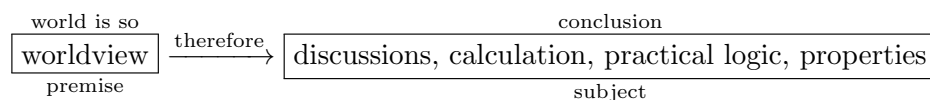

Seeing the literature-like proof in Paradox 2.9, we naturally have the question:

- **Under what kind of worldview is the above literature-like proof presented ?**

Therefore, to solve Zeno's paradoxes is to solve the following problem

Problem 2.10. Propose a certain worldview, in which Zeno's paradoxes (e.g., Flying arrow) can be discussed.

[Answer]; This is answered in Answer2.11 below.

Slogan-wise, we say

(B) **"Without a worldview, there is no logic (or precisely, practical logic)".**

Again see "the worldviewism (A)" in Sec. 1.3.1.

♠**Note 2.17.** The above is not to be taken for granted. As mentioned in Chaps. 11 and 12 later, the spirit of analytic philosophy is "Start from logic" or "Think logically !", though the great tradition of philosophy from Plato to Kant was always based on the worldviewism (*cf.* Chaps. 3-10). Thus, **I am somewhat skeptical of analytic philosophy** since I believe that the above (B) is the fundamental spirit of philosophy.

2.4.2* The solution* about Zeno's paradoxes (e.g., Flying arrow) in the motion function method

If we obey the motion function method (in the mechanical worldview), we can easily solve Zeno's paradoxes (e.g., Flying arrow) as follows.

Answer 2.11. [An answer to Problem 2.10(scientific answer)] Under the motion function method (cf. Section 2.3.3) in the mechanical worldview, we discuss "Flying arrow" as follows.

- Consider the motion function $x(t)$, that is, for each time t , the position $x(t)$ of the arrow is corresponded. It is obvious that
 - "for each time t , the position $x(t)$ of the arrow is corresponded" do not imply that the motion function $x(t)$ is a constant function.
 Therefore, the arrow is not necessarily at rest.

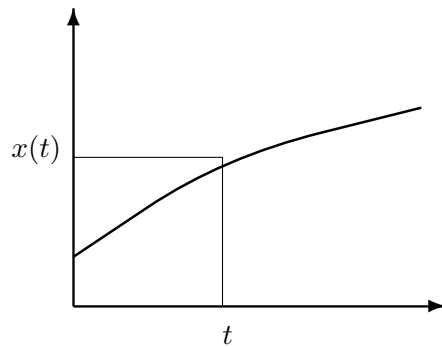

□

♠**Note 2.18.** Recall that we were confused in Paradox2.9[Zeno's paradoxes]. However, we could easily solve it in Answer 2.11. Thus we should be surprised at the power of the motion function method. If a certain worldview is determined, Zeno's paradoxes can be solved. Thus, the motion function method is not necessarily determined uniquely. For example, it is a good exercise to solve Zeno's paradoxes under Newtonian mechanics or the theory of relativity.

♠**Note 2.19.** As mentioned in Section 2.3.2, Parmenides' assertion is similar to the linguistic Copenhagen interpretation. Therefore, we think that the first step of the worldview was formed by Parmenides who belongs to the (quantum) mechanical worldview. Also, Hērakleitos is located in Parmenides' opposite side. Thus we see the following. (cf. Classification 1.11 [the classification of philosophers]):

We consider the following classification of philosophers.

- | | | |
|-----|---|--|
| (b) | { | (b ₁): the realistic worldview (physics) |
| | | Hērakleitos, Aristotle, Archimedes, Galileo, Newton, Einstein, ... |
| | | (b ₂₁): the fictional worldview (Western philosophy) |
| | | Plato, Scholasticism, Descartes, Locke, Leibniz, Berkeley, Hume, Kant, Husserl |
| | | (b ₂₂): the logical worldview (=the logical spirit=the spirit of "Think logically!") |
| | | Boole, Frege, Peirce, Saussure, Russell, Wittgenstein, Hempel, Quine, Popper |
| | | (b ₂₃): the mechanical worldview (statistics, quantum language) |
| | | Parmenides, Zeno, J. Bernoulli, statistics (e.g., Fisher), quantum language |

Since Zeno is a student of Parmenides, it is natural to consider that Parmenides and Zeno are in the

same position. Also, Pythagoras has no position in the above since we decide that mathematics is not a kind of worldview.

2.4.3 DST formula

In this section, we defined and discussed the "motion function method", which was a metaphysical method. However, it is not difficult, and it is similar to the "DST formula" learned in elementary school. To be precise, the "motion function method" is the premise first, and the DST formula has meaning under it. The DST formula was the following formula.

$$\boxed{\text{D}} = \boxed{\text{S}} \times \boxed{\text{T}} \quad (\clubsuit)$$

(distance) (speed) (time)

This "DST formula" may be the most difficult formula / concept in elementary school mathematics. It took me a long time to be able to use this formula when I was a child. Rather, I sometimes get confused even now. The following memory method, which was not available when the author was in elementary school, seems to be quite popular nowadays.

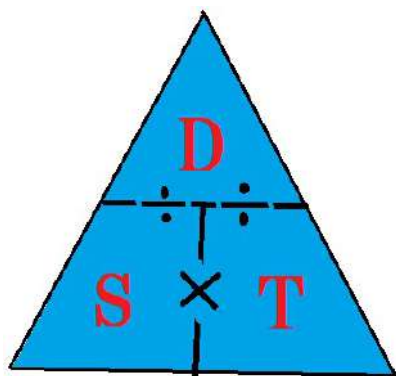

This figure is quite well known even though it does not seem to be a very good memory method. It is not written in the math textbooks of elementary school students, so they must have learned it at a cram school. When I asked the fourth-year students in my laboratory, about 50% of them knew about it. I was surprised at this prevalence. To be sure, let me repeat,

- The DST formula (\clubsuit) is one of the most difficult formulas in elementary arithmetic. Rather, I think it is one of the most difficult formulas taught in junior high school, high school, and university.

The Pythagorean Theorem is a mathematical formula. The law of conservation of momentum is a formula of Newtonian mechanics. Now let's ask,

(A) In which field is the DST formula (\clubsuit) a formula?

This problem is equivalent to the following problem:

- (B) Solve Zeno's paradoxes!

That is, as the answer for (A), we think that

- the DST formula (\clubsuit) is a formula in quantum language.

Thus, I think the DST formula (\clubsuit) is one of the most difficult formulas taught in junior high school, high school, and university.

Zeno's paradox attracted the interest of many philosophers because, in the author's opinion, the

kinetic function method is a metaphysical method. However, Zeno's paradox is mentioned by many philosophers, including Aristotle, Spinoza, Bertrand Russell, and Bergson. But I always think, "Even a wise philosopher looks like a fool when talking about Zeno's paradox." Therefore, if the reader does not consider me stupid, I am lucky.

2.4.4 Appendix: The discussion about Zeno's paradoxes (e.g., Achilles and a tortoise) in the motion function method

The idea of associating Zeno's paradox ("Achilles and a tortoise") with an infinite series misses the essence of Zeno's paradox, because Parmenides and Zeno's interest should be a worldview. That is, "Flying arrow" is the most important paradox in Zeno's paradoxes. However, since geometric series' method is most famous, I add "Achilles and a tortoise" as an appendix (*cf.* ref. [45], or Chap. 14 in ref. [71]). Readers should also taste the literary pleasure in the following.

Paradox 2.12. [Zeno's paradoxes(the literature-like answer)]
[Achilles and a tortoise]

Zeno's paradox (Achilles and a tortoise) is as follows.

- Consider the competition of Achilles (a quick runner) and a tortoise (a late runner). Consider the competition of Achilles and a tortoise. Achilles' starting point will be behind the turtle's starting point. Suppose that both started simultaneously. If Achilles tries to pass a tortoise, Achilles has to go to the place in which a tortoise is present now. However, then, the tortoise should have gone ahead more. Achilles has to go to the place in which a tortoise is present now further. Even if Achilles continues to do this infinite times, he will not be able to keep up with the turtle.

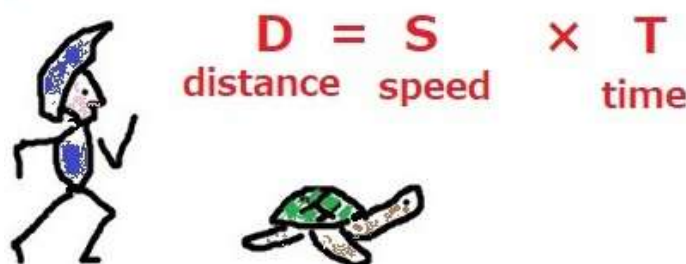

[The scientific answer to Zeno's paradox (Achilles and a tortoise) by the motion function method]

For example, assume that the velocity $v_q(= v)$ [resp. $v_s(= \gamma v)$] of the quickest [resp. slowest] runner is equal to $v(> 0)$ [resp. $\gamma v (0 < \gamma < 1)$]. And further, assume that the position of the quickest [resp. slowest] runner at time $t = 0$ is equal to 0 [resp. $a (> 0)$]. Thus, we can assume that the position $q_1(t)$ of the quickest runner and the position $q_2(t)$ of the slowest runner at time $t (\geq 0)$ is respectively represented by the following motion function:

$$\begin{cases} q_1(t) = vt \\ q_2(t) = \gamma vt + a \end{cases} \quad (2.2)$$

Thus, it suffices to calculate formula (2.2).

Although it can be solved by various method, I present two methods as follows(i.e., (i) or (ii)):

[(i): Algebraic calculation of (2.2)]:

Solving $q_1(s_0) = q_2(s_0)$, that is,

$$vs_0 = \gamma vs_0 + a$$

we get $s_0 = \frac{a}{(1-\gamma)v}$. That is, at time $s_0 = \frac{a}{(1-\gamma)v}$, the fast runner catches up with the slow runner.

[(ii): Iterative calculation of (2.2)]:

Define $t_k (k = 0, 1, \dots)$ such that, $t_0 = 0$ and

$$t_{k+1} = \gamma vt_k + a \quad (k = 0, 1, 2, \dots)$$

Thus, we see that $t_k = \frac{(1-\gamma^k)a}{(1-\gamma)v}$ ($k = 0, 1, \dots$). Then, we have that

$$\begin{aligned} (q_1(t_k), q_2(t_k)) &= \left(\frac{(1-\gamma^k)a}{1-\gamma}, \frac{(1-\gamma^{k+1})a}{1-\gamma} \right) \\ &\rightarrow \left(\frac{a}{1-\gamma}, \frac{a}{1-\gamma} \right) \end{aligned} \tag{2.3}$$

as $k \rightarrow \infty$. Therefore, the quickest runner catches up with the slowest at time $s_0 = \frac{a}{(1-\gamma)v}$.

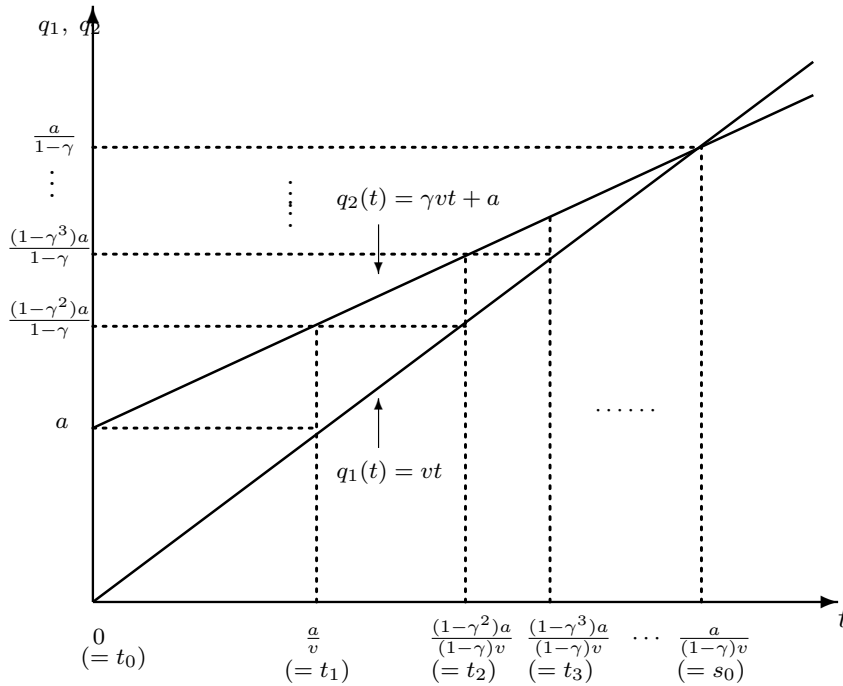

Graph: $q_1(t) = vt$, $q_2(t) = \gamma vt + a$

[(iii): Conclusion]: After all, by the above (i) or (ii), we can conclude that

(#) the quickest runner can overtake the slowest at time $s_0 = \frac{a}{(1-\gamma)v}$.

♠**Note 2.20.** (b_1): Note that the above (ii) [= the solution using a geometric series] is another solution of (i). Of course, there was no need to use geometric series. The point is that there is a difference in the position of whether one considers the Achilles and a turtle paradox to be a mathematical problem or a philosophical problem. Many philosophers have gotten into dead ends by confusing the two positions. Philosophers should have considered it as a problem of world description.

(b_2): From the philosophical point of view, "flying arrow" is definitely better than "Achilles and a tortoise". However, as far as quizzes go, "Achilles and a tortoise" is well done. "Achilles and a tortoise" is well done in the sense that the trick is designed to make it easy for solvers to fall into it. In fact, for 2,500 years, most solvers have fallen for this trick.

♠**Note 2.21.** As mentioned in Preface, the purpose of this paper is to understand the history of western philosophy from the quantum linguistic point of view. Thus,

(#) We aren't interested about how Zeno himself considered his paradoxes. The established theory may say that Zeno might study the infinite division of time in physics (and space)

However, if so, Zeno's paradoxes are the problem in physics and not philosophy. Then the problem should be entrusted to physicists. However, in this paper, we assume that Zeno's paradoxes belong to philosophy and not physics. Also, for the answer to "What is space-time in quantum language?", see Sec. 9.3.2: (Leibniz=Clarke correspondence).

Chapter 3

The Big Three in Greek Philosophy (Socrates, Plato)

By the appearance of The Big Three in Greek Philosophy (Socrates, Plato, Aristotle), the origin of western philosophy was formed as follows.

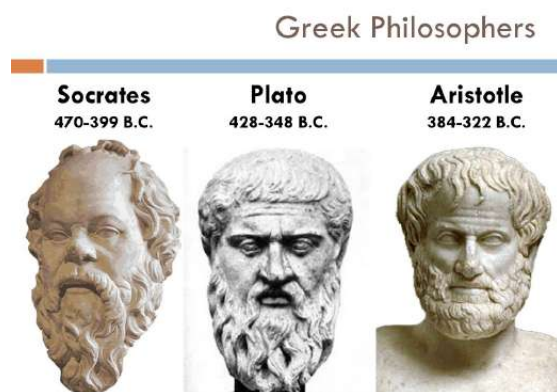
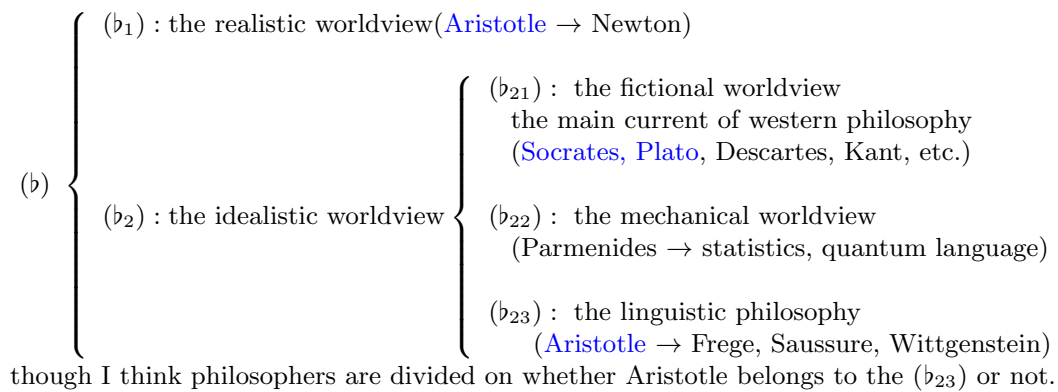

3.1 Protagoras and Socrates

3.1.1 Ethics

The philosophy of worldview aimed at the following problems

- (A) How is the world described? How is the world understood?
 By what kind of language is the world described?

But, there is another philosophy (i.e., philosophy of ethics) different from the worldview.

Ethics, morals [How should we live?]

Many people in the sciences (no, even the liberal arts) may think that ethical philosophy is "debating skills". In fact, **Protagoras (490 BC. - 420 BC.)**, a central figure of the Sophists, preached that **"man is the measure of all things"**. He argued for relativism, which holds that there is no such thing as objective truth. In other words, he argued that only the subjective judgment of each person is essential. Since the common sense of capitalism is

"the average of subjective value" = "price"

one might say that the sophist's claim is reasonable and modern common sense.

However, **Socrates (BC.469 - BC.399)** had objected to this idea. He investigated that

- (B) How should we live?

And, he clarified the following words:

- (C) "goodness", "happiness", "virtue", "justice", "courage", "love"

That is, Socrates asserted that the investigation of the above words is also the central theme of philosophy. In the following dispute:

"relativism (rational sophists) " vs. "absolutism (a man of faith: Socrates) "

Socrates has advocated the ethical philosophy.

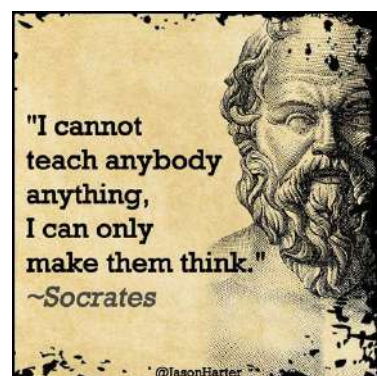
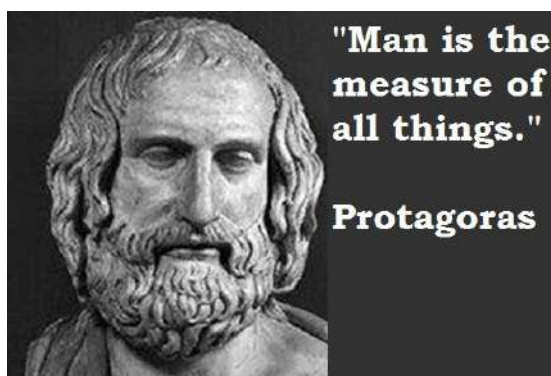

Note that three philosophers (Socrates (BC.469 - BC.399) , Buddha (BC.565 - BC.486), Confucius (BC.551 - BC.479) and Mozi (BC.470 - BC.390)) were contemporary, and investigated the same problem (B). In this sense, we can say that

- (D₁) The mathematics of Pythagoras was unparalleled in the world. Compared to this , **Socrates was common sense and mediocre.**

It is a matter of course that

(D₂) If these words mentioned in the above (C) didn't spread, the human race might have been ruined. At least, we wouldn't be able to form "human society". Maybe the mankind perished.

Therefore, I cannot overemphasize the importance of ethical philosophy. Also, the philosophy of ethics is worldwide. When it isn't so, we're in trouble. That is, when it isn't so, "world peace" isn't achieved. As emphasized throughout this paper, I believe that

- **The main theme of philosophy is ethics (and not worldview). Even if we didn't have a philosophy of world description, we would have done it reasonably well.**

Hence I agree that Socrates is called the father of philosophy.

♠**Note 3.1.** In general, Ethical philosophy does not have any truth or universality. Society of ants has "ethics and morals of ants", and apes must have "ethics and morals of apes". The ethical philosophy of the Neanderthals must have been quite different from ours. Therefore, our ancestors must have destroyed the Neanderthals. Communication and contact with civilized aliens will happen in the future. However, it is too optimistic to expect the aliens to be unconditionally friendly at this time. I remembered that the late Dr. Hawking had emphasized the same opinion.

3.1.2 Magic proposition: I know I know nothing

♠**Note 3.2.** Socrates did not leave a book. The "Sophists vs. Socrates" is Plato's fiction. Since Plato is a disciple of Socrates, it's not fair. For example. The strongest logic, "**I know that I know nothing**" goes something like this.

- Sophists: something is asserted
- Socrates: deny Sophists' assertion
- Sophists and Socrates: debate (called Socratic Method)
 Sophists and Socrates tell eloquently, and thus, they get tired.
- At that time, Socrates says "Your ignorance is now revealed. **I know that I know nothing**, but you do not know that you know nothing. Thus, I am superior to you".

This is Socrates' strongest logic "**I know that I know nothing**". If we, without sticking to an established theory, read Plato's novel which makes Socrates a main character, we may have a variety of opinions on the following issues.

- Which is playing with sophistry, Socrates or sophists?

I may feel that Socrates uses more sophistry (since Socrates uses taboo statement: I know I know nothing). □

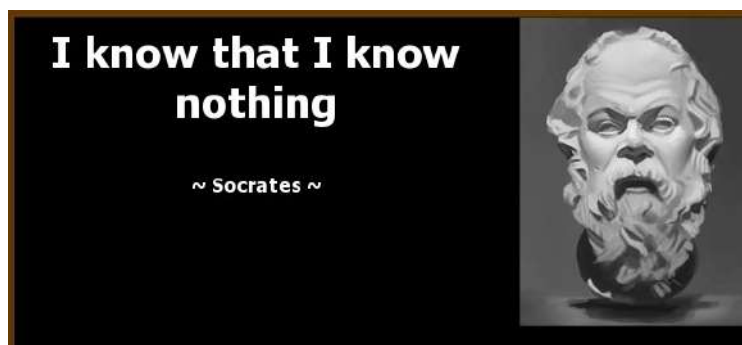

In physics, you can draw conclusions with experiments, in mathematics you can prove them, and in engineering you just need to employ something useful. However, ethical philosophy does not solve the problem in that way. So Socrates (= Plato) came up with the magic word "**I know that I know nothing**" (**self-referential proposition**, anti-Copenhagen interpretive proposition) as a way to end the discussion.

(E) Since Socrates is the main character of Plato's novel, he must always be undefeated.

Recall Figure 1.2 (in Section 1.1.2: The linguistic Copenhagen interpretation) below:

Figure 3.1. (= Figure 1.2 in Section 1.1.2) [Descartes Figure]: Image of "measurement(= \textcircled{a} + \textcircled{b})" in dualism

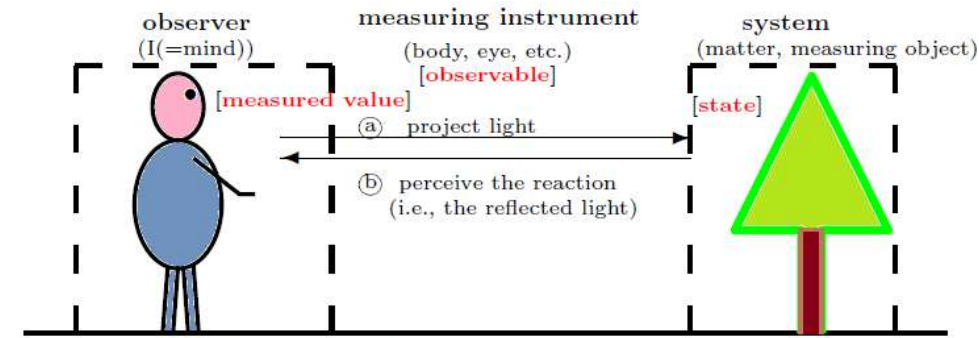

Figure 1.2. **Descartes Figure**: Image of "measurement(= \textcircled{a} + \textcircled{b})" in dualism

Note that

(F) the self-referential propositions (e.g., "I know that I know nothing", "I think, therefore I am", etc.) are out of quantum language (= dualistic language).

That is because the linguistic Copenhagen interpretation says that "observer" and "measuring object" must be completely separated. However, it holds that "observer" = "I" = "measuring object" in the above self-referential propositions. Thus, the self-referential propositions are **taboo statements** in quantum language (= scientific language).

However, it is sure that the wordplay of self-referential propositions ("I know that I know nothing", "I think, therefore I am", etc.) is an important part of philosophy. In the art of argumentation, taboo propositions are often valid. Taboo propositions are so unclear in their meaning that listeners (i.e., readers) often misinterpret them as profound propositions. This is the reason that Socrates and Descartes succeeded. They were excellent sophists. A good sophist doesn't let his readers know that he is a sophist. This is natural. Because philosophy is a kind of literature.

3.2 Plato(BC.427 - BC.347)

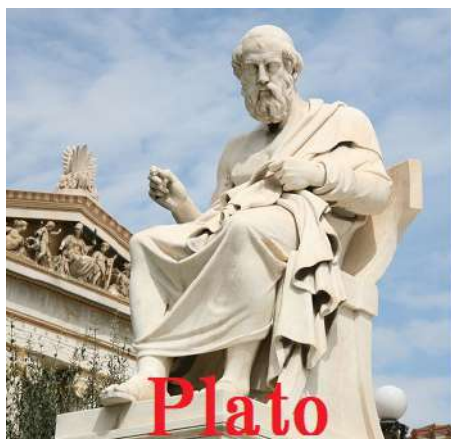

**At the touch of love,
everyone becomes a poet**

**Music gives a soul to
the universe, wings to
the mind, flight to the
imagination and life to
everything**

3.2.1 The theory of Ideas – Asserted fiction –

In the binary opposition (in ethics):

(A) "relativism (rational sophists)" vs. "absolutism (a man of faith: Socrates)"

Plato, a student of Socrates, established "the theory of Ideas" as the foundation of absolutism in order to support Socrates.

If the propositions such as "Man's life is heavier than the Earth", "Love is forever", "Love always overcomes money", etc. are the objective truth, the occupation of the insurance company does not hold. However, Socrates wanted to believe so. To help Socrates, Plato proposed the occult heavenly world (i.e., the world of Idea). That is,

(B) the theory of Ideas is a reckless attempt to derive ethics (i.e., "How should we live?") from worldview (i.e., "How is the world?"), that is,

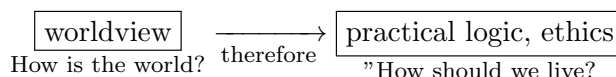

This method (= the form of philosophy) has been accepted as the standard form of "how to tell philosophy" in the history of two thousands hundreds of years.

(C): The fiction called "the theory of Ideas"

Theory 3.2. [Theory of Ideas]:

The theory of Ideas is as follows

- It cannot be said that love always overcomes money in the real world. However, there exists another world (i.e., the world of Idea), where "love always overcomes money" is believed as the objective truth. That is, there exists Idea (= the true form) in heavens. A thing existing on the ground is only the shadow.

This is the theory of Ideas.

Then, the real world is a shadow picture, hence, in the real world,

- (D₁) love sometimes loses money
- (D₂) We can't live on justice alone.
- (D₃) Good man is sometimes unhappy.

That is, Plato wanted to say that

"love always overcomes money" is the objective truth in the world of Idea, therefore, "Believe in love!"

Whether you believe in this reasoning or not, this idea, i.e., the discovery of two key words "Idea world" and "reality world", was the beginning of "dualistic idealism" and has always been the mainstream of Western philosophy, despite the twists and turns that followed. The theory of ideas, which was supposed to be a logistic support of ethical philosophy (Socrates), became the mainstream of the philosophy of worldview.

(E) Our human DNA prefers logic (or reasoning) as if the philosophy of ethics were derived from the philosophy of worldview. That is,

"the world is so", therefore "we should live so"

namely,

(F₁) (= (B))

<div style="border: 1px solid black; padding: 2px; display: inline-block;"> world is so fictional worldview </div>	therefore→	<div style="border: 1px solid black; padding: 2px; display: inline-block;"> we should live so practical logic, ethics·morals </div>
introduction·preface·fiction		main subject

Also, for example,

•

<div style="border: 1px solid black; padding: 2px; display: inline-block;"> invisible man exists fictional worldview (fictional)premise </div>	therefore→	<div style="border: 1px solid black; padding: 2px; display: inline-block;"> don't steal a glance practical logic, ethics·morals main subject </div>
--	------------	---

and

•

<div style="border: 1px solid black; padding: 2px; display: inline-block;"> ultimate beauty exists fictional worldview premise, fiction </div>	therefore→	<div style="border: 1px solid black; padding: 2px; display: inline-block;"> she is an embodiment of beauty. practical logic, ethics, morals,aesthetic sense main assertion </div>
--	------------	---

This is, of course, irrational since this is a reckless attempt such that the problem "How should we live?" is answered from the objective point of view. However, the human brain does not operate on logic alone. "Logic" cannot function without some kind of sensuous common soil. Logic alone is not enough, what is important is **"logic in a common sensory soil" (= "practical logic")**.

In other word, **"without common sensory soil, logic cannot work"**, therefore **"the first thing to do is to form a common sensory soil**. If so, Plato's way of telling philosophy (F₁) may not be reckless. That is because the (F₁) means

(F₂)

<div style="border: 1px solid black; padding: 2px; display: inline-block;"> world is so fictional worldview introduction·preface·fiction common sensory soil </div>	therefore→	<div style="border: 1px solid black; padding: 2px; display: inline-block;"> we should live so practical logic, Ethics · morals main subject </div>
---	------------	---

That is, "logic" depends on "worldview". Slogan-wise, we say

(G) **"Without a worldview, there is no logic (= practical logic)".**

Recall that **this slogan plays an essential role in the solution of Zeno's paradox** (cf. Sec.2.4 (B)). Also, again see "the worldwivism (A)" in Sec. 1.3.1 and Note 1.14.

♠**Note 3.3.** Here, **"logic in the common soil of the senses"** has a similar meaning to "logic under a certain description of the world". In a broader sense, this "logic" is the logic usually used by ordinary people, such as the logic of Newton mechanics, the logic of a court case, the logic of politics, the logic of family life, the logic of insurance solicitation, and so on. One of the various kinds of logic is the logic of mathematical logic (= symbolic logic), which is so universal that even aliens may know it. However,

(‡) this does not mean that mathematical logic experts can master the logic of other disciplines well. Naturally, a good understanding of economics means that one can use the logic of the common soil of

economics. Judges and lawyers don't have to learn mathematical logic. It is natural to expect that logic under the theory of Ideas promote our understanding of Socrates and Plato ethics.

As mentioned in Chap. 12, we have two types of logic (i.e., symbolic logic and practical logic) (cf. Note 1.15), i.e.,

- { symbolic logic (= axiomatic logic =mathematical logic)
- { practical logic (= non-mathematical logic)

Practical logic plays an important role in worldviews. On the other hand, symbolic logic plays an important role in mathematics. I am skeptical of analytic philosophy, in which symbolic logic and practical logic may be confused. I feel that the above spirit (§) is scarce in analytic philosophy.

♠**Note 3.4.** (i): Aesop (BC.620 - BC.510): Idea theory is similar to Aesop's fable in some ways. It is natural to be hesitant to teach morality to others face-to-face. I think Aesop was preaching ethics indirectly through the animals. Aesop's fables were already well known before the late 5th century BC. Of course, Plato must have been aware of the persuasive power of Aesop's fables. And further, Plato might think that

A worldview is an abstraction of many allegories

In this sense, Plato might discover the power of abstraction.

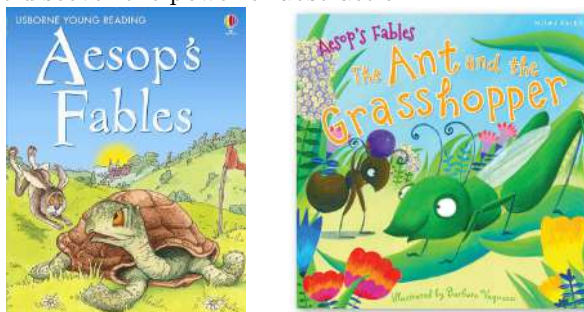

(ii): In the book "Sapiens: A Brief History of Humankind" (cf. [30], 2016), Harari, the author, describes three revolutions which brought about dramatic changes to human societies.

- { ① : the Cognitive revolution, about 70,000 years ago
- { ② : the Agricultural revolution, about 11,000 years ago
- { ③ : the Scientific revolution, beginning a mere 500 years ago

The above ① implies that

- we can rule the world because we are the only animals that can create and believe in fictions like God, the state, money and human rights.

Did Plato know about the cognitive revolution?

Plato's say is as follows: No matter how much we argue, the issue of "relativism (rational sophistry) vs. absolutism (man of faith: Socrates)" can't be concluded. It is not a truth that we seek. There may not be the truth. ////

What people want is an "asserted fiction", not the truth.

And this is the philosophy. I think that's what Plato would have thought. In a simple analogy, it's next.

Say!, "I love you," even if it's a lie.

♠**Note 3.5.** S. Weinberg (1933 -2021), a physicist at the University of Texas, Austin, won a Nobel Prize in 1979 for work that became a cornerstone of particle physics, said in his book [115] "To explain the word; The discovery of modern science" as follows:

- (b) [in Chapter 1] *There is an important feature of modern science that is almost completely missing in all the thinkers I have mentioned, from Thales to Plato: none of them attempted to verify or even (aside perhaps from Zeno) seriously to justify their speculations.*

Plato's philosophy is a representative of idealism (cf. for the definition of "idealism", see Definition 1.8), which is a completely different style of philosophy from (experiment-oriented) science. As noted above, Plato's philosophy is a philosophy that begins with "asserted fiction". Also, it is a time of F.

Bacon (i.e., the father of British Empiricism) of the scientific revolution (the 17th century) that the importance of observation was, for the first time, emphasized. See Section 7.2

Recall the rule of philosophy (\approx idealism) is as follows:

- (#1) Only discussion, no experimentation.
- (#2) the winner will be determined by popularity vote of the general public.



♠**Note 3.6.** In order to avoid eternal argument, Socrates invented "Socratic method", that is, the magic sentence "I know that I know nothing". Plato also invented the theory of Ideas.

For completeness, we add the following:

- (F) I think that Plato did not believe in the existence of the world of Idea. If he believed in it, he was not a philosopher but a founder of religion. He also understood that the theory of Ideas is sophistry, and there is no truth in ethics.

Even so, there may be a reason to consider that

- (G) something such as the sense of ethics of the human commonness is printed in the arrangement of a human DNA,

However, this idea may not be within philosophy.

3.2.2 Allegory of the cave

The allegory of the cave was presented by Plato in his work "Republic" in order to promote the understanding of "the theory of Ideas".

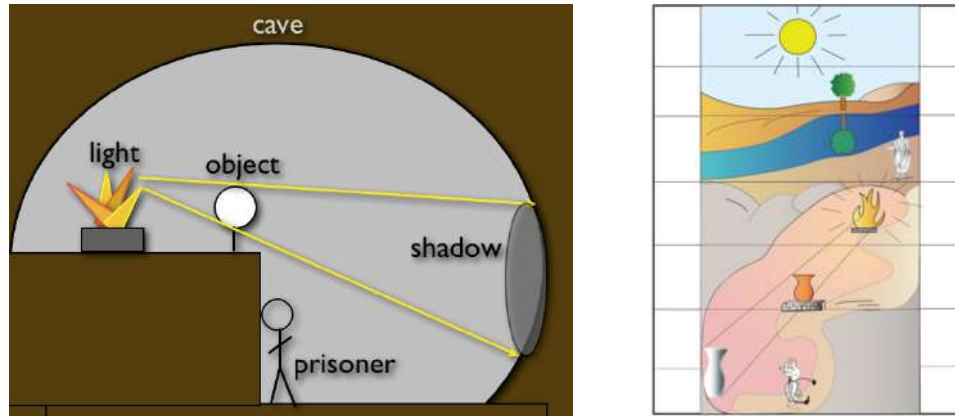

Allegory 3.3. [Allegory of the cave]

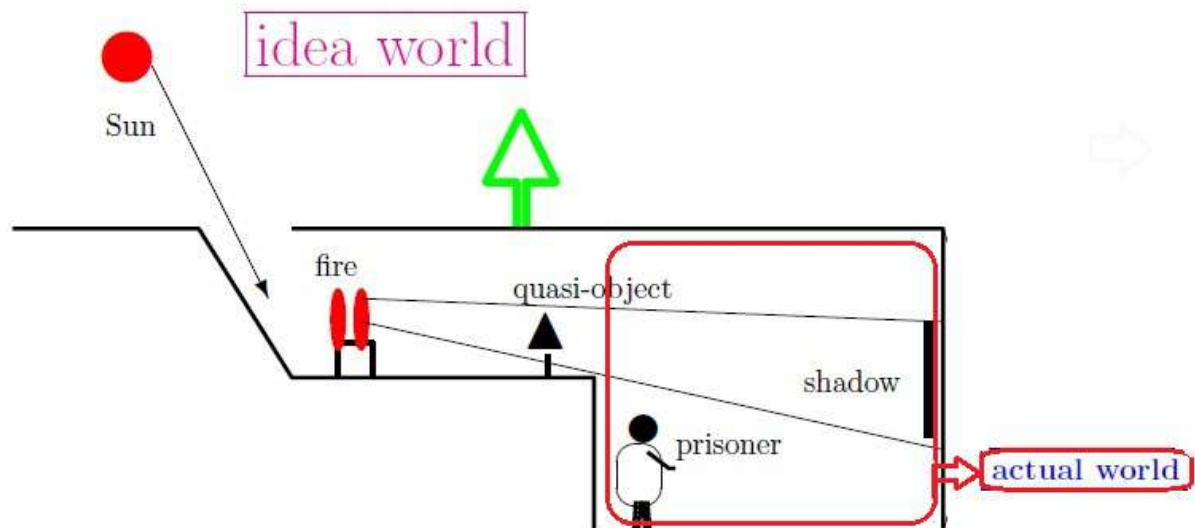

A group of prisoners are looking at the shadows on the back wall of a cave. The shadows just are reality since they have never experienced anything other than shadows. The shadows represent physical reality. One day, one of the prisoners gets free. Namely, he is the philosopher, the lover of wisdom. Let's assume he is Socrates. He turns around and the first thing he sees is objects of stone and wood made to resemble the shapes of real things such as a tree. Further along, generating the light that hits these objects that then produce shadows on the back wall of the cave, is a fire. Beyond the fire is the entrance/exit of the cave. The philosopher exits the cave and is temporarily blinded by the light. The first thing he sees is a real tree. Finally, the philosopher sees the sun which Plato called The Idea of the Good. The freed prisoner (who is assumed to be Socrates) would think that the world outside the cave was superior to the world he experienced in the cave. And he would want to bring his fellow cave dwellers out of the cave and into the sunlight. The returning prisoner, whose eyes have become accustomed to the sunlight, would be blind when he re-enters the cave, just as he was when he was first exposed to the sun. The prisoners would infer from the returning man's blindness that the journey out of the cave had harmed him and that they should not undertake a

similar journey. Hence, there is a possibility that the prisoners would therefore reach out and kill anyone who attempted to drag them out of the cave. In fact Socrates was killed.

Remark 3.4. Thus, Allegory of the cave says that three key-words in Plato philosophy:

$$[A](\mathbf{mind}) \quad \leftarrow [B] \rightarrow \quad [C](\mathbf{matter})$$

(medium)

correspond to as follows:

\	[A](= mind)	[B](Mediating of A and C)	[C](= matter)
Plato (cave)	actual world	sunlight (See Review 3.10 later)	/ [Idea world]
quantum language	measured value	observable	state [system]

3.2.3 The theory of anamnesis

As a mediator between the real world and the idea world, Plato presents the concept of "anamnesis". Namely,

- We had seen the Idea before we were born. But we forget that when we are born. Therefore, to know an Idea is to recall the Idea. In other words, learning is nothing less than recalling (= anamnesis).



Knowledge gained in past lives is the basis for education in the present life

In the history of western philosophy, the theory of anamnesis is located as follows:



Remark 3.5. If we believe in the theory of anamnesis, three key-words in Plato philosophy:

$$[A](\mathbf{mind}) \quad \leftarrow [B] \rightarrow \quad [C](\mathbf{matter})$$

(medium)

correspond to as follows:

\	[A](= mind)	[B](Mediating of A and C)	[C](= matter)
Plato (anamnesis)	actual world	anamnesis (See Review 3.10 later)	/ [Idea world]
quantum language	measured value	observable	state [system]

3.3 The allegory of the sun: Measurement theoretical aspect of Idea theory

The analogy of the sun is found in "Republic", written by Plato. Upon being urged by Glaucon (Plato's elder brother) to define goodness, a cautious Socrates professes himself incapable of doing so. Instead he draws an analogy and offers to talk about "the child of goodness". For the answer to "Why a child?", see Note 3.9.

3.3.1 The allegory of the sun

Note that the North Star can be also regarded as a measuring instrument for orientation. With this in mind, I hope you will read the following.

Allegory 3.6. [The Allegory of the Sun]: The Allegory of the Sun explains what the "Idea of Good" is all about. No matter how much you open your eyes, you cannot see anything "visible" in the "visible" world, such as a flower, a tree, or a dog, without the light of the sun.

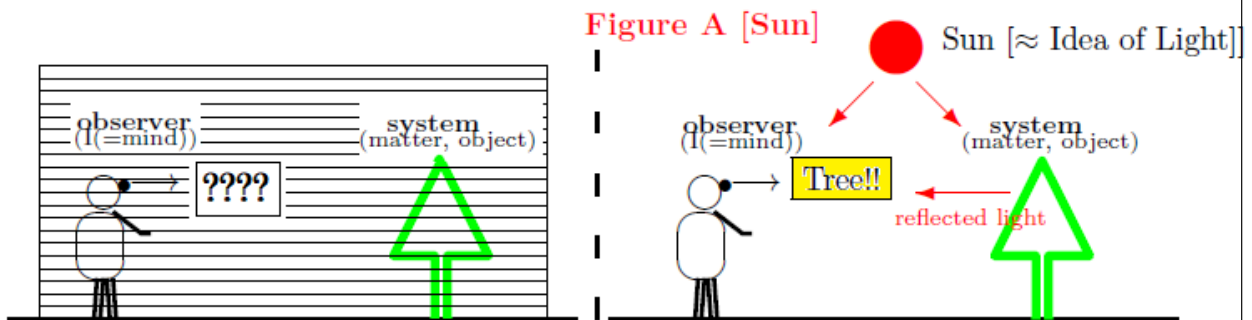

In the beginning, when it's dark as shown on the left figure, you can't see anything, even if your vision is normal. However, by developing the skills to use a measuring instrument called the "Sun [= Idea of Light]," you can see that it is a "tree". Thus, in this fable, the ternary relation ("the beholder," "the sun (the mediating thing)," "the thing to be seen") are clear and very easy to understand.

— In the same way, things that exist in the invisible realm, such as virtue and courage, cannot be known unless one has the skill to use the measuring instrument called the "idea of the good", even if one has reason.

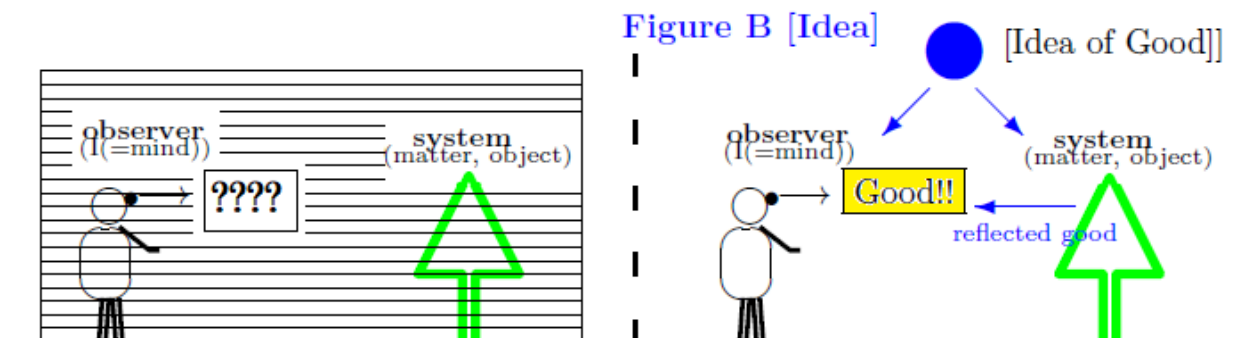

In other words, if you learn how to use a measuring instrument called the sun, you can make the

object "visible". In the same way, the mastery of the measuring instrument, which is called the "idea of Good," makes clear virtue and courage.

Remark 3.7. The polar star can be regarded as a measuring instrument such as a kind of compass (*cf.* Note 1.4 (ii)). Thus, it is reasonable to regard the sum (Idea) as a measure of "Good".

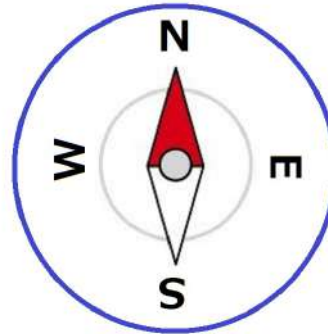
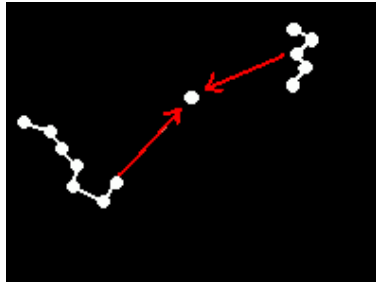

That is, I want to think:

"Idea" = "instrument to make Idea world visible".

though this may not be standard.

Therefore, three key-words in Plato philosophy:

$$[A](\mathbf{mind}) \quad \leftarrow [B] \rightarrow \quad [C](\mathbf{matter})$$

(medium)

correspond to as follows:

	[A](= mind)	[B](Mediating of A and C)	[C](= matter)
Plato (Sun)	actual world	Idea (See Review 3.10 later)	/ [Idea world]
quantum language	measured value	observable	state [system]

It should be noted that this response is somewhat unreasonable. That is because Idea Theory was not proposed with the intention of a theory of measurement (or epistemology).

3.3.2* The measurement theoretical understanding of the allegory of the sun

Recall Figure 1.2 [Descartes figure] in Sec. 1.1.2, namely,
Figure 1.2 ; [Descartes Figure]: Image of "measurement(= \textcircled{a} + \textcircled{b})" in dualism

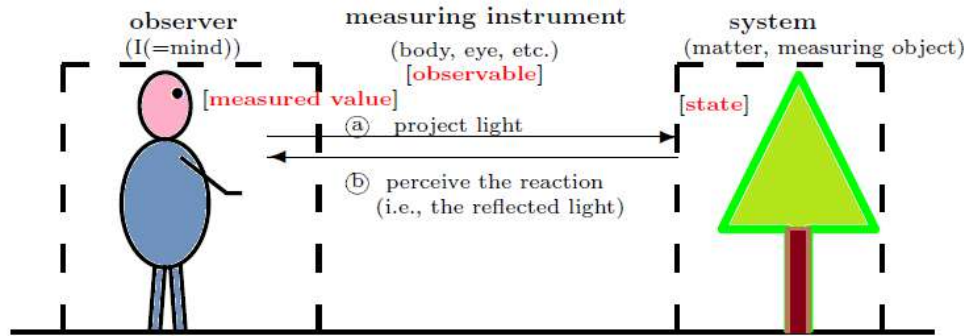
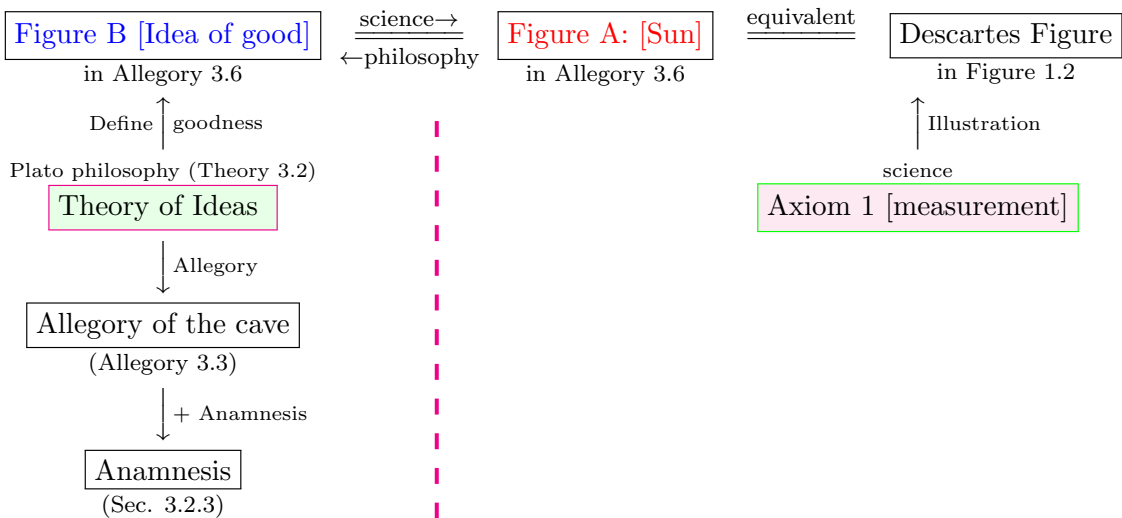

Figure 1.2. **Descartes Figure**: Image of "measurement(= \textcircled{a} + \textcircled{b})" in dualism

Here, it should be noted that this is essentially the same as the figure [Allegory of the sun].

Summary 3.8. We see:



philosophy

science

We consider that

- the understanding of the first line above, namely,

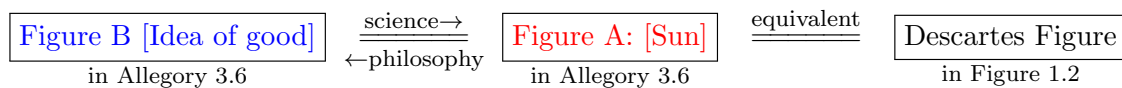

is equal to the measurement theoretical understanding of Allegory 3.6 [Allegory of the sun].

Thus, "Descartes figure" should have been called "Plato figure".

3.4 Plato: The fictional worldview (=Plato's way of telling philosophy)

3.4.1 The necessity of idealism and dualism

Let us review Plato's way of telling philosophy (=the fictional worldview, cf. Sec. 1.3.3.1).

(A): The fictional worldview (=Plato's way of telling philosophy)

Plato's way of telling philosophy (in the main current of western philosophy) is as follows.

(A) (♯): fictional worldview (literary truth, pseudo-truth)

world is so

preface, introduction, (fictional)premise, expedient

you should do so

therefore → (b): ethics, morals, etc.

main subject

Therefore,

(A₁) [world is so] is secondary,

(A₂) [you should do so] is main theme

In Plato philosophy, the theory of Ideas (=the fictional worldview) is only the fiction (= parable, fable). That is,

the theory of Ideas is only a prologue for Plato's ethics.

Plato's way of telling philosophy is common to all philosophies in the genealogy of the dualistic idealism as follows:

(B) Plato(the theory of Ideas) → Augustinus → Thomas Aquinas → Descartes
 → Kant(epistemology)

If so, we may hesitate to reply "Yes" for the following question:

- Does the philosophy of worldview proposed by them merit serious and scientific discussion?

As mentioned throughout this paper, we consider that

- every worldview in the genealogy (B) of the dualistic idealism is an allegory as similar as the theory of Ideas.

♠**Note 3.7.** (i): Kant is highly regarded on today. As seen later (Chapter 10: Kant), the reason is that Kant understood Plato's intention perfectly.

"Critique of Pure Reason (1781)"
"Critique of Practical Reason (1788)"
"Critique of Judgment(1790)"

• fictional worldview therefore → ethics, morals, aesthetics

preface, introduction, (fictional)premise, expedient main subject

where it should be noted that Critique of Pure Reason is not scientific.

(ii): In Plato's way of telling philosophy:

(♯): worldview therefore → (b), etc.

world is so

it should be noted that (b) is not necessarily deduced from (♯). In most cases, (♯) and (b) are not theoretically related. In this text, we are concerned with the following four:

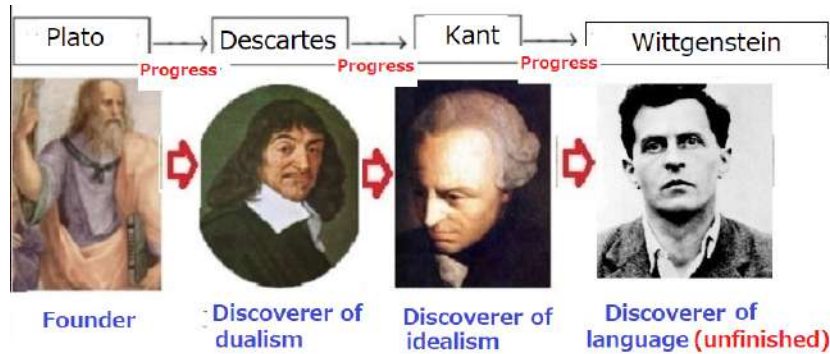

In fact, as seen in the above, "Critique of Pure Reason" and "Critique of Practical Reason" (or, "Critique of Judgment") are not related. Also, recall that

- Descartes philosophy:

$$\boxed{(\#): \text{I think, therefore I am}} \xrightarrow{\text{therefore}} \boxed{(b), \text{God exists}}$$

- analytic philosophy is generally considered as follows.

$$\boxed{(\#): \text{mathematical logic}} \xrightarrow{\text{therefore}} \text{(Frege, Russell etc.)}$$

$$\boxed{(b), \text{philosophy of language, philosophy of mind, analytic aesthetics}}$$

(as I have said throughout this text, I do not believe that mathematics can be a worldview).
That is,

Say!, "therefore," even if it's a lie.

That is because (b) will not be never experimentally verified.

3.4.1.1 The necessity of the worldview

Even if the theory of Ideas is a fairy tale, Plato's idea has a point.

(C) Ethics · morals is dependent on the world (=environment around).

It is a matter of course that there is a difference between the ancient Japanese ethics and the modern American ethics. In this sense, strictly speaking, the following (=Plato's way of telling philosophy) is true:

(D) (= (F₂) in Sec. 3.2.1)

$$\begin{array}{ccc} \text{world is so} & & \text{we should live so} \\ \boxed{\text{fictional worldview}} & \xrightarrow{\text{therefore}} & \boxed{\text{Ethics · morals, etc.}} \\ \text{introduction-preface-fiction} & & \text{main subject} \\ \text{common sensory soil} & & \end{array}$$

3.4.1.2 The necessity of idealism (= metaphysical world)

If the (D) is strictly put into practice, this is not philosophy but life consultation. For example,

- If you are really depressed, go to a psychiatrist and ask him to prescribe some medication. Philosophers are not to be trusted.

Thus, philosophers have to assume an unrealistic world (metaphysical world). This is because if the settings can be verified by experiment, mistakes may be pointed out. Therefore,

(E) Metaphysical worldview (i.e., idealism) is desirable

This is the reason to adopt the idealism (i.e., metaphysical world) in Plato's way of telling philosophy

3.4.1.3 The necessity of dualism

Also,

(F) since the goal is ethics and morality, a world that reflects human beings in some way is preferable. In other words, the dualism of "things" and "people" is preferable.

For example,

- We don't usually take moral lessons from monism, such as Newtonian mechanics.

This is the reason to adopt "mind-matter dualism" in philosophy.

After all, we conclude that

(G) in the philosophy of worldview, dualistic idealism is desirable.

Remark 3.9. Recall that our purpose of this paper is to show that

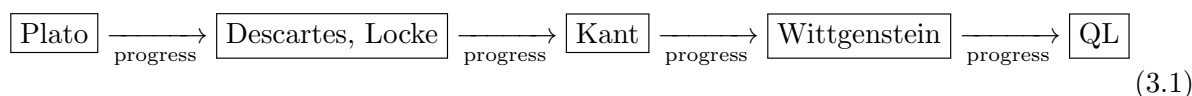

where $\xrightarrow{\text{progress}}$ means "getting closer to quantum language".

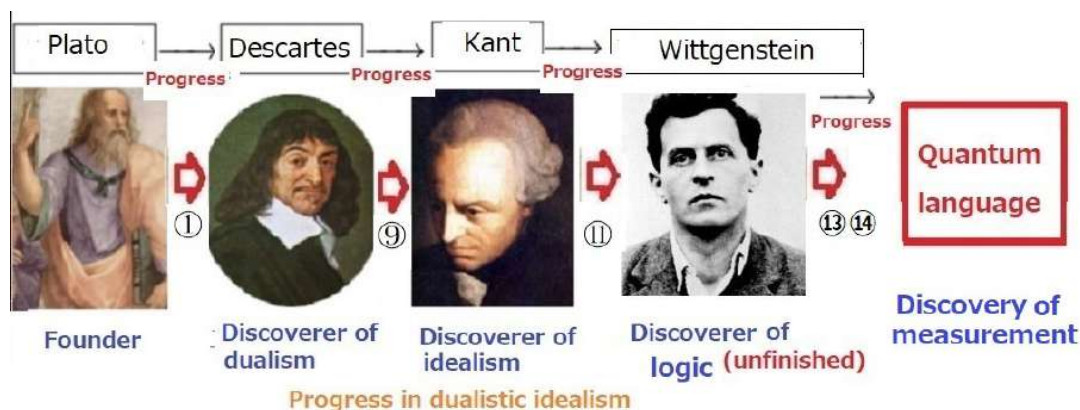

However, some ask the following question:

- Is the series (3.1) inevitable?

Concerning this question, Allegory 3.6 [the Sun] is suggestive. Note that the following facts:

- (#₁) Plato proposed Idea theory, which was an fairy tale as dualistic idealism.
- (#₂) Plato attempted to explain Idea theory in a variety of ways, but the most scientific and rational explanation was Allegory 3.6 [the Sun]. (Of course, "scientific and rational" does not necessarily mean "good" since Idea theory is not scientific and rational.)
- (#₃) Allegory 3.6 [the Sun] is similar to quantum language (= measurement theory).

Further note that

- (b) [History of Western philosophy]
 = [dualistic idealism] + [the spirit of being scientific and rational]
 = [Find the scientific destination of dualistic idealism]

If so (i.e. if (#₁), (#₂), (#₃) and (b) are true), we want to consider that the series (3.1) is inevitable.

3.5 Key words of dualism

3.5.1 Three key-words of dualism

The key-words of dualism are simple. That is because

- Since dualism is a theory concerning measurement, [A](observer) and [C](matter) are needed. However, **if the two are not related, this implies only that there are two monism.** Therefore, there must be [B](medium(=device that mediate [A] and [C]))

Recall Figure 1.2 (in Section 1.1.2: The linguistic Copenhagen interpretation) below:

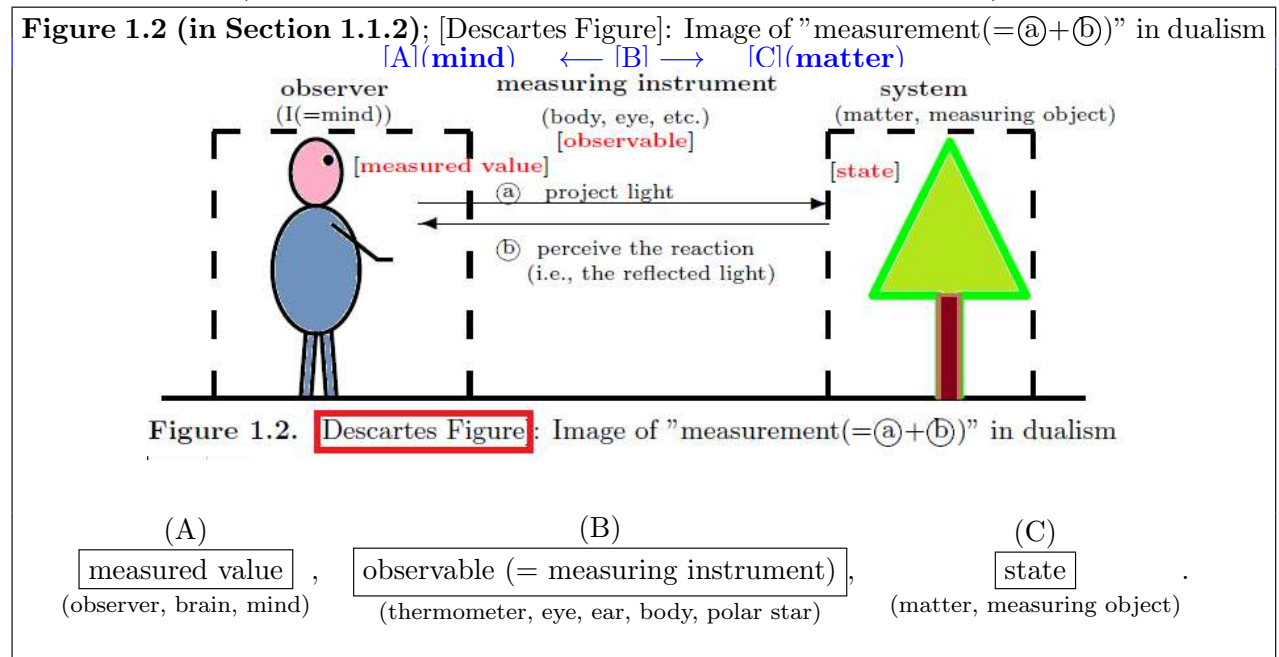

If so,

- The structure of mind-matter dualism is as follows

$$[A](\text{mind}) \leftarrow [B] \rightarrow [C](\text{matter})$$

(medium)

That is, it is composed of [A](mind), [B](medium), [C](matter).

In history, there are incomplete dualism that does not include three [A](mind), [B](medium), [C](matter).

- We consider that [B](medium) is the most important than the other two (*cf. Linguistic Copenhagen interpretation (E₃) in Sec.1.1.2*). Therefore, if the theory includes [B](medium), it is called "dualism".

3.5.2 Is Idea theory related to measurement (i.e., dualism) ?

Now we have a question:

- Where should these key-words (i.e., Idea world, actual world, Idea, anamnesis) be assigned

next?

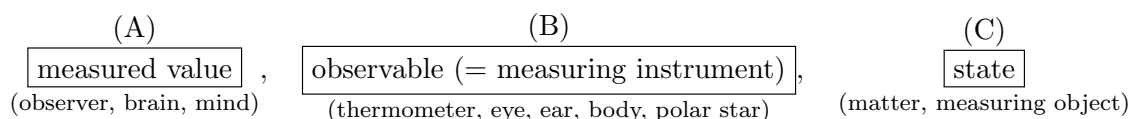

This is answered in what follows.

Review 3.10. Recall that Remark 3.4 (Allegory of the cave), Remark 3.5 (Anamnesis), Remark 3.7 (Allegory of the cave) in the following table:

	[A](= mind)	[B](Mediating of A and C)	[C](= matter)
①:Plato: cave Remark 3.4	actual world	sunlight	/ [Idea world]
②:Plato: anamnesis Remark 3.5	actual world	anamnesis	/ [Idea world]
③:Plato: sun Remark 3.7	actual world	Idea	/ [Idea world]
quantum language	measured value	observable	state [system]

Plato’s theory of ideas was not created for science, so what follows may be too forceful. However, In this text, I consider the following. Here,

(#) **I don’t know Plato’s intention, but I want to choose Remark 3.7(Allegory of the sun)**, which is more scientific than the other two.

That is, I assert that

	[A](= mind)	[B](Mediating of A and C)	[C](= matter)
③: Plato: sun Remark 3.7	actual world	Idea	/ [Idea world]
quantum language	measured value	observable	state [system]

The reason the I think that the above is somewhat persuasive is as follows.

- Since the Sophists said "Man is the measure of all things", Socrates-Plato must have thought the exact opposite claim, "Idea is the measure of all things". Namely,
 - (b) There exists the absolute standard (= idea) of "love", "beauty", "goodness", etc. Thus it is not unnatural to regard Idea as the meter standard, or the touchstone (i.e., a kind of measuring instrument).

♠**Note 3.8.** I am not confident in the correspondence ③ in Review 3.10 because the theory of ideas was not created with the intention of measurement. However, I don’t care if the above claim is wrong. That is because our purpose of this paper is to show that

(#) Plato(the theory of Ideas) →Descartes →Kant →Quantum language

progress

if approaching quantum language is called "progress". It is easy to see that the above (#) holds in all cases of ①, ②, and ③.

♠**Note 3.9.** However, I think that

the Allegory of the Sun is not a proper example for Idea theory,

since it is too scientific and thus too easy to understand. Probably, I think Plato gave too much scientific explanation in an attempt to make readers understand Idea theory. I think Plato was not satisfied with the parable in "the Allegory of the Sun", so he referred to "the Allegory of the Sun" as "the child of goodness". The book : "History of western philosophy" due to B. Russell says that (*cf.* ref. [108]),

- Aristotle's metaphysics, roughly speaking, may be described as Plato diluted by common sense. He is difficult because Plato and common sense do not mix easily.

In the same sense, Idea theory and "the Allegory of the Sun" do not mix easily. Thus, this allegory may hinder our understanding of Idea theory. However, it is interesting that the scientific explanation of Idea theory is similar to measurement theory. Thus, in this paper, I choose ③ as mentioned in Review 3.10.

♠**Note 3.10.** (i): Literature has various genres. As an example, it is a love story, a detective story, SF (science fiction), poetry, nonfiction. In the same sense, **the philosophy of worldview is a kind of literature.**

Therefore, I think that the emphasis on the relationship to mathematics hinders our understanding of ideation theory. The following is famous:

- (♯) It was written in the gate of the entrance of the school (Platonic Academy) which Plato established, **"The person who does not know the geometry should not pass through this gate"**

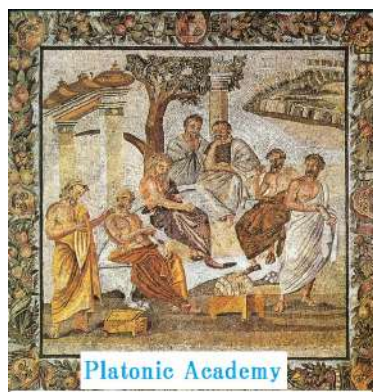

Let no-one ignorant of geometry enter here!

If this is to be taken seriously, Plato's researchers must be well trained in mathematics. But in reality, that has not happened. In science, it is more experimental verification than logic. Thus, the importance of logic is not so emphasized in science. That is, *the proof of the pudding is in the eating*. The field where importance of the logic is emphasized is the field where it is hard to do logical and quantitative arguments. For example, the importance of logic is emphasized in courts. There must be many unknowns in many cases. Still, the judge must judge the person. Therefore, the impression of "logically judged" is very important.

However, "mathematical, logical, reasonable" must be emphasized in philosophy. That is because the difference between philosophy and religion becomes obscure without the emphasis. The reason why the importance of logic is not emphasized in science is that I think it's because if we emphasize the importance of experimentation, it won't be confused with religion.

(ii): The above discussion reminds me of modern "analytic philosophy", in which the importance of logic is emphasized.

Humble people do not promote humility. Also, for mathematicians, logic is like air. Therefore, mathematicians do not emphasize the importance of logic.

Thus, I don't know if analytic philosophers are logical or not.

3.5.3* Plato's Idea theory \approx Locke's secondary quality \approx Sausuure's linguistic theory \approx Zadeh's fuzzy theory

If we assume that

(D) Plato's Idea theory, Locke's secondary quality, Sausuure's linguistic theory and Zadeh's fuzzy theory are one of aspects of quantum language

then, we can discuss as follows.

①:Idea $\xrightarrow{\text{cognitive}}$ ②: secondary qualities $\xrightarrow{\text{quantitative}}$ ③: observable (= measuring instrument)

where,

- ① Idea
 "the meter standard of beauty, the meter standard of goodness, ..."
 \implies
 "device that make beauty visible", "device that make the good visible"
- ② secondary qualities(=sensations of inherent nature (=primary qualities))
 "sweet, pungent", "hot, cold", "beautiful, ugly" ...



- ③ observable(=measuring instrument)
 saccharimeter, thermometer, ...

In this real world, "Man is the measure of all things" may be almost true. On the other hand, in the Idea world, the absolute goodness, the absolute beauty. are always believed. That is,

- There exists the absolute standard of "love", "beauty", "goodness", etc.

Example 3.11. [The argument under the assumption that Idea theory is regarded as measurement theory]

Let Ω be a compact state space. Here, any tree can be represented by a certain state $\omega(\in \Omega)$. Thus, we have the basic structure $[C(\Omega) \subseteq L^\infty(\Omega, \nu) \subseteq B(L^2(\Omega, \nu))]$. Let $O_B = (\{y, n\}, 2^{\{y, n\}}, B)$ be the continuous observable, which is assumed to be measurement instrument of beauty. Let T_0 be a tree with the state $\omega_0(\in \Omega)$. Put $\omega_0 = \tilde{\omega}(T_0)$. Then, we have the measurement $\mathbb{M}_{L^\infty(\Omega, \nu)}(O_B = (\{y, n\}, 2^{\{y, n\}}, B), S_{[\tilde{\omega}(T_0)]})$, where "y" [resp. "n"] means "yes" [resp. "no"].

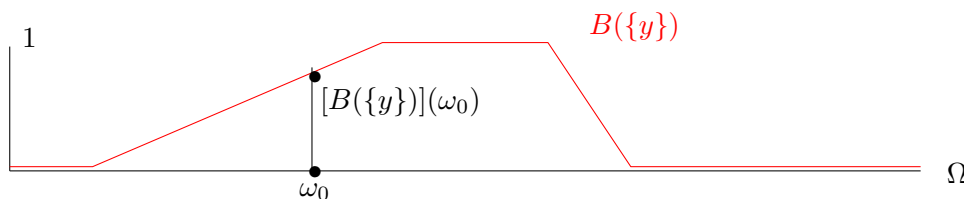

Axiom 1 (in Section 1.5.2) implies that

- the probability that a measured value y is obtained by the measurement $\mathbb{M}_{L^\infty(\Omega, \nu)}$ ($\mathbf{O}_B = (\{y, n\}, 2^{\{y, n\}}, B), S_{[\bar{\omega}(T_0)]}$) is given by $[B(\{y\})](\omega_0)$.

That is,

- the probability that the tree T_0 is beautiful is given by $[B(\{y\})](\omega_0)$.

Remark 3.12. [Plato's Idea theory \approx Locke's secondary quality \approx Saussure's linguistic theory \approx Zadeh's fuzzy theory] Readers may find this example trivial. However, it should be noted that this example is essentially the same as Definition 11.20 ("signifier" and "signified"). That is, we see, from the quantum linguistic point of view, the following three are similar:

- ⎧ Plato's Idea theory
- ⎧ Locke's secondary quality (*cf.* Sec. 9.1)
- ⎧ Saussure's linguistic theory (*cf.* Sec. 11.5)
- ⎧ Zadeh's Fuzzy theory (*cf.* refs. [39, 40, 41, 42])

Or more precisely,

(D)

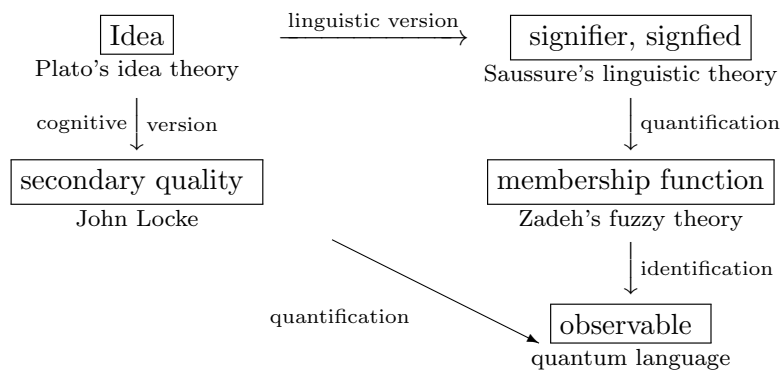

For Zadeh's fuzzy theory, just imagine the following diagram:

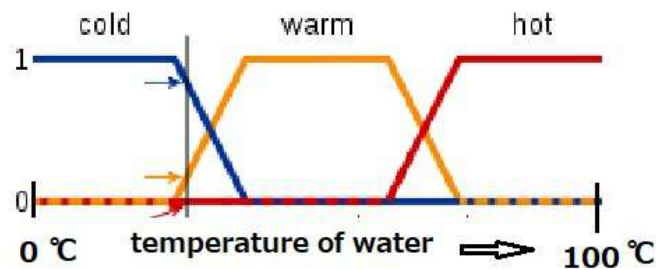

3.6 Summary: Plato's way of telling philosophy

3.6.1 Summary

(A):

Plato's way of telling philosophy (i.e., the fictional worldview)

In Plato's way of telling philosophy,

(A₁) a fictional worldview is characterized as the premise (or, introduction, preface, fiction) of the main theme (i.e., ethics, moral, etc.).

In other words, consider the following figure, i.e., Plato's way of telling philosophy:

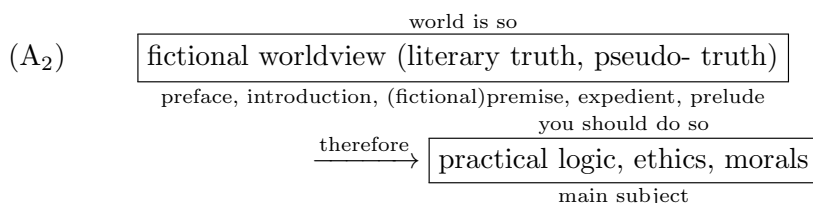

Literature has various genres. As an example, it is a love story, a detective story, SF (science fiction), poetry, nonfiction. In the same sense, the above fictional worldview (as the support of the main assertion [ethics. moral]) is a kind of literature.

(Notice)

(A₃) Some consider that the term: " therefore " implies that the fictional worldview should be "logical". Here, it should be noted that the "logical" is similar to the "logical" of detective story.

Remark 3.13. For example we see,

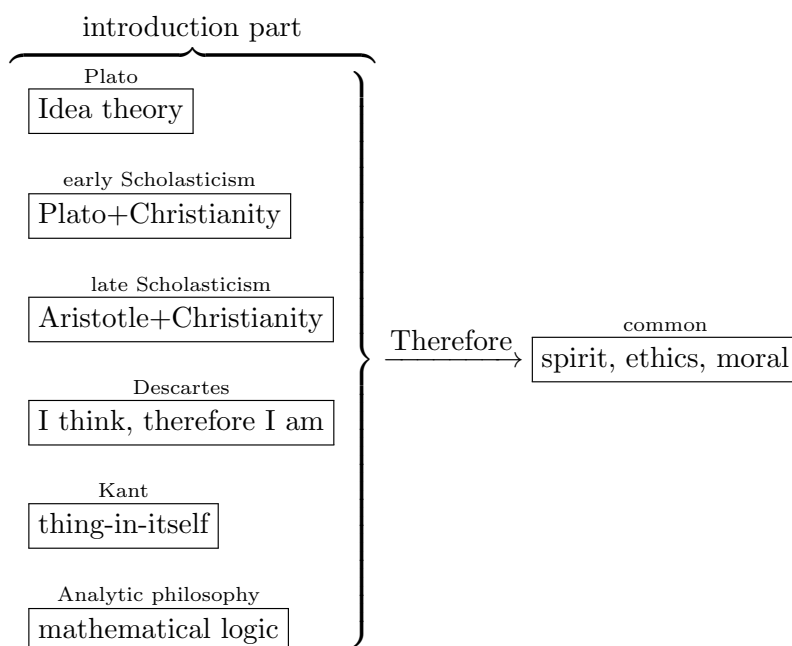

Here it should be noted that all of the worldviews in the left-side of the above are theories that are impossible to deny (thus, non-scientific theories).



If we think about it simply, **the "introduction (= fictional worldview)" part is unnecessary.** In fact, Socrates, Confucius, etc. focused only on ethics and morality. However, the "introduction" part had a variety of benefits. In what follows, let us explain some benefits.

Remark 3.14. Whitehead(1861 - 1947) said:

(B) Western philosophy is characterized as a series of footnotes to Plato

Although we do not know his true intention, our understanding is as follows.

(C) The various fashions of the Buddhism, Confucianism and the Taoism Confucius jumbled up at the Orient. And those continued for 2500 years by a subtle strained relation. On the other hand, in the Western, Christianity was too strong. Thus, the main theme (i.e., ethics, morals) is mostly due to "Christianity + Socrates", and thus, the various fashions were not born. However, according to Plato's way of telling philosophy, the introduction part (i.e., the fictional worldview) is changeable. Therefore, the progress of Western philosophy (which was not realized in the East) can be realized as follows.

• Plato → Augustinus → Thomas Aquinas → Descartes → Locke → ... → Kant

That is,

Plato's way of telling philosophy could keep freshness.

If the example is say, we think that there has been an effect, such as **the model change of car**. The Plato's way of telling philosophy is almost always the main current of Western philosophy. This device (i.e., the model change) brought the prosperity of Western philosophy.

If we do not consider so, we cannot explain the fact that useless world-description (in western philosophy) lasted for 2500 years.

♠**Note 3.11.** We consider that

(#) Philosophy of ethics is common to mankind and is the world standard.

Or, we want to consider so. Otherwise, world peace cannot be achieved. There is a point to the theory that ethics is a rule that keeps society alive. Depending on what kind of society we envision, ethics will be somewhat different. However, we want to consider (#). For example, "Don't lie" or "Don't kill people", etc., are common in the world. Also, the Golden Rule "Do unto others what you would have them do unto you" has been chanted by many philosophers and religious figures (Christ, Confucius, Muhammad, etc.). In this sense, I think that ethics is logical.

However, worldview (= Plato's fictional worldview in the way he tells his philosophy) is not universal. In other words, it is one of the local philosophies that has evolved in its own way. We might say "Galapagos philosophy". For example, consider

(#1)

Idea theory

 $\xrightarrow{\text{cogito turn}}$

epistemology

 $\xrightarrow{\text{linguistic turn}}$

analytic philosophy

If there was no epistemology, it is no wonder. In fact, there is no epistemology in the East or the United States. In this sense, the world description is not logical. On the other hand,

(#2) the realistic worldview is the world standard (moreover, the universe standard)

Aristotle → Archimedes → Newton → ...

(#3) the logical worldview (=the logical spirit=the spirit of "Think logically!") can't be called the world standard since it is quite influenced by Descartes=Kant philosophy.

Aristotle → Frege → Wittgenstein → ...

I think that philosophers need not be more logical than scientists. Thus, I can't understand why philosophers like logic. Kant philosophy was too literary, and it may be the reaction. I highly estimate Wittgenstein's "Tractatus Logico-Philosophicus (widely abbreviated and cited as TLP)", in which he attempted to explore a different logic than the "logic of mathematics". (cf. Section 11.6 later)

(#4) the mechanical worldview is also the world standard:

Parmenides-Zeno (motion function method) → About two thousand years → Bernoulli (the law of large numbers) → Fisher (statistics)

And, it is a matter of course that the above two (the realistic worldview and the mechanical worldview) are useful. It is remarkable that the philosophy of worldview (=the fictional worldview) isn't useful at all but it continued for 2500 years. That is, we think that "Galapagos" ↔ "scientifically useless". This may be due to the shadow supporter (i.e., Christianity), i.e., as mentioned in the above remark, Christianity is too strong.

In spite of the above arguments (i.e., above, (#1) is not the only inevitability), in this note I show the following:

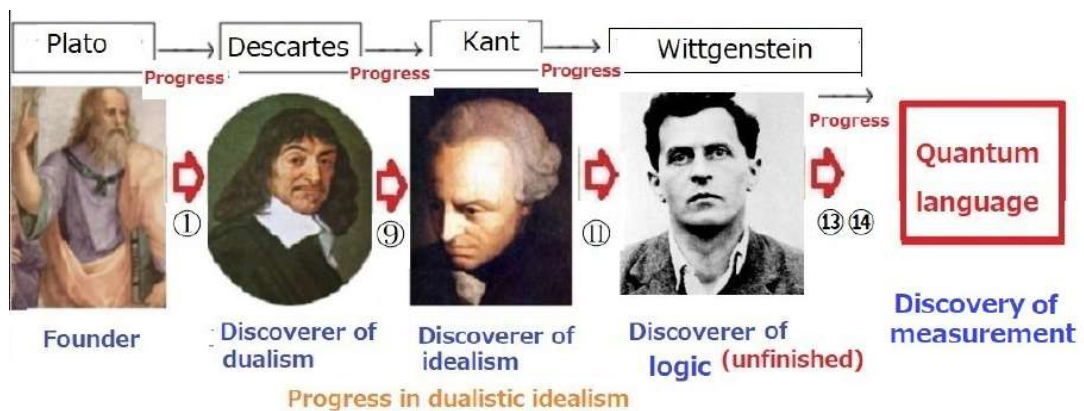

This is a miracle.

♠**Note 3.12.** Now we have the following classification of philosophers. (cf. Classification 1.11 [the classification of philosophers]): Recall the figure (Allegory of the cave) in Allegory 3.3, which is clearly related to measurement (cf. Definition 1.8 of "idealism"). Thus, Plato's Idea theory belongs to the fictional worldview (Western philosophy):

- (b) {
 - (b₁): the realistic worldview (physics)
Hērakleitos, Aristotle, Archimedes, Galileo, Newton, Einstein, ...
 - (b₂₁): the fictional worldview (Western philosophy)
Plato, Scholasticism, Descartes, Locke, Leibniz, Berkeley, Hume, Kant, Husserl
 - (b₂₂): the logical worldview (=the logical spirit=the spirit of "Think logically!")
Boole, Frege, Peirce, Saussure, Russell, Wittgenstein, Hempel, Quine, Popper
 - (b₂₃): the mechanical worldview (statistics, quantum language)
Parmenides, Zeno, J. Bernoulli, statistics (e.g., Fisher), quantum language

Spirit of Pythagoras is inherited, and Parmenides and Zeno have argued establishment of the worldview as science sincerely. However, Plato used the fictional worldview as a means of the protection of Socrates (ethic philosophy) and has dwarfed the worldview in non-scientific way. But, as Whitehead said "Plato's footnote", the fictional worldview, that is,

(#1) Plato → Augustinus → Thomas Aquinas → Descartes → Locke → ... → Kant → Husserl

has continued to be supported over a long time of more than 2000 years. On the other hand, the scientific idealistic worldview was established by Fisher, etc. as follows:

(#2) Parmenides-Zeno → Tunnel of more than 1700 years → Early modern period
the classical mechanical worldview
J. Bernoulli, Bayes, Laplace, etc.

→ Fisher(statistics)→quantum language

Chapter 4

The Big Three in Greek Philosophy (Aristotle)

Although Aristotle was a student of Plato, he proposed the realistic worldview, which was completely different from Plato's philosophy. He is called the father of all sciences (\approx the father of the realistic worldview). It is no exaggeration to say that philosophy was started by these two men. That is, we see:

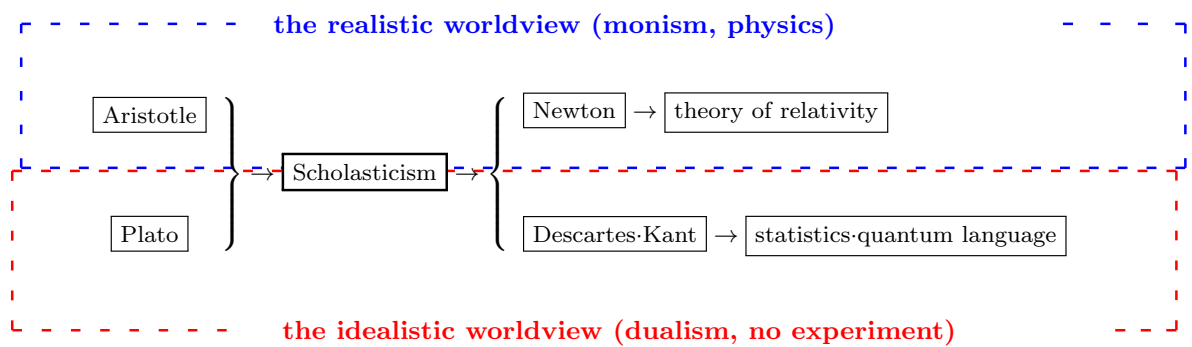

Therefore, it's best to assume that the two men have very different areas of expertise.



Plato & Aristotle

4.1 Aristotle (BC.384 - BC.322)

4.1.1 Realistic worldview vs. idealistic worldview

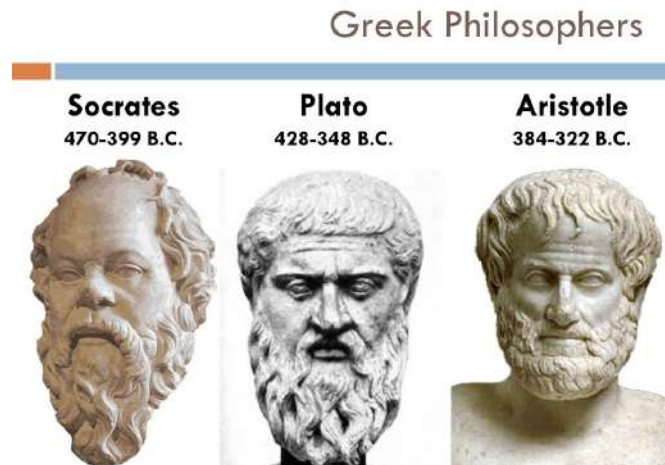

Aristotle (BC.384 - BC.322), the student of Plato, is called the father of all sciences (\approx the father of the realistic worldview). He could not accept Plato's theory of Ideas(= [asserted fiction]). Namely,

- **Philosopher Plato preferred asserted fiction (without experiment) to truth (with experiment)**

On the other hand,

- **Scientist Aristotle preferred truth (with experiment) to asserted fiction (= without experiment)**

♠**Note 4.1.** S. Weinberg (1933 -2021), a physicist at the University of Texas, Austin, won a Nobel Prize in 1979 for work that became a cornerstone of particle physics, said in his book [115] "To explain the word; The discovery of modern science" as follows:

(#) [in Chapter 3] *I confess that I find Aristotle frequently tedious, in a way that Plato is not, but although often wrong Aristotle is not silly, in the way that Plato sometimes is.*

Plato was not aiming for science, that is, Plato's purpose is to support Socrates's ethical philosophy. Therefore, from the scientific point of view, some may feel Plato silly. Namely,

(1) a fiction that was asserted (by Plato) over 2000 years ago is somewhat silly, if not tedious.

On the other hand, Aristotle might be aim for science. Thus, from the modern point of view, some may feel Aristotle tedious. Namely,

(2) truths discovered (by Aristotle) over 2000 years ago are tedious and often wrong, if not silly

The above (1) and (2) are merely statements of the commonplace. And thus, he may not be saying anything negative. Science progresses, so you'll find the old science boring. But literature hasn't faded after 2,000 years. However, our purpose of this text is to show that

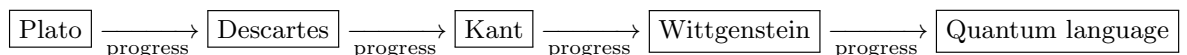

4.1.2 Edios and Hyle

Aristotle proposed the concepts such as "eidos" and "hyle" as follows.

(A): Edios(Aristotle’s Idea) and hyle

Aristotle said that

- **Edios** (= Aristotle’s Idea = true form) is not in the heaven, but in **hyle** (= matter = particle).

Figure 1.2 (in Section 1.1.2); [Descartes Figure]: Image of "measurement(=Ⓐ+Ⓑ)" in dualism: **dualism** and **monism** (= Aristotle’s worldview)

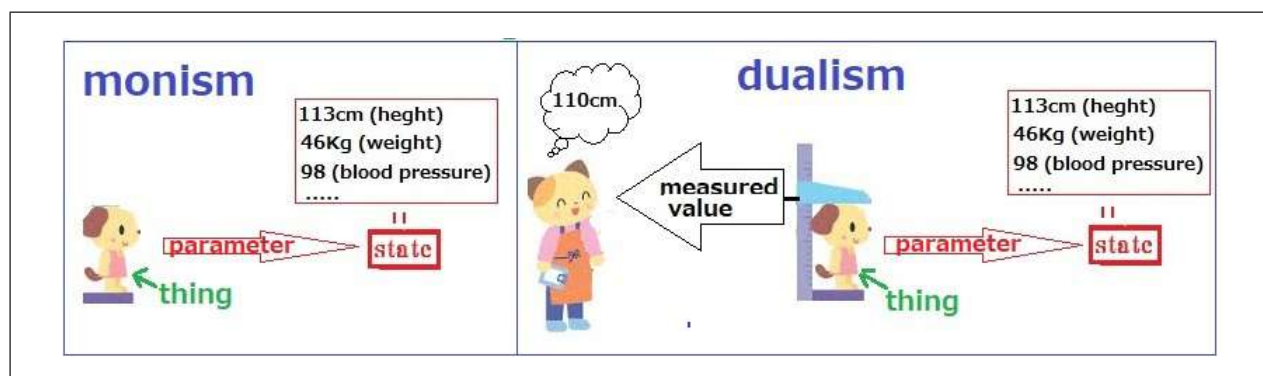
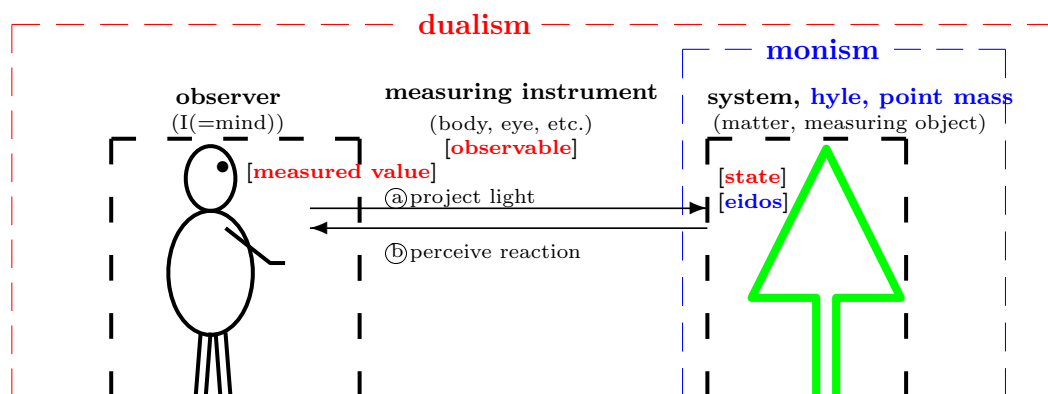

Assertion 4.1. (= Assertion 1.14)

[The key-words of the realistic worldview] The realistic worldview is monism, and its completed version is realized as Newtonian mechanics, whose key-words are "point mass" and "state". Thus, we see:

\	[A](= mind)	[B](Mediating of A and C)	[C](state) [matter]
Aristotle	_____	_____	eidos [hyle]
Newton	_____	_____	state [point mass]

That is, we consider the following progress:

$$[\text{eidos}] \xrightarrow{\text{progress}} [\text{state}] \quad [\text{hyle}] \xrightarrow{\text{progress}} [\text{point mass}]$$

We can easily use Newtonian mechanics as follows.

- **point mass**(=particle with the mass m) with the **state**(=(position, momentum)= $(x, p) \in \mathbb{R}^2$ (= state space))
Thus, it is a matter of course that we conclude that
 - **Aristotle is the founder of the realistic worldview (= physics)**

[Note]: The above table should be compared to the following table in Review 3.10 [i.e., Plato’s Idea theory]:

\	[A](= mind)	[B](Mediating of A and C)	[C](= matter)
③: Plato: Sun Remark 3.7	actual world	Idea	/ [Idea world]
quantum language	measured value	observable	state [system]

♠**Note 4.2.** The book : "History of western philosophy" due to B. Russell says that (*cf.* ref. [108]),
 • *Aristotle’s metaphysics, roughly speaking, may be described as Plato diluted by common sense. He is difficult because Plato and common sense do not mix easily.*
 I think this representation is misleading since the two men have very different areas of expertise. Aristotle proposed a realist philosophy that is quite different from the Platonic philosophy of idealism. As the following diagram shows, Plato and Aristotle are water and oil. In fact, Scholasticism (= a compromise between Plato and Aristotle) was not successful because Plato and Aristotle do not mix.

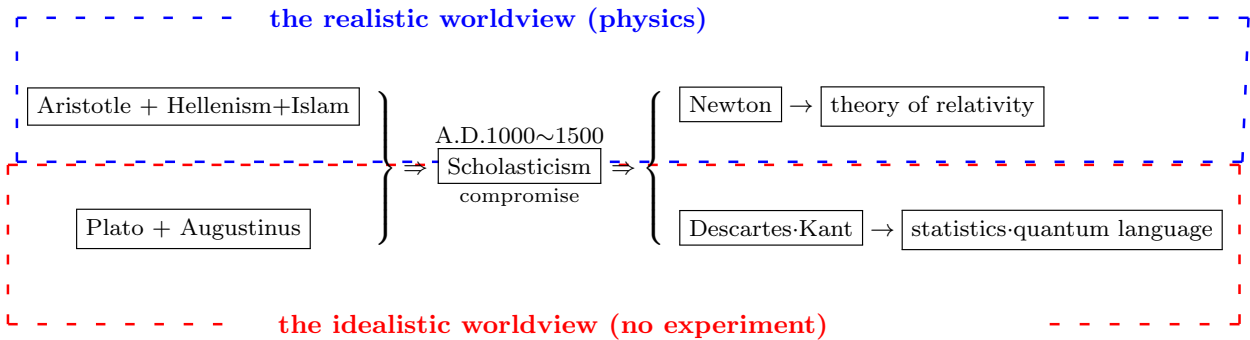

"Realistic worldview (= realism) or idealistic worldview (= metaphysics) ?" is the biggest dispute in the history of philosophy as shown in Assertion 1.12, that is,

realistic worldview vs. idealistic worldview (*cf.* Assertion 1.12)

dispute \ [R] vs. [L]	Realistic worldview (monism, realism, no measurement)	Idealistic worldview (dualism, idealism, measurement)
Ⓐ: motion	Hērakleitos	Parmenides
Ⓑ: Ancient Greece	Aristotle	Plato
Ⓒ: Problem of universals	"Nominalismus"(Ockham)	"Realismus"(Anselmus)
Ⓓ: space-time	Newton	Leibniz
Ⓔ: quantum theory	Einstein	Bohr
Ⓕ: philosophy of science	Carnap	Quine

Ⓐ is my fiction, Ⓒ is a confusion. Ⓓ is the Leibniz=Clarke correspondence (*cf.* Sec. 9.3.2), Ⓔ is Bohr-Einstein debates. Quantum language is proposed as one of answers to Bohr-Einstein debates(*cf.* ref. [71]). Ⓕ: Quine understood the spirit of the linguistic Copenhagen interpretation (i.e., "If you don't measure it, you don't know anything") in the Carnap=Quine debate (*cf.* Sec. 13.3).

4.2 Why does the motion happen?

4.2.1 From purpose to causality: Modern science started from the discovery of "causality"

When a certain thing happens, the cause always exists. This is called *causality*(=*causal relation*). You should just recall the next proverb:

Smoke is not located on the place which does not have fire.

However the situation is not so simple as you think. Consider, for example,

- This morning I feel good.
- (#₁) Is it because that I slept sound yesterday ?
- or
- (#₂) Is it because I go to favorite golf from now on ?

You will find the difficulty in using the word "causality". In daily conversation, the word "causality" is used in many contexts, mixing up "a cause (past)", "a reason (implication)", and "the purpose and a motive (future)".

As mentioned in Sec. 2.3, the pioneers in the study of movement and change are Hērakleitos and Parmenides:

- (A) $\left\{ \begin{array}{l} \bullet \text{ Hērakleitos(BC.540 -BC.480): "Everything flows."} \\ \bullet \text{ Parmenides (born around BC. 515): "There is no movement."} \\ \quad \text{(Zeno's teacher)} \end{array} \right.$

I think the reader will have the following question.

- Why are their names still there, even though it was 2,500 years ago?

As I mentioned before, "motion and change" is the most important keyword in science (= "world-view"), that is, I consider:

- (B) **[The beginning of World description]**
 = [The discovery of movement and change] = $\left\{ \begin{array}{l} \text{Hērakleitos} \\ \text{Parmenides} \end{array} \right.$

This is why their names are still there.

However, Aristotle (BC384–BC322) pursued an even more fundamental problem:

- (C) What is the essence of movement and change?

and concluded as follows.

(D):Purpose (Aristotle)

Aristotle asserted that **all the movements had the "purpose"**.

- For example, a stone falls because it has the purpose to go downward, and smoke rises because it has the purpose to go upward.
A heavy stone falls fast because it has a strong purpose of "falling fast".



4.2.1.1 From purpose to causality

Under the influence of Aristotle, "Purpose" had remained as a mainstream idea of "Movement" for a long period of 1500 years or more.

We were freed from the spell of "Purpose", only after Galileo, Bacon, Descartes, and Newton et al. discovered the essence of movement and change lies in "Causality".

Scientific revolution from "Purpose" to "Causality"

is the greatest paradigm shift in the history of science. It is not an exaggeration even if we call the shift "birth of modern science".

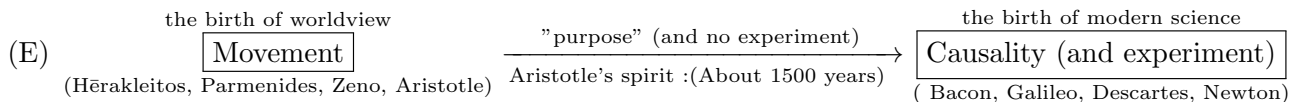

ZXC

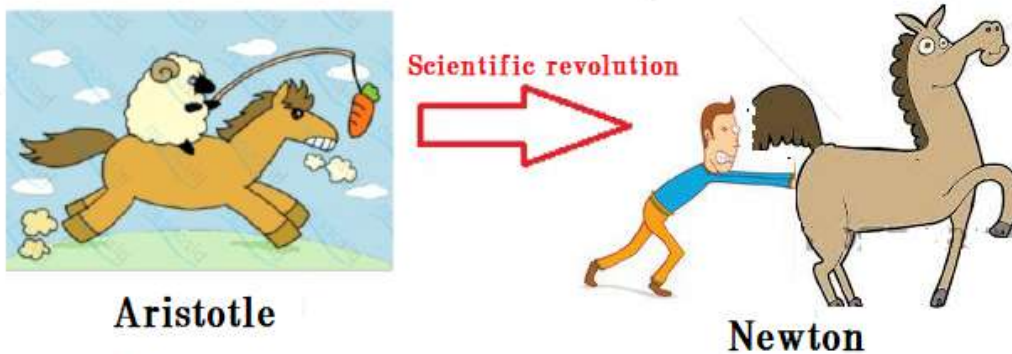

I cannot emphasize too much the importance of the discovery of the term: "causality". That is,

- (‡) Science is the discipline about phenomena that can be represented by the term "causality".
(i.e., "No smoke without fire")

Thus, I consider that the discovery of "causality" is equal to that of science. In the realistic worldview, Newtonian kinetic equation (i.e., the equation of the chain of causality) was final in a sense. However, in the idealistic worldview, the problem "What is causality?" is not solved yet. For the complete answer to the problem, we had wait for the appearance of quantum language (Axiom 2 (causal relation) in Sec.1.1.1, also, see ref. [71]).

Summary 4.2. [Solutions to the causality problem] For example, we see:

- (F₁) The causality is represented by Newtonian kinetic equation in Newtonian mechanics
- (F₂) The causality is represented by Maxwell's equations in electromagnetism
- (F₃) The causality is represented by Schrödinger equation (or equivalently, Heisenberg's kinetic equation) in quantum mechanics
- (F₄) The causality is represented by Axiom 2 (in Section 1.1) in quantum language

(Continued to Sec. 10.2: What is causality?).

♠**Note 4.3.** S. Weinberg (1933 -2021), a physicist at the University of Texas, Austin, won a Nobel Prize in 1979 for work that became a cornerstone of particle physics, said in his book [115] "To explain the word; The discovery of modern science" as follows:

- [in Chapter 3]: *We can agree with the classical scholar R. J. Hankinson that "we must not lose sight of the fact that Aristotle was a man of his time and for that time he was extraordinarily perspicacious, acute, and advanced." Nevertheless, there were principles running all through Aristotle's thought that had to be unlearned in the discovery of modern science. For one thing, Aristotle's work was suffused with teleology: things are what they are because of the purpose they serve.*

Recall the above (E). I think that only people after the scientific revolution (17th century) understand the meaning of "science".

Aristotle is also the father of biology. I think the reason Aristotle failed to discover causality is that biology was one of his major research topics. In biology, we tend to think in terms of purpose theory, and causality is very difficult to understand. It is in astronomy and physics that the causal relationship is very easy to see. In addition, causality is relatively easy to experimentally verify. Thus, the scientific revolution was born out of [(i) geodynamics, (ii) causality (Newtonian mechanics), and (iii) the importance of experimentation (i.e., British empiricism)]. That is,

$$\left. \begin{array}{l} \text{(i) Geocentrism} \\ \text{(ii) causality (Newtonian mechanics)} \\ \text{(iii) the importance of experimentation} \end{array} \right\} \implies \text{scientific revolution}$$

4.3 Practical logic

We consider that two kinds of logic exist such as

- (A₁) mathematical logic (= symbolic logic)
- (A₂) non-mathematical logic (=practical logic)

Here, mathematical logic (due to Boole, Frege) is elementary and well known. A proposition in mathematical logic is usually considered to be a mathematical proposition. Also, A proposition in practical logic is a non-mathematical proposition, written by ordinary language. For example, the (B₂) below is non-mathematical logic.

4.3.1 Practical logic; Aristotle's syllogism in ordinary language

If the ecology of various animals is observed, it will be clear that the base of language was due to intimidation, solidarity, reproduction. Language was one of the strongest arms for the survival and breeding. Such a time have continued for millions of years. Of course, the biggest events in the "history of language" happened one after the other. For example,

- (B₁) "rhythm and song", "logical structure", "quantity concept", "grammar", "tense", etc.

However, it was done gradually by many people, tens of thousands of years ago, and it is not possible to identify the names of the contributors. But the **surprise** that ordinary language had a logical structure is passed down as "Aristotle's syllogism," Namely,

Aristotle's syllogism in ordinary language

- (B₂) Since Socrates is human being, and human being is mortal, it follows that Socrates is mortal.



Although this is quite famous, the reader may have several questions concerning this as follows,

- (C₁) Syllogism is essential for mathematical proofs. Therefore, it is natural to assume that Pythagoras already knew syllogism.
- (C₂) Also, it is natural to consider that syllogism was frequently used in the debate between Socrates and sophists.

Thus I guess that

- (D) The knowledge of syllogism of the time was summarized in Aristotle's book: "Organon", which was compiled by his followers about B.C. 40. And, syllogism was endorsed by Aristotle and remained authoritative for almost 2,000 years.

In fact, Immanuel Kant said that there was nothing else to invent after the work of Aristotle.

♠**Note 4.4.** Here,

- (#1) Who is the discoverer of the syllogism?

Thalēs and Pythagoras would naturally have known about the syllogism, so it is certainly not Aristotle. It is not possible to identify the names of the discoverer. Similarly,
(#₁) Who is the discoverer of the motion function method?
As mentioned in Note 2.16, it is not possible to identify the names of the discoverer. However, the syllogism and motion function method in QL were respectively discovered in refs. [76, 78] and [45]

4.3.2 Mathematical logic; due to Boole, Frege

Let us review symbolic logic as follows.

Postulate 4.3. (= Postulate 11.1)

[Symbolic logic; due to G. Boole, G. Frege]

For any proposition P , the truth function $\phi(P)$ is determined such that

$$\phi(P) = \begin{cases} 1 & \text{(if } P \text{ is true)} \\ 0 & \text{(if } P \text{ is wrong (i.e., not true))} \end{cases}$$

(A₁) Assume that P_1, P_2 are propositions. Then, $P_1 \wedge P_2, P_1 \vee P_2, \neg P_1, P_1 \rightarrow P_2$ are propositions. And it holds that $\phi(P_1 \wedge P_2) = \min\{\phi(P_1), \phi(P_2)\}$, $\phi(P_1 \vee P_2) = \max\{\phi(P_1), \phi(P_2)\}$, $\phi(\neg P) = 1 - \phi(P)$.

where $\wedge, \vee, \neg, \rightarrow$ respectively is called "and", "or", "not", "implies". Note that $P_1 \rightarrow P_2$ is defined by $\neg P_1 \vee P_2$.

Also, assume that P_θ is a proposition ($\theta \in \Theta \equiv \{1, 2, \dots, n\}$), then it holds

(i): $P_1 \wedge P_2 \wedge \dots \wedge P_n$ (denoted by $\bigwedge_{\theta \in \Theta} P_\theta$, or $\forall \theta (\in \Theta)[P_\theta]$) is a proposition

(ii): $P_1 \vee P_2 \vee \dots \vee P_n$ (denoted by $\bigvee_{\theta \in \Theta} P_\theta$, or $\exists \theta (\in \Theta)[P_\theta]$) is a proposition.

Here, $\phi(P_1 \wedge P_2 \wedge \dots \wedge P_n) = \min_{i=1, \dots, n} \phi(P_i)$, $\phi(P_1 \vee P_2 \vee \dots \vee P_n) = \max_{i=1, \dots, n} \phi(P_i)$.

(A₂) The above finite set $\Theta (\equiv \{1, 2, \dots, n\})$ can be extended to an infinite set Θ .

Exercise 4.4. (i): The proof of syllogism: $[(p \rightarrow q) \wedge (q \rightarrow r)] \rightarrow (p \rightarrow r)$

Truth Table

p	q	r	$p \rightarrow q$	$q \rightarrow r$	$p \rightarrow r$	$(p \rightarrow q) \wedge (q \rightarrow r)$	$(p \rightarrow q) \wedge (q \rightarrow r) \rightarrow (p \rightarrow r)$
1	1	1	1	1	1	1	1
1	1	0	1	0	0	0	1
1	0	1	0	1	1	0	1
1	0	0	0	1	0	0	1
0	1	1	1	1	1	1	1
0	1	0	1	0	1	0	1
0	0	1	1	1	1	1	1
0	0	0	1	1	1	1	1

Thus, syllogism: $[(p \rightarrow q) \wedge (q \rightarrow r)] \rightarrow (p \rightarrow r)$ is always true. □

The above is elementary. However, it should be noted that

(E) We have no definition of "non-mathematical proposition".

For example, we can not answer to the following questions:

(F₁) Is the first proposition of philosophy "I think, therefore I am" a proposition?

(F₂) Is the statement "" in Moore's paradox a proposition?

(F₃) Is true syllogism in quantum systems?

If so, symbolic logic is powerless without mathematics. R. Wittgenstein thought so, he challenged to clarify logic in philosophy. However, he failed his challenge.

In spite of his failures, analytic philosophy flourished in the following ways

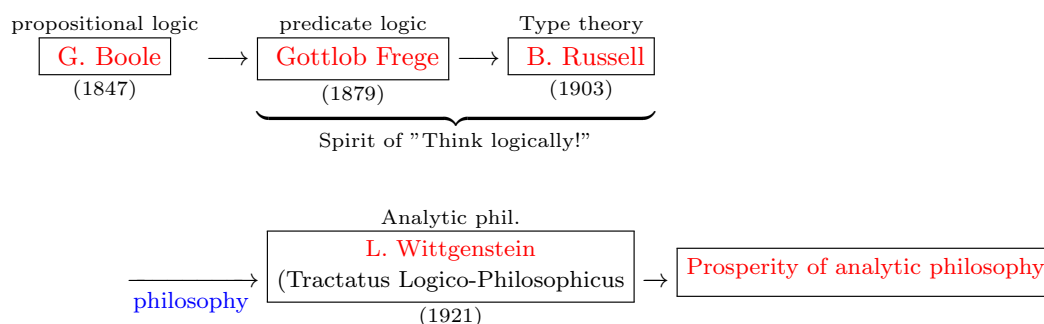

♠**Note 4.5.** To compare Review 3.10 and Assertion 4.1, we can guess that Aristotle cannot understand Plato’s theory of Ideas. That is, Aristotle tried to propose the other theory (i.e., the realistic worldview) than Plato’s theory (i.e., the fictional worldview). And he discovered "eidos" and "hyle", which are the most basic concepts in mechanics. Thus, we conclude that Aristotle is the founder of the realistic worldview. As mentioned before, I am skeptical of the logical worldview (=the logical spirit=the spirit of "Think logically!"), but the following diagram is usual in philosophers:

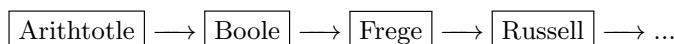

Aristotle’s syllogism may not belong to symbolic logic, thus, I do not add Aristotle to (b₂₂).

- (b) {
 - (b₁): the realistic worldview (physics)
Hērakleitos, Aristotle, Archimedes, Galileo, Newton, Einstein, ...
 - (b₂₁): the fictional worldview (Western philosophy)
Plato, Scholasticism, Descartes, Locke, Leibniz, Berkeley, Hume, Kant, Husserl
 - (b₂₂): the logical worldview (=the logical spirit=the spirit of "Think logically!")
Boole, Frege, Peirce, Saussure, Russell, Wittgenstein, Hempel, Quine, Popper
 - (b₂₃): the mechanical worldview (statistics, quantum language)
Parmenides, Zeno, J. Bernoulli, statistics (e.g., Fisher), quantum language

In science, quantitative discussion and computation become important. In this sense, we consider that physics (or, mechanics) is located in the center of science. On the other hand, the logical worldview (=the logical spirit=the spirit of "Think logically!") is rather qualitative, and therefore, the logical worldview (=the logical spirit=the spirit of "Think logically!") is rather influential in the field of humanities. For example, trials are an area where the importance of logic is most emphasized. Also, I think that philosophers are people who like logic most.

4.3.3* Syllogism does not always hold in quantum systems

We have the following theorem

Theorem 4.5. (G₁) Syllogism does not necessarily hold in quantum systems
 (G₂) Syllogism always holds in both classical and quantum systems

Since (G₁) and (G₂) have different premises, (G₁) and (G₂) are not contradictory (*cf.* Remark 12.9 later).
 The proof of (G₂) is given in Corollary 12.8. ////

Proof 4.6. The proof of Theorem 4.5 (G₁) due to the following:

- [76] Ishikawa, S., (2020) Wittgenstein’s picture theory in the quantum mechanical worldview Journal of quantum information science, Vol. 10, No.4 , 104-125, DOI:10.4236/jqis.2020.104007 (<https://www.scirp.org/journal/paperabs.aspx?paperid=106233>)
- (H) : [Syllogism does not hold in quantum systems]:
 i.e., the following does not always hold in quantum language:
 - if $P_1 \rightarrow P_2$ and $P_2 \rightarrow P_3$, then it holds $P_1 \rightarrow P_3$.

Let us prove it as follows. A quantum two particles system S is formulated in a tensor Hilbert space $H = H_1 \otimes H_1 = L^2(\mathbb{R}_{q_1}) \otimes L^2(\mathbb{R}_{q_2}) = L^2(\mathbb{R}_{(q_1, q_2)}^2)$. The state u_0 ($\in H = H_1 \otimes H_1 = L^2(\mathbb{R}_{(q_1, q_2)}^2)$) (or precisely, $\rho_0 = |u_0\rangle\langle u_0|$) of the system S is assumed to be

$$u_0(q_1, q_2) = \sqrt{\frac{1}{2\pi\epsilon\sigma}} e^{-\frac{1}{8\epsilon^2}(q_1 - q_2 + a)^2 - \frac{1}{8\sigma^2}(q_1 + q_2)^2} \quad (4.1)$$

where $a \neq 0$, a positive number ϵ is sufficiently small, and a positive number σ is sufficiently large. Thus, we see that

$$|\widehat{u_0}(p_1, p_2)| = \left| \sqrt{\frac{1}{2\pi\epsilon\sigma}} e^{-\frac{1}{8\sigma^2}(p_1 - p_2)^2 - \frac{1}{8\epsilon^2}(p_1 + p_2)^2} \right| \quad (4.2)$$

where $\widehat{u_0}$ is the Fourier transform of u_0

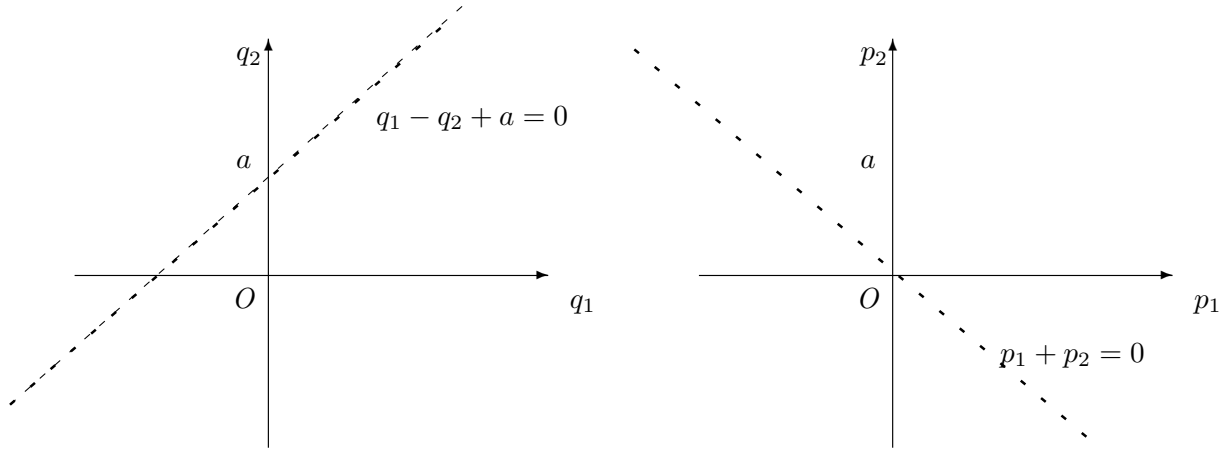

For each $k = 1, 2$, define the self-adjoint operators $Q_k : L^2(\mathbb{R}_{(q_1, q_2)}^2) \rightarrow L^2(\mathbb{R}_{(q_1, q_2)}^2)$ and $P_k : L^2(\mathbb{R}_{(q_1, q_2)}^2) \rightarrow L^2(\mathbb{R}_{(q_1, q_2)}^2)$ by

$$\begin{aligned} Q_1 &= q_1, & P_1 &= \frac{\hbar\partial}{i\partial q_1} \\ Q_2 &= q_2, & P_2 &= \frac{\hbar\partial}{i\partial q_2} \end{aligned} \quad (4.3)$$

(#₁⁰) Let $\mathbf{O}_1 = (\mathbb{R}^3, \mathcal{B}_{\mathbb{R}^3}, F_1)$ be the observable representation of the self-adjoint operator $(Q_1 \otimes P_2) \times (I \otimes P_2)$. And consider the measurement $\mathbf{M}_{B(H)}(\mathbf{O}_1 = (\mathbb{R}^3, \mathcal{B}_{\mathbb{R}^3}, F_1), S_{[|u_0\rangle\langle u_0|]})$. Assume that the measured value $(q_1^0, p_2^0, p_2^0) (\in \mathbb{R}^3)$. That is,

$$\begin{array}{ccc} (q_1^0, p_2^0) & \implies & p_2^0 \\ \text{(the position of } A_1, \text{ the momentum of } A_2) & & \text{the momentum of } A_2 \end{array}$$

(#₂) Let $\mathbf{O}_2 = (\mathbb{R}^2, \mathcal{B}_{\mathbb{R}^2}, F_2)$ be the observable representation of $(I \otimes P_2) \times (P_1 \otimes I)$. And consider the measurement $\mathbf{M}_{B(H)}(\mathbf{O}_2 = (\mathbb{R}^2, \mathcal{B}_{\mathbb{R}^2}, F_2), S_{[|u_0\rangle\langle u_0|]})$. Assume that the measured value $(p_2^0, -p_2^0) (\in \mathbb{R}^2)$. That is,

$$\begin{array}{ccc} p_2^0 & \implies & -p_2^0 \\ \text{the momentum of } A_2 & & \text{the momentum of } A_1 \end{array}$$

(#₃) Therefore, if syllogism holds, we may conclude that

$$\begin{array}{ccc} (q_1^0, p_2^0) & \implies & -p_2^0 \\ \text{(the position of } A_1, \text{ the momentum of } A_2) & & \text{the momentum of } A_1 \end{array}$$

(that is, the momentum of A_1 is equal to $-p_2^0$)

But, the above argument (particularly, “syllogism”) is not true. That is because

(#4) $(Q_1 \otimes P_2) \times (I \otimes P_2)$ and $(I \otimes P_2) \times (P_1 \otimes I)$ (therefore, O_1 and O_2) do not commute, and thus, the simultaneous observable does not exist.

Thus, we can not test the (#3) experimentally.

Remark 4.7. Some arguments differ from the above. In Corollary 12.8 (= Remark 12.9) later, we present the different result, i.e.,

- syllogism always holds in classical and quantum systems. which is more formal.

Chapter 5

Around Alexandria; Hellenistic period

Wisdom of pyramid building for thousands of years was accumulated by Egypt (Alexandria). Bright people studied in Egypt from each place of the Mediterranean Sea coast to learn it. For example,

Euclid ··· geometry

Aristarchus ··· Heliocentrism

Archimedes ··· buoyancy, lever

Eratosthenes ··· the measurement of the earth

Ptolemaeus ··· Geocentrism



5.1 Around Alexandria; Hellenistic period

Influenced by the tradition of pyramid construction engineering, the studies of the Alexandrian school are solid and scientific. Put differently, it could be said that there was no philosophical appeal that transcended mathematical logic. The Alexandrians must have known of Plato's work. However, they had little influence from Plato. I guess that

- they didn't think that Plato's philosophy would survive more than 2,000 years later

Hellenistic period is located as follows:

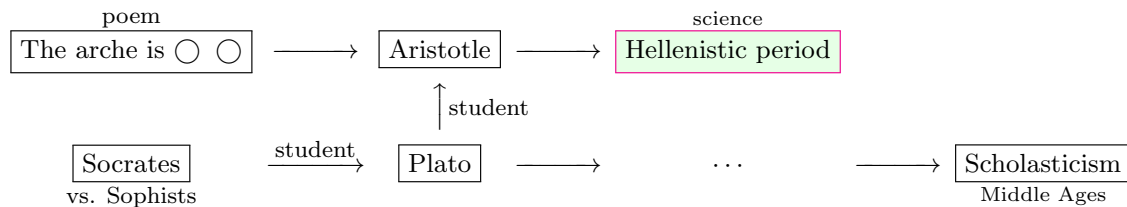

Many Greek philosophers were not willing to put their theories to work. But, in Hellenistic period, Practical research was respected. In Section 5.3, I will explain Heliocentrism of Aristarchus a little in detail as the preparation of Chap. 7, in which we say that

- "Geocentrism vs. Heliocentrism" is a metaphysical problem that cannot be put on black-and-white in the experiment. That is,
 - (#) "Geocentrism vs. Heliocentrism" is a philosophical problem (i.e., the problem of worldview), and not the problem of truth or falsehood.

5.2 Euclid(BC.330 - BC.275)

5.2.1 Euclid geometry - Parallel postulate

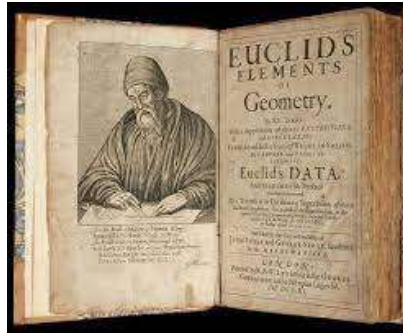

Three great pyramids in the Egyptian Giza desert (deceased person is Khufu, Khafre, Menkaure) erecting time of is the 2500 BC. Since then more than 2,000 years later, Euclid (BC.330 - BC.275) was born. Euclid is referred to as the "father of geometry" who was active in Alexandria (the mouth of the Nile). His book "Elements" is one of the most influential works in the history of mathematics. It has been estimated to be second only to the Bible in the number of editions published since the first printing in 1482 AD. When I think from now,

(A) Euclid advocated geometric **axiomatization** and considered the parallel postulate, and was the mathematician who intuited that the concept of "self-evident" isn't self-evident. Here, the parallel postulate is as follows:

- If a line segment intersects two straight lines forming two interior angles on the same side that sum to less than two right angles, then the two lines, if extended indefinitely, meet on that side on which the angles sum to less than two right angles.

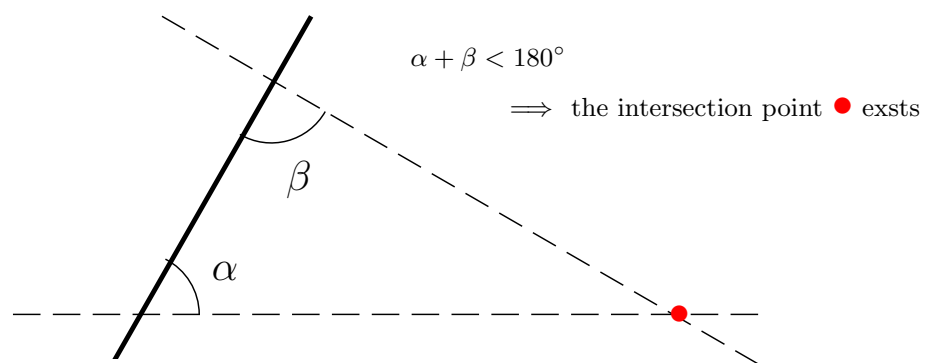

Postulate 1



Postulate 2



Postulate 3

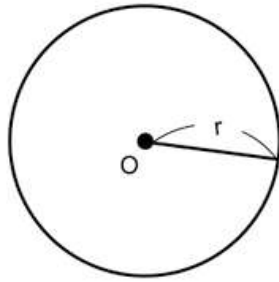

Postulate 4

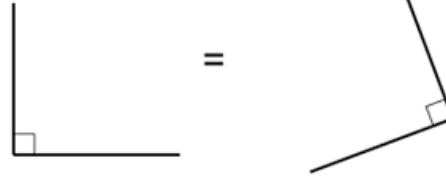

Postulate 5

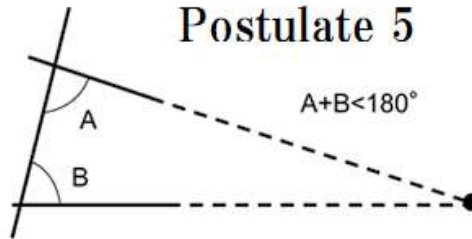

In spite of close attention of Euclid, the next **wrong belief** has been formed by "Element".

(B) **It is the best method to start from a self-evident thing.**

Much philosophers (Descartes and Spinoza, etc.) have fallen into this wrong belief. It is well known by now that Descartes' cogito proposition "I think, therefore I am" is a proposition that is far from self-evident. That is, there is nothing self-evident (= there is not unquestionable truth).

As mentioned in Remark 3.13, many excellent philosophers follow Euclid as follows.

introduction part (unquestionable truth)

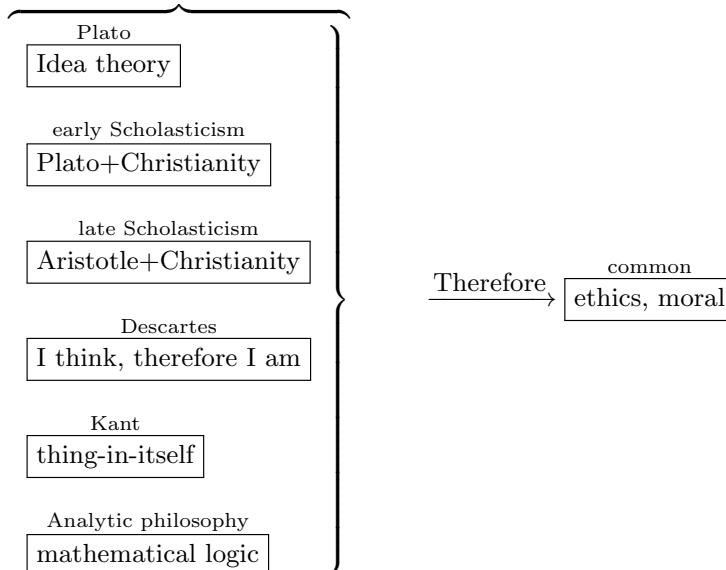

Here it should be noted that all of the worldviews in the left-side of the above are theories that are impossible to deny.

♠**Note 5.1.** In "Elements", geometry is not only written but also algebra. For example, it is shown that prime numbers are infinite. The proof is as follows.

(‡) Assume that the set of prime numbers is finite, that is, $\{2, 3, 5, 7, \dots, n\}$. Put

$$N = (2 \times 3 \times 5 \times 7 \times \dots \times n) + 1$$

Then, N is a prime number or it can be divided by the larger prime number than n . In each case, it contradicts the assumption that n is the largest prime number. □

5.2.2 non-Euclidean revolution

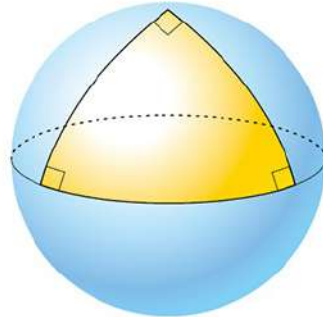

Discovery of non-Euclid geometry (due to Gauss(1777 - 1855), etc.) defeated the wrong belief (B) and asserted

(C) **Start from "productive" than "self-evident"!**

that is, "all is well that ends well". In this paper, the (C) is called the non-Euclidean revolution, that is,

(D) non-Euclidean revolution $[(B): \text{self-evident}] \xrightarrow{\text{non-Euclidean revolution}} (C): \text{productive}]$

It can't be said that the non-Euclidean revolution is still generally also recognized sufficiently in today. There is no successful theory which starts from "self-evident things". For example, Newtonian mechanics, the theory of relativity, quantum mechanics, etc. do not start from "self-evident things". Paradoxically saying, we see that

(E) The question: "What is 'self-evidence'?" is not self-evident.

Axiom of choice of mathematics is not self-evident, where axiom of choice is as follows.

- Given any set X of pairwise disjoint non-empty sets, there exists at least one set C that contains exactly one element in common with each of the sets in X .

(For example, consider a set $X = \{\{a, b\}, \{c, d, e\}, \{g\}, \{h, i, j, k\}\}$. Then, we can construct a set $C = \{a, c, g, j\}$)

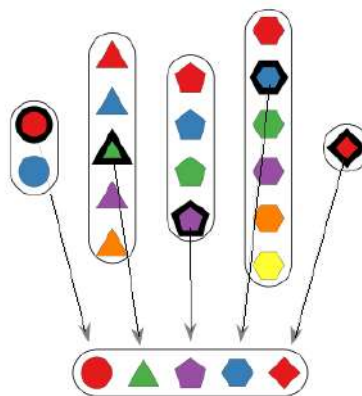

This is not self-evident (i.e., trivial). For instance, Banach-Tarski theorem says that

(F) If we adopt axiom of choice, we have to admit the following

- A ball B is resolved into parts of several finite numbers, and we assume that it's put together again. Then, we can get the same two balls which are also the same as the ball B .

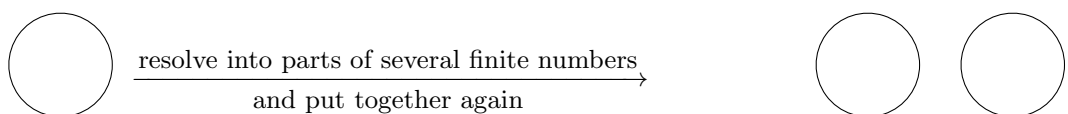

CUTTING UP A BALL INTO TWO BALLS OF THE SAME SIZE .



Then, we want to doubt axiom of choice, but a description of the mathematics largely decreases when I do not accept axiom of choice. Hence, we usually accept axiom of choice.

Remark 5.1. I have an opinion that the main stream of Western philosophy is

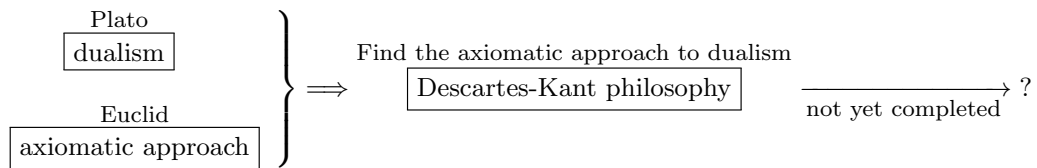

Euclid's "Elements" and the Bible are cultures that we non-Westerners find astonishing.

♠**Note 5.2.** There was also tradition of pyramid construction, and Egypt was an advanced country of mathematics. Pythagoras and Archimedes also learned geometry in Egypt. Then Alexandria was an academic city as there was Alexandria library having 700,000 collection of books. After Euclid, we know that

- Eratosthenes (BC.275 - BC.194) : He was determined to 46250km the whole circumference of the earth. Cf. Sec. 5.5.
- Cleopatra(BC.69 - BC.30): The most beautiful woman in human history.
- Ptolemaeus (AD.83 - 168): Geocentrism

5.3 Aristarchus (BC.310 - BC.230)

5.3.1 the diameter of the moon : the diameter of the sun



Aristarchus
BC310-BC230

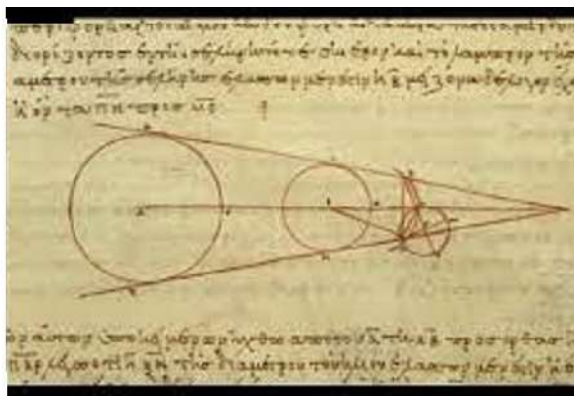

Aristarchus (BC.310 - BC.230) was an ancient Greek astronomer and mathematician who presented Heliocentrism. He calculated as follows.

Proposition 5.2.

- (A₁) the diameter of the moon : the diameter of the earth $\approx 1:3$ (Recent result says that $1 : 3.669$), where $a : b = c : d$ means $a/b = c/d$.
- (A₂) the diameter of the moon : the diameter of the sun $\approx 1:19$
- (A₃) Thus, the diameter of the earth : the diameter of the sun $\approx 1:6.333$ (Recent result says that $1 : 109$)
- (A₄) Since each volume is proportional to [diameter]³, the sun is much larger than the earth.

The answer to (A₁) Look at the lower left figure (lunar eclipse). Since the sun is very far, it suffices to consider that

$$\text{the diameter of the earth} \approx \text{the diameter of the earth's shadow}$$

Hence, measuring by eye, we see (A₁).

The answer to (A₂): Look at the lower right figure (the first quarter moon). Note that $\cos 87^\circ \approx 1/19$. And using the fact that The sun and the moon are seen as the same size, we can calculate:

$$\frac{\text{the diameter of the moon}}{\text{the diameter of the sun}} = \frac{\text{the distance between the moon and the earth}}{\text{the distance between the sun and the earth}} = \cos 87^\circ \approx \frac{1}{19}$$

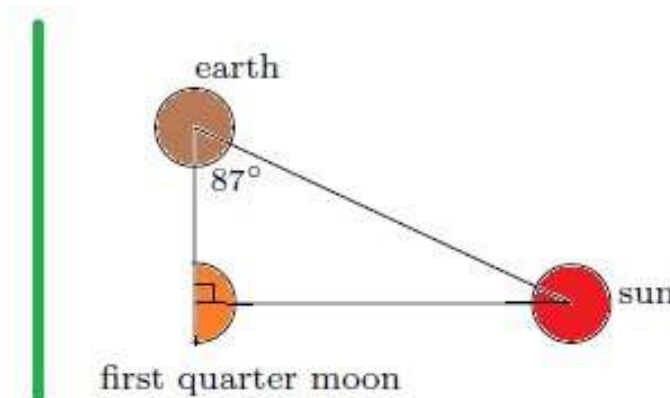
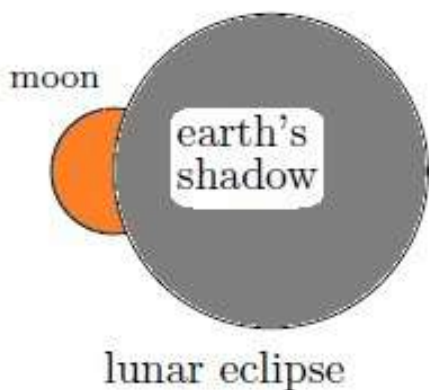

5.3.2 Ancient Heliocentrism

Aristarchus considered as follows:

(B₁) The sun is overwhelmingly larger than the Earth. If so, it is wrong that the big sun goes around the small earth. **It is sure that the small earth goes around the big sun.**

That is,

(B₂) Aristarchus proposed Heliocentrism

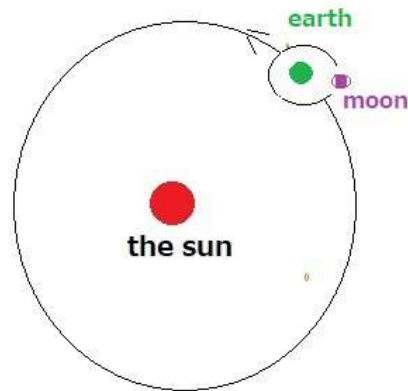

His argument is almost complete since the difference between "the volume" and "the mass" is trivial. Therefore, I agree that

Aristarchus was the first proponent of the heliocentric theory

Next problem is as follows.

(C) measuring the diameter of the earth

This was solved by Eratosthenes (*cf.* Sec.5.5).

5.4 Archimedes (BC.287 - BC.212)

Archimedes was born in Syracuse on the island of Sicily in the Mediterranean. Archimedes studied in Alexandria that was a center of the study and engaged in the study of "Elements" with pupils of Euclid afterwards. He returned to Syracuse later and spent life in Syracuse.



5.4.1 Buoyancy (Archimedes' principle)

Archimedes' principle on buoyancy is as follows.

- (A) Any object, wholly or partially immersed in a fluid, is buoyed up by a force equal to the weight of the fluid displaced by the object. If some want to avoid the term "force", then

$$\begin{aligned} & \text{[the weight of the matter in water]} \\ & = \text{[the weight of the matter]} - \text{[buoyancy]}/g \end{aligned} \quad (5.1)$$

where (g : gravitational constant, the shape of this matter is assumed a cone.)

$$\begin{aligned} \text{[buoyancy]} &= \text{[Sum of the water pressure from the bottom of the object]} \\ & \quad - \text{[Sum of the water pressure from the top of the object]} \\ &= (f_1 + f_2)S = (|f_2| - |f_1|)S = hSg = Vg \quad (\text{the density of water is } \rho(=1).) \end{aligned}$$

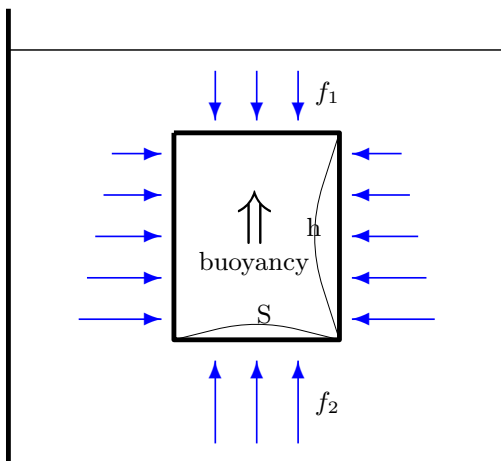

S : bottom area, h : height

$V = hS$; volume

f_k : water pressure, $k = 1, 2$

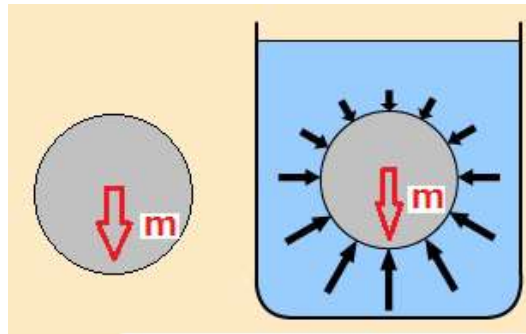

♠**Note 5.3.** A famous anecdote of the golden crown is the delicate anecdote that there is not connected with Archimedes' principle. In like there is a relationship, I try to write this in what follows.

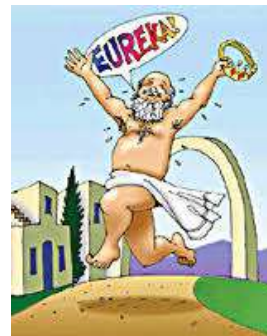

- The King of Syracuse asked Archimedes "Can you check whether silver is not mixed by the crown". Archimedes notices next answer (#) during bathing: while shouting with joy too much "Heureka!"(="I have found it!"), was running around the streets naked without even wearing clothes.

He found:

- (#) Preparing the gold bullion of the weight same as the crown, compare the weight the gold bullion and the weight is the crown in water. Then, we can, by the (5.1), compare the volume of the gold bullion and the volume of the crown.

♠**Note 5.4.** For each great discovery, an anecdote (or, a catch copy, stage effect) is left as follows.

- (#₁) Archimedes.....golden crown, heureka! (cf. Sec.5.4)
 (#₂) Galileo.....Leaning Tower of Pisa, "And Yet It Moves" (cf. Sec.7.3.4)
 (#₃) Newton..... ①:Newton's apple, "Geocentrism vs. Heliocentrism"(cf. Note 7.9)
 (#₄) Descartes..... ①:fly on the ceiling (cf. Note 8.2), ②: I think, therefore I am, (cf. Sec.8.2)
 (#₅) Kant.....clock (cf. Note 10.2), dogmatic slumber (cf. Note 10.6)
 (#₆) Wittgenstein.....primary school teacher, Gardener, Guardian: Russell (cf. Sec.12.1.1)
 (#₇) Einstein.....Elevator
 (#₈) quantum mechanics.....Heisenberg's uncertainty principle (cf. ref. [36], or, Note 4.1 of ref. [71])

Here, the (#₈) is my opinion (Has Heisenberg's uncertainty relation ever been used effectively in physics? (Sec. 4.3 in ref. [71])).

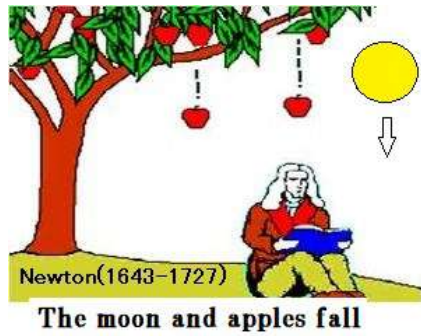

Heisenberg's uncertainty relation

$\Delta p \Delta x \geq \frac{\hbar}{2}$

impossible to know exactly:

- where something is
- how fast it is going

What is the definition of Δp (or, Δx)?

5.4.2 The tomb of Archimedes

Consider the ball B of radius r . Archimedes showed the followings:

The volume of the ball $B = \frac{4\pi r^3}{3}$, The surface area of the ball $B = 4\pi r^2$

If you are a genius, you may find the proof by seeing the lower illustration ('the cylinder which is circumscribed to a ball' called "the tomb of Archimedes"). If you are not genius, you can calculate it by using the differential and integral calculus.

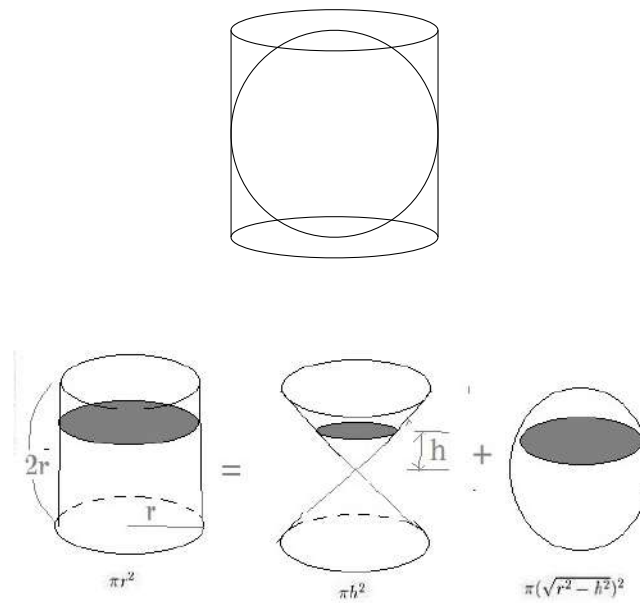

Areas of gray areas of the same height

Thus,

"Volume of Sphere" = "Volume of Cylinder" - 2 × "Volume of Cone"

$$= 2\pi r^3 - 2 \times \frac{\pi r^3}{3} = \frac{4\pi r^3}{3}$$

□

5.4.3 Principle of leverage

Archimedes found "principle of a lever" and did more various invention with a lever.

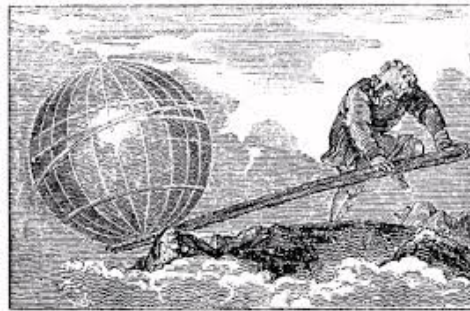
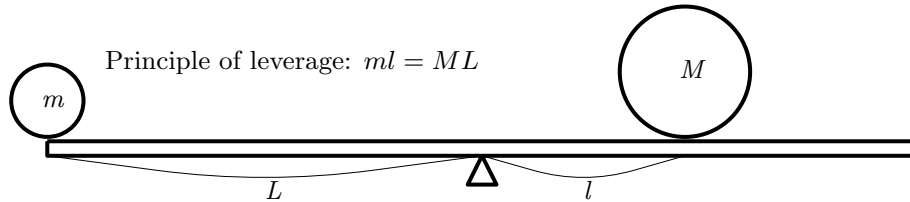

Archimedes said "Give me a lever long enough and a fulcrum on which to place it, and I shall move the world". In spite that he referred Aristarchus' Heliocentrism in his book: "The Sand Reckoner", he supported Aristotle's Geocentric model. However, Archimedes, found "principle of a lever", have to restate Aristarchus' Heliocentrism((B₁) in Sec.5.3) as

- (B) Because the sun is so much bigger than the earth. The center of gravity of the combined Earth and Sun is extremely close to the Sun. Hence, **the Sun and the Earth revolve around the gravity of both the earth and the Sun.**

If Archimedes said so, science history would be history which is completely different from now.

♠**Note 5.5.** Archimedes' arguments were so clear that even elementary school students could understand them, and he did not say ambiguous and unintelligible things like philosophy (Plato, etc.). This clarity is a factor in Archimedes' popularity. As I have mentioned before, his words pierce our hearts,

- Heureka!"(="I have found it!")
- Give me a lever long enough and a fulcrum on which to place it, and I shall move the world and so on. And the "last words" was
- **Do not disturb my circles!**

The city of Syracuse, where Archimedes lived, was a battleground between Carthage (Hannibal the General) and Rome. The Roman army knew that Archimedes was a famous scientist, so they instructed him not to do any harm. However, when Archimedes was thinking about writing a figure on the sand, he was almost taken away by the Roman soldiers, who refused to do so, saying "Do not disturb my circles! And thus he was killed. It can be said that he was the "greatest star of the ancient scientists" until the end of his life.



♠**Note 5.6.** Note that

- Archimedes did not speak ambiguous things like Plato's philosophy.

Therefore the work of Archimedes is quantitative, clear and easy to understand. Since political power could interpret the vague philosophy conveniently, philosophy could influence to maintain harmony with religion or politics. In fact, philosophy survived in the middle ages as a maid of theology. On the other hand, Archimedes' work was almost forgotten.

5.5 Eratosthenes (BC.275 - BC.194)



BC276-BC194

1	2	3	4	5	6	7	8	9	10
11	12	13	14	15	16	17	18	19	20
21	22	23	24	25	26	27	28	29	30
31	32	33	34	35	36	37	38	39	40
41	42	43	44	45	46	47	48	49	50
51	52	53	54	55	56	57	58	59	60
61	62	63	64	65	66	67	68	69	70
71	72	73	74	75	76	77	78	79	80
81	82	83	84	85	86	87	88	89	90
91	92	93	94	95	96	97	98	99	100

Sieve of Eratosthenes

5.5.1 The biggest ancient observer

Pythagoras believed that the earth must be a beautiful shape and believed that the earth was a sphere. Aristotle deduced that the lunar eclipse was the shadow of the Earth and believed that the Earth was a sphere. When you look at the ocean in the distance, it looks like an arc, so there were probably people who believed that the earth was a sphere since long ago. However, if we were to mention the two certain discoverers, it would be the scientist Eratosthenes (BC.275 - BC.194) and the explorer Magellan (AD.1480 - AD.1521).



Aswan High Dam

- Syene (=Aswan) is on the tropic of cancer, thus, the sun is seen in right above at noon on the summer solstice.
 - Syene (=Aswan) is located just south of Alexandria. The distance = $AS=925\text{km}$.
- Eratosthenes measured the whole circumference of the earth as follows.

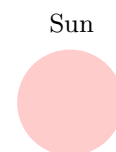
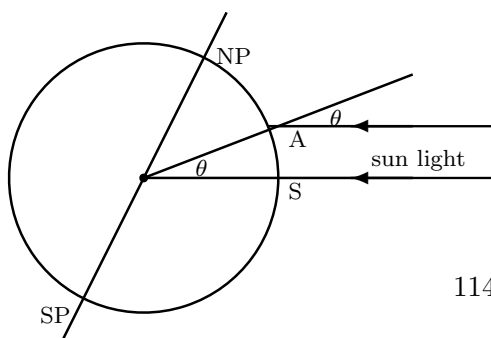

NP:North pole, SP:South pole, A:Alexandria, S:Syene(=Aswan)

Hence,

$$\begin{aligned} \text{the whole circumference of the earth} &= 2 \times 3.14 \times [\text{the radius of the Earth}] = 360AS/\theta \\ &= 360 \times 925/7.2 = 46250km \end{aligned}$$

As the recent result:40009km, it may be surprising.

♠**Note 5.7.** Since Aristarchus discovered

$$\begin{aligned} &[\text{the diameter of the moon}] : [\text{the diameter of the earth}] : [\text{the diameter of the sun}] \\ &= 1 : 3 : 19 \end{aligned}$$

then, by Eratosthenes's result, we know that

$$[\text{the diameter of the moon}], [\text{the diameter of the earth}], [\text{the diameter of the sun}].$$

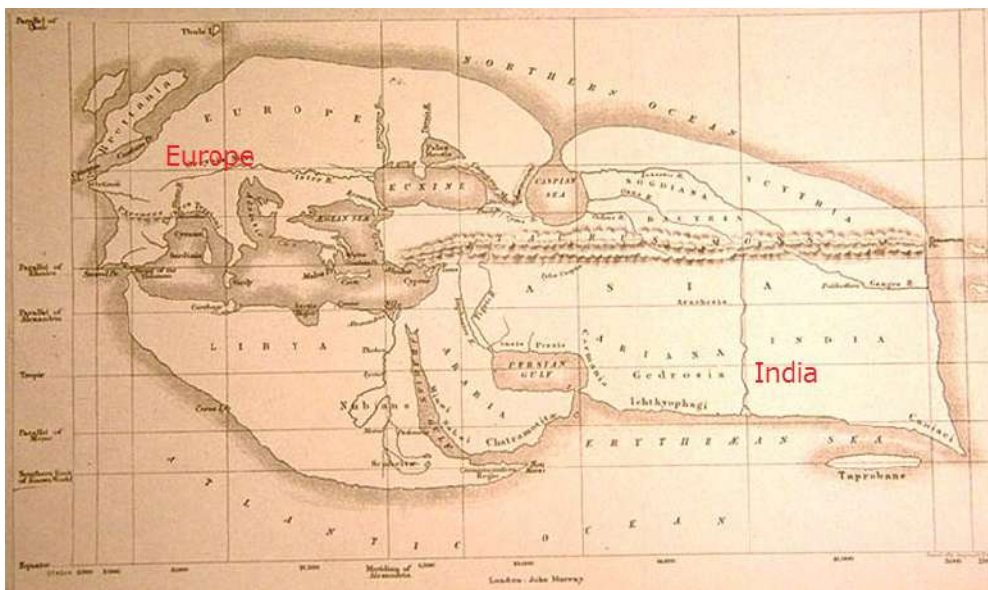

5.6 Claudius Ptolemaeus (AD.83 - AD.168)

5.6.1 The ancient scientific collected studies

Ptolemaic Dynasty is ruined by the death of Cleopatra, Rome became the heyday of the Five Good Emperors era. At this time, Ptolemaeus (AD.83 - 168) played an active part in Alexandria. In his book "Almagest", he adopted Aristotle's Geocentrism (i.e., the sun goes around the earth). Ptolemaeus explained the retrogression seen at a planet in Mars such as Mars revolves around the earth while drawing a small circle as "epicycle".

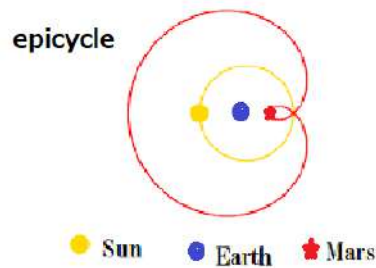

Ptolemaeus compiled the latest theory in those days and concluded the Geocentrism (= Ptolemaic system) under the enormous measured data.

(A) Ptolemaeus followed Aristotle, Archimedes, etc.

And it is sure

(B) **Ptolemaeus is a top-notch researchers.**

He was the scientist who gave the most importance to observation among the ancient scientists.

Although, approximately 1500 years later (at Galileo's trial (1633)), his Ptolemaic system was replaced by the Copernican system, he was surely one of scientists who thought observation and experiment as important most.

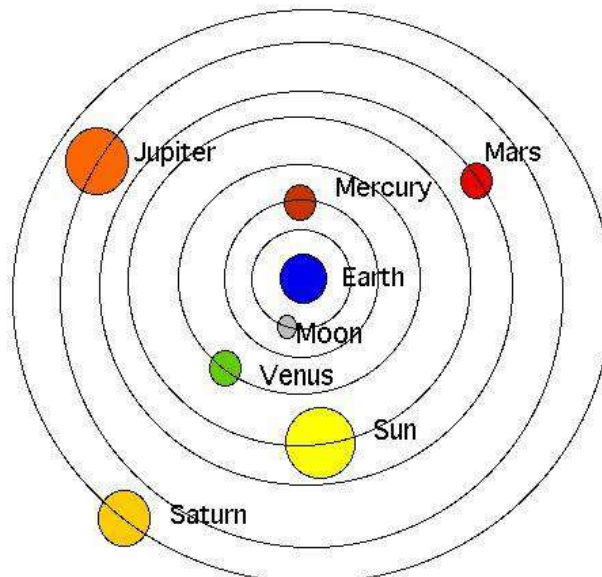

♠**Note 5.8.** S. Weinberg (1933 -2021), a physicist at the University of Texas, Austin, won a Nobel Prize in 1979 for work that became a cornerstone of particle physics, said of his book [115] "To explain the word; The discovery of modern science" as follows:

- [in Chapter 8]: *In one respect the work on this theory described in the Almagest is strikingly modern in its methods. Mathematical models are proposed for planetary motions containing*

various free numerical parameters, which are then found by constraining the predictions of the models to agree with observation.

Decades ago, when I saw the planetarium when I was a kid, a commentator explained that "Ptolemaeus asserted a foolish Geocentrism, and this was corrected by Copernicus." However, when I went to the planetarium a few months ago, a commentator praised Ptolemaeus, saying, "His epicycle model is groundbreaking at the time." It was great to hear a similar opinion to Weinberg's at a planetarium in the Far East island nation.

♠**Note 5.9.** Recall the following figure:

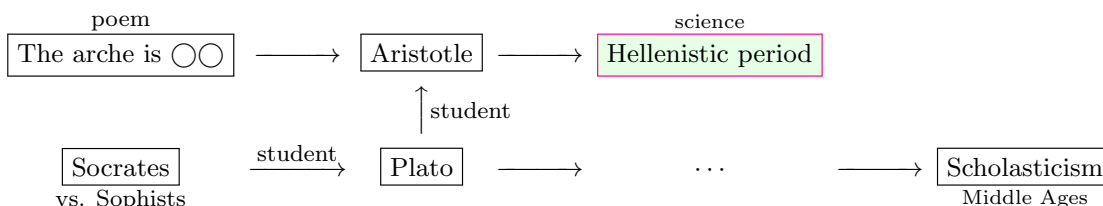

That is, Aristotle bridged the gap between this pseudoscience (\approx the arche is OO) and the base for the foundation that would become science. Archimedes is the discoverer of "principle of buoyancy", which belongs the realistic worldview. Ptolemaic system is based on the realistic motion function method. Thus, we can get as follows (*cf.* Classification 1.11 [the classification of philosophers]).

- (b₁): the realistic worldview (physics)
 - Hērakleitos, Aristotle, Aristarchus, Archimedes, Eratosthenes, Ptolemaeus, Galileo, Newton, Einstein, ...
 - (Although mathematics is not a worldview, Pythagoras, Eudoxus, Euclid)
- (b₂₁): the fictional worldview (Western philosophy)
 - Plato, Scholasticism, Descartes, Locke, Leibniz, Berkeley, Hume, Kant, Husserl
- (b₂₂): the logical worldview (=the logical spirit=the spirit of "Think logically!")
 - Boole, Frege, Peirce, Saussure, Russell, Wittgenstein, Hempel, Quine, Popper
- (b₂₃): the mechanical worldview (statistics, quantum language)
 - Parmenides, Zeno, J. Bernoulli, statistics (e.g., Fisher), quantum language

In the above, the following two are greatest (*cf.* Note 2.7):

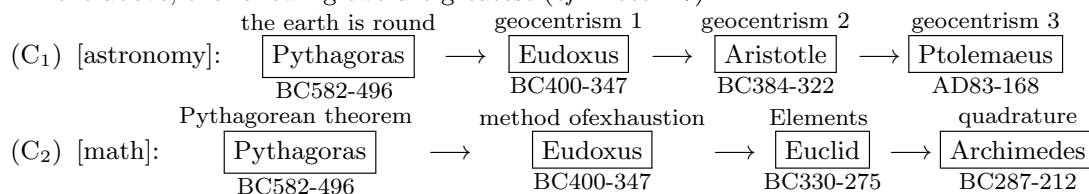

Chapter 6

The Middle Ages

The Middle Ages may be characterized as "the time of the thought stop for about 1500 years" Thus, it is called

"Philosophy is a maidservant of theology"

In this chapter, we discuss:

- (#1) Augustinus(354 - 430): Christianity became the state religion of the Roman Empire. Subjective time theory
- (#2) Anselmus(1033 - 1110): the father of Scholasticism, Arguments for the existence of God, "Realism" in Problem of universals
- (#3) Thomas Aquinas(1225 - 1274): Completion of the scholasticism (Summa Theologica): Compromise between Plato philosophy and Aristotle philosophy
- (#4) Ockham(1285 - 1347): Ockham's razor, "Nominalismus" in Problem of universals

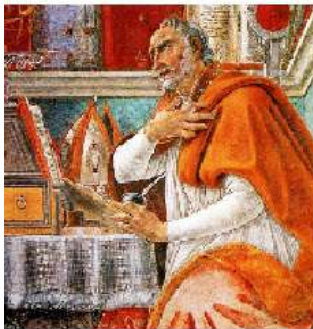

Augustinus
(AD. 354 - AD.430)

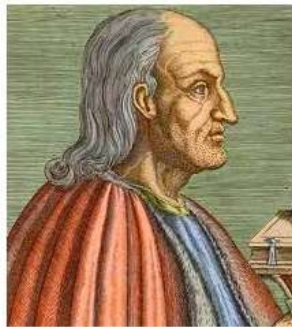

Anselmus
(1033 - 1109)



Thomas Aquinas
(1225 - 1274)



William of Ockham
(1285 - 1347)

6.1 Augustinus(AD. 354 - AD.430)

6.1.1 Philosophy is a maidservant of theology



One of the largest events in the Western history is

AD.380: Christianity became the state religion of the Roman Empire

A wonder of Western philosophy is:

(A) Western philosophy met with a dying crisis many times. Each time, Western philosophy was rescued by a hand of someone's help (such as a hand of help of a god).

Augustinus (AD. 354 - 430) is one who extended a helping hand to dying Plato philosophy. Catholic father Augustinus used Plato philosophy to reinforce a theoretical backbone of Christianity. For this,

(B) It's desirable that God (in Christianity) and Idea (in Plato philosophy) have the similar nature.

The opinion of the sophist ("Man is the measure of all things") is contrary to the opinion of Socrates-Plato, and also to the opinion of Christianity ("God is the measure of all things"). Thus, Socrates-Plato and Christianity have an affinity. In other words, there are reasons to think as follows.

Plato's Idea = (A device that make the absolute goodness visible)

≈ (A device that make the intellect of "God" visible) = **church**

Augustinus might think so. Of course, they cannot accept Aristotle's Idea (i.e., the Idea that came down to earth) . Because it would be more valuable if the Idea were in heaven. It could be said that "Christianity was Idea theory arranged for the people (Nietzsche)," and conversely, it could be said that "Idea theory was celebrated as Christianity for the intellectuals."

The Plato philosophy got the strongest supporter (i.e., Christianity).

(C) Philosophy won a help from Christianity. But this implied "Philosophy is a maidservant of theology".

And philosophy fell into a thought stop, but, at least, Philosophy survived.

All proceeded as Augustinus' plan.

♠**Note 6.1.** If we emulate Review 3.10 and forcefully apply the three key words of dualism to Augustine, we get the following

dualism \ three key-words	[A](= mind)	[B](Mediating of A and C)	[C](= matter)
③: Plato: sun Remark 3.7	actual world	Idea	/ [Idea world]
Augustinus; Christianity	earthly city	church	/ [the city of God]
quantum language	measured value	observable	state [system]

If so, we have to acknowledge the following,

• Plato $\xrightarrow{\text{regress}}$ Augustinus $\xrightarrow{\text{progress}}$ Descartes $\xrightarrow{\text{progress}}$ · $\xrightarrow{\text{progress}}$ Quantum language

but we do not stick to this since Christianity is not related to a measurement theory.

It is unclear whether the Christian fathers (such as Augustine) took Plato's philosophy seriously or not. However, the famous philosopher Anselmus barely appeared 600 years after Augustine, so I don't think they were serious.

♠**Note 6.2.** Readers may have the following question:

(#1) Why is paranormal theory always the mainstream of Western philosophy?

My opinion is as follows. Recall the Platonic method of telling philosophy:

(#2)
$$\boxed{\begin{array}{c} \text{world is so} \\ \text{fictional worldview (literary truth, pseudo- truth)} \\ \text{introduction-preface-fiction} \end{array}} \xrightarrow{\text{therefore}} \boxed{\begin{array}{c} \text{Live so} \\ \text{Ethics \cdot morals} \\ \text{main subject} \end{array}}$$

Therefore,

- [world is so] is secondary, subsidiary,
- [you should do so] is main theme

Since the ethics and morality of the main subject is fully backed by Christianity, the "description of the world" in the introduction part can be any fairy tale or fiction. However, as I explained in Plato's section,

(#3) The description of the world in philosophy requires a "dualistic idealism".

Also, note that dualistic idealism is paranormal. This is the answer to the question (#1). However, assume that there is a scientific theory in dualistic idealism. Then, we can expect that

(#4) while fancy theories wander around in dualistic idealism, they gradually evolve and converge into a solid theory.

It is the purpose of this paper to show this. Specifically, we show that

- $\boxed{\text{Plato}} \rightarrow \boxed{\text{Descartes}} \rightarrow \boxed{\text{Locke}} \rightarrow \boxed{\text{Kant}} \rightarrow \boxed{\text{Wittgenstein}} \rightarrow \boxed{\text{Quantum language}}$
scientific theory

6.1.2* "Confessions" by Augustinus: Only the present exists



This section is written in the following reference:

- [73]:Ishikawa, S: Leibniz-Clarke correspondence, Brain in a vat, Five-minute hypothesis, McTaggart's paradox, etc. are clarified in quantum language Open Journal of philosophy, Vol. 8, No.5 , 466-480, 2018, DOI: 10.4236/ojpp.2018.85032
(<https://www.scirp.org/Journal/PaperInformation.aspx?PaperID=87862>)
[Revised version] (<https://philpapers.org/rec/ISHLCB>)
(http://www.math.keio.ac.jp/academic/research_pdf/report/2018/18001.pdf)

We want to know:

- ① How should we live?
- ② How is the world made?

Augustine (354-430), the greatest Catholic priest, used Plato's philosophy as the "God's intellect = Idea" and armed Christianity. And everything proceeded according to Augustine's plan and intention. What we ordinary people want to know most is, how should we live? Christian Fathers, as God's spokespersons, preached this to the people as the teachings of Christ. Therefore, Christian fathers, like God, had to be able to answer any questions immediately. Among them, the question that puzzled them were, "how is the world made?", "if this world was made by God, what was it like before God made it?" etc. Bible says:

(D₁) This world was made by God.

If so, people may have a question:

(D₂) How about before God made it?

However, if we believe in (D₁), then we consider that

(D₃) Time was also made at the same time as the world.

Therefore,

(D₄) The sentence "before God made it" is nonsense.

If we are told by fathers of Christianity so, we think that

(D₅) Well, I didn't read the Bible very well myself. I had a boring question ((D₂))

It should be noted that people want such a short story, and not scientific arguments. That is, note that it is not an understanding of the world for the sake of truth, but an understanding of the world for the sake of deepening our faith.

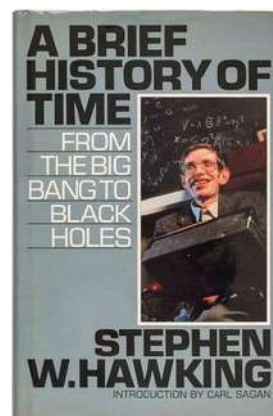
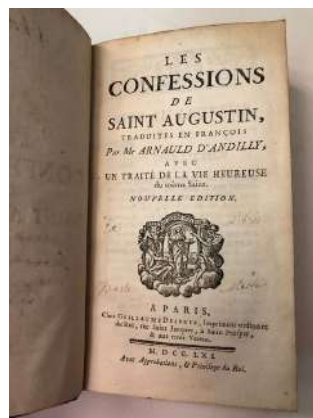

Augustinus asserted the following in his book "Confessions".

(E):Augustinus' theory of time as a short story

(E) Only present exists, and neither future nor past exist.



In fact,

(F) the future is in "prediction", the past is in "memory". There is what we can realize "only now". This is the beginning of the subjective time (which may be a main theme in philosophy). Although this "time" cannot be used in science, this time can be used in the Platonic method of telling philosophy as follows.

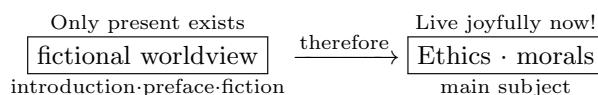

It is well known that St. Augustinus said that

- the past does not exist because of its being already gone, that the future does not exist because of its not coming yet, and that the present really exists.

Here, consider

(G) "Only the present exists"

Note that this proposition (G) is related to "tense". Thus, the linguistic Copenhagen interpretation (E₂) in Sec. 1.1.2 says that this (K) is not a statement in quantum language. Thus, the (G) is not scientific, that is, there is no experiment to verify the (G). Now,

- Augustinus' tense (past, present, future) is a kind of sermon. But it may be interesting in comparison with the linguistic Copenhagen interpretation (cf. (E₂) in Sec.1.1.2), i.e.,

There is no tense in science.

Thus, it is prohibited that Augustinus' tense (i.e., the subjective time) is discussed in science. However, we can appreciate literary pleasure from the philosophical discussions.

6.1.3 "Subjective time" is a magic word which excites our delusion

Augustine's problems such as "subjective time," "tense," and "observer's time" did not enter into the realm of science, but they continued to attract the interest of philosophers. For example, Bergson, a philosopher of "subjective time", tried to challenge Einstein of "theory of relativity" to an argument. But he was rejected by Einstein, saying "I don't know the time of philosophers". Even now, some are still misled by this "observer's time". In quantum mechanics, for example, observer's time is often assumed. For example, some researchers may accept "So-called Copenhagen interpretation" such as

- at the moment when an observer measures it, a wave function collapses.

In order to explain "At the moment when observer measured it", von Neumann made a non-scientific word "abstract ego", and said

- "At the moment when observer measured it" is "at the moment when a signal reach abstract ego" which is of course prohibited by the linguistic Copenhagen interpretation (cf. (E₂) in Sec.1.1.2 earlier).

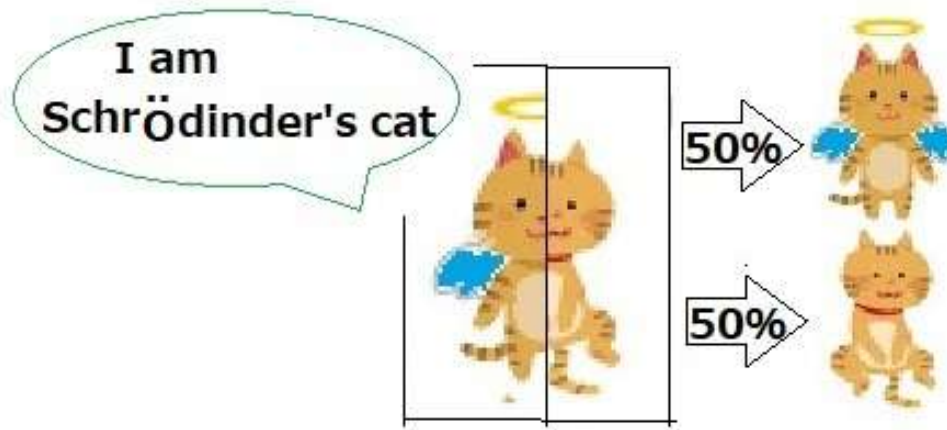

For the quantum linguistic understanding of "wave function collapse", see:

ref. [63] S. Ishikawa, *Linguistic interpretation of quantum mechanics; Projection Postulate*, JQIS, Vol. 5, No.4 , 150-155, 2015, DOI: 10.4236/jqis.2015.54017

(<http://www.scirp.org/Journal/PaperInformation.aspx?PaperID=62464>)

6.1.3.1 Summing up

I think Augustine knew that word play was a useful tool for the spread of Christianity. And I think Augustine also knew that subjective time is a treasure trove of wordplay. Many philosophers were interested in "subjective time". For example,

- (#1) McTaggart's paradox: "
- (#2) Russell's "Five-minute hypothesis"
- (#3) Bergson's subjective time
- etc.

However, the linguistic Copenhagen interpretation says that

- (b) Observer's space-time does not exist. That is, the subjective space-time (= observer's space-time) is non-sense

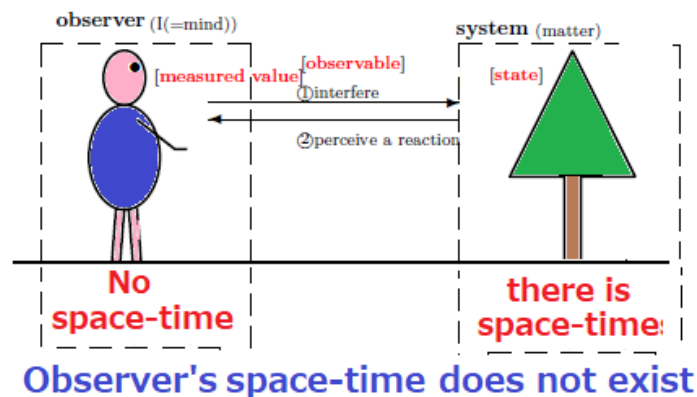

Therefore, QL does not bother with "subjective time."

♠**Note 6.3.** "What is the subjective time?" This is a problem of brain science. It is sure that cats and dogs etc. have clock gene or biological clock, thus they surely feel the subjective time. This is a scientific problem. Also, measuring the time with a clock is also a measurement. However, when you measure time with your brain clock, it is not a measurement. A measurement that only you can make is not a measurement. In science, "I", "now" and "here" are forbidden. Thus, 'Now I am here' is not a scientific proposition (i.e., a proposition in quantum language). Enjoyment of wordplay is an important part of a successful philosophy, e.g., "I know I know nothing", "Only present exists", "I think, therefore I am", etc. However, it should be noted that these are not statements in quantum language, i.e., these violate the linguistic Copenhagen interpretation.

♠**Note 6.4.** For completeness, let us rewrite as follows.

- ① How should we live? ② How is the world made?

Here,

- "①: the problems of life" and "②: the problem of world" are different things

In spite of the difference, we prefer to Platonic method of telling philosophy:

- the "logic" which is dressed so that ① may be derived from ②.

In this sense, the ② is a reason added later. We might be, by common sense, convinced that "the worldview was to describe the world plainly and with no fiction". However, Plato and Augustinus consider that

- the worldview is to create the world that it is convenient for faith or doctrine.

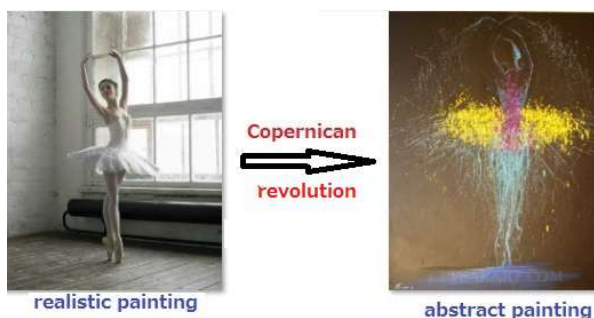

This is a replacement of the problem. However, this succeeds in science as well as philosophy. As seen later (Kant's Copernican revolution, Wittgenstein' words "The limits of my language mean the limits of my world", and finally, quantum language),

- the worldview is not to describe the world plainly and with no fiction, but to create the world that it is convenient for faith or doctrine.

That is, "More abstract painting than realistic painting". Concretely saying, for example,

- When there is a kind of the paint only in "red" and "green", We draw as much as possible it seems realistic picture in this two colors

This is not only the philosophical case but also the scientific case (i.e., quantum language). Quantum language is prohibited from using anything other than two axioms (Axiom 1 and Axiom 2 in Sec.1.1), which is the same as the paint example above. Thus I think that

- It is not an exaggeration to say that, since Plato, the Copernican revolution has been the norm of philosophy.



6.2 Scholasticism –Graft Bamboo (=Aristotle) to a tree (=Plato) –

6.2.1 Aristotle’s philosophy spread to the Islamic world

Plato’s philosophy survived with the backing of Christianity (Augustine). The philosophy of Aristotle spread to Islam. I don’t know the details of the reason why,

(A) Plato’s philosophy must have spread to the Christian world and Aristotle’s philosophy to the Muslim world.

Probably, there were various conflicts in Christianity, and the winners stayed in Rome and supported Plato’s philosophy. The losers were driven to the Muslim world, and Aristotle’s philosophy must have spread to the Muslim world by such a process. Eastern Islam was centered in Baghdad which was famous on the Arabian Nights. Western Islamic culture developed around Cordoba in the Andalusian region of southern Spain and became the largest city in the world in the 10th century. At that time, the Islamic world learned a lot of wisdom from the books of ancient Greeks and Romans and developed its own thought and technology. The Islamic culture was at the forefront of the world under Aristotle’s followership.

♠**Note 6.5.** In this paper we adopt the story such as (A). Actually, it may not be such a simple story.

6.2.2 Crusade expedition and Inflow of Islamic culture



In the era of crusade expedition (1096 - 1270), the Western countries were in a downturn. Such public opinion had been drifting.

- The achievements of the Crusades do not rise by Plato’s way. Thus, let’s study Aristotle at the tip of the Islamic culture!

I think it is true that

- in every age and every place in the world, the human resources required are **the humanities in peacetime, and the sciences in wartime.**

As a byproduct of the pilgrimage to the Holy Land of Jerusalem and the crusade to recapture it, interaction with Islamic culture was facilitated. Aristotle’s philosophy flowed into the West, merged with Plato’s philosophy, and settled in as Schola’s philosophy. That is, Scholasticism was born. As the typical persons of Scholasticism, we list up as follows.

(B₁) Anselmus (1033 - 1109) ”The father of Scholasticism”, ”Realismus”

(B₂) Thomas Aquinas (1225 - 1274) ”Summa Theologica”, Greatest man in Scholasticism

(B₃) Ockham (1285 - 1347) ”Ockham’s razor”, ”Nominalismus”

After all,

- in the beginning, Plato’s dualistic idealism was the most popular , but gradually Aristotle’s influence increased. It has become so ”science-like” that it has abandoned dualistic idealism. And It has become like a product of the fusion of Platonic and Aristotelian philosophies.

Of course, it is impossible to succeed this ”fusion”. That is because Plato philosophy and Aristotle philosophy are ”oil (idealistic dualism) and water (realistic monism)”, and these are different categories (*cf.* Assertion

1.4 [the history of worldview], Assertion 1.14). However, in this paper, we prepare the story such as

- in the process of fusion of Plato philosophy and Aristotle philosophy, disadvantages of the theory of Ideas became clear, which led to Descartes.

Figure 6.1 (Scholasticism is a compromise between Plato and Aristotle).

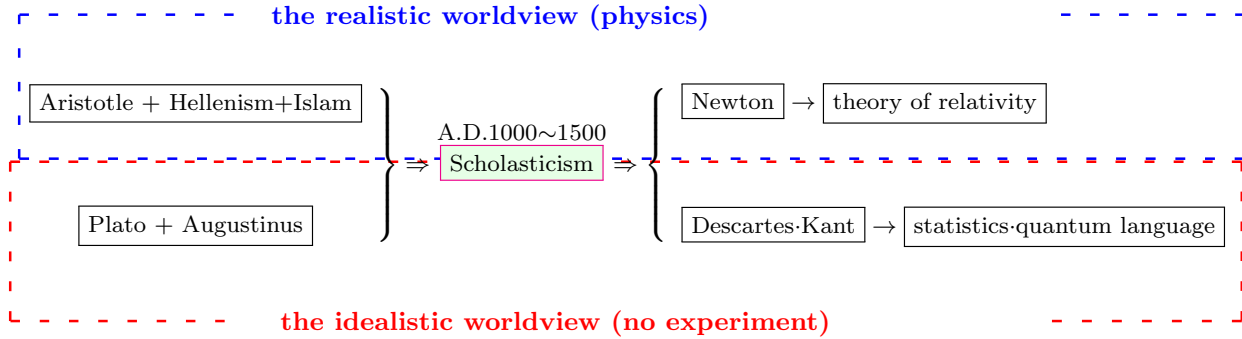

Also, by-product of crusade expedition, we have to note

- "Positional notation (= the discovery of zero)" of the origin in India which will be mentioned in what follows.

6.3 The discovery of zero



6.3.1 Positional notation (= the discovery of zero): Arabic numerals

As mentioned in the previous section,

(A) Plato was introduced to the Christian world and Aristotle to the Muslim world. Although many people must have suffered miserably during the Crusade expedition, the merits for Christian culture is that Aristotle philosophy and the positional notation flowed into Europe from Islam.

♠**Note 6.6.** Which was influential, Aristotle philosophy or the positional notation? If this question is the same as "Which was indispensable for the proposal of Newtonian mechanics?", we may choose the positional notation, because Newton was a calculation maniac.

The positional notation is how to write numbers to learn in an elementary school. For example,

$$\begin{array}{ccccccc} +5040302, & -15, & +39.045, & -81.5, & +3.1415 \\ -1000, & +0.009876, & +0.3333\cdots, & 0, & \end{array}$$

and so on. That is, By 13 symbols "0, 1, 2, 3, 4, 5, 6, 7, 8, 9, +, -, ." (radix point)", we can express all real numbers by the positional notation. Hence, we may say

- the discovery of the positional notation (= Arabic numerals)
= the discovery of all real numbers.

(the radix point was discovered in Europa of 16 century AD.) Of course, the discovery of zero is

(B) the discovery of how to use zero called the positional notation

6.3.2 Arabic numerals and Roman numerals

Roman numerals are often used on the clock face such as

$$1=I, 2=II, 3=III, 4=IV, 5=V, \dots, 10=X, 11=XI,$$

However, it is too hard to represent large numbers such as

$$495 = CDXCV, 1888 = MDCCCLXXXVIII, 3999 = MMMCMXCIX$$

6.3.3 The explosion of mathematics

European mathematics originally had the high potential of Euclidean geometry. With the introduction of the positional notation (the discovery of zeros), computation became easier. The word "ALGEBRA (algebra)" is originally an Arabic word. The formula for the solution of the quadratic equation : $ax^2 + bx + c = 0$:

$$x = \frac{-b \pm \sqrt{b^2 - 4ac}}{2a}$$

was also understood by the Arabic mathematician al-Khwarizmi (about 790 - about 850) Mathematician Gauss(1777 - 1855) said

(C) "If genius Archimedes invented the positional notation , I am certain that the mathematics must have progressed drastically."

The positional notation triggered the "math explosion" such that

(D) Solution of algebraic equations, complex numbers, the function concept, betting of problem (probability), analytic geometry (Descartes coordinates), calculus, differential equations, linear algebra, number theory, etc.

♠**Note 6.7.** There may be several opinions about the three big discoveries of mathematics. We think as follows.

- ① the discovery of the plane (geometry)
- ② the discovery of zero (positional notation)
- ③ the discovery of sets

Of course, it is needless to say that the biggest discovery is "①:the discovery of natural numbers".

6.4 The proof of the existence of God

6.4.1 Anselmus (1033 - 1109)

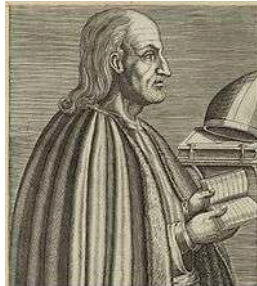

Anselmus (1033-1109)

Anselmus is the founder of Scholastic philosophy, famous for his "Proof of the Existence of God". His proof is nothing more than a play on words that we use on a daily basis. The premise is not clearly stated (i.e., it is not proven under any one worldview). In particular, the meaning of "existence" is not clear. Therefore, there is no need to read the proofs seriously.

Proof 6.2. Anselmus: the proof of God's Existence

- ①: God is a being than which none greater can be imagined . That is, the greatest possible being that can be imagined.
- ②: It is obvious that God exists as an idea in the mind.
- ③: A being that exists as an idea in the mind and in reality is greater than a being that exists only as an idea in the mind.
- ④: Thus, if God exists only as an idea in the mind, then we can imagine something that is greater than God. But we cannot imagine something that is greater than God.
- ⑤: Therefore, God exists in reality. □

The above proof is not worth validating since it is not discussed under a certain worldview. This is a play on words.

♠**Note 6.8.** (i): I don't understand the above proof. However, I associate the above argument with "a set of all sets", which is related to Russell's paradox. Thus, the above may be a kind of self-referential word play.

(ii): If the meaning of "existence" is defined in the sense of Definition 1.7, the existence of "God" is obvious. Because "God" is the most important key-word in the Bible.

6.4.2 Review: the worldviewism

Let us review the worldviewism.

(A): Worldviewism (cf. Sec.1.3.1)

The worldviewism is as follows.



That is,

(B) The worldviewism is the spirit "Start from the worldview" or "Start from the firm premise!".

Thus, from our standing-point (i.e., worldviewism), Proof 6.2 is not trusted. So far, we have seen many paradoxes caused by arguments that ignore worldviewism. For example,

(C) **The list of our answers for philosophical unsolved problems** (cf. (D) in Sec. 1.2.2)

- What is probability (or, measurement, causality) ? cf. Sec. 1.1.1)
- The solution of Zeno paradox (Flying arrow, Achilles and a tortoise), (cf. ref. [45], or, Sec. 2.4.2, Sec. 2.4.3)

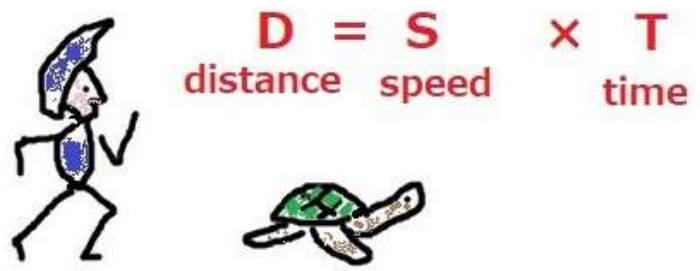

D = S × T

distance speed time

("to solve Zeno paradox" = "to understand DST-formula" (cf. Sec. 2.4.3)

- the measurement theoretical understanding of Plato's allegory of the sum , (cf. Sec. 3.3.2)
- Plato's Idea theory ≈ Zadeh's fuzzy theory ≈ Sausuure's linguistic theory (cf. Sec. 3.5.3)
- Syllogism holds in classical systems, but not in quantum systems (cf. Sec. 4.3.2)
- Only the present exists (cf. Sec. 6.1.2)

which are a part of List 1.6.

6.4.3 The inflow of Aristotle philosophy

Although we cannot understand Proof 6.2, we think that Anselmus did not say much more than the following:
 (D₁) "Aristotle philosophy flowed in via Islam, and I underwent the influence".

That is,

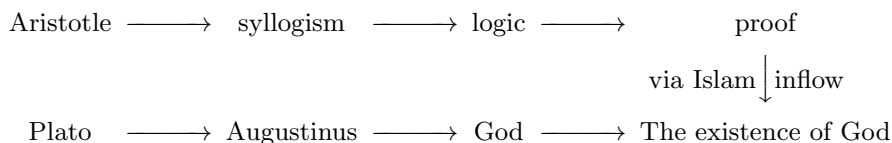

In other words, a priest who had studied Aristotle's syllogism felt like he had "proved the existence of God" by using the syllogism. We can see that "Proof of the Existence of God" is a product of Schola's philosophy (a reckless attempt to fuse and compromise Plato and Aristotle). If one were to choose Aristotle's "syllogism" over Christ's "Bible, we think that

(D₂) the expiry date of Plato's myth "God's intellect = Idea" by Augustine has expired, and Aristotle's influence has increased.

Anselmus' argument itself is nonsense. However, to exaggerate, the Schola philosophy, which is based on Anselmus, is thought as

(E) It is a revolution in Christianity that allows not only "faith" but also "reason".

Of course, even if the theme of thinking is limited, there would be no objection if it is "proof of God's existence". The reason for Anselmus' fame is the above (E), namely,

(F) It is the discovery of the magic word "proof of the existence of God" to be freed from the mind control of "stop thinking".

After all, we see,

(G) the history of Schola's philosophy is that the "eyes to see reality" of Aristotle's style gradually matured from the blind state of faith alone, and Descartes received the baton and opened the curtain of the modern era.

Nevertheless, great philosophers in Europe have repeatedly challenged the "proof of God's existence", but I (especially non-Christian Japanese) would have no right to speak to the significance and motivation of this challenge.

♠**Note 6.9.** All scientists are interested to "God". "What is God ?(= How about neuronal circuit

concerning belief?)” and ”What is subjective time? (= How about biological clock?) are one of the most interesting problems in brain science.

6.5 Scholasticism; Problem of universals

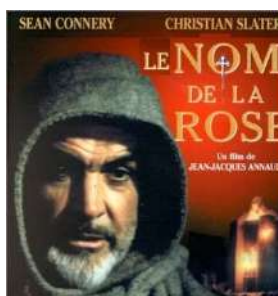

The rose of old
remains only
in its names;
we possess naked
names

6.5.1* What is the problem of universals?

The following is a review. Augustine (354-430), the greatest Catholic priest, adopted Plato's Idea theory to reinforce Christianity. Fortunately, the fundamental keywords (=existence) of both God (Christianity) and Idea (Plato's philosophy) are quite similar, since both of them have the mood of heavenly existence, so Augustine's plan succeeded and the honeymoon era between Christianity and Plato's philosophy lasted for more than 500 years. There, Aristotle's philosophy flowed in via Islam. Plato's philosophy, which is a dualistic and idealistic description of the world, and Aristotle's philosophy, which is a monistic and realistic description of the world, are like water and oil (or, grafting a bamboo to a tree), and thus, naturally it was confusing. As shown in the previous section, the first confusion was the "proof of God's existence" of Anselmus. The second confusion is the "Problem of universals" in this section. The problem of universals is the biggest dispute in Scholasticism. This problem is as follows.

(A): What is "Problem of universals"?

Problem 6.3. "Problem of universals" is as follows.

(A₁) It is certain that Mr. Smith, Mr. White, Mr. Brown, etc. exist. Then, we have the following problem:

Do "optimism", "American", "Japanese", "honesty", "intelligence", etc. exist?

If "Yes", then, "Realismus". If "No", then, "Nominalismus".

Most people may have the following question:

- Why did great Fathers argue eagerly in a problem like such word game?

Thus, our present problem is "**What is 'Problem of universals'?**". In what follows, this will be answered from the quantum mechanical worldview?

The following diagram will promote the reader's understanding

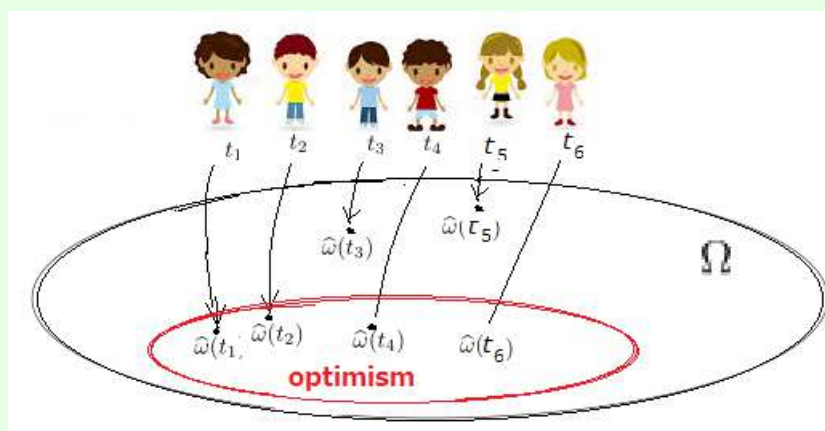

Let Ω be a compact space, in which every human's state is assumed to be represented. Let $m_H : \Omega \rightarrow [0, 1]$ [resp. $m_J : \Omega \rightarrow [0, 1]$] be the membership function of "honesty" [resp. "Japanese"] (see the picture below).

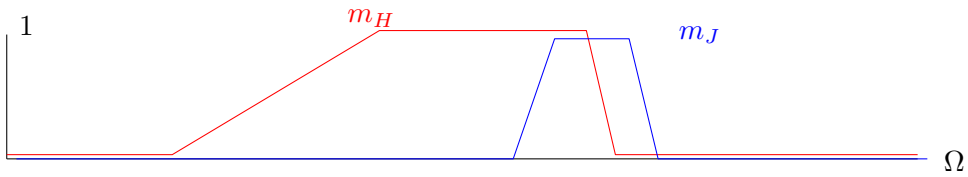

Here, define the observables $O_H = (\{y, n\}, 2^{\{y, n\}}, F_H)$ and $O_J = (\{y, n\}, 2^{\{y, n\}}, F_J)$ (where "y"="yes", "n"="no") such that

$$[F_H(\{y\})](\omega) = m_H(\omega), \quad [F_H(\{n\})](\omega) = 1 - m_H(\omega)$$

$$[F_J(\{y\})](\omega) = m_J(\omega), \quad [F_J(\{n\})](\omega) = 1 - m_J(\omega)$$

for all $\omega \in \Omega$.

And consider the following identification:

$$O_H \approx m_H, \quad O_J \approx m_J$$

Therefore, in the framework of QL, we can say that

- **"Japanese" and "honesty" exist.**

in the sense of Definition 1.7.

Also, recall Example 3.11 (and Remark 3.12), that is,

(A₂)

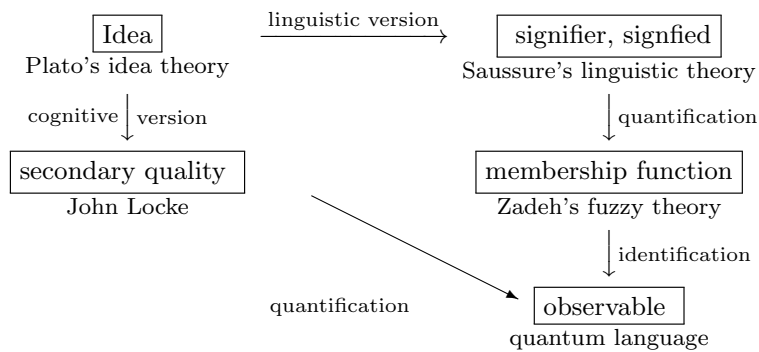

That is,

(A₃) "Idea of honesty" (= "Degree of honesty")

quantification \rightarrow "Membership function of honesty $m_H : \Omega \rightarrow [0, 1]$ "

probabilistic interpretation \rightarrow "the observable concerning honesty $O_{m_H} = (\{y, n\}, 2^{\{y, n\}}, F_{m_H})$ "

Also, note that

\	[A](= mind)	[B](Mediating of A and C)	[C](= matter)
Plato idealism (no experiment)	actual world	Idea	/ [Idea world]
Aristotle realism (experiment)	_____	_____	eidos [hyle]
quantum language	measured value	observable	state [system]

Thus, we see:

Answer 6.4. (A₃) says that

(B₁) "Honesty" is an observable

Also, recall Definition 1.7, that is,

(i): in quantum language (i.e., idealistic dualism), "observable", "measured value" and "state" exist

(ii): in Aristotle standing point (i.e., realistic monism), "state" exists.

Therefore, we say that

(B₂) **Plato school agree to "Realismus"**: that is, "honesty" exists.

e.g., Anselmus (1033 - 1109)

(B₃) **Aristotle school agree to "Nominalismus"**: that is, "honesty" does not exist.

e.g., William of Ockham (1285 - 1347)

After all, we think

- This is the problem such that "(since Augustinus) Plato school ("Realismus") vs. (via Islam) Aristotle school ("Nominalismus"). The power in the church gradually shifted to the Aristotle group. In this sense, it may be called "confusion" than "dispute".

As seen in the following table, the problem "realistic worldview(monism) vs. idealistic worldview(dualism)" is the biggest dispute in philosophy and science. "Nominalismus" (Ockham) in Problem of universals is a little irrational since religion is not realistic.

Table 1.1 : realistic worldview vs. idealistic worldview

dispute \ [R] vs. [L]	Realistic worldview (monism, realism, no measurement)	Idealistic worldview (dualism, idealism, measurement)
Ⓐ: motion	Hērakleitos	Parmenides
Ⓑ: Ancient Greece	Aristotle	Plato
Ⓒ: Problem of universals	"Nominalismus" (Ockham)	"Realismus" (Anselmus)
Ⓓ: space-time	Newton	Leibniz
Ⓔ: quantum theory	Einstein	Bohr
Ⓕ: philosophy of science	Carnap	Quine

Ⓐ is my fiction, Ⓒ is a confusion. Ⓓ is the Leibniz=Clarke correspondence (*cf.* Sec. 9.3.2), Ⓔ is Bohr-Einstein debates. Quantum language is proposed as one of answers to Bohr-Einstein debates(*cf.* ref. [71]). Quantum language is proposed as one of answers to Bohr-Einstein debates(*cf.* ref. [71]). Ⓕ: Quine understood the spirit of the linguistic Copenhagen interpretation (i.e., "If you don't measure it, you don't know anything") in the Carnap=Quine debate (*cf.* Sec. 13.3).

6.6 Thomas Aquinas (1225 - 1274); Scholasticism

6.6.1 Grafting Bamboo (Aristotlelian science) to a Tree (Plato's literature)

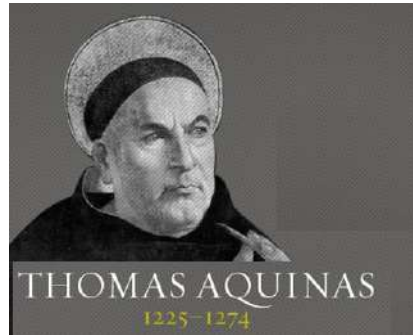

The Catholic priest: Thomas Aquinas (1225 - 1274) wrote "Summa Theologica" as the summing-up of Scholasticism. He was the most important at the intermediate time of Scholasticism (or, Problem of universals), that is,

$$\begin{array}{ccc}
 \begin{array}{c} (1033-1109) \\ \boxed{\text{Anselmus}} \\ \text{"Realismus"} \end{array} & \longrightarrow & \begin{array}{c} (1225-1274) \\ \boxed{\text{Thomas Aquinas}} \\ \text{(compromise or fusion)} \end{array} & \longrightarrow & \begin{array}{c} (1285-1347) \\ \boxed{\text{Ockham}} \\ \text{"Nominalismus"} \end{array} & (6.1)
 \end{array}$$

His proposal is the compromise of "Realismus" (due to Plato) and Ockham (due to Aristotle), thus, his theory has three key-words:

(A₁) : [universalia ante res] as Plato's Idea (i.e., measuring instrument in quantum language)

(A₂) : [universalia in rebus] as Aristotle's eidos (i.e., state in quantum language)

(A₃) : [universalia post rem] as actual world (i.e., measured value in quantum language).

Since Plato philosophy and Aristotle philosophy are "oil and water", and these are different categories (*cf.* Assertion 1.4[the history of worldview]), it is a matter of course that Aquinas' idea is irrational. However, as seen in Table 5.2, we say:

(B) in the process of fusion of Plato philosophy and Aristotle philosophy, deficiencies in the theory of Ideas is turned to reveal, this led to Descartes.

that is,

Table 5.2 : Key-words in each worldview

Plato idealism (no experiment)	actual world	Idea	/ [Idea world]
Aristotle realism (experiment)	_____	_____	eidos [hyle]
Thomas Aquinas	universale post rem	universale ante rem	[universale in re]
Descartes	I, mind, brain	body	/ [matter]
quantum language	measured value	measuring instrument	state [system]

♠**Note 6.10.** As mentioned in Sec.3.5, I am not confident in the above table, because the theory of ideas and Scholasticism were not created with the intention of measurement. However, I will proceed with this policy of discussion in this paper.

Review 6.5. In the above table, the meaning of the correspondence of key-words is as follow.

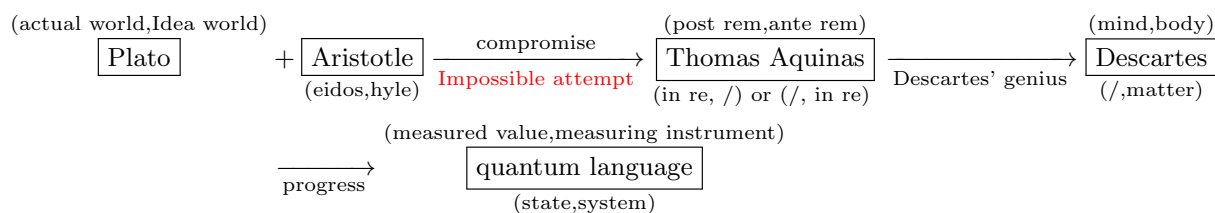

Also, the formula 6.1(=the history of Scholasticism) is rewritten as follows.

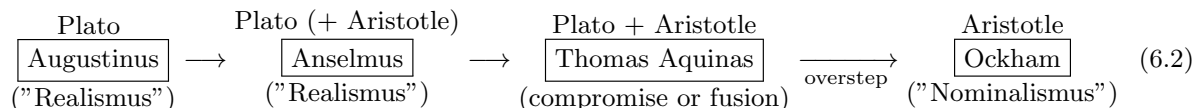

Thus, I guess that

(C) Ockham wanted to shave Plato’s Idea theory with a razor. (cf. (C₃) in Sec. 6.7).

♠**Note 6.11.** It’s said that the problem of universals is incomprehensible. This is due to the fact:

- The fusion of Plato and Aristotle is an unreasonable trial,

That is,

- (#₁) Aristotle (as well as Newton) do not fit in Christianity.
- (#₂) Although the key-words of Thomas Aquinas philosophy and those of Descartes philosophy are similar (i.e., those have three key-words as seen in Table 5.2), this may be accidental. (cf. Review6.5).
- (#₃) The formula (6.2) implies the confusion in Scholasticism. Therefore, the "→ in formula (6.2)" does not mean "progress".

♠**Note 6.12.** A seen in the above, the problem of universals is in confusion. However, we think that Scholasticism belongs to the linguistic worldview. Thus, we have (cf. Classification 1.11 [the classification of philosophers]).

- (b₁): the realistic worldview (physics)
 - Hērakleitos, Aristotle, Aristarchus, Archimedes, Eratosthenes, Ptolemaeus,
 - Galileo, Newton, Einstein, . . .
 - (Although mathematics is not a worldview, Pythagoras, Eudoxus, Euclid)
- (b) {
 - (b₂₁): the fictional worldview (Western philosophy)
 - Plato, Scholasticism, Descartes, Locke, Leibniz, Berkeley, Hume, Kant, Husserl
 - (b₂₂): the logical worldview (=the logical spirit=the spirit of "Think logically!")
 - Boole, Frege, Peirce, Saussure, Russell, Wittgenstein, Hempel, Quine, Popper
 - (b₂₃): the mechanical worldview (statistics, quantum language)
 - Parmenides, Zeno, J. Bernoulli, statistics (e.g., Fisher), quantum language

6.7 Ockham's razor and Plato's beard

William of Ockham (1285 - 1347), a Scholastic philosopher or theologian born in Ockham in England, is known as an advocate of Ockham's razor(=the law of parsimony) in philosophy and science.

(A):Ockham's razor(=the law of parsimony)

Ockham's razor is as follows:

(A) Shave unnecessary assumptions with a razor!

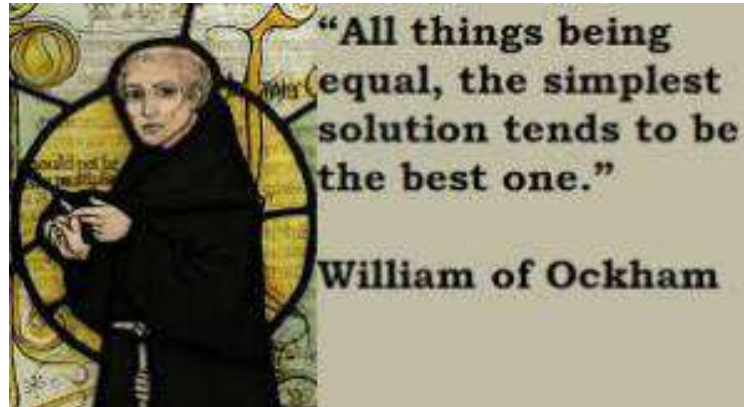

However, this may be a self-evident truth. For example,

(B) Assume that you were a student of Plato and Plato asked you

- "The sun goes around the earth? or the earth goes around the sun?"

Then, which did you answer to Plato?

Probably, you, by Ockham's razor, answer that the sun goes around the earth. In fact Aristotle did so. Ockham's razor is dependent on the environment around. Thus I have a question:

(C) Is there a case as which Ockham's razor is functioning effectively (besides the mathematical theorems) ?

We see that

(D₁) Relying on Ockham's razor, Ptolemy claimed the theory of celestial motion from the observational data of the time.

And

(D₂) relying on Ockham's razor, Galileo claimed for a geodynamic theory from the observational data of the time.

Ockham's Razor is an explanation added later and thus, powerless. But then again...

(E) Is there a case (other than mathematics) in which "Ockham's Razor" is working effectively?

This makes me skeptical of Ockham's razor. Even in the Middle Ages, it is difficult to imagine that people would have been impressed by such a statement if it had been made without any background. The question is, "In what kind of background and context did Ockham say it? I think so. The author is a layman and does not know much about it. Ockham, however, is the leading edge of the Aristotelian sect. Therefore, I agree the following opinion:

(F) What Ockham wanted to shave with a razor is Plato's beard (= the theory of Ideas)

(cf. (C) in Sec. 6.6).

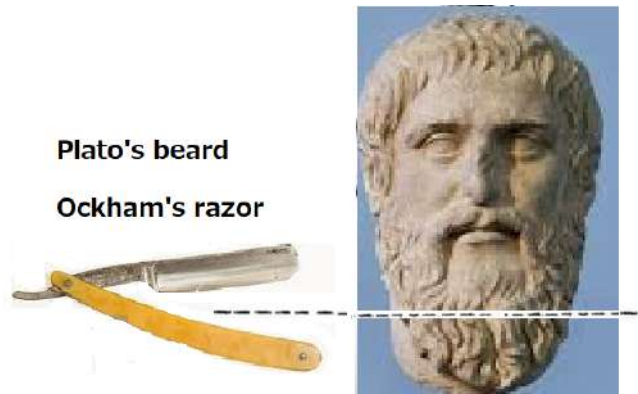

It makes sense, then. However, it would be too short-sighted to think that it must be better to eliminate such hypotheses as the existence of "something ideal in the heavens. Plato must have thought that the idea theory was a fairy tale. It would be immature and foolish to cut off the fairy tale. As mentioned above, Ockham's razor is dependent on the environment around. Under Newtonian mechanics, Geocentric model must be cut off. And thus, we think that

(G) under QL, the theory of Idea must not be cut off since our proposal in this text is the following:

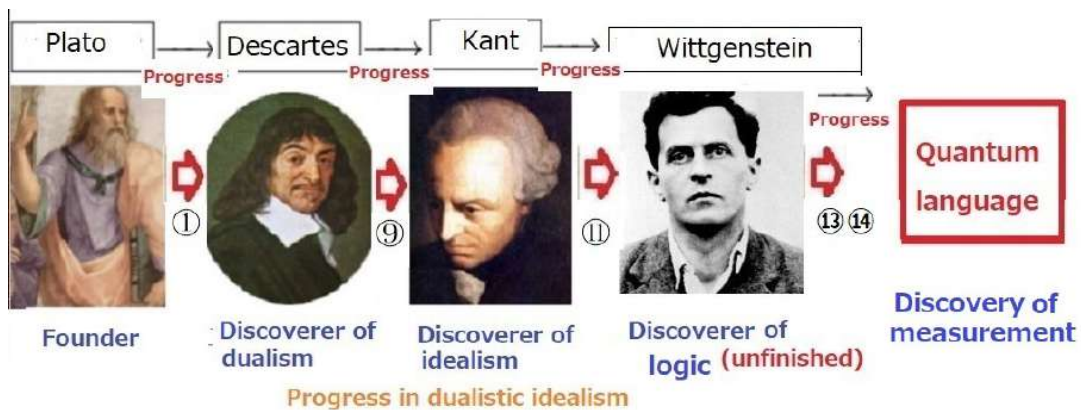

♠**Note 6.13.** Realism and idealism are based on different principles. In realism (e.g., physics), experimental verification is everything. On the other hand, the principles of idealism (e.g., metaphysics) are various, such as "beauty", "usefulness", and "Ockham's razor", but in the end, idealism must be supported by many people. Mathematics is the most successful metaphysics and meets all of "beauty", "usefulness", "Ockham's razor" and so on. In order for quantum language to gain the support of many people, it is necessary to appeal its "usefulness". However, in this book, we adopted a method to deepen the understanding of quantum language by appealing its similarity to Western philosophy.



Chapter 7

Early modern – Scientific revolution: From Geocentrism to Heliocentrism

We assume that the three greatest paradigm shifts are as follows

(#₁) Aristotelian worldview (purpose) → Newtonian worldview (causal relation)

(#₂) Ptolemaic system: Geocentrism → Copernican system: Heliocentrism

(#₃) Christianity: Adam and Eve → Darwin: evolution theory

In this chapter, we are concerned with (#₁) and (#₂), and conclude that

- (#₂) is a metaphysical dispute, which cannot be made clear by experiments. And it was clarified by (#₁). In this sense, (#₂) is included in (#₁).

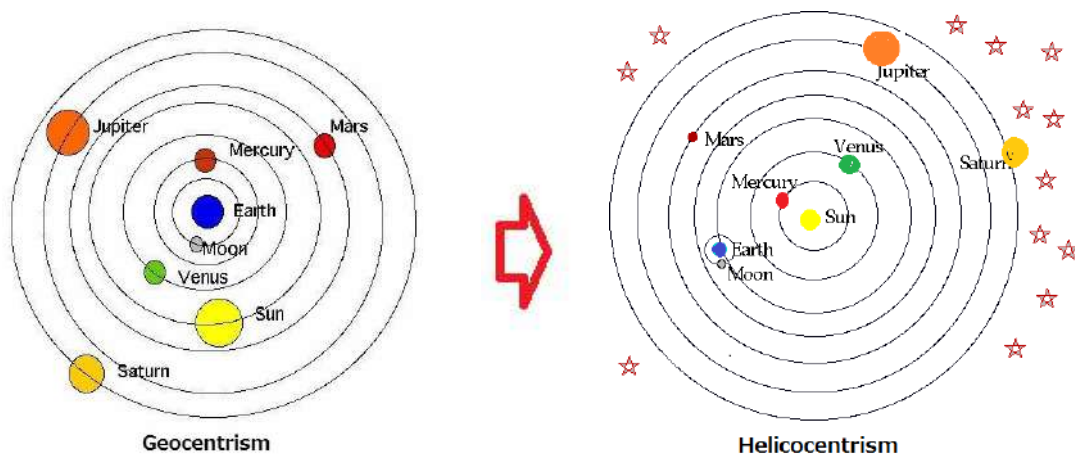

7.1 Paradigm shift

Eastern Roman Empire was made to be ruined by Ottoman Turkey in 1453.

- 1453: The Eastern Roman Empire extinction (Constantinople surrender)

The influence on Christ cultural area of this great event is immeasurable.

Traffic of "Silk Road" became inconvenient. And thus,

Age of Discovery had begun

Also, engineers, artists, cultural people, etc. (of Eastern Roman Empire) had flowed into Western Europe as refugees. And hence,

Renaissance rose suddenly.

The timeline is as follows.

Table 7.1. Scientific revolution; Chronological table

Before Galileo: The era of observation and experiment

• 1450: Gutenberg's printing press	inventor
• 1453: The Eastern Roman Empire extinction (Constantinople surrender)	
• 1492: Columbus, discovery of the American Continental	navigator
• 1498: Vasco da Gama, discovery of the sea route to India	navigator
• 1500s: Leonardo da Vinci, "Mona Lisa's smile"	artist
• 1510: Copernicus, Heliocentrism	scientist
• 1510: Raffaello, "The School of Athens", Admiration to ancient Greece	artist
• 1517: Luther, Protestant Reformation	religionist
• 1519 - 20: Magellan, the first circumnavigation of the Earth	
• 1540s: Michelangelo, "The Last Judgment"	artist
• 1600: G. Bruno, who supported heliocentrism along with Galileo, was burned at the stake by the Vatican	philosopher
• 1609~1619: Kepler's laws of planetary motion	scientist
• 1610: Galileo, A telescope was made and moons of Jupiter were found	scientist
• 1620: F. Bacon, "knowledge is power", The father of British Empiricism	illuminator
• 1633 Galileo's trial "And yet it moves"	scientist

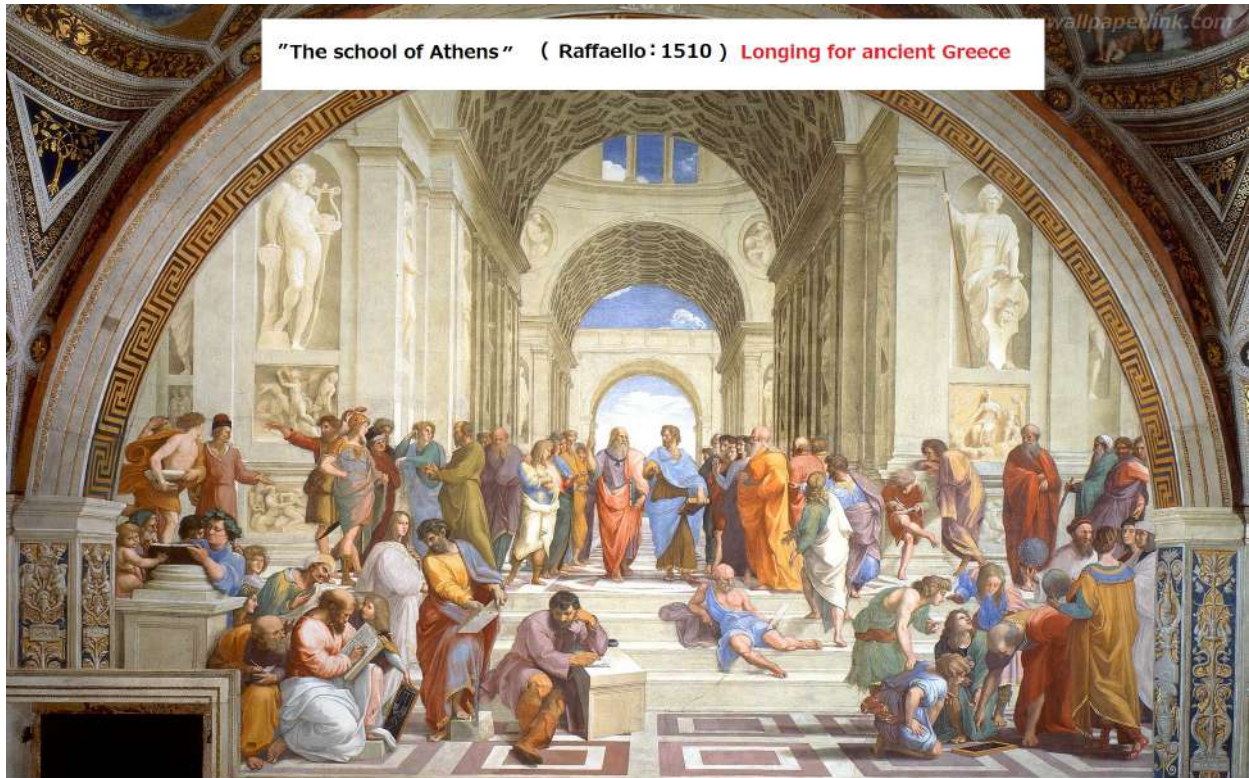

"The school of Athens" (Raffaello : 1510) Longing for ancient Greece

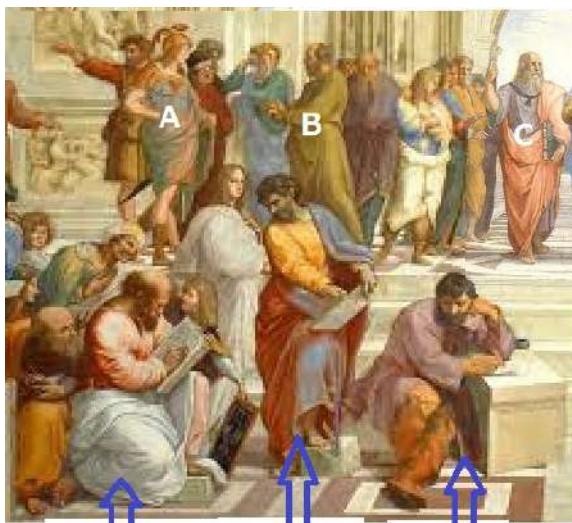

- A: Alexander the Great
- B: Socrates
- C: Plato
- D: Aristotle

Part of "The School of Athens" Artist Raphael Year 1509–1511

Pythagoras (BC.582 - BC.496) Parmenides (BC.515 - ?) Herakleitos (BC.540 - BC.480)



A: Diogenes B: Euclid

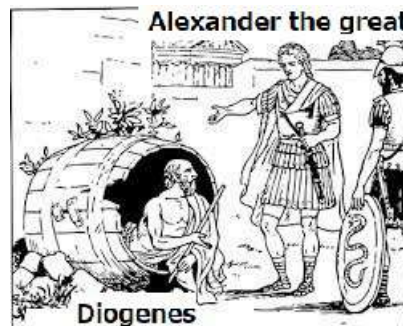

Alexander the great

Diogenes

After Galileo: The era of thought

Table 7.2. • 1637: "Discourse on the Method", Rene Descartes (1596 - 1650),

the father of modern philosophy, Cogito proposition	philosopher
• 1670: Pascal, "Pensées"	enlightener
• 1685 - 1750: Bach	artist
• 1687: Newton, "Principia"	scientist
• 1688: Glorious Revolution	
• 1690: John Locke, the father of British Empiricism, "An Essay Concerning Human Understanding", tabula-rasa, the secondary quality	philosopher
• around 1700: Jakob Bernoulli, the law of large numbers	mathematician
• 1703: Leibniz, "New Essays on Human Understanding"	philosopher
• 1715 - 16: Leibniz-Clarke correspondence (<i>cf.</i> Sec. 9.3.2)	
• 1739: Hume, "A Treatise of Human Nature"	philosopher
• 1781: Kant, "Critique of Pure Reason"	philosopher

♠**Note 7.1.** The law of large numbers, discovered by J. Bernoulli(1654 - 1705), is as follows.

(‡) If a fair coin (one with probability of heads equal to $1/2$) is flipped a large number of times, the proportion of heads will tend to get closer to $1/2$ as the number of tosses increases.

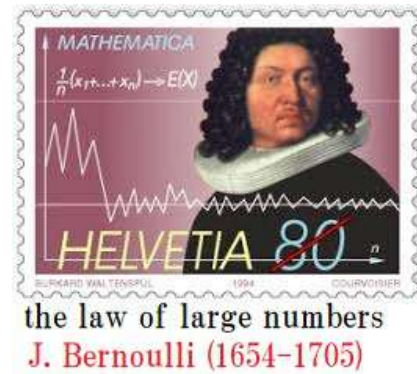
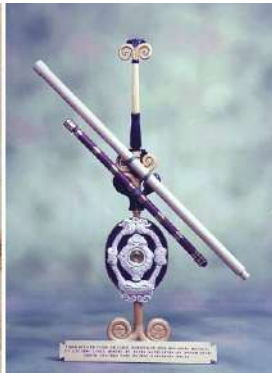

I think that Bernoulli's achievement equals Galileo's achievement. That is,

{ Scientific pioneer in the realistic worldview ... Galileo
 { Scientific pioneer in the idealistic worldview ... J. Bernoulli

It is difficult to identify the founder of the probability theory to one person. But, I think that J. Bernoulli is one of the most important founders (e.g., P.S. Laplace (1749-1827), A. Kolmogorov (1903-1987), etc.).

7.2 Francis Bacon (1561 - 1626): The father of empiricism, Inductive reasoning



7.2.1 How to create science: The exclusion of idols (=prejudice, preconception)

F. Bacon has been called the father of empiricism. He was the greatest enlightener of "scientific revolution" as follows.

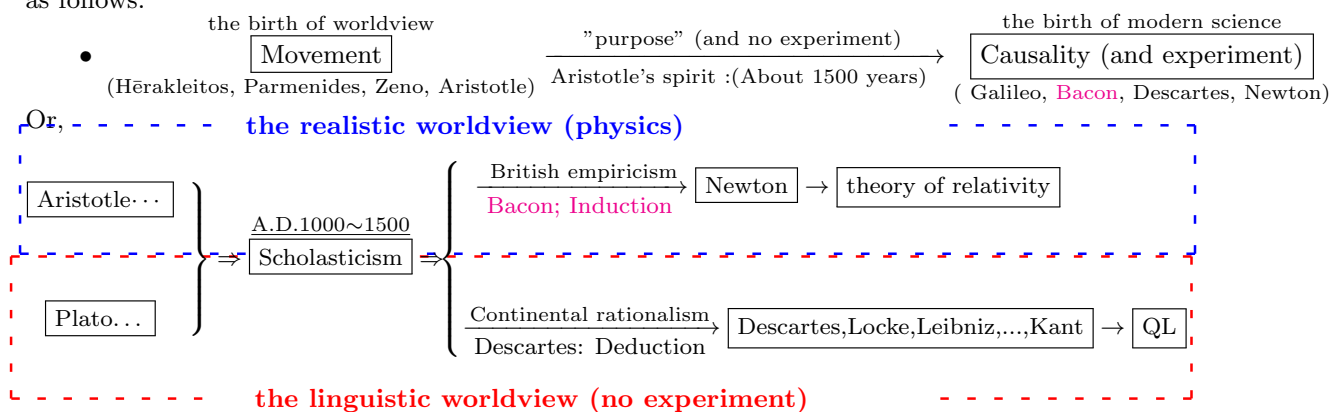

In 1620, he proposed "how to create science" (called inductive reasoning, or induction principle) in his book "Novum organum".

(A):Induction principle (by bad idols), how to create science

His proposal is as follows.

(A) ①:Exclusion of bad idols

→②:data, collection by observation and experiment →③:scientific theory, principle

Let us explain this in what follows.

① : Firstly, we have to exclude bad idols (=prejudice, preconception) Here, idols is as follows.

Idols of the Tribe: prejudice due to sense organs

Idols of the Cave: prejudice due to custom, the education

Idols of the Market: prejudice due to language

Idols of the Theatre: prejudice due to thought, theory

② : Next, we have to collect data by observation, experiments,

③ : Lastly, find the essence from the data, and build science theory.

Here, "②+③" is called "induction".

Recall that Greek philosophy starts from "principle", e.g., "the arche (= the first principle of all things) is ○○", or, Euclid advocated geometric axiomatization, and a lot of theorems were derived from Euclid axioms, that is,

(B₁) Mathematics: Euclid axioms $\xrightarrow{\text{deduction}}$ theorems

On the other hand, Bacon emphasized the importance of observation (or experiments), that is,

(B₂) Science: data, collections $\xrightarrow{\text{induction}}$ principle

which is the scientific method proposed by Bacon (who was called the father of empiricism).

7.2.1.1 Isaac Newton (the exclusion of bad idols) (1642-1727)

Newton said:

"I frame no hypotheses"

And he practiced Bacon's induction principle, and proposed Newtonian mechanics as follows.

(C): ①exclude bad idols (i.e., Aristotle's purpose, Geocentrism) \rightarrow ②Data collection (due to Tycho Brahe, Kepler, Galileo) \rightarrow ③Science theory (Newtonian mechanics)

♠**Note 7.2.** This may be say in a philosophy side. We must add the next section (good idols).

7.2.1.2 Isaac Newton (good idols) (1642-1727)

Bacon's induction principle is not simple. there is another way (by good idols) such as

(D): Induction principle (by good idols)

Induction principle (by good idols) is as follows.

(D) ①believe good idols \rightarrow ②Data collection \rightarrow ③Science theory

Newton said:

"I frame no hypotheses"

And he practiced Bacon's induction principle (good idols), and proposed Newtonian mechanics as follows.

(E): ①believe good idols (i.e., Causal relation) \rightarrow ②Data collection (due to Tycho Brahe, Kepler, Galileo) \rightarrow ③Science theory (Newtonian mechanics)

♠**Note 7.3.** Although ironically,

(‡) Bacon, who proposed the exclusion of idols, was also one of discoverers of "good idols" called "causal relation".

If so, what Bacon wanted to say really may be

[bad idols] = [dogmatism in Scholasticism (or, Aristotle's purpose)]

♠**Note 7.4.** S. Weinberg (1933 -2021), a physicist at the University of Texas, Austin, won a Nobel Prize in 1979 for work that became a cornerstone of particle physics, said in his book [115] "To explain the word; The discovery of modern science" as follows:

(#₁) [in Chapter 13]: *They (i.e., Bacon and Descartes) are, in my opinion, the two individuals whose importance in the scientific revolution is most **overrated**. Scientists in the seventeenth and eighteenth centuries would invoke Bacon as a counterweight to Plato and Aristotle, It is not clear to me that anyone's scientific work was actually changed for the better by Bacon's writing. Galileo did not need Bacon to tell him to do experiments, and neither I think did Boyle or Newton.*

From the pure scientific point of view, I almost agree to the above opinion. However, it should be noted that the scientific revolution was not only achieved by scientists, but by the collective power of philosophers, enlighteners, astronomers, mathematicians, adventurers, artists, educators, politicians, religionists, and the general public. The difficult and important thing is to get public support for the scientific revolution. I think Bacon did this work well. He enlightened the method to create science (i.e., the importance of causality and experiment) to the general public, not the scientists. As I will show in the next chapter, I consider as follows:

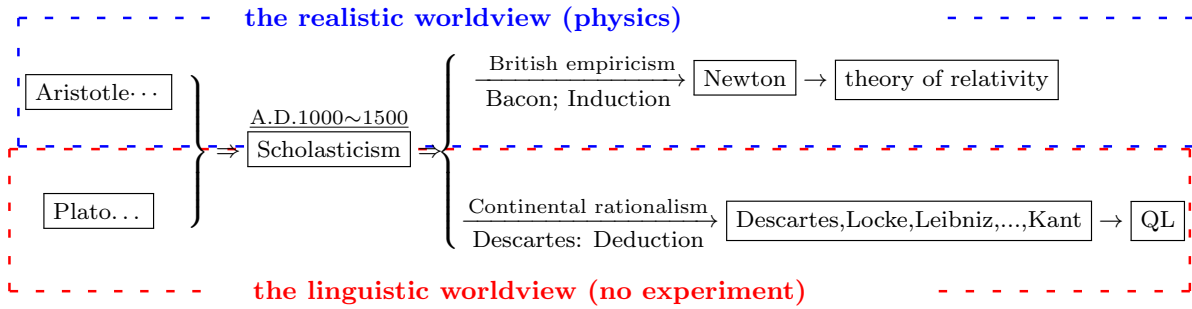

And, the part:

(#1) " $\frac{\text{Continental rationalism}}{\text{Descartes}} \rightarrow \text{Descartes, Locke, Leibniz, ..., Kant}$ "

is usually rewritten by the following (#2), which is called "the flower of modern philosophy"

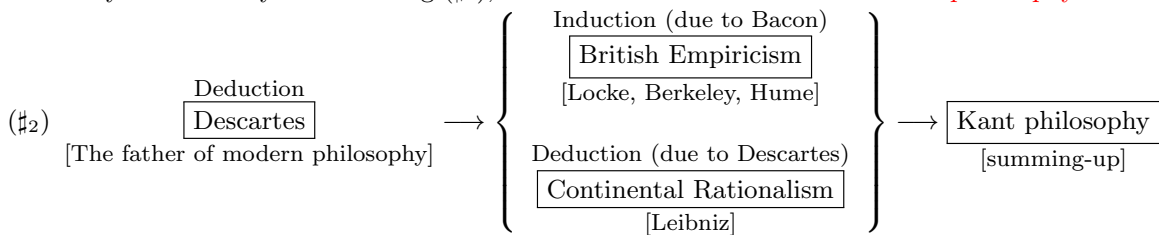

(Note that, in spite of "British Empiricism", Locke, Berkeley, Hume were not concerned with experiment. Thus, I assume that they did not belong to the realistic worldview.)

7.3 From Geocentrism to Heliocentrism

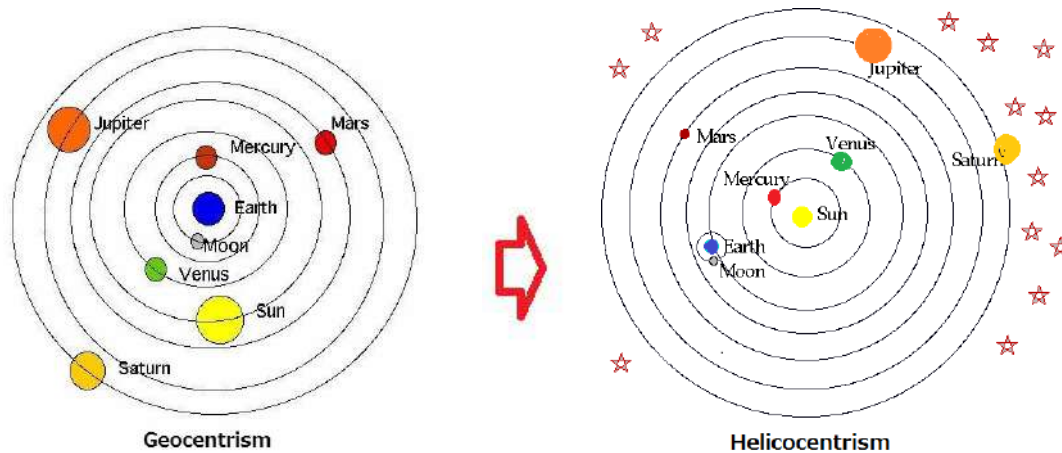

7.3.1 What is "Geocentrism vs. Heliocentrism"?

As mentioned in Chapter 5,

- Heliocentrism due to Aristarchus (BC.310 - BC.230) is based on the arguments:

The big sun cannot go around the small earth.

I think his Heliocentrism to have reached the scientific level. (*cf.* Sec. 5.3).

- Geocentrism due to Ptolemaeus (AD.83 - AD.168) can explain the motion on planets by epicycle theory. Thus, I also think his Geocentrism to have reached the scientific level at the time. (*cf.* Sec. 5.6).

However, Heliocentrism due to Copernicus (1473 - 1543) might be controversial whether it had reached the scientific level. For example, there is an opinion that

- At the time, Europe is in the cold period, the masses were hungry for "the sun". The public was hungry for the sun central principle. Therefore, there is a foundation that allows the germination of Heliocentrism.

In spite of the above, I want to assert that Copernicus is a great scientist. The reason I think so is written in the following Note 7.5.

♠**Note 7.5.** S. Weinberg (1933 -2021), An American physicist, won a Nobel Prize of physics in 1979, said in his book [115] "To explain the world; The discovery of modern science" as follows:

(#) [Chapter 11] *Copernicus could not claim in the Commentariolus that his scheme fitted observation better than that of Ptolemy. For one thing, it didn't. Indeed, it couldn't, since for the most part Copernicus based his theory on data he inferred from Ptolemy's Almagest, rather than on his own observations. Instead of appealing to new observations, Copernicus pointed out a number of his theory's aesthetic advantages.*

It was very interesting to me that Copernicus, the flag bearer of the scientific revolution, valued beauty over observation. In fact, my conclusion in section 7.4 of this paper, "Heliocentrism vs. Geocentrism," is also "Heliocentrism was chosen because it is more beautiful." I've grown to love Copernicus. Thus

I would like to regard him as the great scientist.

In this paper, I discuss the next.

(A): What is "Heliocentrism vs. Geocentrism"?

Now,

(A) Note that motion is relative. Thus, if the earth is assumed to be at center, the sun goes around the earth (i.e., Geocentrism). Also, if the sun is assumed to be at center, the earth goes around the sun (i.e., Heliocentrism). Hence,

The difference between Heliocentrism and Geocentrism may be only a difference of how to take the coordinate system.

7.3.2 Somehow "from Geocentrism to Heliocentrism"

In what follows, I will arrange the history of "Heliocentrism vs. Geocentrism".

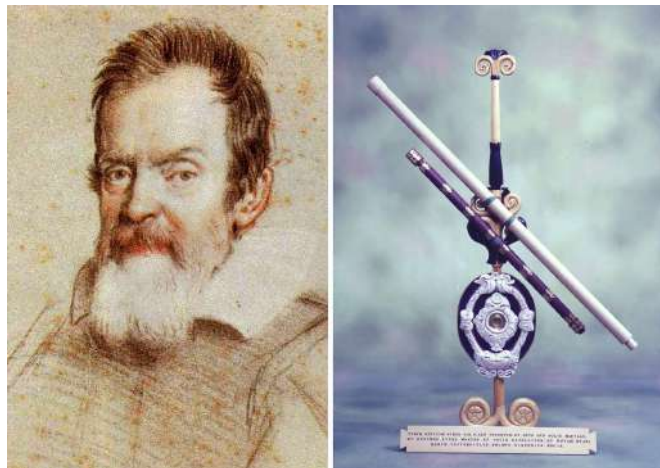

- 1510: Copernicus, Heliocentrism in the Commentariolus
- 1600: G. Bruno, who supported heliocentrism along with Galileo, was burned at the stake by the Vatican

Analyzing the enormous data obtained by Tycho Brahe's steady astronomical observation, Kepler found the following laws:

- Kepler's laws of planetary motion:
 - 1609:
 - (#₁) The first law of elliptical orbits,
 - (#₂) The second law of areal velocity,
 - 1619:
 - (#₃) The third law of Periods:

And

1610: Galileo found the moons of the Jupiter by his telescope of the self-made

And further,

1633: Galileo said "And yet it moves" in the Trial of Galileo

♠**Note 7.6.** In the next year of 1642 when Galileo died, Isaac Newton was born in the British country.

1687: Newton "Principia"

In this way, we think:

(B) Somehow the air "to Heliocentrism" has been formed.

Still, I am worried about this problem (A)"What is 'Geocentrism vs. Heliocentrism'?" That is,

(C₁) Did Both Galileo and the church understand the essence of 'Geocentrism vs. Heliocentrism'? which is equivalent to

(C₂) In order to win the definitive victory, what should they (Galileo or the church) have done?

In order to answer to this question, we first have to clarify the meaning of "Heliocentrism vs. Geocentrism".

7.3.3 "Geocentrism vs. Heliocentrism" is the problem of the worldview

As mentioned in the previous section, how to decide "Geocentrism vs. Heliocentrism" is somewhat difficult. That is because

- (D) Thus, if the earth is assumed to be at center, the sun goes around the earth (i.e., Heliocentrism). Also, if the sun is assumed to be at center, the earth goes around the sun (i.e., Geocentrism). Hence, The difference between Heliocentrism and Geocentrism is only a difference of how to take the coordinate system.

In the same sense, we say that

- (E) **No matter how much there are exact observation data, we cannot decide "Geocentrism or Heliocentrism"**

In the famous trial of Galileo, he said

"And Yet It Moves"

However, I wonder if Galileo knew the (E)?

♠**Note 7.7.** No matter how much there are exact observation data, we cannot decide "Geocentrism vs. Heliocentrism" we have to need the worldview. Namely,

(#₁) it is a matter of course that there is no science without measurement

However, we believe that

(#₂) there is no science without worldview

Thus, as seen later, we cannot decide "Geocentrism vs. Heliocentrism" without worldview

7.3.4 The Galileo legend; Leaning Tower of Pisa, Trial of Galileo

The worldview of Aristotle has kept its position for 1500 years such as (*cf.* Sec. 4.2.1):

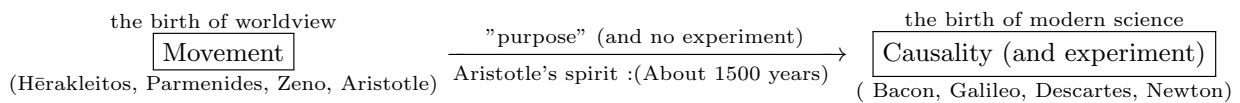

Thus, this worldview is not a so bad worldview.

But, this worldview was a little inconvenient to organize the data, obtained by technological innovation (e.g., telescope, navigation, etc.). The history of the increase of the inconvenience is as follow:

$$[\text{Copernicus}] \Rightarrow [\text{Kepler}] \Rightarrow [\text{Galileo}]$$

However, these are not sufficient to decide "Geocentrism vs. Heliocentrism". It is a matter of course that there were excellent persons in the church. And they might think:

- if they insisted that motion is relative, they did not lose the dispute, at least, they could make "Geocentrism vs. Heliocentrism" endless dispute.

Galileo legend Galileo (1564 - 1642) was an active leader of the overthrow of the worldview of Aristotle, and his targets were the following (F₁) and (F₂):

(F₁) Ptolemaic Geocentrism

(F₂) Aristotelian purpose such as "Heavy objects fall faster"

Concerning the two, We have two episodes called "Galileo legend" as follows.

For (F₁), "And Yet it moves" in trial of Galileo

For (F₂), Leaning Tower of Pisa



Thus, Galileo thought it was a matter of measurement data, but the church thought it was a matter of worldview. Therefore,

- at the time (1633) of the trial of Galileo, the Church was convinced that it would not lose its argument with Galileo and, at worst, could bring it into an endless dispute.

An endless dispute implies the win of the church. The church is not so stupid.

No way, the church did not think that Newton would appear

No one would have predicted the appearance of Newton.



After all, Galileo was the active leader of the overthrow of the worldview of Aristotle, but he could not propose the new worldview. In that sense, the Galileo legend is just the beginning of Newton's appearance

7.4 Principia; Newtonian worldview

7.4.1 Principia (1687)

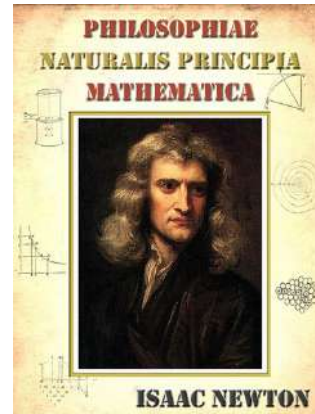
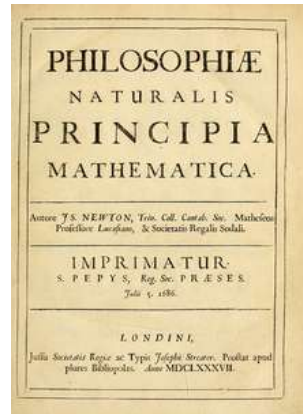

"Philosophiæ Naturalis Principia Mathematica" (in short, "Principia") , written by Newton (1687), is the most famous and important book in science. Three laws of Kepler were derived from three laws of dynamics and the law of universal gravitation. Principia was written based on elementary geometry and not the differential and integral calculus. Why did Newton (= advocate of differential and integral calculus) not write Principia based on differential and integral calculus? Although there may be several opinions for this question, The work (based on differential and integral calculus) was succeeded by Leibniz, J. Bernoulli, Euler, d'Alembert, Lagrange and Laplace, etc. and was completed.

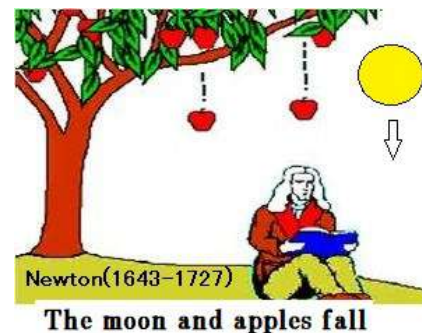
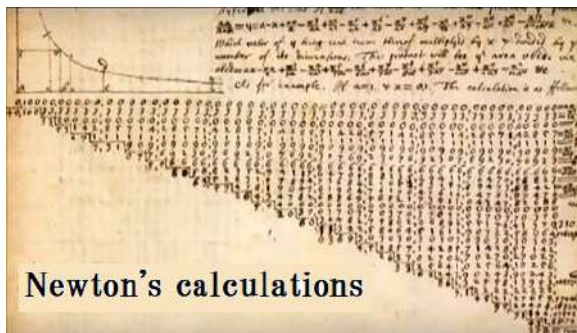

7.4.2* What is "Geocentrism vs. Heliocentrism"? After all, the worldviewism

The following biggest paradigm shift in the history of science is as follows.

(A) Motion [Motion function method: (Parmenides, Zeno, Aristotle)]

→
paradigm shift

Causal relation [Kinetic differential equation method: (Newton)]

That is, we see:

(B): Paradigm shift [Newtonian mechanical worldview]

Now,

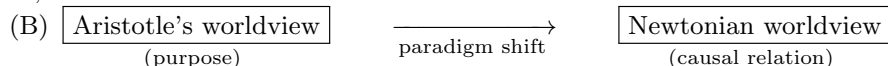

Here, Newtonian worldview means Newtonian mechanics, that is,

Newton's kinetic equation (i.e., the chain of causal relations)
 + the law of universal gravitation

Recall that the main theme of this paper is the worldwivism(*cf.* Sec. 1.3.1). As mentioned frequently up to this point,

(C₁) The argument in ordinary language (or, in the motion function method (*cf.* Sec.2.3.3)) is fuzzy, and thus, "Geocentrism vs. Heliocentrism" cannot be decided. Thus, we need a new worldview.

In Principia, Newton proposed Newtonian mechanics (i.e., Newtonian worldview) and showed that

(C₂) **When the motion of the sun and the planets is studied, the calculation becomes easy under the assumption that the planets go around the sun.**

Therefore, even the definitions "center" and "go around" depend on the worldview. After all, we conclude that

(D) "Geocentrism or Heliocentrism" is not an issue that can be settled, no matter how accurate the observations are. That is, "Geocentrism vs. Heliocentrism" is not the problem of measurements, but the problem of the worldview.

♠**Note 7.8.** Next is said to be the three major discoveries of modern science

(#₁) Aristotelian worldview (purpose) → Newtonian worldview (causal relation)



Aristotle

Scientific revolution

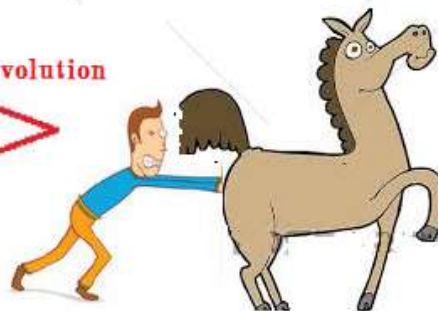
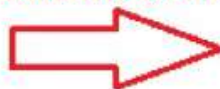

Newton

(#₂) Ptolemaic system: Geocentrism → Copernican system: Heliocentrism

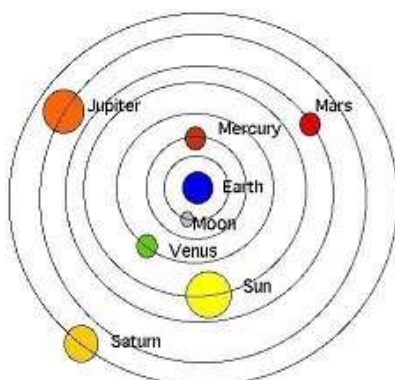

Geocentrism

Copernican

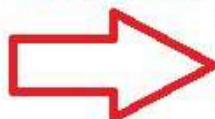

revolution

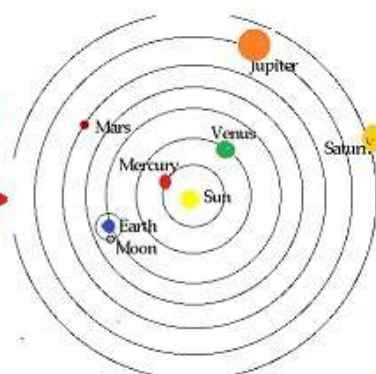

Heliocentrism

(#₃) Christianity: Adam and Eve → Darwin: evolution theory

However, it should be noted that (#₂) is a consequence of (#₁). There may be a reason to consider that (#₂) is a great episode of the birth of (#₁).

♠**Note 7.9.** Here, we have (*cf.* Classification 1.11 [the classification of philosophers]).

- (b₁): the realistic worldview (physics)
 Hērakleitos, Aristotle, Aristarchus, Archimedes, Eratosthenes, Ptolemaeus,
 Galileo, Newton, Einstein, . . .
 (Although mathematics is not a worldview, Pythagoras, Eudoxus, Euclid)
- (b) { (b₂₁): the fictional worldview (Western philosophy)
 Plato, Scholasticism, Descartes, Locke, Leibniz, Berkeley, Hume, Kant, Husserl
- (b₂₂): the logical worldview (=the logical spirit=the spirit of "Think logically!")
 Boole, Frege, Peirce, Saussure, Russell, Wittgenstein, Hempel, Quine, Popper
- (b₂₃): the mechanical worldview (statistics, quantum language)
 Parmenides, Zeno, J. Bernoulli, statistics (e.g., Fisher), quantum language

7.5 Appendix; About "Dialogues concerning two new sciences" by Galileo Galilei

The following issues are discussed

- If you drop a heavy iron ball A and a light iron ball B at the same time, which one will fall to the ground faster?

The only way to settle this issue would be to conduct an experiment. In fact, Galileo conducted this experiment on the Leaning Tower of Pisa, and discovered that "two iron balls fall at the same time". This is the famous "Leaning Tower of Pisa legend". So far, so good.

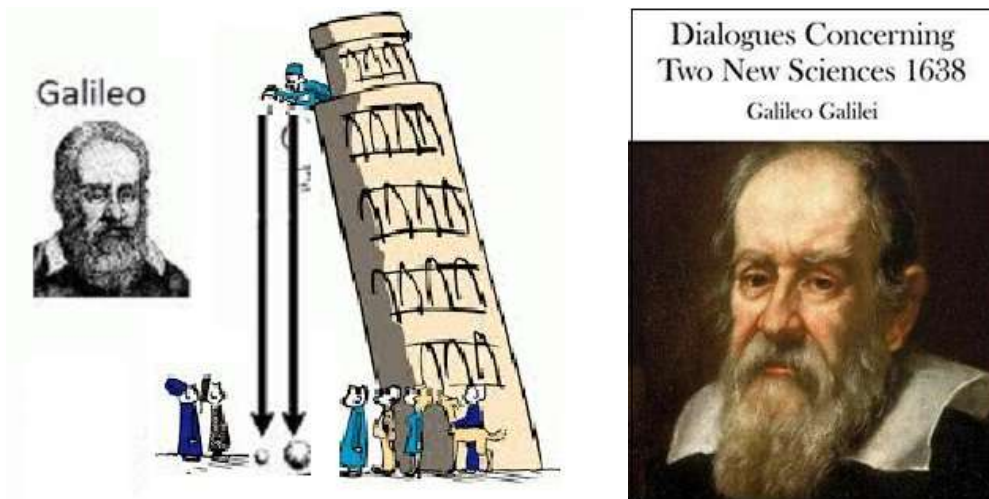

But, in "Dialogues concerning two new sciences", Galileo said:

- It is not necessary to experiment to know that two iron balls fall at the same time. You don't have to go to the Leaning Tower of Pisa to conclude that "two iron balls fall at the same time" if you think about it while lying in bed in your own home.

I will explain Galileo's idea in the following.

(G): "Dialogues concerning two new sciences" by Galileo Galilei ref. [24]

Here, assume that

(G₁) The heavier iron ball A falls faster than the lighter ball B.

If so, at what speed will the iron ball [A+B], which is made up of a heavy iron ball A and a light iron ball B connected by a string, fall?

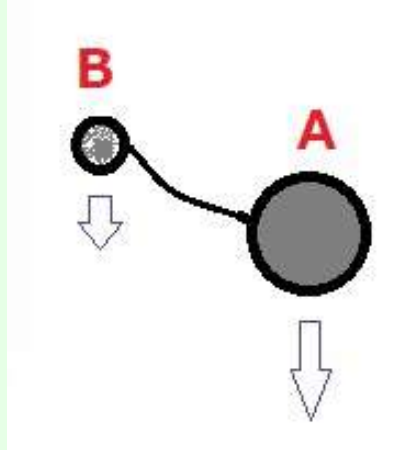

Common sense tells me that

(G₂) The iron ball [A+B] will fall at a speed halfway between the heavy iron ball A and the light iron ball B

However, this contradicts (G₁). Since the iron ball [A+B] is heavier than the heavier iron ball A, according to the assumption (G₁), the iron ball [A+B] should fall faster than the heavier iron ball A. The assumption (G₁) is wrong because it is strange that the falling speed increases only by connecting with a string. Assuming that the lighter iron ball falls faster than the heavier one at (G₁) is a contradiction as well. Therefore,

(G₃) without experiment (and without Newtonian mechanics), we can conclude a heavy iron ball and a light iron ball will fall at the same time.

If it is true, was the "Leaning Tower of Pisa" experiment unnecessary?

The above discussion seems both strange and obvious. I would like the reader to consider this exercise.

♠**Note 7.10.** For convenience, consider two kinds of propositions such as

(H₁) analytic propositions: propositions grounded in meanings, independent of matters of fact.

(H₂) synthetic propositions: propositions grounded in fact.

If so, we have the following question:

(I) Is the proposition "A heavy ball and a light ball fall at the same speed" an analytic proposition or a synthetic proposition?

This will be discussed later (Chap 11).

Chapter 8

Modern philosophy (Dualism): Descartes

The following is called the flower of modern philosophy:

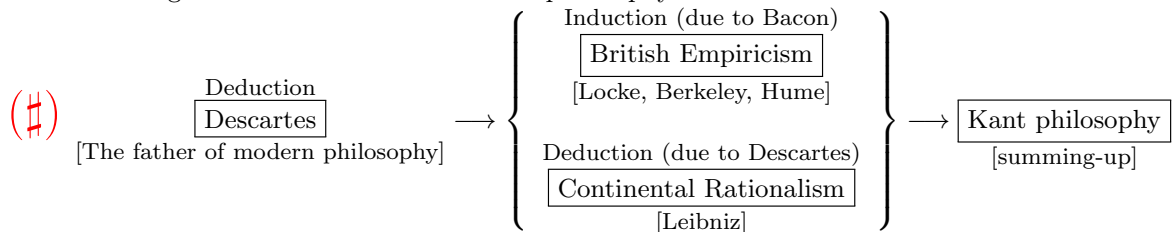

(Note that in spite of "British Empiricism", Locke, Berkeley, Hume were not concerned with experiment. Thus, I assume that they did not belong to the realistic worldview.)

Here, the (#) is located as follows:

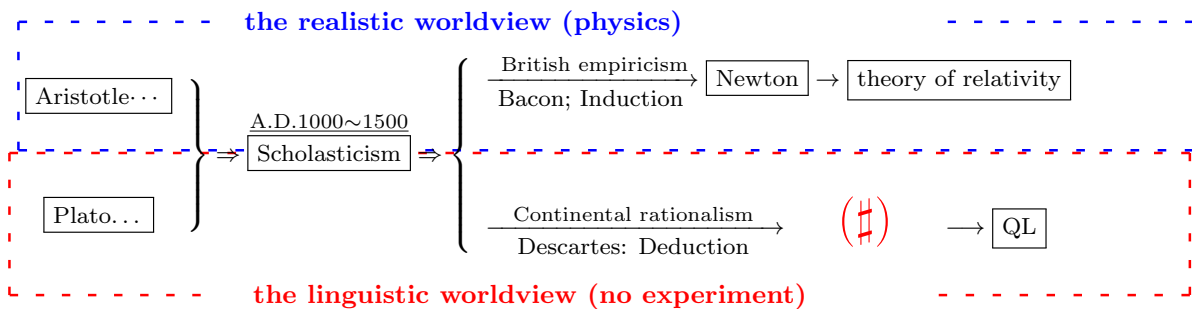

It is unthinkable now, but I think it was a time when philosophers were respected and believed that "philosophy is the king of science". Even so,

- Why were top elites in those days absorbed in the **useless** philosophy?

As mentioned before, I think that this is due to Platonic method of telling philosophy. Is it a desire to replicate the success of Euclidean geometry (i.e., logic about figure) in philosophy? The "science of monism" was completed by Newton. Thus, I think they wanted to pursue a "science of dualism".

In this chapter, we discuss Descartes, British empiricism, Continental rationalism.

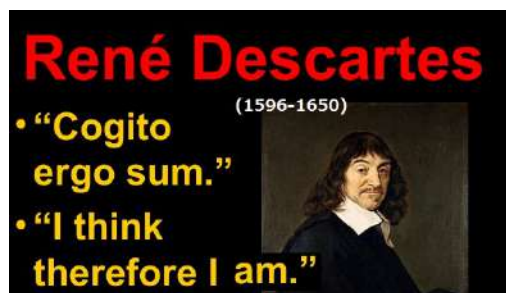

8.1 The theory of Ideas has expired

Let us review Platonic method of telling philosophy:

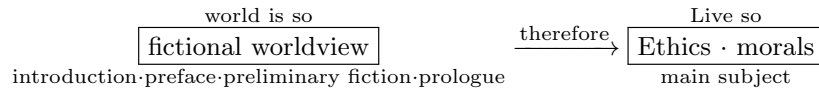

Then, ethics, morals is main, and the fictional worldview is only preface. Although it is desirable that the worldview in preface is related to a dualistic idealism (*cf.* Sec.3.4.1), but it didn't matter even if it was merely a fable. In fact, the theory of Ideas is just a fable. In an extreme case, using the psychological tricks such as

- (A) "Intellectual's remark can be trusted",
 "As for the beautiful woman, a heart is fair",
 "We can trust the assertion of Kant who was too serious and stiff.", etc.

In the preface (=view of the world), it is enough to win the trust of the reader. A scientist is not expected to be a person of character, but a moralist must be a person of character. Therefore, Kant had to be as earnest and honest as a clock.

The main current of western philosophy adhered to Platonic method of telling philosophy. In Plato philosophy, the worldview (=the theory of Ideas) is completely an allegory, and the main subject is due to Socrates' ethics. In cases of Augustinus and Scholasticism, the main subject is of course Christianity. Hence, the worldview in the preface is not so important. For example, "only the present exists" [resp. "barren discussion: Existence of God, Plato or Aristotle?"] is the intellectual act of killing time in Augustinus philosophy [resp. Scholasticism]. However, after the age of geographical discovery and the Renaissance, the momentum for the renewal of fairy tales had increased. And Descartes thought that

The expiry date of the theory of Ideas (\approx a kind of fable) was expired.

Descartes, using self-referential cogito proposition "I think, therefore I am", proposed the worldview (i.e., Descartes philosophy (= mind-matter dualism)). Roughly speaking,

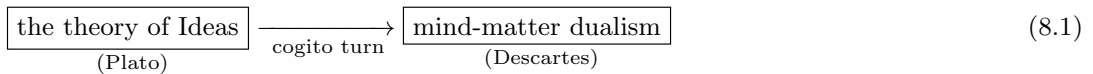

The main problem in this chapter

Problem 8.1. **(A): Is the following model change progress?**

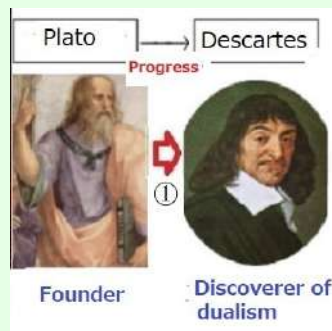
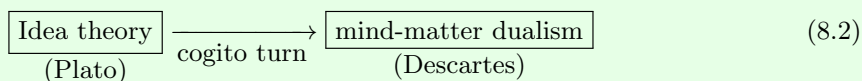

[Note]: This problem is meaningless since the standard of "progress" has not been set. Therefore, in this paper, I replace this problem (A) with the next (B).

(B): Which is closer to quantum language, Plato or Descartes?

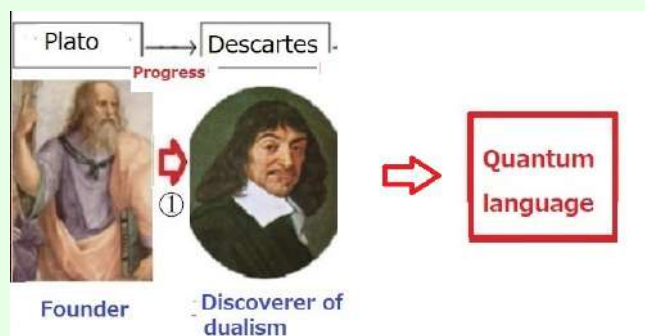

In this chapter, we devote ourselves to this problem.

The philosophy of worldview is only an anecdote, however, it should be effective for general people (and thus, quantitative arguments are not desirable). After all, following Socrates' self-referential statement "I know that I know nothing", Descartes also wanted to use self-referential trick "I think, therefore I am".

♠**Note 8.1.** There is a good reason for the birth of Newtonian mechanics, for example, the Age of Discovery, positional notation (= the discovery of zero), etc. Newtonian mechanics was powerful, for example, and had the power to refute the theory of celestial motion. On the other hand, there may not be a firm reason for the birth of Descartes philosophy as the continuation of Platonic method of telling philosophy. My opinion is as follows.

(#₁) Under the Christian strong influence, it could not be free to discuss the ethics. And thus, western philosophy devoted itself to the preface (i.e., worldview) than the main subject (i.e., ethics).

Platonic method of telling philosophy might be a clever strategy for western philosophy to coexist with Christianity. The following question is significant:

(#₂) **Is the cogito turn (8.1) progress, or a change in trend?**

As mentioned in Preface, to answer this is one of the main purposes of this paper. In Chapter 13, we will conclude that it is "progress", in spite that the change from Plato philosophy (i.e., Idea theory) to Descartes philosophy (i.e., mind-matter dualism) is not inevitable.

8.2 "I think, therefore I am" is meaningless from the scientific point of view

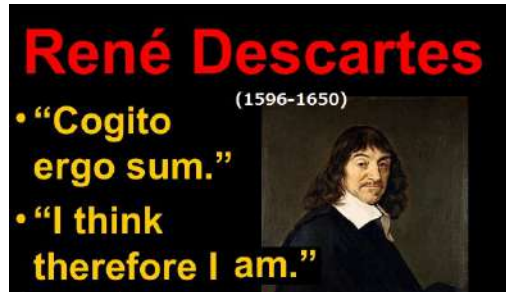

Descartes(1596-1650) was a French philosopher, mathematician, and scientist. He is also widely regarded as one of the founders of modern philosophy.

♠**Note 8.2.** One of Descartes's most enduring legacies was his development of Cartesian or analytic geometry, which uses algebra to describe geometry. There is even a plausible legend that Descartes, who was sleeping in his bed, came up with the system in order to track the position of a fly moving around the ceiling.

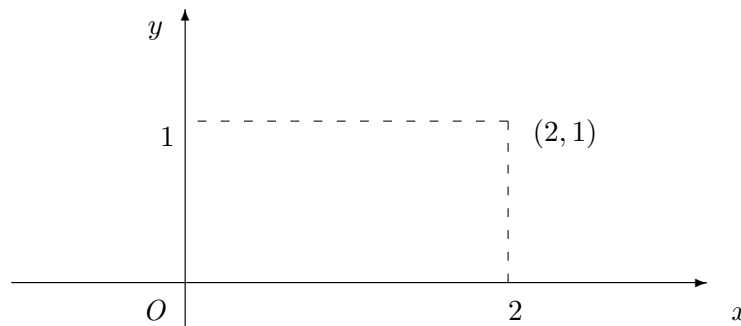
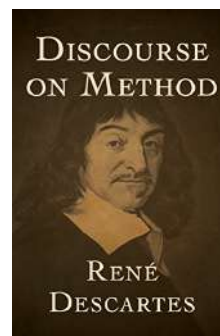

Figure 8.1: [Cartesian coordinates]

8.2.1 Discourse on the Method (1637)



Let us study the most famous book in philosophy: "Discourse on the Method (1637)" by René Descartes, which is the abbreviation of "The method of rightly conducting one's reason and of seeking truth in the sciences". Probably after Descartes read Bacon's "Novum organum", he decided "Start from the unquestionable truth". And he found the most famous philosophical proposition (= cogito proposition):

"I think, therefore I am"

That is, Descartes think:

I think that 'I think, therefore I am'

In spite that this is a most doubtful proposition (and thus, it is not in quantum language, as seen in Note 1.7 or, Proposition 8.3), Descartes believed that it was the unquestionable truth.

And further, bearing in mind Euclid's success in geometry, Descartes was convinced that

- Every statements derived from the cogito proposition are absolutely trusted

This is just "The method of rightly conducting one's reason and of seeking truth in the sciences". Therefore, after all, Bacon and Descartes are in opposite positions. That is,

- (A₁) Bacon emphasized the importance of experiments, and so asserted the inductive method. He was oriented to physics (and further, British empiricism)
- (A₂) Descartes believed "good sense", and so asserted the deductive method. He was oriented to meta-physics (and further, Continental rationalism)

In this paper, the following figure is actually drawn so far repeatedly.

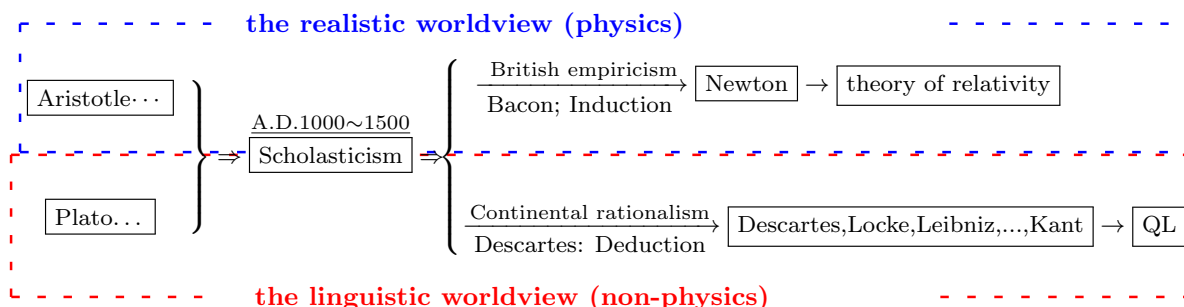

However, the part:

$$(\#1) \text{ " } \xrightarrow[\text{Descartes}]{\text{Continental rationalism}} \text{ Descartes, Locke, Leibniz, ..., Kant "}$$

is usually rewritten by the following (#2), which is called "the flower of modern philosophy"

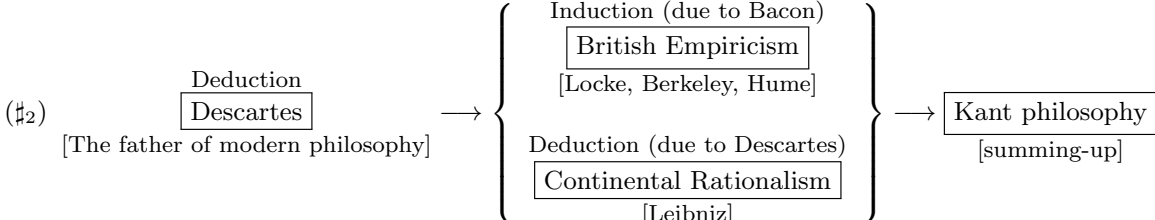

(Note that in spite of "British Empiricism", Locke, Berkeley, Hume were not concerned with experiment. Thus, I assume that they did not belong to the realistic worldview.)

Descartes asserted:

Proclaim 8.2. The first principle (= cogito proposition) in philosophy
 Now,
 (A) Descartes doubted everything. And he arrived in the cogito proposition which has no doubted room.
 That is, he arrived in
 (B) I think, therefore I am.
 And, he proclaimed that the cogito proposition (B) is the first principle in philosophy.

8.2.2* Two (scientific or non-scientific) interpretations of "I think, therefore I am"

What is described in this section has been mentioned many times in the references [44]~[73].

Recall the linguistic Copenhagen interpretation:

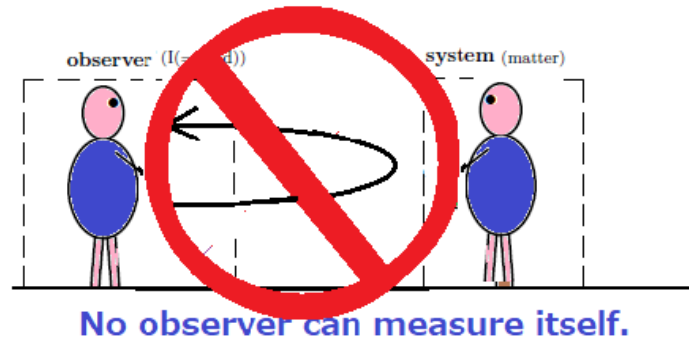

we will show two (scientific or non-scientific) interpretations of the cogito proposition: "I think, therefore I am".

Proposition 8.3. [(i): Scientific interpretation of the cogito proposition]:

Let start from the scientific interpretation of the cogito proposition.

For the sake of convenience, put "I"="Tom". Thus,

- "I think, therefore I am"= "Tom thinks, therefore Tom is"

If this is a scientific proposition, it must be experimentally verifiable. However, it is easy. That is because it is usual that

(C₁) a doctor says "Tom's brainwaves are normal, so he's alive."

which is of course a statement in quantum language, since

"observer = doctor", "matter = Tom".

However, the interpretation (C₁) is a trivial one, and this would not be Descartes' intention.

[(ii): Non-scientific interpretation (i.e., Descartes' intention) of the cogito proposition]:

Similarly, put "I"="Tom". Put

- (b) "I think, therefore I am"= "Tom thinks, therefore Tom is"

Thus, we have the situation:

(C₂) Tom thinks "Tom thinks, therefore Tom is"

which means that

"observer = Tom", "matter = Tom",

That is, this violates the linguistic Copenhagen interpretation. Therefore, the (C₂) is not in quantum language, that is, it is just a play on words.

Thus, the (b) is a non-scientific proposition (i.e., an experimentally unverifiable proposition), but this play on words had captured the interest of philosophy enthusiasts. That is,

This play on words ushered in the modern era.

It is obvious that the above (ii) is the recommended answer.

♠**Note 8.3.** As concluded in chapter 12, "I think, therefore I am" is not a proposition (precisely, a proposition in QL). in spite that it is called "the first proposition of philosophy". Using Wittgenstein's words, we says that

"I think, therefore I am"
="non-proposition" = "what we cannot speak about"

Thus, it can be said that Descartes ignored the teachings of Wittgenstein (i.e., " *What we cannot speak about we must pass over in silence*").

8.3 Descartes' strategy

8.3.1 From cogito to dualistic idealism

The most important key-word in Descartes' philosophy is "I". Descartes thought that

Nobody pays attention even if Descartes appeals for the importance of "I" aloud.

Thus,

(A) Descartes used the advertising slogan (i.e., the cogito proposition): "I think, therefore I am" The cogito proposition is nonsensical, but it is very impressive. Thus, this proposition could be a perfect advertising slogan.

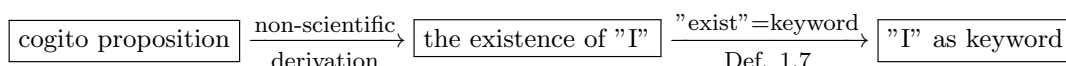

Thus, by the cogito proposition, what Descartes wanted to say was

(B) "I" is the most important key-word in Descartes philosophy.

His strategy succeeded wonderfully. If "I" is accepted, the existence of "matter" (which is perceived by "I") is accepted. And further, the medium of "I" and "matter" is automatically accepted as "body (= sensory organ)". Therefore, the key-words of Descartes philosophy (= mind-matter dualism) is

(C) $\boxed{\text{"I" (= "mind", "brain")}}$, $\boxed{\text{"body" (= "sensory organ")}}$, $\boxed{\text{"matter"}}$

For completeness, it should be noted that this is not a consequence of the cogito proposition. That is the cogito proposition is the reason added afterwards. The cogito proposition is nothing more than a catch copy.

Principle 8.4. The principle of Descartes' philosophy is

(D) **Think of everything in terms of mind-matter dualism and idealism.**

That is, Descartes proposed the fictional worldview the called **mind-matter dualism and idealism** which starts from the three key-words

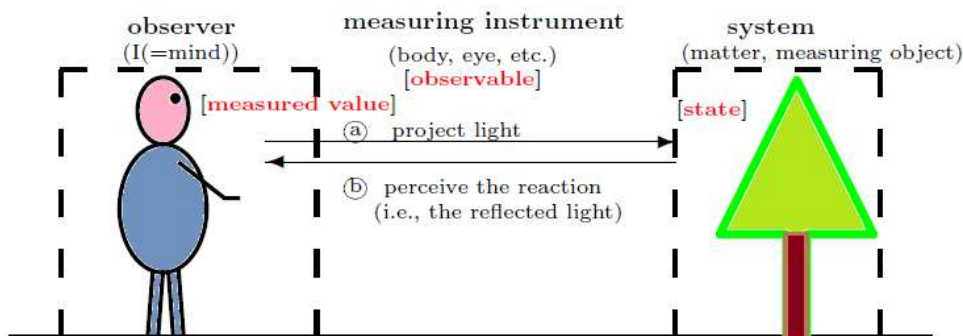
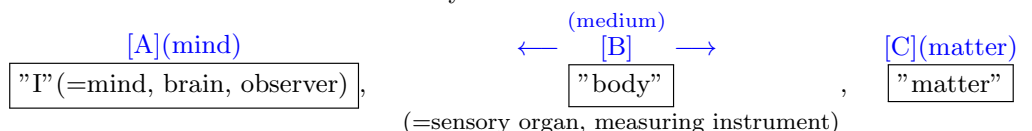
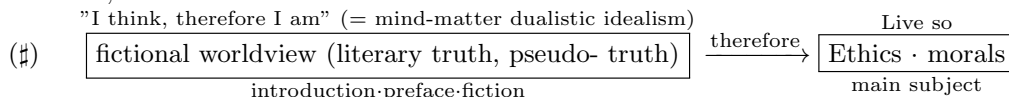

Figure 1.2. **Descartes Figure**: Image of "measurement(=a)+b)" in dualism

For the definitions of "idealism" and "idealism", see Definition 1.8, i.e., idealism = the spirit such that thinking takes precedence over experimentation (since experiments on the mind are almost impossible). Also, dualism=the worldview concerning measurement.

That is, we see



Although Descartes did not emphasize measurement (\approx cognition, epistemology), the importance of cognition was emphasized by his successors (Locke, Hume, etc.).

Also, ethics, moral, etc. are not emphasized in (§), but Descartes asserted "The existence of God is derived". As seen in Sec. 3.4, I think that **the term "therefore" in (§) cannot be relied upon.**

And, Descartes proposed the following two problems;

Problem 8.5. [Descartes problem; mind-body problem, qualia problem]

(D₁) **mind-body problem:**

How are "body" and "mind" connected?

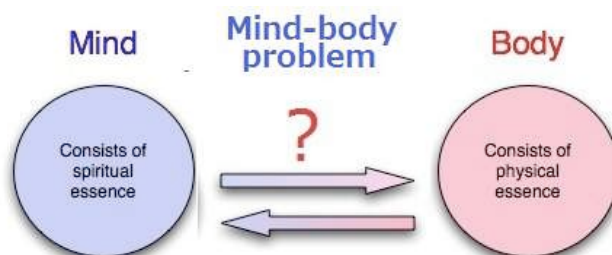

(D₂) **subjectivity problem (= qualia problem):**

Is the world I perceive the same as the world you perceive?

For the answer of (D₁) and (D₂) in the quantum mechanical worldview, see Sec. 12.4 and Sec. 9.5.1 respectively.

♠**Note 8.4.** (i): The above two problems have been touted as the two most difficult problems in modern philosophy. Without raising this issue, the prosperity of modern philosophy might not have been realized. In fact, Kant, Husserl, and others have challenged these problems, and their achievements were supported, earning them respect as great philosophers though their approaches are rather pseudo-psychological. However, from the scientific point of view, the honest impression would be that philosophers are just making a fuss about an unsolvable problem. No scientist thinks that their achievements have "guaranteed the objectivity of natural science."

(ii): For the answer of (D₁) and (D₂) in the quantum mechanical worldview, see Sec. 12.7 and Sec. 9.5.1 respectively. Many philosophers may not be immediately convinced because our approach is not traditional. However, I am sure that our approach is truly philosophical. That is, I think that philosophers should not regard Problem 8.5 as the problems in psychology and brain science.

Descartes might think as follows.

(F) The theory of Ideas has expired expiration date. Thus, in order to refresh philosophy, a new model-change (or, a new wrapping paper) is needed such as Descartes' problem (D). Even if this is a non-sense problem, this model-change won't fade for about 100 years.

In fact, the cogito turn:

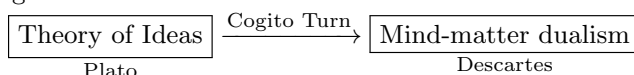

is the biggest model-change in the history of philosophy.

♠**Note 8.5.** Descartes' book: "The method of rightly conducting one's reason and of seeking truth in the sciences" begins with the non-scientific proposition "I think, therefore I am", which is not experimentally verifiable (*cf.* Proposition 8.3.). Some may find this ironic. However, I'd like to think that Descartes had it all figured out. That is because

- Euclid's "Elements" begins with seven axioms, which cannot be proved.

Thus, I guess that,

- As Euclid aimed at a science of figures, Descartes aimed at a science of dualism.

If so, I can expect that Western philosophy may have a destination.

♠**Note 8.6.** As mentioned in ref. [71], I rewrite as follows. It is not true to consider that every phenomenon can be described in terms of quantum language. Although readers may think that the following can be described in measurement theory, but we believe that it is impossible. For example, the followings cannot be written by quantum language:

- $$\left\{ \begin{array}{ll} \textcircled{1} : \text{tense—past, present, future —} & \textcircled{2} : \text{Heidegger's saying "In-der-Welt-sein"} \\ \textcircled{3} : \text{the measurement of a measurement,} & \textcircled{4} : \text{Bergson's subjective time} \\ \textcircled{5} : \text{observer's space-time,} & \\ \textcircled{6} : \text{Only the present exists (due to Augustinus(354-430))} & \end{array} \right.$$

If we want to understand the above words, we have to propose the other scientific languages (except quantum language). We have to recall Wittgenstein's sayings

The limits of my language mean the limits of my world

I consider that ①–⑥ are related to self-reference in the wide sense.

8.4 The correspondence of key-words in Descartes philosophy and quantum language

The key-words of Descartes philosophy (= mind-matter dualism) is

"I" (= "brain", "mind"), "body" (= "sensory organ"), "matter"

However, we cannot expect the substantial result even if we consider Descartes' problem. However, the above three key-words are essentially important in the relation with the quantum language: Now let us explain this.

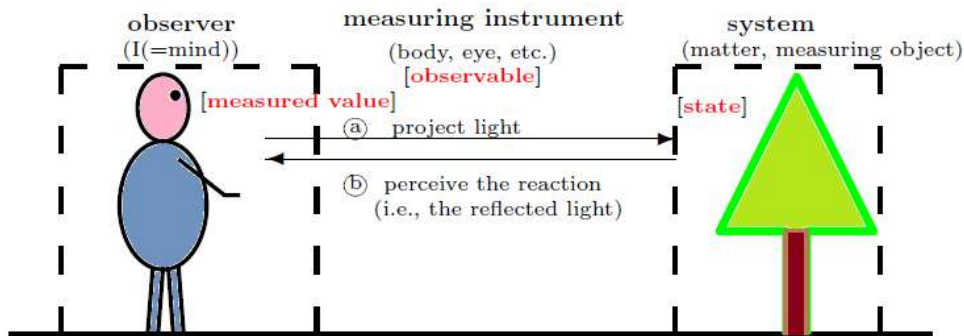

Figure 1.2. Descartes Figure: Image of "measurement(=Ⓐ+Ⓑ)" in dualism

Or,

For example, consider:

- Examine whether the hot or cold water in the bath and put your hands in the bathtub.

In this case, "hand" is regarded as "measuring instrument". In the same sense, "eye" is also regarded as "measuring instrument". Conversely, Glasses, microscope, telescope, etc. is a kind of body (= sensory organ). If so, we want to conclude that

body (particularly, sensory organ) \doteq measuring instrument

In the above Descartes figure, slightly incomprehensible one may be

"I" (= "brain", "mind") \doteq measured value

However, it suffices to consider "there is no measured value without brain". For example when a needle of a voltmeter just moved, it is only a physical phenomenon. Nevertheless a movement of this needle is read, and it's sensed by a brain. Then, it for the first time becomes "measured value". The reason that Descartes philosophy is useless is as follows.

- (A) In spite that three key-words "mind", "body", "matter" are gathered, Descartes philosophy has no computable structure. This is only the fictional worldview, and not the mechanical worldview.

Table8.1 Key-words in each worldview (cf. Assertion 1.14)

mind-matter dualism	[A](= mind)	[B](between A and B)	[C](= matter)
Plato	actual world	Idea	/ [Idea world]
Descartes	I, mind, brain	body	/ [matter]
quantum language	measured value	measuring instrument (= observable)	state [system]

That is, using the following change:

$$[I] \implies [\text{measured value}], [\text{body}] \implies [\text{measuring instrument}], [\text{matter}] \implies [\text{system}]$$

we get the computable worldview (i.e., Axioms 1 and 2 in Sec. 1.1.1), i.e., quantum language.

If so, the following problem is essential.

Problem 8.6. Descartes' model-change:

$$\text{the theory of Ideas} \xrightarrow{\text{model-change}} \text{Descartes philosophy}$$

can be regarded as a progress? That is, it is sure that Descartes' model-change is supported by many people. Almost people certainly believe that science makes progress, that is, science development is not fashionable change. However, there may be a lot of opinions about philosophy. We completely agree that it is fun to think of dualistic idealism (= dualistic metaphysical world). However, we have the question:

- Did western philosophy make essential progress?

which is essentially the same as

- Does dualistic idealism (= dualistic metaphysical world) deserve to study as science?

Brief explanation of Problem 8.6:

Although this will be answered throughout this paper, I add a simple explanation as follows. Our answer to Problem 8.6 is "essential progress". As the reason mentioned in Assertion 1.14 of Sec.1.4, the following key-words converge to "observable" such as

$$\boxed{\text{Idea}}_{\text{(Plato)}} \rightarrow \boxed{\text{body}}_{\text{(Descartes)}} \rightarrow \boxed{\text{secondary qualities}}_{\text{(Locke)}} \rightarrow \dots \rightarrow \boxed{\text{observable(=measuring instrument)}}_{\text{(quantum language)}}$$

It should be noted that there is no settlement (i.e., "essential progress" or "fashionable change"?) without ultimate goal (= quantum language). Therefore, this will be summarized in the final chapter (=Postscript).
 . □

Chapter 9

Modern philosophy(Locke, Leibnitz, Berkeley, Hume)

The fact may be represented by the figure.

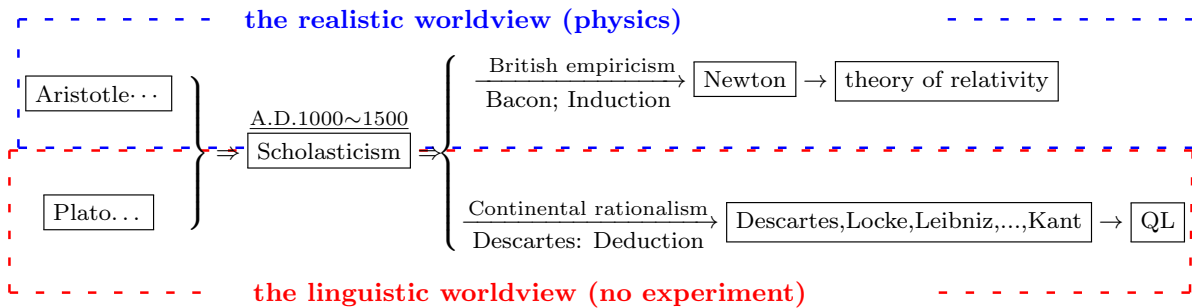

However, the part:

(#1) " $\xrightarrow[\text{Descartes}]{\text{Continental rationalism}}$ [Descartes, Locke, Leibniz, ..., Kant]"

is usually rewritten by the following (#2), which is called "the flower of modern philosophy"

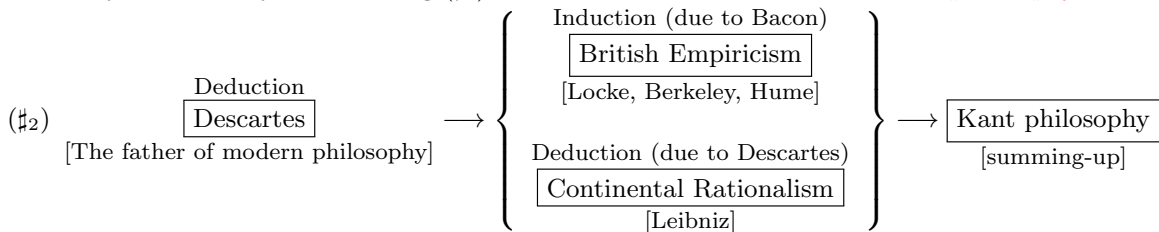

(Note that, in spite of "British Empiricism", Locke, Berkeley, Hume were not concerned with experiment. Thus, I assume that they did not belong to realistic worldview.)

It's unbelievable now, but it was a time when philosophy was believed to be the "king of the academy," and a time when philosophy was respected. Even so,

- Why were top elites in those days absorbed in the useless philosophy?

As I have said many times, I think that this is due to Euclid's success and Platonic method of telling philosophy. .

9.1 Locke (1632 - 1704): The father of British Empiricism

9.1.1 "An Essay Concerning Human Understanding" by Locke (1689)



John Locke (1632-1704)
father of British empiricism

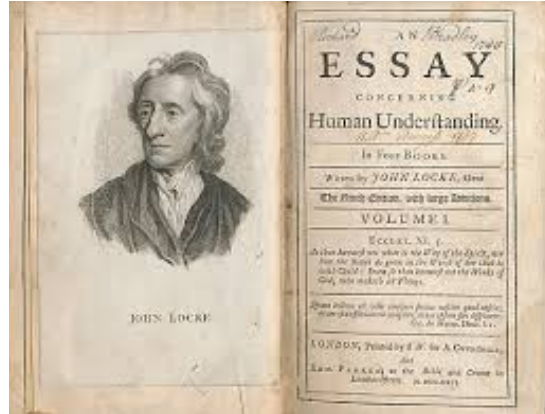

There may be a reason to consider that

- (A) The role of Descartes was the elimination of such "spiritual power" and "supernatural being", and to prepare the social environment of the appearance of Newton. That is, Descartes was only the opening performer. In this sense, "I think, therefore I am" (the existence of "I") was only the side show of the opening performer.

And so,

- (B) The role of Descartes, as the opening performer, had been finished by the appearance of Newton. Even if there was such history, it wasn't strange. However, strangely, there were people who took "the existence of I" or "Descartes Figure 1.2" seriously. For example, John Locke (1632 - 1704) thought as follows.

(C) : "An Essay Concerning Human Understanding" by Locke (1689)

Locke is the successor of Descartes philosophy. He philosophically (i.e., without experiments) discussed the Descartes figure (i.e., the relation among "I" (= "brain", "mind"), "body" (= "sensory organ"), "matter"). He is called "The father of British Empiricism (\approx epistemology)". Since Isaac Newton published his "Principia Mathematica" (1686), John Locke humbly wrote in his "Essay Concerning Human Understanding" (1689) as follows.

- (D₁) ... *and in an age that produces such masters as the great Huygenius and the incomparable Mr. Newton*, with some others of that strain, it is ambition enough to be employed as an under-labourer in clearing the ground a little, ...

However, his true intention might be next.

- (D₂) In the field of "matter" of Descartes figure, activity of Newton is remarkable. However, concerning the relation among "I" (= "brain", "mind"), "body" (= "sensory organ"), "matter", he wanted to reach the summit.

♠**Note 9.1.** I think that "the incomparable Mr. Newton" is the most important key-word in the whole of modern philosophy.

If so,

- (E) It was too early more than 300 years to study "epistemology" in science in earnest.

Thus, it is impossible to expect the result. However,

- (F) If we think that the work of philosophers is "model-change", then the achievements of Locke is enormous.

In fact, modern philosophy had a very easy environment to work in. In other words, philosophers only had to think about how to deal with Newtonian mechanics.

♠**Note 9.2.** If the above (D) is true, Locke may have been trying to create another kind of physics that is different from Newtonian mechanics. If so, his theory should belong to dualistic realism. However,

Locke and others (Descartes, Leibniz, Hume, Kant, etc.) were not concerned with experimental verification (*cf.* for our definition of "realism", see Definition 1.7). Thus, in this paper, we think that Descartes-Kant philosophy belongs to dualistic idealism. This was confused in my previous paper [65].

9.1.2 "Tabula rasa", primary quality and secondary quality

9.1.2.1 "tabula rasa"

Tabula rasa is a Latin phrase often translated as "blank paper" in English, that is,

(G) The "brain circuit" is a blank paper state at the start, but we look and hear in various ways, then "concept (= complex brain circuit)" is made.

Present-day brain science may say:

"It's equal to say nothing by such general opinion."

however, at any rate, the (G) is the starting point of British Empiricism.

♠**Note 9.3.** (i): Maybe Locke wasn't claiming "tabula rasa" in the scientific sense. I think he was following Bacon's empiricism and insisting on a "tabula rasa".

(ii): Considering "language" and not "cognition", we say that

(#) "ordinary language" is like tabula rasa

When a baby was born, a baby doesn't know ordinary language at all (i.e., a baby is with tabula rasa state). The baby is acquiring ordinary language by trial and error.

9.1.2.2 Primary quality and secondary quality

According to Locke,

(H₁) **primary quality** (i.e., inherent nature (=primary quality)) ... weight, temperature, length, etc.

(H₂) **secondary quality** (i.e., sensations of inherent nature) ... sweet, red, hot, salty, etc.

That is,

(I) :Locke's worldview

The world is composed of two (i.e., "matter" and "mind (= observer)". "Matter" has inherent nature (= primary quality), "observer" has body (= "sensory organ"). Through the sensory organ, secondary quality (sweet, red, hot, salty, etc.) is felt by our brain.



John Locke:

A **primary quality** in an object produces ideas in humans that really resemble the object as it is in itself (for example, shape, size, motion).

A **secondary quality** in an object produces ideas in humans that do not really resemble the object as it is in itself (for example, color, taste, smell).

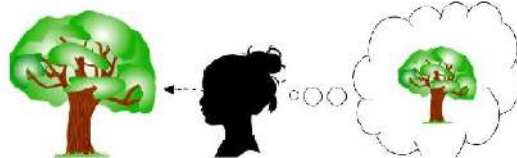

In terms of quantum language, we say:

primary quality \implies **state**,

secondary quality \implies **observable (= measuring instrument)**

as seen in the table below.

Table9.1 The key-words of worldviews (cf. Assertion 1.14)

mind-matter dualism	[A](= mind)	[B](between A and B)	[C](= matter)
Plato	actual world	Idea	/ [idea world]
Descartes	I, mind, brain	body	/ [matter]
Locke	mind	secondary quality	primary quality [matter]
quantum language	measured value	observable	state [system]

Here,

(J) Locke represents the most important concept in dualistic idealism as the term "secondary quality".

The terms such as Idea, body, etc. may be not comprehensive. However,

- "secondary quality" is a word we can understand. Hence, Locke's achievement should be honored.

Again, note that "secondary quality" is a word that forms the foundation of dualism.

If so, we may affirmatively answer Problem 8.6, i.e.,

Can the direction: "Descartes $\xrightarrow[\text{model-change}]{} \text{Locke}$ " be regarded as progress?

That is, we may assert that

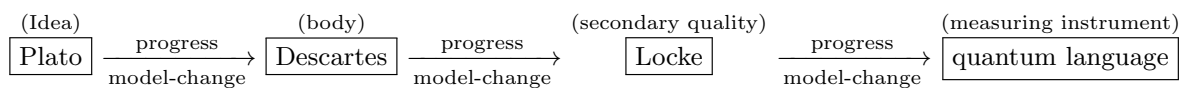

if "to make progress" is defined by "to come near quantum language" (cf. Assertion 1.14). It should be noted that this result cannot be confirmed without an understanding of quantum language. Therefore, this will be summarized in the final chapter (=Postscript)

♠**Note 9.4.** (i): The polar star can be regarded as a measuring instrument such as a kind of compass.

(ii): By the way, Merleau-Ponty (1908 - 1961) might think in the following manner.

- (‡) I shake hands with my right hand and the left hand. In this case, if I regard the right hand as the measuring instrument, I feel the existence of my left hand. On the contrary, if I regard the left hand as the measuring instrument, I feel the existence of my right hand.

It may be interesting, however, I do not know whether such thing is worth arguing.

9.2 Dramatic presentation of "British Empiricism vs. Continental Rationalism"

Modern philosophy became popular through the following rival relation:

British Empiricism vs. Continental Rationalism

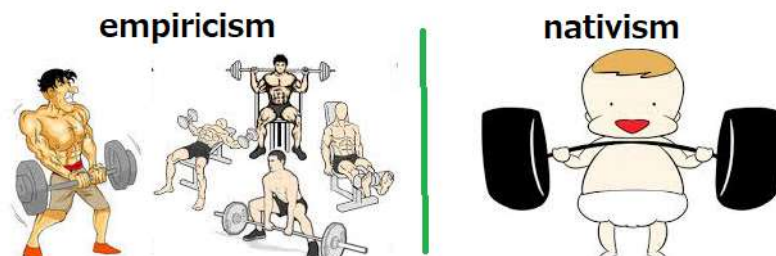

That is,

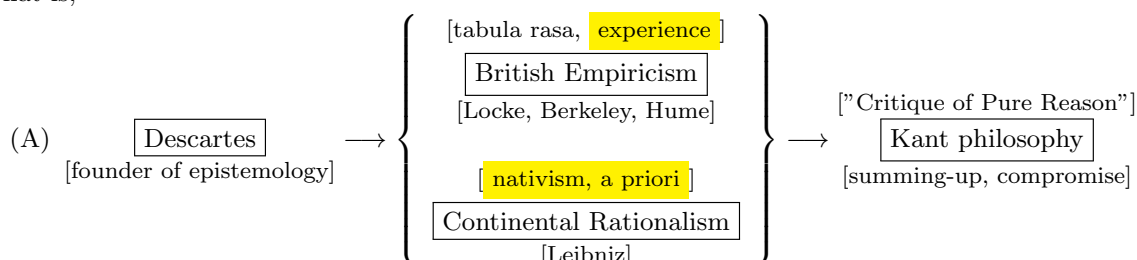

There may be many opinions on this conflict structure. For example, some may consider that

(A') the above (A) is the staging of a conflict structure to make Kant into a hero.



Talent or Effort?

Let us explain the above (A):

Modern philosophy

British Empiricism [\"tabula rasa\" (= blank paper)]

\"An Essay concerning Human Understanding\" (by Locke, 1690) says that

(B) He eliminated the possibility of innate knowledge before experience. Human being is born as the blank state (\"tabula rasa\"). (Locke, Berkeley, Hume, ...)

Continental Rationalism [nativism]

\"New Essays on Human Understanding\" (by Leibniz, 1703) says that

(C) nativism (= Anti-\"tabula rasa\"). the human mind as it is at birth, with ideas or thoughts in it. (Leibniz, ...)

That is, from

"An Essay concerning Human Understanding" vs. "New Essays on Human Understanding"
the rival relation:

British Empiricism["tabula rasa"] vs. Continental Rationalism[nativism]

began. After nearly 100 years of twists and turns,

Appearance of Kant (Critique of Pure Reason: 1781)

And

(D) Kant has integrated "tabula rasa vs. nativism"
It is well known such above story that regards Kant as a hero.



9.2.1 Would Leibniz be serious for this argument (i.e., nativism) ?

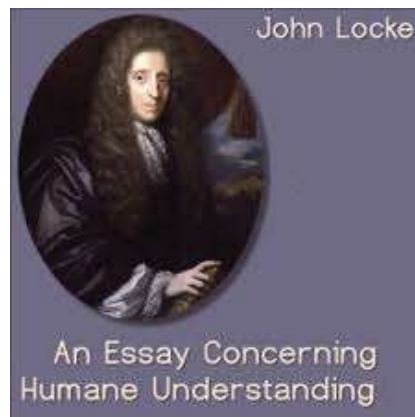

Gottfried Wilhelm Leibniz (1646-1716) was one of the great thinkers of the seventeenth and eighteenth centuries and is known as the last "universal genius". He made deep and important contributions to the fields of metaphysics, epistemology, logic, philosophy of religion, as well as mathematics, physics, geology, jurisprudence, and history. Everyone may have the following question:

(E) Why did such a genius participate in a nonsense argument (i.e., "nativism vs. tabula rasa") ?

It is clear that Locke's theory is too extreme, and thus, it is a matter of course that Leibniz did not completely agree with "tabula rasa". However,

(F₁) However, the story that Leibniz disputed Locke in "New Essays on Human Understanding" is too exaggerated.

The argument about "nativism vs. tabula rasa" is non-sense in the following sense:

(F₂) Even if future brain science will make a decision favorable to one of them (i.e., "nativism vs. tabula rasa"), it is independent of Leibniz's (or, Locke's) evaluation. That is because "Continental Rationalism vs. British Empiricism" is regarded as a pre-science problem. **What is the most important is to form the ground on which the dualistic idealism (or the problem concerning brain) can be argued**

scientifically. Without the ground, it is useless even if they said something

For example, from the scientific point of view, atomism due to Democritus (BC.460-BC.370) is non-sense. It is poem. .

Ordinary people might have wanted to find the big name of "Genius Leibniz" in the debates of "British Empiricism vs. Continental Rationalism". Maybe they just enjoyed a play of the name as "the dawn of modern times" as an entertainment.

In this and next chapters, the readers will find the **miracle fact** :

- as geniuses (Descartes, Locke, Leibniz, Berkeley, Hume, Kant, etc) played with words, their arguments gradually became closer and closer to quantum languag

That is,

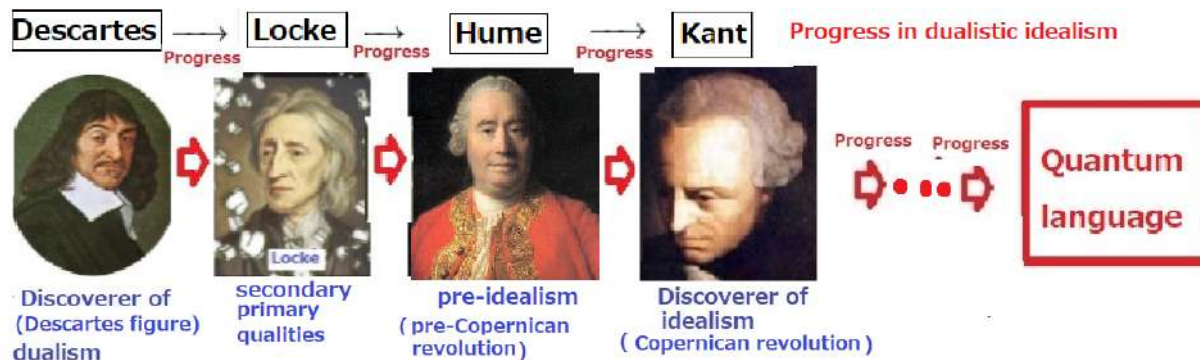

♠**Note 9.5.** Considering "language" and not "cognition", then, we say that

(#₁) mathematics is nativism

That is because mathematics is based on set theory. That is, any mathematical theorem can be derived from Zermelo=Fraenkel Axioms.

Also, recall Note 9.3, in which we say tat

(#₂) "ordinary language" is like tabula rasa

That is because "ordinary language" is not based on some axioms.

9.3* Leibniz-Clarke Correspondence: What is space-time?

Leibniz-Clarke Correspondence

SUBSTANTIVALISM VS. RELATIONALISM



Newton



Clarke

- Space exists!
- 'Even if there is no play tonight, the theatre is still there'



Leibniz

All talk about space is reducible to talk about relations between particles

This section is published in the following:

- ref. [73]; S. Ishikawa; *Leibniz-Clarke correspondence, Brain in a vat, Five-minute hypothesis, McTaggart's paradox, etc. are clarified in quantum language* Open Journal of philosophy, Vol. 8, No.5 , 466-480, 2018, DOI: 10.4236/ojpp.2018.85032 (<https://www.scirp.org/Journal/PaperInformation.aspx?PaperID=87862>)
- ref. [74]; S. Ishikawa; *Leibniz-Clarke correspondence, Brain in a vat, Five-minute hypothesis, McTaggart's paradox, etc. are clarified in quantum language; [Revised version]* ; Keio Research report; 2018; KSTS/RR-18/001, 1-15 (<https://philpapers.org/rec/ISHLCB>) (http://www.math.keio.ac.jp/academic/research_pdf/report/2018/18001.pdf)

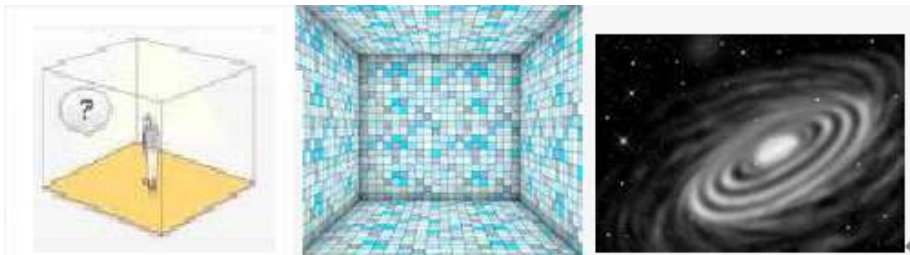

Time is money

The problems (“What is space?” and “What is time?”) are the most important in modern science as well

as the traditional philosophies. In this section, we give the quantum linguistic answer to these problems. As seen later, our answer is similar to Leibniz’s relationalism concerning space-time. In this sense, we consider that Leibniz is one of the discoverers of the linguistic Copenhagen interpretation

9.3.1 “What is space?” and “What is time?”

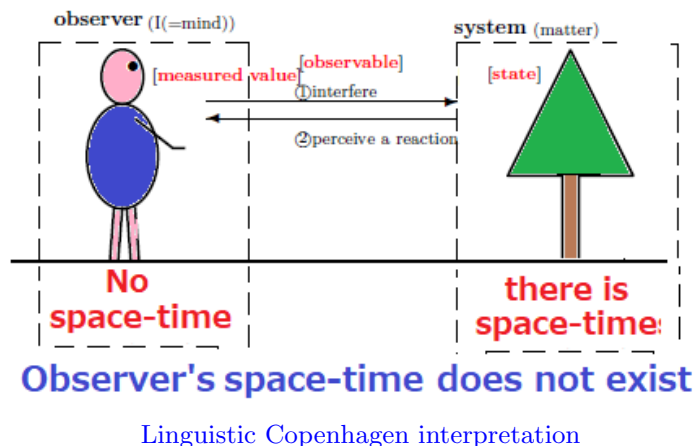

9.3.1.1 Space in quantum language

(How to describe “space” in quantum language)

(Cf. the W^* -algebraic formulation in (A₂) in Sec 1.5) is used in this section.)

In what follows, let us explain “space” in measurement theory (= quantum language). For example, consider the simplest case, that is,

(A) “space” = \mathbb{R}_q (one dimensional space)

Since classical system and quantum system must be considered, we see

(B) $\left\{ \begin{array}{l} (B_1): \text{a classical particle in the one dimensional space } \mathbb{R}_q \\ (B_2): \text{a quantum particle in the one dimensional space } \mathbb{R}_q \end{array} \right.$

In the classical case, we start from the following state:

$$(q, p) = (\text{“position”}, \text{“momentum”}) \in \mathbb{R}_q \times \mathbb{R}_p$$

Thus, we have the classical basic structure:

$$(C_1) \quad [C_0(\mathbb{R}_q \times \mathbb{R}_p) \subseteq L^\infty(\mathbb{R}_q \times \mathbb{R}_p) \subseteq B(L^2(\mathbb{R}_q \times \mathbb{R}_p))]$$

Also, concerning quantum system, we have the quantum basic structure:

$$(C_2) \quad [\mathcal{C}(L^2(\mathbb{R}_q)) \subseteq B(L^2(\mathbb{R}_q)) \subseteq B(L^2(\mathbb{R}_q))]$$

Summing up, we have the basic structure

$$(C) \quad [A \subseteq \bar{A} \subseteq B(H)] \left\{ \begin{array}{l} (C_1): \text{classical } [C_0(\mathbb{R}_q \times \mathbb{R}_p) \subseteq L^\infty(\mathbb{R}_q \times \mathbb{R}_p) \subseteq B(L^2(\mathbb{R}_q \times \mathbb{R}_p))] \\ (C_2): \text{quantum } [\mathcal{C}(L^2(\mathbb{R}_q)) \subseteq B(L^2(\mathbb{R}_q)) \subseteq B(L^2(\mathbb{R}_q))] \end{array} \right.$$

Since we always start from a basic structure in quantum language, we consider that

$$\begin{aligned} &\text{How to describe “space” in quantum language} \\ \Leftrightarrow &\text{How to describe [(A):space] by [(C):basic structure]} \end{aligned} \tag{9.1}$$

This is done in the following steps.

Assertion 9.1. [The linguistic Copenhagen interpretation concerning “space”]

How to describe “space” in quantum language

(D₁) Begin with the basic structure:

$$[A \subseteq \bar{A} \subseteq B(H)]$$

(D₂) Next, consider a certain commutative C^* -algebra $\mathcal{A}_0 (= C_0(\Omega))$ such that

$$\mathcal{A}_0 \subseteq \overline{\mathcal{A}}$$

(D₃) Lastly, the spectrum $\Omega (\approx \mathfrak{S}^p(\mathcal{A}_*))$ is used to represent “space”.
Therefore, in quantum language, we see

- space is a kind of state of a ”thing”.

For example,

(E₁) in the classical case (C₁):

$$[C_0(\mathbb{R}_q \times \mathbb{R}_p) \subseteq L^\infty(\mathbb{R}_q \times \mathbb{R}_p) \subseteq B(L^2(\mathbb{R}_q \times \mathbb{R}_p))]$$

we have the commutative $C_0(\mathbb{R}_q)$ such that

$$C_0(\mathbb{R}_q) \subseteq L^\infty(\mathbb{R}_q \times \mathbb{R}_p)$$

And thus, we get the space \mathbb{R}_q as mentioned in (A)

(E₂) in the quantum case (C₂):

$$[\mathcal{C}(L^2(\mathbb{R}_q) \subseteq B(L^2(\mathbb{R}_q)) \subseteq B(L^2(\mathbb{R}_q))]$$

we have the commutative $C_0(\mathbb{R}_q)$ such that

$$C_0(\mathbb{R}_q) \subseteq B(L^2(\mathbb{R}_q))$$

And thus, we get the space \mathbb{R}_q as mentioned in (A)

9.3.1.2 Time in quantum language

(How to describe “time” in quantum language)

In what follows, let us explain “time” in measurement theory (= quantum language). This is easily done in the following steps.

Assertion 9.2. [The linguistic Copenhagen interpretation concerning ”time”]

How to describe “time” in quantum language

(F₁) Let T be a tree in Axiom 2 in Sec. 1.1. (Don’t mind the finiteness or infinity of T) For each $t \in T$, consider the basic structure:

$$[\mathcal{A}_t \subseteq \overline{\mathcal{A}}_t \subseteq B(H_t)]$$

(F₂) Next, consider a certain linear subtree $T' (\subseteq T)$, which can be used to represent “time”.

Therefore, in quantum language, we see

- time is an order of occurring in succession which changes one after another.

9.3.2 Leibniz-Clarke Correspondence

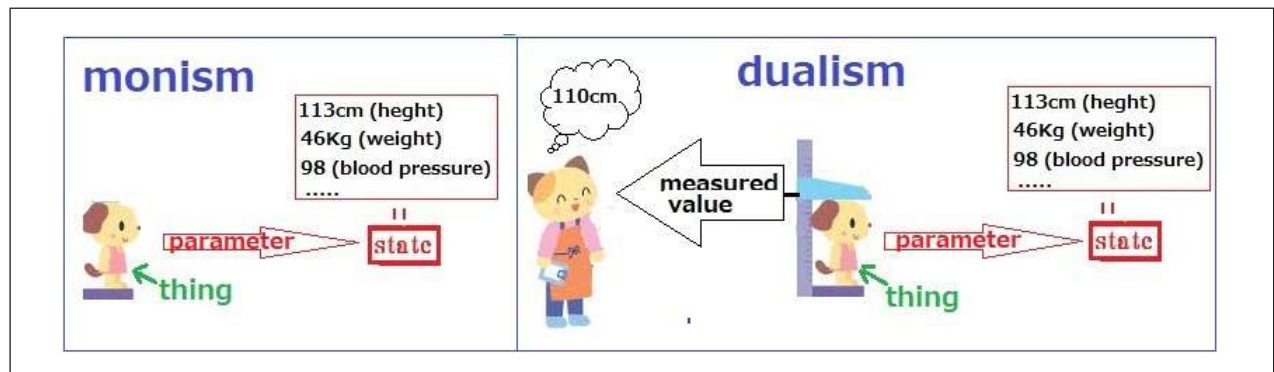

Please read the following while looking at the above figure.

The above argument urges us to recall Leibniz-Clarke Correspondence (1715–1716: *cf.* [1]), which is important to know both Leibniz’s and Clarke’s (=Newton’s) ideas concerning space and time.

- (G) [The realistic space-time] **Newton’s absolutism** says that the space-time should be regarded as a receptacle of a “thing.”
Therefore, even if “thing” does not exist, the space-time exists.

On the other hand,

- (H) [The metaphysical space-time] **Leibniz’s relationalism** says that
 - (H₁) Space is a kind of state of “thing”.
 - (H₂) Time T is also a kind of state space \mathbb{R} (or, \mathbb{Z}), which represents an order of occurring in succession which changes one after another.

Therefore, I regard this correspondence as

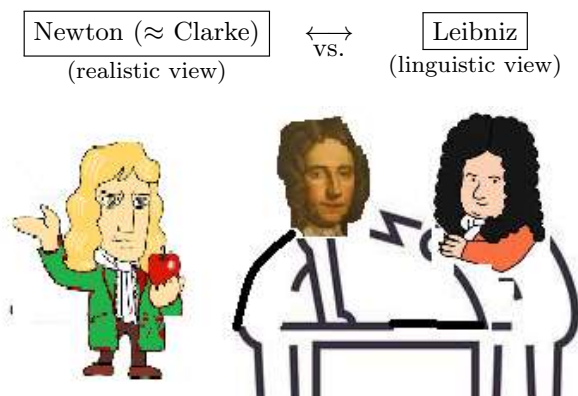

which should be compared to

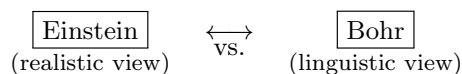

(also, recall Note 4.3).

Again, we emphasize that Leibniz’s relationalism in Leibniz-Clarke correspondence is clarified in quantum language, and it should be regarded as one of the most important parts of the linguistic Copenhagen interpretation of quantum mechanics.

Many scientists may think that

- Newton’s assertion is understandable, in fact, his idea was inherited by Einstein. On the other,
- Leibniz’s assertion is incomprehensible and literary. Thus, his idea is not related to science.

However, recall the classification of the world-description (Classification 1.9):

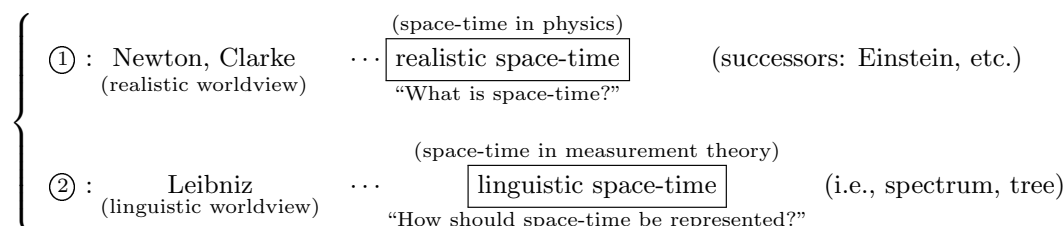

in which Newton and Leibniz respectively devotes himself to ① and ②. Although Leibniz’s assertion is not clear, we believe that

- Leibniz found the importance of “linguistic space and time” in science,

Also, it should be noted that

- (#₁) **Newton proposed the scientific language called Newtonian mechanics,**
on the other hand,
Leibniz could not propose a scientific language

After all, we conclude that

- (#₂) **the cause of philosophers’ failure is not to propose a language.**

Talking cynically, we say that

- (#₃) Philosophers continued investigating “linguistic interpretation” (=“how to use Axioms 1 and 2”)

without language (i.e., Axiom 1(measurement:§2.7) and Axiom 2(causality:§10.3)).

Table 1.1 : realistic worldview vs. idealistic worldview

dispute \ [R] vs. [L]	Realistic worldview (monism, realism, no measurement)	Idealistic worldview (dualism, idealism, measurement)
Ⓐ: motion	Hērakleitos	Parmenides
Ⓑ: Ancient Greece	Aristotle	Plato
Ⓒ: Problem of universals	"Nominalismus" (Ockham)	"Realismus" (Anselmus)
Ⓓ: space-time	Newton	Leibniz
Ⓔ: quantum theory	Einstein	Bohr
Ⓕ: philosophy of science	Carnap	Quine

Ⓐ is my fiction, Ⓒ is a confusion. Ⓓ is the Leibniz=Clarke correspondence (*cf.* Sec. 9.3.2), Ⓔ is Bohr-Einstein debates. Quantum language is proposed as one of answers to Bohr-Einstein debates (*cf.* ref. [71]). Quantum language is proposed as one of answers to Bohr-Einstein debates (*cf.* ref. [71]). Ⓕ: Quine understood the spirit of the linguistic Copenhagen interpretation (i.e., "If you don't measure it, you don't know anything") in the Carnap=Quine debate (*cf.* Sec. 13.3).

- ♠**Note 9.6.** (i): Spinoza (1632-1677) is a popular philosopher, but he has nothing to do with quantum language. Therefore, I did not mention Spinoza.
- (ii): Leibniz is an undisputed genius. I think Leibniz is the only one who can discuss space-time on equal terms with Newton. Unfortunately, however, I cannot understand his "monadology". As I made clear in this section, Leibniz's space-time is the space-time of quantum language. If Leibniz had discussed his space-time in his monadology, I think I could have understood his monadology. And I hope that with some modification of the monadology, it would have become clear that "monad = state" equals quantum language. I hope that researchers in monadology will study the relationship between quantum language and monadology.

9.4 Subjective idealism: Berkeley, "To be is to be perceived"



9.4.1 Priest: Berkeley

Berkeley (1685 -1753) is famous as follows.

(A₁) Berkeley is a priest, and he interpreted Locke's primary quality as the state of things that come from a supernatural power such as a god. Thus his philosophy is called subjective idealism.

Table9.2 The key-words of worldviews (*cf.* Assertion 1.14)

mind-matter dualism	[A](= mind)	[B](between A and B)	[C](= matter)
Plato	actual world	Idea	/ [idea world]
Descartes	I, mind, brain	body	/ [matter]
Locke	mind	secondary quality	primary quality [matter]
Berkeley	mind	secondary quality	/ [God]
quantum language	measured value	observable	state [system]

Thus I don't think that

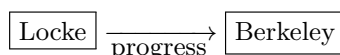

though there may be people who want to believe that.

However, he is an important figure in the following sense.

(A₂) Berkeley indicated that Newton's definition of differentiation " $\lim_{h \rightarrow 0} \frac{f(x+h)-f(x)}{h}$ " is not complete

(A₃) He said "To be is to be perceived", which represented the essential spirit of dualism. Also, "If a tree falls in a forest and no one is around to hear it, does it make a sound?" is said to be due to Berkeley.

Summing up, Berkeley was always the standpoint of anti-Newton (= anti-realism).

- If we think that modern philosophy (from Descartes to Kant) has significance as a buffer zone of Christianity with Newtonian mechanics, we can conclude that Berkeley is honest.

♠**Note 9.7.** The mathematical definition of \lim_0 (i.e., (ϵ, δ) -definition of limit) was more important than Newton thought, and it was discovered one hundred and tens of years later (by Cauchy (1789-1857), Weierstrass (1815-1897), etc.). When I think from now on, there was a possibility that Leibniz discovered it, but he was busy in the other things.

9.4.2 (A₃): To be is to be perceived

Consider the following saying:

(B₁) There is no science without measurement
 (≈ [To be is to be perceived])

Everyone may believe that this saying (B₁) is absolutely true. In fact, the importance of "measurement" is emphasized as follows (*cf.* Sec. 1.1).

$$\begin{aligned}
 \text{[(=quantum language) measurement theory]} &= \text{[Axiom 1] measurement} + \text{[Axiom 2] causal relation} \\
 &+ \text{[linguistic Copenhagen interpretation]} \\
 &\quad \text{[the manual to use Axioms 1 and 2]} \quad (9.2)
 \end{aligned}$$

But, it is Genius Newton (and Einstein) that neglect this absolute truth (H₁). In fact, Newtonian mechanics is formulated as follows.

$$\text{[Newtonian mechanics]} = \text{[No measurement]} + \text{[Newtonian kinetic equation] causal relation} \quad (9.3)$$

Here, note that Newton removed "measurement" from (9.2) in spite of the maxim that there is no science without measurement. The insightfulness of Newton is surprising. A genius isn't confused by "the absolute maxim (B₁)". The following is my fiction:

(B₂) "Exclusion of measurement" is the conclusion reached by the deep consideration of Newton. However, Berkeley, an excellent controversialist of anti-Newton, considered that the exclusion was a weak point of Newtonian mechanics. And he said

To be is to be perceived

This is the golden rule of anti-Newtonianism (i.e., anti-physicalism, idealism). The opposing structure: [Newton vs. Berkeley] continues to [Einstein vs. Bohr] as mentioned in next section.

9.4.3 "Einstein-Tagore Meeting" and "Bohr-Einstein debates"

Concerning "realistic worldview vs. idealistic worldview", Einstein-Tagore (poet, thinker in India) meeting in 1930 is famous, in which they asserted as

- Tagore: "Truth is always limited by human perception."
- Einstein: "Truth is independent of our consciousness, For instance, if nobody is in this house, yet that table remains where it is^{*1}."

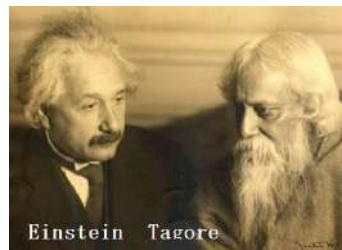

In the above, Tagore's assertion is similar to Berkeley's "To be is to be perceived", which belongs to the situation of dualistic idealism(=idealistic worldview).

On the other hand, Einstein's saying:

^{*1} Einstein often said this kind of statement at various places, for example, "Does the moon disappear when I'm not looking at it?"

(C₁) if nobody is in this house, yet that table remains where it is (= Does the moon disappear when I'm not looking at it?)

is the same as

(C₂) Truth is independent of us (= realistic worldview)

Thus, Einstein and Newton are similar, in the sense that

Truth is independent of human being (i.e., physics holds without measurement)

Therefore, it should be noted that (9.3) is significant. In this paper, we are not concerned with Bohr-Einstein debates in quantum mechanics (in order to solve this problem, I proposed quantum language), (cf. ref. [71]). However, Bohr-Einstein debates is similar to the above. Thus, summing up, we see:

realistic worldview vs. idealistic worldview (cf. Table 1.1 in Assertion 1.12)

Realistic worldview [monism, realism, no measurement]	Idealistic worldview [dualism, idealism, measurement]
Newton	Berkeley
Newton (and Clarke)	Leibniz
Einstein	Tagore
Einstein	Bohr

Now, concerning Bohr-Einstein debates, The impression that Einstein lost now has been left, but the author does not think so (cf. ref. [71]).

♠**Note 9.8.** Omitting "Newton vs. Berkeley" and "Einstein vs. Tagore" in the above table, I repeatedly mention the following table (cf. Assertion 1.12):

Table 1.1 : realistic worldview vs. idealistic worldview

dispute \ [R] vs. [L]	Realistic worldview (monism, realism, no measurement)	Idealistic worldview (dualism, idealism, measurement)
Ⓐ: motion	Hērakleitos	Parmenides
Ⓑ: Ancient Greece	Aristotle	Plato
Ⓒ: Problem of universals	"Nominalismus"(Ockham)	"Realismus"(Anselmus)
Ⓓ: space-time	Newton	Leibniz
Ⓔ: quantum theory	Einstein	Bohr
Ⓕ: philosophy of science	Carnap	Quine

Ⓐ is my fiction, Ⓒ is a confusion. Ⓓ is the Leibniz=Clarke correspondence (cf. Sec. 9.3.2), Ⓔ is Bohr-Einstein debates. Quantum language is proposed as one of answers to Bohr-Einstein debates(cf. ref. [71]). Ⓕ: Quine understood the spirit of the linguistic Copenhagen interpretation (i.e., "If you don't measure it, you don't know anything") in the Carnap=Quine debate (cf. Chap. 12).

♠**Note 9.9.** In Japan, I learned the dualistic proposition: "If a tree falls in a forest and no one is around to hear it, does it make a sound?" in a Zen dialogue (i.e., a question-and-answer exchange between Zen priests and their followers). Zen is one school of Buddhism. In modern Japan, most people may think that Zen monologue is a kind of wordplay.

If a tree falls in a forest and no one is around to hear it, does it make a sound?



George Berkeley



9.4.4 Bohr-Einstein debates: Do the laws of physics require measurement?

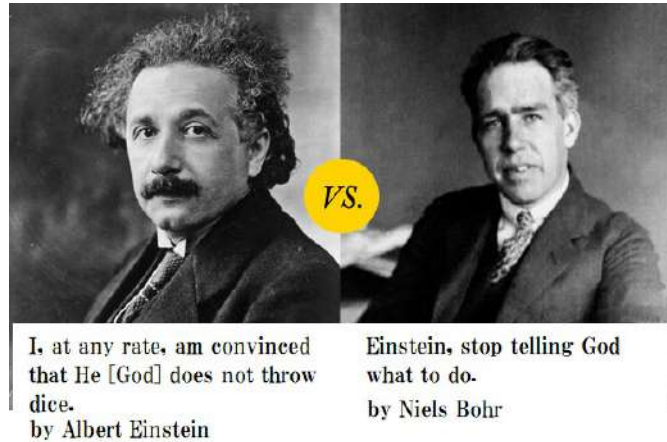

For Bohr-Einstein debates, I discussed in ref. [71]. However, I would like to write something in this section. Almost people agree to the following maxim:

- There is no science without measurement

However, genius Newton neglected this maxim, and proposed Newtonian mechanics as follow: Newtonian mechanics and quantum mechanics are formulated as follows:

$$(\#1) \text{ Newtonian mechanics} = \boxed{\text{Nothing}} + \boxed{\text{Causality}}$$

(Newtonian equation)

On the other hand, quantum mechanics is formulated as follows.

$$(\#2) \text{ quantum mechanics} = \boxed{\text{Measurement}} + \boxed{\text{Causality}}$$

(Born's quantum measurement) (Heisenberg (and Schrödinger) equation)

N. Bohr, the leader of the Copenhagen school, agreed to the (#2), on the other hand, A. Einstein asserted that measurement is not needed for physics since he believed in

(#3) *The moon is there whether one looks at it or not.*

in Einstein and Tagore's conversation. So far, many experimental results support Bohr. However, if Einstein says the following (#4), everyone has no choice but to shut up.

(#4) Then, did the laws of physics not work before the birth of humankind?

Thus, I think that Bohr-Einstein debates is not settled yet.

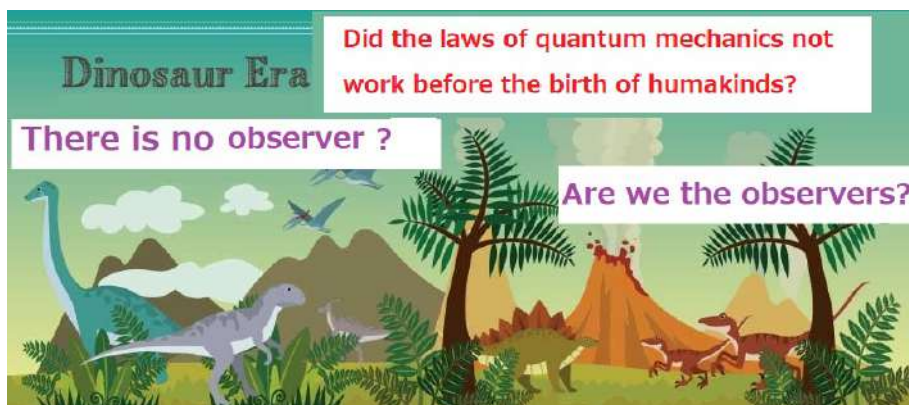

9.5 Qualia problem and Brain in a vat argument

This section was written with reference to the following.

- [73]:Ishikawa, S: Leibniz-Clarke correspondence, Brain in a vat, Five-minute hypothesis, McTaggart's paradox, etc. are clarified in quantum language Open Journal of philosophy, Vol. 8, No.5 , 466-480, 2018, DOI: 10.4236/ojpp.2018.85032
(<https://www.scirp.org/Journal/PaperInformation.aspx?PaperID=87862>)
[Revised version] (<https://philpapers.org/rec/ISHLCB>)
(http://www.math.keio.ac.jp/academic/research_pdf/report/2018/18001.pdf)

9.5.1* The problem of qualia

Jack and Betty were looking at the pink flowers. Betty had the following question (i.e., qualia problem) .

(‡) Is the "pink" that I felt the same as the "pink" that Jack felt?



This question can be answered in the following way.

[(A): Scientific answer (To measure is to believe)]:

With Jack and Betty as test subjects, you (i.e., scientist) can perform various tests (colorblindness test, EEG measurement, electroretinogram, etc.). And if no difference is found in any of the tests, we can conclude that each "pink" felt by Jack and Betty is the same.

♠**Note 9.10.** In science, "absolute" or "100% In other words, no matter how carefully you investigate, you can never be 100%

[(B): Non-scientific argument (To think is not to measure)]:

However, Betty may say:

(b₁) I like the "pink" so much that I has pink walls in my room too. Jack loves blue and always wears blue. Therefore, I find "pink" to be more beautiful than Jack.

However, the scientist may say that

(b₂) According to the linguistic Copenhagen interpretation (*cf.* (E₁) in Sec. 1.1.2), you (= Betty) are not qualified to be an observer. Even if you are qualified to be an observer, you should perform the same tests as in [(A):Scientific answer] for Jack and yourself as test subjects, that is, various tests (colorblindness test, EEG measurement, electroretinogram, etc.). However, if so, it is the same as the situation [(A):Scientific answer].

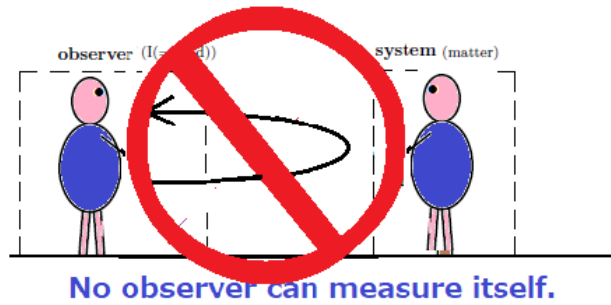

Then, Betty says:

(b₃) OK. I (=Betty) can understand. In short, the measurements I can only make against myself are not scientific measurements. Or, a measurement that only I can make is not a measurement. Is it OK?

Then, the scientist says to Betty:

(b₄) That's right.

□

♠**Note 9.11.** In the book "The astonishing hypothesis" (by F. Click (the most noted for being a co-discoverer of the structure of the DNA molecule in 1953 with James Watson)), Dr. Click said that

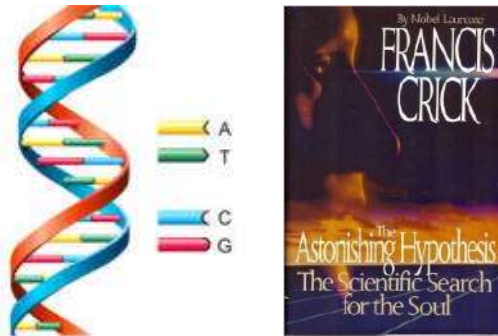

(#₁) *You, your joys and your sorrows, your memories and your ambitions, your sense of personal identity and free will, are in fact no more than the behavior of a vast assembly of nerve cells and their associated molecules.*

That is, he believed the monistic realism such as

(#₂) the movement of the human spirit is also a kind of physical phenomenon.

I agree to his opinion. And I believe that with the development of brain science, even consciousness can be measured in the future. However, no matter how much brain science develops, I believe that there is no solution to the qualia problem other than the one described above.

9.5.2* Brain in a vat argument

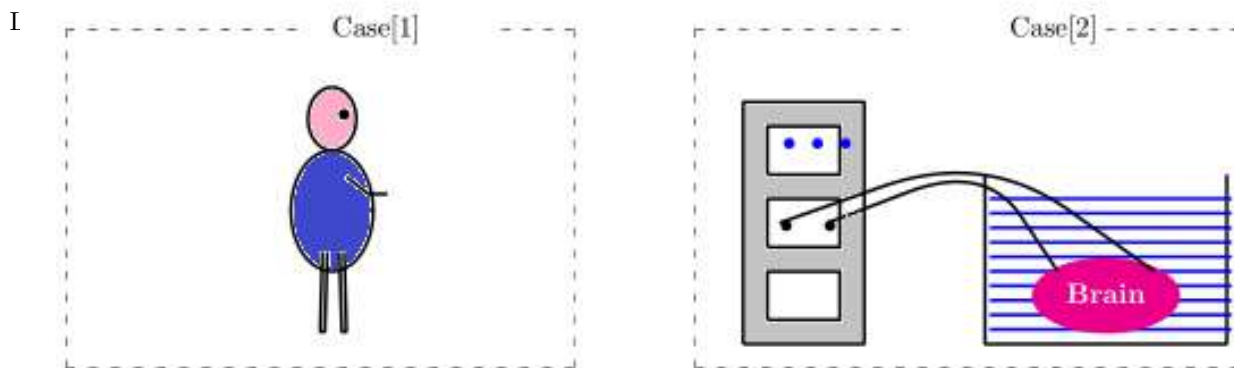

Figure 8.1: [Brain in a vat]

There is a possibility of the following.

- (C₁) a mad scientist has removed your brain, and placed it into a vat of liquid to keep it alive and active. The scientist has also connected your brain to a powerful computer, which sends neurological signals to the brain in the way the brain normally receives them. Thus, the computer is able to send you the data to your brain to fool you into believing that you are still walking around a forest.

Then, you may say;

- (C₂) "Am I a brain in a vat?" Or, "Can I check whether I am a brain vat or not?"

And you think:

- (C₃) "I cannot decide if I am a brain vat or not".

That is, "I cannot decide if I am in Case[1] or Case[2]?"

Therefore, since (C₃) is true, you may say:

- (C₄) "I cannot know if I have a limb or not."

Then, we have the following problem:

Problem 9.3. [The problem concerning "Brain in a vat"]

- Is the (C₄) true?

[Answer]:

The (C₃) clearly is true since (C₁) is assumed. However, (C₄) is not true. That is because

- (#₁) if you are in Case[1], you find that you have a limb.
- (#₂) if you are in Case[2], you also find that you have a limb (under the assumption (C₁)).

Thus, (C₄) is wrong.

[Alternative explanation]:

For completeness, let's rephrase the same thing as follows. You ask someone "Do I have a limb?" If they reply, "Of course you have," you can be sure that you have a limb. In short,

- you only have to believe in the measurement results.

Or,

- To be is to be perceived.

This is just the linguistic Copenhagen interpretation (*cf.* Sec. 9.4.3: Einstein-Tagore meeting). □

♠**Note 9.12.** Recall the worldviewism (in Sec 1.3.1), which says

- (#) Without the principle (i.e., the worldview), we can't say anything

Under the worldview called the quantum mechanical worldview (i.e., quantum language), we have seen the followings.

- What is probability (or, measurement, causality)? *cf.* Sec. 1.1.1)
- The solution of Zeno paradox (Flying arrow), (*cf.* Sec. 2.4.2)
- The solution of Zeno paradox (Achilles and a tortoise), (*cf.* ref. [45], or Sec. 2.4.3)

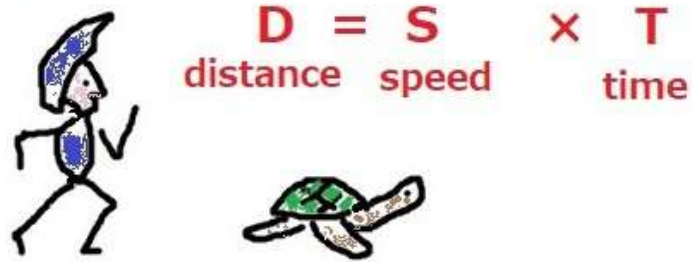

("to solve Zeno paradox" = "to understand DST-formula" (cf. Sec. 2.4.3)

- the measurement theoretical understanding of Plato's allegory of the sum , (cf. Sec. 3.3.2)
- Plato's Idea theory ≈ Zadeh's fuzzy theory ≈ Sausuure's linguistic theory (cf. Sec. 3.5.3)
- Syllogism holds in classical systems, but not in quantum systems (cf. Sec. 4.3.2)
- Only the present exists (cf. Sec. 6.1.2)
- What is the problem of universals? (cf. Sec. 6.5.1)
- What is Geocentrism vs. Heliocentrism? After all, the worldviewism (cf. Sec. 7.4.2)
- Two (scientific or non-scientific) interpretations of I think, therefore I am.(cf. Sec. 8.2.2)
- The problem of qualia (cf. Sec. 9.5.1)
- Brain in a vat argument (cf. Sec. 9.5.2)

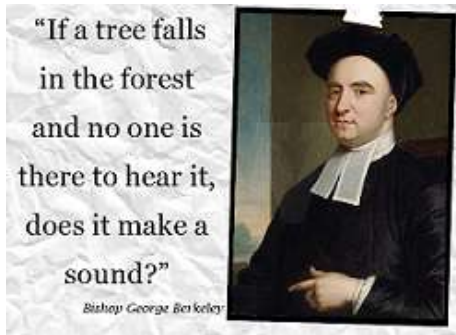

9.6 Hume; skeptic who didn't measure, "A Treatise of Human Nature"

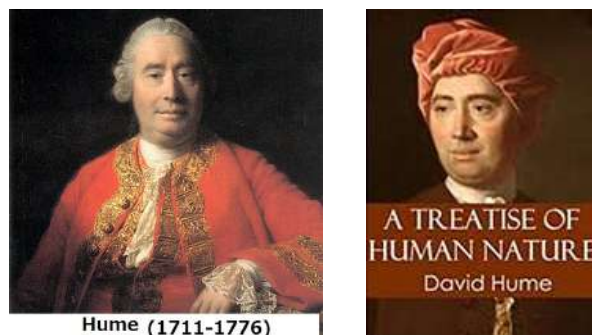

9.6.1 The review of Descartes

Let us review Descartes and Locke.

(A₁) Descartes found the indisputable truth, i.e., cogito proposition "I think, therefore I am". Therefore, he thought that everything derived from cogito proposition can be trusted. That is, he started from "the existence of I".

The purity of Descartes is mind-blowing, but in the first place "I think, therefore I am" and "the existence of I" is suspicious (*cf.* Note 1.7, or Proposition 8.3 in Sec.8.2). Hence, the following is also suspicious:

(A₂) "The existence of I" is certain. **Therefore**, the matters that I perceive exist. And further, Descartes introduced "body (= sensor organ)" which mediates between "I" and "matter". After all, he reached and discussed "mind-matter dualism" (= Descartes problem 8.5), that is, "the problem of mind-matter dualism" and "mind-body problem".

Although Descartes problem 8.5 is, from the scientific point of view, a barren discussion, Descartes philosophy was supported a lot of people. Since the philosophy of worldview is a kind of fashion or "model-change", to be supported by many people is the most important.

(A₃) If Descartes and Locke asserted that

- there is a possibility that mind-matter dualism (with keywords "matter", "I (= mind, brain)", "body(=secondary quality)", "matter") succeeds.

then, I think that they are, from the quantum linguistic point of view, true.

If so, we may affirmatively answer Problem 8.6, i.e.,

Can the direction: "Descartes $\xrightarrow{\text{model-change}}$ Locke" be regarded as progress?

The following figure is near to the linguistic Copenhagen interpretation,

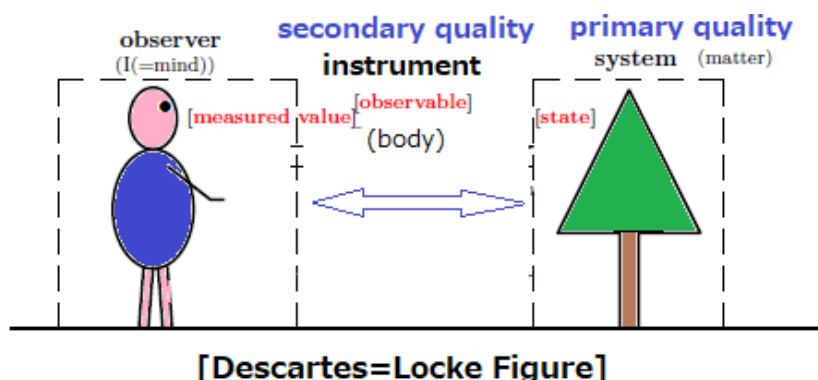

That is, we can assert that

Plato $\xrightarrow[\text{model-change}]{\text{progress}}$ Descartes $\xrightarrow[\text{model-change}]{\text{progress}}$ Locke

9.6.2 Hume's straying [Less than brain science]; Hume's wordplay

Descartes philosophy is a philosophy which has the risk of entering the science. In fact, Hume approached the zone of science. In "A Treatise of Human Nature" (1739), Hume pointed out the leap in logic of **"Therefore"** in the above (A₂). As Hume says, it is sure that "the existence of matter" cannot be derived from "the existence of I"*². Also, it is not guaranteed that "matter I perceive" is equal to "true matter". Thus, the existence of "matter" is doubtful. However, it is sure that I feel so. Hume states that

(B) "a bundle of perceptions" (= brain circuit) exists

That is,

(C) "matter" and "causal relation" are a kind of bundle of perceptions

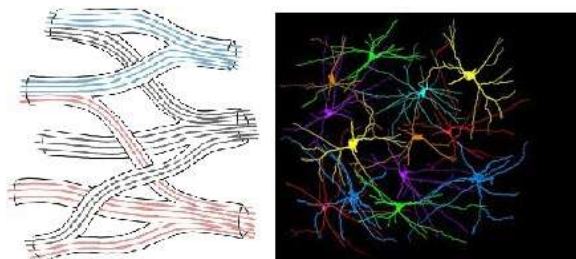

bundle of perceptions ?

I think that the above "(A₁)→(B)→(C)" is self-referential in the wide sense. That is,

- "(A₁)→(B)→(C)" is a kind of psychological illusion as having been able to understand all events by the word "bundle of perceptions".

To enjoy such convinced form may also be a pleasure of philosophy. Thus,

(D) It is said Hume's philosophy is the goal of British Empiricism

Hume took the faultfinding of Descartes, and Hume has entered into wrong direction "brain science". The research of "the bundle of perceptions" belongs to brain science.

(E) If Hume was a scientist, he was too early for 300 years

The cause of victory of Galileo was a "telescope". Hume studied "brain science" without measuring instrument in spite that Hume thought that he himself is a philosopher and not scientist. Hence, I think that

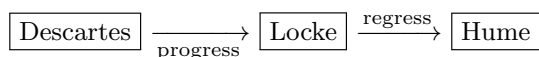

However, Hume was revived by Kant (*cf.* next Chapter 10: Kant: Copernican revolution). Then, I want to say that



9.6.3 Hume; The causality problem

It is a matter of course that the representation of "causal relation" is the most important theme in worldview. In Newtonian mechanics, the causality is represented by Newtonian kinetic equation. In Descartes=Kant philosophy, the representation of "causal relation" is as follows.

(#₁) **[Cognitive causality]:** David Hume, Immanuel Kant, etc. thought as follows. :

We cannot say that "causality" actually exists in the world, or that it does not exist in the world. And when we think that "something" in the world is "causality", we should just believe that the it has "causality". Hume argues that scientific wisdom is a product of **"habitual thinking"**, not objective truth.

*² This kind of logic is a typical self-reference (*cf.* Note 1.7, or Proposition 8.3 in Sec.8.2). Thus, Hume's logic (or generally, philosophical logic, wordplay) in ordinary language cannot be trusted. That is, it is only a wordplay.

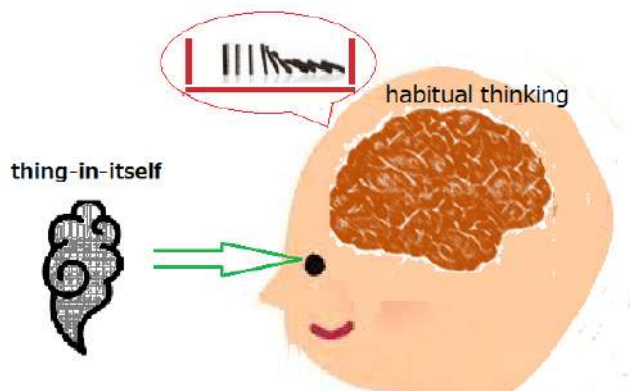

Most readers may regard this as "a kind of rhetoric", however, several readers may be convinced in "Now that you say that, it may be so." Surely, since you are looking through the prejudice "causality", you may look such. This is Kant's famous "Copernican revolution" (i.e., "Kant was awakened from his dogmatic slumber by Hume's idea and came up with the Copernican revolution", this will be discussed in Sec. 10.2 [What is causality?]), that is,

"cognition constitutes the world."

which is considered that the cognition circuit of causality is installed in the brain, and when it is stimulated by "something" and reacts, "there is causal relationship." Probably, many readers doubt about the substantial influence which this (♯) had on the science after it. However, in this book, I adopted the friendly story to the utmost to Kant. Hume served as a bridge between Locke and Kant. Thus we think that

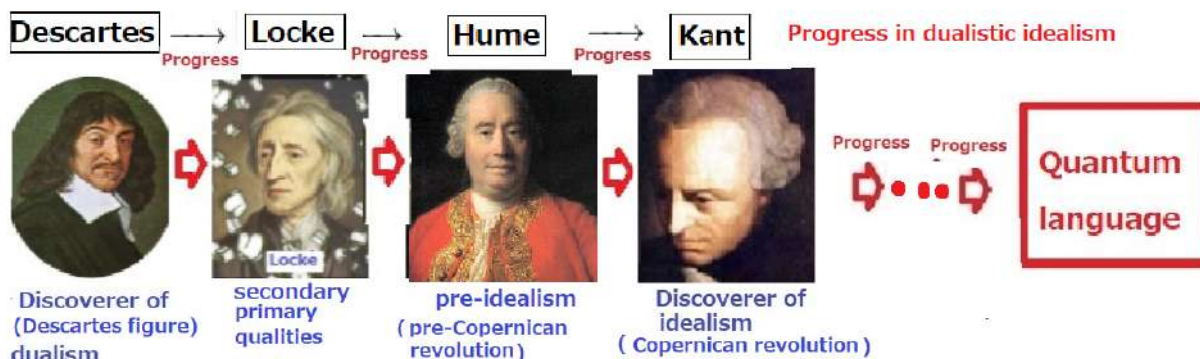

This will be discussed again in the next chapter (cf. Section 10.3 What is causality?).

♠**Note 9.13.** In the book "The astonishing hypothesis" (by F. Click (the most noted for being a co-discoverer of the structure of the DNA molecule in 1953 with James Watson)),



Dr. Click said that

(♯₁) *You, your joys and your sorrows, your memories and your ambitions, your sense of personal identity and free will, are in fact no more than the behavior of a vast assembly of nerve cells and their associated molecules.*

That is, he believed the monistic realism such as

(♯₂) the movement of the human spirit is also a kind of physical phenomenon.

Also, since the title of his book is "The astonishing hypothesis", Click must have felt that

(♯₃) Descartes philosophy is based on dualistic realism.

However, the definition of "realism" is different from our definition (Definition 1.8), where we consider that realism is a worldview based on experimental verification. It is clear that Descartes, Locke, Hume were not concerned with about experimental validation. That is, they are not scientists but philosophers. Therefore, it may be "astonishing" by common sense, but it's not "astonishing" by our definition. In Chapter 11, we will show that the monistic realism and the dualistic idealism (i.e., quantum language) are compatible.

9.7 Hume’s problem of induction in the quantum mechanical worldview

♠**Note 9.14.** It is important to doubt a certain worldview, but you need to be careful about how you doubt it. For example, some may be interested in the justifications of the followings:

- (#₁) Newtonian mechanics has been right to this day. So, will the Newtonian mechanics be right tomorrow?
- (#₂) Quantum language have been very useful to this day. So, will quantum language be useful tomorrow?

The justification problem of these may be called Hume’s problem of induction, though David Hume suspected the justification of induction. It cannot be said that these are meaningless. In fact, the following (#₃) (which is regarded as the particular case of (#₁)) was just Einstein’s interest.

- (#₃) Newtonian mechanics has been right to this day. However, Is Newtonian mechanics correct when particles move at very high speeds?

However, Einstein was praised for advocating the theory of relativity. He would not have been evaluated if he had only doubted as in (#₃). It is important to doubt, but if there is no result, it is a word-play. I think many philosophers have enjoyed wordplay on Hume’s problem of induction.

Thus, in this section, we devote ourselves to

Hume’s problem of induction in the framework of quantum language.

9.7.1* The solution of Hume’s problem of induction

(Cf. the W^* -algebraic formulation in (A₂) in Sec 1.5) is used in this section.)

This section was written with reference to the following.

- [75]:Ishikawa, S: Philosophy of science for scientists; The probabilistic interpretation of science Journal of quantum information science, Vol. 9, No.3 , 140-154, DOI: 10.4236/jqis.2019.93007 (<https://www.scirp.org/Journal/paperinformation.aspx?paperid=95447>)

For example, consider the following inferences (= inductive inferences):

- (A₁) Until now, the sun has always risen in the east. So, tomorrow the sun will rise in the east again.
- (A₂) When a coin is thrown ten times, we get (H,H,T,H,H,H,H,H,H,T) (where H=”head”, T=”tail”). Thus, we infer that ”H” will be obtained with probability 8/10 by the next coin-tossing
- (A₃)



Here, our present problem is

- (B) Can such induction (= inductive inference) as above be justified?

Recall that our spirit in this paper is ”No scientific arguments without worldview”, or, ”true justification” = ”justification under a certain worldview”.

♠**Note 9.15.** In Note 7.1, we say that Bernoulli’s achievement (i.e., the discovery of the law of large numbers) equals Galileo’s achievement. That is,

$$\left\{ \begin{array}{l} \text{Scientific pioneer in the realistic worldview} \cdots \text{Galileo} \\ \text{Scientific pioneer in the idealistic worldview} \cdots \text{J. Bernoulli} \end{array} \right.$$

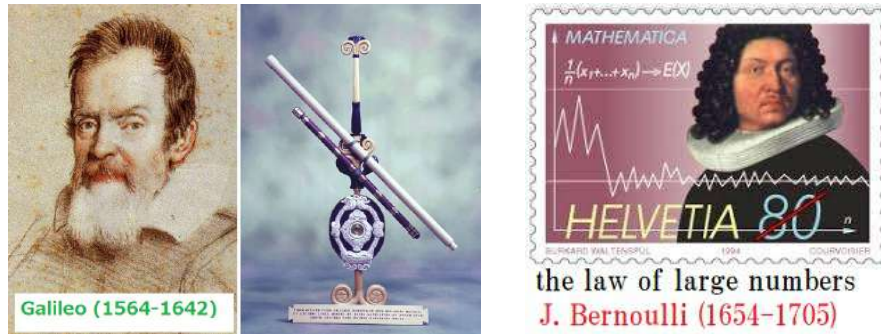

The reason that we consider so is that Galileo=Newton mechanics and Bernoulli's law of large numbers have the power to predict the future. Further we think that there are essentially only two of these theories that have the power to predict the future. Therefore, we are convinced that Hume's problem of induction and Bernoulli's law of large numbers are closely related as mentioned below.

In this section we show that the justification is easily solved in our quantum mechanical worldview. If we expect a scientific answer to Hume's problem, we must start with the scientific definition of "the uniformity principle of nature", i.e., the following Definition 9.4 [The uniformity principle of nature]. Some may feel that the uniformity principle of nature (i.e., the condition in Definition 9.4) is quite different from what Hume thought. However, we think that it is impossible to propose the different quantitative definition of the uniformity principle of nature that leads to a result like Theorem 9.6 [Inductive reasoning] (i.e., *If similar measurements are performed, the similar measured values are obtained*).

Definition 9.4. [The uniformity principle of nature] For simplicity, consider a classical basic structure $[C(\Omega) \subseteq L^\infty(\Omega, \nu) \subseteq B(L^2(\Omega, \nu))]$ such that Ω is compact and $\nu(\Omega) = 1$. (Cf. the W^* -algebraic formulation in (A_2) in Sec 1.5) is used in this section) A family of measurements $\{M_{L^\infty(\Omega, \nu)}(O_i := (X, \mathcal{F}, F_i), S_{[\omega_i]}) \mid i = -n, -n + 1, \dots, -1, 0, 1, 2, \dots, N\}$ is said to satisfy the *uniformity principle of nature* (concerning μ), if there exists a probability space (X, \mathcal{F}, μ) such that

$$[F_i(\Xi)](\omega_i) = \mu(\Xi) \quad \forall \Xi \in \mathcal{F}, \forall i = -n, -n + 1, \dots, -1, 0, 1, 2, \dots, N$$

Remark 9.5. [No scientific arguments without worldview] The uniformity principle of nature is not a principle (= axiom) of a worldview, and thus it should be defined as an assumption under a certain world description. The argument without world description leads contraction as follows.

- (C₁) It worked well, assuming the uniformity principle of nature up to now.
- (C₂) So it will continue to work.
- (C₃) Thus, the uniformity principle of nature can be justified.

This is not true, since it is a cyclic argument. That is, the above is a wordplay.

Under the above definition, we assert the following theorem (essentially the same as the law of large numbers), which should be regarded as the fundamental theorem in philosophy of science. Also, recall that the law of large numbers is illustrated as follows.



Theorem 9.6. [Inductive reasoning, the quantum linguistic solution of Hume's problem of induction]. Let

$[C(\Omega) \subseteq L^\infty(\Omega, \nu) \subseteq B(L^2(\Omega, \nu))]$ be a basic structure such that Ω is compact and $\nu(\Omega) = 1$. Assume that a family of measurements $\{\mathbf{M}_{L^\infty(\Omega, \nu)}(\mathbf{O}_i := (X, \mathcal{F}, F_i), S_{[\omega_i]}) \mid i = -n, -n+1, \dots, -1, 0, 1, 2, \dots, N\}$ satisfies the uniformity principle of nature (concerning μ). Let $(x_{-n}, x_{-n+1}, \dots, x_{-1}, x_0, x_1, \dots, x_N) \in \times_{i=-n}^N X$ be a measured value by the parallel measurement $\otimes_{i=-n}^N \mathbf{M}_{L^\infty(\Omega, \nu)}(\mathbf{O}_i := (X, \mathcal{F}, F_i), S_{[\omega_i]})$. Then, we see that

$$\frac{\#\{k \mid x_k \in \Xi, k = -n, -n+1, \dots, -1, 0\}}{n} \approx \mu(\Xi) (= [F_i(\Xi)](\omega_i))$$

$$(\Xi \in \mathcal{F}, i = -n, -n+1, \dots, -1, 0, 1, 2, \dots, N) \tag{9.4}$$

where n is sufficiently large. Here $\#\{\Theta\}$ is the number of elements in a set Θ . Roughly speaking, from the quantum linguistic point of view, I think that

inductive reasoning \approx the law of large numbers

Proof. Let $\Xi_i \in \mathcal{F}$ ($i = -n, -n+1, \dots, -1, 0, 1, \dots, N$). **Axiom 1 [measurement] (in Section 1.1)** says that the probability that a measured value $(x_{-n}, x_{-n+1}, \dots, x_{-1}, x_0, x_1, \dots, x_N)$ obtained by the parallel measurement $\otimes_{i=-n}^N \mathbf{M}_{L^\infty(\Omega, \nu)}(\mathbf{O}_i := (X, \mathcal{F}, F_i), S_{[\omega_i]})$ belongs to $\times_{i=-n}^N \Xi_i$ is given by $\times_{i=-n}^N [F_i(\Xi_i)](\omega_i) = \times_{i=-n}^N \mu(\Xi_i)$. Thus, the sequence $\{x_i\}_{i=-n}^N$ can be regarded as independent random variables with the identical distribution μ . Hence, using the law of large numbers, we can immediately get the formula (9.4). Also, this theorem is a direct consequence of the law of large numbers for parallel measurements (cf. refs. [42], or § 4.2 in ref.[71]). \square

♣**Note 9.16.** The reader may wonder why philosophers have always failed to formulate inductive reasoning? Because they did not first declare a worldview and then formulate induction under that worldview. We cannot say anything without a worldview (such as quantum language), that is,

there is no formulaion without a worldview

Remark 9.7. (i): Recall that the law of large numbers (which is almost equivalent to Theorem 9.6) says that

”frequency probability” = ”the probability in **Axiom 1 [measurement] (in Section 1.1)**”

(cf. ref. [42]), though the probability in **Axiom 1 [measurement] (in Section 1.1)** has the several aspects. Also, note that the law of large numbers in statistics (cf. ref. [83]) has already been accepted as the fundamental theorem in science. Therefore, even if Theorem 9.6 ([Inductive reasoning]+(9.4)) is called the fundamental theorem in philosophy of science, we don't think it's exaggerated. We believe that our proposal (i.e., Theorem 9.6) is completely true in our worldview. Thus, we think that the solution of Hume's problem of induction was practically already found as the law of large numbers. In the framework of our worldview, we are convinced that the above is the definitive solution to Hume's problem. However, there may be another idea if some start from another worldview. Hence, as described at the end of this paper, we hope that many philosophers propose various mathematical foundations of scientific philosophy, in which Hume's problem of induction are discussed from the various viewpoints.

(ii): In Definition 9.4 [The uniformity principle of nature] and Theorem 9.6 [Inductive reasoning], we consider the family of measurements $\{\mathbf{M}_{L^\infty(\Omega, \nu)}(\mathbf{O}_i := (X, \mathcal{F}, F_i), S_{[\omega_i]}) \mid i = -n, -n+1, \dots, -1, 0, 1, 2, \dots, N\}$. This may be too general. Usually, it suffices to consider that $\{\mathbf{M}_{L^\infty(\Omega, \nu)}(\mathbf{O}_i := (X, \mathcal{F}, F), S_{[\omega_i]}) \mid i = -n, -n+1, \dots, -1, 0, 1, 2, \dots, N\}$, i.e., $F = F_i$ ($-n \leq \forall i \leq N$).

(iii): It may be understandable to consider two measurements: $\otimes_{i=-n}^0 \mathbf{M}_{L^\infty(\Omega, \nu)}(\mathbf{O} := (X, \mathcal{F}, F_i), S_{[\omega_i]})$ and $\otimes_{i=1}^N \mathbf{M}_{L^\infty(\Omega, \nu)}(\mathbf{O} := (X, \mathcal{F}, F_i), S_{[\omega_i]})$. The reason that we do not consider two measurements is due to the linguistic Copenhagen interpretation (G_1), i.e., *only one measurement is permitted*.

Example 9.8. [Coin tossing]. Let us discuss the unfair coin tossing as the most understandable example of Theorem 9.6 [Inductive reasoning]. Consider a basic structure $[C(\Omega) \subseteq L^\infty(\Omega, \nu) \subseteq B(L^2(\Omega, \nu))]$. Let $\{\omega_i\}_{i=-n}^N$ be a sequence in Ω , where ω_i is the state of i -th coin tossing ($i = -n, -n+1, \dots, 0, 1, 2, 3, \dots, N$). Let $\mathbf{O} = (X, 2^X, F)$ be an observable in $L^\infty(\Omega, \nu)$ such that

$$X = \{H, T\}, \text{ (where } H: \text{ head, } T: \text{ tail) ,}$$

$$[F(\{H\})](\omega_i) = \mu(\{H\}) = 2/3, \quad [F(\{T\})](\omega_i) = \mu(\{T\}) = 1/3$$

$$(\forall i = -n, -n+1, \dots, -1, 0, 1, 2, \dots, N) \tag{9.5}$$

That is, a family of measurements $\{M_{L^\infty(\Omega, \nu)}(\mathcal{O} := (X, 2^X, F), S_{[\omega_i]}) \mid i = -n, -n+1, \dots, -1, 0, 1, 2, \dots, N\}$ satisfies the uniformity principle of nature (concerning μ). Let $(x_{-n}, x_{-n+1}, \dots, x_{-1}, x_0, x_1, \dots, x_N) \in \prod_{i=-n}^N X$ be a measured value obtained by the parallel measurement $\bigotimes_{i=-n}^N M_{L^\infty(\Omega, \nu)}(\mathcal{O} := (X, 2^X, F), S_{[\omega_i]})$, i.e., infinite coin throws. Here, Theorem 9.6 [Inductive reasoning] say that it is natural to assume that, for sufficiently large n ,

$$(x_{-n}, x_{-n+1}, \dots, x_{-1}, x_0) = (\underbrace{\text{T H H T H H H T T} \dots \text{T H H}}_{n+1}) \tag{9.6}$$

(where the number of H s $\approx 2n/3$, T s $\approx n/3$)

Then we can believe that we see that $x_i = H$ with probability $2/3$ [resp. $x_i = T$ with probability $1/3$] for each $i = 1, 2, \dots, N$. It should be noted that even without knowing (9.5), we can conclude that if we know (9.6).

Remark 9.9. It should be noted that the above example shows that Theorem 9.6 [Inductive reasoning] (or equivalently, the law of large numbers), like Newton's kinetic equation, has the power to predict the future. This is the reason that Hume's problem of induction keeps attracting much researcher's interest for a long time. If the justification of Hume's problem of induction is solved, it should be the most fundamental theory in science. Thus, we are convinced that our assertion (i.e., the law of large numbers \approx the justification of Hume's problem of induction) is true. As said in Note 9.16, many philosophers have not considered induction under a certain worldview. This is why they failed.

In Sec. 11.4, we summarize as follows.

Logical worldview [no measurement]		Quantum mechanical worldview [measurement]
deduction (cf. Sec 11.4)	\leftrightarrow	measurement
abduction (cf. Sec 11.4)	\leftrightarrow	inference
induction (cf. Sec 9.7)	\leftrightarrow	the law of large numbers

Here, the logical worldview (=the logical spirit=the spirit of "Think logically!") may not be a true worldview.

9.8* grue paradox cannot be represented in quantum language

(Cf. the W^* -algebraic formulation in (A_2) in Sec 1.5) is used in this section.)

♠**Note 9.17.** I've read several books that explain Goodman's arguments concerning "grue Paradox" (cf. ref. [25]), but I've never been impressed with them. Rather, I think that the grue paradox is a strange paradox that no one understands, yet everyone knows its importance (If this paradox wasn't so important, it wouldn't be so famous.) I think that grue Paradox evokes the inevitability of the quantum mechanical worldview. That is, grue paradox can not be understood without quantum language.

This section was written with reference to the following.

- [75]:Ishikawa, S: Philosophy of science for scientists; The probabilistic interpretation of science Journal of quantum information science, Vol. 9, No.3 , 140-154,
DOI: 10.4236/jqis.2019.93007
(<https://www.scirp.org/Journal/paperinformation.aspx?paperid=95447>)

♠**Note 9.18.** The summary is as follows. If our understanding of inductive reasoning under the quantum mechanical worldview (mentioned in the above) is true, that is,

(‡) Hume's problem of induction \approx the law of large numbers,

we can easily solve the grue paradox (cf. ref. [25]). The grue paradox arises, since the grue paradox is due to the fact that the conditions for the law of logarithms to hold are not met. That's all I'm going to say below.

Let us mention it as follows.

Consider a basic structure $[C(\Omega) \subseteq L^\infty(\Omega, \nu) \subseteq B(L^2(\Omega, \nu))]$. Let Ω_g, Ω_b be the open subsets of the state space Ω such that $\Omega_g \cap \Omega_b = \emptyset$. And put $\Omega_o = \Omega \setminus (\Omega_g \cup \Omega_b)$. Let $\mathbf{O} = (X \equiv \{g, b, o\}, 2^X, F)$ be the observable in $L^\infty(\Omega, \nu)$ such that

$$\begin{aligned} [F(\{g\})](\omega) &= 1 \quad (\omega \in \Omega_g), \quad = 0 \quad (\omega \in \Omega \setminus \Omega_g) & [F(\{b\})](\omega) &= 1 \quad (\omega \in \Omega_b), \quad = 0 \quad (\omega \in \Omega \setminus \Omega_b) \\ [F(\{o\})](\omega) &= 1 - [F(\{g\})](\omega) - [F(\{b\})](\omega) \quad (\omega \in \Omega) \end{aligned} \quad (9.7)$$

where "g", "b", "o" respectively means "green", "blue", "others".

Let $\{e_{-n}, e_{-n+1}, \dots, e_{-1}, e_0, e_1, e_2, \dots, e_N\}$ be the set of (green) emeralds. And assume that $\omega_i (\in \Omega_g^o)$ is the state of emerald e_i ($i = -n, -n+1, \dots, -1, 0, 1, 2, \dots, N$).

A family of measurements $\{\mathbf{M}_{L^\infty(\Omega, \nu)}(\mathbf{O}_i := (X, 2^X, F), S_{[\omega_i]}) \mid i = -n, -n+1, \dots, -1, 0, 1, 2, \dots, N\}$ clearly satisfies the uniformity principle of nature, that is, there exists an probability space $(X, 2^X, \mu)$ such that

$$[F(\Xi)](\omega_i) = \mu(\Xi) \quad \forall \Xi \in 2^X, \forall i = -n, -n+1, \dots, -1, 0, 1, 2, \dots, N$$

where $\mu(\{g\}) = 1, \mu(\{b, o\}) = 0$.

Let $(x_{-n}, x_{-n+1}, \dots, x_{-1}, x_0, x_1, \dots, x_N) \in \times_{i=-n}^N X$ be a measured value obtained by the parallel measurement $\otimes_{i=-n}^N \mathbf{M}_{L^\infty(\Omega, \nu)}(\mathbf{O} := (X, 2^X, F), S_{[\omega_i]})$. We see, of course, that $x_i = g$ ($i = -n, -n+1, \dots, -1, 0$). And thus, we can believe, by Theorem 9.6 [Inductive reasoning], that $x_1 = x_2 = \dots = x_N = g$. For the sake of completeness, note that we can predict $x_1 = x_2 = \dots = x_N = g$ only by the data $x_{-n} = x_{-n+1} = \dots = x_0 = g$. This is usual arguments concerning Theorem 9.6 [Inductive reasoning].

On the other hand, Goodman's grue paradox is as follows (cf. ref. [25]).

- (D₁) Define that Y has a **grue** property iff Y is green at time i such that $i \leq 0$ and Y is blue at time i such that $0 < i$. Suppose that we have examined the emeralds at $-n, -n+1, \dots, -1, 0$, and found them to all be green (and hence also grue). Then, "so-called inductive reasoning" says that emeralds at $1, 2, \dots, N$ have the grue property (and hence blue) as well as green. Thus, a contradiction is gotten.

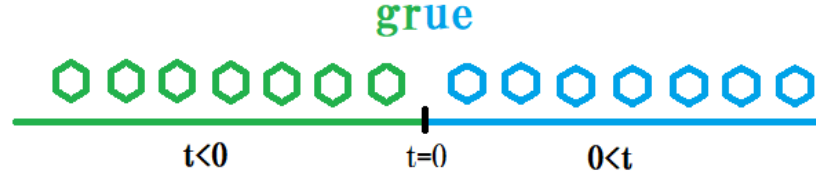

However, we think that this (D₁) cannot be described in quantum language. If we try to describe the (D₁), we may consider as follows.

(D₂) Let $\{e_{-n}, e_{-n+1}, \dots, e_{-1}, e_0, e_1, e_2, \dots, e_N\}$ be the set of emeralds. Let $\omega_i (\in \Omega_g^\circ)$ be the state of emerald e_i ($i = -n, -n + 1, \dots, -1, 0$), and let $\omega_i (\in \Omega_b^\circ)$ be the state of emerald e_i ($i = 1, 2, \dots, N$). However, it should be noted that a family of measurements $\{M_{L^\infty(\Omega, \nu)}(\mathbf{O}_i := (X, 2^X, F), S_{[\omega_i]}) \mid i = -n, -n + 1, \dots, -1, 0, 1, 2, \dots, N\}$ does not satisfy the uniformity principle of nature. That is because

$$[F(\{g\})](\omega_i) = 1 \quad (i = -n, -n + 1, \dots, 0), \quad [F(\{g\})](\omega_i) = 0 \quad (i = 1, 2, \dots, N)$$

Hence Theorem 9.6 [Inductive reasoning] cannot be applied.

Or,

(D₃) Let $\{e_{-n}, e_{-n+1}, \dots, e_{-1}, e_0, e_1, e_2, \dots, e_N\}$ be the set of emeralds. And let $\omega_i (\in \Omega_g^\circ)$ is the state of emerald e_i such that $\omega = \omega_i$ ($i = -n, -n + 1, \dots, -1, 0, 1, 2, \dots, N$). Let $\mathbf{O}_i = (X, 2^X, F_i)$ be the observable ($i = -n, -n + 1, \dots, -1, 0, 1, 2, \dots, N$) such that \mathbf{O}_i is the same as $\mathbf{O} (= (X \equiv \{g, b, o\}, 2^X, F))$ in (9.7) (if $i = -n, -n + 1, \dots, -1, 0$), and $\mathbf{O}_i = (X, 2^X, F_i)$ (if $0, 1, 2, \dots, N$) is defined by $F_i(\{g\}) = F(\{b\})$, $F_i(\{b\}) = F(\{g\})$, $F_i(\{o\}) = F(\{o\})$. However, in this case, it should be noted that a family of measurements $\{M_{L^\infty(\Omega, \nu)}(\mathbf{O}_i := (X, 2^X, F_i), S_{[\omega_i]}) \mid i = -n, -n + 1, \dots, -1, 0, 1, 2, \dots, N\}$ does not satisfy the uniformity principle of nature. That is because

$$\begin{aligned} [F_i(\{g\})](\omega_i) &= [F(\{g\})](\omega_i) = 1 & (i = -n, -n + 1, \dots, 0), \\ [F_i(\{g\})](\omega_i) &= [F(\{b\})](\omega_i) = 0 & (i = 1, 2, \dots, N) \end{aligned}$$

Hence Theorem 9.6 [Inductive reasoning] cannot be applied.

Therefore Goodman's grue paradox (D₁) cannot be described in quantum language.

Remark 9.10. We believe that there is no scientific argument without scientific worldview. Thus, we can immediately conclude that Goodman's discussion (D₁) is doubtful since his argument is not based on any scientific worldview. In this sense, the above arguments (D₂) and (D₃) may not be needed. That is, the confusion of grue paradox is due to lack of the understanding of Hume's problem of induction in the linguistic quantum mechanical worldview, and not lack of the term "grue" is non-projectible (*cf.* ref. [25]). If we want to solve grue paradox only, we may add a condition like "projectible property". However, what philosophy should do is to propose a certain worldview and solve various paradoxes under the worldview at once. That is, we think that to solve Goodman's grue paradox is to answer the following:

(E) Propose a worldview! And further formulate Hume's induction as the fundamental theorem in the worldview! In this formulation, confirm that Goodman's paradox is eliminated naturally.

What I did is this.

Remark 9.11. Readers think that the grue paradox is too unnatural. I agree. That is, the grue paradox is like playing football and then before you know it, you're playing rugby. If the rules change in the middle of a game, there is no sport. I think that this is due to that N. Goodman (1906-1998) belonged to the school of analytic philosophy. Analytic philosophy does not emphasize much of the worldviewism (it *cf.* Sec. 1.3.1) such that

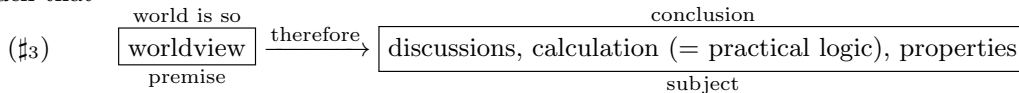

Thus, the grue paradox is a paradox resulting from the failure to follow world descriptivism. I think that the worldviewism should be emphasized even in analytic philosophy. Thus, I think that the grue paradox is unproductive for us, if the weaknesses of analytic philosophy are not pointed out. Also, see Wittgenstein's paradox in Sec. 12.2.3.

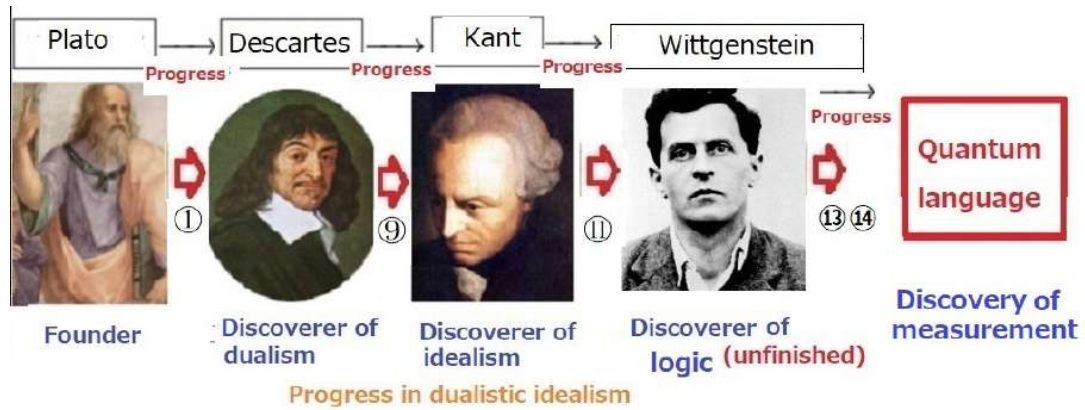

♠**Note 9.19.** Here, we have (*cf.* Classification 1.11 [the classification of philosophers]).

- (b₁): the realistic worldview (physics)
 - Herakleitos, Aristotle, Aristarchus, Archimedes, Eratosthenes, Ptolemaeus, Galileo, Newton, Einstein, ...
 - (Although mathematics is not a worldview, Pythagoras, Eudoxus, Euclid)
- (b) {
 - (b₂₁): the fictional worldview (Western philosophy)
 - Plato, Scholasticism, Descartes, Locke, Leibniz, Berkeley, Hume, Kant, Husserl
 - (b₂₂): the logical worldview (=the logical spirit=the spirit of "Think logically!")
 - Boole, Frege, Peirce, Saussure, Russell, Wittgenstein, Hempel, Quine, Popper
 - (b₂₃): the mechanical worldview (statistics, quantum language)
 - Parmenides, Zeno, J. Bernoulli, statistics (e.g., Fisher), quantum language

Chapter 10

Kant: Copernican revolution

The following is usually called the flower of modern philosophy (i.e., epistemology, or dualistic idealism):

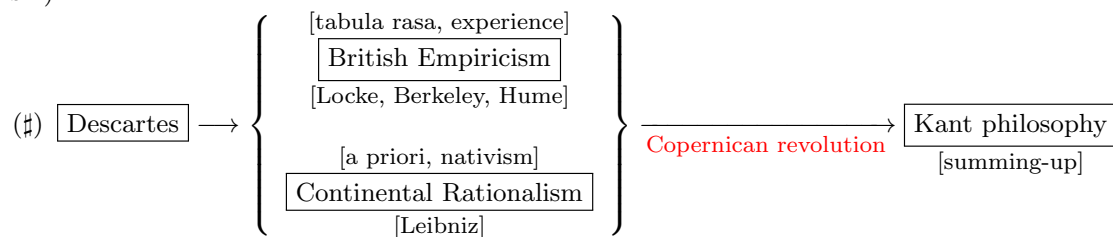

Thus, it implies that Kant is the greatest philosopher in modern philosophy.

Kant completely followed Platonic method of telling philosophy (i.e., the fictional worldview: *cf.* Sec. 1.3) as follows.

- | | | |
|--|-----------|------------------------------------|
| (♯ ₁): world is so | therefore | (♯ ₂):you should do so |
| fictional worldview (literary truth, pseudo-truth) | | ethics, morals |
| preface, introduction, (fictional)premise, expedient | | main subject |

That is, Kant executed the following:

(♯₁) [world is so] is secondary, "Critique of Pure Reason (1781)":

(♯₂) [you should do so] is main theme "Critique of Practical Reason (1788)", "Critique of Judgment(1790)"

Hence, it is generally believed that Kant's philosophy has been a great success. That is because many people believe that

- Kant's (♯₁) is powerful enough to guarantee the legitimacy of the great Newtonian mechanics. Hence, Kant can be trusted. Therefore, the (♯₂) is also reliable.

In this sense, Kant is the perfecter of Platonic method of telling philosophy. However, I think that

- the above (♯₁) "Critique of Pure Reason" is about Kant's dream .

This is because he was only imagining things that could not be confirmed without experimentation. But, a miracle happens. The Copernican revolution in (♯₁) is very similar to quantum language (*cf.* Chapter 11).

Kant must have dreamed of a good relationship between philosophy and natural sciences. Specifically, he dreamed that philosophy would provide the basis for Newtonian mechanics. I think he wanted to write about that dream in the Critique of Pure Reason. So I think this book is a kind of enlightenment book that promotes a good relationship between philosophy and natural science. And I think this book had a tremendous impact on the acceptance of natural science by the general public. Thus, I think that the goal of the modern philosophy (♯) was achieved by Kant. That is, I believe he said the following.

- Philosophy is greater than Newtonian mechanics. So let's not be afraid of science, but get along with it.

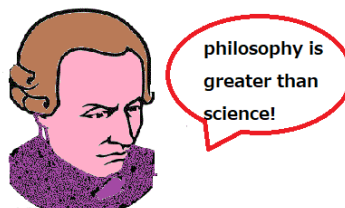

10.1 Critique of Pure Reason

10.1.1 Three Critiques



Immanuel Kant (1724 - 1804), a professor at the University of Königsberg, is one of the most influential philosophers in the history of Western philosophy. His main work is "Critique of Pure Reason (1781)", "Critique of Practical Reason (1788)", "Critique of Judgment(1790)", whose theme is respectively "truth" (i.e., "pseudo- truth" in the sense of this paper), "virtue", "beauty".

Kant, who is at the top of the three fields, may look like a superhuman (for example, just as one person simultaneously wins three Nobel Prizes (physics, chemistry, physiology or medicine), however, in the case of philosophy, the three ("truth, goodness, and beauty") are one. As I said before, concerning "good" and "beauty", most philosophers have similar arguments. Therefore, they appeal a clear difference in the part of "true". It is the wisdom of Western philosophy to keep fresh by model change.

That is, he followed Platonic method of telling philosophy as follows.

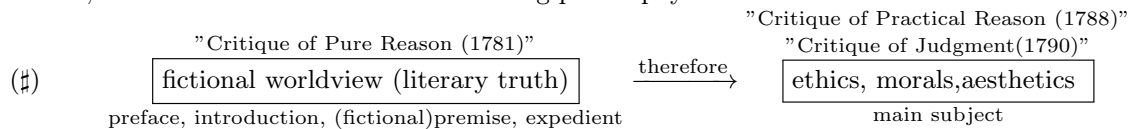

Of course, the interest of this text is concentrated to the worldview (i.e., "Critique of Pure Reason"). Have said many times in this text, philosophy of the worldview is a "preface" of (#). Thus, it must be built with as "meticulous logic" as a detective novel.

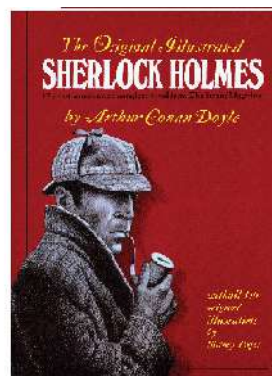
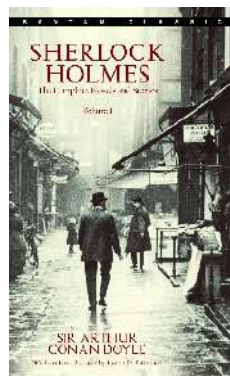

In fact,

- "Critique of pure reason" is very good as a preface, because it succeeded in impressing the reader that philosophy is not inferior to science. Considering the state of the world at the time, if Kant was a smart philosopher, the conclusion was bound to be "the coexistence of philosophy and science." What kind of discussion is used to draw this conclusion is the showcase of Kant's skill.

♠**Note 10.1.** As mentioned frequently up to this point, the fictional worldview is really "asserted fiction", however, we must pretend not to regard the fictional worldview as "non-logical", or we must accept it as "logical in a wide sense". That is because it must be prohibited that the difference between philosophy and religion becomes fuzzy. Therefore, we must use the terms such as "logic", "reason", etc. in the fictional worldview, for example, "Critique of Pure Reason", "Tractatus Logico philosophicus (=TLP)", etc. I think that Platonic method of telling philosophy (i.e., The fictional

worldview) is a survival strategy for Western philosophy to co-exist with Christianity.

♠**Note 10.2.** It is often held that Kant lived a very strict and disciplined life, leading to an oft-repeated story that neighbors would set their clocks by his daily walks. In fact, he may have been a cheerful and sociable man. However, the image of Kant as strict and honest promotes an understanding of Kant’s philosophy. For the philosopher, his image itself is a part of his work. Therefore, if you have seen a painting of Kant chatting with friends at a luncheon, it is better to pretend you did not see it and forget about it. To have a strong impact on his word ”Copernican Revolution,” Kant must be a modest and non-joking philosopher.



Kant chatting with friends at a luncheon

10.1.2 The purpose of ”Critique of Pure Reason” (1781)



It is usually said that

(A) with the advent of Newton, the natural sciences have grown exponentially. People believe in that systematic knowledge as ”objective truth” and come to have great expectations. It was Hume who made a bitter blow to it. He argues that scientific wisdom is a product of ”habitual thinking”, not objective truth. Kant is shocked by Hume’s opinion. One of the central issues of ”Critique of Pure Reason” is to rebuild the objectivity and reliability of the natural sciences that were shattered by Hume.

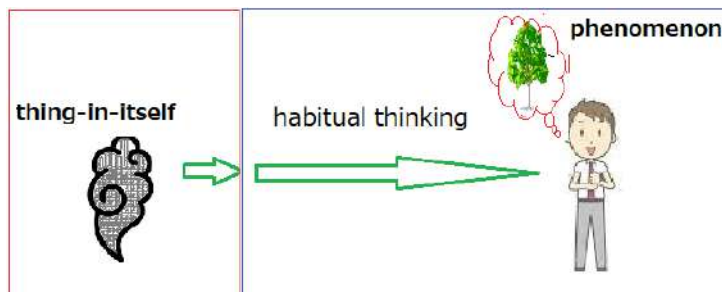

Thus, I think that

(B) His purpose is to answer the following

- Why does Newtonian mechanics hold? though his challenge failed.

♠**Note 10.3.** (i): Next is Einstein’s words:

- *The most incomprehensible thing about the world is that it is comprehensible.*

Or

One may say "the eternal mystery of the world is its comprehensibility." It is one of the great realizations of Immanuel Kant that the postulation of a real external world would be senseless without this comprehensibility. (on page 292 of ref. [18]: *Ideas and Opinions*, Crown Publishers, Inc. . . New York 1954)



Note that the above (B) is essentially the same as the following:

- Why is the world comprehensible?

With Einstein's endorsement, it seems certain that Kant is the discoverer of "the most incomprehensible problem in scientific history," even if his theory is inadequate from a scientific point of view. I don't think any researcher would challenge this today, because everyone would think that this kind of problem is impossible to solve. This is a problem to enjoy not understanding, not a problem to solve. (ii): I don't think Hume's point was so serious for scientists at the time. But I can understand that many philosophers of the time wanted to think so. I also believe that the intellectuals of the time were also interested in knowing the various perspectives on the relationship between Newtonian mechanics and philosophy. Therefore, Kant's real goal was to provide philosophy fans with the answers that they wanted, not the truth. Thus, I think that

- Kant's true purpose was to write a literary work on the theme of "Why does Newtonian mechanics hold?"

(iii): As seen in Chap. 12 later, I assert that the purpose of Wittgenstein's TPL (i.e., ref. [117]: "Tractatus Logico-Philosophicus") is to explain

- **Why does logic work in our usual world?**

10.1.3 Thing-in-itself, Copernican revolution; from copy theory to constitution theory

In order to solve the problem (B), Kant thought that

(C) We can understand the "world" only through the human perception. Also, cats can understand the "world" only through the cat perception. Thus,

- There is "cat's world" for cats. and further, there is "butterfly's world" for butterflies.



If there are aliens whose cognitive ability is finer than ours, their world is different ours. Although the difference of the worlds is made by that of the cognitive ability, it is sure there exists something, which is called "thing-in-itself" by Kant.

That is, Kant thought as follows.

(D) we do not perceive the world as copy, but we perceive the world as it is constituted by cognition ability.

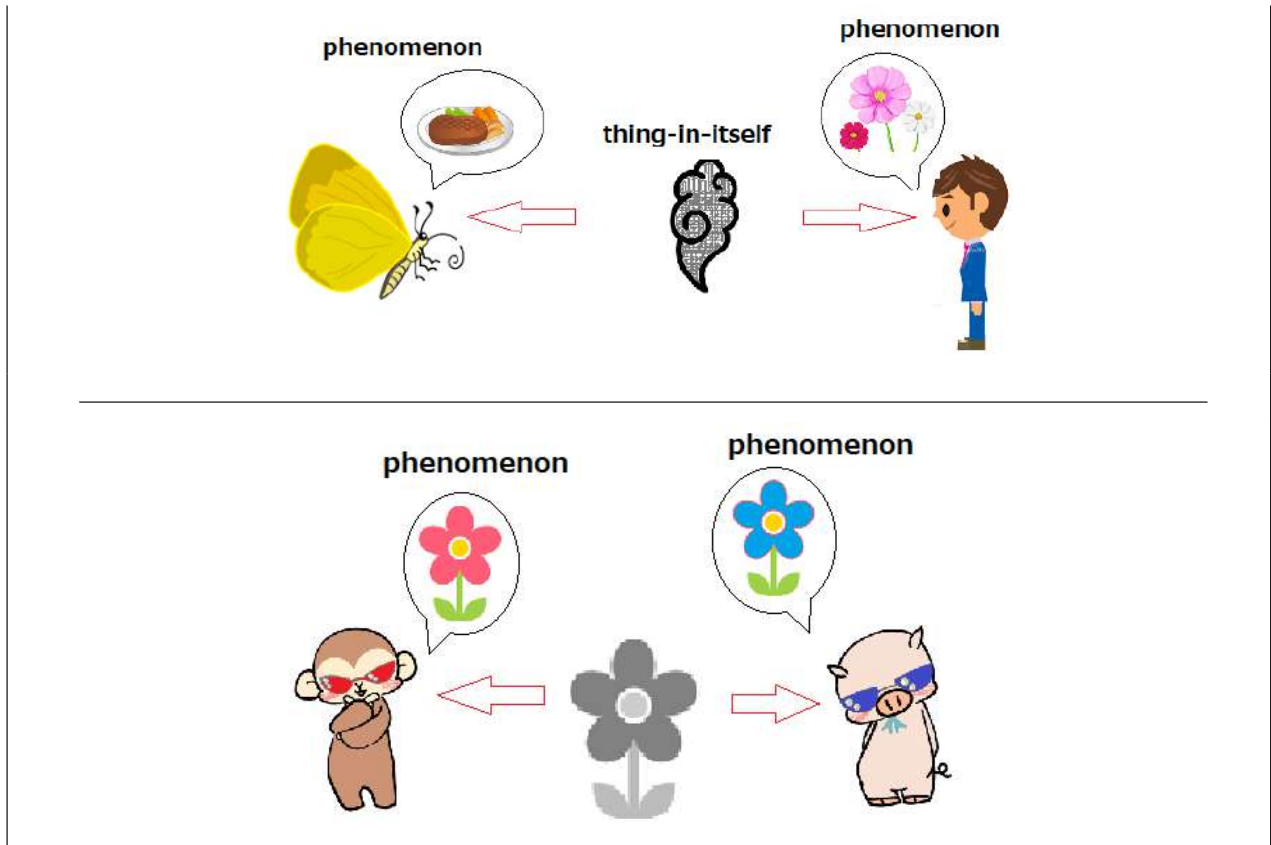

That is, Kant proposed so called **Copernican revolution** such that

"copy theory" $\xrightarrow{\text{Copernican revolution}}$ "constitution theory"
 realism (transcendental) idealism

namely,

(E₁) It's not "the world first, cognition later", but "cognition first, the world later".

or

(E₂) Cognition is not about painting a photorealistic picture, but it is similar to painting an abstract picture.

Then our problem is as follows.

Problem 10.1. [Kant's metaphysical foundation for Newtonian mechanics (natural science)]:

Assume the above Copernican revolution is true. Then, study the following problems:

- (#₁) Why can we make and understand Newtonian mechanics?
- (#₂) Is there a question we can't answer?

(F): [A rough sketch of Kant's Answer for (#₁)]:

In order to understand Newtonian mechanics, we need the scientific ability, that is,

- (G₁) Sensibility: The cognitive ability to organize the various sensations received through the sense organs within the framework of "space-time"
- (G₂) Understanding: The ability to judge and understand material obtained through sensibility based on concepts such as quantity and cause-effect relationships.

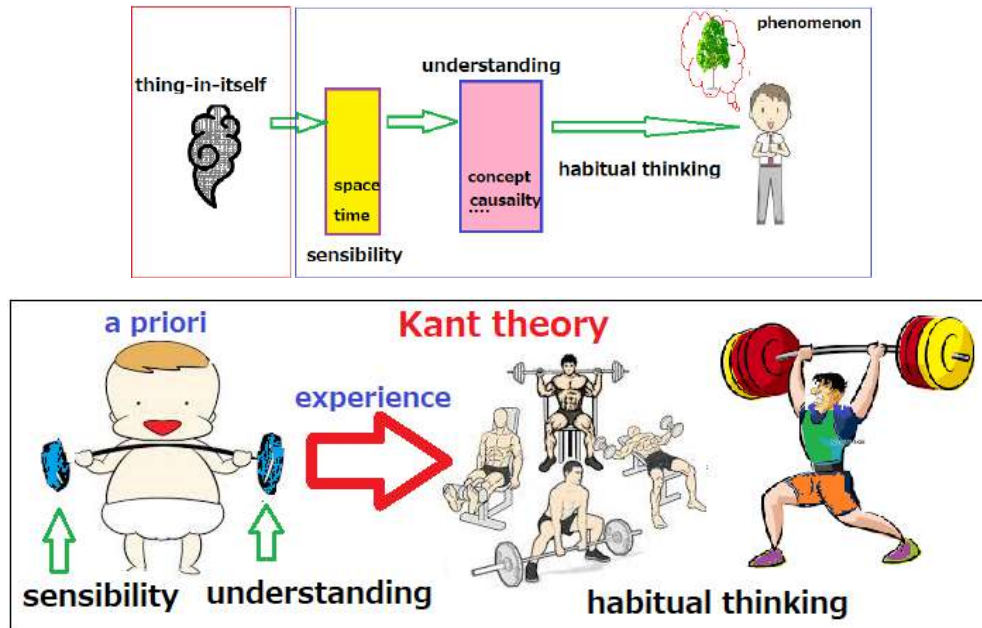

These abilities are a priori, that is, they are innate and must be common to all human beings. And through experience and training, these abilities will increase. Hence, our habitual thinking is also common to all human beings at its core, and in this sense, it is universal. Therefore, we can understand Newton mechanics (though it depends on our sensibility and understanding).

[About (§2)]: Kant describes four examples of unanswerable problems.

- (H₁) Is the universe finite or infinite?
- (H₂) Does the atom exist?
- (H₃) Does free will exist?
- (H₄) Does God exist?

Kant provides proofs for these by deriving antinomies, but I think this is more word play than proof.

♠**Note 10.4.** Of course, the above solution makes little sense from a scientific point of view. To be precise, it does not even reach the level of being able to judge right from wrong. If Kant claims the above to be a scientific hypothesis, he must provide a way to experimentally test it. However, from a philosophical point of view, Kant's explanation was sufficient. That is, his difficult and seemingly elaborate arguments were supported by the general public of philosophy lovers. Probably, they thought that

- Even Einstein said that he didn't understand this difficult question, so Kant's explanation in "Critique of Pure Reason" was sufficient. And thus, Kant is reliable.

And the following is also reliable.

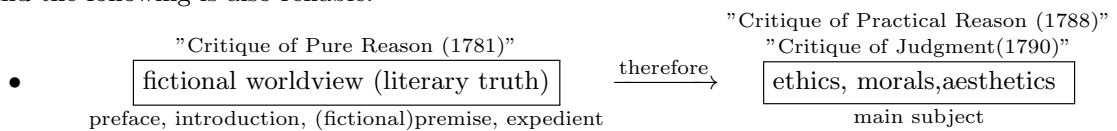

□

It should be noted that the above proof is not scientific. However, it is sure that Many philosophical fans agreed with Kant's explanation. Further, they regarded the above proof as the following (I)

Now, it is usually said that

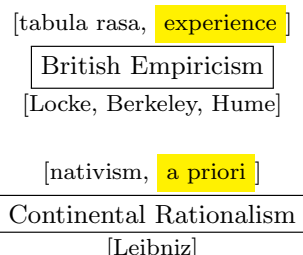
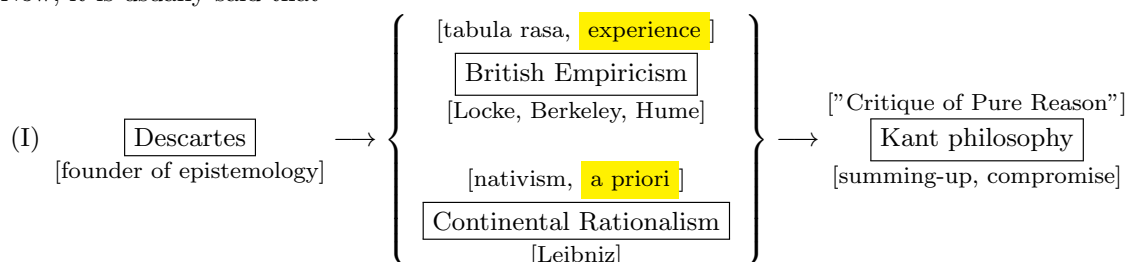

In this sense, Kant is sometimes said to have integrated British Empiricism and Continental Rationalism.



Also, we see the following table:

Table10.1 The key-words of worldviews (*cf.* Assertion 1.14)

mind-matter dualism	[A](= mind)	[B](between A and B)	[C](= matter)
Plato	actual world	Idea	/ [idea world]
Descartes	I, mind, brain	body	/ [matter]
Locke	mind	secondary quality	primary quality [matter]
Kant	phenomenon	cognition	/ [thing-in-itself]
quantum language	measured value	observable	state [system]

Seeing the above table, some may think:

(J) Is it true?



This will be answered in Problem 10.4 later.

10.2 * Summary: What is causality?

As mention in Sec 4.2, Aristotle considered the cause of the movement to be the "purpose" of the movement. Although this was what should be praised, it was not able to be said that "the purpose was to the point." For human beings to discover that the essence of movement and change is "causal relationship", we had to wait for the appearance of Galileo, Bacon, Descartes, Newton, etc.

Revolution to "Causality" from "Purpose"

is the greatest paradigm shift in the history of science. It is not an overstatement even if we call it "**birth of modern science**".

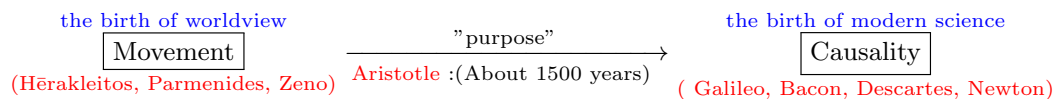

Aristotle

Scientific revolution

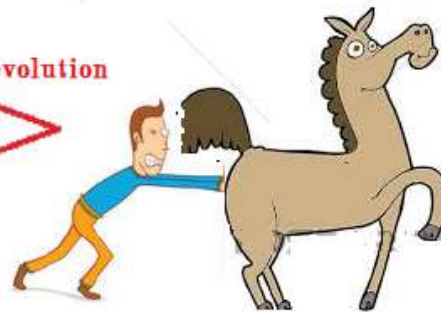
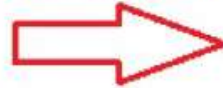

Newton

- ♠**Note 10.5.** I cannot emphasize too much the importance of the discovery of the term: "causality". That is,
 (‡) Science is the discipline about phenomena can be represented by the term "causality".
 Thus, I consider that the discovery of "causality" is equal to that of science.

10.2.1 Four answers to "what is causality?"

As mentioned above, about "what is an essence of movement and change?", it was once settled with the word "causality." However, not all were solved now. We do not yet understand "causality" fully. In fact,

Problem 10.2. Problem:

"What is causality?"

is the most important outstanding problems in modern science.

Answer this problem!

There may be some readers who are surprised with saying like this, although it is the outstanding problems in the present. Below, I arrange the history of the answer to this problem.

- (A) **[Realistic causality]:** Newton advocated the realistic describing method of Newtonian mechanics as a final settlement of accounts of ideas, such as Galileo, Bacon, and Descartes, and he thought as follows. :

"Causality" actually exists in the world. Newtonian equation described faithfully this "causality". That is, Newtonian equation is the equation of a causal chain.



This realistic causality may be a very natural idea, and you may think that you cannot think in addition to this. In fact, probably, we may say that the current of the realistic causal relationship which continues like

"Newtonian mechanics → Electricity and magnetism → Theory of relativity → ..."

is the mainstream of science.

However, there are also other ideas, i.e., three "non-realistic causalities" as follows.

(B) **[Cognitive causality]:** David Hume, Immanuel Kant, etc. thought as follows. :

We can not say that "Causality" actually exists in the world, or that it does not exist in the world. And when we think that "something" in the world is "causality", we should just believe that it has "causality".

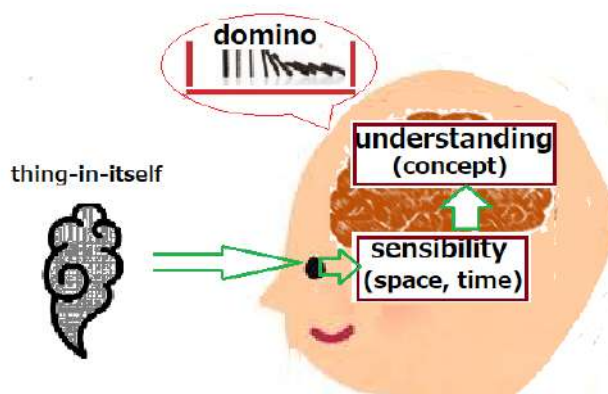

Most readers may regard this as "a kind of rhetoric", however, some readers may believe it. It may look like that, because you are looking through the prejudice of "causality." This is Kant's famous "Copernican revolution" (i.e., "Kant was awakened from his dogmatic slumber by Hume's idea and came up with the Copernican revolution"), that is,

"cognition constitutes the world."

which is considered that the cognition circuit of causality is installed in the brain, and when it is stimulated by "something" and reacts, "there is causal relationship."

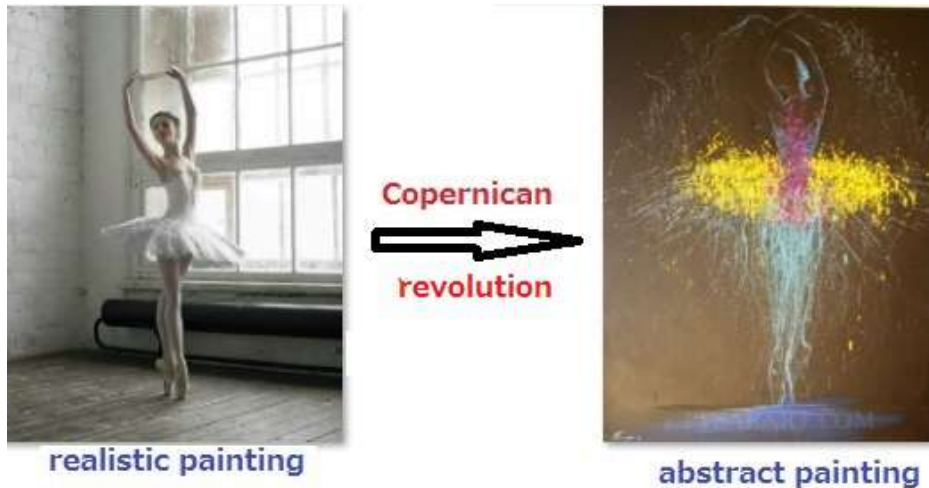

♠**Note 10.6.** About his discovery of "the Copernican revolution", Kant says in his book "Prolegomena" (1783):

(‡) *I freely admit that it was the remembrance of David Hume which, many years ago, first interrupted my **dogmatic slumber** and gave my investigations in the field of speculative philosophy a completely different direction.*

Readers may ask, "Why did honest Kant made such an exaggerated description?" It is a matter of course that Kant had great confidence such that it was the greatest discovery in the history of philosophy. I agree to his opinion. For additional explanation about this, see Problem 10.4 later. Also, see Section 11.5.2. □

(C) **[Mathematical causality(Dynamical system theory)]:**



Since dynamical system theory has developed as the mathematical technique in engineering, they have not investigated "What is causality?" thoroughly. However,

In dynamical system theory, we start from the **state equation** (i.e., simultaneous ordinary differential equation of the first order) such that

$$\begin{cases} \frac{d\omega_1}{dt}(t) = v_1(\omega_1(t), \omega_2(t), \dots, \omega_n(t), t) \\ \frac{d\omega_2}{dt}(t) = v_2(\omega_1(t), \omega_2(t), \dots, \omega_n(t), t) \\ \dots\dots\dots \\ \frac{d\omega_n}{dt}(t) = v_n(\omega_1(t), \omega_2(t), \dots, \omega_n(t), t) \end{cases} \quad (10.1)$$

and, we think that

(‡) **the phenomenon described by the state equation has "causality."**

This is the spirit of dynamical system theory (= statistics). Although this is proposed under the confusion of mathematics and worldview, it is quite useful. In this sense, I think that (C) should be evaluated more.

(D) **[Linguistic causal relationship (MeasurementTheory)]:**

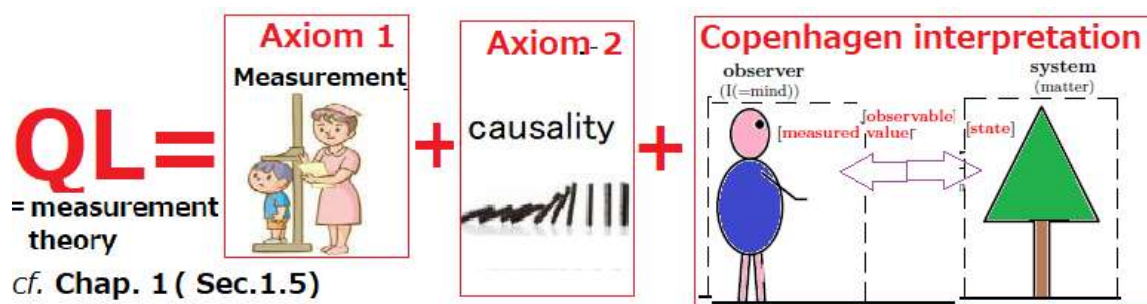

The causal relationship of measurement theory is decided by the **Axiom 2 (causality; Sec. 1.1)** of Chap. 1. If I say in detail,:

Although measurement theory consists of the two **Axioms 1 and 2**, it is the **Axiom 2** that is concerned with causal relationship. When describing something in quantum language (i.e., a language called measurement theory) and using **Axiom 2 (causality; Sec. 1.1)**, we think that thing has causality.

Summary 10.3. The above is summarized as follows.

- (A) World is first
- (B) Recognition is first
- (C) Mathematics(buried into ordinary language) is first
- (D) Language (= quantum language) is first

Now, in measurement theory, we assert the next as said repeatedly:

Quantum language is a basic language which describes various sciences.

Supposing this is recognized, we can assert the next. Namely,

In science, causality is just as mentioned in the above (D).

This is my answer to "What is causality?".

♠**Note 10.7.** Consider the following problems:

(#₁) What is time (space, causality, probability, etc.) ?

There are two ways to answer.

(#₂) The answer of "What is XX ?" $\left\{ \begin{array}{l} \text{(a): To show the definition of XX} \\ \text{(b): To show how to use the term "XX"} \end{array} \right.$

In this note, the answer to the question (#₁) is presented from the linguistic point of view (b).

10.3 Summary; Descartes=Kant philosophy

10.3.1 Hume might be more scientific than Kant

I think, from the scientific point of view, that Hume's theory and Kant' theory are not so different, where

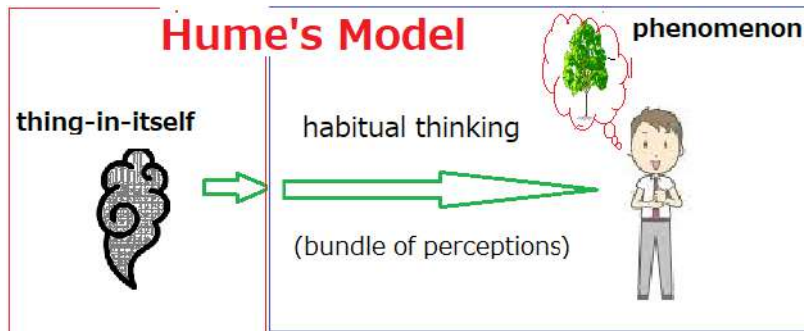

and

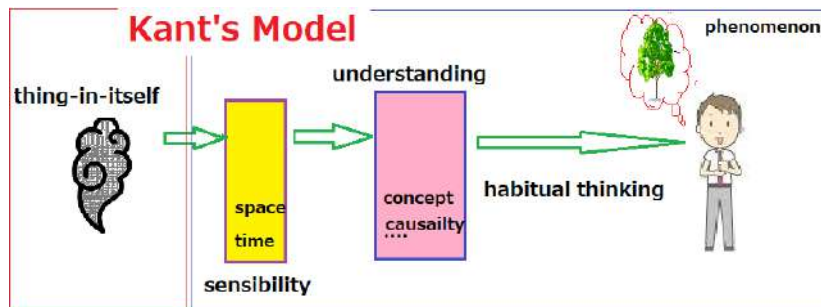

That is, Hume was scientific, so I think he was hesitant to say anything imaginary. Kant, on the other hand, was eloquent about imaginary things.

Thus I think that

- "From Hume to Kant" is not progress from the scientific point of view. Rather, Hume may have more scientific sense.

10.3.2 Why was Kant so successful?

Why was Kant so successful? I'll give you four reasons as follows.

10.3.2.1 [I]: Platonic method of telling philosophy

Kant followed this method exactly such as

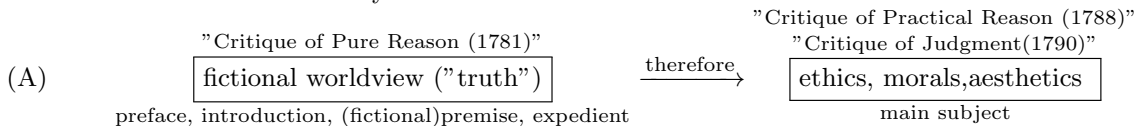

Recall that philosophy is a literary art, not a science In "truth, goodness, and beauty," he was well aware that "true" is not "scientifically true", "majority true".

Recall that

♠**Note 10.8.** The rule of philosophy (\approx idealism) is as follows:

- (#1) Only discussion, no experimentation.
- (#2) the winner will be determined by popularity vote of the general public.



10.3.2.2 [II]: Kant had a good understanding of modern philosophy

Kant understood the meaning of the following (not in the East) genealogy of modern Western philosophy.

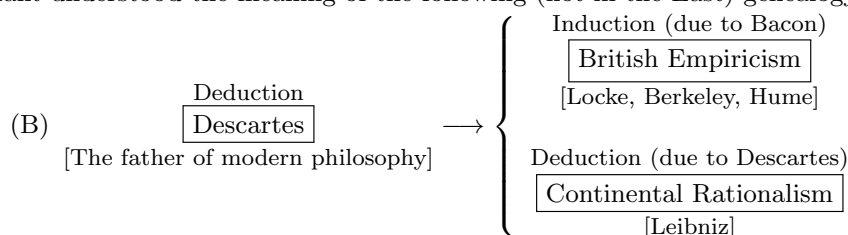

The following is my opinion. Kant might think that

- the controversy: British Empiricism vs. Continental Rationalism is only apparent controversy.

Kant understood the meaning of the following (not in the East) genealogy of modern Western philosophy. This controversy is only a superficial dispute. What they cared about most was the success of science (by Copernicus, Galileo, and Newton). In other words, modern philosophy also functioned as a buffer between "church versus science". Moreover, emotionally, philosophy was closer to the Church (e.g., Berkeley).

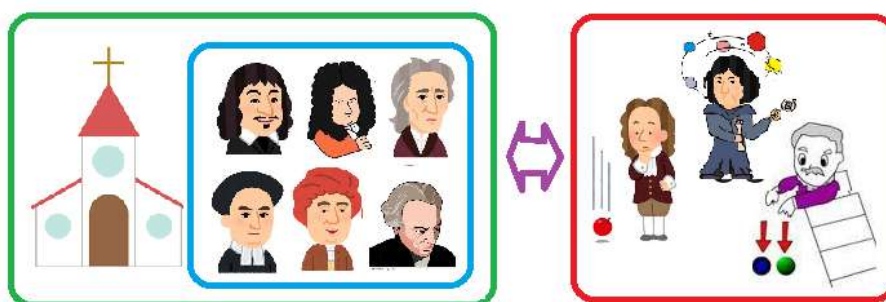

The general public was hoping that someone would declare that they had proven the superiority of philosophy over science, even if it was a lie. So Kant decided that the main theme of his book "Critique of Pure Reason" would be to lay the foundation for Newtonian mechanics. For this, Kant prepared the following two **magic words** that would never be defeated by science no matter how advanced it was.

"Thing-in-itself" "Copernican revolution"

Christianity would also have expected early modern philosophy to have played a role in competing with Newtonian mechanics. This strategy was a great success, because the public was looking forward to the emergence of a philosopher who could stand up to Newton. The general public received the following.

- (C) Kant's book is too difficult to understand, but apparently "philosophy is greater than Newtonian mechanics." Of course, I think that this is preferable to "the general public thinks science is all-powerful."

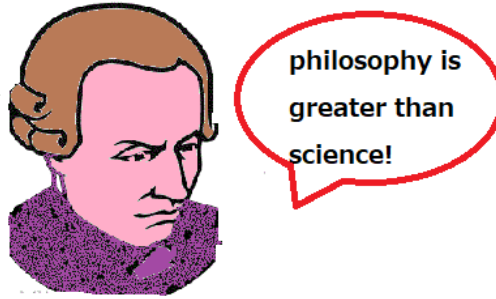

♠**Note 10.9.** In view of the above, we can understand what the modest and humble Kant meant when he spoke of a "Copernican revolution". The honest Kant could not hide his real intention to re-invert the relationship between philosophy (+church) and science. To increase the effectiveness of "Copernican revolution", Kant may have created an image of humility and modesty. I don't know Kant's intention, but in the end, "Kant's image" contributed to the great success of Kant's philosophy. Also, the freshness is gone it had been about 150 years since Descartes' "Discourse on the Method (1630)," and it was time for someone to make a stopping point. Continued to the next section.

10.4 Is Kant a progress from Descartes ?

10.4.1 The inevitability of Kant's appearance

We think that

when it comes to the 1770s, the expiration date of epistemology was running out.

Therefore, many people might want to say

(D) Newtonian mechanics moved the world. Does the world move by epistemology? It was too early for 300 years? After all, is the "epistemology" important or not ?

(E) **We are tired of the epistemology. Someone please finish the epistemology nicely.**

This is the atmosphere of 1770's, in which Kant appeared. Thus, Kant was accepted easily.

♠**Note 10.10.** The immature state of a discipline at the time of its birth is sometimes regarded as philosophy. For example, in ancient Greece, mathematics, astronomy, and atomic theory were philosophies. It is also reasonable to consider the epistemology of Locke and Hume as the birth of brain science. Kant, however, rejected this trend as follows.

(F₁) Greatness of Kant is to have prevented that epistemology faces the direction of the brain science by the showy name called "Copernican revolution".

That is, Kant understand that, even if the epistemology is clarified by the brain science, this is non-sense from the philosophical point of view. We think that

(F₂) **using the term "Copernican revolution", Kant prevented that epistemology enters into the zone of brain science.**

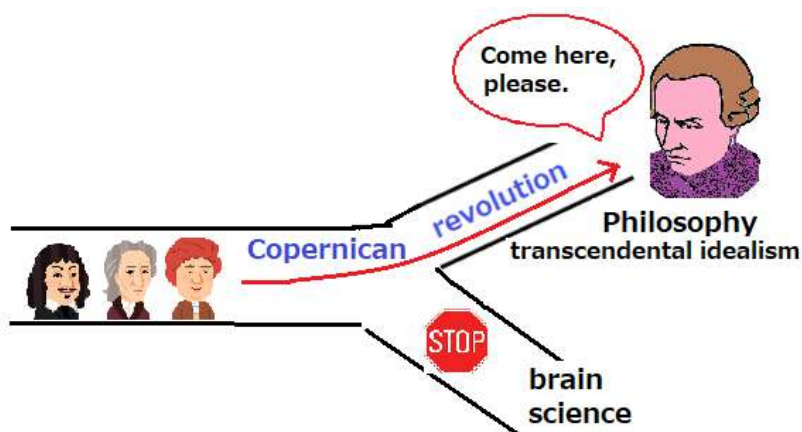

Naming of "Copernican revolution" does not mean that self-congratulation of Kant. I'd like to believe that

- strong intention of Kant which says "Epistemology is not experimental science, but philosophy" (or, "philosophy should not aim at experimental sciences"), is included in the term: "Copernican revolution".

Therefore, I think that

- **"The Copernican revolution (due to Kant)" is the greatest discovery in the history of philosophy.**

That is,

the Copernican revolution = the discovery of "true idealism"

This will be also emphasized again in the next chapter.

Thus, Kant follows Platonic method of telling philosophy such that

(G) "Critique of Pure Reason (1781)"
fictional worldview (literary truth) therefore, "Critique of Practical Reason (1788)"
"Critique of Judgment(1790)"
ethics, morals, aesthetics
preface, introduction, (fictional)premise, expedient
main subject

This was a great success. Today, no scientist is interested in "Critique of Pure Reason (1781)". However,

"Critique of Practical Reason (1788)" is a must for any ethicist. Thus, I think that the (G) is the most typical example of Platonic method of telling philosophy.

And I think "Critique of Pure Reason" had a tremendous impact on the acceptance of natural science by the general public. Thus, I think that the goal of the modern philosophy was achieved by Kant This implies the end of Grand Narratives (i.e., epistemology), and the start of "non-physical law (i.e., the philosophy of proverb)" such as

(H₁) Bentham(1789): "the greatest happiness of the greatest number"

(H₂) Hegel (1770 - 1831) : "thesis-antithesis-synthesis"

(H₃) Darwin(1809 - 1882) : "the survival of the fittest"

(H₄) Nietzsche(1844 - 1900) : "God is dead"

It is natural, since the job of the philosopher is to make non-physical laws (= golden sayings, proverbs, copies) that are supported by many philosophy enthusiasts.

10.4.2 Is Kant a progress from Descartes ?

I think that

(I) **Nevertheless, many readers must think that the Copernican revolution is far too overrated.**

In the next chapter, I will show that this is a fair estimation. Here, I will say somewhat more about this issue as follows.

Problem 10.4. It is sure that both Descartes worldview and Kant worldview are useless. Thus, the following problem may not be easy.

(J₁) Is the following reform progress?

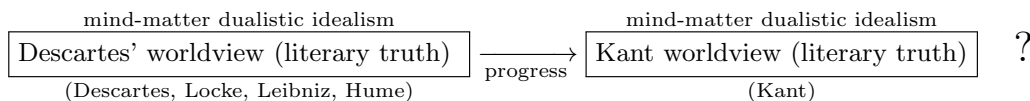

Namely, what parts of Descartes' worldview have advanced?

Brief Answer: The difference between the two are as follows.

(#₁) "Idealism" in Descartes' worldview means "a theory that is possible in the distant future but not currently experimental "

for example, Hume's theory is regarded as the immature early state of brain science.

Therefore, it is possible to think that Descartes-Hume's theory belongs to pre-science (i.e., a kind of realism) rather than philosophy (like Democritus atom theory).

(#₂) "Idealism" in Kant's worldview means "transcendental idealism", that is, "idealism made by the Copernican revolution".

Therefore, Kant's theory belongs to philosophy (≈ true idealism), not to science (≈ realism).

That is,

(J₂)



Thus, I believe that

"transcendental idealism" is true idealism.

The precise answer will be presented in Answer 11.17 of Chapter 11 (i.e., quantum language is also transcendental idealism). Thus, we can conclude that the (J) is yes.

(K): my answer: Now we proved $\xrightarrow{\textcircled{1}}$ and $\xrightarrow{\textcircled{9}}$ below.

(K₁) If "to make progress" is defined by "to come near quantum language" (i.e., "becoming more and more like quantum language" we can say that the time series [$\textcircled{1}$ - $\textcircled{9}$ - $\textcircled{11}$ - $\textcircled{13}$] can be regarded as progress, that is,

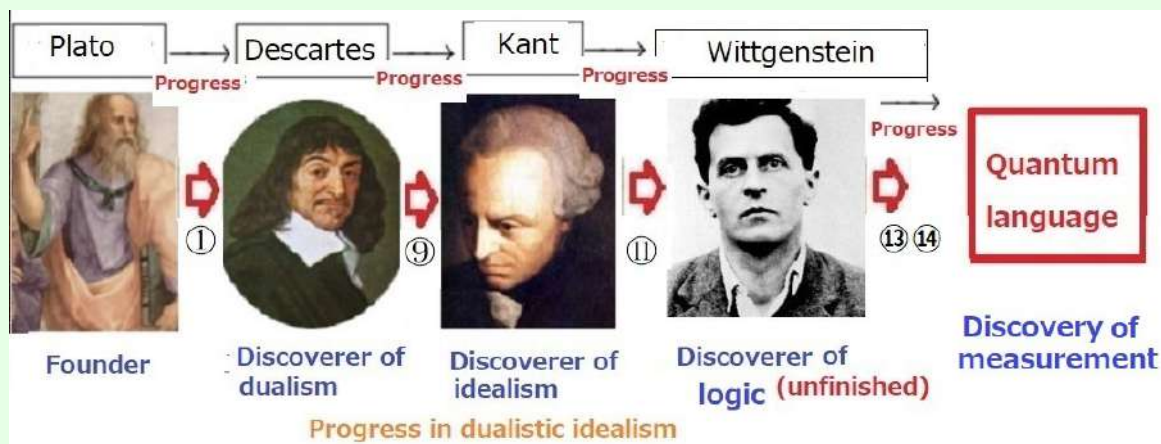

The precise answer $\textcircled{9}$ will be presented in Answer 11.17 of Chapter 11 (i.e., quantum language is also transcendental idealism).

That is,

(K₂) the time line: [$\textcircled{1}$ - $\textcircled{9}$ - $\textcircled{11}$ - $\textcircled{13}$] is not only a refreshing change, but also a progress.

♠**Note 10.11.** Physics and science make up a theory while making modifications by the result of the experiment. Thus, physics and science can expect sound development. On the other hand, the philosophy of worldview is metaphysics, which cannot be determined by experiments. Thus, the question "Did the philosophy of worldview make a progress?" is not easy to answer. That is because, if we consider that

- the western philosophy was able to keep freshness for a long time by renewing a preface part (i.e., the worldview), much like a car model change.

then, we must conclude that the philosophy of worldview does not make a progress. However, in this paper, we assert that

(#₁) the philosophy of worldview has been making a progress. And moreover, it finally converges to quantum language.

More precisely, we assert that

(#₂) If "to make progress" is defined by "to come near quantum language" (cf. Assertion 1.5), then the philosophy of worldview has been making a progress.

Remark 10.5. Recall Remark 3.13 such as

Introduction part (Pseudoscientific theories)

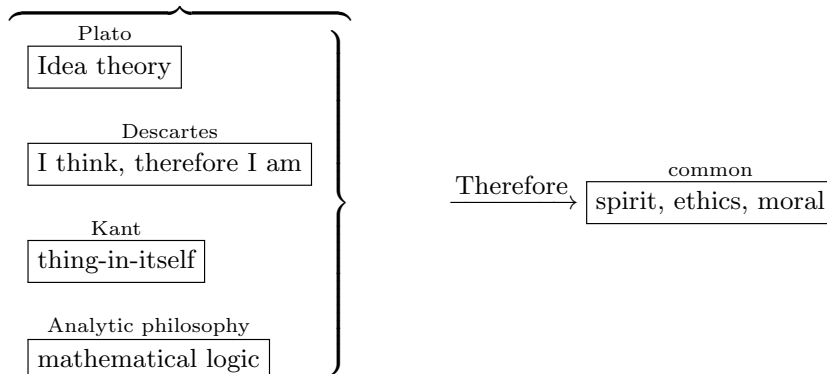

It was the method of the great philosophies (i.e., Plato's way of telling philosophy) to find something

impossible to doubt, and then declare that they had "deduced" various things from it. Kant's "thing-in-itself" is also something impossible to doubt. No matter what someone says about Kant's "thing-in-itself", there is no experimental data to contradict it. If this is the case, then the rest is up to the power of literature. It is no wonder even if philosophers after Kant thought this way. In this sense, Kant is also the founder of literature about "thing itself". The most successful were probably A. Schopenhauer (1788 - 1860) and Husserl, though I have not understood their writings. I am sure they are great philosophers, but I do not think they are up to par with Kant, since the discoverer of "thing-in-itself" is Kant.

Remark 10.6. Someone may want to consider the following progress:

$$\boxed{\text{Plato}} \xrightarrow{\text{progress}} \boxed{\text{Descartes}} \xrightarrow{\text{progress}} \boxed{\text{Kant}} \xrightarrow{\text{progress}} \boxed{\text{Husserl}} \tag{10.2}$$

This is because it is widely accepted that Husserl overcame the heights of Kant. In terms of literary enjoyment, I think the above is correct. However, in this text, the symbol " $X \xrightarrow{\text{progress}} Y$ " is defined by

- "Y" is closer to quantum language than "X"

Thus, we consider that "Husserl" is located as follows.

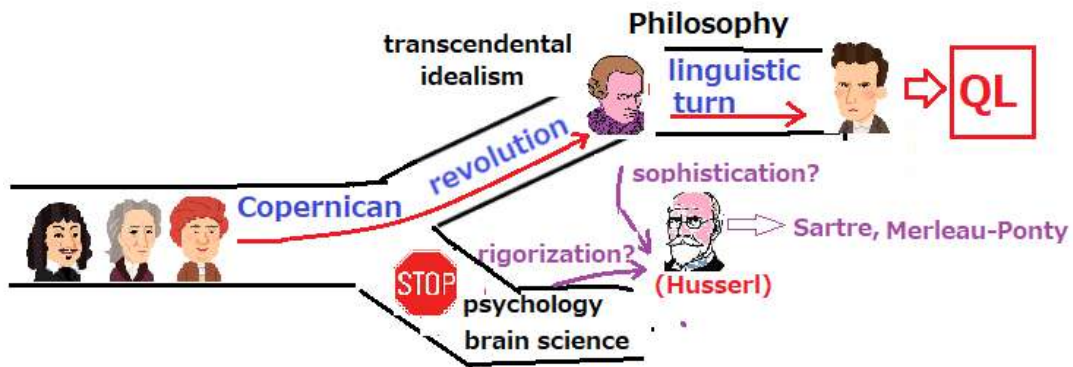

Rather, I think Husserl was enjoying the word "rigor" from a literary point of view without mathematics. The idea of starting with the obvious does not sit well with science. Husserl's phenomenology is one of the great achievements of Western philosophy, but it has little to do with science.

However, as mentioned in Note 11.3, we must follow the following rules of philosophy (= idealism).

- (#1) Only discussion, no experimentation.
- (#2) the winner will be determined by popularity vote of the general public.



♠**Note 10.12.** Here, we have (*cf.* Classification 1.11 [the classification of philosophers]).

- (b) {
- (b₁): the realistic worldview (physics)
Hērakleitos, Aristotle, Aristarchus, Archimedes, Eratosthenes, Ptolemaeus,
Galileo, Newton, Einstein, . . .
(Although mathematics is not a worldview, Pythagoras, Eudoxus, Euclid)
 - (b₂₁): the fictional worldview (Western philosophy)
Plato, Scholasticism, Descartes, Locke, Leibniz, Berkeley, Hume, Kant, Husserl
 - (b₂₂): the logical worldview (=the logical spirit=the spirit of "Think logically!")
Boole, Frege, Peirce, Saussure, Russell, Wittgenstein, Hempel, Quine, Popper
 - (b₂₃): the mechanical worldview (statistics, quantum language)
Parmenides, Zeno, J. Bernoulli, statistics (e.g., Fisher), quantum language

Chapter 11

Linguistic philosophy (Before TLP)

Throughout this text, we consider that linguistic philosophy = analytic philosophy. In this final chapter, we devote ourselves to the $\xrightarrow[\text{measurement}]{\text{dualism}}$ ⑬+⑭ in the following Figure 0 (i.e., Figure 0 in preface).

Figure 0 (in preface)

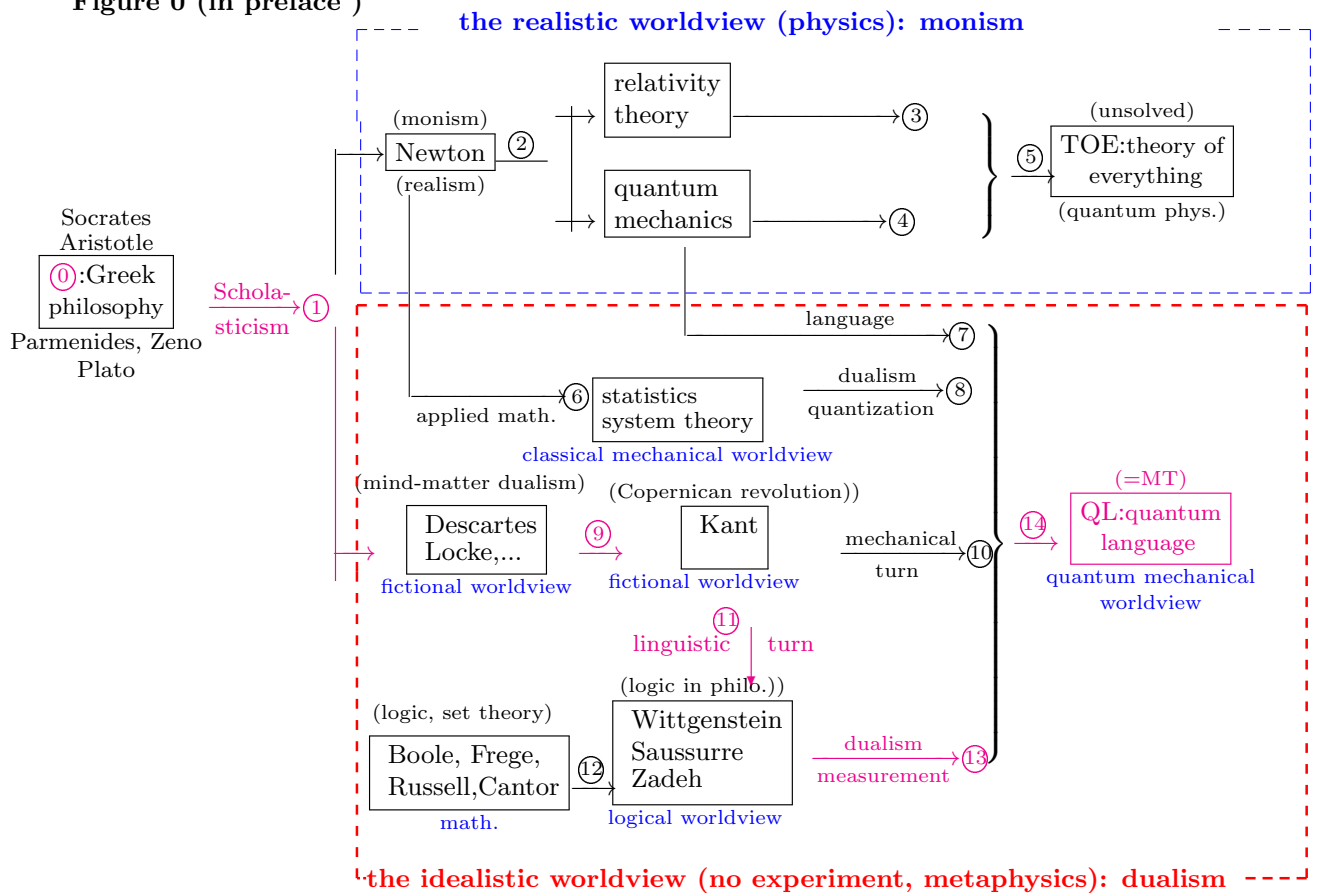

Figure 0: The history of the world-descriptions
 Philosophy (≈ dualistic idealism) has progressed toward QL
 (i.e., ① → ⑨ → ⑪ → ⑬ → ⑭)

I think that

- (#₁) Frege may have just tried to apply mathematical logic to our world, without a firm reason, just by strong belief.
- (#₂) Wittgenstein sought to find out why mathematical logic works in our world, but his considerations were non-theoretical and too literary.

But nevertheless, I would like to conclude that they are the two founders of analytic philosophy. The reason is that quantum language shows that their direction was correct.

Frege and Russell asserted that

- from "logic as detective novel" to "logic as Euclid's Element"

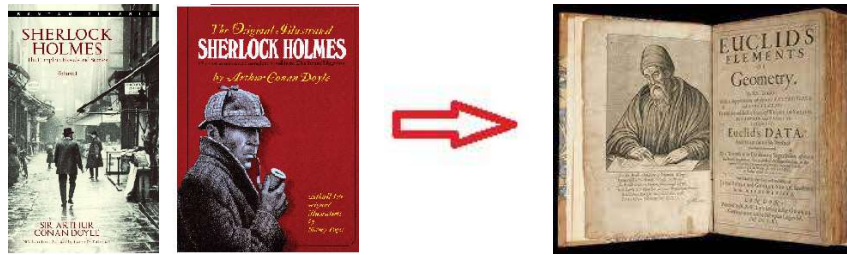

However, philosophy is not mathematics. Thus, we need the next step " $\xrightarrow[\text{measurement}]{\text{dualism}}$ ⑬+⑭" .

In order to explain " $\xrightarrow[\text{measurement}]{\text{dualism}}$ ⑬+⑭" , I first need to make sure that the reader understands my understanding of Wittgenstein's picture theory (in TLP (i.e., ref. [117]: "Tractatus Logico-Philosophicus")). For this, in Sec. 11.7, I will propose "Fuzzy logic in QL", which is characterized as the simultaneous justification of Wittgenstein picture theory and Zadeh's fuzzy sets theory. That is,

(#3) "Fuzzy logic in QL (in Sec. 11.7)" ="Wittgenstein picture theory"+"Zadeh's fuzzy sets theory"

And I see that

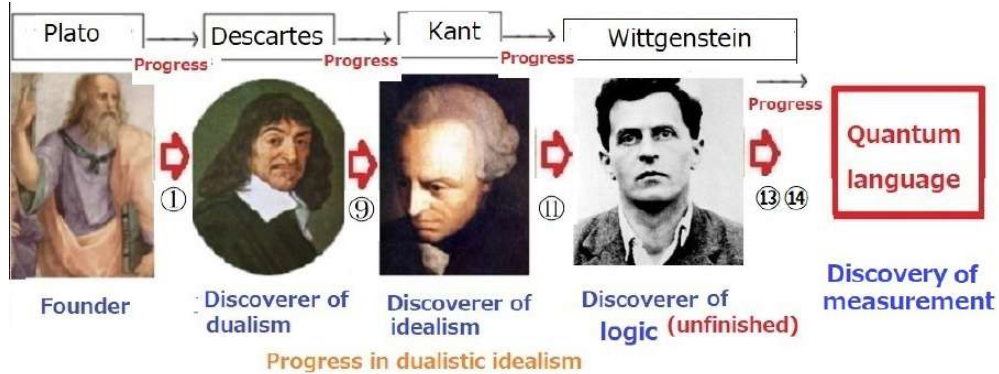

where "progress" means "getting closer to QL". To assert the above, we must find a dualistic idealism in Tractatus Logico-Philosophicus (abbreviated as TLP), i.e.,

(#4) "logic" should be regarded as a "binary measurement" (See Sec.11.7; Fuzzy logic ...)



For this, we must rebuild the core of analytic philosophy. In any case, I think my fiction above requires strict reader checking.

11.1 Elementary knowledge of symbolic logic in mathematics

11.1.1 Propositional logic and predicate logic

Let's review the basics of logic. That's enough to read this text.

Postulate 11.1. [Symbolic logic (i.e., **Propositional logic** and **predicate logic**: G. Boole, G. Frege)]
 For any proposition P , the truth function $\phi(P)$ is determined such that

$$\phi(P) = \begin{cases} 1 & \text{(if } P \text{ is true)} \\ 0 & \text{(if } P \text{ is wrong (i.e., not true))} \end{cases}$$

(A₁) Assume that P, P_1, P_2 are propositions. Then, $\neg P, P_1 \wedge P_2, P_1 \vee P_2, P_1 \rightarrow P_2$ are propositions. And it holds that

$$\phi(\neg P) = \begin{cases} 1 & \text{(if } \phi(\neg P) = 0) \\ 0 & \text{(if } \phi(\neg P) = 1) \end{cases}$$

$$\phi(P_1 \wedge P_2) = \begin{cases} 1 & \text{(if } \phi(P_1) = \phi(P_2) = 1) \\ 0 & \text{(otherwise)} \end{cases}$$

$$\phi(P_1 \vee P_2) = \phi(\neg(\neg P_1 \wedge \neg P_2)) = \begin{cases} 1 & \text{(if } (\phi(P_1), \phi(P_2)) = (1, 1), (1, 0), (0, 1)) \\ 0 & \text{(otherwise)} \end{cases}$$

$$\phi(P_1 \rightarrow P_2) = \phi(\neg P_1 \vee P_2) = \begin{cases} 1 & \text{(if } (\phi(P_1), \phi(P_2)) = (1, 1), (0, 1), (0, 0)) \\ 0 & \text{(otherwise)} \end{cases}$$

where $\wedge, \vee, \neg, \rightarrow$ respectively is called "and", "or", "not", "implies".

Also, assume that P_θ is a proposition ($\theta \in \Theta \equiv \{1, 2, \dots, n\}$), then it holds

(i): $P_1 \wedge P_2 \wedge \dots \wedge P_n$ (denoted by $\bigwedge_{\theta \in \Theta} P_\theta$,) is a proposition

(ii): $P_1 \vee P_2 \vee \dots \vee P_n$ (denoted by $\bigvee_{\theta \in \Theta} P_\theta$,) is a proposition.

Here, $\phi(P_1 \wedge P_2 \wedge \dots \wedge P_n) = \min_{i=1, \dots, n} \phi(P_i)$, $\phi(P_1 \vee P_2 \vee \dots \vee P_n) = \max_{i=1, \dots, n} \phi(P_i)$.

(A₂) The above finite set $\Theta(\equiv \{1, 2, \dots, n\})$ can be extended to an infinite set Θ .

Remark 11.2. The most important point to note above is that "proposition" is not defined. In mathematics, we can define a "mathematical proposition" in set theory. However,

(#₁) In non-mathematics, the lack of definition of "propositions" is a fatal weakness of analytic philosophy.

In this sense, analytic philosophy is not "logical". Also recall Carnap=Quine debate, which stems from the lack. Wittgenstein tried to overcome this and wrote [117]: "Tractatus Logico-Philosophicus (abbreviated as TLP)", but he could not do it. TLP was successful as an enlightening book on analytic philosophy, but incomplete as a theory.

♠**Note 11.1.** In the above, it should be noted that

(#₁) the most difficult and important problem is "What is 'P is true'?" (or, equivalently, "What is a proposition?"). Therefore, in general, the existence of a proposition is not guaranteed.

In mathematics (= set theory), we know the answer for "What is a mathematical proposition?". Thus, mathematics is a typical example of symbolic logic at work. Therefore, our present problem is

(#₂) Is there any other world besides mathematics where symbolic logic works? (This question is our main interest in this chapter)

Although it is important that symbolic logic also works in logic gate, our interest here is not

engineering.

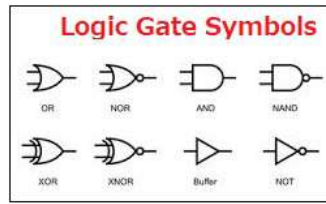

(iii): Thus, I think that, in the 100-year history of analytic philosophy, the most important question: "What is a proposition?" has always been ambiguous.

Exercise 11.3. The truth table below is well known. Wittgenstein was one of the contributors to the popularization of truth tables.

(i): The proof of syllogism: $[(p \rightarrow q) \wedge (q \rightarrow r)] \rightarrow (p \rightarrow r)$

Truth Table

p	q	r	$p \rightarrow q$	$q \rightarrow r$	$p \rightarrow r$	$(p \rightarrow q) \wedge (q \rightarrow r)$	$(p \rightarrow q) \wedge (q \rightarrow r) \rightarrow (p \rightarrow r)$
1	1	1	1	1	1	1	1
1	1	0	1	0	0	0	1
1	0	1	0	1	1	0	1
1	0	0	0	1	0	0	1
0	1	1	1	1	1	1	1
0	1	0	1	0	1	0	1
0	0	1	1	1	1	1	1
0	0	0	1	1	1	1	1

Thus, syllogism: $[(p \rightarrow q) \wedge (q \rightarrow r)] \rightarrow (p \rightarrow r)$ is always true.

(ii): Modus ponens $((p \rightarrow q) \wedge p) \rightarrow q$ is always true, but $((p \rightarrow q) \wedge q) \rightarrow p$ is not always true.

Proof of (ii)

p	q	$p \rightarrow q$	$(p \rightarrow q) \wedge p$	$(p \rightarrow q) \wedge q$	$((p \rightarrow q) \wedge p) \rightarrow q$	$((p \rightarrow q) \wedge q) \rightarrow p$
1	1	1	1	1	1	1
1	0	0	0	0	1	1
0	1	1	0	1	1	0
0	0	1	0	0	1	1

For example, put $p :=$ "it rains", $q :=$ "the ground is wet". Modus ponens says that

$$[["it rains" \rightarrow "the ground is wet"] \wedge "it rains"] \rightarrow "the ground is wet".$$

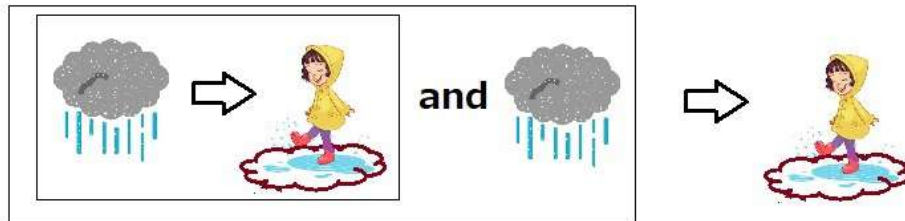

(iii): [The elementary mathematical problem concerning predicate logic]

" $\lim_{n \rightarrow \infty} a_n = a$ (i.e., "A real-valued sequence $\{a_n\}_{n=1}^{\infty}$ converges to a ") is defined by

$$\forall \epsilon (> 0) \exists N (\text{natural number}) [|a_n - a| < \epsilon (\forall n > N)]$$

This was due to the great mathematicians Cauchy and Weierstrass etc. □

11.1.2 Which do you trust more, logic or statistics?

In a word, logic is used in fields where quantitative discussion is difficult, and statistics is used in fields where detailed data is available as follows.

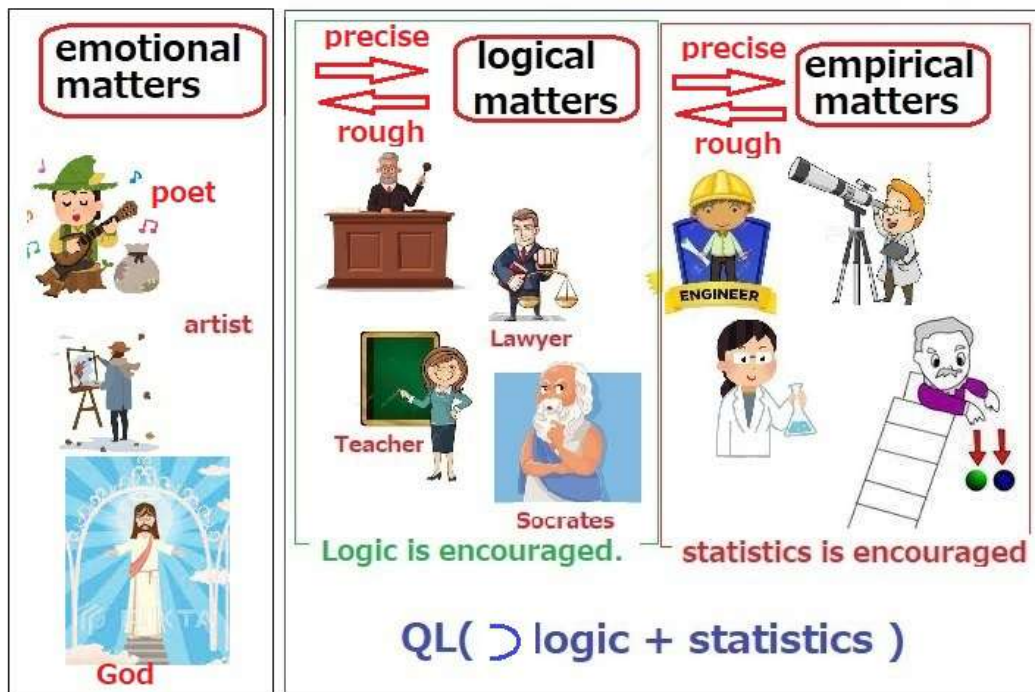

In motto terms, this figure says the following.

(B) **”Logic for the humanities, statistics for the sciences”**
 which is common sense that everyone knows.

Thus, we see that

(C₁) ”ordinary logic” =”rigorous theory” is not true.

though the following is of course true:

(C₂) ”mathematical logic” =”rigorous theory”

♠**Note 11.2.** I belong to a math department and know many brilliant mathematicians, but most of them know nothing more about logic than I mentioned above. I was surprised that philosophers knew difficult theorems of mathematical logic (e.g., Gödel’s incompleteness theorem, Löwenheim–Skolem theorem, Banach-Tarski theorem, etc.). It is curious that the overwhelmingly successful worldview is the (classical and quantum) mechanical worldview, yet many philosophers are indifferent to it. Of course, this is due to the misunderstanding (C₁).

Frege and Russell might have deliberately exploited the confusion between (C₁) and (C₂) to promote analytic philosophy. As I have said many times in this text, Plato, Descartes, and Kant began their philosophy by ”affirming lies”. Wittgenstein tried to resolve the confusion between (C₁) and (C₂), but he failed in the end.

In Sec. 12.2, we prove that

(D) ”ordinary logic” =”rough argument in QL”

That is, in statistics, errors are exposed and discussed, on the other hand, in ordinary logic, errors are hidden and are not discussed openly.

11.2 Probabilistic symbolic logic in mathematics

This section consists of excerpts from the following paper:

- (A) Ref. [78]: Ishikawa, S., (2021) Fuzzy Logic in the Quantum Mechanical Worldview ; Related to Zadeh, Wittgenstein, Moore, Saussure, Quine, Lewis Carroll, etc. JAMP, Vol. 9, No.3 , 140-154, (<https://www.scirp.org/Journal/paperinformation.aspx?paperid=95447>)

Now let us introduce probabilistic symbolic logic, which is a slight generalization of mathematical symbol logic mentioned in the previous section. Probabilistic symbolic logic plays an essential role in fuzzy logic in QL (in Sec. 11.7). Since I am convinced that this fuzzy logic is what Wittgenstein had wanted to insist, I encourage readers to read this section. This section is written in such a way that it can be read without knowledge of quantum language. It's very easy and I think it's readable by normal high school students. However, it should be noted that this probabilistic symbolic logic, like mathematical symbolic logic, is not sufficient for philosophy in the sense that it does not have a definition of "proposition".

11.2.1 Easy example

Let us start from the following easy example.

Example 11.4. For example, consider a proposition P_1 such that

- (B) $P_1 = \text{"this tomato is red"}, \quad \neg P_1 = \text{"this tomato is not red"},$

And suppose that there are 100 respondents, and furthermore, the following question is asked to them.

- (C) Is this tomato red? (i.e., is the proposition P_1 true or not?)

Assume that the results of the responses are as follows.

- (D) $\left\{ \begin{array}{l} 70 \text{ respondents say "Yes, this tomato is red" (i.e., the proposition } P_1 \text{ is true, i.e., "T")} \\ 30 \text{ respondents say "No, this tomato is not red" (i.e., the proposition } P_1 \text{ is false, i.e., "F")} \end{array} \right.$

It is possible to consider that $T = \text{"Yes"} = 1$ and $F = \text{"No"} = 0$.

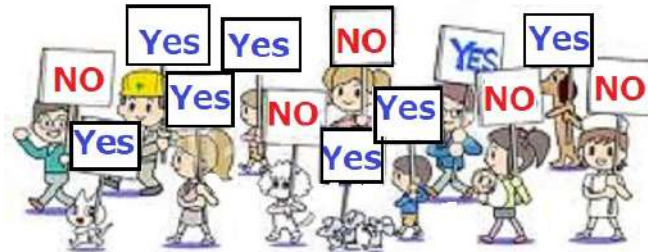

This can be probabilistically interpreted as follows.

- (E) When any respondent is *randomly* selected out of 100, the probability that this respondent will answer "yes" to question (C) is $p_1 (= 0.7)$. Or simply, the probability that the proposition P_1 is true is p_1 . In symbolic form,

$$\text{Prob}[P_1; \{T\}] = p_1 (= 0.7)$$

Then we generally denote that

$$\text{Prob}[P_1; \{T\}] = p_1, \quad \text{Prob}[P_1; \{F\}] = 1 - p_1 \quad (\text{where } 0 \leq p_1 \leq 1)$$

Also, note that $\text{Prob}[\neg P_1; \{T\}] = \text{Prob}[P_1; \{F\}] = 1 - p_1$.

Remark 11.5. (i): In the above, it should be noted that the definition of "proposition" is not written. For example, is Descartes' "I think, therefore I am" a scientific proposition? This is one of the most important problems in philosophy of science. The definition of scientific proposition is proposed in Sec. .

(ii): Zadeh often emphasized that fuzziness and probability are different concepts. However, I believe that fuzziness without a probability interpretation cannot be a scientific concept. In this sense, the above (E) is essential. Thus, the difference between fuzziness and probability are mood. As mentioned before, in this paper "probabilistic logic" in quantum language is called "fuzzy logic".

11.2.2 Quasi-product probability

In addition, assume another proposition P_2 such that $\text{Prob}[P_2; \{T\}] = p_2, \text{Prob}[P_2; \{F\}] = 1 - p_2$. Thus, we have two probability spaces $(\{T, F\}, 2^{\{T, F\}}, \mu_i), (i = 1, 2)$, such that

$$\mu_1(\{T\}) = p_1, \quad \mu_1(\{F\}) = 1 - p_1, \quad \mu_2(\{T\}) = p_2, \quad \mu_2(\{F\}) = 1 - p_2$$

And consider the quasi-product probability space $(\{T, F\}^2, \mathcal{P}(\{T, F\}^2), \mu_1 \times^{qp} \mu_2)$, which satisfies the following marginal conditions:

$$(\mu_1 \times^{qp} \mu_2)(\{T\} \times \{T, F\}) = \mu_1(\{T\}), \quad (\mu_1 \times^{qp} \mu_2)(\{F\} \times \{T, F\}) = \mu_1(\{F\}),$$

and

$$(\mu_1 \times^{qp} \mu_2)(\{T, F\} \times \{T\}) = \mu_2(\{T\}), \quad (\mu_1 \times^{qp} \mu_2)(\{T, F\} \times \{F\}) = \mu_2(\{F\}),$$

Putting the above together, we get the following table (i.e., Table 11.1).

	\backslash	$\mu_1(\{T\})$	$\mu_1(\{F\})$
$\mu_2(\{T\})$	$\mu_1 \times^{qp} \mu_2$	$(\{T, T\}) (\equiv \alpha)$	$(\{F, T\}) (\equiv \mu_2(\{F\}) - \alpha)$
$\mu_2(\{F\})$	$\mu_1 \times^{qp} \mu_2$	$(\{T, F\}) (\equiv \mu_1(\{F\}) - \alpha)$	$(\{F, F\}) (\equiv 1 - \mu_1(\{F\}) - \mu_2(\{F\}) + \alpha)$

where

$$\max\{\mu_1(\{T\}) + \mu_2(\{T\}) - 1, 0\} \leq \alpha \leq \min\{\mu_1(\{T\}), \mu_2(\{T\})\}$$

Thus, the quasi-product probability is not unique in general.

Remark 11.6. The followings (i) and (ii) are typical. Assume that $P_1 = P_2$. Thus, $\mu_1 = \mu_2$.

(i):[Product probability space]

Assume that each respondent randomly chooses "T" [resp. "F"] with probability 0.7 [resp. 0.3] in the same way for the two questions P_1 and P_2 . Then, the $\mu_1 \times^{qp} \mu_2$ is considered as the ordinary product probability $\mu_1 \times \mu_2$ such that

$$(\mu_1 \times^{qp} \mu_2)(\{(x_1, x_2)\}) = \mu_1(\{x_1\}) \times \mu_1(\{x_2\}) \quad (\forall (x_1, x_2) \in \{T, F\}^2)$$

If we write the above in a table, we get the following table (i.e., Table 11.2).

	\backslash	$\mu_1(\{T\})$	$\mu_1(\{F\})$
$\mu_2(\{T\})$	$\mu_1 \times \mu_2$	$\mu_1(\{T\}) \times \mu_2(\{T\}) (\equiv \alpha)$	$\mu_1(\{F\}) \times \mu_2(\{T\}) (\equiv \mu_2(\{F\}) - \alpha)$
$\mu_2(\{F\})$	$\mu_1 \times \mu_2$	$\mu_1(\{T\}) \times \mu_2(\{F\}) (\equiv \mu_1(\{F\}) - \alpha)$	$\mu_1(\{F\}) \times \mu_2(\{F\}) (\equiv 1 - \mu_1(\{F\}) - \mu_2(\{F\}) + \alpha)$

(ii):[Standard situation when $P_1 = P_2$] It is natural to think that the respondent selected in (C) will give the same answer to the same question (i.e., P_1 and P_1). In this case we see $\mu_1 \times^{qp} \mu_1$ such that $(\mu_1 \times^{qp} \mu_1)(\{(T, T)\}) = p_1$ and $(\mu_1 \times^{qp} \mu_1)(\{(F, F)\}) = 1 - p_1$. Thus,

$$(\mu_1 \times_{i=1,2}^{qp} \mu_1)(\{(x_1, x_2)\}) = \begin{cases} p_1 & \text{(if } (x_1, x_2) = (T, T) \\ 1 - p_1 & \text{(if } (x_1, x_2) = (F, F) \\ 0 & \text{(if } (x_1, x_2) = (T, F), (F, T) \end{cases}$$

If we write the above in a table, we get the following table (i.e., Table 11.3).

	\backslash	$\mu_1(\{T\})$	$\mu_1(\{F\})$
$\mu_1(\{T\})$	$\mu_1 \times^{qp} \mu_1$	$(\{T, T\}) = p_1$	$(\{F, T\}) = 0$
$\mu_1(\{F\})$	$\mu_1 \times^{qp} \mu_1$	$(\{T, F\}) = 0$	$(\{F, F\}) = 1 - p_1$

In this paper, unless otherwise stated, this quasi-product probability measure $\mu_1 \times^{qp} \mu_1$ will be used. However, if so, it is not necessary to ask the same question twice; we only need to ask it once. For further discussion, see Example 11.8 later. Also, this $\times_{i=1,2}^{qp} \mu_i (= \mu)$ is easily extended to the case that $\times_{i=1,2,\dots,n}^{qp} \mu_i$ (where $\mu_i = \mu$, $i = 1, 2, \dots, n$). such that

$$\left(\times_{i=1,2,\dots,n}^{qp} \mu \right) (\{(x_i)_{i=1}^n\}) = \begin{cases} p_1 & (\text{if } (x_i)_{i=1}^n = (T)_{i=1}^n) \\ 1 - p_1 & (\text{if } (x_i)_{i=1}^n = (F)_{i=1}^n) \\ 0 & (\text{others}) \end{cases}$$

11.2.3 Logic symbols and logical operations

For the sake of convenience, we will define as follows (also, see (G) for the formal definition):

(F) $P_1 \wedge P_2 =$ " P_1 and P_2 ", $P_1 \vee P_2 =$ " P_1 or P_2 ", $P_1 \rightarrow P_2 =$ " $\neg P_1$ or P_2 ", $\neg P =$ not P
If we write the above (i.e., $P_1 \wedge P_2$, $\neg P_1 \wedge P_2$, $P_1 \wedge \neg P_2$, $\neg P_1 \wedge \neg P_2$) in a table, we get the following table (i.e., Table 11.4).

Table 11.4: quasi-product probability measure $\mu_1 \times^{qp} \mu_2$ concerning $P_1 \wedge P_2$, $\neg P_1 \wedge P_2$, $P_1 \wedge \neg P_2$, $\neg P_1 \wedge \neg P_2$

	$P_1; \text{Prob}[P_1; \{T\}]$ $p_1 = \mu_1(\{T\})$	$\neg P_1; \text{Prob}[\neg P_1; \{T\}]$ $p_{\bar{1}} = \mu_1(\{F\})$
$P_2; \text{Prob}[P_2; \{T\}]$ $p_2 = \mu_2(\{T\})$	$P_1 \wedge P_2; \text{Prob}[P_1 \wedge P_2; \{T\}]$ $p_{12} (= (\mu_1 \times^{qp} \mu_2)(\{(T, T)\}) \equiv \alpha)$	$\neg P_1 \wedge P_2; \text{Prob}[\neg P_1 \wedge P_2; \{T\}]$ $p_{\bar{1}2} (= (\mu_1 \times^{qp} \mu_2)(\{(F, T)\}) \equiv p_2 - \alpha)$
$\neg P_2; \text{Prob}[\neg P_2; \{T\}]$ $p_{\bar{2}} = \mu_2(\{F\})$	$P_1 \wedge \neg P_2; \text{Prob}[P_1 \wedge \neg P_2; \{T\}]$ $p_{1\bar{2}} (= (\mu_1 \times^{qp} \mu_2)(\{(T, F)\}) \equiv p_1 - \alpha)$	$\neg P_1 \wedge \neg P_2; \text{Prob}[\neg P_1 \wedge \neg P_2; \{T\}]$ $p_{\bar{1}\bar{2}} (= (\mu_1 \times^{qp} \mu_2)(\{(F, F)\}) \equiv 1 - p_1 - p_2 + \alpha)$

where $\max\{p_1 + p_2 - 1, 0\} \leq \alpha \leq \min\{p_1, p_2\}$. Note that Tables 11.1~11.3 are related to only quasi-product probability $\mu_1 \times^{qp} \mu_2$, but Table 11.4 is related to $\mu_1 \times^{qp} \mu_2$ and logical symbol (i.e., \wedge, \neg).

Now we can explain the following example:

Example 11.7. [Simple probabilistic truth table] The following table (i.e., Table 11.5: Simple probabilistic truth table) is the same as a well-known truth table, except for the "probability column".

Table 11.5: Simple Probabilistic Truth (Elementary propositions P_1, P_2)

P_1	P_2	probability $p = \times_{i=1,2}^{qp} \mu_i$	$\neg P_1$	$P_1 \rightarrow P_2$	$P_1 \wedge P_2$	$P_1 \vee P_2$
T	T	$p_{12} = \times_{i=1,2}^{qp} \mu_i(\{(T, T)\})$	F	T	T	T
T	F	$p_{1\bar{2}} = \times_{i=1,2}^{qp} \mu_i(\{(T, F)\})$	F	F	F	T
F	T	$p_{\bar{1}2} = \times_{i=1,2}^{qp} \mu_i(\{(F, T)\})$	T	T	F	T
F	F	$p_{\bar{1}\bar{2}} = \times_{i=1,2}^{qp} \mu_i(\{(F, F)\})$	T	T	F	F

Thus, it will be enough to explain hoe to use the "probability column" as follows. For example, consider the above proposition $\neg P_1$, which can be regarded as the map from $\{T, F\}^2$ to $\{T, F\}$ such that

$$[\neg P_1](x_1, x_2) = \begin{cases} T & \text{if } (x_1, x_2) = (F, T), \text{ or } (F, F) \\ F & \text{if } (x_1, x_2) = (T, T), \text{ or } (T, F) \end{cases}$$

(or $\neg P_1 : \{T, F\} \rightarrow \{T, F\}$ such that $[\neg P_1](T) = F$, $[\neg P_1](F) = T$).

Thus, we see that $\text{Prob}[\neg P_1; \{T\}]$ (i.e., the probability that $\neg P_1$ is true) is equal to

$$(\mu_1 \times^{qp} \mu_2)([\neg P_1]^{-1}(\{T\})) = p_{\bar{1}2} + p_{\bar{1}\bar{2}}$$

Next consider $[P_1 \rightarrow P_2]$ ($= [\neg P_1 \vee P_2]$), which is regarded as the map from $\{T, F\}^2$ to $\{T, F\}$ such that

$$[P_1 \rightarrow P_2](x_1, x_2) = \begin{cases} T & \text{if } (x_1, x_2) = (T, T) \text{ or } (F, T) \text{ or } (F, F) \\ F & \text{if } (x_1, x_2) = (T, F) \end{cases}$$

Thus, we see that $\text{Prob}[P_1 \rightarrow P_2; \{T\}]$ (i.e., the probability that $[P_1 \rightarrow P_2]$ is true) is equal to

$$(\mu_1 \times^{qp} \mu_2)([P_1 \rightarrow P_2]^{-1}(\{T\})) = p_{12} + p_{\bar{1}2} + p_{\bar{1}\bar{2}}$$

Similarly we see

$$\text{Prob}[P_1 \wedge P_2; \{T\}] = p_{12}, \quad \text{Prob}[P_1 \vee P_2; \{T\}] = p_{12} + p_{\bar{1}2} + p_{1\bar{2}}$$

Furthermore, we must note that

- (G) $\neg P_1$, $[P_1 \wedge P_2]$, $[P_1 \vee P_2]$ and $[P_1 \rightarrow P_2]$ can be respectively regarded as maps from $\{T, F\}^2$ to $\{T, F\}$ as shown in the above Table 11.5. Rather than (F), this map is the formal definition of logic symbols (i.e., \neg , \wedge , \vee , \rightarrow).

Example 11.8. [Probabilistic truth table ((i): $P_1 \neq P_3$, (ii): $P_1 = P_3$)]

- (i) (Simplest case: $P_1 \neq P_3$): The following table (i.e., Table 11.6) is the preparation of the next (ii) (i.e., Tables 7, 8, 9). Consider the truth table of $[P_1 \rightarrow P_2] \wedge P_3$ as follows.

Table 11.6: Probabilistic Truth Table (Elementary propositions P_1, P_2, P_3)

P_1	P_2	P_3	probability: $p = \times_{i=1,2,3}^{qp} \mu_i$	$[P_1 \rightarrow P_2] \wedge P_3$
T	T	T	$p_{123} = \times_{i=1,2,3}^{qp} \mu_i(\{(T, T, T)\})$	T
T	T	F	$p_{12\bar{3}} = \times_{i=1,2,3}^{qp} \mu_i(\{(T, T, F)\})$	F
T	F	T	$p_{1\bar{2}3} = \times_{i=1,2,3}^{qp} \mu_i(\{(T, F, T)\})$	F
T	F	F	$p_{\bar{1}\bar{2}\bar{3}} = \times_{i=1,2,3}^{qp} \mu_i(\{(T, F, F)\})$	F
F	T	T	$p_{\bar{1}23} = \times_{i=1,2,3}^{qp} \mu_i(\{(F, T, T)\})$	T
F	T	F	$p_{\bar{1}2\bar{3}} = \times_{i=1,2,3}^{qp} \mu_i(\{(F, T, F)\})$	F
F	F	T	$p_{\bar{1}\bar{2}3} = \times_{i=1,2,3}^{qp} \mu_i(\{(F, F, T)\})$	T
F	F	F	$p_{\bar{1}\bar{2}\bar{3}} = \times_{i=1,2,3}^{qp} \mu_i(\{(F, F, F)\})$	F

This says that the proposition $[P_1 \rightarrow P_2] \wedge P_3$ is the map from $\{T, F\}^3 \rightarrow \{T, F\}$ such that

$$[[P_1 \rightarrow P_2] \wedge P_3](x_1, x_2, x_3) = \begin{cases} T & \text{if } (x_1, x_2, x_3) = (T, T, T), (F, T, T), (F, F, T) \\ F & \text{if } (x_1, x_2, x_3) = (T, T, F), (T, F, T), (T, F, F), (F, T, F), (F, F, F) \end{cases}$$

Thus,

$$\text{Prob}[[[P_1 \rightarrow P_2] \wedge P_3]; \{T\}] = \left(\times_{i=1,2,3}^{qp} \mu_i \right) ([[P_1 \rightarrow P_2] \wedge P_3]^{-1}(\{T\})) = p_{123} + p_{\bar{1}23} + p_{1\bar{2}3}$$

- (ii) (Case; $P_1 = P_3$ in the above (i)): Furthermore, assume that $P_1 = P_3$ in the above. Then, recalling Remark 11.6 (ii), we usually assume that $\times_{i=1,2,3}^{qp} \mu_i(\{(x_1, x_2, x_3)\}) = 0$ (if $x_1 \neq x_3$). Thus, putting $\times_{i=1,2}^{qp} \mu_i(\{(x_1, x_2)\}) = \times_{i=1,2,3}^{qp} \mu_i(\{(x_1, x_2)\} \times \{T, F\})$, we see the following: (Note that Table 11.6= Table 11.7 except the probability column).

Table 11.7: Probabilistic Truth Table (Overlapping elementary propositions $P_1, P_2, P_3(= P_1)$)

P_1	P_2	$P_3(= P_1)$	probability: $p = \times_{i=1,2}^{qp} \mu_i$	$[P_1 \rightarrow P_2] \wedge P_3(= P_1)$
T	T	T	$p_{123}(= p_{12}) = \times_{i=1,2}^{qp} \mu_i(\{(T, T)\})$	T
T	T	F	$p_{12\bar{3}}(= 0)$	F
T	F	T	$p_{1\bar{2}3}(= p_{1\bar{2}}) = \times_{i=1,2}^{qp} \mu_i(\{(T, F)\})$	F
T	F	F	$p_{\bar{1}\bar{2}\bar{3}}(= 0)$	F
F	T	T	$p_{\bar{1}23}(= 0)$	T
F	T	F	$p_{\bar{1}2\bar{3}}(= p_{\bar{1}2}) = \times_{i=1,2}^{qp} \mu_i(\{(F, T)\})$	F
F	F	T	$p_{\bar{1}\bar{2}3}(= 0)$	T
F	F	F	$p_{\bar{1}\bar{2}\bar{3}}(= p_{\bar{1}\bar{2}}) = \times_{i=1,2}^{qp} \mu_i(\{(F, F)\})$	F

Since the case of the probability 0 (i.e., $p_{12\bar{3}} = p_{1\bar{2}3} = p_{\bar{1}\bar{2}\bar{3}} = p_{\bar{1}\bar{2}3} = 0$) can be omitted, we have the following table:

Table 11.8: Probabilistic Truth Table (Overlapping elementary propositions $P_1, P_2, P_3(= P_1)$)

P_1	P_2	$P_3(= P_1)$	probability: $p = \times_{i=1,2}^{qp} \mu_i$	$[P_1 \rightarrow P_2] \wedge P_3(= P_1)$
T	T	T	$p_{123}(= p_{12}) = \times_{i=1,2}^{qp} \mu_i(\{(T, T)\})$	T
T	F	T	$p_{1\bar{2}3}(= p_{1\bar{2}}) = \times_{i=1,2}^{qp} \mu_i(\{(T, F)\})$	F
F	T	F	$p_{\bar{1}2\bar{3}}(= p_{\bar{1}2}) = \times_{i=1,2}^{qp} \mu_i(\{(F, T)\})$	F
F	F	F	$p_{\bar{1}\bar{2}\bar{3}}(= p_{\bar{1}\bar{2}}) = \times_{i=1,2}^{qp} \mu_i(\{(F, F)\})$	F

Therefore, we see that $\text{Prob}[[P_1 \rightarrow P_2] \wedge P_3(= P_1); \{T\}]$ (i.e., the probability that $[P_1 \rightarrow P_2] \wedge P_1$ is true) is equal to

$$(\mu_1 \times^{qp} \mu_2)([[P_1 \rightarrow P_2] \wedge P_3(= P_1)]^{-1}(\{T\})) = p_{12}$$

Note that this is essentially the same as the following table.

Table 11.9: Probabilistic Truth Table (Non-overlapping elementary propositions P_1, P_2)

P_1	P_2	probability: $p = \times_{i=1,2}^{qp} \mu_i$	$[P_1 \rightarrow P_2] \wedge P_1$
T	T	$p_{12} = \times_{i=1,2}^{qp} \mu_i(\{(T, T)\})$	T
T	F	$p_{1\bar{2}} = \times_{i=1,2}^{qp} \mu_i(\{(T, F)\})$	F
F	T	$p_{\bar{1}2} = \times_{i=1,2}^{qp} \mu_i(\{(F, T)\})$	F
F	F	$p_{\bar{1}\bar{2}} = \times_{i=1,2}^{qp} \mu_i(\{(F, F)\})$	F

Hence, we conclude that Tables 7, 8 and 9 are essentially the same. And therefore, we see;

(H) the calculation will be more concise if we start with non-overlapping propositions (such as Table 11.9).

Example 11.9. [Modus ponens in probabilistic truth table] The following table (i.e., Table 11.10: Probabilistic truth table) is the same as a well-known truth table, except for the "probability column".

Table 11.10: Probabilistic Truth Table (Elementary propositions P_1, P_2)

P_1	P_2	probability: $p = \times_{i=1,2}^{qp} \mu_i$	$[P_1 \rightarrow P_2] \wedge P_1$	$[P_1 \rightarrow P_2] \wedge P_1 \rightarrow P_2$
T	T	$p_{12} = \times_{i=1,2}^{qp} \mu_i(\{(T, T)\})$	T	T
T	F	$p_{1\bar{2}} = \times_{i=1,2}^{qp} \mu_i(\{(T, F)\})$	F	T
F	T	$p_{\bar{1}2} = \times_{i=1,2}^{qp} \mu_i(\{(F, T)\})$	F	T
F	F	$p_{\bar{1}\bar{2}} = \times_{i=1,2}^{qp} \mu_i(\{(F, F)\})$	F	T

For example, consider the proposition $[P_1 \rightarrow P_2] \wedge P_1$, which is regarded as the map from $\{T, F\}^2$ to $\{T, F\}$ such that

$$[[P_1 \rightarrow P_2] \wedge P_1](x_1, x_2) = \begin{cases} T & \text{if } (x_1, x_2) = (T, T) \\ F & \text{if } (x_1, x_2) = (T, F), (F, T), (F, F) \end{cases}$$

Thus, we see that $\text{Prob}[[[P_1 \rightarrow P_2] \wedge P_1]; \{T\}]$ (i.e., the probability that $[[P_1 \rightarrow P_2] \wedge P_1]$ is true) is equal to

$$(\mu_1 \times^{qp} \mu_2)([[P_1 \rightarrow P_2] \wedge P_1]^{-1}(\{T\})) = p_{12}$$

By the same way, we can calculate as follows.

$$(\mu_1 \times^{qp} \mu_2)((((P_1 \rightarrow P_2) \wedge P_1) \rightarrow P_2)^{-1}(\{T\})) = p_{12} + p_{1\bar{2}} + p_{\bar{1}2} + p_{\bar{1}\bar{2}} = 1$$

That is,

$$\text{Prob}(((P_1 \rightarrow P_2) \wedge P_1) \rightarrow P_2; \{T\}) = p_{12} + p_{1\bar{2}} + p_{\bar{1}2} + p_{\bar{1}\bar{2}} = 1$$

Thus, modus ponens is always true even in probabilistic logic.

For example, put $P_1 :=$ "it rains", $P_2 :=$ "the ground is wet". Modus ponens says that

$$[["it rains" \rightarrow "the ground is wet"] \wedge "it rains"] \rightarrow "the ground is wet".$$

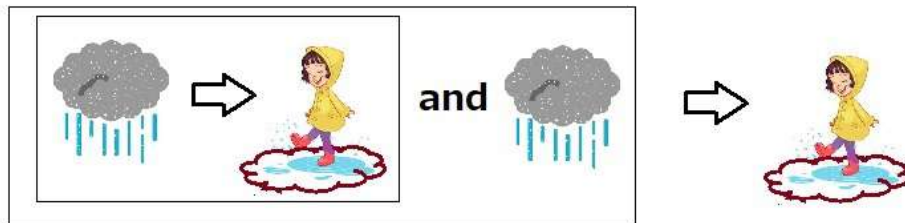

The statement (H) in Examples 11.8 says that it suffices to consider the case of non-overlapping propositions. Thus we have the following theorem.

Theorem 11.10. [Logical sample space] Let $P_1, P_2, \dots, P_i, \dots, P_n$ be non-overlapping propositions (i.e., $P_i \neq P_j (\forall i, j \text{ such that } i \neq j, \text{ cf. (H) above})$, and consider the probability space $(\{T, F\}, 2^{\{T, F\}}, \mu_i)$ such that $\mu_i(\{T\}) = \text{Prob}[P_i; \{T\}]$, $\mu_i(\{F\}) = \text{Prob}[P_i; \{F\}]$. Consider a quasi-product probability space $(\{T, F\}^n, \mathcal{P}(\{T, F\}^n), \times_{i=1,2,\dots,n}^{qp} \mu_i)$ such that

$$\left(\times_{i=1,2,\dots,n}^{qp} \mu_i \right) (\{T, F\}^{k-1} \times \{x\} \times \{T, F\}^{n-k}) = \text{Prob}[P_k; \{x\}] \quad (x \in \{T, F\}, \quad k = 1, 2, \dots, n)$$

Then, the pair $[\{P_1, P_2, \dots, P_n\}; (\{T, F\}^n, \mathcal{P}(\{T, F\}^n), \times_{i=1,2,\dots,n}^{qp} \mu_i)]$ is called the *logical sample space*. Let P be a proposition which is constructed by P_1, \dots, P_n . Note that P is regarded as the map from $\{T, F\}^n \rightarrow \{T, F\}$. Then, we see that

$$\text{Prob}[P; \{T\}] = \left(\times_{i=1,2,\dots,n}^{qp} \mu_i \right) (P^{-1}(\{T\}))$$

Also, it is clear that the above Example 11.9 implies the following corollary.

Corollary 11.11. [Tautology in probabilistic logic] Let P be a proposition constructed from non-overlapping propositions P_1, P_2, \dots, P_n . Then, the followings are equivalent:

- (i) P is a tautology in the sense of usual logic.
- (ii) $\text{Prob}[P; \{T\}] = 1$.

That is, tautology always holds even in probabilistic logic. For example,

- (#) syllogism (i.e., $[[P_1 \rightarrow P_2] \wedge [P_2 \rightarrow P_3]] \rightarrow [P_1 \rightarrow P_3]$ always holds.

Remark 11.12. It is usually said that the following is the typical example of syllogism.

- (#) Since Socrates is human being, and human being is mortal, it follows that Socrates is mortal.



However we do not know the definition of "proposition" other than "mathematical proposition". For example, as seen in Sec. 8.2, "I think" and "I am" are not propositions in QL. A discussion of mathematics alone, without a worldview, is powerless.

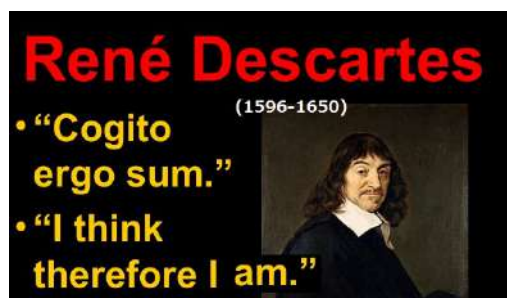

Therefore, the above Corollary 11.11 does not guarantee that (#) holds. This will be discussed in Sec. 12.2.

11.3 George Boole (1815-1864), Gottlob Frege (1848-1925) and Bertrand Russell (1872-1970)

George Boole (1815-1864) was a mathematician, philosopher and logician in England. Particularly, it's said that the propositional logic (i.e., Boolean algebra) was proposed by him. Also, Gottlob Frege (1848-1925) was a German philosopher, logician, and mathematician. He is called **the father of analytic philosophy**, concentrating on the philosophy of language, logic, and mathematics. Particularly, it's said that the predicate logic was proposed by him. Bertrand Russell (1872-1970) was mathematician, philosopher, logician, social critic in England. With A. N. Whitehead he wrote *Principia Mathematica*, an attempt to create a logical basis for mathematics.



self-taught English mathematician
G. Boole (1815-1864)

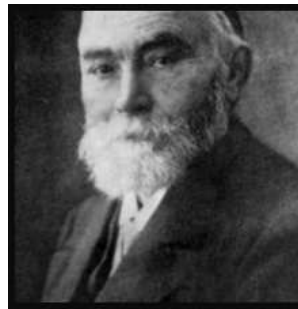

Every good mathematician is at least half a philosopher, and every good philosopher is at least half a mathematician.

~ Gottlob Frege (1848-1925)

Recall Remark 10.5 such as

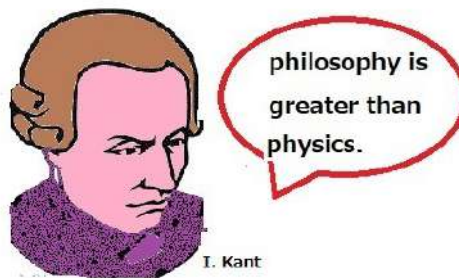
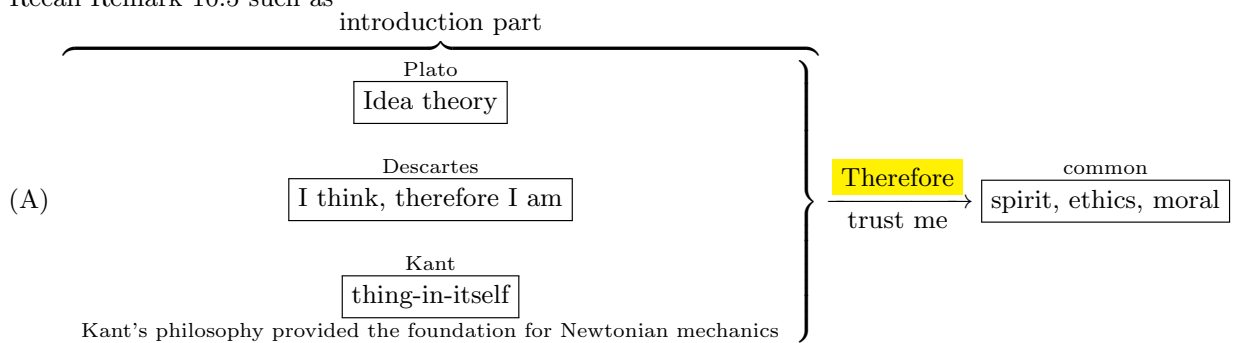

That is, it was the method of philosophy (i.e., Plato's way of telling philosophy) to find something impossible to doubt, and then declare that they had "deduced" various things from it.

Following the example of Kant, B. Frege and B. Russell must have thought the following (or they must have thought that the general public would support them if they said the following):

(B₁) Mathematical logic provides the foundation for mathematics. Mathematics is just one area of mathematical logic. Mathematical logic is so powerful that there is no doubt about it. Thus, mathematical logic is greatest. **Therefore**, we have to be "logical".

That is,

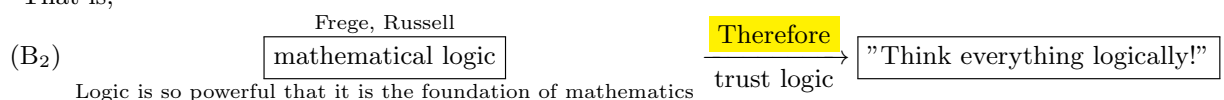

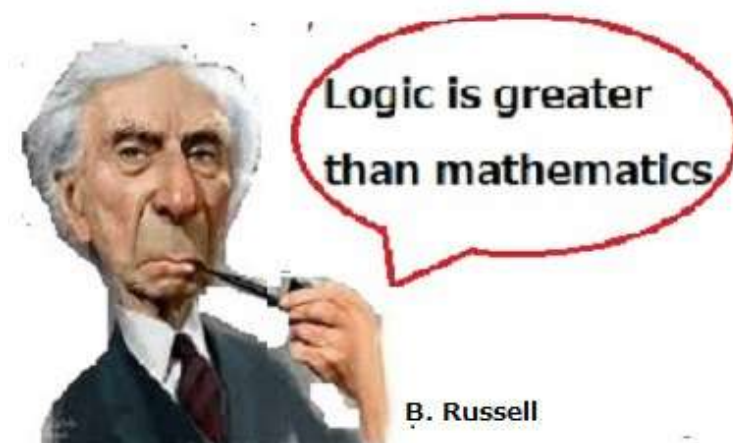

I think that Frege and Russell did not inherit Kant's philosophy, but they learned how to spread philosophy from Kant's methods.

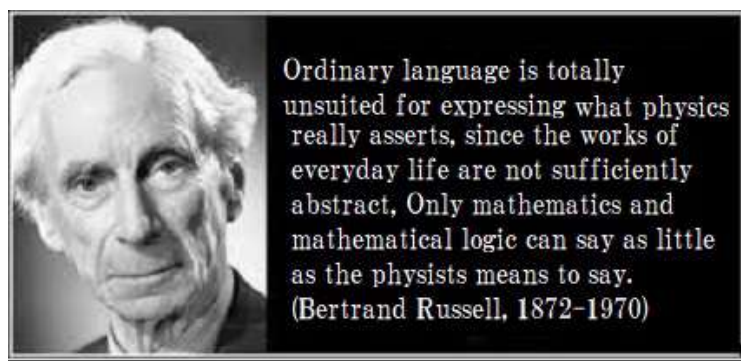

B. Russell wrote in "The Basic Writings of Bertrand Russell, 1903-1959", (p.608, Psychology Press) such as (C) *Ordinary language is totally unsuited for expressing what physics really asserts, since the words of everyday life are not sufficiently abstract. Only mathematics and mathematical logic can say as little as the physicist means to say.*

I think Russell was sociable and interacted with many scientists in different fields, so of course he knew that "Einstein was not familiar with mathematical logic". So why did he make the above statement? My guess is as follows. He knew the method of philosophy (i.e., Plato's way of telling philosophy), that is,

Philosophy is "asserted fiction" that is, to say "Therefore" in the (B), even if it's a lie.

Moreover, I think Russell was a man of integrity, and he could not keep lying, so he made his student Wittgenstein say,

(D₁) "The 'Therefore' in (B) is a lie."

(D₂) "Russell's (C) is a lie, since he cannot define "non-mathematical proposition"

For example, is "the fist proposition "I think, therefore, I am" a non-mathematical proposition?

Otherwise, Russell's generosity to Wittgenstein cannot be understood.

♠**Note 11.3.** The rule of philosophy (\approx idealism) is as follows:

- (#1) Only discussion, no experimentation.
- (#2) the winner will be determined by popularity vote of the general public.



Therefore, philosophers are not necessarily in pursuit of truth. Sometimes it is necessary to bluff a little to gain a lot of support. Russell did not mean to say that logic is greater than mathematics. However, ordinary enthusiasts of philosophy may have felt from Russell's words and actions that "logic is greater than mathematics."

11.4 Peirce (1839-1914): Abduction



Charles Sanders Peirce (1839-1914)

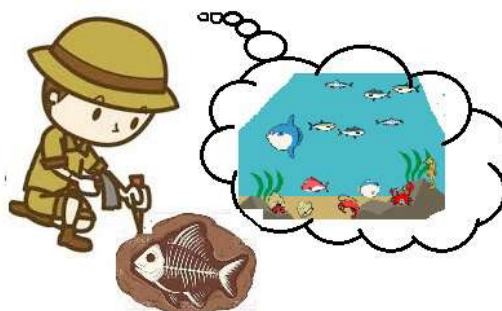

Charles Sanders Peirce (1839-1914) was an American philosopher, logician, mathematician, and scientist who is sometimes known as "the father of pragmatism". This paper will not touch on pragmatism, but will speak of his "abduction" (also called abductive reasoning, abductive inference, or retrodution). In ref. [96] (Vol. II p.375), as the typical example of "abduction", Peirce mentioned as follows.

- Fossils are found; say, remains like those of fishes, but far in the interior of the country. To explain the phenomenon, we suppose the sea once washed over this land.

This kind of reasoning was called "abduction" by Peirce. As most readers will immediately realize, abduction is essentially the same as the qualitative representation of Fisher's maximum likelihood method. Recall the following figure in Sec. 1.5.3:

Is it a man or a woman? [Fisher's maximum likelihood method]

$$\frac{\text{Number of men wearing skirts}}{\text{Number of men}} \cong 1\% < 50\% \cong \frac{\text{Number of women wearing skirts}}{\text{Number of women}}$$

Therefore, by **Fisher's maximum likelihood method**, we infer that

it is a woman.

This section was written with reference to the following.

- [75]:Ishikawa, S: Philosophy of science for scientists; The probabilistic interpretation of science Journal of quantum information science, Vol. 9, No.3 , 140-154, DOI: 10.4236/jqis.2019.93007 (<https://www.scirp.org/Journal/paperinformation.aspx?paperid=95447>)

The purpose of this section is to explain the following table:

Logical worldview [no measurement (Qualitative, logical approach)]		Quantum mechanical worldview [measurement (Quantitative, probabilistic approach)]
deduction (cf. Sec 11.4)	←→	measurement
abduction (cf. Sec 11.3)	←→	inference (maximum likelihood method)
induction (cf. Sec 9.7)	←→	the law of large numbers

where

- (#) $\left\{ \begin{array}{ll} \text{the logical approach} & (\text{rough, handy}) \\ \text{the probabilistic approach} & (\text{exact, calculation required}) \end{array} \right.$

♠**Note 11.4.** Peirce's work was done before 1900. The pioneering nature of his work can be clearly seen in the following timeline

- (i) Born's discovery "the probabilistic interpretation of quantum mechanics" in ref. [6] (1926)
- (ii) Tractatus Logico-Philosophicus by L. Wittgenstein in ref. [117] (1921)
- (iii) Fisher's great book "Statistical Methods for Research Workers" in ref. [22] (1925)

These three are among the major works of the top ten most influential writings of the 20th century. Therefore, I believe that Peirce's work was ahead of its time.

11.4.1 * What is Peirce's abduction?

11.4.1.1 Deduction, abduction and induction in "logic"

According to Peirce, three kinds of inferences (i.e., deduction, abduction, induction) are important. Let us explain deduction, abduction and induction as follows.

[Deduction]

A typical example of deduction is as follows: (In the following, (A_1') and (\hat{A}_1') are often omitted.)

(A_1) All the beans in this bag B_1 are white: [bag $B_1 \rightarrow$ "w" (\approx white)]

(A_1') All the beans in that bag B_2 are white or black fifty-fifty (or generally, the ratio of white beans to black beans is $p/(1-p)$ where $0 < p < 1$): [bag $B_2 \rightarrow$ "w" (\approx white) or "b" (\approx black)]

(A_2) This bean is from this bag B_1 : [bag B_1]

(A_3) Therefore, this bean is white: ["w" (\approx white)]

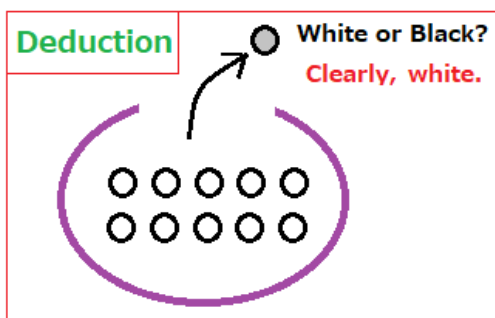

It is, of course, obvious and ordinary.

♠**Note 11.5.** It is clear that the following is a tautology:

$$(\#_1) \quad [[B_1 \rightarrow w] \wedge [B_2 \rightarrow [w \vee b]] \wedge B_1] \rightarrow [w]$$

Thus, the above conclusion (A_3) can be understood as a consequence of this tautology $(\#_1)$.

However, this has not solved everything. We have the following problem:

$(\#_2)$ Is there a more natural solution than the above solution (due to the logical worldview (=the logical spirit=the spirit of "Think logically!"))?

This new solution will be introduced in the following section.

[Abduction]

C.S. Peirce (cf. ref. [96]) proposed abduction as follows.. The example of abduction is as follows:

(\hat{A}_1) All the beans in this bag B_1 are white: [bag $B_1 \rightarrow$ "w" (\approx white)]

(\hat{A}_1') All the beans in that bag B_2 are white and black fifty-fifty (or generally, the ratio of white beans to black beans is $p/(1-p)$): [bag $B_2 \rightarrow$ "w" (\approx white) or "b" (\approx black)]

(\hat{A}_2) This bean (from B_1 or B_2 (i.e., it is not known whether it is B_1 or B_2)) is white: ["w" (\approx white)]

(\hat{A}_3) Therefore, this bean is from this bag B_1 : [bag B_1]

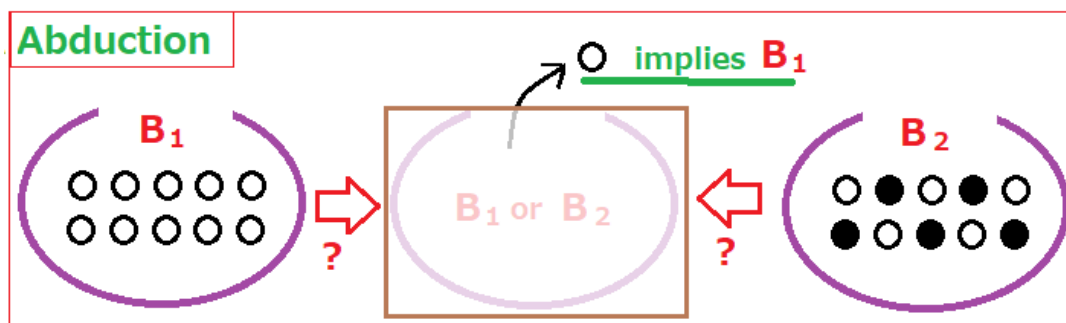

♠**Note 11.6.** It is clear that the following is not a tautology:

$$(\#_1) \quad [[B_1 \rightarrow w] \wedge [B_2 \rightarrow [w \vee b]] \wedge w] \rightarrow [B_1]$$

Thus, the above conclusion (\hat{A}_3) can not be understood since this $(\#_3)$ is not a tautology. However, the above conclusion (\hat{A}_3) has a point as follows. For simplicity, assume that $0 \leq p \ll 1$ (i.e., most of the beans in the B_2 are black).

$(\#_2)$ After (\hat{A}_2) , assume that this white bean is from the bag B_2 .

If so, this is a very rare event that has happened since most of the beans in the B_2 are black. The assumption $(\#_2)$ is unreasonable. That is, it is reasonable to consider that this white bean is from the bag B_1 , namely, (\hat{A}_3) .

Now from the theoretical point of view, we have two ways to think the above problem.

- $(\#_3)$ $\left\{ \begin{array}{l} \textcircled{1}: \text{To invent another symbolic logic in which } (\#_1) \text{ is derived} \\ \textcircled{2}: \text{To propose a different worldview than the logical worldview (=the logical spirit} \\ \text{=the spirit of "Think logically!"}. \\ \text{And to derive } (\hat{A}_3) \text{ in the new worldview.} \end{array} \right.$

I think that $\textcircled{1}$ is impossible. $\textcircled{2}$ will be introduced in the following section.

[Induction]

Further, induction (inductive reasoning) is as follows.

(\tilde{A}_1) 1000p white beans and 1000(1 - p) black beans are mixed well in this bag B_3 (here, $0 < p < 1$). Assume that we do not know the value p ($0 < p < 1$).

(\tilde{A}_2) When we took 20 beans out of this bag B_3 , every bean was white.

(\hat{A}_3) Therefore, the bean picked out from this bag B_3 next can be presumed to be white.



This will be again discussed in the following section.

11.4.1.2 Deduction, abduction and induction in quantum language (i.e., the quantum mechanical worldview)

In our worldview (i.e., the quantum mechanical worldview \approx the quantum linguistic worldview), the relation among deduction, abduction and induction is characterized as follows.

First, we will show that the abduction $[(\hat{A}_1)-(\hat{A}_3)]$ can be justified in quantum language. Consider the state space $\Theta = \{\theta_1, \theta_2\}$ with the discrete topology, and the classical basic structure $[C(\Theta) \subseteq L^\infty(\Theta, \nu) \subseteq B(L^2(\Theta, \nu))]$, where $\nu(\{\theta_1\}) = \nu(\{\theta_2\}) = 1/2$. Assume that

$$\theta_1 \approx \text{the state of the bag } B_1, \quad \theta_2 \approx \text{the state of the bag } B_2,$$

Assume that 1000 white beans belong to bag B_1 , and further, 1000p white beans and 1000(1 - p) black beans belong to the bag B_2 (where $0 < p < 1$). Thus we have the observable $O = (\{w, b\}, 2^{\{w, b\}}, F)$ in $L^\infty(\Theta, \nu)$ such that

$$\begin{aligned} [F(\{w\})](\theta_1) &= 1 & [F(\{b\})](\theta_1) &= 0 \\ [F(\{w\})](\theta_2) &= p & [F(\{b\})](\theta_2) &= 1 - p \quad (0 < p < 1) \end{aligned}$$

where "w" and "b" means "white" and "black" respectively.

Thus, we have the measurement $M_{L^\infty(\Theta, \nu)}(O := (\{w, b\}, 2^{\{w, b\}}, F), S_{[\theta_i]})$, $i = 1, 2$. For example, **Axiom 1 [measurement] (in Section 1.1)** says that

(B_1) [measurement]: The probability that the measured value w is obtained by $M_{L^\infty(\Theta, \nu)}(O := (\{w, b\}, 2^{\{w, b\}}, F), S_{[\theta_1]})$ is equal to 1

This is the same as the deduction (i.e., $(A_1)-(A_3)$).

Next, under the circumstance that bags B_1 and B_2 cannot be distinguished, we consider the following inference problem:

(\hat{B}_2) [inference problem]: When the measured value w is obtained by the measurement $M_{L^\infty(\Theta, \nu)}(O := (\{w, b\}, 2^{\{w, b\}}, F), S_{[*]})$, which do you infer, $[*] = \theta_1$ or $[*] = \theta_2$?

Fisher's maximum likelihood method **Theorem 1.19** [Fisher's maximum likelihood method] says that $[*] = \theta_1$, since

$$\max\{F(\{w\})](\theta_1), F(\{w\})](\theta_2)\} = \max\{1, p\} = 1 = [F(\{w\})](\theta_1)$$

This implies (\hat{A}_3) .

Therefore, the above (\hat{B}_2) is the quantum linguistic representation of abduction (i.e., $(\hat{A}_1)-(\hat{A}_3)$). For the sake of completeness, note that (B_1) and (\hat{B}_2) are in reverse problem (cf. Remark 1.20). That is, we have the following correspondence:

Correspondence 11.13.	
(B_1) : measurement Axiom 1 [measurement] (in Section 1.1)	$\xrightarrow{\text{simplified form}}$ $[(A_1), (A'_1), (A_2) \rightarrow (A_3)]$ deduction
\downarrow reverse	\downarrow reverse
(\hat{B}_2) : inference (Fisher's maximum likelihood method)	$\xrightarrow{\text{simplified form}}$ $[(\hat{A}_1), (\hat{A}'_1), (\hat{A}_2) \rightarrow (\hat{A}_3)]$ abduction
	(11.1)

Thus, the scientific meaning of abduction can be completely clarified in the translation from logic to quantum language. Lastly we should mention that

(\hat{B}_3) the above $(\hat{A}_1)-(\hat{A}_3)$ (i.e., inductive reasoning) are already discussed in quantum language (cf. Section 9.7: Hume's problem of induction).

After all, I think that

- logic is useful for making broad arguments.

However, a logical approach is of course also important since quantitative data is not available in most cases on a daily basis. In fact, I think that Detective Sherlock Holmes was a great master of Peirce's abduction.

As a slogan,

the humanities are logic, and the sciences are statistics.

which is similar to

logic for rough arguments, statistics for precise arguments.

This will be proved in Sec. 12.2.

♠**Note 11.7.** Philosophers may like logic (i.e., the logical worldview (=the logical spirit=the spirit of "Think logically!")), thus, they may want to think that deduction, abduction and induction are kinds of logic. However, I think that Peirce's argument in Sec. 11.4 is not natural. On the other hand, we think that our quantum mechanical formulation is reasonable as follows.

- (C₁) deduction ····· measurement
 (possible but unnatural) (possible and natural)
- (C₂) abduction ····· inference (Fisher's maximum likelihood method)
 (theoretically impossible) (possible and natural)
- (C₃) induction ····· the law of large numbers
 (theoretically impossible) (possible and natural)

That is,

Logical worldview [no measurement]	↔	Quantum mechanical worldview [measurement, probability]
deduction (cf. Sec 11.3)	↔	measurement
abduction (cf. Sec 11.3)	↔	inference
induction (cf. Sec 9.7)	↔	the law of large numbers

where

- (#) { the logical approach (rough, handy)
 { the probabilistic approach (exact, calculation required)

Here, recall Sec. 9.8, i.e., the grue paradox arises in the logical worldview (or precisely, logical method), and not in quantum mechanical worldview.

Finally, note the following:

- In the case that quantitative data is available, "quantum mechanical worldview" is superior to "logical worldview". However, "logical worldview" has the advantage that it can be used without using mathematical formulas. Therefore, **from a daily point of view, it may be said that "logical worldview" is superior.**

11.5 Bertrand Russell: five-minute hypothesis, McTaggart's paradox, Moore's paradox

This section consists of excerpts from the following paper:

- Ref. [78]: Ishikawa, S., (2021) Fuzzy Logic in the Quantum Mechanical Worldview ; Related to Zadeh, Wittgenstein, Moore, Saussure, Quine, Lewis Carroll, etc. JAMP, Vol. 9, No.3 , 140-154, (<https://www.scirp.org/Journal/paperinformation.aspx?paperid=95447>)

Bertrand Russell (1872-1970) was a great intellectual and one of the founders of analytic philosophy along with Gottlob Frege (and student Ludwig Wittgenstein). Russell is a multi-talented philosopher who has produced many achievements. However, his greatest achievement may have been the production of the "genius Wittgenstein".

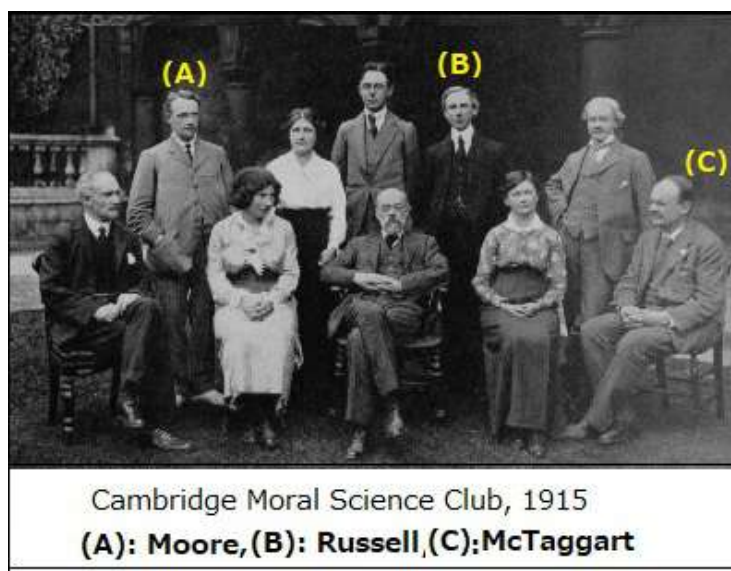

In this section, I mention "Russell's paradox", "Five-minute hypothesis", and "McTaggart's paradox", Moore's paradox. And we see that these are closely related to the linguistic Copenhagen interpretation (or equivalently, to the problem "What is a 'proposition'?"). Thus, it can be said that

- the three of them prepared the ground for the appearance of Wittgenstein at Cambridge University. Also, it may be interesting to read ref. [109] for the delicate relationship between Russell and McTaggart.

11.5.1 Russell's paradox in set theory

As mentioned frequently in this text, I think that mathematical logic is one of fields of mathematics and thus, Russell's study of logic has little to do with traditional Western philosophy (i.e., Descartes-Kant philosophy).

However, some things should be mentioned below. The following is famous as Russell's paradox (or, Russell-Zermelo paradox).

The naive set theory (i.e., Cantor's set theory) involves contradictions. For example, Russell showed Russell's paradox such that

- (A) if it is assumed that $\{U \mid U \notin U\}$ is a set, then it leads contradiction (1902).^{*1}

To avoid such a paradox, Alfred North Whitehead and Bertrand Russell proposed "type theory" (i.e., a kind of axiomatic set theory), which was published as the **Principia Mathematica** on the foundations of mathematics in 1910–1913. Also, the axiomatic system of set theory was developed by Zermelo and others. Most modern mathematicians study mathematics developed under a system of axioms called ZFC (1921), which consists of eight axioms by Zermelo and Fraenkel plus an axiom called the Axiom of Choice.

^{*1} I it is assumed that "the set of all sets" is a set, the it leads contradiction. This is called Cantor's paradox.

Remark 11.14. The above is closely related to the problem: "What is a 'mathematical proposition'?". That is because this problem is essentially the same as the problem: "What is a 'set'?". Therefore, It is believed that the problem:"What is a 'mathematical proposition'?" was solved by Zermelo and Fraenkel. Therefore, the next biggest and only remaining philosophical question is

- "What is a 'non-mathematical proposition'?"

This, of course, was the problem Wittgenstein pursued in ref. [117]: "Tractatus Logico-Philosophicus".

**Something that looks like a bird
but is not a bird.**



Summing up, we see that

(B) Russell's paradox (i.e., the discovery of something like a set but not a set) prompted the birth of axiomatic set theory (e.g., Zermelo-Fraenkel set theory), in which "mathematical proposition" can be completely defined.

This (B) should be compared with the following (C).

(C) Similarly, the discovery of something like a proposition but not a proposition (e.g., "I think, therefore I am", Moore's paradox, etc.) prompted the development of the linguistic Copenhagen interpretation (which serves to distinguish between "scientific proposition" and "non-scientific proposition").

Recall the final chapter of Wittgenstein's TLP (i.e., ref. [117]: "Tractatus Logico-Philosophicus") in which only " *What we cannot speak about we must pass over in silence*" is written. This implies that Wittgenstein's central theme in his TLP is to draw a line between what we can speak about (= scientific propositions) and what we cannot speak about (= non-scientific propositions), which is the same as the theme of this text (i.e., the linguistic Copenhagen interpretation \approx the quantum mechanical world view \approx quantum language). This will be discussed in later (Sec. 11.7).

♠**Note 11.8.** Note that

Russell's paradox(1902)	—————→	Zermelo-Fraenkel set theory
	about 20 years later	
Descartes' "I think therefore I am"(1637)	—————→	linguistic Copenhagen interpreta- tion
	about 350 years later	

This is due to the fact:

- There was a strong belief in mathematics that paradox should be avoided at all costs. On the other hand, philosophers have enjoyed and exploited paradoxes.

11.5.2 * Five-minute hypothesis



**Nothing ... can disprove
the hypothesis that
the world began
five minutes ago.**

Bertrand Russell was a very eloquent philosopher who communicated many thought-provoking things to the general public. For a layman like me, he is a very helpful philosopher. If the following quote had not come from Russell, I don't think it would have been as famous as it is.

- *There is no logical impossibility in the hypothesis that the world sprang into being five minutes ago, exactly as it then was, with a population that "remembered" a wholly unreal past. There is no logically necessary connection between events at different times; therefore nothing that is happening now or will happen in the future can disprove the hypothesis that the world began five minutes ago.*

Ref. [106] "The Analysis of Mind", p.223, Bertrand Russell

This section was written with reference to the following.

- [73]:Ishikawa, S: Leibniz-Clarke correspondence, Brain in a vat, Five-minute hypothesis, McTaggart's paradox, etc. are clarified in quantum language Open Journal of philosophy, Vol. 8, No.5 , 466-480, 2018, DOI: 10.4236/ojpp.2018.85032

(<https://www.scirp.org/Journal/PaperInformation.aspx?PaperID=87862>)

[Revised version] (<https://philpapers.org/rec/ISHLCB>)

(http://www.math.keio.ac.jp/academic/research_pdf/report/2018/18001.pdf)

The five-minute hypothesis is a skeptical hypothesis put forth by the philosopher Bertrand Russell. However, as seen later, I do not think that this hypothesis is not related to skepticism though my understanding to skepticism may be insufficient. The five-minute hypothesis, proposed by B. Russell (*cf.* ref. [106]), is as follows.

(A₁) the universe was created five minutes ago. Or equivalently, the universe was created ten years ago.

Now we show that this (A₁) is not the statement in quantum language as follows (i.e., The first answer (i) and the second answer (ii))

Answer:

Recall the linguistic Copenhagen interpretation:

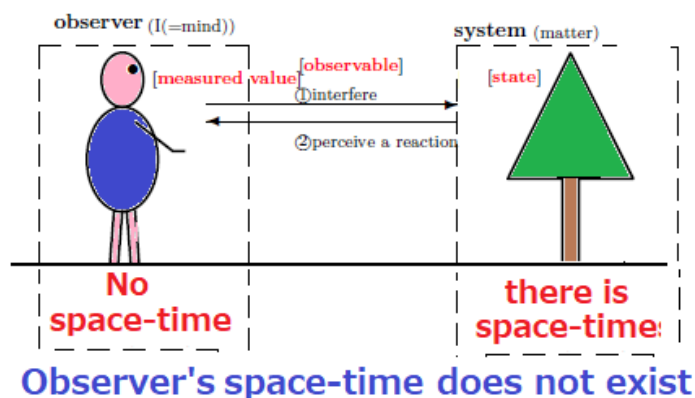

Thus, observer's time (e.g., "tense", "now",...) can not used in quantum language.

Note that this hypothesis (A₁) is related to "tense". Thus, the linguistic Copenhagen interpretation (E₂) in Sec. 1.1.2 says that this (A₁) is not a statement in quantum language. Thus, the (A₁) is not scientific, that is, there is no experiment to verify the statement (A₁).

Therefore, we can conclude that

(A₂) "the universe was created five minutes ago" is not a proposition in QL.



Some may want to relate this hypothesis to skepticism (*cf.* ref. [106]), However we do not think that this direction is productive.

Remark 11.15. (i): Also, the above (A₁) should be compared to the following (A₂)

(A₃) The universe was created in A.D. 2010. (Or equivalently, now is A.D. 2020, and the universe was created ten years ago.)

This (A₃) can be denied by experiment, that is, it is different from the fact. Thus, this is a proposition in quantum language.

(ii): Consider the following situation:



In the above, we say that

(#₁) Russell's statement is scientific, but it is wrong.

(#₂) Wittgenstein is making a logical error. That is, he misunderstands Russell's scientific statements as unscientific.

11.5.3 * McTaggart's paradox

This section was written with reference to the following.

- [73]:Ishikawa, S: Leibniz-Clarke correspondence, Brain in a vat, Five-minute hypothesis, McTaggart's paradox, etc. are clarified in quantum language Open Journal of philosophy, Vol. 8, No.5 , 466-480, 2018, DOI: 10.4236/ojpp.2018.85032
 (https://www.scirp.org/Journal/PaperInformation.aspx?PaperID=87862)
 [Revised version] (https://philpapers.org/rec/ISHLCB)
 (http://www.math.keio.ac.jp/academic/research_pdf/report/2018/18001.pdf)

J.M.E. McTaggart (1866–1921) was an English philosopher. He was a member of the Cambridge Apostles, along with B. Russell (1877-1970). In ref. [90], McTaggart asserted "the Unreality of Time" as follows.

The sketch of McTaggart's proof

(B₁) Assume that there are two kinds of times. i.e., "observer's time (A-series)" and "objective time (B-series)". (Note that this assumption is against the linguistic Copenhagen interpretation (E₂) in Sec. 1.1.2.)

(B₂)

(B₃) After all, the contradiction is obtained

Therefore, by the reduction to the absurd (i.e., the proof by contradiction), we get;

(B₄) A-series does not exist (in science).

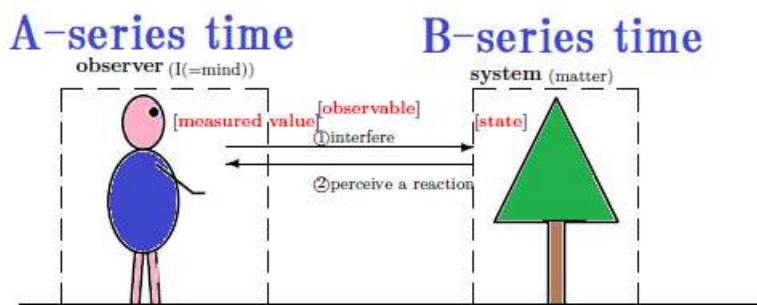

Recall the linguistic Copenhagen interpretation:

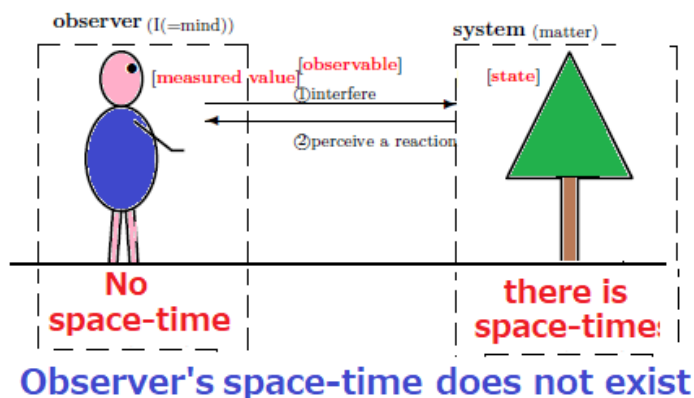

This implies that the above McTaggart's proof is non-sense.

For completeness, we add the following. About this proof, there are various opinions also among philosophers. Although I cannot understand the above part (B₂) (since the properties of A-series are not clear), I agree to him if his assertion is (B₄) (cf. ref. [47]). That is, I agree that McTaggart noticed first that observer's time is not scientific. Recall the linguistic Copenhagen interpretation (E₂) in Sec. 1.1.2:

- While "matter" is in the space-time, the observer is not.

Thus, I agree to the opinion that McTaggart is one of discoverers of the linguistic Copenhagen interpretation. I think, from the quantum linguistic point of view, that he should be estimated more highly.

Therefore, we can say that

(C) **McTaggart was also related to the linguistic Copenhagen interpretation (≈ the problem**

such that "What is a 'propositin' ?")

11.5.4 Moore's paradox: "It is raining, but I do not believe it is raining"

11.5.4.1 "It is raining, but I do not believe it is raining" and Wittgenstein

G.E. Moore (1873-1958) was an English philosopher. He was, with Bertrand Russell, Ludwig Wittgenstein, and Gottlob Frege, one of the founders of analytic philosophy.



As his quote, the following is famous:

(A) "It is raining, but I do not believe it is raining"

That is, Moore raised the following question (i.e., Moore's paradox).

(B) Is the (A) a proposition? That is, can we define the truth value of (A)?

This problem is famous because Wittgenstein was very interested in it. I don't remember where it was written, but I heard that Wittgenstein said that the discovery of (A) was the greatest of all Moore's achievements. The reason why Wittgenstein was interested in (A) is clear as follows.

(C₁) His purpose at TLP was to answer "What is a proposition?" And at the end of his TLP, he wrote, "For something that is not a proposition, you must be silent." However, TLP was not theoretically successful, and "what is a proposition?" was the philosophical theme of his life.

And Wittgenstein thought:

(C₂) The first thing to do in order to answer "what is a proposition?" is to study a pseudo-proposition such as "It is raining, but I do not believe it is raining". It would be great if we could make a theory of pseudo-propositions (and pseudo-truth values).

Now that I think about it, there are various detailed themes in this direction (ordinary language school), which are practically interesting (relationship between everyday language and AI, etc.), but there was not much possibility that a big theory would be born. Of course, the future is still undecided, and it's too early to say for sure.

11.5.4.2 "It is raining, but I do not believe it is raining" in the linguistic Copenhagen interpretation

Remember the linguistic Copenhagen interpretation as follows.

- (D₁) Audience should not go on stage
- (D₂) The measurement is not dependent on the observer
- (D₃) the observer cannot measure the observer himself
- (D₄) Don't use terms "I", "here", "now".

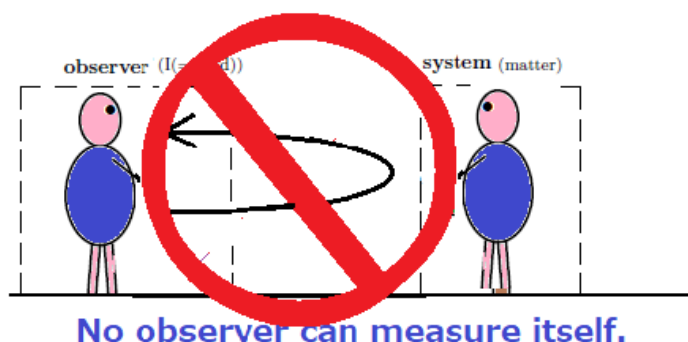

Although the sentence: "It is raining, but I do not believe it is raining" can be interpreted in many ways, but let's discuss the following two ([I] and [II]) scientific interpretations

[I]: Thus,

(E₁) "I" in "It is raining, but I do not believe it is raining" is a violation of rule (d). Thus, if "I" is "Mr. X", this should be rewritten by

"It is raining, but Mr. X does not believe it is raining"

(E₂) Since "Audience should not go on stage", the measurer can be anyone except Mr. X.

That is, this implies that

(F) the above "It is raining, but I do not believe it is raining" is the measured value of the measurement for

(the state of the weather, the state of Mr. X's mind).

[II]: "It is raining, but I do not believe it is raining" can be interpreted by "I know it is raining, but I do not believe it is raining". Similarly, this should be rewritten by "Mr. X knows it is raining, but Mr. X does not believe it is raining". If this can be interpreted by "Mr. X knows it is raining, but Mr. X does not hope it is raining", we say as follows.

(G) "Mr. X knows it is raining, but Mr. X does not hope it is raining" is the measured value of the measurement for

(the state of Mr. X's knowledge of the weather, the state of Mr. X's wish of the weather).

The above two (F) and (G) are scientific interpretation of Moore's paradox. However, The important thing is to propose a non-scientific understanding within everyday language, rather than a scientific understanding through a linguistic Copenhagen interpretation. However, I don't think we have obtained satisfactory results on this yet.

If I were to write the author's prediction, I would say that the results are probably not conclusive. However, I believe that with the use of AI, the school of everyday language will make steady progress.

Therefore, we can say that

(H) **"It is raining, but I do not believe it is raining" is not a proposition in QL.**

11.5.4.3 Wittgenstein was interested in this paradox

However, the purpose here is not to examine this paradox in detail. What I have focused on is the following

(I) *when Wittgenstein first heard this paradox one evening (which Moore had earlier stated in a lecture), he rushed round to Moore's lodgings, got him out of bed and insisted that Moore repeat the entire lecture to him.*

If this anecdote is true, it is because it clearly shows that the central theme of Wittgenstein's research is "What is a scientific proposition?" And Wittgenstein must have thought: (R₁) is "what we cannot speak about". Furthermore, he must have thought Descartes' cogito proposition "I think, therefore I am" (which is called the first principle of philosophy) was not also a proposition (*cf.* the linguistic Copenhagen interpretation (E₁) in Sec. 1.1.2).

At that time, Russell, Moore, and McTaggart were professors in the Department of Philosophy at Cambridge University. Moore's paradox, Russell's "five-minute hypothesis," and McTaggart's "non-existence of time" (*cf.* ref. [73]) were all based on the question such that "What is a scientific proposition?" (or equivalently "What is the Copenhagen interpretation?"). This was the environment in which analytic philosophy (or symbolically, "Wittgenstein") was born.

11.6 Saussure: Copernican revolution in language



Ferdinand de Saussure (1857-1913) was a Swiss linguist. He is widely considered one of the founders of 20th-century linguistics.

11.6.1 Saussure's linguistics: What comes first, things or words?

Let's think a little more about the implications of Saussureian linguistics. We tend to think that there are things at the beginning, and that we give each thing a name, just like we put a label on it. However, that is not the case. Rather, Saussureian linguistics says that we understand the order of things by the act of giving them names. I think that his theory is almost the linguistic version of the Copernican revolution of Kant. That is,

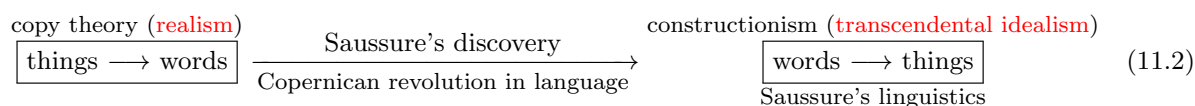

For example,

(A₁) I, who live in Japan, an island nation, know the names of many fish, but rarely distinguish between "cow, bull, ox, calf," etc.

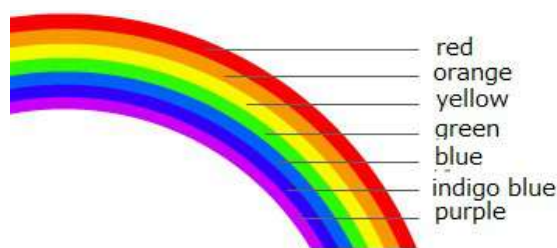
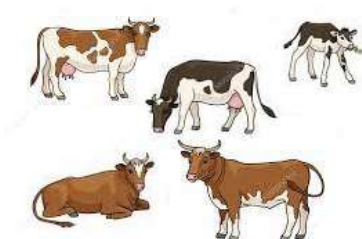

(A₂) Also, in Japan, the rainbow has seven colors (i.e., red, orange, yellow, green, blue, indigo, violet(=purple)), and I was surprised when I first heard that there is a country where the rainbow does not have seven colors.

(A₃) Quantum language changes the way we see the world. In other words, quantum language is like a kind of worldview (*cf.* (D) in Preface).

In the above, I'd like to assume that (A₁)~(A₃) are about the same.

11.6.2 Several Copernican revolutions

♠**Note 11.9.** The original Copernican revolution is of course as follows (*cf.* Chap. 7):

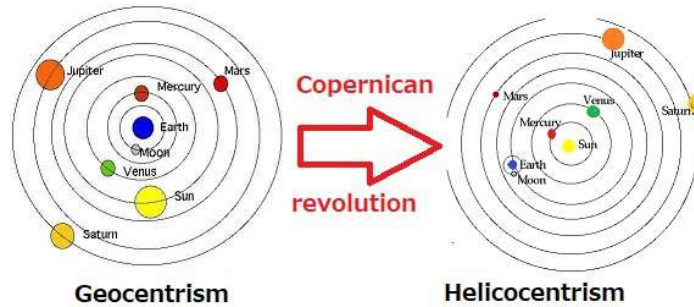

Thus, the original Copernican revolution means

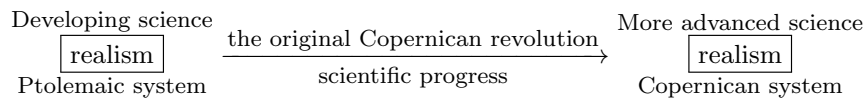

////

However, the philosophical Copernican revolution means

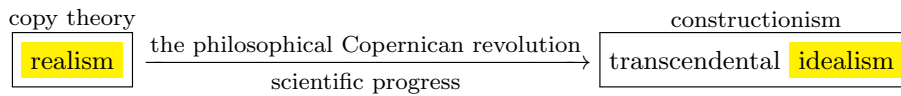

And thus, there are several "Copernican revolution". In this text, the term is used to represent the turn from "realism" to idealism". That is, the Copernican revolution is common to Kant, Saussure, quantum language as follows.

Assertion 11.16. Recall our main figure:

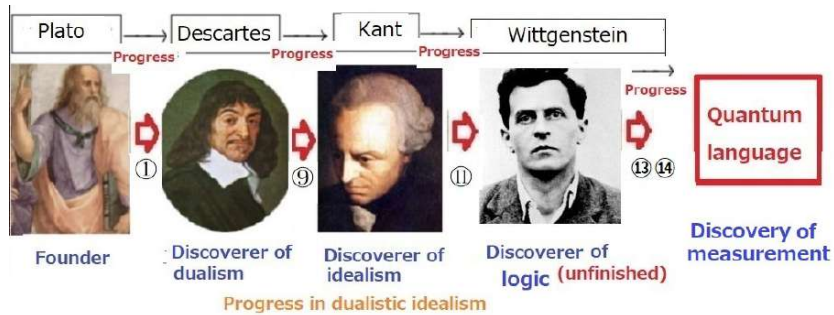

The above ⑨, ⑪, ⑬ are realized in the following diagram:

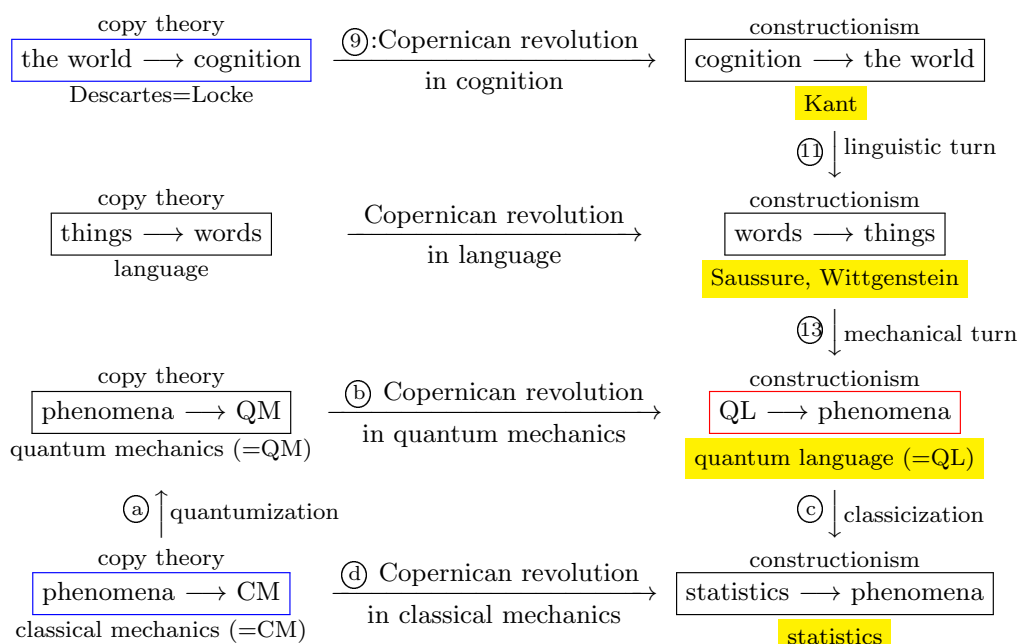

- (i) It is very difficult to discover QL in the "⑨, ⑪, ⑬" path.
- (ii) I think the discovery of statistics is the most difficult. I don't know how Fisher and others discovered statistics. "⑪" alone does not tell us the source of the probability. From now on, even ordinary people may have discovered statistics through the "⑨→⑩→⑪" path.
- (iii) In the above, we see several "Copernican revolution". Thus we think that **"The Copernican revolution (due to Kant)" is the greatest discovery in the history of philosophy.**
That is,

the Copernican revolution = the discovery of "true idealism"

where we think that "true idealism"="scientific idealism"="transcendental idealism".

♠**Note 11.10.** Recall the quotes in "Tractatus Logico-Philosophicus" (by Wittgenstein) such that
 (♯) The limits of my language mean the limits of my world.
 which implies the constructionism ⑪.

Answer 11.17. [The answer of Problem 10.4: Is "From Descartes to Kant" progress?]

Now we can answer Problem 10.4, i.e.,

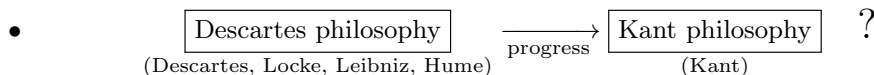

by the first line of the diagram above, that is,

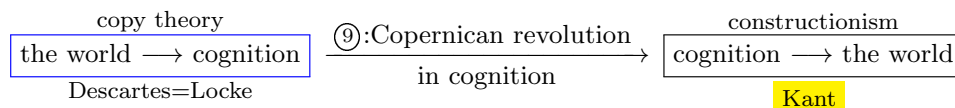

where "to make progress" is defined by "to come near quantum language" (cf. Assertion 1.5).

11.6.3 * The quantitative expressions of "signified"

Now let us explain the terms "signifier" and "signified", which were introduced by Saussure.

Definition 11.18. ["signifier" and "signified" in ordinary language]

For example, we explain "signifier" and "signified" concerning "dog"

- (B₁) The "dog" in front of you is itself a physical being, isn't it? The image of the dog you have in mind, the barking, or the image of the dog in your head, is "signified".
- (B₂) When this becomes a word (letter/sound) such as "dog", it is called "signifier".

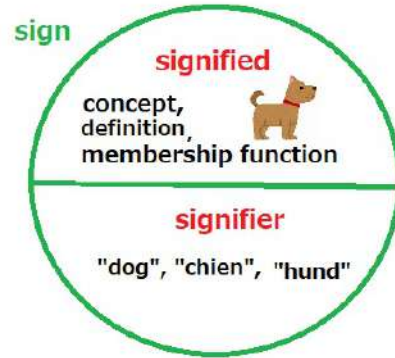
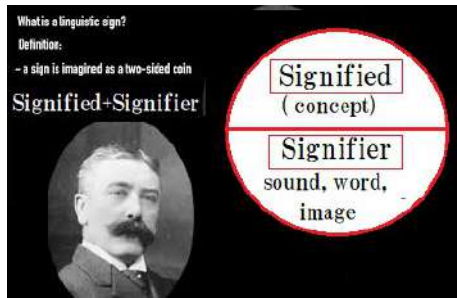

Although Saussure's proposal (i.e., the above definition) is very significant, his ideas are not quantitative, so they are not very useful from a scientific standpoint. As emphasized frequently throughout the paper, I consider

- (C) Without a quantitative worldview, we can't say anything solid from a scientific standpoint. In fact, Saussure's idea does not play an important role in science.

Thus, I will propose Definition 11.19, in which Saussure's idea is realized in quantum language as follows.

Definition 11.19. [Membership function (= Fuzzy set, cf. [39, 40, 41, 42, 121])] Let Ω be a state space. A continuous function $m : \Omega \rightarrow [0, 1]$ (i.e., the closed interval in the real \mathbb{R}) is called a membership function. Assume that the state (i.e., quantitative property) of any animal can be expressed by a point in the state space Ω . Define the membership functions $m_D : \Omega \rightarrow [0, 1]$ of dogs as follows. Suppose that there are 100 zoologists and the following question is made them.

- (D) Is this animal with the state $\omega_1 (\in \Omega)$ a dog or not?

The answer is as follows.

- (E) $\left\{ \begin{array}{l} 70 \text{ zoologists say that this bird is a dog.} \\ 30 \text{ zoologists say that this animal is not a dog.} \end{array} \right.$

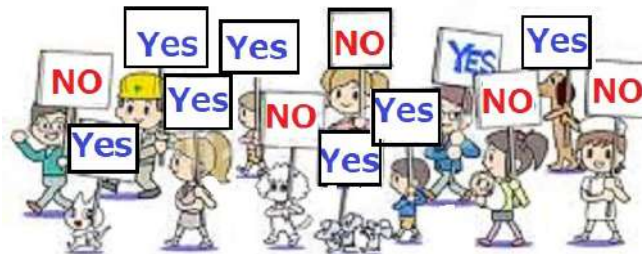

Then the value of $m_D(\omega_1)$ is defined by 0.7. For many animals with the state $\omega_i (i = 2, 3, \dots, N)$, repeating the experiment in the same way, the value of $m_D(\omega_i) (i = 2, 3, \dots, N)$ is determined. And the membership function $m_D : \Omega \rightarrow [0, 1]$ of dogs is defined by the interpolation method (which may be rather subjective). Put $\Omega_D = \{\omega \in \Omega \mid m_D(\omega) = 1\}$, which is called [the dog state class](#).

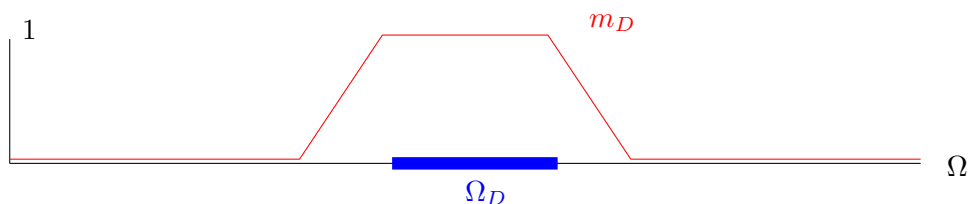
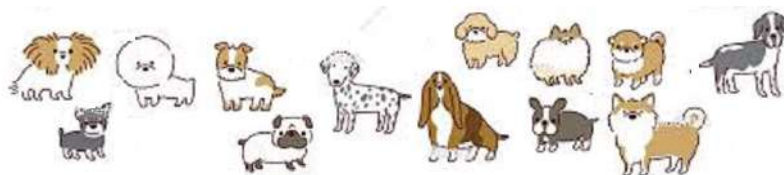

Figure 11.1: [membership function $m_D : \Omega \rightarrow [0, 1]$, and Ω_D]

Thus we have the dog-like observable $O_D = (\{T, F\}, 2^{\{T, F\}}, G_D)$ in $C(\Omega)$ with the membership function $G_D(\{T\}) (= m_D)$ (cf. Definition 12.3).



With the above preparation, we get the following definitions.

Definition 11.20. [”signifier” and ”signified” in quantum language]

(F₁) ”signifier” — ”dog”

(F₂) ”signified” — membership function $m_D : \Omega \rightarrow [0, 1]$ (or roughly, Ω_D)

The above will play an essential role in Hempel’s raven problem in Sec. 12.7.

♠**Note 11.11.** (i); The above definition is essential to the solution of Hempel raven problem. See Section 12.7

(ii): From the quantum linguistic point of view, As mentioned in Remark 3.12, Saussure’s theory is located in the following.

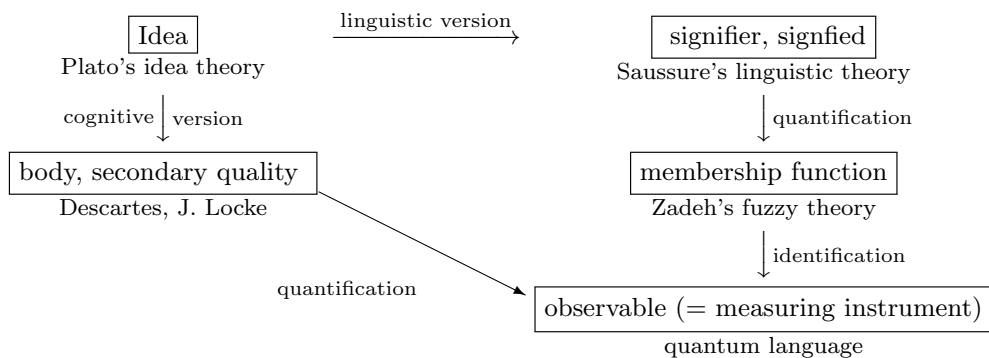

Some readers may disagree with me about Plato’s Idea, as I’ve made a rather dogmatic assumption about it. However, I like the diagram above because it makes me feel like I understand the history of Western philosophy as the history of dualistic idealism.

Chapter 12

Linguistic philosophy (After TLP)

I agree with the following Dummett’s words: (cf. ref. [15]: Origins of analytical philosophy):

(#1) *If we identify the linguistic turn as the starting-point of analytical philosophy proper, there can be no doubt that, to however great an extent Frege, Moore and Russell prepared the ground, the crucial step was taken by Wittgenstein in the Tractatus Logico-philosophicus (= TLP) of 1922 (127 page)*

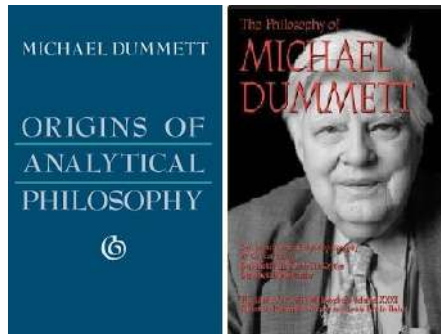

That is because I, roughly speaking, think that
 Frege, Russell

(#2) mathematical logic
 Logic is so powerful that
 it is the foundation of mathematics

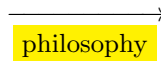

Wittgenstein
TLP
 What we cannot speak about
 we must pass over in silence

Many philosophers may not agree with the above opinion (#1) (= (#2)). Because Wittgenstein failed to fulfill the purpose of TLP, i.e., to answer the following questions:

- (#3) What is the definition of "what we cannot speak about" (= "proposition")?
- (#4) Why does logic work in our daily lives?

Although he failed in this task, his aspirations were enthusiastically praised by the general public, and he laid the foundation for today’s analytic philosophy.

I agree with opinion (#1) (= (#2)) because the philosopher’s job is not to solve problems, but to present them.

In Sec. 12.1, I answer the above questions (#3) and (#4) in QL. And thus, the reader can be sure that Wittgenstein’s direction was the right one.

12.1 * Fuzzy logic in QL; My scientific understanding of "Tractatus Logico-Philosophicus (=TLP)"

This section consists of excerpts from the following paper:

- Ref. [78]: Ishikawa, S., (2021) Fuzzy Logic in the Quantum Mechanical Worldview ; Related to Zadeh, Wittgenstein, Moore, Saussure, Quine, Lewis Carroll, etc. JAMP, Vol. 9, No.3 , 140-154, (<https://www.scirp.org/Journal/paperinformation.aspx?paperid=95447>)

12.1.1 Wittgenstein and Zadeh

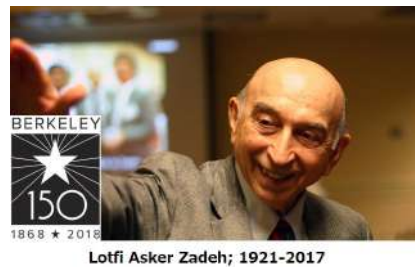
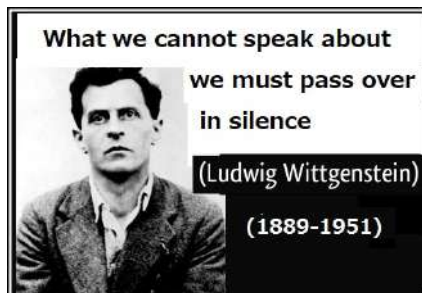

In 1965, L.A. Zadeh proposed an engineering concept called "fuzzy sets" (cf. ref. [121]), which was enthusiastically supported by some engineers. However, R.E. Kalman did not recognize "fuzzy sets" as a scientific concept, and argued as follows (1972): *"Let me say quite categorically that there is no such thing as a fuzzy concept... We do talk about fuzzy things but they are not scientific concepts. Some people in the past have discovered certain interesting things, formulated their findings in a non-fuzzy way, and therefore we have progressed in science"* (cf. ref. [122]).

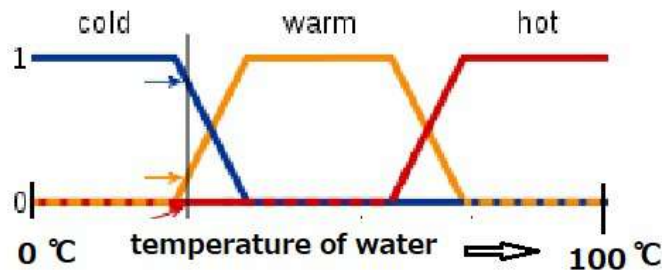

Even now, more than 50 years later, I don't think Kalman's claim can be denied. In fact, the concept of "fuzzy sets" has not yet acquired the status of more than a convenient engineering method. Kalman might have thought that the basic philosophy of engineering is a mechanical worldview, and thus, "scientific concepts"="concepts in the (classical) mechanical worldview". Note that dynamical system theory (which is essentially the same as statistics) is considered as the mathematical representation of the (classical) worldview. That is,

$$(A) \quad \boxed{\text{Dynamical system theory}} \stackrel{\text{(classical mechanical worldview)}}{=} \boxed{\text{state equation}} + \boxed{\text{measurement equation}}$$

(= statistics) (causality) (probability)

(See ⑥ in Figure 0 (in preface))

On the other hand, quantum language is characterized as follows:

$$(B) \quad \boxed{\text{Quantum language}} \stackrel{\text{(quantum mechanical worldview)}}{=} \boxed{\text{Axiom 2}} + \boxed{\text{Axiom 1}} + \boxed{\text{linguistic (Copenhagen) interpretation}}$$

(= measurement theory) (causality) (measurement) (how to use Axioms 1 and 2)

(See ⑭ in Figure 0 (in preface))

which is a mathematical representation of quantum mechanical worldview (cf. refs. [44], [71], [66]). And we assert that "scientific concepts"="concepts within the quantum mechanical worldview". If so, and if "fuzzy sets" is a scientific concept, "fuzzy sets" must be completely understood in quantum language.

In ref. [117] (i.e., Wittgenstein’s ”Tractatus Logico Philosophicus” (abbreviated as TLP)), which is one of the most famous philosophy books of the 20th century, Wittgenstein studied ”logic” in philosophy (and not in mathematics). However, in hindsight, he may have written literary work on the subject of ”logic” (cf. refs. [13], [85]). It is a fact, however, that TLP was accepted by much of the general public. I think the general public felt that Boole and Frege’s ”symbolic logic” was just mathematics, and that this was not sufficient as philosophy. In other words, they expected TLP to answer the question, such that ”Why does logic work in our world?” or ”What is the definition of non-mathematical proposition?.” Wittgenstein’s motivation of TLP would have been to answer these questions, but he was too poet and dreamer. Also, TLP was published in 1921, and Wittgenstein was unaware of the discovery of quantum mechanics (around 1925).

In 1965, L.A. Zadeh proposed an engineering concept called ” fuzzy sets” (cf. ref. [121]), which was not recognize as a scientific concept by some excellent scientists. And furthermore, Zadeh couldn’t convince them of his idea. However, ref. [121] was one of the most cited papers in the 20th century. This implies that many engineers felt that ” mathematical set” is not enough, expected more from his ” fuzzy set” .

I think the situation of Wittgenstein and Zadeh is very similar in the sense that they were ardently supported by a large number of the general public even though they were not supported by the best experts. I would rather trust the senses of the many general public than the senses of a few experts. And what Wittgenstein and Zadeh lacked, I believe, was a worldview.

Therefore, their claims are vague and incomprehensible, but if I understand them under the quantum mechanical worldview, I think they are claiming almost the same thing.

In this section, we will explain it. That is, we simultaneously justify Wittgenstein’s TLP and Zadeh’s fuzzy sets theory.

12.1.2 Easy example; classical system

Now let us explain ”Fuzzy logic in QL” (i.e., my understanding of TLP). Let us start from easy example as follows.

Although our theory is valid for quantum systems as well as classical systems, in this Sec. 4.1 we explain our idea in classical systems (i.e., the case that $\mathcal{A} = C(\Omega)$). Again let us start from the following example (= Example 11.4).

Example 12.1. [= Example 11.4]: For example, consider a proposition P_1 such that

$$P_1 = \text{”this tomato is red”}, \quad \neg P_1 = \text{”this tomato is not red”},$$

And suppose that there are 100 respondents, and furthermore, the following question is asked to them.

(C) Is this tomato red? (i.e., is the proposition P_1 true or not?)

Assume that the results of the responses are as follows.

(D) $\left\{ \begin{array}{l} 70 \text{ respondents say ”Yes, this tomato is red” (i.e., the proposition } P_1 \text{ is true, i.e., ”T”)} \\ 30 \text{ respondents say ”No, this tomato is not red” (i.e., the proposition } P_1 \text{ is false, i.e., ”F”)} \end{array} \right.$

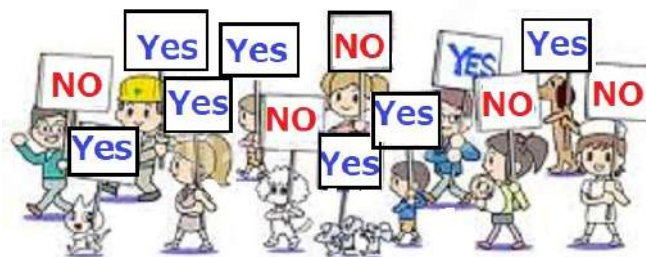

This can be probabilistically interpreted as follows.

(E) When any respondent is *randomly* selected out of 100, the probability that this respondent will answer ”yes” to question (C) is $p_1 (= 0.7)$. Or simply, the probability that the proposition P_1 is true is p_1 . In symbolic form,

$$\text{Prob}[P_1; \{T\}] = p_1 (= 0.7)$$

Then we generally denote that

(F) $\text{Prob}[P_1; \{T\}] = p_1, \quad \text{Prob}[P_1; \{F\}] = 1 - p_1 \quad (\text{where } 0 \leq p_1 \leq 1)$

Also, note that $\text{Prob}[\neg P_1; \{T\}] = \text{Prob}[P_1; \{F\}] = 1 - p_1$.

The above will be formulated in terms of QL as follows. Let Ω a state space, which is a compact space $\Omega \subseteq \mathbb{R}^N$ ($= N$ -dimensional real space), where N is sufficiently large natural number. Consider many tomatoes, that is, roughly speaking, consider T as the set of all tomatoes. Assume that any tomato $t(\in T)$ is represented by a state ω , which is an element of the state space Ω . Thus, we have the map $\hat{\omega} : T \rightarrow \Omega$. That is, the quantitative property of a tomato t is represented by $\hat{\omega}(t)$. For example, it suffices to consider Ω such that

$$(G) \quad \omega = \left(\omega^{(1)} (= \text{weight}), \omega^{(2)} (= \text{diameter}), \omega^{(3)} (= \text{color value}), \right. \\ \left. \omega^{(4)} (= \text{calorie}), \omega^{(5)} (= \text{sugar content}), \dots, \omega^{(N)} (= \dots) \right) \in \Omega \subseteq \mathbb{R}^N$$

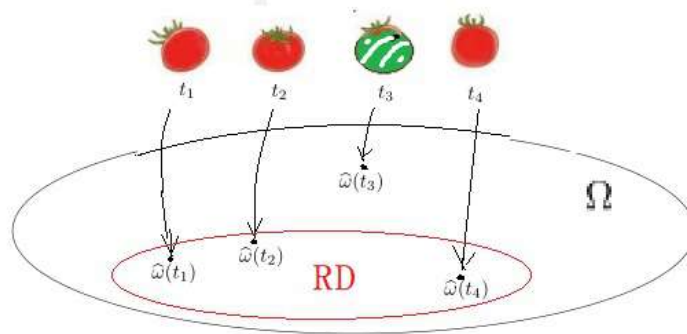

Consider a binary observable (or, $\{T, F\}$ -valued observable) $O_1 = (\{T, F\}, 2^{\{T, F\}}, G_1)$ in $C(\Omega)$. The measurement $M_{C(\Omega)}(O_1, S_{[\delta_\omega]})$ is called a (TF) -measurement, which is also called a *fuzzy proposition*. Axiom 1 says that

(H) the probability that measured value T is obtained by the (TF) -measurement $M_{C(\Omega)}(O_1, S_{[\delta_\omega]})$ is given by $\delta_\omega(G_1) (= {}_{C(\Omega)} \langle \delta_\omega, G_1 \rangle_{C(\Omega)} = G_1(\omega))$

This is the quantum linguistic representation of the above (E). That is, we identify a proposition P_1 with a (TF) -measurement $M_{C(\Omega)}(O_1, S_{[\delta_\omega]})$.

Remark 12.2. (I): Someone might say that the term "the set of all tomatoes" is as ambiguous as "the set of all dinosaurs". However, for the sake of convenience, here we use the term "the set of all tomatoes". This problem is the same as that of the Hempel' raven paradox (i.e., "the set of all ravens" leads to contradiction). For further discussion about this, see refs. [66], [75].

(J): If we want to consider another proposition $P_2 (= M_{C(\Omega)}(O_1, S_{[\delta_{\omega'}]}))$ such as

$$P_2 = \text{"that tomato is red"}, \quad \neg P_2 = \text{"that tomato is not red"},$$

we must define $M_{C(\Omega)}(O_1, S_{[\delta_\omega]}) \wedge M_{C(\Omega)}(O_1, S_{[\delta_{\omega'}]})$ ($\omega \neq \omega'$). This will be explained in Sec.4.3.

(K): If we want to consider both tomato's world Ω_1 and apple's world Ω_2 , it suffices to start from the tensor space $C(\Omega_1) \otimes C(\Omega_2)$ ($= C(\Omega_1 \times \Omega_2)$). This will be also explained in Sec.4.3.

12.1.3 Fuzzy logic in QL

Let's start with the following definition.

Definition 12.3. [(TF)-measurement (=Fuzzy proposition), Fuzzy set (= Membership function)]

Let $\mathbf{O} = (\{T, F\}, 2^{\{T, F\}}, G)$ be a binary observable (or, (TF)-observable, $\{T, F\}$ -valued observable) in a C^* -algebra \mathcal{A} . A measurement $M_{\mathcal{A}}(\mathbf{O}, S_{[\rho]})$ is called a (TF)-measurement, which is also called a fuzzy proposition.

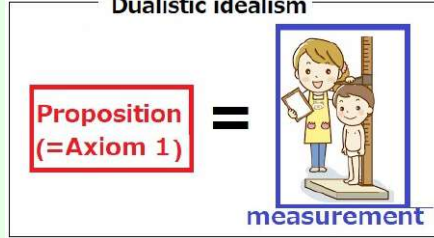

Since Axiom 1 says that the probability that a measured value T is obtained by (TF)-measurement $M_{\mathcal{A}}(\mathbf{O}, S_{[\rho]})$ is given by $\rho(G(\{T\}))$, we say that

(L) a (TF)-measurement $M_{\mathcal{A}}(\mathbf{O}, S_{[\rho]})$ is true with probability $\rho(G(\{T\}))$

Or,

(M) $\text{Prob}[M_{\mathcal{A}}(\mathbf{O}, S_{[\rho]}); \{T\}] = \rho(G(\{T\})) (= {}_{\mathcal{A}^*} \langle \rho, G(\{T\}) \rangle_{\mathcal{A}})$

Also, $G(\{T\})(\in \mathcal{A})$ is called the membership function of \mathbf{O} (cf. Definition 11.19).

♠**Note 12.1.** Our interest is "Kant philosophy" $\xrightarrow{\text{progress}}$ "Analytic philosophy", and thus, the main concept "proposition" in analytic philosophy must be formulated in the framework of dualistic idealism. This is realized in the above definition.

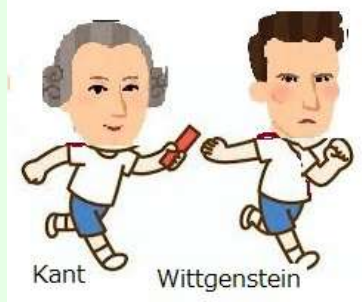

That is, Wittgenstein took over the baton of "dualistic idealism (i.e., the mainstream of philosophy)" from Kant (cf. ref. [78], or Sec. 12.1).

In general, we must consider many propositions $\{P_i = M_{\mathcal{A}_i}(\mathbf{O}_i, S_{[\rho_i]}) : i = 1, 2, \dots, n\}$. In this section, we devote ourselves to the following simple case:

- (N₁) \mathcal{A} is fixed, i.e., $\mathcal{A}_1 = \mathcal{A}_2 = \dots = \mathcal{A}_n$
- (N₂) $\mathbf{O}_1, \mathbf{O}_2, \dots, \mathbf{O}_n$ commute,
- (N₃) a state ρ is only one, i.e., $\rho_1 = \rho_2 = \dots = \rho_n$

For the general case, we discuss in next section (i.e., Sec.12.1.4). That is, in this section, we devote ourselves to $\{P_i = M_{\mathcal{A}}(\mathbf{O}_i = (\{T, F\}, 2^{\{T, F\}}, G_i), S_{[\rho]}) : i = 1, 2, \dots, n\}$. However, it should be noted that the above simple case (N) is essential, that is, the general case is an easy consequence of the simple case as seen in the next section.

Definition 12.4. [Fuzzy logic symbols ($\neg, \wedge, \vee, \rightarrow$)] Let $\mathbf{O}_i = (\{T, F\}, 2^{\{T, F\}}, G_i)$ be binary observables (or, $\{T, F\}$ -valued observable) in a C^* -algebra \mathcal{A} . ($i = 1, 2$). Assume that $\mathbf{O}_i (i = 1, 2)$ commute. Fix the quasi-product observable $\mathbf{O}_1 \times^{qp} \mathbf{O}_2 = (\{T, F\}^2, \mathcal{P}(\{T, F\}^2), G_1 \times^{qp} G_2)$. Consider (TF)-measurement $M_{\mathcal{A}}(\mathbf{O}_i = (\{T, F\}, 2^{\{T, F\}}, G_i), S_{[\rho]})$ (which is abbreviated as P_i) in a C^* -algebra \mathcal{A} . Put $\mu_i(\Xi) = \rho(G_i(\Xi))$ ($\Xi \in \{T, F\}, i = 0, 1, 2$), and $(\times_{i=1,2}^{qp} \mu_i)(\Xi_1 \times \Xi_2) = (\rho(G_1 \times^{qp} G_2))(\Xi_1 \times \Xi_2)$ ($\Xi_1, \Xi_2 \in \{T, F\}$).

(i): Put $i = 1, 2$. Define $\neg M_{\mathcal{A}}(\mathbf{O}_i, S_{[\rho]})$ such that

$$\neg M_{\mathcal{A}}(\mathbf{O}_i, S_{[\rho]}) = M_{\mathcal{A}}(\pi^- \mathbf{O}_i, S_{[\rho]})$$

where the map $\pi^- \{T, F\} \rightarrow \{T, F\}$ is defined by $\pi^-(T) = F, \pi^-(F) = T$. Clearly it holds that $\text{Prob}[\neg M_{\mathcal{A}}(\mathbf{O}_i,$

$$S_{[\rho]}; \{T\} = \rho(G_i(\{\{F\}\})). = \mu_i(\{F\}).$$

(ii): Define $M_{\mathcal{A}}(\mathbf{O}_1, S_{[\rho]}) \wedge M_{\mathcal{A}}(\mathbf{O}_2, S_{[\rho]})$ such that

$$M_{\mathcal{A}}(\mathbf{O}_1, S_{[\rho]}) \wedge M_{\mathcal{A}}(\mathbf{O}_2, S_{[\rho]}) = M_{\mathcal{A}}(\pi^{\wedge}(\mathbf{O}_1 \times^{qp} \mathbf{O}_2), S_{[\rho]})$$

where $\pi^{\wedge} : \{T, F\}^2 \rightarrow \{T, F\}$ is defined by $\pi^{\wedge}(T, T) = T, \pi^{\wedge}(T, F) = \pi^{\wedge}(F, T) = \pi^{\wedge}(T, F) = F$.

It holds that $\text{Prob}[M_{\mathcal{A}}(\mathbf{O}_1, S_{[\rho]}) \wedge M_{\mathcal{A}}(\mathbf{O}_2, S_{[\rho]}); \{T\}] = \rho(G_1 \times^{qp} G_2)((\pi^{\wedge})^{-1}(\{T\})) = (\mu_1 \times^{qp} \mu_2)(\{(T, T)\})$.

(iii): Define $M_{\mathcal{A}}(\mathbf{O}_1, S_{[\rho]}) \vee M_{\mathcal{A}}(\mathbf{O}_2, S_{[\rho]})$ such that

$$M_{\mathcal{A}}(\mathbf{O}_1, S_{[\rho]}) \vee M_{\mathcal{A}}(\mathbf{O}_2, S_{[\rho]}) = M_{\mathcal{A}}(\pi^{\vee}(\mathbf{O}_1 \times^{qp} \mathbf{O}_2), S_{[\rho]})$$

where $\pi^{\vee} : \{T, F\}^2 \rightarrow \{T, F\}$ is defined by $\pi^{\vee}(T, T) = \pi^{\vee}(T, F) = \pi^{\vee}(F, T) = T, \pi^{\vee}(F, F) = F$.

It holds that $\text{Prob}[M_{\mathcal{A}}(\mathbf{O}_1, S_{[\rho]}) \vee M_{\mathcal{A}}(\mathbf{O}_2, S_{[\rho]}); \{T\}] = \rho(G_1 \times^{qp} G_2)((\pi^{\vee})^{-1}(\{T\})) = (\mu_1 \times^{qp} \mu_2)(\{(T, T), (T, F), (F, T)\})$.

(iv): Define $M_{\mathcal{A}}(\mathbf{O}_1, S_{[\rho]}) \rightarrow M_{\mathcal{A}}(\mathbf{O}_2, S_{[\rho]})$ such that

$$M_{\mathcal{A}}(\mathbf{O}_1, S_{[\rho]}) \rightarrow M_{\mathcal{A}}(\mathbf{O}_2, S_{[\rho]}) = M_{\mathcal{A}}(\pi^{\rightarrow}(\mathbf{O}_1 \times^{qp} \mathbf{O}_2), S_{[\rho]})$$

where $\pi^{\rightarrow} : \{T, F\}^2 \rightarrow \{T, F\}$ is defined by $\pi^{\rightarrow}(T, T) = \pi^{\rightarrow}(F, T) = \pi^{\rightarrow}(F, F) = 1, \pi^{\rightarrow}(T, F) = F$.

It holds that $\text{Prob}[M_{\mathcal{A}}(\mathbf{O}_1, S_{[\rho]}) \rightarrow M_{\mathcal{A}}(\mathbf{O}_2, S_{[\rho]}); \{T\}] = \rho(G_1 \times^{qp} G_2)((\pi^{\rightarrow})^{-1}(\{T\})) = (\mu_1 \times^{qp} \mu_2)(\{(T, T), (F, F), (F, T)\})$.

Theorem 12.5. [Fundamental theorem in Fuzzy logic] Let $\mathbf{O}_i = (\{T, F\}, 2^{\{T, F\}}, G_i)$ be binary observables (i.e., $\{T, F\}$ -valued observable) in a C^* -algebra \mathcal{A} . ($i = 1, 2, \dots, n$). Assume that $\mathbf{O}_i \neq \mathbf{O}_j$ ($\forall i, j$ such that $i \neq j$) (i.e., non-overlapping condition in Theorem 11.10) and \mathbf{O}_i ($i = 1, 2, \dots, n$) commute. Fix the quasi-product observable $\times_{i=1, \dots, n}^{qp} \mathbf{O}_i = (\{T, F\}^n, \mathcal{P}(\{T, F\}^n), \times_{i=1, \dots, n}^{qp} G_i)$. Consider (TF)-measurement $M_{\mathcal{A}}(\mathbf{O}_i = (\{T, F\}, 2^{\{T, F\}}, G_i), S_{[\rho]})$ (which is abbreviated as P_i) in a C^* -algebra \mathcal{A} . And consider the quasi-product measurement $\times_{i=1, \dots, n}^{qp} M_{\mathcal{A}}(\mathbf{O}_i = (\{T, F\}, 2^{\{T, F\}}, G_i), S_{[\rho]}) = M_{\mathcal{A}}(\times_{i=1, \dots, n}^{qp} \mathbf{O}_i = (\{T, F\}^n, \mathcal{P}(\{T, F\}^n), \times_{i=1, \dots, n}^{qp} G_i), S_{[\rho]})$. Put

$$\bullet \mu_i(\{x_i\}) = \rho(G_i(\{x_i\})) \quad (x_i \in \{T, F\}, i = 1, 2, \dots, n)$$

$$\bullet \times_{i=1, \dots, n}^{qp} \mu_i(\{(x_1, x_2, \dots, x_n)\}) = \rho\left(\left(\times_{i=1, \dots, n}^{qp} G_i\right)(\{(x_1, x_2, \dots, x_n)\})\right) = \left(\times_{i=1, \dots, n}^{qp} \mu_i\right)(\{(x_1, x_2, \dots, x_n)\})$$

$$(\forall (x_1, x_2, \dots, x_n) \in \{T, F\}^n)$$

Here, the pair $[\{P_1, P_2, \dots, P_n\}; (\{T, F\}^n, \mathcal{P}(\{T, F\}^n), \times_{i=1, 2, \dots, n}^{qp} \mu_i)]$ is a logical sample space.

Then, by Theorem 11.10, we see the following:

- Let P be a proposition which is constructed by P_1, \dots, P_n . Note that P is regarded as the map from $\{T, F\}^n \rightarrow \{T, F\}$. Then, we see that

$$\text{Prob}[P; \{T\}] = \left(\times_{i=1, 2, \dots, n}^{qp} \mu_i\right)(P^{-1}(\{T\}))$$

Remark 12.6. Since the linguistic Copenhagen interpretation says that "only one measurement is permitted", we only take the measurement: $\times_{i=1, \dots, n}^{qp} M_{\mathcal{A}}(\mathbf{O}_i = (\{T, F\}, 2^{\{T, F\}}, G_i), S_{[\rho]}) = M_{\mathcal{A}}(\times_{i=1, \dots, n}^{qp} \mathbf{O}_i = (\{T, F\}^n, \mathcal{P}(\{T, F\}^n), \times_{i=1, \dots, n}^{qp} G_i), S_{[\rho]})$. Therefore, the measurements (i.e., $M_{\mathcal{A}}(\pi^{\wedge}(\mathbf{O}_1 \times^{qp} \mathbf{O}_2), S_{[\rho]}) (= M_{\mathcal{A}}(\mathbf{O}_1, S_{[\rho]}) \wedge M_{\mathcal{A}}(\mathbf{O}_2, S_{[\rho]}))$ etc. in Definition 12.4) are not actually done. To be precise, these measurements are included in the quasi-product measurement $\times_{i=1, \dots, n}^{qp} M_{\mathcal{A}}(\mathbf{O}_i = (\{T, F\}, 2^{\{T, F\}}, G_i), S_{[\rho]})$.

Example 12.7. [The QL version of Table 11.10]. Replacing P_1 and P_2 with $M_{\mathcal{A}}(\mathcal{O}_1, S_{[\rho]})$ and $M_{\mathcal{A}}(\mathcal{O}_2, S_{[\rho]})$, we get the following Table 11.11, i.e., the QL version of Table 11.10.

Table 11.11: Probabilistic Truth Table (Elementary propositions $M_{\mathcal{A}}(\mathcal{O}_1, S_{[\rho]})(= P_1)$, $M_{\mathcal{A}}(\mathcal{O}_2, S_{[\rho]})(= P_2)$)

$M_{\mathcal{A}}(\mathcal{O}_1, S_{[\rho]})$ (= P_1)	$M_{\mathcal{A}}(\mathcal{O}_2, S_{[\rho]})$ (= P_2)	probability: $p = \times_{i=1,2}^{qp} \mu_i$	$[P_1 \rightarrow P_2] \wedge P_1$	$[P_1 \rightarrow P_2] \wedge P_1 \rightarrow P_2$
T	T	$p_{12} = \times_{i=1,2}^{qp} \mu_i(\{(T, T)\})$	T	T
T	F	$p_{1\bar{2}} = \times_{i=1,2}^{qp} \mu_i(\{(T, F)\})$	F	T
F	T	$p_{\bar{1}2} = \times_{i=1,2}^{qp} \mu_i(\{(F, T)\})$	F	T
F	F	$p_{\bar{1}\bar{2}} = \times_{i=1,2}^{qp} \mu_i(\{(F, F)\})$	F	T

Thus, we see that

$$\text{Prob}[[P_1 \rightarrow P_2] \wedge P_1; \{T\}] = p_{12}$$

Similarly, we see the modus ponens:

$$\text{Prob}[[[P_1 \rightarrow P_2] \wedge P_1] \rightarrow P_2; \{T\}] = 1$$

For example, put $P_1 :=$ "it rains", $P_2 :=$ "the ground is wet". Modus ponens says that

$$[["it rains" \rightarrow "the ground is wet"] \wedge "it rains"] \rightarrow "the ground is wet".$$

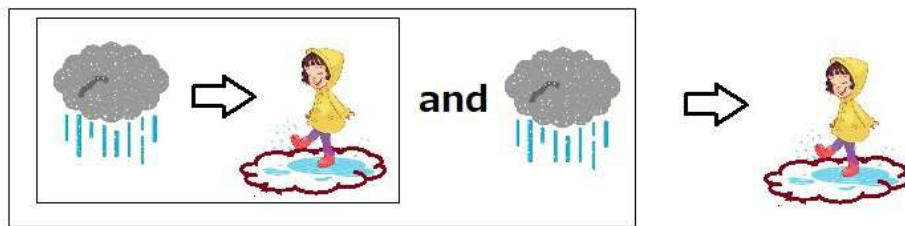

The following is the quantum linguistic version of Corollary 11.11.

Corollary 12.8. [Tautology in fuzzy logic] Let $P(= M_{\mathcal{A}}(\mathcal{O}, S_{[\rho]}))$ be a proposition constructed from elementary propositions $P_1(= M_{\mathcal{A}}(\mathcal{O}_1, S_{[\rho]}))$, $P_2(= M_{\mathcal{A}}(\mathcal{O}_2, S_{[\rho]}))$, ..., $P_n(= M_{\mathcal{A}}(\mathcal{O}_n, S_{[\rho]}))$. Then, the followings are equivalent:

- (i) P is a tautology in the sense of crisp logic.
- (ii) $\text{Prob}[P; \{T\}] = 1$.

That is, tautology always holds even in practical fuzzy logic. For example,

- (O) syllogism (i.e., $[[P_1 \rightarrow P_2] \wedge [P_2 \rightarrow P_3]] \rightarrow [P_1 \rightarrow P_3]$ always holds.

Remark 12.9. We have two results such that

- (i) in ref. [76], I showed that syllogism does not always hold in quantum system (*cf.* Sec.4.3.3).
- (ii) in Corollary 12.8, I showed that syllogism always holds in classical and quantum systems.

Thus, readers may think that (i) and (ii) are contradictory. However these are not contradictory since Corollary 12.8 requires that $\mathcal{O}_1, \mathcal{O}_2, \mathcal{O}_3$ commute. On the other hand, in ref. [76], the commutativity of \mathcal{O}_1 and \mathcal{O}_3 is not required. The most important one, of course, is Corollary 12.8.

Remark 12.10. [Cogito proposition is not a proposition in QL; *cf.* refs. [44], [67]]: Examine the cogito proposition "I think, therefore I am", in which it is natural to consider that

$$\text{"observer"} = \text{"I"} = \text{"measurement object (=system)"}$$

This is against the linguistic Copenhagen interpretation (E_1) "No observer can measure itself" in Sec. 1.1.2. Therefore, the cogito proposition is not a proposition in QL. The fact that the first proposition of philosophy is not a proposition is interesting.



Thus we see the following non-sense table:

Table 11.11': Probabilistic Truth Table (non-propositions "I think" (= P'_1), "I am" (= P'_2))

"I think" (= P'_1)	"I am" (= P'_2)	probability: $p = \times_{i=1,2}^{qp} \mu_i$	$[P'_1 \rightarrow P'_2] \wedge P'_1$	$[P'_1 \rightarrow P'_2] \wedge P'_1 \rightarrow P'_2$
?	?	$p_{12}=?$?	?
?	?	$p_{1\bar{2}}=?$?	?
?	?	$p_{\bar{1}2}=?$?	?
?	?	$p_{\bar{1}\bar{2}}=?$?	?

Remark 12.11. The linguistic Copenhagen interpretation (E_0) in Sec.1.1.2 says that

(#₁) Don't talk about what you can't measure!

Thus, as shown in ref. [63], we see:



Also, the (#₁) is equivalent to Berkely's saying

(#₂) To be is to be perceived:

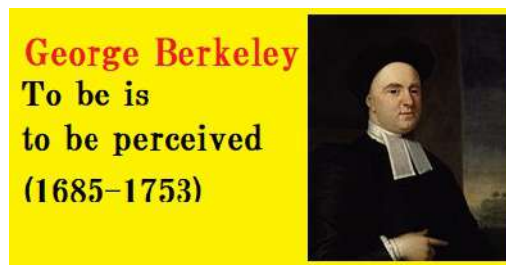

This implies the following figure:

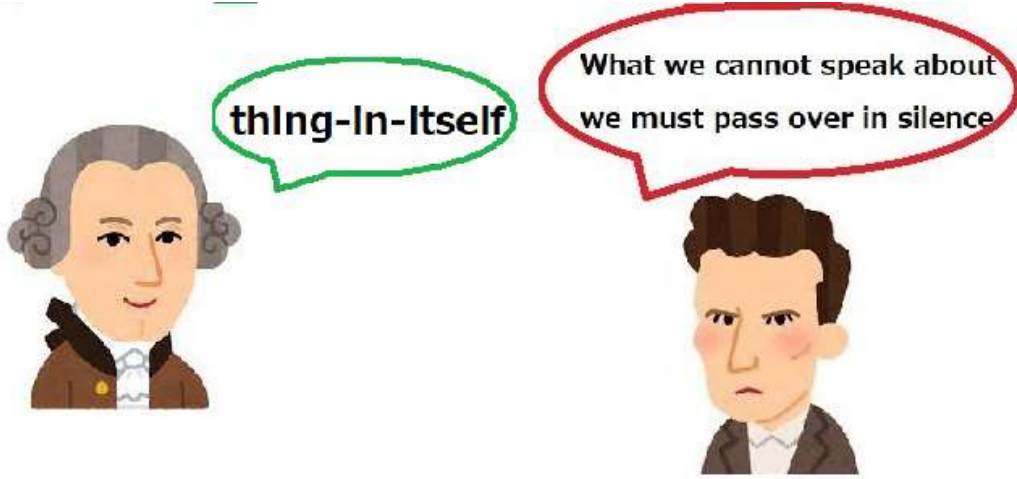

12.1.4 General case

In previous section, we devote ourselves to $\{M_{\mathcal{A}}(\mathcal{O}_i = (\{T, F\}, 2^{\{T, F\}}, G_i), S_{[\rho]}) : i = 1, 2, \dots, n\}$ under the conditions $(N_1) \sim (N_3)$, which are not so wide as mentioned in Remark 12.2 (ii) and (iii), In this section, we consider the general case: $\{P_i = M_{\mathcal{A}_i}(\mathcal{O}_i = (\{T, F\}, 2^{\{T, F\}}, G_i), S_{[\rho_i]}) : i = 1, 2, \dots, n\}$. Put

$$\widehat{P}_i = M_{\otimes_{j=1}^n \mathcal{A}_j}(\widehat{\mathcal{O}}_i = (\{T, F\}, 2^{\{T, F\}}, \widehat{G}_i), S_{[\otimes_{j=1}^n \rho_j]})$$

where

$$[\widehat{G}_i](\Xi_i) = \left(\bigotimes_{j=1}^{i-1} I \right) \otimes G_i(\Xi_i) \otimes \left(\bigotimes_{j=i+1}^n I \right) \quad (\forall \Xi_i \in \mathcal{P}(\{T, F\}), i = 1, 2, \dots, n)$$

Here, note that $\{\widehat{P}_i = M_{\otimes_{j=1}^n \mathcal{A}_j}(\widehat{\mathcal{O}}_i = (\{T, F\}, 2^{\{T, F\}}, \widehat{G}_i), S_{[\otimes_{j=1}^n \rho_j]}) : i = 1, 2, \dots, n\}$ satisfies that

- (P₁) $\widehat{\mathcal{A}} = \otimes_{j=1}^n \mathcal{A}_j$ is fixed,
- (P₂) $\widehat{\mathcal{O}}_1, \widehat{\mathcal{O}}_2, \dots, \widehat{\mathcal{O}}_n$ commute,
- (P₃) a state $\otimes_{j=1}^n \rho_j$ is only one.

Therefore, the general case: $\{P_i = M_{\mathcal{A}_i}(\mathcal{O}_i = (\{T, F\}, 2^{\{T, F\}}, G_i), S_{[\rho_i]}) : i = 1, 2, \dots, n\}$ can be understood.

Remark 12.12. (i): From the theoretical point of view, some may want to extend the above result to infinite tensor product. For this, we must prepare the W^* -algebraic formulation of QL. I think challenging this problem is a good exercise for the reader.

(ii): In this paper, we devote ourselves to binary logic (i.e., $\{T, F\}$ -valued logic). If we want to consider many valued logic (i.e., X -valued logic), we can start from X -value observable. In this case, it is clear that "fuzzy many valued proposition"="Axiom 1". Therefore, we can see the following equivalence:

- (#₁) Why does fuzzy logic work in our usual world?
- (#₂) Why does Axiom 1 (measurement in QL) work in our usual world?

Example 12.13. [Hempel's raven problem (cf. [75]); Any sweet tomato is red]

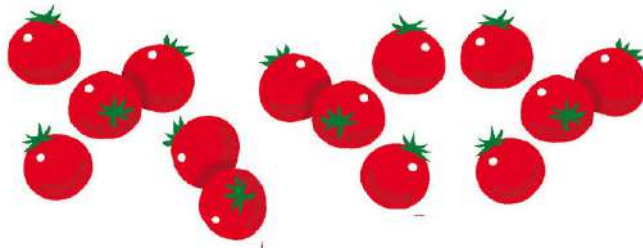

Consider (TF) -valued observables $\mathcal{O}_{SW} = (\{T, F\}, 2^{\{T, F\}}, G_{SW})$ and $\mathcal{O}_{RD} = (\{T, F\}, 2^{\{T, F\}}, G_{RD})$ in $C(\Omega)$, where \mathcal{O}_{SW} and \mathcal{O}_{RD} is respectively called the sweet observable and the red observable. It is natural to consider that "Any sweet tomato is red" is defined by

$$(Q) \quad SW \subseteq RD$$

where $SW = \{\omega \in \Omega | G_{SW}(\omega) = 1\}$ and $RD = \{\omega \in \Omega | G_{RD}(\omega) = 1\}$. In order to examine (Q) (i.e., to answer the problem: "Is the (Q) a proposition?"), it suffices to check the following:

$$\text{Prob}[M_{C(\Omega)}(\mathbf{O}_{RD}, S_{[\delta_\omega]}); \{T\}] = 1 \quad (\forall \omega \in SW)$$

For simplicity's sake, we assume $SW = \{\omega_1, \omega_2, \dots, \omega_n\}$. Recall the linguistic Copenhagen interpretation (L₁) such that only one measurement is permitted. Thus, consider the tensor space $\bigotimes_{i=1}^n C(\Omega) = C(\Omega^n)$, and the tensor product measurement

$$M_{C(\Omega^n)}(\bigotimes_{i=1}^n \mathbf{O}_{RD} = (\{T, F\}^n, \mathcal{P}\{T, F\}^n, \bigotimes_{i=1}^n G_{RD}), S_{[\delta_{(\omega_1, \omega_2, \dots, \omega_n)}]})$$

where

$$(\bigotimes_{i=1}^n G_{RD})(\{(x_1, x_2, \dots, x_n)\}) = \bigotimes_{i=1}^n G_{RD}(\{x_i\}) \quad (\forall (x_1, x_2, \dots, x_n) \in \{T, F\}^n)$$

Assume that the measured value $x = (x_1, x_2, \dots, x_n)$ belongs to $\{T\}^n$. Then, we can conclude that (Q) is true. Also, as an analogy of (ii) in Definition 12.4, we may consider as follows. Let $\pi^\wedge : \{T, F\}^n \rightarrow \{T, F\}$ be a map such that

$$\pi^\wedge(x_1, x_2, \dots, x_n) = \begin{cases} T & \text{if } x_1 = x_2 = \dots = x_n = T \\ F & \text{(otherwise)} \end{cases}$$

Then, (Q) is equivalent to

$$\text{Prob}[M_{C(\Omega^n)}(\pi^\wedge(\bigotimes_{i=1}^n \mathbf{O}_{RD}), S_{[\delta_{(\omega_1, \omega_2, \dots, \omega_n)}]})]; \{T\}] = 1$$

Thus, (Q) is a fuzzy proposition. If SW is an infinite set, we must prepare the infinite tensor algebra (i.e., the W^* -algebraic formulation of QL (*cf.* refs. [71], [76])). We omit it in this paper, since this is simply a matter of mathematics.

12.2 Wittgenstein; the biggest star of analytic philosophy.

12.2.1 What did he wanted to insist on in TLP?

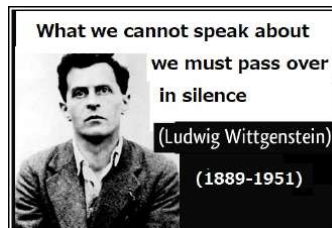

Ludwig Wittgenstein (1889 - 1951), who was the student of B. Russel, was the most famous philosopher (in analytic philosophy) in the 20th century.

Wittgenstein wrote two books, i.e.,

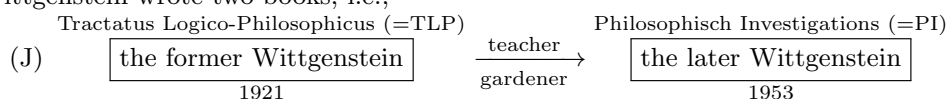

The former is concerned with world description, while the latter is literary. Thus, I think that the above is similar to the following:

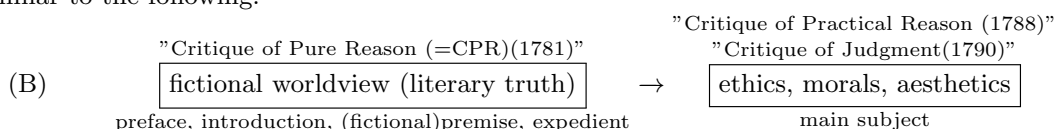

Thus we devote ourselves to TLP.

It has already been more than 100 years since analytic philosophy was born. Moreover, today, many philosophers specialize in analytic philosophy. However, strangely enough, I don't think that the evaluation of TLP has been settled yet. I think that TLP is theoretically insufficient. In fact, in the last 100 years, no philosopher has been able to read TLP in a theoretical way.

In the preface of his book "Tractatus Logico-Philosophicus", L. Wittgenstein said that

(C) *This book will perhaps only be understood by those who have themselves already thought the thoughts which are expressed in it — or similar thoughts.*

Here, what is "the thoughts which are expressed in it"? I think that his interest is not "mathematical logic", but "non-mathematical logic (i.e., practical logic)".

Thus I believe:

(D) What Wittgenstein wanted to insist on in TLP is to answer the following questions:

- (D₁) What is "proposition"? (i.e., what is the definition of "(practical) proposition"?)
- (D₂) Why does logic work in our usual world?

If so, we can consider (D) (= (D₁) + (D₂)) directly, without reading the TLP. The reason is that we have many powerful weapons (statistics, quantum mechanics, etc.) that Wittgenstein did not know about. It should be noted that

- **The 20th century was the century of statistics and quantum mechanics.** though the 21th century may be the century of (quantum) computer.

♠**Note 12.2.** I believe that (D) is due to Wittgenstein. However, even if it were not, it is certain that (D₁) and (D₂) are the most important in practical logic.

If so, I would be in a very favorable situation. Because I already know the answer to this problem.

(E) About 20 years ago, I wrote papers on "Why does logic work in our world?" (cf. refs. [39, 40, 41, 42])

At the time, I was not aware that "Why logic does work in our world?" was a question of philosophy. After reading (G), I immediately rewrote the following papers.

(F) Ref. [76]: Ishikawa, S., (2020) Wittgenstein's picture theory in the quantum mechanical worldview, Journal of quantum information science, Vol. 10, No.4 , 104-125, DOI:10.4236/jqis.2020.104007 (<https://www.scirp.org/journal/paperabs.aspx?paperid=106233>)

(G) Ref. [78]: Ishikawa, S., (2021) Fuzzy Logic in the Quantum Mechanical Worldview ; Related to Zadeh, Wittgenstein, Moore, Saussure, Quine, Lewis Carroll, etc. JAMP, Vol. 9, No.3 , 140-154, (<https://www.scirp.org/Journal/paperinformation.aspx?paperid=95447>) This is essentially the same as Sec. 117 in this text.

Thus, I can assert the following:

Answers to the above (D)

(D₁) What is "proposition"? (i.e., what is the definition of "proposition"?)

(D₂) Why does logic work in our usual world?

Answer 12.14. The above problems (D) are already solved in the previous section.

That is;

(#₁) Problem (D₁) is already answered in Definition 12.3.

That is,

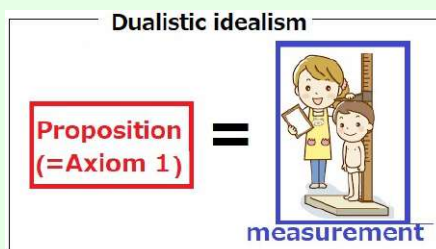

Also,

(#₂) Problem (D₂) is clear since QL is more powerful than statistics.

Furthermore, as seen in Remark 12.12, Fuzzy logic in QL has the same power as Axiom 1.

Summing up, we say

- "To speak what we can speak about" = "To speak QL"

□

♠**Note 12.3.** There may be a certain number of people in the world who have a special personality that feels status in reading difficult books that are impossible to understand. I would like to believe that Wittgenstein did not write TLP for those people. I tend to like the following Einstein quote;

- "If you can't explain it to a six year old, you don't understand it yourself"

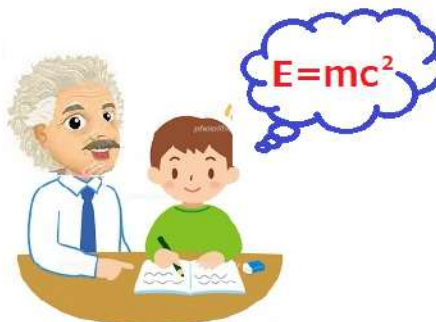

////

Therefore, I thought Wittgenstein himself did not understand TLP at all. Reading his confident explanation, I thought he was convinced that he understood TLP. For example, since Wittgenstein confidently concluded "What we cannot speak about we must pass over in silence" in TLP, I thought he assumed that he had defined "what we can speak about (= proposition)" in TLP. If this is true, it is the worst, since without definition, this can be said of anyone. However, I was relieved when I read the following (§38 in [118])

- "The basic of Russell's logic, as also of mine in the TLP, is that what a proposition is illustrated by a few commonplace examples, and then pre-supposed as understood in full generality"

When I read this, I knew I could trust Wittgenstein. So, the following §6.54 in TLP means that Wittgenstein knew that TLP was like a ladder that could be thrown down.

- §6.54: "He must so to speak throw away the ladder, after he has climbed up on it"

Also, despite the hot love call from logical positivism, Wittgenstein set himself apart from logical positivism because he had an intuition that TPL was powerless to science.

The fact that his TLP is incomplete is inevitable. No matter how much of a genius Wittgenstein was, it would have been impossible for him to discover "Fuzzy logic in QL". The environment in 1920 was as follows.

- (i) Born's discovery "the probabilistic interpretation of quantum mechanics" in ref. [6] (1926)
- (ii) Tractatus Logico-Philosophicus by L. Wittgenstein in ref. [117] (1921)
- (iii) Fisher's great book "Statistical Methods for Research Workers" in ref. [22] (1925)

The integration of these three is QL, and I don't think any genius at the time could have reached QL. I think that von Neumann's [113] and Davies' [14] are indispensable for QL. If von Neumann had taken an interest in TLP, though, the history of analytic philosophy might have been different.

♠**Note 12.4.** (i):Even if TLP is a poem whose logic is broken, if it raises issues (D₁) and (D₂), TLP is still a top-notch philosophy book. Descartes and Kant are not logical either.

(ii): As mentioned in the previous section (Sec. 12.1), I believe that QL is the central theory of analytic philosophy, which is also obvious if you look at List 13.1 in Chap.13. Of course, Kripke's possible worlds semantics is one of greatest theories in analytic philosophy. However, I have the same opinion (for Kripke's possible worlds semantics) as Dummett as follows

(‡₂) *I have been struck by the enormous influence of fashion in philosophy: possible-worlds semantics is an excellent example. Such a fashion seizes almost everyone at a particular moment and they all go haring off after it. I don't think that the vague for possible-worlds semantics was just a mistake. It is occurred because Kripke succeeded in using that apparatus to make some strong points that struck everybody forcibly; most then got themselves into a state of mind in which they could hardly think except in those terms. (188-189 pages)*

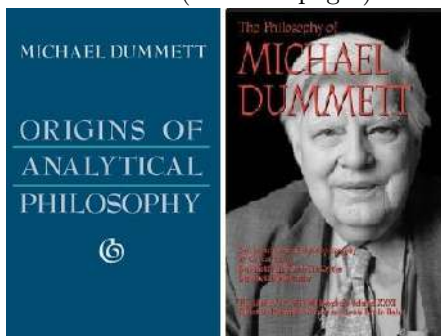

12.2.2 The power of Wittgenstein's word: Linguistic turn

However, in this paper, I want to assert that Wittgenstein is one of the greatest philosophers (Plato, Descartes, Kant, etc.). That is because he said the following sayings (H₁) - (H₃):

(H₁) "The limits of my language mean the limits of my world."

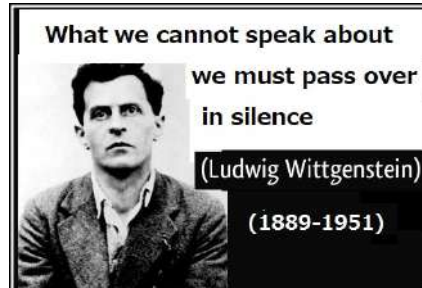
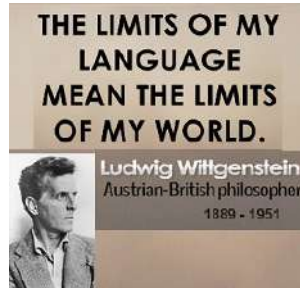

(H₂) "What we cannot speak about we must pass over in silence"

(H₃) "Language-game"

The above is just the spirit of quantum language. Instead of my poor explanation of the spirit of quantum language, I prefer to saying

(I) "The spirit of quantum language is represented by the above (H₁) - (H₃)"

Seeing the above (H₁)~(H₃), I can understand "Why did Russell support Wittgenstein as his guardian?". Russell must have thought "Without Wittgenstein, we (i.e., Frege and Russell) cannot spread analytic philosophy alone." That is, I think Russell expected Wittgenstein to be an enlightener of the philosophy of language.

♠**Note 12.5.** For each great discovery, an anecdote (or, a catch copy, stage effect) is left as follows.

- (#₁) Archimedes.....golden crown, heureka! (cf. Sec.5.4)
- (#₂) Galileo.....Leaning Tower of Pisa, "And Yet It Moves" (cf. Sec.7.3.4)
- (#₃) Newton..... :Newton's apple, "Geocentrism vs. Heliocentrism" (cf. Note 7.8)
- (#₄) Descartes..... :fly on the ceiling (cf. Note 8.2), : I think, therefore I am, (cf. Sec.8.2)
- (#₅) Kant.....clock (cf. Note 10.2), dogmatic slumber (cf. Note 10.6)
- (#₆) Wttgenstein.....primary school teacher, Gardener, Architect, Guardian: Russell (cf. Sec.12.1.1)
- (#₇) Einstein.....Elevator
- (#₈) quantum mechanics..... Heisenberg's uncertainty principle (cf.ref. [36], or, Note 4.1 of ref. [71])

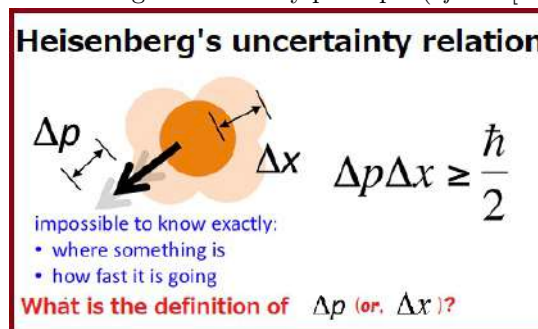

Here, the (#₈) is my opinion Has Heisenberg's uncertainty relation ever been used effectively in physics? (Sec. 4.3 in ref. [71]).



12.2.3 Philosophical Investigations (1953) and Wittgenstein's paradox

12.2.3.1 the later Wittgenstein

Wittgenstein wrote two books, i.e.,

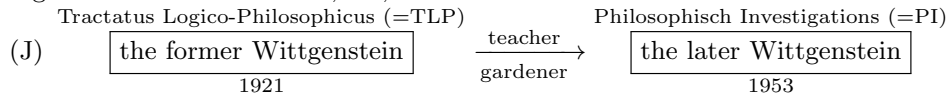

TLP is concerned with world description, while PI consists of a mishmash of miscellaneous things that could not be written in the TLP. The outline of the PI (the part 1) is as follows.

- (i) Sec.1-88; language game
- (ii) Sec.89-133; logic and philosophy
- (iii) Sec.134-242; Wittgenstein's paradox
- (iv) Sec.242-315; private language
- (v) Sec.315-693; psychology

Although PI (the part 2) is famous for rabbit-duck illusion, we are not concerned with psychology and brain science. Psychology (or, cognitive science) is an important discipline, but it is a discipline in which experimentation and observation are essential, and it is not really Wittgenstein's cup of tea. I have an opinion that the "philosophy of mathematics" should be left to mathematicians. That is, I believe that philosophers should concentrate on "world description (= world view)" in the first sense.

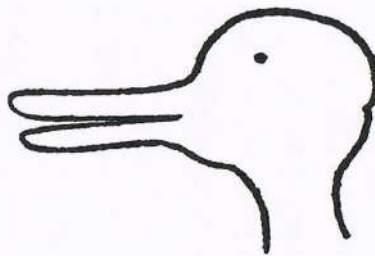

All of them (i.e., parts 1 and 2) may be of interest to Wittgenstein fans. From a QL point of view, I think the above (i), (iii), and (iv) are important. (i) has already been mentioned in Section 11.8.2.

12.2.3.2 (iii): Wittgenstein's paradox; Sec.

I have attempted this paradox several times, but none of them have been satisfactory. However, some things should be mentioned below.

For skepticism, the most important question is: "What should we be skeptical about?" I think. The object of skepticism is neither "chess game", "quus calculation" nor "private language". That is, we must be skeptical about QL (particularly, the linguistic Copenhagen interpretation), i.e.,

$$\begin{matrix} (= \text{dualistic idealism}) \\ \boxed{\text{Quantum language}} \\ (= \text{measurement theory}) \end{matrix} = \begin{matrix} \boxed{\text{measurement}} \\ (\text{Axiom 1}) \end{matrix} + \begin{matrix} \boxed{\text{causality}} \\ (\text{Axiom 2}) \end{matrix} + \begin{matrix} \boxed{\text{linguistic (Copenhagen) interpretation}} \\ (\text{how to use Axioms 1 and 2}) \end{matrix}$$

**If I were forced to sum up in one sentence
what the Copenhagen interpretation says
to me, it would be "Shut up and calculate!"**



since Axioms 1 and 2 are kinds of spells (i.e., incantation, magic words, metaphysical statements) as mentioned in Sec. 1.1.1. Also, recall the following spirit of "Copenhagen interpretation" (cf. Note 1.3):

- (i) Stop being bothered!
- (ii) Shut up and calculate!

In this spirit, we have solved many unsolved problems in this paper and ref. [71]. However, I think it is time for us to be skeptical about QL.

Thus I believe that the following problem is important:

- (#) How are the rules of QL learned?

Note that QL is a kind of idealism (or, a kind of metaphysics). I myself learned quantum language as an analogy after learning quantum mechanics. Therefore, I initially thought that it would be difficult to learn a quantum language only after learning quantum mechanics. However, in my graduate laboratory, students with no knowledge of quantum mechanics have easily learned quantum languages. This fact surprised me, and I still wonder about it. Just as a baby gradually learns an everyday language, a quantum language can be gradually learned by solving exercises. It is possible to gradually expand the range of objects that can be expressed in a quantum language. I can't help but marvel at the human capacity for language.

♠**Note 12.6.** AI (= artificial intelligence) that understands mathematics better than humans will be a reality in 20 to 30 years. However, I think the emergence of AI that understands QL will be delayed a bit longer. Of course, with a quantum computer, the difference between math and QL may be trivial. About Wittgenstein's paradox, S. Kripke said in ref. [86] as follows.

- (K) *Wittgenstein has invented a new form of scepticism. Personally I am inclined to regard it as the most radical and original sceptical problem that philosophy has seen to date, one that only a highly unusual cast of mind could have produced.*

I agree to Kripke's opinion, but I think that Wittgenstein's paradox is not only a problem for philosophy.

It is a problem for psychology, neuroscience, cognitive science, and AI. However, I was not sure what Kripke's quus meant, so I fear I am misreading ref. [86].

12.2.3.3 (iv): Private language

Private language is a language that records internal experiences such as sensations, emotions, will, and thoughts entirely for one's own use.

Words belonging to this language refer only to direct internal phenomena, and their meanings are determined independently of externally observable expressions and actions, so they cannot be understood by others.

Thus private language does not satisfy the linguistic Copenhagen interpretation. For example, we already discussed "I think", "I am", Qualia problem, etc.

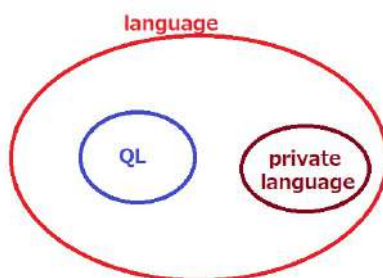

However, theoretical research on private languages seems to be difficult, and the PI only lists examples of private languages.

12.3 Quine's analytic-synthetic distinction and Popper's falsifiability in QL;

This section consists of excerpts from the following paper:

- Ref. [78]: Ishikawa, S., (2021) Fuzzy Logic in the Quantum Mechanical Worldview ; Related to Zadeh, Wittgenstein, Moore, Saussure, Quine, Lewis Carroll, etc. JAMP, Vol. 9, No.3 , 140-154, (<https://www.scirp.org/Journal/paperinformation.aspx?paperid=95447>)



Rudolf Carnap
1891-1971



W.V.O. Quine
1908-2000

12.3.1 Quine's analytic-synthetic distinction in QL;

12.3.1.1 What is a (non-mathematical) proposition?

Rudolf Carnap was a philosopher who was active in Europe before 1935 and in the United States thereafter. He was a major member of the Vienna Circle and an advocate of logical positivism. He is considered "one of the giants among twentieth-century philosophers."

Carnap reconsidered the dichotomy of analytic proposition/comprehensive proposition since Kant in the framework of linguistic and factual factors. Carnap reconsidered the dichotomy of analytic proposition/comprehensive proposition since Kant in the framework of linguistic and factual factors. According to him, an analytic statement is a statement of the syntax of the language we use to formulate it. According to him, an analytic statement is true only according to the syntactic or semantic rules of the language we use to establish it, that is, according to linguistic factors alone. In other words, it is a statement that is judged to be true only by linguistic factors. In contrast, a comprehensive statement is a statement whose truth is not determined by linguistic factors alone, but depends on factual factors. In other words, it is a statement whose truth depends on factual factors.

For example,

- analytic proposition: "*Horses are animals*", "*Unmarried men are single*", " $1 + 3 = 5$ "
- synthetic proposition: "*The horse is fast*", "*Jack is single*",

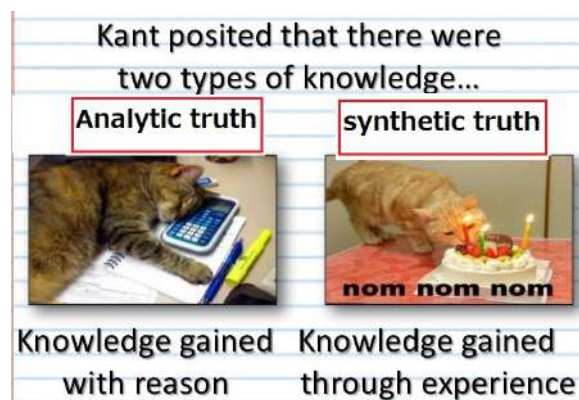

♠**Note 12.7.** Actually, I am not sure about the above distinction. I think the fact that there is so

much discussion about Carnap=Quine debate suggests that this is an important issue. That is, this question ultimately comes down to "What is a proposition? After Wittgenstein, I think the most important question in analytic philosophy is "What is a proposition?"

In ref. [101], Willard Van Orman Quine published the essay "Two Dogmas of Empiricism" in which he argued that the analytic-synthetic distinction is untenable. The argument at bottom is that there are no "analytic" truths, but all truths involve an empirical aspect. The question of "analytic vs. synthetic" is one of the most important philosophical questions since Kant.

Quine's philosophy is based on logical positivism. He was originally a follower of the philosophy of R. Carnap, a central member of the Vienna School, who developed the ideas of logical positivism most rigorously.

However, he later became the sharpest critic of Carnap's philosophy (and logical positivism). In this way, he formed his own philosophy.

It is well known that it was the concept of "analyticity" that Quine attacked most vigorously. One of the doctrines that Carnap and others defended that Quine regarded as dogma was the idea that a clear line could be drawn between analytic and synthetic truths. Analytic truths can be characterized as truths about the meaning of words alone. Quine, however, does not recognize the concept of "meaning" of words in the first place. Therefore, of course, he does not recognize "truth by the meaning of words alone" either.

12.3.1.2 My answer

Many philosophers have entered the fray on this issue, but all of them argued without a "definition of proposition". Since QL has the definition of proposition, we can easily solve it. That is, since "proposition in QL"=" (TF)-measurement (= experimental verification)", we can naturally conclude that all propositions are synthetic in QL.

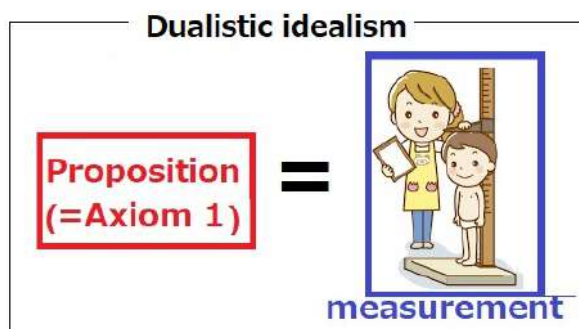

Of course, different worldviews (i.e., theoretical systems) can have different ideas, and our proposal is not the only correct one. For example, in theoretical system called mathematics, it is clear that every proposition is analytic.

I hope that many readers will make various proposals. I think that philosophers of analytic philosophy should argue the problem after presenting a worldview. I think that logic without a worldview is just a branch of mathematical logic.

12.3.2 Popper's falsifiability in QL

From the quantum linguistic point of view, as asserted in Assertion 1.3, we think that

to do science =to describe by QL
=to study in the quantum mechanical worldview

However, when it comes to "what is science?", I can't help but mention Popper. Thus let me mention a little about Karl Popper (1902-1994).

12.3.2.1 Popper's falsifiability

This may be common to many philosophers of science, if not Popper, but their work is "enlightening" and it is difficult for us in science to understand its true meaning. Popper's books on probability theory and quantum mechanics are also a little far from the interests of science, so I do not fully understand them.

Popper is famous for "falsifiability" as follows. Falsifiability is the following view of science (*cf.* ref. [97]).

(A) In order to guarantee the objectivity of a scientific theory, there must be a possibility that the hypothesis will be disproved by experiment or observation. In other words, truth must always be subjected to experiments that negate it. And if the denying experiment is confirmed, the truth must be denied.

Many scientists would take this claim for granted. For example,

(B) it is a common belief that mammoths are extinct, but if someone discovers a mammoth near the North Pole, this belief will be debunked.

This is a matter of course.

However, there seem to be various arguments against falsifiability (A) in the philosophy of science as well. For example, some may say as follows:

(C₁) The objectivity of a scientific theory is guaranteed by the majority vote of a group of highly qualified scientists.

I think ordinary scientists would agree that this may be true. However, I don't think most scientists are interested in the "definition of scientific truth."

(C₂) The objectivity of a scientific theory is guaranteed by the majority vote of a group of highly qualified scientists.

Philosophers of science may ask, "Why aren't you interested in being involved in this essence of science?" However, scientists would say, "Science cannot be understood without experiments and calculations." So, although it is a "parallel line state that does not intersect forever", the purpose of this text is to break this.

12.3.2.2 Falsifiability in philosophy

As mentioned in Remark 3.13, many excellent philosophers follow Euclid as follows.

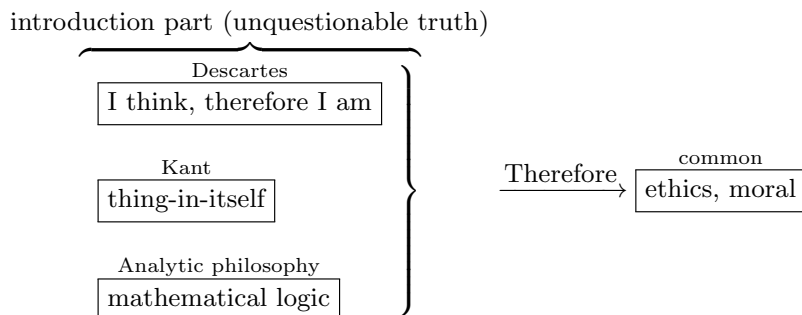

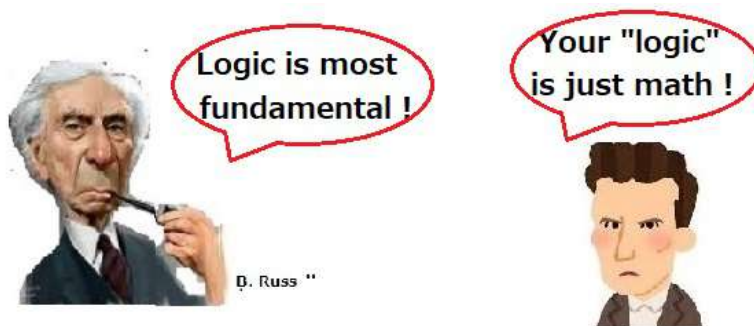

That is, they wanted to start from "unquestionable truth" since they were afraid of being pointed out the error of their ways. They started with an unfalsifiable claims (i.e., "I think, therefore I am", "thing-in-itself", "mathematical logic"), which are out of QL. However, I think that they should have kept in mind the following word*1.

- **"The biggest risk is not taking any risk"**

On the other hand, QL starts from Axioms 1 and 2, which is a kind of "incantation" (i.e., "spell", "metaphysical statements"), i.e.,

$$\begin{array}{l}
 \boxed{\text{(=quantum language)}} \\
 \boxed{\text{measurement theory}} = \boxed{\text{[Axiom 1]}} + \boxed{\text{[Axiom 2]}} \\
 \boxed{\text{measurement}} + \boxed{\text{causal relation}} \\
 + \boxed{\text{linguistic Copenhagen interpretation}} \quad (*) \\
 \boxed{\text{[the manual to use Axioms 1 and 2]}}
 \end{array}$$

Here, Axioms 1 and 2 are metaphysical statements, whose truth are uncertain.

I have my doubts about the following classification.

- (D₁) [Science]: Newtonian mechanics, quantum mechanics, the theory of relativity,...
- (D₂) [Pseudoscience]: individual psychology, psychoanalysis, ...

12.3.2.3 Falsifiability in QL

In conclusion, I suggest the following:

- (E) View falsifiability (A) as part of the Copenhagen interpretation ! (cf. (E₀) in Sec. 1.1.2.2)

This is because we can see

- (A) ≈ "there is no science without measurements"
- ≈ To be is to be perceived

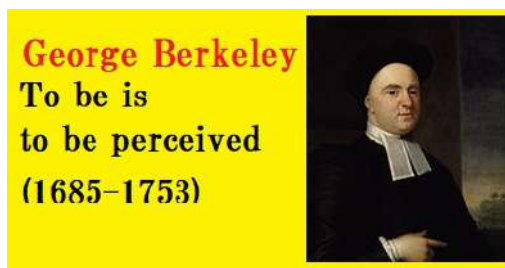

Let me explain (E) below.

- (F) The conclusion of Wittgenstein's TLP was "what we cannot speak about we must pass over in silence". In order to do so, we need a rule to distinguish between "what we cannot speak about (=pseudoscience)" and "what we can speak about (=science)". Otherwise, the argument is meaningless. It is with this in mind that Popper formulated falsifiability.

*1 This is known as the word of Mark Zuckerberg, the founder of facebook

On the other hand, QL has the form:

$$\begin{aligned} \boxed{\text{ (=quantum language) }} \\ \boxed{\text{ measurement theory }} &= \boxed{\text{ [Axiom 1] }} + \boxed{\text{ [Axiom 2] }} \\ &+ \boxed{\text{ linguistic Copenhagen interpretation }} \\ &\quad \boxed{\text{ [the manual to use Axioms 1 and 2] }} \end{aligned} \quad (*)$$

This came about in the following way. Above, Axiom 1 and Axiom 2 alone lead to a messed up conclusion. For example,

(G₁) There's a cat that you can't tell if it's alive or dead, and the moment you see it, it's confirmed that the cat is alive or dead.

(G₂) An incomprehensible non-proposition such as "I think, therefore I am" becomes a major proposition as "the first proposition of philosophy".

It is the "linguistic Copenhagen interpretation" that contains such pseudoscientific propositions and keeps them out of the open. In short,

(H) "linguistic Copenhagen interpretation" draws a line between scientific and pseudoscientific propositions.

Therefore, we can think that

$$(F) \approx (H)$$

If so, all scientists will understand the meaning of falsificationism.

♠**Note 12.8.** Recall the linguistic Copenhagen interpretation (particularly, (E₇) in Sec. 1.1.2). That is,

(I) (= (E₇) in Sec. 1.1.2); most maxims of the philosophers (particularly, the dualistic idealism) can be regarded as expressions in linguistic Copenhagen interpretation.

That is because philosophers have been investigating dualistic idealism (without Axioms 1 and 2).

♠**Note 12.9.** (i): "Why can't scientists and philosophers understand each other?" is a quite important question, but I think as follows. As I have said in this text in general, philosophers have been discussing the Copenhagen interpretation without knowing Axioms 1 and 2 in (*). This is why scientists could not understand the philosophy of science.

(ii): This is a story about a philosophical study group led by Wittgenstein. Popper was also a participant in that seminar. For Wittgenstein, there were no philosophical problems, only trivial puzzles. All the while, Wittgenstein, seated by the fireplace, had, says Popper, "been nervously playing with the poker". After an exchange of views on ethics, Wittgenstein asked Popper to give an example of an ethical rule. Popper replied, "Not to threaten visiting lecturers with pokers." Wittgenstein then threw away the poker and stormed off.

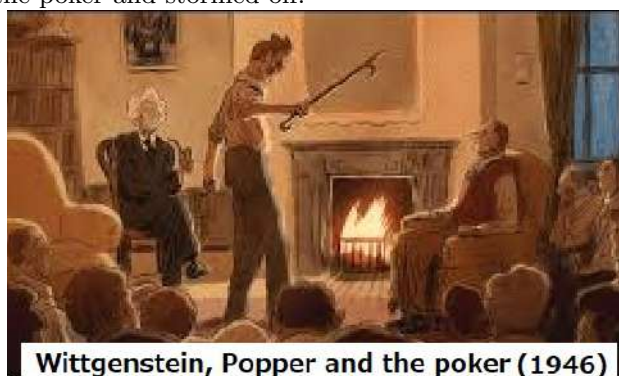

Wittgenstein, Popper and the poker (1946)

This episode implies an adversarial relationship between Wittgenstein and Popper. However, I think Popper just did the next.

- using falsificationism, he drew a line between scientific propositions (= what we can speak about) and pseudoscientific propositions (= what we cannot speak about).

12.4 Lewis Carroll's logical paradox in fuzzy logic

Lewis Carroll (1832–1898) was an English writer of children's fiction, notably "Alice's Adventures in Wonderland" and its sequel Through the Looking-Glass. He was also a mathematician, photographer, inventor, and Anglican deacon.



This section consists of excerpts from the following paper:

- Ref. [78]: Ishikawa, S., (2021) Fuzzy Logic in the Quantum Mechanical Worldview ; Related to Zadeh, Wittgenstein, Moore, Saussure, Quine, Lewis Carroll, etc. JAMP, Vol. 9, No.3 , 140-154, (<https://www.scirp.org/Journal/paperinformation.aspx?paperid=95447>)

In ref. [10] "What the Tortoise said to Achilles" (1895), Lewis Carroll raised the following question.

- Is logic logical?

According to [10], let us explain it as follows.

Achilles says: "Can you understand the following modus ponens?"

Premise (a): $(P_1 \rightarrow P_2)$

Premise (b): P_1

Conclusion: (z) P_2

the Tortoise says: "I can understand (a) and (b). However, why do (a) and (b) imply (z)?"

Achilles says: "I see, then, the following OK?"

Premise (a): $(P_1 \rightarrow P_2)$

Premise (b): P_1

Premise (c): (a) and (b) are "true", therefore (z) is "true"

Conclusion: (z) P_2

the Tortoise says: "I can understand Premises (a),(b) and (c). However, why do (a), (b) and (c) conclude (z)?"

Achilles says: "I see, then, the following OK?"

Premise (a): $(P_1 \rightarrow P_2)$

Premise (b): P_1

Premise (c): (a) and (b) are "true", therefore (z) is "true"

Premise (d): (a), (b) and (c) are "true", therefore (z) is "true"

Conclusion: (z) P_2

the Tortoise says: "I can understand Premises (a),(b), (c) and (d). However, why do (a), (b), (c) and (d)

conclude (z)?"

: (Infinite regress)

This is Lewis Carroll's Paradox

Several philosophers have tried to resolve Carroll's paradox. For example, Bertrand Russell discussed the paradox briefly in ref. [107]. His opinion is as follows.

- (A₁) The above (a), (b) and (z) are propositions, on the other hand, (c) and (d) are inference rules. And, therefore, both the Tortoise and Achilles are confusing this.

I agree to his opinion. I think that their confusion is due to the lack of a definition of proposition. Note that QL says that

(A₂) "proposition P " = "(TF)-measurement $M_A(O, S_{[\rho]})$ ". And the essence of the modus ponens is all described in the following Table 11.12 (= Table 11.11). Therefore, logic is a simple calculation of elementary arithmetic.

Table 11.12: Probabilistic Truth Table (Elementary propositions $M_A(O_1, S_{[\rho]}) (= P_1)$, $M_A(O_2, S_{[\rho]}) (= P_2)$)

$M_A(O_1, S_{[\rho]})$ (= P_1)	$M_A(O_2, S_{[\rho]})$ (= P_2)	probability: $p = \times_{i=1,2}^{qp} \mu_i$	$[P_1 \rightarrow P_2] \wedge P_1$	$[P_1 \rightarrow P_2] \wedge P_1 \rightarrow P_2$
T	T	$p_{12} = \times_{i=1,2}^{qp} \mu_i(\{(T, T)\})$	T	T
T	F	$p_{1\bar{2}} = \times_{i=1,2}^{qp} \mu_i(\{(T, F)\})$	F	T
F	T	$p_{\bar{1}2} = \times_{i=1,2}^{qp} \mu_i(\{(F, T)\})$	F	T
F	F	$p_{\bar{1}\bar{2}} = \times_{i=1,2}^{qp} \mu_i(\{(F, F)\})$	F	T

For example, put P_1 := "it rains", P_2 := "the ground is wet". Modus ponens says that

$$[["it rains" \rightarrow "the ground is wet"] \wedge "it rains"] \rightarrow "the ground is wet".$$

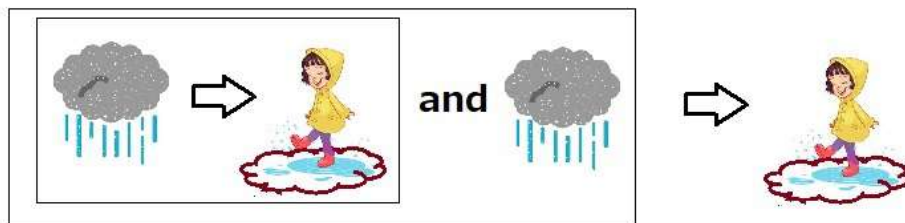

Maybe the Tortoise thought of logic as a noble discipline and tried to understand it rigorously. However, all we have to do is only what is written in the table above. Note that the above © and Ⓓ are not written in this table.

Rather, in the case of mathematics, the definition of "proposition" is so clear that I think it is rare for mathematicians to take Carroll's logical paradox seriously. When I asked the mathematicians around me, they all just said, "What are you saying stupid things?" or "Isn't that the same as saying, I don't understand '1+1=2'?"

Since the definition of a proposition is not clear in the case of philosophy, we tend to confuse propositions with inference rules. We know the definition of a proposition so clearly that we could avoid any confusion.

I don't know Carroll's own intentions, but I think the reason this paradox has been of interest to people for over 100 years is that it is closely related to the question "what is a scientific proposition?". Carroll's logical paradox is not the childish problem that most mathematicians think it is.

12.5 Flagpole problem in the quantum mechanical worldview

This section was written with reference to the following.

- [75]:Ishikawa, S: Philosophy of science for scientists; The probabilistic interpretation of science Journal of quantum information science, Vol. 9, No.3 , 140-154, DOI: 10.4236/jqis.2019.93007 (<https://www.scirp.org/Journal/paperinformation.aspx?paperid=95447>)

Remark 12.15. Recall that fuzzy logic in QL (in Sec. 12.2) is practical logic within the quantum mechanical world view. As I have said many times in this text, philosophers like "logic" (or, the word "logic") too much. They always want to "be logical". I think that the following fact is incomprehensible.

- **Philosophers are more fond of "logic" (or, the word "logic") than mathematicians**

That is, I assert that

- the scientific explanation should not be described in the logical worldview (=the logical spirit=the spirit of "Think logically!"), but in the quantum mechanical worldview.

The flagpole problem below is caused by philosophers' excessive love of logic.

12.5.1 * The quantum linguistic solution of Flagpole problem

Carl Gustav Hempel (1905-1997) was a German philosopher. He was a major figure in logical empiricism, a 20th-century movement in the philosophy of science. His studies of induction, explanation, and rationality in science exerted a profound influence upon a young generation of philosophers of science. He is also known for the raven paradox (also known as "Hempel's paradox"). Recalling that

(A) our spirit is "(quantum) mechanics" rather than "logic".

the reader should read this section. Most scientists know Newtonian mechanics, but not mathematical logic.

12.5.1.1 Flagpole problem in Hempel's model (= the deductive-nomological model (DN model))

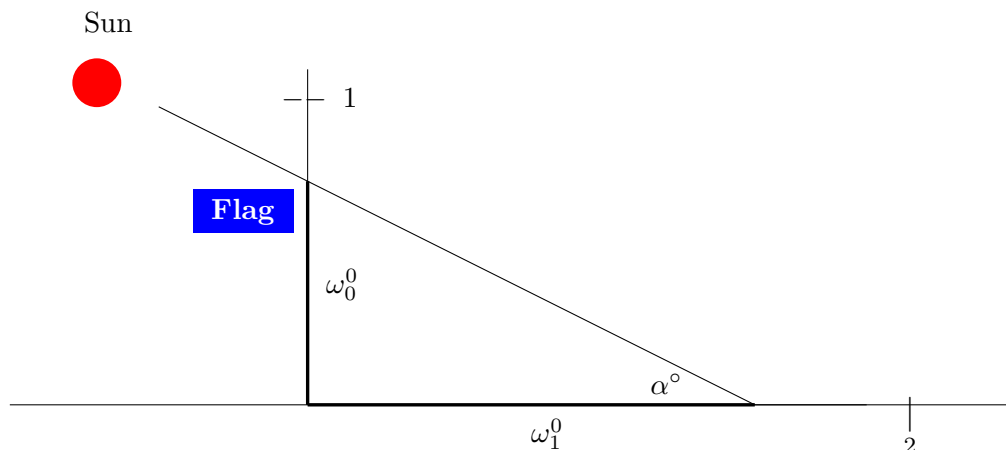

Figure 11.2: [Flagpole problem]

Let us explain the flagpole problem as follows. Suppose that the sun is at an elevation angle α° in the sky. Assume that $\tan \alpha^\circ = 1/2$. There is a flagpole which is ω_0^0 meters tall ($0 \leq \omega_0^0 \leq 1$). The flagpole casts a shadow ω_1^0 meters long. Suppose that we want to explain the length of the flagpole's shadow. On Hempel's model, the following explanation is sufficient.

(B₁) 1. The sun is at an elevation angle α° in the sky.

2. Light propagates linearly.

3. The flagpole is ω_0^0 meters high.

Then,

4. The length of the shadow is $\omega_1^0 = \omega_0^0 / \tan \alpha^\circ = 2\omega_0^0$

This is a good explanation of "Why is that shadow $2\omega_0^0$ meters long?"

Similarly, we may consider as follows.

- (B₂)
1. The sun is at an elevation angle α° in the sky.
 2. Light propagates linearly.
 3. The length of the shadow is ω_1^0

Then,

4. The flagpole is $\omega_0^0 (= (\tan \alpha^\circ)\omega_1^0 = \omega_1^0/2)$ meters tall.

However, this is not sufficient as the explanation of "Why is the flagpole $\omega_0^0 (= \omega_1^0/2)$ meters tall?"

Thus we have the flagpole problem as follows:

- (B₃) [**Flagpole problem**]

Why do we feel that the solution (B₂) is unnatural?

My opinion is as follows.

- (C) the above explanations (B₁) and (B₂) rely on DN model (i.e., deductive-nomological model), which is due to a kind of the logical worldview (=the logical spirit=the spirit of "Think logically!") (i.e., the spirit that science should be written logically). And thus, the most important concepts "measurement" and "causality" are not used in (B₁) and (B₂).

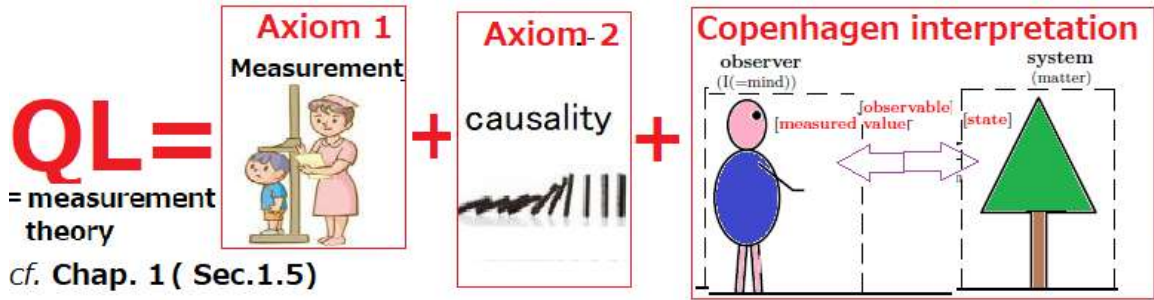

Therefore, in what follows, I will present the quantum linguistic explanation.

12.5.1.2 Flagpole problem by the quantum linguistic explanation

In what follows, we discuss the flagpole problem in terms of quantum language.

Consider two times $t = 0, \epsilon$ ($0 < \epsilon \ll 1$). For simplicity, put $\epsilon = 1$. Consider a basic structure $[C(\Omega_t) \subseteq L^\infty(\Omega_t, \nu_t) \subseteq B(L^2(\Omega_t, \nu_t))]$ (cf. the W^* -algebraic formulation in (A₂) in Sec 1.5) is used in this section), where $\Omega_0 = [0, 1]$ is the state space (in which the length of the flagpole is assumed to be represented) at time 0 (where the closed interval in the real line \mathbb{R}), $\Omega_1 = [0, 2]$ is the state space (in which the length of the shadow is assumed to be represented) at time 1 and the ν_t is the Lebesgue measure.

Since the sun is at an elevation angle α° in the sky, it suffices to consider to the causal map $\phi_{0,1} : \Omega_0 \rightarrow \Omega_1$ such that $\phi_{0,1}(\omega_0) = 2\omega_0$ ($\forall \omega_0 \in \Omega_0$). Thus, we can define the causal operator $\Phi_{0,1} : L^\infty(\Omega_1) \rightarrow L^\infty(\Omega_0)$ such that

$$(\Phi_{0,1}f_1)(\omega_0) = f_1(\phi(\omega_0)) \quad (\forall f_1 \in L^\infty(\Omega_1), \omega_0 \in \Omega_0)$$

Let $O_e = (X, \mathcal{F}, F_e)$ be the exact observable in $L^\infty(\Omega_1, \nu_1)$ (cf. [?, 75]). That is, it satisfies that $X = \Omega_1, \mathcal{F} = \mathcal{B}_{\Omega_1}$ (i.e., the Borel field in Ω_1), $[F_e(\Xi)](\omega_1) = 1$ (if $\omega_1 \in \Xi$), $= 0$ (otherwise).

Thus, we have the measurement $M_{L^\infty(\Omega_0, \nu_0)}(\Phi_{0,1}O_e = (X, \mathcal{F}, \Phi_{0,1}F_e), S_{[\omega_0^0]})$. Then we have the following statement

- (D₁) [Measurement]; the probability that the measured value $x(\in X)$ obtained by the measurement $M_{L^\infty(\Omega_0, \nu_0)}(\Phi_{0,1}O_e = (X, \mathcal{F}, \Phi_{0,1}F_e), S_{[\omega_0^0]})$ is equal to $2\omega_0^0$ is given by 1.

which is the quantum linguistic representation of (B₁). That is, we consider that the (B₁) is the simplified form (or, the rough representation) of (D₁). Also,

- (D₂) [Inference]; Assume that the measured value $\omega_1^0(\in X)$ is obtained by the measurement $M_{L^\infty(\Omega_0, \nu_0)}(\Phi_{0,1}O_e = (X, \mathcal{F}, \Phi_{0,1}F_e), S_{[*]})$. Then, we can infer that $[*] = \omega_1^0/2$

which is the quantum linguistic representation of (B₂). That is, we consider that the (B₂) is the simplified form (or, the rough representation) of (D₂). Thus, we conclude that "scientific explanation" is to describe by quantum language. Also, we have to add that the flagpole problem is not trivial but significant, since this is never solved without **Axiom 1 [measurement]** (in Chap. 1) and **Axiom 2 [causality]** (in Chap. 1) (i.e., the answers to the problems "What is measurement ?" and "What is causality ?").

Remark 12.16. Recall the following the mainstream of western philosophy:

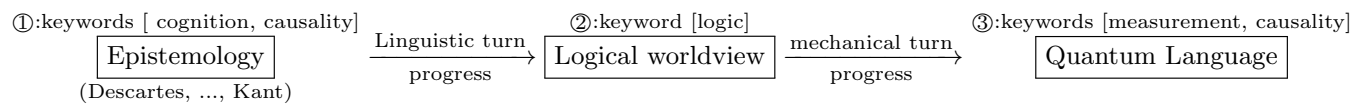

where we see that

” $\textcircled{1}$: keywords [cognition, causality]” \approx ” $\textcircled{3}$: keyword [measurement, causality]”

Thus, ” $\textcircled{2}$:logic” is too specific. Thus, I am skeptical of the logical worldview (=the logical spirit=the spirit of ”Think logically!”). As mentioned often in this text, I believe that

- (#₁) quantum language is the language of science (*cf.* Assertion 1.3).
- (#₂) mathematical logic is the language of mathematics.

12.6 * Hempel's raven problem

12.6.1 Is "the set of all tyrannosaurus" meaningful? : the set theoretical worldview

Let us explain "the set theoretical worldview", (which is a kind of "the logical worldview (=the logical spirit=the spirit of "Think logically!")"). Logic and set theory are similar, and thus, it usually believed that set theory as well as logic are considered reliable.

As mentioned Sec. 11.1, the following is the greatest history of mathematics (i.e., the beginning of modern mathematics):

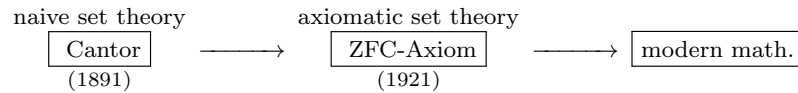

However, the difference between naive set theory and axiomatic set theory is negligible for most mathematicians (except mathematicians specializing in foundations of mathematics). Therefore, for simplicity, let's assume that "set theory" = "naive set theory" in this section (*cf.* Note 1.13). Therefore, we assume that "set" is defined by "a collection of things". This is the same as the use of "set" in everyday language.

General people (including philosophers) may think

(#₁) Set theory is very reliable because it is used to lay the foundation for mathematics. Therefore, if we use sets to describe the concept of this world, we will not fall into a mistake.

In this text, this is called the set theoretical worldview. However, I am skeptical of the set theoretical worldview (#₁). That is, I think that

(#₂) It is true that set theory is a very reliable and solid discipline. However, we must be cautious in using sets to describe the world.

For example,

(#₃) Is "the set of all tyrannosaurus" meaningful? Or, is "the set of all raven" meaningful? If it is not meaningless, how do we represent "All ravens are black"?

This (#₃) is **Hempel's raven problem**.

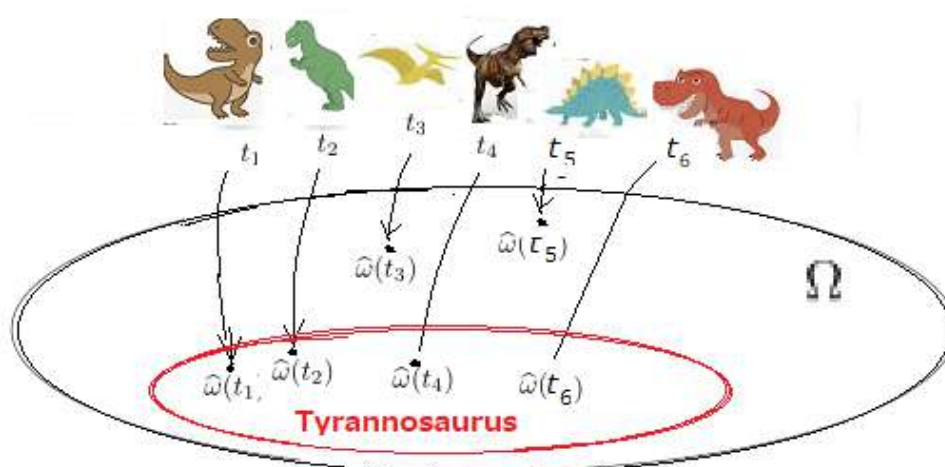

12.6.2 Hempel's raven problem in the set theoretical worldview

First, let us review the traditional arguments concerning Hempel's raven problem (*cf.* refs. [31, 32]). Thus, we start from the followings:

(A₀) Let U be the set of all birds. Let $B(\subseteq U)$ be a set of all black birds. Let $R(\subseteq U)$ be a set of all ravens.



Is "the set of all tyrannosaurs" meaningful?

Although these should be doubtful (since these are as ambiguous as "the set of all tyrannosaurs"), we advance towards the next argument. The statement: "Every raven is black" is logically denoted by

(A₁) "Every raven is black" : $(\forall x)[x \in R \rightarrow x \in B]$ *i.e.*, $R \subseteq B \subseteq U$,

Also, this is logically equivalent to the following contraposition:

(A₂) "Every non-black bird is a nonraven" : $(\forall x)[x \in U \setminus B \rightarrow x \in U \setminus R]$
i.e., $U \setminus B \subseteq U \setminus R$

However, if these are equivalent, then we have the following problems (*i.e.*, raven problem):

(A₃) Why is the actual verification of (A₂) much more difficult than the actual verification of (A₁)?

(A₄) Why can the truth of "(A₁): any raven is black" be known by (A₂), *i.e.*, without seeing a raven also at once?

(A₅) Is it possible to experimentally verify "Every raven is black"?

These may be so called Hempel's raven paradox. However, there is a reason to consider that "the set of all ravens" is as ambiguous as "the set of all tyrannosaurs". If so, that is, if the above (A₀) is ambiguous, all other (A₁)-(A₅) are also ambiguous. That is, (A₃)-(A₅) are not scientific problems.

Now we think that the most essential problem concerning Hempel's raven problem is as follows:

(B) What is the scientific meaning of "Every raven is black"?

In order to study this problem, we must prepare the quantum linguistic formulation of ornithology, under which the meaning of "Every raven is black" will be clarified in this section. We believe that the above problems cannot be solved without measurement theory since the above problems includes the terms "actual verification" and "experimentally verify" which are closely related to measurement.

Remark 12.17. Just to be sure, in this paper we assume that the followings are the same:

"any raven is black" = "every raven is black" = "all ravens are black".

This is the same as the usage in mathematics (*i.e.*, "any" = "every" = "all" = "∀").

12.6.3 Hempel's raven problem in the quantum mechanical worldview



In this section we slightly improve our result in

- Ref. [75]: Ishikawa, S., (2019) Philosophy of science for scientists; The probabilistic interpretation of science, Journal of quantum information science, Vol. 9, No.3 , 140-154, (<https://www.scirp.org/Journal/paperinformation.aspx?paperid=95447>)

We think that Hempel's raven problem raises the problem of "What is the scientific meaning of 'Every raven is black'?". In order to answer this problem, we must prepare the quantum linguistic formulation of ornithology

The arguments below are essentially the same as Saussure's "signifier" and "signified" in Sec. 11.5.3.

Definition 12.18. [Membership function (= Fuzzy set, cf. [39, 40, 41, 42, 121]), Observable] Let Ω be a state space. For simplicity, we always assume that Ω is compact. A continuous function $m : \Omega \rightarrow [0, 1]$ (i.e., the closed interval in \mathbb{R}). is called a membership function. Also, we consider the following correspondence:

$$\begin{array}{ccc}
 m : \Omega \rightarrow [0, 1] & \xleftrightarrow{\text{correspondence}} & \mathbf{O} = (\{y, n\}, 2^{\{y, n\}}, F) \\
 \text{membership function} & & \text{observable}
 \end{array} \tag{12.1}$$

such that

$$F(\{y\})(\omega) = m(\omega) \quad F(\{n\})(\omega) = 1 - m(\omega), \quad (\forall \omega \in \Omega)$$

where "y" and "n" respectively means "yes" and "no".

Definition 12.19. [Membership functions of black birds and ravens] Let Ω be a state space. A continuous function $m : \Omega \rightarrow [0, 1]$ (i.e., the closed interval in \mathbb{R}) is called a membership function. Assume that the state (i.e., quantitative property) of any bird can be expressed by a point in the state space Ω . Define the membership functions $m_B : \Omega \rightarrow [0, 1]$ of black birds and the membership function $m_R : \Omega \rightarrow [0, 1]$ of ravens as follows. Suppose that there are 100 specialists of ornithology and the following question is made them.

(C) Is this bird with the state $\omega_1 (\in \Omega)$ a black bird or not?

The answer is as follows.

- (D) $\left\{ \begin{array}{l} 70 \text{ specialists say that this bird is a black bird.} \\ 30 \text{ specialists say that this bird is not a black bird.} \end{array} \right.$

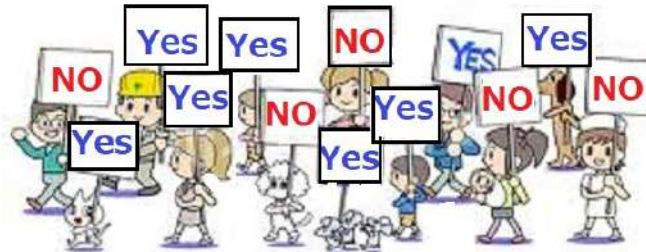

Then the value of $m_B(\omega_1)$ is defined by 0.7. For many birds with the state $\omega_i (i = 2, 3, \dots, N)$, repeating the experiment in the same way, the value of $m_B(\omega_i) (i = 2, 3, \dots, N)$ is determined. And the membership function $m_B : \Omega \rightarrow [0, 1]$ of black birds is defined by the interpolation method (which may be rather subjective). Similarly we get the membership function $m_R : \Omega \rightarrow [0, 1]$ of ravens.

Definition 12.20. (i): [Raven state class, Black bird state class]: Put

$$\Omega_B := \{\omega \in \Omega \mid m_B(\omega) = 1\}, \quad \Omega_R := \{\omega \in \Omega \mid m_R(\omega) = 1\}$$

which is respectively called a *black bird state class* and a *raven state class* (see Fig. 11.3 below).

(ii): [Raven, Black bird]: If the state of a certain bird belongs to Ω_R [resp. Ω_B], this bird of a certain is called a raven [resp. a black bird]. It is not asked whether this bird exists really. This bird may be extirpated like tyrannosaurs. Moreover, this bird may be a biology newly made by genome edit.

(iii): ["Every raven is a black bird"]: We say "Every raven is black", if it holds that $\Omega_R \subseteq \Omega_B$. (see Fig. 11.6 later).

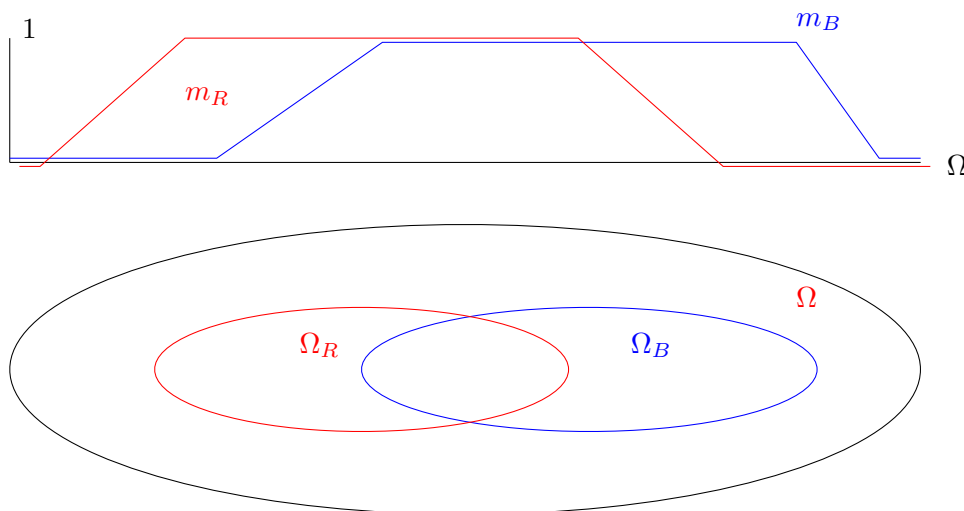

Figure 11.3: [Raven state class Ω_R , black bird state class Ω_B]

Definition 12.21. [Raven observable, Black bird observable]: Using the above membership functions, we define two observables (i.e., Black bird observable, Raven observable) $\mathcal{O}_B = (\{y, n\}, 2^{\{y, n\}}, F_B)$, $\mathcal{O}_R = (\{y, n\}, 2^{\{y, n\}}, F_R)$ in $C(\Omega)$, such that

$$\begin{aligned} F_B(\{y\})(\omega) &= m_B(\omega) & F_B(\{n\})(\omega) &= 1 - m_B(\omega), \\ F_R(\{y\})(\omega) &= m_R(\omega) & F_R(\{n\})(\omega) &= 1 - m_R(\omega) \end{aligned} \quad (\forall \omega \in \Omega)$$

where "y" and "n" respectively means "yes" and "no". Thus, a membership function can be identified with a binary observable.

Since we assume that any bird is characterized by a certain point in the state space Ω , it is natural to consider that systematic ornithology is formulated as follows.

Formulation [I] [The quantum linguistic formulation of systematic ornithology [I]]:

(E₁) Ravens are characterize by the membership function $m_R : \Omega \rightarrow [0, 1]$ (or, equivalently, the observable $\mathcal{O}_B = (\{y, n\}, 2^{\{y, n\}}, F_B)$). If the state ω of a bird belongs to Ω_R , then the bird is called a raven.

(E₂) Black birds are characterize by the membership function $m_B : \Omega \rightarrow [0, 1]$. (or, equivalently, the observable $\mathcal{O}_R = (\{y, n\}, 2^{\{y, n\}}, F_R)$). If the state ω of a bird belongs to Ω_B , then the bird is called a black bird.

Interpretation 12.22. [The probabilistic interpretation of membership functions] We add the following probabilistic interpretation to this formulation [I]: For example, again consider Definition 12.19, and moreover, the statement (D). i.e.,

- (D') $\left\{ \begin{array}{l} 70 \text{ specialists say that this bird with a state } \omega_0 \text{ is a black bird.} \\ 30 \text{ specialists say that this bird with a state } \omega_0 \text{ is not a black bird.} \end{array} \right.$

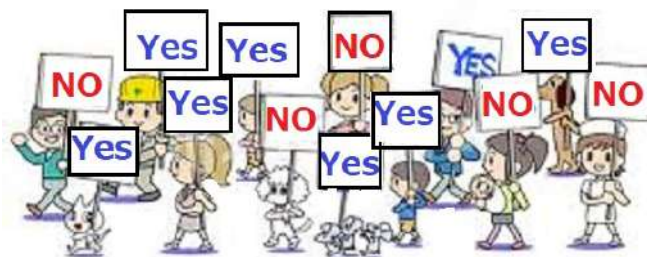

If we choose one person from the 100 specialists at random, the probability that he/she says that this bird is black is given 0.7. Such a measurement is represented by the symbol $M_{C(\Omega)}(\mathcal{O}_B = (\{y, n\}, 2^{\{y, n\}}, F_R), S_{[\omega_0]})$. Therefore, we can use **Axiom 1 [measurement] (in Section 1.1)** as follows.

- (F₁) for a bird with a state $\omega_0(\in \Omega_R)$, the probability that the measured value y [resp. n] is obtained by the measurement $M_{C(\Omega)}(\mathcal{O}_R = (\{y, n\}, 2^{\{y, n\}}, F_R), S_{[\omega_0]})$ is equal to $[F_R(\{y\})](\omega)$ [resp. $[F_R(\{n\})](\omega)$].
- (F₂) for a bird with a state $\omega_1(\in \Omega_B)$, the probability that the measured value y [resp. n] is obtained by the measurement $M_{C(\Omega)}(\mathcal{O}_B = (\{y, n\}, 2^{\{y, n\}}, F_B), S_{[\omega_1]})$ is equal to $[F_B(\{y\})](\omega_1)$ [resp. $[F_B(\{n\})](\omega_1)$].

12.6.4 A priori proposition: "Any small black bird is black"

Next consider the following figure:

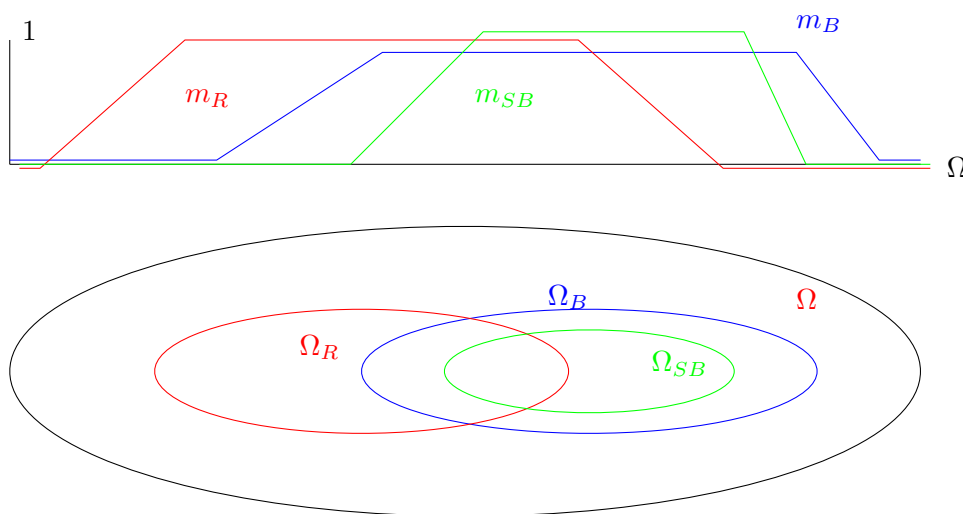

Figure 11.4: [Raven state class Ω_R , black bird state class Ω_B , small black bird state class Ω_{SB}]

That is, we add the small black bird observable:

- Definition 12.23.** (i): [Membership function of small black birds]: Define the membership function $m_{SB} : \Omega \rightarrow [0, 1]$ of small black birds such as Definition 12.19.
- (ii): [Small black bird state class] The small black bird state class Ω_{SB} is defined by $\{\omega \in \Omega \mid m_{SB}(\omega) = 1\}$.
- (iii): [Small black bird]: If the state of a certain bird belongs to Ω_{SB} , this bird is called a small black bird.
- (iv): ["Every small black bird is black"]: We say "Every small black bird is black" if it holds that

$$\Omega_{SB} \subseteq \Omega_B$$

Note that this necessarily holds without actual verification since it is assumed that a small black bird is defined by a black bird such that it is small. Thus, "Every small black bird is black" is a priori proposition.

(v): [Small black bird observable]: And define Small black observable $\mathcal{O}_{SB} = (\{y, n\}, 2^{\{y, n\}}, F_{SB})$ such that $[F_{SB}(\{y\})](\omega) = m_{SB}(\omega)$, $[F_{SB}(\{n\})](\omega) = 1 - m_{SB}(\omega)$, $(\forall \omega \in \Omega)$.

Thus, we have the new formulation, which is a development of Formulation [I] (i.e., The quantum linguistic formulation of systematic ornithology [I]):

Formulation [II] [The quantum linguistic formulation of systematic ornithology [II]]:

- (G₁) Ravens are characterize by the membership function $m_R : \Omega \rightarrow [0, 1]$. A bird with a state ω_R such that $\omega_R \in \Omega_R$ is called a raven.
- (G₂) Black birds are characterize by the membership function $m_B : \Omega \rightarrow [0, 1]$. A bird with a state ω_B such that $\omega_B \in \Omega_B$ is called a black bird.
- (G₃) Small black birds are characterize by the membership function $m_{SB} : \Omega \rightarrow [0, 1]$. A bird with a state ω_{SB} such that $\omega_{SB} \in \Omega_{SB}$ is called a small black bird.
- (G₄) It holds that $\Omega_{SB} \subseteq \Omega_B$, i.e., Every small black bird is black. This is a priori statement, which is directly derived from Definition 12.23 (iv).

Exercise 12.24. It is easy to see that the above (G₄): $\Omega_{SB} \subseteq \Omega_B$ says that

(H) Let $u_i (i = 1, 2, \dots, N)$ be a small black bird with the state $\omega_i (\in \Omega_{SB})$, which is denoted by $\tilde{\omega}(u_i)$. For each small black bird u_i , the probability that the measured value y is obtained by the measurement $M_{C(\Omega)}(\mathcal{O}_B = (\{y, n\}, 2^{\{y, n\}}, F_B), S_{[\tilde{\omega}(u_i)]})$ is equal to 1.

According to the linguistic Copenhagen interpretation (E₄) in Sec. 1.1: "Only one measurement is permitted", the above (H₁) is formally written as follows.

(I) the probability that the measured value $\underbrace{(y, y, y, \dots, y)}_N$ is obtained by the parallel measurement

$$\bigotimes_{i=1}^N M_{C(\Omega)}(\mathcal{O}_B = (\{y, n\}, 2^{\{y, n\}}, F_B), S_{[\tilde{\omega}(u_i)]}) \text{ is equal to 1.}$$

12.6.5 A posteriori proposition: "Every raven is black"

12.6.5.1 Popper's falsificationism in measurement theory

♠**Note 12.10.** As mentioned in Sec. 12.3.2, Karl Popper (1902-1994) was one of the 20th century's most influential philosophers of science. Popper claims that, in order for something to be considered science, it must be falsifiable. If it is false, it can be shown through observation and experiment to be false. However, I think that the meaning of "observation and experiment" is ambiguous. That is, it must be "observation and experiment that is described by quantum language". This will be done below.

In the previous section, we discussed " $\Omega_{SB} \subseteq \Omega_B$ " (i.e., Every small black bird is black). Since this is a priori statement, we can accept this statement without verification by experiment.

In this section we will discuss the statement " $\Omega_R \subseteq \Omega_B$ " (i.e., Every raven is black), which is not a priori proposition but a posteriori proposition.

Hence, our problem is as follows:

(J) How can we be sure of $\Omega_R \subseteq \Omega_B$ (i.e., "Every raven is black")?
i.e., What should we do to be sure of " $\Omega_R \subseteq \Omega_B$ "?

In order to do it, we obey Popper's falsificationism (*cf.* ref. [97]) such that

(K) " $\Omega_R \subseteq \Omega_B$ " should be accepted, if many experiments which deny " $\Omega_R \subseteq \Omega_B$ " are conducted and " $\Omega_R \subseteq \Omega_B$ " still cannot be denied.

For instance, we mention the following two tests ([Test I] and [Test II])

[**Test I**]: In order to deny " $\Omega_R \subseteq \Omega_B$ ",

(L) we try to find a bird with the state ω_0 such that $\omega_0 \in \Omega_R \setminus \{\omega \mid m_B(\omega) = 0\}$ (See Figure 11.5 below)

This test is quite natural, and thus, we should try this first.

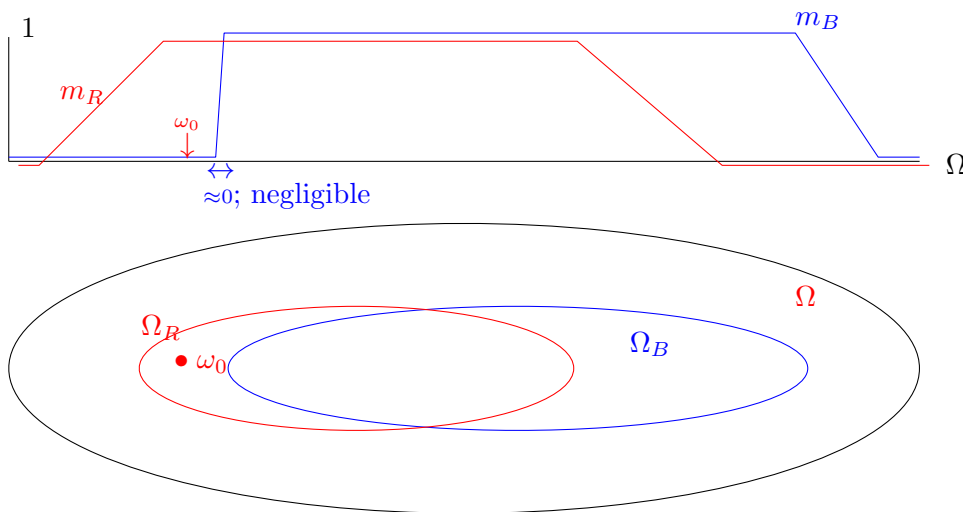

Figure 11.5: [$\omega_0 \in \Omega_R \setminus \{\omega \mid m_B(\omega) = 0\}$, $\rho_0(\{\omega \in \Omega \mid 0 < m_B(\omega) < 1\} \cap \Omega_R) \approx 0$, i.e., negligible.]

[**Test II**]: In order to deny " $\Omega_R \subseteq \Omega_B$ ",

(M₀) we try to confirm the hypothesis that there are non-black ravens by 3 percentages in 100 ravens.

That is, we take the parallel mixed measurement (*cf.* [?, 75]) $\bigotimes_{i=1}^{100} M_{C(\Omega)}(\mathcal{O}_B := (\{y, n\}, 2^{\{y, n\}}, F_B), S_{[*]}(\rho_0))$, where a mixed state $\rho_0 (\in \mathfrak{S}^m(C(\Omega)^*))$ satisfies $\rho_0(\Omega_R) = 1$ and $\rho_0(\Omega_R \setminus \Omega_B) = 0.03$. Here,

we, for simplicity, assume that $\rho_0(\{\omega \in \Omega \mid 0 < m_B(\omega) < 1\} \cap \Omega_R) \approx 0$, i.e., negligible. (See Figure 11.5 above.)

And assume that

(M₁) as the result of the (M₀), we get that one hundred ravens were black continuously which is written in terms of quantum language as follows:

(M₂) By the parallel mixed measurement (cf. [?, 75]) $\otimes_{i=1}^{100} \mathbf{M}_{C(\Omega)}(\mathbf{O}_B := (\{y, n\}, 2^{\{y, n\}}, F_B), S_{[*]}(\rho_0))$, a measured value $\underbrace{(y, y, y, \dots, y)}_{100}$ is obtained.

Then, we calculate:

(M₃) the probability that a measured value $\underbrace{(y, y, y, \dots, y)}_{100}$ is obtained by the parallel mixed measurement

$\otimes_{i=1}^{100} \mathbf{M}_{C(\Omega)}(\mathbf{O}_B := (\{y, n\}, 2^{\{y, n\}}, F_B), S_{[*]}(\rho_0))$ is given by $(97/100)^{100} (< 0.048)$. That is, the probability that (M₂) is realized (i.e., we meet one hundred black ravens continuously) is less than 0.048 ($> (97/100)^{100}$).

Thus, if we believe (M₀), a very rare thing (i.e., (M₃)) happened since probability 0.048 is quite rare. Therefore, we should doubt the hypothesis (M₀). That is, we couldn't deny "Ω_R ⊆ Ω_B (i.e., any raven is black)". When we can't do such test many times and still deny "Ω_R ⊆ Ω_B (i.e., any raven is black)", according to Popper's falsificationism, we will believe this.

If we believe in "Ω_R ⊆ Ω_B (i.e., any raven is black)", we can propose the following new formulation:

Formulation [III] [The quantum linguistic formulation of systematic ornithology [III]]:

- (N₁) Ravens are characterize by the membership function $m_R : \Omega \rightarrow [0, 1]$. The definition of ravens is given by a raven state class Ω_R as shown in Definition 12.20 (ii).
- (N₂) Black birds are characterize by the membership function $m_B : \Omega \rightarrow [0, 1]$. The definition of black birds is given by a raven state class Ω_B as shown in Definition 12.20 (ii).
- (N₃) Small black birds are characterize by the membership function $m_{SB} : \Omega \rightarrow [0, 1]$. The definition of small black birds is given by a raven state class Ω_{SB} as shown in Definition 12.23 (iii).
- (N₄) It holds that Ω_{SB} ⊆ Ω_B, i.e., Every small black bird is black. This is a priori statement, which is directly derived from Definition 12.23 (iv).
- (N₅) It holds that Ω_R ⊆ Ω_B, i.e., Every raven bird is black, This is a posteriori statement, which is guaranteed in the sense of Popper's falsificationism (or, statistical hypothesis testing)

Thus we see the progress of ornithology (i.e., Formulation [I] $\xrightarrow{\text{progress}}$ Formulation [II] $\xrightarrow{\text{progress}}$ Formulation [III]).

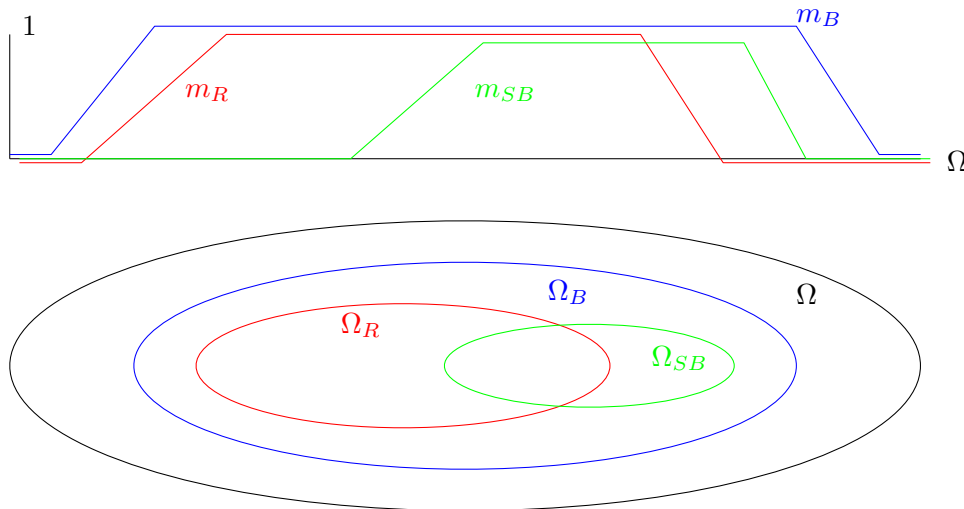

Figure 11.6: [All ravens are black: (Ω_R ⊆ Ω_B)]

12.7 Three approaches to the mind-body problem

The mind-body problem is the most famous problem in Descartes philosophy. There are two standing positions on whether we see this as a problem of science or a problem of philosophy.

(A) [Science]: If we are in the position of existential monism (i.e., the scientific position), i.e., if we expect a scientific solution, then the mind-body problem is a problem of brain science, AI, and cognitive science.

(B) [Philosophy]: if we consider the mind-body problem as a philosophical problem (i.e., dualistic idealism), it is a question of proposing a worldview with "mind" and "body" as the key words.

Of course, our interest is focused on (B). This section was written with reference to the following.

(C) [67] Ishikawa, S., A Final solution to mind-body problem by quantum language, *Journal of quantum information science*, Vol. 7, No.2, 48-56, 2017, DOI: 10.4236/jqis.2017.72005 (<http://www.scirp.org/Journal/PaperInformation.aspx?PaperID=76391>)

If quantum language is the only scientifically successful theory in dualistic idealism, it is natural to study the mind-body problem in quantum language. This will be discussed in Section 9.4.4 (The third approach).

12.7.1 The mind-body problem

Now let us introduce the mind-body problem, which is said to be the greatest unsolved problem in dualistic idealism.

In spite that the cogito proposition "I think, therefore I am" is non-sense (*cf.* Sec. 8.2), Descartes used it in order to propose Descartes philosophy (i.e., mind-matter dualism). That is, his argument is as follows.

(D) If the existence of "I" is deduced from the cogito proposition, the existence of "matter" (which is perceived by "I") is accepted. And further, the medium of "I" and "matter" is automatically accepted as "body (= sensory organ)".

Therefore, the key-words of Descartes philosophy (= mind-matter dualism) is

(E) "I" (= "mind"), "body" (= "sensory organ"), "matter"

Here, we have the following problem:

(F): The mind-body problem in dualistic idealism

How are "mind" and "body" connected?

(or more generally, how are "mind", "body" and "matter" connected?)

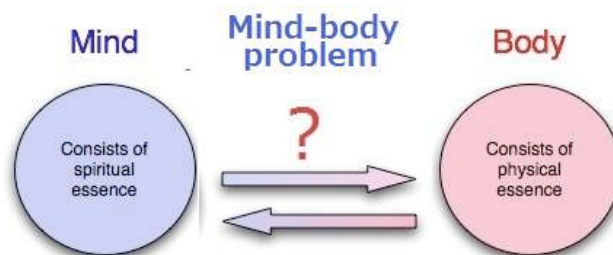

This is generally considered to be the most important problem in Descartes philosophy.

12.7.2 The first approach; Cognitive scientific approach

As mentioned in Note 9.11, Dr. Click (the most noted for being a co-discoverer of the structure of the DNA molecule in 1953 with James Watson) said in his book "The astonishing hypothesis" [12]) as follows.

(G₁) *You, your joys and your sorrows, your memories and your ambitions, your sense of personal identity and free will, are in fact no more than the behavior of a vast assembly of nerve cells and their associated molecules.*

From the scientific point of view, I agree to his opinion (G₁). (i.e., the denial of the substance dualism). Therefore, I believe that the following will be realized.

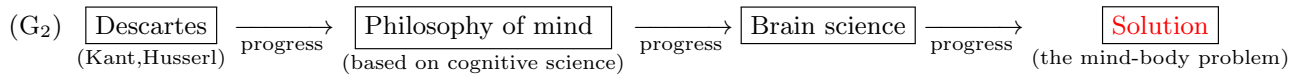

This may imply that

(G₃) the mind-body problem will be solved in science

However, it should be noted that the (H₁) (i.e., the denial of the substance dualism) and the dualistic idealism (i.e., quantum language) do not contradict each other. That is because quantum language says:

(H) *Describe any monistic phenomenon (such as (G₁)) by dualistic language (=quantum language) !*

12.7.3 The second approach; Illusory problem?

It should be noted that

(I₁) the term "mind" and "body" in the mind-body problem (F) is ambiguous in Descartes=Kant epistemology.

That is, the sentence "How are 'mind' and 'body' connected?" is meaningless in Descartes=Kant epistemology. Thus, there may be a reason to consider that the mind-body problem is just "what we cannot speak about". Therefore, according to Wittgenstein's famous saying "What we cannot speak about we must pass over in silence" (in [117]), some may conclude that we must speak nothing about the problem (F). That is, the mind-body problem is an illusory problem. However, I think, by (J) and (K) mentioned in the following section, that this second approach is not only non-productive but also wrong. As mentioned before, I think that the Wittgenstein's next assertion is non-productive:

(I₂) philosophical problems arise from insufficient attention to the variety of natural language use.

12.7.4 * The third approach; Quantum linguistic solution to the mind-body problem

It should be noted that

(J) the demarcation problem (i.e., how to distinguish between "what we cannot speak about" and "what we can speak about") depends on language.

For example, the proposition "the earth goes around the sun" cannot be written in mathematics but in the Newtonian mechanical language. Note that both "the limits of my language mean the limits of my world" and "the limits of your language mean the limits of your world" are true. Therefore,

(K) in order to solve the mind-body problem in dualistic idealism, we should create the language in which the mind-body problem can be regarded as "what we can speak about"

Without this challenge (K), we cannot obtain the solution to the mind-body problem (F). In this sense, the second approach in Section 9.4.3 may be shallow.

Concerning the causality problem (i.e., What is causality?), we already answered it in Problem 1,1 (and Note 1.2), that is,

$$\text{"The solution to the causality problem"} \Leftrightarrow \text{Axiom 2} \tag{12.2}$$

Similarly, I can give the solution to the mind-body problem (i.e., How are "mind" and "body" connected?) as follows.

Answer 12.25. [The solution to the mind-body problem]; The correspondence of the key-words (Assertion 1.14) says that

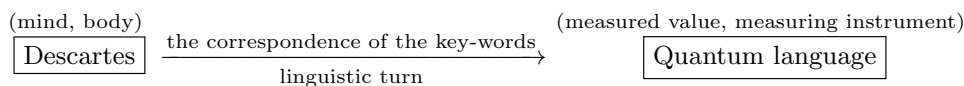

This says:

the epistemological mind-body problem

$\xrightarrow{\text{linguistic turn}}$ $\boxed{\text{Descartes}}$
How are "mind" and "body" connected?

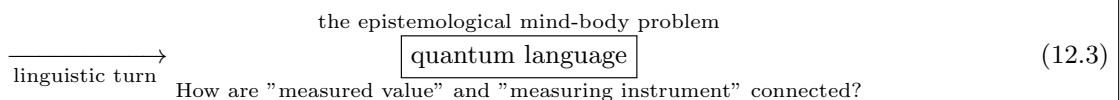

Also, recall Figure 1.2 as follows:

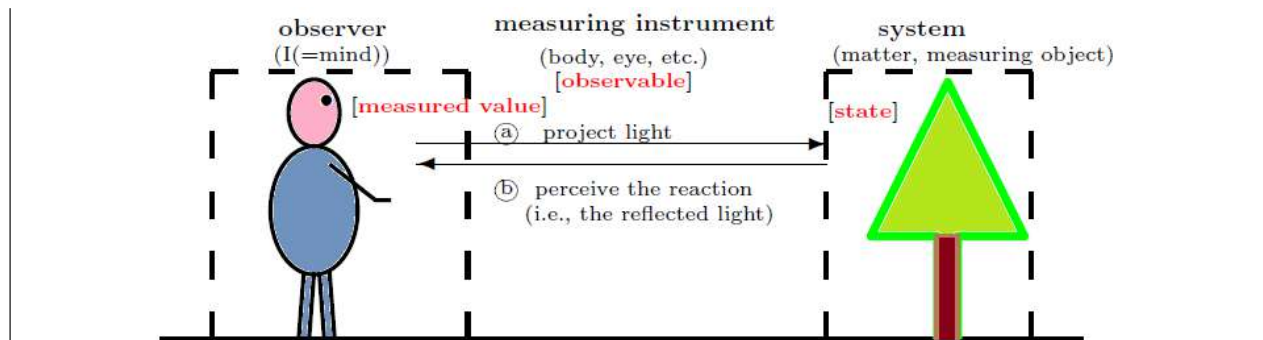

Figure 1.2. **Descartes Figure**: Image of "measurement(=Ⓐ+Ⓑ)" in dualism

If so, we can easily solve the mind-body problem (in the right-hand side of formula (12.3) that is,

The solution to the mind-body problem

The solution to the mind-body problem is just Axiom 1 (in Sec.1.1.1), that is, the relation between "measured value" and "measuring instrument" is given as follows.

- With any system S , a basic structure $[\mathcal{A} \subseteq \mathcal{N} \subseteq B(H)]$ can be associated in which measurement theory of that system can be formulated. When the observer takes a measurement of an **observable** (or, by a **measuring instrument**) $O=(X, \mathcal{F}, F)$ for a system $S_{[\rho]}$ i.e., a system S with a state ρ , the probability that a **measured value** $x (\in X)$ obtained by the measurement belongs to $\Xi (\in \mathcal{F})$ is given by $\rho(F(\Xi))(\equiv_{\mathcal{A}^*}(\rho, F(\Xi))_{\mathcal{N}})$.

Therefore,

(L) "The solution to the mind-body problem" \Leftrightarrow "Axiom 2"

Hence, by this (L) and the formula (12.2), we have the following equivalences:

- to propose quantum language
- \Leftrightarrow to propose Axiom 1 (measurement) and Axiom 2 (causality)
- \Leftrightarrow to solve the mind-body problem and the causality problem

and further, we want to add:

$$\Leftrightarrow \text{to build a firm theory in dualistic idealism (i.e., metaphysics)} \tag{12.4}$$

If so, then my next desire has been fulfilled.

- **"mind-body problem" should be the greatest problem in philosophy.**

Chapter 13

Postscript: Can QL be post-analytic philosophy?

13.1 Philosophy (of worldviews) has progressed towards quantum language

In this text, I discussed the history of western philosophy, i.e.,

the time series [① - ② - ③ - ④ - ⑤ - ⑥ - ⑦ - ⑧ - ⑨ - ⑩ - ⑪ - ⑫ - ⑬ - ⑭]

in the following figure

Assertion 0.1 (in Preface):

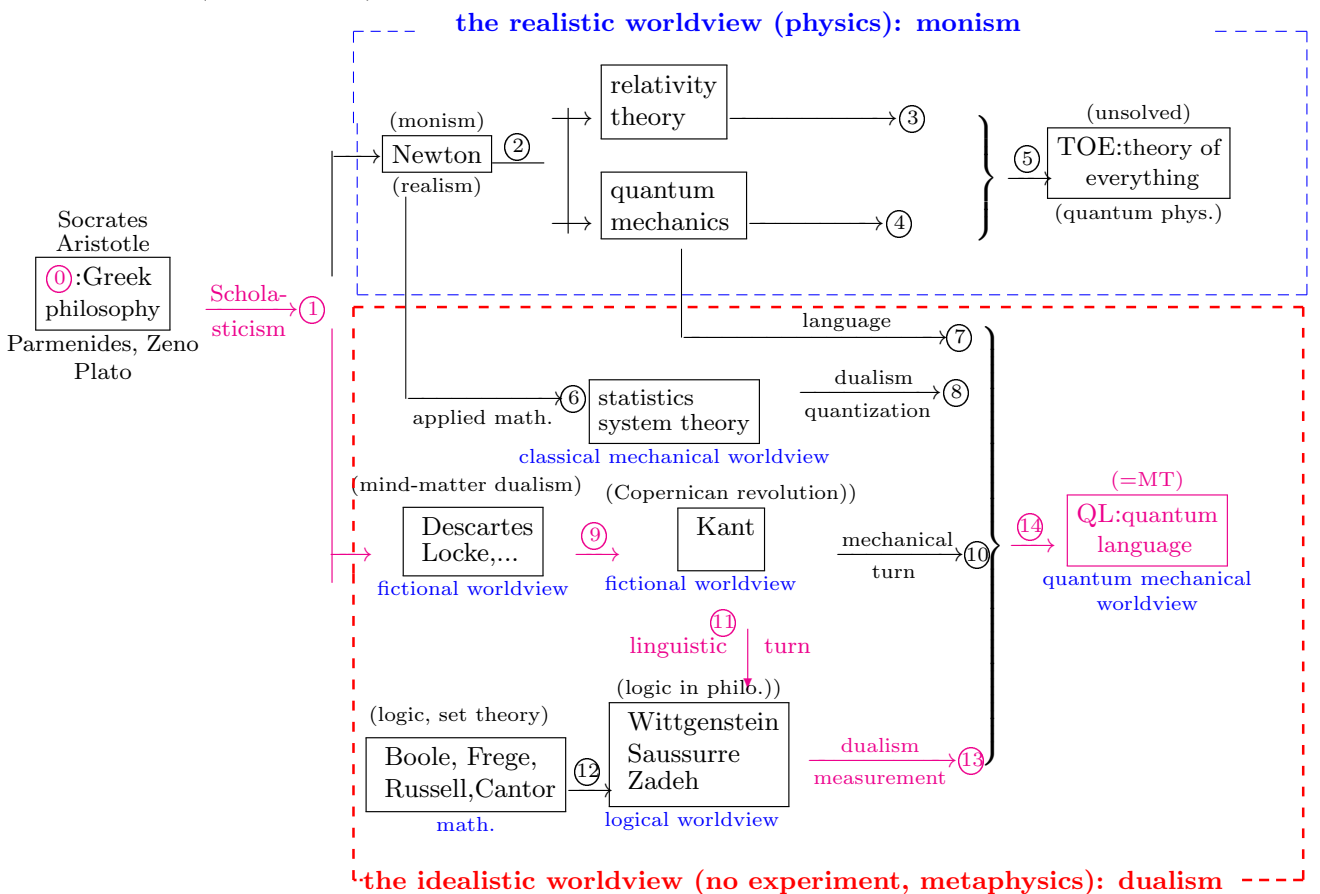
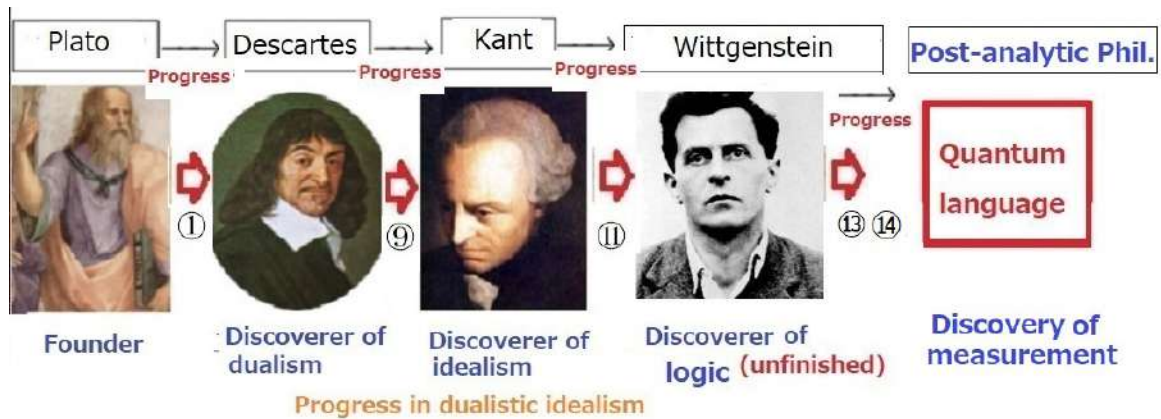

Figure 0: The history of the world-descriptions
 Philosophy (≈ dualistic idealism) has progressed toward QL
 (i.e., ① → ② → ③ → ④ → ⑤ → ⑥ → ⑦ → ⑧ → ⑨ → ⑩ → ⑪ → ⑫ → ⑬ → ⑭)

And I conclude that

(A) If "to make progress" is defined by "to come near quantum language" (i.e., "becoming more and more like quantum language" we can say that the time series (of philosophies of dualistic idealism) [① - ① - ⑨ - ⑪- ⑬- ⑭] can be regarded as progress, that is,



Therefore,

(A') the time line: [① - ⑨ - ⑪- ⑬] is not only a refreshing change, but also a progress.

Thus, quantum language, roughly speaking, has the four aspects as follows.

The four aspects of quantum language

- = {
- ⑦: the linguistic turn of quantum mechanics (i.e., the true color of the Copenhagen interpretation)
 - ⑧: the dualistic (i.e., measurement theoretical) reconstruction of statistics
 - ⑩: the final goal of dualistic idealism (i.e., the linguistic and mechanical turn of the Descartes=Kant epistemology)
 - ⑬: the measurement theoretical understanding of analytic philosophy (i.e., fuzzy logic in QL)

Thus, I assert that **QL is the unified theory of dualistic idealism**

I believe, from the scientific point of view, that

(B₁) **quantum language is the final destination of the genealogy of Western philosophy.**

And

(B₂) **a scientific perfection of dualism and idealism is realized by quantum language**

In order to assert the (B) (= (B₁), (B₂)), we proved the following proposition throughout this paper:

13.2 If the above (A) and (B) are true, almost all unsolved problems concerning dualistic idealism have to be solved in QL

13.2.1 The list of my answers of unsolved problems

If (A) and (B) (= (B₁) + (B₂)) are true, it is natural to consider:

(C) **many unsolved problems raised in the 2500 year history of dualistic idealism can be solved within the framework of quantum languages.**

My results concerning quantum language are summarized in the following two texts

- (D) { (D₁): This text: History of western philosophy from the quantum theoretical point of view; [Ver. 3]
 (D₂): Ref. [71]: The linguistic Copenhagen interpretation of quantum mechanics: Quantum language [Ver 5]

The (C) is shown throughout this paper as follows.

List 13.1.

(D₁) **Almost famous unsolved problems concerning dualistic idealism can be solved in QL**

- What is probability (or, measurement, causality) ? *cf.* Sec. 1.1.1)
- The solution of Zeno paradox (Flying arrow, Achilles and a tortoise), (*cf.*ref. [45], or Sec. 2.4)

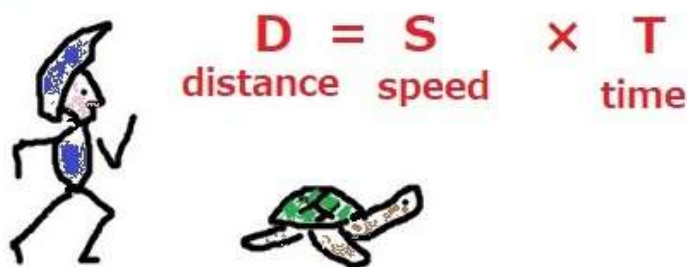

("to solve Zeno paradox" = "to understand DST-formula" (*cf.* Sec. 2.4.3)

- the measurement theoretical understanding of Plato's allegory of the sum , (*cf.* Sec. 3.3.2)
- Plato's Idea theory≈Zadeh's fuzzy theory≈Sausuure's linguistic theory (*cf.* Sec. 3.5.3)
- Syllogism does not always holds in quantum systems (*cf.* Sec. 4.3.3)
- Syllogism always holds in classical and quantum systems (*cf.* Remark 12.9 in Sec. 12.1)
- Only the present exists (*cf.* Sec. 6.1.2)
- What is the problem of universals? (*cf.* Sec. 6.5.1)
- What is Geocentrism vs. Heliocentrism? After all, the worldviewism (*cf.* Sec. 7.4)
- Two (scientific or non-scientific) interpretations of I think, therefore I am .(*cf.* Sec. 8.2.2)
- Leibniz-Clark correspondence (i.e., what is space-time?), (*cf.* Sec. 9.3)
- The problem of qualia (*cf.* Sec. 9.5.1)
- Brain in a vat argument (*cf.* Sec. 9.5.2)
- The solution of Hume's problem of induction (*cf.* Sec. 9.7.1)
- grue paradox cannot be represented in quantum language (*cf.* Sec. 9.8)
- What is causality? (*cf.* Sec. 10.2)
- What is Peirce's abduction? (*cf.* Sec. 11.4.1)
- Five-minute hypothesis (*cf.* Sec. 11.5.2)
- McTaggart's paradox (*cf.* Sec. 11.5.3)
- quantitative representation of "Signifier" and "signified" (*cf.* Sec. 12.1)
- My scientific understanding of "Tractatus Logico-Philosophicus (=TLP)" and "Zadeh's fuzzy sets" (*cf.* ref. [78], or Sec. 12.1)

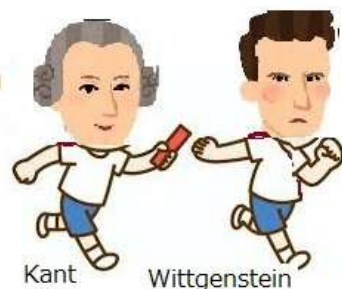

That is, Wittgenstein took over the baton of "dualistic idealism (i.e., the mainstream of philosophy)" from Kant. This is essentially important, since Wittgenstein's picture theory must belong to

dualistic idealism in order to assert (A) (= Assertion 1.5)

- Lewis Carroll's paradox (*cf.* Sec. 12.4)
- Flagpole problem, (*cf.* Sec. 12.5)
- Hempel's raven paradox (*cf.* Sec. 12.6)
- the mind-body problem (i.e., How are mind and body connected?), (*cf.* Sec. 12.7)

Also, for the solutions of unsolved problems in quantum mechanics, statistical mechanics, statistics and probability theory, see ref. [71]), that is,

- (#) ref. [71]: S. Ishikawa, "Linguistic Copenhagen interpretation of quantum mechanics: Quantum Language [Ver. 5]", Dept. Math. Keio University, 2019, KSTS/RR-19/003, 473 pages (http://www.math.keio.ac.jp/academic/research_pdf/report/2019/19003.pdf)

(D₂) **The list of my answers for scientific unsolved problems in (D₂)**

ref. [71]; Linguistic Copenhagen interpretation of quantum mechanics; Quantum Language [Ver 5], Research Report, Dept. Math. Keio University, KSTS/RR-19/003 (2019); 473 p (http://www.math.keio.ac.jp/academic/research_pdf/report/2019/19003.pdf)

- Kolmogorov's extension theorem in quantum language (Sec.4.1 in ref. [71]) (Sec.4.1 in ref. [71])
- The law of large numbers in quantum language (Sec.4.2 in ref. [71])
- the discovery of Heisenberg's uncertainty relation (*cf.* ref. [36], or, Sec. 4.3 in ref. [71])

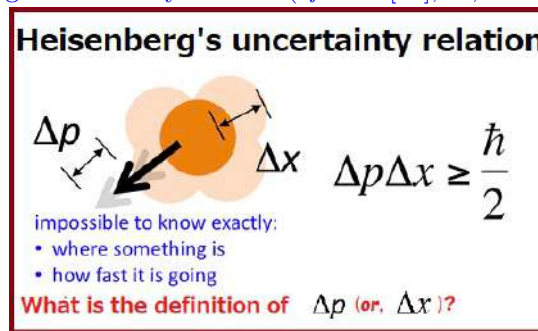

Has Heisenberg's uncertainty relation ever been used effectively in physics? (Sec. 4.3 in ref. [71])

- Bell's inequality holds in both classical and quantum systems (Sec. 4.5.2 in ref. [71])
- Measurement theoretical formulation of measurement, inference, control (Sec. 5.2 in ref. [71])
- Monty-Hall problem in quantum language (non-bayesian approach) (Sec.5.5 in ref. [71])
- Two envelope problem in quantum language (non-bayesian approach) (Sec.5.6 in ref. [71])
- Confidence interval and statistical hypothesis test (Chapter 6 in ref. [71])
- Analysis of variance (Chapter 7 in ref. [71])
- Syllogism holds in classical systems, but not in quantum systems (Sec.8.6 and Sec.8.7 in ref. [71])
- Mixed measurement theory (Bayesian measurement theory) (Chap. 9 in ref. [71])
- The measurement theoretical characterization of the wave-function collapse (= projection postulate) (*cf.* ref. [63], or Sec.11.2 in ref. [71])

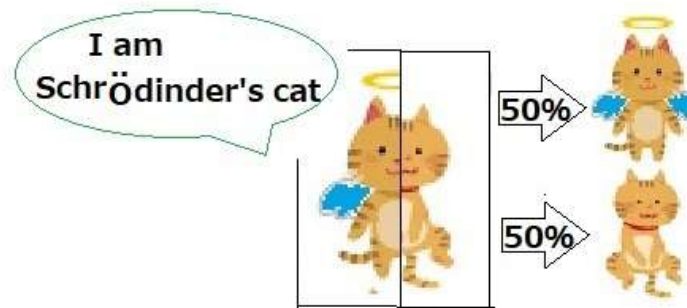

(von Neumann-Lüders Projection Postulate can be justified in QL: ref. [63])

- The measurement theoretical characterizations of de Broglie's paradox, quantum Zeno effect, **Schrödinger's cat**, Wigner's friend, Wheeler's delayed choice experiment, Hardy Paradox, quantum eraser (Sec.11.3~Sec.11.8 in ref. [71])
- The measurement theoretical characterizations of double-slit experiment, Wilson cloud chamber (Sec.12.2, Sec.12.3 in ref. [71])
- The measurement theoretical characterizations of regression analysis (Sec.13.2 in ref. [71])
- The measurement theoretical characterizations of Brownian motion, Zeno's paradox (Sec.14.2 ,

Sec.14.4 in ref. [71], also, see [45])

- The measurement theoretical characterizations of least-squares method (Chap.15 in ref. [71])
- The measurement theoretical characterizations of Kalman filter (Chap.16 in ref. [71])
- The measurement theoretical characterizations of equilibrium statistical mechanics (Chap.17 in ref. [71])
- The measurement theoretical characterizations of psychological tests (Chap.18 in ref. [71])
- The measurement theoretical characterizations of belief (Chap.19 in ref. [71])
- The mathematical foundation of science (Hempel's raven paradox) (Chap.20 in ref. [71])

If you look at the tables above, you will notice the following.

(E) The philosophies up to analytic philosophy (⑩-①-⑨-⑪-⑬) merely posed important unsolved problems. It is QL that has solved these problems.

In this sense, we can again assert the (B) (=B₁+ (B₂)):

(B₁) **quantum language is the final destination of the genealogy of Western philosophy.**

And

(B₂) **a scientific perfection of dualism and idealism is realized by quantum language**

To put it another way,

(F₁) QL has, for the first time, proven that these philosophies ("Plato" → "Descartes " → "Kant" → "Wittgenstein") are not just word games.

In other words. we can conclude that

(F₂) These philosophies were pursuing problems that had scientific answers.

That is,

(F₃) the strangeness of philosophy (i.e., dualistic idealism) is due to the strangeness of the Copenhagen interpretation of quantum mechanics



The above figure explains the following:

(F₄) Why could QL solve almost all the unsolved problems of dualistic idealism (Descartes, Kant, analytic philosophy)?

13.3 Can QL be post-analytic philosophy?

I think most philosophy enthusiasts have thought about the following.

(G₁) Does the future of analytic philosophy look rosy?

In regards to this, Dr. Hawking said in his best seller book [27]:

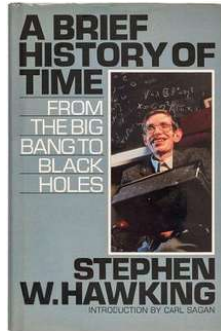

- However, in the nineteenth and twentieth centuries, science became too technical and mathematical for the philosophers, or anyone else except a few specialists. Philosophers reduced the scope of their inquiries so much that Wittgenstein the most famous philosopher this century, said "The sole remaining task for philosophy is the analysis of language." What a comedown from the great tradition of philosophy from Aristotle to Kant!

I'm sure there are many thoughts on this opinion of Hawking. I think the following;

(G₂) analytic philosophy has expired!

It has been 100 years since the emergence of analytic philosophy. Compared to modern mathematics, physics and statistics, which emerged around the same time as analytic philosophy, I think it is difficult to say that analytic philosophy has developed smoothly. If the (G₂) is true and history (Plato→Descartes→Kant→Wittgenstein) repeats, everyone may think that

(G₃) the current situation of philosophy is a once-in-a-century (or, once-in-two-centuries) opportunity.

I thought so too. And I believe that QL is a strong candidate for post-analytic philosophy because, as I have shown in List 13.1, it has solved most of the open problems of dualistic idealism. However, I am not even sure that the term "post-analytic philosophy" will take hold.

In fact, I also think

(G₄) the future of theoretical physics and mathematics is also not optimistic.

In theoretical physics, there has been too great a gap between theory and experiment. One of the reasons why Hawking did not win the Nobel Prize in Physics is that "his theory could not be experimentally verified". Also, it took more than 50 years to verify the existence of the Higgs boson. This means that Einstein-class physicists can only be recognized after death.

Mathematics is in a more serious situation. This is because mathematicians must solve the Riemann conjecture before a quantum computer can be launched in earnest. And there will be a situation where mathematicians will not be able to understand the proof of the Riemann prediction solved by computers.

It's hard to predict the future, but I think that

(H) In the not too distant future, there will come an era in which humans cannot beat quantum computers when it comes to logic.

Therefore, what I am thinking now is the following.

(I) It is lucky to discover QL (and solve many problems in List 13.1) before the quantum computer will be in full swing.

The Copenhagen interpretation is so powerful that it explains the principle of quantum computers. If I am allowed to bluff, I may say that

(J) QL is greater than QC (= quantum computer).

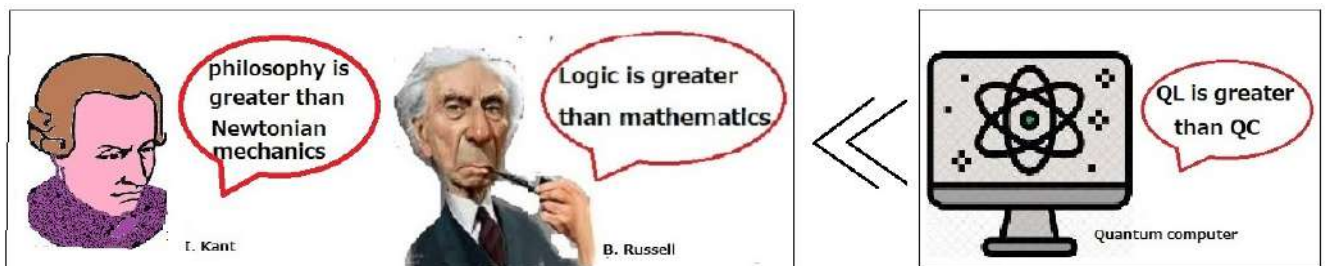

Since I am an amateur in the history of Western philosophy, I can make many mistakes in this book. However, I would like to confidently argue that QL is the scientific final form of dualistic idealism. I hope that readers read ref. [71] quickly, and examine the power of QL.

August 2021
Shiro ISHIKAWA^{*1}

ishikawa@math.keio.ac.jp

^{*1} For the further information concerning quantum language,
see home page: <http://www.math.keio.ac.jp/~ishikawa/indexe.html>

References

- [1] Alexander, H. G., ed. *The Leibniz-Clarke Correspondence*, Manchester University Press, 1956.
- [2] Arthurs, E. and Kelly, J.L., Jr. *On the simultaneous measurement of a pair of conjugate observables*, Bell System Tech. J. **44**, 725-729 (1965)
- [3] Aspect, A, Dallibard, J. and Roger, G. *Experimental test of Bell inequalities time-varying analysis*, Physical Review Letters **49**, 1804–1807 (1982)
- [4] Bell, J.S. *On the Einstein-Podolsky-Rosen Paradox*, Physics **1**, 195–200 (1966)
- [5] Bohr, N. *Can quantum-mechanical description of physical reality be considered complete?*, Phys. Rev. (48) 696-702 1935
- [6] Born, M. *Zur Quantenmechanik der Stoßprozesse (Vorläufige Mitteilung)*, Z. Phys. (37) 863–867 1926
- [7] Busch, P. *Indeterminacy relations and simultaneous measurements in quantum theory*, International J. Theor. Phys. **24**, 63-92 (1985)
- [8] G. Caella, R.L. Berger, *Statistical Inference*, Wadsworth and Brooks, 1999.
- [9] D.J. Chalmers, *The St. Petersburg Two-Envelope Paradox*, Analysis, Vol.62, 155-157, 2002.
- [10] L. Carroll, "What the Tortoise said to Achilles" Mind, Vol.4, no.14, pp.278-280, 1895
- [11] Clauser, J.F., Horne M.A., Shimony, A, Holt, R.A., Proposed experiment to test local hidden variable theories, *Phys, Rev, Lett*, 23(15), 880-884 (1969)
- [12] F. Click, *The Astonishing Hypothesis: The Scientific Search For The Soul*, New York: Charles Scribner's Sons., 1994.
- [13] Conant, J. and Diamond, C. *On Reading the Tractatus Resolutely*: "On Reading the Tractatus Resolutely: to Meredith Williams and Peter Sullivan" in Max Kölbel and Bernhard Weiss, *The Lasting Significance of Wittgenstein's Philosophy*, Routledge 2004,
- [14] Davies, E.B. *Quantum theory of open systems*, Academic Press 1976
- [15] Dummett, Michael, *Origins of Analytical Philosophy*, Harvard University Press, Cambridge, Massachusetts 1994
- [16] Dunford, Nelson; Schwarz, Jacob T. *Linear Operators part I: general theory (Wiley Classics ed.)*, John Wiley and Sons (1988)
- [17] Einstein, A., Podolsky, B. and Rosen, N. *Can quantum-mechanical description of reality be considered completely?* Physical Review Ser 2(47) 777–780 (1935)
- [18] Einstein, A. *Ideas and Opinions* (Translated by Sonja Bergmann) Crown Publishers 377 pp (1954)
- [19] Everett, Hugh *Relative State Formulation of Quantum Mechanics* Reviews of Modern Physics. Ser 29(3) 454-462 (1957)
- [20] R. P. Feynman *The Feynman lectures on Physics; Quantum mechanics* Addison-Wesley Publishing Company, 1965
- [21] G.A. Ferguson, Y. Takane, *Statistical analysis in psychology and education* (Sixth edition). New York: McGraw-Hill. (1989)
- [22] R.A. Fisher *Statistical Methods for Research Workers* Oliver and Boyd (1925) 1970
- [23] Gaarder, J. *Sophie's World* New York Dover Publ (translated by Paulette Moller) 1994
- [24] Galileo Galilei *Dialogues concerning two new sciences* New York Dover Publ (translated from the Italian and Latin into English by Henry Crew, et al.) 1950
- [25] Goodman, Nelson (1983) *Fact, fiction, and forecast*, Harvard University Press
- [26] L. Hardy, *Quantum mechanics, local realistic theories, and Lorentz-invariant realistic theories*, Physical Review Letters **68** (20): 2981-2984 1992
- [27] Hawking, Stephen *A brief History of Time*, Bantam Dell Publishing Group 1988
- [28] Heisenberg, W. *Über den anschaulichen Inhalt der quantentheoretischen Kinematik und Mechanik*, Z. Phys. **43**, 172–198 (1927)
- [29] Halmos, P. R. *Naive set theory*, (1960) Princeton, NJ: D. Van Nostrand Company. Reprinted by Springer-Verlag, New York, 1974. Harper
- [30] Harari, Y.N. (2014) *Sapiens: A Brief History of Humankind*, Harper
- [31] Hempel, C.G. (1945) *Studies in the Logic of Confirmation(I)*, Mind, **54** 1-26
- [32] Hempel, C.G. (1965) *Aspects of Scientific Explanations and other Essays in the Philosophy of Science*, Free Press
- [33] Holevo, A.S. *Probabilistic and statistical aspects of quantum theory*, North-Holland publishing company (1982)
- [34] D.Howard, Who invented the "Copenhagen Interpretation"? A study in mythology, Philosophy of Science, **71** 2004, 669-682
- [35] Isaac, R. *The pleasures of probability*, Springer-Verlag (Undergraduate texts in mathematics) 1995
- [36] S. Ishikawa, *Uncertainty relation in simultaneous measurements for arbitrary observables*, Rep. Math. Phys., **9**, 257-273, 1991
doi: 10.1016/0034-4877(91)90046-P

- [37] Ishikawa, S. *Uncertainties and an interpretation of nonrelativistic quantum theory*, International Journal of Theoretical Physics 30 401–417 (1991) doi: 10.1007/BF00670793
- [38] Ishikawa, S., Arai, T. and Kawai, T. *Numerical Analysis of Trajectories of a Quantum Particle in Two-slit Experiment*, International Journal of Theoretical Physics, Vol. 33, No. 6, 1265-1274, 1994 doi: 10.1007/BF00670793
- [39] Ishikawa, S. *Fuzzy inferences by algebraic method*, Fuzzy Sets and Systems 87, 181–200 (1997) doi:10.1016/S0165-0114(96)00035-8
- [40] Ishikawa, S. *A Quantum Mechanical Approach to Fuzzy Theory*, Fuzzy Sets and Systems, Vol. 90, No. 3, 277-306, 1997, doi: 10.1016/S0165-0114(96)00114-5
- [41] Ishikawa, S. *Fuzzy logic in measurements*, Fuzzy Sets and Systems, Vol. 100, 291-300, 1998, doi:10.1016/S0165-0114(97)00154-1
- [42] Ishikawa, S. *Statistics in measurements*, Fuzzy sets and systems, Vol. 116, No. 2, 141-154, 2000 doi:10.1016/S0165-0114(98)00280-2
- [43] S. Ishikawa, T. Arai, T. Takamura, *A dynamical system theoretical approach to Newtonian mechanics*, Far east journal of dynamical systems 1, 1-34 (1999) (<http://www.pphmj.com/abstract/191.htm>)
- [44] S. Ishikawa, *Mathematical Foundations of Measurement Theory*, Keio University Press Inc. 335pages, 2006, (<http://www.keio-up.co.jp/kup/mfont/>) (This was often revised e.g., refs. [69, 70, 71])
- [45] S. Ishikawa, *Dynamical systems, measurements, quantitative languages and Zeno's paradox*, Far East Journal of Dynamical Systems, Volume 10, Issue 3, Pages 277 - 292 (October 2008) (<http://www.pphmj.com/abstract/3595.htm>)
- [46] S. Ishikawa, *A New Interpretation of Quantum Mechanics*, Journal of quantum information science, Vol. 1, No. 2, 35-42, 2011, doi: 10.4236/jqis.2011.12005 (<http://www.scirp.org/journal/PaperInformation.aspx?paperID=7610>)
- [47] S. Ishikawa, *Quantum Mechanics and the Philosophy of Language: Reconsideration of traditional philosophies*, Journal of quantum information science, Vol. 2, No. 1, 2-9, 2012 doi: 10.4236/jqis.2012.21002 (<http://www.scirp.org/journal/PaperInformation.aspx?paperID=18194>)
- [48] S. Ishikawa, *A Measurement Theoretical Foundation of Statistics*, Applied Mathematics, Vol. 3, No. 3, 283-292, 2012, doi: 10.4236/am.2012.33044 (<http://www.scirp.org/journal/PaperInformation.aspx?paperID=18109&>)
- [49] S. Ishikawa, *Monty Hall Problem and the Principle of Equal Probability in Measurement Theory*, Applied Mathematics, Vol. 3 No. 7, 2012, pp. 788-794, doi: 10.4236/am.2012.37117. (<http://www.scirp.org/journal/PaperInformation.aspx?PaperID=19884>)
- [50] S. Ishikawa, *Ergodic Hypothesis and Equilibrium Statistical Mechanics in the Quantum Mechanical World View*, World Journal of Mechanics, Vol. 2, No. 2, 2012, pp. 125-130. doi: 10.4236/wim.2012.22014. (<http://www.scirp.org/journal/PaperInformation.aspx?PaperID=18861#.VKevmiusWap>)
- [51] S. Ishikawa, *The linguistic Copenhagen interpretation of quantum mechanics*, arXiv:1204.3892v1[physics.hist-ph],(2012) (<http://arxiv.org/abs/1204.3892>)
- [52] S. Ishikawa, *Zeno's paradoxes in the Mechanical World View*, arXiv:1205.1290v1 [physics.hist-ph], (2012)
- [53] S. Ishikawa, *What is Statistics?; The Answer by Quantum Language*, arXiv:1207.0407 [physics.data-an] 2012. (<http://arxiv.org/abs/1207.0407>)
- [54] S. Ishikawa, *Measurement Theory in the Philosophy of Science*, arXiv:1209.3483 [physics.hist-ph] 2012. (<http://arxiv.org/abs/1209.3483>)
- [55] S. Ishikawa, *Heisenberg uncertainty principle and quantum Zeno effects in the linguistic interpretation of quantum mechanics*, arxiv:1308.5469[quant-ph],(2013)
- [56] S. Ishikawa, *A quantum linguistic characterization of the reverse relation between confidence interval and hypothesis testing*, arxiv:1401.2709[math.ST],(2014)
- [57] S. Ishikawa, *ANOVA (analysis of variance) in the quantum linguistic formulation of statistics*, arxiv:1402.0606[math.ST],(2014)
- [58] S. Ishikawa, *Regression analysis in quantum language*, arxiv:1403.0060[math.ST],(2014)
- [59] S. Ishikawa, K. Kikuchi: *Kalman filter in quantum language*, arXiv:1404.2664 [math.ST] 2014. (<http://arxiv.org/abs/1404.2664>)
- [60] S. Ishikawa, *The double-slit quantum eraser experiments and Hardy's paradox in the quantum linguistic interpretation*, arxiv:1407.5143[quantum-ph],(2014)
- [61] S. Ishikawa, *The Final Solutions of Monty Hall Problem and Three Prisoners Problem*, arXiv:1408.0963 [stat.OT] 20 14. (<http://arxiv.org/abs/1408.0963>)
- [62] S. Ishikawa, *Two envelopes paradox in Bayesian and non-Bayesian statistics* arXiv:1408.4916v4 [stat.OT] 2014. (<http://arxiv.org/abs/1408.4916>)
- [63] S. Ishikawa, *Linguistic interpretation of quantum mechanics; Projection Postulate*, Journal of quantum information science, Vol. 5, No.4, 150-155, 2015, DOI: 10.4236/jqis.2015.54017 (<http://www.scirp.org/Journal/PaperInformation.aspx?PaperID=62464>)
Or see the following preprint;
(http://www.math.keio.ac.jp/academic/research_pdf/report/2015/15009.pdf)
- [64] S. Ishikawa, *History of Western Philosophy from the quantum theoretical point of view*, Research Report (Department of mathematics, Keio university, Yokohama), (KSTS-RR-16/005, 2016, 142 pages)

- (http://www.math.keio.ac.jp/academic/research_pdf/report/2016/16005.pdf)
- [65] S. Ishikawa, *History of Western Philosophy from the quantum theoretical point of view [Ver. 2]*, Research Report (Department of mathematics, Keio university, Yokohama), (KSTS-RR-17/004, 2017, 132 pages) (http://www.math.keio.ac.jp/academic/research_pdf/report/2017/17004.pdf)
- [66] S. Ishikawa, *History of Western Philosophy from the quantum theoretical point of view [Ver. 3]*, Research Report (Department of mathematics, Keio university, Yokohama), (KSTS-RR-20/001, 2020, 296 pages) (http://www.math.keio.ac.jp/academic/research_pdf/report/2017/17004.pdf)
- [67] Ishikawa,S., A Final solution to mind-body problem by quantum language, *Journal of quantum information science*, Vol. 7, No.2 , 48-56, 2017, DOI: 10.4236/jqis.2017.72005 (<http://www.scirp.org/Journal/PaperInformation.aspx?PaperID=76391>)
- [68] Ishikawa,S., Bell's inequality should be reconsidered in quantum language , *Journal of quantum information science*, Vol. 7, No.4 , 140-154, 2017, DOI: 10.4236/jqis.2017.74011 (<http://www.scirp.org/Journal/PaperInformation.aspx?PaperID=80813>)
- [69] S. Ishikawa, Linguistic interpretation of quantum mechanics; Quantum Language, Research Report, Dept. Math. Keio University, (<http://www.math.keio.ac.jp/en/academic/research.html>) [Ver 1]; KSTS/RR-15/001 (2015); 416 p (http://www.math.keio.ac.jp/academic/research_pdf/report/2015/15001.pdf)
- [Ver 2]; KSTS/RR-16/001 (2016); 426 p (http://www.math.keio.ac.jp/academic/research_pdf/report/2016/16001.pdf)
- [70] S. Ishikawa, Linguistic Copenhagen interpretation of quantum mechanics; Quantum Language, Research Report, Dept. Math. Keio University, (<http://www.math.keio.ac.jp/en/academic/research.html>) [Ver 3]; KSTS/RR-17/007 (2017); 434 p (http://www.math.keio.ac.jp/academic/research_pdf/report/2017/17007.pdf) [Ver 4]; KSTS/RR-18/002 (2018); 449 p (http://www.math.keio.ac.jp/academic/research_pdf/report/2018/18002.pdf)
- [71] S. Ishikawa, Linguistic Copenhagen interpretation of quantum mechanics; Quantum Language, Research Report, Dept. Math. Keio University, (<http://www.math.keio.ac.jp/en/academic/research.html>) [Ver 5]; KSTS/RR-19/003 (2019); 473 p (http://www.math.keio.ac.jp/academic/research_pdf/report/2019/19003.pdf)
- [72] S. Ishikawa, Linguistic Interpretation of Quantum Mechanics –Towards World-Description in Quantum Language– Shiho-Shuppan Publisher, 411 p. (2017) (<http://www.shiho-shuppan.com/index.php?LIQM>)
- [73] Ishikawa,S., Leibniz-Clarke correspondence, Brain in a vat, Five-minute hypothesis, McTaggart's paradox, etc. are clarified in quantum language , *Open Journal of philosophy*, Vol. 8, No.5 , 466-480, 2018, DOI: 10.4236/ojpp.2018.85032 (<https://www.scirp.org/Journal/PaperInformation.aspx?PaperID=87862>)
- [74] Ishikawa,S., Leibniz-Clarke correspondence, Brain in a vat, Five-minute hypothesis, McTaggart's paradox, etc. are clarified in quantum language [Revised version] , (<https://philpapers.org/rec/ISHLCB>) (http://www.math.keio.ac.jp/academic/research_pdf/report/2018/18001.pdf)
- [75] Ishikawa, S., (2019) Philosophy of science for scientists; The probabilistic interpretation of science, *Journal of quantum information science*, Vol. 9, No.3 , 140-154, DOI: 10.4236/jqis.2019.93007 (<https://www.scirp.org/Journal/paperinformation.aspx?paperid=95447>)
- [76] Ishikawa, S., (2020) Wittgenstein's picture theory in the quantum mechanical worldview, *Journal of quantum information science*, Vol. 10, No.4 , 104-125, DOI:10.4236/jqis.2020.104007 (<https://www.scirp.org/journal/paperabs.aspx?paperid=106233>)
- [77] Ishikawa, S., (2021) Wittgenstein's picture theory in the linguistic Copenhagen interpretation of dualism, *PhilPaper*, (<https://philpapers.org/rec/SHIWPT>)
- [78] Ishikawa, S., (2021) Fuzzy Logic in the Quantum Mechanical Worldview ; Related to Zadeh, Wittgenstein, Moore, Saussure, Quine, Lewis Carroll, etc. *Journal of applied mathematics and physics*, Vol. 9, No.7 , 1583-1610, DOI:10.4236/jamp.2021.97108 (<https://www.scirp.org/journal/paperinformation.aspx?paperid=110830>)
- [79] K. Kikuchi, S. Ishikawa, *Psychological tests in Measurement Theory*, *Far east journal of theoretical statistics*, 32(1) 81-99, (2010) ISSN: 0972-0863
- [80] K. Kikuchi,, *Axiomatic approach to Fisher's maximum likelihood method*, *Non-linear studies*, 18(2) 255-262, (2011)
- [81] Kalman, R. E. *A new approach to linear filtering and prediction problems*, *Trans. ASME, J. Basic Eng.* 82, 35 (1960)
- [82] I. Kant, *Critique of Pure Reason (Edited by P. Guyer, A. W. Wood)*, Cambridge University Press, 1999
- [83] A. Kolmogorov, *Foundations of the Theory of Probability (Translation)*, Chelsea Pub Co. Second Edition, New York, 1960,
- [84] U. Krengel, "Ergodic Theorems," Walter de Gruyter. Berlin, New York, 1985.
- [85] Kremer, Michael *The purpose of Tractarian Nonsense*, *Noûs*, Volume35, Issue 1, March 2001, Pages 39-73
- [86] Kripke, Saul A. *Wittgenstein on Rules and Private Language: An Elementary Exposition* Blackwell Publisher Ltd. 1982,
- [87] Lee, R. C. K. *Optimal Estimation, Identification, and Control*, M.I.T. Press 1964

- [88] G. Lüders, Über die Zustandsänderung durch den Messprozess, *Ann. Phys. (Leipzig)* (6)8,322-328, 1951
- [89] Magee, Bryan *Confessions of a Philosopher* Random House 1997
- [90] J. M. E. McTaggart, *The Unreality of Time*, *Mind* (A Quarterly Review of Psychology and Philosophy), Vol. 17, 457-474, 1908
- [91] G. Martin, *Aha! Gotcha: Paradoxes to Puzzle and Delight* Freeman and Company, 1982
- [92] B. Misra and E. C. G. Sudarshan, *The Zeno's paradox in quantum theory*, *Journal of Mathematical Physics* 18 (4): 756-763 (1977)
- [93] N.D. Mermin, *Boojums all the way through, Communicating Science in a Prosaic Age*, Cambridge university press, 1994.
- [94] Ozawa, M. *Quantum limits of measurements and uncertainty principle*, in *Quantum Aspects of Operational Communication* edited by Bendjaballah et all. Springer, Berlin, 3–17, (1991)
- [95] M. Ozawa, *Universally valid reformation of the Heisenberg uncertainty principle on noise and disturbance in measurement*, *Physical Review A*, Vol. 67, pp. 042105-1–042105-6, 2003,
- [96] Peirce. C.S. (1970) *Collected Papers of Charles Sanders Peirce*, edited by Charles Hartshorne and Paul Weiss, The Belknap Press of Harvard Univ. Press.
- [97] Popper, K.R. (1959) *The logic of Scientific Discover*, London Hutchinson
- [98] Popper, K.R. (1982) *Quantum mechanics and the schism in physics*, London Hutchinson
- [99] Prugovečki, E. *Quantum mechanics in Hilbert space*, Academic Press, New York. (1981)
- [100] Putnam, H. *Reason, Truth, and History*, Cambridge University Press. (1982).
- [101] Quine, W.V. (1951) *From a Logical Point of View* Harvard U. P., 1951
- [102] Redhead, M. *Incompleteness, nonlocality, and realism*, Oxford University Press, Oxford (1987)
- [103] Robertson, H.P. *The uncertainty principle*, *Phys. Rev.* 34, 163 (1929)
- [104] D. Ruelle, "Statistical Mechanics, Rigorous Results," World Scientific, Singapore, 1969.
- [105] Russell. B. *The Problems of Philosophy*, London: Williams and Norgate. (1912).
- [106] Russell. B. *The Analysis of Mind*, London: George Allen and Unwin. (1921).
- [107] Russell. B. *The principles of Mathematics*, 2nd Eddition, George Allen and Unwin Ltd, London (1937).
- [108] Russell. B. *A History of Western philosophy*, Simon and Schuster. (1945).
- [109] Russell. B. *The autobiography of Bertrand Russell*, London: George Allen and Unwin. (1956).
- [110] Sakai, S. *C*-algebras and W*-algebras*, *Ergebnisse der Mathematik und ihrer Grenzgebiete (Band 60)*, Springer-Verlag, Berlin, Heidelberg, New York 1971
- [111] Selleri, F. *Die Debatte um die Quantentheorie*, Friedr. Vieweg&Sohn Verlagsgesellschaft MBH, Braunschweig (1983)
- [112] Shannon, C.E., Weaver. W *A mathematical theory of communication*, *Bell Syst. Tech.J.* 27 379–423, 623–656, (1948)
- [113] von Neumann, J. *Mathematical foundations of quantum mechanics* Springer Verlag, Berlin (1932)
- [114] S. P.Walborn, et al. "Double-Slit Quantum Eraser," *Phys.Rev.A* 65, (3), 2002
- [115] Weinberg, Steven "To Explain the World: The Discovery of Modern Science" HarperCollins Publishers (2015), (2015)
- [116] J. A. Wheeler, *The 'Past' and the 'Delayed-Choice Double-Slit Experiment'*, pp 9-48, in A.R. Marlow, editor, *Mathematical Foundations of Quantum Theory*, Academic Press (1978)
- [117] Wittgenstein, L *Tractatus Logico-philosophicus*, Oxford: Routledge and Kegan Paul, 1921
- [118] Wittgenstein, L *Remarks on the philosophy of psychology (vol. 1)*, Edited by G.E.M. Anscombe, G.H. von Wright Blackwell 1980[1947]
- [119] Wittgenstein, L *Philosophisch Investigations, (part 1)*, Macmillan Publishing Company 1953
- [120] Yosida, K. *Functional analysis*, Springer-Verlag (Sixth Edition) 1980
- [121] Zadeh, L.A. *Fuzzy sets, Information and Control*, Vol. 8, 338-353 1965
- [122] Zadeh, L.A. (2004) *Fuzzy Logic Systems, origin, concepts and trends*, (<https://wi-consortium.org/wicweb/pdf/Zadeh.pdf>)

Index

- abduction, 235, 237
 abstract ego (von Neumann), 123
[Aesop](#)(BC.620 - BC.510), 67
 allegory of the cave, 69
 allegory of the sun, 72
 ambiguity of ordinary language
 Arguments for the existence of God(Anselmus), 130
 Geocentrism and Heliocentrism, 153
 Zeno's paradoxes, 54
 analytic philosophy(=linguistic philosophy), 221
 analytic-synthetic distinction, 273
[Anselmus](#)(1033 - 1109), 27, 90, 135, 180, 183
 antinomy, 54
[Archimedes](#)(BC287 - BC212), 109
[Aristarchus](#)(BC310 - BC230), 107
[Aristotle](#)(BC384 - BC322), 29, 88, 136
 asserted fiction, 65
[Augustinus](#)(354-430), 123, 165
 axiom of choice, 105
 Axiom 1 [measurement], 3, 31
 Axiom 2[causality], 3, 31

[Bacon](#)(1561 - 1626), 92, 208
 Banach-Tarski theorem, 105
 Bell's inequality, 183
[Bergson, Henri-Louis](#)(1859-1941), 165
[Berkeley, George](#)(1685-1753) , 181
[J. Bernoulli](#)(1654 - 1705), 144, 193
[Bohr](#)(1885 - 1962), 27, 90, 135, 180, 183
 Bohr-Einstein debates, 6, 182-184
[Boole, George](#)(1815-1864), 232
[Born](#)(1882-1970), 236, 267
 British Empiricism, 170
 buoyancy, 109

 C*-algebraic formulation, 30
 Cantor's paradox, 241
[Carnap, Ludorf](#) (1891-1970) , 273
[Carroll, Lewis](#)(1838-1898), 277
 Carroll's logical paradox, 277
 causal relation, 2, 146, 152
[F. Click](#) (1916 – 2004), 186
 cogito proposition, 11, 104, 160, 162, 189
 cogito turn, 158
 Continental Rationalism, 173
 ICopenhagen interpretation(=linguistic Copenhagen interpretation), 4
 Copernican revolution, 125, 191, 209
 Critique of Pure Reason (Kant), 202

[Democritus](#) (BC.460-BC.370), 175
[Descartes](#)(1596-1650), 5, 160
 Descartes figure, 5, 166
 Discourse on the Method (Descartes), 160
 discovery of zero, 128
 dogmatic slumber, 191, 209
 DST-formula, 57
 dualism(=mind-matter dualism), 27

[Dummett, David](#) (1925-2011) , 255, 267

 eidos(Aristotle), 28, 29, 89, 136
[Einstein](#)(1879 - 1955), 27, 90, 135, 180, 183, 266
 Einstein-Tagore meeting, 182
[Eratosthenes](#)(BC275 - BC194), 114
 ethics · morals, 62
[Euclid](#)(BC330 - BC275) , 103
[Eudoxus](#)(BC.400 BC.347), 44

 falsifiability, 8, 274, 287
 fictional worldview (the main current of western philosophy), 21
[Fisher](#)(1890-1962), 236, 267
 Five-minute hypothesis, 243
 flagpole problem, 279
[Frege, G.](#)(1848-1925), 232
 Fuzzy logic, 256

 Galapagos philosophy, 85
[Galileo](#)(1564 - 1642), 92, 144, 193, 208
[Gauss](#)(1777 - 1855), 129
 Geocentrism(Ptolemaeus), 116
 grue paradox, 197

 habitual thinking (=worldview), 53
[Harari.Y.N](#)(1976 -), 67
[Hawking](#)(1942 –2018), 23, 297
[Heidegger](#)(1889-1976), 165
 Heisenberg's uncertainty principle, 110, 268
 Heliocentrism, 148
[Heliocentrism](#)(Aristarchus), 107
[Hempel, C.G](#)(1905-1997), 279
[Hērakleitos](#)(BC.540 -BC.480), 49, 91
[Hume, David](#) (1711-1776) , 189, 193
 Hume's problem of induction, 193
[Husserl](#) (1859-1938) , 218
 hyle(Aristotle), 28, 29, 89, 136

 I think, therefore I am., 160
 Idea(Plato), 28, 29, 136, 166, 172
 I know that I know nothing, 63
 induction, 145
 inductive reasoning, 145

[Kant](#)(1724-1804), 191, 209
[Kelvin](#)(1824 –1907), 19
[J, Kepler](#)(1571 - 1630), 146, 149
 Kripke's quus, 271

 law of large numbers, 144, 193
 leaning Tower of Pisa, 150
[Leibniz](#)(1646-1716), 174, 177
 Leibniz-Clarke Correspondence, 177
 linguistic philosophy(=analytic philosophy), 221
 linguistic interpretation(=linguistic Copenhagen interpretation), 4
 List of unsolved problem, 15

- [J. Locke](#) (1632 - 1704), 170
 logical spirit (=the spirit of Think logically!) (analytic philosophy) , 23
 logical positivism, 272
 logical spirit (=the spirit of Think logically logical worldview, 20
- [McTaggart. J.M.E.](#)(1866–1921), 245
 McTaggart's paradox, 245
 measurement, 3
[Merleau-Ponty](#)(1908-1961), 172
 metaphysics, 19
 mind-body problem, 164, 289
 modal logic, 24
 model-change, 84, 164
[Moore, E.J.](#) (1873 –1958) , 247
 Moore's paradox, 247
 Motion function method, 52
- naive set theory, 19
 nativism, 173
 necessity of dualism, 77
 necessity of idealism, 76
[Newton](#)(1643-1727), 92, 179, 208
 non-Euclidean revolution, 105
- [Ockham](#)(1285 - 1347), 27, 90, 135, 180, 183
 Ockham's razor, 138
 Only the present exists, 123
- paradigm shift, 142
 parallel postulate, 103
[Parmenides](#)(born around BC. 515), 27, 91
[Peirce, C.S.](#)(1839-1914), 235
 PI(= Philosophisch Investigations), 265
[Plato](#)(BC427 - BC347), 29, 136, 166
 Plato's beard, 138
[Popper](#)(1902-1994), 8, 274, 287
 population, 28, 29, 136
 practical logic, 24
 predicate logic, 223
 primary quality, secondary quality, 28, 29, 136, 172
 Principia, 152
 Problem of universals, 27, 90, 135, 180, 183
 projection postulate, 9, 124
 Proof of the existence of God, 130
 propositional logic, 223
[Protagoras](#)(BC490 - BC420), 62
[Ptolemaeus](#)(AD.83 - AD.168), 116
 pure Pythagoreanism, 47
 purpose, 91
[Pythagoras](#)(BC582 - BC496), 41
- QL(=quantum language), iii
 qualia problem, 185
 qualia (=subjectivity) problem, 164
 quantum computer, 298
 quasi-product observable, 32
[Quine, Willard Van Orman](#) (1908-2000) , 273
- raven problem, 282
 realistic worldview(physics), 21
[Russell. B.](#)(1872 - 1970), 79, 90, 241
 Russell's paradox, 241
- [Saussure, F.](#)(1857-1913), 249
 Scholasticism, 126
- Schrödinger's cat, 296
 mechanical worldview(statistics, quantum language), 24
 secondary quality, primary quality, 172
 self-reference
 cogito proposition, 11
 subjective time, 124
 set theoretical worldview, 19
 signified, 252
 signifier, 252
[Socrates](#)(BC469 - BC399), 62
 spectrum, 178
 state equation, 210
 subjective time, 123
 subjectivity (= qualia) problem, 164
 subjectivity problem, 164
 syllogism, 261
 syllogism(Aristotle), 94
- tabula rasa (blank paper), 171
 temporal logic, 24
 tense, 123
 tensor quasi-product observable, 32
[Thales](#)(BC640 - BC546), 36
 thing-in-itself, 207
[Thomas Aquinas](#)(1225 - 1274), 29, 136
 time theory(Augustinus), 123
 TLP(=Tractatus Logico-Philosophicus), iii, 255
 transcendental idealism, 216, 251
 trial of Galileo, 149
- [von Neumann](#)(1903- 1957) , 123
 von Neumann-Lüders Projection Postulate, 296
- W^* -algebraic formulation, 30
 wave function collapse, 9, 123, 124
[Weinberg](#)(1933 -2021), 37, 67, 88, 93, 116, 146, 148
 What is space-time?, 53
[Whitehead](#)(1861 - 1947), 37, 84
[Wittgenstein](#)(1889 - 1951), 16, 24, 165
 Wittgenstein's paradox, 270
 worldviewism, 17
- [Zadeh, A. L.](#)(1921 -2017), 257
 Zadeh's fuzzy set, 81, 256
[Zeno](#)(BC490 - BC430), 54
 Zeno's paradoxes , 54

