

[Erschienen in: Ingo Nussbaumer, *Restraint versus Intervention: Painting as Alignment* (Nuernberg: Verlag für moderne Kunst, 2010), pp. 150-171].

## **Colour Spectral Counterpoints**

### **Case Study on Aesthetic Judgement in the Experimental Sciences**

*Olaf L. Müller, Humboldt-Universität zu Berlin (www.gehirnimtank.de)*

#### CONTENT

- I. Are we allowed to speak of beauty?
  - II. From theoretical to experimental beauty
  - III. Ingo Nussbaumer's work on colour science:  
    Classic experiments in a new form
  - IV. Starting point: The white analysis
  - V. The aesthetic disadvantage of Newton's white synthesis
  - VI. The aesthetic fascination of time reversal
  - VII. Desaguliers' version of the white synthesis
  - VIII. The new white synthesis is more beautiful than Newton's
  - IX. Nussbaumer's purple synthesis
  - X. Escaping ugly arbitrariness
  - XI. Seven syntheses
  - XII. Multi-coloured counterpoints
  - XIII. A banal counterpoint to the white synthesis
  - XIV. Goethe's surprising rebellion: The black analysis
  - XV. Masterpiece black analysis
  - XVI. Sevenfold counterpoint
  - XVII. Comprehensive symmetry
- Bibliography

*ABSTRACT:* When it became uncool to speak of beauty with respect to pieces of art, physicists started claiming that their results are beautiful. They say, for example, that a theory's beauty speaks in favour of its truth, and that they strive to perform beautiful experiments. What does that mean? The notion cannot be defined. (It cannot be defined in the arts either). Therefore, I elucidate it with examples of optical experimentation. Desaguliers' white synthesis, for example, is more beautiful than Newton's, and the many colourful syntheses done by Viennese painter Ingo Nussbaumer exemplify even greater beauty. Here are some criteria (which, of course, do not implement a decision procedure concerning beauty in experiments): cleanliness, simplicity, intellectual clarity, symmetry. Similar criteria are relevant to our aesthetical judgements about *some* pieces of music. So we can assume that our notion of beauty concerning art is related to the one concerning scientific experiments.

# Colour Spectral Counterpoints

## Case Study on Aesthetic Judgement in the Experimental Sciences <sup>Olaf L. Müller</sup>

### I Are we allowed to speak of beauty?

Anyone claiming to have a universal catalogue of criteria for beauty is a fool. Or a charlatan. For about a hundred years, artists and critics avoid applying the word “beauty” to refer to the aesthetic value of a work of art. They have good reasons for this. From their perspective, the word is too reminiscent of matters of taste.<sup>2</sup> Even so, there are value judgments about art. They refer either to the special features of the work admired (for example, to the lines’ impressive sweep), or else they use an abstract, general term of praise such as “aesthetic”. (Even this word can be used negatively in discourse about art). It does not matter which form an aesthetic value judgment takes, one thing is for sure: Although such judgments are not grounded on a universal catalogue of criteria, they offer more than something wishy-washy. There is more to them than just the contingency of a sudden mood or an individual taste. At least there can be more to them. No doubt, there is such a thing as aesthetic judgment. It can be learned, and learning is never based solely upon something wishy-washy.

Not only when discussing art do we speak about what appeals to us aesthetically. A blooming magnolia, a sharp-edged desert landscape, a beloved face or body can elicit enthusiastic aesthetic judgments from us. The words “beautiful” and “beauty” then sound appropriate again, and the Greek word “aesthetic” suddenly appears persnickety, even over the top.<sup>3</sup>

Thus, when confronted with natural things, we tend to control our aesthetic vocabulary less strictly than in discussions about art. Yet words such as “beautiful” play a large role even outside of *emotional* appreciation of nature. They also do this in *scientific* approaches to nature, that is – even in the mouths of those who are not suspiciously overenthusiastic. Physicists, for example, love speaking of their theories’ mathematical beauty. Surprisingly, the physicists’ trend in this direction is just about as old as the opposite trend in art.<sup>4</sup>

I will adopt the manner of speech of these physicists. For I want to examine the role of aesthetic value judgment in the natural sciences. I would ask artists and art connoisseurs, who are suspicious of this mode of speech, to be patient.<sup>5</sup> One of my goals is to bring the discussion between both sides a step forward. Which word one chooses to use when crossing such bounds is less important than the real issue. Aesthetic judgments matter to both artists and scientists. It would be odd if this similarity did not offer a good starting point.

1 Heisenberg [MoBi], [BSiE]: 288.

2 With regards to modern art, Barnett Newman says: “The invention of beauty by the Greeks, that is, their postulate of beauty as an ideal, has been the bugbear of European art and European aesthetic philosophies. Man’s natural desire in the arts to express his relation to the absolute became identical and confused with the absolutism of perfect creations – with the fetish of quality – so that the European artist has been continually involved in the moral struggle between notions of beauty and the desire for sublimity [...]. I believe that here in America, some of us, free from the weight of European culture, are finding the answer, *by completely denying that art has any concern with the problem of beauty and where to find it*” (Newman [SWI]: 171 – 173; my italics). Even those who do not want to treat old Europe so rudely will agree that the word “beauty” does not play a large role in aesthetic exchanges about art, see Wittgenstein [VüÄ], [LoA]: Part I §8.

3 The word seems better suited to desert landscapes than to faces or people or their actions.

4 In any case this trend has culminated in declarations by prominent proponents of twentieth century physics such as Heisenberg, Dirac, and Weinberg. See, e.g., Heisenberg [TG]: 86, [Pb]; Dirac [ToT]: 21/2; Weinberg [TvEU]: 140.

5 Misunderstandings are pre-programmed by these divergences in language use. (This is reflected in the anecdote about the indignant museum director concerning Weinberg’s remarks about beauty in physics, see Weinberg [TvEU]: 140).

## II From theoretical to experimental beauty

First a sentence to appease those who do not want to see aesthetic values reduced to pleasant experiences. In the natural sciences, beauty is not just something for delighting physicists or for improving the moods of chemists. Rather, in the history of science there have been many cases in which a theory prevailed because it was beautiful. Leading 20<sup>th</sup> century physicists confess, without blushing, that beauty increases a theory's credibility. Or at least, they maintain that a theory is more plausible if it is beautiful *ceteris paribus* (i.e. all other things being equal). Conversely, sometimes a scientific idea is too ugly to be true, and therefore must die.

What is scientific beauty? What is it based on and how does it work? If I wanted to answer these philosophical questions with the help of some universal catalogue of criteria, you would accuse me of being a charlatan, or a fool. So let's approach the question by considering an example.

Natural science is created by the interplay of theory and experiment. Although both can be beautiful, I will focus on beauty in scientific experiments. My reason for this is that experiments (in contrast to theories) are concrete products of scientific work and are thus more easily brought before the tribunal of our sense impressions. I find it surprising that the beauty of scientific theories is much more widely discussed in the literature.

## III Ingo Nussbaumer's work in colour science: Classic experiments in a new form

Over the last centuries, our technical possibilities for doing experiments have improved at break neck speed. Today's physicists use instruments that are only understood by a few specialists and that are based on lots of theory. For this reason, the beauty of today's experiments can only be appreciated by those few specialists who know their way around regarding instruments and the theories behind them.

In their aesthetic judgment, theoretical and experimental beauty merge on quite a complex level. Access to these fields is restricted. Tickets are only available after years of science studies. At the beginning of these studies, however, a student is exposed to grand historical examples of the art of scientific experimentation. These examples are presented to the astounded student mostly with modern means, i.e. without any effort to be historically accurate. They mould the student's first impressions of scientific beauty. As their understanding requires much less theory than any recent experiment, they are well-suited for showing the novice how to make aesthetic judgments that will be needed in later work.

For these reasons, I will begin with three classic experiments. First, I will present the famous white analysis, which dates back to the old master of the art of optical experimentation. Isaac Newton constructed and presented it to his surprised audience in 1672. Second, I will show another of Newton's co-published experiments: the white synthesis; and third, I will show Desaguliers' more elegant white synthesis from 1714.

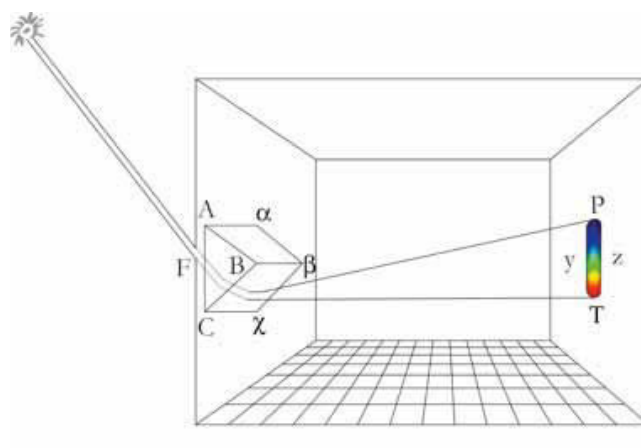
Later, we will deal with experiments that do not have ancestors from back in the old days. But all these experiments deliver variations on Newton's experiments. Their means do not include high technology. Therefore, they are well-suited for the purpose of my aesthetic case study.

All of the new experiments that I will deal with come from colour research by the Viennese artist Ingo Nussbaumer. I will also present Newton's white analysis and Desaguliers' white synthesis in the forms designed by Nussbaumer (with aesthetic, even artistic intentions). He conducts the experiments with technical means that were not around in Newton's days. Instead of the sun, which was used in the experiments back then, Nussbaumer uses artificial light from a slide projector. However, the other elements of the experiments could almost date from Newton's era – I say 'almost', because the quality of the material (as for example the purity of glass) has improved dramatically, and why not exploit such fruits of progress?

In spite of the rewarding use of today's experimental tools, Nussbaumer is performing these experiments in a style very different from that of contemporary physics. Wherever possible, he is avoiding modern technology. For example, he neither erects the highly complex lens systems (of his slide projectors) on an optical bench, nor does he demonstrate each of them separately. On the contrary, just as he wants to concentrate on the visible phenomena, he treats the slide projectors without any theoretical agenda. (Newton did not have to deal with the physics of the sun either). In this regard, Nussbaumer strives for as much simplicity as possible. Nevertheless, he shows us complex patterns of tightly entangled phenomena that stem from many individual experiments and still belong together. What other experimenters would eventually build up sequentially (if at all), he shows us simultaneously. (More on this in section X). In addition, the objects of light that form Nussbaumer's experiments invite the beholder into an artistic-contemplative interaction. Nussbaumer gives us installations in a space that makes the beholder take a trip with his eyes – an aesthetic adventure as well as a pleasure.<sup>6</sup>

It is possible to look at Nussbaumer's experiments from an artistic perspective, just like the light installations of Olafur Eliasson. However, as opposed to Eliasson, Nussbaumer aims for both aesthetic clarity and scientific knowledge. He thereby creates a bridge between art and science. Nonetheless, his main goal is, and stays, art. In light of this goal, the experiments fall under an extended notion of painting. As a philosopher of science, I only want to comment on the aesthetics of the scientific aspects of his work. I am not writing about new aesthetic achievements in the fine arts. Let me leave that to others. Anyway, my aim is to contribute to the actual discourse between the arts and sciences. (And from time to time, I will digress into the field of music).

6 Compare **Hollows in Newton's Garden** [187–188], **See What Happens By Cutting Out** [189], **Blossoms in Goethe's Apple Tree** [197–199].



**Fig 1** *Newton's white analysis* (1672) [colour graphic by Ingo Nussbaumer based on a drawing in Newton's sketch book; Newton's original graphic is printed in Lohne [LN]: 126/7, "Figure 1"]. Rays of light are sent through a hole in the window shutter (F) into a prism. The light is refracted and split into its multi-coloured parts.



**Fig 2** Projector and water prism in Nussbaumer's dark chamber [I.N. 2009]. The prism is not illuminated by the sun in Nussbaumer's version of Newton's experiment (Fig. 1), but by the light from a slide projector (that projects the image of a slide with a gap on it). The light from the projector's bulb is weaker than the sun's, but it hardly differs with respect to its composition.

#### IV Starting point: The white analysis

First, we turn to the Newtonian white analysis – Viennese style. (For Newton's version of the experiment, see Fig. 1). Nussbaumer spreads two opaque rectangles across a slide frame so that only a narrow vertical gap is left open. If you project this slide on a white screen in a darkened room, you see a narrow white stripe surrounded by pitch black. This is the optical situation from which to start. Nussbaumer places a water prism on its end in front of the projector's lens (see Fig. 2).

The projector's white light must pass through two surfaces of the water prism. In both cases, the light is refracted to the right as it crosses through the border. That is why the projected image now appears much farther to the right on the screen. But two further effects are more dramatic than this change in location. First, the previously narrow white stripe has now become a much wider image; and second, the image is no longer white, but is now a colour spectrum: red on the left, green in the middle, and blue to the right – with continuous colour transitions in between (see Fig. 3).

What causes these two surprising experimental effects? Orthodox optics, dating back to Newton, offers an attractive answer. The original white light from the projector (that appears when the water prism is not in the way) consists of light of several different colours (red, green, and blue). Without prismatic refraction, these colours are blended out because they overlap. Now, each different colour of light has a different angle of refraction. As it passes through the prism, blue light changes its direction the most; red light changes its direction the least; and green light in between. The water prism pulls apart the multi-coloured bundles because "refrangibility" (degree of refraction) and colour are, in the end, the same. As we know today, they both can be traced back to the different wavelengths of light. Plain and simply, white light is a mixture of rays of different colour, diversely refracted. That is the most famous result of Newton's research in optics.<sup>7</sup>



**Fig 3** Newton's spectrum [I.N. 2009]. Left: red; in the middle: green; right: blue – with flowing transitions.

<sup>7</sup> Newton announces the diverse refrangibility of white light in Newton [NTaL]: 3079. That there are different colours in white light is proposed by Newton in Newton [NTaL]: 3083, point 7.

#### V The aesthetic disadvantage of Newton's white synthesis

If white light consists of different coloured rays, then it must be possible to mix these different colours back into white again. We expect there to be a white *synthesis* that corresponds to the analysis of white. To meet such expectations, Newton introduces a convex lens and thus manages to pull the dispersed colours back together. Observation: a white spot. See Fig. 4.

I agree that this is quite a nice experiment. But does it really do justice to every aspect of our sense of beauty? That's debatable. There are good reasons to strive for more experimental beauty. First of all, Newton's white synthesis requires a lot of fumbling. The lens must be placed just so that the desired white light spot can be seen without disturbances from the other colours; and that only works if the distances between prism, lens, and screen are adjusted to each other and to the properties of the lens. Such fumbling lacks beauty. Admittedly, this aesthetic imperfection lies right on the surface. But it corresponds to a deeper aesthetic imperfection of the experiment. With the convex lens, an entirely new element comes into play. This threatens the attractive simplicity of the original set-up. It's less easy to understand how a convex lens works than it is to understand how a prism works. Try to remember that moment of panic when your physics teacher announced – *ex cathedra* – that a convex lens is nothing other than a collection of infinitely many small prisms. See Fig. 5.<sup>8</sup>

Such flirting with infinity is quite a flight of fancy, and admittedly beautiful in its own way. But in our present context it is unsatisfactory and unaesthetic. Trying to put an *infinite number* of prisms into view disrupts all proportion, especially when we are trying to reverse the effects of *one* prism. It would be more beautiful if the white synthesis didn't demand more elements and more efforts intellectually than the white analysis.

To be sure, I don't want to deny that Newton's experiment must be accepted as a successful proof of the white synthesis. I articulate the aesthetic discomfort with Newton's experiment not in order to challenge its veracity. Rather, I want to encourage the search for a simpler, and thereby more beautiful experiment. Only if this search should be fruitless, would we have to make do with Newton's experiment from 1672. This is not necessary, because later, Desaguliers (a student and ally of Newton) invented a better experiment. His version of the white synthesis is simpler. It works without a convex lens and delivers a clear phenomena: clear to our eye and clear to our intellect.

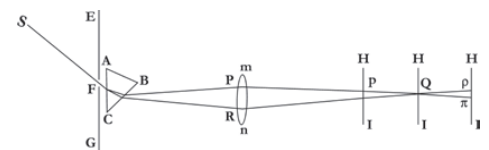
## VI The aesthetic fascination of time reversal

Before I explain the more beautiful version of the white synthesis (next section), I would like to engage you in an intellectual puzzle. Let's return to the coloured rectangle on the screen that resulted from the white analysis. Consider the following thought experiment. We change the direction of time of the entire set-up; putting it into rewind as it were. Then the red, green, and blue light rays would travel from the screen back to the prism, and would be refracted by both surfaces (into the prism and out of it) exactly along the same trajectory they came from. Each ray would be refracted more or less strongly, according to its refrangibility. (The red rays will be refracted in both cases the least, the blue rays both times the most).

Where do these rays go after they return through the prism? The answer is simple. They meet right back on the lens of the slide projector. Exactly there, rays of all different colours are superimposed so that they lose their colour. We end up exactly as we started in the original experiment, with a white spot on a black background.

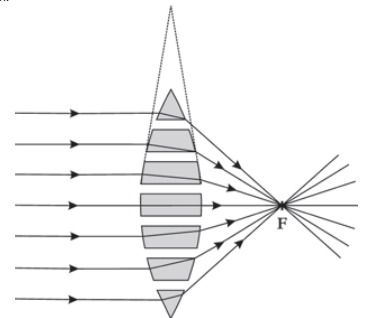
This thought experiment is based on a motif that mathematicians and physicists find beautiful: the motif of time symmetry. It is beautiful when a process works the same forwards and backwards (i.e., when the laws governing the process don't depend on its temporal direction).

Not every process in nature has this temporal symmetry. If that were the case, we could raise the dead or turn a lukewarm cup of coffee with milk back into a half a cup of black coffee and a half a cup of cool milk. Such things are prevented by the time asymmetries in thermodynamics, especially by its cruel second law: Entropy (disorder) always increases with time.



**Fig 4** Newton's white synthesis (1672) [source of the drawing: Newton [NTaL]:3086; redrawn by Ingo Nussbaumer]. The multi-coloured light refracted through the prism (ABC) is collected by a convex lens (mn). Whether the white synthesis works depends on how far the screen (HI) is from the lens (mn). Some fumbling about is necessary. On the right, the figure shows three examples of screen positions that the experimenter had to try. The only optimal one is the middle position. The white synthesis only takes place there. One could say that trying to find this optimal position is like trying to find an axis of symmetry.

- 8 It's a struggle to understand why Newton cannot simply use one prism to re-collect the fanned out light rays of the spectrum. One can indeed refract each single light ray to the desired spot with the help of a prism, but this must be done for all the light rays simultaneously, and for that you would need to introduce and adjust prisms at each and every point of the whole spectrum.



**Fig 5** Lens theoretically composed of prisms [the figure is from a high-school text book, Dorn et al [PM]:238/9 (Figure 239.2), redrawn with alterations by I.N. 2009]. The figure bears the cheerful caption "convex lens composed of prism pieces", and that although it looks like prism hide-and-see, not like a clear representation of a collection of prisms.

In short, the aesthetic motif of temporal symmetry does not run through all of the natural sciences. On the other hand, we appreciate temporal symmetry outside of natural science; for example, in music. Bach's crab canon (*Krebskanon*) from the *Musical Offering* (BWV 1079) is famous for that (see Fig. 6). It is a canon in two voices, though only one of its voices is written down. The second voice is created by playing the first one backwards. That this was Bach's intention can be seen at the end of the notated voice. There the mirror-image symbols invite you to play the voice, that actually appears in the notation, backwards: the mirror image of the symbols for the key signature (three mirror image flat signs); four-four time (a mirror image of 'C'), and a G-clef (right at the end). And as the canon is explicitly called *canon à 2*, both voices (forwards and backwards) should be played simultaneously. They meet exactly in the middle of the canon, at the end of the ninth of eighteen bars, where the time axis is. Thus the entire two-voiced canon sounds the same forwards as backwards. Once you know of the canon's time symmetry, you hear it and find it pleasing.

Composers have many other possibilities to demonstrate their mastery of form. So it's no wonder that time symmetries are not that common in music. They are less important than in physics. On the other hand, in physics they do not apply everywhere, as already mentioned. Nonetheless, the laws of optics are more similar to Bach's fascinating canon than to the cruel second law of thermodynamics.

## VII Desaguliers' version of the white synthesis

In my thought experiment, I assumed that optical processes can be reversed through time. Can this be proven? It would be nice to have an optical experiment that exhibits such time symmetry to the naked eye; for example, in form of a symmetry between white analysis and white synthesis. How might this work? Consider the following simple question: How come we actually see a coloured image on the screen in the original experiment? How does this image get to our eyes? Here is too simple an answer: All of the different colours of rays arriving at the screen are reflected straight into our pupils. To our pupils? Recall that every one of us can see each colour from the illuminated rectangle; so these light rays have to travel to all of our pupils. They have to travel everywhere. This means that light rays are reflected from the screen in every direction. They disperse everywhere throughout the room.

So far this is trivial. Less trivial is the following special case. If the light rays are reflected from the screen in every direction, then some of them must return from the screen *precisely along the same path they came from*.

This is the idea that Desaguliers exploited for his white synthesis; Nussbaumer perfects it beautifully. The coloured rays travelling backwards (from our earlier thought experiment about reversing time, section VI) already occur in the original experiment itself.

Of course, not every light ray is reflected from the screen exactly back along the path by which it came. Most of the rays are reflected somewhere else. But even so, a fair, though paler part of the light reflected goes straight back where it came from. Not only did we not think of this, we didn't see it either.

Now watch. If already in the original experiment, the light rays go between the screen and the prism twice (first forwards and second backwards), then the original prism from Newton's analysis also serves the purpose of the synthesis. One just leaves the prism where it already was.

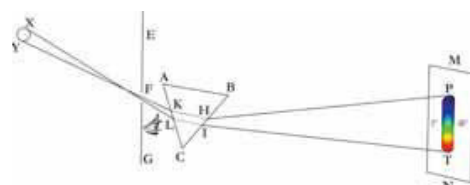
If the laws of optics (in our case the laws of prismatic refraction) are beautiful, if they are symmetrical with respect to the direction of time, then in the original experiment an image just like the one at the start of the experiment should be cast back toward the slide projector.



Fig 6 Bach's "crab canon"  
(*Krebskanon*) from the *Musical Offering* (BWV 1079).

In any case, that is the idea behind the white syntheses by both Desaguliers and Nussbaumer. Figure 7 shows Desaguliers' white synthesis. Desaguliers takes a long prism so that there is enough space for him to look through it right along the same path as the rays of sunlight.<sup>9</sup> In Nussbaumer's version, it works even easier, as he has generously large water prisms at his disposal. We look in the same direction through the prism that the projector sends its light. We put our eyes either above or below the projector's lens. *Voilà*, the white synthesis. We look through the water prism at the screen, which appears, from other angles (without the prism in the way), as a wide, variously coloured rectangle. When looking through the prism, however, we do not see a wide multi-coloured rectangle, but a narrow white stripe of light; which is the superposition of different zones of the coloured rectangle. Figure 8 shows the starting image and its synthesis.

9 Desaguliers [AoSE]:442 (= Experiment V).



**Fig 7** Desaguliers' white synthesis (1714) [redrawn with an inserted spectrum by I.N. 2009]. In Desaguliers' original drawing, two experiments are shown at once. One in which the experimenter looks at the analysis through prism AB (top), and one in which he looks through another prism CD (bottom). Newton already knew of the lower experiment. In Desaguliers, it's called "Fig. 15", which illustrates his fifth experiment; it can be found at the end of his essay (Desaguliers [AoSE]:442).

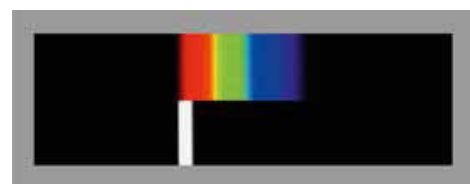
### VIII The new white synthesis is more beautiful than Newton's

To appreciate its beauty, you have to see the effect that I described in the last section for yourself. From my experience, I can report how much delight surges through me each time I see the white stripe of light that is synthesized from the different colours; and how surprising and engaging its clarity and definiteness is. This is an aesthetic reaction to the new experimental result: delight about how neatly and precisely it works. It is the same delight that a connoisseur of music has when she hears a daring quadruple fugue. And it is the same delight that is lacking since the last few bars of *Contrapunctus* 14 (BWV 1080/19) from Bach's *The Art of the Fugue* (*Kunst der Fuge*) were lost.

Of course, the image of some distinct, snow white stripe of light against a pitch black background does not, by itself, rank high as an aesthetic experience. The image of the narrow stripe only gets its allure due to background knowledge. In order to be engaged aesthetically, you have to understand where the little stripe of light comes from. You have to know that the synthesis starts from a multi-coloured rectangle with many fine shades of colour that came from a narrow little stripe of light.

One fascinating aspect is the interplay of the almost infinite variety of colours on the screen as compared to how unified it appears through the prism. In addition, it is fascinating and beautiful that the time symmetry of the optical laws can be made tangible in the space of the experiment. Desaguliers' white synthesis follows almost exactly the same path as Newton's white analysis. Who is blind to the beauty in this fact?

Moreover, the experiment offers more beauty than Newton's own white synthesis for six reasons: First, because it requires fewer devices (especially no convex lens); second, because the experimental result requires far less fumbling around; third because the effect appears more clearly and distinctly; fourth, because it is easier to understand; fifth, because the light goes the same direction you look; and sixth, because analysis and synthesis meld into a single experimental result.



**Fig 8** Photograph of the Viennese white synthesis [I.N. 2009]. The top of the figure shows a picture of the Newtonian spectrum. The bottom shows a picture of it taken by the camera through the refracting prism. All the colours of the Newtonian spectrum converge and mix into white.



## IX Nussbaumer's purple synthesis

In the next sections, I want to talk about variations of the experiment that I just praised. They were introduced by Nussbaumer, thus creating even more beauty than there is in the classical versions. So let us look over Nussbaumer's shoulder while he is doing his own research. As we shall see, his results are spectacular: extremely surprising and elegant.

Nussbaumer's basic idea is simple and ingenious. According to Newton, not only must we assume that white light is a composite of different spectral colours, we must also assume that many other colours are composites. There must not only be a white synthesis. There must also be, for example, a purple, a turquoise, and a yellow synthesis. It would be nice if we could synthesize these colours by the same rules as with white. Nussbaumer shows us how this works. Instead of looking through the prism at the *entire* spectrum of colours from the rectangle that fanned out onto the screen, Nussbaumer looks at parts of that coloured rectangle under otherwise identical conditions.

How? It's simple. Nussbaumer cuts out those parts of the dispersed spectrum that he wishes to exclude from the synthesis. More precisely, he cuts holes in the screen exactly where the colours that he wants to exclude appear. And if the space behind the screen is dark, then this very darkness swallows the undesired areas of the coloured rectangle.

Let us consider Nussbaumer's purple synthesis. In the middle of the multi-coloured rectangle (Fig.3), there is a green zone that fills roughly 30% of the entire coloured rectangle. Nussbaumer cuts out this green centre from the rectangle, leaving unchanged the red part to the left and the blue part to the right. About 70% of the entire spectrum can still be seen. Nussbaumer looks at it through the prism from the same angle as in the white synthesis. Again, there is an astounding effect. The fragmented spectrum reunites sharply into a narrow stripe of uniformly coloured light. Its not bright white (as before), but beautiful purple (see Fig.9). And the purple stripe of light is exactly the same size as the white one before. Exactly the same size? How can you be sure? Before, you saw a white stripe of light, now you see a purple one. Who can claim to remember well-enough? Good question. Nussbaumer avoids it by producing the purple and white syntheses simultaneously, that is, by combining them into a single experiment.

To do this, he splits the multi-coloured rectangle on the screen into horizontal halves, as shown in Fig. 10. The first half he leaves intact for the white synthesis. From the second half, he eliminates the green middle for the purple synthesis (as before, by letting the green light disappear into the darkness behind the screen). Now he can take his usual observation post, and look at the screen through the water prism. He sees a narrow stripe of light whose top half is white and whose bottom half is purple.

These two halves of the stripe have exactly the same width, as can easily be checked, because the vertical borderlines of the upper purple half form a straight extension of the lower white half. See Fig. 11. It all clicks into place, and this surprising precision appeals to our sense of beauty even more strongly than in the white synthesis alone. For this time, we have two different images on the screen that are pulled together as they return through the prism – one complete and one cut out. Both halves of these optical geometries fit cleanly, which is as pleasing as the homogeneous colour impressions of white and purple. This tidiness in geometry and colour go hand in hand.



**Fig 9** Photograph of the Viennese purple synthesis [J.N. 2009]. The top of the figure shows a picture of the Newtonian spectrum with its green centre cut away by Nussbaumer. The bottom shows a picture of this fragmented spectrum taken by the camera through the refracting prism. All the colours of the Newtonian spectrum (except green) converge and mix into purple, which is green's complement.

## X Escaping ugly arbitrariness

There is an ugly step in the simultaneous white and purple syntheses that were described and praised in the last section. It seems somehow haphazard and arbitrary that on the one side, the *entire* multi-coloured rectangle is pulled back together, while on the other side just *some* of its parts (namely just the red and blue ones). Why does Nussbaumer choose to pull just these parts of the multi-coloured rectangle together, and why not any other parts of it? It appears arbitrary. And arbitrariness almost always annoys our sense of beauty.<sup>10</sup> One exception would be John Cage's aleatoric music, but even there randomness reigns within definite borders. Nussbaumer rectifies the aesthetic defect. He shows that the purple synthesis is a special case of a more comprehensive order; of a strict mathematical order that appears anything but arbitrary.

Here is the idea. In one case, *two* of the three coloured areas of the multi-coloured rectangle are mixed (red + blue = purple), while in the other case all *three* coloured areas are mixed (red + green + blue = white). These are but special cases of all seven conceivable combinations:

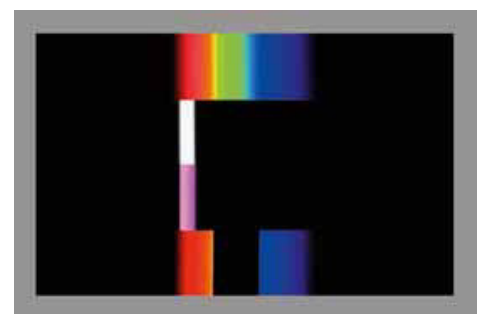
- 1 | red
- 2 | red + green
- 3 | green
- 4 | red + green + blue
- 5 | green + blue
- 6 | red + blue
- 7 | blue

There are exactly these seven combinations due to mathematical necessity. This shows how to escape arbitrariness in the double experiment. Let's run all seven possible combinations simultaneously, in one single experiment. That is what Nussbaumer did. He rationed the screen with the multi-coloured rectangle into seven rows, one combination per row. The screen then looks, for example, like what you see in Fig. 12. This pattern already has its own artistic value; moreover, it leads to an innovation in colour science. As soon as such a pattern is illuminated by a Newtonian spectrum, we have all of the seven possible combinations of the three primary colours (red, green, and blue). See Fig. 13. What result does this combination deliver by way of colour synthesis?



**Fig 10** Photograph of the starting point for the simultaneous white and purple syntheses [I.N. 2009]. The top of the figure shows a picture of the Newtonian spectrum (as in Fig.8). The bottom shows a picture of the Newtonian spectrum with its green centre cut away by Nussbaumer (as in Fig.9). The two-rowed starting point is viewed through a prism. Fig. 11 shows the result.

10 Weinberg points out that a simple enumeration of the properties of all known elementary particles, which is published every two years by the Lawrence Berkeley Laboratory, seems ugly (Weinberg [TVEU]: 154/5).



**Fig 11** Comparison of the simultaneous white and purple syntheses [I.N. 2009]. The results of looking through a prism at the starting image (Fig.10) appear in the middle (rows 2 and 3). The photograph of these results proves that both syntheses are exactly the same size.



**Fig 12** *Windows into darkness* [photo: I.N. 2009]. The screen is split into seven rows and three columns. In each row, different combinations are cut away. For example in the third row, the left and right columns are removed (here ochre). Only the middle row is complete (white). The holes offer a view into the darkness of the space behind the screen, or more precisely of its back panel. That is why the

windows into darkness do not appear black, but ochre, as the picture was taken by daylight. That does not matter. Given the comparatively strongly illuminated screen (that appears beige in the picture) the ochre holes in the slide are dark enough to carry out the experiment. Fig. 13 shows what you see when you illuminate the slide with the Newtonian spectrum.

## XI Seven syntheses

Let's look through the prism at all seven combination of the colour zones on the screen. The result is pleasing to the eye. As if on a line drawn with a ruler, there are seven stripes of light, geometrically identical, neatly stacked one on top of the other. Each stripe offers its own pure colour impression. Purple and white are just two special cases of a comprehensive palette: Turquoise and yellow appear as pure as red, green, and blue. See Fig. 14.

Especially surprising I find the pure yellow in the second row. It is a synthesized product of the red and green zones on the screen. Computer veterans may dismiss this as a bore, but that doesn't matter, since they are used to RGB-screens. To the inexperienced eye, it is as astounding an effect as the white synthesis.

At first glance, the three combinations that I have not yet discussed seem banal:

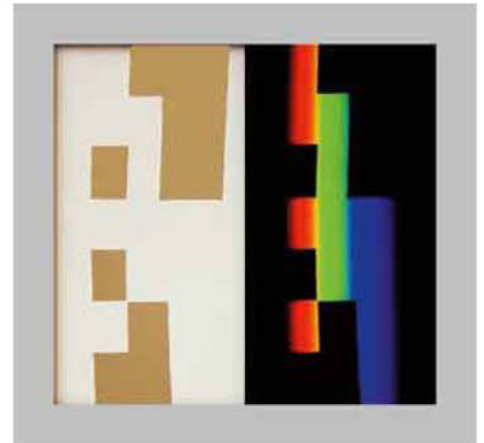
- 1 | red = red
- 3 | green = green
- 7 | blue = blue

But let's have a closer look. On the screen, the areas in question look different than their counterparts (the images pulled together through the prism). On the screen, you can distinguish blurring colour nuances that are easiest to see toward the border between the colour zones. Compare Fig. 14. (For example, the left edge of the green tone in the third row tends toward yellow, its right border to red toward blue).

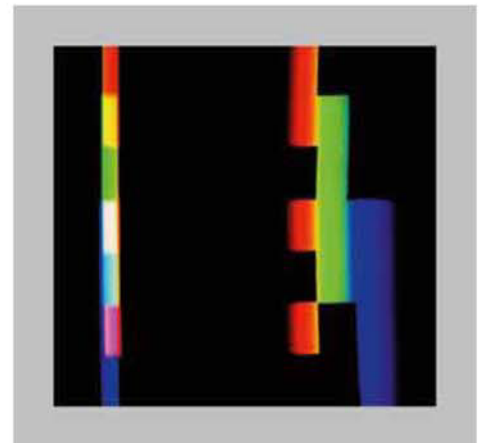
By contrast, each of the *composite* images appears completely uniform and clear. (The camera does not capture this as clearly as the human eye, so go ahead and have a look at the real experiment for yourself). Many fine nuances of red are melded into a uniform red in the experiment; just as with many of the fine green and blue nuances of the multi-coloured rectangle. To bring this triple effect to the point, we could say: The experiment discretely synthesizes the continuous diversity of nature. The confusing infinity of the world of colours is reduced – quite an aesthetic accomplishment. All six bright synthesized results (red, yellow, green, turquoise, purple, and blue) appear pure. They are pure representations of an often variegated colour world. We might call them primary colours.

Before I proceed, I want to sum up. First, the experiment is exemplary in displaying time symmetry in optics. Second, out of a continuum of colours, the experiment identifies seven, clean, colour syntheses. Ordering the chaos triggers our sense of beauty. Third, it is surprising that to each theoretically possible combination, there corresponds a colour impression that is empirically clear. The experiment exhibits completeness. It exhibits all possible syntheses of the visible spectrum. Such completeness is aesthetically pleasing. Fourth, the geometrical precision of the visual images speaks to our sense of beauty – and offers a surprise. Fifth, each of the colour syntheses produces a beautiful image. But stop. That is perhaps just a matter of taste. Really? Even with purple?

The next of Nussbaumer's experiments that I want to make aesthetic comments about brings counterpoint to the experiments that we considered so far. Before we turn to it, I need to say a few words about counterpoint music.



**Fig 13** Nussbaumer's slide with and without spectral illumination [montage: I.N. 2009]. The cut up screen with its windows into darkness (left half) is illuminated by a wide Newtonian spectrum (right half). As both spectra have a black border along the long side, the slide only looks coloured in the middle. Here you see in each row those parts of the Newtonian spectrum that are not lost in the darkness behind the screen. One could call the image the six-fold fragmentation of the Newtonian spectrum.



**Fig 14** Nussbaumer's seven-fold colour synthesis [comparison: I.N. 2009]. If you look at the cut screen illuminated by red, green, and blue light, you see all six main colours (left). Top: red, yellow, and green – bottom: turquoise, purple, and blue. The white synthesis takes place in the middle.

## XII Multi-coloured counterpoints

Whoever puts a counterpoint to some melody puts another melody against the first melody's progression. It is often the case that gaps in the first melody are thereby filled by tones from the second melody. To the untrained ear, the overlapping counterpoints sound a little confused. It takes practice to learn to hear which notes belong together.

Is there counterpoint outside of music? That depends on how much we are willing to stretch its meaning. If carried too far, it would result in banalities. Quite a banal form of counterpoint can be seen in the cut screen. In this sense, the third row on the screen is the counterpoint to the sixth row, as in the third row there are holes exactly where there are no holes in the sixth, and vice versa. This is a type of combinatorial counterpoint. In total, the cut screen has three pairs of such counterpoints. So far, so banal.

The synthesized products of these counterpoints, however, are less banal. Whoever looks through a prism at one of the rows on the cut screen and then at its counterpoint sees first a synthetic colour and then its exact opposite: its complementary colour.

So one could say that the complementary colour pairs belong together like colour counterpoints. But that is not the end of the story. There are more comprehensive and much more fascinating counterpoints awaiting us in the cosmos of colours. They make their first appearance in the next (and last) of Nussbaumer's series of experiments that I want to make aesthetic comments about. More precisely put, the next series offers an exact counterpoint to the series of experiments that we just worked through. (Or anyway, it offers their colour complement).

## XIII A banal counterpoint to the white synthesis

In order to introduce the new experiment, I want to take one more look at the last experiment, where I identified three pairs of counterpoints:

1	red = red
5	turquoise = green + blue
2	yellow = red + green
7	blue = blue
3	green = green
6	purple = red + blue

Since the experiment had seven rows, exactly one row is left with no counterpoint: the row with the white synthesis. That is the row on the screen from which absolutely nothing was cut away. What would its combinatorial counterpoint be? It's simple: a row in which the entire screen is missing; a window completely open into darkness.

And what would be the prismatic synthesis of this darkness? Again the answer is simple. From nothing comes nothing. So if you look through a prism in a direction from which no light is returning, you see black, which is a counterpoint to the result of the white synthesis. Question: Should Nussbaumer have provided an eighth row for the counterpoint to the white synthesis? No, because the eighth row only leads to a trivial 'synthesis' of blackness. From nothing comes nothing, as I said. It would be pretentious to call an optical effect that does not take place a 'synthesis'.

However, there is another more fascinating and all but trivial black synthesis. It alone can rightly claim the title *counterpoint to the white synthesis*. It is a masterpiece of experimental art. Before I present it (section XV), there is first another surprise: the black analysis.

#### XIV Goethe's surprising rebellion: The black analysis

Just like in the first of the old series of experiments (the white analysis, section IV), the first of the new series is an analysis, not a synthesis. Moreover, the complete new series is derived from the old one with but a single change. Nussbaumer replaces the slide he used before with its (combinatory) counterpoint. Until now the slide had two rectangles that filled almost the entire frame. They almost touch each other in the middle, leaving free a narrow vertical gap. To create the combinatory counterpoint to this constellation, Nussbaumer fastens an opaque narrow vertical section in the new slide frame exactly where there was a gap in the old one; he leaves the rest of the frame free. If you project this slide without refracting the light through a prism, you get a small black stripe across a white background.

Nussbaumer follows Goethe and pushes the water prism into the path of the projection.<sup>11</sup> Again, the once narrow image jumps to the right and fans out. And again, the image is multi-coloured, but what colours! The left end of the rectangle is turquoise, the middle is purple and the right is yellow – with flowing transitions just as before. See Fig. 15.

Let's compare the series of colours of the original experiment (the white analysis, Fig. 3):

red  
green  
blue  
(with flowing transitions; on a black background)

with the colour series in the new experiment (Fig. 15):

turquoise  
purple  
yellow  
(with flowing transitions; on a white background)

Both colour series are equally multi-coloured. They display the same colour diversity and the same blurred boundaries in colour transitions. Moreover, they exhibit the same geometry. See Fig. 16. All these structural analogies occur if the projectors, prisms, and screens are arranged identically in both set-ups and if the slides are perfect geometric counterpoints of each other. The only differences between the two series are the colours themselves. The second colour series is the exact complement of the first (including both the blurred boundaries and the respective background colours).

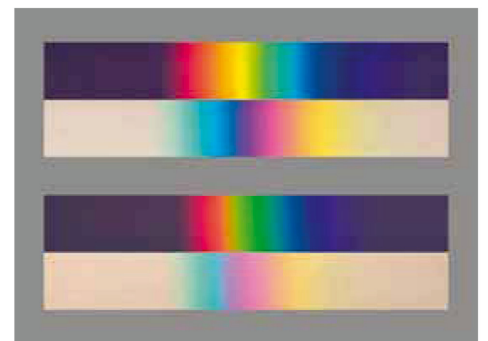
This effect is most easily apparent to those who have the relevant background knowledge; that is to those who realize the relationship between the original experiment and this reversed version. A new form of symmetry is offered to the mind's eye. Unlike before, the symmetry exhibited does not concern time's direction (as in the symmetry between white analysis and white synthesis, or as in Bach's crab canon). Now we have a symmetry in the colour tones; in the observable material itself. This type of symmetry is also well-known in music, as in Bach's *The Art of the Fugue (Kunst der Fuge)*, where the tones are mirrored along a horizontal axis: Each skip a fifth *upwards* (from the first *Mirror Fugue* BWV 1080/12<sub>1</sub>) matches a mirror jump a fifth *downwards* (from the second *Mirror Fugue* BWV 1080/12<sub>2</sub>). This musical symmetry corresponds nicely to its visual counterpart, as each of the colour tones in the original image is transformed into its complement.

That very reversal affects the *whole* colour image, with each blurry boundary between the main colours red, green, and blue. Thus, the new experiment exposes a new, more comprehensive counterpoint in the colour cosmos than previously witnessed. The three pairs of colour counterpoints from section XIII only concerned the discrete, synthesized main colours. They did not concern any of their transitions. The new experiment extends the motif of colour counterpoint from the realm of the discrete to the realm of continuity. That's both surprising and beautiful.

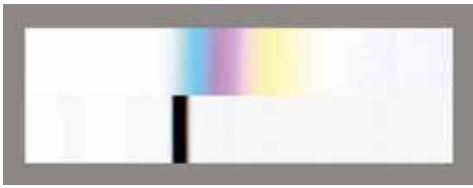
11 See, e.g., Goethe [EF], [GTC], [ToC]:§331.



**Fig 15** *The reversed Newtonian spectrum* [I.N. 2009]. Left: turquoise; in the middle: purple; right: yellow – with flowing transitions. These colours are the counterpoints to the colours of the Newtonian spectrum (Fig. 3).



**Fig 16** *Two Newtonian spectra with their corresponding counterpoints* [I.N. 2009]. You see a Newtonian spectrum at the top, resulting from a widely opened gap on the slide, and its complementary counterpart with exactly the same geometry. The pair of spectra at the bottom results from a comparatively narrow gap on the slide.



**Fig 17** Nussbaumer's black synthesis [I.N. 2009]. The top of the figure shows a picture of the complementary spectrum. The bottom shows a picture of it taken by a camera through the refracting prism. All the colours of the complementary spectrum converge and mix to black.

But it gets even better. The colour symmetries that until now only appear in the complementary reversal of the white analysis can be produced for each of the Newtonian experiments. Each of these experiments has its counterpoint. I had been promoting this daring claim in diverse lecture before I became acquainted with Ingo Nussbaumer's work. In particular, I predicted: As the white synthesis could be done with the colours red, green, and blue (together with their intermediary colour tones), it must be equally possible to perform its exact counterpoint – a black synthesis from turquoise, purple, and yellow (and their intermediary colour tones).

## XV Masterpiece black analysis

Empirical predictions are risky, especially when they come from the philosopher's arm chair. Back then I took the risk because I thought: The *colour* symmetry between white analysis and black analysis (known since Goethe) can be combined with the *time* symmetry between white analysis and white synthesis known since Desaguliers. Let us put both symmetries in the following table:

	↓ Colour axis of symmetry	
Time axis of symmetry →	White analysis	Black analysis
	White synthesis	?

Our sense of symmetrical beauty demands that we fill the open field. With what? With the black synthesis. The expected black synthesis would have to be related to the black analysis in just the same way as the white synthesis is related to the white analysis; in any case, that was my prediction back then.<sup>12</sup>

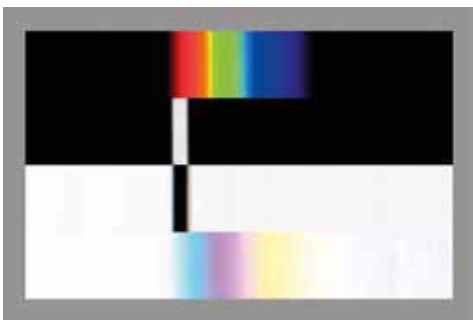
Those who claim that in the natural sciences a thought's beauty increases its credibility will find my prediction less daring than those who are not impressed by aesthetic symmetries in the natural sciences.

Of course, the beauty of a prediction does not prove its truth. That is what we need experiments for. But this does not make the prediction's beauty worthless. Just the reverse, it makes it rational to invest research resources and bet, as it were, on the truth of a beautiful prediction.

In the case of my prediction that proved unnecessary, as Nussbaumer had already performed the empirical work. Unbeknownst to me, he had accomplished the black synthesis at the end of the twentieth century. If I had known about it, I would have had fewer sleepless nights.

Can you guess how it works? It is as simple as the white synthesis. Nussbaumer looks through the prism at the projected complementary spectrum, and sees its synthesis: a black stripe on a white background, as clean and sharp as in the white synthesis (Fig. 17). Even by itself the black synthesis shows all the facets of beauty that I ascribed before to the white synthesis (Section VIII). But due to the perfect colour symmetry between the two experiments more beauty has been brought into the world; as only now is the doubly symmetrical schema complete.

This double symmetry has a counterpart in music. Schönberg's twelve tone series, for example, varies both through the reversal of time (as a crab, like in Bach's *Crab Canon*), and also through switching the direction of step in tone (as inversion like in Bach's *Mirror Fugues*). According to the rules of twelve tone music, both symmetry variations can occur simultaneously (which is called "crab inversion"). Schönberg's *Präludium der Suite für Klavier op. 25* provides examples of such double variation. To be sure, the rules of variation in twelve tone music are a little more relaxed than what would be demanded by strict symmetries. Each variation on the original series does not have to start with its first note; it can have any of its notes as its starting point. The twelve tone composer has more than four degrees of freedom (more, that is, than the four possibilities corresponding to the four fields in our schema above). According to these relaxed rules of the game, the time symmetries are well-hidden. Only someone who would be able to hear a twelve tone series in a *circle* of reversed time could claim that real time symmetry is audible in twelve tone music freed up in this way. Too difficult for us humans.



**Fig. 18** Nussbaumer's white and black syntheses in synopsis [I.N. 2009]. The top of the figure shows a picture of the Newtonian spectrum (and directly below the white that results). The bottom shows a picture of the complementary spectrum (and directly above the black that results).

12 O.M. [GPUB]:95–96.

## XVI Sevenfold counterpoint

How far do the symmetries in the colour cosmos reach? Thanks to Nussbaumer we have an answer: Wherever you look in our cosmos of colours, there are multi-coloured counterpoints. The sevenfold colour synthesis has a sevenfold counterpoint. To prove this, it suffices to throw a single optical switch. The appropriate parts of the complementary spectrum have to be eliminated complementarily, that is, not in front of a dark background (as before), but in front of a *white* background. Suppose, for example, we wish to see the synthesis of the yellow and purple parts of the complementary spectrum (see Fig. 19). This means that we have to erase the colour turquoise (far left in Fig. 15) from the complementary spectrum – erase it complementarily, that is. It must be swallowed not by darkness but by brightness. How to execute this idea? The holes in the cut screen should no longer be windows of darkness; they must be windows of lightness, of white light. Without metaphor: Nussbaumer closes the gaps in the cut screen with a white, semi-transparent screen (see Fig. 20), which he lights from behind with a second projector. As long as the first (original) projector stays off, the rows of the newly produced screen look like combinatory counterpoints of the rows in the original cut pattern. Where before we saw darkness, now we see white, and vice versa.

Next Nussbaumer puts the new slide into the old projector. In the fourth (uncut) row, the entire complementary spectrum that we already know can be seen. In the other rows, we see combinations of either one or two fields from that spectrum. Each missing field looks almost white (or anyway beige), as the strong white light (illuminating the transparent screen from behind) blends out the corresponding parts of our spectrum. So we have a sevenfold counterpoint to the multi-coloured pattern of the earlier sevenfold experiment. (Although up-side down, see Fig. 20 in a counterpoint comparison with Fig. 12. To compare the multi-coloured illuminated screens, see Fig. 21 and its counterpart Fig. 13. All four of these images are shown in the synopsis of Fig. 23, left and middle columns).

Time for the new colour synthesis. Once again Nussbaumer looks through the water prism in the direction of the projected slide. The black synthesis in the fourth row is no longer surprising, but the syntheses in the other six rows are all the more fascinating (see Fig. 22):

row	original series	complementary series	row
1	red = red	turquoise = turquoise	7
2	yellow = red + green	blue = turquoise + purple	6
3	green = green	purple = purple	5
4	white = red + green + blue	black = turquoise + purple + yellow	4
5	turquoise = green + blue	red = purple + yellow	3
6	purple = red + blue	green = turquoise + yellow	2
7	blue = blue	yellow = yellow	1

In summary, all colour syntheses occur precisely according to what our sense of symmetry demands and predicts. For example, red is shown (against a white background) as a mixture of yellow and purple (Fig. 22, third row) – just as in the original series (with black background), turquoise appears as a mixture of blue and green.



Fig 15 The reversed Newtonian spectrum [I.N. 2009].

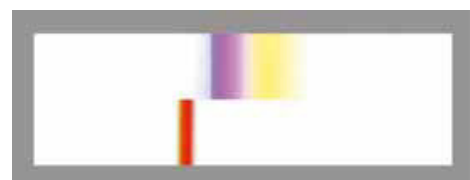
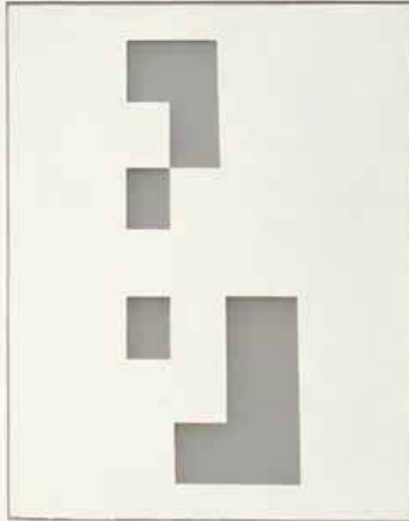


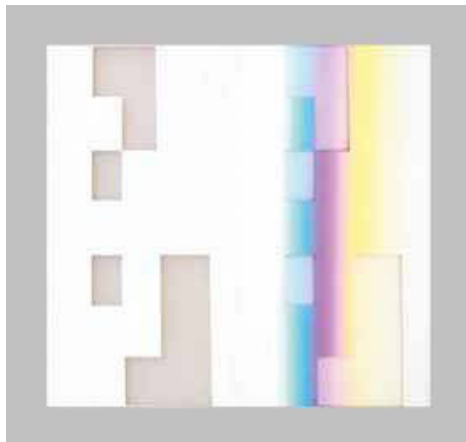
Fig 19 Nussbaumer's red synthesis [I.N. 2009]. The top of the figure shows a picture of the complementary spectrum from which the left turquoise part is removed. The bottom shows a picture of this fragmented spectrum (without turquoise) taken by a camera through the refracting prism. Purple and yellow from the complementary spectrum (all its colours except turquoise) converge and are mixed to red.



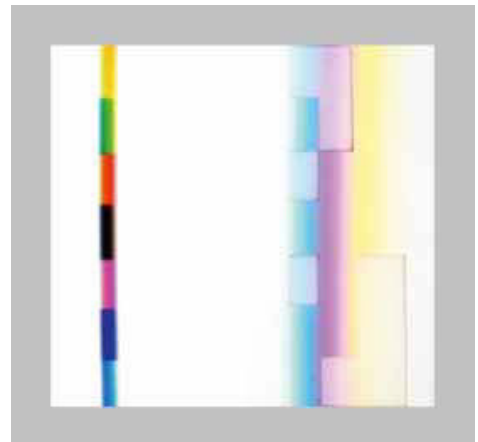


**Fig 20** *Nussbaumer's counterpoint (upside-down) to the original pattern* [photo: I.N. 2009]. What were once windows to darkness (Fig. 12) are now taped closed with transparent paper (and then later illuminated from behind). A complication deserves noting. If you compare this figure with Fig. 12, you will see

that Ingo Nussbaumer also reversed the order of the combinations, upside-down as it were. For example, where there was a window into darkness (ochre) in Fig. 12 in the second row, there is now a window of brightness (grey) in the second to last row – just as in the first and last rows, etc.



**Fig 21** *Nussbaumer's new pattern complementarily illuminated, [montage: I.N. 2009]. On the left, the newly cut screen (Fig.20) is illuminated from the front by a wide complementary spectrum (Fig.15) and simultaneously by equally strong white light from behind (right part of the figure). Parts of the spectrum are thereby blended out, that is, inversely cut away. This is the starting image for the sevenfold complementary colour synthesis.*



**Fig 22** *Nussbaumer's counterpoint to the original seven-fold colour synthesis [I.N. 2009]. If you look through a prism at the screen with its windows of brightness (right half) when it is illuminated by the complementary colours, you see again all six main colours, only in a different order. Top: yellow, green, red – bottom: purple, blue, turquoise. The black synthesis is in the middle. If you switch the top and the bottom in this picture, you get the exact complement to Fig. 14.*

## XVII Comprehensive symmetry

The new experiment is in itself as aesthetic as its counterpart; again our sense of beauty is stimulated by the clean colours and their geometric precision. And as before, the interplay between the multi-coloured continuum on the screen and the discrete order in the prismatic syntheses fascinates us too.

But something else evokes our sense of beauty more strongly than could be evoked by looking at each of the sevenfold syntheses separately. The perfect colour symmetry *between* the two experiments is both pleasing to our eyes and to our mind's eye. It triggers our sense of order. Here we encounter beauty on a higher level. It arises from the symmetrical relation between two experiments, each of which is already beautifully ordered.<sup>13</sup> On the same higher level, there is additional beauty in Bach's *Kunst der Fuge*, when each of the fugues (BWV 1080/12<sub>1</sub>, and its mirror image BWV 1080/12<sub>2</sub>) are compared with one another.

In order to get a better overview of the bewitching order of the experimental results, Nussbaumer presents them in two-dimensional diagrams: see Fig. 24. They are of aesthetic value, as they offer the first step toward systematizing the phenomena with basic mathematical tools. The diagrams reflect order and symmetry in the cosmos of colour phenomena. They do not say where this order and symmetry come from. They offer no theoretical explanation – no theory.<sup>14</sup> For Ingo Nussbaumer theoretical austerity is the program. He is an artist who strives after the regularities exhibited by colour phenomena. What he discovered is not just visually beautiful, but also quite elegant structurally. Where the hell do these symmetries come from?<sup>15</sup>

13 With the help of a fascinating series of experiments that I can only briefly mention here, Nussbaumer shows that this beauty is only the peak of an iceberg with a much deeper beauty – both highly symmetrical and multi-coloured. If you start with complementary colour contrasts instead of just a black and white contrast, then six additional colour spectra appear, each exhibiting exactly the same symmetry that I just mentioned. Nussbaumer calls these spectra "disorderly spectra" (without pejorative undertones), see Nussbaumer [zF]:200–206 et passim. He will demonstrate these spectra in September 2010 at the Humboldt-Universität zu Berlin in an exhibition called *Working Shade – Formed Light (A Serial Color Project)*. I give a short summary in O.M. [NFd], section V.

14 See – following Goethe – Nussbaumer [zF]:25–28. Ingo Nussbaumer suggests that instead of theoretical terms, we use terms that are semantically open; see Nussbaumer [zF]:197, 206.  
15 This is a translation of a shortened version of a philosophical case study on beauty in the sciences. I thank Sophie De Beukelaer, Astrid Schomäcker and Saad Nasir for diverse advice concerning music; Matthias Herder for help with the figures; and Ingo Nussbaumer for tireless support and all the images illustrating the text. I also thank Matthias Rang, Hannah Riniker, Janila Ruck, and Astrid Schomäcker for comments on an earlier draft of the text, and Ingo Nussbaumer for suggestions on at least two dozen earlier versions. Thanks to Eric Oberheim for help with the translation.

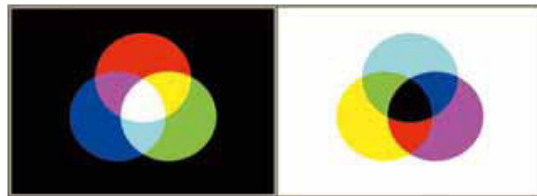
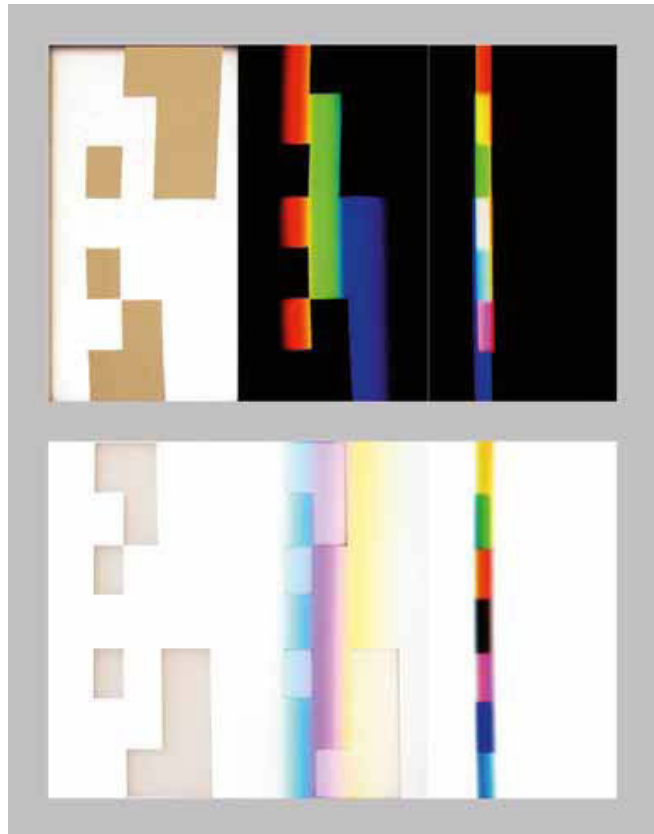
### Bibliography

Desaguliers, J.T. [AoSE]: "An account of some experiments of light and colours, formerly made by Sir Isaac Newton, and mention'd in his Opticks, lately repeated before the Royal Society by J. T. Desaguliers, F. R. S." *Philosophical Transactions* (1683–1775), Bd.29 (1714–1716), pp.433–447.  
Dirac, Paul [ToT]: "The test of time". *The Unesco Courier*, Jahrgang 32 (Mai 1979) pp. 17–23.  
Dorn, Friedrich/Bader, Franz [PM]: *Physik Mittelstufe*. (Hannover: Schroedel, 1974).  
Glasauer, Stefan/Steinbrenner, Jakob (Hg.) [F]: *Farben*. (Frankfurt/M.: Suhrkamp, 2007).  
Goethe, Johann Wolfgang von [EF]: *Entwurf einer Farbenlehre. Des ersten Bandes erster, didaktischer Teil*. In Goethe [SzN] I.4: 11–266. (= LA I.4, pp. 11–266). [For an English translation, see Goethe [GTC], [ToC]].  
Goethe, Johann Wolfgang von [GTC]: *Goethe's theory of colours*. Translated into English by Charles Lock Eastlake (London: Murray, 1840). Reprinted in 1970 by MIT Press, Cambridge. [English translation of Goethe [EF]].  
Goethe, Johann Wolfgang von [SzN] I.4: *Die Schriften zur Naturwissenschaft. Erste Abteilung, Band 4. Zur Farbenlehre: Widmung, Vorwort und didaktischer Teil*. (Rupprecht Matthaei (ed); Weimar: Hermann Böhlau Nachfolger, 1955). (= LA I.4).  
Goethe, Johann Wolfgang von [SS]: *Scientific studies. The collected works. Volume 12*. (Edited and translated by Douglas Miller; Princeton: Princeton University Press, 1995).  
Goethe, Johann Wolfgang von [ToC]: *Theory of color: Didactic section*. In Goethe [SS]: 157–302. [English translation of Goethe [EF]].  
Heisenberg, Werner [aF]: *Across the frontiers*. (Translated by Peter Heath; New York: Harper and Row, 1974). [English translation of Heisenberg [SuG]]

Heisenberg, Werner [BSIE]: *Die Bedeutung des Schönen in der exakten Naturwissenschaft*. In Heisenberg [SuG]: 288–305. [For an English translation, see Heisenberg [MoBi]].  
Heisenberg, Werner [MoBi]: *The Meaning of beauty in the exact sciences*. In Heisenberg [aF]: 166–183. [English translation of Heisenberg [BSIE]].  
Heisenberg, Werner [Pb]: *Physics and beyond: Encounters and conversations*. (Translated by Arnold J. Pomerans; New York, Harper and Row, 1971). [English translation of Heisenberg [TG]].  
Heisenberg, Werner [SuG]: *Schritte über Grenzen. Gesammelte Reden und Aufsätze*. (München: Piper, 1971). [For an English translation, see Heisenberg [aF]].  
Heisenberg, Werner [TG]: *Der Teil und das Ganze. Gespräche im Umkreis der Atomphysik*. (München: Deutscher Taschenbuchverlag, 6. Auflage 1981). [For an English translation, see Heisenberg [Pb]].  
Lohne, Johannes A. [IN]: *Isaac Newton: The rise of a scientist 1661–1671. Notes and records of the Royal Society of London 20* (1965), pp. 125–139.  
Müller, Olaf [GPub]: *Goethes philosophisches Unbehagen beim Blick durchs Prisma*. In Glasauer, Steinbrenner (Hg.) [F]: 64–101. [For an English version, contact muelleol@staff.hu-berlin.de].  
Müller, Olaf [NFd]: *Die Neuvermessung der Farbenwelt durch Ingo Nussbaumer. Eine kleine Sensation*. In Nussbaumer [zF]: 11–20.  
Newman, Barnett [SI]: *Schriften und Interviews. 1925–1970*. (Aus dem Amerikanischen von Tarcisius Schelbert; Bern: Gachnang und Springer, 1996).  
Newman, Barnett [SW]: *Selected writings and interviews*. Edited by John O'Neill. (New York: Alfred A Knopf, 1990).  
Newton, Isaac [NTaL]: *A new theory about light and colors. Philosophical Transactions* 80 (19. Februar, 1672), pp.3075–3087.

Nussbaumer, Ingo [zF]: *Zur Farbenlehre. Entdeckung der unordentlichen Spektren*. (Wien: Edition Splitter, 2008).  
Weinberg, Steven [TeU]: *Der Traum von der Einheit des Universums*. (Aus dem Amerikanischen von Friedrich Griese; München: Bertelsmann, 1993).  
Weinberg, Steven [ToFT]: *Dream of a final theory*. (New York: Random House, 1992).  
Wittgenstein, Ludwig [LCoA]: *Lectures & conversations on aesthetics, psychology and religious belief*. (Compiled from notes taken by Yorick Smythies, Rush Rhees and James Taylor, edited by Cyril Barrett; Berkeley/Los Angeles: University of California Press, 1967).  
Wittgenstein, Ludwig [LoA]: *Lectures on aesthetics*. In Wittgenstein [LCoA]: 1–40.  
Wittgenstein, Ludwig [VGüÄ]: *Vorlesungen und Gespräche über Ästhetik, Psychoanalyse und religiösen Glauben*. (Yorick Smythies/Rush Rhees/James Taylor (Hg.); aus dem Englischen von Ralf Funke; Stuttgart: Fischer, 3. Auflage 2004). [German translation of Wittgenstein [LCoA]].  
Wittgenstein, Ludwig [VüÄ]: *Vorlesungen über Ästhetik*. In Wittgenstein [VGüÄ]. [German translation of Wittgenstein [LoA]].

**Fig 23** *Comparison of both seven-fold colour syntheses [montage: I.N. 2009]. Left: each of the two slides; in the middle: the fragmented spectra as starting points (as they appear when illuminated by the spectrum); right: each of the seven-fold syntheses.*



**Fig 24** *Two seven-fold colour syntheses [graphic: Ingo Nussbaumer [zF]: 133]. Left: the resulting syntheses from the original experiment (Fig. 13); right: their counterpoints.*



