

Optical Response of MoSe₂ Crystals

H. S. Patel¹, S. P. Shukla², Hitesh Parmar³, R. K. Shah³, V. M. Pathak⁴

¹Arts, Commerce & Science College, Borsad, Gujarat State, India

²V. P. & R. P. T. P. Science College VallabhVidyanagar, Gujarat State, India

³Arts, Commerce & Science College, Bhadran, Gujarat State, India

⁴Department of Physics, Sardar Patel University, VallabhVidyanagar, Gujarat State, India

ABSTRACT

Solar power is a very important source of renewable energy for many low power systems. Matching the power consumption level with the supply level can make a great difference in the efficiency of power utilization. MoSe₂ crystals (photo-electrodes) have been grown via a direct vapour transport technique. This paper presents results of Photo Voltage (V_{ph}) Vs. Photo current (I_{ph}) curves measured for MoSe₂ crystals of different Intensity levels between 10, 20, ... 100W/cm² in Polychromatic as well as Monochromatic light. We finding the Open circuit Voltage (V_{oc}), Short circuit current (I_{sc}), fill factor and photo conversion efficiency (η) of MoSe₂ crystals. The Photo conversion efficiency of this MoSe₂ crystals are less than 0.1% in Polychromatic light but nearly 1% in Monochromatic light.

1. INTRODUCTION

Photovoltaic which also known as a PV, solar energy conversion system are the most widely used power systems. However, these devices suffer of very low conversion efficiency. This is due to the wavelength mismatch between the narrow wavelength band associated with the semi conductor energy gap and the broad band of the (blackbody) emission curve of the Sun.

The MoSe₂ crystals were grown by direct vapor transport technique using dual zone horizontal Furnace. We take its optical response in poly chromatic light as well as mono chromatic light. In mono chromatic light we used filter paper for 4725 Å, 5325 Å, 6050 Å and 6850 Å and finding different parameter like short circuit current, Open circuit voltage and photo conversion efficiency of MoSe₂ crystals.

2. EXPERIMENTAL

The MoSe₂ crystals were grown by direct vapour Transport techniques using dual zone horizontal Furnace. We prepared two electrodes using grown MoSe₂ crystals, Theohmiccontacts were made in plane geometry on the periphery of irregularly shaped crystals by using conductive silver paste (Elteck-1228C) and copper wire (0.285 mm). We used tungsten filament lamp for polychromatic illumination and filter paper for monochromatic illumination.

3. RESULTS AND DISCUSSIONS

In this invistigation we prepared MoSe₂ electrodes among these, two electrodes are selected for the detailed studies of optical response. Figure 1 shows the simple circuit diagram for study of optical response. The photovoltage \rightarrow photocurrent characteristics of MoSe₂ crystals have been shown in figure 2 and figure 3. All these figures contain the data regarding the variation of photovoltage and photocurrent for different intensities of incident polychromatic illuminations. The range of intensity of these polychromatic illuminations was from 10 mW/cm² to 100 mW/cm². From all these figure, it is quite evident that the photovoltage \rightarrow photocurrent characteristics at all the intensities for all the electrodes exhibit the similar nature. All the characteristics have a diverging nature wherein the photovoltage is increase as the series resistance increase which is connected in circuit shown in figure 1. For all monocromatic as well as polycromatic ight (4725 Å, 5325 Å, 6050 Å and 6850 Å)[1-6]. It is also observed that open circuit voltage (which is always measured under the condition of no resistance connected in the external circuit) and short circuit current (which is measured under the short circuit conditions) increase with increase in intensity. It is also quite evident from all figures corroseponding to all solar cell structures that area under photovoltage \rightarrow photocurrent characteristics increases with increase in intensity of incident polychromatic illumination. This is obviously an expected result because the increase in the intensity of incident illumination directly means that the number of quanta available to the absorbed by the semiconductor increases. The absorption of these quanta by the semiconductor leads to the photogeneration of the charge carriers which increases with the intensity of illumination. This ultimately lead to the improvement in the overall photovoltage \rightarrow photocurrent characteristics of the solar cells. The large deviation of photovoltaic characteristics from the ideal behaviour may be attributed to the fact that there are various parameters associated with the semiconducting material, which govern the effective photogeneration and charge transfer mechanism in the semiconductor interface[7,8]. Since in present case, all the photovoltaic characteristics deviate from the ideal behaviour, it can be concluded that the semiconductor

parameters of the semiconducting materials have a large contribution to mar the photovoltaic behaviour. It is also possible that the bend bending which is required for better quality. But the photovoltaic characteristics observed in all the cases confirm the following facts[9].

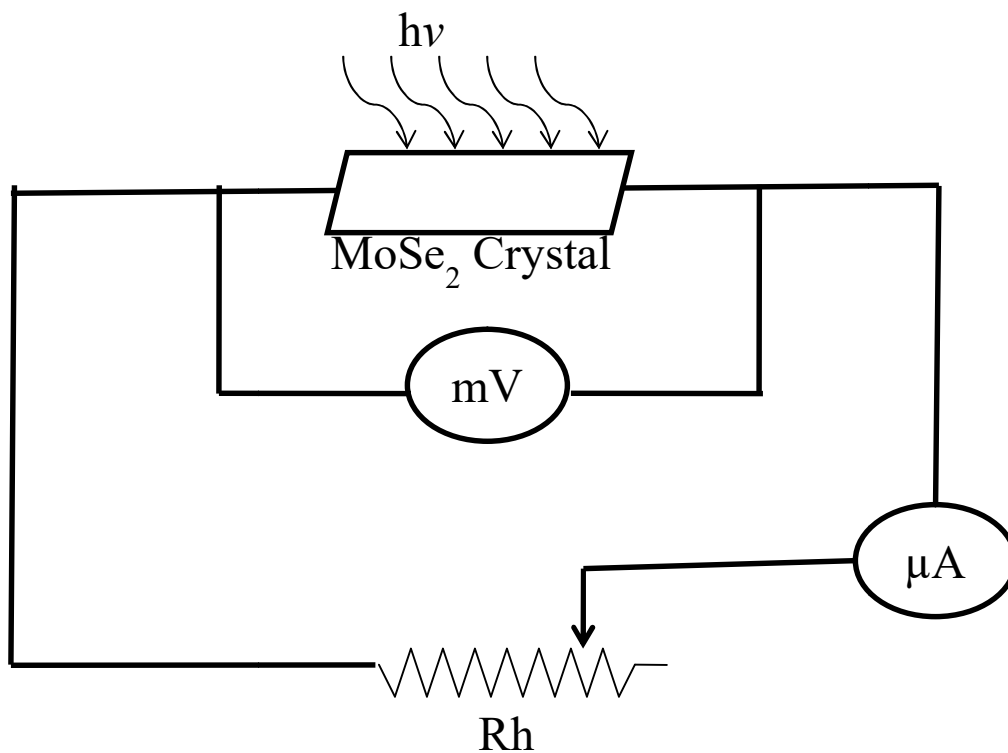

Figure 1. Simple circuit diagram of MoSe₂ crystal Optical Response.

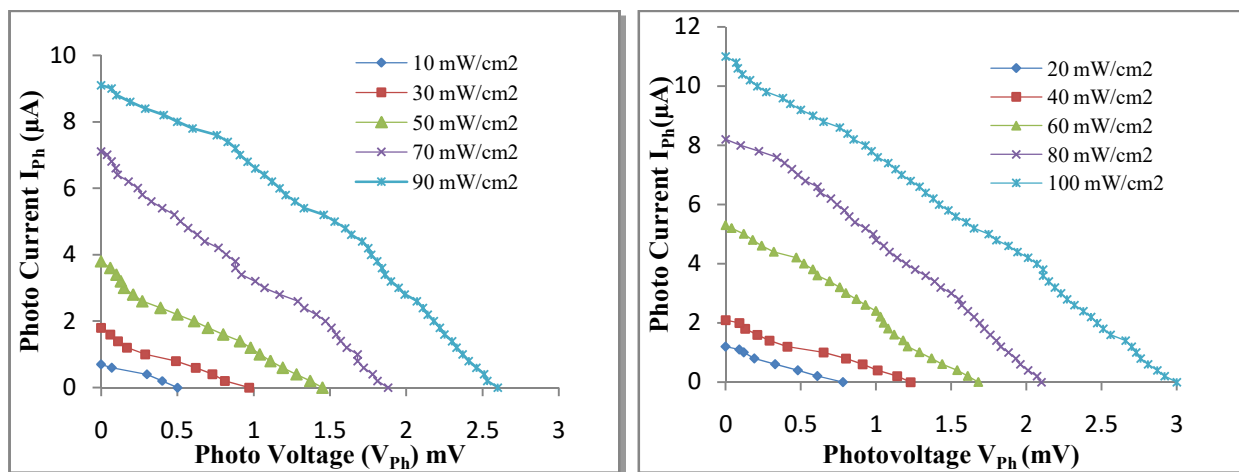

Figure: 2. $V_{ph} \rightarrow I_{ph}$ characteristics of MoSe₂ crystal at different intensities of illuminations (Polychromatic light) for sample 1.

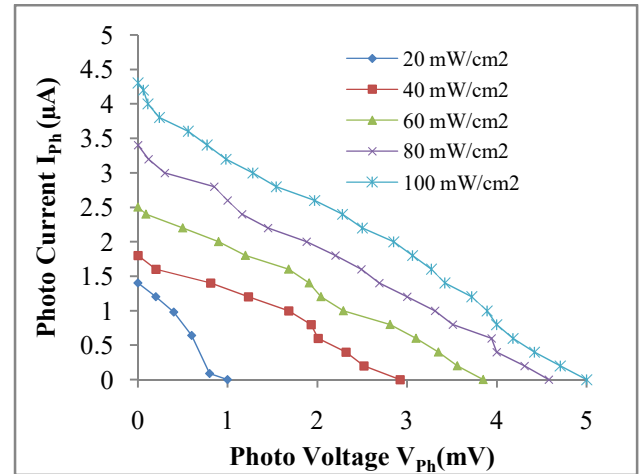
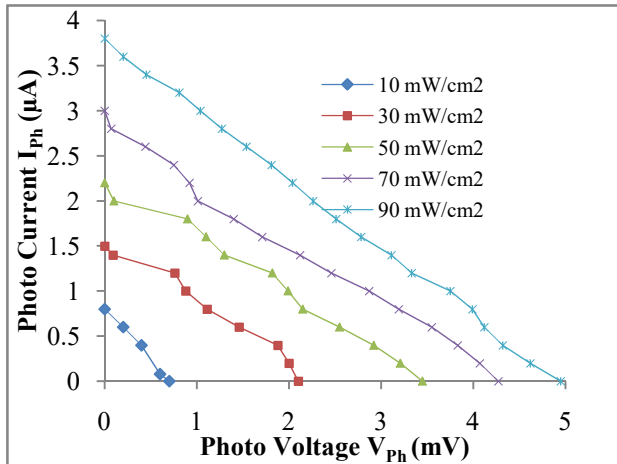

Figure: 3. $V_{ph} \rightarrow I_{ph}$ characteristics of $MoSe_2$ crystal at different intensities of illuminations (Polychromatic light) for sample 2.

We take optical response of $MoSe_2$ crystals and estimate the below parameters, [10]

1. Short circuit current
2. Open circuit voltage
3. Fill factor
4. Incident Photoconversion efficiency

3.1. Short circuit current (I_{sc})

Ideally, this is equal to the light generated current I_L . The current measured directly across the electrode in the absence of any load (without load) in the external circuit is referred to as the short circuit current. It is given as,

$$I_{sc} = I_0 \left[\exp\left(\frac{eV_{oc}}{kT}\right) - 1 \right] \quad (1)$$

This parameter depends on the band gap of the semiconductor. Smaller the band gap greater is the expected short circuit current.

3.2. Open circuit voltage (V_{oc})

The voltage measured in plane of the $MoSe_2$ crystals when there is infinite load (i.e. open circuit) in the circuit is termed as the open circuit voltage. It can be written as,

$$V_{oc} = \left(\frac{nkT}{e} \right) \ln(I_L) \quad (2)$$

where n = ideality factor
 $kT/e = 0.0259$ volt (at =300K)
 I_L = Intensity of illumination

Thus, the open circuit voltage is expected to increase with the increase in the incident illumination intensity and both samples have same behavior. In comparison of open circuit voltage and short circuit current for monochromatic is higher than open circuit voltage and short circuit current for polychromatic illumination.

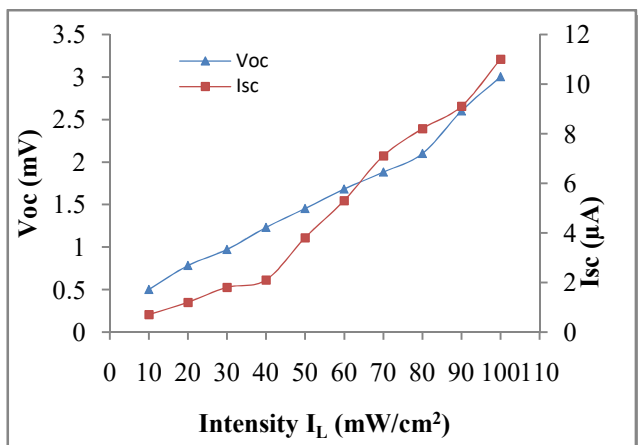

Sample : 1

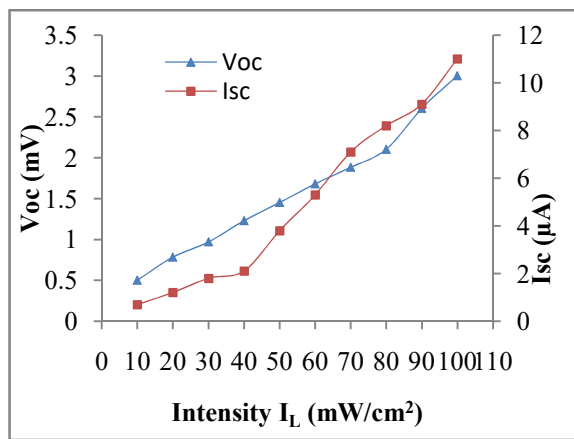

Sample : 2

Figure 4. V_{oc} , $I_{sc} \rightarrow I_L$ characteristics of $MoSe_2$ crystals at different intensities of illuminations (Polychromatic) for sample1 and 2.

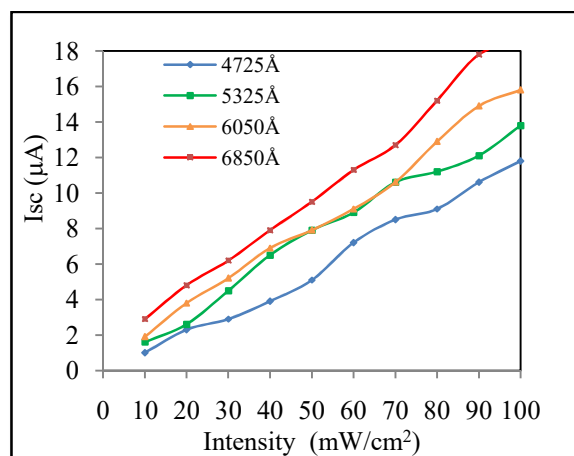
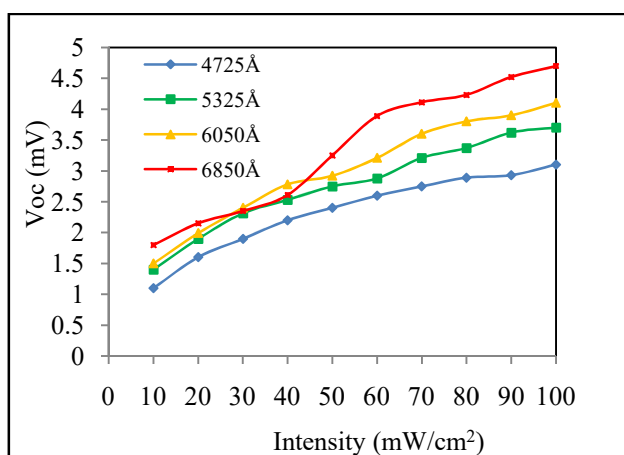

Figure 5. $V_{oc} \rightarrow I_L$ and $I_{sc} \rightarrow I_L$ characteristics of $MoSe_2$ crystals at different intensities of illuminations (Monochromatic) for sample1.

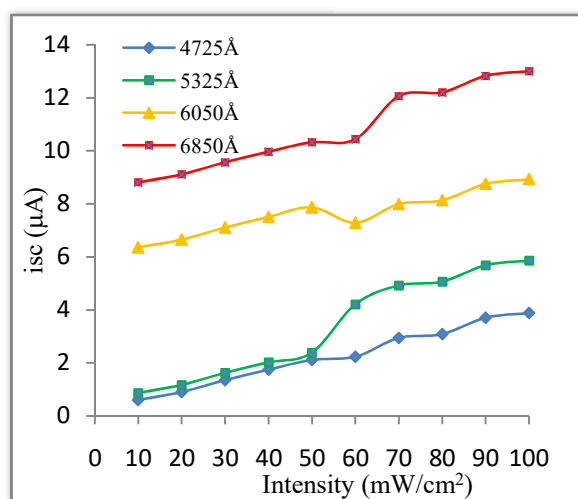
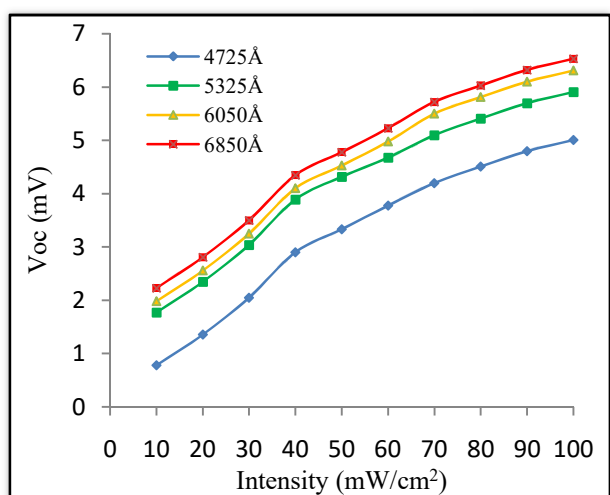

Figure 6. $V_{oc} \rightarrow I_L$ and $I_{sc} \rightarrow I_L$ characteristics of $MoSe_2$ crystals at different intensities of illuminations (Monochromatic) for sample2.

3.3 Fill factor

We draw the photovoltage (V_{ph}) – photocurrent (I_{ph}) characteristics of $MoSe_2$ crystals at polychromatic light and calculated some parameters of term used to express this departure is known as the fill factor (F.F.) defined as,

$$\text{Fill Factor} = \left(\frac{J_{mp} * V_{mp}}{J_{sc} * V_{oc}} \right) \tag{3}$$

where $J_{mp} = \left(\frac{I_{mp}}{Area} \right)$ and $J_{sc} = \left(\frac{I_{sc}}{Area} \right)$

where J_{mp} = the current density at maximum power point

V_{mp} = the voltage at maximum power point

I_{mp} = the short circuit current at maximum power point

J_{sc} = short circuit current density

V_{oc} = open circuit voltage

3.4 Photoconversion Efficiency (η)

The photoconversion efficiency of solar cells is given by the relation,

$$\eta = \left(\frac{V_{mp} * J_{mp}}{I_L} \right) \tag{4}$$

I_L = the intensity of incident illumination.

The photoconversion efficiency and a fill factor were calculated for all solar cell structures under investigations for all the intensities of incident illuminations. The variation of the photoconversion efficiency and fill factor with the incident illumination intensity for all the solar cell structures has been shown in figures 7. From figure 7, we can conclude that as the intensity increase fill factor and photoconversion efficiency is decrease and increase respectively. The values of photoconversion efficiencies were found to be less than 0.1% which is significantly low. So, it can be said that the solar cell structure fabricated in present investigations have so many factors governing the overall photoconversion mechanism [10-17].

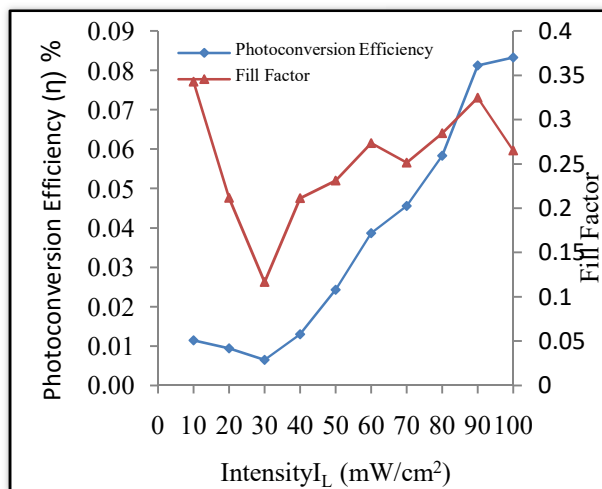

Sample : 1

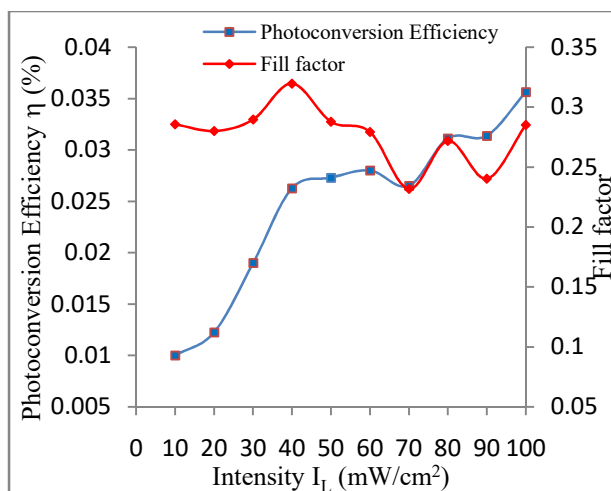

Sample : 2

Figure 7. Variation of photoconversion efficiency (η) and fill factor with intensity of illuminations (polychromatic light) for Sample 1 and 2.

We take also optical response of $MoSe_2$ crystals of Monochromatic light at 4725 Å, 5325 Å, 6050 Å and 6850 Å, and estimating the photoconversion efficiency for studying particular wavelength by using formula (Eq. 4). The values of photoconversion efficiencies were found to be nearly 1% which is significantly low.

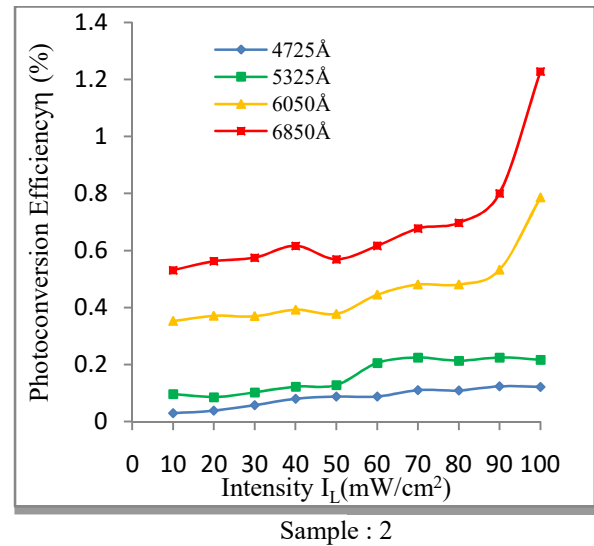
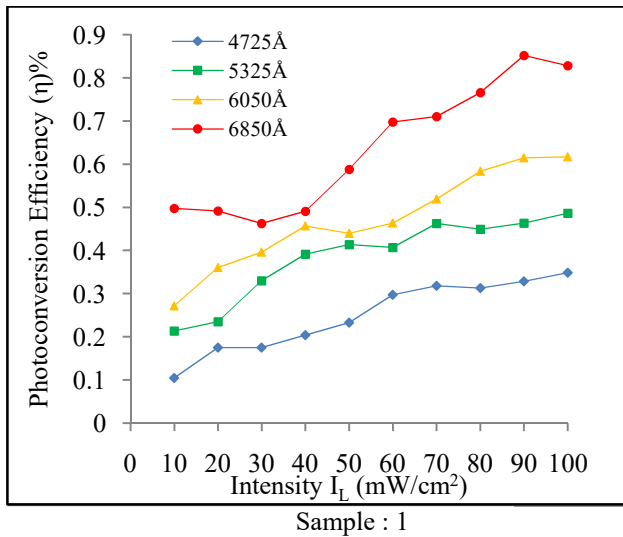

Figure 8. Variation of photoconversion efficiency (η) with intensity of illuminations (Monochromatic light) for Sample 1 and 2.

4. CONCLUSION

A photovoltaic cell consists of light absorbing material which is connected with external circuits in asymmetric manner. Charge carriers are generated in the material by the absorption of photon of light, and are driven towards one or other of the contact by the built in spatial asymmetry. When a load connected to external circuit, the cell produce current and voltage and can to electric work this light driven charge separation established a photovoltage at open circuit & generated a photocurrent at short circuit.

We are finding the photo conversion efficiency of MoSe₂ crystals in polychromatic light nearly 0.1% and monochromatic light nearly 1%.

5. REFERENCES

- 1) B Bhattacharya, S. K. Tomar and Jung – Ki Park *Nanotechnology*, **18**(2007) 48571.
- 2) M. S. Kang *et al.*, *Chem. Commun.*, (2005) 889.
- 3) Fei Cao, Gerkooskam and Peter C. Searson, *J. Phys. Chem.*, **99** (1995) 17071.
- 4) A F Nogueira *Solar energy Materials & Solar Cells*, **61** (2000) 135.
- 5) C Fang, Qianfeixu *Applied Physics Letters*, ISSN 0003-6951 **84** (2004) 31813.
- 6) C. D. Lokhande and Pawar S. H., *Solar Energy Mater.*, **7** (1982) 313.
- 7) J. F. McCann, M Kazacos and D Haneman, *Nature*, **289** (1981) 780.
- 8) Lynn F. Schneemeyer and Mark S. WrightonSchneemeyer, *Appl. Phys. Lett.*,
- 9) V. M. Pathak & R. Srivastava, *Nat. Acad. Sci. letters*, **12**, No, 11 (1989).
- 10) martin A. Green, *Solar cells operating principles, technology and system applications*, Nick Holonyak, Jr., Editor
- 11) Fei Cao, GerkoOskam, and Peter C. Searson, *J. Phys. Chem.* (1995), **99** 17071.
- 12) B. Bhattacharya, S. K. Tomar and Jung – Ki Park, *Nanotechnology*, **18**(2007) 48571.
- 13) Marco A. De Paoli, A F. Nogueira *Solar energy Materials & Solar Cells*, **61**(2000)135
- 14) M. M. Salleh, M.Y.A Rahman, I. A.Talib & A. Ahemed, *J. Current Appl.Phys.*, **7** Issues **4**, (2007), 446.
- 15) N. Mullen and D. Cahen, *Solar cells***9** (1983), 229.
- 16) M SkyallusKazacos., F.F.McCann and D. Haneman, *Solar Energy Mater.*, **4** (1981) 215.