

# Neutrosophic Crisp Set Theory

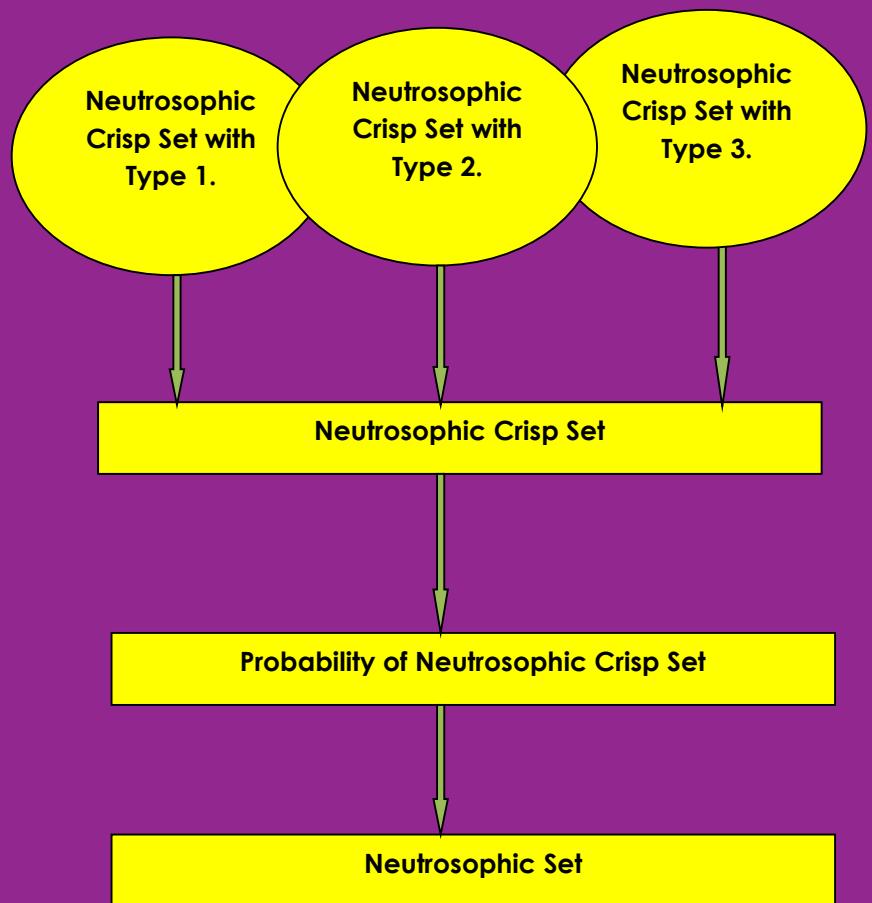

**A. A. Salama**

Department of Mathematics and Computer Science, Faculty of Sciences,  
Port Said University, Egypt  
[drsalama44@gmail.com](mailto:drsalama44@gmail.com)

**Florentin Smarandache**

Department of Mathematics, University of New Mexico Gallup, NM, USA  
[smarand@unm.edu](mailto:smarand@unm.edu)

# **Neutrosophic Crisp Set Theory**

**Educational Publisher  
Columbus / 2015**

*Peer Reviewers:*

*Prof. Rajesh Singh*, School of Statistics, DAVV, Indore (M.P.), India.

*Dr. Linfan Mao*, Academy of Mathematics and Systems,  
Chinese Academy of Sciences, Beijing 100190, P. R. China.

*Mumtaz Ali*, Department of Mathematics, Quaid-i-Azam University,  
Islamabad, 44000, Pakistan

*Said Broumi*, University of Hassan II Mohammedia,  
Hay El Baraka Ben M'sik, Casablanca B. P. 7951, Morocco.

*Copyright:* © Publisher, A. A. Salama, Florentin Smarandache 2015

**The Educational Publisher, Inc.**  
**1313 Chesapeake Ave.**  
**Columbus, Ohio 43212**  
**USA**  
**Toll Free: 1-866-880-5373**

ISBN 978-1-59973-323-4

# Contents

|  |    |
|--|----|
| Neutrosophic Science .....             | 23 |
| 1. Neutrosophic Crisp Set Theory ..... | 27 |
| 1.1 Neutrosophic Crisp Set .....       | 27 |
| Definition 1.1.1 .....                 | 27 |
| Definition 1.1.2 .....                 | 27 |
| Remark 1.1.1 .....                     | 28 |
| Definition 1.1.3 .....                 | 28 |
| Definition 1.1.4 .....                 | 28 |
| Proposition 1.1.1 .....                | 29 |
| Definition 1.1.5 .....                 | 29 |
| Proposition 1.1.2 .....                | 29 |
| Proposition 1.1.3 .....                | 29 |
| Definition 1.1.6 .....                 | 30 |
| Definition 1.1.7 .....                 | 30 |
| Definition 1.1.8 .....                 | 30 |
| Definition 1.1.9 .....                 | 30 |
| Corollary 1.1.1 .....                  | 31 |
| Example 1.1.1 .....                    | 31 |
| Definition 1.1.10 .....                | 31 |
| Example 1.1.2 .....                    | 32 |
| Proposition 1.1.4 .....                | 32 |
| Definition 1.1.11 .....                | 33 |
| Corollary 1.1.2.....                   | 33 |
| Proof.....                             | 33 |

|  |    |
|--|----|
| 1.2 Neutrosophic Crisp Points.....         | 33 |
| Definition 1.2.1 .....                     | 34 |
| Theorem 1.2.1 .....                        | 34 |
| Proof.....                                 | 34 |
| Theorem 1.2.2 .....                        | 34 |
| Proof.....                                 | 34 |
| Proposition 1.2.1 .....                    | 34 |
| Proposition 1.2.2 .....                    | 35 |
| Proposition 1.2.3 .....                    | 35 |
| Definition 1.2.2 .....                     | 35 |
| Definition 1.2.3 .....                     | 35 |
| Definition 1.2.4 .....                     | 36 |
| Example 1.2.1 .....                        | 36 |
| Definition 1.2.5 .....                     | 36 |
| Proposition 1.2.4 .....                    | 36 |
| Proof.....                                 | 36 |
| Proposition 1.2.5 .....                    | 36 |
| Proof.....                                 | 37 |
| Proposition 1.2.6 .....                    | 37 |
| Proof.....                                 | 37 |
| Definition 1.2.6 .....                     | 37 |
| Proposition 1.2.7 .....                    | 37 |
| Proposition 1.2.8 .....                    | 38 |
| Proof.....                                 | 38 |
| 1.3 Neutrosophic Crisp Set Relations ..... | 38 |
| Definition 1.3.1 .....                     | 38 |
| Definition 1.3.2 .....                     | 38 |

|                                  |    |
|----------------------------------|----|
| Example 1.3.1 .....              | 39 |
| Example 1.3.2 .....              | 39 |
| Definition 1.3.3 .....           | 39 |
| Theorem 1.3.1 .....              | 40 |
| Proof.....                       | 40 |
| Definition 1.3.4 .....           | 40 |
| Definition 1.3.5 .....           | 40 |
| Example 1.3.3 .....              | 41 |
| Theorem 1.3.2 .....              | 41 |
| Proof.....                       | 41 |
| 2. Neutrosophic Set Theory ..... | 42 |
| 2.1 Neutrosophic Sets.....       | 42 |
| Definition 2.1.1 .....           | 42 |
| Remark 2.1.1 .....               | 43 |
| Remark 2.1.2 .....               | 43 |
| Example 2.1.1 .....              | 43 |
| Definition 2.1.2 .....           | 43 |
| Definition 2.1.3 .....           | 43 |
| Proposition 2.1.1 .....          | 44 |
| Definition 2.1.4 .....           | 44 |
| Definition 2.1.5 .....           | 44 |
| Definition 2.1.6 .....           | 44 |
| Proposition 2.1.2 .....          | 45 |
| Definition 2.1.7 .....           | 45 |
| Remark 2.1.3 .....               | 45 |
| Example 2.1.2 .....              | 45 |
| Example 2.1.3 .....              | 45 |

|  |    |
|--|----|
| 2.2 The Characteristic Function of a Neutrosophic Set..... | 46 |
| Definition 2.2.1 .....                                     | 46 |
| Proposition 2.2.1 .....                                    | 46 |
| Definition 2.2.2 .....                                     | 46 |
| Example 2.2.1 .....  | 46 |
| Definition 2.2.3 .....                                     | 47 |
| Definition 2.2.4 .....                                     | 47 |
| Proposition 2.2.2 .....                                    | 48 |
| Proposition 2.2.3 .....                                    | 48 |
| Definition 2.2.5 .....                                     | 48 |
| Proposition 2.2.4 .....                                    | 49 |
| Proposition 2.2.5 .....                                    | 49 |
| 2.3 Some Types of Neutrosophic Sets .....                  | 49 |
| Definition 2.3.1 .....                                     | 49 |
| Definition 2.3.2 .....                                     | 50 |
| Definition 2.3.3 .....                                     | 50 |
| Definition 2.3.4 .....                                     | 50 |
| Definition 2.3.5 .....                                     | 50 |
| Theorem 2.3.1 .....  | 51 |
| Proof.....   | 51 |
| Definition 2.3.6 .....                                     | 51 |
| Theorem 2.3.2 .....  | 52 |
| Proof.....   | 52 |
| Definition 2.3.7 .....                                     | 52 |
| Definition 2.3.8 .....                                     | 52 |
| Definition 2.3.9 .....                                     | 52 |
| Definition 2.3.10 .....                                    | 53 |

|  |    |
|--|----|
| Theorem 2.3.3 .....  | 53 |
| Proof.....   | 53 |
| 2.4 Distances, Hesitancy Degree and Cardinality for Neutrosophic Sets..... | 54 |
| Definition 2.4.1 .....   | 54 |
| Example 2.4.1 .....  | 54 |
| Example 2.4.2 .....  | 55 |
| Remark 2.4.1 .....   | 55 |
| Remark 2.4.2 .....   | 56 |
| Definition 2.4.2 .....   | 56 |
| Definition 2.4.3 .....   | 56 |
| Remark 2.4.3 .....   | 57 |
| Definition 2.4.4 .....   | 58 |
| 2.5 Neutrosophic Relations.....  | 58 |
| Definition 2.5.1 .....   | 58 |
| Definition 2.5.2 .....   | 59 |
| Example 2.5.1 .....  | 59 |
| Example 2.5.2 .....  | 59 |
| Definition 2.5.3 .....   | 60 |
| Theorem 2.5.1 .....  | 61 |
| Proof.....   | 61 |
| Definition 2.5.4 .....   | 61 |
| Definition 2.5.5 .....   | 62 |
| Theorem 2.5.2 .....  | 62 |
| Proof.....   | 62 |
| Definition 2.5.6 .....   | 63 |
| Theorem 2.5.3 .....  | 63 |



|  |    |
|--|----|
| Proof.....   | 63 |
| Definition 2.5.7 .....   | 63 |
| Theorem 2.5.4 .....  | 63 |
| Proof.....   | 63 |
| Definition 2.5.8 .....   | 64 |
| Definition 2.5.9 .....   | 64 |
| Example 2.5.3 .....  | 64 |
| 3. Introduction to Neutrosophic Crisp Topological Spaces ..... | 65 |
| 3.1 Neutrosophic Crisp Topological Spaces .....                | 65 |
| Definition 3.1.1 .....   | 65 |
| Remark 3.1.1 .....   | 66 |
| Example 3.1.1 .....  | 66 |
| Example 3.1.2 .....  | 66 |
| Definition 3.1.2 .....   | 67 |
| Proposition 3.1.1 .....  | 67 |
| Proof.....   | 67 |
| Definition 3.1.3 .....   | 67 |
| Remark 3.1.2 .....   | 67 |
| Proposition 3.1.2 .....  | 67 |
| Proof.....   | 68 |
| Proposition 3.1.3 .....  | 68 |
| Proof.....   | 68 |
| 3.2 Neutrosophic Crisp Continuity .....                        | 68 |
| Definition 3.2.1 .....   | 69 |
| Corollary 3.2.1 .....  | 69 |
| Proof.....   | 69 |
| Definition 3.2.2 .....   | 69 |

|  |    |
|--|----|
| Definition 3.2.3 .....                           | 70 |
| Example 3.2.1 .....                              | 70 |
| Proposition 3.2.1 .....                          | 70 |
| Proposition 3.2.2 .....                          | 70 |
| Example 3.2.2 .....                              | 70 |
| 3.3 Neutrosophic Crisp Compact Space (NCCS)..... | 70 |
| Definition 3.3.1 .....                           | 71 |
| Definition 3.3.2 .....                           | 71 |
| Example 3.3.1 .....                              | 71 |
| Corollary 3.3.1 .....                            | 71 |
| Corollary 3.3.2.....                             | 72 |
| Definition 3.3.3 .....                           | 72 |
| Corollary 3.3.3.....                             | 72 |
| 3.4 Nearly Neutrosophic Crisp Open Sets .....    | 72 |
| Definition 3.4.1 .....                           | 72 |
| Definition 3.4.2 .....                           | 73 |
| Remark 3.4.1 .....                               | 73 |
| Theorem 3.4.1 .....                              | 73 |
| Proof.....                                       | 73 |
| Theorem 3.4.2 .....                              | 74 |
| Proof.....                                       | 74 |
| Proposition 3.4.1 .....                          | 75 |
| Proof.....                                       | 75 |
| Corollary 3.4.1 .....                            | 75 |
| Corollary 3.4.2.....                             | 75 |
| Proposition 3.4.2 .....                          | 76 |
| Corollary 3.4.3.....                             | 76 |

|   |    |
|---|----|
| Proposition 3.4.3 .....   | 76 |
| Definition 3.4.3 .....  | 76 |
| Proposition 3.4.4 .....   | 76 |
| Proof.....  | 77 |
| Corollary 3.4.4.....  | 77 |
| 4. Neutrosophic Crisp Topological Ideal Spaces &Neutrosophic Crisp Filters..... | 78 |
| 4.1 Neutrosophic Crisp Ideals .....   | 78 |
| Definition 4.1.1 .....  | 78 |
| Remark 4.1.1 .....  | 79 |
| Example 4.1.1 .....   | 79 |
| Definition 4.1.2 .....  | 79 |
| Proposition 4.1.1 .....   | 79 |
| Remark 4.1.2 .....  | 80 |
| Proposition 4.1.2 .....   | 80 |
| Proof.....  | 80 |
| Proposition 4.1.3 .....   | 80 |
| Proof.....  | 80 |
| Corollary 4.1.1 .....   | 80 |
| Theorem 4.1.1 .....   | 80 |
| Proof.....  | 80 |
| Remark 4.1.3 .....  | 81 |
| Corollary 4.1.2.....  | 81 |
| Proof.....  | 81 |
| Theorem 4.1.2 .....   | 81 |
| Proof.....  | 81 |
| Theorem 4.1.3 .....   | 81 |

|  |    |
|--|----|
| 4.2 Neutrosophic Crisp Local Functions .....                                 | 81 |
| Definition 4.2.1 .....   | 81 |
| Theorem 4.2.1 .....  | 82 |
| Proof.....   | 82 |
| Definition 4.2.2 .....   | 82 |
| Example 4.2.1 .....  | 82 |
| Theorem 4.2.2 .....  | 82 |
| Proof.....   | 83 |
| Theorem 4.2.3 .....  | 84 |
| Proof.....   | 84 |
| Theorem 4.2.4 .....  | 84 |
| Proof.....   | 84 |
| Theorem 4.2.5 .....  | 85 |
| Theorem 4.2.6 .....  | 85 |
| Proof.....   | 85 |
| Corollary 4.2.1 .....  | 85 |
| Proof.....   | 86 |
| 4.3 Neutrosophic Crisp L-Open Sets and Neutrosophic Crisp L-Continuity ..... | 86 |
| Definition 4.3.1 .....   | 86 |
| Theorem 4.3.1 .....  | 86 |
| Proof.....   | 86 |
| Remark 4.3.1 .....   | 86 |
| Theorem 4.3.2 .....  | 86 |
| Proof.....   | 86 |
| Corollary 4. 3.1 .....   | 87 |
| Corollary 4.3.2.....   | 87 |

|                        |    |
|------------------------|----|
| Proof.....             | 87 |
| Definition 4.3.2 ..... | 87 |
| Theorem 4.3.3 .....    | 87 |
| Proof.....             | 87 |
| Remark 4.3.2 .....     | 87 |
| Corollary 4.3.3.....   | 88 |
| Proof.....             | 88 |
| Theorem 4.3.4 .....    | 88 |
| Proof.....             | 88 |
| Corollary 4.3.4.....   | 88 |
| Remark 4.3.3 .....     | 88 |
| Corollary 4.3.5.....   | 88 |
| Proof.....             | 89 |
| Definition 4.3.3 ..... | 89 |
| Theorem 4.3.5 .....    | 89 |
| Proof.....             | 89 |
| Theorem 4.3.6 .....    | 89 |
| Proof.....             | 89 |
| Corollary 4.3.6.....   | 90 |
| Definition 4.3.4 ..... | 90 |
| Theorem 4.3.7 .....    | 90 |
| Proof.....             | 90 |
| Theorem 4.3.8 .....    | 90 |
| Proof.....             | 90 |
| Corollary 4.3.7 .....  | 90 |
| Definition 4.3.5 ..... | 91 |
| Theorem 4.3.9 .....    | 91 |

|                                      |    |
|--------------------------------------|----|
| Proof.....                           | 91 |
| Theorem 4.3.10 .....                 | 92 |
| Proof.....                           | 92 |
| Corollary 4.3.8.....                 | 92 |
| Proof.....                           | 92 |
| Definition 4.3.6 .....               | 92 |
| Theorem 4.3.11 .....                 | 92 |
| Proof.....                           | 93 |
| Theorem 4.3.12 .....                 | 93 |
| Proof.....                           | 93 |
| Theorem 4.3.13 .....                 | 93 |
| Proof.....                           | 93 |
| Corollary 4.3.9.....                 | 93 |
| Proof.....                           | 93 |
| 4.4 Neutrosophic Crisp Filters ..... | 94 |
| Definition 4.4.1 .....               | 94 |
| Proposition 4.4.1 .....              | 94 |
| Proposition 4.4.2 .....              | 94 |
| Theorem 4.4.1 .....                  | 94 |
| Proof.....                           | 95 |
| Theorem 4.4.2 .....                  | 95 |
| Proof.....                           | 95 |
| Definition 4.4.2 .....               | 95 |
| Proposition 4.4.3 .....              | 95 |
| Remark 4.4.1 .....                   | 95 |
| Theorem 4.4.3 .....                  | 96 |
| Proof.....                           | 96 |

|  |     |
|--|-----|
| Corollary 4.4.1 .....                                    | 96  |
| Corollary 4.4.2.....                                     | 96  |
| Corollary 4.4.3.....                                     | 96  |
| Theorem 4.4.4 .....                                      | 97  |
| Definition 4.4.3 .....                                   | 97  |
| Remark 4.4.2 .....                                       | 97  |
| Proposition 4.4.4 .....                                  | 97  |
| Proof.....   | 97  |
| Proposition 4.4.5 .....                                  | 97  |
| Proof.....   | 98  |
| Proposition 4.4.6 .....                                  | 98  |
| Definition 4.4.4 .....                                   | 98  |
| Theorem 4.4.5 .....                                      | 98  |
| Proposition 4.4.7 .....                                  | 98  |
| Proof.....   | 98  |
| Corollary 4.4.4.....                                     | 98  |
| Definition 4.4.5 .....                                   | 99  |
| Definition 4.4.6 .....                                   | 99  |
| Proposition 4.4.8 .....                                  | 99  |
| Proof.....   | 99  |
| Definition 4.4.7 .....                                   | 99  |
| Proposition 4.4.9 .....                                  | 99  |
| 5. Introduction to Neutrosophic Topological Spaces ..... | 100 |
| 5.1 Neutrosophic Topological Spaces.....                 | 100 |
| Definition 5.1.1 .....                                   | 100 |
| Example 5.1.1 .....                                      | 101 |
| Remark 5.1.1 .....                                       | 101 |

|  |            |
|--|------------|
| Example 5.1.2 .....  | 101        |
| Example 5.1.3 .....  | 101        |
| Proposition 5.1.1 .....  | 101        |
| Proof.....   | 101        |
| Definition 5.1.2 .....   | 102        |
| Proposition 5.1.2 .....  | 102        |
| Proof.....   | 102        |
| Definition 5.1.3 .....   | 102        |
| Definition 5.1.4 .....   | 102        |
| Proposition 5.1.3 .....  | 102        |
| Proof.....   | 103        |
| Proposition 5.1.4 .....  | 103        |
| Proof.....   | 103        |
| Definition 5.1.5 .....   | 103        |
| <b>5.2 Some Neutrosophic Topological Notions of Neutrosophic</b> |            |
| <b>Region .....</b>  | <b>104</b> |
| Corollary 5.2.1 .....  | 104        |
| Definition 5.2.1 .....   | 104        |
| Corollary 5.2.2.....   | 104        |
| Proof.....   | 105        |
| Definition 5.2.2 .....   | 105        |
| Proposition 5.2.1 .....  | 105        |
| Proof.....   | 106        |
| Proposition 5.2.2 .....  | 106        |
| Proof.....   | 106        |
| Definition 5.2.3 .....   | 106        |
| Definition 5.2.4 .....   | 106        |



|   |     |
|---|-----|
| Definition 5.2.5 .....  | 106 |
| 5.3 Generalized Neutrosophic Topological Spaces .....                     | 107 |
| Definition 5.3.1 .....  | 107 |
| Remark 5.3.1 .....  | 107 |
| Example 5.3.1 .....   | 107 |
| Example 5.3.2 .....   | 108 |
| Proposition 5.3.1 .....   | 108 |
| Proof.....  | 108 |
| Definition 5.3.2 .....  | 108 |
| Proposition 5.3.2 .....   | 108 |
| Proof.....  | 108 |
| Definition 5.3.3 .....  | 109 |
| Definition 5.3.4 .....  | 109 |
| Proposition 5.3.3 .....   | 109 |
| Proof.....  | 109 |
| Proposition 5.3.4 .....   | 109 |
| Proof.....  | 110 |
| 5.4 Neutrosophic Closed Set and Neutrosophic Continuous<br>Functions..... | 110 |
| Definition 5.4.1 .....  | 110 |
| Proposition 5.4.1 .....   | 110 |
| Remark 5.4.1 .....  | 110 |
| Example 5.4.1 .....   | 110 |
| Proposition 5.4.2 .....   | 111 |
| Proposition 5.4.3 .....   | 111 |
| Proof.....  | 111 |
| Proposition 5.4.4 .....   | 111 |

|                          |     |
|--------------------------|-----|
| Proof.....               | 111 |
| Proposition 5.4.5 .....  | 112 |
| Definition 5.4.2 .....   | 112 |
| Corollary 5.4.1 .....    | 112 |
| Proof.....               | 112 |
| Definition 5.4.3 .....   | 112 |
| Definition 5.4.4 .....   | 113 |
| Example 5.4.2 .....      | 113 |
| Proposition 5.4.6 .....  | 113 |
| Proposition 5.4.7 .....  | 113 |
| Example 5.4.3 .....      | 113 |
| Definition 5.4.5 .....   | 113 |
| Proposition 5.4.8 .....  | 114 |
| Proposition 5.4.9 .....  | 114 |
| Proposition 5.4.10 ..... | 114 |
| Proof.....               | 115 |
| Proposition 5.4.11 ..... | 115 |
| Example 5.4.4 .....      | 115 |
| Example 5.4.5 .....      | 115 |
| Proposition 5.4.12 ..... | 116 |
| Example 5.4.6 .....      | 116 |
| Proposition 5.4.13 ..... | 116 |
| Example 5.4.7 .....      | 116 |
| Proposition 5.4.14 ..... | 117 |
| Example 5.4.8 .....      | 117 |
| Proposition 5.4.15 ..... | 117 |
| Proposition 5.4.16 ..... | 117 |

|  |     |
|--|-----|
| Definition 5.4.6 .....   | 118 |
| Proposition 5.4.17 .....   | 118 |
| Example 5.4.9 .....  | 118 |
| 6. Neutrosophic Ideal Topological Spaces & Neutrosophic Filters .... | 119 |
| 6.1 Neutrosophic Ideals .....  | 119 |
| Definition 6.1.1 .....   | 119 |
| Remark 6.1.1 .....   | 120 |
| Example 6.1.1 .....  | 120 |
| Example 6.1.2 .....  | 120 |
| Example 6.1.3 .....  | 120 |
| Definition 6.1.2 .....   | 120 |
| Proposition 6.1.1 .....  | 121 |
| Remark 6.1.2 .....   | 121 |
| Proposition 6.1.2 .....  | 121 |
| Proof.....   | 121 |
| Proposition 6.1.3 .....  | 121 |
| Proof.....   | 121 |
| Corollary 6.1.1 .....  | 121 |
| Theorem 6.1.1 .....  | 121 |
| Proof.....   | 122 |
| Remark 6.1.3 .....   | 122 |
| Corollary 6.1.2.....   | 122 |
| Corollary 6.1.3.....   | 122 |
| 6.2 Neutrosophic Local Functions .....                               | 122 |
| Definition 6.2.1 .....   | 122 |
| Example 6.2.1 .....  | 122 |
| Theorem 6.2.1 .....  | 123 |

|                                       |            |
|---------------------------------------|------------|
| Proof.....                            | 123        |
| Theorem 6.2.2 .....                   | 124        |
| Proof.....                            | 124        |
| Theorem 6.2.3 .....                   | 125        |
| Proof.....                            | 125        |
| Theorem 6.2.4 .....                   | 125        |
| Theorem 6.2.5 .....                   | 125        |
| Proof.....                            | 125        |
| Corollary 6.1.1 .....                 | 126        |
| Proof.....                            | 126        |
| <b>6.3 Neutrosophic Filters .....</b> | <b>126</b> |
| Definition 6.3.1 .....                | 126        |
| Proposition 6.3.1 .....               | 126        |
| Proposition 6.3.2 .....               | 126        |
| Theorem 6.3.1 .....                   | 127        |
| Proof.....                            | 127        |
| Theorem 6.3.2 .....                   | 127        |
| Proof.....                            | 127        |
| Definition 6.3.2 .....                | 127        |
| Proposition 6.3.3 .....               | 128        |
| Remark 6.3.1 .....                    | 128        |
| Theorem 6.3.3 .....                   | 128        |
| Proof.....                            | 128        |
| Corollary 6.3.1 .....                 | 128        |
| Corollary 6.3.2.....                  | 129        |
| Corollary 6.3.3.....                  | 129        |
| Theorem 6.3.4 .....                   | 129        |

|   |     |
|---|-----|
| Definition 6.3.3 .....                                  | 129 |
| Remark 6.3.2 .....                                      | 129 |
| Proposition 6.3.4 .....                                 | 129 |
| Proof.....  | 130 |
| Proposition 6.3.5 .....                                 | 130 |
| Proof.....  | 130 |
| Proposition 6.3.6 .....                                 | 130 |
| Definition 6.3.4 .....                                  | 130 |
| Theorem 6.3.5 .....                                     | 130 |
| Proposition 6.3.7 .....                                 | 130 |
| Proof.....  | 130 |
| Corollary 6.3.4.....                                    | 131 |
| Definition 6.3.5 .....                                  | 131 |
| Definition 6.3.6 .....                                  | 131 |
| Proposition 6.3.8 .....                                 | 131 |
| Proof.....  | 131 |
| Definition 6.3.7 .....                                  | 131 |
| Proposition 6.3.9 .....                                 | 131 |
| 7. Applications.....                                    | 132 |
| 7.1 Neutrosophic Database.....                          | 133 |
| Definition A.7.1.1 .....                                | 133 |
| Definition A.7.1.2 .....                                | 133 |
| Conclusion .....  | 135 |
| 7.2 Security Model for MANET via Neutrosophic Data..... | 136 |
| Introduction .....                                      | 136 |
| Public Key Security.....                                | 139 |
| The proposed model for security.....                    | 140 |

|  |            |
|--|------------|
| Neutrosophic Model (Key Size Determination Function) .....                 | 141        |
| Key Distribution .....   | 143        |
| Experimental Results .....   | 145        |
| PKI vs. non-PKI and indeterminacy distribution.....                        | 147        |
| Conclusions.....   | 149        |
| <b>7.3 Non-Classical Sets via Probability Neutrosophic Components</b>      | <b>150</b> |
| Definition A.7.3.1 .....   | 150        |
| Remark A.7.3.1 .....   | 151        |
| Probability axioms of NCS .....  | 151        |
| Remark A.7.3.2.....  | 152        |
| Definition A.7.3.2 (Monotonicity) .....                                    | 152        |
| Definition A.7.3.3 .....   | 153        |
| Proposition A.7.3.1 .....  | 153        |
| Proposition A.7.3.2.....   | 153        |
| Example A.7.3.1 .....  | 154        |
| Example A.7.3.2.....   | 154        |
| Example A.7.3.3.....   | 154        |
| <b>7.4 Social Network Analysis e-Learning Systems via Neutrosophic Set</b> | <b>157</b> |
| .....  | 157        |
| Introduction .....   | 157        |
| Related work.....  | 159        |
| Proposed Framework .....   | 160        |
| Experimental Results and Comments on Results .....                         | 165        |
| Conclusion and Future Work .....   | 167        |
| <b>7.5 Some Neutrosophic Topological Notions of Neutrosophic</b>           | <b>167</b> |
| <b>Region .....</b>  | <b>167</b> |
| Corollary A.7.4.1 .....  | 167        |

|   |            |
|---|------------|
| Definition A.7.4.1 .....  | 168        |
| Corollary A.7.4.2 .....   | 168        |
| Proof.....  | 168        |
| Definition A.7.4.2 .....  | 168        |
| Proposition A.7.4.1 .....   | 169        |
| Proof.....  | 169        |
| Proposition A.7.4.2.....  | 169        |
| Proof.....  | 169        |
| Definition A.7.4.3 .....  | 170        |
| Definition A.7.4.4 .....  | 170        |
| Definition A.7.4.5 .....  | 170        |
| <i>Graphs: The Relation between Neutrosophic Notions and Fuzzy</i><br><i>Notions.....</i> | <i>171</i> |
| List of Figures .....   | 174        |
| References .....  | 175        |

## Neutrosophic Science

Since the world is full of indeterminacy, the Neutrosophics found their place into contemporary research. We now introduce for the first time the notions of Neutrosophic Crisp Sets and Neutrosophic Topology on Crisp Sets. We develop the 2012 notion of Neutrosophic Topological Spaces and give many practical examples. Neutrosophic Science means development and applications of Neutrosophic Logic, Set, Measure, Integral, Probability etc., and their applications in any field. It is possible to define the neutrosophic measure and consequently the neutrosophic integral and neutrosophic probability in many ways, because there are various types of indeterminacies, depending on the problem we need to solve.

Indeterminacy is different from randomness. Indeterminacy can be caused by physical space, materials and type of construction, by items involved in the space, or by other factors. In 1965 [51], Zadeh generalized the concept of crisp set by introducing the concept of fuzzy set, corresponding to the situation in which there is no precisely defined set; there are increasing applications in various fields, including probability, artificial intelligence, control systems, biology and economics. Thus, developments in abstract mathematics using the idea of fuzzy sets possess sound footing. In accordance, fuzzy topological spaces were introduced by Chang [12] and Lowen [33]. After the development of fuzzy sets, much attention has been paid to the generalization of basic concepts of classical topology to fuzzy sets and accordingly developing a theory of fuzzy topology [1-58]. In 1983, the intuitionistic fuzzy set was introduced by K. Atanassov [55, 56, 57] as a generalization of the fuzzy set, beyond the degree of membership and the degree of non-membership of each element. In 1999 and 2002, Smarandache [71, 72, 73, 74] defined the notion of Neutrosophic Sets, which is a generalization of Zadeh's fuzzy set and Atanassov's intuitionistic fuzzy set. Some neutrosophic concepts have been investigated by Salama et al. [61-70]. Forwarding the study of neutrosophic sets, this book consists of seven chapters, targeting to:

- generalize the previous studies in [1-59], and [91-94] so to define the neutrosophic crisp set and neutrosophic set concepts;
- discuss their main properties;



- introduce and study some concepts of neutrosophic crisp and neutrosophic topological spaces and deduce their properties;
- deduce many types of functions and give the relationships between different neutrosophic topological spaces, which helps to build new properties of neutrosophic topological spaces;
- stress once more the importance of Neutrosophic Ideal as a nontrivial extension of neutrosophic set and neutrosophic logic [71, 72, 73, 74];
- propose applications on computer sciences by using neutrosophic sets.

In the first chapter, further results on neutrosophic sets are given, introducing and studying the concepts of a new types of crisp sets, called the neutrosophic crisp set. After giving the fundamental definitions and operations, we obtain several properties, and discuss the relationship between neutrosophic crisp sets and other sets. Also, we advance and examine the Neutrosophic Crisp Points, and analyze the relation between two new neutrosophic crisp notions. Finally, we introduce and study the notion of Neutrosophic Crisp Relations. In 1.1, we consider some possible definitions for types of neutrosophic crisp sets. In 1.2, we define the nature of the neutrosophic crisp set in  $X$ , called neutrosophic crisp point in  $X$ , corresponding to an element  $X$ . In 1.3, we introduce and explore the relations on neutrosophic crisp sets and its properties. We point out that results in this chapter were published in [61-70].

In the second chapter, we scrutinize the concept of neutrosophic set. After giving the fundamental definitions and operations, we obtain several properties, and discuss the relationship between neutrosophic sets and other sets. Also, we introduce and converse about the Generalized Neutrosophic Sets, and establish relation between two neutrosophic notions. Finally, we consider the notion of Neutrosophic Relations. In 2.1, we analyze several possible definitions for some types of neutrosophic sets. In 2.2, we consider some possible definitions for basic concepts of the neutrosophic sets generated by  $Ng$  (characteristic functions) and its operations. In 2.3, we introduce the concept of  $\alpha$ -cut levels for neutrosophic sets, and study some types of neutrosophic sets. In 2.4, we introduce the distances between neutrosophic sets: the Hamming distance, the normalized Hamming distance, the Euclidean distance and normalized Euclidean distance. We extend the concepts of

distances to the case of Neutrosophic Hesitancy Degree. In 2.5, we suggest relations on neutrosophic sets and study properties. The results in chapter 2 were published in [61-70].

In the third chapter, we generalize the Crisp Topological Spaces and Intuitionistic Topological Space to the notion of Neutrosophic Crisp Topological Space. In 3.1, we study the neutrosophic topological spaces and build the basic concepts of the neutrosophic crisp topology. In 3.2, we introduce the definitions of Neutrosophic Crisp Continuous Function and we obtain some characterizations of Neutrosophic Continuity. In 3.3, we introduce the Neutrosophic Crisp Compact Spaces. Finally, some characterizations concerning neutrosophic crisp compact spaces are presented and one obtains several properties. In 3.4, we establish definitions of Neutrosophic Crisp Nearly Open Sets, and we obtain several properties and some characterizations. We point out that results in chapter 3 were published in [64, 65, 66, 67, 68].

The purpose of the fourth chapter is to define the Neutrosophic Crisp Ideals, and the Neutrosophic Crisp Filter. In 4.1, we introduce neutrosophic crisp ideals and obtain their fundamental properties. In 4.2, we define the Neutrosophic Crisp Local Functions. In 4.3, we introduce a new notion of neutrosophic crisp sets via Neutrosophic Crisp Ideals and investigate some basic operations and results in neutrosophic crisp topological spaces. Also, Neutrosophic Crisp L-Openness and Neutrosophic Crisp L-Continuity are considered as generalizations for crisp and fuzzy concepts. Relationships between the new neutrosophic crisp notions and other relevant classes are investigated. Finally, we define and study two distinctive types of neutrosophic crisp functions. In 4.4, we advance the notion of filters on neutrosophic crisp set, considered as a generalization of filters studies. Several relations between various neutrosophic crisp filters and neutrosophic topologies are also investigated here. We point out that results in chapter 4 were accepted for publication in [64, 65, 66, 67].

In the fifth chapter, we extend the concepts of fuzzy topological space [4] and intuitionistic fuzzy topological space [12, 65, 66] to the case of neutrosophic sets. We generalize the concept of fuzzy topological space, first intuited by Chang [12] to the case of neutrosophic sets. In 5.1, we introduce and study the neutrosophic topological spaces. In 5.2, some neutrosophic topological notions of neutrosophic region are given and we add some further definitions and propositions for a Neutrosophic Topological Region. In 5.3, we explore a generalized neutrosophic

topological space. In 5.4, we initiate the concepts of Neutrosophic Closed Set and Neutrosophic Continuous Function. Results in chapter 5 were accepted for publication in [62, 63, 66].

In the sixth chapter, we extend the concept of intuitionistic fuzzy ideal [58] and filters to the case of neutrosophic set. In 6.1, we introduce the notion of Ideals on neutrosophic set, which is considered as a generalization of ideals studies. Several relations between diverse neutrosophic ideals and neutrosophic topologies are also examined here. In 6.2, we introduce and study the Neutrosophic Local Functions. Several relations between different neutrosophic topologies are also researched. In 6.3, we introduce the notion of Filters on neutrosophic set which is considered as a generalization of filters studies. Several relations between different neutrosophic filters and neutrosophic topologies are also studied here. We point out that results in chapter 6 are published in [62, 63, 64, 70].

In the seventh chapter, we propound some applications via neutrosophic sets. In 7.1, we introduce the concept of Neutrosophic Database. In 7.2, we suggest a security scheme based on Public Key Infrastructure (PKI) for distributing session keys between nodes. The length of those keys is decided using Neutrosophic Logic Manipulation. The proposed algorithm of Security Model is an adaptive neutrosophic logic-based algorithm (membership function, non-membership and indeterminacy) that can adapt itself according to the dynamic conditions of mobile hosts. The experimental results show that using of neutrosophic-based security one can enhance the security of MANETs. In 7.3, we introduce and study the Probability of neutrosophic crisp sets. After giving the fundamental definitions and operations, we obtain several properties, and discuss the relationship between neutrosophic crisp sets and other sets. The purpose of the section 7.4 is to present the Social Learning Management System that integrates social activities in e-Learning, and utilize neutrosophic sets in order to analyze social networks data conducted through learning activities. Results show that recommendations can be enhanced through using the proposed system. Section 7.5 talks about the Geographical Information Systems (GIS), giving fundamental concepts and properties of a neutrosophic spatial region. There is a need to model spatial regions with indeterminate boundary and under indeterminacy. We introduce a new theoretical framework via neutrosophic topology and we add some further definitions and schemes for a neutrosophic topological region.

# 1. Neutrosophic Crisp Set Theory

In this chapter, we introduce the basic properties of the concept of neutrosophic crisp set and investigate some new neutrosophic concepts. We obtain several properties, and discuss the relationship between neutrosophic crisp sets and other sets. Also, we introduce and study the neutrosophic crisp points and relation between new neutrosophic crisp notions. Conclusively, we explain the notion of neutrosophic crisp relations. In 1.1, we investigate some possible definitions for some types of neutrosophic crisp sets. In 1.2, we define a type of neutrosophic crisp set in  $X$ , called neutrosophic crisp point in  $X$ , corresponding to an element  $X$ . In 1.3, we introduce relations and study properties of the neutrosophic crisp sets.

## 1.1 Neutrosophic Crisp Set

Let us consider some possible definitions for various types of neutrosophic crisp sets.

### Definition 1.1.1

Let  $X$  be a non-empty fixed sample space. A neutrosophic crisp set (NCS)  $A$  is an object having the form  $A = \langle A_1, A_2, A_3 \rangle$  where  $A_1, A_2$  and  $A_3$  are subsets of  $X$ .

### Definition 1.1.2

The object having the form  $A = \langle A_1, A_2, A_3 \rangle$  is called:

- (a) A neutrosophic crisp set of Type 1 (NCS-Type1) if satisfying  $A_1 \cap A_2 = \phi$ ,  $A_1 \cap A_3 = \phi$  and  $A_2 \cap A_3 = \phi$ .
- (b) A neutrosophic crisp set of Type2 (NCS-Type2) if satisfying  $A_1 \cap A_2 = \phi$ ,  $A_1 \cap A_3 = \phi$ ,  $A_2 \cap A_3 = \phi$ ,  $A_1 \cup A_2 \cup A_3 = X$ .
- (c) A neutrosophic crisp set of Type 3 (NCS-Type3) if satisfying  $A_1 \cap A_2 \cap A_3 = \phi$  and  $A_1 \cup A_2 \cup A_3 = X$ .

**Remark 1.1.1**

A neutrosophic crisp set  $A = \langle A_1, A_2, A_3 \rangle$  can be identified to an ordered triple  $\langle A_1, A_2, A_3 \rangle$ , subsets in X, and one can define several relations and operations between NCSs.

Since our purpose is to construct the tools for developing neutrosophic crisp set, we must introduce types of CNS  $\varphi_N, X_N$  in X.

- 1)  $\varphi_N$  may be defined as the following four types:
  - (a) Type 1:  $\varphi_N = \langle \varphi, \varphi, X \rangle$ ,
  - (b) Type 2:  $\varphi_N = \langle \varphi, X, X \rangle$ ,
  - (c) Type 3:  $\varphi_N = \langle \varphi, X, \varphi \rangle$ ,
  - (d) Type 4:  $\varphi_N = \langle \varphi, \varphi, \varphi \rangle$ .
- 2)  $X_N$  may be defined as the following four types:
  - (a) Type 1:  $X_N = \langle X, \varphi, \varphi \rangle$ ,
  - (b) Type 2:  $X_N = \langle X, X, \varphi \rangle$ ,
  - (c) Type 3:  $X_N = \langle X, \varphi, X \rangle$ ,
  - (d) Type 4:  $X_N = \langle X, X, X \rangle$ .

Every neutrosophic crisp set A on a non-empty set X is obviously NCS having the form  $A = \langle A_1, A_2, A_3 \rangle$ .

**Definition 1.1.3**

Let  $A = \langle A_1, A_2, A_3 \rangle$  be a NCS in X, then the complement of the set A ( $A^c$  for short) may be defined as three kinds of complements:

- (C<sub>1</sub>)  $A^c = \langle A^c_1, A^c_2, A^c_3 \rangle$ , or
- (C<sub>2</sub>)  $A^c = \langle A_3, A_2, A_1 \rangle$  or
- (C<sub>3</sub>)  $A^c = \langle A_3, A^c_2, A_1 \rangle$ .

One can define several relations and operations between NCS as it follows:

**Definition 1.1.4**

Let X be a non-empty set, and the NCSS A and B be in the form  $A = \langle A_1, A_2, A_3 \rangle, B = \langle B_1, B_2, B_3 \rangle$ . We consider two possible definitions for subsets ( $A \subseteq B$ ). So ( $A \subseteq B$ ) may be defined as two types:

- Type 1.  $A \subseteq B \Leftrightarrow A_1 \subseteq B_1, A_2 \subseteq B_2 \text{ and } A_3 \supseteq B_3,$
- Type 2.  $A \subseteq B \Leftrightarrow A_1 \subseteq B_1, A_2 \supseteq B_2 \text{ and } A_3 \supseteq B_3.$

**Proposition 1.1.1**

For any neutrosophic crisp set A, we hold the following:

- a)  $\phi_N \subseteq A, \phi_N \subseteq \phi_N.$
- b)  $A \subseteq X_N, X_N \subseteq X_N.$

**Definition 1.1.5**

Let X be a non-empty set, and the NCSs A and B be of the form  $A = \langle A_1, A_2, A_3 \rangle, B = \langle B_1, B_2, B_3 \rangle$  be NCSs. Then:

- 1.  $A \cap B$  may be defined as two types:
  - Type 1.  $A \cap B = \langle A_1 \cap B_1, A_2 \cap B_2, A_3 \cup B_3 \rangle,$
  - Type 2.  $A \cap B = \langle A_1 \cap B_1, A_2 \cup B_2, A_3 \cup B_3 \rangle.$
- 2.  $A \cup B$  may be defined as two types:
  - Type 1.  $A \cup B = \langle A_1 \cup B_1, A_2 \cap B_2, A_3 \cup B_3 \rangle,$
  - Type 2.  $A \cup B = \langle A_1 \cup B_1, A_2 \cap B_2, A_3 \cap B_3 \rangle.$
- 3.  $[ ]A = \langle A_1, A_2, A^c_1 \rangle.$
- 4.  $\langle \rangle A = \langle A^c_3, A_2, A_3 \rangle.$

**Proposition 1.1.2**

For all two neutrosophic crisp sets A and B in X, the following assertions are true:

$$(A \cap B)^c = A^c \cup B^c;$$

$$(A \cup B)^c = A^c \cap B^c.$$

*We can easily generalize the operations of intersection and union in Definition 1.1.2 to an arbitrary family of neutrosophic crisp subsets as it follows:*

**Proposition 1.1.3**

Let  $\{A_j : j \in J\}$  be an arbitrary family of neutrosophic crisp subsets in X, then:

- 1)  $\cap A_j$  may be defined as the following two types:
  - (a) Type 1.  $\cap A_j = \langle \cap A_{j_1}, \cap A_{j_2}, \cup A_{j_3} \rangle,$
  - (b) Type 2.  $\cap A_j = \langle \cap A_{j_1}, \cup A_{j_2}, \cup A_{j_3} \rangle.$

2)  $\cup A_j$  may be defined as the following types:

(a) Type 1.  $\cup A_j = \langle \cup A_{j_1}, \cap A_{j_2}, \cap A_{j_3} \rangle,$

(b) Type 1.  $\cup A_j = \langle \cup A_{j_1}, \cup A_{j_2}, \cap A_{j_3} \rangle.$

**Definition 1.1.6**

The product of two neutrosophic crisp sets A and B is a neutrosophic crisp set  $A \times B$  given by  $A \times B = \langle A_1 \times B_1, A_2 \times B_2, A_3 \times B_3 \rangle.$

**Definition 1.1.7**

A NCS-Type1  $\phi_{N_1}, X_{N_1}$  in X may be defined as it follows:

1.  $\phi_{N_1}$  may be defined as three types:

(a) Type1:  $\phi_{N_1} = \langle \phi, \phi, X \rangle,$

(b) Type2:  $\phi_{N_1} = \langle \phi, X, \phi \rangle,$

(c) Type3:  $\phi_N = \langle \phi, \phi, \phi \rangle.$

2.  $X_{N_1}$  may be defined as one type:

(a) Type1:  $X_{N_1} = \langle X, \phi, \phi \rangle.$

**Definition 1.1.8**

A NCS-Type2,  $\phi_{N_2}, X_{N_2}$  in X may be defined it as follows:

1)  $\phi_{N_2}$  may be defined as two types:

(a) Type1:  $\phi_{N_2} = \langle \phi, \phi, X \rangle,$

(b) Type2:  $\phi_{N_2} = \langle \phi, X, \phi \rangle.$

2)  $X_{N_2}$  may be defined as one type:

(a) Type1:  $X_{N_2} = \langle X, \phi, \phi \rangle.$

**Definition 1.1.9**

A NCS-Type 3,  $\phi_{N_3}, X_{N_3}$  in X may be defined as it follows:

1)  $\phi_{N_3}$  may be defined as three types:

(a) Type1:  $\phi_{N_3} = \langle \phi, \phi, X \rangle,$  or

(b) Type2:  $\phi_{N_3} = \langle \phi, X, \phi \rangle,$  or

(c) Type3:  $\phi_{N_3} = \langle \phi, X, X \rangle.$

2)  $X_{N3}$  may be defined as three types:

(a) Type1:  $X_{N3} = \langle X, \phi, \phi \rangle$ ,

(b) Type2:  $X_{N3} = \langle X, X, \phi \rangle$ ,

(c) Type3:  $X_{N3} = \langle X, \varphi, X \rangle$ .

**Corollary 1.1.1**

In general,

- (a) Every NCS-Type 1, 2, 3 is NCS.
- (b) Every NCS-Type 1 is not NCS-Type2, 3.
- (c) Every NCS-Type 2 is not NCS-Type1, 3.
- (d) Every NCS-Type 3 is not NCS-Type2, 1, 2.
- (e) Every crisp set is NCS.

The following Venn diagram represents the relation between NCSs:

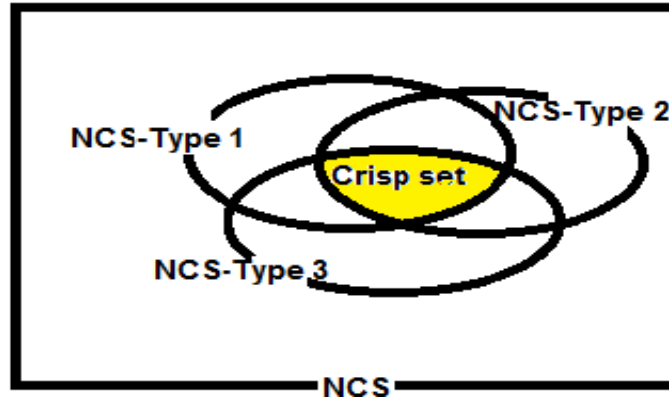

Figure 1. Venn diagram representing the relation between NCSs.

**Example 1.1.1**

Let  $X = \{a, b, c, d, e, f\}$ ,  $A = \langle \{a, b, c, d\}, \{e\}, \{f\} \rangle$ ,  $D = \langle \{a, b\}, \{e, c\}, \{f, d\} \rangle$  be a NCS-Type 2,  $B = \langle \{a, b, c\}, \{d\}, \{e\} \rangle$  be a NCT-Type1, but not NCS-Type2, 3,  $C = \langle \{a, b\}, \{c, d\}, \{e, f, a\} \rangle$  be a NCS-Type 3, but not NCS-Type1, 2.

**Definition 1.1.10**

Let X be a non-empty set,  $A = \langle A_1, A_2, A_3 \rangle$ .



- 1) If A is a NCS-Type1 in X, then the complement of the set A ( $A^c$ ) may be defined as one kind of complement Type1:  $A^c = \langle A_3, A_2, A_1 \rangle$ .
- 2) If A is a NCS-Type 2 in X, then the complement of the set A ( $A^c$ ) may be defined as one kind of complement  $A^c = \langle A_3, A_2, A_1 \rangle$ .
- 3) If A is NCS-Type3 in X, then the complement of the set A ( $A^c$ ) may be defined as one kind of complement defined as three kinds of complements:
  - ( $C_1$ ) Type1:  $A^c = \langle A^c_1, A^c_2, A^c_3 \rangle$
  - ( $C_2$ ) Type2:  $A^c = \langle A_3, A_2, A_1 \rangle$
  - ( $C_3$ ) Type3:  $A^c = \langle A_3, A^c_2, A_1 \rangle$

### Example 1.1.2

Let  $X = \{a, b, c, d, e, f\}$ ,  $A = \langle \{a, b, c, d\}, \{e\}, \{f\} \rangle$  be a NCS-Type 2,  $B = \langle \{a, b, c\}, \{\emptyset\}, \{d, e\} \rangle$  be a NCS-Type1,  $C = \langle \{a, b\}, \{c, d\}, \{e, f\} \rangle$  be a NCS-Type 3, then

- 1) the complement  $A = \langle \{a, b, c, d\}, \{e\}, \{f\} \rangle$ ,  
 $A^c = \langle \{f\}, \{e\}, \{a, b, c, d\} \rangle$  NCS-Type 2;
- 2) the complement of  $B = \langle \{a, b, c\}, \{\emptyset\}, \{d, e\} \rangle$ ,  
 $B^c = \langle \{d, e\}, \{\emptyset\}, \{a, b, c\} \rangle$  NCS-Type1;
- 3) the complement of  $C = \langle \{a, b\}, \{c, d\}, \{e, f\} \rangle$  may be defined as three types:
  - Type 1:  $C^c = \langle \{c, d, e, f\}, \{a, b, e, f\}, \{a, b, c, d\} \rangle$ .
  - Type 2:  $C^c = \langle \{e, f\}, \{a, b, e, f\}, \{a, b\} \rangle$ ,
  - Type 3:  $C^c = \langle \{e, f\}, \{c, d\}, \{a, b\} \rangle$ .

### Proposition 1.1.4

Let  $\{A_j : j \in J\}$  be an arbitrary family of neutrosophic crisp subsets in X, then:

- 1)  $\cap A_j$  may be defined as two types:
  - (a) Type1:  $\cap A_j = \langle \cap A_{j_1}, \cap A_{j_2}, \cup A_{j_3} \rangle$ ,
  - (b) Type2:  $\cap A_j = \langle \cap A_{j_1}, \cup A_{j_2}, \cup A_{j_3} \rangle$ .

2)  $\cup A_j$  may be defined as two types:

(a) Type1:  $\cup A_j = \langle \cup A_{j_1}, \cap A_{j_2}, \cap A_{j_3} \rangle,$

(b) Type2:  $\cup A_j = \langle \cup A_{j_1}, \cup A_{j_2}, \cap A_{j_3} \rangle.$

**Definition 1.1.11**

If  $B = \langle B_1, B_2, B_3 \rangle$  is a NCS in Y, then the preimage of B under  $f$ , denoted by  $f^{-1}(B)$ , is a NCS in X defined by  $f^{-1}(B) = \langle f^{-1}(B_1), f^{-1}(B_2), f^{-1}(B_3) \rangle.$

If  $A = \langle A_1, A_2, A_3 \rangle$  is a NCS in X, then the image of A under  $f$ , denoted by  $f(A)$ , is the a NCS in Y defined by  $f(A) = \langle f(A_1), f(A_2), f(A_3)^c \rangle.$

*Here we introduce the properties of images and preimages, some of which we frequently use in the following chapters.*

**Corollary 1.1.2**

Let A,  $\{A_i : i \in J\}$  be a family of NCS in X, and B,  $\{B_j : j \in K\}$  a NCS in Y, and  $f : X \rightarrow Y$  a function. Then:

- (a)  $A_1 \subseteq A_2 \Leftrightarrow f(A_1) \subseteq f(A_2), B_1 \subseteq B_2 \Leftrightarrow f^{-1}(B_1) \subseteq f^{-1}(B_2),$
- (b)  $A \subseteq f^{-1}(f(A))$  and if  $f$  is injective, then  $A = f^{-1}(f(A)) ,$
- (c)  $f^{-1}(f(B)) \subseteq B$  and if  $f$  is surjective, then  $f^{-1}(f(B)) = B,$
- (d)  $f^{-1}(\cup B_i) = f^{-1}(B_i), f^{-1}(\cap B_i) = \cap f^{-1}(B_i),$
- (e)  $f(\cup A_{ii}) = \cup f(A_{ii}); f(\cap A_{ii}) \subseteq \cap f(A_{ii});$  and if  $f$  is injective, then  $f(\cap A_{ii}) = \cap f(A_{ii});$
- (f)  $f^{-1}(Y_N) = X_N, f^{-1}(\phi_N) = \phi_N .$
- (g)  $f(\phi_N) = \phi_N, f(X_N) = Y_N,$  if  $f$  is surjective.

**Proof**

Obvious.

**1.2 Neutrosophic Crisp Points**

One can easily define the nature of neutrosophic crisp set in X, called neutrosophic crisp point in X, corresponding to an element X.

*Now we present some types of inclusion of a neutrosophic crisp point to a neutrosophic crisp set.*

**Definition 1.2.1**

Let  $A = \langle A_1, A_2, A_3 \rangle$  be a neutrosophic crisp set on a set X, then  $p = \langle \{p_1\}, \{p_2\}, \{p_3\} \rangle, p_1 \neq p_2 \neq p_3 \in X$  is called a neutrosophic crisp point.

An NCP  $p = \langle \{p_1\}, \{p_2\}, \{p_3\} \rangle$  belongs to a neutrosophic crisp set  $A = \langle A_1, A_2, A_3 \rangle$ , of X, denoted by  $p \in A$ , if it may be defined by two types:

- (a) Type 1:  $\{p_1\} \subseteq A_1, \{p_2\} \subseteq A_2$  and  $\{p_3\} \subseteq A_3$
- (b) Type 2:  $\{p_1\} \subseteq A_1, \{p_2\} \supseteq A_2$  and  $\{p_3\} \subseteq A_3$ .

**Theorem 1.2.1**

Let  $A = \langle A_1, A_2, A_3 \rangle$  and  $B = \langle \langle B_1, B_2, B_3 \rangle \rangle$  be neutrosophic crisp subsets of X. Then  $A \subseteq B$  if  $p \in A$  and  $p \in B$  for any neutrosophic crisp point  $p$  in X.

**Proof**

Let  $A \subseteq B$  and  $p \in A$ . Then we have:

- (a) Type 1:  $\{p_1\} \subseteq A_1, \{p_2\} \subseteq A_2$  and  $\{p_3\} \subseteq A_3$ , or
- (b) Type 2:  $\{p_1\} \subseteq A_1, \{p_2\} \supseteq A_2$  and  $\{p_3\} \subseteq A_3$ .

Thus,  $p \in B$ . Conversely, take any x in X. Let  $p_1 \in A_1$  and  $p_2 \in A_2$  and  $p_3 \in A_3$ . Then  $p$  is a neutrosophic crisp point in X, and  $p \in A$ . By the hypothesis,  $p \in B$ . Thus  $p_1 \in B_1$  or Type 1:  $\{p_1\} \subseteq B_1, \{p_2\} \subseteq B_2$  and  $\{p_3\} \subseteq B_3$  or Type 2:  $\{p_1\} \subseteq B_1, \{p_2\} \supseteq B_2$  and  $\{p_3\} \subseteq B_3$ . Hence,  $A \subseteq B$ .

**Theorem 1.2.2**

Let  $A = \langle A_1, A_2, A_3 \rangle$  be a neutrosophic crisp subset of X.

Then  $A = \cup \{p : p \in A\}$ .

**Proof**

Since  $\cup \{p : p \in A\}$ , we get the following two types:

- (a) Type 1:  $\langle \cup \{p_1 : p_1 \in A_1\}, \cup \{p_2 : p_2 \in A_2\}, \cap \{p_3 : p_3 \in A_3\} \rangle$ , or
- (b) Type 2:  $\langle \cup \{p_1 : p_1 \in A_1\}, \cap \{p_2 : p_2 \in A_2\}, \cap \{p_3 : p_3 \in A_3\} \rangle$ . hence  $A = \langle A_1, A_2, A_3 \rangle$ .

**Proposition 1.2.1**

Let  $\{A_j : j \in J\}$  be a family of NCSs in X. Then:

$$(a_1) p = \langle \{p_1\}, \{p_2\}, \{p_3\} \rangle \in \bigcap_{j \in J} A_j \text{ if } p \in A_j \text{ for each } j \in J.$$

$$(a_2) p \in \bigcup_{j \in J} A_j \text{ if } \exists j \in J \text{ such that } p \in A_j.$$

**Proposition 1.2.2**

Let  $A = \langle A_1, A_2, A_3 \rangle$  and  $B = \langle B_1, B_2, B_3 \rangle$  be two neutrosophic crisp sets in X. Then  $A \subseteq B$  if for each  $p$  we have  $p \in A \Leftrightarrow p \in B$  and for each  $p$  we have  $p \in A \Rightarrow p \in B$ . If  $A = B$  for each  $p$  we have  $p \in A \Rightarrow p \in B$  and for each  $p$  we have  $p \in A \Leftrightarrow p \in B$ .

**Proposition 1.2.3**

Let  $A = \langle A_1, A_2, A_3 \rangle$  be a neutrosophic crisp set in X. Then:

$$A = \bigcup \langle \{p_1 : p_1 \in A_1\}, \{p_2 : p_2 \in A_2\}, \{p_3 : p_3 \in A_3\} \rangle.$$

**Definition 1.2.2**

Let  $f : X \rightarrow Y$  be a function and  $p$  be a neutrosophic crisp point in X. Then the image of  $p$  under  $f$ , denoted  $f(p)$ , is defined by:

$$f(p) = \langle \{q_1\}, \{q_2\}, \{q_3\} \rangle, \text{ where } q_1 = f(p_1), q_2 = f(p_2) \text{ and } q_3 = f(p_3).$$

It is easy to see that  $f(p)$  is indeed a NCP in Y, namely  $f(p) = q$ , where  $q = f(p)$ , and it has exactly the same meaning of the image of a NCP under the function  $f$ .

**Definition 1.2.3**

Let X be a non-empty set and  $p \in X$ . Then the neutrosophic crisp point  $p_N$  defined by  $p_N = \langle \{p\}, \phi, \{p\}^c \rangle$  is called a neutrosophic crisp point (NCP) in X, where NCP is a triple ({only element in X}, empty set, {the complement of the same element in X}).

The neutrosophic crisp points in X can sometimes be inconvenient when expressing the neutrosophic crisp set in X in terms of neutrosophic crisp points. This situation occurs if  $A = \langle A_1, A_2, A_3 \rangle$ ,  $p \notin A_1$ , where  $A_1, A_2, A_3$  are three subsets such that  $A_1 \cap A_2 = \phi$ ,  $A_1 \cap A_3 = \phi$ ,  $A_2 \cap A_3 = \phi$ .

*Therefore, we have to define "vanishing" neutrosophic crisp points.*

**Definition 1.2.4**

Let  $X$  be a non-empty set and  $p \in X$  be a fixed element in  $X$ . The neutrosophic crisp set  $p_{N_N} = \langle \phi, \{p\}, \{p\}^c \rangle$  is called "vanishing" neutrosophic crisp point (VNCP) in  $X$ , where VNCP is a triple (empty set, {only element in  $X$ }, {the complement of the same element in  $X$ }).

**Example 1.2.1**

Let  $X = \{a, b, c, d\}$  and  $p = b \in X$ . Then:

$$p_N = \langle \{b\}, \phi, \{a, c, d\} \rangle,$$

$$p_{N_N} = \langle \phi, \{b\}, \{a, c, d\} \rangle,$$

$$P = \langle \{b\}, \{a\}, \{d\} \rangle.$$

**Definition 1.2.5**

Let  $p_N = \langle \{p\}, \phi, \{p\}^c \rangle$  be a NCP in  $X$  and  $A = \langle A_1, A_2, A_3 \rangle$  be a neutrosophic crisp set in  $X$ .

- (a)  $p_N$  is said to be contained in  $A$  ( $p_N \in A$ ) if  $p \in A_1$ .
- (b)  $p_{N_N}$  is VNCP in  $X$  and  $A = \langle A_1, A_2, A_3 \rangle$  a neutrosophic crisp set in  $X$ . Then  $p_{N_N}$  is said to be contained in  $A$  ( $p_{N_N} \in A$ ) if  $p \notin A_3$ .

**Proposition 1.2.4**

Let  $\{A_j : j \in J\}$  be a family of NCSs in  $X$ . Then:

- (a<sub>1</sub>)  $p_N \in \bigcap_{j \in J} A_j$  if  $p_N \in A_j$  for each  $j \in J$ .
- (a<sub>2</sub>)  $p_{N_N} \in \bigcap_{j \in J} A_j$  if  $p_{N_N} \in A_j$  for each  $j \in J$ .
- (b<sub>1</sub>)  $p_N \in \bigcup_{j \in J} A_j$  if  $\exists j \in J$  such that  $p_N \in A_j$ .
- (b<sub>2</sub>)  $p_{N_N} \in \bigcap_{j \in J} A_j$  if  $\exists j \in J$  such that  $p_{N_N} \in A_j$ .

**Proof**

Straightforward.

**Proposition 1.2.5**

Let  $A = \langle A_1, A_2, A_3 \rangle$  and  $B = \langle B_1, B_2, B_3 \rangle$  be two neutrosophic crisp sets in  $X$ . Then:

- (a)  $A \subseteq B$  if for each  $p_N$  we have  $p_N \in A \Leftrightarrow p_N \in B$  and for each  $p_{NN}$  we have  $p_N \in A \Rightarrow p_{NN} \in B$ .
- (b)  $A = B$  if for each  $p_N$  we have  $p_N \in A \Rightarrow p_N \in B$  and for each  $p_{NN}$  we have  $p_{NN} \in A \Leftrightarrow p_{NN} \in B$ .

**Proof**

Obvious.

**Proposition 1.2.6**

Let  $A = \langle A_1, A_2, A_3 \rangle$  be a neutrosophic crisp set in X. Then:

$$A = (\cup \{p_N : p_N \in A\}) \cup (\cup \{p_{NN} : p_{NN} \in A\}).$$

**Proof**

It is sufficient to show the following equalities:

$$A_1 = (\cup \{p : p_N \in A\}) \cup (\cup \{\phi : p_{NN} \in A\}), A_3 = \phi, \text{ and}$$

$$A_2 = (\cap \{p : p_N \in A\}) \cap (\cap \{p : p_{NN} \in A\}), \text{ which are fairly obvious.}$$

**Definition 1.2.6**

Let  $f : X \rightarrow Y$  be a function and  $p_N$  be a neutrosophic crisp point in X. Then the image of  $p_N$  under  $f$  denoted by  $f(p_N)$  is defined by  $f(p_N) = \langle \{q\}, \phi, \{q\}^c \rangle$  where  $q = f(p)$ . Let  $p_{NN}$  be a VNCP in X. Then the image of  $p_{NN}$  under  $f$  denoted by  $f(p_{NN})$  is defined by  $f(p_{NN}) = \langle \phi, \{q\}, \{q\}^c \rangle$  where  $q = f(p)$ . It is easy to observe that  $f(p_N)$  is indeed a NCP in Y, namely  $f(p_N) = q_N$  where  $q = f(p)$ , and it has exactly the same meaning of the image of a NCP under the function  $f$ .  $f(p_{NN})$  is also a VNCP in Y, namely  $f(p_{NN}) = q_{NN}$ , where  $q = f(p)$ .

**Proposition 1.2.7**

We state that any NCS A in X can be written in the form:

$$A = A_N \cup A_{NN} \cup A_{NNN} \text{ where}$$

$$A_N = \cup \{p_N : p_N \in A\}$$

$$A = \phi_N$$

$$A_{NNN} = \cup \{p_{NN} : p_{NN} \in A\}$$

It is easy to show that, if  $A = \langle A_1, A_2, A_3 \rangle$ , then:

$$A_N = \langle A_1, \phi, A_1^c \rangle$$

and

$$A_{NN} = \langle \phi, A_2, A_3 \rangle.$$

### Proposition 1.2.8

Let  $f : X \rightarrow Y$  be a function and  $A = \langle A_1, A_2, A_3 \rangle$  be a neutrosophic crisp set in  $X$ . Then we have  $f(A) = f(A) \cup f(A_N) \cup f(A_{NN})$ .

### Proof

This is obvious from  $A = A_N \cup A_{NN} \cup A_{NNN}$ .

## 1.3 Neutrosophic Crisp Set Relations

Here we give the definition of some relations on neutrosophic crisp sets and study their properties.

Let  $X, Y$  and  $Z$  be three ordinary non-empty sets.

### Definition 1.3.1

Let  $X$  and  $Y$  be two non-empty crisp sets and NCSS  $A$  and  $B$  in the form  $A = \langle A_1, A_2, A_3 \rangle$  in  $X$ ,  $B = \langle B_1, B_2, B_3 \rangle$  on  $Y$ . Then:

- (a) The product of two neutrosophic crisp sets  $A$  and  $B$  is a neutrosophic crisp set  $A \times B$  given by  $A \times B = \langle A_1 \times B_1, A_2 \times B_2, A_3 \times B_3 \rangle$  on  $X \times Y$ .
- (b) We call a neutrosophic crisp relation  $R \subseteq A \times B$  on the direct product  $X \times Y$ .
- (c) The collection of all neutrosophic crisp relations on  $X \times Y$  is denoted as  $NCR(X \times Y)$ .

### Definition 1.3.2

Let  $R$  be a neutrosophic crisp relation on  $X \times Y$ , then the inverse of  $R$  is given by  $R^{-1}$  where  $R \subseteq A \times B$  on  $X \times Y$ , then  $R^{-1} \subseteq B \times A$  on  $Y \times X$ .

**Example 1.3.1**

Let  $X = \{a, b, c, d\}$  ,  $A = \langle \{a, b\}, \{c\}, \{d\} \rangle$  and  $B = \langle \{a\}, \{c\}, \{d, b\} \rangle$ . Then the product of two neutrosophic crisp sets is given by:

$$A \times B = \langle \{(a, a), (b, a)\}, \{(c, c)\}, \{(d, d), (d, b)\} \rangle \text{ and}$$

$$B \times A = \langle \{(a, a), (a, b)\}, \{(c, c)\}, \{(d, d), (b, d)\} \rangle, \text{ and}$$

$$R_1 = \langle \{(a, a)\}, \{(c, c)\}, \{(d, d)\} \rangle,$$

$$R_1 \subseteq A \times B \text{ on } X \times X,$$

$$R_2 = \langle \{(a, b)\}, \{(c, c)\}, \{(d, d), (b, d)\} \rangle R_2 \subseteq B \times A \text{ on } X \times X,$$

$$R_1^{-1} = \langle \{(a, a)\}, \{(c, c)\}, \{(d, d)\} \rangle \subseteq B \times A \text{ and}$$

$$R_2^{-1} = \langle \{(b, a)\}, \{(c, c)\}, \{(d, d), (d, b)\} \rangle \subseteq B \times A.$$

**Example 1.3.2**

Let  $X = \{a, b, c, d, e, f\}$ ,

$$A = \langle \{a, b, c, d\}, \{e\}, \{f\} \rangle,$$

$$D = \langle \{a, b\}, \{e, c\}, \{f, d\} \rangle \text{ be a NCS-Type 2,}$$

$$B = \langle \{a, b, c\}, \{\emptyset\}, \{d, e\} \rangle \text{ be a NCS-Type 1.}$$

$$C = \langle \{a, b\}, \{c, d\}, \{e, f\} \rangle \text{ be a NCS-Type 3.}$$

Then:

$$A \times D = \langle \{(a, a), (a, b), (b, a), (b, b), (b, b), (c, a), (c, b), (d, a), (d, b)\}, \{(e, e), (e, c)\}, \{(f, f), (f, d)\} \rangle$$

$$D \times C = \langle \{(a, a), (a, b), (b, a), (b, b)\}, \{(e, c), (e, d), (c, c), (c, d)\}, \{(f, e), (f, f), (d, e), (d, f)\} \rangle$$

and we can construct many types of relations on products.

*We now define the operations of neutrosophic crisp relation.*

**Definition 1.3.3**

Let  $R$  and  $S$  be two neutrosophic crisp relations between  $X$  and  $Y$  for every  $(x, y) \in X \times Y$  and NCSS  $A$  and  $B$  in the form  $A = \langle A_1, A_2, A_3 \rangle$  in  $X$ ,  $B = \langle B_1, B_2, B_3 \rangle$  on  $Y$ . Then we can define the following operations:

1.  $R \subseteq S$  may be defined as two types:
  - a) Type1:  $R \subseteq S \Leftrightarrow A_{1R} \subseteq B_{1S}, A_{2R} \subseteq B_{2S}, A_{3R} \supseteq B_{3S}$ ;
  - b) Type2:  $R \subseteq S \Leftrightarrow A_{1R} \subseteq B_{1S}, A_{2R} \supseteq B_{2S}, B_{3S} \subseteq A_{3R}$ .
2.  $R \cup S$  may be defined as two types:
  - a) Type1:  $R \cup S = \langle A_{1R} \cup B_{1S}, A_{2R} \cup B_{2S}, A_{3R} \cap B_{3S} \rangle$ ;



- b) Type2:  $R \cup S = \langle A_{1R} \cup B_{1S}, A_{2R} \cap B_{2S}, A_{3R} \cap B_{3S} \rangle$ .
3.  $R \cap S$  may be defined as two types:
- a) Type1:  $R \cap S = \langle A_{1R} \cap B_{1S}, A_{2R} \cup B_{2S}, A_{3R} \cup B_{3S} \rangle$ ;
- b) Type2:  $R \cap S = \langle A_{1R} \cap B_{1S}, A_{2R} \cap B_{2S}, A_{3R} \cup B_{3S} \rangle$ .

### Theorem 1.3.1

Let  $R$ ,  $S$  and  $Q$  be three neutrosophic crisp relations between  $X$  and  $Y$  for every  $(x, y) \in X \times Y$ , then:

- i.  $R \subseteq S \Rightarrow R^{-1} \subseteq S^{-1}$ .
- ii.  $(R \cup S)^{-1} \Rightarrow R^{-1} \cup S^{-1}$ .
- iii.  $(R \cap S)^{-1} \Rightarrow R^{-1} \cap S^{-1}$ .
- iv.  $(R^{-1})^{-1} = R$ .
- v.  $R \cap (S \cup Q) = (R \cap S) \cup (R \cap Q)$ .
- vi.  $R \cup (S \cap Q) = (R \cup S) \cap (R \cup Q)$ .
- vii. If  $S \subseteq R$ ,  $Q \subseteq R$ , then  $S \cup Q \subseteq R$ .

### Proof

Clear.

### Definition 1.3.4

We have the neutrosophic crisp relation  $I \in NCR(X \times X)$ ; the neutrosophic crisp relation of identity may be defined in two ways:

$$\text{Type1: } I = \langle \{A \times A\}, \{A \times A\}, \phi \rangle,$$

$$\text{Type2: } I = \langle \{A \times A\}, \phi, \phi \rangle.$$

Now we define two composite relations of neutrosophic crisp sets.

### Definition 1.3.5

Let  $R$  be a neutrosophic crisp relation in  $X \times Y$ , and  $S$  be a neutrosophic crisp relation in  $Y \times Z$ . Then the composition of  $R$  and  $S$ ,  $R \circ S$ , which is a neutrosophic crisp relation in  $X \times Z$ , as a definition may be defined in two ways:

Type1:

$$R \circ S \leftrightarrow (R \circ S)(x, z) = \cup \{ \langle \{(A_1 \times B_1)_R \cap (A_2 \times B_2)_S\}, \{(A_2 \times B_2)_R \cap (A_2 \times B_2)_S\}, \{(A_3 \times B_3)_R \cap (A_3 \times B_3)_S\} \rangle \}.$$

Type2:

$$R \circ S \leftrightarrow (R \circ S)(x, z) = \cap \{ \langle \{(A_1 \times B_1)_R \cup (A_2 \times B_2)_S \}, \{(A_2 \times B_2)_R \cup (A_2 \times B_2)_S \}, \{(A_3 \times B_3)_R \cup (A_3 \times B_3)_S \} \rangle \}.$$

**Example 1.3.3**

Let  $X = \{a, b, c, d\}$ ,  $A = \langle \{a, b\}, \{c\}, \{d\} \rangle$  and  $B = \langle \{a\}, \{c\}, \{d, b\} \rangle$ . Then the product of two events is given by:

$$\begin{aligned} A \times B &= \langle \{(a, a), (b, a)\}, \{(c, c)\}, \{(d, d), (d, b)\} \rangle, \\ B \times A &= \langle \{(a, a), (a, b)\}, \{(c, c)\}, \{(d, d), (b, d)\} \rangle, \\ R_1 &= \langle \{(a, a)\}, \{(c, c)\}, \{(d, d)\} \rangle, R_1 \subseteq A \times B \text{ on } X \times X \\ R_2 &= \langle \{(a, b)\}, \{(c, c)\}, \{(d, d), (b, d)\} \rangle R_2 \subseteq B \times A \text{ on } X \times X \\ R_1 \circ R_2 &= \cup \langle \{(a, a)\} \cap \{(a, b)\}, \{(c, c)\}, \{(d, d)\} \rangle = \langle \{\emptyset\}, \{(c, c)\}, \{(d, d)\} \rangle \\ I_{A1} &= \langle \{(a, a).(a, b).(b, a)\}, \{(a, a).(a, b).(b, a)\}, \{\emptyset\} \rangle \\ I_{A2} &= \langle \{(a, a).(a, b).(b, a)\}, \{\emptyset\}, \{\emptyset\} \rangle. \end{aligned}$$

**Theorem 1.3.2**

Let  $R$  be a neutrosophic crisp relation in  $X \times Y$ , and  $S$  be a neutrosophic crisp relation in  $Y \times Z$ , then  $(R \circ S)^{-1} = S^{-1} \circ R^{-1}$ .

**Proof**

Clear.

## 2. Neutrosophic Set Theory

---

In this chapter, we introduce and study the concept of neutrosophic set. After granting the fundamental definitions and operations, we obtain several properties, and discuss the relationship between neutrosophic sets and other sets. Also, we usher in and investigate the generalized neutrosophic set and relations between neutrosophic notions. Eventually, we examine some neutrosophic relations. In 2.1, we consider some possible definitions for types of neutrosophic sets. In 2.2, we deem possible definitions for basic concepts of the neutrosophic sets, and their operations. In 2.3, we introduce the concept of  $\alpha$ -cut levels for neutrosophic sets. Added to, we introduce and study some types of neutrosophic sets. In 2.4, we establish the distances between neutrosophic sets: the Hamming distance, the normalized Hamming distance, the Euclidean distance and the normalized Euclidean distance. We extend the concepts of distances to the case of neutrosophic hesitancy degree. In 2.5, we determine the relations on neutrosophic sets and study their properties.

---

### 2.1 Neutrosophic Sets

*We now consider some possible definitions for the basic concepts of the neutrosophic set and its operations.*

#### **Definition 2.1.1**

Let  $X$  be a non-empty fixed set. A neutrosophic set (NS)  $A$  is an object having the form  $A = \{ \langle \mu_A(x), \sigma_A(x), \gamma_A(x) \rangle : x \in X \}$  where  $\mu_A(x)$ ,  $\sigma_A(x)$  and  $\gamma_A(x)$  represent the degree of membership function (denoted  $\mu_A(x)$ ), the degree of indeterminacy (denoted  $\sigma_A(x)$ ), and the degree of non-membership (denoted  $\gamma_A(x)$ ) respectively of each element  $x \in X$  to the set  $A$ .

**Remark 2.1.1**

A neutrosophic set  $A = \{ \langle \mu_A(x), \sigma_A(x), \gamma_A(x) \rangle : x \in X \}$  can be identified to an ordered triple  $\langle \mu_A, \sigma_A, \gamma_A \rangle$  in  $]^{-}0, 1^{+}[$  in  $X$ .

**Remark 2.1.2**

For simplicity, we use the symbol  $A = \langle \mu_A(x), \sigma_A(x), \gamma_A(x) \rangle$  for NS  $A = \{ \langle \mu_A(x), \sigma_A(x), \gamma_A(x) \rangle : x \in X \}$ .

**Example 2.1.1**

Every IFS  $A$ , which is a non-empty set in  $X$ , is obviously a NS, having the form

$$A = \{ \langle \mu_A(x), 1 - (\mu_A(x) + \gamma_A(x)), \gamma_A(x) \rangle : x \in X \}$$

Since our main purpose is to construct the tools for developing neutrosophic set and neutrosophic topology, we must introduce the NSS  $0_N$  and  $1_N$  in  $X$  as it follows:

$0_N$  may be defined as four types:

- ( $0_1$ ) Type 1:  $0_N = \{ \langle 0, 0, 1 \rangle : x \in X \}$ ;
- ( $0_2$ ) Type 2:  $0_N = \{ \langle 0, 1, 1 \rangle : x \in X \}$ ;
- ( $0_3$ ) Type 3:  $0_N = \{ \langle 0, 1, 0 \rangle : x \in X \}$ ;
- ( $0_4$ ) Type 4:  $0_N = \{ \langle 0, 0, 0 \rangle : x \in X \}$ .

$1_N$  may be defined as four types:

- ( $1_1$ ) Type 1:  $1_N = \{ \langle 1, 0, 0 \rangle : x \in X \}$ ;
- ( $1_2$ ) Type 2:  $1_N = \{ \langle 1, 0, 1 \rangle : x \in X \}$ ;
- ( $1_3$ ) Type 3:  $1_N = \{ \langle 1, 1, 0 \rangle : x \in X \}$ ;
- ( $1_4$ ) Type 4:  $1_N = \{ \langle 1, 1, 1 \rangle : x \in X \}$ .

**Definition 2.1.2**

Let  $A = \{ \langle \mu_A(x), \sigma_A(x), \gamma_A(x) \rangle : x \in X \}$  be a GNSS in  $X$ , then the complement of the set  $A$  ( $C(A)$ ) may be defined as three kinds of complements:

- (C1)  $C(A) = \{ \langle 1 - \mu_A(x), 1 - \sigma_A(x), 1 - \gamma_A(x) \rangle : x \in X \}$ ;
- (C2)  $C(A) = \{ \langle \gamma_A(x), \sigma_A(x), \mu_A(x) \rangle : x \in X \}$ ;
- (C3)  $C(A) = \{ \langle \gamma_A(x), 1 - \sigma_A(x), \mu_A(x) \rangle : x \in X \}$ .

Let us define relations and operations between NSS as it follows:

**Definition 2.1.3**

Let  $X$  be a non-empty set, and NSS  $A, B$  in the form:

$$A = \langle \mu_A(x), \sigma_A(x), \gamma_A(x) \rangle, B = \langle \mu_B(x), \sigma_B(x), \gamma_B(x) \rangle.$$

We consider two definitions for subsets ( $A \subseteq B$ ):

Type 1:  $A \subseteq B \Leftrightarrow \mu_A(x) \leq \mu_B(x), \gamma_A(x) \geq \gamma_B(x)$  and  $\sigma_A(x) \leq \sigma_B(x) \forall x \in X$  ;

Type 2:  $A \subseteq B \Leftrightarrow \mu_A(x) \leq \mu_B(x), \gamma_A(x) \geq \gamma_B(x)$  and  $\sigma_A(x) \geq \sigma_B(x)$ .

### Proposition 2.1.1

For any neutrosophic set A, we hold the following:

1.  $0_N \subseteq A, 0_N \subseteq 0_N$  ;
2.  $A \subseteq 1_N, 1_N \subseteq 1_N$ .

### Definition 2.1.4

Let X be a non-empty set, and  $A = \langle \mu_A(x), \sigma_A(x), \gamma_A(x) \rangle$ ,  $B = \langle \mu_B(x), \sigma_B(x), \gamma_B(x) \rangle$  be a NSS. Then:

1.  $A \cap B$  may be defined as three types:

$$(I_1) \text{ Type 1: } A \cap B = \langle x, \mu_A(x) \cdot \mu_B(x), \sigma_A(x) \cdot \sigma_B(x), \gamma_A(x) \cdot \gamma_B(x) \rangle,$$

$$(I_2) \text{ Type 2: } A \cap B = \langle x, \mu_A(x) \wedge \mu_B(x), \sigma_A(x) \wedge \sigma_B(x), \gamma_A(x) \vee \gamma_B(x) \rangle,$$

$$(I_3) \text{ Type 3: } A \cap B = \langle x, \mu_A(x) \wedge \mu_B(x), \sigma_A(x) \vee \sigma_B(x), \gamma_A(x) \vee \gamma_B(x) \rangle.$$

2.  $A \cup B$  may be defined as two types :

$$(U_1) \text{ Type 1: } A \cup B = \langle x, \mu_A(x) \vee \mu_B(x), \sigma_A(x) \vee \sigma_B(x), \gamma_A(x) \wedge \gamma_B(x) \rangle,$$

$$(U_2) \text{ Type 2: } A \cup B = \langle x, \mu_A(x) \vee \mu_B(x), \sigma_A(x) \wedge \sigma_B(x), \gamma_A(x) \wedge \gamma_B(x) \rangle.$$

3.  $[ ]A = \langle x, \mu_A(x), \sigma_A(x), 1 - \mu_A(x) \rangle$ ,  $\langle \rangle A = \langle x, 1 - \gamma_A(x), \sigma_A(x), \gamma_A(x) \rangle$ .

We can easily generalize the operations of intersection and union to arbitrary family of NSS as it follows:

### Definition 2.1.5

Let  $\{A_j : j \in J\}$  be an arbitrary family of NSS in X, then:

1.  $\cap A_j$  may be defined as two types:

$$\text{Type 1: } \cap A_j = \left\langle x, \bigwedge_{j \in J} \mu_{A_j}(x), \bigwedge_{j \in J} \sigma_{A_j}(x), \bigvee \gamma_{A_j}(x) \right\rangle;$$

$$\text{Type 2: } \cap A_j = \left\langle x, \bigwedge \mu_{A_j}(x), \bigvee \sigma_{A_j}(x), \bigvee \gamma_{A_j}(x) \right\rangle.$$

2.  $\cup A_j$  may be defined as two types:

$$\text{Type 1: } \cup A_j = \langle \bigvee \mu_{A_j}(x), \bigwedge \sigma_{A_j}(x), \bigwedge \gamma_{A_j}(x) \rangle;$$

$$\text{Type 2: } \cup A_j = \langle \bigvee \mu_{A_j}(x), \bigvee \sigma_{A_j}(x), \bigwedge \gamma_{A_j}(x) \rangle.$$

### Definition 2.1.6

Let A and B be two neutrosophic sets; then:

$A|B$  may be defined as  $A|B = \langle x, \mu_A \wedge \gamma_B, \sigma_A(x)\sigma_B(x), \gamma_A \vee \mu_B(x) \rangle$ .

**Proposition 2.1.2**

For all two neutrosophic sets A, B, the following statements are true:

- (a)  $C(A \cap B) = C(A) \cup C(B)$ ;
- (b)  $C(A \cup B) = C(A) \cap C(B)$ .

We now take into consideration some possible definitions for the generalized neutrosophic set.

**Definition 2.1.7**

Let X be a non-empty fixed set. A generalized neutrosophic set (GNS) A is an object having the form  $A = \langle \mu_A(x), \sigma_A(x), \nu_A(x) \rangle$ , where  $\mu_A(x)$ ,  $\sigma_A(x)$  and  $\nu_A(x)$  represent the degree of membership function (denoted  $\mu_A(x)$ ), the degree of indeterminacy (denoted  $\sigma_A(x)$ ), and the degree of non-membership (denoted  $\nu_A(x)$ ) of each element  $x \in X$  of the set A, where the functions satisfy the condition  $\mu_A(x) \wedge \sigma_A(x) \wedge \nu_A(x) \leq 0.5$ .

**Remark 2.1.3**

A generalized neutrosophic  $A = \langle \mu_A(x), \sigma_A(x), \nu_A(x) \rangle$  can be identified to an ordered triple  $\langle \mu_A, \sigma_A, \nu_A \rangle$  in  $]0^-, 1^+[$  in X, where the triple functions satisfy the condition  $\mu_A(x) \wedge \sigma_A(x) \wedge \nu_A(x) \leq 0.5$ .

**Example 2.1.2**

Every GIFS A (non-empty set in X) is a GNS, having the form:

$$A = \left\{ \langle x, \mu_A(x), 1 - (\mu_A(x) + \gamma_A(x)), \gamma_A(x) \rangle : x \in X \right\}$$

**Example 2.1.3**

Let  $X = \{a, b, c, d, e\}$  and  $A = \langle \mu_A(x), \sigma_A(x), \nu_A(x) \rangle$  given by:

| X | $\mu_A(x)$ | $\nu_A(x)$ | $\sigma_A(x)$ | $\mu_A(x) \wedge \nu_A(x) \wedge \sigma_A(x)$ |
|---|------------|------------|---------------|---|
| a | 0.6        | 0.3        | 0.5           | 0.3   |
| b | 0.5        | 0.3        | 0.6           | 0.3   |
| c | 0.4        | 0.4        | 0.5           | 0.4   |
| d | 0.3        | 0.5        | 0.3           | 0.3   |
| e | 0.3        | 0.6        | 0.4           | 0.3   |

Then A is a GNS in X.

## 2.2 The Characteristic Function of a Neutrosophic Set

### Definition 2.2.1

Let  $X$  be a non-empty fixed set. A neutrosophic set (NS)  $A$  is an object having the form  $A = \langle \mu_A(x), \sigma_A(x), \nu_A(x) \rangle$  where  $\mu_A(x)$ ,  $\sigma_A(x)$  and  $\nu_A(x)$  represent the degree of membership function (denoted  $\mu_A(x)$ ), the degree of indeterminacy (denoted  $\sigma_A(x)$ ), and the degree of non-membership (denoted  $\nu_A(x)$ ) respectively of each element  $x \in X$  to the set  $A$ , and also let  $g_A : X \times [0,1] \rightarrow [0,1] = I$  be a function, then  $Ng_A(\lambda) = Ng_A(\langle x, \lambda_1, \lambda_2, \lambda_3 \rangle)$  is called a genuine neutrosophic set in  $X$ , if:

$$Ng_A(\lambda) = \begin{cases} 1 & \text{if } \mu_A(x) = \lambda_1, \sigma_A(x) = \lambda_2, \nu_A(x) = \lambda_3 \text{ where } \lambda = (\langle x, \lambda_1, \lambda_2, \lambda_3 \rangle). \\ 0 & \text{otherwise} \end{cases}$$

Then the object

$$G(A) = \langle x, \mu_{G(A)}(x), \sigma_{G(A)}(x), \nu_{G(A)}(x) \rangle$$

is a neutrosophic set generated by  $Ng$ , where:

$$\mu_{G(A)} = \sup_{\lambda_1} \{Ng_A(\lambda) \wedge \lambda\}$$

$$\sigma_{G(A)} = \sup_{\lambda_2} \{Ng_A(\lambda) \wedge \lambda\}$$

$$\nu_{G(A)} = \sup_{\lambda_3} \{Ng_A(\lambda) \wedge \lambda\}.$$

### Proposition 2.2.1

- 1)  $A \subseteq^{Ng} B \Leftrightarrow G(A) \subseteq G(B)$ .
- 2)  $A =^{Ng} B \Leftrightarrow G(A) = G(B)$ .

### Definition 2.2.2

Let  $A$  be a neutrosophic set of  $X$ . Then the neutrosophic complement of  $A$  generated by  $Ng$  denoted by  $A^{Ngc}$  if  $[G(A)]^c$  may be defined as it follows:

$$(Ng^{c1}) \langle \mu^c_A(x), \sigma^c_A(x), \nu^c_A(x) \rangle;$$

$$(Ng^{c2}) \langle \nu_A(x), \sigma_A(x), \mu_A(x) \rangle;$$

$$(Ng^{c3}) \langle \nu_A(x), \sigma^c_A(x), \mu_A(x) \rangle.$$

### Example 2.2.1

Let  $X = \{x\}$ ,  $A = \langle 0.5, 0.7, 0.6 \rangle$ ,  $Ng_A = 1$ ,  $Ng_A = 0$ ; then:

$$G(A) = (\langle 0.5, 0.7, 0.6 \rangle).$$

Since our main purpose is to construct the tools for developing neutrosophic set and neutrosophic topology, we must introduce the  $G(0_N)$  and  $G(1_N)$  as it follows:

$G(0_N)$  may be defined as four types:

- (a) Type 1:  $G(0_N) = \langle 0, 0, 1 \rangle$ ;
- (b) Type 2:  $G(0_N) = \langle 0, 1, 1 \rangle$ ;
- (c) Type 3:  $G(0_N) = \langle 0, 1, 0 \rangle$ ;
- (d) Type 4:  $G(0_N) = \langle 0, 0, 0 \rangle$ .

$G(1_N)$  may be defined as four types:

- (a) Type 1.  $G(1_N) = \langle 1, 0, 0 \rangle$ ;
- (b) Type 2.  $G(1_N) = \langle 1, 0, 1 \rangle$ ;
- (c) Type 3.  $G(1_N) = \langle 1, 1, 0 \rangle$ ;
- (d) Type 4.  $G(1_N) = \langle 1, 1, 1 \rangle$ .

We will define the following operations of intersection and union for neutrosophic sets generated by  $Ng$  denoted by  $\cap^{Ng}$  and  $\cup^{Ng}$  respectively.

### Definition 2.2.3

Let  $A = \langle \mu_A(x), \sigma_A(x), \nu_A(x) \rangle$  and  $B = \langle \mu_B(x), \sigma_B(x), \nu_B(x) \rangle$  be two neutrosophic sets in  $X$ , and  $G(A) = \langle \mu_{G(A)}(x), \sigma_{G(A)}(x), \nu_{G(A)}(x) \rangle$ ,  $G(B) = \langle \mu_{G(B)}(x), \sigma_{G(B)}(x), \nu_{G(B)}(x) \rangle$ .

Then:

1.  $A \cap^{Ng} B$  may be defined as three types:

Type 1:  $G(A \cap B) = \langle \mu_{G(A)}(x) \wedge \mu_{G(B)}(x), \sigma_{G(A)}(x) \wedge \sigma_{G(B)}(x), \nu_{G(A)}(x) \vee \nu_{G(B)}(x) \rangle$

Type 2:  $G(A \cap B) = \langle \mu_{G(A)}(x) \wedge \mu_{G(B)}(x), \sigma_{G(A)}(x) \vee \sigma_{G(B)}(x), \nu_{G(A)}(x) \vee \nu_{G(B)}(x) \rangle$

Type 3:  $G(A \cap B) = \langle \mu_{G(A)}(x) \times \mu_{G(B)}(x), \sigma_{G(A)}(x) \times \sigma_{G(B)}(x), \nu_{G(A)}(x) \times \nu_{G(B)}(x) \rangle$ .

2.  $A \cup^{Ng} B$  may be defined as two types:

Type 1:  $G(A \cup B) = \langle \mu_{G(A)}(x) \vee \mu_{G(B)}(x), \sigma_{G(A)}(x) \wedge \sigma_{G(B)}(x), \nu_{G(A)}(x) \wedge \nu_{G(B)}(x) \rangle$

Type 2:  $G(A \cup B) = \langle \mu_{G(A)}(x) \vee \mu_{G(B)}(x), \sigma_{G(A)}(x) \vee \sigma_{G(B)}(x), \nu_{G(A)}(x) \wedge \nu_{G(B)}(x) \rangle$

### Definition 2.2.4

Let  $A = \langle \mu_A(x), \sigma_A(x), \nu_A(x) \rangle$  be a neutrosophic set, and



$G(A) = \langle \mu_{G(A)}(x), \sigma_{G(A)}(x), \nu_{G(A)}(x) \rangle$ . Then:

(a)  $[ ]^{Ng} A = \langle \mu_{G(A)}(x), \sigma_{G(A)}(x), 1 - \nu_{G(A)}(x) \rangle$

(b)  $\langle \rangle^{Ng} A = \langle 1 - \mu_{G(A)}(x), \sigma_{G(A)}(x), \nu_{G(A)}(x) \rangle$

**Proposition 2.2.2**

For all two neutrosophic sets A and B in X generated by Ng , then the following are true

1)  $(A \cap B)^{cNg} = A^{cNg} \cup B^{cNg}$ .

2)  $(A \cup B)^{cNg} = A^{cNg} \cap B^{cNg}$ .

We can easily generalize the operations of intersection and union to an arbitrary family of neutrosophic subsets generated by Ng as it follows:

**Proposition 2.2.3**

Let  $\{A_j : j \in J\}$  be an arbitrary family of neutrosophic subsets in X generated by Ng , then:

a)  $\cap^{Ng} A_j$  may be defined as :

Type I :  $G(\cap A_j) = \langle \wedge \mu_{G(A_j)}(x), \wedge \sigma_{G(A_j)}(x), \vee \nu_{G(A_j)}(x) \rangle$ ,

Type II:  $G(\cap A_j) = \langle \wedge \mu_{G(A_j)}(x), \vee \sigma_{G(A_j)}(x), \vee \nu_{G(A_j)}(x) \rangle$ .

b)  $\cup^{Ng} A_j$  may be defined as two types :

Type I:  $G(\cup A_j) = \langle \vee \mu_{G(A_j)}(x), \wedge \sigma_{G(A_j)}(x), \wedge \nu_{G(A_j)}(x) \rangle$  or

Type II :  $G(\cup A_j) = \langle \vee \mu_{G(A_j)}(x), \vee \sigma_{G(A_j)}(x), \wedge \nu_{G(A_j)}(x) \rangle$ .

**Definition 2.2.5**

Let  $f : X \rightarrow Y$  be a mapping.

(a) The image of a neutrosophic set A generated by Ng in X under f is a neutrosophic set B in Y generated by Ng , denoted by  $f(A)$  whose reality function  $g_B : Y \times I \rightarrow I = [0,1]$  satisfies the properties:

$$\mu_{G(B)} = \sup_{\lambda_1} \{Ng_A(\lambda) \wedge \lambda\}$$

$$\sigma_{G(B)} = \sup_{\lambda_2} \{Ng_A(\lambda) \wedge \lambda\}$$

$$\nu_{G(B)} = \sup_{\lambda_3} \{Ng_A(\lambda) \wedge \lambda\}$$

- (b) The preimage of a neutrosophic set B in Y generated by Ng under f is a neutrosophic set A in X generated by Ng, denoted by  $f^{-1}(B)$ , whose reality function  $g_A : X \times I \rightarrow I = [0,1]$  satisfies the property  $G(A) = G(B) \circ f$ .

**Proposition 2.2.4**

Let  $\{A_j : j \in J\}$  and  $\{B_j : j \in J\}$  be families of neutrosophic sets in X and Y generated by Ng respectively. Then, for a function  $f : X \rightarrow Y$ , the following properties hold:

1. If  $A_j \subseteq^{Ng} A_k ; j, k \in J$ , then  $f(A_j) \subseteq^{Ng} f(A_k)$ .
2. If  $B_j \subseteq^{Ng} B_k$ , for  $j, k \in J$ , then  $f^{-1}(B_j) \subseteq^{Ng} f^{-1}(B_k)$ .

**Proposition 2.2.5**

Let A and B be neutrosophic sets in X and Y generated by Ng, respectively. Then, for a mapping  $f : X \rightarrow Y$ , we have:

- (a)  $A \subseteq^{Ng} f^{-1}(f(A))$  (if f is injective, the equality holds);
- (b)  $f(f^{-1}(B)) \subseteq^{Ng} B$  (if f is surjective, the equality holds);
- (c)  $[f^{-1}(B)]^{Ngc} \subseteq^{Ng} f^{-1}(B^{Ngc})$ .

**2.3 Some Types of Neutrosophic Sets**

We introduce the concept of  $\alpha$ -cut levels for neutrosophic sets. Added to, we bring in and study some types of neutrosophic sets.

**Definition 2.3.1**

Let  $A = \langle \mu_A(x), \sigma_A(x), \nu_A(x) \rangle$  be a neutrosophic set of the set X. For  $\alpha \in [0,1]$ , the  $\alpha$ -cut of A is the crisp set  $A_\alpha$  defined by as two types:

1. Type 1.  $A_\alpha = \{x : x \in X, \text{either } \mu_A(x), \sigma_A(x) \geq \alpha \text{ or } \nu_A(x) \leq 1 - \alpha\}, \alpha \in ]\bar{0}, \dagger[$
2. Type 2.  $A_\alpha = \{x : x \in X, \text{either } \mu_A(x) \geq \alpha \text{ or } \sigma_A(x) \leq \alpha \text{ or } \nu_A(x) \leq 1 - \alpha\}, \alpha \in ]\bar{0}, \dagger[$

Condition  $\mu_A(x) \geq \alpha$  ensures  $\nu_A(x) \leq 1 - \alpha$ , but not conversely. So, we can define  $\alpha$ -cut of A as  $A_\alpha = \{x : x \in X, \nu_A(x) \leq 1 - \alpha\}$ .

**Definition 2.3.2**

For a neutrosophic set  $A = \langle \mu_A(x), \sigma_A(x), \nu_A(x) \rangle$  the weak  $\alpha$ -cut can be defined as two types:

i) Type 1.  $A_\alpha = \{x : x \in X, \text{ either } \mu_A(x), \sigma_A(x) > \alpha \text{ or } \nu_A(x) < 1 - \alpha\}, \alpha \in \left] 0, 1 \right[$

or

ii) Type 2.  $A_\alpha = \{x : x \in X, \text{ either } \mu_A(x) > \sigma_A(x) < \alpha \text{ or } \nu_A(x) < 1 - \alpha\}, \alpha \in \left] 0, 1 \right[$

The strong  $\alpha$ -cut can be defined as two types:

i) Type 1.  $A_\alpha = \{x : x \in X, \text{ either } \mu_A(x), \sigma_A(x) \geq \alpha \text{ or } \nu_A(x) \leq 1 - \alpha\}, \alpha \in \left] 0, 1 \right[$

or

ii) Type 2.  $A_\alpha = \{x : x \in X, \text{ either } \mu_A(x) \geq \sigma_A(x) \leq \alpha \text{ or } \nu_A(x) \leq 1 - \alpha\}, \alpha \in \left] 0, 1 \right[$

**Definition 2.3.3**

A neutrosophic set with  $\mu_A(x) = 1, \sigma_A(x) = 1, \nu_A(x) = 1$  is called normal neutrosophic set. In other words, A is called normal neutrosophic set if and only if  $\max_{x \in X} \mu_A(x) = \max_{x \in X} \sigma_A(x) = \max_{x \in X} \nu_A(x) = 1$ .

**Definition 2.3.4**

When the support set is a real number set and the following applies for all  $x \in [a, b]$  over any interval  $[a, b]$ :

$$\mu_A(x) \geq \mu_A(a) \wedge \mu_A(b); \quad \nu_A(x) \geq \nu_A(a) \wedge \nu_A(b) \text{ and } \sigma_A(x) \geq \sigma_A(a) \wedge \sigma_A(b),$$

A is said to be neutrosophic convex.

**Definition 2.3.5**

When  $A \subset X$  and  $B \subset Y$ , the neutrosophic subset  $A \times B$  of  $X \times Y$  is the direct product of A and B.

$$A \times B \leftrightarrow \mu_{A \times B}(x, y) = \mu_A(x) \wedge \mu_B(y);$$

$$\sigma_{A \times B}(x, y) = \sigma_A(x) \wedge \sigma_B(y);$$

$$\nu_{A \times B}(x, y) = \nu_A(x) \wedge \nu_B(y).$$

Making use of  $\alpha$ -cut, the following relational equation is called the resolution principle.

**Theorem 2.3.1**

$$\mu_A(x) = \gamma_A(x) = \sigma_A(x) = \text{Sup}_{x \in ]_{0,1}^-+} [\alpha \wedge \chi_{A_\alpha}(x)];$$

$$\mu_A(x) = \sigma_A(x) = \gamma_A(x) = \text{Sup}[\alpha \wedge \chi_{A_{\bar{\alpha}}}(x)].$$

**Proof**

Clear.

The resolution principle is expressed in the form:

$$A = \bigcup_{\alpha \in ]_{0,1}^-+} \alpha A_\alpha$$

In other words, a neutrosophic set can be expressed in terms of the concept of  $\alpha$ -cuts without resorting to grade functions  $\mu$ ,  $\sigma$  and  $\gamma$ .

This is what brings up the representation theorem.  $\alpha$ -cuts are very convenient for the calculation of the operations and relational equations of neutrosophic sets.

*Subsequently, let us discuss the extension principle; we use the functions from X to Y.*

**Definition 2.3.6**

Extending the function  $f : X \rightarrow Y$ , the neutrosophic subset A of X is made to correspond to neutrosophic subset  $f(A) = (\mu_{f(A)}, \sigma_{f(A)}, \gamma_{f(A)})$  of Y in the following ways (Type1, 2):

$$\mu_{f(A)}(y) = \begin{cases} \vee \{\mu_A(x) : x \in f^{-1}(y)\}, & \text{if } f^{-1}(y) \neq \phi \\ 0 & \text{otherwise} \end{cases}$$

$$\sigma_{f(A)}(y) = \begin{cases} \wedge \{\sigma_A(x) : x \in f^{-1}(y)\}, & \text{if } f^{-1}(y) \neq \phi \\ 1 & \text{otherwise} \end{cases}$$

$$\gamma_{f(A)}(y) = \begin{cases} \wedge \{\gamma_A(x) : x \in f^{-1}(y)\}, & \text{if } f^{-1}(y) \neq \phi \\ 1 & \text{otherwise} \end{cases}$$

$$\mu_{f(A)}(y) = \begin{cases} \vee \{\mu_A(x) : x \in f^{-1}(y)\}, & \text{if } f^{-1}(y) \neq \phi \\ 0 & \text{otherwise} \end{cases}$$

$$\sigma_{f(A)}(y) = \begin{cases} \vee \{\sigma_A(x) : x \in f^{-1}(y)\}, & \text{if } f^{-1}(y) \neq \phi \\ 0 & \text{otherwise} \end{cases}$$

$$\gamma_{f(A)}(y) = \begin{cases} \wedge \{\gamma_A(x) : x \in f^{-1}(y)\}, & \text{if } f^{-1}(y) \neq \phi \\ 1 & \text{otherwise} \end{cases}$$

Let  $B$  be a neutrosophic set in  $Y$ . Then the preimage of  $B$  under  $f$ , denoted by  $f^{-1}(B) = (\mu_{f^{-1}(B)}, \sigma_{f^{-1}(B)}, \gamma_{f^{-1}(B)})$ , is defined by:

$$\mu_{f^{-1}(B)} = \mu(f(B)), \sigma_{f^{-1}(B)} = \sigma(f(B)), \gamma_{f^{-1}(B)} = \gamma(f(B)).$$

### Theorem 2.3.2

Let  $A, A_i$  in  $X$ ,  $B$  and  $B_j$ ,  $i \in I$ ,  $j \in J$  in  $Y$ , be neutrosophic subsets, and  $f: X \rightarrow Y$  be a function. Then:

- a.  $A_1 \subset A_2 \Rightarrow f(A_1) \subset f(A_2)$ ,
- b.  $B_1 \subset B_2 \Rightarrow f^{-1}(B_1) \subset f^{-1}(B_2)$ ,
- c.  $A \subset f(f^{-1}(A))$ , the equality holds if  $f$  is injective,
- d.  $f(f^{-1}(B)) \subset B$ , the equality holds if  $f$  is surjective,
- e.  $f^{-1}(\cup_j B_j) = \cup_j f^{-1}(B_j)$ ,
- f.  $f^{-1}(\cap_j B_j) = \cap_j f^{-1}(B_j)$ ,
- g.  $f(\cup_i A_i) = \cup_i f(A_i)$ .

### Proof

Clear.

### Definition 2.3.7

A neutrosophic set  $A$  with  $\mu_A(x) = 1$ , or  $\sigma_A(x) = 1$ ,  $\gamma(x) = 1$  is called normal neutrosophic set.

In other words,  $A$  is called normal if and only if

$$\max_{x \in X} \mu_A(x) = \max_{x \in X} \sigma_A(x) = \max_{x \in X} \gamma_A(x) = 1.$$

### Definition 2.3.8

$A$  is said to be convex when the support set is a real number set and the following assertion applies for all  $x \in [a, b]$  over any interval  $[a, b]$ :

$$\mu_A(x) \geq \mu_A(a) \wedge \mu_A(b); \sigma_A(x) \geq \sigma_A(a) \wedge \sigma_A(b) \text{ and } \gamma_A(x) \geq \gamma_A(a) \wedge \gamma_A(b).$$

### Definition 2.3.9

When  $A \subset X$  and  $B \subset Y$ , the neutrosophic subset  $A \times B$  of  $X \times Y$  is the direct product of  $A$  and  $B$ .

$$A \times B \leftrightarrow \mu_{A \times B}(x, y) = \mu_A(x) \wedge \mu_B(y)$$

$$\sigma_{A \times B}(x, y) = \sigma_A(x) \wedge \sigma_B(y)$$

$$\gamma_{A \times B}(x, y) = \gamma_A(x) \wedge \gamma_B(y)$$

We must introduce now the concept of  $\alpha$ -cut.

**Definition 2.3.10**

For a neutrosophic set  $A = \langle \mu_A(x), \sigma_A(x), \nu_A(x) \rangle$

$$A_\alpha = \{x : x \in X, \text{either } \mu_A(x), \sigma_A(x) > \alpha \text{ or } \nu_A(x) < 1 - \alpha\}; \alpha \in ]0, 1[$$

$$A_{\bar{\alpha}} = \{x : x \in X, \text{either } \mu_A(x), \sigma_A(x) \geq \alpha \text{ or } \nu_A(x) \leq 1 - \alpha\}; \alpha \in ]0, 1[$$

are called the weak and strong  $\alpha$ -cut respectively.

Making use of  $\alpha$ -cut, the following relational equation is called the resolution principle.

**Theorem 2.3.3**

$$\mu_A(x) = \sigma_A(x) = \gamma_A(x) = \text{Sup}_{x \in ]0, 1[} [\alpha \wedge \chi_{A_\alpha}(x)]$$

$$\mu_{A_{\bar{\alpha}}}(x) = \sigma_{A_{\bar{\alpha}}}(x) = \gamma_{A_{\bar{\alpha}}}(x) = \text{Sup}[\alpha \wedge \chi_{A_{\bar{\alpha}}}(x)]$$

**Proof**

$$\begin{aligned} \text{Sup}_{x \in ]0, 1[} [\alpha \wedge \chi_{A_{\bar{\alpha}}}(x)] &= \text{Sup}_{\alpha \in \left\{ \begin{array}{l} ]0, \mu_{A_{\bar{\alpha}}}(x) \\ ]0, \sigma_{A_{\bar{\alpha}}}(x) \\ ]0, \gamma_{A_{\bar{\alpha}}}(x) \end{array} \right\}} [\alpha \wedge \chi_{A_{\bar{\alpha}}}(x)] = \text{Sup}_{\alpha \in \left\{ \begin{array}{l} ]\mu_{A_{\bar{\alpha}}}(x), 1 \\ ]\sigma_{A_{\bar{\alpha}}}(x), 1 \\ ]\gamma_{A_{\bar{\alpha}}}(x), 1 \end{array} \right\}} [\alpha \wedge \chi_{A_{\bar{\alpha}}}(x)] \\ &= \text{Sup}_{\alpha \in (0, \mu_A(x))} [\alpha \wedge 1] \vee \text{Sup}_{\alpha \in \left\{ \begin{array}{l} ]0, \mu_A(x) \\ ]0, \sigma_A(x) \\ ]0, \gamma_A(x) \end{array} \right\}} [\alpha \wedge 0] = \text{Sup}_{\alpha \in (0, \mu_A(x))} \alpha = \mu_A(x) = \sigma_A(x) = \gamma_A(x) \end{aligned}$$

We defined the neutrosophic set  $\alpha A_\alpha$  as:

$$\begin{aligned} \alpha A_\alpha &\leftrightarrow \mu_{\alpha A_\alpha} = \alpha \wedge \chi_{A_\alpha}(x) = \sigma_{\alpha A_\alpha}(x) = \gamma_{\alpha A_\alpha}(x) \\ \gamma_{f(A)}(y) &= \begin{cases} \wedge \{\gamma_A(x) : x \in f^{-1}(y)\}, & \text{if } f^{-1}(y) \neq \emptyset \\ 1 & \text{otherwise} \end{cases} \end{aligned}$$

Let  $B$  neutrosophic set in  $Y$ . Then the preimage of  $B$  under  $f$ , denoted by

$$f^{-1}(B) = (\mu_{f^{-1}(B)}, \sigma_{f^{-1}(B)}, \gamma_{f^{-1}(B)})$$

is defined by  $\mu_{f^{-1}(B)} = \mu(f(B)), \sigma_{f^{-1}(B)} = \sigma(f(B)), \gamma_{f^{-1}(B)} = \gamma(f(B))$ .

## 2.4 Distances, Hesitancy Degree and Cardinality for Neutrosophic Sets

We now extend the concepts of distances presented in [7] to the case of neutrosophic sets.

### Definition 2.4.1

Let  $A = \{(\mu_A(x), \nu_A(x), \gamma_A(x)), x \in X\}$  and

$B = \{(\mu_B(x), \nu_B(x), \gamma_B(x)), x \in X\}$  in  $X = \{x_1, x_2, x_3, \dots, x_n\}$ , then:

The *Hamming distance* is equal to

$$d_{Ns}(A, B) = \sum_{i=1}^n (|\mu_A(x_i) - \mu_B(x_i)| + |\nu_A(x_i) - \nu_B(x_i)| + |\gamma_A(x_i) - \gamma_B(x_i)|).$$

The *Euclidean distance* is equal to:

$$e_{Ns}(A, B) = \sqrt{\sum_{i=1}^n ((\mu_A(x_i) - \mu_B(x_i))^2 + (\nu_A(x_i) - \nu_B(x_i))^2 + (\gamma_A(x_i) - \gamma_B(x_i))^2)}.$$

The *normalized Hamming distance* is equal to:

$$NH_{Ns}(A, B) = \frac{1}{2n} \sum_{i=1}^n (|\mu_A(x_i) - \mu_B(x_i)| + |\nu_A(x_i) - \nu_B(x_i)| + |\gamma_A(x_i) - \gamma_B(x_i)|).$$

The *normalized Euclidean distance* is equal to:

$$NE_{Ns}(A, B) = \sqrt{\frac{1}{2n} \sum_{i=1}^n ((\mu_A(x_i) - \mu_B(x_i))^2 + (\nu_A(x_i) - \nu_B(x_i))^2 + (\gamma_A(x_i) - \gamma_B(x_i))^2)}.$$

### Example 2.4.1

Let us consider for simplicity the degenerated neutrosophic sets  $A, B, D, G, F$  in  $X = \{a\}$ . A full description of each neutrosophic set, i.e.:

$A = \{(\mu_A(x), \nu_A(x), \gamma_A(x)), a \in X\}$ , may be exemplified by

$A = \{ \langle 1, 0, 0 \rangle, a \in X \}$ ,

$B = \{ \langle 0, 1, 0 \rangle, a \in X \}$ ,

$D = \{ \langle 0, 0, 1 \rangle, a \in X \}$ ,

$G = \{ \langle 0.5, 0.5, 0 \rangle, a \in X \}$ ,

$E = \{ \langle 0.25, 0.25, 0.05 \rangle, a \in X \}$ .

Let us calculate four distances between the above neutrosophic sets using the previous formulas. We obtain:

$$e_{Ns}(A, D) = \frac{1}{2}, \quad e_{Ns}(B, D) = \frac{1}{2}, \quad e_{Ns}(A, B) = \frac{1}{2}, \quad e_{Ns}(A, G) = \frac{1}{2}, \quad e_{Ns}(B, G) = \frac{1}{2},$$

$$e_{Ns}(E, G) = \frac{1}{4}, e_{Ns}(D, G) = \frac{1}{4}, NE_{Ns}(A, B) = 1, NE_{Ns}(A, D) = 1, NE_{Ns}(B, D) = 1,$$

$$NE_{Ns}(A, G) = \frac{1}{2}, NE_{Ns}(B, G) = \frac{1}{2}, NE_{Ns}(B, G) = \frac{1}{2}, NE_{Ns}(E, G) = \frac{\sqrt{3}}{4},$$

$$NE_{Ns}(D, G) = \frac{\sqrt{3}}{2}.$$

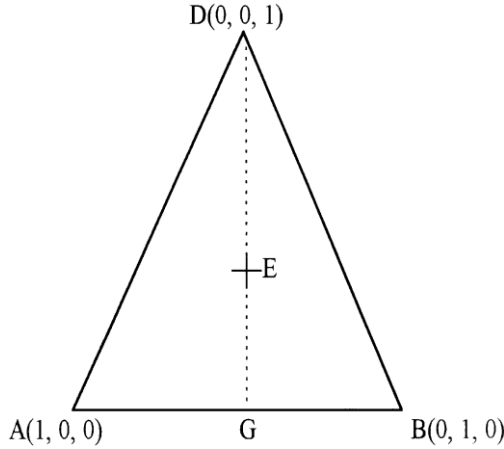

Figure 2: A geometrical neutrosophic interpretation

The triangle ABD in the Figure [A geometrical neutrosophic interpretation](#) has edges equal to  $\sqrt{2}$  and  $e_{Ns}(A, D) = e_{Ns}(B, D) = e_{Ns}(A, B) = \frac{1}{2}$ , and  $NE_{Ns}(A, B) = NE_{Ns}(A, D) = NE_{Ns}(B, D) = 2NE_{Ns}(A, G) = 2NE_{Ns}(B, G) = 1$ ,  $NE_{Ns}(E, G)$  equal to half of the height of triangle with all edges equal to  $\sqrt{2}$  multiplied by  $\frac{1}{\sqrt{2}}$  i.e.  $\frac{\sqrt{3}}{4}$ .

**Example 2.4.2**

Let us consider the following neutrosophic sets A and B in  $X = \{a, b, c, d, e\}$ ,  $A = \{\langle 0.5, 0.3, 0.2 \rangle, \langle 0.2, 0.6, 0.2 \rangle, \langle 0.3, 0.2, 0.5 \rangle, \langle 0.2, 0.2, 0.6 \rangle, \langle 1, 0, 0 \rangle\}$ ,  $B = \{\langle 0.2, 0.6, 0.2 \rangle, \langle 0.3, 0.2, 0.5 \rangle, \langle 0.5, 0.2, 0.3 \rangle, \langle 0.9, 0, 0.1 \rangle, \langle 0, 0, 0 \rangle\}$ .

Then  $d_{Ns}(A, B) = 3$ ,  $NH_{Ns}(A, B) = 0.43$ ,  $e_{Ns}(A, B) = 1.49$  and  $NE_{Ns}(A, B) = 0.55$ .

**Remark 2.4.1**

These distances clearly satisfy the conditions of metric space.



**Remark 2.4.2**

It is easy to notice that the following assertions are valid:

- a)  $0 \leq d_{Ns}(A, B) \leq n$
- b)  $0 \leq NH_{Ns}(A, B) \leq 1$
- c)  $0 \leq e_{Ns}(A, B) \leq \sqrt{n}$
- d)  $0 \leq NE_{Ns}(A, B) \leq 1$ .

The representation of a neutrosophic set in Figure [A three-dimension representation of a Neutrosophic Set](#) is a point of departure for neutrosophic crisp distances, and entropy of neutrosophic sets.

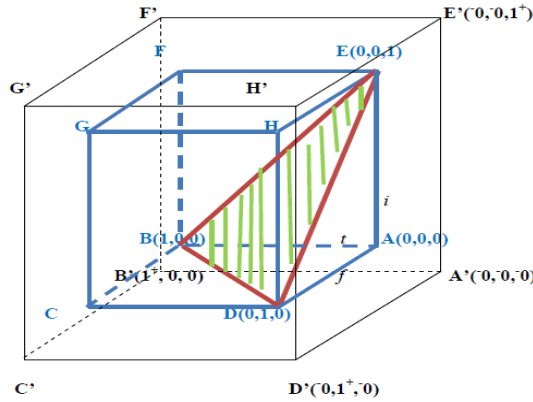

**Figure 3: A three-dimension representation of a Neutrosophic Set.**

We extend the concepts of distances to the case of neutrosophic hesitancy degree by taking into account the four parameters characterization of neutrosophic sets,

$$\text{i.e. } A = \{ \langle \mu_A(x), \nu_A(x), \gamma_A(x), \pi_A(x) \rangle, x \in X \}.$$

**Definition 2.4.2**

Let  $A = \{ (\mu_A(x), \nu_A(x), \gamma_A(x)), x \in X \}$  and  $B = \{ (\mu_B(x), \nu_B(x), \gamma_B(x)), x \in X \}$  on  $X = \{ x_1, x_2, x_3, \dots, x_n \}$ . For a neutrosophic set  $A = \{ (\mu_A(x), \nu_A(x), \gamma_A(x)), x \in X \}$  in  $X$ , we call  $\pi_A(x) = 3 - \mu_A(x) - \nu_A(x) - \gamma_A(x)$ , the neutrosophic index of  $x$  in  $A$ . It is a hesitancy degree of  $x$  with respect to  $A$ ; it is obvious that  $0 \leq \pi_A(x) \leq 3$ .

**Definition 2.4.3**

Let  $A = \{ (\mu_A(x), \nu_A(x), \gamma_A(x)), x \in X \}$  and  $B = \{ (\mu_B(x), \nu_B(x), \gamma_B(x)), x \in X \}$  in  $X = \{ x_1, x_2, x_3, \dots, x_n \}$  then:

i) The *Hamming distance* is equal to

$$d_{Ns}(A, B) = \sum_{i=1}^n (|\mu_A(x_i) - \mu_B(x_i)| + |\nu_A(x_i) - \nu_B(x_i)| + |\gamma_A(x_i) - \gamma_B(x_i)| + |\pi_A(x_i) - \pi_B(x_i)|)$$

Taking into account that:

$$\begin{aligned} \pi_A(x_i) &= 3 - \mu_A(x_i) - \nu_A(x_i) - \gamma_A(x_i) \quad \text{and} \\ \pi_B(x_i) &= 3 - \mu_B(x_i) - \nu_B(x_i) - \gamma_B(x_i) \end{aligned}$$

we have

$$\begin{aligned} |\pi_A(x_i) - \pi_B(x_i)| &= |3 - \mu_A(x_i) - \nu_A(x_i) - \gamma_A(x_i) - 3 + \mu_B(x_i) + \nu_B(x_i) + \gamma_B(x_i)| \\ &\leq |\mu_B(x_i) - \mu_A(x_i)| + |\nu_B(x_i) - \nu_A(x_i)| + |\gamma_B(x_i) - \gamma_A(x_i)|. \end{aligned}$$

ii) The *Euclidean distance* is equal to

$$e_{Ns}(A, B) = \sqrt{\sum_{i=1}^n ((\mu_A(x_i) - \mu_B(x_i))^2 + (\nu_A(x_i) - \nu_B(x_i))^2 + (\gamma_A(x_i) - \gamma_B(x_i))^2 + (\pi_A(x_i) - \pi_B(x_i))^2)}$$

we have

$$\begin{aligned} (\pi_A(x_i) - \pi_B(x_i))^2 &= (-\mu_A(x_i) - \nu_A(x_i) - \gamma_A(x_i) + \mu_B(x_i) + \nu_B(x_i) + \gamma_B(x_i))^2 = \\ &= (\mu_B(x_i) - \mu_A(x_i))^2 + (\nu_B(x_i) - \nu_A(x_i))^2 + (\gamma_B(x_i) - \gamma_A(x_i))^2 \\ &\quad + 2(\mu_B(x_i) - \mu_A(x_i))(\nu_B(x_i) - \nu_A(x_i))(\gamma_B(x_i) - \gamma_A(x_i)) \end{aligned}$$

iii) The *normalized Hamming distance* is equal to

$$NH_{Ns}(A, B) = \frac{1}{2n} \sum_{i=1}^n (|\mu_A(x_i) - \mu_B(x_i)| + |\nu_A(x_i) - \nu_B(x_i)| + |\gamma_A(x_i) - \gamma_B(x_i)| + |\pi_A(x_i) - \pi_B(x_i)|)$$

iv) The *normalized Euclidean distance* is equal to

$$NE_{Ns}(A, B) = \sqrt{\frac{1}{2n} \sum_{i=1}^n ((\mu_A(x_i) - \mu_B(x_i))^2 + (\nu_A(x_i) - \nu_B(x_i))^2 + (\gamma_A(x_i) - \gamma_B(x_i))^2 + (\pi_A(x_i) - \pi_B(x_i))^2)}$$

### Remark 2.4.3

It is easy to notice that for the formulas above the following assertions are valid:

- a)  $0 \leq d_{Ns}(A, B) \leq 2n$
- b)  $0 \leq NH_{Ns}(A, B) \leq 2$
- c)  $0 \leq e_{Ns}(A, B) \leq \sqrt{2n}$
- d)  $0 \leq NE_{Ns}(A, B) \leq \sqrt{2}$ .

*In our further considerations on entropy for neutrosophic sets the concept of Cardinality of a neutrosophic set is also useful.*

**Definition 2.4.4**

Let  $A = \{(\mu_A(x), \nu_A(x), \gamma_A(x)), x \in X\}$  be a neutrosophic set in X. We define two cardinalities of a neutrosophic set:

- The least (sure) cardinality of A is equal to the so-called sigma-count, and it is called here the

$$\min \Sigma cont(A) = \sum_{i=1} \mu_A(x_i) + \sum_{i=1} \nu_A(x_i).$$

- The biggest cardinality of A, which is possible due to  $\pi_A(x)$  is equal to  $\max \Sigma cont(A) = \sum_{i=1} (\mu_A(x_i) + \pi_A(x_i)) + \sum_{i=1} (\nu_A(x_i) + \pi_A(x_i))$  and

clearly for  $A^c$  we have  $\min \Sigma cont(A^c) = \sum_{i=1} \gamma_A(x_i) + \sum_{i=1} \nu_A(x_i),$

$$\max \Sigma cont(A^c) = \sum_{i=1} (\gamma_A(x_i) + \pi_A(x_i)) + \sum_{i=1} (\nu_A(x_i) + \pi_A(x_i)).$$

Then the cardinality of neutrosophic set is defined as the interval  $Card(A) = [\min \Sigma Cont(A), \max \Sigma Cont(A)].$

**2.5 Neutrosophic Relations**

*Let X, Y and Z be three ordinary finite non-empty sets.*

**Definition 2.5.1**

We call a neutrosophic relation R from set X to set Y (or between X and Y) a neutrosophic subset of the direct product  $X \times Y = \{(x, y) : x \in X, y \in Y\}.$

That is  $R = \{(x, y), (< \mu_R(x, y), \sigma_R(x, y), \gamma_R(x, y) > : x \in X, y \in Y)\},$  where (x, y) is characterized by the degree of membership function  $\mu_R(x),$  the degree of indeterminacy  $\sigma_R(x),$  and the degree of non-membership  $\gamma_R(x)$  respectively of each element  $x \in X, y \in Y$  to the set X and Y, where

$$\mu_R : X \times Y \rightarrow ]0, 1^+], \sigma_R : X \times Y \rightarrow ]0, 1^+], \text{ and } \gamma_R : X \times Y \rightarrow ]0, 1^+].$$

We have the sets  $X = \{x_1, x_2, \dots, x_m\}, Y = \{y_1, y_2, \dots, y_n\}.$  A neutrosophic relation in  $X \times Y$  can be expressed by a  $m \times n$  matrix. This kind of matrix expressing a neutrosophic relation is called neutrosophic matrix.

Since the triple  $(\mu_R, \sigma_R, \gamma_R)$  has values within the interval  $]0, 1^+],$  the elements of the neutrosophic matrix also have values within  $]0, 1^+]$  in order to express neutrosophic relation R for

$$(\mu_R(x_i, y_j), \sigma_R(x_i, y_j), \gamma_R(x_i, y_j)).$$

The neutrosophic relation is defined as neutrosophic subsets of  $X \times Y$ , having the form  $R = \{ \langle x, y \rangle, \langle \mu_R(x, y), \sigma_R(x, y), \gamma_R(x, y) \rangle : x \in X, y \in Y \}$ , where the triple  $(\mu_R, \sigma_R, \gamma_R)$  has values within the interval  $]_0^- \ ^+_1[$ , and the elements of the neutrosophic matrix also have values within  $]_0^- \ ^+_1[$ .

**Definition 2.5.2**

Given a neutrosophic relation between  $X$  and  $Y$ , we can define  $R^{-1}$  between  $Y$  and  $X$  by means of

$$\mu_{R^{-1}}(y, x) = \mu_R(x, y), \sigma_{R^{-1}}(y, x) = \sigma_R(x, y), \gamma_{R^{-1}}(y, x) = \gamma_R(x, y) \forall (x, y) \in X \times Y,$$

which we call inverse neutrosophic relation of  $R$ .

**Example 2.5.1**

When a neutrosophic relation  $R$  in  $X = \{a, b, c\}$  is

$$R = \langle (x, y), (0.2, 0.4, 0.3)(a, a), (1, 0.2, 0)(a, b), (0.4, 0.1, 0.7)(a, c), (0.6, 0.2, 0.1)(b, b), (0.3, 0.2, 0.6)(b, c), (0.2, 0.4, 0.1)(c, c) \rangle,$$

the neutrosophic matrix for  $R$  is as shown:

$$R = \begin{bmatrix} \langle 0.2, 0.4, 0.3 \rangle & \langle 1, 0.2, 0 \rangle & \langle 0.4, 0.1, 0.7 \rangle \\ \langle 0.6, 0.2, 0.1 \rangle & \langle 0.3, 0.2, 0.6 \rangle & \langle 0.3, 0.2, 0.6 \rangle \end{bmatrix}.$$

**Example 2.5.2**

Let  $X$  be a real number set. For  $x, y \in X$ , the neutrosophic relation  $R$  can be characterized by the following assertions:

$$\mu_R(x, y) = \begin{cases} 0 & ; x \geq y \\ \frac{1}{1 + \left(\frac{10}{y-x}\right)^2} & ; x < y \end{cases}$$

$$\sigma_R(x, y) = \begin{cases} 0 & ; x \geq y \\ \frac{1}{1 + \left(\frac{2}{y-x}\right)^2} & ; x < y \end{cases}$$

$$\gamma_R(x, y) = \begin{cases} 0 & ; x \geq y \\ \frac{1}{1 + \left(\frac{2}{y-x}\right)^2} & ; x < y \end{cases}$$

As a generalization of neutrosophic relations, the  $n$ -array neutrosophic relation  $R$  in  $X_1 \times X_2 \times X_3 \times \dots \times X_n$  is given by:

$$R = \int_{X_1 \times X_2 \times X_3 \times \dots \times X_n} (\mu_R(x_1, x_2, \dots, x_n), \sigma_R(x_1, x_2, \dots, x_n), \gamma_R(x_1, x_2, \dots, x_n)), x_i \in X$$

and we get the following:

$$\mu_R : X_1 \times X_2 \times \dots \times X_n \rightarrow ]0, 1[$$

$$\sigma_R : X_1 \times X_2 \times \dots \times X_n \rightarrow ]0, 1[$$

$$\gamma_R : X_1 \times X_2 \times \dots \times X_n \rightarrow ]0, 1[$$

When  $n=1$ ,  $R$  is an unary neutrosophic relation, and this is clearly a neutrosophic set in  $X$ . Other ways of expressing neutrosophic relations include matrices.

*We can define the operations of neutrosophic relations.*

### Definition 2.5.3

Let  $R$  and  $S$  be two neutrosophic relations between  $X$  and  $Y$  for every  $(x, y) \in X \times Y$ .

1.  $R \subseteq S$  may be defined as two types

(a) Type 1:  $R \subseteq S \Leftrightarrow \mu_R(x, y) \leq \mu_S(x, y), \sigma_R(x, y) \leq \sigma_S(x, y), \gamma_R(x, y) \geq \gamma_S(x, y)$

(b) Type 2:  $R \subseteq S \Leftrightarrow \mu_R(x, y) \leq \mu_S(x, y), \sigma_R(x, y) \geq \sigma_S(x, y), \gamma_R(x, y) \geq \gamma_S(x, y)$

2.  $R \cup S$  may be defined as two types

(a) Type 1:

$$R \cup S = \{ \langle x, y \rangle, (\langle \mu_R(x, y) \vee \mu_S(x, y), \sigma_R(x, y) \vee \sigma_S(x, y), \gamma_R(x, y) \wedge \gamma_S(x, y) \rangle) \}$$

(b) Type 2:

$$R \cup S = \{ \langle x, y \rangle, (\langle \mu_R(x, y) \vee \mu_S(x, y), \sigma_R(x, y) \wedge \sigma_S(x, y), \gamma_R(x, y) \wedge \gamma_S(x, y) \rangle) \}$$

3.  $R \cap S$  may be defined as types:

(a) Type 1:

$$R \cap S = \{ \langle x, y \rangle, (\langle \mu_R(x, y) \wedge \mu_S(x, y), \sigma_R(x, y) \wedge \sigma_S(x, y), \gamma_R(x, y) \vee \gamma_S(x, y) \rangle) \}$$

(b) Type 2:

$$R \cap S = \{ \langle x, y \rangle, (\langle \mu_R(x, y) \wedge \mu_S(x, y), \sigma_R(x, y) \vee \sigma_S(x, y), \gamma_R(x, y) \vee \gamma_S(x, y) \rangle) \}$$

4. The complement of neutrosophic relation  $R$  ( $R^c$ ) may be defined as three types:

(a) Type 1:  $R^c = \{ \langle x, y \rangle, (\langle \mu^c_R(x, y), \sigma^c_R(x, y), \gamma^c_R(x, y) \rangle) \}$ ;

(b) Type 2:  $R^c = \{ \langle x, y \rangle, (\langle \gamma_R(x, y), \sigma^c_R(x, y), \mu_R(x, y) \rangle) \}$ ;

(c) Type 3:  $R^c = \{ \langle x, y \rangle, (\langle \gamma_R(x, y), \sigma_R(x, y), \mu_R(x, y) \rangle) \}$ .

**Theorem 2.5.1**

Let R, S and Q be three neutrosophic relations on  $N(X \times Y)$ , then:

- i)  $R \subseteq S \Rightarrow R^{-1} \subseteq S^{-1}$ ,
- ii)  $(R \cup S)^{-1} = R^{-1} \cup S^{-1}$ ,
- iii)  $(R \cap S)^{-1} = R^{-1} \cap S^{-1}$
- iv)  $(R^{-1})^{-1} = R$ .
- v)  $R \cap (S \cup Q) = (R \cap S) \cup (R \cap Q)$ .
- vi)  $R \cup (S \cap Q) = (R \cup S) \cap (R \cup Q)$ .
- vii) If  $S \subseteq R, Q \subseteq R$ , then  $S \vee Q \subseteq R$ .
- viii) If  $R \subseteq S, R \subseteq Q$ , then  $R \leq S \cap Q$ .

**Proof**

If  $R \subseteq S$  then  $\mu_{R^{-1}}(y, x) = \mu_R(x, y) \leq \mu_S(x, y) = \mu_{S^{-1}}(y, x)$ , for every  $(x, y)$  of  $X \times Y$ . Analogously  $\sigma_{R^{-1}}(y, x) = \sigma_R(x, y) \geq \sigma_S(x, y)$  or  $\leq \sigma_S(x, y)$  and  $\gamma_{R^{-1}}(y, x) = \gamma_R(x, y) \geq \gamma_S(x, y) = \gamma_{S^{-1}}(y, x)$  for every  $(x, y)$  of  $X \times Y$ .

$$\mu_{(R \vee S)^{-1}}(y, x) = \mu_{R \vee S}(x, y) = \mu_R(x, y) \vee \mu_S(x, y) = \mu_{R^{-1} \cup S^{-1}}(y, x) = \mu_{R^{-1}}(y, x) \vee \mu_{S^{-1}}(y, x).$$

The proof for:

$$\sigma_{(R \cup S)^{-1}}(y, x) = \sigma_{R^{-1} \cup S^{-1}}(x, y) \text{ and } \gamma_{(R \cup S)^{-1}}(y, x) = \gamma_{R^{-1} \cup S^{-1}}(x, y),$$

can be done in a similar way.

The others are clear from the definition of the operators  $\wedge$  and  $\vee$ .

**Definition 2.5.4**

(1) The neutrosophic relation  $I \in NR(X \times X)$  is called relation of identity and it is represented by the symbol  $I = I^{-1}$  if

$$\mu_I(x, y) = \begin{cases} 1 & \text{if } x = y \quad \forall (x, y) \in X \times X \\ 0 & \text{if } x \neq y \end{cases}$$

$$\sigma_I(x, y) = \begin{cases} 1 & \text{if } x = y \quad \forall (x, y) \in X \times X \\ 0 & \text{if } x \neq y \end{cases} \text{ or } \sigma_I(x, y) = \begin{cases} 0 & \text{if } x = y \\ 1 & \text{if } x \neq y \end{cases}$$

$$\forall (x, y) \in X \times X$$

$$\gamma_I(x, y) = \begin{cases} 0 & \text{if } x = y \quad \forall (x, y) \in X \times X \\ 1 & \text{if } x \neq y \end{cases}$$

(2) The complementary neutrosophic relation  $I^c$  is defined by:

$$\mu_{I^c}(x, y) = \begin{cases} 0 & \text{if } x = y \quad \forall (x, y) \in X \times X \\ 1 & \text{if } x \neq y \end{cases}$$

$$\sigma_{I^c}(x, y) = \begin{cases} 0 & \text{if } x = y \\ 1 & \text{if } x \neq y \end{cases} \quad \forall (x, y) \in X \times X \quad \text{or} \quad \sigma_{I^c}(x, y) = \begin{cases} 1 & \text{if } x = y \\ 0 & \text{if } x \neq y \end{cases}$$

$$\sigma_{I^c}(x, y) = \begin{cases} 0 & \text{if } x = y \\ 1 & \text{if } x \neq y \end{cases} \quad \forall (x, y) \in X \times X$$

$$\gamma_{I^c}(x, y) = \begin{cases} 1 & \text{if } x = y \\ 0 & \text{if } x \neq y \end{cases} \quad \forall (x, y) \in X \times X$$

Note that  $I^c = (I^c)^{-1}$ .

We can defined some types of neutrosophic relations.

### Definition 2.5.5

The neutrosophic relation  $R \in NR(X \times X)$  is called:

- (1) Neutrosophic reflexive relation, if for every  $x \in X$ ,  $\mu_R(x, x) = 1$ , and  $\sigma_R(x, x) = 0$  or  $\sigma_R(x, x) = 1$ . Note  $\gamma_R(x, x) = 0 \quad \forall x \in X$ .
- (2) Anti-reflexive neutrosophic relation if for every  $x \in X$ ,

$$\begin{cases} \mu_R(x, x) = 0 \\ \sigma_R(x, x) = 0, \text{ or } \sigma_R(x, x) = 1 \\ \gamma_R(x, x) = 1 \end{cases} .$$

### Theorem 2.5.2

Let  $R$  be a reflexive neutrosophic relation in  $X \times X$ . Then:

- (1)  $R_1^{-1}$  is a reflexive neutrosophic relation;
- (2)  $R_1 \cup R_2$  is a reflexive neutrosophic relation for every  $R_2 \in NR(X \times X)$ ;
- (3)  $R_1 \cap R_2$  is a reflexive neutrosophic relation  $\Leftrightarrow R_2 \in NR(X \times X)$  is a reflexive neutrosophic relation.

### Proof

Clear. Note that:

$$\begin{aligned} \mu_{R_1 \cup R_2}(x, x) &= \mu_{R_1}(x, x) \vee \mu_{R_2}(x, x) = 1 \vee \mu_{R_2}(x, x) = 1 \\ \sigma_{R_1 \cup R_2}(x, x) &= \sigma_{R_1}(x, x) \vee \sigma_{R_2}(x, x) = 1 \vee \sigma_{R_2}(x, x) = 1 \quad \text{or} \\ &= 0 \vee \sigma_{R_2}(x, x) = \sigma_{R_2}(x, x) \\ \mu_{R_1 \cap R_2}(x, x) &= \mu_{R_1}(x, x) \wedge \mu_{R_2}(x, x) = 1 \wedge \mu_{R_2}(x, x) = \mu_{R_2}(x, x) \\ \sigma_{R_1 \cap R_2}(x, x) &= \sigma_{R_1}(x, x) \wedge \sigma_{R_2}(x, x) = 1 \wedge \sigma_{R_2}(x, x) = \sigma_{R_2}(x, x) \\ &\text{or } = 0 \wedge \sigma_{R_2}(x, x) = 0. \end{aligned}$$

**Definition 2.5.6**

The neutrosophic relation  $R \in NR(X \times X)$  is called symmetric if  $R = R^{-1}$ , that is for every  $(x, y) \in X \times Y$

$$\begin{cases} \mu_R(x, y) = \mu_R(y, x) \\ \sigma_R(x, y) = \sigma_R(y, x) \\ \gamma_R(x, x) = \gamma_R(y, x) \end{cases}$$

We consider the neutrosophic relation  $R \in NR(X \times X)$  an anti-symmetrical neutrosophic relation if  $\forall (x, y) \in X \times Y$ . The definition of anti-symmetrical neutrosophic relation is justified by the following argument:  $x \leq_R y$  if and only if the neutrosophic relation  $R \in NR(X \times X)$  is reflexive and anti-symmetrical.

**Theorem 2.5.3**

Let  $R \in NR(X \times X)$ .  $R$  is an anti-symmetrical neutrosophic relation if and only if  $\forall (x, y) \in X \times Y$ , with  $x \neq y$ , then  $\mu_R(x, y) \neq \mu_R(y, x)$ .

**Proof**

As  $\gamma_R(x, y) = \mu^c_R(x, y) \forall (x, y) \in X \times Y$ , then  $\mu_R(x, y) \neq \mu_R(y, x)$  if and only if  $\begin{cases} \mu_R(x, y) \neq \mu_R(y, x) \\ \sigma_R(x, y) \neq \sigma_R(y, x) \text{ or } \sigma_R(x, y) = \sigma_R(y, x) \\ \gamma_R(x, y) \neq \gamma_R(y, x) \end{cases}$ .

**Definition 2.5.7**

Let  $R \in NR(X \times X)$ . We call a transitive neutrosophic closure of  $R$  to the minimum neutrosophic relation  $T$  on  $X \times X$  which contains  $R$  and it is transitive, that is to say:

- (a)  $R \subseteq T$
- (b) If  $R, P \in N(X, X)$ ,  $R \subseteq P$  and  $P$  is transitive, then  $T \subseteq P$ .

**Theorem 2.5.4**

Let  $R, P, T, S \in NR(X \times X)$  and  $R \subseteq P$  and  $R \subseteq T$ ,  $R \subseteq S$ , then  $T \subseteq S$ .

**Proof**

Clear from *Definitions*.



**Definition 2.5.8**

If R is a neutrosophic relation in  $X \times Y$  and S is a neutrosophic relation in  $Y \times Z$ , the composition of R and S,  $R \circ S$ , is a neutrosophic relation in  $X \times Z$ , as defined below:

$$1 \quad R \circ S \leftrightarrow (R \circ S)(x, z) = \left\{ \bigvee_y (\mu_R(x, y) \wedge \mu_S(y, z)), \bigvee_y (\sigma_R(x, y) \wedge \sigma_S(y, z)), \bigvee_y (\gamma_R(x, y) \wedge \gamma_S(y, z)) \right\}$$

$$2 \quad R \circ S \leftrightarrow (R \circ S)(x, z) = \left\{ \bigwedge_y (\mu_R(x, y) \vee \mu_S(y, z)), \bigwedge_y (\sigma_R(x, y) \vee \sigma_S(y, z)), \bigwedge_y (\gamma_R(x, y) \vee \gamma_S(y, z)) \right\}$$

**Definition 2.5.9**

A neutrosophic relation R on the Cartesian set  $X \times X$  is called

- (a) A neutrosophic tolerance relation on  $X \times X$  if R is reflexive and symmetric;
- (b) A neutrosophic similarity (equivalence) relation on  $X \times X$  if R is reflexive, symmetric and transitive.

**Example 2.5.3**

Consider the neutrosophic tolerance relation T on  $X = \{x_1, x_2, x_3, x_4\}$

|    | x1            | x2            | x3            | x4            |
|----|---------------|---------------|---------------|---------------|
| x1 | <1,0,0>       | <0.8,0.2,0.1> | <0.6,0.1,0.2> | <0.3,0.3,0.4> |
| x2 | <0.8,0.2,0.1> | <1,0,0>       | <0.4,0.4,0.5> | <0.5,0.2,0.3> |
| x3 | <0.6,0.1,0.2> | <0.4,0.4,0.5> | <1,0,0>       | <0.6,0.2,0.3> |
| x4 | <0.3,0.3,0.4> | <0.5,0.2,0.3> | <0.6,0.2,0.3> | <1,0,0>       |

It can be computed that for  $\alpha = 1$ , the partition of X determined by  $T_\alpha$  given by  $\{\{x_1\}, \{x_2\}, \{x_3\}, \{x_4\}\}$ , for  $\alpha = 0.9$ , the partition of X determined by  $T_\alpha$  given by  $\{\{x_1, x_2\}, \{x_3\}, \{x_4\}\}$ ,  $\alpha = 0.8$ , the partition of X determined by  $T_\alpha$  given by  $\{\{x_1, x_2, x_3\}, \{x_4\}\}$ ,  $\alpha = 0.7$ , the partition of X determined by  $T_\alpha$  given by  $\{\{x_1, x_2, x_3, x_4\}\}$ .

Moreover, we see that when  $\alpha \in (0.9, 1]$  the partition of X determined by  $T_\alpha$  is given by  $\{\{x_1\}, \{x_2\}, \{x_3\}, \{x_4\}\}$ , when  $\alpha \in (0.8, 0.9]$ , the partition of X determined by  $T_\alpha$  given by  $\{\{x_1, x_2, x_3\}, \{x_4\}\}$ , when  $\alpha \in (0.7, 0.8]$ , the partition of X determined by  $T_\alpha$  given by  $\{\{x_1, x_2, x_3\}, \{x_4\}\}$ , when  $\alpha \in (0, 0.7]$ , the partition of X determined by  $T_\alpha$  given by  $\{\{x_1, x_2, x_3\}, \{x_4\}\}$ .

### 3. Introduction to Neutrosophic Crisp Topological Spaces

In this chapter, we generalize the crisp topological spaces and intuitionistic topological space to neutrosophic crisp topological space. In 3.1, we introduce and study the neutrosophic topological spaces and construct the basic concept of neutrosophic crisp topology. In 3.2, we define the neutrosophic crisp continuous function and we obtain some characterizations of neutrosophic continuity. In 3.3, we develop the neutrosophic crisp compact spaces. Characterization and properties of neutrosophic crisp compact spaces are framed. In 3.4, we approach the neutrosophic crisp nearly open sets and their properties.

#### 3.1 Neutrosophic Crisp Topological Spaces

We extend the concepts of topological space and intuitionistic topological space to the case of neutrosophic crisp sets.

##### Definition 3.1.1

A neutrosophic crisp topology (NCT) in a non-empty set  $X$  is a family  $\Gamma$  of neutrosophic crisp subsets in  $X$  satisfying the axioms:

- (a)  $\phi_N, X_N \in \Gamma$ .
- (b)  $A_1 \cap A_2 \in \Gamma$  for any  $A_1$  and  $A_2 \in \Gamma$ .
- (c)  $\cup A_j \in \Gamma \forall \{A_j : j \in J\} \subseteq \Gamma$ .

The pair  $(X, \Gamma)$  is called a neutrosophic crisp topological space (NCTS) in  $X$ . The elements in  $\Gamma$  are called neutrosophic crisp open sets (NCOSs) in  $X$ . A neutrosophic crisp set  $F$  is closed if and only if its complement  $F^C$  is an open neutrosophic crisp set.

**Remark 3.1.1**

The neutrosophic crisp topological spaces are generalizations of topological spaces and intuitionistic topological spaces, and they allow more general functions to be members of topology.

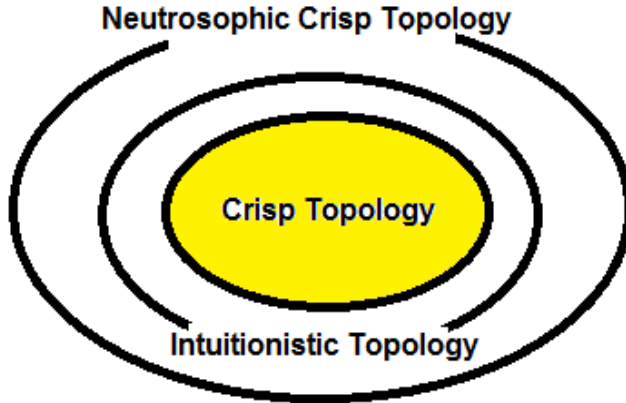

Figure 4: Neutrosophic Crisp Topological Spaces are generalizations of topological spaces and intuitionistic topological spaces

**Example 3.1.1**

Let  $X = \{a, b, c, d\}$ , and  $\phi_N, X_N$  be any type of universal and empty subset, and A, B be two neutrosophic crisp subsets on X defined by

- (a)  $A = \langle \{a\}, \{b, d\}, \{c\} \rangle$ ;
- (b)  $B = \langle \{a\}, \{b\}, \{c\} \rangle$ .

The family  $\Gamma = \{\phi_N, X_N, A, B\}$  is a neutrosophic crisp topology in X.

**Example 3.1.2**

Let  $(X, \tau_0)$  be a topological space such that  $\tau_0$  is not indiscrete. Suppose  $\{G_i : i \in J\}$  is a family, and  $\tau_0 = \{X, \phi\} \cup \{G_i : i \in J\}$ . Then we can construct the following topologies:

1) Two intuitionistic topologies:

- (a)  $\tau_1 = \{\phi_I, X_I\} \cup \{\langle G_i, \phi \rangle, i \in J\}$ ;
- (b)  $\tau_2 = \{\phi_I, X_I\} \cup \{\langle \phi, G_i^c \rangle, i \in J\}$ .

2) Four neutrosophic crisp topologies:

- (a)  $\Gamma_1 = \{\phi_N, X_N\} \cup \{\langle \phi, \phi, G_i^c \rangle, i \in J\}$ ;
- (b)  $\Gamma_2 = \{\phi_N, X_N\} \cup \{\langle G_i, \phi, \phi \rangle, i \in J\}$ ;

- (c)  $\Gamma_3 = \{\phi_N, X_N\} \cup \{G_i, \phi, G_i^c, i \in J\}$ ;  
 (d)  $\Gamma_4 = \{\phi_N, X_N\} \cup \{G_i^c, \phi, \phi, i \in J\}$ .

**Definition 3.1.2**

Let  $(X, \Gamma_1), (X, \Gamma_2)$  be two neutrosophic crisp topological spaces in X. Then  $\Gamma_1$  is contained in  $\Gamma_2$  (symbolized  $\Gamma_1 \subseteq \Gamma_2$ ) if  $G \in \Gamma_2$  for each  $G \in \Gamma_1$ . In this case, we say that  $\Gamma_1$  is coarser than  $\Gamma_2$ .

**Proposition 3.1.1**

Let  $\{\Gamma_j : j \in J\}$  be a family of NCTs on X. Then  $\cap \Gamma_j$  is a neutrosophic crisp topology in X. Furthermore,  $\cap \Gamma_j$  is the coarsest NCT in X containing all topologies.

**Proof**

Obvious.

*Now, we define the neutrosophic crisp closure and neutrosophic crisp interior operations in neutrosophic crisp topological spaces.*

**Definition 3.1.3**

Let  $(X, \Gamma)$  be NCTS and  $A = \langle A_1, A_2, A_3 \rangle$  be a NCS in X. Then the neutrosophic crisp closure of A (NCCI(A), for short) and neutrosophic interior crisp (NCInt(A), for short) of A are defined by:

- (a)  $NCCI(A) = \cap \{K : K \text{ is an NCS in X and } A \subseteq K\}$ ,  
 (b)  $NCInt(A) = \cup \{G : G \text{ is an NCOS in X and } G \subseteq A\}$ ,

where NCS is a neutrosophic crisp set and NCOS is a neutrosophic crisp open set. It can be also shown that NCCI(A) is a NCCS (neutrosophic crisp closed set) and NCInt(A) is a CNOS in X.

**Remark 3.1.2**

For any neutrosophic set A in X, we have

- (a)  $NCCI(A) \supseteq A$ .  
 (b) A is a NCCS in X if and only if  $NCInt(A) = A$ .

**Proposition 3.1.2**

For any neutrosophic crisp set A in  $(X, \Gamma)$ , we have:

$$(a) \quad NCCI(A^c) = (NCInt(A))^c,$$

$$(b) \quad NCInt(A^c) = (NCCI(A))^c.$$

**Proof**

Let  $A = \langle A_1, A_2, A_3 \rangle$ , and suppose that the family of neutrosophic crisp subsets contained in  $A$  are indexed by the family; if NCSs contained in  $A$  are indexed by the family  $A = \{ \langle A_{j_1}, A_{j_2}, A_{j_3} \rangle : i \in J \}$ , then we have either

$$\begin{aligned} NCInt(A) &= \{ \langle \cup A_{j_1}, \cup A_{j_2}, \cap A_{j_3} \rangle \}, \text{ or} \\ NCInt(A) &= \{ \langle \cup A_{j_1}, \cap A_{j_2}, \cap A_{j_3} \rangle \}, \text{ hence} \\ (NCInt(A))^c &= \{ \langle \cap A_{j_1}, \cap A_{j_2}, \cup A_{j_3} \rangle \}, \text{ or} \\ (NCInt(A))^c &= \{ \langle \cap A_{j_1}, \cup A_{j_2}, \cup A_{j_3} \rangle \}, \text{ hence} \\ NCCI(A^c) &= (NCInt(A))^c, \text{ analogously.} \end{aligned}$$

**Proposition 3.1.3**

Let  $(X, \Gamma)$  be a NCTS and  $A, B$  be two neutrosophic crisp sets in  $X$  holding the following properties:

- 1)  $NCInt(A) \subseteq A$ ,
- 2)  $A \subseteq NCCI(A)$ ,
- 3)  $A \subseteq B \Rightarrow NCInt(A) \subseteq NCInt(B)$ ,
- 4)  $A \subseteq B \Rightarrow NCCI(A) \subseteq NCCI(B)$ ,
- 5)  $NCInt(A \cap B) = NCInt(A) \cap NCInt(B)$ ,
- 6)  $NCCI(A \cup B) = NCCI(A) \cup NCCI(B)$ ,
- 7)  $NCInt(X_N) = X_N$ ,
- 8)  $NCCI(\phi_N) = \phi_N$ .

**Proof**

(a), (b) and (e) are obvious, (c) follows from (a), and from *Definitions*.

**3.2 Neutrosophic Crisp Continuity**

*The basic definitions are:*

**Definition 3.2.1**

If  $B = \langle B_1, B_2, B_3 \rangle$  is a NCS in  $Y$ , then the preimage of  $B$  under  $f$ , denoted  $f^{-1}(B)$ , is a NCS in  $X$  defined by  $f^{-1}(B) = \langle f^{-1}(B_1), f^{-1}(B_2), f^{-1}(B_3) \rangle$ . If  $A = \langle A_1, A_2, A_3 \rangle$  is a NCS in  $X$ , then the image of  $A$  under  $f$ , denoted  $f(A)$ , is a NCS in  $Y$  defined by  $f(A) = \langle f(A_1), f(A_2), f(A_3)^c \rangle$ .

*We introduce the properties of images and preimages, some of which we frequently use in the following sections.*

**Corollary 3.2.1**

Let  $A, \{A_i : i \in J\}$ , be NCSs in  $X$ , and  $B, \{B_j : j \in K\}$ , a NCS in  $Y$ , and  $f : X \rightarrow Y$  a function.

We have:

$$\begin{aligned} A_1 \subseteq A_2 &\Leftrightarrow f(A_1) \subseteq f(A_2), \\ B_1 \subseteq B_2 &\Leftrightarrow f^{-1}(B_1) \subseteq f^{-1}(B_2), \\ A &\subseteq f^{-1}(f(A)). \end{aligned}$$

If  $f$  is injective, then:

$$\begin{aligned} A &= f^{-1}(f(A)); \\ f^{-1}(f(B)) &\subseteq B. \end{aligned}$$

If  $f$  is surjective, then:

$$\begin{aligned} f^{-1}(f(B)) &= B, \quad f^{-1}(\cup B_i) = \cup f^{-1}(B_i), \\ f^{-1}(\cap B_i) &= \cap f^{-1}(B_i), \\ f(\cup A_i) &= \cup f(A_i); \quad f(\cap A_i) \subseteq \cap f(A_i); \end{aligned}$$

If  $f$  is injective, then:

$$\begin{aligned} f(\cap A_i) &= \cap f(A_i); \\ f^{-1}(Y_N) &= X_N, \quad f^{-1}(\phi_N) = \phi_N \cdot f(\phi_N) = \phi_N, \quad f(X_N) = Y_N, \end{aligned}$$

if  $f$  is subjective.

**Proof**

Obvious.

**Definition 3.2.2**

Let  $(X, \Gamma_1)$  and  $(Y, \Gamma_2)$  be two NCTSSs, and let  $f : X \rightarrow Y$  be a function;  $f$  is said to be continuous if the preimage of each NCS in  $\Gamma_2$  is a NCS in  $\Gamma_1$ .

**Definition 3.2.3**

Let  $(X, \Gamma_1)$  and  $(Y, \Gamma_2)$  be two NCTSs, and let  $f : X \rightarrow Y$  be a function;  $f$  is said to be open if the image of each NCS in  $\Gamma_2$  is a NCS in  $\Gamma_1$ .

**Example 3.2.1**

Let  $(X, \Gamma_o)$  and  $(Y, \Psi_o)$  be two NCTSs.

If  $f : X \rightarrow Y$  is continuous in the usual sense, then  $f$  is continuous.

Here we consider the NCTs in  $X$  and  $Y$ , respectively, as it follows:

$$\Gamma_1 = \{ \langle G, \phi, G^c \rangle : G \in \Gamma_o \} \text{ and } \Gamma_2 = \{ \langle H, \phi, H^c \rangle : H \in \Psi_o \}.$$

In this case, we have for each  $\langle H, \phi, H^c \rangle \in \Gamma_2, H \in \Psi_o,$

$$f^{-1} \langle H, \phi, H^c \rangle = \langle f^{-1}(H), f^{-1}(\phi), f^{-1}(H^c) \rangle = \langle f^{-1}H, f(\phi), (f(H))^c \rangle \in \Gamma_1.$$

If  $f : X \rightarrow Y$  is open in the usual sense, then in this case,  $f$  is open in the sense of *Definition 3.2.1*.

*Now we obtain some characterizations of neutrosophic continuity.*

**Proposition 3.2.1**

Let  $f : (X, \Gamma_1) \rightarrow (Y, \Gamma_2)$ . Then  $f$  is neutrosophic continuous if the preimage of each crisp neutrosophic closed set (CNCS) in  $\Gamma_2$  is a CNCS in  $\Gamma_1$ .

**Proposition 3.2.2**

The following are equivalent to each other:

- (a)  $f : (X, \Gamma_1) \rightarrow (Y, \Gamma_2)$  is neutrosophic continuous.
- (b)  $f^{-1}(CNInt(B)) \subseteq CNInt(f^{-1}(B))$  for each CNS  $B$  in  $Y$ .
- (c)  $CNCl(f^{-1}(B)) \subseteq f^{-1}(CNCl(B))$  for each CNC  $B$  in  $Y$ .

**Example 3.2.2**

Let  $(Y, \Gamma_2)$  be a NCTS and  $f : X \rightarrow Y$  be a function. In this case,  $\Gamma_1 = \{ f^{-1}(H) : H \in \Gamma_2 \}$  is a NCT in  $X$ . Indeed, it is the coarsest NCT in  $X$ , which makes the function  $f : X \rightarrow Y$  continuous. One may call it the initial neutrosophic crisp topology with respect to  $f$ .

**3.3 Neutrosophic Crisp Compact Space (NCCS)**

*Let us firstly discuss the basic concepts.*

**Definition 3.3.1**

Let  $(X, \Gamma)$  be an NCTS.

If a family  $\langle\langle G_{i_1}, G_{i_2}, G_{i_3} \rangle\rangle : i \in J$  of NCOSs in X satisfies the condition  $\cup \langle\langle X, G_{i_1}, G_{i_2}, G_{i_3} \rangle\rangle : i \in J = X_N$ , then it is called a neutrosophic open cover of X.

(a) A finite subfamily of an open cover  $\langle\langle G_{i_1}, G_{i_2}, G_{i_3} \rangle\rangle : i \in J$  in X, which is also a neutrosophic open cover of x, is called a neutrosophic finite subcover  $\langle\langle G_{i_1}, G_{i_2}, G_{i_3} \rangle\rangle : i \in J$ .

(b) A family  $\langle\langle K_{i_1}, K_{i_2}, K_{i_3} \rangle\rangle : i \in J$  of NCCSs in X satisfies the Finite Intersection Property (FIP) if every finite subfamily  $\langle\langle K_{i_1}, K_{i_2}, K_{i_3} \rangle\rangle : i = 1, 2, \dots, n$  of the family satisfies the condition  $\cap \langle\langle K_{i_1}, K_{i_2}, K_{i_3} \rangle\rangle : i \in J \neq \phi_N$ .

**Definition 3.3.2**

A NCTS  $(X, \Gamma)$  is called neutrosophic crisp compact if each crisp neutrosophic open cover of X has a finite subcover.

**Example 3.3.1**

Let  $X = N$  and let us consider the NCSs (neutrosophic crisp sets) given below:

$$A_1 = \langle\langle \{2, 3, 4, \dots\}, \phi, \phi \rangle\rangle, A_2 = \langle\langle \{3, 4, \dots\}, \phi, \{1\} \rangle\rangle, A_3 = \langle\langle \{4, 5, 6, \dots\}, \phi, \{1, 2\} \rangle\rangle,$$

$$A_n = \langle\langle \{n+1, n+2, n+3, \dots\}, \phi, \{1, 2, 3, \dots, n-1\} \rangle\rangle.$$

Then  $\Gamma = \{\phi_N, X_N\} \cup \{A_n = 3, 4, 5, \dots\}$  is a NCT in X and  $(X, \Gamma)$  is a neutrosophic crisp compact.

Let  $X = (0, 1)$  and let's take the NCSs  $A_n = \langle\langle (\frac{1}{n}, \frac{n-1}{n}), \phi, (0, \frac{1}{n}) \rangle\rangle, n = 3, 4, 5, \dots$  in X. In this case  $\Gamma = \{\phi_N, X_N\} \cup \{A_n = 3, 4, 5, \dots\}$  is an NCT in X, which is not a neutrosophic crisp compact.

**Corollary 3.3.1**

A NCTS  $(X, \Gamma)$  is a neutrosophic crisp compact if every family  $\langle\langle X, G_{i_1}, G_{i_2}, G_{i_3} \rangle\rangle : i \in J$  of NCCSs in X satisfying the FIP has a non-empty intersection.



**Corollary 3.3.2**

Let  $(X, \Gamma_1), (Y, \Gamma_2)$  be NCTSs and  $f: X \rightarrow Y$  be a continuous surjection. If  $(X, \Gamma_1)$  is a neutrosophic crisp compact, then so is  $(Y, \Gamma_2)$ .

**Definition 3.3.3**

If a family  $\{ \langle G_{i_1}, G_{i_2}, G_{i_3} \rangle : i \in J \}$  of NCCSs in X satisfies the condition  $A \subseteq \cup \{ \langle G_{i_1}, G_{i_2}, G_{i_3} \rangle : i \in J \}$ , then it is called a neutrosophic crisp open cover of A.

Let us consider a finite subfamily of a neutrosophic crisp subcover of  $\{ \langle G_{i_1}, G_{i_2}, G_{i_3} \rangle : i \in J \}$ .

A neutrosophic crisp set  $A = \langle A_1, A_2, A_3 \rangle$  in a NCTS  $(X, \Gamma)$  is called neutrosophic crisp compact if every neutrosophic crisp open cover of A has a finite neutrosophic crisp subcover.

**Corollary 3.3.3**

Let  $(X, \Gamma_1), (Y, \Gamma_2)$  be NCTSs and  $f: X \rightarrow Y$  be a continuous surjection. If A is a neutrosophic crisp compact in  $(X, \Gamma_1)$ , then so is  $f(A)$  in  $(Y, \Gamma_2)$ .

### 3.4 Nearly Neutrosophic Crisp Open Sets

**Definition 3.4.1**

A neutrosophic crisp topology (NCT) in a non-empty set X is a family  $\Gamma$  of neutrosophic crisp subsets in X satisfying the following axioms:

- (a)  $\phi_N, X_N \in \Gamma$ ;
- (b)  $A_1 \cap A_2 \in \Gamma$  for any  $A_1$  and  $A_2 \in \Gamma$ ;
- (c)  $\cup A_j \in \Gamma \forall \{A_j : j \in J\} \subseteq \Gamma$ .

In this case, the pair  $(X, \Gamma)$  is called a neutrosophic crisp topological space (NCTS) in X. The elements in  $\Gamma$  are called neutrosophic crisp open sets (NCOSs) in X. A neutrosophic crisp set F is closed if and only if its complement  $F^C$  is an open neutrosophic crisp set. Let  $(X, \Gamma)$  be a NCTS (identified with its class of neutrosophic crisp open sets), and  $NCint$  and  $NCcl$  denoting neutrosophic interior crisp set and neutrosophic crisp closure with respect to neutrosophic crisp topology.

**Definition 3.4.2**

Let  $(X, \Gamma)$  be a NCTS and  $A = \langle A_1, A_2, A_3 \rangle$  be a NCS in X, then A is called:

- (a) Neutrosophic crisp  $\alpha$ - open set if  $A \subseteq NC \text{ int}(NCcl(NC \text{ int}(A)))$ ,
- (b) Neutrosophic crisp  $\beta$ - open set if  $A \subseteq NCcl(NC \text{ int}(A))$ .
- (c) Neutrosophic crisp semi-open set if  $A \subseteq NC \text{ int}(NCcl(A))$ .

We denote the class of all neutrosophic crisp  $\alpha$ - open sets  $NCF^\alpha$ , all neutrosophic crisp  $\beta$ - open sets  $NCF^\beta$ , and the class of all neutrosophic crisp semi-open sets  $NCF^s$ .

**Remark 3.4.1**

A class consists of exactly all neutrosophic crisp  $\alpha$ -structure (resp. NC  $\beta$ -structure). Evidently,  $NCF \subseteq NCF^\alpha \subseteq NCF^\beta$ .

We notice that every non-empty neutrosophic crisp  $\beta$ -open has NC  $\alpha$ - non-empty interior.

If all neutrosophic crisp sets following  $\{B_i\}_{i \in I}$  are NC  $\beta$ -open sets, then  $\{\cup_{i \in I} B_i\}_{i \in I} \subset NCcl(NC \text{ int}(B_i)) \subset NCcl(NC \text{ int}(B_i))$ , that is a NC  $\beta$ -structure is a neutrosophic closed with respect to arbitrary neutrosophic crisp unions.

*We now characterize  $NCF^\alpha$  in terms  $NCF^\beta$ .*

**Theorem 3.4.1**

Let  $(X, \Gamma)$  be a NCTS.  $NCF^\alpha$  consists of exactly those neutrosophic crisp set A for which  $A \cap B \in NCF^\beta$  for  $B \in NCF^\beta$ .

**Proof**

Let  $A \in NCF^\alpha$ ,  $B \in NCF^\beta$ ,  $p \in A \cap B$ , and U be a neutrosophic crisp neighbourhood (NCnbd) of p.

Clearly,  $U \cap NC \text{ int}(NCcl(NC \text{ int}(A)))$  is a neutrosophic crisp open neighbourhood of p.

So  $V = (U \cap NC \text{ int}(NCcl(NC \text{ int}(A)))) \cap NC \text{ int}(B)$  is a non-empty. Since  $V \subset NCcl(NC \text{ int}(A))$ , we imply that

$$(U \cap NC \text{ int}(A) \cap NC \text{ int}(B)) = V \cap NC \text{ int}(A) = \phi_N.$$

It follows that

$$A \cap B \subset NCcl(Nc \text{ int}(A) \cap NC \text{ int}(B)) = NCcl(NC \text{ int}(A \cap B)) \text{ i.e.}$$

$$A \cap B \in NCF^\beta.$$

Conversely, let  $A \cap B \in NCF^\beta$  for all  $B \in NCF^\beta$ , in particular  $A \in NCF^\beta$ .

Assume that  $p \in A \cap (NC \text{ int}(NCcl(A) \cap NC \text{ int}(A)))^c$ .

Then  $p \in NCcl(B)$ , where  $(NCcl(NC \text{ int}(A)))^c$ .

Clearly  $\{p\} \cup B \in NCF^\beta$ , and consequently  $A \cap \{\{p\} \cup B\} \in NCF^\beta$ .

But  $A \cap \{\{p\} \cup B\} = \{p\}$ . Hence  $\{p\}$  is a neutrosophic crisp open. As  $p \in (NCcl(NC \text{ int}(A)))$ , this implies that  $p \in NC \text{ int}(NCcl(NC \text{ int}(A)))$ , contrary to assumption. Because  $p \in A, p \in NCcl(NC \text{ int}(A))$  and  $A \in NCF^\alpha$ .

The proof is complete.

Thus, we have found that  $NCF^\alpha$  is completely determined by  $NCF^\beta$  i.e. all neutrosophic crisp topologies with the same NC  $\beta$ -structure also determine the same NC  $\alpha$ -structure, explicitly given.

We converse all neutrosophic crisp topologies with the same NC  $\alpha$ -structure, so that  $NCF^\beta$  is completely determined by  $NCF^\alpha$ .

### Theorem 3.4.2

Every neutrosophic crisp NC  $\alpha$ -structure is a neutrosophic crisp topology.

#### Proof

$NCF^\beta$  contains the neutrosophic crisp empty set and is closed with respect to arbitrary unions. A standard result gives the class of those neutrosophic crisp sets A for which  $A \cap B \in NCF^\beta$  for all  $B \in NCF^\beta$  constitutes a neutrosophic crisp topology, hence the theorem. Onwards, we also use the term NC  $\alpha$ -topology for NC  $\alpha$ -structure; two neutrosophic crisp topologies deterring the same NC  $\alpha$ -structure are called NC  $\alpha$ -equivalent, and the equivalence classes are called NC  $\alpha$ -classes.

*We now characterize  $NCF^\beta$  in terms of  $NCF^\alpha$ .*

**Proposition 3.4.1**

Let  $(X, \Gamma)$  be a NCTS. Then  $NC\Gamma^\beta = NC\Gamma^{\alpha\beta}$  and hence  $NC\alpha$ -equivalent topologies determine the same  $NC\beta$ -structure.

**Proof**

Let  $NC\alpha-cl$  and  $NC\alpha-int$  denote the neutrosophic closure and the neutrosophic crisp interior with respect to  $NC\Gamma^\alpha$ . If  $p \in B \in NC\Gamma^\beta$  and  $p \in B \in NC\Gamma^\alpha$ , then  $(NC\text{int}(NCcl(NC\text{int}(A))) \cap NC\text{int}(B)) \neq \phi_N$ , since  $NC\text{int}(NCcl(NC\text{int}(A)))$  is a crisp neutrosophic neighbourhood of point  $p$ . So certainly,  $NC\text{int}(B)$  meets  $NCcl(NC\text{int}(A))$  and therefore (being neutrosophic open) meets  $NC\text{int}(A)$ , proving  $A \cap NC\text{int}(B) \neq \phi_N$ . This means  $B \subset NC\alpha cl(NC\text{int}(B))$  i.e.  $B \in NC\Gamma^{\alpha\beta}$ .

On the other hand, let  $A \in NC\Gamma^{\alpha\beta}$ ,  $p \in A$  and  $p \in V \in NC\Gamma$ . As  $V \in NC\Gamma^\alpha$  and  $p \in NCcl(NC\text{int}(A))$ , we have  $V \cap NC\text{int}(A) \neq \phi_N$  and there exists a neutrosophic crisp set  $W \in \Gamma$  such that  $W \subset V \cap NC\alpha\text{int}(A) \subset A$ .

In other words,  $V \cap NC\text{int}(A) \neq \phi_N$  and  $p \in NCcl(NC\text{int}(A))$ . Thus we have verified  $NC\Gamma^{\alpha\beta} \subset NC\Gamma^\alpha$ , and the proof is complete. We get  $NC\Gamma^{\alpha\alpha} = NC\Gamma^\alpha$ .

**Corollary 3.4.1**

A neutrosophic crisp topology  $NC\Gamma$  is a  $NC\alpha$ -topology if  $NC\Gamma = NC\Gamma^\alpha$ . Thus, a  $NC\alpha$ -topology belongs to the  $NC\alpha$ -class if all determinants are neutrosophic crisp topologies, and if it is the finest topology of finest neutrosophic topology of this class. Evidently  $NC\Gamma^\beta$  is a neutrosophic crisp topology if  $NC\Gamma^\alpha = NC\Gamma^\beta$ .

In this case,  $NC\Gamma^{\beta\beta} = NC\Gamma^{\alpha\beta} = NC\Gamma^\beta$ .

**Corollary 3.4.2**

If  $NC\beta$ -structure  $B$  is a neutrosophic crisp topology, then  $B = B^\alpha = B^\beta$ .

*We proceed giving some results of the neutrosophic structure of neutrosophic crisp  $NC\alpha$ -topology.*

**Proposition 3.4.2**

The  $NC\alpha$  – open sets with respect to a given neutrosophic crisp topology are exactly those sets which may be written as a difference between a neutrosophic crisp open set and a neutrosophic crisp nowhere dense set.

If  $A \in NCI\Gamma^\alpha$ , we have:

$$A = (NC \text{int}(NCcl(NC \text{int}(A))) \cap (NC \text{int}(NCcl(NC \text{int}(A))) \cap A^C)^C,$$

where  $(NC \text{int}(NCcl(NC \text{int}(A))) \cap A^C)$  is clearly neutrosophic crisp nowhere dense set; we easily see that  $B \subset NCcl(NC \text{int}(A))$  and consequently  $A \subset B \subset NC \text{int}(NCcl(NC \text{int}(A)))$ , so the proof is complete.

**Corollary 3.4.3**

A neutrosophic crisp topology is a  $NC\alpha$  – topology if all neutrosophic crisp nowhere dense sets are neutrosophic crisp closed.

A neutrosophic crisp  $NC\alpha$  – topology may be characterized as neutrosophic crisp topology when the difference between neutrosophic crisp open and neutrosophic crisp nowhere dense set is again a neutrosophic crisp open, and evidently, this is equivalent to the stated condition.

**Proposition 3.4.3**

The neutrosophic crisp topologies which are  $NC\alpha$  – equivalent determine the same class of neutrosophic crisp nowhere dense sets.

**Definition 3.4.3**

We recall that a neutrosophic crisp topology is a neutrosophic crisp extremely disconnected if the neutrosophic crisp closure of every neutrosophic crisp open set is a neutrosophic crisp open.

**Proposition 3.4.4**

If  $NC\alpha$  – structure  $B$  is a neutrosophic crisp topology, all neutrosophic crisp topologies  $\Gamma$  for which  $\Gamma^\beta = B$  are neutrosophic crisp extremely disconnected.

In particular: Either all or none of the neutrosophic crisp topologies of a  $NC\alpha$  – class are extremely disconnected.

**Proof**

Let  $\Gamma^\beta = B$ , and suppose there is a  $A \in \Gamma$  such that  $NCcl(A) \notin \Gamma$ .  
 Let  $p \in NCcl(A) \cap (NC\text{int}(NCcl(A)))^C$  with  $B = \{p\} \cup NC\text{int}(NCcl(A))$ ,  
 $M = (NC\text{int}(NCcl(A)))^C$ .

$$\begin{aligned} \text{We have } \{p\} \subset M &= (NC\text{int}(NCcl(A)))^C = NCcl(NC\text{int}(M)), \\ \{p\} \subset NCcl(A) &= NCcl(NC\text{int}(NCcl(A))) \subset NCcl(NC\text{int}(B)) \end{aligned}$$

hence both  $B$  and  $M$  are in  $\Gamma^\beta$ . The intersection  $B \cap M = \{p\}$  is not neutrosophic crisp open since  $p \in NCcl(A) \cap M^C$ , hence not  $NC\beta$ -open, so  $\Gamma^\beta = B$  is not a neutrosophic crisp topology. Now suppose  $B$  is not a topology, and  $\Gamma^\beta = B$ . There is a  $B \in \Gamma^\beta$  such that  $B \notin \Gamma^\alpha$ . Assume that  $NCcl(NC\text{int}(B)) \in \Gamma$ . Then  $B \subset NCcl(NC\text{int}(B)) = NC\text{int}(NCcl(NC\text{int}(B)))$  i.e.  $B \in \Gamma^\alpha$ , contrary to assumption. Thus, we have produced an open set whose closure is not open, which completes the proof.

**Corollary 3.4.4**

A neutrosophic crisp topology  $\Gamma$  is a neutrosophic crisp extremely disconnected if and only if  $\Gamma^\beta$  is a neutrosophic crisp topology.

## 4. Neutrosophic Crisp Topological Ideal Spaces & Neutrosophic Crisp Filters

The purpose of this chapter is to specify and characterize the neutrosophic crisp ideal (in 4.1) and the neutrosophic crisp filter (in 4.2). We also define the neutrosophic crisp local functions, and introduce the notion of neutrosophic crisp sets via neutrosophic crisp ideals, distinguishing basic operations and results in neutrosophic crisp topological spaces (in 4.3). Neutrosophic crisp L-openness and neutrosophic crisp L-continuity are considered as generalizations for crisp and fuzzy concepts. Relationships between the above new neutrosophic crisp notions and other relevant classes are investigated. Conclusively, we individualize two different types of neutrosophic crisp functions. In 4.4, we familiarize the reader with Filters on neutrosophic crisp set, considered as a generalization of filters studies. Several relations between different neutrosophic crisp filters and neutrosophic topologies are also studied here.

### 4.1 Neutrosophic Crisp Ideals

#### Definition 4.1.1

Let  $X$  be a non-empty set and  $L$  a non-empty family of NCSs. We call  $L$  a neutrosophic crisp ideal (NCL) in  $X$  if

- (a)  $A \in L$  and  $B \subseteq A \Rightarrow B \in L$  [heredity],
- (b)  $A \in L$  and  $B \in L \Rightarrow A \vee B \in L$  [finite additivity].

A neutrosophic crisp ideal  $L$  is called a  $\sigma$ -neutrosophic crisp ideal if  $\{A_j\}_{j \in \mathbb{N}} \leq L$ , which implies that  $\bigcup_{j \in \mathbb{N}} A_j \in L$  (countable additivity).

The smallest and the largest neutrosophic crisp ideals in a non-empty set  $X$  are  $\{\varphi_N\}$ , and NSs in  $X$ . Also,  $NC.L_f, NC.L_c$  denote the neutrosophic crisp ideals (NCL for short) of neutrosophic subsets having

finite and countable support of  $X$ , respectively. Moreover, if  $A$  is a non-empty NS in  $X$ , then  $\{B \in NCS : B \subseteq A\}$  is an NCL in  $X$ . This is called the principal NCL of all NCSs, denoted by  $NCL\langle A \rangle$ .

**Remark 4.1.1**

- (a)  $\phi_N \in L$ ;
- (b) If  $X_N \notin L$ , then  $L$  is called a neutrosophic crisp proper ideal.
- (c) If  $X_N \in L$ , then  $L$  is called a neutrosophic crisp improper ideal.

**Example 4.1.1**

Let  $X = \{a, b, c, d\}$ ,  $A = \langle \{a\}, \{b, c\}, \{d\} \rangle$ ,  $B = \langle \{a\}, \{d\}, \{c\} \rangle$ ,  $C = \langle \{a\}, \{b\}, \{c\} \rangle$ ,  $D = \langle \{a\}, \{c\}, \{b\} \rangle$ ,  $E = \langle \{d\}, \{a, b\}, \{c\} \rangle$ ,  $F = \langle \{a\}, \{c\}, \{d\} \rangle$ ,  $G = \langle \{a\}, \{b, c\}, \{d\} \rangle$ , then the family  $L = \{\phi_N, A, B, D, E, F, G\}$  of NCSs is an NCL in  $X$ .

**Definition 4.1.2**

Let  $L_1$  and  $L_2$  be two NCL in  $X$ . Then  $L_2$  is said to be finer than  $L_1$  or  $L_1$  is coarser than  $L_2$  if  $L_1 \leq L_2$ . If also  $L_1 \neq L_2$ , then  $L_2$  is said to be strictly finer than  $L_1$  or  $L_1$  is strictly coarser than  $L_2$ .

Two NCL are comparable, if one is finer than the other. The set of all NCL in  $X$  is ordered by the relation  $L_1$  coarser than  $L_2$ ; this relation is induced by the inclusion in NCSs.

The next *Proposition* is considered as a useful result in this sequel, whose proof is clear:  $L_j = \langle A_{j_1}, A_{j_2}, A_{j_3} \rangle$ .

**Proposition 4.1.1**

Let  $\{L_j : j \in J\}$  be any non-empty family of the neutrosophic crisp ideals in a set  $X$ . Then  $\bigcap_{j \in J} L_j$  and  $\bigcup_{j \in J} L_j$  are neutrosophic crisp ideal in  $X$ , where

$$\begin{aligned} \bigcap_{j \in J} L_j &= \left\langle \bigcap_{j \in J} A_{j_1}, \bigcap_{j \in J} A_{j_2}, \bigcup_{j \in J} A_{j_3} \right\rangle \\ \bigcap_{j \in J} L_j &= \left\langle \bigcap_{j \in J} A_{j_1}, \bigcup_{j \in J} A_{j_2}, \bigcup_{j \in J} A_{j_3} \right\rangle \\ \bigcup_{j \in J} L_j &= \left\langle \bigcup_{j \in J} A_{j_1}, \bigcup_{j \in J} A_{j_2}, \bigcap_{j \in J} A_{j_3} \right\rangle \\ \bigcup_{j \in J} L_j &= \left\langle \bigcup_{j \in J} A_{j_1}, \bigcap_{j \in J} A_{j_2}, \bigcap_{j \in J} A_{j_3} \right\rangle. \end{aligned}$$



In fact,  $L$  is the smallest upper bound of the set of the  $L_j$  in the ordered set of all neutrosophic crisp ideals in  $X$ .

**Remark 4.1.2**

The neutrosophic crisp ideal of the single neutrosophic set  $O_N$  is the smallest element of the ordered set of all neutrosophic crisp ideals in  $X$ .

**Proposition 4.1.2**

A neutrosophic crisp set  $A = \langle A_1, A_2, A_3 \rangle$  in neutrosophic crisp ideal  $L$  in  $X$  is a base of  $L$  if every member of  $L$  contained in  $A$ .

**Proof**

(*Necessity*) Suppose  $A$  is a base of  $L$ . Then clearly every member of  $L$  contained in  $A$ .

(*Sufficiency*) Suppose the necessary condition holds. Then the set of neutrosophic crisp subset in  $X$  contained in  $A$  coincides with  $L$  by the *Definition 4.3*.

**Proposition 4.1.3**

For a neutrosophic crisp ideal  $L_1$  with base  $A = \langle A_1, A_2, A_3 \rangle$ , is finer than a fuzzy ideal  $L_2$  with base  $B = \langle B_1, B_2, B_3 \rangle$  if every member of  $B$  contained in  $A$ .

**Proof**

Immediate outcome of *Definitions*.

**Corollary 4.1.1**

Two neutrosophic crisp ideals bases  $A, B$ , in  $X$  are equivalent if every member of  $A$  is contained in  $B$  and vice versa.

**Theorem 4.1.1**

Let  $\eta = \langle A_{j_1}, A_{j_2}, A_{j_3} \rangle : j \in J$  be a non-empty collection of neutrosophic crisp subsets of  $X$ . Then there exists a neutrosophic crisp ideal  $L(\eta) = \left\{ A \in NCS : A \subseteq \bigcup_{j \in J} A_j \right\}$  in  $X$  for some finite collection  $\{A_j : j = 1, 2, \dots, n \subseteq \eta\}$ .

**Proof**

Clear.

**Remark 4.1.3**

The neutrosophic crisp ideal  $L(\eta)$  defined above is said to be generated by  $\eta$ , and  $\eta$  is called the sub-base of  $L(\eta)$ .

**Corollary 4.1.2**

Let  $L_1$  be a neutrosophic crisp ideal in  $X$  and  $A \in \text{NCSs}$ , then there is a neutrosophic crisp ideal  $L_2$  which is finer than  $L_1$  such that  $A \in L_2$  if  $A \cup B \in L_2$  for each  $B \in L_1$ .

**Proof**

Clear.

**Theorem 4.1.2**

If  $L = \{\varphi_N, \langle \mathbf{A}_1, \mathbf{A}_2, \mathbf{A}_3 \rangle\}$  is a neutrosophic crisp ideal in  $X$ , in the same way:

(a)  $[L = \{\varphi_N, \langle A_1, A_2, A_3^c \rangle\}$  is a neutrosophic crisp ideal in  $X$ .

(b)  $\langle L = \{\varphi_N, \langle A_3, A_2, A_1^c \rangle\}$  is a neutrosophic crisp ideal in  $X$ .

**Proof**

Obvious.

**Theorem 4.1.3**

Let  $A = \langle A_1, A_2, A_3 \rangle \in L_1$ , and  $B = \langle B_1, B_2, B_3 \rangle \in L_2$ , where  $L_1$  and  $L_2$  are neutrosophic crisp ideals in  $X$ ; then we have the neutrosophic crisp set  $A * B = \langle A_1 * B_1, A_2 * B_2, A_3 * B_3 \rangle$  where  $A_1 * B_1 = \cup\{A_1 \cap B_1, A_2 \cap B_2, A_3 \cap B_3\}$ ,  $A_2 * B_2 = \cap\{A_1 \cap B_1, A_2 \cap B_2, A_3 \cap B_3\}$  and  $A_3 * B_3 = \cap\{A_1 \cap B_1, A_2 \cap B_2, A_3 \cap B_3\}$ .

**4.2 Neutrosophic Crisp Local Functions**

**Definition 4.2.1**

Let  $p$  be a neutrosophic crisp point of a neutrosophic crisp topological space  $(X, \tau)$ . A neutrosophic crisp neighbourhood (NCNBD) is a neutrosophic crisp point  $p$  if there exists a neutrosophic crisp open set (NCOS)  $B$  in  $X$  such that  $p \in B \subseteq A$ .

**Theorem 4.2.1**

Let  $(X, \tau)$  be a neutrosophic crisp topological space (NCTS) of  $X$ . Then the neutrosophic crisp set  $A$  of  $X$  is NCOS if  $A$  is a NCNBD of  $p$  for every neutrosophic crisp set  $p \in A$ .

**Proof**

Let  $A$  be NCOS of  $X$ . Clearly  $A$  is a NCBD of any  $p \in A$ . Conversely, let  $p \in A$ . Since  $A$  is a NCBD of  $p$ , there is a NCOS  $B$  in  $X$  such that  $p \in B \subseteq A$ .

So we have  $A = \cup\{p : p \in A\} \subseteq \cup\{B : p \in A\} \subseteq A$ , hence  $A = \cup\{B : p \in A\}$ . Subsequently, each  $B$  is NCOS.

**Definition 4.2.2**

Let  $(X, \tau)$  be a neutrosophic crisp topological space (NCTS) and  $L$  be a neutrosophic crisp ideal (NLI) in  $X$ . Let  $A$  be any NCS of  $X$ . Then the neutrosophic crisp local function  $NCA^*(L, \tau)$  of  $A$  is the union of all neutrosophic crisp points (NCP)  $P = \langle \{p_1\}, \{p_2\}, \{p_3\} \rangle$ , such that if  $U \in N((p))$ , and:

$NA^*(L, \tau) = \cup\{p \in X : A \wedge U \notin L \text{ for every } U \text{ nbd of } N(P)\}$ ,  $NCA^*(L, \tau)$  being called a neutrosophic crisp local function of  $A$  with respect to  $\tau$  and  $L$ , which we symbolize by  $NCA^*(L, \tau)$ , or simply  $NCA^*(L)$ .

**Example 4.2.1**

One may easily verify that:

- (a) If  $L = \{\phi_N\}$ , then  $NCA^*(L, \tau) = NCcl(A)$ , for any neutrosophic crisp set  $A \in NCSs$  in  $X$ .
- (b) If  $L = \{\text{all NCSs on } X\}$  then  $NCA^*(L, \tau) = \phi_N$ , for any  $A \in NCSs$  in  $X$ .

**Theorem 4.2.2**

Let  $(X, \tau)$  be a NCTS and  $L_1, L_2$  two topological neutrosophic crisp ideals in  $X$ . Then for any neutrosophic crisp sets  $A, B$  of  $X$ , the following statements are verified:

- (a)  $A \subseteq B \Rightarrow NCA^*(L, \tau) \subseteq NCB^*(L, \tau)$ .
- (b)  $L_1 \subseteq L_2 \Rightarrow NCA^*(L_2, \tau) \subseteq NCA^*(L_1, \tau)$ .
- (c)  $NCA^* = NCcl(A^*) \subseteq NCcl(A)$ .

- (d)  $NCA^{**} \subseteq NCA^*$ .
- (e)  $NC(A \cup B)^* = NCA^* \cup NCB^*$ .
- (f)  $NC(A \cap B)^*(L) \subseteq NCA^*(L) \cap NCB^*(L)$ .
- (g)  $\ell \in L \Rightarrow NC(A \cup \ell)^* = NCA^*$ .
- (h)  $NCA^*(L, \tau)$  is a neutrosophic crisp closed set.

**Proof**

Since  $A \subseteq B$ , let  $p = \langle \{p_1\}, \{p_2\}, \{p_3\} \rangle \in NCA^*(L_1)$  then  $A \cap U \notin L$  for every  $U \in N(p)$ . By hypothesis, we get  $B \cap U \notin L$ , then  $p = \langle \{p_1\}, \{p_2\}, \{p_3\} \rangle \in NB^*(L_1)$ .

Clearly,  $L_1 \subseteq L_2$  implies  $NCA^*(L_2, \tau) \subseteq NCA^*(L_1, \tau)$  as there may be other IFSSs which belong to  $L_2$  so that for GIFP  $p = \langle \{p_1\}, \{p_2\}, \{p_3\} \rangle \in NCA^*(L_1)$  but P may not be contained in  $NCA^*(L_2)$ .

Since  $\{\phi_N\} \subseteq L$  for any NCL in X, therefore by (b) and Example 4.2.1,  $NCA^*(L) \subseteq NCA^*(\{O_N\}) = NCcl(A)$  for any NCS A in X.

Suppose  $P_1 = \langle \{p_1\}, \{p_2\}, \{p_3\} \rangle \in NCcl(A^*(L_1))$ . So for every  $U \in NC(P_1)$ ,  $NC(A^*) \cap U \neq \phi_N$ , there exists  $P_2 = \langle \{q_1\}, \{q_2\}, \{q_3\} \rangle \in NCA^*(L_1) \cap U$  such that for every VNCNBD of  $P_2 \in N(P_2)$ ,  $A \cap U \notin L$ .

Since  $U \wedge V \in N(P_2)$  then  $A \cap (U \cap V) \notin L$  which leads to  $A \wedge U \notin L$ , for every  $U \in N(P_1)$  therefore  $P_1 \in NC(A^*(L))$  and so  $NCcl(NCA^*) \subseteq NCA^*$ , while the other inclusion follows directly, hence  $NCA^* = NCcl(NCA^*)$ , but the inequality  $NCA^* \subseteq Ncl(NCA^*)$ .

The inclusion  $NCA^* \cup NCB^* \subseteq NC(A \cup B)^*$  follows directly from (a). To show the other implication, let  $p \in NC(A \cup B)^*$  then for every  $U \in NC(p)$ ,  $(A \cup B) \cap U \notin L$ , i.e.,  $(A \cap U) \cup (B \cap U) \notin L$ . We have two cases:  $A \cap U \notin L$  and  $B \cap U \in L$  or the converse, this means that exist  $U_1, U_2 \in N(P)$  such that  $A \cap U_1 \notin L, B \cap U_1 \notin L, A \cap U_2 \notin L$ , and  $B \cap U_2 \notin L$ . Then  $A \cap (U_1 \cap U_2) \in L$  and  $B \cap (U_1 \cap U_2) \in L$ . This gives  $(A \cup B) \cap (U_1 \cap U_2) \in L, U_1 \cap U_2 \in N(C(P))$  which contradicts the hypothesis. Hence the equality holds in various cases.

By (c), we have  $NCA^{**} = NCcl(NCA^*)^* \subseteq NCcl(NCA^*) = NCA^*$ .

Let  $(X, \tau)$  be a NCTS and L be NCL in X. Let us define the neutrosophic crisp closure operator  $NCcl^*(A) = A \cup NC(A^*)$  for any NCS A of

X. Clearly, let  $NCcl^*(A)$  be a neutrosophic crisp operator. Let  $NC\tau^*(L)$  be NCT generated by  $NCcl^*$  i.e.  $NC\tau^*(L) = \{A : NCcl^*(A^c) = A^c\}$ .

Now  $L = \{\phi_N\} \Rightarrow NCcl^*(A) = A \cup NCA^* = A \cup NCcl(A)$  for every neutrosophic crisp set A. So,  $NC\tau^*(\{\phi_N\}) = \tau$ . Again  $L = \{all\ NCSs\ on\ X\} \Rightarrow NCcl^*(A) = A$ , because  $NCA^* = \phi_N$  for every neutrosophic crisp set A. So  $NC\tau^*(L)$  is the neutrosophic crisp discrete topology in X. We can conclude that  $NC\tau^*(\{\phi_N\}) = NC\tau^*(L)$ , i.e.  $NC\tau \subseteq NC\tau^*$  for any neutrosophic ideal  $L_1$  in X. In particular, we have two topological neutrosophic ideals  $L_1$  and  $L_2$  in X,  $L_1 \subseteq L_2 \Rightarrow NC\tau^*(L_1) \subseteq NC\tau^*(L_2)$ .

### Theorem 4.2.3

Let  $\tau_1, \tau_2$  be two neutrosophic crisp topologies in X. Then for any topological neutrosophic crisp ideal L in X,  $\tau_1 \leq \tau_2$ , which implies  $NA^*(L, \tau_2) \subseteq NA^*(L, \tau_1)$  for every  $A \in L$ , then  $NC\tau_1^* \subseteq NC\tau_2^*$ .

### Proof

Clear.

A basis  $NC\beta(L, \tau)$  for  $NC\tau^*(L)$  can be described as:

$$NC\beta(L, \tau) = \{A - B : A \in \tau, B \in L\}.$$

Then we have the following theorem:

### Theorem 4.2.4

$NC\beta(L, \tau) = \{A - B : A \in \tau, B \in L\}$  forms a basis for the generated NT of the NCT  $(X, \tau)$  with topological neutrosophic crisp ideal L in X.

### Proof

Straightforward.

*The relationship between  $NC\tau$  and  $NC\tau^*(L)$  establishes throughout the following result, to which have an immediate proof.*

**Theorem 4.2.5**

Let  $\tau_1, \tau_2$  be two neutrosophic crisp topologies in X. Then for any topological neutrosophic ideal L in X,  $\tau_1 \subseteq \tau_2$  which implies that  $NC\tau_1^* \subseteq NC\tau_2^*$ .

**Theorem 4.2.6**

Let  $(X, \tau)$  be a NCTS and  $L_1, L_2$  be two neutrosophic crisp ideals in X. Then for any neutrosophic crisp set A in X, we have:

$$NCA^*(L_1 \cup L_2, \tau) = NCA^*(L_1, NC\tau^*(L_1)) \wedge NCA^*(L_2, NC\tau^*(L_2))$$

$$NC\tau^*(L_1 \cup L_2) = (NC\tau^*(L_1))^*(L_2) \wedge (NC\tau^*(L_2))^*(L_1).$$

**Proof**

Let  $p \notin (L_1 \cup L_2, \tau)$ ; this means that there exists  $U_p \in N(P)$  such that  $A \cap U_p \in (L_1 \cup L_2)$ , i.e. there exists  $\ell_1 \in L_1$  and  $\ell_2 \in L_2$  such that  $A \cap U \in (\ell_1 \vee \ell_2)$  because of the heredity of  $L_1$ , and assuming  $\ell_1 \wedge \ell_2 = 0_N$ . Thus, we have  $(A \cap U) - \ell_1 = \ell_2$  and  $(A \cap U_p) - \ell_2 = \ell_1$ , therefore  $(U - \ell_1) \cap A = \ell_2 \in L_2$  and  $(U - \ell_2) \cap A = \ell_1 \in L_1$ . Hence  $p \notin NCA^*(L_2, NC\tau^*(L_1))$  or  $p \notin NCA^*(L_1, NC\tau^*(L_2))$  because  $p$  must belong to either  $\ell_1$  or  $\ell_2$ , but not to both. This gives  $NCA^*(L_1 \cup L_2, \tau) \geq NCA^*(L_1, NC\tau^*(L_1)) \cap NCA^*(L_2, NC\tau^*(L_2))$ . To show the second inclusion, let us assume  $p \notin NCA^*(L_1, NC\tau^*(L_2))$ . This implies that there exist  $U \in N(P)$  and  $\ell_2 \in L_2$  such that  $(U_p - \ell_2) \cap A \in L_1$ . By the heredity of  $L_2$ , if we assume that  $\ell_2 \subseteq A$  and define  $\ell_1 = (U - \ell_2) \cap A$ , then we have  $A \cap U \in (\ell_1 \cup \ell_2) \in L_1 \cup L_2$ .

Thus,  $NCA^*(L_1 \cup L_2, \tau) \subseteq NCA^*(L_1, NC\tau^*(L_1)) \cap NCA^*(L_2, NC\tau^*(L_2))$  and similarly, we can get  $NCA^*(L_1 \cup L_2, \tau) \subseteq NCA^*(L_2, \tau^*(L_1))$ . This gives the other inclusion, which complete the proof.

**Corollary 4.2.1**

Let  $(X, \tau)$  be a NCTS with topological neutrosophic crisp ideal L in X. Then:

$$NCA^*(L, \tau) = NCA^*(L, \tau^*) \text{ and } NC\tau^*(L) = NC(NC\tau^*(L))^*(L)$$

$$NC\tau^*(L_1 \cup L_2) = (NC\tau^*(L_1)) \cup (NC\tau^*(L_2)).$$

**Proof**

It follows by applying the previous statement.

### 4.3 Neutrosophic Crisp L-Open Sets and Neutrosophic Crisp L-Continuity

**Definition 4.3.1**

Let  $(X, \tau)$  be a NCTS with neutrosophic crisp ideal  $L$  in  $X$ ;  $A$  is called a neutrosophic crisp  $L$ -open set if there exists  $\zeta \in \tau$  such that  $A \subseteq \zeta \subseteq NCA^*$ . We denote the family of all neutrosophic crisp  $L$ -open sets by  $NCLO(X)$ .

**Theorem 4.3.1**

Let  $(X, \tau)$  be a NCTS with a neutrosophic crisp ideal  $L$ , then  $A \in NCLO(X)$  if  $A \subseteq NCint(NCA^*)$ .

**Proof**

Let us assume that  $A \in NCLO(X)$ . Then, by Definition 3.1, there exists  $\zeta \in \tau$  such that  $A \subseteq \zeta \subseteq NCA^*$ . But  $NCint(NCA^*) \subseteq NCA^*$ , and  $\zeta = NCint(NCA^*)$ , hence  $A \subseteq NCint(NCA^*)$ . Conversely,  $A \subseteq NCint(NCA^*) \subseteq NCA^*$ . Then there exists  $\zeta = NCint(NCA^*) \in \tau$ , hence  $A \in NCLO(X)$ .

**Remark 4.3.1**

For a NCTS  $(X, \tau)$  with a neutrosophic crisp ideal  $L$  and  $A$  a neutrosophic crisp set in  $X$ , the following holds: If  $A \in NCLO(X)$ , then  $NCint(A) \subseteq NCA^*$ .

**Theorem 4.3.2**

Let  $(X, \tau)$  be a NCTS with a neutrosophic crisp ideal  $L$  in  $X$  and  $A, B$  be neutrosophic crisp sets such that  $A \in NCLO(X)$ ,  $B \in \tau$ ; then  $A \cap B \in NCLO(X)$ .

**Proof**

From the assumption  $A \cap B \subseteq NCint(NCA^*) \cap B = NCint(NCA^* \cap B)$ , we have  $A \cap B \subseteq NCintNC(A \cap B)^*$ , and this completes the proof.

**Corollary 4.3.1**

If  $\{A_j\}_{j \in J}$  is a neutrosophic crisp L-open set in NCTS  $(X, \tau)$  with a neutrosophic crisp ideal L, then  $\cup \{A_j\}_{j \in J}$  is a neutrosophic crisp L-open set.

**Corollary 4.3.2**

For a NCTS  $(X, \tau)$  with neutrosophic crisp ideal L, and neutrosophic crisp set A in X and  $A \in \text{NCLO}(X)$ , then  $\text{NCA}^* = \text{NC}(\text{NCintNC}(\text{NCA}^*))$  and  $\text{NCcl}^*(A) = \text{NCint}(\text{NCA}^*)$ .

**Proof**

It's clear.

**Definition 4.3.2**

A NCTS  $(X, \tau)$  with a neutrosophic crisp ideal L in X and the neutrosophic crisp set A are given. Then A is said to be:

- (i) A neutrosophic crisp  $\tau^*$ -closed (or  $\text{NC}^*$ -closed) if  $\text{NCA}^* \leq A$ ;
- (ii) A neutrosophic crisp L-dense-in-itself (or  $\text{NC}^*$ -dense-in-itself) if  $A \subseteq \text{NCA}^*$ ;
- (iii) A neutrosophic crisp  $\tau^*$ -perfect if A is  $\text{NC}^*$ -closed and  $\text{NC}^*$ -dense-in-itself.

**Theorem 4.3.3**

Let NCTS  $(X, \tau)$  with a neutrosophic crisp ideal L be given, and let A be a neutrosophic crisp set in X; then:

- (i)  $\text{NC}^*$ -closed if  $\text{NCcl}^*(A) = A$ .
- (ii)  $\text{NC}^*$ -dense-in-itself if  $\text{NCcl}^*(A) = \text{NCA}^*$ .
- (iii)  $\text{NC}^*$ -perfect if  $\text{NCcl}^*(A) = \text{NCA}^* = A$ .

**Proof**

It follows directly from the neutrosophic crisp closure operator  $\text{NCcl}^*$  for a neutrosophic crisp topology  $\tau^*(L)$  ( $\text{NC}\tau^*$ ).

**Remark 4.3.2**

One can deduce that:

- (a) Every  $\text{NC}^*$ -dense-in-itself is a neutrosophic crisp dense set.
- (b) Every neutrosophic crisp closed (resp. neutrosophic crisp open) set is  $\text{N}^*$ -closed (resp.  $\text{NC}\tau^*$ -open).
- (c) Every neutrosophic crisp L-open set is  $\text{NC}^*$ -dense-in-itself.



**Corollary 4.3.3**

We have a NCTS  $(X, \tau)$  with a neutrosophic crisp ideal  $L$  in  $X$ , and  $A \in \tau$ , then:

- (a) If  $A$  is  $NC^*$ -closed then  $A^* \subseteq NC_{int}(A) \subseteq NC_{cl}(A)$ ;
- (b) If  $A$  is  $NC^*$ -dense-in-itself then  $NC_{int}(A) \subseteq NCA^*$ ;
- (c) If  $A$  is  $NC^*$ -perfect then  $NC_{int}(A) = NC_{cl}(A) = NCA^*$ .

**Proof**

Obvious.

*We give the relationship between neutrosophic crisp L-open set and some known neutrosophic crisp openness.*

**Theorem 4.3.4**

There are given a NCTS  $(X, \tau)$  with a neutrosophic crisp ideal  $L$ , and a neutrosophic crisp set  $A$  in  $X$ ; then the following assertions holds:

- (a) If  $A$  is both a neutrosophic crisp L-open and a  $NC^*$ -perfect, then  $A$  is a neutrosophic crisp open.
- (b) If  $A$  is both a neutrosophic crisp open and a  $NC^*$ -dense-in-itself, then  $A$  is a neutrosophic crisp L-open.

**Proof**

Following from the *Definitions*.

**Corollary 4.3.4**

For a neutrosophic crisp subset  $A$  of a NCTS  $(X, \tau)$  with a neutrosophic crisp ideal  $L$  in  $X$ , we have:

- (a) If  $A$  is a  $NC^*$ -closed and a  $NL^*$ -open, then  $NC_{int}(A) = NC_{int}(NCA^*)$ ;
- (b) If  $A$  is a  $NC^*$ -perfect and a  $NL$ -open, then  $A = NC_{int}(NCA^*)$ .

**Remark 4.3.3**

One can deduce that the intersection of two neutrosophic crisp L-open sets is a neutrosophic crisp L-open.

**Corollary 4.3.5**

Let  $(X, \tau)$  be a NCTS with neutrosophic crisp ideal  $L$  and a neutrosophic crisp set  $A$  in  $X$ . If  $L = \{N^x\}$ , then  $NCA^*(L) = \phi_N$  and hence  $A$  is a neutrosophic crisp L-open if  $A = \phi_N$ .

**Proof**

It's obvious.

**Definition 4.3.3**

There are given a NCTS  $(X, \tau)$  with a neutrosophic crisp ideal  $L$ , and a neutrosophic crisp set  $A$ ; then the neutrosophic crisp ideal interior of  $A$  is defined as the largest neutrosophic crisp  $L$ -open set contained in  $A$ ; we denoted by  $NCL-NCint(A)$ .

**Theorem 4.3.5**

If  $(X, \tau)$  is a NCTS with a neutrosophic crisp ideal  $L$  and a neutrosophic crisp set  $A$ , then:

- (a)  $A \cap Nint(NCA^*)$  is a neutrosophic crisp  $L$ -open set.
- (b)  $NL-NCint(A) = 0_N$  if  $Nint(NCA^*) = 0_N$ .

**Proof**

- (a) Since  $NCint NCA^* = NCA^* \cap NCint(NCA^*)$ , then  $NCint NCA^* = NCA^* \cap NCint(NCA^*) \subseteq NC(A \cap NCA^*)^*$ . Thus  $A \cap NCA^* \subseteq (A \cap A \cap NCint NC(NCA^*))^* \subseteq NCint NC(A \cap NCint NC(NCA^*))^*$ . Hence  $A \cap NCint NCA^* \in NCLO(X)$ .
- (b) Let  $NCL-NCint(A) = \phi_N$ , then  $A \cap A^* = \phi_N$ , it implies  $NCcl(A \cap NCint(NCA^*)) = \phi_N$  and so  $A \cap NintA^* = \phi_N$ . Conversely, we assume that  $NCint NCA^* = \phi_N$ , then  $A \cap NCint(NCA^*) = \phi_N$ . Hence  $NCL-NCint(A) = \phi_N$ .

**Theorem 4.3.6**

If  $(X, \tau)$  is a NCTS with a neutrosophic crisp ideal  $L$  and  $A$  is a neutrosophic crisp set in  $X$ , then  $NCL-NCint(A) = A \cap NCint(NCA^*)$ .

**Proof**

The first implication is  $A \cap NCA^* \subseteq NCL-NCint(A)$ . (1)

For the reverse inclusion, if  $\zeta \in NCLO(X)$  and  $\zeta \subseteq A$ , then  $NC\zeta^* \subseteq NCA^*$  and hence  $NCint(NC\zeta^*) \subseteq NCint(NCA^*)$ . This implies  $\zeta = \zeta \cap NCint(NC\zeta^*) \subseteq A \cap NCA^*$ .

Thus  $NCL-NCint(A) \subseteq A \cap NCint(NCA^*)$ . (2)

From (1) and (2) we have the result.

**Corollary 4.3.6**

For a NCTS  $(X, \tau)$  with a neutrosophic crisp ideal  $L$  and a neutrosophic crisp set  $A$  in  $X$ , the following holds:

- (a) If  $A$  is  $NC^*$ -closed then  $NL\text{-}Nint(A) \subseteq A$ .
- (b) If  $A$  is  $NC^*$ -dense-in-itself then  $NL\text{-}Nint(A) \subseteq A^*$ .
- (c) If  $A$  is  $NC^*$ -perfect set then  $NCL\text{-}NCint(A) \subseteq NCA^*$ .

**Definition 4.3.4**

Let  $(X, \tau)$  be a NCTS with a neutrosophic crisp ideal  $L$  and  $\zeta$  be a neutrosophic crisp set in  $X$ ;  $\zeta$  is called a neutrosophic crisp  $L$ -closed set if its complement is a neutrosophic crisp  $L$ -open set. We denote the family of the neutrosophic crisp  $L$ -closed sets by  $NLCC(X)$ .

**Theorem 4.3.7**

Let  $(X, \tau)$  be a NCTS with a neutrosophic crisp ideal  $L$  and  $\zeta$  be a neutrosophic crisp set in  $X$ .  $\zeta$  is a neutrosophic crisp  $L$ -closed, then  $NC(NCint\zeta)^* \leq \zeta$ .

**Proof**

It's clear.

**Theorem 4.3.8**

Let  $(X, \tau)$  be a NCTS with a neutrosophic crisp ideal  $L$  in  $X$  and  $\zeta$  be a neutrosophic crisp set in  $X$ , such that  $NC(NCint\zeta)^{*c} = NCint\zeta^{c*}$ , then  $\zeta \in NLC(X)$  if  $NC(NCint\zeta)^* \subseteq \zeta$ .

**Proof**

*(Necessity)* It follows immediately from the above Theorem.

*(Sufficiency)* Let  $NC(NCint\zeta)^* \subseteq \zeta$ , then  $\zeta^c \subseteq NC(NCint\zeta)^{*c} = NCint(NC\zeta)^{c*}$  from the hypothesis. Hence  $\zeta^c \in NCLO(X)$ . Thus  $\zeta \in NLC(X)$ .

**Corollary 4.3.7**

For a NCTS  $(X, \tau)$  with a neutrosophic crisp ideal  $L$  in  $X$ , the following holds:

- (a) The union of a neutrosophic crisp  $L$ -closed set and a neutrosophic crisp closed set is a neutrosophic crisp  $L$ -closed set.
- (b) The union of a neutrosophic crisp  $L$ -closed and a neutrosophic crisp  $L$ -closed is a neutrosophic crisp perfect.

By employing the notion of NL open sets, we establish a class of neutrosophic crisp L-continuous function. Many characterizations and properties of this concept are investigated.

**Definition 4.3.5**

A function  $f : (X, \tau) \rightarrow (Y, \sigma)$  with a neutrosophic crisp ideal  $L$  in  $X$  is said to be neutrosophic crisp L-continuous if for every  $\zeta \in \sigma$ ,  $f^{-1}(\zeta) \in \text{NCLO}(X)$ .

**Theorem 4.3.9**

For a function  $f : (X, \tau) \rightarrow (Y, \sigma)$  with a neutrosophic crisp ideal  $L$  in  $X$ , the following are equivalent:

- i.  $f$  is a neutrosophic crisp L-continuous.
- ii. For a neutrosophic crisp point  $p$  in  $X$  and each  $\zeta \in \sigma$  containing  $f(p)$ , there exists  $A \in \text{NCLO}(X)$  containing  $p$  such that  $f(A) \subseteq \zeta$ .
- iii. For each neutrosophic crisp point  $p$  in  $X$  and  $\zeta \in \sigma$  containing  $f(p)$ ,  $(f^{-1}(\zeta))^*$  is a neutrosophic crisp nbd of  $p$ .
- iv. The inverse image of each neutrosophic crisp closed set in  $Y$  is a neutrosophic crisp L-closed.

**Proof**

(i)  $\rightarrow$  (ii) Since  $\zeta \in \sigma$  containing  $f(p)$ , then by (i)  $f^{-1}(\zeta) \in \text{NCLO}(X)$ , by putting  $A = f^{-1}(\zeta)$  containing  $p$ , we have  $f(A) \subseteq \zeta$ .

(ii)  $\rightarrow$  (iii). Let  $\zeta \in \sigma$  containing  $f(p)$ . Then by (ii) there exists  $A \in \text{NCLO}(X)$  containing  $p$  such that  $f(A) \subseteq \zeta$ , so  $p \in A \subseteq \text{NCint}(\text{NCA}^*) \subseteq \text{NCint}((f^{-1}(\zeta))^* \subseteq (f^{-1}(\zeta))^*$ . Hence  $(f^{-1}(\zeta))^*$  is a neutrosophic crisp nbd of  $p$ .

(iii)  $\rightarrow$  (i) Let  $\zeta \in \sigma$ , since  $(f^{-1}(\zeta))^*$  is a neutrosophic crisp nbd of any point  $f^{-1}(\zeta)$ , every point  $x_\epsilon \in (f^{-1}(\zeta))^*$  is a neutrosophic crisp interior point of  $(f^{-1}(\zeta))^*$ . Then  $f^{-1}(\zeta) \subseteq \text{NCint NC}((f^{-1}(\zeta))^*$  and hence  $f$  is a neutrosophic crisp L-continuous.

(i)  $\rightarrow$  (iv) Let  $\zeta \in \sigma$  be a neutrosophic crisp closed set. Then  $\zeta^c$  is a neutrosophic crisp open set, by  $f^{-1}(\zeta^c) = (f^{-1}(\zeta))^c \in \text{NCLO}(X)$ . Thus  $f^{-1}(\zeta)$  is a neutrosophic crisp L-closed set.

The following theorem establish the relationship between the neutrosophic crisp L-continuous and the neutrosophic crisp continuous by using the previous neutrosophic crisp notions.

**Theorem 4.3.10**

Let  $f: (X, \tau) \rightarrow (Y, \sigma)$  be a function with a neutrosophic crisp ideal L in X; then we have  $f$  a neutrosophic crisp L-continuous of each neutrosophic crisp \*-perfect set in X, then  $f$  is a neutrosophic crisp continuous.

**Proof**

Obvious.

**Corollary 4.3.8**

Given a function  $f: (X, \tau) \rightarrow (Y, \tau)$  and each member of X being a neutrosophic crisp NC\*-dense-in-itself, then we have that every neutrosophic crisp continuous function is a neutrosophic crisp NCL-continuous.

**Proof**

It's clear.

We now define and study two different types of neutrosophic crisp functions.

**Definition 4.3.6**

A function  $f: (X, \tau) \rightarrow (Y, \sigma)$  with neutrosophic crisp ideal L in Y is called neutrosophic crisp L-open (resp. neutrosophic crisp NCL- closed), if for each  $A \in \tau$  (resp. A is neutrosophic crisp closed in X),  $f(A) \in NCLO(Y)$  (resp.  $f(A)$  is NCL-closed).

**Theorem 4.3.11**

Let  $f: (X, \tau) \rightarrow (Y, \sigma)$  be a function with neutrosophic crisp ideal L in Y. Then the following are equivalent:

- (a)  $f$  is a neutrosophic crisp L-open.
- (b) For each  $p$  in X and each neutrosophic crisp NCNBD A of p, there exists a neutrosophic crisp L-open set  $B \in I^Y$  containing  $f(p)$  such that  $B \subseteq f(A)$ .

**Proof**

Obvious.

**Theorem 4.3.12**

Let a neutrosophic crisp function  $f:(X,\tau)\rightarrow(Y,\sigma)$  with a neutrosophic crisp ideal L in Y be a neutrosophic crisp L-open (resp. neutrosophic crisp L-closed), if A in Y and B in X is a neutrosophic crisp closed (resp. neutrosophic crisp open) set C in Y containing A such that  $f^{-1}(C)\subseteq B$ .

**Proof**

Assume that  $A=1_Y - (f(1_X - B))$ , since  $f^{-1}(C)\subseteq B$  and  $A\subseteq C$  then C is a neutrosophic crisp L-closed and  $f^{-1}(C)=1_X - f^{-1}(f(1_X - A))\subseteq B$ .

**Theorem 4.3.13**

If a function  $f:(X,\tau)\rightarrow(Y,\sigma)$  with a neutrosophic crisp ideal L in Y is a neutrosophic crisp L-open, then  $f^{-1}NC(NC\text{int}(A))^* \leq NC(f^{-1}(A))^*$  such that  $f^{-1}(A)$  is a neutrosophic crisp \*-dense-in-itself and A in Y.

**Proof**

Since A in Y,  $NC(f^{-1}(A))^*$  is a neutrosophic crisp closed in X containing  $f^{-1}(A)$ ,  $f$  is a neutrosophic crisp L-open, then, by using Theorem 4.4, there is a neutrosophic crisp L-closed set  $A\subseteq B$  such that,  $(f^{-1}(A))^* \supseteq f^{-1}(B) \geq f^{-1}NC(\text{int}(B))^* \supseteq f^{-1}NC(NC\text{int}(\mu))^*$ .

**Corollary 4.3.9**

For any bijective function  $f:(X,\tau)\rightarrow(Y,\sigma)$  with neutrosophic crisp ideal L in Y, the following are equivalent:

- (a)  $f^{-1}:(Y,\sigma)\rightarrow(X,\tau)$  is a neutrosophic crisp L-continuous.
- (b)  $f$  is a neutrosophic crisp L-open.
- (c)  $f$  is a neutrosophic crisp L-closed.

**Proof**

It follows directly from *Definitions*.

## 4.4 Neutrosophic Crisp Filters

### Definition 4.4.1

Let  $\Psi$  be a neutrosophic crisp subsets in a set  $X$ . Then  $\Psi$  is called a neutrosophic crisp filter in  $X$ , if it satisfies the following conditions:

- (a)  $(N_1)$  Every neutrosophic crisp set in  $X$  containing a member of  $\Psi$  belongs to  $\Psi$  ;
- (b)  $(N_2)$  Every finite intersection of members of  $\Psi$  belongs to  $\Psi$  ;
- (c)  $(N_3)$   $\phi_N$  not in  $\Psi$  .

In this case, the pair  $(X, \mathcal{N})$  is called neutrosophic crisp filtered by  $\Psi$  . It follows from  $(N_2)$  and  $(N_3)$  that every finite intersection of members of  $\Psi$  is not  $\phi_N$ . Furthermore, there is no neutrosophic crisp set. We obtain the following results.

### Proposition 4.4.1

The condition  $(N_2)$  is equivalent to the following two conditions  $(N_{2a})$ . The intersection of two members of  $\Psi$  belongs to  $\Psi$  .

$(N_{2b})$   $X_N$  belongs to  $\Psi$  .

### Proposition 4.4.2

Let  $\Psi$  be a non-empty neutrosophic crisp subsets in  $X$  satisfying  $(N_1)$ . Then,

- (1)  $X_N \in \Psi$  if  $\Psi \neq \phi_N$
- (2)  $\phi_N \notin \Psi$  if  $\Psi \neq$  all neutrosophic crisp subsets of  $X$ .

*From above Propositions, we can characterize the concept of neutrosophic crisp filter.*

### Theorem 4.4.1

Let  $\Psi$  be a neutrosophic crisp subsets in a set  $X$ . Then  $\Psi$  is a neutrosophic crisp filter in  $X$ , if and only if it is satisfies the following conditions:

- (i) Every neutrosophic crisp set in  $X$  containing a member of  $\Psi$  belongs to  $\Psi$  .
- (ii) If  $A, B \in \Psi$  , then  $A \cap B \in \Psi$  .
- (iii)  $\Psi^X \neq \Psi \neq \phi_N$  .

**Proof**

It's clear.

**Theorem 4.4.2**

Let  $X \neq \emptyset$ , then the set  $\{X_N\}$  is a neutrosophic crisp filter in X. Moreover if A is a non-empty neutrosophic crisp set in X, then  $\{B \in \Psi^X : A \subseteq B\}$  is a neutrosophic crisp filter in X.

**Proof**

Let  $N = \{B \in \Psi^X : A \subseteq B\}$ . Since  $X_N \in \Psi$  and  $\phi_N \notin \Psi, \phi_N \neq \Psi \neq \Psi^X$ . Suppose  $U, V \in \Psi$ , then  $A \subseteq U, A \subseteq V$ . Thus  $A_1 \subseteq U_1 \cap V_1, A_2 \subseteq U_2 \cap V_2$  or  $A_2 \subseteq U_2 \cup V_2$  and  $A_3 \subseteq U_3 \cup V_3$  for all  $x \in X$ .

So  $A \subseteq U \cap V$  and hence  $U \cap V \in N$ .

**Definition 4.4.2**

Let  $\Psi_1$  and  $\Psi_2$  be two neutrosophic crisp filters in a set X. Then  $N_2$  is said to be finer than  $N_1$  or  $\Psi_1$  coarser than  $\Psi_2$  if  $\Psi_1 \subset \Psi_2$ .

If also  $\Psi_1 \neq \Psi_2$ , then  $\Psi_2$  is said to be strictly finer than  $\Psi_1$  or  $\Psi_1$  strictly coarser than  $N_2$ .

Two neutrosophic crisp filters are said to be comparable, if one is finer than the other. The set of all neutrosophic crisp filters in X is ordered by the relation  $N_1$  coarser than  $N_2$ ; this relation is induced by the inclusion relation in  $\Psi^X$ .

**Proposition 4.4.3**

Let  $(\Psi_j)_{j \in J}$  be any non-empty family of neutrosophic crisp filters in X. Then  $\Psi = \bigcap_{j \in J} \Psi_j$  is a neutrosophic crisp filter in X. In fact  $\Psi$  is the greatest lower bound of the neutrosophic crisp set  $(\Psi_j)_{j \in J}$  in the ordered set of all neutrosophic crisp filters in X.

**Remark 4.4.1**

The neutrosophic crisp filter by the single neutrosophic set  $X_N$  is the smallest element of the ordered set of all neutrosophic crisp filters in X.



**Theorem 4.4.3**

Let  $A$  be a neutrosophic crisp set in  $X$ . Then there exists a neutrosophic filter  $\Psi(A)$  in  $X$  containing  $A$  if for any finite subset  $\{S_1, S_2, \dots, S_n\}$  of  $A$ ,  $\bigcap_{i=1}^n S_i \neq \emptyset_N$ . In fact  $\Psi(A)$  is the coarsest neutrosophic crisp filter containing  $A$ .

**Proof**

( $\Rightarrow$ ) Suppose there exists a neutrosophic filter  $N(A)$  in  $X$  containing  $A$ . Let  $B$  be the set of all the finite intersections of members of  $A$ . Then by  $(N_2)$ ,  $B \subset \Psi(A)$ . By  $(N_3)$ ,  $O_N \notin N(A)$ . Thus for each member  $B$  of  $B$ , hence the necessary condition holds.

( $\Leftarrow$ ) Suppose the necessary condition holds. Let  $\Psi(A) = \{A \in \Psi^X : A \text{ contains a member of } B\}$  where  $B$  is the family of all the finite intersections of members of  $A$ . Then we can easily check that  $\Psi(A)$  satisfies the conditions in Definition 3.4. The neutrosophic crisp filter  $N(A)$  defined above is said to be generated by  $A$ , and  $A$  is called a sub-base of  $N(A)$ .

**Corollary 4.4.1**

Let  $\Psi$  be a neutrosophic crisp filter in a set  $X$  and  $A$  neutrosophic set. Then there is a neutrosophic crisp filter  $\Psi'$  which is finer than  $\Psi$  and such that  $A \in \Psi'$  if and  $A$  neutrosophic set. Then there is a neutrosophic crisp filter  $\Psi'$  which is finer than  $\Psi$  and such that  $A \in \Psi'$  if  $A \cap U \neq \emptyset_N$  for each  $U \in \Psi$ .

**Corollary 4.4.2**

A set  $\varphi_N$  of a neutrosophic crisp filter in a non-empty set  $X$  has at least the upper bound in the set of all neutrosophic crisp filters in  $X$ , for all finite sequence  $(\Psi_j)_{j \in J}, 0 \leq j \leq n$  of elements of  $\varphi_N$  and all  $A_j \in \Psi_j (1 \leq j \leq n)$ ,  $\bigcap_{j=1}^n A_j \neq \emptyset_N$ .

**Corollary 4.4.3**

The ordered set of all neutrosophic crisp filters in a non-empty set  $X$  is inductive.

If  $A$  is a sub-base of a neutrosophic filter  $N$  in  $X$ , then  $\Psi$  is not in general the set of neutrosophic sets in  $X$  containing an element of  $A$ ; for

$\mathcal{A}$  to have this property it is necessary and sufficient that every finite intersection of members of  $\mathcal{A}$  contains an element of  $\mathcal{A}$ .

*Henceforth, we have the following result:*

**Theorem 4.4.4**

Let  $\beta$  be a set of neutrosophic crisp sets in a set X. Then the set of neutrosophic crisp sets in X containing an element of  $\beta$  is a neutrosophic filter in X if  $\beta$  meets the following two conditions:

- ( $\beta_1$ ) The intersection of two members of  $\beta$  contains a member of  $\beta$ .
- ( $\beta_2$ )  $\beta \neq \phi_N$  and  $\phi_N \notin \beta$ .

**Definition 4.4.3**

Let  $\mathcal{A}$  and  $\beta$  be two neutrosophic crisp sets in X satisfying conditions ( $\beta_1$ ) and ( $\beta_2$ ), and the base of the neutrosophic crisp filter it generates. Two neutrosophic bases are said to be equivalent if they generate the same neutrosophic crisp filter.

**Remark 4.4.2**

Let  $\mathcal{A}$  be a sub-base of a neutrosophic filter  $\Psi$ . Then the set  $\beta$  of a finite intersections of members of  $\mathcal{A}$  is a base of a neutrosophic filter  $\Psi$ .

**Proposition 4.4.4**

A subset  $\beta$  of a neutrosophic crisp filter  $\Psi$  in X is a base of  $\Psi$  if every member of  $\Psi$  contains a member of  $\beta$ .

**Proof**

( $\Rightarrow$ ) Suppose  $\beta$  is a base of  $\mathcal{N}$ . Then clearly, every member of  $\Psi$  contains an element of  $\beta$ .

( $\Leftarrow$ ) Suppose the necessary condition holds. Then the set of neutrosophic sets in X containing a member of  $\beta$  coincides with  $\Psi$  by reason of  $(\Psi_j)_{j \in J}$ .

**Proposition 4.4.5**

In a set X, a neutrosophic crisp filter  $\Psi'$  with base  $\beta'$  is finer than a neutrosophic crisp filter  $\Psi$  with base  $\beta$  if every member of  $\beta$  contains a member of  $\beta'$ .

**Proof**

This is an immediate consequence of *Definitions 2.4* and *4.4*.

**Proposition 4.4.6**

Two neutrosophic crisp filters bases  $\beta$  and  $\beta'$  in a set  $X$  are equivalent if every member of  $\beta$  contains a member of  $\beta'$  and every member of  $\beta'$  and every member of  $\beta'$  contains a member of  $\beta$ .

**Definition 4.4.4**

A neutrosophic crisp ultra-filter in a set  $X$  is a neutrosophic crisp filter  $\mathcal{F}$  such that there is no neutrosophic crisp filter in  $X$  which is strictly finer than  $\mathcal{F}$  (in other words, a maximal element in the ordered set of all neutrosophic crisp filters in  $X$ ).

*Since the ordered set of all the neutrosophic crisp filters in  $X$  are inductive, Zorn's lemma shows that:*

**Theorem 4.4.5**

If  $\mathcal{F}$  is any neutrosophic crisp ultra-filter in a set  $X$ , then there is a neutrosophic crisp ultra-filter than  $\mathcal{F}$ .

**Proposition 4.4.7**

Let  $\mathcal{F}$  be a neutrosophic crisp ultra-filter in a set  $X$ . If  $A$  and  $B$  are two neutrosophic subsets such that  $A \cup B \in \mathcal{F}$ , then  $A \in \mathcal{F}$  or  $B \in \mathcal{F}$ .

**Proof**

Suppose not. Then there exist neutrosophic sets  $A$  and  $B$  in  $X$  such that  $A \notin \mathcal{F}, B \notin \mathcal{F}$  and  $A \cup B \in \mathcal{F}$ . Let  $\mathcal{A} = \{M \in \mathcal{F}^X : A \cup M \in \mathcal{F}\}$ .

It is straightforward to check that  $\mathcal{A}$  is a neutrosophic crisp filter in  $X$ , and  $\mathcal{A}$  is strictly finer than  $\mathcal{F}$ , since  $B \in \mathcal{A}$ . This contradict the hypothesis that  $\mathcal{F}$  is a neutrosophic crisp ultra-filter.

**Corollary 4.4.4**

Let  $\mathcal{F}$  be a neutrosophic crisp ultra-filter in a set  $X$  and let  $(\mathcal{F}_j)_{1 \leq j \leq n}$  be a finite sequence of neutrosophic sets in  $X$ . If  $\bigcup_{j=1}^n \mathcal{F}_j \in \mathcal{F}$ , then at least one of the  $\mathcal{F}_j$  belongs to  $\mathcal{F}$ .

**Definition 4.4.5**

Let  $A$  be a neutrosophic crisp set in a set  $X$ . If  $U$  is any neutrosophic crisp set in  $X$ , then the neutrosophic crisp set  $A \cap U$  is called trace of  $U$  on  $A$  and denoted by  $U_A$ . For all neutrosophic crisp sets  $U$  and  $V$  in  $X$ , we have  $(U \cap V)_A = U_A \cap V_A$ .

**Definition 4.4.6**

Let  $A$  be a neutrosophic crisp set in a set  $X$ . Then the set  $\mathcal{A}_A$  of traces  $A \in \Psi^X$  of members of  $\mathcal{A}$  is called the trace of  $\mathcal{A}$  on  $A$ .

**Proposition 4.4.8**

Let  $\Psi$  be a neutrosophic crisp filter in a set  $X$  and  $A \in \Psi^X$ . Then the trace of  $\Psi_A$  of  $\Psi$  on  $A$  is a neutrosophic crisp filter if each member of  $\Psi$  intersect to  $A$ .

**Proof**

From the results, we see that  $\Psi_A$  satisfies  $(N_2)$ . If  $M \cap A \subset P \subset A$ , then  $P = (M \cup P) \cap A$ . Thus  $\Psi_A$  satisfies  $(N_1)$ . Hence  $\Psi_A$  is a neutrosophic crisp filter if it satisfies  $(N_3)$ , i.e. if each member of  $\Psi$  intersect to  $A$ .

**Definition 4.4.7**

Let  $\Psi$  be a neutrosophic crisp filter in a set  $X$  and  $A \in \Psi^X$ . If we have the trace  $\Psi_A$  of  $\Psi$  on  $A$ , then  $\Psi_A$  is said to be induced by  $\Psi$  on  $A$ .

**Proposition 4.4.9**

Let  $\Psi$  be a neutrosophic crisp filter in a set  $X$  induced by a neutrosophic filter  $N_A$  where  $A \in \Psi^X$ . Then the trace  $\beta_A$  on  $A$  of a base  $\beta$  of  $\Psi$  is a base of  $\Psi_A$ .

## 5. Introduction to Neutrosophic Topological Spaces

The purpose of this chapter is to extend the concepts of fuzzy topological space [4], and intuitionistic fuzzy topological space [5, 6] to the case of neutrosophic sets. Here we generalize the concept of fuzzy topological space, first introduced by Chang to the case of neutrosophic sets. In 5.1, we introduce and study the neutrosophic topological spaces. In 5.2, some neutrosophic topological notions of neutrosophic region are given and we add some further definitions and propositions for a neutrosophic topological region. In 5.3, we introduce and study the generalized neutrosophic topological space. In 5.4, we initiate and analyze the concepts of neutrosophic closed set and neutrosophic continuous function.

### 5.1 Neutrosophic Topological Spaces

Here we extend the concepts of fuzzy topological space [4], and intuitionistic fuzzy topological space [5, 7] to the case of neutrosophic sets.

#### Definition 5.1.1

A neutrosophic topology ( $\tau$ ) in a non-empty set  $X$  is a family  $\tau$  of neutrosophic subsets in  $X$  satisfying the following axioms:

$$(NT_1) \quad 0_N, 1_N \in \tau,$$

$$(NT_2) \quad G_1 \cap G_2 \in \tau \text{ for any } G_1, G_2 \in \tau,$$

$$(NT_3) \quad \bigcup G_i \in \tau \quad \forall \{G_i : i \in J\} \subseteq \tau$$

In this case the pair  $(X, \tau)$  is called a neutrosophic topological space (NTS) and any neutrosophic set in  $\tau$  is known as neutrosophic open set (NOS) in  $X$ . The elements of  $\tau$  are called open neutrosophic sets. A neutrosophic set  $F$  is closed if and only if it  $C(F)$  is neutrosophic open.

**Example 5.1.1**

Any fuzzy topological space  $(X, \tau_0)$  in the sense of Chang is obviously a *NTS* in the form  $\tau = \{A : \mu_A \in \tau_0\}$  wherever we identify a fuzzy set in  $X$  whose membership function is  $\mu_A$  with its counterpart.

**Remark 5.1.1**

The neutrosophic topological spaces are very natural generalizations of fuzzy topological spaces allowing more general functions to be members of fuzzy topology.

**Example 5.1.2**

Let  $X = \{x\}$  and

$$A = \{ \langle x, 0.5, 0.5, 0.4 \rangle : x \in X \}$$

$$B = \{ \langle x, 0.4, 0.6, 0.8 \rangle : x \in X \}$$

$$D = \{ \langle x, 0.5, 0.6, 0.4 \rangle : x \in X \}$$

$$C = \{ \langle x, 0.4, 0.5, 0.8 \rangle : x \in X \}$$

Then the family  $\tau = \{O_n, 1_n, A, B, C, D\}$  of NSs in  $X$  is a neutrosophic topology in  $X$ .

**Example 5.1.3**

Let  $(X, \tau_0)$  be a fuzzy topological space, such that  $\tau_0$  is not indiscrete; suppose now that  $\tau_0 = \{0_N, 1_N\} \cup \{V_j : j \in J\}$ ; then we can construct two *NTSS* in  $X$  as it follows:

$$\tau_0 = \{0_N, 1_N\} \cup \{ \langle x, V_j, \sigma(x), 0 \rangle : j \in J \}.$$

$$\tau_0 = \{0_N, 1_N\} \cup \{ \langle x, V_j, 0, \sigma(x), 1 - V_j \rangle : j \in J \}.$$

**Proposition 5.1.1**

Let  $(X, \tau)$  be a *NTS* in  $X$ ; then we can also construct several *NTSS* in  $X$  in the following way:

$$\tau_{o,1} = \{ [ ]G : G \in \tau \},$$

$$\tau_{o,2} = \{ \langle \rangle G : G \in \tau \}.$$

**Proof**

a)  $(NT_1)$  and  $(NT_2)$  are easy.

$$^{(NT_1)} \text{ Let } \{ [ ]G_j : j \in J, G_j \in \tau \} \subseteq \tau_{o,1}.$$

<sup>(NT)</sup> Since

$$\cup G_j = \left\{ \langle x, \vee \mu_{G_j}, \vee \sigma_{G_j}, \wedge \gamma_{G_j} \rangle \right\} \text{ or } \left\{ \langle x, \vee \mu_{G_j}, \wedge \sigma_{G_j}, \wedge \gamma_{G_j} \rangle \right\} \text{ or } \left\{ \langle x, \vee \mu_{G_j}, \wedge \sigma_{G_j}, \vee \gamma_{G_j} \rangle \right\} \in \tau,$$

we have

$$\cup (\cap G_j) = \left\{ \langle x, \vee \mu_{G_j}, \vee \sigma_{G_j}, \wedge (1 - \mu_{G_j}) \rangle \right\} \text{ or } \left\{ \langle x, \vee \mu_{G_j}, \vee \sigma_{G_j}, (1 - \vee \mu_{G_j}) \rangle \right\} \in \tau_{0,1}$$

b) This is similar to (a).

### Definition 5.1.2

Let  $(X, \tau_1), (X, \tau_2)$  be two neutrosophic topological spaces on X. Then  $\tau_1$  is said be contained in  $\tau_2$  (in symbols  $\tau_1 \subseteq \tau_2$ ) if  $G \in \tau_2$  for each  $G \in \tau_1$ . In this case, we also say that  $\tau_1$  is coarser than  $\tau_2$ .

### Proposition 5.1.2

Let  $\{\tau_j : j \in J\}$  be a family of NTSS in X. Then  $\cap T_j$  is a neutrosophic topology in X. Furthermore,  $\cap \tau_j$  is the coarsest NT in X containing all  $\tau_j$ .

### Proof

Obvious.

### Definition 5.1.3

The complement of A ( $C(A)$  for short) of NOS  $A$  is called a neutrosophic closed set (NCS) in X.

Now, we define neutrosophic closure and interior operations in neutrosophic topological spaces:

### Definition 5.1.4

Let  $(X, \tau)$  be NTS and  $A = \langle \mu_A(x), \sigma_A(x), \nu_A(x) \rangle$  be a NS in X.

Then the neutrosophic closer and neutrosophic interior of A are defined by:

$$NCl(A) = \cap \{K : K \text{ is an NCS in X and } A \subseteq K\}$$

$$NInt(A) = \cup \{G : G \text{ is an NOS in X and } G \subseteq A\}.$$

It can be also shown that  $NCl(A)$  is NCS and  $NInt(A)$  is a NOS in X:

$$A \text{ is in } X \text{ if and only if } NCl(A)$$

$$A \text{ is NCS in } X \text{ if and only if } NInt(A) = A.$$

### Proposition 5.1.3

For any neutrosophic set  $A$  in  $(X, \tau)$  we have:

- (a)  $NCl(C(A)) = C(NInt(A))$ ,
- (b)  $NInt(C(A)) = C(NCl(A))$ .

**Proof**

Let  $A = \langle \mu_A(x), \sigma_A(x), \nu_A(x) \rangle$  and suppose that the family of neutrosophic subsets contained in A is indexed by the family if NSS contained in A are indexed by the family  $A = \{ \langle \mu_{G_i}, \sigma_{G_i}, \nu_{G_i} \rangle : i \in J \}$ . Then we see that:

$$NInt(A) = \left\{ \langle \bigvee \mu_{G_i}, \bigvee \sigma_{G_i}, \bigwedge \nu_{G_i} \rangle \right\} \text{ and hence}$$

$$C(NInt(A)) = \left\{ \langle \bigwedge \mu_{G_i}, \bigvee \sigma_{G_i}, \bigvee \nu_{G_i} \rangle \right\}.$$

Since  $C(A)$  and  $\mu_{G_i} \leq \mu_A$  and  $\nu_{G_i} \geq \nu_A$  for each  $i \in J$ , we obtain  $NCl(C(A)) = \left\{ \langle \bigwedge \nu_{G_i}, \bigvee \sigma_{G_i}, \bigvee \mu_{G_i} \rangle \right\}$ .

**Proposition 5.1.4**

Let  $(x, \tau)$  be a NTS and A, B be two neutrosophic sets in X. Then the following properties hold:

- (a)  $NInt(A) \subseteq A$ ,
- (b)  $A \subseteq NCl(A)$ ,
- (c)  $A \subseteq B \Rightarrow NInt(A) \subseteq NInt(B)$ ,
- (d)  $A \subseteq B \Rightarrow NCl(A) \subseteq NCl(B)$ ,
- (e)  $NInt(NInt(A)) = NInt(A) \wedge NInt(B)$ ,
- (f)  $NCl(A \cup B) = NCl(A) \vee NCl(B)$ ,
- (g)  $NInt(1_N) = 1_N$ ,
- (h)  $NCl(0_N) = 0_N$ .

**Proof**

(a), (b) and (e) are obvious; (c) follows from (a) and *Definitions*.

Now we shall define the image and preimage of NSS. Let X and Y be two non-empty sets and  $f : x \rightarrow y$  be a function.

**Definition 5.1.5**

a) If  $B = \left\{ \langle x, \mu_B^{(y)}, \sigma_B^{(y)}, \nu_B^{(y)} \rangle : y \in Y \right\}$  is a NS in Y, then the preimage of B under f, denoted by  $f^{-1}(B)$ , is the NS in X defined by

$$f^{-1}(B) = \left\{ \langle x, f^{-1}(\mu_B)^{(x)}, f^{-1}(\sigma_B)^{(x)}, f^{-1}(\nu_B)^{(x)} \rangle : x \in X \right\}$$



b) If  $A = \left\{ \langle x, \mu_A^{(x)}, \sigma_A^{(x)}, \nu_A^{(x)} \rangle : x \in X \right\}$  is a NS in  $X$ , then the image of  $A$  under  $f$ , denoted by  $f(A)$ , is the NS in  $Y$ , defined by

$$f(A) = \left\{ \langle y, f(\lambda_A)^{(y)}, f(\delta_A)^{(y)}, (1-f(1-\nu_A))^{(y)} \rangle : y \in Y \right\}, \text{ where}$$

$$f(\lambda_A)^{(y)} = \begin{cases} \sup \lambda_A^{(y)} \text{ if } f_{(y)}^{-1} \neq \phi \\ x \in f_{(y)}^{-1} \\ 0 \text{ other wise} \end{cases}$$

$$f(\delta_A)^{(y)} = \begin{cases} \sup (\delta_A)^{(y)} \text{ if } f_{(y)}^{-1} \neq \phi \\ x \in f_{(y)}^{-1} \\ 0 \text{ other wise} \end{cases}$$

$$(1-f(1-\nu_A))^{(y)} = \begin{cases} \inf \nu_A^{(x)} \text{ if } f_{(y)}^{-1} \neq \phi \\ 1 \text{ other wise} \end{cases}.$$

## 5.2 Some Neurosophic Topological Notions of Neurosophic Region

Now, we add some further definitions and propositions for a neurosophic topological region.

### Corollary 5.2.1

Let  $A = \langle \mu_A(x), \sigma_A(x), \nu_A(x) \rangle$  and  $B = \langle \mu_B(x), \sigma_B(x), \nu_B(x) \rangle$  be two neurosophic sets in a neurosophic topological space  $(X, \tau)$ , holding the following:

- $Nint(A) \cap Nint(B) = Nint(A \cap B)$ ,
- $Ncl(A) \cap Ncl(B) = Nint(A \cup B)$ ,
- $Nint(A) \subseteq A \subseteq Ncl(A)$ ,
- $(Nint(A))^c \cap Ncl(A^c), (Ncl(A))^c = Nint(A^c)$ .

### Definition 5.2.1

We define a neurosophic boundary (NB) of a neurosophic set  $A = \langle \mu_A(x), \sigma_A(x), \nu_A(x) \rangle$  by:  $\partial A = Ncl(A) \cap Ncl(A^c)$ .

The following theorem shows the intersection method no longer guarantees a unique solution.

### Corollary 5.2.2

$\partial A \cap Nint(A) = O_N$  if  $Nint(A)$  is crisp (i.e.  $Nint(A) = O_N$  or  $Nint(A) = 1_N$ ).

**Proof**

Obvious.

**Definition 5.2.2**

Let  $A = \langle \mu_A(x), \sigma_A(x), \nu_A(x) \rangle$  be a neutrosophic set in a neutrosophic topological space  $(X, \tau)$ . Suppose that the family of neutrosophic open sets contained in A is indexed by the family  $\langle \mu_{G_i}(x), \sigma_{G_i}(x), \nu_{G_i}(x) \rangle: i \in I$  and the family of neutrosophic open subsets containing A is indexed by the family  $\langle \mu_{K_j}(x), \sigma_{K_j}(x), \nu_{K_j}(x) \rangle: j \in J$ .

Then two neutrosophic interior sets - closure and boundaries -, are defined as it follows:

- a)  $Nint(A)_{[\ ]}$  may be defined as two types
  - i) Type 1.  $Nint(A)_{[\ ]} = \langle \max(\mu_{G_i}(x)), \max(\sigma_{G_i}(x)), \min(1 - \mu_{G_i}(x)) \rangle$
  - ii) Type 2.  $Nint(A)_{[\ ]} = \langle \max(\mu_{G_i}(x)), \min(\sigma_{G_i}(x)), \min(1 - \mu_{G_i}(x)) \rangle$
- b)  $Nint(A)_{\langle \rangle}$  may be defined as two types
  - iii) Type 1.  $Nint(A)_{\langle \rangle} = \langle \max(1 - \nu_{G_i}(x)), \max(\sigma_{G_i}(x)), \min(\nu_{G_i}(x)) \rangle$
  - iv) Type 2.  $Nint(A)_{\langle \rangle} = \langle \max(1 - \nu_{G_i}(x)), \min(\sigma_{G_i}(x)), \min(\nu_{G_i}(x)) \rangle$
- c)  $Ncl(A)_{[\ ]}$  may be defined as two types
  - i) Type 1.  $Ncl(A)_{[\ ]} = \langle \max(\mu_{K_j}(x)), \min(\sigma_{K_j}(x)), \max(1 - \mu_{K_j}(x)) \rangle$
  - ii) Type 2.  $Ncl(A)_{[\ ]} = \langle \max(\mu_{K_j}(x)), \max(\sigma_{K_j}(x)), \max(1 - \mu_{K_j}(x)) \rangle$
- d)  $Ncl(A)_{\langle \rangle}$  may be defined as two types
  - i) Type 1.  $Ncl(A)_{\langle \rangle} = \langle \min(1 - \nu_{K_i}(x)), \min(\sigma_{G_i}(x)), \max(\nu_{G_i}(x)) \rangle$
  - ii) Type 2.  $Ncl(A)_{\langle \rangle} = \langle \min(1 - \nu_{K_i}(x)), \max(\sigma_{G_i}(x)), \max(\nu_{G_i}(x)) \rangle$ .
- e) A neutrosophic boundaries may be defined as
  - i)  $\partial A_{[\ ]} = Ncl(A_{[\ ]}) \cap Ncl(A^c_{[\ ]})$
  - ii)  $\partial A_{\langle \rangle} = Ncl(A_{\langle \rangle}) \cap Ncl(A^c_{\langle \rangle})$

**Proposition 5.2.1**

- a)  $Nint(A)_{[\ ]} \subseteq Nint(A) \subseteq Nint(A)_{\langle \rangle}$ ,
- b)  $Ncl(A)_{[\ ]} \subseteq Ncl(A) \subseteq Ncl(A)_{\langle \rangle}$
- c)  $Nint(A_{\{[\ ], \langle \rangle\}}) = \{[\ ], \langle \rangle\}Nint(A)$  and  $Ncl(A_{\{[\ ], \langle \rangle\}}) = \{[\ ], \langle \rangle\}Ncl(A)$

**Proof**

We must only prove (c), as the others are obvious.

$$[ ] N \text{int}(A) = \langle \max(\mu_{G_i}(x), \max(\sigma_{G_i}(x), (1 - \max \mu_{G_i}(x))) \rangle \text{ or } = \\ \langle \max(\mu_{G_i}(x), \min(\sigma_{G_i}(x), (1 - \max \mu_{G_i}(x))) \rangle$$

Based on knowing that  $(1 - \max \mu_{G_i}(x)) = \min(1 - \mu_{G_i}(x))$  then

$$[ ] N \text{int}(A) = \langle \max(\mu_{G_i}(x), \max(\sigma_{G_i}(x), \min(1 - \mu_{G_i}(x))) \rangle \text{ or } \\ \langle \max(\mu_{G_i}(x), \min(\sigma_{G_i}(x), \min(1 - \mu_{G_i}(x))) \rangle = [ ] N \text{int}(A)$$

In a similar way one can prove the others.

**Proposition 5.2.2**

- a)  $N \text{int}(A_{\{[ ] , < > \}}) = (N \text{int}(A))_{\{[ ] , < > \}}$
- b)  $Ncl(A_{\{[ ] , < > \}})_{\{[ ] , < > \}} = (Ncl(A))_{\{[ ] , < > \}}$

**Proof**

Obvious.

**Definition 5.2.3**

Let  $A = \langle \mu_A(x), \sigma_A(x), \nu_A(x) \rangle$  be a neutrosophic set in a neutrosophic topological space  $(X, \tau)$ . We define neutrosophic exterior of A as it follows:

$$A^{NE} = 1_N \cap A^C$$

**Definition 5.2.4**

Let  $A = \langle \mu_A(x), \sigma_A(x), \nu_A(x) \rangle$  be a neutrosophic open set and  $B = \langle \mu_B(x), \sigma_B(x), \nu_B(x) \rangle$  be a neutrosophic set in a neutrosophic topological space  $(X, \tau)$  then:

- a) A is called neutrosophic regular open if  $A = N \text{int}(Ncl(A))$ .
- b) If  $B \in NCS(X)$  then B is called neutrosophic regular closed if  $A = Ncl(N \text{int}(A))$ .

Now, we obtain a formal model for simple spatial neutrosophic region based on neutrosophic connectedness.

**Definition 5.2.5**

Let  $A = \langle \mu_A(x), \sigma_A(x), \nu_A(x) \rangle$  be a neutrosophic set in a neutrosophic topological space  $(X, \tau)$ . Then A is called a simple neutrosophic region in connected NTS, such that:

- i)  $Ncl(A)$ ,  $Ncl(A)_{[\ ]}$ , and  $Ncl(A)_{< >}$  are neutrosophic regular closed.
- ii)  $Nint(A)$ ,  $Nint(A)_{[\ ]}$ , and  $Nint(A)_{< >}$  are neutrosophic regular open.
- iii)  $\partial(A)$ ,  $\partial(A)_{[\ ]}$ , and  $\partial(A)_{< >}$  are neutrosophically connected.

Having  $Ncl(A)$ ,  $Ncl(A)_{[\ ]}$ ,  $Ncl(A)_{< >}$ ,  $Nint(A)$ ,  $Nint(A)_{[\ ]}$ ,  $Nint(A)_{< >}$  are  $\partial(A)$ ,  $\partial(A)_{[\ ]}$ , and  $\partial(A)_{< >}$  for two neutrosophic regions, we are able to find relationships between two neutrosophic regions.

### 5.3 Generalized Neutrosophic Topological Spaces

#### Definition 5.3.1

A generalized neutrosophic topology (GNT) in a non-empty set  $X$  is a family  $\tau$  of generalized neutrosophic subsets in  $X$  satisfying the following axioms:

- (GNT<sub>1</sub>)  $0_N, 1_N \in \tau$ ,
- (GNT<sub>2</sub>)  $G_1 \cap G_2 \in \tau$ , for any  $G_1, G_2 \in \tau$ ,
- (GNT<sub>3</sub>)  $\cup G_i \in \tau \forall \{G_i : i \in J\} \subseteq \tau$ .

In this case, the pair  $(X, \tau)$  is called a generalized neutrosophic topological space (GNTS) and any neutrosophic set in  $\tau$  is known as neutrosophic open set (NOS) in  $X$ . The elements of  $\tau$  are called open generalized neutrosophic sets. A generalized neutrosophic set  $F$  is closed if and only if  $C(F)$  is a generalized neutrosophic open.

#### Remark 5.3.1

The generalized neutrosophic topological spaces are very natural generalizations of intuitionistic fuzzy topological spaces, allowing more general functions to be members of intuitionistic fuzzy topology.

#### Example 5.3.1

Let  $X = \{x\}$  and

$$A = \{ \langle x, 0.5, 0.5, 0.4 \rangle : x \in X \}$$

$$B = \{ \langle x, 0.4, 0.6, 0.8 \rangle : x \in X \}$$

$$D = \{ \langle x, 0.5, 0.6, 0.4 \rangle : x \in X \}$$

$$C = \{ \langle x, 0.4, 0.5, 0.8 \rangle : x \in X \}$$

Then the family  $\tau = \{O_n, 1_n, A, B, C, D\}$  of GNSs in X is a generalized neutrosophic topology in X.

**Example 5.3.2**

Let  $(X, \tau)$  be a fuzzy topological space in changes [4] sense such that  $\tau_0$  is not indiscrete; suppose now that  $\tau_0 = \{0_N, 1_N\} \cup \{V_j : j \in J\}$  then we can construct two GNTSS in X as it follows:

$$\tau_0 = \{0_N, 1_N\} \cup \{ \langle x, V_j, \sigma(x), 0 \rangle : j \in J \} \tau_0 = \{0_N, 1_N\} \cup \{ \langle x, V_j, 0, \sigma(x), 1 - V_j \rangle : j \in J \}$$

**Proposition 5.3.1**

Let  $(X, \tau)$  be a GNT in X, then we can also construct several GNTSS in X in the following way:

$$\tau_{o,1} = \{ \sqcup G : G \in \tau \},$$

$$\tau_{o,2} = \{ \diamond G : G \in \tau \},$$

**Proof**

$(GNT_1)$  and  $(GNT_2)$  are easy.

$(GNT_3)$  Let  $\{ \sqcup G_j : j \in J, G_j \in \tau \} \subseteq \tau_{o,1}$ .

Since  $\cup G_j = \{ \langle x, \vee \mu_{G_j}, \vee \sigma_{G_j}, \wedge \gamma_{G_j} \rangle \}$  or  $\{ \langle x, \vee \mu_{G_j}, \wedge \sigma_{G_j}, \wedge \gamma_{G_j} \rangle \}$  or  $\{ \langle x, \vee \mu_{G_j}, \wedge \sigma_{G_j}, \vee \gamma_{G_j} \rangle \} \in \tau$ , we have  $\cup ( \sqcup G_j ) = \{ \langle x, \vee \mu_{G_j}, \vee \sigma_{G_j}, \wedge (1 - \mu_{G_j}) \rangle \}$  or  $\{ \langle x, \vee \mu_{G_j}, \vee \sigma_{G_j}, (1 - \vee \mu_{G_j}) \rangle \} \in \tau_{o,1}$

This is similar to (a).

**Definition 5.3.2**

Let  $(X, \tau_1), (X, \tau_2)$  be two generalized neutrosophic topological spaces in X. Then  $\tau_1$  is said to be contained in  $\tau_2$  (in symbols  $\tau_1 \subseteq \tau_2$ ) if  $G \in \tau_2$  for each  $G \in \tau_1$ . In this case, we also say that  $\tau_1$  is coarser than  $\tau_2$ .

**Proposition 5.3.2**

Let  $\{ \tau_j : j \in J \}$  be a family of NTSS in X. Then  $\cap \tau_j$  is a generalized neutrosophic topology in X. Furthermore,  $\cap \tau_j$  is the coarsest NT in X containing all  $\tau_j$ .

**Proof**

Obvious.

**Definition 5.3.3**

The complement of A ( $C(A)$ ) of NOS A is called a generalized neutrosophic closed set (GNCS) in X.

*Now, we define the generalized neutrosophic closure and interior operations in generalized neutrosophic topological spaces.*

**Definition 5.3.4**

Let  $(X, \tau)$  be GNTS and  $A = \langle \mu_A(x), \sigma_A(x), \nu_A(x) \rangle$  be a GNS in X.

Then the generalized neutrosophic closer and generalized neutrosophic interior of A are defined by:

$$GNCl(A) = \bigcap \{K : K \text{ is an NCS in } X \text{ and } A \subseteq K\}$$

$$GNInt(A) = \bigcup \{G : G \text{ is an NOS in } X \text{ and } G \subseteq A\}.$$

It can be also shown that  $NCI(A)$  is NCS and  $NInt(A)$  is a GNOS in X. A is in X if and only if  $GNCl(A)$ .

A is GNC in X if and only if  $GNInt(A) = A$ .

**Proposition 5.3.3**

For any generalized neutrosophic set A in  $(X, \tau)$  we have

(a)  $GNCl(C(A)) = C(GNInt(A))$ ,

(b)  $GNInt(C(A)) = C(GNCl(A))$ .

**Proof**

Let  $A = \{ \langle \mu_A, \sigma_A, \nu_A \rangle : x \in X \}$  and suppose that the family of generalized neutrosophic subsets contained in A are indexed by the family if GNSS contained in A are indexed by the family  $A = \{ \langle \mu_{G_i}, \sigma_{G_i}, \nu_{G_i} \rangle : i \in J \}$ .

Then, we see that  $GNInt(A) = \{ \langle x, \nu_{\mu_{G_i}}, \nu_{\sigma_{G_i}}, \wedge \nu_{G_i} \rangle \}$  and hence  $C(GNInt(A)) = \{ \langle x, \wedge \mu_{G_i}, \nu_{\sigma_{G_i}}, \nu_{\nu_{G_i}} \rangle \}$ . Since  $C(A)$  and  $\mu_{G_i} \leq \mu_A$  and  $\nu_{G_i} \geq \nu_A$  for each  $i \in J$ , we obtain  $C(A)$  i.e.  $GNCl(C(A)) = \{ \langle x, \wedge \nu_{G_i}, \nu_{\sigma_{G_i}}, \nu_{\mu_{G_i}} \rangle \}$ . Hence  $GNCl(C(A)) = C(GNInt(A))$ , it immediately follows.

This is analogous to (a).

**Proposition 5.3.4**

Let  $(X, \tau)$  be a GNTS and A, B be two neutrosophic sets in X. Then the following properties hold:

- a)  $GNInt(A) \subseteq A$ ,
- b)  $A \subseteq GNCl(A)$ ,
- c)  $A \subseteq B \Rightarrow GNInt(A) \subseteq GNInt(B)$ ,
- d)  $A \subseteq B \Rightarrow GNCl(A) \subseteq GNCl(B)$ ,
- e)  $GNInt(GNInt(A)) = GNInt(A) \wedge GNInt(B)$ ,
- f)  $GNCl(A \cup B) = GNCl(A) \vee GNCl(B)$ ,
- g)  $GNInt(1_N) = 1_N$ ,
- h)  $GNCl(O_N) = O_N$ ,

**Proof**

(a), (b) and (e) are obvious (c) follows from (a) and *Definitions*.

### 5.4 Neutrosophic Closed Set and Neutrosophic Continuous Functions

**Definition 5.4.1**

Let  $(X,T)$  be a neutrosophic topological space. A neutrosophic set  $A$  in  $(X,T)$  is said to be neutrosophic closed (N-closed). If  $Ncl(A) \subseteq G$  whenever  $A \subseteq G$  and  $G$  is neutrosophic open; the complement of neutrosophic closed set is neutrosophic open.

**Proposition 5.4.1**

If  $A$  and  $B$  are neutrosophic closed sets, then  $A \cup B$  is a neutrosophic closed set.

**Remark 5.4.1**

The intersection of two neutrosophic closed (N-closed) sets does not need to be a neutrosophic closed set.

**Example 5.4.1**

Let  $X = \{a, b, c\}$  and

$$A = \langle (0.5,0.5,0.5) , (0.4,0.5,0.5) , (0.4,0.5,0.5) \rangle$$

$$B = \langle (0.3,0.4,0.4) , (0.7,0.5,0.5) , (0.3,0.4,0.4) \rangle$$

Then  $T = \{ 0_N, 1_N, A, B \}$  is a neutrosophic topology in  $X$ . We define the two neutrosophic sets  $A_1$  and  $A_2$  as it follows,

$$A_1 = \langle (0.5,0.5,0.5), (0.6,0.5,0.5), (0.6,0.5,0.5) \rangle$$

$$A_2 = \langle (0.7,0.6,0.6)(0.3,0.5,0.5), (0.7,0.6,0.6) \rangle$$

$A_1$  and  $A_2$  are neutrosophic closed set but  $A_1 \cap A_2$  is not a neutrosophic closed set.

**Proposition 5.4.2**

Let  $(X,T)$  be a neutrosophic topological space. If  $B$  is neutrosophic closed set and  $B \subseteq A \subseteq Ncl(B)$ , then  $A$  is N-closed.

**Proposition 5.4.3**

In a neutrosophic topological space  $(X,T)$ ,  $T=\mathfrak{T}$  (the family of all neutrosophic closed sets) if every neutrosophic subset of  $(X,T)$  is a neutrosophic closed set.

**Proof**

Suppose that every neutrosophic set  $A$  of  $(X,T)$  is N-closed. Let  $A \in T$ , since  $A \subseteq A$  and  $A$  is N-closed,  $Ncl(A) \subseteq A$ . But  $A \subseteq Ncl(A)$ . Hence,  $Ncl(A) = A$ . Thus,  $A \in \mathfrak{T}$ . Therefore,  $T \subseteq \mathfrak{T}$ . If  $B \in \mathfrak{T}$  then  $1-B \in T \subseteq \mathfrak{T}$ . and hence  $B \in T$ . That is,  $\mathfrak{T} \subseteq T$ . Therefore  $T = \mathfrak{T}$  conversely, suppose that  $A$  be a neutrosophic set in  $(X,T)$ . Let  $B$  be a neutrosophic open set in  $(X,T)$ , such that  $A \subseteq B$ . By hypothesis,  $B$  is neutrosophic N-closed. By definition of neutrosophic closure,  $Ncl(A) \subseteq B$ . Therefore  $A$  is N-closed.

**Proposition 5.4.4**

Let  $(X,T)$  be a neutrosophic topological space. A neutrosophic set  $A$  is neutrosophic open if  $B \subseteq Nint(A)$ , whenever  $B$  is neutrosophic closed and  $B \subseteq A$ .

**Proof**

Let  $A$  be a neutrosophic open set and  $B$  be a N-closed, such that  $B \subseteq A$ . Now,  $B \subseteq A \Rightarrow 1-A \Rightarrow 1-B$  and  $1-A$  is a neutrosophic closed set  $\Rightarrow Ncl(1-A) \subseteq 1-B$ . That is,  $B = 1-(1-B) \subseteq 1-Ncl(1-A)$ . But  $1-Ncl(1-A) = Nint(A)$ . Thus,  $B \subseteq Nint(A)$ . Conversely, suppose that  $A$  is a neutrosophic set, such that  $B \subseteq Nint(A)$  whenever  $B$  is neutrosophic closed and  $B \subseteq A$ . Let  $1-A \subseteq B \Rightarrow 1-B \subseteq A$ . Hence by assumption  $1-B \subseteq Nint(A)$ . That is,  $1-Nint(A) \subseteq B$ . But  $1-Nint(A) = Ncl(1-A)$ . Hence  $Ncl(1-A) \subseteq B$ . That is  $1-A$  is neutrosophic closed set. Therefore,  $A$  is neutrosophic open set.



**Proposition 5.4.5**

If  $\text{Nint}(A) \subseteq B \subseteq A$  and if  $A$  is neutrosophic open set then  $B$  is also neutrosophic open set.

**Definition 5.4.2**

i) If  $B = \langle \mu_B, \sigma_B, \nu_B \rangle$  is a NS in  $Y$ , then the preimage of  $B$  under  $f$ , denoted by  $f^{-1}(B)$ , is a NS in  $X$  defined by  $f^{-1}(B) = \langle f^{-1}(\mu_B), f^{-1}(\sigma_B), f^{-1}(\nu_B) \rangle$ .

ii) If  $A = \langle \mu_A, \sigma_A, \nu_A \rangle$  is a NS in  $X$ , then the image of  $A$  under  $f$ , denoted by  $f(A)$ , is the a NS in  $Y$  defined by  $f(A) = \langle f(\mu_A), f(\sigma_A), f(\nu_A)^c \rangle$ .

Here we introduce the properties of images and preimages, some of which we frequently use in the following sections.

**Corollary 5.4.1**

Let  $A \{A_i : i \in J\}$  be a NS in  $X$ , and  $B \{B_j : j \in K\}$  be a NS in  $Y$ , and  $f : X \rightarrow Y$  be a function. Then:

- (a)  $A_1 \subseteq A_2 \Leftrightarrow f(A_1) \subseteq f(A_2), B_1 \subseteq B_2 \Leftrightarrow f^{-1}(B_1) \subseteq f^{-1}(B_2)$ ,
- (b)  $A \subseteq f^{-1}(f(A))$  and if  $f$  is injective, then  $A = f^{-1}(f(A))$ ,
- (c)  $f^{-1}(f(B)) \subseteq B$  and if  $f$  is surjective, then  $f^{-1}(f(B)) = B$ ,
- (d)  $f^{-1}(\cup B_i) = \cup f^{-1}(B_i), f^{-1}(\cap B_i) = \cap f^{-1}(B_i)$ ,
- (e)  $f(\cup A_i) = \cup f(A_i); f(\cap A_i) \subseteq \cap f(A_i)$ ;  
and if  $f$  is injective, then  $f(\cap A_i) = \cap f(A_i)$ ;
- (f)  $f^{-1}(1_N) = 1_N, f^{-1}(0_N) = 0_N$ ,
- (g)  $f(0_N) = 0_N, f(1_N) = 1_N$  if  $f$  is surjective.

**Proof**

Obvious.

**Definition 5.4.3**

Let  $(X, \Gamma_1)$  and  $(Y, \Gamma_2)$  be two NTSs, and let  $f : X \rightarrow Y$  be a function. Then  $f$  is said to be continuous if the preimage of each NCS in  $\Gamma_2$  is a NS in  $\Gamma_1$ .

**Definition 5.4.4**

Let  $(X, \Gamma_1)$  and  $(Y, \Gamma_2)$  be two NTSs and let  $f : X \rightarrow Y$  be a function. Then  $f$  is said to be open if the image of each NS in  $\Gamma_1$  is a NS in  $\Gamma_2$ .

**Example 5.4.2**

Let  $(X, \Gamma_o)$  and  $(Y, \Psi_o)$  be two NTSs.

(a) If  $f : X \rightarrow Y$  is continuous in the usual sense, then in this case  $f$  is Continuous. Here we consider the NTs in X and Y, respectively, as it follows:

$$\Gamma_1 = \{ \langle \mu_G, 0, \mu_G^c \rangle : G \in \Gamma_o \} \text{ and } \Gamma_2 = \{ \langle \mu_H, 0, \mu_H^c \rangle : H \in \Psi_o \}.$$

In this case, we have for each  $\langle \mu_H, 0, \mu_H^c \rangle \in \Gamma_2, H \in \Psi_o,$

$$f^{-1} \langle \mu_H, 0, \mu_H^c \rangle = \langle f^{-1}(\mu_H), f^{-1}(0), f^{-1}(\mu_H^c) \rangle = \langle f^{-1} \mu_H, f(0), (f(\mu))^c \rangle \in \Gamma_1.$$

(b) If  $f : X \rightarrow Y$  is neutrosophic open in the usual sense, then in this case,  $f$  is neutrosophic open in the sense of Definition 3.2.

*Now we obtain some characterizations of neutrosophic continuity:*

**Proposition 5.4.6**

Let  $f : (X, \Gamma_1) \rightarrow (Y, \Gamma_2),$  where  $f$  is a neutrosophic continuous if the preimage of each NS (neutrosophic closed set) in  $\Gamma_2$  is a NS in  $\Gamma_1.$

**Proposition 5.4.7**

The following are equivalent to each other:

1.  $f : (X, \Gamma_1) \rightarrow (Y, \Gamma_2)$  is neutrosophic continuous.
2.  $f^{-1}(NInt(B)) \subseteq NInt(f^{-1}(B))$  for each CNS B in Y.
3.  $NCl(f^{-1}(B)) \subseteq f^{-1}(NCl(B))$  for each NCB in Y.

**Example 5.4.3**

Let  $(Y, \Gamma_2)$  be a NTS and  $f : X \rightarrow Y$  be a function. In this case  $\Gamma_1 = \{ f^{-1}(H) : H \in \Gamma_2 \}$  is a NT in X. Indeed, it is the coarsest NT in X which makes the function  $f : X \rightarrow Y$  continuous. One may call it the initial neutrosophic crisp topology with respect to  $f.$

**Definition 5.4.5**

Let  $(X, T)$  and  $(Y, S)$  be two neutrosophic topological spaces, then:

(a) A map  $f : (X,T) \rightarrow (Y,S)$  is called N-continuous if the inverse image of every closed set in  $(Y,S)$  is neutrosophic closed in  $(X,T)$ .

(b) A map  $f:(X,T) \rightarrow (Y,S)$  is called neutrosophic-gc irresolute if the inverse image of every neutrosophic closed set in  $(Y,S)$  is neutrosophic closed in  $(X,T)$ . Equivalently if the inverse image of every neutrosophic open set in  $(Y,S)$  is neutrosophic open in  $(X,T)$ .

(c) A map  $f:(X,T) \rightarrow (Y,S)$  is said to be strongly neutrosophic continuous if  $f^{-1}(A)$  is both neutrosophic open and neutrosophic closed in  $(X,T)$  for each neutrosophic set  $A$  in  $(Y,S)$ .

(d) A map  $f : (X,T) \rightarrow (Y,S)$  is said to be Perfectly neutrosophic continuous if  $f^{-1}(A)$  is both neutrosophic open and neutrosophic closed in  $(X,T)$  for each neutrosophic open set  $A$  in  $(Y,S)$ .

(e) A map  $f:(X,T) \rightarrow (Y,S)$  is said to be Strongly N-Continuous if the inverse image of every neutrosophic open set in  $(Y,S)$  is neutrosophic open in  $(X,T)$ .

(f) A map  $f:(X,T) \rightarrow (Y,S)$  is said to be perfectly N-continuous if the inverse image of every neutrosophic open set in  $(Y,S)$  is both neutrosophic open and neutrosophic closed in  $(X,T)$ .

**Proposition 5.4.8**

Let  $(X,T)$  and  $(Y,S)$  be any two neutrosophic topological spaces. Let  $f : (X,T) \rightarrow (Y,S)$  be generalized neutrosophic continuous. Then for every neutrosophic set  $A$  in  $X$  , $f(Ncl(A)) \subseteq Ncl(f(A))$ .

**Proposition 5.4.9**

Let  $(X,T)$  and  $(Y,S)$  be any two neutrosophic topological spaces. Let  $f : (X,T) \rightarrow (Y,S)$  be generalized neutrosophic continuous. Then for every neutrosophic set  $A$  in  $Y$  , $Ncl(f^{-1}(A)) \subseteq f^{-1}(Ncl(A))$ .

**Proposition 5.4.10**

Let  $(X,T)$  and  $(Y, S)$  be any two neutrosophic topological spaces. If  $A$  is a neutrosophic closed set in  $(X,T)$  and if  $f:(X,T) \rightarrow (Y, S)$  is neutrosophic continuous and neutrosophic closed, then  $f(A)$  is neutrosophic closed in  $(Y, S)$ .

**Proof**

Let  $G$  be a neutrosophic open in  $(Y, S)$ . If  $f(A) \subseteq G$ , then  $A \subseteq f^{-1}(G)$  in  $(X, T)$ . Since  $A$  is neutrosophic closed and  $f^{-1}(G)$  is neutrosophic open in  $(X, T)$ ,  $Ncl(A) \subseteq f^{-1}(G)$ , i.e.  $f(Ncl(A)) \subseteq G$ . Now by assumption,  $f(Ncl(A))$  is neutrosophic closed and  $Ncl(f(A)) \subseteq Ncl(f(Ncl(A))) = f(Ncl(A)) \subseteq G$ . Hence  $f(A)$  is N-closed.

**Proposition 5.4.11**

Let  $(X, T)$  and  $(Y, S)$  be any two neutrosophic topological spaces. If  $f : (X, T) \rightarrow (Y, S)$  is neutrosophic continuous, then it is N-continuous.

*The converse of Proposition is not true. See Example.*

**Example 5.4.4**

Let  $X = \{a, b, c\}$  and  $Y = \{a, b, c\}$ . We define the neutrosophic sets  $A$  and  $B$  as it follows:

$$A = \langle (0.4, 0.4, 0.5), (0.2, 0.4, 0.3), (0.4, 0.4, 0.5) \rangle$$

$$B = \langle (0.4, 0.5, 0.6), (0.3, 0.2, 0.3), (0.4, 0.5, 0.6) \rangle$$

Then the family  $T = \{0_N, 1_N, A\}$  is a neutrosophic topology in  $X$  and  $S = \{0_N, 1_N, B\}$  is a neutrosophic topology in  $Y$ . Thus  $(X, T)$  and  $(Y, S)$  are neutrosophic topological spaces. We define  $f : (X, T) \rightarrow (Y, S)$  as  $f(a) = b, f(b) = a, f(c) = c$ . Clearly,  $f$  is N-continuous. Now  $f$  is not neutrosophic continuous, since  $f^{-1}(B) \notin T$  for  $B \in S$ .

**Example 5.4.5**

Let  $X = \{a, b, c\}$ . We define the neutrosophic sets  $A$  and  $B$  as it follows:

$$A = \langle (0.4, 0.5, 0.4), (0.5, 0.5, 0.5), (0.4, 0.5, 0.4) \rangle$$

$$B = \langle (0.7, 0.6, 0.5), (0.3, 0.4, 0.5), (0.3, 0.4, 0.5) \rangle$$

$$C = \langle (0.5, 0.5, 0.5), (0.4, 0.5, 0.5), (0.5, 0.5, 0.5) \rangle$$

$T = \{0_N, 1_N, A, B\}$  and  $S = \{0_N, 1_N, C\}$  are neutrosophic topologies in  $X$ . Thus  $(X, T)$  and  $(X, S)$  are neutrosophic topological spaces. We define  $f : (X, T) \rightarrow (X, S)$  as it follows:  $f(a) = b, f(b) = b, f(c) = c$ . Clearly,  $f$  is N-continuous. Since  $D = \langle (0.6, 0.6, 0.7), (0.4, 0.4, 0.3), (0.6, 0.6, 0.7) \rangle$  is neutrosophic open in  $(X, S)$ ,  $f^{-1}(D)$  is not neutrosophic open in  $(X, T)$ .

**Proposition 5.4.12**

Let  $(X,T)$  and  $(Y,S)$  be any two neutrosophic topological spaces. If  $f: (X,T) \rightarrow (Y,S)$  is strongly N-continuous, then  $f$  is neutrosophic continuous.

*The converse of Proposition is not true. See Example.*

**Example 5.4.6**

Let  $X = \{a, b, c\}$ . We define the neutrosophic sets A and B as it follows:

$$A = \langle (0.9,0.9,0.9), (0.1,0.1,0.1), (0.9,0.9,0.9) \rangle$$

$$B = \langle (0.9,0.9,0.9), (0.1,0.1,0), (0.9,0.1,0.8) \rangle$$

$$C = \langle (0.9,0.9,0.9), (0.1,0,0.1), (0.9,0.9,0.9) \rangle$$

$T = \{0_N, 1_N, A, B\}$  and  $S = \{0_N, 1_N, C\}$  are neutrosophic topologies in X. Thus  $(X,T)$  and  $(X,S)$  are neutrosophic topological spaces. Also, we define  $f : (X,T) \rightarrow (X,S)$  as it follows:  $f(a) = a, f(b) = c, f(c) = b$ . Clearly,  $f$  is neutrosophic continuous. But  $f$  is not strongly N-continuous. Since  $D = \langle (0.9,0.9,0.99), (0.05,0,0.01), (0.9,0.9,0.99) \rangle$  is an neutrosophic open set in  $(X,S), f^{-1}(D)$  is not neutrosophic open in  $(X,T)$ .

**Proposition 5.4.13**

Let  $(X,T)$  and  $(Y, S)$  be any two neutrosophic topological spaces. If  $f: (X,T) \rightarrow (Y, S)$  is perfectly N-continuous, then  $f$  is strongly N-continuous.

*The converse of Proposition is not true. See Example.*

**Example 5.4.7**

Let  $X = \{a, b, c\}$ . We define the neutrosophic sets A and B as it follows:

$$A = \langle (0.9,0.9,0.9), (0.1,0.1,0.1), (0.9,0.9,0.9) \rangle,$$

$$B = \langle (0.99,0.99,0.99), (0.01,0,0), (0.99,0.99,0.99) \rangle$$

$$C = \langle (0.9,0.9,0.9), (0.1,0.1,0.05), (0.9,0.9,0.9) \rangle$$

$T = \{0_N, 1_N, A, B\}$  and  $S = \{0_N, 1_N, C\}$  are neutrosophic topologies space in X. Thus  $(X,T)$  and  $(X, S)$  are neutrosophic topological spaces. Also we define  $f : (X,T) \rightarrow (X,S)$  as it follows:  $f(a) = a, f(b) = f(c) = b$ . Clearly,  $f$  is

strongly N-continuous. But  $f$  is not perfectly N-continuous. Since  $D = \langle (0.9, 0.9, 0.9), (0.1, 0.1, 0), (0.9, 0.9, 0.9) \rangle$  is a neutrosophic open set in  $(X, S)$ ,  $f^{-1}(D)$  is neutrosophic open and not neutrosophic closed in  $(X, T)$ .

**Proposition 5.4.14**

Let  $(X, T)$  and  $(Y, S)$  be any neutrosophic topological spaces. If  $f: (X, T) \rightarrow (Y, S)$  is strongly neutrosophic continuous, then  $f$  is strongly N-continuous.

*The converse of Proposition is not true. See Example.*

**Example 5.4.8**

Let  $X = \{a, b, c\}$ . We define the neutrosophic sets A and B as it follows.

$$A = \langle (0.9, 0.9, 0.9), (0.1, 0.1, 0.1), (0.9, 0.9, 0.9) \rangle$$

$$B = \langle (0.99, 0.99, 0.99), (0.01, 0, 0), (0.99, 0.99, 0.99) \rangle$$

$$C = \langle (0.9, 0.9, 0.9), (0.1, 0.1, 0.05), (0.9, 0.9, 0.9) \rangle$$

$T = \{0_N, 1_N, A, B\}$  and  $S = \{0_N, 1_N, C\}$  are neutrosophic topologies in X. Thus  $(X, T)$  and  $(X, S)$  are neutrosophic topological spaces. Also, we define  $f : (X, T) \rightarrow (X, S)$  as it follows:  $f(a) = a, f(b) = f(c) = b$ . Clearly,  $f$  is strongly N-continuous. But  $f$  is not strongly neutrosophic continuous. Since  $D = \langle (0.9, 0.9, 0.9), (0.1, 0.1, 0), (0.9, 0.9, 0.9) \rangle$ , a neutrosophic set in  $(X, S)$ ,  $f^{-1}(D)$  is neutrosophic open and not neutrosophic closed in  $(X, T)$ .

**Proposition 5.4.15**

Let  $(X, T), (Y, S)$  and  $(Z, R)$  be any three neutrosophic topological spaces. Suppose  $f : (X, T) \rightarrow (Y, S)$ ,  $g : (Y, S) \rightarrow (Z, R)$  be maps. Assume  $f$  is neutrosophic gc-irresolute and  $g$  is N-continuous then  $g \circ f$  is N-continuous.

**Proposition 5.4.16**

Let  $(X, T), (Y, S)$  and  $(Z, R)$  be any three neutrosophic topological spaces. Let  $f : (X, T) \rightarrow (Y, S)$ ,  $g : (Y, S) \rightarrow (Z, R)$  be map, such that  $f$  is strongly N-continuous and  $g$  is N-continuous. Then the composition  $g \circ f$  is neutrosophic continuous.

**Definition 5.4.6**

A neutrosophic topological space  $(X,T)$  is said to be neutrosophic  $T_{1/2}$  if every neutrosophic closed set in  $(X,T)$  is neutrosophic closed in  $(X,T)$ .

**Proposition 5.4.17**

Let  $(X,T),(Y,S)$  and  $(Z,R)$  be any neutrosophic topological spaces. Let  $f : (X,T) \rightarrow (Y,S)$  and  $g : (Y,S) \rightarrow (Z,R)$  be mapping and  $(Y,S)$  be neutrosophic  $T_{1/2}$  if  $f$  and  $g$  are N-continuous then the composition  $g \circ f$  is N-continuous.

*The proposition 4.11 is not valid if  $(Y, S)$  is not neutrosophic  $T_{1/2}$ .*

**Example 5.4.9**

Let  $X = \{a,b,c\}$ . We define the neutrosophic sets A, B and C as it follows:

$$A = \langle (0.4,0.4,0.6), (0.4,0.4,0.3) \rangle$$

$$B = \langle (0.4,0.5,0.6), (0.3,0.4,0.3) \rangle$$

$$C = \langle (0.4,0.6,0.5), (0.5,0.3,0.4) \rangle$$

Then the family  $T = \{0_N, 1_N, A\}$ ,  $S = \{0_N, 1_N, B\}$  and  $R = \{0_N, 1_N, C\}$  are neutrosophic topologies on X. Thus  $(X,T),(X,S)$  and  $(X,R)$  are neutrosophic topological spaces. Also, we define  $f : (X,T) \rightarrow (X,S)$  as  $f(a) = b, f(b) = a, f(c) = c$  and  $g : (X,S) \rightarrow (X,R)$  as  $g(a) = b, g(b) = c, g(c) = b$ . Clearly,  $f$  and  $g$  are N-continuous function. But  $g \circ f$  is not N-continuous. For  $1 - C$  is neutrosophic closed in  $(X, R)$ .  $f^{-1}(g^{-1}(1-C))$  is not N-closed in  $(X,T)$ .  $g \circ f$  is not N-continuous.

## 6. Neutrosophic Ideal Topological Spaces & Neutrosophic Filters

In this chapter, we extend the concept of intuitionistic fuzzy ideal [8] and fuzzy filters to the case of neutrosophic sets. In 6.1 we pioneer the notion of ideals on neutrosophic set, pondered as a generalization of ideals studies. Several relations between different neutrosophic ideals and neutrosophic topologies are also studied here. In 6.2 we introduce and study the neutrosophic local functions. Several relations between different neutrosophic topologies are also discussed. In 6.3 we develop the notion of filters on neutrosophic set, as a generalization of filters studies, the important neutrosophic filters been given. Several relations between distinctive neutrosophic filters and neutrosophic topologies are also examined here.

### 6.1 Neutrosophic Ideals

#### Definition 6.1.1

Let  $X$  be a non-empty set and  $L$  a non-empty family of NSs. We call  $L$  a topological neutrosophic ideal (NL) in  $X$  if:

- (a)  $A \in L$  and  $B \subseteq A \Rightarrow B \in L$  [heredity],
- (b)  $A \in L$  and  $B \in L \Rightarrow A \vee B \in L$  [finite additivity].

A topological neutrosophic ideal  $L$  is called a  $\sigma$ -topological neutrosophic ideal if  $\{A_j\}_{j \in N} \leq L$ , which implies

$$\bigvee_{j \in J} A_j \in L \text{ (countable additivity).}$$

The smallest and the largest topological neutrosophic ideals in a non-empty set  $X$  are  $\{0_N\}$ , NSs in  $X$ . Also,  $N.L_f$ ,  $N.L_c$  stand for the topological neutrosophic ideals of neutrosophic subsets having finite and countable support in  $X$ . Moreover, if  $A$  is a non-empty NS in  $X$ , then  $\{B \in NS : B \subseteq A\}$  is a NL in  $X$ . This is called the principal NL of all NSs, and is denoted by  $NL\langle A \rangle$ .



**Remark 6.1.1**

- (a) If  $1_N \notin L$ , then  $L$  is called a neutrosophic proper ideal.
- (b) If  $1_N \in L$ , then  $L$  is called a neutrosophic improper ideal.
- (c)  $0_N \in L$ .

**Example 6.1.1**

Any intuitionistic fuzzy ideal  $\ell$  in  $X$  in the sense of Salama is obviously a NL of the form  $L = \{A : A = \langle x, \mu_A, \sigma_A, \nu_A \rangle \in \ell\}$ .

**Example 6.1.2**

Let  $X = \{a, b, c\}$   $A = \langle x, 0.2, 0.5, 0.6 \rangle$ ,  $B = \langle x, 0.5, 0.7, 0.8 \rangle$ , and  $D = \langle x, 0.5, 0.6, 0.8 \rangle$ , then the family  $L = \{0_N, A, B, D\}$  of NSs is a NL in  $X$ .

**Example 6.1.3**

Let  $X = \{a, b, c, d, e\}$  and  $A = \langle x, \mu_A, \sigma_A, \nu_A \rangle$  be given by:

| X | $\mu_A(x)$ | $\sigma_A(x)$ | $\nu_A(x)$ |
|---|------------|---------------|------------|
| a | 0.6        | 0.4           | 0.3        |
| b | 0.5        | 0.3           | 0.3        |
| c | 0.4        | 0.6           | 0.4        |
| d | 0.3        | 0.8           | 0.5        |
| e | 0.3        | 0.7           | 0.6        |

Then the family  $L = \{0_N, A\}$  is an NL in  $X$ .

**Definition 6.1.2**

Let  $L_1$  and  $L_2$  be two NL in  $X$ . Then  $L_2$  is said to be finer than  $L_1$  or  $L_1$  is coarser than  $L_2$  if  $L_1 \leq L_2$ . If also  $L_1 \neq L_2$ , then  $L_2$  is said to be strictly finer than  $L_1$  or  $L_1$  is strictly coarser than  $L_2$ . Two NL are comparable if one is finer than the other. The set of all NL in  $X$  is ordered by the relation  $L_1$  coarser than  $L_2$ . This relation is prompted by the inclusion in NSs.

*The next Proposition is considered as a useful result in this sequel, whose Proof is clear.*

**Proposition 6.1.1**

Let  $\{L_j : j \in J\}$  be any non-empty family of topological neutrosophic ideals in a set X.

Then  $\bigcap_{j \in J} L_j$  and  $\bigcup_{j \in J} L_j$  are topological neutrosophic ideals in X.

In fact, L is the smallest upper bound of the set of the  $L_j$  in the ordered set of all topological neutrosophic ideals in X.

**Remark 6.1.2**

The topological neutrosophic ideal by the single neutrosophic set  $O_N$  is the smallest element of the ordered set of all topological neutrosophic ideals in X.

**Proposition 6.1.2**

A neutrosophic set A in a topological neutrosophic ideal L in X is a base of L if every member of L contained in A.

**Proof**

(Necessity) Suppose A is a base of L. Then clearly every member of L is contained in A.

(Sufficiency) Suppose the necessary condition holds. Then the set of neutrosophic subset in X contained in A coincides with L by the *Definition* 4.3.

**Proposition 6.1.3**

A topological neutrosophic ideal  $L_1$  with base A is finer than a fuzzy ideal  $L_2$  with base B if every member of B contained in A.

**Proof**

Immediate consequence of *Definitions*.

**Corollary 6.1.1**

Two topological neutrosophic ideals bases A, B in X are equivalent if every member of A contained in B and viceversa.

**Theorem 6.1.1**

Let  $\eta = \{\langle \mu_j, \sigma_j, \gamma_j \rangle : j \in J\}$  be a non-empty collection of neutrosophic subsets of X. Then there exists a topological neutrosophic ideal  $L(\eta) = \{A \in \text{NSs} : A \subseteq \bigvee A_j\}$  in X for some finite collection  $\{A_j : j = 1, 2, \dots, n \subseteq \eta\}$ .

**Proof**

Evident.

**Remark 6.1.3**

The neutrosophic ideal  $L(\eta)$  defined above is said to be generated by  $\eta$  and  $\eta$  is called the sub-base of  $L(\eta)$ .

**Corollary 6.1.2**

Let  $L_1$  be a neutrosophic ideal in  $X$  and  $A \in NSs$ ; then there is a neutrosophic ideal  $L_2$  which is finer than  $L_1$ , such that  $A \in L_2$  if  $A \vee B \in L_2$ , for each  $B \in L_1$ .

**Corollary 6.1.3**

Let  $A = \langle x, \mu_A, \sigma_A, \nu_A \rangle \in L_1$  and  $B = \langle x, \mu_B, \sigma_B, \nu_B \rangle \in L_2$ , where  $L_1$  and  $L_2$  are topological neutrosophic ideals in the set  $X$ .

The neutrosophic set  $A^*B = \langle \mu_{A^*B}(x), \sigma_{A^*B}(x), \nu_{A^*B}(x) \rangle \in L_1 \vee L_2$  in  $X$ , where  $\mu_{A^*B}(x) = \vee \{ \mu_A(x) \wedge \mu_B(x) : x \in X \}$ ,  $\sigma_{A^*B}(x)$  may be  $= \vee \{ \sigma_A(x) \wedge \sigma_B(x) \}$ , or  $\wedge \{ \sigma_A(x) \vee \sigma_B(x) \}$  and  $\nu_{A^*B}(x) = \wedge \{ \nu_A(x) \vee \nu_B(x) : x \in X \}$ .

**6.2 Neutrosophic Local Functions**

**Definition 6.2.1**

Let  $(X, \tau)$  be a neutrosophic topological spaces (NTS) and  $L$  be neutrosophic ideal (NL) in  $X$ . Let  $A$  be any NS of  $X$ . Then the neutrosophic local function  $NA^*(L, \tau)$  of  $A$  is the union of all neutrosophic points (NP)  $C(\alpha, \beta, \gamma)$  such that  $U \in N(C(\alpha, \beta, \gamma))$

$$NA^*(L, \tau) = \vee \{ C(\alpha, \beta, \gamma) \in X : A \wedge U \notin L \text{ for every } U \text{ nbd of } C(\alpha, \beta, \gamma) \}, NA^*(L, \tau),$$

called a neutrosophic local function of  $A$  with respect to  $\tau$  and  $L$  which we denote by  $NA^*(L, \tau)$ , or simply  $NA^*(L)$ .

**Example 6.2.1**

One may easily verify that if  $L = \{0_N\}$ , then  $NA^*(L, \tau) = Ncl(A)$ , for any neutrosophic set  $A \in NSs$  in  $X$ .

As well, if  $L = \{ \text{all NSs on } X \}$  then  $NA^*(L, \tau) = 0_N$ , for any  $A \in NSs$  in  $X$ .

**Theorem 6.2.1**

Let  $(X, \tau)$  be a NTS and  $L_1, L_2$  be two topological neutrosophic ideals in X. Then for any neutrosophic sets A, B of X, the following statements are verified:

- (a)  $A \subseteq B \Rightarrow NA^*(L, \tau) \subseteq NB^*(L, \tau)$ ,
- (b)  $L_1 \subseteq L_2 \Rightarrow NA^*(L_2, \tau) \subseteq NA^*(L_1, \tau)$ .
- (c)  $NA^* = Ncl(A^*) \subseteq Ncl(A)$ .
- (d)  $NA^{**} \subseteq NA^*$ .
- (e)  $N(A \vee B)^* = NA^* \vee NB^*$ .
- (f)  $N(A \wedge B)^*(L) \leq NA^*(L) \wedge NB^*(L)$ .
- (g)  $\ell \in L \Rightarrow N(A \vee \ell)^* = NA^*$ .
- (h)  $NA^*(L, \tau)$  is neutrosophic closed set.

**Proof**

- a. Since  $A \subseteq B$ , let  $p = C(\alpha, \beta, \gamma) \in NA^*(L_1)$  then  $A \wedge U \notin L$  for every  $U \in N(p)$ . By hypothesis, we get  $B \wedge U \notin L$ , then  $p = C(\alpha, \beta, \gamma) \in NB^*(L_1)$ .
- b. Clearly,  $L_1 \subseteq L_2$  which implies  $NA^*(L_2, \tau) \subseteq NA^*(L_1, \tau)$  as there may be other IFSs which belong to  $L_2$  so that for GIFP  $p = C(\alpha, \beta, \gamma) \in NA^*$  but  $C(\alpha, \beta, \gamma)$  may not be contained in  $NA^*(L_2)$ .
- c. Since  $\{O_N\} \subseteq L$  for any NL in X, therefore by (b),  $NA^*(L) \subseteq NA^*(\{O_N\}) = Ncl(A)$  for any NS A in X.  
 Suppose  $p_1 = C_1(\alpha, \beta, \gamma) \in Ncl(NA^*(L_1))$ . So for every  $U \in N(p_1)$ ,  $NA^* \wedge U \neq O_N$ , there exists  $p_2 = C_2(\alpha, \beta) \in A^*(L_1) \wedge U$  such that for every  $V$  nbd of  $p_2 \in N(p_2)$ ,  $A \wedge U \notin L$ . Since  $U \wedge V \in N(p_2)$  then  $A \wedge (U \cap V) \notin L$  which leads to  $A \wedge U \notin L$ , for every  $U \in N(C(\alpha, \beta))$  therefore  $p_1 = C(\alpha, \beta) \in (A^*(L))$  and so  $Ncl(NA^*) \leq NA^*$  while the other inclusion follows directly. Hence  $NA^* = Ncl(NA^*)$ , but the inequality  $NA^* \leq Ncl(NA^*)$ .
- d. The inclusion  $NA^* \vee NB^* \leq N(A \vee B)^*$  follows directly by (a). To show the other implication, let  $p = C(\alpha, \beta, \gamma) \in N(A \vee B)^*$  then for

every  $U \in N(p)$ ,  $(A \vee B) \wedge U \notin L$ , i.e.,  $(A \wedge U) \vee (B \wedge U) \notin L$ . Then, we have two cases  $A \wedge U \notin L$  and  $B \wedge U \in L$  or the converse, this means that exist  $U_1, U_2 \in N(C(\alpha, \beta, \gamma))$  such that  $A \wedge U_1 \notin L$ ,  $B \wedge U_1 \notin L$ ,  $A \wedge U_2 \notin L$  and  $B \wedge U_2 \notin L$ . Then  $A \wedge (U_1 \wedge U_2) \in L$  and  $B \wedge (U_1 \wedge U_2) \in L$ ; this gives  $(A \vee B) \wedge (U_1 \wedge U_2) \in L$ ,  $U_1 \wedge U_2 \in N(C(\alpha, \beta, \gamma))$  which contradicts the hypothesis. Hence the equality holds in various cases.

e. By (c), we have  $NA^{**} = Ncl(NA^*)^* \leq Ncl(NA^*) = NA^*$

Let  $(X, \tau)$  be a GIFTS and  $L$  be GIFL in  $X$ . Let us define the neutrosophic closure operator  $cl^*(A) = A \cup A^*$  for any GIFS  $A$  of  $X$ . Clearly,  $Ncl^*(A)$  is a neutrosophic operator.

Let  $N\tau^*(L)$  be NT generated by  $Ncl^*$  i.e.:

$$N\tau^*(L) = \{A : Ncl^*(A^c) = A^c\}$$

Now  $L = \{O_N\} \Rightarrow Ncl^*(A) = A \cup NA^* = A \cup Ncl(A)$  for every neutrosophic set  $A$ . So,  $N\tau^*(\{O_N\}) = \tau$ .

Again  $L = \{all\ NSs\ on\ X\} \Rightarrow Ncl^*(A) = A$ , because  $NA^* = O_N$ , for every neutrosophic set  $A$ , so  $N\tau^*(L)$  is the neutrosophic discrete topology in  $X$ .

So we can conclude that  $N\tau^*(\{O_N\}) = N\tau^*(L)$  i.e.  $N\tau \subseteq N\tau^*$ , for any neutrosophic ideal  $L_1$  in  $X$ . In particular, we have for two topological neutrosophic ideals  $L_1$ , and  $L_2$  in  $X$ ,

$$L_1 \subseteq L_2 \Rightarrow N\tau^*(L_1) \subseteq N\tau^*(L_2).$$

### Theorem 6.2.2

Let  $\tau_1, \tau_2$  be two neutrosophic topologies in  $X$ . Then for any topological neutrosophic ideal  $L$  in  $X$ ,  $\tau_1 \leq \tau_2$  we have  $NA^*(L, \tau_2) \subseteq NA^*(L, \tau_1)$ , for every  $A \in L$  then  $N\tau^*_1 \subseteq N\tau^*_2$ .

### Proof

Clear.

A basis  $N\beta(L, \tau)$  for  $N\tau^*(L)$  can be described as it follows:

$$N\beta(L, \tau) = \{A - B : A \in \tau, B \in L\}$$

Therefore, we have the following theorem:

**Theorem 6.2.3**

$N\beta(L, \tau) = \{A - B : A \in \tau, B \in L\}$  forms a basis for the generated NT of the NT  $(X, \tau)$  with a topological neutrosophic ideal L in X.

**Proof**

Straightforward.

The relationship between  $\tau$  and  $N\tau^*(L)$  establishes throughout the following result which have an immediate proof.

**Theorem 6.2.4**

Let  $\tau_1, \tau_2$  be two neutrosophic topologies in X. Then for any topological neutrosophic ideal L in X,  $\tau_1 \subseteq \tau_2$ ; it implies that  $N\tau_1^* \subseteq N\tau_2^*$ .

**Theorem 6.2.5**

Let  $(X, \tau)$  be a NTS and  $L_1, L_2$  be two neutrosophic ideals in X. Then for any neutrosophic set A in X, we have

- (a)  $NA^*(L_1 \vee L_2, \tau) = NA^*(L_1, N\tau^*(L_1)) \wedge NA^*(L_2, N\tau^*(L_2))$
- (b)  $\tau^*(L_1 \vee L_2) = (\tau^*(L_1))^*(L_2) \wedge (\tau^*(L_2))^*(L_1)$

**Proof**

Let  $p = C(\alpha, \beta) \notin (L_1 \vee L_2, \tau)$ , this means that there exists  $U_p \in N(P)$  such that  $A \wedge U_p \in (L_1 \vee L_2)$  i.e. There exists  $\ell_1 \in L_1$  and  $\ell_2 \in L_2$  such that  $A \wedge U_p \in (\ell_1 \vee \ell_2)$  because of the heredity of  $L_1$ , and assuming  $\ell_1 \wedge \ell_2 = 0_N$ .

Thus, we have  $(A \wedge U_p) - \ell_1 = \ell_2$  and  $(A \wedge U_p) - \ell_2 = \ell_1$

Therefore  $(U_p - \ell_1) \wedge A = \ell_2 \in L_2$  and  $(U_p - \ell_2) \wedge A = \ell_1 \in L_1$ .

Hence  $p = C(\alpha, \beta, \gamma) \notin NA^*(L_2, N\tau^*(L_1))$ , or  $p = C(\alpha, \beta, \gamma) \notin NA^*(L_1, N\tau^*(L_2))$ , because  $p$  must belong to either  $\ell_1$  or  $\ell_2$  but not to both. This gives  $NA^*(L_1 \vee L_2, \tau) \geq NA^*(L_1, N\tau^*(L_1)) \wedge NA^*(L_2, N\tau^*(L_2))$ .

To show the second inclusion, let us assume

$$p = C(\alpha, \beta, \gamma) \notin NA^*(L_1, N\tau^*(L_2)).$$

This implies that there exist  $U_p \in N(P)$  and  $\ell_2 \in L_2$  such that  $(U_p - \ell_2) \wedge A \in L_1$ . By the heredity of  $L_2$ , we assume that  $\ell_2 \leq A$  and define  $\ell_1 = (U_p - \ell_2) \wedge A$ .

Then we have  $A \wedge U_p \in (\ell_1 \vee \ell_2) \in L_1 \vee L_2$ .

Thus,  $NA^*(L_1 \vee L_2, \tau) \leq NA^*(L_1, \tau^*(L_1)) \wedge NA^*(L_2, N\tau^*(L_2))$  and similarly, we can get  $A^*(L_1 \vee L_2, \tau) \leq A^*(L_2, \tau^*(L_1))$ .

This gives the other inclusion, which complete the proof.

### Corollary 6.1.1

Let  $(X, \tau)$  be a NTS with topological neutrosophic ideal  $L$  in  $X$ . Then:

(a)  $NA^*(L, \tau) = NA^*(L, \tau^*)$  and  $N\tau^*(L) = N(N\tau^*(L))^*(L)$

(b)  $N\tau^*(L_1 \vee L_2) = (N\tau^*(L_1)) \vee (N\tau^*(L_2))$

### Proof

It follows by applying the previous statement.

## 6.3 Neutrosophic Filters

### Definition 6.3.1

Let  $N$  be a neutrosophic subsets in a set  $X$ . Then  $N$  is called a neutrosophic filter in  $X$ , if it satisfies the following conditions:

- (a)  $(N_1)$  Every neutrosophic set in  $X$  containing a member of  $N$  belongs to  $N$ .
- (b)  $(N_2)$  Every finite intersection of members of  $N$  belongs to  $N$ .
- (c)  $(N_3)$   $O_N$  not in  $N$ .

In this case, the pair  $(X, N)$  is neutrosophically filtered by  $N$ . It follows from  $(N_2)$  and  $(N_3)$  that every finite intersection of members of  $N$  is not  $O_N$ . Furthermore, there is no neutrosophic set. *We obtain the following results:*

### Proposition 6.3.1

The condition  $(N_2)$  is equivalent to the following two conditions:

$(N_{2a})$  The intersection of two members of  $N$  belongs to  $N$ .

$(N_{2b})$   $1_N$  belongs to  $N$ .

### Proposition 6.3.2

Let  $N$  be a non-empty neutrosophic subsets in  $X$  satisfying  $(N_1)$ . Then,  $1_N \in N$  if  $N \neq O_N$  and  $O_N \notin N$  if  $N \neq$  all neutrosophic subsets of  $X$ .

From the above, we can characterize the concept of neutrosophic filter.

**Theorem 6.3.1**

Let  $N$  be a neutrosophic subsets in a set  $X$ . Then  $N$  is neutrosophic filter in  $X$ , if and only if it is satisfies the following conditions:

- (a) Every neutrosophic set in  $X$  containing a member of  $N$  belongs to  $N$  .
- (b) If  $A, B \in N$  , then  $A \cap B \in N$  .
- (c)  $N^X \neq N \neq O_N$  .

**Proof**

It's clear.

**Theorem 6.3.2**

Let  $X \neq \emptyset$  . Then the set  $\{1_N\}$  is a neutrosophic filter in  $X$ . Moreover if  $A$  is a non-empty neutrosophic set in  $X$ , then  $\{B \in N^X : A \subseteq B\}$  is a neutrosophic filter in  $X$ .

**Proof**

Let  $N = \{B \in N^X : A \subseteq B\}$  . Since  $1_N \in N$  and  $O_N \notin N, O_N \neq N \neq N^X$  . Suppose  $U, V \in N$ , then  $A \subseteq U, A \subseteq V$  .

Thus

$$\begin{aligned} \mu_A(x) &\leq \min(\mu_U(x), \mu_V(x)), \\ \sigma_A(x) &\leq \min(\sigma_U(x), \sigma_V(x)) \text{ or} \\ \sigma_A(x) &\leq \max(\sigma_U(x), \sigma_V(x)) \text{ and} \\ \gamma_A(x) &\leq \max(\gamma_U(x), \gamma_V(x)) \text{ for all } x \in X . \end{aligned}$$

So  $A \subseteq U \cap V$  and hence  $U \cap V \in N$ .

**Definition 6.3.2**

Let  $N_1$  and  $N_2$  be two neutrosophic filters in a set  $X$ . Then  $N_2$  is said to be finer than  $N_1$  or  $N_1$  coarser than  $N_2$  if  $N_1 \subset N_2$  . If also  $N_1 \neq N_2$ , then  $N_2$  is said to be strictly finer than  $N_1$  or  $N_1$  is strictly coarser than  $N_2$  . Two neutrosophic filters are said to be comparable, if one is finer than the other. The set of all neutrosophic filters in  $X$  is ordered by the



relation  $N_1$  which is coarser than  $N_2$ ; this relation is induced by the inclusion relation in  $N^X$ .

**Proposition 6.3.3**

Let  $(N_j)_{j \in J}$  be any non-empty family of neutrosophic filters in X. Then  $N = \bigcap_{j \in J} N_j$  is a neutrosophic filter in X. In fact  $N$  is the greatest lower bound of the neutrosophic set  $(N_j)_{j \in J}$  in the ordered set of all neutrosophic filters in X.

**Remark 6.3.1**

The neutrosophic filter by the single neutrosophic set  $1_N$  is the smallest element of the ordered set of all neutrosophic filters in X.

**Theorem 6.3.3**

Let  $A$  be a neutrosophic set in X. Then there exists a neutrosophic filter  $N(A)$  in X containing A if for any finite subset  $\{S_1, S_2, \dots, S_n\}$  of  $A$ ,  $\bigcap_{i=1}^n S_i \neq O_N$ . In fact  $N(A)$  is the coarsest neutrosophic filter containing A.

**Proof**

( $\Rightarrow$ ) Suppose there exists a neutrosophic filter  $N(A)$  in X containing  $A$ . Let B be the set of all the finite intersections of members of  $A$ . Then by  $(N_2)$ ,  $B \subset N(A)$ . By  $(N_3)$ ,  $O_N \notin N(A)$ . Thus for each member  $B$  of B, hence the necessary condition holds.

( $\Leftarrow$ ) Suppose the necessary condition holds.

Let  $N(A) = \{A \in N^X : A \text{ contains a member of } B\}$ , where B is the family of all the finite intersections of members of A. Then we can easily check that  $N(A)$  satisfies the conditions in *Definition*.

*The neutrosophic filter  $N(A)$  defined above is said to be generated by A and A is called a sub - base of  $N(A)$ .*

**Corollary 6.3.1**

Let  $N$  be a neutrosophic filter in a set X and let A be a neutrosophic set. Then there is a neutrosophic filter  $N'$  which is finer than  $N$  such that  $A \in N'$  if A is a neutrosophic set. Then there is a neutrosophic filter  $N''$  which is finer than  $N$  such that  $A \in N''$  if  $A \cap U \neq O_N$  for each  $U \in N$ .

**Corollary 6.3.2**

A set  $\varphi$  of a neutrosophic filter in a non-empty set  $X$ , has a least the upper bound in the set of all neutrosophic filters in  $X$  if for all finite sequence  $(N_j)_{j \in J}, 0 \leq j \leq n$  of elements of  $\varphi$  and all  $A_j \in N_j (1 \leq j \leq n)$ ,  $\bigcap_{j=1} A_j \neq O_N$

**Corollary 6.3.3**

The ordered set of all neutrosophic filters in a non-empty set  $X$  is inductive. If  $\mathcal{A}$  is a sub-base of a neutrosophic filter  $N$  in  $X$ , then  $N$  is not in general the set of neutrosophic sets in  $X$  containing an element of  $\mathcal{A}$ ; for  $\mathcal{A}$  to have this property, it is necessary and sufficient that every finite intersection of members of  $\mathcal{A}$  contains an element of  $\mathcal{A}$ .

*Hence we have the following result:*

**Theorem 6.3.4**

Let  $\beta$  be a set of neutrosophic sets in a set  $X$ . Then the set of neutrosophic sets in  $X$  containing an element of  $\beta$  is a neutrosophic filter in  $X$  if  $\beta$  holds the following two conditions:

- $(\beta_1)$  The intersection of two members of  $\beta$  contains a member of  $\beta$ .
- $(\beta_2)$   $\beta \neq O_N$  and  $O_N \notin \beta$ .

**Definition 6.3.3**

Let  $\mathcal{A}$  and  $\beta$  be the neutrosophic sets in  $X$  satisfying conditions  $(\beta_1)$  and  $(\beta_2)$ , called the base of neutrosophic filter it generates. Two neutrosophic bases are said to be equivalent if they generate the same neutrosophic filter.

**Remark 6.3.2**

Let  $\mathcal{A}$  be a sub-base of neutrosophic filter  $N$ . Then the set  $\beta$  of finite intersections of members of  $\mathcal{A}$  is a base of filter  $N$ .

**Proposition 6.3.4**

A subset  $\beta$  of a neutrosophic filter  $N$  in  $X$  is a base of  $N$  if every member of  $N$  contains a member of  $\beta$ .

**Proof**

( $\Rightarrow$ ) Suppose  $\beta$  is a base of  $N$ . Then, clearly, every member of  $N$  contains an element of  $\beta$ . ( $\Leftarrow$ ) Suppose the necessary condition holds. Then the set of neutrosophic sets in  $X$  containing a member of  $\beta$  coincides with  $N$  by reason of  $(N_j)_{j \in J}$ .

**Proposition 6.3.5**

On a set  $X$ , a neutrosophic filter  $N'$  with base  $\beta'$  is finer than a neutrosophic filter  $N$  with base  $\beta$  if every member of  $\beta$  contains a member of  $\beta'$ .

**Proof**

This is an immediate consequence of *Definitions*.

**Proposition 6.3.6**

Two neutrosophic filters bases  $\beta$  and  $\beta'$  in a set  $X$  are equivalent if every member of  $\beta$  contains a member of  $\beta'$  and every member of  $\beta'$  and every member of  $\beta'$  contains a member of  $\beta$ .

**Definition 6.3.4**

A neutrosophic ultrafilter in a set  $X$  is a neutrosophic filter  $N$  such that there is no neutrosophic filter in  $X$  which is strictly finer than  $N$  (in other words, a maximal element in the ordered set of all neutrosophic filters in  $X$ ).

*Since the ordered set of all the neutrosophic filters in  $X$  is inductive, Zorn's lemma shows that:*

**Theorem 6.3.5**

If  $N$  is any neutrosophic ultrafilter in a set  $X$ , then there is a neutrosophic ultrafilter than  $N$ .

**Proposition 6.3.7**

Let  $N$  be a neutrosophic ultrafilter in a set  $X$ . If  $A$  and  $B$  are two neutrosophic subsets such that  $A \cup B \in N$ , then  $A \in N$  or  $B \in N$ .

**Proof**

Suppose not. Then there exists the neutrosophic sets  $A$  and  $B$  in  $X$  such that  $A \notin N, B \notin N$  and  $A \cup B \in N$ . Let  $A = \{M \in N^X : A \cup M \in N\}$ .

It is straightforward to check that  $\mathcal{A}$  is a neutrosophic filter in  $X$ , and  $\mathcal{A}$  is strictly finer than  $N$ , since  $B \in \mathcal{A}$ . This contradicts the hypothesis that  $N$  is a neutrosophic ultrafilter.

**Corollary 6.3.4**

Let  $N$  be a neutrosophic ultrafilter in a set  $X$  and let  $(N_j)_{1 \leq j \leq n}$  be a finite sequence of neutrosophic sets in  $X$ . If  $\bigcup_{j=1}^n N_j \in N$ , then at least one of the  $N_j$  belongs to  $N$ .

**Definition 6.3.5**

Let  $A$  be a neutrosophic set in a set  $X$ . If  $U$  is any neutrosophic set in  $X$ , then the neutrosophic set  $A \cap U$  is called trace of  $U$  on  $A$  and is denoted by  $U_A$ . For all neutrosophic sets  $U$  and  $V$  in  $X$ , we have  $(U \cap V)_A = U_A \cap V_A$ .

**Definition 6.3.6**

Let  $\mathcal{A}$  be a neutrosophic set in a set  $X$ . Then the set  $\mathcal{A}_A$  of traces  $A \in N^X$  of member of  $\mathcal{A}$  is called the trace of  $\mathcal{A}$  on  $A$ .

**Proposition 6.3.8**

Let  $N$  be a neutrosophic filter in a set  $X$  and  $A \in N^X$ . Then the trace of  $N_A$  of  $N$  on  $A$  is a neutrosophic filter if each member of  $N$  meets  $A$ .

**Proof**

From the results in *Definition*, we see that  $N_A$  satisfies  $(N_2)$ . If  $M \cap A \subset P \subset A$ , then  $P = (M \cup P) \cap A$ . Thus  $N_A$  satisfies  $(N_1)$ . Hence  $N_A$  is a neutrosophic filter if it satisfies  $(N_3)$  i.e. if each member of  $N$  meets  $A$ .

**Definition 6.3.7**

Let  $N$  be a neutrosophic filter in a set  $X$  and  $A \in N^X$ . If the trace  $N_A$  of  $N$  on  $A$ , then  $N_A$  is said to be induced by  $N$  on  $A$ .

**Proposition 6.3.9**

Let  $N$  be a neutrosophic filter in a set  $X$  induced by the neutrosophic filter  $N_A$  on  $A \in N^X$ . Then the trace  $\beta_A$  on  $A$  of a base  $\beta$  of  $N$  is a base of  $N_A$ .

## 7. Applications

---

In this chapter, we discuss some applications via neutrosophic sets. In 7.1, we introduce the concept of neutrosophic database. In 7.2 we suggest a security scheme based on Public Key Infrastructure (PKI) for distributing session keys between nodes. The length of those keys is determined by neutrosophic logic manipulation. The proposed algorithm of Security model is an adaptive neutrosophic logic – membership, non-membership and indeterminacy – based algorithm that can adjust itself according to the dynamic conditions of mobile hosts. The experimental results prove that using of neutrosophic based security can enhance the security of MANETs. In 7.3, we acquaint the reader with the study of probability of neutrosophic crisp sets. We give the fundamental definitions and operations, and we obtain several properties, examining the relationship between neutrosophic crisp sets and others sets. The purpose of section 7.4 is to bestow the Neutrosophic Set Theory to analyze social networks data conducted through learning activities in a Social Learning Management System – that integrates social activities in e-Learning. The section 7.5 imparts basic concepts and properties of a neutrosophic spatial region, responding to the need to model spatial regions with indeterminate boundary under indeterminacy in Geographical Information Systems (GIS). We lead into a new theoretical framework via neutrosophic topology and we add some further definitions and propositions for a neutrosophic topological region.

---

## 7.1 Neutrosophic Database

### Definition A.7.1.1

A neutrosophic database relation  $R$  is a subset of cross product  $2^{D_1} \times 2^{D_2} \times \dots \times 2^{D_m}$ , where  $2^{D_j} = 2^{D_j} - \phi$ .

### Definition A.7.1.2

Let  $R \subseteq 2^{D_1} \times 2^{D_2} \times \dots \times 2^{D_m}$ , be a neutrosophic database relation. A neutrosophic set tuple (with respect to  $R$ ) is an element of  $R$ . Let  $t_i = (d_{i_1}, d_{i_2}, \dots, d_{i_m})$  be a neutrosophic tuple. An interpolation of  $t$  is a tuple  $\theta = (a_1, a_2, \dots, a_m)$  where  $a_j \in d_{ij}$  for each domain  $D_j$ . If  $T_j$  is the neutrosophic tolerance relation, then the membership function is given by:

$$\mu_{T_j} : D_j \times D_j \rightarrow [0,1],$$

the non-membership function is given by:

$$\gamma_{T_j} : D_j \times D_j \rightarrow [0,1]$$

and indeterminacy:  $\sigma_{T_j} : D_j \times D_j \rightarrow [0,1]$ .

*Let us make a hypothetical case study below.*

We consider a criminal data file. Suppose that one murder has taken place at some area in deem light. The police suspects that the murderer is also from the same area and so police refer to a data file of all the suspected criminals of that area. Listening to the eye-witness, the police has discovered that the criminal for that murder case has more or less or non-more and less curly hair texture and he is moderately large built. Form the criminal data file, the information table with attributes "Hair Coverage", "Hair Texture", and "Build" is given by:

| Name | Hair Coverage   | Hair Texture   | Build          |
|------|-----------------|----------------|----------------|
| Soso | Full Small (FS) | Stc            | Large          |
| Toto | Rec.            | Wavy           | Very Small(VS) |
| Koko | Full Small(FS)  | Straight(Str.) | Small(S)       |
| Momo | Bald            | Curly          | Average(A)     |
| Wowo | Bald            | Wavy           | Average(A)     |
| Bobo | Full Big (FB)   | Stc.           | Very large(VL) |
| Hoho | Full Small      | Straight       | Small(S)       |
| Vovo | Rec.            | Curly          | Average(A)     |

Now, consider the neutrosophic tolerance relation  $T_{D_1}$  where  $D_1$  = "Hair Coverage", which is given by:

|             | <b>FB</b>     | <b>FS</b>     | <b>Rec.</b> | <b>Bald</b> |
|-------------|---------------|---------------|-------------|-------------|
| <b>FB</b>   | <1,0,0>       | <0.8,0.3,0.1> | <0.4,0,0.4> | <0,0.2,1>   |
| <b>FS</b>   | <0.8,0.3,0.1> | <1,0,0>       | <0.5,0,0.4> | <0,0,0.9>   |
| <b>Rec.</b> | <0.4,0,0.4>   | <0.5,0,0.4>   | <1,0,0>     | <0.4,0,0.4> |
| <b>Bald</b> | <0,0.2,1>     | <0,0,0.9>     | <0.4,0,0.4> | <1,0,0>     |

where Hair Coverage= {FB, FS, Rec., Bald }.

The neutrosophic tolerance relation  $T_{D_2}$  where  $D_2$  = "Hair Texture" is given by:

|             | <b>Str.</b>   | <b>Stc.</b>   | <b>Wavy</b>   | <b>Curly</b>  |
|-------------|---------------|---------------|---------------|---------------|
| <b>Str.</b> | <1,0,0>       | <0.7,0.2,0.3> | <0.2,0.2,0.7> | <0.1,0.2,0.7> |
| <b>Stc.</b> | <0.7,0.2,0.3> | <1,0,0>       | <0.3,0,0.4>   | <0.5,0,0.2>   |
| <b>Wavy</b> | <0.2,0.2,0.7> | <0.3,0,0.4>   | <1,0,0>       | <0.4,0,0.4>   |
| <b>Bald</b> | <0.1,0.2,0.7> | <0.5,0,0.2>   | <0.4,0,0.4>   | <1,0,0>       |

where Hair Texture= {Str., Stc., Wavy, Curly }.

Also, neutrosophic tolerance relation  $T_{D_3}$  where  $D_3$  = "Build" is given by:

|           | <b>VI</b>   | <b>L</b>    | <b>A</b>    | <b>S</b>    | <b>Vs</b>   |
|-----------|-------------|-------------|-------------|-------------|-------------|
| <b>VI</b> | <1,0,0>     | <0.8,0,0.2> | <0.5,0,0.4> | <0.3,0,0.6> | <0,1,1>     |
| <b>L</b>  | <0.8,0,0.2> | <1,0,0>     | <0.6,0,0.4> | <0.4,0,0.5> | <0,0,0.9>   |
| <b>A</b>  | <0.5,0,0.4> | <0.6,0,0.4> | <1,0,0>     | <0.6,0,0.3> | <0.3,0,0.6> |
| <b>S</b>  | <0.3,0,0.6> | <0.4,0,0.5> | <0.5,0,0.4> | <1,0,0>     | <0.8,0,0.2> |
| <b>Vs</b> | <0,1,1>     | <0,0,0.9>   | <0.3,0,0.6> | <0.8,0,0.2> | <1,0,0>     |

where Build = { VI, L, A, S, Vs }.

Now, the job is to find out a list of those criminals who resemble with more or less or non-big hair coverage with more or less or non-curly hair texture and moderately large built. This list will be useful to the police for further investigation. It can be translated into relational algebra in the following form:

Project (Select (CRIMINALS DATA FILE)  
 Where HAIR COVERAGE="FULL BIG",  
 HAIR TEXRURE="CURLY"  
 BUILLD="LARG"  
 With  $\alpha$ -LEVEL (HAIR COVERAGE) =0.8  
 $\alpha$ -LEVEL (HAIR TEXRURE) =0.8  
 $\alpha$ -LEVEL (BUILLD) =0.7  
 With  $\alpha$ -LEVEL (NAME) =0.0  
 With  $\alpha$ -LEVEL (HAIR COVERAGE) =0.8  
 $\alpha$ -LEVEL (HAIR TEXRURE) =0.8  
 $\alpha$ -LEVEL (BUILLD) =0.7  
 giving LIKELY MURDERER)

**Result:** It can be computed that the above neutrosophic query gives rise to the following relation:

*LIKELY MURDERER*

| NAME         | HAIR COVERAGE          | HAIR TEXRURE  | BUILLD           |
|--------------|------------------------|---------------|------------------|
| {SOSO, BOBO} | {FULL BIG, FULL SMALL} | {CURLY, STC.} | {LARG,VERY LARG} |

Therefore, according to the information obtained from the eye-witness, police concludes that Soso or Bobo are the likely murderers, and further investigation now is to be done on them only, instead of dealing with huge list of criminals.

**Conclusion**

Neutrosophic Set Theory takes care of such indeterministic part in connection with each references point of its universe. In the presentsection, we have introduced the concept of Neutrosophic Database (NDB) and have exemplified the usefulness of neutrosophic queries on a neutrosophic database.



## 7.2 Security Model for MANET via Neutrosophic Data

In this section, we will now extend the concepts presented in [75-90] to the case of neutrosophic sets, and we propose a security scheme based on Public Key infrastructure (PKI) for distributing session keys between nodes. The length of those keys is decided using Neutrosophic Logic Manipulation. The proposed algorithm of Security Model is an adaptive Neutrosophic Logic-based Algorithm - membership function, non-membership and indeterminacy -that can adapt itself according to the dynamic conditions of mobile hosts. The experimental results show that the using of Neutrosophic-based Security can enhance the security of MANETs. The rest of the section is organized as it follows: some backgrounds are given in part 1. Part 2 provides the propositioned security mechanism. Thereafter, a comparison of the mechanism with some of the current security mechanisms is provided. Finally, we provide conclusions and envisage future work.

### Introduction

*Adhoc* is a Latin word that means "for this or that only". AdHoc Networks, as its name indicates, are "intended to be" temporary. The idea is to completely remove any Base Station. Imagine a scenario in a relief operation when the event of timely communication is a very important factor, aid workers in the area are without the need of any existing infrastructure, just turn on the phone and start communicating with each other during movement and the execution of rescue operations. A major challenge in the design of these networks is their vulnerability to security attacks. This section presents an overview of the security and *ad hoc networks*, and security threats applicable to *ad hoc networks*. There are a wide range of military and commercial applications for MANET.

For example, a unit of soldiers that moves in the battlefield cannot afford to install a base station every time they go to a new area. Similarly, it applies to the creation of a communication infrastructure for an informal and spontaneous conference meeting between a small numbers of people that cannot be economically justified otherwise [5]. It is relevant even for robot-based networks in which multiple robots work at the same time, or for smart homes or auto-routing vehicles. In addition, MANET can be the perfect tool for disaster recovery or emergency situations, when the existing communications infrastructure is destroyed or disabled.

*Mobile ad hoc Networks* are self-organized, temporary networks consisting of a set of wireless nodes. The nodes can move in an arbitrary manner, and communicate with each other by forming a multi-hop radio network, maintaining connectivity in a decentralized manner. Each node in MANETs plays both the role of routers and terminals. Such devices can communicate with another device that is immediately within their radio range or one that is outside their radio range not relying on access point. A *mobile ad hoc network* is self-organizing, self-discipline and self-adaptive. The main characteristics of *mobile ad hoc network* are:

- Lack of Infrastructure: (Dynamic Topology), since nodes in the network can move arbitrarily, the topology of the network also changes.
- Limitations on the Bandwidth: The bandwidth of the link is constrained and the capacity of the network is also tremendously variable [8]. Because of the dynamic topology, the output of each relay node will vary in time and then the link capacity will change with the link change.
- Power considerations: it is a serious factor. Because of the mobility characteristic of the network, devices use battery as their power supply. As a result, the advanced power conservation techniques are very necessary in designing a system.
- Security precautions: The security is limited in physical aspect. The mobile network is easier to be attacked than the fixed network. Overcoming the weakness in security and the new security trouble in wireless network is on demand.

A side effect of the flexibility is the ease with which a node can join or leave a MANET. Lack of any fixed physical and, sometimes, administrative infrastructure in these networks makes the task of securing these networks extremely challenging.

In MANETs it is very important to address the security issues related to the dynamically changing topology of the MANET; these issues may be defined as:

1. **Confidentiality.** The primary confidentiality threat in the context of MANET is to the privacy of the information being transmitted between nodes, which lead to a secondary privacy threat to information such as the network topology, geographical location, etc.

2. **Integrity.** The integrity of data over a network depends on all nodes in the network. Therefore threats to integrity are those which either introduce incorrect information or alter existing information.
3. **Availability.** This is defined as access information at all times upon demand. If a mobile node exists, then any node should be able to get information when they require it. Related to this, a node should be able to carry out normal operations without excessive interference caused by the routing protocol or security.
4. **Authorization.** An unauthorized node is one which is not allowed to have access to information, or is not authorized to participate in the *ad hoc network*. There is no assumption that there is an explicit and formal protocol, but simply an abstract notion of authorization. However, formal identity authentication is a very important security requirement, needed to provide access control services within the *ad hoc network*.
5. **Dependability and Reliability.** One of the most common applications for *ad hoc networks* is in emergency situations when the use of wired infrastructure is infeasible. Hence, MANET must be reliable, and emergency procedures may be required. For example, if a routing table becomes full due to memory constraints, a reactive protocol should still be able to find an emergency solution.
6. **Accountability.** This will be required so that any actions affecting security can be selectively logged and protected, allowing for appropriate reaction against attacks. The misbehaviors demonstrated by different types of nodes will need to be detected, if not prevented. Event logging will also help provide non-repudiation, preventing a node from repudiating involvement in a security violation.
7. **Non-repudiation.** Ensures that the origin of a message cannot deny having sent the message.

Neutrosophic sets can be viewed as a generalization of fuzzy sets that may better model imperfect information which is omnipresent in any conscious decision making.

### Public Key Security

The distinctive technique used in public key cryptography is the use of asymmetric key algorithms, where the key used to encrypt a message is not the same as the key used to decrypt it. Each user has a pair of cryptographic keys - a public encryption key and a private decryption key. The provision of public key cryptography is widely distributed, while the private-decryption key is known only to the recipient. Messages are encrypted with the recipient's public key and can only be decrypted with the corresponding private key. The keys are mathematically related, but the parameters are chosen so that the determination of the private key of the public key is prohibitively expensive. The discovery of algorithms that can produce pairs of public / private key revolutionized the practice of cryptography in mid-1970. By contrast, symmetric key algorithms, variations of which have been used for thousands of years, uses a single secret key - that should be shared and kept private by the sender and receiver - for encryption and decryption. To use a symmetric encryption scheme, the sender and receiver must share the key securely in advance. Because symmetric key algorithms are almost always much less computationally intensive, it is common to exchange a key using a key exchange algorithm and transmit data using that key and symmetric key algorithm. Family PGP and SSL / TLS schemes do this, for example, and therefore speak of hybrid crypto system.

The two main branches of public key cryptography are:

- **Public Key Encryption:** a message encrypted with the recipient's public key can be decrypted by anyone except a holder of the corresponding private key - presumably this will be the owner of that key and the person associated with the public key used. This is used for confidentiality.
- **Digital Signatures (Authentication):** a signed message with the sender's private key can be verified by anyone with access to the sender's public key, which shows that the sender had access to the private key (and therefore likely to be the person associated with the public key used), and part of the message has not been tampered with. On the question of authenticity, see also the summary of the message.

The main idea behind public-key (or asymmetric) cryptosystems is the following:

One entity has a pair of keys which are called the private key and the public key (by contrast to the symmetric cryptosystems). These two parts of the key pair are always related in some mathematical sense. As for using them, the owner of such a key pair may publish the public key, but it is crucial to keep secret the private key. Let  $(sk, pk)$  be such a key pair, where  $sk$  is the Secret private Key for node (A) and  $pk$  is the corresponding public key [18]. If a second node wants to securely send a message to (A), it computes:  $C = \text{encrypt}(M, pk)$ , where  $\text{encrypt}$  denotes the so-called encryption function which is also publicly known as shown in Figure [Asymmetric Key encryption / decryption](#).

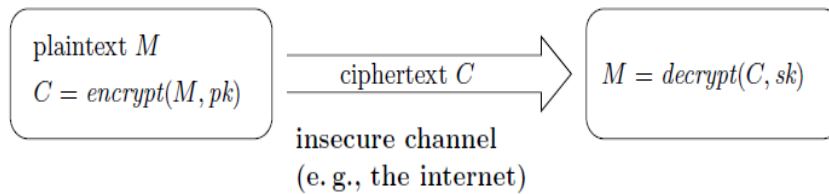

Figure 5: Asymmetric Key encryption / decryption

This function is a one-way function with a trap-door. In other words, the trap-door allows for the creation of the secret key  $sk$ , which in turn enables the beneficiary to easily invert the encryption function. We call  $C$  the cipher text. Obtaining  $M$  from  $C$  can be done easily using the (publicly known) decryption function  $\text{decrypt}$  and the beneficiary private key ( $sk$ ). On the other hand, it is much harder to decrypt without having any knowledge of the private key. As already mentioned, the great advantage of this approach is that no secure key exchange is necessary before a message is transmitted.

### The proposed model for security

In this section, a Security algorithm applied to MANETs is presented. This algorithm may be viewed as a two stages: firstly, a neutrosophic model to decide the key length for the current session, then the key distribution between nodes in MANET; both stages are illustrated furthermore.

### Neutrosophic Model (Key Size Determination Function)

The security offered by the algorithm is based on the difficulty of discovering the secret key through a brute force attack. Mobile Status (MS) Security Level is the correlative factor being analyzed with three considerations:

- (a) The longer the password, the harder to withstand a severe attack of brute force. In this research, the key lengths from 16 to 512 are assumed.
- (b) The quickest way to change passwords, the more secure the mobile host. It is more difficult to decipher the key in a shorter time. A mobile host to change the secret key is often safer than a mobile host using a constant secret key.
- (c) The neighbor hosting the mobile host has the more potential attacker. i.e. the possibility of attack is greater.

There are many other factors affecting the safety of mobile hosts, such as bandwidth. The security level of mobile hosts is a function with multiple variables and affects more than one condition.

At this point, a neutrosophic logic system is defined. Inputs of the neutrosophic logic system are the frequency of changing keys ( $f$ ) and the number of neighbor hosts ( $n$ ).

Output of the neutrosophic logic system is the Security Level of MS. It is assumed that the three factors are independent with each other. The relationship of them is as following:

$$S \propto l.f. \frac{1}{n} \quad \text{Formula 1}$$

It means that the Security-Level of MH is in direct proportion to the length of the key and the frequency of changing keys, in inverse proportion to the number of neighbor hosts. The  $S$  value is updated by the neutrosophic logic system. When the key length is short, the Security-Level of MH should be low; otherwise the Security-Level of MS should be high.

1. The first input parameter to the neutrosophic variable “the number of neighbor hosts” has three neutrosophic sets, few, normal and many. Membership function, non-membership and indeterminacy of  $n$  is illustrated in Figure [Membership function, non-membership and indeterminacy of Neutrosophic Set with variable  \$n\$ .](#)

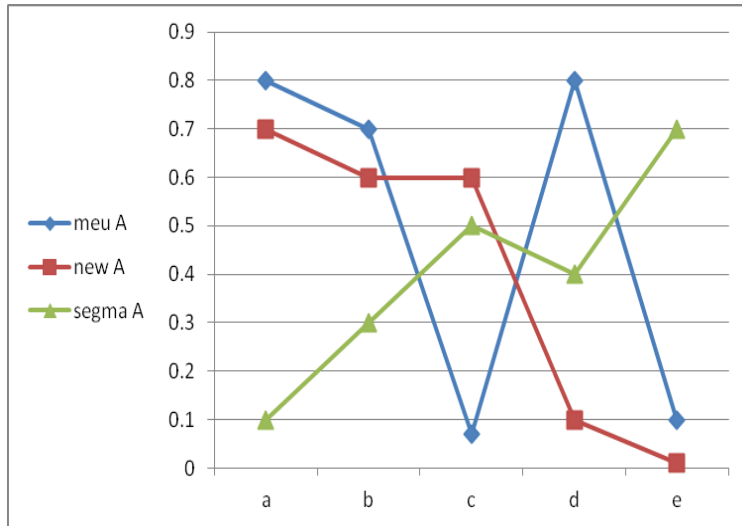

Figure 6: Membership function, non-membership and indeterminacy of Neutrosophic Set with variable  $n$ .

- The input neutrosophic variable “the frequency of changing keys” has two neutrosophic sets, slow and fast and none of them. The membership functions, non-membership and indeterminacy of  $f$  is put below:

$$f = \begin{cases} \text{slow} & \text{the secretKey is constant} \\ \text{fast} & \text{the secretKey is variable} \\ \text{Indeterminacy} & \text{non(slow,fast)} \end{cases} \text{ Formula 2}$$

- The output neutrosophic variable “the Security-Level of MS” has five neutrosophic sets containing the set and its complementary set. These sets are: lowest, low, normal, high and highest. It should be noted that modifying the membership functions, non-membership and indeterminacy will change the sensitivity of the neutrosophic logic system’s output to its inputs. Also increasing the number of neutrosophic sets of the variables will provide better sensitivity control, but also increases computational complexity of the system. Table [The neutrosophic system rules](#) shows the rules used in the neutrosophic system.

| Input |        |                   | Output                               |
|-------|--------|-------------------|--------------------------------------|
| F     | N      | I                 | S                                    |
| Slow  | Few    | non(Slow, Few)    | $\mathcal{E}$ (Low, ~Low, I)         |
| Slow  | Normal | non(Slow, Normal) | $\mathcal{E}$ (Lowest, ~Lowest, I)   |
| Slow  | Many   | non(Slow, Many)   | $\mathcal{E}$ (Lowest, ~Lowest, I)   |
| Fast  | Few    | non(Fast, Few)    | $\mathcal{E}$ (Normal, ~Normal, I)   |
| Fast  | Normal | non(Fast, Normal) | $\mathcal{E}$ (Low, ~Low, I)         |
| Fast  | Many   | non(Fast, Many)   | $\mathcal{E}$ (Low, ~Low, I)         |
| Slow  | Few    | non(Slow, Few)    | $\mathcal{E}$ (High, ~High, I)       |
| Slow  | Normal | non(Slow, Normal) | $\mathcal{E}$ (Normal, ~Normal, I)   |
| Slow  | Many   | non(Slow, Many)   | $\mathcal{E}$ (Low, ~Low, I)         |
| Fast  | Few    | non(Fast, Few)    | $\mathcal{E}$ (Highest, ~Highest, I) |
| Fast  | Normal | non(Fast, Normal) | $\mathcal{E}$ (High, ~High, I)       |
| Fast  | Many   | non(Fast, Many)   | $\mathcal{E}$ (High, ~High, I)       |

Table 1: The neutrosophic system rules

The output of that system determines the number of bits used and the security level required for the current situation varying the number of bits between 16 and 256 bits. This determination is based on the NS analysis which passes the three parameters of  $A = \langle x, \mu_A(x), \sigma_A(x), \nu_A(x) \rangle$  where  $\mu_A(x)$ ,  $\sigma_A(x)$  and  $\nu_A(x)$  which represent the degree of membership function (namely  $\mu_A(x)$ ), the degree of indeterminacy (namely  $\sigma_A(x)$ ), and the degree of non-membership (namely  $\nu_A(x)$ ) respectively of each element  $x \in X$  to the set  $A$  where  $0^- \leq \mu_A(x), \sigma_A(x), \nu_A(x) \leq 1^+$  and  $0^- \leq \mu_A(x) + \sigma_A(x) + \nu_A(x) \leq 3^+$ , then based on that analysis the system decides the accurate key size in each situation.

### Key Distribution

Once the neutrosophic set has decided the length of the session key based on its criteria the problem of key creation and distribution arises. The nature of MANET poses great challenges due to the lack of infrastructure and control over the network. To overcome such problems, the use of PK scheme is used to distribute the key under the assumption that one node (let us say the first node that originates the network) is responsible for the creation of session keys. If that node is going to leave the network, it must transfer the process of key creation to another trusted node in the network.



- 1) Each node sends a message (Session Key Request SKR) encrypted with its private key (that message contains a key request and a timer) to the key creator node which owns a table that contains the public key for each node in the network, as in the Figure, where the direction of the arrow's head denotes the private key used encryption is the originating node.
- 2) The key creator node simply decrypts the message and retrieves the request and the timer with one of the following scenarios occurs:
  - a. The timer was expired or the message is unreadable the message is neglected.
  - b. The timer is valid and the decryption of the message using the corresponding Public Key gives a readable request. The key creator node sends a message to that node containing the current session key. That message is encrypted two times first using the key creator's private key (for authentication) then using the destination's public key. Where the direction of the arrow's head denotes the private key used encryption is the trusted node then with the destination node's public key.

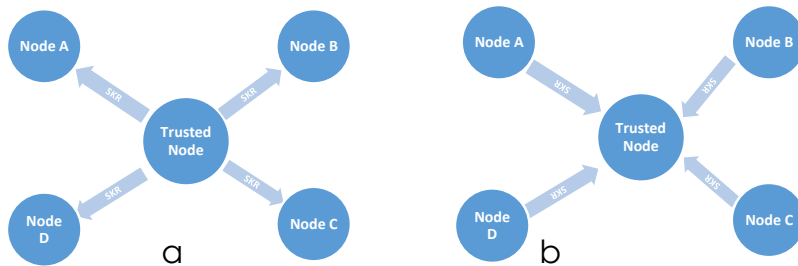

Figure 7: Key Distribution: (a) SK Request (b) SK Response

- 3) Any time the neutrosophic model reports that the network condition changes, the key creator node sends a jamming message for every node currently in the network asking them to send a key request message.
- 4) Any authenticated node (including the Trusted node) on the network knowing the current session key can send messages either to every node or to a single node on the network, simply by encrypting the message using the current session key.

**Experimental Results**

In this research a new security algorithm for MANETs is presented; this algorithm is based on the idea of periodically changing the encryption key, thus make it harder for any attacker to track that changing key. The algorithm is divided into stages, key size determination function and key distribution. In this section, we talk about the set of experimental results for the attempts to decide the way for creating a more secured MANETs. These experiments are clarified.

**Neutrosophic vs. Key size determination membership, non-membership functions and indeterminacy**

The first type of experiments had taken place to decide the key size for the encryption process. To accomplish this job the ordinary mechanism of KNN is used as a neutrosophic technique. Given the same parameters, we pass to the membership function, non-membership function and indeterminacy. The performance is measured with evaluation criteria, which are the average security-level and the key creation time. *The performance criteria are demonstrated in the following sections.*

**The Percentage Average Security-Level**

Average security level is measured for both techniques as the corresponding key provided how much strength given the number of nodes; the results are scaled from 0 to 5; these results are shown in [Table ASL of membership vs. non-membership and indeterminacy classification](#) and Figure [The Neutrosophic Average Percentage Security Level](#).

| No. nodes                               | 25    | 50    | 75    | 100   | 125   | 150   | 175   | 200   | 225   | 250   |
|---|-------|-------|-------|-------|-------|-------|-------|-------|-------|-------|
| Percentage Average of Classification    | 0.026 | 0.021 | 0.025 | 0.022 | 0.015 | 0.017 | 0.014 | 0.023 | 0.02  | 0.015 |
| Percentage Average of nonClassification | 0.034 | 0.036 | 0.038 | 0.038 | 0.004 | 0.004 | 0.004 | 0.004 | 0.004 | 0.004 |
| indeterminacy                           | 0.94  | 0.943 | 0.937 | 0.939 | 0.981 | 0.979 | 0.982 | 0.973 | 0.976 | 0.981 |

**Table 1: ASL of membership vs. non-membership and indeterminacy classification**

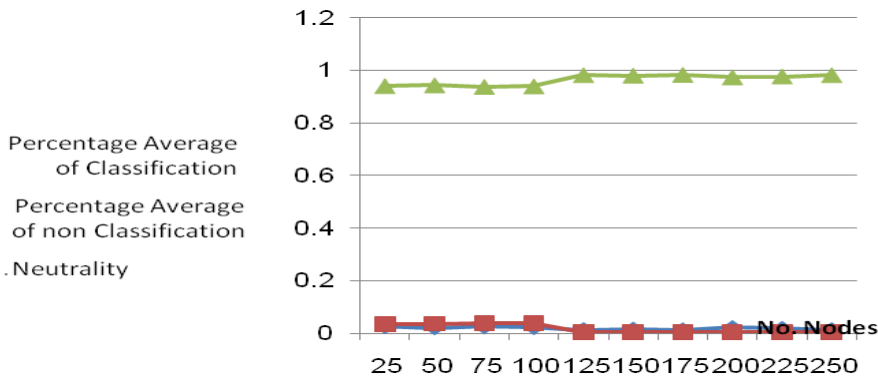

Figure 8: The Neutrosophic Average Percentage Security Level

Figure [The Neutrosophic Average Percentage Security Level](#) and Table [ASL of membership vs. non-membership and indeterminacy classification](#) shows the average percentage security level with the number of mobile nodes between 25 and 250. As shown in the figure and the table, the average security-level of the Neutrosophic Classifier (NC) is much higher than the average security-level of the membership, non-membership and indeterminacy classifier, especially for many mobile nodes. This is an expected result since the neutrosophic classifier adapts its self upon the whole set of criteria.

**The key creation time**

The time required to generate the key in both cases are measured, the results are scaled from 0 to 1 and are shown in Table [KCR of membership, non-membership and indeterminacy](#) and Figure [Neutrosophic Key Creation Time](#).

| No. nodes                     | 25    | 50    | 75   | 100   | 125   | 150   | 175  | 200  | 225  | 250  |
|-------------------------------|-------|-------|------|-------|-------|-------|------|------|------|------|
| Non-membership Classification | 0.95  | 0.93  | 0.95 | 0.96  | 0.96  | 0.96  | 0.96 | 0.96 | 0.96 | 0.96 |
| membership Classification     | 0.93  | 0.9   | 0.85 | 0.92  | 0.93  | 0.94  | 0.94 | 0.94 | 0.94 | 0.94 |
| indeterminacy                 | -0.88 | -0.83 | -0.8 | -0.88 | -0.89 | -0.89 | -0.9 | -0.9 | -0.9 | -0.9 |

Table 2: KCR of membership, non-membership and indeterminacy (Neutrosophic Classifiers)

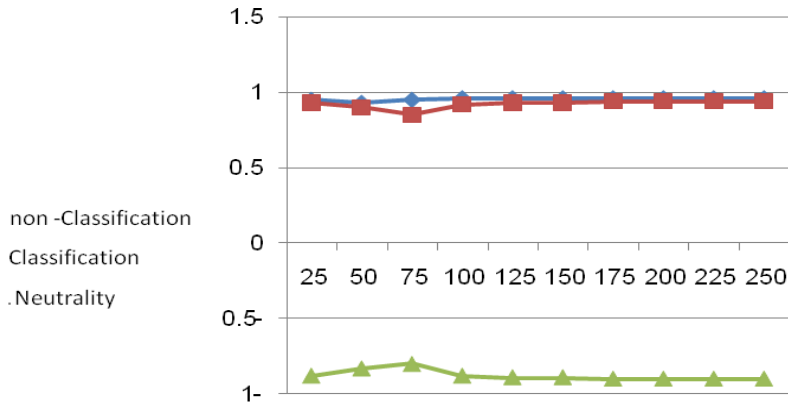

Figure 9: Neutrosophic Key Creation Time

Table [KCR of membership, non-membership and indeterminacy](#) and Figure [Neutrosophic Key Cereation Time](#) show the key creation time with the number of mobile nodes between 25 and 250. The speed of key creation is very high (mostly above 0.94) for all two techniques. However, the neutrosophic technique has some faster key creation time, especially with few mobile nodes. The reason is that the smaller the number of nodes with the same amount of calculation the bigger the time taken.

**PKI vs. non-PKI and indeterminacy distribution**

After the key size had been determined via the Key size determination function, the final problem is to distribute that key among nodes on the network. There were two approaches for the key distribution problem, either PKI or non-PKI. In this subsection the results of applying PKI and non-PKI and indeterminacy (neutrosophic) techniques are illustrated as applied in terms of security and processing time.

**Neutrosophic Security**

The PKI presents more overall security than ordinary non-PKI (single key) that is illustrated by applying both techniques over the network and recording the results regarding to the time required for an external attacker to break the session key. Table [Security of PKI vs. non-PKI and indeterminacy](#) and Figure [Neutrosophic Security Data of PKI](#) show that results under the assumption of using small public-private key pairs.

|               |      |       |       |       |       |       |      |       |       |      |
|---------------|------|-------|-------|-------|-------|-------|------|-------|-------|------|
| No. nodes     | 25   | 50    | 75    | 100   | 125   | 150   | 175  | 200   | 225   | 250  |
| Non-PKI       | 0.15 | 0.2   | 0.23  | 0.26  | 0.3   | 0.32  | 0.36 | 0.4   | 0.44  | 0.45 |
| PKI           | 0.85 | 0.85  | 0.85  | 0.92  | 0.93  | 0.94  | 0.94 | 0.94  | 0.94  | 0.94 |
| indeterminacy | 0    | -0.05 | -0.08 | -0.18 | -0.23 | -0.26 | -0.3 | -0.38 | -0.38 | 0.55 |

Table 3: Security of PKI vs. non-PKI and indeterminacy

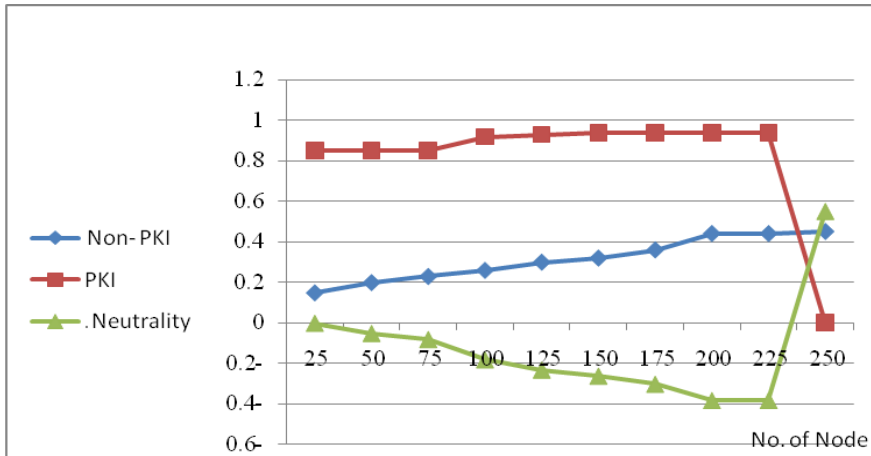

Figure 10: Neutrosophic Security Data of PKI

Table [Security of PKI vs. non-PKI and indeterminacy](#) and Figure [Neutrosophic Security Data of PKI](#) show the huge difference in the security level provided by the PKI technique over the Non-PKI mechanism given the same experimental conditions.

**Processing time of neutrosophic data**

Another factor had been taken into consideration while developing the model, that is: time required to process the key and distribute it. Table [Processing time of PKI vs. non-PKI and indeterminacy](#) and Figure [Processing Time of Neutrosophic Data PKI](#) show that results under the assumption of using small public-private key pairs.

|               |     |      |      |      |       |       |      |       |       |       |
|---------------|-----|------|------|------|-------|-------|------|-------|-------|-------|
| No. nodes     | 25  | 50   | 75   | 100  | 125   | 150   | 175  | 200   | 225   | 250   |
| Non-PKI       | 0.3 | 0.32 | 0.35 | 0.37 | 0.4   | 0.44  | 0.47 | 0.51  | 0.55  | 0.58  |
| PKI           | 0.2 | 0.35 | 0.5  | 0.6  | 0.68  | 0.75  | 0.83 | 0.87  | 0.93  | 0.97  |
| indeterminacy | 0.5 | 0.33 | 0.15 | 0.03 | -0.08 | -0.19 | -0.3 | -0.38 | -0.46 | -0.55 |

Table 4: Processing time of PKI vs. non-PKI and indeterminacy

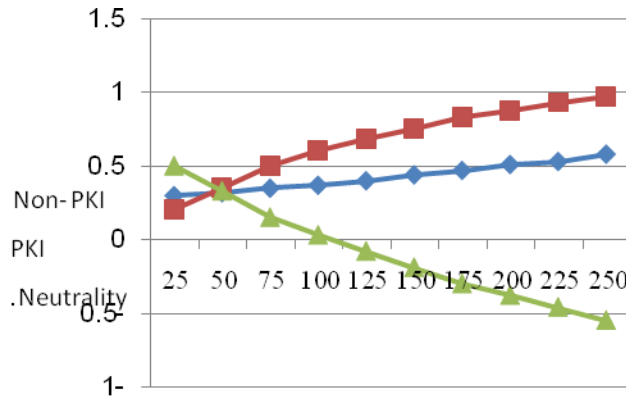

Figure 11: Processing Time of Neutrosophic Data PKI

Table [Processing time of PKI vs. non-PKI and indeterminacy](#) and Figure [Processing Time of Neutrosophic Data PKI](#) show that Non-PKI techniques provide relatively small amount of processing time comparing to PKI and indeterminacy, due to the amount of modular arithmetic performed in the PKI mechanisms. However, the difference in the processing time is neglectable comparing to the security level provided by the PKI under the same conditions.

### Conclusions

MANETs require a reliable, efficient, scalable, and most importantly, a secure protocol, as they are highly insecure, self-organizing, rapidly deployed, and they use dynamic routing. In this section, we discussed the vulnerable nature of the *mobile ad hoc network*. Also, the security attributes and the various challenges to the security of MANET had been covered. The new security mechanism which combines the advantages of both neutrosophic classification and the public key infrastructure had been demonstrated. The advantages of the proposed mechanism comparing to other existing mechanisms had been shown firstly by comparing the neutrosophic to the non-classification, showing that neutrosophic is more adaptable and provides a better response in MANET. Also, the PKI is compared to the non-PKI and indeterminacy showing that it provides a far better security with a neglect table amount of delay.

### 7.3 Non-Classical Sets via Probability Neutrosophic Components

The purpose of this application is to introduce and study the probability of neutrosophic crisp sets. After giving the fundamental definitions and operations, we obtain several properties, and discuss the relationship between neutrosophic crisp sets and other sets.

The neutrosophic experiments are experiments that produce indeterminacy. Collecting all results, including the indeterminacy, we get the neutrosophic sample space (or the neutrosophic probability space) of the experiment. The neutrosophic power set of the neutrosophic sample space is formed by all different collections (that may or may not include the indeterminacy) of possible results. These collections are called Neutrosophic Events.

In classical experimental probability, we have:

$$\left( \frac{\text{number of times event A occurs}}{\text{total number of trials}} \right)$$

Similarly, Smarandache introduced Neutrosophic Experimental Probability in [74]:

$$\left( \frac{\text{number of times event A occurs}}{\text{total number of trials}}, \frac{\text{number of times indeterminacy occurs}}{\text{total number of trials}}, \frac{\text{number of times event A does not occur}}{\text{total number of trials}} \right)$$

Probability of NCS is a generalization of the classical probability in which the chance that event  $A = \langle A_1, A_2, A_3 \rangle$  occurs is

$$P(A_1) \text{ true}, P(A_2) \text{ indeterminate}, P(A_3) \text{ false}$$

on a sample space X, then  $NP(A) = \langle P(A_1), P(A_2), P(A_3) \rangle$  probability of NCS space the universal set, endowed with a neutrosophic probability defined for each of its subset, from a probability neutrosophic crisp space.

#### Definition A.7.3.1

Let X be a non-empty set and A be any type of neutrosophic crisp set in a space X, then the probability is a mapping  $NP: X \rightarrow [0,1]^3$ ,

$$NP(A) = \langle P(A_1), P(A_2), P(A_3) \rangle$$

The probability of a neutrosophic crisp set has the following property:

$$NP(A) = \begin{cases} (p_1, p_2, p_3) & \text{where } p_{1,2,3} \in [0,1] \\ 0 & \text{if } p_1, p_2, p_3 < 0 \end{cases}$$

**Remark A.7.3.1**

1. In case if  $A = \langle A_1, A_2, A_3 \rangle$  we have NCS-Type 1, then:

$$0 \leq P(A_1) + P(A_2) + P(A_3) \leq 2 .$$

2. In case if  $A = \langle A_1, A_2, A_3 \rangle$  we have NCS, then:

$$^-0 \leq P(A_1) + P(A_2) + P(A_3) \leq 3^+ .$$

3. The Probability of NCS-Type2 is a neutrosophic set, where:

$$^-0 \leq P(A_1) + P(A_2) + P(A_3) \leq 2^+ .$$

4. The Probability of NCS-Type2 is a neutrosophic set, where:

$$^-0 \leq P(A_1) + P(A_2) + P(A_3) \leq 3^+ .$$

**Probability axioms of NCS**

The probability of intuitionistic neutrosophic crisp and NCS Type3s A in X is expressed as:

$$NP(A) = \langle P(A_1), P(A_2), P(A_3) \rangle,$$

where

$$P(A_1) \geq 0, P(A_2) \geq 0, P(A_3) \geq 0,$$

or

$$NP(A) = \begin{cases} (p_1, p_2, p_3) & \text{where } p_{1,2,3} \in [0,1] \\ 0 & \text{if } p_1, p_2, p_3 < 0 . \end{cases}$$

1. The probability of intuitionistic neutrosophic crisp and NCS-Type3s A in X  $NP(A) = \langle P(A_1), P(A_2), P(A_3) \rangle$  where

$$^-0 \leq p(A_1) + p(A_2) + p(A_3) \leq 3^+ .$$

2. Bonding the probability of intuitionistic neutrosophic crisp and NCS-Type3s  $NP(A) = \langle P(A_1), P(A_2), P(A_3) \rangle$  where

$$1 \geq P(A_1) \geq 0, P(A_2) \geq 0, P(A_3) \geq 0.$$

3. Additional law for any two intuitionistic neutrosophic crisp sets or NCS-Type3:

$$NP(A \cup B) = \langle (P(A_1) + P(B_1) - P(A_1 \cap B_1)),$$

$$(P(A_2) + P(B_2) - P(A_2 \cap B_2)), (P(A_3) + P(B_3) - P(A_3 \cap B_3)) \rangle$$

if  $A \cap B = \phi_N$ , then  $NP(A \cap B) = NP(\phi_N)$ .

$$NP(A \cup B) = \langle NP(A_1) + NP(B_1) - NP(\phi_{N_1}), NP(A_2) + NP(B_2) - NP(\phi_{N_2}),$$



$$NP(A_3) + NP(B_3) - NP(\phi_{N_3}).$$

Since our main purpose is to construct the tools for developing the neutrosophic probability, we must introduce the following:

1. Probability of neutrosophic crisp empty set with three types ( $NP(\phi_N)$ ) may be defined as four types:

(a) Type 1:  $NP(\phi_N) = \langle P(\phi), P(\phi), P(X) \rangle = \langle 0, 0, 1 \rangle$

(Type 1: intuitionistic neutrosophic crisp empty);

(b) Type 2:  $NP(\phi_N) = \langle P(\phi), P(X), P(X) \rangle = \langle 0, 1, 1 \rangle$

(Type 1: ultra neutrosophic crisp empty);

(c) Type 3:  $NP(\phi_N) = \langle P(\phi), P(\phi), P(\phi) \rangle = \langle 0, 0, 0 \rangle$

(Type 2: intuitionistic neutrosophic crisp empty);

(d) Type 4:  $NP(\phi_N) = \langle P(\phi), P(X), P(\phi) \rangle = \langle 0, 1, 0 \rangle$

(Type 3: intuitionistic neutrosophic crisp empty).

2. Probability of intuitionistic neutrosophic crisp universal and NCS-Type3 universal sets ( $NP(X_N)$ ) may be defined as four types:

(a) Type 1:  $NP(X_N) = \langle P(X), P(\phi), P(\phi) \rangle = \langle 1, 0, 0 \rangle$

(Type 1: intuitionistic neutrosophic crisp universal)

(b) Type 2:  $NP(X_N) = \langle P(X), P(X), P(\phi) \rangle = \langle 1, 1, 0 \rangle$

(Type 1: NCS Type3 universal)

(c) Type 3:  $NP(X_N) = \langle P(X), P(X), P(X) \rangle = \langle 1, 1, 1 \rangle$

(Type 2: NCS Type3 universal)

(d) Type 4:  $NP(X_N) = \langle P(X), P(\phi), P(X) \rangle = \langle 1, 0, 1 \rangle$

(Type 3: NCS Type3 universal)

### Remark A.7.3.2

$NP(X_N) = 1_N$ ,  $NP(\phi_N) = O_N$ , where  $1_N, O_N$  are in Definition 2.1 [6], or equals any type for  $1_N$ .

### Definition A.7.3.2 (Monotonicity)

Let  $X$  be a non-empty set, and NCSS  $A$  and  $B$  in the form:

$$A = \langle A_1, A_2, A_3 \rangle, B = \langle B_1, B_2, B_3 \rangle \text{ with } NP(A) = \langle P(A_1), P(A_2), P(A_3) \rangle,$$

$$NP(B) = \langle P(B_1), P(B_2), P(B_3) \rangle,$$

then we may consider two possible definitions for subsets ( $A \subseteq B$ ):

1) Type1:

$$NP(A) \leq NP(B) \Leftrightarrow P(A_1) \leq P(B_1), P(A_2) \leq P(B_2) \text{ and } P(A_3) \geq P(B_3)$$

2) Type2:

$$NP(A) \leq NP(B) \Leftrightarrow P(A_1) \leq P(B_1), P(A_2) \geq P(B_2) \text{ and } P(A_3) \geq P(B_3) .$$

### Definition A.7.3.3

Let  $\chi$  be a non-empty set, and NCSs  $A, B$  in the form  $A = \langle A_1, A_2, A_3 \rangle$ ,  $B = \langle B_1, B_2, B_3 \rangle$  be NCSs. Then:

1)  $NP(A \cap B)$  may be defined two types as:

Type1:  $NP(A \cap B) = \langle P(A_1 \cap B_1), P(A_2 \cap B_2), P(A_3 \cup B_3) \rangle$  or

Type2:  $NP(A \cap B) = \langle P(A_1 \cap B_1), P(A_2 \cup B_2), P(A_3 \cup B_3) \rangle$

2)  $NP(A \cup B)$  may be defined two types as:

Type1:  $NP(A \cup B) = \langle P(A_1 \cup B_1), P(A_2 \cap B_2), P(A_3 \cap B_3) \rangle$  or

Type 2:  $NP(A \cup B) = \langle P(A_1 \cup B_1), P(A_2 \cup B_2), P(A_3 \cap B_3) \rangle$

3)  $NP(A^c)$  may be defined by three types

Type1:  $NP(A^c) = \langle P(A_1^c), P(A_2^c), P(A_3^c) \rangle = \langle (1 - A_1), (1 - A_2), (1 - A_3) \rangle$  or

Type2:  $NP(A^c) = \langle P(A_3), P(A_2^c), P(A_1) \rangle$  or

Type3:  $NP(A^c) = \langle P(A_3), P(A_2), P(A_1) \rangle$ .

### Proposition A.7.3.1

Let  $A$  and  $B$  in the form  $A = \langle A_1, A_2, A_3 \rangle$ ,  $B = \langle B_1, B_2, B_3 \rangle$  be NCSs in a non-empty set  $\chi$ . Then:

1)  $NP(A)^c + NP(A) = \langle (1, 1, 1) \rangle$ . Or Type (iii) of  $NP(X_N) = 1_N$  or = any types for  $1_N$ .

2)  $NP(A - B) = NP(A - B) = \langle (P(A_1) - P(A_1 \cap B_1), (P(A_2) - P(A_2 \cap B_2)), (P(A_3) - P(A_3 \cap B_3)) \rangle$

3)  $NP(A/B) = \langle \frac{NP(A_1)}{NP(A_1 \cap B_1)}, \frac{NP(A_2)}{NP(A_2 \cap B_2)}, \frac{NP(A_3)}{NP(A_3 \cap B_3)} \rangle$

### Proposition A.7.3.2

Let  $A$  and  $B$  in the form  $A = \langle A_1, A_2, A_3 \rangle$ ,  $B = \langle B_1, B_2, B_3 \rangle$  be NCSs in a non-empty set  $X$ , and  $p, p_N$  be NCSs. Then:

$$i) \quad NP(p) = \left\langle \frac{1}{n(X)}, \frac{1}{n(X)}, \frac{1}{n(X)} \right\rangle$$

$$ii) \quad NP(p_N) = \left\langle 0, \frac{1}{n(X)}, 1 - \frac{1}{n(X)} \right\rangle$$

**Example A.7.3.1**

1) Let  $X = \{a, b, c, d\}$ , and  $A, B$  be two neutrosophic crisp events in  $X$  defined by  $A = \langle \{a\}, \{b, c\}, \{c, d\} \rangle$ ,  $B = \langle \{a, b\}, \{a, c\}, \{c\} \rangle$ ,  $p = \langle \{a\}, \{c\}, \{d\} \rangle$ .

We observe that:

$$NP(A) = \langle 0.25, 0.5, 0.5 \rangle, \quad NP(B) = \langle 0.5, 0.5, 0.25 \rangle, \quad NP(p) = \langle 0.25, 0.25, 0.25 \rangle,$$

and one can compute all probabilities from definitions.

2) If  $A = \langle \{\phi\}, \{b, c\}, \{\phi\} \rangle$  and  $B = \langle \{\phi\}, \{d\}, \{\phi\} \rangle$  are intuitionistic neutrosophic crisp sets in  $X$ , then:

$$\text{Type1: } A \cap B = \langle \{\phi\}, \{\phi\}, \{\phi\} \rangle, \text{ and } NP(A \cap B) = \langle 0, 0, 0 \rangle = 0_N,$$

$$\text{Type2: } A \cap B = \langle \{\phi\}, \{b, c, d\}, \{\phi\} \rangle \text{ and } NP(A \cap B) = \langle 0, 0.75, 0 \rangle \neq 0_N.$$

**Example A.7.3.2**

Let  $X = \{a, b, c, d, e, f\}$ ,

$A = \langle \{a, b, c, d\}, \{e\}, \{f\} \rangle$ ,  $D = \langle \{a, b\}, \{e, c\}, \{f, d\} \rangle$  be a NCS-Type 2,

$B = \langle \{a, b, c\}, \{d\}, \{e\} \rangle$  be a NCT-Type1 but not NCS-Type2, 3,

$C = \langle \{a, b\}, \{c, d\}, \{e, f, a\} \rangle$  be a NCS-Type 3, but not NCS-Type1, 2,

$E = \langle \{a, b, c, d, e\}, \{c, d\}, \{e, f, a\} \rangle$ ,  $F = \langle \{a, b, c, d, e\}, \phi, \{e, f, a, d, c, b\} \rangle$

We can compute the probabilities for NCSs by the following:

$$NP(A) = \left\langle \frac{4}{6}, \frac{1}{6}, \frac{1}{6} \right\rangle, \quad NP(D) = \left\langle \frac{2}{6}, \frac{2}{6}, \frac{2}{6} \right\rangle, \quad NP(B) = \left\langle \frac{3}{6}, \frac{1}{6}, \frac{1}{6} \right\rangle,$$

$$NP(C) = \left\langle \frac{2}{6}, \frac{2}{6}, \frac{3}{6} \right\rangle, \quad NP(E) = \left\langle \frac{4}{6}, \frac{2}{6}, \frac{3}{6} \right\rangle, \quad NP(F) = \left\langle \frac{5}{6}, 0, \frac{6}{6} \right\rangle,$$

**Example A.7.3.3**

Let  $X = \{a, b, c, d\}$ ,  $A = \langle \{a, b\}, \{c\}, \{d\} \rangle$ ,  $B = \langle \{a\}, \{c\}, \{d, b\} \rangle$  be NCS-Type1 in  $X$  and  $U_1 = \langle \{a, b\}, \{c, d\}, \{a, d\} \rangle$ ,  $U_2 = \langle \{a, b, c\}, \{c\}, \{d\} \rangle$  be NCS-Type3 in  $X$ , then we can find the following operations:

*Union, intersection, complement, difference and its probabilities.*

$$\text{Type1: } A \cap B = \langle \{a\}, \{c\}, \{d, b\} \rangle, \quad NP(A \cap B) = \langle 0.25, 0.25, 0.5 \rangle \text{ and}$$

Type2,3:  $A \cap B = \langle \{a\}, \{c\}, \{d, b\} \rangle$ ,  $NP(A \cap B) = \langle 0.25, 0.25, 0.5 \rangle$ .

$NP(A - B)$  may be equals.

Type1:  $NP(A - B) = \langle 0.25, 0, 0 \rangle$ ,

Type 2:  $NP(A - B) = \langle 0.25, 0, 0 \rangle$ ,

Type 3:  $NP(A - B) = \langle 0.25, 0, 0 \rangle$ ,

Type2:  $A \cup B = \langle \{a, b\}, \{c\}, \{d\} \rangle$ ,

$NP(A \cup B) = \langle 0.5, 0.25, 0.25 \rangle$  and

Type 2:  $A \cup B = \langle \{a, b\}, \{c\}, \{d\} \rangle$   $NP(A \cup B) = \langle 0.5, 0.25, 0.25 \rangle$ .

Type1:  $A^c = \langle \{c, d\}, \{a, b, d\}, \{a, b, c\} \rangle$

NCS-Type3 set in X,  $NP(A^c) = \langle 0.5, 0.75, 0.75 \rangle$ .

Type2:  $A^c = \langle \{d\}, \{a, b, d\}, \{a, b\} \rangle$

NCS-Type3 in X,  $NP(A^c) = \langle 0.25, 0.75, 0.5 \rangle$

Type3:  $A^c = \langle \{d\}, \{c\}, \{a, b\} \rangle$

NCS-Type3 in X,  $NP(A^c) = \langle 0.75, 0.75, 0.5 \rangle$ .

Type1:  $B^c = \langle \{b, c, d\}, \{a, b, d\}, \{a, c\} \rangle$

NCS-Type3 in X,  $NP(B^c) = \langle 0.75, 0.75, 0.5 \rangle$

Type2:  $B^c = \langle \{b, d\}, \{c\}, \{a\} \rangle$

NCS-Type1 in X, and  $NP(B^c) = \langle 0.5, 0.25, 0.25 \rangle$ .

Type3:  $B^c = \langle \{b, d\}, \{a, b, d\}, \{a\} \rangle$

NCS-Type3 in X and  $NP(B^c) = \langle 0.5, 0.75, 0.25 \rangle$ .

Type 1:  $U_1 \cup U_2 = \langle \{a, b, c\}, \{c, d\}, \{a, d\} \rangle$ ,

NCS-Type 3:  $NP(U_1 \cup U_2) = \langle 0.75, 0.5, 0.5 \rangle$ ,

Type2:  $U_1 \cup U_2 = \langle \{a, b, c\}, \{c\}, \{a, d\} \rangle$ ,

NCS-Type3,  $NP(U_1 \cup U_2) = \langle 0.75, 0.25, 0.5 \rangle$ ,

Type1:  $U_1 \cap U_2 = \langle \{a, b\}, \{c, d\}, \{a, d\} \rangle$ ,

NCS-Type3,  $NP(U_1 \cap U_2) = \langle 0.5, 0.5, 0.5 \rangle$ ,

Type2:  $U_1 \cap U_2 = \langle \{a, b\}, \{c\}, \{a, d\} \rangle$ ,

NCS-Type3, and  $NP(U_1 \cap U_2) = \langle 0.5, 0.25, 0.5 \rangle$ ,

$$\text{Type 1: } U_1^c = \langle \{c, d\}, \{a, b\}, \{c, b\} \rangle,$$

$$\text{NCS-Type3 and } NP(U_1^c) = \langle 0.5, 0.5, 0.5 \rangle$$

$$\text{Type 2: } U_1^c = \langle \{a, d\}, \{c, d\}, \{a, b\} \rangle,$$

$$\text{NCS-Type3 and } NP(U_1^c) = \langle 0.5, 0.5, 0.5 \rangle$$

$$\text{Type3: } U_1^c = \langle \{a, d\}, \{a, b\}, \{a, b\} \rangle,$$

$$\text{NCS-Type3 and } NP(U_1^c) = \langle 0.5, 0.5, 0.5 \rangle.$$

$$\text{Type1: } U_2^c = \langle \{d\}, \{a, b, d\}, \{a, b, c\} \rangle$$

$$\text{NCS-Type3 and } NP(U_2^c) = \langle 0.25, 0.75, 0.75 \rangle,$$

$$\text{Type2: } U_2^c = \langle \{d\}, \{c\}, \{a, b, c\} \rangle$$

$$\text{NCS-Type3 and } NP(U_2^c) = \langle 0.25, 0.25, 0.75 \rangle,$$

$$\text{Type3: } U_2^c = \langle \{d\}, \{a, b, d\}, \{a, b, c\} \rangle$$

$$\text{NCS-Type3. } NP(U_2^c) = \langle 0.25, 0.75, 0.75 \rangle.$$

*Probabilities for events:*

$$NP(A) = \langle 0.5, 0.25, 0.25 \rangle,$$

$$NP(B) = \langle 0.25, 0.25, 0.5 \rangle,$$

$$NP(U_1) = \langle 0.5, 0.5, 0.5 \rangle,$$

$$NP(U_2) = \langle 0.75, 0.25, 0.25 \rangle,$$

$$NP(U_1^c) = \langle 0.5, 0.5, 0.5 \rangle,$$

$$NP(U_2^c) = \langle 0.25, 0.75, 0.75 \rangle$$

Let  $(A \cap B)^c = \langle \{b, c, d\}, \{a, b, d\}, \{a, c\} \rangle$  be a NCS-Type3.

Let  $NP(A \cap B)^c = \langle 0.75, 0.75, 0.25 \rangle$  be a neutrosophic set.

$$NP(A)^c \cap NP(B)^c = \langle 0.5, 0.75, 0.75 \rangle,$$

$$NP(A)^c \cup NP(B)^c = \langle 0.75, 0.75, 0.5 \rangle$$

$$NP(A \cup B) = NP(A) + NP(B) - NP(A \cap B) = \langle 0.5, 0.25, 0.25 \rangle$$

$$NP(A) = \langle 0.5, 0.25, 0.25 \rangle,$$

$$NP(A)^c = \langle 0.5, 0.75, 0.75 \rangle,$$

$$NP(B) = \langle 0.25, 0.25, 0.5 \rangle,$$

$$NP(B^c) = \langle 0.75, 0.75, 0.5 \rangle$$

*Probabilities for Products:*

The product of two events is given by

$$A \times B = \langle \{(a, a), (b, a)\}, \{(c, c)\}, \{(d, d), (d, b)\} \rangle,$$

$$\text{and } NP(A \times B) = \langle \frac{2}{16}, \frac{1}{16}, \frac{2}{16} \rangle$$

$$B \times A = \langle \{(a, a), (a, b)\}, \{(c, c)\}, \{(d, d), (b, d)\} \rangle$$

$$\text{and } NP(B \times A) = \langle \frac{2}{16}, \frac{1}{16}, \frac{2}{16} \rangle$$

$$A \times U_1 = \langle \{(a, a), (b, a), (a, b), (b, b)\}, \{(c, c), (c, d)\}, \{(d, d), (d, a)\} \rangle,$$

$$\text{and } NP(A \times U_1) = \langle \frac{4}{16}, \frac{2}{16}, \frac{2}{16} \rangle$$

$$U_1 \times U_2 = \langle \{(a, a), (b, a), (a, b), (b, b), (a, c), (b, c)\}, \{(c, c), (d, c)\}, \{(d, d), (a, d)\} \rangle$$

$$\text{and } NP(U_1 \times U_2) = \langle \frac{6}{16}, \frac{2}{16}, \frac{2}{16} \rangle$$

## 7.4 Social Network Analysis e-Learning Systems via Neutrosophic Set

The purpose of this section is to put on view a Social Learning Management System that integrates social activities in e-Learning, employing neutrosophic set to analyze social networks data conducted through learning activities. Results show that recommendations can be enhanced through utilizing proposed system.

We will now extend the concepts of Social Learning Management System that integrates social activities in e-Learning presented in [95-107] to the case of neutrosophic sets.

### Introduction

E-learning can be thought of as structured learning conducted over an electronic platform. One of the recommendations of Clayton Christensen's Disrupting Class is to take a "student-centric" approach to education, one that responds to students' unique learning styles and preferences.

This is difficult in face-to-face setting with our usual educational model as it is formed in very systematic "teacher-centric" way. Nowadays, is indirectly designed to mold every student with the same method, on the same path, in same pace, and with teacher as the standard mold. E.A. Ross describes education as "the most effective means of control."

Teacher is the most significant agency, even in this era that many countries' governments are highly promoted "student-centric" as a key strategy for education. The word "program" is commonly used in terms of conducting curriculum. Such fact make many conclude that "education is all about control."

Ideally, education always means *right and freedom*, as reaffirmed by many international organizations' articles such as UNESCO's. It is such a big dilemma to set education in controlled way for making result with the freedom. Stanford University's Dr. Moe mentioned, in American Experiment luncheon in August 2009, *Technology is always an answer for education*.

He particularly mentioned that technology is E-learning. E-learning is promised to give freedom to learners in many aspects, such as learning at any place and at any time. While many aim that E-learning is a revolutionize tool for education, it has delivered lower impact than expected. More than 70% of e-learning courses existed are designed to, more or less, duplicate face-to-face learning, which are more than half in presentation style. BYU's Clark Gilbert observed that most existed e-learning style with "the lack of meaningful content and quality standards in many dot-com publications". Most online courses are "flexible from a schedule standpoint, but not the best learning experience".

Good online courses would require "innovative, first-rate course designs and strategies for engaging students." Most online courses reflected the assumption that instruction is either all in the classroom or all from online. In fact, a hybrid course also effectively reaches to students with differing learning styles.

A combination of both online and in-class instruction allows the various learning activities to be conducted via more effective medium. Many activities traditionally done in classroom, such as listening to a lecture or taking a test, can be effectively conducted online. Even an instructor-led discussion may be better if it occurs both in-class and online, allowing shy students to make their points in the more anonymous online setting.

Online technology is not just to make learning more efficient, but to enhance it by allowing students and professors to better prepare for face-to-face or online learning experiences. With all mentioned potentials, now-a-day, online learning is on the rise across all areas of education. For higher education in the U.S., 79% of students access

course-specific materials at least once a week. So, to achieve freedom in learning system, teacher control and peers interaction advantages.

We propose system of learning management system (LMS) that incorporates within its beneath social networks and makes use of social network analysis in understanding students behavior and helps shaping their learning path.

### Related work

Social networks are graph structures whose nodes or vertices represent people or other entities embedded in a social context, and whose edges represent interaction or collaboration between these entities. As Clayton M. Christensen and Henry J. Eyring mentioned “most online courses allow students to work at their own pace but provided no student-to-student interaction until social media came along.

In 2004, Mark Zuckerberg developed a website which was the first iteration of the Facebook and social networking phenomena. Social network has been raised to mutuality in very short ages from the tools for communication in the close circle to the medium of communication for all, thanks to rapid development of mobile communication and information technology. As of today, social network has developed to become a new and true definition of "sharing", "collaborating", and "conversation" in the new form. While social networking means conversation, share, and collaborate, it is naturally in opposite polar from highly controlled education. Therefore integrating social networking to exist controlled programs of e-learning suggests chaos, especially in already-unstable world of e-learning.

Social networks are highly dynamic, evolving relationships among people or other entities. This dynamic property of social networks makes studying these graphs a challenging task. A lot of research has been done recently to study different properties of these networks. Such complex analysis of large, heterogeneous, multi-relational social networks has led to an interesting field of study known as Social Network Analysis (SNA). Social network analysis, which can be applied to analysis of the structure and the property of personal relationship, web page links, and the spread of messages, is a research field in sociology.

Recently social network analysis has attracted increasing attention in the data mining research community. From the viewpoint of data mining, a social network is a heterogeneous and multi-relational dataset represented by graph.



Tools used to support social media in e-learning cover a wide range of different applications. They include discussion forums, chat, file sharing, video conferences, shared whiteboards, e-portfolios, weblogs and wikis. Such tools can be used to support different activities involved in the learning process.

The question of organizing e-learning tools involves the problem of integration vs. separation and distribution.

A logic in which each proposition is estimated to have the percentage of truth in a subset T, the percentage of indeterminacy in a subset I, and the percentage of falsity in a subset F, where T, I, F are defined above, is called neutrosophic logic in [71-74].

We use a subset of truth (or indeterminacy, or falsity), instead of a number only, because in many cases we are not able to exactly determine the percentages of truth and of falsity but to approximate them: for example a proposition is between 0.30-0.40 true and between 0.60-0.70 false, even worst: between 0.30-0.40 or 0.45-0.50 true (according to various analyzers), and 0.60 or between 0.66-0.70 false.

The subsets are not necessary intervals, but any sets (discrete, continuous, open or closed or half-open/half-closed interval, intersections or unions of the previous sets, etc.) in accordance with the given proposition. A subset may have one element only in special cases of this logic. Constants: (T, I, F) truth-values, where T, I, F are standard or non-standard subsets of the non-standard interval  $] -0, 1^+ [$ , where  $n_{inf} = \inf T + \inf I + \inf F \geq -0$ , and  $n_{sup} = \sup T + \sup I + \sup F \leq 3^+$ .

Atomic formulas: a, b, c, ... .

Arbitrary formulas: A, B, C, ... .

### Proposed Framework

The Figure [Social LMS Components](#) below presents our proposed Social LMS that incorporates social networks in the e-Learning system. Social LMS consists of two main components:

- *Learning System*, and
- *Social Network*.

Proposed system incorporates traditional learning activities as depicted in the Figure [Traditional e-Learning Activities](#).

### Learning System

- Use LMS that is responsible for learning activities;
- Use synchronous and asynchronous e-learning:

- Enable Synchronous e-learning: any learning event delivered in real time to remote learners, such as e-mail, comments, downloadable learning materials;
- Enable Asynchronous e-learning: learning situations in which the learning event does not take place in real-time, such as multicast webinars, chat, tele-video conferencing.

**Social Network**

- Use relationship between teacher and students (one-to-many);
- Use Graph Theory Clustering Algorithm;
- Use video and voice conference and electronic posts and exams with high level quality.

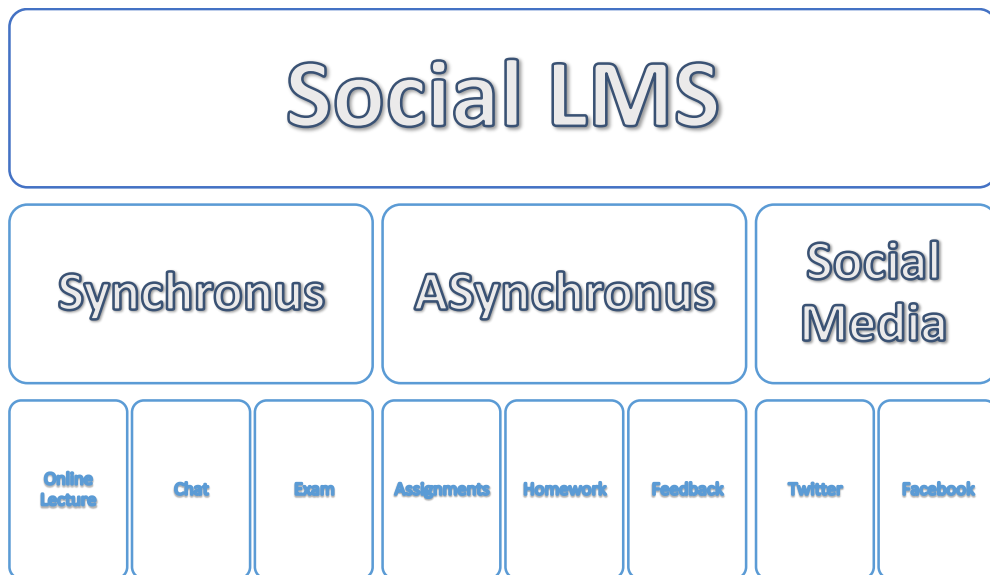

Figure 12: Social LMS Components

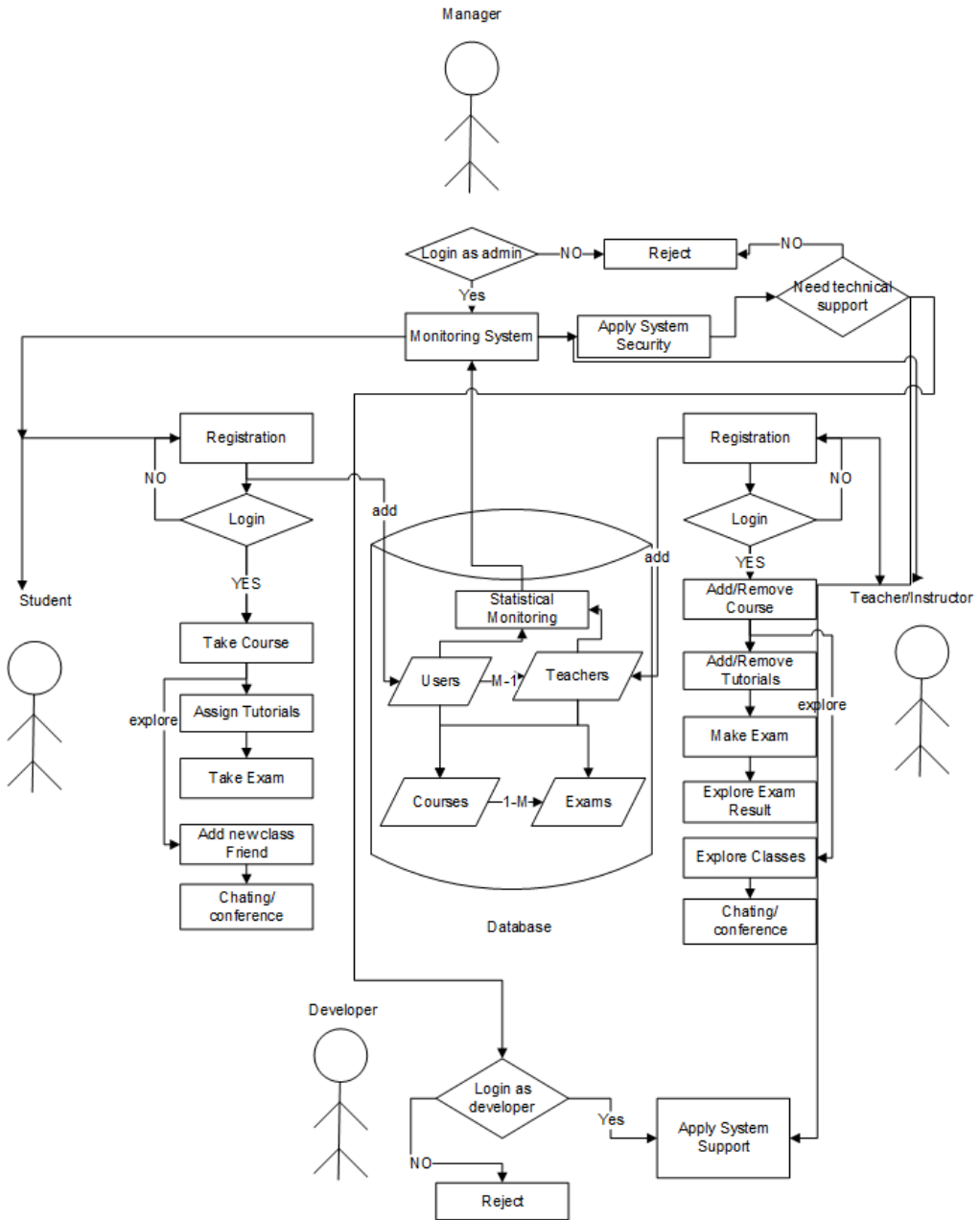

Figure 13: Traditional e-Learning Activities

In our proposed Social LMS, we utilize Graph Theory in analyzing the relations between students on social networks such as Facebook and twitter. Basically Graph theory clustering algorithm uses objects and

links among objects (data classes) to make clustering analysis. Similarly, social network also includes objects and links among these objects. [16] The Figure [A sample of social network](#) presents a sample of social network representation using nodes and edges.

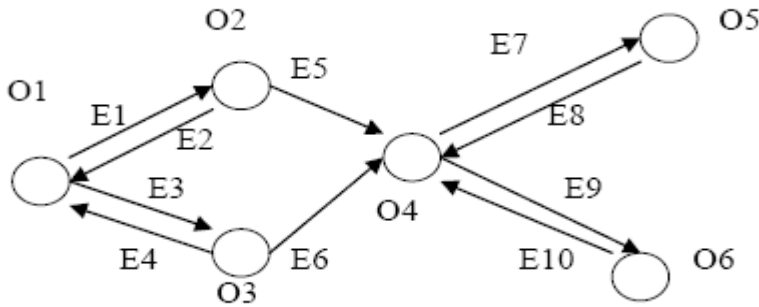

Figure 14: A sample of social network

In view of the same pre-condition, the Business System Planning (BSP) clustering algorithm can be used in social network clustering analysis. According to graph theory, social network is a direct graph composed by objects and their relationship. In Figure [A sample of social network](#), the circle represents an object; the line with arrow is an edge of the graph, and it represents direct link between two objects, so a social network is a direct graph. In the same Figure, let  $O_i$  be an object in social network ( $i = 1...m$ ), and let  $E_j$  meaning direct link between two objects be a direct edge of the graph ( $j = 1...n$ ).

After definition of objects and direct edges, let also define reachable relation between two objects. There are two kinds of reachable relation among objects, shown as following:

- (a) One-step reachable relation: if there exists a direct link from  $O_i$  to  $O_j$  through one and only one direct edge, then  $O_i$  to  $O_j$  is a one-step reachable relation. For instance in Figure [Social LMS Components](#) there exists a direct link from  $O_1$  to  $O_2$  through the direct edge  $E_1$ ,  $O_1$  to  $O_2$  is one-step reachable relation.
- (b) Multi-steps reachable relation: if there exists a direct link from  $O_i$  to  $O_j$  through two or more direct edges, then  $O_i$  to  $j$  is a multi-steps reachable relation.

For instance in Figure [A sample of social network](#) has a direct link from O1 to O4 through direct edges E1 and E5, then O1 to O4 is a 2-steps reachable relation.

To Generate edge creation matrix and edge pointed matrix, we can consume the following steps. The Figure [Example of graph theory](#) shows an example of a graph that will have graph theory applied upon. First according to the objects and edges in the graph, define two matrixes Lc and Lp. Let Lc be a  $m \times n$  matrix which means the creation of edges. In the matrix,  $L_c(i, j) = 1$  denotes object  $O_i$  connects with the tail of edge  $E_j$ , which means that object  $O_i$  creates the direct edge  $E_j$ .  $L_c(i, j) = 0$  denotes  $O_i$  doesn't connect with the tail of edge  $E_j$ , which means  $E_j$  isn't created by object  $O_i$ .

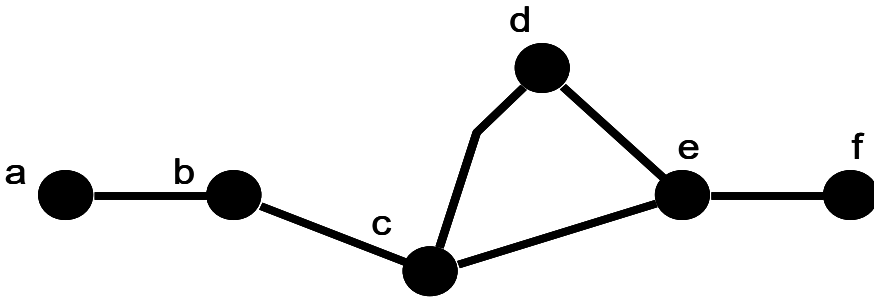

Figure 15: Example of graph theory

|   | a | b | c | d | e | f |
|---|---|---|---|---|---|---|
| A | 0 | 1 | 0 | 0 | 0 | 0 |
| B | 1 | 0 | 1 | 0 | 0 | 0 |
| C | 0 | 1 | 0 | 1 | 1 | 0 |
| D | 0 | 0 | 1 | 0 | 1 | 0 |
| E | 0 | 0 | 1 | 1 | 0 | 1 |
| F | 0 | 0 | 0 | 0 | 1 | 0 |

Table 5: Adjacency matrix for graph in Figure above

### Experimental Results and Comments on Results

We have developed an Excel package to be utilized for calculating neutrosophic data and analyze them. We have used Excel as it is a powerful tool that is widely accepted and used for statistical analysis. The Figure [Neutrosophic Package Class Diagram](#) shows Class Diagram of the implemented package. The Figure [Neutrosophic Package Interface and Calculating Complement](#) presents a working example of the package interface calculating the complement. Our implemented neutrosophic package can calculate intersection, union, and complement of the neutrosophic set. The Figure [Neutrosophic Chart](#) presents our neutrosophic package capability to draw figures of presented neutrosophic set. The Figure [Neutrosophic Package Union Chart](#) presents charting of union operation calculation, and the Figure [Neutrosophic Package Intersection Chart](#), the intersection operation.

The neutrosophic set are characterized by its efficiency as it takes into consideration the three data items: True, Intermediate, and False. It is believed that integrating neutrosophic calculation in e-Learning will yield more accurate results in the overall learning process for different activities as will be followed in the future work.

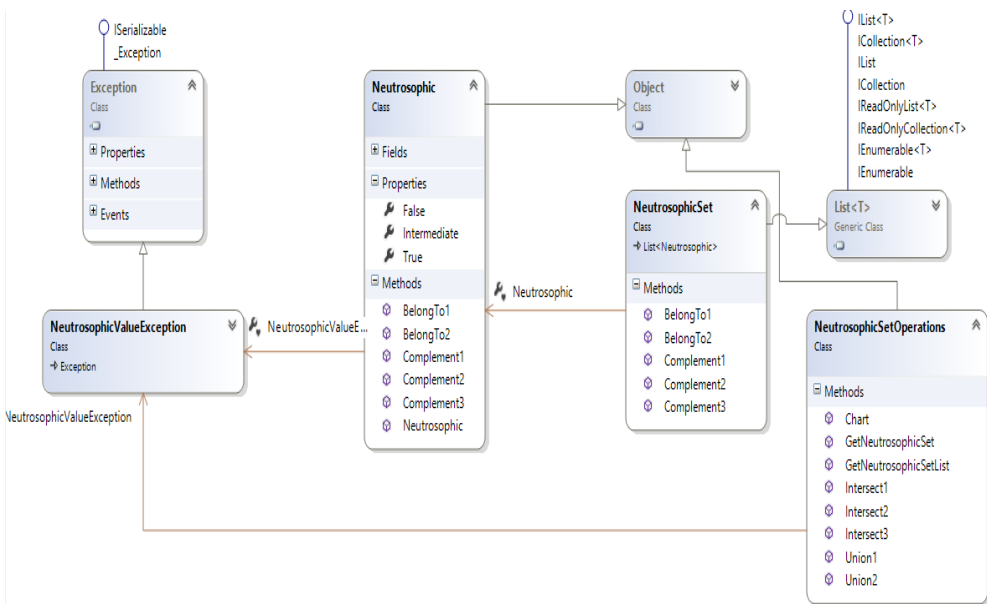

Figure 16: Neutrosophic Package Class Diagram

The screenshot shows the Microsoft Excel interface with the 'Neutrosophic' ribbon selected. The active cell is A2, containing the formula  $\{.2,.3,.4\}$ . The table below shows the results of calculating the complement for various neutrosophic sets.

|    | A              | B | C | D | E | F                 | G                 | H                 |
|----|----------------|---|---|---|---|-------------------|-------------------|-------------------|
| 1  | $\{.2,.3,.4\}$ |   |   |   |   | Complement may be | Complement may be | Complement may be |
| 2  | $\{.5,.3,.8\}$ |   |   |   |   | 0.8,0.7,0.6       | 0.4,0.3,0.2       | 0.4,0.3,0.2       |
| 3  | $\{.9,.8,.5\}$ |   |   |   |   | 0.5,0.7,0.2       | 0.8,0.3,0.5       | 0.8,0.3,0.5       |
| 4  | $\{.2,.5,.6\}$ |   |   |   |   | 0.1,0.2,0.5       | 0.5,0.8,0.9       | 0.5,0.8,0.9       |
| 5  | $\{.5,.9,.8\}$ |   |   |   |   | 0.8,0.5,0.4       | 0.6,0.5,0.2       | 0.6,0.5,0.2       |
| 6  | $\{.1,.7,.5\}$ |   |   |   |   | 0.5,0.1,0.2       | 0.8,0.9,0.5       | 0.8,0.9,0.5       |
| 7  | $\{.3,.7,.4\}$ |   |   |   |   | 0.9,0.3,0.5       | 0.5,0.7,0.1       | 0.5,0.7,0.1       |
| 8  | $\{.5,.8,.9\}$ |   |   |   |   | 0.7,0.3,0.6       | 0.4,0.7,0.3       | 0.4,0.7,0.3       |
| 9  | $\{.8,.6,.1\}$ |   |   |   |   | 0.5,0.2,0.1       | 0.9,0.8,0.5       | 0.9,0.8,0.5       |
| 10 | $\{.5,.7,.6\}$ |   |   |   |   | 0.2,0.4,0.9       | 0.1,0.6,0.8       | 0.1,0.6,0.8       |
| 11 |                |   |   |   |   | 0.5,0.3,0.4       | 0.6,0.7,0.5       | 0.6,0.7,0.5       |

Figure 17: Neutrosophic Package Interface and Calculating Complement

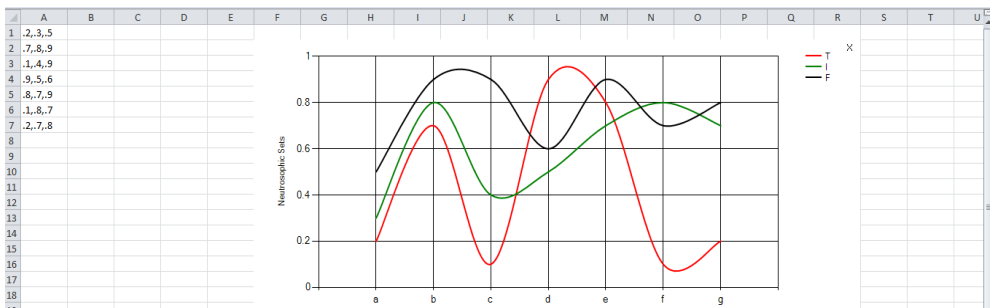

Figure 18: Neutrosophic Chart

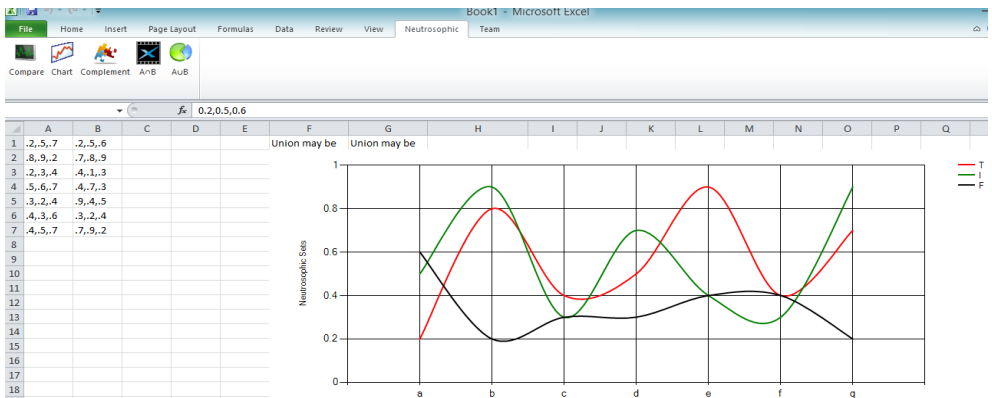

Figure 19: Neutrosophic Package Union Chart

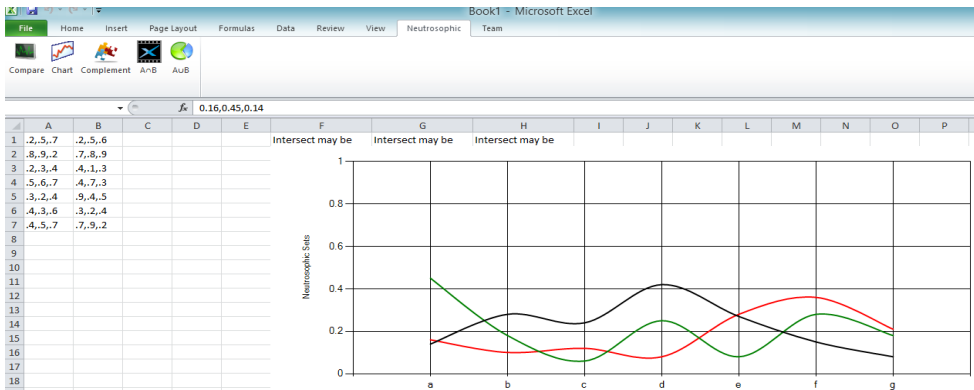

Figure 20: Neutrosophic Package Intersection Chart

### Conclusion and Future Work

e-Learning is moving rapidly towards integrating social network activities in presented enhanced learning experience to students. Social Networks are dominating nowadays, and students spend long times there. In this section, we presented an effective e-Learning model that integrates social networks activities in e-Learning. We have presented an effective e-Learning system that utilizes the newly presented Neutrosophic Setting analysis of social network data integrated in e-Learning. Identifying relationships between students is important for learning. Future work include incorporating the results we have achieved in customizing course contents to students, and recommending new learning objects more suitable for personalized learning.

### 7.5 Some Neutrosophic Topological Notions of Neutrosophic Region

In Geographical information systems (GIS) there is a need to model spatial regions with indeterminate boundary and under indeterminacy. This section gives fundamental concepts and properties of a neutrosophic spatial region. We introduce a new theoretical framework.

*For the start, let us add some further definitions and propositions for a neutrosophic topological region.*

#### Corollary A.7.4.1

Let  $A = \langle \mu_A(x), \sigma_A(x), \nu_A(x) \rangle$  and  $B = \langle \mu_B(x), \sigma_B(x), \nu_B(x) \rangle$  be two neutrosophic sets on a neutrosophic topological space  $(X, \tau)$  then the following holds:



- i)  $N\text{int}(A) \cap N\text{int}(B) = N\text{int}(A \cap B),$
- ii)  $Ncl(A) \cup Ncl(B) = N\text{int}(A \cup B),$
- iii)  $N\text{int}(A) \subseteq A \subseteq Ncl(A),$
- iv)  $(N\text{int}(A))^c = Ncl(A^c), (Ncl(A))^c = N\text{int}(A^c) .$

**Definition A.7.4.1**

We define the neutrosophic boundary (NB) of a neutrosophic set  $A = \langle \mu_A(x), \sigma_A(x), \nu_A(x) \rangle$  by:  $\partial A = Ncl(A) \cap Ncl(A^c)$ .

The following theorem shows that the intersection method no longer guarantees a unique solution.

**Corollary A.7.4.2**

$\partial A \cap N\text{int}(A) = O_N$  if  $N\text{int}(A)$  is crisp, i.e.  $N\text{int}(A) = O_N$  or  $N\text{int}(A) = 1_N$ .

**Proof**

Obvious.

**Definition A.7.4.2**

Let  $A = \langle \mu_A(x), \sigma_A(x), \nu_A(x) \rangle$  be a neutrosophic set in a neutrosophic topological space  $(X, \tau)$ . Suppose that the family of neutrosophic open sets contained in A is indexed by the family  $\langle \mu_{G_i}(x), \sigma_{G_i}(x), \nu_{G_i}(x) \rangle: i \in I$  and the family of neutrosophic open subsets containing A is indexed by the family  $\langle \mu_{K_j}(x), \sigma_{K_j}(x), \nu_{K_j}(x) \rangle: j \in J$ . Then two neutrosophic interior, closer and boundaries, are defined as it follows:

- 1.  $N\text{int}(A)_{[\ ]}$  may be defined as two types

Type 1.  $N\text{int}(A)_{[\ ]} = \langle \max(\mu_{G_i}(x)), \max(\sigma_{G_i}(x)), \min(1 - \mu_{G_i}(x)) \rangle$

Type 2.  $N\text{int}(A)_{[\ ]} = \langle \max(\mu_{G_i}(x)), \min(\sigma_{G_i}(x)), \min(1 - \mu_{G_i}(x)) \rangle$

- 2.  $N\text{int}(A)_{< >}$  may be defined as two types

Type 1.  $N\text{int}(A)_{< >} = \langle \max(1 - \nu_{G_i}(x)), \max(\sigma_{G_i}(x)), \min(\nu_{G_i}(x)) \rangle$

Type 2.  $N\text{int}(A)_{< >} = \langle \max(1 - \nu_{G_i}(x)), \min(\sigma_{G_i}(x)), \min(\nu_{G_i}(x)) \rangle$

- 3.  $Ncl(A)_{[\ ]}$  may be defined as two types

Type 1.  $Ncl(A)_{[\ ]} = \langle \max(\mu_{K_j}(x)), \min(\sigma_{K_j}(x)), \max(1 - \mu_{K_j}(x)) \rangle$

Type 2.  $Ncl(A)_{[ ]} = \langle \max(\mu_{K_j}(x)), \max(\sigma_{K_j}(x)), \max(1 - \mu_{K_j}(x)) \rangle$

4.  $Ncl(A)_{< >}$  may be defined as two types

Type 1.  $Ncl(A)_{< >} = \langle \min(1 - \nu_{K_i}(x)), \min(\sigma_{G_i}(x)), \max(\nu_{G_i}(x)) \rangle$

Type 2  $Ncl(A)_{< >} = \langle \min(1 - \nu_{K_i}(x)), \max(\sigma_{G_i}(x)), \max(\nu_{G_i}(x)) \rangle$ .

5. The neutrosophic boundaries may be defined as:

$$\partial A_{[ ]} = Ncl(A_{[ ]}) \cap Ncl(A^c_{[ ]})$$

$$\partial A_{< >} = Ncl(A_{< >}) \cap Ncl(A^c_{< >})$$

**Proposition A.7.4.1**

- (a)  $Nint(A)_{[ ]} \subseteq Nint(A) \subseteq Nint(A)_{< >}$ ,
- (b)  $Ncl(A)_{[ ]} \subseteq Ncl(A) \subseteq Ncl(A)_{< >}$
- (c)  $Nint(A_{\{ [ ], < > \}}) = \{ [ ], < > \} Nint(A)$  and  
 $Ncl(A_{\{ [ ], < > \}}) = \{ [ ], < > \} Ncl(A)$

**Proof**

We shall only prove (c), and the others are obvious.

$$[ ] Nint(A) = \langle \max(\mu_{G_i}(x)), \max(\sigma_{G_i}(x)), (1 - \max \mu_{G_i}(x)) \rangle$$

$$\text{or} = \langle \max(\mu_{G_i}(x)), \min(\sigma_{G_i}(x)), (1 - \max \mu_{G_i}(x)) \rangle$$

Based on knowing that  $(1 - \max \mu_{G_i}(x)) = \min(1 - \mu_{G_i}(x))$  then

$$[ ] Nint(A) = \langle \max(\mu_{G_i}(x)), \max(\sigma_{G_i}(x)), \min(1 - \mu_{G_i}(x)) \rangle$$

$$\text{or} \langle \max(\mu_{G_i}(x)), \min(\sigma_{G_i}(x)), \min(1 - \mu_{G_i}(x)) \rangle = [ ] Nint(A)$$

In a similar way one can prove the others.

**Proposition A.7.4.2**

$$Nint(A_{\{ [ ], < > \}}) = (Nint(A))_{\{ [ ], < > \}}$$

$$Ncl(A_{\{ [ ], < > \}})_{\{ [ ], < > \}} = (Ncl(A))_{\{ [ ], < > \}}$$

**Proof**

Obvious.

**Definition A.7.4.3**

Let  $A = \langle \mu_A(x), \sigma_A(x), \nu_A(x) \rangle$  be a neutrosophic set in a neutrosophic topological space  $(X, \tau)$ . We define neutrosophic exterior of A as it follows:

$$A^{NE} = 1_N \cap A^C.$$

**Definition A.7.4.4**

Let  $A = \langle \mu_A(x), \sigma_A(x), \nu_A(x) \rangle$  be a neutrosophic open set, and  $B = \langle \mu_B(x), \sigma_B(x), \nu_B(x) \rangle$  be a neutrosophic set in a neutrosophic topological space  $(X, \tau)$ , then:

- 1) A is called a neutrosophic regular open if  $A = N \text{int}(Ncl(A))$ .
- 2) If  $B \in NCS(X)$  then B is called a neutrosophic regular closed if  $A = Ncl(N \text{int}(A))$ .

*Now, we obtain a formal model for simple spatial neutrosophic region based on neutrosophic connectedness.*

**Definition A.7.4.5**

Let  $A = \langle \mu_A(x), \sigma_A(x), \nu_A(x) \rangle$  be a neutrosophic sets on a neutrosophic topological space  $(X, \tau)$ . A is called a simple neutrosophic region in connected NTS, such that:

- $Ncl(A)$ ,  $Ncl(A)_{[\ ]}$ , and  $Ncl(A)_{< >}$  are neutrosophic regular closed;
- $N \text{int}(A)$ ,  $N \text{int}(A)_{[\ ]}$ , and  $N \text{int}(A)_{< >}$  are neutrosophic regular open;
- $\partial(A)$ ,  $\partial(A)_{[\ ]}$ , and  $\partial(A)_{< >}$  are neutrosophically connected, having:
- $Ncl(A)$ ,  $Ncl(A)_{[\ ]}$ ,  $Ncl(A)_{< >}$ ,  $N \text{int}(A)$ ,  $N \text{int}(A)_{[\ ]}$ ,  $N \text{int}(A)_{< >}$ ,

which are  $\partial(A)$ ,  $\partial(A)_{[\ ]}$ , and  $\partial(A)_{< >}$  for two neutrosophic regions, so we are able to find relationships between two neutrosophic regions.

## Graphs: The Relation between Neutrosophic Notions and Fuzzy Notions

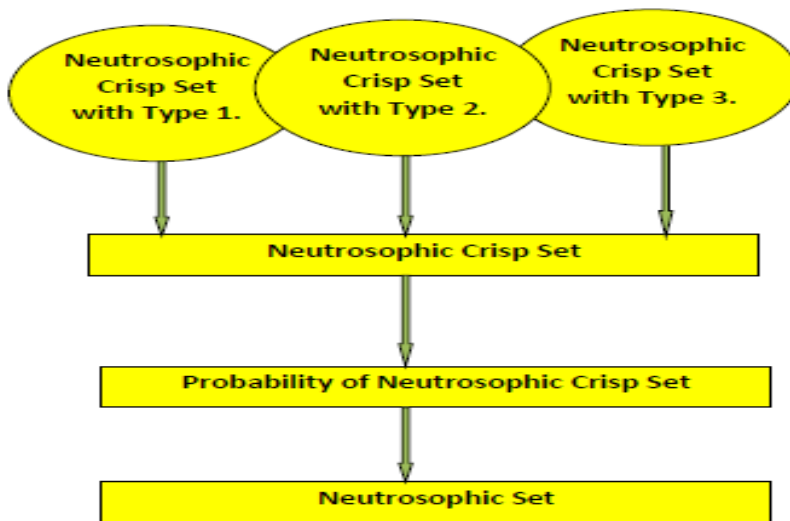
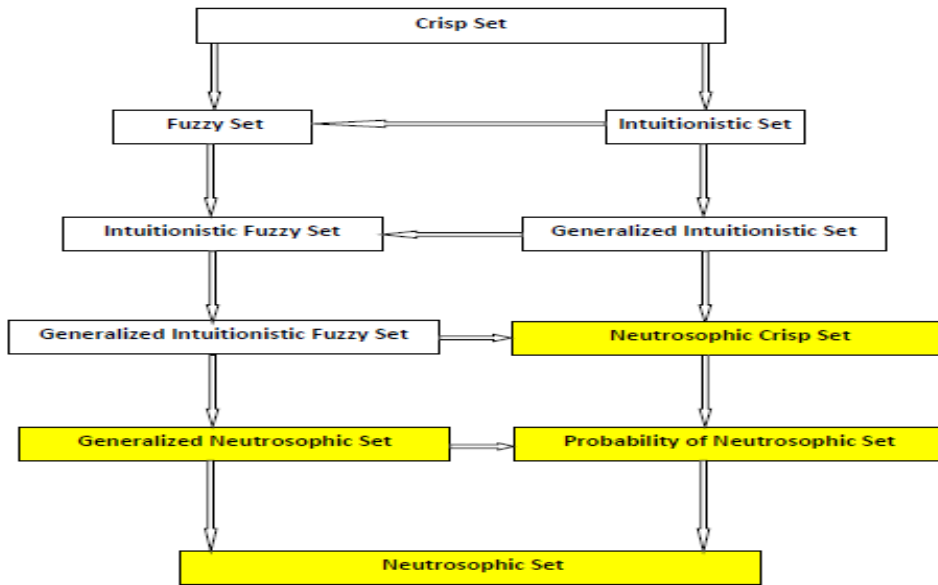

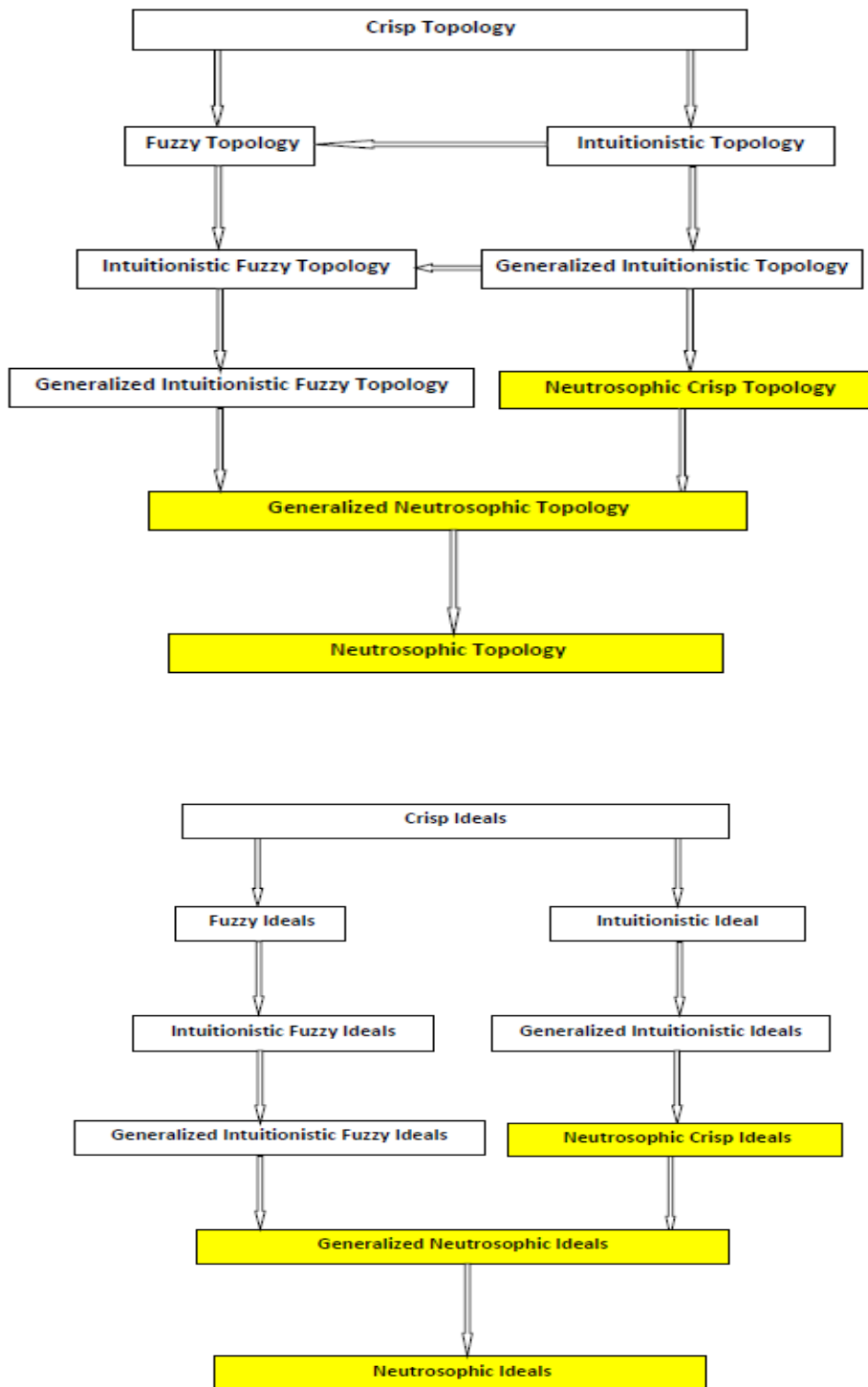

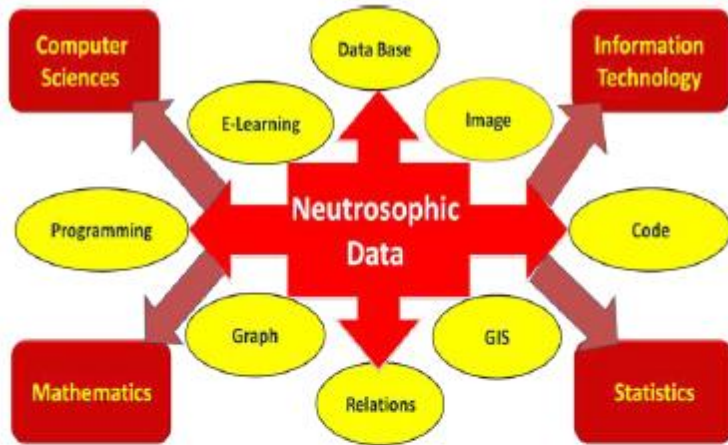

**Neutrosophic Package**

| <i>Programming</i>                | <i>Math</i>            | <i>Statistics</i>     | <i>GIS Rules</i> |
|-----------------------------------|------------------------|-----------------------|------------------|
| Neutrosophic Charts               | Neutrosophic Events    | Neutrosophic Topology |                  |
| Neutrosophic Operations           | Neutrosophic Relations | Neutrosophic Ideals   |                  |
| Neutrosophic Statistical Analysis | Neutrosophic Matrices' | Neutrosophic Filters  |                  |

## List of Figures

|  |     |
|--|-----|
| Figure 1. Venn diagram represents the relation between NCSs.....   | 31  |
| Figure 2: A geometrical neutrosophic interpretation .....  | 55  |
| Figure 3: A three-dimension representation of a Neutrosophic Set....   | 56  |
| Figure 4: Neutrosophic Crisp Topological Spaces are generalizations<br>of topological spaces and intuitionistic topological spaces ..... | 66  |
| Figure 5: Asymmetric Key encryption / decryption.....  | 140 |
| Figure 6: Membership function, non-membership and indeterminacy<br>of Neutrosophic Set with variable $n$ . .....                         | 142 |
| Figure 7: Key Distribution: (a) SK Request (b) SK Response .....   | 144 |
| Figure 8: The Neutrosophic Average Percentage Security Level .....   | 146 |
| Figure 9: Neutrosophic Key Creation Time .....   | 147 |
| Figure 10: Neutrosophic Security Data of PKI.....  | 148 |
| Figure 11: Processing Time of Neutrosophic Data PKI.....   | 149 |
| Figure 12: Social LMS Components .....   | 161 |
| Figure 13: Traditional e-Learning Activities .....   | 162 |
| Figure 14: A sample of social network .....  | 163 |
| Figure 15: Example of graph theory .....   | 164 |
| Figure 16: Neutrosophic Package Class Diagram.....   | 165 |
| Figure 17: Neutrosophic Package Interface and Calculating<br>Complement .....  | 166 |
| Figure 18: Neutrosophic Chart .....  | 166 |
| Figure 19: Neutrosophic Package Union Chart .....  | 166 |
| Figure 20: Neutrosophic Package Intersection Chart .....   | 167 |

## References

- [1] M.E. Abd EL-Monsef and M.H. Ghanim, *On semi open fuzzy sets*, Delta J. Sci. 5, 1981, pp. 30-40.
- [2] M.E. Abd EL-Monsef, E.F. Lashien and A.A. Nasef, *Remarks on the \*-topology*, Tamkang, J. Math.,24(1), 1993, pp. 9-22.
- [3] M.E. Abd EL-Monsef, E.F. Lashien and A.A. Nasef, *On I-open Sets and I-continuous functions*, Kyungpook, Math. J. V (32) No.1, 1992, pp. 21-30.
- [4] M.E. Abd EL-Monsef, R.A.Mahmoud and A.A.Nasef, *On quasi I-openness and quasi I-continuity*, Tamkang, J. Math., V (31) No. 4.2, 2000, pp. 101-108.
- [5] M.E.Abd EL-Monsef, A.A.Nasef and A. A. Salama, *Extensions of Fuzzy Ideals*, Bull. Cal. Math. Soc., 92, (3), 2000, pp. 181-188.
- [6] M.E. Abd EL-Monsef, A. A. Nasef and A. A. Salama, *Some fuzzy topological operators via fuzzy ideals*, Chaos Solitons & Fractals 12, 2001, pp. 2509-2515.
- [7] M. E. Abd EL-Monsef, A. A. Nasef and A. A. Salama, *Fuzzy L-open sets and fuzzy L-continuous functions*, Proc.of The First Saudi Science Conference, KFUPM, Vol. 3, 9-11 April 2001, pp. 457-465.
- [8] K.K. Azad, *On fuzzy semi continuity, fuzzy almost continuity and fuzzy weakly continuity*, J. Math. Anal. Appl., 82, 1981, pp. 24-32.
- [9] R.Badard, *Fuzzy pretopological spaces and their representations*, J. Math Anal. Appl., 81, 1981, pp. 378 -390.
- [10] R.N.Bahaumik and Makherjee, *Fuzzy weakly completely continuous functions*, Fuzzy Sets and Systems, 55, 1993, pp. 347-354.
- [11] N. Blasco, M. Mardones and M.A. Deprada Vicente, *On fuzzy compactifications*, Fuzzy Sets and Systems, 43, 1991, pp. 189-197.
- [12] C.L. Chang, *Fuzzy Topological Spaces*, J. Math. Anal. Appl., 245, 1968, pp. 182-190.
- [13] M.K. Chakroborty and T.M.G. Ahsanullah, *Fuzzy topology on fuzzy sets and tolerance topology*, Fuzzy Sets and Systems, 45, 1992, pp. 103-108.
- [14] M.K. Chakroborty and T.M.G. Ahsanullah, *Fuzzy topology on fuzzy sets and tolerance topology*, Fuzzy Sets and Systems, 45, 1991, pp. 189-197.
- [15] F.T. Christoph, *Quotient fuzzy topology and local compactness*, J.Math. Anal. Appl., 57, 1977, pp. 497-504.
- [16] A. Diconilio and Gerla, *Almost compactness in fuzzy topological spaces*, Fuzzy Sets and Systems, 13, 1984, pp. 187-192.



- [17] H. Driankov, D.H. Hellendoorn and M. Reinfrank, *An Introduction to fuzzy Control*, Springer-Verlag, New York, 1993.
- [18] T.E. Gonter, R.S. Steinlage and R.H. Warren, *Compactness in fuzzy topological spaces*, J.Math. Anal. Appl., 62, 1978, pp. 547-562.
- [19] L.O.Hall and A.Kandel, *Designing Fuzzy Expert Systems*, Verlag TUV Rheinland, Cologne, Germany, 1986.
- [20] T.R. Hamlett and D.Jankovic, *Ideals in topology*, Marcel Dekker Lecture Notes Series, Proc. of the Northeast Conference on General Topology and its Applications, Vol. 123, 1990, pp. 115-125.
- [21] T.R.Hamlett and D. Jankovic, *Compactness with respect to anideal*, Boll. V.M., I, 7, 4-B, 1990, pp. 849 – 861.
- [22] T.R. Hamlett and D.Rose, *\*-topological properties*, Internat. J.Math, and Math Sci., Vol.13, No. 3, 1990, pp.507-512.
- [23] T.R. Hamlett and D. Jankovic, *New topologies from old via ideals*, Amer.Math. Monthly, 97 No. 4, 1990, pp. 295-310.
- [24] T.R. Hamlett and D.Jankovic, *The ideal generated by codense sets and the Banach localization property*, to appear in the proc. of the Colloquium on Topology, Hungary, 1990. North-Holland Publishing Co.
- [25] A. HaydarEs, *Almost compactness and near compactness in fuzzy topological spaces*, Fuzzy Sets and Systems, 3, 1980, pp. 93-104.
- [26] B.Hutlon and I.Reily, *Separation axioms in fuzzy topological spaces*, Fuzzy Sets and Systems, 3, 1980, pp. 93-104.
- [27] G.J.Klir and B.Yuan, *Fuzzy Sets and Fuzzy Logic: Theory and Applications*. Prentice Hall PTR, Upper Saddle River, NJ 07458, 1995.
- [28] G.J.Klir, U.S.Clair and B.Yuan, *Fuzzy set theory. Foundations and applications*, Prentice Hall International, inc., 1997.
- [29] B. Kosko, *Fuzzy thinking*, Flamingo, Glasgow, 1994.
- [30] K.Kuratowski, *Topologies I*, Warszawa, 1933.
- [31] K.Kuratowski, *Topologies, Vol. 1*, Academic Press, New York, 1966.
- [32] E.E.Lashien and A.A.Nasef, *On ideals in general topology*, To appear in Delta Journal of Science.
- [33] R. Lowen, *Fuzzy topological spaces and compactness*, J.Math. Anal. Appl.56, 621-633, 1976.
- [34] G.D.Maio and T.Noiri, *On s-closed spaces*, Indian J.Pure. Appl. Math. 18 (3) 1987, pp. 226-233.
- [35] T. Newcomb, *Topologies which are compact modulo an ideal*, Ph.D. dissertation, Univ. of Cal. at Santa Barbara, 1967.

- [36] P.M.Pu and Y.M. Liu, *Fuzzy Topology, I. Neighborhood structure of fuzzy point and Moore smith convergence*, J. Math. Anal. Appl. 76, 1980, pp. 571-599.
- [37] D.V.Rancin, *Compactness modulo an ideal*, Soviet Math. Dok., 1., Vol. 13, No.1, 1972, pp. 193-197.
- [38] S. E. Rodobugh, *The Hausdorff separation axioms for fuzzy topological spaces, General topology and its applications II*, 1980, pp. 319-334.
- [39] T.J. Roos, *Fuzzy Logic with Engineering Applications*, McGraw Hill, New York, 1995.
- [40] D. Sarkar, *Fuzzy ideal theory, Fuzzy local function and generated fuzzy topology*, Fuzzy Sets and Systems, 87, 1997, pp. 117-123.
- [41] S.P.Sinha, *Separation axioms in fuzzy topological spaces*, Fuzzy Sets and Systems, 45, 1992, pp. 261-270.
- [42] Vaidyanathaswamy, *The localization Theory in set topology*, Proc.Indian Acad.Sci., 20, 1945, pp. 51-61.
- [43] Vaidyanathaswamy, *Set Topology*, Chelsea, New York, 1960.
- [44] R.H.Warren, *Continuity of mappings of fuzzy topological spaces*, Notices Amer.Math.Soc., 21, 1974, A-451.
- [45] R.H.Warren, *Boundary of a fuzzy set*, Indian Univ.Math.J., 26, 1977, pp. 191-197.
- [46] R.H.Warren, *Neighbourhoods, bases and continuity in fuzzy topological spaces*, Rocky Mountain J. Math. 8, 1978, pp. 459-470.
- [47] C.K.Wong, *Covering properties of fuzzy topological spaces*, J. Math. Anal. Appl. 43, 1973, pp. 697-704.
- [48] C.K. Wong, *Fuzzy point and local properties of fuzzy topology*, J. Math. Anal. Appl. 46, 1974, pp. 316-328.
- [49] R.R.Yager, S.Ovchinnikov, R.M.Tong and H.T. Nguyen (editors). *Fuzzy Sets and Applications. Selected Papers*, by L.A. Zadeh, John Wiley, New York, 1987.
- [50] T.H.Yalvic, *Fuzzy sets and functions on fuzzy spaces*, J. Math. Anal. Appl., 126, 1987, pp. 409-423.
- [51] L.A. Zadeh, *Fuzzy Sets, Inform and Control*, 8, 1965, pp. 338- 353.
- [52] L.Zhongfu, *Compactness in fuzzy topological spaces*, Kexue Tongbau 29, 1984, pp. 582-585.
- [53] H.J. Zimmermann, *Fuzzy Sets Decision Making, and Expert Systems*, Kluwer, Boston, MA, USA, 1987.
- [54] H.J. Zimmermann, *Fuzzy Sets Theory and Its Applications*, 2nd rev. ed., Kluwer, Boston MA, 1991.

- [55] K. Atanassov, *Intuitionistic Fuzzy Sets*, in V.Sgurev, ed., VII ITKRS Session, Sofia, June 1983, Central Sci. and Techn. Library, Bulg. Academy of Sciences, 1984.
- [56] K. Atanassov, *Intuitionistic Fuzzy Sets*, *Fuzzy Sets and Systems* 20, 87-96, 1986.
- [57] K. Atanassov, *Review and new result on intuitionistic fuzzy sets*, preprint IM-MFAIS-1-88, Sofia, 1988.
- [58] A. A. Salama and S. A. Alblowi, *Intuitionistic Fuzzy Ideals Spaces*, *Advances in Fuzzy Mathematics*, Vol. (7), Number 1, 2012, pp. 51- 60.
- [59] S. A. Alblowi, A. A. Salama, Mohamed Eisa, *New Concepts of Neutrosophic Sets*, *International Journal of Mathematics and Computer Applications Research (IJMCAR)*, Vol. 4, Issue 1, 2014, pp. 59-66.
- [60] I. M. Hanafy, A.A. Salama and K. Mahfouz, *Correlation of Neutrosophic Data*, *International Refereed Journal of Engineering and Science (IRJES)*, Vol. (1), Issue 2, 2012, pp. 39-33.
- [61] I. M. Hanafy, A. A. Salama and K.M. Mahfouz, *Neutrosophic Classical Events and Its Probability*, *International Journal of Mathematics and Computer Applications Research (IJMCAR)* Vol.(3), Issue 1, Mar. 2013, pp. 171-178.
- [62] A. A. Salama and S.A. Alblowi, *Generalized Neutrosophic Set and Generalized Neutrosophic Spaces*, *Journal Computer Sci. Engineering*, Vol. (2) No. (7), 2012, pp. 129-132.
- [63] A. A. Salama and S. A. Alblowi, *Neutrosophic Set and Neutrosophic Topological Spaces*, *ISOR J. Mathematics*, Vol.(3), Issue (3), 2012, pp-31-35.
- [64] A. A. Salama, *Neutrosophic Crisp Point & Neutrosophic Crisp Ideals*, *Neutrosophic Sets and Systems*, Vol. 1, No. 1, 2013, pp. 50-54.
- [65] A. A. Salama and F. Smarandache, *Filters via Neutrosophic Crisp Sets*, *Neutrosophic Sets and Systems*, Vol. 1, No. 1, 2013, pp. 34-38.
- [66] A.A. Salama, and H. Elagamy, *Neutrosophic Filters*, *International Journal of Computer Science Engineering and Information Technology Research (IJCSEITR)*, Vol.3, Issue (1), Mar 2013, pp 307-312.
- [67] A. A. Salama, F. Smarandache and Valeri Kroumov, *Neutrosophic crisp Sets & Neutrosophic crisp Topological Spaces*, *Bulletin of the Research Institute of Technology, Okayama University of Science, Japan*, in January-February 2014.
- [68] A. A. Salama, Mohamed Eisa and M. M. Abdelmoghny, *Neutrosophic Relations Database*, *International Journal of Information Science and Intelligent System*, 3(1), 2014.

- [69] A. A. Salama, Florentin Smarandache and S. A. Alblawi, *New Neutrosophic Crisp Topological Concepts*, Neutrosophic Sets and Systems, Vol. 2, No. 1, 2014.
- [70] A.A.Salama, *The Concept of Neutrosophic Set and Basic Properties of Neutrosophic Set Operations*, WASET 2012 PARIS, FRANC, International University of Science, Engineering and Technology,2012.
- [71] Florentin Smarandache, *Neutrosophy and Neutrosophic Logic*, First International Conference on Neutrosophy, Neutrosophic Logic, Set, Probability, and Statistics, University of New Mexico, Gallup, NM 87301, USA, 2002.
- [72] F. Smarandache, *A Unifying Field in Logics: Neutrosophic Logic. Neutrosophy, Neutrosophic Set, Neutrosophic Probability*. American Research Press, Rehoboth, NM, 1999.
- [73] F. Smarandache, *Neutrosophic Set, A Generalization of The Intuitionistics Fuzzy Sets*, Inter. J. Pure Appl. Math., 24, pp. 287 – 297, 2005.
- [74] Florentin Smarandache (2013), *Introduction to Neutrosophic Measure, Neutrosophic Integral, And Neutrosophic Probability*, <http://fs.gallup.unm.edu/eBooks-otherformats.htm>
- [75] I.M. Hanafy, A.A. Salama , M. Abdelfattah and Y.M.Wazery, *AIS Model For Botnet Detection In MANET Using Fuzzy Function*, International Journal of Computer Networking, Wireless and Mobile Communications (IJCNWMC) ISSN 2250-1568 ,Vol. 3, Issue 1, Mar 2013, 95-102.2013.
- [76] I.M.Hanafy, A.A. Salama , M. Abdelfattah and Y.Wazery,*Security in MANET Based on Pki using Fuzzy Function*, IOSR Journal of Computer Engineering, Vol.(6), Issue 3 (Sep-Oct. 2012), pp. 54-60, 2012.
- [77] A. W. Stallings, *Cryptography and Network Security: Principles and Practice*, 9th Edition; Prentice Hall, 2010.
- [78] A. Rajaram, S. Vaithiyalingam. *Distributed Adaptive Clustering Algorithm for Improving Data Accessibility in MANET*. IJCSI International Journal of Computer Science Issues, Vol. 8, Issue 4, No 1, July 2011.
- [79] S. Balachandran, D. Dasgupta and L. Wang. *Hybrid Approach for Misbehavior Detection in Wireless Ad-Hoc Networks*. Published in Symposium on Information Assurance, New York, and June 14-15, 2006.
- [80] A. Rajaram, S. Palaniswami. *The Modified Security Scheme for Data Integrity in Manet*. International Journal of Engineering Science and Technology. Vol. 2(7), 2010, pp. 3111-3119.
- [81] C. Balakrishnan, V. Varadharajan, U. K. Tupakula, and P. Lucs, *Trust Integrated Cooperation Architecture for Mobile Ad-hoc Networks*, Proceedings of 4th IEEE International Symposium on Wireless Communication Systems (ISWCS 2007), Trondheim, Norway, 2007.

- [82] A. Srinivasan, J. Teitelbaum, H. Liang, J. Wu, and M. Cardei, *Reputation and Trust-Based Systems for Ad-hoc and Sensor Networks*, Algorithms and Protocols for Wireless Ad-hoc and Sensor Networks, A. Boukerche (ed.), Wiley & Sons, 2011.
- [83] K. Seshadri Ramana et al. *Trust Based Security Routing in Mobile Adhoc Networks*, (IJCSE) International Journal on Computer Science and Engineering, Vol. 02, No. 02, 2010, pp. 259-263.
- [84] Yan L. Sun, Wei Yu, *Information Theoretic Framework of Trust Modeling and Evaluation for Ad Hoc Networks*, 2006 IEEE, pp. 305-317.
- [85] Er. Banita Chadhaa, Er. Zatin Gupta, *Security Architecture for Mobile Adhoc Networks* (IJAEST) International Journal of Advanced Engineering Sciences and Technologies, No. 9, 2011, pp 101 – 104.
- [86] F. L. Bauer, *Decrypted Secrets: Methods and Maxims of Cryptology*, Springer, Secaucus, NJ, USA, 9th edition, 2009.
- [87] Dabrowski J. and Kubale M., *Computer Experiments with a Parallel Clonal Selection Algorithm for the Graph Coloring Problem*. IEEE International Symposium on Parallel and Distributed Processing (IPDPS 2008), 14-18 April, Miami, FL, USA, pp.1-6.
- [88] Rajaram A and Palaniswami S, *A Trust-Based Cross-Layer Security Protocol for Mobile Ad hoc Networks*, International Journal of Computer Science and Information Security, Vol. 6, No. 1, pp. 165 – 172, 2009.
- [89] Reza Azarderskhsh, Arash Reyhani-Masoleh. *Secure Clustering and Symmetric Key Establishment in Heterogeneous Wireless Sensor Networks*. EURASIP Journal on Wireless Communications and Networking, 2011.
- [90] K. Ren, S. Yu, W. Lou, and Y. Zhang, *Multi-user broadcast authentication in wireless sensor networks*, IEEE Transactions on Vehicular Technology, vol. 58, no. 8, pp. 4554–4564, 2009.
- [91] Eulalia Szmidt and Janus Koeprzyk, *Distance between intuitionistic fuzzy sets*, Fuzzy Sets and Systems, 114, 2000, pp. 505-518.
- [92] Debasis Sarker, *Fuzzy ideal theory, Fuzzy local function and generated fuzzy topology*, Fuzzy Sets and Systems 87, pp. 117 – 123, 1997.
- [93] L.A. Zadeh, *Fuzzy Sets*, Inform and Control 8, pp. 338-353, 1965.
- [94] Christensen, C. M., Horn, M. B., Johnson, C. W., *Disrupting Class: How Disruptive Innovation Will Change the Way the World Learns*, New York: McGraw-Hill, 2008.
- [95] Opoire, S., *Overview of Social Control Theories*. The Hewett School. Retrieved on: September 2, 2007.
- [96] Center of the American Experiment (2010). *Capital Solutions: Educational Freedom & Technology*. Retrieved March 30, 2012, from

- <http://www.amexp.org/publications/capitol-solutions/educational-freedom-technology>
- [97] The national Association of State Boards of Education. (2001). *Any Time, Any Place, Any Path, Any Pace: Taking the Lead on e-Learning Policy - The Report of the NASBE Study Group on e-Learning: The Future of Education*. Virginia.
- [98] Guralnick, D. (2007). *New Learning Methodologies and Tools for Corporate E-Learning*. Conference ICL2007, Retrieved March 15, 2012, from [http://telearn.archives-ouvertes.fr/docs/00/19/72/18/PDF/29\\_Final\\_Paper.pdf](http://telearn.archives-ouvertes.fr/docs/00/19/72/18/PDF/29_Final_Paper.pdf)
- [99] Fouler, N. (2010). *Which are the Favorite E-learning Authoring Tools?* Retrieved March 17, 2012, from <http://www.litmos.com/authoring-tools/which-are-the-favorite-elearning-authoring-tools/>
- [100] Christensen. C. M., Eyring. H. J. *The Innovative University: Changing the DNA of Higher Education from the Inside Out*. San Francisco, CA: Jossey-Bass, 2011.
- [101] Christensen. C. M., Eyring. H. J. *The Innovative University: Changing the DNA of Higher Education from the Inside Out* (Statement of Alan Young, leader of online course development at BYU-Idaho). San Francisco, CA: Jossey-Bass, 2011.
- [102] U.S. Department of Education. (2008) *Evaluating Online Learning: Challenges and Strategies for Success*. Retrieved March 18, 2012, from [http://www2.ed.gov/admins/lead/academic/evalonline/report\\_pg12.html](http://www2.ed.gov/admins/lead/academic/evalonline/report_pg12.html)
- [103] Lawrence, R. (2009). *E-Learning and Social Networking*. Retrieved March 28, 2012, from <http://ezinearticles.com/?E-Learning-and-Social-Networking&id=2811820>
- [104] Antal, B. T. (2007). *The Facebook Phenomenon*. Retrived March 28, 2012, from <http://www.seochat.com/c/a/Search-Engine-News/The-Facebook-Phenomenon/>
- [105] Mason, C. (2006). *Edge of Chaos - eLearning*. Retrieved March 28, 2012, from <http://scope.bccampus.ca/mod/forum/discuss.php?d=197>
- [106] Han J., Kamber M., *Data Mining: Concepts and Techniques*, 2nd edition, San Francisco: The Morgan Kaufmann Publishers, 2006.
- [107] Communications of the IIMA, Volume 7, Issue 4 "Social Network Analysis Based on BSP Clustering Algorithm", Gong Yu School of Business Administration China University of Petroleum, 2007.



---

*Since the world is full of indeterminacy, the Neutrosophics found their place into contemporary research. We now introduce for the first time the notions of Neutrosophic Crisp Sets and Neutrosophic Topology on Crisp Sets. We develop the 2012 notion of Neutrosophic Topological Spaces and give many practical examples.*

*Neutrosophic Science means development and applications of Neutrosophics Logic / Set / Measure / Integral / Probability etc. and their applications in any field. It is possible to define the Neutrosophic Measure and consequently the Neutrosophic Integral and Neutrosophic Probability in many ways, because there are various types of indeterminacies, depending on the problem we need to solve. Indeterminacy is different from randomness. Indeterminacy can be caused by physical space materials and type of construction, by items involved in the space, or by other factors.*

---

