

An ARISTOTELIAN
REALIST PHILOSOPHY
of MATHEMATICS

*Mathematics as the Science
of Quantity and Structure*

JAMES
FRANKLIN



Also by James Franklin

CORRUPTING THE YOUTH: A HISTORY OF PHILOSOPHY IN AUSTRALIA

PROOF IN MATHEMATICS: AN INTRODUCTION (*with A. Daoud*)

THE SCIENCE OF CONJECTURE: Evidence and Probability before Pascal

WHAT SCIENCE KNOWS: And How It Knows It

An Aristotelian Realist Philosophy of Mathematics

Mathematics as the Science of Quantity
and Structure

James Franklin

University of New South Wales, Sydney, Australia

© James Franklin 2014

All rights reserved. No reproduction, copy or transmission of this publication may be made without written permission.

No portion of this publication may be reproduced, copied or transmitted save with written permission or in accordance with the provisions of the Copyright, Designs and Patents Act 1988, or under the terms of any licence permitting limited copying issued by the Copyright Licensing Agency, Saffron House, 6–10 Kirby Street, London EC1N 8TS.

Any person who does any unauthorized act in relation to this publication may be liable to criminal prosecution and civil claims for damages.

The author has asserted his right to be identified as the author of this work in accordance with the Copyright, Designs and Patents Act 1988.

First published 2014 by
PALGRAVE MACMILLAN

Palgrave Macmillan in the UK is an imprint of Macmillan Publishers Limited, registered in England, company number 785998, of Houndmills, Basingstoke, Hampshire RG21 6XS.

Palgrave Macmillan in the US is a division of St Martin's Press LLC, 175 Fifth Avenue, New York, NY 10010.

Palgrave Macmillan is the global academic imprint of the above companies and has companies and representatives throughout the world.

Palgrave® and Macmillan® are registered trademarks in the United States, the United Kingdom, Europe and other countries

ISBN: 978–1–137–40072–7

This book is printed on paper suitable for recycling and made from fully managed and sustained forest sources. Logging, pulping and manufacturing processes are expected to conform to the environmental regulations of the country of origin.

A catalogue record for this book is available from the British Library.

A catalog record for this book is available from the Library of Congress.

Contents

<i>List of Figures</i>	ix
<i>List of Tables</i>	x
Introduction	1
Part I The Science of Quantity and Structure	
1 The Aristotelian Realist Point of View	11
The reality of universals	11
Platonism and nominalism	12
The reality of relations and structure	15
‘Unit-making’ properties and sets	16
Causality	17
Aristotelian epistemology	18
2 Uninstantiated Universals and ‘Semi-Platonist’ Aristotelianism	21
Determinables and determinates	22
Uninstantiated shades of blue and huge numbers	23
Possibles by recombination?	25
Semi-Platonist Aristotelianism	26
3 Elementary Mathematics: The Science of Quantity	31
Two realist theories of mathematics: quantity versus structure	31
Continuous quantity and ratios	34
Discrete quantity and numbers	36
Discrete quantity and sets	38
Discrete and continuous quantity compared	44
Defining ‘quantity’	45
4 Higher Mathematics: Science of the Purely Structural	48
The rise of structure in mathematics	48
Structuralism in recent philosophy of mathematics	49
Abstract algebra, groups, and modern pure mathematics	51
Structural commonality in applied mathematics	54
Defining ‘structure’	56
The sufficiency of mereology and logic	59
Is quantity a kind of structure?	63

5	Necessary Truths about Reality	67
	Examples of necessity	67
	Objections and replies	71
6	The Formal Sciences Discover the Philosophers' Stone	82
	A brief survey of the formal or mathematical sciences	83
	The formal sciences search for a place in the sun	89
	Real certainty: program verification	92
	Real certainty: the other formal sciences	95
	Experiment in the formal sciences	98
7	Comparisons and Objections	101
	Frege's limited options	101
	The Platonist/nominalist false dichotomy	104
	Nominalism	106
	Constructions in set theory	108
	Avoiding the question: what are sets?	110
	Overemphasis on the infinite	111
	Measurement and the applicability of mathematics	113
	The indispensability argument	114
	Modal and Platonist structuralism	117
	Epistemology and 'access'	121
	Naturalism: non-Platonist realisms	122
8	Infinity	129
	Infinity, who needs it?	130
	Paradoxes of infinity?	134
	'Potential' infinity?	136
	Knowing the infinite	140
9	Geometry: Mathematics or Empirical Science?	141
	What is geometry? Plan A: multidimensional quantities	143
	What is geometry? Plan B: the shapes of possible spaces	146
	The grit-or-gunk controversy: does space consist of points?	150
	Real non-spatial 'spaces' with geometric structure	153
	The space of colours	154
	Spaces of vectors	155
	The real space we live in	156
	Non-Euclidean geometry: the 'loss of certainty' in mathematics?	160

Part II Knowing Mathematical Reality

10	Knowing Mathematics: Pattern Recognition and Perception of Quantity and Structure	165
	The registering of mathematical properties by measurement devices and artificial intelligence	167
	Babies and animals: the simplest mathematical perception	172
	Animal and infant knowledge of quantity	173
	Perceptual knowledge of pattern and structure	176
11	Knowing Mathematics: Visualization and Understanding	180
	Imagination and the uninstantiated	180
	Visualization for understanding structure	181
	The return of visualization, and its neglect	185
	Why visualization has been <i>persona non grata</i> in the philosophy of mathematics	185
	The mind and structural properties: the mysteriousness of understanding	188
	The chiliagon and the limits of visualization	191
12	Knowing Mathematics: Proof and Certainty	192
	Proof: a chain of insights	192
	Symbolic proof ‘versus’ visualization: their respective advantages	196
	Proof: logicist, ‘if-thenist’ and formalist errors	197
	Axioms, formalization and understanding	200
	Counting	202
	Knowing the infinite	203
13	Explanation in Mathematics	207
	Explanation in pure mathematics	208
	How do pure mathematical explanations fit into accounts of explanation?	212
	Geometrical explanation in science	215
	Non-geometrical mathematical explanation in science	217
	Aristotelian realism for explanatory success	220
14	Idealization: An Aristotelian View	222
	Applied mathematics without idealization	224
	Approximation with simple structures, not idealization	225
	Negative and complex numbers, ideal points, and other extensions of ontology	229

Zero	234
The empty set	238
15 Non-Deductive Logic in Mathematics	241
Estimating the probability of conjectures	242
Evidence for (and against) the Riemann Hypothesis	245
The classification of finite simple groups	250
Probabilistic relations between necessary truths?	254
The problem of induction in mathematics	257
Epilogue: Mathematics, Last Bastion of Reason	260
<i>Notes</i>	263
<i>Select Bibliography</i>	302
<i>Index</i>	305

List of Figures

1.1	There are six different pairs in four objects	1
3.1	Squares whose intersection is another square	37
3.2	Why $2 \times 3 = 3 \times 2$	43
4.1	The bridges of Königsberg	48
4.2	Graphs of the same relation between different quantities	54
4.3	Exponential growth curve	55
4.4	Combinatorics with six points	60
5.1	Tiling of the plane by squares	68
5.2	Tiling of the plane by regular hexagons	68
5.3	Regular pentagons cannot tile the plane	68
5.4	Escher's Waterfall	70
5.5	A figure vertically, horizontally, and centrally symmetric	71
6.1	The Königsberg bridges again	96
8.1	'Approximation' of the diagonal by a path of many steps	132
8.2	Approximating the circumference by inscribed and circumscribed polygons	133
9.1	Ordered set in two dimensions	145
9.2	Cross product of totally ordered set with itself, with natural two-dimensional ordering	145
9.3	Pappus's Theorem	148
9.4	The seven-point plane	149
9.5	The Munsell version of the colour sphere	154
10.1	Simple neural net to predict y from x	169
10.2	Line of best fit to a set of points	170
10.3	Square, diamond, and 'diamond' with context suggesting a square	177
10.4	Three realizations of the same tree structure	178
11.1	Why $2 \times 3 = 3 \times 2$	182
12.1	Combinatorics with six points again	193
12.2	Why $(2k)^2 = 4k^2$	195
13.1	Sum of odd numbers is a square	210
13.2	The Bridges of Königsberg again	215
13.3	Watermill gearing, Worthing, Norfolk, 1876	216
14.1	Dilation of the plane by a factor r	231
14.2	The number line, with zero included	237

List of Tables

3.1	Possible outcomes of four coin tosses	38
11.1	Array with i,j 'th entry equal to $\min(i,j)$	184
15.1	Early calculations of roots of the Riemann zeta function	246
15.2	Later calculations of roots of the Riemann zeta function	246
15.3	First few values of the Möbius function	248

Introduction

According to the philosophy of mathematics to be defended here, mathematics is a science of the real world, just as much as biology or sociology are. Where biology studies living things and sociology studies human social relations, mathematics studies the quantitative and structural or patterned aspects of things.

A typical mathematical truth is that there are six different pairs in four objects:

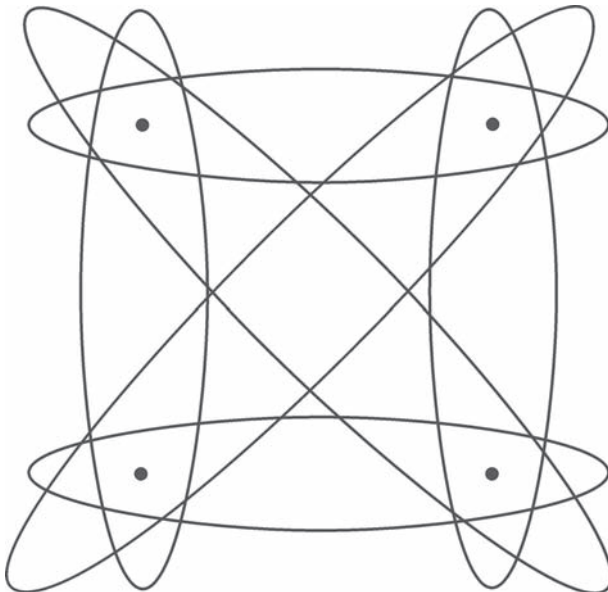

Figure I.1 There are six different pairs in four objects

The objects may be of any kind: physical, mental or abstract. The mathematical statement does not refer to any properties of the objects, but only to patterning of the parts in the complex of the four objects. The truth is thus about pure structure, and is also quantitative, in dealing with the necessary relation between the number of objects and the number of pairs.

If the statement seems to us a less solid truth about the real world than, say, the causation of flu by viruses, that is simply due to our blindness about relations, or our tendency to regard them as somehow less real than things and properties. But relations (in the example, relations of equality between parts of a structure) are as real as colours or causes. There is nothing to be said for the view of engineers that mathematics is no more than a grab-bag of methods and formulas, a 'theoretical juice-extractor' for deriving one substantial truth from others. The truth about pairs of objects is not hypothetical or logical or symbolic in nature, but a straightforward truth about objects – objects of any kind, physical or otherwise, but real objects.

A philosophy of mathematics which starts from that direction has many contrasts with the two philosophies that have dominated discussion in the philosophy of mathematics, Platonism and nominalism. Platonism attributes to the objects of mathematics a reality in some sense necessarily abstract and separate from physical objects, and regards mathematical objects as individual things (such as the number 3). But Aristotelianism takes symmetry, ratio and other mathematical properties to be capable of multiple realization in physical reality, and whatever other reality there may be. (The qualification 'capable of' is important: it is for the world, not theory, to decide if infinities, for example, are realized in the physical world, but Aristotelianism, unlike Platonism, insists that they are properties that *could* be literally realized.) Where nominalism (including versions like formalism and logicism) regards mathematics as having no real subject but being only a manner of speaking about or making inferences concerning ordinary physical objects, Aristotelianism regards mathematics as literally being about some aspect of reality, but about certain kinds of properties and relations rather than about individual objects.

This perspective raises a number of questions, which are pursued in the following chapters.

First, what kind of reality do relations and other properties have? The first chapter provides an introduction to Aristotelian realism, explaining the general metaphysical perspective of which an Aristotelian philosophy of mathematics is an instance. Aristotelian realism holds that mathematical

and all other properties can be instantiated in physical or other reality (though which ones actually are instantiated is not an a priori matter but one for nature to determine and science to discover). Chapter 2, 'Uninstantiated universals and "semi-Platonist" Aristotelianism', develops one aspect of Aristotelian realism that is especially relevant to the philosophy of mathematics because of mathematics' commitment to structures like higher orders of infinity that are not found in physical reality: the standing of uninstantiated properties. Then, what exactly does 'quantity', 'structure' or 'pattern' mean? Those are notoriously vague words, especially 'structure'. Chapter 3, 'Elementary mathematics: the science of quantity', deals with 'quantity', the traditional object of mathematics and still the main topic in its bread-and-butter applications. Ratios, numbers and sets are explained in Aristotelian terms as properties or relations found in reality. Chapter 4, 'Higher mathematics: science of the purely structural', deals with structure, the typical subject-matter of modern advanced mathematics. The various attempts to develop a structuralist philosophy of mathematics have either not addressed the definitional problem of what structure is or have sought some kind of sets or other abstract objects to be 'structures'. One should look instead for a precise characterization of what properties of things are structural.

The next question concerns the necessity of mathematical truths, from which follows the possibility of having certain knowledge of them. Philosophies of mathematics have generally been either empiricist in the style of Mill and Lakatos, denying the necessity and certainty of mathematics, or admitting necessity but denying mathematics a direct application to the real world (for different reasons in the case of Platonism, formalism and logicism). An Aristotelian philosophy of mathematics, however, finds necessity in truths directly about the real world. Examples and a defence against objections are given in Chapter 5, 'Necessary truths about reality'. The situation in the wider mathematical or formal sciences such as operations research, where the combination of necessity and reality is in some ways clearer than in mathematics proper, is described in Chapter 6, 'The formal sciences discover the philosophers' stone'. The role of mathematics in science, especially the recent exciting 'science of complexity' is explained as a natural outcome of the Aristotelian point of view: complexity is simply richness of structure.

With the essentials of Aristotelian philosophy of mathematics now laid out, Chapter 7 makes comparisons with the Platonist and nominalist philosophies of mathematics that were dominant in the twentieth century, and replies to objections arising from them.

Chapter 8 deals with the special topic of infinity – we are rightly convinced that the numbers never run out, but what that means and how we can know anything so far beyond experience is something that any philosophy of mathematics must explain convincingly. And since the world may in fact be finite, infinity is a test case for whether Aristotelian philosophy can give an account of uninstantiated properties.

Chapter 9 deals with geometry, regarded in ancient times as a central part of mathematics but, since the discovery of non-Euclidean geometries, under a cloud and suspected of being merely the physics of real space. The division between what is mathematical and what physical is determined.

Chapters 10, 11 and 12 on ‘Knowing mathematics’ deal with epistemology, which is very different in an Aristotelian perspective from traditional alternatives. Direct knowledge of small-scale quantity and structure is possible from perception, and Aristotelian epistemology connects well with what is known from research on infant development. But mathematical knowledge needs a good deal of intellectual work to extend the deliverances of perception. Visualization supplements proof by providing a direct global insight into unperceived structure. There are some surprises in explaining how proof leads to knowledge of mathematical necessity. Chapter 13 deals with a special topic in mathematical epistemology, explanation. Mathematical explanations show why patterns in the real world must be as they are. Chapter 14 deals with another special topic, idealization: as Platonists have emphasized, mathematics often seems to deal with idealized entities such as perfect circles which are not exactly found in reality, so the role of such entities in studying the mathematical structures that reality does actually have needs careful explanation.

The fact that mathematical truths may often be proved does not exclude the possibility that there should be experimental evidence bearing on them. A realist perspective, whether Platonist or Aristotelian, would expect to find that normal logical methods of scientific inquiry are applicable also to mathematics. Some conjectures have good evidence for them, and it is that evidence that justifies the effort of trying to prove them. Chapter 15, ‘Non-deductive logic in mathematics’, surveys the topic. The existence of experimental evidence in *mathematics*, where truths are necessary, shows the need to revive Keynes’ view that probability is, at least sometimes, a matter of pure logic, a kind of partial implication which holds between hypotheses and the evidence for them.

Mathematics, then, is a genuine science, giving us knowledge of one kind of properties of the real world – the quantitative properties like

number and size and the structural properties like symmetry, continuity and partedness. Knowledge of mathematical truths can come through the same means as any other factual truths – perception and inference from particulars. But mathematics also has a necessity absent from the truths of natural science, a necessity knowable, in some cases, with certainty through proof.

Unique features of Aristotelian philosophy of mathematics – claims which distinguish it sharply from all the alternatives in the philosophy of mathematics – are:

- Certain real properties of the (physical and any other) world (ratio, symmetry, ...) are among the objects of mathematics.
- Although some mathematical properties may not be actually instantiated, they all could be instantiated.
- There are no abstract objects (in the Platonist sense of acausal entities in a non-physical realm) and no need for them.
- Applied mathematics is central to the philosophy of mathematics.
- There are necessary mathematical truths literally true of physical reality.
- The simplest mathematical truths can be perceived to be true, while others can be established by more intellectual methods.

Strong claims have always been made for the truth, necessity, certainty and significance of mathematics. Those claims are all true. In these times especially, a clear defence of those claims is needed. Freed of unanswerable questions about how either remote Platonist entities or a mere language could be so effective in science, an Aristotelian structuralist view of mathematics will reinstate mathematics in its deserved place as one of civilization's prime grips on reality.

Before beginning the philosophy strictly so called in the first chapter, let us undertake a short thought experiment. It will prepare for the philosophy by dramatizing what it is like to conceive of the mathematical features of the world in themselves.

Imagine a world that is, as far as possible, purely physical. It contains no abstract entities like Platonist numbers, no minds human or divine, no languages – just physical objects as we ordinarily conceive them to be, pieces of stuff with their various masses, shapes, relative distances, forces, velocities, atomic constitutions, quantum states and so on. (Of course, there is some difficulty with imagining a world without one's imagination in it, but let us separate the physical world as far as possible – by supposing, let us say, that we are dealing with the earth before conscious

animal life began.) Is there or is there not, in that world, anything of a mathematical nature (to speak as non-committally as possible)?

If there are massy objects, then the masses stand in certain relations to one another – some are more massy than others, some much more. Those relations are not created by any perception, naming or measuring of them; they are inherent in the physical stuff itself. Furthermore, masses being what they are, they do not stand just in relations of more and less, but in relations of exact ratios, or relations of proportion. For example, if a mass is copied (such as when a bacterium breeds), then the mass of the sum stands in a definite relation to the original mass. That ratio can itself be replicated in the ratio holding between velocities, or between distances, or between forces. The ratios have interrelationships; for example, if the ratio of (force, mass ...) a to b is the same as that of c to d , then the ratio of a to c is the same as that of b to d . Each system of ratios between entities of the same kind, though fully realized in physical reality, bears an uncanny resemblance to (at least part of) what we are accustomed to call the continuum or system of real numbers. (The qualification ‘at least part of’ is to allow for the fact that if the universe is finite, it may be that very large and very small ratios are not realized in physical reality. We are speaking here just of those ratios that do happen to be so realized.)

Similarly with discrete quantity. Parts of the world, prior to any naming operation, come in discrete chunks that are identical in some respect; for example electrons identical in mass and charge, and apples having close similarities in shape, size and biochemistry. Masses of such chunks are so organized as to bear a certain relation to the individual of that kind, leading to certain characteristic relations between masses: for example, any heap of electrons consists either of a part and an identical part, or a part and an identical part with one electron left over. That is, what we call the arithmetic of whole numbers is realized, prior to any human thought or to intervention by abstract objects, in the relations between parts of physical reality (again, up to the number of things in the universe).

The way mass is arranged in the universe is not totally random, but often symmetric (whether exactly or approximately). Snowflakes grow with hexagonal symmetry, planetary orbits repeat cyclically, animals grow with near bilateral symmetry, trees have an approximate circular symmetry with random elements. Again, these samenesses between parts pre-exist any thoughts or descriptions of them, and *prima facie*, at least, do not involve any abstract entities or blueprints. But symmetry and its kinds (including approximate symmetries) are the subject-matter

of the division of higher pure mathematics called group theory. So again it appears that considerable mathematical structure of that kind is, like quantity, literally realized in the physical world.

Many flows and similar processes in the world are continuous, at least at the scale of animal perception. Those flows thus literally realize the relations studied in the science of continuity, the calculus, such as those holding between distance, velocity and acceleration. Or, if the universe at a microscale is discrete, they realize those corresponding relations in discrete approximations to calculus – for example, the relation between constant relative growth rates and exponential growth curves holds in both the continuous and the discrete case. In either case, the universe literally realizes the mathematical structure.

Now let us begin explaining the philosophical perspective that makes sense of those facts.

Part I

The Science of Quantity and Structure

1

The Aristotelian Realist Point of View

Much of the unpleasantness in traditional philosophy of mathematics – its neglect of applied mathematics, its fixation on sets, numbers and logic rather than complex structures, its concern with infinities before small finite structures, its epistemological impasse over how to know about ‘abstract’ objects – comes from its oscillation between Platonism and nominalism, as if those were the only alternatives. So it is desirable to begin with a brief introduction to the Aristotelian option in metaphysics. The chapter is conceived as a ‘tutorial’ introduction, which outlines Aristotelian realism about properties and an overview of the main reasons for believing it. While Aristotelian realism has been a neglected option in the philosophy of mathematics,¹ it is well known in general metaphysics, so the ground can be covered in summary, leaving the extensive debates for and against Aristotelianism, Platonism and nominalism to the references in the notes.

The main issues have nothing to do with mathematics in particular, so I deliberately avoid more than passing reference to mathematical examples.

The reality of universals

‘Orange is closer to red than to blue.’ That is a statement about *colours*, not about the particular things that have the colours – or if it is about the things, it is only about them *in respect of their colour*: orange things resemble red things but not blue things in respect of their colour. There is no way to avoid reference to the colours themselves.

Colours, shapes, sizes, masses are the repeatables or ‘universals’ or ‘types’ that particulars or ‘tokens’ share. A certain shade of blue, for example, is something that can be found in many particulars – it is a

‘one over many’ in the classic phrase of the ancient Greek philosophers. On the other hand, a particular electron is a non-repeatable. It is an individual; another electron can resemble it (perhaps resemble it exactly except for position), but cannot literally be it.²

Science is about universals. There is perception of universals – indeed, it is universals that have causal power. We perceive an individual stone, but only *as* a certain shape, colour and weight, because it is those properties of it that confer on it the power to affect our senses. It is in virtue of being blue that a body reflects certain light and looks blue. Science gives us classification and understanding of the universals we perceive and finds the laws connecting them – physics deals with such properties as mass, length and electrical charge, biology deals with the properties special to living things, psychology with mental properties and their effects, mathematics with... well, we’ll get to that.

Aristotelian realism about universals takes the straightforward view that the world contains both particulars and universals, and that the basic structure of the world is ‘states of affairs’ of a particular’s having a universal, such as this page’s being approximately rectangular.³

Science is also the arbiter of what universals there are. To know what universals there are, just as to know what particulars there are, one must investigate, and accept the verdict of the best science (including inference as well as observation). Photosynthesis turned out to exist, phlogiston not. Thus universals are not created by (or postulated to account for) the meanings of words, nor can one make up more of them by talking or thinking. On the other hand, language is part of nature, and it is not surprising if our common nouns, adjectives and prepositions name some approximation of the properties there are or seem to be (just as our proper names label individuals), or if the subject–predicate form of many basic sentences often mirrors the particular-property structure of reality.

Platonism and nominalism

Not everyone agrees with the foregoing. *Nominalism* holds that universals are not genuine constituents of reality but are only words or concepts or classes, and that the only realities are particular things. In the philosophy of mathematics, logicism and formalism are theories of nominalist tendency, as they regard mathematics as not about any external reality but a matter of symbols. (Nominalist and Platonist arguments specific to mathematics will be discussed in Chapter 7.)

The main problem for nominalism is its failure to give an account of *why* different individuals should be collected under the same name (or

concept or class), if universals are not admitted. According to 'predicate nominalism' for example (that is, nominalism that takes universals to be mere words), 'The word "white" correctly applies to Socrates' is prior to 'Socrates is white.' That is counterintuitive, since it appears that things were white prior to language existing, and that we apply the term correctly because of the commonality between white things. And our recognition of that commonality, which is a condition of our learning to apply the word correctly, arises from the ability of all white things to affect us in the same way – 'causality is the mark of being'. A further problem is that the predicates or concepts relied upon by nominalists to unite the particulars are themselves universals – the word 'white' means not a particular inscription on a certain page, but the word type 'white' in general; thus predicate or concept nominalism simply pushes the problem of the 'one over many' back one stage.⁴

A serious attempt to show that mathematics can be done nominalistically, that of Hartry Field, will be examined in Chapter 7. It will be concluded that, although not Platonist, the project implicitly includes a realist view of quantitative properties.

Platonism (in its extreme version, at least, which is the version usually found in the philosophy of mathematics⁵) holds that there are universals, but they are pure Forms in an abstract world, the objects of this world being related to them by a mysterious relation of 'participation' or 'approximation'. Thus, what unites all blue things is solely their relation to the Form of blue, and what unites all pairs is their relation to the abstract number 2. Mathematicians' unreflective use of names like '2', 'the continuum' and 'the Monster group', as if they name particular entities with which mathematicians have dealings, is felt to support a Platonist view of such beings.

The problems for Platonism, both ontological and epistemological, arise from the *relational* view of its solution to the 'one over many' problem. First, there is the difficulty of explaining the nature of the relation: 'participation' and 'approximation' are metaphors that it is hard to clarify, while if we consider examples such as the relation of pairs to the number 2, we seem to have no insight into the relation.⁶ Second, the relational nature of how the Form works means that it bypasses the commonalities between things that do unite them: if we imagine the Form of blue not existing, which of the individuals are the ones that would be united by their relation to the Form of blue, if it did exist? Surely there is something about them that makes those the ones apt for participating in the Form of blue, and distinguishes them from red ones? That is what perception suggests. Blue things affect our retinas in

a characteristic way because the blue in the things acts causally, without any apparent need to consult a Form elsewhere before doing so.

Epistemologically too, Platonism has difficulties because of its relational nature. Either there is a perception-like intuition into the realm of the Forms, or we have knowledge of them through some process of inference such as inference to the best explanation. The first is not possible, since the realm of the Forms is acausal, so no messages can come from that realm to our brains, as happens from coloured surfaces to our retinas. How can humans 'reliably access truths about an abstract realm to which they cannot travel and from which they receive no signals'?⁷ (It has been maintained that in mathematical visualization we do have direct access to a realm of mathematical necessities;⁸ as will be argued in Chapter 11, that is true but the necessities are realized or realizable in diagrams, not in a separate abstract world.) The second option, access to the Forms via inference to the best explanation, faces the initial problem that young children appear to have a great deal of direct mathematical knowledge from counting and pattern recognition, without the need for any sophisticated reasoning to abstract entities. The nature of that basic knowledge will be treated in Chapter 10, while more elaborate attempts to argue to Platonism from the indispensability of mathematics in science will be considered in Chapter 7.

A complete answer to Platonism must include an account of what the number 2, the continuum and other mathematical entities are, if they are not abstract objects in a Platonic world. An alternative, Aristotelian, account will be given in Chapters 3 and 4.

This is not the place for more detailed criticism of Platonism and nominalism, which has been extensively pursued in general works on metaphysics.

At this point it can be seen how the Platonist–nominalist dichotomy that has been assumed in most of the philosophy of mathematics is a false one. If Platonism is taken to mean 'there are abstract objects' and nominalism to mean 'There aren't', then it can appear that Platonism and nominalism are mutually exclusive and exhaustive positions. However, the words 'abstract' and 'object' both work to distract attention from the Aristotelian alternative: 'abstract' by suggesting a Platonist disconnection from the physical world and 'object' by suggesting the particularity and perhaps simplicity of a billiard ball. Indeed, the concept of 'abstract object' that has had such a high profile in the philosophy of mathematics is a comparatively recent notion and a very unclear one. It is an artifact of the determination of nominalists (especially Locke) and Platonists (especially Frege) to carve up the field between themselves.

In particular, the notion is a creation of Frege's conclusion that since the objects of mathematics are neither concrete nor mental, they must inhabit some 'third realm' of the purely abstract.⁹

Aristotelians do not accept the dichotomy of objects into abstract and concrete, in the sense used in talk of 'abstract objects'. A property like blue is not a concrete particular, but neither does it possess the central classical features of an 'abstract object', causal inefficacy and separation from the physical world. On the contrary, a concrete object's possession of the property blue is exactly what gives it causal efficacy (to be perceived as blue).

Thus an entity of interest to the philosophy of mathematics – say the ratio of your height to mine – could be either an inhabitant of an acausal, 'abstract' world of Numbers, or a real-world relation between lengths, or nothing. The three options – Platonist, Aristotelian and nominalist – need to be kept distinct and on the table, or discussion will be confused from the beginning.

Because of the special relation of mathematics to complexity, there are three issues in the theory of universals that are of comparatively minor importance in general but are crucial in applying Aristotelian realism to mathematics. They are the problem of uninstantiated universals, the reality of relations, and questions about structural and 'unit-making' universals. The first of these, perhaps the most important, will be left to the next chapter.

The reality of relations and structure

Aristotelian realism is committed to the reality of relations as well as properties. The relation being-taller-than is a repeatable and is accessible to observation in the same way as the property of being orange.¹⁰ The visual system can make an immediate judgement of comparative tallness, even if its internal arrangements for doing so may be somewhat more complex than those for registering orange. Equally important is the reality of relations between universals themselves, such as betweenness among colours – if the colours are real, the relations between them are 'locked in' and also real. Western philosophical thought has had an ingrained tendency to ignore or downplay the reality of relations, from ancient views that attempted to regard relations as properties of the individual related terms to early modern ones that they were purely mental.¹¹ But a solid grasp of the reality of relations such as ratios and symmetry is essential for understanding how mathematics can directly apply to reality. Blindness to relations is surely behind the plausibility of

Bertrand Russell's celebrated saying that 'Mathematics may be defined as the subject where we never know what we are talking about, nor whether what we are saying is true'¹² (though elsewhere Russell writes in a fully realist way of the similarity or isomorphism of relations¹³).

The internal relations between the parts of an object or system constitute its *structure*, a concept of crucial importance in mathematics. A structural property is one that makes essential reference to the *parts* of the particular that has the property. 'Being a certain tartan pattern' means having stripes of certain colours and widths, arranged in a certain pattern. 'Being a methane molecule' means having four hydrogen atoms and one carbon atom in a certain configuration. 'Being check-mated' implies a complicated structure of chess pieces on the board.¹⁴ Properties that are structural without requiring any particular properties of their parts such as colour could be called 'purely structural'. They will be considered in Chapter 4 as the fundamental objects of higher mathematics.

'Unit-making' properties and sets

'Being an apple' differs from 'being water' in that it structures its instances discretely. 'Being an apple' is said to be a 'unit-making' or 'sortal' property,¹⁵ in that a heap of apples is divided by the universal 'being an apple' into a unique number of non-overlapping parts, apples, and the parts of those parts are not themselves apples. That is the reason why the word 'apple' has a plural and 'water' (in its normal sense) does not, but the distinction is fundamentally about properties, not about language. A given heap may be differently structured by different unit-making properties. For example, a heap of shoes may consist of twenty shoes but ten pairs of shoes. Notions of (discrete, natural, whole) number should give some account of this phenomenon, taking note of the fact that the unit-making universal is prior to the number it creates in the heap it structures. By contrast, 'being water' is homoiomerous, that is, any part of water is water (at least until we go below the molecular level).¹⁶ Therefore the universal 'being water' does not create any particular number of units in an individual mass of water.

The fact that 'being an apple' divides the heap into individual apples also ensures that there is a set of apples, raising the issue of the relation between sets and universals. A set, whatever it is, is a particular, not a universal. The set {Sydney, Hong Kong} is as unrepeatable as the cities themselves. The idea of Frege's 'comprehension axiom', that any property ought to define the set of all things having that property, is a good

one, and survives in principle the tweakings of it necessary to avoid paradoxes. It emphasizes the difference between properties and sets, by calling attention to the possibility that different properties should define the same set. In a classical (philosophers') example, the properties 'cordate' (having a heart) and 'renate' (having a kidney) are co-extensive, that is, define the same set of animals, although they are not the same property and in another possible world would not define the same set.

Most discussion of sets, in the tradition of Frege, has tended to assume a Platonist view of them, as 'abstract' entities in some other world, so it is not clear what an Aristotelian view of their nature might be. One suggestion is that a set is just the heap of its singleton sets, and the singleton set of an object x is no more than x 's having some unit-making property: the fact that Joe has some unit-making property such as 'being a human' is all that is needed for there to be the set {Joe}.¹⁷ This theory and alternatives to it will be discussed further in Chapter 3.

Causality

A large part of the general theory of universals concerns causality, dispositions and laws of nature, with all of these being explained in terms of relations between universals.¹⁸ A principal strength of Aristotelian realism is that it can give a natural account of the difference between a law of nature and a cosmic coincidence: a law that all As are Bs (unlike a coincidence that all As happen to be Bs) is the result of some real connection – the nature of which is to be discovered by science – between the real properties A and B. (The properties A and B may be complex and the connection between them the result of connections between simple components: for example, the law-like connection between acidity and corrosion is a result of properties at the molecular level.) Similarly, Aristotelianism gives a straightforward account of counterfactuals: a piece of salt is soluble – that is, would dissolve in water if placed in it even if never actually placed there – in virtue of the properties inherent in the salt (resulting from the bonds between sodium and chloride ions and the properties of water molecules). There is thus an important distinction drawn between those properties that are dispositions or powers (defined counterfactually by what they would do in certain circumstances), like solubility and inertia, and categorical properties, which 'just are', like shape. The relation between the two is a matter of controversy.

For mathematics, part of this is significant and part not. Properties normally considered mathematical, like shape, size, partedness, symmetry, continuity and so on, are categorical – they are not defined by what they

would do in counterfactual circumstances. But they do have causal powers, at least in conjunction with other properties. The reason one cannot fit a square peg into a round hole is the shape of the two (in conjunction, of course, with the rigidity of the peg and hole, that is, their dispositions to maintain their shapes when forces act). To be cubical supports a disposition to fit measuring instruments in certain ways, but that is a matter of how the categorical nature of shape fits with other causes.¹⁹ For the purposes of philosophy of mathematics, difficult questions about dispositionality and causes do not need to be resolved.

The causal powers of mathematical properties are significant for perception of them, just as the causal powers of other properties are: the symmetry of a face can affect our vision, for example, as much as its colour.

Aristotelian epistemology

Despite the commonalities between Platonism and Aristotelianism, their approach to epistemology is entirely different. Platonism, as described above, is bedevilled by an ‘access problem’, as to how there can be knowledge of a realm of Forms with which we have no causal interaction. Whatever problems Aristotelian epistemology has, that problem is not one of them. Aristotelian universals are not ‘abstract’ in the sense of lacking causal power (to produce signals). On the contrary, the objects of perception have the causal powers they do – such as to give off signals, affect the senses differentially, and so on – precisely in virtue of the properties they have, such as shape and colour. The eye can see that an object is square because its square shape causes it to have a different effect on the retina from that of a non-square object.

But there is more to the Aristotelian story of knowledge than perception. Aristotelian epistemology distinguishes between sensory and intellectual knowledge, giving rather different accounts of each.

Sensory knowledge is straightforwardly naturalistic and causal. For the most basic kind of non-inferential sensory knowledge in both animals and humans (and for that matter in robots), Aristotelians accept a ‘thermometer’ model of knowledge: the senses know a fact if there is a reliable connection between the fact’s holding and the knower’s believing it. ‘Reliable’ is explained in terms of nomic connections between sorts of facts, which have been given a realist interpretation on the Aristotelian view. There is no requirement for the connection itself to be known.²⁰ Thus we know that a surface in our range of vision is yellow through the yellowness of the object causally affecting our retina (in a way that is the same as other yellow things but different from the way that things of

other colours affect us). The senses can thus ‘track’ colour differences, in having a range of causal response (translatable as appropriate into motor response) to the range of real colours.

The simplicity of that example may suggest that the analysis is not applicable to knowledge of complex or general truths, but research in perceptual psychology in recent decades has shown the amazing range of abilities of animal cognitive systems to respond automatically to very complicated or structural properties. In a classic example, a certain fibre in the frog optic nerve

responds best when a dark object, smaller than the receptive field, enters that field, stops, and moves about intermittently thereafter. The response is not affected if the lighting changes or if the background (say a picture of grass and flowers) is moving, and is not there if only the background, moving or still, is in the field.²¹

Experimenters naturally call such a fibre a ‘bug detector’, but what it responds to is just a certain highly complex spatio-temporal pattern. Especially significant is the ability of higher levels of the perceptual system to respond to tempo and other ‘intermodal’ properties that can be registered by more than one sense, since that indicates the possibility of high-level (but still automatic) comparisons between the deliverances of different sense organs.²² It is explained naturalistically how the cognitive system extracts the knowledge from the perceptual flow that ‘affords’ the structure of the external world that causes it – for example, how the total visual system interprets the optical flow of all visible objects as information that the organism is moving forward into the scene.²³ Cognitive systems are also capable of a certain amount of automatic inference, such as interpolating the unobserved surfaces of partially observed bodies²⁴ and generalizing from examples; research in these areas in Artificial Intelligence, though slow to progress, has indicated how to extend a straightforwardly naturalistic, causal analysis of knowledge to such complex cognitive abilities.

But for human knowledge, more is required. Given that the world is a world of states of affairs (of the form *Fa*, ‘individual *a* has property *F*’) there needs to be some cognitive power of ‘abstraction’ able to recognize that. It must on the one hand recognize the continuing thing *a* that participates in the fact, and distinguish it (or ‘separate it in thought’) from the universal *F* (and recognize *F* as distinct from the other properties that *a* has). Despite Wittgensteinian arguments that such a cognitive power is impossible,²⁵ developmental psychology on categorization and learning discovers such an ability and casts some light on how it works.

Very young infants can group together objects according to similarity in perceptual features and form a mental representation of categories; for example, infants three to four months old, shown several varied pictures of cats, can then recognize that new pictures of cats are similar to the category learned but that pictures of dogs or horses are novel. It is possible to say which features of the examples are most important – for cats versus dogs, the shape of the head is much more important than the shape of the body. The same applies to spatial relations, with infants shown a variety of pictures of a dot above a horizontal line then proving able to distinguish between similar pictures and those with a dot below a line. Those abilities require an implicit recognition of the different perceptual properties of the objects and their distinction from the objects themselves.²⁶

It is not quite so clear whether it is possible to give a naturalistic account of more specifically human kinds of knowledge such as self-awareness and linguistic capabilities, but those difficult areas do not have close relevance to the philosophy of mathematics.

There is, however, one further kind of human knowledge that is central to mathematics. Aristotelians are impressed by the fact that human knowledge includes not only facts but understanding of why certain facts must be so. One can not only know that all equiangular triangles are equilateral, but understand by following a proof why they *must* be. In Aristotle's classic example, 'it is the physician's business to know that circular wounds heal more slowly, the geometer's to know the reason why'.²⁷ Traditional Aristotelianism posited a faculty of the 'intellect' with almost magical powers of not only 'abstraction' to isolate universals in the mind but also of insight into the universals and their necessary interrelations.²⁸ Since the prime examples of this kind of knowledge come from mathematics, further discussion can be left to the chapters on the higher levels of mathematical epistemology (Chapters 11 and 12).

That is a basic sketch of epistemology from the standpoint of Aristotelian realism. Ideally it should be possible to refer to a book that gives a full account of the matter based on contemporary cognitive science. Unfortunately there is no such book,²⁹ as recent Aristotelians have concentrated on metaphysics rather than epistemology. The philosophy of mathematics cannot await the writing of that book. It need not do so, as only the most basic features of epistemology are essential for tackling the general issues involved in knowing mathematics.

2

Uninstantiated Universals and 'Semi-Platonist' Aristotelianism

Aristotelian philosophy of mathematics holds that the objects of mathematics – such properties as symmetry, continuity and order – are realized in the physical world, so that mathematics is a science of aspects of the world, as much as biology is. The principal objection to that thesis is, 'Some of the objects of mathematics are *not* realized in the physical world, such as large infinite numbers'. It may be that the world is finite, in which case infinite numbers and very large lengths are not instantiated in the real world. Even more so the higher infinities: 'set theory is committed to the existence of infinite sets that are so huge that they simply dwarf garden variety infinite sets, like the set of all the natural numbers. There is just no plausible way to interpret this talk of gigantic infinite sets as being about physical objects.'¹ Or as Shapiro writes:

It seems reasonable to insist that there is *some* limit to the size of the physical universe. If so, then any branch of mathematics that requires an ontology larger than that of the physical universe must leave the realm of physical objects if these branches are not to be doomed to vacuity. Even with arithmetic, it is counterintuitive for an account of mathematics to be held hostage to the size of the physical universe.²

What then is the Aristotelian account of mathematical truths about those unrealized quantities?

Before answering that question, one may pause to wonder if the question does not cut two ways. Is there something too swift about asking, 'Even if the Aristotelian could give an account of small number, ratios, etc., how could he deal with the huge and uninstantiated ones to deal with?' Compare someone who responded to the claim 'Perception gives knowledge' with the objection 'Even if perception gives knowledge

about some things, how could it explain knowledge of the unobserved?' True, but let us stop and smell the roses first. Small finite structures have plenty to keep the mathematician occupied, and the body of knowledge about them is extensive. If it were admitted that those truths were literally true of mundane reality, then there would be a large body of Aristotelian mathematical knowledge, in no need of Platonist reinterpretation. If then the world did expand so that the boundary between the instantiated and the uninstantiated blew out infinitely, perhaps to the higher infinities, most of mathematical knowledge might be literally true of the (non-abstract) world.

Be that as it may, the 'problem of uninstantiated universals' is a genuine one and must be faced. It is especially urgent in, but not unique to, the philosophy of mathematics. It needs very careful treatment. It will be argued that Aristotelian realism does have an answer to the problem, but it requires an Aristotelianism of somewhat Platonist tinge. The resulting theory is, however, very far from standard Platonism and cannot be reconciled with it.

Determinables and determinates

The reason we know about uninstantiated universals such as huge numbers is that they occur in structured ranges of universals called *determinables*. Colour is a determinable, while an exact shade of colour such as Cambridge Blue is a *determinate* – a precise way of being a colour, among the wide range of possible ways of being a colour. ('Blue' is thus a range of determinate colours – colour partly but not fully determined.) Similarly with quantities: length is a determinable, 1.57 metres a determinate length.

The way in which determinables are divided into determinates is unlike the way in which classification works via genus and differentia. While (in the traditional example) humans are of the genus animal with the differentia of rationality added, Cambridge Blue is not colour with some differentia added (other than Cambridge Blue itself). It is just one of the different ways of being coloured.³

While it is possible that a determinable should divide into a discrete mass of unrelated determinates – the space of smells has something of that character, though not exactly – in the most important cases such as colour and quantity, the determinates are subject to continuous variation. Colours resemble closely or not, and between two colours there is a range of intermediate colours.⁴ Similarly for lengths. To all appearances, ranges of colours and lengths are infinitely divisible, though it is for empirical science to say if the appearance corresponds to reality.

Facts about the relations between the determinates of a determinable, such as the betweenness relations holding among the colours or the ratios in which lengths stand, appear to be necessary. Surely there is no possible world in which a given shade of blue is between scarlet and vermilion, or in which A is twice the length of B, B twice the length of C and A three times the length of C?

It would be possible in principle for our perception to register some individual determinates without noticing that they formed instances of the range of a determinable. That is not what actually happens. Our sense organs respond continuously, and no doubt imprecisely, to ranges of colours and lengths, and we recognize explicitly the variation, and that it is variation within a single determinable. As a result, we have an ability to interpolate and extrapolate, to imagine colours and lengths close to but distinct from those experienced. That gives us *prima facie* reason to believe in the reality, in some sense, of colours and lengths other than those we have directly experienced.

That is epistemology. What of the ontology?

Uninstantiated shades of blue and huge numbers

The Aristotelian slogan is that universals are *in re*: in the things themselves (as opposed to in a Platonic heaven). It would not do to be too fundamentalist about that dictum, especially when it comes to uninstantiated universals such as numbers bigger than the number of things in the universe. How big the universe is, or what colours actually appear on real things, is surely a contingent matter, whereas at least some truths about universals appear to be independent of whether they are instantiated – for example, if some shade of blue were uninstantiated, it would still lie between whatever other shades it does lie between.⁵ What exactly is the Aristotelian account of the reality (if any) of a shade of blue that happens never to have been instantiated?

Many Aristotelians argue that admitting uninstantiated universals in any way at all would be excessively Platonist, by acknowledging a realm of Forms beyond the real world, ungrounded in any true reality.⁶ They must say, then, that lengths greater than the diameter of the universe or uninstantiated shades of blue are mere possibilities. The difficulty for that suggestion is that those 'merely' possible lengths appear themselves to stand in ratios to each other, in ways correctly described by mathematics, and an uninstantiated shade of blue appears to lie between two determinate instantiated ones. The 'mere' possibilities thus themselves form a Platonic-like world of forms, complex in structure, the

truths of which have no apparent truthmaker. Our knowledge of ratios, such as that three times a length lies between twice and four times that length, applies to lengths beyond the diameter of the universe. Those truths stand ready to be, so to speak, clothed in reality if the universe expands.

Brent Mundy argues for the reality of uninstantiated universals by asking how a general theory of quantity relates to empirical evidence about quantities. A nominalist theory faces the problem that standard postulates of the theory of (extensive) quantity such as that the sum of two quantities is a quantity are literally false (for example, if mass means, operationally, measurement in a balance, then two large enough masses may be too large to fit together in a balance, though they do fit individually). That problem is shared by an Aristotelian realism that admits only instantiated quantities: the sum of two instantiated lengths and the average of two shades of blue may not be instantiated. Mundy suggests that for a posteriori realism – one which takes it as a matter for science to determine which universals there are – the empirical evidence supports the reality of determinable quantity more than of the arbitrary collection of those determinates that happen to be instantiated. On grounds of theoretical simplicity, length-in-general is the theoretical entity that makes sense of the empirical evidence, not lengths-in-the-happenstancedly-instantiated-range.⁷ To restrict lengths or colours to the instantiated range would be a ‘simplification’ analogous to supposing that only observed bodies exist – it fails to posit the natural range of which the data happen to be a sample. One expects the science of colour to be able to deal with any uninstantiated shades of blue that there may be on a par with instantiated shades – of course direct experimental evidence can only be of instantiated shades, but science consists not just of heaps of experimental data but of inference from experiment, so extrapolation (or interpolation) arguments are possible to ‘fill in’ gaps between experimental results.

Similarly, Brian Ellis argues that laws of nature do not connect individual values of ‘dimensions’ or ‘generic universals’, such as mass, but the dimensions themselves. They express ‘concomitant variation’, in Mill’s phrase, or ‘generic relations between the quantitative properties of things’, that is, relations between *ranges* of, for example, depth and pressure. So science suggests that it is the determinable rather than the determinates or values that are ontologically prior, since laws connect determinables in the first instance.⁸ The lack of instantiation of some values does not tell against the reality of the determinable in general.

It is the same with mathematical structures such as the continuum, Euclidean geometry or infinite numbers (on which more in Chapter 8) and idealizations such as perfect spheres (on which more in Chapters 5 and 14). Those can be described as (possibly) uninstantiated structures or as (merely) possible structures, but in either case they are complex forms which *could* be instantiated in reality – forms about which there can be necessary knowledge. They differ from the Forms of classical Platonism which necessarily lie beyond mundane reality and cannot be literally instantiated in it. Aristotelian forms *can* be instantiated, but it is for the contingencies of historical reality (or the will of God, or whatever decides such matters) to determine which are in fact instantiated.

Possibles by recombination?

Because of the tendency of quantity to apply across vast ranges of size, it is particularly difficult to make sense of quantity in terms of a strict Aristotelian realism that does not in some way admit uninstantiated universals. The best attempt to do so is the combinatorial theory of possibility of David Armstrong. Armstrong holds that possibilities are recombinations of actual elements in the world – there being a unicorn is possible because it is a recombination of parts of actually existing entities. But combination is to allow addition and deletion of actually existing particulars (though not addition of universals): 'Combination is to be understood widely. It includes the notion of expansion (perhaps "repetition" is a less misleading term) and also contraction.'⁹ Individuals are to be allowed to clone themselves indefinitely, indeed infinitely often, to create new possibilities.

The difficulty is that the possibility of very large or infinite numbers is then built into the theory, or presupposed by it, rather than analysed by it. Why are numbers larger than those instantiated in the universe possible? Because the actual individuals in the universe are subject to 'indefinite multiplication'.¹⁰ (Similarly, the possibility of a length greater than the diameter of the universe is grounded in the possibility of replication of actual individuals to give a body of greater total length: an uninstantiated quantity is 'combinatorially accessible from actual' quantities.¹¹) But what is the ground of the possibility of indefinite replication of individuals itself? The theory does not say. Instead it has to assume that possibility in order to get started.¹² What, for example, is the ground of the possibility of some particular infinite cardinal? It is the possibility that actual individuals should be infinitely replicated at least that many times (a possibility normally regarded as controversial,

in view of traditional Aristotelian doubts about actual infinities). That may indeed be the ground, but the combinatorial theory of possibility has not given an analysis of that possibility, only an assertion of it. So the combinatorial theory is not a complete account of possibility. In particular it has not given, as it claimed to do, a reductive analysis of uninstantiated universals in terms of instantiated ones.

There is a remaining problem as to the possibility of truly ‘alien’ universals, which are like nothing in the actual universe.¹³ However, these seem beyond the range of what needs to be considered in mathematics – for all the vast size and esoteric nature of Hilbert spaces and inaccessible infinite cardinals, they seem to be in some sense made out of a small range of simple properties. What those properties are and how they make up the larger ones is something to be considered later (Chapters 3 and 4).

Semi-Platonist Aristotelianism

At this point it may be wondered whether it is not a very Platonist form of Aristotelianism that is being defended here. It has a structured space of universals, not all instantiated, into whose necessary interconnections the soul has insights. That is so. But there are three, not two, distinct positions covered by the names Platonism and Aristotelianism:

1. (extreme) Platonism, according to which universals are of their nature ‘abstract objects’, that is, they are not the kind of entities that could exist (fully or exactly) in this world, and they lack causal power;
2. semi-Platonist or modal Aristotelianism (the position defended here), according to which universals can exist and be perceived to exist in this world and often do, but it is a contingent matter which do so exist, and we can have knowledge even of those that are uninstantiated, and of their necessary interrelations;
3. strict this-worldly Aristotelianism, according to which uninstantiated universals do not exist in any way: all universals really are *in re*.¹⁴

These positions are very distinct. The gap between semi-Platonist Aristotelianism and extreme Platonism is unbridgeable. Aristotelian universals are ones that could be in real things (even if some of them happen not to be), and knowledge of them comes from the senses being directly affected by instantiated universals (even if indirectly and after inference, so that knowledge can be of universals beyond those

directly experienced). By contrast, extreme Platonism calls universals 'abstract', meaning that they do not have causal powers or location and hence cannot be perceived (but can only be postulated or inferred by argument).¹⁵

It is true that whether the gap between the second and third positions is large depends on what account one gives of possibilities. If the 'this-worldly' Aristotelian were to have a robust view of merely possible universals (for example, by granting full existence to possible worlds), there might be little difference in the two kinds of Aristotelianism. But that would be to adopt Platonism about possible worlds. But supposing a deflationary view of possibilities (as would be expected from an Aristotelian and as is developed in Armstrong's theory), a this-worldly Aristotelian will believe in a much narrower realm of real entities.

Shapiro argues that there is no acceptable view of necessity and possibility that can be relied on here by 'modal' Aristotelianism, so that reliance on necessity cannot replace Platonism. Indeed, this is his objection to what he calls the 'eliminative structuralist' Aristotelian alternative to Platonism. He discusses Hellman's 'modal realism', which agrees with Aristotelianism to the extent of regarding mathematics as (at least sometimes) about *possible* structures (though Hellman does not support this with an Aristotelian theory of universals; Hellman's theory is considered further in Chapter 7). According to Hellman, an arithmetic claim Φ means that for any *logically possible* system S , if S exemplifies the natural-number structure, then Φ is true of S . Shapiro objects:

Recall that in contemporary logic textbooks and classes, the logical modalities are understood in terms of sets. To say that a sentence is logically possible is to say that *there is* a certain set that satisfies it. According to the modal option of eliminative structuralism, however, to say that there is a certain set is to say something about every logically possible system that exemplifies the structure of the set-theoretic hierarchy. This is an unacceptable circularity. It does no good to render mathematical 'existence' in terms of logical possibility if the latter is to be rendered in terms of existence in the set-theoretic hierarchy.¹⁶

It is a dubious claim that contemporary logic textbooks do regard sets as more basic than logical necessity;¹⁷ to the extent that they do, they follow Frege's Platonism, which will be criticized in Chapter 7. And such a view is particularly implausible in the kind of cases that have just been

discussed. The necessity of the betweenness relations between colours, for example, is due to the necessity of relations between universals in general. Similarly with the transitivity of 'greater than' between lengths. Colours and lengths, and the properties of them, do not in any way depend on sets. Whatever the nature of those necessities, there is no motivation for regarding them as dependent on set theory. So Shapiro's contention of circularity in appeals to necessity and possibility cannot be sustained.

Let us return to the question of the relation between the second (semi-Platonist Aristotelian) and third (strictly earthbound Aristotelian) positions, which disagree on whether to admit in some way necessities concerning uninstantiated universals. The discrepancy is not a matter of great urgency in considering the usual universals of science which are known to be instantiated because they cause perception of themselves. It is the gargantuan and esoteric specimens in the mathematical zoo that strike fear into the strict empirically oriented Aristotelian realist. Our knowledge of mathematical entities that are not or may not be instantiated has always been a leading reason for believing in Platonism, and rightly so, since it is knowledge that goes well beyond the here and now. It does create insuperable difficulties for a strict this-worldly Aristotelianism. But it needs to be considered whether one might move only partially in the Platonist direction. There is room to move only halfway towards extreme Platonism for the same reason that there is space in the blue spectrum between two instantiated shades for an uninstantiated shade. The non-adjacency of shades of blue is a necessary fact about the blue spectrum (as Platonism holds), but whether an intermediate shade of blue is instantiated is contingent (contrary to extreme Platonism, which holds that universals cannot be literally instantiated in reality). It is the same with uninstantiated mathematical structures, according to the Aristotelian of Platonist bent: a ratio (say), whether small and instantiated or huge and uninstantiated, is part of a necessary spectrum of ratios (as Platonists think) but an instantiated ratio is literally a relation between two actual (say) lengths (as Aristotelians think) and is thus something found in the physical world. The fundamental reason why an intermediate position between extreme Platonism and extreme Aristotelianism is possible is that the Platonist insight that there is knowledge of uninstantiated universals is compatible with the Aristotelian insight that instantiated universals can be directly perceived in things.

The slogan of semi-Platonist Aristotelianism is 'Instantiation is possible but not necessary'.

Should an uninstantiated universal be said to 'exist'? That is not regarded as a meaningful question by the semi-Platonist Aristotelian.

When a universal is instantiated in a particular in some state of affairs, a being exists with that universal; when a universal is not instantiated, there are knowable possibilities concerning it and its relations to other universals, but there is no need to grant it an 'existence' parallel to that of particulars. It may be convenient to set up names and mathematical notations for such possibilities, but it is not the business of the philosophy of universals or the philosophy of mathematics to deal with complex questions in the philosophy of language concerning reference to objects beyond the here and now (such as fictional and future objects, as well as possibilities).¹⁸ It is sufficient to insist on the reality of relations between universals, instantiated or not, and on the reality of knowledge of them.

Semi-Platonist Aristotelianism makes sense of two conflicting intuitions about the objectivity of mathematics, which create difficulties for other theories. On the one hand, its Aristotelian aspect allows it to connect the objectivity of mathematics with the usual objectivity of science arising from perception and measurement: the symmetry of a physical object, for example, can be perceived, quantities can be counted and measured. That is because symmetry and quantitative properties like length are genuinely instantiated in reality and can cause perceptual and measurable knowledge of themselves in the ordinary way of science. On the other hand, pure mathematics is felt to cantilever our knowledge out beyond perceptible reality, and to give us insight into realms of necessities that may well not be instantiated in the actual world. As Armstrong puts it, 'in mathematics, we gain knowledge of entities which are merely possible, and indeed, perhaps nomically impossible...there can be no question of establishing these conclusions *a posteriori*...Mathematical "existence", then, is the possibility of actual existence.'¹⁹

Those opposing sources of mathematical objectivity must be compatible despite their apparent tension, since sometimes it happens that pure mathematics discovers structures whose applicability is unsuspected, followed by scientists' discovery that those very structures describe some aspect of reality. (Einstein's use of esoteric aspects of differential geometry in general relativity is one of many celebrated cases.²⁰) Semi-Platonist Aristotelianism explains the metaphysics underlying these different aspects of the objectivity of mathematics. The same mathematical properties may be instantiated (hence perceptible and measurable) or uninstantiated and merely possible (hence accessible, if at all, by some other, purely intellectual, method).

The details of the epistemology – how perception in simple cases meshes with intellectual insight into the non-existent – will be dealt

with in Chapters 10, 11 and 12. Chapter 11 in particular deals with the faculty of the imagination, which is capable of the recombinations of learned concepts that launches us out beyond the directly perceived, into the realm of the possibly uninstatiated.

3

Elementary Mathematics: The Science of Quantity

If Aristotelian realists are to establish that mathematics is the science of some properties of the world, they must explain *which* properties. That is particularly necessary since it is much less obvious what the answer is for mathematics than it is for sciences like physics, biology or sociology. It is clear enough what properties of things physics studies – properties such as mass and attraction (even if it is hard to say what they have in common that makes them physical). Likewise it is clear that biology studies the properties unique to living things. But when the properties of things studied by those special sciences have been listed, what properties are there left over for mathematics to be about? The answer is less than obvious.

To be convincing, an Aristotelian realism must answer this question convincingly and precisely. The answer must be convincing in terms of covering the examples that are uncontroversially mathematical, and precise in terms of a clear definition.

There have been two main suggestions from realists about the object of mathematics, as to what that object is. The first theory, the one that dominated the field from Aristotle to Kant and that has been revived by a few recent authors, is that mathematics is the ‘science of quantity’. The second is that its subject matter is structure or pattern.

Reasons will be given for taking both of these to be objects of mathematics, and exact definitions of both these (notoriously vague) concepts will be offered. The exactitude of the definitions will be sufficient to permit a demonstration that the concepts are not identical, though closely related.

Two realist theories of mathematics: quantity versus structure

Quantity is examined in this chapter and structure in the next. It is concluded that *both* quantity and structure are real properties and are

studied by mathematics, but are quite distinct properties. The division between the two objects of study roughly corresponds to the division between elementary and higher mathematics. It will be explained how to characterize the notions of 'quantity' and 'structure' precisely enough so that it can be established that the two are not the same. Yet they have a close enough relationship to give some degree of unity to the subject matter of mathematics.

From the time of Aristotle to the eighteenth century, one philosophy of mathematics dominated the field. Mathematics, it was said, is the 'science of quantity'. Quantity, one of Aristotle's basic categories of being, is divided into the discrete, studied by arithmetic, and the continuous, studied by geometry.¹ That theory plainly gives an initially reasonable picture of at least elementary mathematics, with its emphasis on counting and measuring, and calculating with the resulting numbers. It promises direct and comprehensible answers to questions about what the object of mathematics is (certain properties of physical and perhaps non-physical things such as their size), and how those properties are known (the same way other natural properties of physical things are known: by perception in simple cases and inference from perception in more complex ones).

Following dissatisfaction with the classical twentieth-century philosophies of mathematics such as formalism and logicism, and in the absence of a general wish to return to an unreconstructed Platonism about numbers and sets, another realist philosophy of mathematics became popular in the 1990s. Structuralism holds that mathematics studies structure or patterns. As Shapiro explains it, number theory deals not with individual numbers but with the 'natural number structure', which is 'a single abstract structure, the pattern common to any infinite collection of objects that has a successor relation, a unique initial object, and satisfies the induction principle'.² The structure is 'exemplified by' an infinite sequence of distinct moments in time. Number theory studies just the properties of the structure, so that for number theory, there is nothing to the number 2 but its place or 'office' near the beginning of the system. Other parts of mathematics study different structures, such as the real number system or abstract groups.

The structuralist theory of mathematics has, like the quantity theory, some initial plausibility, in view of the concentration of modern mathematics on structural properties like symmetry and the purely relational aspects of systems both physical and abstract. It is supported by the widespread concentration of modern pure mathematics on 'abstract structures' such as groups and topological spaces.

In view of the underlying philosophical similarity between these two realist theories of mathematics, it is surprising that questions have not been asked about the relation between them, or about the relation between the concepts of quantity and structure. This is particularly remarkable in that the quantity theory, or something very like it, was revived in the 1990s, and a school of philosophers has tried to show that sets, numbers and ratios should also be interpreted as real properties of things (or more exactly real relations between universals: for example the ratio ‘the double’ may be something in common between the relation two lengths have and the relation two weights have). The fact that this project has been pursued in Australia³ while structuralism is North American does not seem sufficient excuse for this theory’s being unmentioned in most recent discussion in the philosophy of mathematics.

Nor is it sufficient excuse – though it may to some extent explain the lack of communication – that the quantity theory tends to be more Aristotelian and structuralism more Platonist in its realism. The quantity theorists tend to discuss ratios existing between actual lengths, times and so on, and mostly situate their theory in an Aristotelian realist theory of universals such as that of Armstrong. But, as will be described in the next chapter, the two leading structuralists, Shapiro and Resnik, are largely Platonist about structures: Shapiro favours an ‘*ante rem* structuralism’ which he compares to Platonism about universals, and Resnik is also Platonist with certain qualifications.⁴ But the gulf between the two sides is not as wide as it seems. Shapiro and Resnik allow arrangements of physical objects, such as basketball defences, to ‘exemplify’ abstract structures, thus allowing mathematics to apply to the real world in a somewhat more direct way than classical Platonism, while certain other structuralist authors place much greater emphasis on instantiated patterns.⁵ On the other hand, quantity theorists admit a need to deal with uninstantiated quantities such as very large numbers, tending to make their approach a semi-Platonist form of Aristotelianism (as described in Chapter 2).

Once the existence of the science-of-quantity and science-of-structure theories is noticed, some obvious questions arise. Are they really the same theory, with ‘structure’ being just a modern understanding of what was previously called quantity? Or is structure a genus of which quantity is a species, so that structuralism is a generalization of the quantity theory that reflects the wider compass of modern mathematics? If, on the other hand, quantity and structure are both genuine sorts of universals, but different ones, are there sciences of both, and if so, what are they?

These questions are important for reasons beyond the need of an Aristotelian philosophy of mathematics to say clearly and exactly what mathematics is about, if the philosophy of mathematics is to move beyond its concentration on the items studied in kindergartens and logic seminars, such as numbers and sets, and deal with those studied by real mathematicians, including applied mathematicians. (Even philosophers' discussions of the applicability of mathematics foreground numbers and real analysis rather than, say, operations research or fluid dynamics.⁶) An initial classification of the entities appearing in the discourse of mathematicians is surely desirable in advance of any philosophically inspired projects to, for example, reconstruct those entities in some other material such as sets or categories.

The position that will be argued for here is that quantity and structure *are* different sorts of universals, both real. The sciences of them are approximately those called by the (philosophically somewhat unsatisfying) names of elementary mathematics and advanced mathematics. That is a more exciting conclusion than might appear. It means that the quantity theory will have to be incorporated into any acceptable philosophy of mathematics, something very far from being done by any of the current leading contenders. It also means that modern (post-eighteenth-century) mathematics has discovered a completely new subject matter, pure structure, thus creating a science unimagined by the ancients.

Let us first examine quantity, addressing such traditional questions of the philosophy of mathematics as 'What are numbers?', while at the same time keeping to elementary matters where purely structural considerations are less evident.

Continuous quantity and ratios

According to the traditional division of mathematics, geometry studies continuous quantity while arithmetic studies discrete quantity or numbers. That division at least highlights the fact that it is far from clear initially whether the two kinds of quantity have much in common, for example whether the ratio 'the double' has much in common with the counting number 2. So let us examine them separately.

The crucial concept of continuous quantity is *ratio* or *proportion*. Bigelow introduces ratios as follows. His Aristotelian language is chosen to keep close to physically real relations, and also to remind us how easily we deal with the reality of relations, and relations between relations:

Physical objects, like elephants and Italians, humming-birds and Hottentots, have many physical properties and relations: volume and surface area, for example. And the physical properties of these objects stand in important relations to one another. In particular, such physical properties stand in relations of proportion to one another. There is a relation between the surface area of the humming-bird and that of the Hottentot; and this may or may not be the same as the relationship that holds between the surface areas of an Italian and an elephant.

Relationships such as proportion will hold not only between surface areas but also between volumes. Conceivably, the relationship between the surface areas of two objects might be the same as the relationship between volumes for two other objects. But it is a fact of considerable biological significance that the relation between surface areas of two objects will not, in general, be the same as the relationship between their volumes. Ignoring differences in shape (say, by supposing an elephant were shaped like an Italian, or vice versa), it turns out that if the elephant has ten times the height then it will have a hundred times the surface area and a thousand times the volume. The volumes of the elephant and the Italian, or the Hottentot and the humming-bird, will be 'more different' than their surface areas. There are several distinct relationships present; furthermore, there are distinctive ways in which these relationships differ from one another. There are also distinctive relationships among these relationships. These facts have consequences of physical significance: for instance, with regard to problems of heat regulation. It is from such fertile soil as this that most of mathematics has grown.⁷

Thus, for example, the universal 'being 1.57 kilograms in mass' stands in a certain relation, a ratio, to the universal 'being 0.35 kilograms in mass'. Pairs of lengths can stand in that same ratio, as can pairs of time intervals. (It is not so clear whether pairs of temperature intervals can stand in a ratio to one another; that depends on physical facts about the kind of scale that temperature is.) The ratio itself is just what those binary relations between pairs of masses, lengths and time intervals have in common. 'A ratio is a sort of relation in respect of size between two magnitudes of the same kind', in Euclid's words.⁸

Ratios are most easily appreciated in the kind of quantity called 'extensive'. Modern physics makes a basic distinction between extensive quantities like length and mass, and intensive ones like temperature and speed.⁹

If a body has length two metres, it consists of two parts, each of length one metre. It is the same with mass or volume: a two-unit mass or volume consists (in many different ways) of two parts of unit mass or volume. A time of two seconds consists of two parts, each of one second. Such a quantity is called 'extensive'. In the language of the International Union of Pure and Applied Chemistry, 'a quantity that is additive for independent, non-interacting subsystems is called *extensive*'.¹⁰

Extensive quantities are easy to measure since a unit can be repeated to fill up the quantity to be measured. For example, a length can be measured by concatenating identical rods, because the length occupied by the rods is the sum of the lengths of each one. It is easy to see how the ratios arise in such cases: necessarily, if an object with an extensive quantity is cloned, the ratio of the sum to the original is necessarily the double ratio.

A (particular) ratio is thus not merely a 'place in a structure' (of all ratios), for the same reason as a colour is not merely a position in the space of all possible colours – the individual ratio or colour has intrinsic properties that can be grasped without reference to other ratios or colours. Though there is indeed a system or space of all ratios or all colours, having its own structure, it makes sense to say that a certain one is instantiated and a neighbouring one not. It is perfectly determinate which ratios are instantiated by the pairs of energy levels of the hydrogen atom, just as it is perfectly determinate which, if any, shades of blue are missing.¹¹

Although ratios are most easily seen in extensive quantities, they are also crucial in some kinds of intensive quantities, namely, those that are rates of extensive quantities. A body with speed of two metres per second does not consist of two parts, each with speed one metre per second, so speed is not an extensive quantity. Nevertheless, speeds have determinate ratios, since a body with speed twice another covers twice the space in equal times.

Ratios appear to have no close connection with sets. The ratio of your height to mine does not suggest or require the existence of any sets (of heights, people, numbers or anything else).

Discrete quantity and numbers

Discrete quantities arise in quite a different way from ratios. It is characteristic of 'unit-making' or 'count' or sortal universals like 'being an apple' to structure their instances discretely. That is what distinguishes them from mass universals like 'being water'. A heap of apples stands in a certain relation to 'being an apple'. That relation is the number of apples in the heap. The same relation can hold between a heap of shoes

and ‘being a shoe’. The number is just what these binary relations have in common.¹²

Thus, suppose there are seven black swans on the lake now. The proposition refers to a part of the world, the black biomass on the lake now, and a structuring property, being a black swan. Both are necessary to determining that the relation between the mass and the property should be ‘seven’: if it were a different mass (for example the black swans on or beside the lake now) or a different unit-making property (for example being a swan organ) then the numerical relation would be different. Therefore numbers are not properties of parts of the world simply, but must be properties of the relation between parts of the world and the unit-making properties that structure them.

So the fact that a heap of shoes stands in one such numerical relation to ‘being a shoe’ and another numerical relation to ‘being a pair of shoes’ (made much of by Frege¹³) does not show that the number of a heap is subjective or not about something in the world, but only that number is relative to the count universal being considered; and Aristotelians take that universal to be part of the world’s furniture. (Similarly, the fact that the probability of a hypothesis is relative to the evidence for it does not show that probability is subjective, but that it is a relation between hypothesis and evidence.) We will consider the significance and baneful consequences of Frege’s mistake in Chapter 7.

One may picture the structuring unit-making property as a ‘cookie-cutter’ that cuts the mereological sum, the black mass on the lake, into seven black swans. However, that is potentially misleading in suggesting that the individuals cut out should be disjoint. That is often so, but it need not be, since the way some unit-making properties structure their instances allows for the possibility of a proper part of an individual being also an individual of the same kind. For example, in the diagram below,¹⁴ the space surrounded by the outside lines consists of three delineated squares, but they are not disjoint:

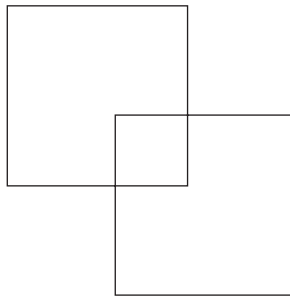

Figure 3.1 Squares whose intersection is another square

So the relation of a part of space to ‘being a square’ can be a little more complex than the relation of apple mass to ‘being an apple’, but there is nothing especially problematic about that.

Like a ratio, a number is not merely a position in the system of numbers. There is a perfectly determinate number of apples in a heap, independently of anything systematic about numbers (and independent of any knowledge about it, such as through counting). Thus the theory of Shapiro and others that the number 2 is merely a position in the series of numbers is incomplete. It arises from a confusion between the ordinal and cardinal aspect of numbers. Although 2 as an ordinal number is merely the second place in the number sequence, 2 as cardinal number is the unique relation between, for example, Sirius and ‘being a star’ (since Sirius is a double star).

Discrete quantity and sets

Whereas ratios have nothing to do with sets, numbers are intimately connected with them. Given a set, there is something to count. And conversely, if there is counting, there is a set of entities being counted, and indeed sets are good for little else.¹⁵ Given a heap and a unit-making property structuring it, there is immediately created (there supervenes) both the set of things of which the heap is the mereological sum, and the number of things in that set. If there is no unit-making property – if there is just stuff – there is no number and no set.

Thus sets have a critical role in mathematics, and not just at an advanced level. Philosophers sometimes speak as if sets were only discovered in the nineteenth century in connection with esoteric questions in the foundations of real analysis.¹⁶ An explicit set *theory* was only needed at that stage, but there is plenty of reference to sets in earlier mathematics. In combinatorics, such as the counting of structured sets like ‘how many ways’ to do something (say, how many pairs can be chosen from a set of objects), it is difficult to avoid explicit reference to the sets involved. For example, in their correspondence of 1654 that founded the mathematical theory of probability, Fermat and Pascal considered the ways of completing a game with four coin tosses, and explicitly listed the set of sixteen possibilities:¹⁷

Table 3.1 Possible outcomes of four coin tosses

a	a	a	a	a	a	a	a	b	b	b	b	b	b	b	b
a	a	a	a	b	b	b	b	a	a	a	a	b	b	b	b
a	a	b	b	a	a	b	b	a	a	b	b	a	a	b	b
a	b	a	b	a	b	a	b	a	b	a	b	a	b	a	b

The widespread idea of a ‘majority’¹⁸ is an explicit concept of a subset, needed for example in explaining the validity of the argument:

Most As are Bs

Most As are Cs

Therefore some Bs are Cs¹⁹

The reasoning needed here resembles that in the most elementary problems now normally solved at school via explicit reference to sets (using Venn diagrams), questions such as, ‘If ten students in the class play violin, five play piano and two play both, how many play at least one of those instruments?’ In the graph of a function – such as Oresme’s graphs of the shape of motion, Descartes’ graphing of algebraic equations in the Cartesian plane, or Playfair’s eighteenth-century graphs of expenditure over time – the axes represent the domain and codomain of the function, that is, the sets of, respectively, the inputs and the possible outputs of the function. Thus sets are and have long been very familiar objects in quite elementary parts of mathematics.

Nor was reference to sets found only in mathematics. The relation of a platoon to a brigade (or of corresponding divisions in ancient armies) is numerical, rather than measured by biomass, because they are both sets of soldiers. The *Oxford English Dictionary* records many early uses of ‘group’, ‘collection’, ‘class’, ‘multitude’, ‘aggregate’, ‘pair’ and ‘set’ in the modern sense of sets of things,²⁰ and that does not begin to deal with the more specialized language dealing with sets of people and animals, such as ‘company’,²¹ ‘society’, ‘committee’, ‘congregation’, ‘member of Parliament’, and the entire array of collective nouns such as ‘flocks’, ‘herds’, ‘gaggles’²² and so on. Even philosophers could manage the concept to some degree: when Plato is recorded as being forced to add to the ‘featherless biped’ definition of ‘man’ the characteristic ‘with broad flat nails’ (in response to Diogenes’ plucked chicken),²³ there is plainly an understanding involved of the extension of a predicate. Even sets of sets of sets... are not uncommon in ordinary life – if I sign off for a consignment of three truckloads each with four crates of ten packages with five pairs of shoes each, I have dealt with a set of a set of a set of a set of a set of a set of shoes; the example indicates why multiplication is as important in elementary arithmetic as addition.

So what are sets, from an Aristotelian point of view? The Aristotelian cannot rest content with the Platonist story that sets are a simple ‘abstract’ object at which questions should stop, and that the membership

relation is *sui generis*. That conception is problematic, as will be argued in Chapter 7, but even if it were intelligible and satisfactory, it would interpose a Platonist entity in a story where there should be no role for it, the story of how unit-making properties structure a heap into something able to be counted.

The Aristotelian desires a theory according to which sets are ontologically nothing over and above there being a unit-making property to structure a heap. Several theories are available and the differences among them are inessential:

- Armstrong adopts David Lewis's proposal that a set is the mereological sum of its singletons, and adds the idea that the singleton of x is simply the state of affairs of there being some unit-making universal that singles out x .²⁴
- Forrest suggests that an appealing *antirealism* about sets would take the set $\{a, b, \dots\}$ to be the heap $a + b + \dots$ *regarded as* having a, b, \dots as parts, and a realist version of this would be to take the set to be the 'trope' or state of affairs of the heap $a + b + \dots$'s having a, b, \dots as parts.²⁵
- Bigelow argues that a singleton is an 'individual essence' or haecceity of its only member, which 'captures its uniqueness', so that a set is 'a universal that nothing could possibly instantiate without being identical to one of the things that actually instantiate that universal'.²⁶
- Simons suggests that the same formal properties can be obtained by allowing the singleton of x to be the state of affairs of x 's being identical to itself²⁷ (the unit-making property is implicit here, in that without such a property there would not be an x to pick out).

The essence of all these suggestions is that at the basic philosophical level necessary in this question, we cannot help ourselves naively to the notion of 'object'. When we assert 'The cat sat on the mat', 'The', in 'the cat', indicates that we are dealing with a single unified *object*, cut out from the background. In the continuum of matter that is the universe and the flux it undergoes, what cuts out the warm furry item, draws its boundaries and points it out as an individual thing deserving a common noun?²⁸ It is the property, the repeatable unit-making property 'being a cat', that cuts the cat from the background, and in doing so creates a singleton (and when actually repeated creates other sets) and at the same time creates something to be counted.

This casts light on the intuitively attractive theory that numbers are properties of sets: that, for example, {Sydney, Hong Kong} and {temperance, patience} are particulars which share the property 'being 2' or 'being pairs'.²⁹ That theory as it stands is straightforward and natural, but as a total theory of the nature of number it suffers from two problems: the lack of an account of what sets are, and a mystery as to how numbers were understood for so many millennia before any explicit connection with sets was made. Nevertheless, any attempted account of sets should either deliver the numbers-as-properties-of-sets theory as a consequence, or explain away the attractiveness of the theory.

The present account of numbers and sets does deliver the theory as a consequence – or almost. Let us take the simplest case, that of 1-element sets: the set {Sydney} is (taking the Armstrong version) the state of affairs of there being a unit-making property of the mass of buildings in eastern Australia, such as 'being a city'. But on the other hand, 1 is the relation which that mass of buildings has to the unit-making property 'being a city' (a repeatable property). So the connection between the number and the set is very close. However, note that the set is constituted just as well by any *other* unit-making property of that mass of buildings, whereas the number 1 is strictly a relation between the mass and the *chosen* property: Sydney is 'one city'. So, a set refers to the division of a heap into objects in abstraction from which unit-making properties are doing the dividing. Thus the view that numbers are properties of sets is somewhat more abstract than the claim that they are relations between a heap and a unit-making property, but compatible with it.

That gives some explanation, too, of why numbers are much older than explicit set-theory: to count 'two cities' can be done prior to abstracting from which unit-making property is dividing the heap into two, as is needed to form the set {Sydney, Hong Kong}.

Another consequence of these definitions of sets, one that will prove important for the definition of structure in the next chapter, is that on an Aristotelian view there is not the same sharp distinction between set theory and mereology as there is in standard nominalist and Platonist discussions. The mereology normally discussed in philosophy is mereology with units or atoms – the 'calculus of individuals'. That was the mereology of nominalists such as Goodman, who hoped to use it to reconstruct mathematics free of Platonist entities.³⁰ But if one goes beyond mereology with undifferentiated or continuous stuff and helps oneself to objects or units then, on an Aristotelian view, one needs unit-making universals to enable one to do so. For example, it is usually said that in set theory, $a \neq \{a\}$, while

mereology sees only one object there and denies that there exists a second object, the singleton of a . But on an Aristotelian view, to take there to be a unitary object a is already to admit some unit-making universal, which is something distinct from the stuff that a is made of and on which the existence of the singleton $\{a\}$ supervenes. Set theory and mereology with individuals thus have essentially the same ontological commitments (namely, to objects and the states of affairs of objects' having unit-making properties).

The only issue on which they might thereafter diverge concerns the indefinite iterability of set formation, so that issue deserves debate. If it is to be possible to form $\{\{a\}\}$ from $\{a\}$, 'the state of affairs of a 's having some unit-making property' must itself be a 'one'. Our willingness to use the definite article in front of 'state of affairs' creates a presumption that that is so and there seems to be no clear reason against that. It could be argued however that allowing indefinite iterability creates a bloated ontology. Thus Chihara argues, of Maddy's view that sets of physical objects are located where their members are,

there is on my desk, not only the apple and the unit set whose only member is the apple, but also the unit set whose only element is this unit set whose only element is the apple. Clearly, by this line of reasoning, we can infer that there are infinitely many such objects on my desk. And all these objects take up exactly the same amount of space on my desk.³¹

The implication that the desk is becoming overcrowded with objects and hence that we should not believe in them is unreasonable. The shape and the colour of the apple do not crowd each other out, because they are not physical objects, but (really distinct) aspects of the one physical object. The hierarchy of sets do not create overcrowding for the same reason.

A view of sets as a kind of states of affairs, or indeed any other reductive account of sets, can raise such problems as whether sets have causal power, whether they are spatio-temporally located (and if so, located where their members are) and whether the entities to which they are reduced are more naturalistically acceptable than Platonist sets themselves.³² Those are genuine questions but they should be left to the metaphysics of states of affairs to deal with. Provided that the concept of states of affairs is sound, the philosophy of mathematics can accept whatever answers metaphysics delivers about whether states of affairs

Fa should be said to possess, for example, the causal powers of the individual *a* and the property *F*.

This view of sets raises the possibility that small sets of physical objects should be directly perceivable, as argued by Maddy.³³ If I open an egg carton and see that there are three eggs in it, I perceive both the pale curved surface of the egg-heap and that it is structured by 'being an egg' into three parts, each an egg. That is sufficient to perceive the heap as a set of three eggs.

Perception of sets *of sets* of physical objects is not beyond our capabilities either. For example, in this diagram,

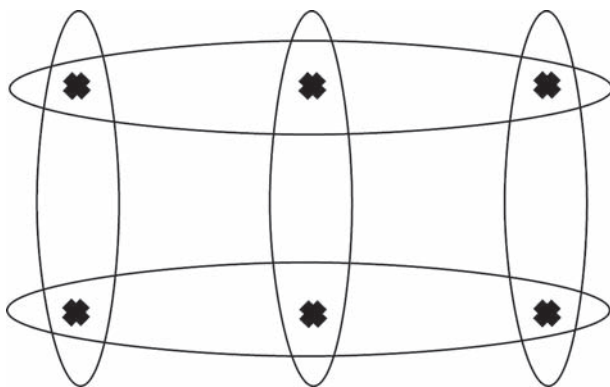

Figure 3.2 Why $2 \times 3 = 3 \times 2$

the point of the ovals is to guide the visual system so as to see the six objects as alternately two sets of triples and three sets of pairs.

We will discuss knowledge of small numbers and sets further in the first chapter on epistemology (Chapter 10), and the knowledge of large ones in the chapter on infinity (Chapter 8).

It remains to give an account of the empty set, which is special and is not covered by the discussion so far, which has concerned sets of actual objects. From an Aristotelian point of view, there would be nothing lost in giving a fictionalist account of it. As we will see later, Aristotelian views of mathematical structures do not need them to be constructed out of sets, so the empty set is not needed to construct, for example, the continuum. We will leave the discussion to our treatment of ideal entities and zero in Chapter 14.

Discrete and continuous quantity compared

Despite their different origins, the discrete number 2 and the ratio 'the double' do have certain close connections. If I take an apple and create an exact non-overlapping copy, then the mereological sum of them stands in the relation 2 to 'being an apple', while the mass, volume and surface area of the sum stand in the double ratio to the mass, volume and surface area, respectively, of a single apple. Conversely, if I take a length A that stands in the ratio double to a length B, then a string of length A consists of certain disjoint parts of length B to which it stands in the numerical relation 2. Some explanation is called for of why that should be so.

The relation between discrete and continuous quantity may be clarified by asking: is 'being one kilogram mass' a unit-making property in the sense of the previous sections on discrete quantity? The answer is: yes and no. On the one hand, a unit such as one kilogram is subject to repetition, so in that sense resembles a discrete entity such as an apple. On the other hand, 'being one kilogram' contrasts with 'being an apple' in being subject to continuous variation: being 1 kilogram is an arbitrary point in a range of indefinitely close weights, but there is no quantity of apples between one and two apples. (Although I may eat one and a half apples, the half is a quantity of apple-stuff which is half that of a typical apple either by weight or volume.)

However the differing origins of continuous and discrete quantity led to some classical problems in Aristotelian philosophy of quantity. A natural idea is to try to reduce continuous quantity to discrete by taking *units*: small quantities of which all other quantities (of the same kind, for example lengths) in some given problem could be expressed as whole number multiples. The impossibility of making this idea work was the import of perhaps the first truly surprising result in mathematics, the one attributed (traditionally but without much evidence) to Pythagoras: the proof of the incommensurability of the side and diagonal of a square. There is *no* unit, however small, such that both the side and the diagonal of a square are whole number multiples of it. That is, there can exist a continuous ratio that is not the ratio of any two whole numbers. Therefore geometry, and continuous quantity in general, are in some fundamental sense richer than arithmetic and not reducible to it via choice of units. While much about the continuous can be captured through discrete approximations, it always has secrets in reserve.

That only increased the mystery as to why some of the more structural features of the two kinds of ratios (continuous and discrete) should be

identical, such as the principle of alternation of ratios (that if the ratio of a to b equals the ratio of c to d , then the ratio of a to c equals that of b to d). Is this principle part of a ‘universal mathematics’, a science of quantity in general?³⁴ Is there anything to be gained, philosophically or mathematically, by Euclid’s attempt to define equality of ratios without defining a way of measuring ratios (Book V, definition 5)?³⁵ Genuine and interesting as these questions are, they will not be attacked here. The purpose of mentioning them is simply to indicate the scope of a realist theory of quantity.³⁶

Defining ‘quantity’

The theory of the ancients that the science of quantity comprises arithmetic plus geometry may be approximately correct, but needs some qualification. Arithmetic as the science of discrete quantity is adequate, though as Benacerraf’s example of the theory of infinite progressions shows, the study of a certain kind of linear order structure is reasonably regarded as part of arithmetic too. But geometry as the science of continuous quantity has more serious problems. It was always hard to regard shape as straightforwardly ‘quantity’ – it contrasts with size, rather than resembling it – though geometry certainly studies it. From the other direction, there is the problem that there can be discrete geometries: the spaces in computer graphics are discrete or atomic, but obviously geometrical. Hume, though no mathematician, certainly trounced the mathematicians of his day in arguing that real space might be discrete.³⁷ Further, there is an alternative body of knowledge with a better claim to being the science of continuous quantity in general, namely, the calculus. Study of continuity requires the notion of a limit, as defined and used in the differential calculus of Newton and Leibniz, and made more precise in the real analysis of Cauchy and Weierstrass. On yet another front, there is a different body of knowledge which seems to concern itself with quantity as it exists in reality. It is measurement theory, the science of how to associate numbers with quantities.³⁸ It includes, for example, the requirement that physical quantities to be equated or added should be dimensionally homogeneous³⁹ and the classification of scales into ordinal, linear interval and ratio scales.⁴⁰

There is then the final question of whether there is a formal definition of ‘quantity’ that might be compared with one of ‘structure’ so as to exhibit their mutual logical relations.

Inspired by Aristotle’s concept of what is ‘subject to more and less’, a definition can be based on the mathematics of order structures. A partial

order (in mathematical terminology) is a binary relation that is reflexive, antisymmetric and transitive. (An example is inclusion among sets: it arranges sets in an ordering of smaller and larger, but not every pair of sets is comparable.) A linear or total order is a partial order in which any two elements *are* comparable (for example, 'greater than' among whole numbers).⁴¹ In the language of measurement theory, the items are said to be comparable on an ordinal scale; however, the 'scale', in the sense of a scale of numbers, is not part of the definition but a consequence: if items are linearly ordered, they may be assigned numbers such that items later in the ordering have greater numbers. If items are linearly ordered, it may or may not be that there is a notion of distance between the items being ordered, that is, it is meaningful to compare the interval between *a* and *b* with that between *c* and *d*, as less, equal or more (in the language of measurement theory, the items are comparable on an interval scale). If so, it may or may not be that the items have a size such that the ratio between sizes is meaningful ('comparable on a ratio scale').

The most core or paradigmatic quantities are those comparable on at least an interval scale. That implies that the ordering of items is a system isomorphic to the continuum, or to a piece of it (for example, the interval from 0 to 1, in the case of probabilities) or a substructure of it (such as the rationals or integers). It is not entirely out of the question to call a purely ordinal scale such as the 1-to-10 scale of mineral hardness or IQ a 'quantity',⁴² but it is stretching the meaning of the term because there is no 'quantum' or repeatable atom separating items and care is needed not to attribute meaning to differences between items.

One may more loosely call any (not necessarily linear) order structure a kind of quantity (in that it permits *some* comparisons on a kind of scale). Thus vectors and complex numbers can be called quantities in that all the real-number multiples of a fixed one form a linear order and are thus subject to comparison as 'more or less'. Although ones in different directions are not strictly comparable, direction varies continuously and hence a vector is approximately comparable with one in a nearby direction (in that the projection of the first on the second is similar to the first and comparable to the second); vectors in different directions are also comparable in respect of length.⁴³ Vectors and their relation to geometry will be discussed in Chapter 9.

One might go so far as to allow fuzzy quantities such as imprecise probabilities by a family resemblance, as they share the properties of the continuum except for absolute precision.⁴⁴

In summary, the science of quantity is elementary mathematics, up to and including the calculus, plus measurement theory. In the next chapter we see how structure contrasts with quantity, yet has a close connection.

4

Higher Mathematics: Science of the Purely Structural

The last three centuries have seen mathematics move well beyond its original subject-matter of quantity. It has discovered an entirely different subject-matter, structure or pattern. We survey the historical development with an eye to philosophically significant examples, then address the crucial philosophical question of characterizing precisely what ‘structure’ is.

The rise of structure in mathematics

Ideas of pattern were not unknown in the ‘ethnomathematics’ of cultures without writing, for example the use of diagrams to indicate family relationships and a clear sense of what repetitive patterns are possible in decorations, but they did not lead to well-defined mathematical problems.¹ The earliest case of a serious mathematical problem that seemed clearly not well described as being about ‘quantity’ was Euler’s example of the bridges of Königsberg. The bridges connected two islands and two riverbanks as shown in the diagram:

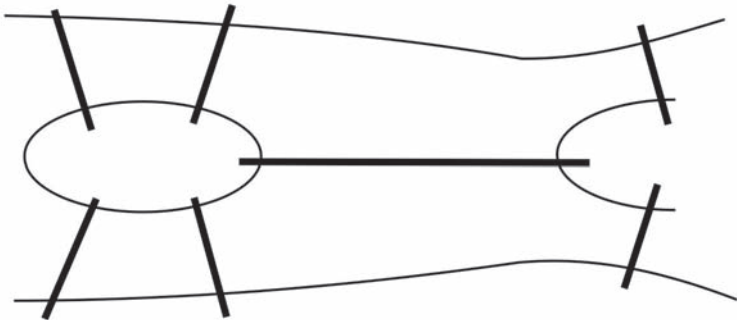

Figure 4.1 The bridges of Königsberg

The citizens of Königsberg in the eighteenth century noticed that it was impossible to walk over all the bridges once, without walking over at least one of them twice. Euler proved they were correct.² The result is intuitively about the ‘arrangement’ or pattern of the bridges, rather than about anything quantitative like size or number. As Euler puts it, the result is ‘concerned only with the determination of position and its properties; it does not involve measurements’. The length of the bridges and the size of the islands are irrelevant. That is why we can draw the diagram so schematically. All that matters is which land masses are connected by which bridges. Euler’s result is now regarded as the pioneering effort in the topology of networks. As will be described briefly in Chapter 6, there now exist large bodies of work on such topics as graph theory, networks, and operations research problems like time-tabling, where the emphasis is on arrangements and connections rather than quantities.³

A second kind of example where structure contrasts with quantity is symmetry, brought to the fore by nineteenth-century group theory and twentieth-century physics. Symmetry is a real property of things, things which may be but need not be physical (an argument, for example, can have symmetry if its second half repeats the steps of the first half in the opposite order; Platonist mathematical entities, if there were any, could be symmetrical). The kinds of symmetry are classified by group theory, the central part of modern abstract algebra.⁴

Structuralism in recent philosophy of mathematics

The example of structure most discussed in the philosophical world is a different one. In a celebrated paper, Benacerraf observed that if the sequence of natural numbers were constructed in set theory, there would be no principled way to choose which sets exactly the numbers should be; the sequence

$$\emptyset, \{\emptyset\}, \{\{\emptyset\}\}, \{\{\{\emptyset\}\}\}, \dots$$

would do just as well as

$$\emptyset, \{\emptyset\}, \{\emptyset, \{\emptyset\}\}, \{\emptyset, \{\emptyset\}, \{\emptyset, \{\emptyset\}\}\}, \dots$$

simply because both form a ‘progression’ or ‘ ω -sequence’ – an infinite sequence with a start, which does not come back on itself. The only

reason for starting with the empty set is that minimalism is the name of the game, so the sequence

virtue, {virtue}, {{virtue}}, ...

would be acceptable, but

1 o'clock, 2 o'clock, 3 o'clock, ...

would not be, since it comes back to the beginning at the thirteenth step. He concluded that, 'Arithmetic is...the science that elaborates the abstract structure that all progressions have in common merely in virtue of being progressions'.⁵ The assertion that that is all there is to arithmetic is more controversial than the assertion that ω -sequences are indeed one kind of order structure, and that the study of them is a part of mathematics.

As a result of Benacerraf's work and of an increasing appreciation of the role of structure in mathematical practice, a philosophy of mathematics called 'structuralism' has been one of the leading contenders in the field in the last two decades.⁶ It is natural to compare it with the present Aristotelian version of a structuralist view of what mathematics is. The structuralism of the two leading theorists, Stewart Shapiro and Michael Resnik, does point to similar examples as the present work as typical of mathematics. The primary difference is that their conception of structure is essentially Platonist, in that 'structures' are thought of as a kind of Platonist entity like sets or numbers ('abstract objects' as those are traditionally understood). Shapiro favours an '*ante rem* structuralism' which he compares to Platonism about universals,⁷ and Resnik is also Platonist with certain qualifications.⁸

It is true that Shapiro and Resnik allow arrangements of physical objects, such as basketball defences, to 'exemplify' abstract structures, thus allowing mathematics to apply to the real world in a potentially more direct way than classical Platonism, while certain other structuralist authors place much greater emphasis on instantiated patterns.⁹ However, any Platonist theory of mathematics, structuralist or not, is far removed from an Aristotelian theory, for the reasons explained in the first two chapters above.

Further consideration of Resnik and Shapiro's views can await the treatment of Platonist philosophies of mathematics in general in Chapter 7.

Abstract algebra, groups, and modern pure mathematics

Modern pure mathematics has concentrated more and more on pure structure. Poincaré recognized the new direction of mathematics in his celebrated comment:

Mathematicians do not study objects, but the relations between objects; to them it is a matter of indifference if these objects are replaced by others, provided that the relations do not change. Matter does not engage their attention, they are interested in form alone.¹⁰

That comment is not especially true of mathematics conceived as the science of quantity, but it is true of the higher mathematics of 1900 and since. It includes on the one hand the small but philosophically prominent corner of mathematics traditionally called mathematical ‘foundations’, which deals with what structures can be made from the purely topic-neutral material of sets and categories, using logical concepts, as well as matters concerning axiomatization. On the other hand, most of modern pure mathematics deals with the richer structures classified by Bourbaki into algebraic, topological and order structures.¹¹ Twentieth-century pure mathematics pushed in an ever more abstract and structural direction. Powerful thinkers such as Emmy Noether in algebra, the founders of category theory and the Bourbaki school made notable advances by emphasizing more and more the structural aspects of pure mathematics, the relations between objects as against properties of the objects themselves.¹² Certainly if philosophy of mathematics is to move beyond a fixation with elementary mathematics and the allegedly foundational early twentieth-century work on logic and set theory, then it must take seriously what G.H. Hardy called the “‘real’ mathematics of the “‘real’ mathematicians’ (that is, of the higher pure mathematicians).¹³

These developments have a natural Platonist interpretation, in that pure mathematicians appear, to themselves as well as to others, to be exploring a realm of abstract objects with fixed objective properties and relations. The challenge for the Aristotelian philosopher of mathematics is therefore to explain how pure mathematics is really about universals that could be and sometimes are realized in (non-abstract, possibly physical) reality.

There are two features of the objects of pure mathematics that would appear, at first glance, to prevent their realizability in the physical world. One is their high degree of abstractness and the other is the huge size

of some of them, such as infinite-dimensional Hilbert spaces. Those are quite separate problems. The latter is best dealt with under the topic of infinity, the subject of Chapter 8. Abstractness is a different kind of problem, so to concentrate attention on it, it is desirable to begin with an example that is both as abstract as possible and as small and easy to understand as possible (while being otherwise uncontroversially typical of the entities of pure mathematics).

So let us examine the smallest non-trivial group, the cyclic group of order 2.¹⁴ It has two elements, which we will denote ι (for 'identity') and α . The group is completely specified by its multiplication table:

*	ι	α
ι	ι	α
α	α	ι

That is, ι acts as an identity (multiplying by it has no effect), while the other element, α , is an 'involution', that is, squaring it gives the identity. That description gives the same information as the multiplication table, and does so in purely structural terms. One may construct the group in set theory if one is so minded.

Two familiar examples of the group in numbers and their operations are $\{0, 1\}$ with addition mod 2:

+	0	1
0	0	1
1	1	0

and $\{1, -1\}$ with multiplication:

\times	1	-1
1	1	-1
-1	-1	1

The question for the Aristotelian is then whether this abstract structure is a universal that could be realized, literally and fully, in ordinary non-abstract reality.

This structure is very common. It is what is called in computer science a toggle. On a computer keyboard, Caps Lock works as a toggle: press it once and it puts the keyboard input into the capitals state; press it again and the operation is cancelled and the system is back where it started. Another familiar realization of the group is:

$\alpha \rightarrow$ turn the page on the desk over

$\iota \rightarrow$ leave the page on the desk as it is

The operations of causing a keyboard to go into Caps Lock mode and back, and the operations of turning a page over, are familiar and not at all abstract parts of reality. They are events (event-types) in the ordinary sense.¹⁵ And the abstract entity, the cyclic group of order 2, is a universal literally realized in the Caps Lock toggle on a keyboard. That says no more than that pressing Caps Lock twice cancels the operation of Caps Lock, and thus that Caps Lock is an involution.

One can then derive theorems from the axioms (the axioms being in this case merely the multiplication table itself), theorems which are then true of the realizations. For example, any even power of the operation α is the identity, while any odd power is α . That somewhat complex difference between even and odd powers explains why it is an important principle of human–computer interaction that a toggle ought to have some status indicator such as a light to inform the user of which state the system is in, without the user having to dangerously operate the system to check what the state is. Theorems of the abstract group thus apply to the system which has the group structure, because the theorems are a consequence of the structure described by the axioms.

Similar considerations apply to any of the abstract entities mentioned in pure mathematics, at least if they are not too large to be realized in anything physical. For example, a typical Lie group is $SO(3)$, the special orthogonal group in three dimensions. It is realized in the system of all rotations in three-dimensional space (about one fixed point). An individual rotation is an unproblematic non-abstract entity: a physical object may be subjected to an actual rigid rotation, which is a perceivable movement in space. The multiplication table of $SO(3)$ will describe the effect of combining two such operations, for example predicting the effect of twisting a Rubik's cube about one axis and then about another (keeping the centre fixed); thus the abstract multiplication table, which is the essence of the abstract structure $SO(3)$, is literally realized in physical rotations.¹⁶

The (infinite) system of *all* possible rotations, which would be needed to realize the whole of $SO(3)$ at once, is possibly not itself a physical object. However, any lack of realizability of $SO(3)$ on that score would be like the unrealizability of the order structure of the natural numbers, ω , due to the universe's finitude: it is the result of a contingent feature of the world that could have been otherwise, and so not an obstacle to the 'semi-Platonist' Aristotelian view of Chapter 2, which emphasizes the realizability, rather than actual realization, of universals.

The example of the toggle (group of order 2) is also a test-bed for understanding the close connection, seen across all of higher pure

mathematics, between the concepts of formal axiomatization and that of structure. The structure in question may be defined not directly via its multiplication table but as any system of two entities with an operation $*$ (that is, a ternary relation with certain formal restrictions) satisfying the group axioms:

$$(x*y)*z = x*(y*z)$$

There exists ι such that $\iota*x = x*\iota = x$ for all x

For each x there exists γ such that $x*\gamma = \gamma*x = \iota$

Any two entities (with an operation) satisfying these axioms is a toggle, that is, has a multiplication table as given above. To say that the axioms are ‘formal’ is just to say that the names x, γ, ι do not attribute any properties to the entities named other than those given in the axioms, and that the other language in the axioms is purely logical (‘there exists’, ‘for all’, ‘equals’). That gives content to the assertion (to be made below) that structure – in this case the structure of the group of order 2 – is definable in topic-neutral or purely logical terms.¹⁷

Structural commonality in applied mathematics

An emphasis on structure is not unique to pure mathematics. Let us take two examples with a more applied flavour. It is common to draw graphs of how one quantity varies with another: profits over time, velocity with time, temperature with distance along a rod. For example,

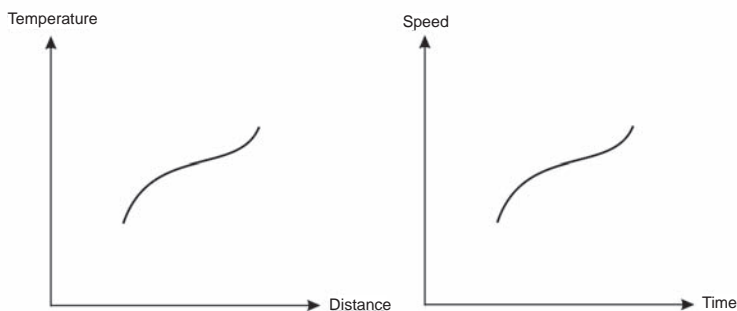

Figure 4.2 Graphs of the same relation between different quantities

The graphs assert that the variation of a certain temperature with distance is literally identical to the variation of a certain speed with

time. It is possible for a line (any of the axes) to represent indifferently distance, temperature, time and speed, because all those quantities have the same structure: the one-dimensional structure of the continuum (or at least, they have this structure locally; though globally there are certain differences, in that, for example, speed has a natural zero while time does not). And the continuum can be cashed out in purely structural terms, as will be described below.

The last example introduces one of the longest-running themes in mathematics, the interaction between local and global structure.¹⁸ Suppose that a large population grows steadily at 4% a year, or that a bank account grows at 4% a year compound interest, compounded daily. Those statements give the local structure of the situation, how the quantity (of population or money) at one time relates to the population a short time earlier. (In the bank case, the amount of money at one day is

exactly $\left(1 + \frac{4}{36500}\right)$ times the amount the day before, while in the popu-

lation case this is true approximately.) The global structure – how the interactions of the local structure ‘add up’ over time to give the ‘shape’ of the whole time-variation of population – is the well-known exponential growth curve. The curviness (non-straightness) is a property of the global structure, which is not in the local structure though it is implied by it.

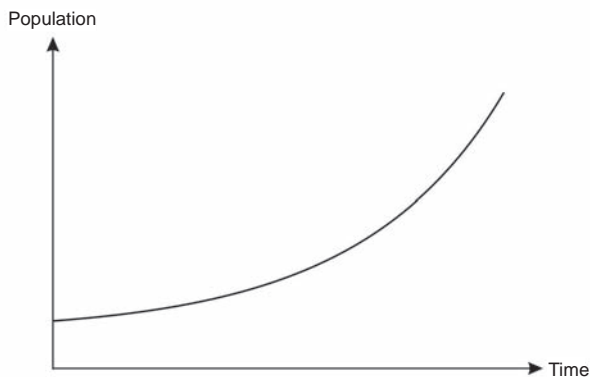

Figure 4.3 Exponential growth curve

To discuss the interaction of local and global at that high level, independent of any realizations in population or money, requires a very

abstract point of view on pure structure. That does not mean ‘abstract’ in the sense of abstract objects, but ‘abstract’ in the sense of relations of parts and wholes in abstraction from the properties of those parts and wholes.

As we will see in the chapters on epistemology, a view of mathematics as the science of the purely structural gives an insight into how mathematical knowledge can have the special kind of certainty it has. A mind, whatever it is, like a computer simulation, can have parts and hence can literally realize purely structural properties. Hence mathematics can be literally present to minds in a way that physics or biology cannot.

That completes the exposition of structure as it has come to be a central notion in modern mathematics, pure and applied. Now it is time for some philosophical reflection on the slippery notion of ‘structure’.

Defining ‘structure’

It is all very well to recognize intuitively the centrality of ‘structure’ to mathematics, but that is philosophically unsatisfying unless there is clarity as to what structure is – as to what properties are structural and what are not. It must be admitted that the difficulty of defining ‘structure’ has been the Achilles heel of structuralist philosophies of mathematics. As one observer says, ‘It’s probably not too gross a generalization to say that the main problems that have faced structuralism have been concerned with lack of clarity. After all, the slogans used to describe the view are nothing but highly evocative metaphors. In particular, philosophers have wondered: What is a structure?’¹⁹

That is a fair demand. ‘Structure’ can be defined as follows.

First, a property *S* is *structural* if and only if ‘proper parts of particulars having *S* have some properties *T*... not identical to *S*, and this state of affairs is, at least in part, constitutive of *S*’.²⁰ Under this definition, structural properties include such examples as ‘being a certain tartan pattern’²¹ or ‘being a baseball defence’.²² To be a tartan pattern, parts have to be arranged a certain way. But plainly the reference in such examples to the parts having colours or being baseball players makes such structures not appropriate as objects of mathematics – not of pure mathematics, at least. Something more *purely* structural is needed. As Shapiro puts it in more Platonist language, a baseball defence is a kind of system, but the purer structure to be studied by mathematics is ‘the abstract form of a system, highlighting the interrelationships among the objects, and ignoring any features of them that do not affect how they relate to other objects in the system’,²³ or again, ‘a position [in a

pattern]... has no distinguishing features other than those it has in virtue of being the particular position it is in the pattern to which it belongs'.²⁴ Shapiro suggests the following definition of (pure) structure:

I define a *system* to be a collection of objects with certain relations... A *structure* is the abstract form of a system, highlighting the interrelationships among the objects, and ignoring any features of them that do not affect how they relate to other objects in the system.²⁵

That is helpful as intuitive description, but as a definition it leaves much to be desired. From the Aristotelian perspective, its main defect is its appeal to the apparently Platonist notion of 'abstract form' (and possibly also of 'collection'). For the non-Platonist, it is unclear what that could mean. Other defects include the assumption that a 'collection of objects with certain relations' should have only one 'abstract form', the appearance of human activities like 'highlighting' and 'ignoring' where there should be no place for them, and the indefinite import of 'affect' (in that, for example, non-structural properties of the objects such as their colour may well 'affect', in the sense of 'cause', how they relate to other objects of the system). Something much more precise is needed of a definition of 'structure'. That can be achieved by the following definition:

A property is *purely structural* if it can be defined wholly in terms of the concepts same and different, and part and whole (along with purely logical concepts).²⁶

In short, a purely structural property is one definable in logic and mereology. For example, to be symmetrical with the simplest sort of symmetry is to consist of two parts which are the same in some respect.²⁷

If we are relying on 'logic' as part of the definition of structure, some clarification is needed as to what counts as logic, since that is a matter on which there is no agreement on borderline cases.²⁸ Some of those issues are not relevant to the definition of structure, but there are three that are.

The first is that we must count 'being a property' and 'being a relation' as purely logical notions; Aristotelians are happy to do that, as it merely states what logical category entities are in. Of course a property has a logic different from a relation: Fx works differently from Rxy .

The second is that 'logic' means 'logic with identity': identity or equality is crucial to mathematics and including equality as a logical

notion is necessary to do the most basic mathematics. If we paraphrase, in the style of Bertrand Russell,

There are two dogs

as

There is a dog A and a dog B and $A \neq B$

then the number, 2, is eliminated in favour of logic including ‘not equal to’: the notion of equality is essential. Since equality and inequality of objects are engendered by the repeated instantiation of a unit-making universal, this confirms the lesson of the previous chapter, the crucial role of unit-making universals in generating numbers and sets. Equality is admitted into the logic for the same reason as that the mereology being used is the ‘calculus of individuals’: there must be objects constituted as units.

The third issue on the limits of logic concerns whether plural quantification is genuinely logical. Plural quantification concerns such propositions as ‘there are critics who admire only one another’, which cannot be translated into standard first-order logic without referring to the group of people. So the question arises whether such quantification is logic, and hence ontologically immaculate, or whether it is set theory in disguise and hence involves commitment to sets in some Platonist sense.²⁹ This is a subtle and interesting issue, but its resolution is not important for the present thesis on the nature of mathematics and the definition of structure, for two reasons. The first is that mathematical practice has found single quantification (‘there is’ and ‘for all’) adequate, with the Russellian paraphrase for the assertion that there are more than one ($\exists x \exists y \dots$ and $x \neq y$); the irreducibly plural quantification of the philosophers’ examples does not seem to arise in normal mathematical practice. The second reason is that as we have already given an Aristotelian reading of sets, any reference to them need not be understood in a Platonist sense.

It was explained in the previous chapter that the ontological commitments of set theory and of mereology (with individuals) were the same, as sets supervene on objects and the existence of unit-making properties for them, which are the same entities needed for a ‘calculus of individuals’. (There was scope for some debate about the possibility of indefinite iterability of the set formation operator, but it was argued that that should be allowed.) It follows that to demonstrate that a concept is purely structural, it is sufficient to construct a model of it out of sets – the

capacities of set theory and pure mereology for construction are identical.³⁰ That is indeed the main philosophical point of the construction of mathematical entities in set theory. While construction in set theory is normally taken to support Platonism, by reducing the objects of mathematics to sets considered as Platonic entities, it can equally be read as mereology and structure in disguise.

Nevertheless – and especially in view of the possible doubts about the indefinite interability of set formation and hence about the realm of higher sets resulting from it – it would be much more convincing, as a defence of structuralism, to show directly from the definition of structure how various mathematical concepts are purely structural. Even so, one can be guided by the project of set-theoretical construction, where most of the difficult technical work has been done.

The sufficiency of mereology and logic

The assertion that higher mathematics deals with only purely structural properties poses a substantial challenge for Aristotelian philosophy of mathematics. The challenge is to demonstrate that properties uncontroversially mathematical, such as order and topological properties, are purely structural in this sense. With the clarity now available from a definition of ‘structure’, we can see in some simple but typical examples how mathematics does develop using only logic and mereology.

For example, we can demonstrate that the concept ‘being an ω -sequence’ is purely structural either by exhibiting an example constructed purely out of sets, such as $\{\emptyset, \{\emptyset\}, \{\{\emptyset\}\}, \{\{\{\emptyset\}\}\}, \dots\}$ with the membership relation, or by noting that the Peano axioms characterize the structure using only logic with equality: a system of objects with a binary relation S satisfies Peano’s axioms if for each object x , there is one and only object related to x by S , denoted $S(x)$; $S(x) = S(y)$ implies $x = y$; there is an object which is not $S(x)$ for any x , denoted 1 ; and if any property P is such that if it holds for 1 and holds for $S(x)$ whenever it holds for x , then it holds for all objects in the system. In that description, there are only some objects (of unspecified properties), a binary relation S (otherwise unspecified) and logic (including equality and quantification over properties). Hence the description is purely structural according to the above definition.

Hellman clarifies the example further in the course of explaining his ‘modal-structural’ reconstruction of the notion of progression or ω -sequence.³¹ If, he says, we have a progression of concreta such as strokes or stars, then arbitrary sums of these concreta correspond one-to-one with subsets of the set $\{0, 1, 2, 3, \dots\}$ (the ‘standard’ ω -sequence).

The correspondence is guaranteed by ‘the fact that each sum is uniquely decomposable into items forming the progression. But this was guaranteed by the fact that the initial items chosen were pairwise discrete (containing no common part).’ (So it is essential here that the mereology is a mereology with atoms, or ‘calculus of individuals’.) There are therefore enough sums to support all the truths of arithmetic which are normally expressed using subsets of the numbers, but the sums are as concrete as the individuals and are parts (not subsets) of the whole progression.

Platonists will object that to found mathematics on mereology would just be doing ‘set theory in disguise’. Aristotelians conclude on the contrary that set theory is mereology in disguise. As I will argue in Chapter 7, following David Lewis, the standard Platonist conception of sets lacks clarity and carries Platonist ontological baggage that has been assumed rather than argued for. Mereology by comparison is ontologically immaculate, and if its capacities can rival those of set theory, then the difficulties of Platonism in general and the unclarity of Platonist set theory in particular make the pared-down ontology of mereology a preferable foundation for mathematics. However, since the mereology involved is mereology with individuals, and as argued in the previous chapter, there is a reductive account of sets available, the ontological commitments of mereology and (non-Platonist) set theory differ very little.

Now let us take an example typical of combinatorics, the (conceptually) simplest division of advanced mathematics.

Consider six points, with each pair joined by a line. The lines are all coloured, in one of two colours (represented by dotted and undotted lines in the figure). Then there must exist a triangle of one colour (that is, three points such that all three of the lines joining them have the same colour).

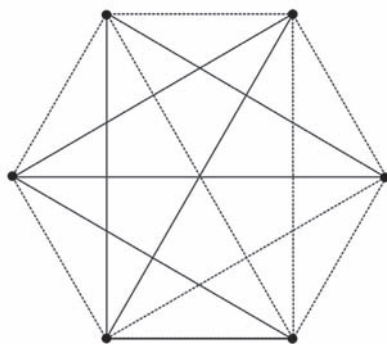

Figure 4.4 Combinatorics with six points

Here is the proof: Take one of the points, and call it O. Then of the five lines from that point to the others, at least three must have the same colour, say colour A. Consider the three points at the end of those lines. If any two of them are joined by a line of colour A, then they and O form an A-colour triangle. But if not, then the three points must all be joined by B-colour lines, so there is a B-colour triangle. So there is always a single-coloured triangle. QED.

Notice that this is not really about geometry. The 'points' could be any things whatever, physical or mental, electronic or astral. The 'lines' could be any relations between them, and the 'colours' any division of the 'lines' into two kinds. So it is a truth of a very high level of abstractness, in one sense, but a truth about any possible arrangement of any real things.

Bare hands. No axioms. No calculations. Pure understanding. *That* is mathematics.

Some serious mathematics has been done here with a very small array of concepts. Over and above purely logical concepts, there are only the concepts of same and different, part and whole. The points are different from one another, and there is some respect in which they differ. That is all that is needed for the problem to be described and the proof to proceed. As mentioned above, statements about two and three points can also be paraphrased using only these notions: 'there are two points' is equivalent to 'there is a point A and a point B and A is different from B'. The reasoning in the proof also requires no new notions: when the five lines from O are considered, three of them must be of the same kind (Let the first line be of kind A; then the second is either of kind A or B; then the third is also either A or B...) Hence all is purely structural as defined above.

Moving beyond combinatorics, one of the central concepts in anything dealing with variation or the very small is *continuity*. It is a little harder to define continuity in purely structural terms, but the work has been done by mathematicians from a slightly different point of view. The standard definition of a topological space, with some adaptation to more mereological language, is: an object with a collection of its parts, called the 'open' parts, forms a *topological space* if:

1. The empty part and the whole object are open
2. Any sum of open parts is open
3. Any finite intersection of open parts is an open part.³²

(For example, the real line or continuum forms a topological space where the open parts are arbitrary unions of open intervals.) Then a

function is defined to be *continuous* if the inverse image of any open part is also open. It is true that this definition of continuity is rather far from the initial understanding of continuity, based on intuitions of movements in space, that a continuous function is one that makes no ‘sudden jumps’. But the genius of the definition lies exactly in its ability to cash out these spatial and dynamic notions in purely structural terms.³³

Similar remarks apply to the other classical constructions of mathematical objects out of sets, such as the construction of real numbers as sets of Cauchy sequences of rationals (the rationals themselves having been already constructed out of the natural numbers), or the construction of abstract groups as sets satisfying certain properties. In each case, a prior knowledge of the structure being aimed at guides the choice of sets in the constructions, while what the actual construction shows is that nothing more than purely ‘abstract’ materials are needed, that is, that nothing over and above purely structural properties is needed in explicating the mathematical concepts in question. (We will consider constructions in set theory further in Chapter 7.)

Let us take another well-known example. Every law of propositional calculus can be translated simply into a law of set theory. For example, the distributive law of propositions:

p and $(q$ or $r)$ is logically equivalent to $(p$ and $q)$ or $(p$ and $r)$

(for any propositions p , q and r) corresponds to the distributive law of sets:

$$P \cap (Q \cup R) = (P \cap Q) \cup (P \cap R)$$

(for any sets P , Q and R). The correspondence can be expressed by saying that both propositions and sets exhibit the structure of a complemented distributed Boolean lattice (the axioms of a complemented distributed Boolean lattice simply lay down basic principles from which laws such as the distributive law follow). Propositions and sets are very different things, but the mathematical structures created by them and their relations are isomorphic. All there is to be said mathematically about either one follows from the structure they have in common.

Is quantity a kind of structure?

Such examples of pure structure, and their apparent difference from the examples of quantities in the previous chapter, provide the main reasons for thinking that quantity and structure are quite different kinds of universals, and hence for thinking that there must be two different bodies of knowledge, one corresponding to each. But there are two substantial reasons for believing the opposite, or at least that quantity is one kind of structure. While they are not convincing in establishing such a strong thesis, they do show why so much of what can be said about quantity is purely structural, hence explaining to some degree the unity of mathematics, if it is the science that studies both quantity and structure.

The first reason arises from the purely structural nature of order relations. As explained in the previous chapter, quantity was always thought to be intuitively characterizable as what is susceptible of 'the more and the less', emphasizing the *ordered* nature of quantities. But, as noted by Peirce and Dedekind³⁴ and followed in Benacerraf's example noted earlier, order can be characterized in purely formal or structural terms. A binary relation is said to be an *order* if it is antisymmetric and transitive; a *linear* or *total* order if in addition every pair of items of the relevant kind are related one way or the other. No more than logical language is needed to make those definitions, so the notion of a linear order is purely structural.

That is an important result. But, it seems, there is no simple and natural way to extend these ideas to a purely formal or structural characterization of the paradigm of quantities, ratio scales. The best that can be done is as in Hölder's axiomatization of (continuous) quantity (1901). He lays down seven axioms for (positive) quantity with the relation $<$ (less than) and the operation $+$ (addition):

Given any two magnitudes a and b , one of the following is true: $a = b$, $a < b$, $b < a$

For every magnitude there exists one that is less

For any magnitudes a and b , their sum $a + b$ is well-defined

$a + b > a$ and $a + b > b$

If $a < b$, there exist x and y such that $a + x = b$ and $y + a = b$

It is always true that $a + (b + c) = (a + b) + c$

Whenever all magnitudes are divided into two classes such that each magnitude belongs to one and only one class, neither class is empty, and any magnitude in the first class is less than each magnitude in the second class, then there exists a magnitude ξ such that every $\xi' < \xi$ is in the first class and every ξ'' for which $\xi < \xi''$ belongs to the second class.³⁵

The last axiom is strictly speaking purely structural, but it is very complicated and has a heavy commitment to classes (or parts of the whole system of magnitudes). That corresponds to the very complex and unnatural way of imitating a ratio scale (with a full range of possible ratios), the classical construction of the continuum in pure set theory, as a set of Cauchy sequences, or Dedekind cuts, of the rationals. For the continuum seems to contain all there is to ratios: the system of all ratios, with their mutual relations of closeness to one another, just is the continuum. Constructing it in set theory does show its purely structural nature, but at the cost of a great deal of unintuitive machinery.

Granted however that the continuum is purely structural, it might seem to follow that ratios (and hence quantity in general) are purely structural. Identifying the flaw in this argument casts light on a number of problems of the relationship between structural and non-structural properties, and hence on many issues concerning the applicability of mathematics to reality. It is true that the continuum is a purely structural entity. It does not follow that the individual ratios themselves are purely structural. The continuum is a structure which the system of ratios shares with several other quite different entities, for example, an infinite line in real space (if real space is infinite and infinitely divisible), and the set of infinite decimals (with distance defined by the difference).³⁶ It does not follow that either individual spatial points or individual infinite decimals are purely structural. Only the system of all the entities of each kind instantiates the (same) structure, the continuum.

The same line of reasoning, it will be obvious, solves another old problem. The fact that 'being an ω -sequence' is purely structural, and that the numbers taken as a whole instantiate this structure, does not imply that individual numbers are purely structural. Numbers are places or 'offices' in structures but not *merely* places in structures. The real relations between heaps and unit-making properties – the true numbers – taken as a whole system, form an ω -sequence, but still retain their own

characters. Other entities, such as sets formed out of the empty set, can also form an ω -sequence, without anyone needing to mistake them for numbers. That would be like mistaking the commuters in the queue for the 8.21 bus to the City for those in the queue for the 8.46, simply because both are queues.

The second reason for thinking that quantity is a kind of structure is that it seems discrete quantity, at least, can arise in places where there is nothing other than pure structure. Aristotle's treatment of quantity emphasizes not so much order as divisibility.³⁷ To be divisible is merely to have parts, which is a purely structural matter. The same applies, therefore, to consisting of parts that do not themselves have parts (that is, atoms). The number of atoms will therefore be a quantity, which can be calculated without using any non-structural machinery. (Some quantity, it would seem, must be purely structural.

Some suspicion arises from the fact that this argument cannot be carried through in the case of continuous quantity. If bodies or spaces are continuous (in the sense of being infinitely divisible), one cannot define their quantity in pure mereology, but must import a *measure*, which will decide on the comparability of small parts of the bodies or spaces. If one then looks back at the discrete case and asks why no measure was needed there, one may well wonder if there was not some hidden assumption of equality between the atoms. To admit that it was equality *in size* would of course be to admit that quantity was not definable purely structurally. Yet if the atoms were, intuitively, of different sizes, one would be less inclined to count them, and disposed instead to weigh or measure them. Two atoms might stand in no finite ratio: if one tried to measure the probability of a proposition by counting the reasons for it, one would be ignoring the fact that deductive and non-deductive reasons cannot be balanced (one deductive reason outweighs any number of merely probable ones). In such cases, counting would become pointless, or grossly misleading as a way of determining total 'weight'. No doubt selection committees would be unable to get through their work if they did not measure academic worth using the default assumption that all papers and citations are equal, but the results of that assumption are not entirely satisfactory.

So neither of the arguments to show that quantity is a kind of structure succeed. Nevertheless, it must be admitted that quantity has escaped from the clutches of structure by the skin of its teeth, and that there is little prospect of saying anything interesting about quantity without concentrating on its structural aspects.

With the definitions we now have of quantity and of structure, the question as to whether structure and quantity are one and the same (or one a kind of the other) admits of a precise answer. It is 'no'. The ratio of 1.57 metres to 0.35 metres is a quantity but not a structure. The symmetry of a table is a purely structural universal but is not a quantity.

5

Necessary Truths about Reality¹

An essential theme of the Aristotelian viewpoint is that the truths of mathematics, being about universals and their relations, should be both necessary and about reality. That thesis stands in opposition to the common view expressed in Einstein's classic dictum, 'As far as the propositions of mathematics refer to reality, they are not certain; and as far as they are certain, they do not refer to reality'.² Einstein made it clear that by 'certain' he meant 'necessary', and philosophers of recent times have mostly agreed with him that there cannot be mathematical truths that are at once necessary and about reality.

Examples of necessity

Mathematics provides, however, many *prima facie* cases of necessities that are directly about reality. One is the classic case of Euler's bridges, mentioned in the previous chapter. Euler proved that it was impossible for the citizens of Königsberg to walk exactly once over (not an abstract model of the bridges but) the actual bridges of the city.

To take another example: It is impossible to tile my bathroom floor with (equally sized) regular pentagonal lines. My bathroom floor has some close relation – to be specified shortly – to a Euclidean plane. It is a provable proposition of geometry that it is impossible to tile the Euclidean plane with regular pentagons. That is, although it is possible to fit together (equally sized) squares or regular hexagons so as to cover the whole space, thus:

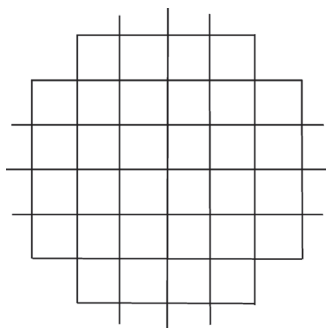

Figure 5.1 Tiling of the plane by squares

and

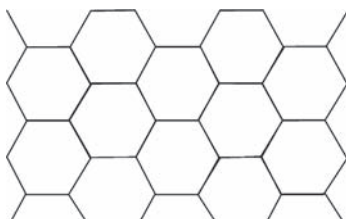

Figure 5.2 Tiling of the plane by regular hexagons

it is impossible to do this with regular pentagons:

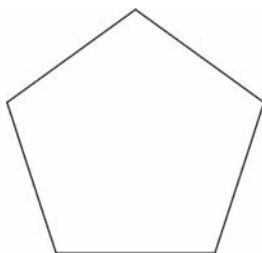

Figure 5.3 Regular pentagons cannot tile the plane

No matter how they are put on the plane, there is space left over between them.

Now the 'Euclidean plane' is no doubt an abstraction, or a Platonic form, or an idealization, or a mental being – in any case it is not exactly and literally the reality of floors. If the 'Euclidean plane' is something that could have real instances, my bathroom floor is not one of them, and it may be that there are no exact real instances of it at all. It is a further fact of mathematics, however, that the proposition about the Euclidean plane has 'stability', in the sense that it remains true if the terms in it are varied slightly. That is, it is impossible to tile a (substantial part of) an almost Euclidean-plane with shapes that are nearly regular pentagons. (The qualification 'substantial part of' is simply to avoid the possibility of taking a part that is exactly the shape and size of one tile; such a gerrymandered part could of course be tiled.) This proposition has the same status, as far as reality goes, as the original one, since 'being an almost Euclidean plane' and 'being a nearly regular pentagon' are as purely abstract or mathematical as 'being an exact Euclidean plane' and 'being an exactly regular pentagon'. The proposition has the consequence that if anything, real or abstract, does have the shape of a nearly Euclidean-plane, then it cannot be tiled with nearly regular pentagons. But my bathroom floor does have, exactly, the shape of a nearly Euclidean-plane. Or put another way, being a nearly Euclidean plane is not an abstract model of my bathroom floor, it is its literal shape. Therefore, it cannot be tiled with tiles which are, nearly or exactly, regular pentagons.

The 'cannot' in the last sentence is a necessity at once mathematical and about reality.

To take another example: It is impossible to build a circular or nearly circular staircase that goes up all the way round and ends at its starting point. (The famous Escher drawings such as Figure 5.4 which seem to show this kind of thing happening are thus impossible to realize.)

The impossibility is not just empirical, since no change in the laws of nature would make such a staircase possible. There is a purely mathematical fact underlying the impossibility, namely, that there is no continuous function from the circle to the real numbers which is increasing all the way round. The proposition has therefore nothing to do with the Euclideanness or otherwise of space; in any substantial portion of a space where there is a coherent 'up', the statement is true.

If a staircase as described were to be built, there would be a real thing which violated the mathematical theorem. So the existence of the real thing is mathematically impossible.

Those three examples were of impossibility. The next is an example of a positive necessity.

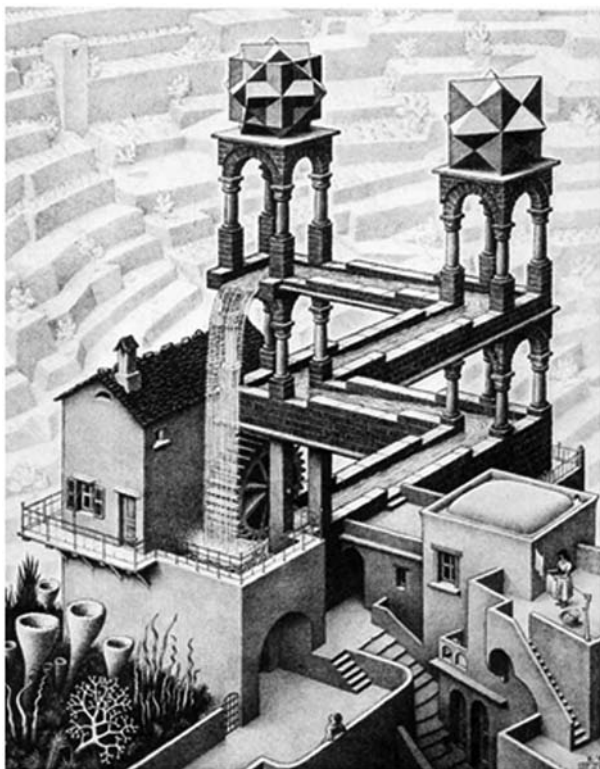

Figure 5.4 Escher's Waterfall

Source: http://en.wikipedia.org/wiki/File:Escher_Waterfall.jpg.

For simplicity, let us restrict ourselves to two dimensions, though there are similar examples in three dimensions. A body is said to be symmetrical about an axis when a point is in the body if and only if the point opposite it across the axis is also in the body. Thus a square is symmetrical about a vertical axis, about a horizontal axis and about both its diagonals. A body is said to be symmetrical about a point P when a point is in the body if and only if the point directly opposite it across P is also in the body. Thus a square is symmetrical about its centre. The following is a necessarily true statement about real bodies: All bodies symmetrical about both a horizontal and a vertical axis are also symmetrical about the point of intersection of the axes:

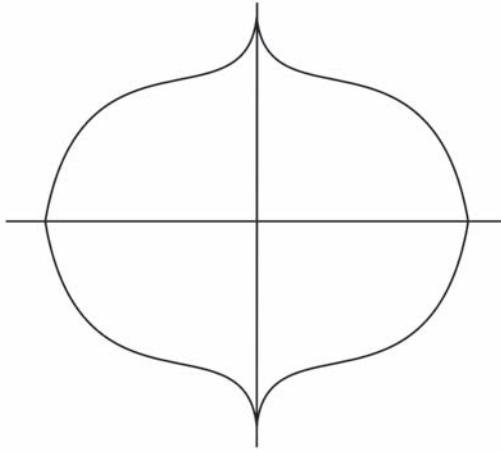

Figure 5.5 A figure vertically, horizontally, and centrally symmetric

Again, the space need not be Euclidean for this proposition to be true. All that is needed is a space in which the terms make sense.

Objections and replies

These examples appear to be necessarily true mathematical propositions which are about reality. It remains to defend this appearance against some well-known objections.

Objection 1

It is easy enough to think of counter-examples to these supposed necessities. For example, ‘imagine a staircase built around the Earth at the equator, with steps one mile long. If each step begins as a tangential plane, and the next starts below its end, then surely we have a refutation’ of the example of the staircase?³

Reply: Whichever way one is imagined walking around the earth on this staircase, one is not stepping *up*. If ‘up’ is taken to mean ‘away from the earth’s centre’, and one steps (supposing one is a giant) in the middle of each step, then one is exactly as far away from the centre of the earth at each step. So there is no counter-example. It is hard to imagine any other sense of ‘up’ applicable to the case.

It is easy to suspect that if that counter-example does not quite work, there must be others to be found from imagining space to be toroidal, elliptical or having some such unusual topology that would in fact permit an upward circular staircase to come back to its starting point. That misunderstands the nature of the mathematical result. It is about local topology, not global. It requires that the space is locally Euclidean (that is, a part of the space that includes the whole staircase is close to Euclidean). Then one may choose any direction in the space to be 'up', such as the direction up the middle of the staircase. The global topology of any larger space that includes this local region, and whether a global notion of 'up' is definable, is irrelevant.

There is no future in trying to imagine counter-examples to mathematical theorems, for the same reason as there is no point wasting time trying to square the circle.

Objection 2

The impossibility of tiling my bathroom floor with pentagons only follows from my floor's being nearly Euclidean, and that is a contingent fact. Similarly with the staircase example, it may be that if we move to a distant part of space, no global 'up' can be defined, so our being in a region where 'up' does make sense is contingent.

Reply: A parallel objection would 'prove' that 'all red things are coloured' is not necessary on the grounds that it is contingent whether something is red. The necessity in 'all red things are coloured' comes from the *connection* between being red and being coloured. The contingency of something's being red is irrelevant to that (and the point would be unaffected even if one thought the necessity were analytic or in some other way trivial). The necessity claimed to be true of my bathroom floor comes from the connection between its near-Euclidean shape and the shape of pentagons. The fact that it is contingent what shape my floor has is irrelevant to that. Similarly the contingency of the place in the universe of a staircase and its surrounding space is irrelevant to the necessary consequences of the shape it actually has.

*Counter-objection:*⁴ The necessity established is still merely a *de dicto* one, not as claimed a *de re* one. Take this parallel argument: Let *s* be a sphere of radius 1 metre. Suppose I have 12 square metres of soft leather. Mathematics establishes the *de dicto* claim:

- 1 Necessarily, a sphere of radius 1 metre cannot be covered by 12 square metres of soft material.

But that is not the same as the *de re* claim:

2 Necessarily, s cannot be covered by 12 square metres of soft material.

The truth of (1) does not ensure the truth of (2), for it need not be necessary to s that its radius is 1 metre; for example s could be a gigantic ball which only contingently has radius 1 metre.

Counter-reply: It is impossible for a proof to apply to spheres in general without applying to each sphere in particular, since general proofs are still proofs when specialized to particular cases. For example, the proof that the square of any even number is even (If $n = 2k$, then $n^2 = (2k)^2 = 2(2k^2)$) is still a proof when specialized to say 6 ($6 = 2.3$, so $6^2 = (2.3)^2 = 2(2.3^2)$). The proof that any sphere of radius 1 metre cannot be covered by 12 square metres can be carried through for the particular sphere s , showing that the necessity applies *de re*. Cutting leather and sticking it on s will confirm that the impossibility of covering the sphere with the leather applies to s , the proof meanwhile showing why the impossibility is not merely due to lack of strength or ingenuity.

As to the suggestion of the counter-objection that the proof might be evaded by the sphere s becoming different, e.g. growing to a gigantic size, there is first an ambiguity to identify in 's could be a gigantic ball...'. It could mean either

- A. The name s could name something other than the sphere in question, or
- B. The object s could (remain the same thing but) change in some non-essential property such as size

To take option (A) would prove too much, since it would rule out *any* purported *de re* necessity. A paradigm of *de re* necessity is '47 is necessarily prime'. But one could deny that, using the reasoning of the counter-objection, by arguing: Let s be the number 47. Then mathematics establishes the claim:

(A') Necessarily, 47 is prime.

But that is not the same as the claim

(B') Necessarily, s is prime,

since s could be 48. There has just been a trick played about the detachability of names from their referents.

If on the other hand one takes option (B), then one is committed to a distinction between essential and accidental properties.⁵ To say that this sphere s could have been gigantic is to say that the sphere retains its identity while changing in a real but inessential property, its size. That is acceptable, but it then does not contradict the claim that the necessity was *de re*. The 're' in *de re* necessity includes, according to Aristotelians, universals such as shape. My bathroom floor is untileable by pentagons in virtue of its shape, and its shape, though not possessed by it necessarily, is a reality – a reality *of it* – of which necessities may be true.

Objection 3

The proposition $7 + 5 = 12$ appears at first both to be necessary and to say something about reality. For example, it appears to have the consequence that if I put seven apples in a bowl and then put in another five, there will be twelve apples in the bowl. A standard objection begins by noting that it would be different for raindrops, since they may coalesce. So in order to say something about reality, the mathematical proposition must need at least to be conjoined with some proposition such as, 'Apples don't coalesce', which is plainly contingent. This consideration is reinforced by the suspicion that the proposition $7 + 5 = 12$ is tautological, or almost so, in some sense.

Reply: Perhaps these objections can be answered, but there is plainly at least a *prima facie* case for a divorce between the necessity of the mathematical proposition $7 + 5 = 12$ and its application to reality. The application seems to be at the cost of introducing stipulations about bodies which may be empirically false.

The examples above are not susceptible to this objection. Being nearly pentagonal, being symmetrical and so on are properties that real things can have, and the mathematical propositions say something about things with these properties, without the need for any empirical assumptions.

Objection 4

This objection is perhaps in effect the same as the second one, but historically it has been posed separately. It does at least cast more light on how the examples given escape objections of this kind.

The objection goes as follows: Geometry does not study the shapes of real things. The theory of spheres, for example, cannot apply to bronze spheres, since bronze spheres are not perfectly spherical.⁶ Those who

thought along these lines postulated a relation of ‘idealization’, variously understood, between the perfect spheres of geometry and the bronze spheres of mundane reality. Any such thinking, even if not leading to fully Platonist conclusions, will result in a contrast between the ideal (and hence necessary) realm of mathematics and the physical (and contingent) world.

Reply: It has been found that the problem was simply a result of the primitive state of Greek mathematics. Ancient mathematics could only deal with simple shapes such as perfect spheres. Modern mathematics, by studying continuous variation, has been able to extend its activities to more complex shapes such as imperfect spheres. That is, there are results not about particular imperfect spheres, but about the ensemble of imperfect spheres of various kinds. For example, consider all imperfect spheres which differ little from a sphere of radius one metre – say which do not deviate by more than one centimetre from the sphere anywhere. Then the volume of any such imperfect sphere differs from the volume of the perfect sphere by less than one tenth of a cubic metre. So imperfect-sphere shapes can be studied mathematically just as well as – though with more difficulty than – perfect spheres. But real bronze things do have imperfect-sphere shapes, without any ‘idealization’ or ‘simplification’. So mathematical results about imperfect spheres can apply directly to the real shapes of real things.

The examples above involved no idealizations. They therefore escape any problems from objection 4.

(Idealization is, however, a useful method in mathematics. It will be considered in Chapter 14.)

Objection 5

This objection proceeds from the supposed hypothetical nature of mathematics. Bertrand Russell’s dictum, ‘Pure mathematics consists entirely of assertions to the effect that, if such and such a proposition is true of anything, then such and such another proposition is true of that thing’,⁷ suggests a connection between hypotheticality and lack of content. Even those who have not gone so far as to think that mathematics is just logic have often thought that mathematics is not about reality, but only, like logic, relates statements which may happen to be about reality. Physicists, Einstein included, have been especially prone to speak in this way, since for them mathematics is primarily a bag of tricks used to deduce consequences from theories. Any necessity in mathematics, it is claimed, is only in the ‘if... then’ statement, and does not remain when the proposition is applied to reality.

Reply: Mathematics is no more hypothetical than any other science. The examples given above do not look hypothetical. They speak simply of ‘my bathroom floor’ and ‘all symmetrical shapes’. They could, it is true, easily be cast in hypothetical form. But the fact that mathematical statements are often written in if-then form is not in itself an argument that mathematics is especially hypothetical. Any science, even a purely classificatory one, contains universally quantified statements, and any ‘All As are Bs’ statement can equally well be expressed hypothetically, as ‘If anything is an A then it is a B’. A hypothetical statement may be convenient, especially in a logically complex situation, but it is just as much about real As and Bs as ‘All As are Bs’.

No one argues that

All applications of 550 ml/hectare Igran are effective against normal infestations of capeweed

is not about reality merely because it can be expressed hypothetically as

If 550 ml/hectare Igran is applied to a normal infestation of capeweed, the weed will die.

Neither should mathematical propositions such as those in the examples be thought to be not about reality because they can be expressed hypothetically. Real portions of liquid can be (approximately) 550 ml of Igran. Real tables can be (approximately) symmetrical about axes. Real bathroom floors can be (nearly) flat and real tiles (nearly) regular pentagons.⁸

The impact of this argument is not lessened even if the process of recasting mathematics into if-then form goes as far as axiomatization. Einstein thought it was: his quotation with which the chapter began continues:

As far as the propositions of mathematics refer to reality, they are not certain; and as far as they are certain, they do not refer to reality. It seems to me that complete clarity as to this state of things became common property only through that trend in mathematics which is known by the name of ‘axiomatics’.

Einstein goes on to argue that deductive axiomatized geometry is mathematics, is certain and is ‘purely formal’, that is, uninterpreted; while

applied geometry, which includes the proposition that solid bodies are related as bodies in three-dimensional Euclidean space, is a branch of physics. Granted that it is a contingent physical proposition that solid bodies are related in this way, and granted that an uninterpreted system of deductive 'geometry' is possible, there remain two main problems about Einstein's conclusion that 'mathematics as such cannot predicate anything about...real objects'.⁹

First, non-mathematical topics, such as special relativity or ethics, can be axiomatized without thereby ceasing to be about real things. That remains so even if one sets up a parallel system of 'purely formal axiomatized special relativity' or 'axiomatic ethics' which one pretends not to interpret.

Second, even if some of the propositions of 'applied geometry' are contingent, not all are, as the examples above showed. Doubtless there is a 'proposition' of 'purely formal geometry' corresponding to 'It is impossible to tile my bathroom floor with regular pentagonal tiles'; the point is that the modality, 'impossible', is still there when it is interpreted.

In theory this completes the reply to the objection that mathematics is necessary only because it is hypothetical. Unfortunately it does nothing to explain the strong feeling among ordinary users of mathematics, such as physicists and engineers, that mathematics is a kind of tool kit for getting one scientific proposition out of another. If an electrical engineer is accustomed to working out currents by reaching for his table of Laplace transforms, he will inevitably see this mathematical method as a tool whose 'necessity', if any, arises because mathematics is not about anything, but is only a kind of theoretical juice extractor.¹⁰

It must be admitted that a certain amount of applicable mathematics really does consist of tricks or calculatory devices. Tricks, in mathematics or anywhere else, are not *about* anything, and any real mathematics that concerns them will be in explaining why and when they work; that is a problem the engineer has little interest in, except perhaps for the final answer. The difficulty is to explain how mathematics can have both necessity and application to reality, without appearing to do so to many of its users.

The short answer to this lies in the mind's tendency to think of relations as not really existing, as described in Chapter 1. Since mathematics is so tied up with relations of certain kinds, its subject matter is easy to overlook. A familiar example of how mathematics applies in physics will make this clearer.

Newton postulated the inverse square law of gravitation, and derived from it the proposition that the orbits of the planets are (very nearly)

elliptical. Let us look a little more closely at the derivation, to see whether the mathematical reasoning is in some direct way about reality or is only a logical device for deriving one scientific law from another.

First of all, Newton did not derive the shape of the orbits from the law of gravitation alone. An orbit is a path along which a planet moves, so there needs to be a proposition connecting the law of force with movement; the link is, of course,

$$\text{force} = \text{mass} \times \text{acceleration}$$

Then there must be an assertion that net accelerations other than those caused by the gravitation of the sun are negligible. Ideally this should be accompanied by a stability analysis showing that small extra net forces will only produce small deviations from the calculated paths. Adding the necessary premises has not, however, introduced any ellipses. What the premises give is the *local* change of motion of a planet at any point; given any planet at any point with any speed, the laws give the force, and hence the acceleration – change of speed – that the planet undergoes. The job of the mathematics – the only job of the mathematics – is to add together these changes of motion at all the points of the path, and reveal that the resulting path must be an ellipse. The mathematics must track the path; that is, it must extract the global motion from the local motions. The necessity established is not that orbits must be ellipses absolutely speaking, but the necessity of the connection between the local force-driven motions being as they are and the overall shape of the path being close to elliptical.

There are two ways to do this mathematics. In this particular case, there are some neat tricks available with angular momentum. They are remarkable enough, but are still purely matters of technique that luckily allow an exact solution to the problem with little work. The other method is more widely applicable and is here more revealing because more direct. It is to use a computer to approximate the path by cutting it into small pieces. At the initial point the acceleration is calculated and the motion of the planet calculated for a short distance, then the new acceleration is calculated for the new position, and so on. The smaller the pieces the path is cut into, the more accurate the calculation. This is the method actually used for calculating planetary orbits, since it can easily take account of small extra forces, such as the gravitational interaction of the planets, which render special tricks useless. The absence of computational tricks exposes what the mathematics is actually doing – extracting global structure from local.

The example is typical of how mathematics is applied, as is clear from the large proportion of applied mathematics that is concerned one way or another with the solution of differential equations. Solving a differential equation is, normally, entirely a matter of getting global structure from local – the equation describes what is happening in the neighbourhood of each point; the solution is the global behaviour that results.¹¹ A good deal of mathematical modelling and operations research also deals with calculating the overall effects of local causes. The examples above all involved some kind of interaction of local with global structure. (The simplest non-trivial example of this kind is exponential growth, described in the previous chapter.)

It is notoriously difficult to say what ‘structure’ is. But even if the detailed proposals of the previous chapter are not correct, it is plainly at least something to do with relations, especially internal part-whole relations. If an orbit is elliptical globally, its curvature at each point is necessarily that given by the inverse square law, and vice versa. In general the connections between local and global structure are necessary, though it seems to make the matter more obscure rather than less to call the necessity ‘logical’. Seen this way, there is little temptation to regard the function of mathematics as merely the deducing of consequences, like a logical engine. It is easy to see, though, why mathematics has often been seen as having no subject matter – if the western mind has had enormous difficulty focussing on the reality of relations at all, such abstract relations as structural ones are even more invisible. Nevertheless, symmetry, continuity and the rest are just as real as relations that can be measured, such as ratios of masses; bought and sold, such as interest rate futures; and litigated over, such as paternity.

Typically, then, a scientist will postulate or observe some simple local behaviour in a system, such as the inverse square law of attraction or a population growth rate proportional to the size of the population. The mathematical work, whether by hand or computer, will put the pieces together to find out the global effect of the continued operation of the proposed law – in these cases elliptical orbits and exponential growth. There are bad reasons for thinking the mathematics is just ‘turning the handle’ – for example that it costs less than experiment, and that many scientists’ expertise runs to only simple mathematical techniques. But there are no good reasons. The mathematics investigates the necessary interconnections between the parts of the global structure, which are properties of the system as real as any others.

This completes the explanation of why mathematics seems to many to be just a deduction engine, or to be purely hypothetical, even though it is not.

Objection 6

Certain schools of philosophy have thought there can be *no* necessary truths that are genuinely about reality, so that any necessary truth must be vacuous. In a famous phrase summarizing Hume's views, 'There can be no necessary connections between distinct existences'.

Reply: The philosophy of mathematics has enough to do dealing with mathematics, without taking upon itself the refutation of outmoded metaphysical dogmas. Mathematics must be appreciated on its own terms, and wider metaphysical theories adjusted to take account of whatever is found.

Nevertheless, something can be said about the exact points where this objection fails to make contact with the examples above. The first is at the word 'distinct'. The word suggests a kind of logical atomism, as if relations can be thought of as strings joining point particulars. One need not be F.H. Bradley to find that view too simple. It is especially inappropriate when treating things with internal structure, as is typical in mathematics. In an infinitely divisible thing like the surface of a bathroom floor, where are the point particulars with purely external relations? (The points of space, perhaps? But the relations between tile-sized parts of space and the whole space either have nothing to do with points at all or are properties of the whole system of relations between points.)

The second point at which the Humean dictum fails is at 'existences'. Perhaps it is true that there can be no necessary connections between distinct substances – independent stand-alone entities. But it is not so with properties, which are, on an Aristotelian view, real (though perhaps doubtfully called 'existences'). 'Being symmetrical about a vertical axis', 'being symmetrical about a horizontal axis' and 'being symmetrical about the point of intersection' are real properties. They are 'distinct' or independent, in the sense that a body can have one without having another. But, as we saw, there is a provable necessary connection between them, namely that having any two of them implies having the third.

All the objections are thus answered. The conclusion stands, therefore, that the three examples are, as they appear to be, mathematical, necessary and about reality.

The thesis defended has been that *some* necessary mathematical statements refer directly to reality. The stronger thesis that *all* mathematical truths refer to reality seems too strong – at least if that is understood to mean any sort of direct or literal reference to reality. It would indeed follow, if there were no relevant differences between the examples above and other mathematical truths. But there are differences. In particular, there are more things dreamed of in mathematics than there seem likely to be in reality. Some mathematical entities are just too big; even if something in physical reality could have the structure of an infinite dimensional vector space, it would be too big for us to know it did. (Infinities will be considered in Chapter 8, where it is argued that they are genuine universals of which we can have knowledge, but may not be instantiated.) Other mathematical entities may be non-referring by intention from the way they are introduced, being intended as fictions. The Aristotelian can admit that negative numbers, the square root of minus 1, the average Londoner and other such entities could be fictions. An account will be given in Chapter 14.

What has been asserted is that there are properties, such as symmetry, continuity, divisibility, increase, order, part and whole, which are possessed by real things and are studied directly by mathematics, resulting in necessary propositions about them.

6

The Formal Sciences Discover the Philosophers' Stone

Aristotelians deplore the narrow range of examples chosen for discussion in traditional philosophy of mathematics. The traditional diet – numbers, sets, infinite cardinals, axioms, theorems of formal logic – is far from typical of what mathematicians do. It has led to intellectual anorexia, by depriving the philosophy of mathematics of the nourishment it could and should receive from the expansive world of mathematics of the last hundred years. Philosophers have almost completely ignored not only the broad range of pure and applied mathematics and statistics, but a whole suite of ‘formal’ or ‘mathematical’ sciences that have appeared only in the last eighty years. I give here a few brief examples to indicate why these developments are of philosophical interest to those pursuing realist views of mathematics. Of special significance is that they contain many examples of necessities about the real world.

It used to be that the classification of sciences was clear. There were natural sciences, and there were social sciences. Then there were mathematics and logic, which might or might not be described as sciences, but seemed to be plainly distinguished from the other sciences by their use of proof instead of experiment and hypothesizing.

That neat picture has been disturbed by the appearance in the last seventy years of a number of new sciences, variously called the ‘formal’ or ‘mathematical’ sciences, or the ‘sciences of complexity’¹ or ‘sciences of the artificial’.²

The number of these sciences is large, very many people work in them, and even more use their results. It is a pity that philosophers have taken so little notice of them, since they provide exceptional opportunities for the exercise of the arts peculiar to philosophy. First, their formal nature would seem to entitle them to the special consideration mathematics and logic have obtained. Being formal, they should appeal

to the Platonist and devotee of certainty latent in most philosophers, especially those who suspect that most philosophical speculation about quantum mechanics, cosmology and evolution, for example, will probably be rendered obsolete by new scientific discoveries.

Not only that, but the knowledge in the formal sciences, with its proofs about network flows, proofs of computer program correctness and the like, gives every appearance of having achieved the *philosophers' stone*: a method of transmuting opinion about the base and contingent beings of this world into necessary knowledge of pure reason. It will be argued that this appearance is correct. Even if it is not so, and there is a gap between abstraction and reality, the gap is in some sense smaller here than it is elsewhere.

On the other hand, the word-oriented aspect of philosophy is also catered for. If one aim of studying philosophy is to be able to speak plausibly on all subjects, as Descartes says, then the formal sciences can be of assistance. They supply a number of concepts, like 'feedback', which permit in-principle explanatory talk about complex phenomena, without demanding too much attention to technical detail. It is just this feature of the theory of evolution that has provided a century of delight to philosophers, so the prospects for the formal sciences must be bright.

The formal sciences may appeal, too, to the many who feel that philosophers of science have chatted on to one another sufficiently about theory change, realism, induction, sociology, and so on, while real science has been producing a huge and diverse body of knowledge to which all of that is irrelevant.

A brief survey of the formal or mathematical sciences

Since this chapter contends that the formal sciences are little known in the philosophical world, it is undesirable to assume any familiarity with them. There follows a minimal overview of these sciences, listing them and describing a typical problem or two in some of them. Philosophical analysis can follow later. For convenience, the names of sciences and sub-sciences are in bold type.

While antecedents can be found for almost anything, the oldest properly identifiable formal science is *operations research* (OR). Its origin is normally dated to the years just before and during World War II, when multi-disciplinary scientific teams investigated the most efficient patterns of search for U-boats, the optimal size of convoys, and the like.³ Typical problems now considered are task scheduling and bin packing.

Given a number of factory tasks, subject to constraints about which must follow which, which cannot be run simultaneously because they use the same machine, and so on, one seeks the way to fit them into the shortest time. Bin packing deals with how to fit a heap of articles of given sizes most efficiently into a number of bins of given capacities.⁴ The methods used rely essentially on search through the possibilities, using mathematical ideas to cut down the search space.

Although it began in applications, OR is now very much an abstract science.

Another relatively old formal science is *control theory*, which aims to adapt a working system, such as a chemical manufacturing plant, to some desired end, often by comparing actual and desired outputs and reducing the difference between these by changing the settings of the system.⁵ To control theory belong two 'systems' concepts which have become part of public vocabulary. The first is feedback. (Of course, feedback *mechanisms* are much older,⁶ but feedback as an object of abstract study came to prominence only with Wiener's work on '*cybernetics*' in the late 1940s.⁷ The word 'feedback' is first recorded in English only in 1920, in an electrical engineering context; outside that area, it appears only from 1943.) The second concept is that of 'trade-off' ('a balance achieved between two desirable but incompatible features' – *Oxford English Dictionary*). It is first recorded in English in 1961.

There is a not very unified body of techniques that deals with finding and interpreting structure in large amounts of data, called, depending on the context, (*descriptive*) *statistics*, *pattern recognition*, *data mining*, *data analytics*, *signal processing* or *numerical taxonomy*. The names of products are even more varied: if one purchases a 'neural net to predict parolee recidivism' or an 'adaptive fuzzy logic classifier', one actually receives an implementation of a pattern recognition algorithm. Statistics is a science rather more than fifty years old, but the word usually refers to probabilistic inference from sample to population, rather than the simple finding of patterns in data that is being considered here. When one finds the average or median of a set of figures, one is not doing anything probabilistic, but merely finding some central point in the data. Drawing a bar graph of several years' profits is likewise simply summarizing the data, allowing its structures or patterns to become evident. A typical technique in these sciences is *cluster analysis*. One lists various features for items to be classified; for example, to classify the stringed instruments of various cultures, one could list the number of strings, the ratio of length to width, and so on. It will normally happen that these lists of features fall naturally into clusters: items within clusters share similar profiles of

features, while there are few items in the large 'spaces' between clusters.⁸ It is normally hoped that the clusters are meaningful and will allow generally correct classification of new items. *Scene analysis*, or *image understanding*, performs similar tasks for data which is laid out in two or three dimensions,⁹ while *signal processing* and *time series analysis* deal with data streams in time, such as stock-market prices and meteorological records.¹⁰

Then there are several sciences that study flows – of traffic, customers, information, or just flows in the abstract. Where will there be bottlenecks in traffic flow, and what addition of new links would relieve them? Such questions are studied with mathematical analysis and computer modelling in *network analysis*. There are obvious applications to telecommunications networks.¹¹ (It is this science that most naturally uses the widely known technique of the flow diagram. Such diagrams are perhaps more often used to design the flow of control in, say, a computer program, but that simply illustrates the commonality of structures in many of these sciences.) Suppose customers arrive at a counter at random times, but at an average rate of one per minute. If the serving staff can process them at only one per minute, a long queue will form for much of the time. It is found that to keep the queue to a reasonable length most of the time, the capacity of service needs to be about 1½ customers per minute. This is a result in *queueing theory*, a discipline widely applied in telecommunications, since telephone calls also arrive at random times but with predictable average rates.¹² The famous work of Shannon¹³ in *information theory* drew attention to the problem of measuring the amount of information in a flow of 0s and 1s. A sub-branch is the theory of *data compression*: most messages have many redundancies in them, in that commonly occurring parts (like the word 'the' in English text) can be replaced by a single symbol, plus the instruction to replace this symbol with 'the' upon decompression. This allows the message to be stored and transmitted more efficiently. There are applications (or at least, attempted applications) to the DNA 'code'.¹⁴ The use of 'entropy' by Shannon in measuring information relates this subject to thermodynamics. The sense in which thermodynamics resembles the formal sciences is discussed below.

The concept of expected pay-off of different possible strategies for various actors in a (competitive or cooperative) environment allows analysis of systems whose dynamics depend on the interactions of such decisions. This is *game theory*. Such systems include business negotiations and competition,¹⁵ animals preparing to fight¹⁶ and stock-market trading. Possibly to be seen as a part of game theory are some aspects of *mathematical*

economics, dealing with such questions as how people's individual preferences issue in global expressions of preference, that is, prices.¹⁷ (The better-known areas of mathematical economics, involving modelling of interest rates, unemployment, and so on, have had difficulty producing certain knowledge about real economies, for reasons much debated.)

More recently there have emerged some overlapping sciences variously known as the *theory of self-organizing systems*, the *theory of cellular automata*, *artificial life*, *non-equilibrium thermodynamics* and *mathematical ecology*. They all deal with how small-scale interactions in large systems create global patterns of organization. As an example, the paradigm of cellular automata is the Game of Life. On an indefinitely large grid of squares, some of these cells are initially chosen as 'live'. The board then evolves according to these rules for updating:

Death by overcrowding: if four or more of the eight cells surrounding a live cell are live, the cell 'dies'.

Death by exposure: if none or only one of the eight cells surrounding a live cell is live, it dies.

Survival: a live cell with exactly two or three live neighbours survives.

Birth: a dead cell becomes live if exactly three of its eight neighbours are alive.

(Updates occur simultaneously at each time step.) The remarkable thing is that certain initial configurations lead to complicated and unexpected developing patterns, such as shapes that, after a certain number of 'generations', have produced several copies of themselves.¹⁸ Similar self-organizing phenomena, in which complex systems arise out of simple local interactions, have been discovered in thermodynamic systems far from equilibrium.¹⁹ The study of systems of interacting predators and prey in *mathematical ecology* likewise involves the prediction and explanation of global phenomena from local ones. As prey increase, so do predators, though more slowly. Then if the prey decrease, hordes of hungry predators can nearly wipe out the remaining prey, leading to the near-extinction of the predators too; then the prey can slowly revive. The discovery of chaotic patterns in the cycles of predators and prey was one of the early drivers of *chaos theory*.²⁰ There has been, of course, much resulting speculation about evolution, the origin of the universe, learning in the brain, and so on,²¹ some of which will doubtless amount to something someday.

Most of the formal sciences use computers and mathematical modelling in one way or another. Indeed, the advent of the computer has been one of the main factors in the success of these subjects, in allowing results to be obtained in large-scale cases where hand computation is not feasible. But over and above the applications of computing in each science and the engineering of hardware, there exists a *theoretical computer science*. One branch is *computational complexity theory*. Typically, one wants to measure the intrinsic complexity of a computational problem, in terms of the number of simple operations (like additions or comparisons of single digits) needed to solve it. Since computation time is proportional to the number of simple operations, this will show whether it is realistic to solve the problem by computer. For example, the addition of two n -digit numbers (with the usual school algorithm) requires between n and $2n$ single-digit additions. The exact number depends on how many carries there are, as illustrated in the following example, where $n = 4$ and there are three carries:

$$\begin{array}{r} 1 \quad 0 \quad 3 \quad 6 \\ 3_1 \quad 9_1 \quad 8_1 \quad 7 \\ \hline 5 \quad 0 \quad 2 \quad 3 \end{array}$$

This requires seven single-digit additions. Thus, as n grows, the amount of computation needed grows linearly with n , being bounded by $2n$. By contrast, the travelling salesman problem (to find the shortest route that visits n cities once each, given the distances between the cities) demands an amount of computation that grows exponentially with n (at least, that is believed, though not proved). This problem of ‘combinatorial explosion’ makes the travelling salesman problem infeasible for large n (in practice, for n larger than about 40).²²

Other issues studied in theoretical computer science include formal specification (to describe exactly what a program is intended to do), and the effects of a modular or ‘structured programming’ design of programs, which is intended to make understanding and modifying them easier and safer. There is also the discipline of ‘*program verification*’, or proof of the correctness of computer programs, of which more later.

Usually included in computer science is *artificial intelligence* (AI). The core of AI has come to consist of a combination of computer science and operations research techniques. To play chess by computer, for example, one employs guided search through the space of all possible moves and counter-moves from a given position. Complexity theory reveals that the space of *all* possible moves is far too big to search, so

one observes human players to extract ‘heuristics’, that is, programmable strategies for deciding which of the possible moves are most worth searching next.²³ AI might seem to contradict the assertion that there has been little philosophical interest in any of the formal sciences. It is true, of course, that the philosophy of mind has given much attention to AI, but usually only as a model of mental workings. True AI workers, on the contrary, are often embarrassed by the connection with the mind, and seek to re-badge their product as ‘expert systems’ or ‘adaptive information processing’. The reason is that the computer science view of AI is of an independent discipline concerned with guided search through trees of possibilities, which can only be harmed in the marketplace by unfulfillable claims about imitating the human mind.

There is some theory of *computer simulation* or *mathematical modelling* applicable across all subject matters; it studies, for example, the losses in accuracy that arise in modelling a continuous situation on a digital computer and the commonalities between models of different phenomena.²⁴ It is possible to change what the variables in a computer simulation mean, rendering the same entity a simulation of something else. To take the excessively simple example of Chapter 4 above, if money is invested in a bank at 1% per month compound interest, the accumulated amount after t months, P_t , is related to the amount of the month before, P_{t-1} , by

$$P_t = P_{t-1} + (1/100) P_{t-1}$$

This equation expresses the local structure, the connection between the amounts in consecutive months. The bank’s computer starts out with the original principal, and goes through step by step using this equation to calculate the accumulated amount after t months. The resulting global structure is represented by the familiar rising exponential growth curve. But P_t could just as well mean the temperature of a rod at a point t notches from the left-hand end. If it happens that the temperature at any notch is 1% more than the temperature of the notch to its left, then the problem has the same local structure, the same equation, and the same graph, showing the temperature increasing exponentially from its value at the left-hand end. What is being modelled on the computer is, therefore, independent of whether the quantity varying is money or temperature, and independent of whether those quantities are varying with respect to time or space. Like any mathematics, it deals with the purely structural.

Likewise, the computer simulation of, say, the growth of a city, will exhibit phenomena explainable as the results of gradual accumulation of interactions among its parts, the details depending on the assumptions made about, for instance, the impact of siting a factory near a residential area on the medium-term development of the area.²⁵

It is true that studying real phenomena by mathematical modelling involves measurement and observation, as well as purely formal work. That will be discussed in the last section.

In retrospect, certain aspects of theoretical physics have a character recognizably like the formal sciences. *Statistical mechanics*, going back to Maxwell and Boltzmann, looks at how macroscopic properties of gases, like pressure and temperature, arise as global averages of the movements of the individual particles.²⁶ The emphasis is not on details about the properties of the particles themselves, but on the transition from local to global properties. The same is true of *fluid dynamics*, especially in the very difficult study of turbulent fluids. The organization of fluid flow into eddies and smoke rings is plainly not explained by examining the individual atoms more closely.²⁷ *Non-linear physics* treats more generally the ways in which complicated global structures can arise from simple local interactions.²⁸

The formal sciences search for a place in the sun

It is at first sight strange that so many new sciences have appeared without attracting much interest from philosophers of science. It could be argued that there is simply not much new in them, and, like accountancy perhaps, there is just nothing very philosophical about them. It is more likely, however, that the philosophical profession has not created an internal representation of the formal sciences in general, because no one has clearly described their common core.

It is easy to say something imprecise about this, but harder to be definite. An attempt was made decades ago to group some of these topics together and claim great things for them, under the name 'general systems theory'.²⁹ But the attempt was regarded on the whole as too vacuous to cast light on anything, and it made little impression on either the scientific or the philosophical worlds. The problem was that just about anything is a 'system', so it is not clear what is the content of the assertion that something should be studied 'as a system'.

So, is it possible to say more precisely what it is that the formal sciences have in common, which distinguishes them from other sciences? Despite their origins in some cases in engineering problems, they are

bodies of pure science. Just as geometry was originally thought of in connection with land surveying but then studied in the abstract, more recently network flow analysis was invented for studying the flows of liquids, telephone calls and factory products, but is studied without any reference to what material it is that flows.

Can the formal sciences be regarded as applied mathematics?

There are at least some reasons for regarding the formal sciences as something beyond applied mathematics. They are certainly not applied mathematics in the sense that they are applications of already existing bodies of pure mathematics: in almost all cases, the mathematics had to be created to solve the problems thrown up by the demands of the subject. (But, then, the same is true of some parts of traditional applied mathematics.) On the other hand, it is obvious that the formal sciences *are* either applied mathematics or something very closely related. (Is it possible, then, to create a new formal science by placing the word 'mathematical' in front of the name of an old science? The title 'Mathematical Ethology' seems to be still free; but there are already books on 'quantitative ethology'³⁰ – one would need to be quick. Perhaps 'Mathematical Ethnology' would be a better bet.) It may in fact be a historical accident that the formal sciences are not actually called applied mathematics and housed in departments of applied mathematics. In the mid-century, mathematics went through a particularly pure phase, obsessed with rigour and generality,³¹ and was not receptive to new applied disciplines. Of the leading mathematicians, only von Neumann and Norbert Wiener took any serious notice of the new directions. By default, the formal sciences had to find academic homes in corners of departments of engineering, economics and business, psychology or whoever else would take them.

The important point philosophically is that nothing depends on there being any principled distinction between the formal sciences and applied mathematics. It is certainly not being maintained here that the formal sciences have discovered a new 'philosophers' stone' which mathematics has overlooked. It is not likely that the formal sciences have discovered ways of being certain about really instantiated structures which are essentially different to those in applied mathematics. The philosophical interest of the formal sciences is that they promise to circumvent the defences that philosophers have evolved against the claim that mathematics offers certainty about the real world. Those well-known defences are the ones summarized in Einstein's dictum that was the starting-point for the previous chapter: 'As far as the propositions of mathematics refer to reality, they are not certain; and as far as they are

certain, they do not refer to reality.' Variations of that thought include claims that mathematics is about 'idealizations' or 'abstractions', or that it is purely about what follows from (uninterpreted) axioms. Perhaps these defences can be overcome, as argued in other chapters; nevertheless, it may be easier to circumvent them by moving the battleground to sciences where the standard defences are not so easily deployed. The next section works through some examples from the formal sciences, to see how they do resist Platonist defences directly, without needing any tedious excursus through such questions as the reality or abstractness of numbers or sets.

It would be desirable to have a unified theory that covered mathematics, pure and applied, as well as the formal sciences, and explained both their affinity and their differences. This is so far no help, philosophically, as it is not agreed what the philosophical status of applied mathematics is. As argued later in Chapters 7 and 14, the Platonist perspective of twentieth-century philosophy of mathematics has left the relation of (pure) mathematics to the real world to be covered by the unexamined dual notions of 'application to' and 'idealization from', to the detriment of applied mathematics considered directly. As we have seen already and will discuss further in Chapter 7, authors like Resnik, Shapiro, Field, Hellman, Bigelow and Maddy, in various ways, agreed that mathematics was in some sense the 'science of structure', giving some hope of assimilating a philosophy of the formal sciences or sciences of complexity into a coherent philosophy of mathematics. From the present point of view, it is unfortunate that these writers also agree that the main point of the philosophy of mathematics is to explain what numbers and sets are, as if once that were done, everything else would be clear. That is not correct. To have understood numbers is no guarantee that one understands symmetry, or continuity, or network topology, or statistical mechanics. Those things are not made out of numbers. They are not made out of sets, either – it is true that one can construct models of them in set theory, but as will be argued in Chapter 7, that is a fact of less significance than some have thought.

It is not hard to extend a view of numbers as structural to the view that there are many other structures, of which some are symmetry, continuity and network topology. But thinking that one should start with numbers and 'extend' to symmetry and continuity already puts structuralism and similar theories at an unfair disadvantage, as it requires them to explain the most unfavourable example first. Numbers and sets are not structuralism's home turf. Cardinality is an almost degenerate

structure, as it arises merely from a heap's being divisible (by some unit-making property). In counting, the only relation between parts that is relevant is their mutual distinctness. It is only when richer interrelations between parts are considered that symmetry, continuity and other such structures arise and the structuralist view of mathematics comes into its own. It is also where the formal sciences begin.

A structuralist account of the formal sciences is, then, already available in structuralist philosophies of mathematics in general, at least if 'structure' is interpreted in an Aristotelian rather than Platonist sense. The only thing to be added is an explanation of what structures exactly are studied by the particular disciplines. But that is a mathematical question, and the answer is found (if not always clearly expressed) in the axioms and definitions of each discipline. Topology studies one kind of structure, whose nature is captured by the definition of a topological space; information theory studies another. Conversely, a structuralist account of the formal sciences is an advantage for the philosophy of structuralism in mathematics. Since we recognize the similarity between the formal sciences, traditional applied mathematics and pure mathematics, we should prefer a philosophy of mathematics that demonstrates their unity.

Real certainty: program verification

The greatest philosophical interest in the formal sciences is surely the promise they hold of necessary, provable knowledge which is at the same time about the real world, not just some Platonic or abstract idealization of it.

There is just one of the formal sciences in which a debate on precisely this question has taken place, and has done so with a degree of philosophical sophistication. It is worth reviewing the arguments, as they address matters that are common to all the formal sciences. At issue is the status of proofs of correctness of computer programs. The late 1960s were the years of the 'software crisis', when it was realized that creating large programs free of bugs was much harder than had been thought. It was agreed that in most cases the fault lay in mistakes in the logical structure of the programs: there were unnoticed interactions between different parts, or possible cases not covered. One suggested remedy was that, since a computer program is a sequence of logical steps like a mathematical argument, it could be *proved* to be correct. The 'program verification' project has had a certain amount of success in making software error-free, mainly, it appears, by encouraging the writing of programs

whose logical structure is clear enough to allow proofs of their correctness to be written. A great deal of time and money is invested in this activity. But the question is, does the proof guarantee the correctness of the actual physical program that is fed into the computer, or only of an abstraction of the program? C.A.R. Hoare, a leader in the field, made strong claims:

Computer programming is an exact science, in that all the properties of a program and all the consequences of executing it can, in principle, be found out from the text of the program itself by means of purely deductive reasoning.³²

Some other authors explain the idea entertainingly:

By contrast [to hardware], a computer program is built from ideal mathematical objects whose behaviour is defined, not modelled approximately, by abstract rules. When an if-statement follows a while-statement, there is no need to study whether the if-statement will draw power from the while-statement and thereby distort its output, or whether it could overstress the while-statement and make it fail.³³

The philosopher James Fetzer,³⁴ however, argued that the program verification project was impossible in principle. Published not in the obscurity of a philosophical journal, but in the prestigious *Communications of the Association for Computing Machinery*, his attack had effect, being suspected of threatening the livelihood of thousands. Fetzer's argument relies wholly on the gap between abstraction and reality:

These limitations arise from the character of computers as complex causal systems whose behaviour, in principle, can only be known with the uncertainty that attends empirical knowledge as opposed to the certainty that attends specific kinds of mathematical demonstrations. For when the domain of entities that is thereby described consists of purely abstract entities, conclusive absolute verifications are possible; but when the domain of entities that is thereby described consists of non-abstract physical entities... only inconclusive relative verifications are possible.³⁵

It has been subsequently pointed out that to predict what an actual program does on an actual computer, one needs to model not only the program and the hardware, but also the environment, including, for

example, the skills of the operator.³⁶ And there can be changes in the hardware and environment between the time of the proof and the time of operation.³⁷ In addition, the program runs on top of a complex operating system, which is known to contain bugs. Plainly, certainty is not attainable about any of those matters.

But there is some mismatch between those undoubtedly true considerations and what was being claimed. Aside from a little inadvised hype, the advocates of proofs of correctness had admitted that such proofs could not detect, for example, typos.³⁸ And, on examination, the entities Hoare had claimed to have certainty about were, while real, not unsurveyable systems including machines and users, but written programs.³⁹ That is, they are the same kind of things as published mathematical proofs.

For comparison: If a mathematician says, in support of his assertion, 'my proof is published on page X of volume Y of *Inventiones Mathematicae*', one does not normally say – even a philosopher does not normally say⁴⁰ – 'your assertion is attended with uncertainty because there may be typos in the proof', or 'perhaps the Deceitful Demon is causing me to misremember earlier steps as I read later ones'. The reason is that what the mathematician is offering is not, in the first instance, absolute certainty in principle, but necessity. That is how his assertion differs from one made by a physicist. A proof offers a necessary connection between premises and conclusion. One may extract practical certainty from this, given the practical certainty of normal sense perception, but that is a separate step. That is, the certainty offered by mathematics does depend on a normal anti-scepticism about the senses, but it removes, through proof, the further source of uncertainty found in the physical and social sciences, arising from the uncertainty of inductive reasoning and of theorizing.⁴¹ Assertions in physics about a particular case have two types of uncertainty: that arising from the measurement and observation needed to check that the theory applies to the case, and that of the theory itself, arising from the non-necessary nature of physical reality. Mathematical proof has only the first.

It is the same with programs. While there is a considerable certainty gap between reasoning and the effect of an actually executed computer program, there is no such gap in the case Hoare was considering, the unexecuted program. A proof (in, say, the predicate calculus) is a sequence of steps exhibiting the logical connection between formulas, and checkable by humans (if it is short enough). Likewise a computer program is a logical sequence of instructions, the logical connections among which are checkable by humans (if there are not too many).

Thus Fetzer's arguments fail to show that computer programs cannot be proved correct. They can have provability in the same maximally strong sense as mathematical proofs.

One feature of programs that is inessential to this reply is their being textual. So, one line taken by Fetzer's opponents was to say that not only could programs be proved correct, but so could machines. Again, it was admitted that there was a theoretical possibility of a perceptual mistake, but this was regarded as trivial, and it was suggested that the safety of, say, a physically installed railway signalling system could be assured by proofs that it would never allow two trains on the same track, no matter what failures occurred.⁴² The advertisement that said:

VIPER is the first commercially available microprocessor with both a formal specification and a proof that the chip conforms to it

was felt by the experts to be a danger to the gullible public, but not an impossibility in principle.⁴³ An aggrieved purchaser began legal action on the grounds that the proof was not complete, but the bankruptcy of the plaintiff unfortunately prevented this interesting philosophical debate from being pursued in the courts.⁴⁴

Real certainty: the other formal sciences

The following features of the program verification example carry over to reasoning in all the formal sciences:

- There are connections between the parts of the system being studied, which can be reasoned about in purely logical terms.
- That complexity is, in small cases, surveyable. That is, one can have practical certainty by direct observation of the local structure. Any uncertainty is limited to the mere theoretical uncertainty one has about even the best sense knowledge.
- Hence the necessity in the connections between parts translates into practical certainty about the system.
- Computer checking can extend the practical certainty to much larger cases.

Let us recall once again the classical example of network topology, Euler's proof that it is impossible to walk over all the bridges of Königsberg once and once only:

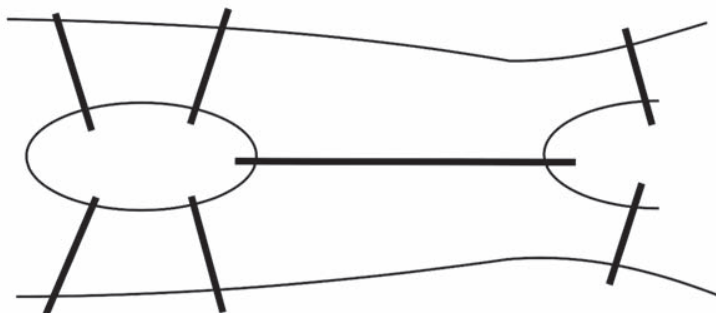

Figure 6.1 The Königsberg bridges again

The first three of the above points are obvious in this example: one perceives all the (relevant) structure and can write it down so as to reason formally about it. The case may perhaps be best appreciated by noticing that it is possible to solve the problem without any ingenuity at all, by simply checking by computer whether all the possible paths which do not go over any bridge twice (there are certainly less than a thousand of these) go over all bridges once. It is a less exciting method than a more abstract proof, but the result is exactly the same: it demonstrates an impossibility about an actual physical thing, resulting from its structure. No idealization is needed to obtain a mathematical result.

There is a temptation to see such a result as merely epistemological. On that view, there would be no metaphysical necessity involved, since how bridges are arranged is a contingent fact. The only necessities, as with any mathematical model, would lie within the model itself, not in the reality described by the model. The interest in these examples, and in the formal sciences more generally, would then be that the model–reality gap is narrow, in that it is very easy to establish by direct perception whether the model does apply to reality. Then, the small amount of data would result in many facts being deducible, some of them surprising. The formal sciences would be of interest primarily for the narrowness of the gap, but it would be wrong to claim that they had discovered any ‘philosophers’ stone’ for discovering real-world necessities.

Here, a stronger metaphysical reading is being defended. As argued in the previous chapter in more strictly mathematical cases, the difficulty with dismissing necessity claims on the grounds that how the

bridges are arranged is contingent is that it proves too much. Any necessity claim, about any aspect of reality, could be so dismissed. The necessity of 'scarlet things must be red' (whatever kind of necessity that is) is not subverted by the observation that it is a contingent matter whether something is scarlet. The necessity is not in things' being scarlet or red, but in the necessary connection between being scarlet and being red. It is the same with the bridges. Of course it is a contingent matter where the bridges were built. The necessity lies in the connection between the bridges having the arrangement they do and the properties of paths through them. And like scarlet, arrangements of bridges and properties of paths are found not in abstract models but in real systems.

The motivation for trying to replace the bridges by a model in which to perform deductions may be further reduced by the following considerations. Checking the paths is the same kind of activity as checking the steps in a (fully expanded, purely syntactic) proof in symbolic logic or set theory. It gives the same kind of certainty, for the same reason. If one succeeded in expressing Euler's proof, or the brute force proof, as a sequence of steps in predicate calculus, one would not have achieved either more certainty or certainty of a different kind. There would be exactly the same kind of necessary connection between the individual steps, resulting in certainty, modulo the usual understanding that one has not misperceived or misremembered any of the symbols. Again, one can move to a model made out of sets, but that model has literally the same topological structure as the real system of bridges. A truth about the network structure applies to the bridges as directly as to the sets, not to the bridges via the sets.

Indeed, one can just as well regard a proof of symbolic logic as an exercise in network theory as vice versa. In the lattice of all propositions, some are linked directly to one another by logical relations like modus ponens and contraposition. The relations are purely syntactic, that is, checkable by direct inspection of the symbol strings. One seeks a proof, that is, a path through the lattice from premise to conclusion. This is why it is irrelevant that mathematical proofs and computer programs are logical, or textual, while bridges are stone or steel, and structured entities in the other formal sciences may be electronic, biochemical, mental, astral, legal, flesh, fish or fowl.

If one is still inclined to think that any instantiation in physical materials must create a gap between abstract system and (possibly faulty) mechanism, then one must remember that there is the same gap in logic. The distinction the Poles used to make between 'socialism' and

‘actually existing socialism’ has a counterpart in that between logic and actually implemented logical inference. Since formal systems are systems of symbol-types, not symbol-tokens,⁴⁵ the act of classifying tokens into types must be part of any implementation. Therefore, in a brain, syntactic symbol processing of discrete symbols has only the reliability permitted by the optical character recognition capabilities of the underlying architecture. These are limited in principle and unreliable in fact, as anyone proofreading knows. And that is always assuming that the brain does implement deduction by syntactic symbol processing; if deduction in humans is actually done with models or simulations, as many experiments suggest,⁴⁶ then real logic is even more obviously on a par with the other formal sciences.

It is with Euler’s diagram in mind that we should attempt to fit the formal sciences into the long war between the Empiricists and the Rationalists. In the Empiricist’s heaven, science is mostly observation and the organizing of observations into universal statements. There are no ‘necessary connections between distinct existences’ (not logically or mathematically necessary connections, at least, even if there may be ‘nomic’ necessities). D’Alembert⁴⁷ describes the Rationalist’s heaven: most of science consists of mathematical deduction from certain extremely simple facts. These facts are, in the best case, symmetry principles clear a priori, and in the worst case easily measurable numerical relationships like Galileo’s law of free fall. Developments in the formal sciences suggest we are closer to the Rationalist’s heaven than, perhaps, we believed. The computer has much shortened our stay in the Rationalist’s purgatory, the frustrating state of being unable to perform the complicated deductions we know must be possible.

As Aristotle says, discussing the relation of propositions in optics and astronomy to those in mathematics: ‘For here it is for the empirical scientists to know the fact and for the mathematical to know the reason why; for the latter have the demonstrations of the explanations.’⁴⁸

Experiment in the formal sciences

Real certainty for armchair work – surely that is too rosy a picture of the formal sciences? If it were right, it ought to be possible to issue real-world predictions by computer without needing to do any experiments. Anyone who has worked in applied mathematics knows it is rarely like that. It is well known that fitting a realistic mathematical model to actual data is in general difficult. Sometimes, as in meteorology and

macroeconomics, it is close to impossible to find an accurate enough fit to issue reliable predictions.

To explain when experiment and fitting to data are necessary, one must return to the gap Fetzer insisted on between the abstract model and the real world. Everyone agrees that formal work can proceed with the usual necessity of mathematics, provided one keeps within the model. The important point is that there is wide variability in the certainty as to whether the real world has the structure described by the model. The model–reality gap may be wide or narrow. The word ‘model’ directs attention to cases where fitting is difficult, by the implied suggestion that there may be many models, among which it is difficult to choose. The extreme case is stock-market prediction, where there are plenty of models, but nearly total uncertainty as to which if any fit the data. Any case where an underlying structure has to be inferred from insufficient data will be like that to a greater or lesser extent. The examples above were chosen near the opposite extreme, even, so it was argued, to the extent that there was no gap at all. What structure a system of bridges or a computer program has is open to perceptual inspection, with the practical certainty that attends unimpeded sense perception. So all the hard work is in the mathematics, and the results are directly applicable, again with practical certainty. Examples like the statistical mechanics of gases fall somewhere in between, but still closer to the formal end. Whether the kinetic theory of gases is true is a contingent fact, not easily established. But it is in fact true, and the way temperature arises from the random motion of gas particles is a matter of necessity. Though it is harder than in the case of Euler’s bridges to determine if things have the properties the model attributes to them, there is real necessity in the *connections* of the properties. Being provable, it is a stronger necessity than nomic or Kripkean necessities.

It has been argued that though cases of real certainty in modelling like Euler’s bridges may be possible, they are rare because typically a mathematical model or computer simulation is a simplification or idealization of the real situation it models, so that any certainties proved about the model do not carry over to certainty about the situation modelled. ‘But in the majority of realistic modelling situations the models involved are simplified abstractions of the real system, and strict isomorphism between the model and the physical system is impossible to establish.’⁴⁹ One thinks typically of modelling coins by perfect Euclidean circles and using that model to calculate their area: the answer will not be exactly true.

The flaw in this reasoning is that it does not appreciate that (as will be explained in Chapter 14) modern mathematical models are ‘structurally stable’, that is, their (qualitative or approximate quantitative) predictions are insensitive to small changes. A circle is not structurally stable, in that a slightly deformed circle is not a circle. But the system of Königsberg bridges retains exactly the same topological structure if its islands are eroded slightly or its river narrows. Similarly with the predictions of typical chaotic dynamical models: the qualitative predictions of the model do not change at all if the inputs or parameters vary slightly – the individual trajectories do change, but the observable long-term average behaviours do not. It follows that accuracy of measurement of the inputs or parameters is not needed for certainty of the predictions. In a particular case, one will need to know something about how robust the model actually is to changes – but that is a purely mathematical fact about the model, itself knowable with the certainty of proof.⁵⁰

There is another kind of experiment in the formal sciences: ‘numerical experiment’. It also contributes to uncertainty in the formal sciences, but it should be distinguished from model-fitting work. It is part of the purely mathematical investigations, and is used when the mathematical model is hard to solve (‘solving’ generally means deriving global from local structure). Usually, the problem is that the model is too complex for the mathematical methods available, but it may also happen, as in chaos theory, that a quite simple model does not admit of a solution by normal methods. In such cases one runs the model on a computer, perhaps with various choices of values of parameters, and graphs the results in an effort to understand the structures that result. Any conjectures based on these experiments will be uncertain (unless a proof can be found later). That sort of uncertainty, though, is found even in pure mathematics where there can be calculatory experiments to confirm a conjecture, as will be described in Chapter 15. The existence of numerical experiments is therefore not an objection to the claim that the formal sciences can often achieve mathematical certainty about the world. Instead it confirms their affinity with pure mathematics.

7

Comparisons and Objections

Because the main body of philosophy of mathematics since Frege has moved along a path unsympathetic to Aristotelian views, it is natural to collect in one place the comparisons of the present point of view with standard philosophy of mathematics.

It is argued that the work of the most widely read philosophers of mathematics of the last hundred years is vitiated by the assumption that Platonism and nominalism are the only options. That has biased the questions asked, the mathematical examples chosen and the conclusions reached. It has been to the detriment of both Aristotelian realism in the philosophy of mathematics and to the connections that ought to hold between the philosophy of mathematics and what mathematicians are doing.

Finally, the present theory is compared to those few strands in the philosophy of mathematics that have been more sympathetic to Aristotelian realism, whether or not explicitly so called.

Frege's limited options

Frege set terms for the debate in the philosophy of mathematics that were essentially Platonist. His language is Platonist about sets and numbers, and almost all subsequent philosophy of mathematics has either accepted Frege's views literally and hence embraced Platonism, or attempted to deploy broad-based nominalist strategies to undermine realism (Platonist or not) in general.

The crucial move towards Platonism in modern philosophy of numbers occurred in Frege's argument for the conclusion that numbers are not properties of physical things. From the Aristotelian point of view, there is a core of Frege's argument that is correct, but his Platonist conclusion

does not follow. Frege argues, in a central passage of his *Foundations of Arithmetic*, that attributing a number to things is quite unlike attributing an ordinary property like ‘green’:

It is quite true that, while I am not in a position, simply by thinking of it differently, to alter the colour or hardness of a thing in the slightest, I am able to think of the *Iliad* as one poem, or as 24 Books, or as some large Number of verses. Is it not in totally different senses that we speak of a tree as having 1000 leaves and again as having green leaves? The green colour we ascribe to each single leaf, but not the number 1000. If we call all the leaves of a tree taken together its foliage, then the foliage too is green, but it is not 1000. To what then does the property 1000 really belong? It almost looks as though it belongs neither to any single one of the leaves nor to the totality of them all; is it possible that it does not really belong to things in the external world at all?¹

Frege’s preamble in this passage is sound and his question ‘to what does the property 1000 really belong?’ is a good one. The Platonist direction of his conclusion that numbers must be something beyond the external world does not follow, because he has not included the Aristotelian option among those that resolve the question of the preamble. There are three possible directions to go at this point:

1. an idealist or psychologist or nominalist direction, according to which number is relative to how we choose to think or speak about objects – Frege quotes Berkeley as taking that option² but is firmly against it himself as unable to make sense of the objectivity of mathematics;
2. a Platonist direction, as Frege and his followers adopt, according to which number is either a self-subsistent entity itself or an objective property of something not in this world, such as a Concept (in Frege’s non-psychological sense of that term) or an extension of a Concept (a set or function conceived Platonistically);³
3. an Aristotelian direction, which Frege does not consider, according to which 1000 is not a property of the foliage simply but of the (real) relation between the foliage and the universal ‘being a leaf’, while the foliage’s being divided into so many leaves is a property of it ‘in the external world’, as much as its green colour is.

The Aristotelian option ought to have been suggested by a moment’s further reflection on the example of the *Iliad*. If I cannot alter by thinking

the colour and hardness of a thing, neither can I alter the number of *books* in the *Iliad*. That is because the relation between the *Iliad* and 'book' is as objective as hardness. Frege's conclusion that a relation 'does not really belong to things in the external world at all' is a classic case of blindness to the reality of relations. If taken seriously, it would have wider inconvenient consequences, as Glenn Kessler explains:

Consider the following question: Is Charlottesville west? Here, too, there is no determinate answer. Following Frege's strategy, one might be inclined to conclude that direction does not apply to objects. This is clearly the wrong conclusion to draw. The above question lacks a determinate answer because 'west' refers to a relation and not to a simple property. The problem about determinateness arises not from applying 'west' to objects, but from treating 'west' as a monadic rather than a relational predicate. Frege's relativity argument may be regarded as establishing the same point with respect to numbers. The question 'Does 52 apply to this pack of cards?' lacks a determinate answer not because we have applied a number to an external object, but because we have mistaken a relation for a simple property... in claiming that a certain aggregate x contains 52 cards we are claiming that the numerical relation 52 holds between the aggregate x and the property of *being a card*.⁴

Indeed when Frege returns to the issue later in the *Foundations*, he comes close to making the same point himself, and uses language that is interpretable at least as naturally from an Aristotelian as from a Platonist perspective:

the concept, to which the number is assigned, does in general isolate in a definite manner what falls under it. The concept 'letters in the word three' isolates the t from the h , the h from the r , and so on. The concept 'syllables in the word three' picks out the word as a whole, and as indivisible in the sense that no part of it falls any longer under the same concept. Not all concepts possess this quality. We can, for example, divide up something falling under the concept 'red' into parts in a variety of ways... Only a concept which falls under it in a definite manner, and which does not permit an arbitrary division of it into parts, can be a unit relative to a finite Number.⁵

On an Aristotelian view, Frege is here correctly distinguishing unit-making universals from others and has almost come to an understanding

that number is a relation between a heap and a unit-making universal that divides it into parts. Indeed, the parallel he draws between them and a straightforward physical property like 'red' is reason against his unargued Platonist understanding of 'concepts' rather than for it. If red's being homoiomerous (true of parts) is compatible with red's being physical, it is unclear why being non-homoiomerous is in itself incompatible with being physical. Being large is not homoiomerous, in that the parts of a large thing are not all large, but that does not suggest that the property large is non-physical. Similarly, the reasons Frege adduces do not imply that 1000 is not a physical relation between foliage and the universal, being a leaf.

The degree of Frege's Platonism has been debated, as he does not emphasize the otherworldliness of the Forms and in epistemology he is content with the kind of Reason that performs mathematical proofs as a means of knowledge (rather than requiring a mysterious intuition).⁶ But the concern here is not so much with the correct interpretation of Frege as on the effect that his forceful statements of Platonism have had on later work. Frege never showed any nervousness or qualification in expressing himself that way, concerning mathematical or any other 'abstract' entities. As one commentator writes, 'At the beginning of [Frege's] formalisation of logic, the only objects whose existence can be taken for granted are the two truth-values, the True and the False'.⁷ That is excessively gnomic, in a way that in the pre-Socratics would be excused on the grounds of paucity of the sources.

The Platonist/nominalist false dichotomy

Frege's Platonism, in logic as much as in mathematics, has dominated the agenda of later analytic philosophy of logic, language and mathematics. It has led to a characteristic view of what counts as an adequate answer to questions in those areas, a view that Aristotelians (and often other naturalists) find inadequate. To take a non-mathematical example, the idea that belief is a relation between a believer and a proposition is regarded by Platonists as clear and by Aristotelians as standing in need of some naturalistic account of what a proposition is.

Aristotelians believe that Platonists and nominalists share an unexamined and unargued for – and incorrect – assumption: that everything that exists is a particular. (Naturalist) nominalists think that all the particulars are physical, while Platonists add 'abstract' particulars such as sets and numbers. Platonists and nominalists thus hope to divide the field between themselves by definition. (Platonism: there exist abstract

objects; nominalism: there don't.) But that fails to consider the possibility of universals, that is, genuine repeatables fully realizable in all their instances. As argued in Chapter 1, the Platonist-nominalist concept of 'abstract object' does not fit the case of properties and relations: colours or other properties, on an Aristotelian view, are not another kind of (particular) object, abstract or otherwise. They are what objects share (or ways they resemble one another).

That unexamined supposed dichotomy has meant that Aristotelian realism has been all but invisible in the philosophy of mathematics in the twentieth century and since. It did not make any appearance in the debate early in the century between the schools of logicism, intuitionism and formalism.⁸ (Of these, logicism and intuitionism deny that mathematics has an object, while formalism is in one way nominalist as reducing mathematics to language, but could also be regarded as a form of Platonism, with the Platonic entities being uninterpreted 'symbols' – one was not supposed to ask about whether one needed some kind of optical character recognition to discern when two marks were instances of the same 'symbol'.⁹) And Aristotelian realism does not appear in the usually reliable *Routledge Encyclopedia of Philosophy* (even under 'Realism in mathematics: anti-Platonist realism'),¹⁰ nor in the recent wide-ranging *Oxford Handbook of Philosophy of Mathematics and Logic* (even in the briefly mentioned anti-nominalist 'moderate realism' of Burgess and Rosen),¹¹ and is barely mentioned in the *Stanford Encyclopedia of Philosophy's* article 'Naturalism in the philosophy of mathematics'.¹² The extensive classification of realist philosophies of mathematics in Balaguer's *Platonism and Anti-Platonism in Mathematics* instances only Mill under (non-mentalistic) 'realistic anti-Platonism'.¹³ The North Holland *Handbook of the Philosophy of Science* volume *Philosophy of Mathematics* does have a chapter entitled 'Aristotelian realism', but it is a forerunner of the present work.¹⁴ As we will see in the last section below, there has in fact been some Aristotelian work, but plainly its impact has been minimal.

The assumed dichotomy of Platonism and nominalism has had unfortunate consequences. Characteristic features of the philosophy of mathematics of the last hundred years that seem to Aristotelians to be mistakes inspired by Frege, or at least unfortunate biases in emphasis, include:

- regarding Platonism and nominalism as mutually exhaustive answers to the question 'Do numbers exist?', and hence taking a fundamentalist attitude to mathematical entities, as if they exist as 'abstract' Platonic particulars or not at all;

- accepting that nominalism would be established if Platonism were refuted;
- resting satisfied that a mathematical concept (such as ‘structure’ or ‘the continuum’) has been explained if it has been constructed out of some simple Platonic entities such as pure sets;
- feeling no need to ask for an account of what sets are, in terms of better-understood entities;
- emphasizing infinities and downplaying the role of small finite structures and the counting of small numbers;
- ignoring such physically realized mathematical universals as ratios of quantities and hence not giving measurement a central role;
- regarding the problem of the ‘applicability of mathematics’ or ‘indispensability of mathematics’ as a question about the relation between some Platonic entities (such as numbers and functions) and the physical world;
- regarding measurement as a relation between numbers and measured parts of the world;
- taking the epistemology of mathematics to be mysterious because requiring access to a Platonic realm.

Let us examine how some of these issues have played out in the most prominent writings in the philosophy of mathematics in recent decades.

Nominalism

The Platonist/nominalist dichotomy makes it too easy for nominalists to claim success if they succeed in analysing a concept without explicit reference to numbers or sets. As Burgess and Rosen bluntly put it at the beginning of their survey of nominalist strategies, *A Subject with No Object*:

Numbers and other mathematical objects are exceptional in having no locations in space and time and no causes or effects in the physical world. This makes it difficult to account for the possibility of mathematical knowledge, leading many philosophers to embrace nominalism, the doctrine that there are no abstract entities.¹⁵

That is, *by definition* if extreme Platonism loses nominalism wins. Intermediate options are not graced with a mention.

How nominalists wrongly claim all non-Platonist territory is illustrated by the strategy in Hartry Field's justly celebrated *Science Without Numbers*, in its attempt to 'nominalize' basic mathematical physics. Typical of his strategy is his account of temperature, considered as a quantity that varies continuously over space. Temperature is often described in mathematical physics textbooks as a function (that is, a Platonist mathematical entity) from space-time points to the set of real numbers (the function that gives, for each point, the number that is the temperature at that point). Field rightly argues that one can say what one needs to say about temperature without reference to functions or numbers. He begins with 'a three-place relation [among space-time points] Temp-Bet, with y Temp-Bet xz meaning intuitively that y is a space-time point at which the temperature is (inclusively) between the temperatures of points x and z ; and a 4-place relation Temp-Cong, with xy Temp-Cong zw meaning intuitively that the temperature difference between points x and y is equal in absolute value to the temperature difference between points z and w '. He then provides axioms for Temp-Cong and Temp-Bet so as ensure they behave as congruence and betweenness should, and so that it is possible to prove a 'representation theorem' stating that a structure $\langle A, \text{Temp>Bet}_A, \text{Temp>Cong}_A \rangle$ is a model of the axioms if and only if there is a function ψ from A to an interval of real numbers such that

- (a) for all x, y, z, y Temp-Bet_A $xz \leftrightarrow \psi(x) \leq \psi(y) \leq \psi(z)$ or $\psi(z) \leq \psi(y) \leq \psi(x)$
- (b) for all x, y, z, w, xy Temp-Cong_A $zw \leftrightarrow |\psi(x) - \psi(y)| = |\psi(z) - \psi(w)|$ ¹⁶

Since the clauses to the right of the double-arrows refer to numbers and functions while the terms to the left do not, Field can rightly claim to have dispensed with numbers and functions understood Platonistically. He has also provided a convincing alternative to the 'mapping' account of the applicability of mathematics to the world,¹⁷ according to which there is a mapping or isomorphism between the realm of mathematics and the real world – a reading of the situation which obviously favours Platonism.

But is the result nominalist? It is all very well to write Temp-Bet and Temp-Cong as if they are atomic predicates, but they can only perform the task of representing facts about temperature if they really do 'intuitively mean' betweenness and interval-equality of temperature, and if the axioms describe those relations as they hold of the real property of temperature (to a close approximation at least). In virtue of what, the

Aristotelian asks, is Temp-Cong taken to be, say, transitive? It must be required because congruence of temperature intervals really is transitive.¹⁸ Field has not gone any way towards eliminating reference to the real continuous quantity, temperature, and to the real structural properties of temperature.

Constructions in set theory

The case of the ‘construction of the continuum’ well illustrates the second problem with Platonist strategy, arising from its analysis of concepts via construction of them out of sets. According to Platonists, an obscure concept such as the continuum, or ‘structure’, or the meaning of sentences in natural language, is adequately explained if the concept is constructed out of some simpler Platonist entities such as sets or propositions which are taken to be so basic as to need no further explanation. Aristotelian scepticism about this strategy focusses on two points: first, the alleged self-explanatoriness of these basic entities, and second, on how we know that the proposed construction in sets or propositions is adequate to the original concept we were trying to explicate – or rather (since the question is not fundamentally epistemological) what it is that would make the construction an adequate explanation. We treat the second problem here, and the first in the next section.

What account is to be given of why that particular set of sets of sets of... is the (or a) correct construction of the explanandum, such as ‘the continuum’? We have an initial intuitive notion of the continuum as a continuous line, a universal that could be realized in real space (though whether real space is infinitely divisible is an empirical question, to which the answer is currently not known¹⁹). There exists an elaborate classical construction of ‘the continuum’ as a set of equivalence classes of Cauchy sequences of rational numbers, with Cauchy sequences and rational numbers themselves constructed in complex ways out of sets. What is it that makes that particular set an analysis of the original notion of the continuum? The Aristotelian has an answer to that question: namely that the notion of closeness definable between two equivalence classes of Cauchy sequences reflects the notion of closeness between points in the original continuum. ‘Reflects’ means here an identity of universals: closeness is a universal literally identical in the two cases (and so satisfying the same properties such as the triangle inequality). The statement that closeness is the same in both cases is not subject to mathematical proof, because the original continuum is not a formalized entity. It can only be subject to the same kind of understanding as any statement that

a portion of the real world is adequately modelled by some formalism, for example, that a rail transport system is correctly described as a network with nodes. The Platonist, however, does not have any answer to the question of why that construction models the continuum; the Platonist will avoid mention of real space as far as possible and simply rely on the tradition of mathematicians to call the set-theoretical construction 'the continuum'. The Platonist prefers not to look at the actual history and notice that Cantor constructed something with exactly the properties assigned by Aristotle to the continuum.²⁰

Similar considerations apply to all of the many constructions of mathematical concepts out of sets. All or almost all mathematical concepts can be so constructed, and there is some mathematical point to the exercise, mainly to demonstrate the consistency of the concepts (or more exactly, the consistency of the concepts relative to the consistency of set theory). But there is no philosophical point to them. The Aristotelian is not impressed by the construction of a relation as a set of ordered pairs, for example. To see that as an analysis of relations would make the same mistake as identifying a property with its extension.²¹ The set of blue things is not the property blue, nor is it in any sense an 'analysis' of the concept blue. It is the property blue that pre-exists and unifies the set (and supports the counterfactual that if anything else were blue, it would be a member of the set). Similarly the ordered pair (3,4) is a member of the extension of the relation 'less than' because 3 is less than 4, not vice versa.

It is the same with, for example, the definition of a group as a set with a binary operation satisfying the associative, identity and inverse laws, an example typical of modern pure mathematics. That definition only has point because of pre-existing mathematical experience with groups of symmetries that do satisfy those laws, and the abstraction from those cases is what makes the abstract definition of a group a correct one. Certainly if one has sets one can construct any number of sets of sets of sets... of them, but the Aristotelian demands an answer as to why one such construction is an adequate analysis of symmetry groups and a different one an adequate analysis of topological spaces. That answer must be in terms of one construction sharing a property with symmetry groups and another sharing a different property with topology. It is the shared property – as the mathematician using the sets as an analysis well knows – that is the reason for the whole exercise. The philosopher with less mathematical experience is likely to make the mistake (in Aristotle's language) of confusing formal and material cause, that is, of thinking something is explained when one knows what it is made of.

Constructing some structure or concept out of sets does not mean that the structure or concept is therefore about sets, for the same reason as an ability to construct the concept out of wood would not make the concept one of carpentry.

The case of groups is an instance of the more general Bourbakist notion of (algebraic or topological) ‘structure’ as a set-theoretical construction.²² Any attempt to use the same ideas to define ‘structure’ itself – say by defining a structure as a set with some distinguished relations (themselves conceived as sets) – would face the same problem. The fact that one can build groups (say) out of sets as well as one can build them out of (say) motions of cubes fails to explain what the two have in common, and the same problem arises when it needs to be explained what all instances of ‘structure’ have in common. Saying that structures may be made out of sets makes no progress on answering that question. However, as stated in Chapter 4, a concept being constructable out of sets would show that it was a purely structural concept (provided that it was remembered that what can be constructed out of sets can be constructed in mereology with less ontological cost).

There is thus nothing to recommend the idea that if the philosophy of mathematics can explain sets, it can explain anything in mathematics since ‘technically, any object of mathematical study can be taken to be a set’.²³ Philosophers’ fixation on sets is one reason why mathematicians find standard philosophy of mathematics so irrelevant to their concerns. If mathematicians are studying the structures that can be constructed in sets while philosophers are discussing the material in which they are constructed, there is the same mismatch of concerns as there would be if experts in concrete pouring set themselves up as gurus on architecture.

Avoiding the question: what are sets?

In any case, if some concept is constructed out of sets, that would only be a philosophical advance for Platonism if the Platonist conception of sets were clear. That is not the case. David Lewis in *Parts of Classes* exposes the unclarity of the concept in Cantor and in mathematics textbooks:

Cantor taught that a set is a ‘many, which can be thought of as one, i.e., a totality of definite elements that can be combined into a whole by a law’. To this day, when a student is first introduced to set theory, he is apt to be told something similar. ‘A set is a collection of objects... [It] is formed by gathering together certain objects

to form a single object' (Shoenfeld)... But after a time, the student is told that some classes – the singletons – have only a single member. Here is a just cause for student protest, if ever there was one. This time, he has no 'many' ... We were told nothing about the nature of the singletons, and nothing about the nature of their relation to their elements... [and] all those allusions to human activity in the forming of classes are a bum steer. Sooner or later our student will hear that there are countless classes, most of them infinite and miscellaneous, so that the vast majority of them must have somehow got 'formed' with absolutely no attention or assistance from us...²⁴

Philosophers, Lewis suggests, have done even worse with the problem of what a set is than the writers of mathematics textbooks. They have simply ignored it. The *Stanford Encyclopedia of Philosophy's* article expresses the official view, that the question does not need answering: 'As sets are fundamental objects that can be used to define all other concepts in mathematics, they are not defined in terms of more fundamental concepts. Rather, sets are introduced either informally, and are understood as something self-evident, or, as is now standard in modern mathematics, axiomatically...'²⁵ When titles of works appear to promise an 'account' of sets, they turn out on examination to assume that sets of individuals are unproblematic and that set-membership is primitive, and to address such topics as the existence of large infinite sets.²⁶

And when Aristotelians have offered an answer – some reductive account of sets such as David Armstrong's suggestion that the singleton set of an object x is the state of affairs of x 's having some unit-making property,²⁷ or the alternatives considered in Chapter 3 – Platonists have ignored it on the grounds that they do not need it. Since any analysis of the basic Platonist entities in terms of something non-Platonist (such as states of affairs) would threaten the whole Platonist edifice, Platonists must pretend that their basic building blocks are perfectly clear and have no need of analysis.

Overemphasis on the infinite

The Platonist mindset prefers to rush into the higher infinities and the technicalities associated with them, at the expense of achieving a correct philosophical view of the simpler finite cases first – cases such as counting small numbers, measuring small quantities, the symmetries of the cube, the combinatorics of timetabling and the like. Philosophers

of mathematics have been quick to accept that physics requires the full ontology of traditional real analysis, including the continuum conceived of an infinite set of points, and hence have envisioned their task as essentially including an explanation of the role of infinities. But that does things in the wrong order. First, the simple should in general be explained first and extended to the complex, so it is natural to ask first that we understand small numbers and counting before we ask about infinities. Second, as we will see more fully in the next chapter, a huge amount of real mathematics is finite. The computer age has shown how to do most mathematics with finite means – a computer is a finite object operating on finite symbols strings but can do a great deal of mathematics. It is possible to put forward with at least some degree of credibility an ‘ultrafinitist’ philosophy that admits only finite numbers, which if not philosophically convincing is a sufficient reminder of how much of the mathematics one needs to do can be done in a strictly finite setting. Proposals that the universe (including space and time) is finite and can be adequately described by a discrete (though computationally intensive) mathematics in place of traditional real analysis also cast doubt on whether infinities are really needed in applied mathematics.

One example of the way in which overemphasis on infinities has created problems for the philosophy of mathematics is the reaction to Benacerraf’s suggestion that arithmetic is about ‘ ω -sequences’ or ‘progressions’, that is, any one-way-infinite sequence of things satisfying Peano’s axioms.²⁸ That suggestion has a potentially Aristotelian flavour, in that being a progression could naturally be taken to be a universal that could be shared by an infinite sequence of strokes, stars or other objects. Discussion has, however, been able to evade that conclusion because the infinite nature of the example prompts questions with a Platonist agenda, such as ‘What if the universe is finite and there are no ω -sequences?’ That is in itself a fair question to ask about any possibly uninstantiated mathematical structure, but it is not one what would have been asked so naturally if Benacerraf had chosen a small finite structure, such as ‘being the first 100 members of an ω -sequence’. Yet the most familiar truths of arithmetic, such as ‘ $2 + 2 = 4$ ’ and ‘17 is a prime’ are realized in that structure just as well as in a full ω -sequence. The suggestion that ‘arithmetic is the theory of ω -sequences’ is true, but it does not imply that ‘17 is a prime’ is vacuous or inapplicable if there are only finitely many things in the universe.

Measurement and the applicability of mathematics

Nowhere is the divergence between the Aristotelian and Platonist standpoints more obvious than in how they approach the problem of the applicability of mathematics. That very description of the problem has a Platonist bias, as if the problem is about the relations between ‘abstract’ mathematical entities and something distinct from them in the ‘world’ to which they are ‘applied’. On an Aristotelian view, there is no such initial separation between mathematics and its ‘applications’, since the symmetry, continuity and so on that pure mathematics studies is the same symmetry and continuity that is found in the physical world.

That undesirable assumed split between mathematical entities and their ‘applications’ is first evident in accounts of measurement. Considering the fundamental importance of measurement as the first point of contact between mathematics and what it is about, it is surprising how little attention has been paid to it in the standard literature of the philosophy of mathematics. The little work there has been has tended to concentrate on ‘representation theorems’ that describe the conditions under which quantities can be represented by numbers.²⁹ ‘Measurement theory officially takes homomorphisms of empirical domains into (intended) models of mathematical systems as its subject matter’, as one recent writer expresses it.³⁰ That again poses the problem as if it is one about the association of numbers to parts of the world, which leads to a Platonist perspective on the problem.

But a closer look suggests an Aristotelian reinterpretation. What is it about the quantitative properties of the measured world that ensures a homomorphism to numbers exists? The standard treatment (of measurement of length) begins by looking at the properties of concatenating identical rods, and axiomatizing those properties as a basis for showing that the homomorphism exists.³¹ Just as in the case of Field’s example of temperature, the quantitative properties exist prior to the homomorphism and are the condition of its existence: as the Aristotelian maintains, the system of ratios of lengths, for example, pre-exists in the physical things being measured, and measurement consists in identifying the ratios that are of interest in a particular case; the arbitrary choice of unit that allows ratios to be converted to digital numerals for ease of calculation is something that happens at the last step.³² That in turn suggests an Aristotelian realist view of the real numbers arising in measurement. As the Australian Aristotelian Michell puts it, in language similar to that used of ratios in Chapter 3 above:

The commitment that measurable attributes sustain ratios has a further implication, viz., that *the real numbers are spatiotemporally located relations*. It commits us to a realist view of number. If Smith's weight is 90 kg, then this is equivalent to asserting that the real number, 90, is a kind of relation, viz., the kind of relation holding between Smith's weight and the weight of the standard kilogram. Since these weights are real, spatiotemporally located instances of the attribute, any relation holding between them will likewise be real and spatiotemporally located. This kind of relation is what was referred to above as a ratio. So the realist view of measurement implies that *real numbers are ratios*. By way of contrast, the standard view within the philosophy of mathematics is that numbers are abstract entities of some kind, entities not intrinsic to the empirical context of measurement, but related externally to features of that situation by human convention. This neatly fits the representational view of measurement and in the 20th century, the representational view has dominated philosophical thinking about measurement. The representational view was strongly informed by non-realist thinking within the philosophy of mathematics.³³

The indispensability argument

Fregean Platonism about logic and linguistic items has also contributed to a distorted view of the indispensability argument, widely agreed to be the best argument for Platonism in mathematics. It is obvious that *mathematics* (mathematical practice, mathematical statement of theories, mathematical deduction from theories) is indispensable to science, but the indispensability argument arises from more specific claims about the indispensability of reference to mathematical entities (such as numbers, sets and functions), concluding that such entities exist (in some Platonist sense). As Quine put the argument:

Ordinary interpreted scientific discourse is as irredeemably committed to abstract objects – to nations, species, numbers, functions, sets – as it is to apples and other bodies. All these things figure as values of the variables in our overall system of the world. The numbers and functions contribute just as genuinely to physical theory as do hypothetical particles.³⁴

As stated (and as further explained by Quine and Putnam) that argument implies an attitude to language both exceedingly reverent and

exceedingly fundamentalist,³⁵ an attitude that was only credible – in the mid-twentieth-century heyday of linguistic philosophy when it was credible at all – in the wake of Frege’s Platonism about such entities as propositions and the objects of reference. Later more naturalist perspectives have not found it plausible that the language tail can wag the ontological dog in that way. No doubt at present we understand how to paraphrase reference to the ‘average Londoner’ in a statement like ‘the average Londoner will have 1.5 children in a lifetime’ so that we need not be committed to an entity ‘the average Londoner’; but what if our language became more restricted (for example through the inability of the iPod-addled younger generation to cope with subtle intellectual concepts like averages)? That would not be reason to believe in a Platonist entity ‘the average Londoner’, just because reference to it could no longer be eliminated in our language. Ontology is not subject to the vagaries of language in that way.

It is true that the careful defence of the indispensability argument by Colyvan is not so easily dismissed. Nevertheless his treatment preserves the main features that Aristotelians find undesirable, the fundamentalism of the interpretation of reference to entities (if it cannot be paraphrased away) and the assumed Platonism of the conclusion. Colyvan does begin by redefining ‘Platonism’ so widely as to include Aristotelian realism.³⁶ That is not a good idea, because Plato and Aristotle do not bear the same relation as Cicero and Tully, and the name ‘Platonism’ has traditionally been reserved for a realist philosophy that contrasts with the Aristotelian. But in any case Colyvan’s discussion proceeds without further notice of that option.³⁷ The options for the realist, he says, are either a mysterious perception-like ‘intuition’ of the Forms, or an inference to mathematical objects as ‘posits’ similar to black holes and electrons, which are not perceived but are posited to exist by the best physical theory. And he takes it for granted that the Platonism to which he believes the indispensability argument leads denies the ‘Eleatic principle’ that ‘causality is the mark of being’. The numbers, sets or other objects whose existence is supported by the indispensability argument are, he believes, causally inactive, in contrast to scientific properties like colours, and hence he argues that the Eleatic principle is false.³⁸

Cheyne and Pigden, however, argue that any indispensability argument ought to conclude to entities that have causal powers, as atoms do: it is their causal power that makes atoms indispensable to the theory. ‘If we are genuinely unable to leave those objects out of our best theory of what the world is like... then they must be responsible in some way for that world’s being the way it is. In other words, their indispensability is

explained by the fact that they are causally affecting the world, however indirectly. The indispensability argument may yet be compelling, but it would seem to be a compelling argument for the existence of entities with causal powers.³⁹ At the very least, the existence of atoms causally explains the observations that led to their postulation. It is not clear what corresponds in the case of Platonic mathematical entities.⁴⁰

But there is another problem with the indispensability argument. Surely there is something far-fetched in thinking of numbers as inferred hidden entities like atoms or genes? The existence of atoms is not obvious. It is only inferred from complex considerations about the ratios in which pure chemicals combine and from subtle observations of suspensions in fluids. On the other hand, a five-year-old understands all there is to know about why $2 + 2 = 4$. As Parsons comments, the Quinean view 'leaves unaccounted for precisely the obviousness of elementary mathematics'.⁴¹ Kant's view that we understand counting thoroughly because we impose the counting structure on experience may be going too far,⁴² but he was right in believing that we do understand counting completely. We do not need inference to hidden entities or information on the web of total science to do so. It is the same with symmetry and any other small mathematical structure realized in the world. As explained at length in Chapter 4, it can be perceived in a single instance and can be understood to be repeated in another instance, without any extra-worldly form of symmetry needing to be inferred.

If the Platonist then insists that the question was not about 'applications' of numbers like counting by children but about the Numbers themselves, he faces the dilemma that was dramatized by Plato and Aristotle as the Third Man Argument. What good, Aristotle asks, is a Form of Man, conceived of as a separate entity from the individual men it is supposed to unify? What does it have in common with the men that enables it to perform the act of unifying them? Would not that require a 'Third Man' to unite both the Form of Man and the individual men? An infinite regress threatens.⁴³ The regress exposes the inability of a Platonic form outside space and time and without causal power, even if it existed, to perform the role assigned to it. Either the individual men already have something in common that makes them resemble the Form of Man, in which case the Form is not needed, or they don't, in which case the Form has no power to gather them together and distinguish them from non-men. The same reasoning applies to the relation of numbers and sets (conceived of as Platonic entities) to counting and measurement. If a five-year-old can see by counting that a parrot aggregate is four-parrot-parted, and knows equally well how to count four

apples if asked, no postulation of hidden other-worldly entities can add anything to the child's understanding, as it is already complete. The division of an apple heap into apple parts by the universal 'being an apple', and its parallel with the division of a parrot heap into parrot parts, is accomplished in the physical world; there is no point of entry for the supposed other-worldly entities to act, even if they had any causal power. Epistemologically, too, counting and measurement are as open to us as it is possible to be (self-knowledge possibly excepted), and again there is neither the need nor the possibility of intervention by other-worldly entities in our perception that a heap is four-apple-parted or that one tree is about twice as tall as another.

Modal and Platonist structuralism

Platonist confusions about 'applications' also infect two of the most interesting attempts to explain mathematics as the 'science of structure', Hellman's 'modal-structural' theory and the Platonist theory of structures or patterns of Shapiro and Resnik.

Hellman argues that mathematics does have a subject-matter, namely 'structural possibilities':

ordinary mathematical statements are construed as elliptical for hypothetical statements as to what would hold in any structure of the appropriate type, this being describable directly in second-order logical notation ... Absolute reference to mathematical objects is eliminated entirely. Instead, there is, in addition to the translation scheme (the 'hypothetical component'), a categorical component to the effect that structures of the appropriate type are logically possible.⁴⁴

For example, a statement of arithmetic S is interpreted as asserting

Necessarily, for all X , if X is an ω -sequence then S holds in X

together with the modal existential assumption

Possibly, there exists X such that X is an ω -sequence.⁴⁵

From the Aristotelian point of view, these statements are true, and, of the philosophies of mathematics widely discussed in the recent literature, Hellman's is the closest to that of the present book. It agrees with the present work in being anti-Platonist, and in replacing reference to

Platonist entities by talk of necessities and possibilities. It is thus worth a careful comparison.

The Aristotelian's first complaint with Hellman's theory is that the modalities in it are ungrounded and are put in an excessively hypothetical form. If there could possibly be ω -sequences, then the statement S should be literally true in all *actual* ω -sequences – that is what 'possibility' means. Choosing an infinite structure like ω -sequences, of which we lack knowledge as to whether it is instantiated or not, biases the debate, but Hellman's theory is intended to be perfectly general and apply to all structures, including those we know are instantiated such as the topological structure of Euler's Königsberg bridges. There is no need to take refuge in the purely hypothetical, or to force a Platonistically conceived modal logic to do the job of the necessities discovered in the actually existing structure. Hellman's account is correct of uninstantiated structures, but avoids mention of what happens when the structures are in fact instantiated. In that case, the modal and hypothetical statements in his theory need to be grounded in actualities.

Compare what would happen if one were so unnerved by the fact that some shade of blue might be uninstantiated that one took the physics of colour to be not about colour but about colour possibilities. That would be an overreaction. The reference to possibilities is otiose. Colour physics is about colours simply, both those that exist and any that may not.

Second, even in the case of infinite structures, a close examination of Hellman's modalist theory reveals a hidden reference to realistically interpreted universals, in much the same way as in Field's attempted nominalism. Hellman rightly says that to characterize ω -sequences, one needs a second-order statement of mathematical induction:

$$\forall P[(P(0) \ \& \ \forall x \forall y(P(x) \ \& \ s(x) = y \supset P(y))] \supset \forall x P(x)]$$

In this formula, what is P ? That is, over what sort of entities does the first universal quantifier range? Hellman says they are classes, so the statement means 'Any class containing 0 and closed under successor contains every number' (where 'number' here just means 'member of an ω -sequence').⁴⁶ But 'class' cannot mean 'class of actual entities', since at this point Hellman is envisaging the possibility that there are no actual ω -sequences – that is the point of his modalist analysis. While a standard view of second-order logic does regard the properties quantified over as actual classes,⁴⁷ Hellman himself emphasizes that the

logical modalities are primitive and avoid set-theoretic commitments.⁴⁸ Nor does he admit classes of possibilia. Hellman's plan of relying on second-order modal logic suggests that the P 's are really universals – any properties that members of an ω -sequence could share. The same question can be asked about the successor relation s – what kind of thing is that, if not a relation, a repeatable that can hold between members of ω -sequences? Indeed, Hellman speaks exactly that way: 'we may consider concrete marks, *à la* Hilbert, and a constructive rule R for generating a "next mark" ... this [there always existing a successor mark] may not in fact hold in the real world, but I can see no reason why it should not be logically possible'.⁴⁹ What is a 'rule R ' except a real relation, a repeatable that holds between pairs of marks? The relation is the same kind of thing – specified and understood beforehand – irrespective of whether the world is such that the marks go on to infinity or run out. Whether the writing of marks is the kind of thing that could in principle continue indefinitely is a fact about the universal, repetition-of-marks, not a free-standing fact about modal logic. Thus Hellman's appeal to modal logic to explain his structuralism leaves the modalities both ungrounded and in need of a realist theory of universals even to explain what they apply to.

Third and finally, Hellman's project falls foul of a problem that was one of the principal obstacles to logicism: the non-logical nature of the axiom of infinity. Hellman hopes to replace the necessities of Platonist entities with necessities of modal *logic*. Hellman writes 'One can first postulate the logical possibility of an infinitude of atoms...'⁵⁰ but it is implausible that this possibility is in any sense a matter of logic. (Nor do logical possibilities need 'postulation'.) As will be explained in the next chapter, the lesson of a century of work on axiomatic set theory is that the axiom of infinity cannot be derived from anything simpler by purely logical means, but has to be accepted on its own terms (though there can be reasons for believing it).

So Hellman, like Field, had some success in showing how to do mathematics while avoiding Platonism, but in so doing required non-nominalist entities that naturally take on an Aristotelian interpretation.

Shapiro and Resnik, as we saw in Chapter 4, present a different form of structuralism. They conceive of their 'structures' and 'patterns' as Platonist entities, something like sets.⁵¹

The Aristotelian then demands of them their account of how such Platonist entities relate to structures or patterns realized in the physical world. Shapiro does attempt an answer to that question, with a substantial account of the example of a 'baseball defence':

Another important difference between mathematical and ordinary structures concerns the sorts of items that can occupy the places in the structures. Imagine a system that consists of a ballpark with nine piles of rocks, or nine infants, placed where the fielders usually stand. Imagine also a system of chalk marks on a diagram of a field, on which a baseball manager makes assignments and discusses strategy. Intuitively, neither of these systems exemplifies the defense structure. A system is not a baseball defense unless its positions are filled by people prepared to play ball. Piles of rocks, infants, and chalk marks are excluded. *Prima facie*, these requirements on the officeholders in potential defense systems are not 'structural.' For example, the requirement that the officeholders be people prepared to play is not described solely in terms of relations among the offices and their occupants. The system of rock piles and the system of chalk marks can perhaps be said to model or simulate the baseball-defense structure, but they do not exemplify it...

In contrast, mathematical structures are freestanding. Every office is characterized completely in terms of how its occupant relates to the occupants of the other offices of the structure, and any object can occupy any of its places. In the natural-number structure, for example, there is no more to holding the 6 office than being the successor of the item in the 5 office, which in turn is the successor of the item in the 4 office. Anything at all can play the role of 6 in a natural-number system. Any *thing*. There are no requirements on the individual items that occupy the places; the requirements are solely on the relations between the items. A consequence of this feature is that in mathematics there is no difference between simulating a structure and exemplifying it.⁵²

Aristotelians consider these examples as correctly drawing the distinction between (merely) structural and purely structural features – being a baseball defence, like being a tartan pattern, is not purely structural because it requires certain properties of the constituents. But they believe that Shapiro, as a Platonist, has misread this as a difference between one kind of entity, abstract 'mathematical structures' and another kind, instantiated (?) 'ordinary' structures such as baseball defences. And he does not attempt any extensive account of what such instantiated structures are, or of the relation of 'modelling' or 'simulation' that is said to hold between mathematical and instantiated structures. When later discussing applied mathematics, he speaks of 'discovering exemplifications of mathematical structures among observable physical objects',⁵³

but again the Platonist nature of the relation of exemplification is emphasized and there is no definite theory of it (e.g. in terms of a resemblance between the worlds of forms and of physical objects).

The Aristotelian holds that instantiation is the correct choice of relation: there is a purely structural relation which, if instantiated by people prepared to play baseball, is a baseball defence, and that is all there is to being a baseball defence.

Epistemology and 'access'

Shapiro well explains how the epistemological problem in mathematics looks when Platonism is taken to be the only realist option:

To sharpen the critique of realism in ontology, note that the causal theory of knowledge is an instance of a widely held genre called 'naturalized epistemology,' whose thesis is that the human subject is a thoroughly natural being situated in the physical universe. Any faculty that the knower has and can invoke in pursuit of knowledge must involve only natural processes amenable to ordinary scientific scrutiny. The realist thus owes some account of how a physical being located in a physical universe can come to know about *abstracta* like mathematical objects. There may be no refutation of realism in ontology, but there is a deep challenge to it. The burden is on the realist to show how realism in ontology is compatible with naturalized epistemology.⁵⁴

If the problem is posed from the beginning as one of knowing acausal *abstracta*, there will be problems with access and incompatibilities with naturalized epistemology which are unlikely ever to be solved.

There has indeed been one serious attack on the problem from a Platonist perspective. Brown argues that the causal theory of knowledge is not exactly correct for some of the more theoretical kinds of knowledge. For example, knowledge arrived at inductively that all 'swans are white' is not caused by all swans, since only a few of them are observed; instead, the knowledge arises by inference from sensory perceptions, which could be true of mathematical knowledge as well.⁵⁵ In his *Philosophy of Mathematics: An introduction to the world of proofs and pictures* Brown gives a more positive account of Platonist knowledge. He sees the mathematical mind as grasping truths via proofs suggested by diagrams drawn in the physical world. 'Some "pictures"', he says, 'are not really pictures, but windows to Plato's heaven.'⁵⁶ It is certainly convincing that diagrams

induce understanding, which is a kind of vision of mathematical reality, but there is some paradox in maintaining that that account is Platonist. The more Brown insists that we can see mathematical truths directly in diagrams, the more Aristotelian and less Platonist his theory looks, since it is Aristotelianism that insists on the realizability of mathematical truths, in all their necessity, in the real world including diagrams. How this works will be considered in Chapter 11.

The problems dealt with above with the indispensability argument recur. Our direct perception of instantiated mathematical properties like the symmetry of tables would not be aided by any separate access we had to acausal *abstracta*, even if we had any. Aristotelian epistemology is a form of naturalized epistemology so there is no problem of incompatibility with it. That does leave a challenge as to how Aristotelian epistemology can account for knowledge of unrealized possibilities, whether of the existence of a golden mountain or of infinite cardinals. That is a challenge not peculiar to mathematical knowledge, and one that was taken up initially in Chapter 2 but will be more fully considered in the later chapters.

Naturalism: non-Platonist realisms

Platonists have not had quite the whole field of realism in mathematics to themselves. Here we briefly survey realist philosophies of mathematics that are closer in spirit to the Aristotelianism being defended here, explaining how they compare with it and where the present theory has advantages over them.

Aristotle not only provided the general metaphysical framework of non-Platonist realism but laid down a number of themes specific to mathematics. Mathematics was for him a study of properties of physical things, abstracted from them only in thought:

Obviously physical bodies contain surfaces, volumes, lines and points, and these are the subject-matter of mathematics ... the mathematician does not consider the attributes indicated as the attributes *of* physical bodies. That is why he separates them, for in thought they are separable from motion... While geometry investigates physical lengths, but not *as* physical, [the more physical branch of mathematics,] optics, investigates mathematical lengths, but *as* physical.⁵⁷

The contrast of this realism with Platonism is explicit: ‘mathematical objects exist and are as they are said to be’, but they are not separate objects. ‘There are attributes peculiar to animals as being male or as being female (yet there is no male or female separate from animals).

So there are properties holding true of things merely *as* lengths or *as* planes.⁵⁸

Aristotle also laid out the basic distinction between discrete and continuous quantity, along with the resemblance between them in their both referring to divisibility into parts:

‘Quantum’ means that which is divisible into two or more constituent parts of which each is by nature a ‘one’ and a ‘this’. A quantum is a plurality if it is numerable, a magnitude if it is measurable. ‘Plurality’ means that which is divisible potentially into non-continuous parts, ‘magnitude’ that which is divisible into continuous parts.⁵⁹

And on discrete quantity, he emphasized the instantiability of number via a unit-making universal, if cryptically:

‘The one’ means the measure of some plurality, and ‘number’ means a measured plurality and a plurality of measures... The measure must always be some identical thing predicable of all the things it measures, e.g. if the things are horses, the measure is ‘horse’, and if they are men, ‘man’. If they are a man, a horse, and a god, the measure is perhaps ‘living being’, and the number of them will be a number of living beings.⁶⁰

By the seventeenth and eighteenth centuries, a version of an Aristotelian theory of mathematics as a realist science of quantity, both discrete and continuous, was standard.⁶¹ Newton writes of continuous quantity, in his uniquely magisterial style, ‘By *Number* we understand not so much a Multitude of Unities, as the abstracted Ratio of any Quantity, to another Quantity of the same kind, which we take for Unity’.⁶² The realist quantity theory apparently died of inanition. It was neither attacked nor defended in later times.

John Stuart Mill presented what is still the best-known naturalist philosophy of mathematics. His theory represented mathematics as an inductive science of the quantity of ‘aggregates’, differing from other sciences such as chemistry simply in the generality of its subject matter. Roundly abused by Frege and regarded as hopelessly naïve by almost all later philosophers, it nevertheless posed and attempted to answer certain questions that remain good questions, despite the determination of later writers to ignore them. Mill writes:

The fundamental truths of that science [arithmetic] all rest on the evidence of sense; they are proved by showing to our eyes and our

fingers that any given number of objects, ten balls for example, may by separation and re-arrangement exhibit to our senses all the different sets of numbers the sum of which is equal to ten. All the improved methods of teaching arithmetic to children proceed on a knowledge of this fact.⁶³

He thereby raises acutely the need for a philosophy of mathematics that can explain how numbers do relate to the properties of physical objects, and how our moving discrete physical objects around can induce in us knowledge of arithmetical truths. His is 'a serious attempt to understand [arithmetic and geometry] as dealing with the physical properties of everyday things and our mathematical knowledge as grounded in our perceptual interactions with the physical world'.⁶⁴ Mill's emphasis on manipulation leaves him open to Frege's sarcasm that it is fortunate objects are not nailed down and that it is a mystery how strokes on a clock could be counted.⁶⁵ But then that still leaves Frege and his followers with no account of how manipulations, movements and perceptions could be relevant to mathematical learning, as they plainly are.

Frege argued that number could not be a property of things, as Mill thought, because many different numbers apply to a given heap, depending on how we choose to count (as books, words, letters, etc). However, Mill was not entirely unaware of that. His actual statement of the nature of number is:

[Number is]...some property belonging to the agglomeration of things which we call by the name; and that property is the characteristic manner in which the agglomeration is made up of, and may be separated into, parts...When we call a collection of objects two, three, or four, they are not two, three, or four in the abstract, but two, three, or four things of some particular kind; pebbles, horses, inches, ...⁶⁶

Mill thus comes close to the theory defended in Chapter 3, that discrete number is a relation between a heap (if 'agglomeration' may be interpreted as a mereological sum) and a unit-making property ('characteristic manner') that structures it.⁶⁷ He is perhaps less successful in arguing that mathematical truths, like scientific truths, are not necessary.

Philosophy of mathematics then moved in entirely different directions, with Frege's Platonism followed by half a century of excitement over the mathematical results of Russell, Hilbert and Gödel on 'foundations' and axiomatics. The classical schools of logicism, formalism and

intuitionism fought one another to a standstill, exposing one another's weaknesses while keeping clear of any awkward questions about the relation of mathematics to the world. The field was recalled to reality by Körner's 1960 book *The Philosophy of Mathematics* which, after reviewing the classical schools and their problems, pointed out the need to take applied mathematics seriously and argued, similarly to Mill, that "One apple and one apple make two apples" is an empirical law of nature which, unlike " $1 + 1 = 2$ ", is capable of being confirmed or refuted by experiment'.⁶⁸ The message was reinforced by the physicist Wigner's very widely read essay 'The unreasonable effectiveness of mathematics in the natural sciences'.⁶⁹

Philosophy of mathematics was then reoriented by Benacerraf's influential article 'What numbers could not be'.⁷⁰ As we saw, he used language that could have been naturally interpreted in an Aristotelian fashion, but that was generally not how the article was read. Instead, Platonism came to dominate the field, coming either from Quine's indispensability argument, from the structuralism of Shapiro and Resnik, or from Brown's ideas on the direct visualizability of Platonic forms.⁷¹ While Platonism ruled, the pretender to the throne has been nominalism, such as that of Field, with little recognition that there might be alternative candidates.

Some thread of a more naturalist realist approach, at least about whole numbers, was maintained by Kitcher, Irvine and Maddy. Kitcher's *The Nature of Mathematical Knowledge* (1983) revived Mill's empiricism about mathematical truths and the knowledge of them, arguing that mathematical epistemology must be connected to how children learn simple arithmetical truths using their ordinary sense-perception and ability to manipulate objects. He writes:

A young child is shuffling blocks on the floor. A group of his blocks is segregated and inspected, and then merged with a previously scrutinized group of three blocks. The event displays a small part of the mathematical structure of reality...By having experiences like that...we recognize, for example, that if one performs the collective operation called 'making two', then performs on different objects the collective operation called 'making three', then performs the collective operation of combining, the total operation is an operation of 'making five'...to present my thesis in a way that will bring out its realist character, we might consider arithmetic to be true in virtue not of *what we can do* to the world but rather of what *the world* will let us do *to it*. To coin a Millian phrase, arithmetic is about 'permanent possibilities of manipulation'. More straightforwardly, arithmetic

describes those structural features of the world in virtue of which we are able to segregate and recombine objects.⁷²

Those comments are suggestive of where a realist mathematical epistemology might begin. But the approach as it stands has certain inadequacies, ones it shares with most attempts to explain basic numerical knowledge in terms of children's activities. It makes it hard to understand the countability of non-manipulable objects, such as musical notes, although there is no reason to believe that number applies differently to movable and immovable objects. And in any case the notion of segregating and recombining or performing any kind of manipulation is unclear as to how it relates to both numerosity and mereology: to move some objects around changes neither their number nor their mereological sum but only our perceptual tendency to see them as one group or several subgroups; it is thus left unexplained how movements 'make three' or otherwise connect with number. Finally, the approach begins with the assumption that the heap is uniquely divided into (perceptually salient) objects, which, as we saw in Chapter 3, is precisely the crucial point in the creation of number.

Maddy's *Realism in Mathematics* (1990) dealt specifically with sets and their relation to numbers. Although calling her view of sets Platonist, she defended a view of them according to which small sets of physical objects could be directly perceived; for example, it could be perceived that a carton has a set of three eggs in it, in virtue of the egg-mass being divided into three eggs.⁷³ Further, she connected her view closely with the findings of perceptual psychology and to some degree infant development, thus giving her approach to sets some resemblance to that taken in this book to mathematics in general. Her later work, although called *Naturalism*, concentrated on a Platonist approach to higher set theory, with overtones of Wittgensteinian anti-philosophy.⁷⁴

Several of the authors just mentioned contributed to Irvine's edited collection *Physicalism in Mathematics* (1990). Irvine saw room for an 'immanent mathematical realism (any realism acceptable to a physicalist)', lying between the transcendent realism of traditional Platonism and nominalism.⁷⁵ His hope that work would proceed in that direction has not entirely been realized, but the present theory is in that tradition.

Wilholt's *Number and Reality* dramatizes the difficulties of both nominalism and Platonism in explaining the applicability of mathematics with the example of the stuntman Colt. Wishing to know if it safe to drive across a gorge, Colt consults a physicist, who calculates a function

f such that it is safe to attempt the gorge if there is no real number r in a certain interval such that $f(r) = 0$. Colt then asks for advice from his assistant, an amateur metaphysician and nominalist, who tells him that there are no real numbers at all, hence it is safe to drive. And if nominalism has a problem with the example, so does Platonism, which has to explain how the properties of abstract objects can bear on driving across gorges, given the lack of physical connection between the two – a problem not addressed by indispensability arguments. His ‘limited realist’ proposal resembles that of this book in regarding whole numbers as properties of aggregates and real numbers as ratios that can be physically instantiated, but gives an essential role to causality. Unlike the present proposal, his view of higher mathematics like abstract algebra is formalist.⁷⁶

The theory of whole numbers advanced in this book, that they are relations between unit-making properties and the heaps they structure, was put forward in the 1980s by Kessler and developed by the Australians Forrest and Armstrong (though as just seen, it has a close resemblance to a remark of Aristotle’s).⁷⁷ Most of the subsequent developments in the Aristotelian metaphysics of quantities have also been by Australians: Bigelow’s realist theory of numbers,⁷⁸ Bigelow and Pargetter’s realist theory of continuous quantity, Armstrong’s theory of sets as states of affairs,⁷⁹ Ellis and Michell’s work on the crucial connection between measurement and quantities,⁸⁰ and Mortensen’s work on ‘metrical realism’ and geometry with mereology instead of sets.⁸¹

Bigelow’s work, in *The Reality of Numbers: A Physicalist’s Philosophy of Mathematics* (1988) and *Science and Necessity* (1990), is probably the closest fully developed philosophy of mathematics to the present work. It has little on epistemology and not much on structure, though approving of structuralist perspectives in general terms. It does however have an extensively developed Aristotelian view of quantity, both discrete and continuous (though preferring to call it physicalist, Platonist and Pythagorean). Bigelow’s theory of whole numbers is that the number n is the relation of n -fold mutual distinctness between objects. Thus the fact that A and B are two is just the fact that A is not equal to B.⁸² That is not so much incompatible with the present theory as operating at a higher or subsequent level of abstraction. Recall that in Chapter 3, numbers were taken to be the relation between a heap and a unit-making universal; however, once units are identified, one could then prescind from which unit-making universal created them and arrive at a set. Bigelow’s theory of numbers is at the same level as Armstrong’s theory of sets, in dealing with objects and their relations

without alluding to the unit-making universals that constituted them as objects (of a certain kind) in the first place.

Bigelow admits the reality of relations of proportion between quantities such as lengths but highlights instead (rational) ratios, which are a kind of relation between relations: the relation double holds between being-a-grandparent and being-a-parent, while the ratio 3:2 holds between being-a-great-grandparent and being-a-grandparent. Any irrational proportion between, say, lengths, can then be approximated by rational ratios between relations holding between the objects which have length.⁸³ That is a workable approach, but tends to obscure the simplicity of the relations of proportion that hold between lengths, prior to any questions about units. The proportion of the circumference of a circle to its diameter is as simple a relation as any other proportion, integral, rational or otherwise, and surely all such relations should be given an account of the same kind.⁸⁴

Bigelow gives interesting treatments of some other kinds of quantity, such as vectors and complex numbers, which go beyond what is attempted here.⁸⁵

Those works deal with the ontology of mathematics. As to epistemology, that has largely remained trapped by the Platonist–nominalist dichotomy into problems of ‘access’ to ‘abstract’ entities. There have been two notable recent exceptions, both based on looking directly at instances of mathematical knowledge, free of the usual philosophical presuppositions. One is Brown’s *Philosophy of Mathematics: An introduction to the world of proofs and pictures*, mentioned above. The other is Giaquinto’s *Visual Thinking in Mathematics*,⁸⁶ which took a serious interest in the results of cognitive science to understand the cognition of structure and generalization in mathematics. Several examples are taken from it in Chapter 11 below, on visualization.

Mathematical epistemology could well have taken closer notice of relevant work in the developmental psychology of mathematics, such as Dehaene’s well-known *The Number Sense*,⁸⁷ and of work by educationists on early learning,⁸⁸ since both of those fields have a natural tendency to be realist without being Platonist. That has not occurred.⁸⁹

8

Infinity

The standard Zermelo–Fraenkel axioms of set theory lay out conditions of identity of sets, then methods of forming new sets from old – via unions, power sets and the like. When those methods are fed finite sets they yield finite sets and when they are fed infinite sets they (can) yield infinite sets. But there is no way to build an infinite set from finitely many finite sets. The ZF axioms cope with that limitation by adding a bald ‘Axiom of Infinity’, which states ‘there is an infinite set’.

The ZF system encapsulates a good deal of experience with sets, numbers and axiomatization. The starkness of the Axiom of Infinity is a summary of an important discovery: the gap between the finite and the infinite is unbridgeable by any resources from the side of the finite, using just logic. The infinite – if it is needed at all – simply has to be swallowed whole.

Questions that a philosophy of mathematics must answer about infinity include:

- Do we need infinity? How much mathematics (pure and applied) would we have if we restricted ourselves to finite entities and methods?
- Is there anything paradoxical about infinity?
- Is there anything to the notion of a ‘potential infinity’ as an alternative to or mean between the finite and the actual infinite?
- What should we make of the complaints of ‘constructivist’ and similar philosophers over many centuries that since our finite minds cannot grasp the infinite, there is something wrong with the concept?
- How can we know about infinity? Whether we need it or not, is infinity a reality, and how do we know, given our limitations? How do we know that the natural numbers do not run out?

Infinity is also a crucial test case for an Aristotelian philosophy that emphasizes the reality of mathematical properties. Since the world may be finite, what is Aristotelianism's account of possibly uninstantiated infinities?

Infinity, who needs it?

If infinity were abolished, how much serious mathematics would be left? Would we cope?¹

We know the answer to that question, because we have been teaching mathematics to computers for decades. When computers came to do mathematics, infinity *was* abolished, since computers are finite objects. They deal in whole numbers with a fixed maximum size. Instead of real numbers, they are restricted to 'floating point numbers' of limited precision.² Computer graphics packages do geometry on a large but finite grid of points. Symbolic manipulation packages such as *Mathematica* and *Maple* deal in finite formulas and can solve differential equations, draw graphs and can pass mathematics exams more reliably than most mathematics students.³ The search for theorem-proving and especially theorem-discovering software has been much less successful, but there are some worthwhile advances.⁴ The end result is that finite machines with finite resources can output a product that reads to humans like mathematics, in greater quantity and quality than any individual human.

The success of computers in doing mathematics (or imitating it, if one insists that mathematics must be a product of a mental process) depends on two facts. The first is that so much of the mathematics we need to do is finite. The second is a purely mathematical fact about the abilities of discrete and continuous mathematical structures to imitate one another.

First, much of what we really need to do in mathematics is finite and requires no reference even remotely to infinity. The truth that $2 \times 3 = 3 \times 2$ is purely finite. It stands on its own irrespective of any generalizations of which it may be an instance. One could choose to derive it from Peano's axioms of arithmetic, which do refer to the infinite system of numbers, but that does not make the truth itself have any reference to infinity – the derivability is just a consequence of the obvious fact that a finite structure can be embedded in an infinite one. All the (finitely many) arithmetical facts that can be output by a standard electronic calculator are finite, and such facts are generally sufficient for applications of mathematics in the fields that are its bread-and-butter, accounting and data analysis. Since J.G. Kemeny's classic 1957 textbook on finite mathematics,⁵ there have been very many books and courses on 'finite' and 'discrete' mathematics, including topics such as logic, combinatorics, matrices and networks with their applications to

business and the social sciences. Examples we have seen in earlier chapters such as Euler's bridges and the six-point star proof illustrate that there are many interesting and subtle proofs involved in studying even very small finite structures.

The picture is less clear with geometry and with the measurement in physics and engineering of such (possibly) continuous quantities as time and mass. First, it is unknown whether actual space and time are infinitely divisible. Hume was right, contrary to the mathematicians on his day, in maintaining that the question whether space is infinitely divisible is an empirical one.⁶ The lesson of the discovery of non-Euclidean geometries was that the shape of the space we live in – that is, which of the mathematically possible geometrical structures it instantiates – is something to be discovered by measurement, not imposed *a priori*.⁷ That lesson applies just as much to the microstructure of space as to large-scale properties like curvature and dimension. (Further in Chapter 9.)

The verdict of modern physics on the question is so far ambiguous. The standard modern theories, relativity and quantum mechanics, are expressed in terms of continuous space and time but there are no observations – probably no possible observations – to confirm directly that that is so. Erwin Schrödinger, like many physicists dealing with the very small, was impressed with how elaborate the structure of the continuum was and how little observational support there was for supposing it was instantiated in its entirety in real space. The observations on which quantum mechanics are based are discrete, and Schrödinger writes that the 'facts of observation are irreconcilable with a continuous description in space and time'.⁸ However orthodoxy in quantum mechanics has taken that to be a fact about *observation*, and has founded the theory on the (unobservable) wave function, which gives the description of a system as a function of the usual continuous space and time. Discreteness then re-enters only in the 'collapse of the wave function', which produces discrete observations but does not cast doubt on the continuity of space or time.⁹ Some less standard later physical theories have raised many proposals for deriving our apparently continuous space and time from something more basic, possibly discrete, but no such theories have become firmly established (nor on the other hand has that approach been ruled out.)¹⁰ In those circumstances, it is possible to speculate that the universe is digital in its entirety and to offer a discrete mathematics to do all of physics.¹¹ But at the moment, it would be safer to assume, at least for the sake of argument, that space and time really are continuous.

Even given that, it is not clear that the standard mathematics of the continuum is needed for work in applied mathematics. While humans most naturally think of space, time, mass and other such quantities as

continuous, perceptions and measurements have finite precision, so it could reasonably be hoped that any practical mathematical tasks in physics and engineering could be accomplished with finite-precision arithmetic. But it is not obvious whether that hope is realistic: although direct measurement might well need only numbers as precise as the limits of the measuring device, it is not clear whether, for example, computing the advance of a wave might prove impossible if space and time in the computation are restricted to a discrete approximation.

The development of digital computers spurred the effort to see whether continuous processes *could* be calculated via discrete approximations. Indeed, that is what computers were invented for. Long before word-processing, spreadsheets and databases were thought of, computers were built to compute ballistic tables and simulate the weather, that is, to compute discrete approximations to continuous dynamics.¹² The verdict was: discrete simulations work well across the board, but they are very painful to program and there are many pitfalls in making sure the discretized version correctly tracks the continuous process it is simulating. Chaos theory shows there are fundamental limitations in certain cases on how far ahead in time the discrete simulation and the continuous process will stay close. Nevertheless, in principle computation with finite objects can imitate a continuous process to any required degree of precision.

The nature of this fact is mathematical rather than philosophical. Discrete functions are one kind of mathematical structure, continuous functions another. How the behaviour of one imitates the behaviour of the other is a topic to be investigated mathematically in the usual ways, with theorems, lemmas and corollaries.¹³ The need for hard mathematical analysis is illustrated by a simple example where a naïve or hand-waving approach to the approximation of the continuous by the discrete gives a wrong answer. Suppose we ‘approximate’ the diagonal of a 1×1 square by a path of tiny horizontal and vertical steps, thus:

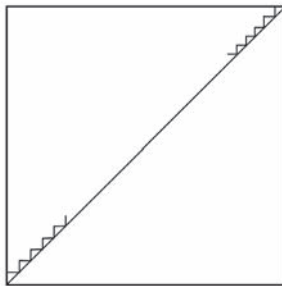

Figure 8.1 ‘Approximation’ of the diagonal by a path of many steps

Then the zig-zag path is in one sense a close approximation to the diagonal. It stays very close to the diagonal and is indistinguishable from it if seen from a distance. But its length is not a good approximation to the length of the diagonal. No matter how tiny the steps are made, the horizontal steps add up to 1 and the vertical steps add up to 1, so the length of the path is 2, whereas the length of the diagonal is $\sqrt{2}$.

Attempts to approximate the continuous with the discrete and vice versa need, then, mathematical care and adequate proofs. For example, Archimedes' project of calculating the circumference of a circle by successive approximations with circumscribed and inscribed polygons, as pictured, requires the support of a proof that the decreasing lengths of the circumscribed polygons converge to the same limit as the increasing lengths of the inscribed polygons. That limit can then be taken to be a reasonable definition of the length of the circumference.

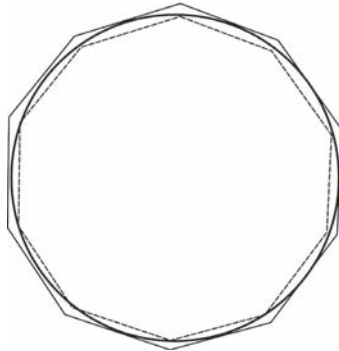

Figure 8.2 Approximating the circumference by inscribed and circumscribed polygons

Although the ability of the discrete and the continuous to imitate one another is a mathematical fact, it has some philosophical consequences when we consider arguments of a Quinean nature as to what mathematical entities are indispensable to the mathematics used in physical science. It is certainly easier to do geometry and mathematical analysis under the assumption of the continuity of space: for example, on that assumption one can always find the midpoint of two points, without having to worry whether there might be an atom of space missing where the midpoint should be. So naturally traditional geometry and analysis have helped themselves freely to assumptions of continuity. But the mathematical ability of the continuous and the discrete to imitate one another suggests that may simply be a convenience, and that we could,

if we wished, take the painful but honest route of a fully finite mathematics. We have indeed been forced to go far along that route to allow computers to work with finite-precision numbers, and in another direction, ‘constructivist’ analysts have had considerable success in imitating many of the traditional theorems of infinitist analysis.¹⁴

In most of mathematics, infinity is a luxury. Smooth functions, like smooth chocolate, are our preference, but we can cope with the gritty variety if need be.

Paradoxes of infinity?

Despite the simplicity of the concept of infinity, there have been doubts about its coherence. They arise from either the alleged paradoxicality or the alleged unknowability of the infinite.

There have been many allegations that the infinite involves paradoxes, but none of them has withstood scrutiny.

Zeno’s ‘paradox’ of Achilles and the tortoise has been discussed endlessly. So has that arising from the possibility of pairing an infinite set with a proper subset of itself, such as the integers paired with the even integers.¹⁵ Nothing strictly paradoxical, in the sense of inconsistent, ever appeared in either case. The two ‘paradoxes’ do show that infinity in some ways behaves differently from the finite, a conclusion that should give rise to curiosity rather than angst. They also show how necessary is an Aristotelian realism even to state questions about the infinite: the Achilles paradox requires a repeatable relation ‘being half’ to hold between the successive lengths that Achilles traverses, while the pairing of the integers and even numbers requires a repeatable ‘being twice’ to hold between an integer and its double. If we cannot rely on the reality of those relations, we cannot cash out the ‘and so on’ involved in the statements of the problem, and we will find ourselves mired in a Wittgensteinian scepticism as to how to continue the ‘rule’ of dividing space or of associating an integer with its double.

Some more genuine causes for concern about the infinite were thrown up by Cantor’s program and Russell’s paradox. They turned out to be either concerns but not paradoxes, or paradoxes but not about infinity.

There is certainly something strange in the relation between the cardinality of sets of points (on the real line) and the length of the sets. The upshot of Cantor’s diagonal proof was that the cardinality of the continuum, considered as a set of points, was strictly larger than \aleph_0 , the cardinality of the natural numbers. Any set of \aleph_0 points in the continuum has total length (as defined in measure theory) zero. The result that taking an infinity – the lowest infinity – of zero-length points

gives zero total length but that taking even more zero-length points can give a non-zero total length is certainly strange. Further, it is possible to take continuum-many points and still have total length zero (as for example in Cantor's middle-third 'dust' set). Those results are a strain on intuition, but not paradoxical. They simply show that length cannot be reduced to cardinality, and hence that measure theory is a subject distinct from set theory, a subject whose proper axioms and subsequent developments will themselves need to be examined for possible inconsistencies. A century of experience with measure theory has found none.

A second concern arises from the Continuum Hypothesis. It is unprovable from the usual axioms of set theory whether there is or is not a cardinality between that of the integers and that of the continuum. That is, it is not provable from those axioms whether there does or does not exist a subset of the continuum that can be paired off with neither the natural numbers nor the whole continuum. That has been taken to be some reason to believe that there is no fact of the matter as to whether such a set exists, a conclusion which would be problematic on a realist view of infinite sets. But this anti-realist interpretation of the result is not justified. The unprovability result is what it purports to be: a truth about what follows (or not) from certain simple axioms. There is no reason to believe that all the truths about a complex infinite structure, such as the continuum, should follow from simple axioms. We know from Gödel's Incompleteness Theorem that that is not the case for the natural numbers – the truths about them escape any simple axiomatization. Further experience with number theory has shown that there are many perfectly 'normal' statements of number theory (in contrast to Gödel's original artificial self-reference style example) that do not follow from the standard axioms.¹⁶ The Continuum Hypothesis is in the same position as such statements, relative to the standard axioms of set theory. Its failure to follow from those axioms is not in itself a reason to think the Hypothesis has no determinate truth value. As Gödel puts it, 'For in this reality [of the set-theoretic universe] Cantor's conjecture [the Continuum Hypothesis] must be either true or false, and its undecidability from the axioms as known today can only mean that these axioms do not contain a complete description of this reality.'¹⁷ It is true that that would leave it mysterious how we could know if it were true, but epistemological questions have no place in an argument as to whether there is anything paradoxical in the Hypothesis.

Russell's Paradox and others of its kind, such as the Burali-Forti Paradox, are genuine paradoxes. But they are not exactly paradoxes of *infinity*, even though it so happens that the sets mentioned in them (or rather, purportedly mentioned in them) are infinite (or would be if they

existed). The problem with the purported ‘set of all sets that are not members of themselves’ is not that it is infinite, but that it involves an unrestricted use of comprehension, that is, of allowing the formation of a set corresponding to any predicate. But on a realist view of sets and infinity, sets and infinity have no essential connection with predication or anything linguistic – the universe of sets, whatever its structure may be, exists prior to any human attempts to name it. A century of experience with axiomatizations of set theory has shown how to deal safely with infinite sets while restricting predication so as to avoid generating paradoxes. Therefore the paradoxes of predication provide no reason for considering infinity, even the higher orders of infinity, to involve paradox.

‘Potential’ infinity?

Beginning with Aristotle, there has been a tradition of trying to find a position between strict finitism and belief in actual infinities. If the finite is too restrictive and actual infinities too huge to accept, can a ‘potential infinity’ avoid these unattractive extremes?¹⁸

The search for a potential infinity that is in any sense between the finite and the actual infinite, it will be argued, is as doomed as the quest for a mean between the true and the false, such as ‘true for me’ or ‘true in our culture’. And for much the same reason – between mutually exclusive absolute alternatives, there is no room for something relative (relative to us, to construction, to the capacities of our minds, to history, etc.).

The motivations for talk of potential infinity are clear and are in themselves reasonable. It is just that ‘potential infinity’, conceived as a mean between the finite and the actual infinite, is not an answer to the genuine questions raised.

There are two phenomena that form the basis of talk about indefinite replicability, sometimes badged as potential infinity. The first is simply the repeatability of an Aristotelian universal, which is what makes it a *universal*. A universal such as ‘blue’ can be instantiated in multiple individuals, and unless there is something special about the universal, such as ‘even prime’, there is no barrier in the universal itself to its being instantiated indefinitely often. It is possible and perhaps natural to call that lack of limitation a ‘potentially infinite’ replicability. ‘Potential infinity’, in that sense, is a property of a count-universal, whereas finitude or actual infinity (as the case may be) is a property of the *extension* of the universal: ‘apple’ is indefinitely replicable, but it is the set of apples that is either finite or actually infinite. Thus there is no motivation from

this line of reasoning to consider 'potential infinity' as in any sense a mean between the finite and the actual infinite.

The same is true of the distinctions now drawn using the order of quantifiers. The statement,

There are points infinitely distant from us

can mean either

There is a point such that, for every natural number n , the point is more distant than n metres from us

or

For every natural number n , there is a point which is more distant than n metres from us.¹⁹

This distinction was used in the classical work of Cauchy and Riemann on the foundations of calculus to explain how talk of limits 'at infinity' could be cashed out without needing to give a function a value at an (actual) infinity. One could also express these results using an actual/potential infinity distinction, saying that the first of the above statements asserts the existence of a point at an actually infinite distance, while the second asserts only a potential infinity, in that while any point is at a finite distance, there is the potentiality to exceed any given finite distance.

Whether or not this is a helpful language, it does not suggest that there is such a thing as a potential infinity between the finite and the actual infinite. On the contrary, the example suggests that it is impossible to be committed to the potential infinite, in the sense of the possibility of indefinite size, without being committed to actual infinities. How could it be possible that

For every natural number n , there is a point which is more distant than n metres from us

is true, without there being both an actual infinity of natural numbers to quantify over, and an actual infinity of points to act as truth-makers of the possibility of distances indefinitely large? If there were not an actual infinity of points 'out there', would there not be a finite number of them, and hence one of them at a maximum finite distance? The problem is pointed up by Quine's criterion of ontological commitment, according to which one is committed to the existence of what one quantifies over.

In that case, ‘for every natural number $n...$ ’ already implies commitment to an actual infinity of natural numbers (and corresponding points). But one does not need to be a card-carrying Quinean to be nonplussed as to how the world could be such that the statement

For every natural number n , there is a point which is more distant than n metres from us

were true if there were less than an actual infinity of numbers and points.

One popular attempt to evade this kind of reasoning has been to connect potential infinities with intuitionist and constructivist views of numbers (and of whatever else is potentially infinite, such as space).²⁰ On that view, infinity, like every other mathematical concept such as numbers and sets, is a construction of the human mind in time. The human mind, being finite, can only actually construct finite numbers but ‘potentially’ can always construct more. Thus the ‘potential infinite’ is the only kind of infinity there is and it is a property of human mental constructions – but then so are all other numbers. For the constructivist, there is in a sense no more an ‘actual 4’ than there is an ‘actual infinity’: there is only the mind’s successively making 4 out of 1s.

It has been explained in previous chapters why we should take a realist view of mathematics rather than a constructivist one. For example, a realist philosophy of mathematics calls attention to how 4 is found in the relation of a heap of parrots to the universal being-a-parrot, a relation that exists prior to any human action of counting parrots. That realist philosophy should undermine any motivation to found mathematics on human constructions in time – the mathematics of infinity as much as any other part. But the topic of infinity is one where the defects of the constructivist approach are particularly evident.

Thus A.W. Moore describes a natural way to think of the ‘iterative’ conception of Cantor’s hierarchy of sets. Some such conception was forced on set theory by the discovery of the paradoxes, which were avoided by keeping to sets ‘built up’ from simpler, safer ones by such safe processes (sic) as taking unions and power sets. If one starts reading ‘processes’, ‘built up’ and ‘taking’ literally, then one will speak like a constructivist. As Moore writes:

Sets, we see, form a ‘V’-shaped hierarchy. At its base there is \emptyset , and every other set lies somewhere further up, constituting a collection of Sets taken from below it. The hierarchy has no top. Any attempt

to close it off would abnegate the very idea of the endlessness of Set construction. They would 'burst through'. This ties in with a deep temporal metaphor that underlies the iterative conception (witness its name, and witness also the fact that it is so natural to talk in terms of 'Set construction'). According to the metaphor the members of a Set must exist *before* the Set itself, ready to be collected together, and the different stages by which Sets are constructed are different stages in time, so that a temporal axis can be thought of as running up the middle of the hierarchy: to say that Set construction is endless is to say that it is never (at any stage in time) complete. The infinitude of the Set hierarchy is thus potential, never actual. It is spread over endless time...²¹

As a metaphor for ontological priority, set growth may be harmless, but if taken at all literally, it is incoherent. It would imply there must have been a date when the empty set existed but the set whose only member is the empty set did not. What date was that? Somewhere about 1325, perhaps, when the scholastics first mastered the technique of bloating ontologies? Or did Cantor himself create the bottom layers of the hierarchy? If so, how many, and on his death were they still there or do we need to construct them again? All these questions would have answers, if sets were constructed in time, as the constructivist holds they are (unless of course sets could spawn each other infinitely fast, but then the point of the metaphor would be lost, as we might as well construct the whole hierarchy at once). Plainly, however, these questions do not have answers. They are artefacts of a fundamentalist attitude to construction. But that is an inevitable result of trying to give a coherent meaning to 'potential infinity'.

There is a medieval scholastic argument that dramatizes the case for the impossibility of being committed to some sort of potential infinity, considered as involving construction in time, without also being committed to actual infinity. (Like the question 'How many angels can dance on the head of a pin?' it seems to be attributed to the scholastics in general without being attributable to any one of them in particular.²²) The argument is:

Suppose the concept of potential infinity is coherent. Then it is possible that the world has existed for a potential infinity of past days. Suppose that on each of those days, an angel laid down a grain of sand. How many grains of sand are there now? There must be an actual infinity. Therefore, potential infinity implies actual infinity.

This line of reasoning shows what is wrong with attempting to bring time and the human mind into discussions of infinity. Being spread out in time is not essentially different from being spread out in space or any other way, as the spreading out can be mapped from one to the other as the imagined angel does.

Knowing the infinite

To refute arguments against the intelligibility of infinity is not to show how it could actually be known, given our limitation to the finite. It is evident that the idea of an infinite structure cannot be derived purely from perceptual experience – or, even if the infinite is merely the logical negation of the finite and hence comprehensible in some sense, it seems impossible to learn about actual or possible infinite structures by finite means. Our perceptual experience is finite in character. Surely no finite amount of repetition of a single perceptual act will construct an infinite object for us, or give us access to any actual infinity?

That is a good question. It will be taken up again in Chapter 12 on knowledge of higher mathematical structures.

9

Geometry: Mathematics or Empirical Science?

Geometry was always an essential part of mathematics. In the classical conception, arithmetic and geometry were the main divisions of mathematics, and both were equally taken to be bodies of necessary truths about reality. It was thought that space – the real space we live in – is evidently and necessarily exactly as described by Euclid’s axioms.

The discovery of non-Euclidean geometries changed all that. The standard alternatives to Euclidean geometry, hyperbolic and elliptic geometry, are as mathematically sound as Euclidean geometry, so it cannot be a mathematically necessary fact that space is Euclidean. On reflection, there are several other features of the geometry of actual space that appear to be contingent. Hume was right in maintaining that at the small scale, there is no impossibility in space being atomic.¹ And it is hard to believe that it is necessary that the space we live in has the dimension it has, namely three.²

The natural conclusion to draw is that geometry is an empirical science, a part of physics. To discover the properties of the space we live in – its dimension, curvature at various points, whether on the small scale it is continuous or discrete, the relation of space to space-time and gravity, and so on – it is necessary to observe and measure. Indeed, there are projects in physics to do exactly that; I will survey later what they have found.

Another conclusion widely drawn from the existence of alternative geometries is in favour of ‘if-thenism’ in the philosophy of mathematics: if applied geometry is about physical space, then ‘pure geometry’, and by extension other parts of pure mathematics, must be merely about drawing conclusions from uninterpreted systems of axioms. As Hempel puts it:

What the rigorous proof of a theorem – say the proposition about the sum of the angles in a triangle – establishes is not the truth of

the proposition in question but rather a conditional insight to the effect that that proposition is certainly true *provided that* the postulates are true; in other words, the proof of a mathematical proposition establishes the fact that the latter is logically implied by the postulates of the theory in question... The fact that these different types of geometry have been developed in modern mathematics shows clearly that mathematics cannot be said to assert the truth of any particular set of geometrical postulates; all that pure mathematics is interested in, and all that it can establish, is the deductive consequences of given sets of postulates and thus the necessary truth of the ensuing theorems relatively to the postulates under consideration.³

A third natural conclusion is that geometry is very different from arithmetic. There seem to be no alternative arithmetics in the same sense as there are alternative geometries. There are indeed many algebraic systems with some similarities to the numbers, such as the quaternions, but they are not regarded as *alternatives*, for example, as possible other ways to count, in the way that hyperbolic space is a genuine alternative to the Euclidean way of being spatial.

There are, however, reasons to think that those conclusions have overstated the matter. Geometry has continued to be part of mathematics. Far from the discovery of non-Euclidean geometries convincing mathematicians to quit the area and leave it to physicists and surveyors, it encouraged them to expand the field to include those geometries, as well as higher-dimensional geometries, Riemannian geometries, discrete geometries, finite geometries and other later discoveries. Mathematicians argued, or rather took it for granted, that while it might be the business of physicists to determine which of the possible geometries the universe actually had, the study of all geometries as such remained their province. Nor did they play with arbitrary axioms. Instead they looked for generalizations and modifications that gave insight into the structure of existing geometries.

Thus, an important part of modern mathematics, both pure and applied, is still called geometry. Students who will become engineers, data analysts and so on are subjected to intensive study of 'vector geometry' in \mathbf{R}^2 and \mathbf{R}^3 , and the results taken to be applicable not only to real space (to a very good approximation) but to 'vector spaces' of forces, velocities and so on. Prima facie, \mathbf{R}^2 and \mathbf{R}^3 are the same kind of abstract entity as \mathbf{R} , the continuum, is (whatever account may be given of that). So it appears that some mathematical entity naturally called 'geometric

structure' can be instantiated in something other than real space. Some account of that is needed.

That leaves it mysterious as to what the 'geometries' studied by mathematics are. Are they certain mathematical structures that are 'space-like', and if so, what does that mean and which mathematical structures can be so counted?

An Aristotelian philosophy of mathematics which allows for uninstantiated universals provides a natural framework for addressing these questions. It allows real space to instantiate a mathematical structure, but distinguishes that structure from space. It allows that structure to be compared with similar ones, which may not be instantiated. It thus allows a literal interpretation of the natural way to speak about the shape of space: that there are many possible mathematical geometries for space, exactly one of which is actually has (or instantiates). It also allows that structure to be instantiated in non-spatial items.

To address these questions, we consider first pure mathematical geometries, asking what features a mathematical structure should have to count as a geometry. Then we examine some non-spatial 'spaces' in reality that do have such a structure, such as time and the space of colours; doing so will clarify the distinction between the geometrical (a certain kind of mathematical structure) and the spatial (pertaining to the real space we live in).

What is geometry? Plan A: multidimensional quantities

Two approaches are possible to identifying the mathematical structures that should count as geometries. The first starts with the one-dimensional structure of quantities, studied in Chapter 4, and generalizes to higher dimensions. The second gradually generalizes from the paradigm example of the Euclidean structure of our space, asking what the possible shapes of space might be. Both are legitimate projects. The results of the two processes do not exactly coincide.

The first idea on what mathematical structures should count as 'geometries' arises from generalizing the 'quantities' of Chapter 3 to higher dimensions. The result is a theory of higher-dimensional quantitative structures, independent of any facts or intuitions about space. This was the approach of Riemann and of Bertrand Russell. Riemann writes:

I have...set myself the task of constructing the notion of a multiply extended magnitude out of general notions of magnitude. It will

follow from this that...space is only a particular case of a triply extended magnitude...the properties which distinguish space from other conceivable triply extended magnitudes are only to be deduced from experience.⁴

According to Russell, 'Geometry is the study of series of two or more dimensions',⁵ where a (one-dimensional) series means any totally ordered set.

The essential difference between a quantity and space is clear in one dimension. As we saw in Chapter 3, it is in the nature of ratios that they extend without limit. Twice a length is a length, even if twice the length is not realized as the length of any object. Indeed, space may not fit twice the length (if space is finite in extent). If one extends a line in space indefinitely, one may come back to one's starting point. But one cannot keep doubling length (or volume, or force) and eventually reach zero. Length is only 'aptitudinally situat' (in Suárez's suggestive phrase)⁶ – a length of one metre is suited to fit into pieces of space, but only if the space under discussion permits it (for example, by the whole space being at least one metre in diameter).

The argument for accepting that all of \mathbf{R} should be included in the mathematical structure, 'the geometric continuum', or system of all ratios, is simply a realist interpretation of the usual method of constructing the continuum:

1. Ratios of quantities (as discussed in Chapter 3) may be of various sizes.
2. Ratios may be indefinitely precise.
3. There is a ratio for every positive rational number, since there is a ratio of m copies of a quantity to n copies, for any natural numbers m and n .
4. Ratios do not respect the division between rational and irrational: the ratio of the diagonal to side of a square is on an equal footing to the exact ratio 2.
5. Hence, by the symmetry invoked in (4.), there are no gaps in the system of ratios: any way of dividing ratios into a greater and a lesser half has a ratio in the middle
6. Therefore, there is a ratio for any (positive) real number.
7. This applies for the particular quantity of length.
8. The system of all lengths (positive and negative) is the continuum.⁷

Thus the standard real number continuum \mathbf{R} is a correct mathematical model of the 'space' of lengths – the space of all possible lengths in all

possible spaces. It has a natural zero, infinite extent and infinite divisibility. That has no connection with modelling any particular physical space. If real space were Euclidean, a line in it would in fact have the same structure (after introduction of an arbitrary zero); but that would be a matter of contingent fact.

‘Geometry’, in Riemann and Russell’s conception, involves quantity extending not just in one dimension, but in many. For this to be coherent, ‘dimension’ must be explained in purely structural or topic-neutral (rather than spatial) terms. That can be done in various abstract ways,⁸ but the philosophical intuition is clearer in Russell’s treatment.⁹ Begin with a totally ordered set (such as \mathbf{R} , or the natural numbers). Suppose that at each member of the set, there is another ordered set of which it is a member; most naturally, each of those sets being a copy of the original ordered set. That is sufficient to have a set ordered in two dimensions:

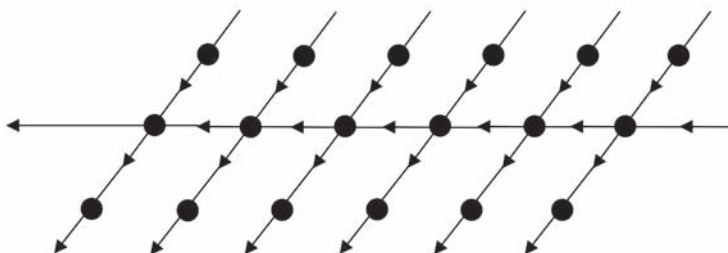

Figure 9.1 Ordered set in two dimensions

Normally, one also has comparability between members of the different ‘vertical’ sets, and hence one can arrive at the standard construction of the cross product of two ordered sets, such as $\mathbf{R} \times \mathbf{R}$:

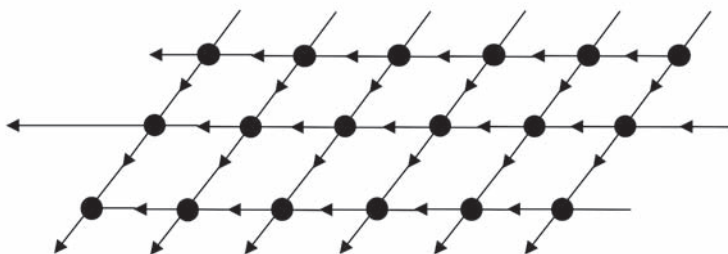

Figure 9.2 Cross product of totally ordered set with itself, with natural two-dimensional ordering

The generalization to more than two dimensions is obvious. Doubts about whether *space* could have more than three dimensions are not relevant to the generalization of ordered quantity to higher dimensions.

\mathbf{R}^2 and \mathbf{R}^3 are thus paradigmatic mathematical geometries. They are ‘Euclidean geometry’ itself, freed of any empirical claims about real space (or indeed, of any reference to real space at all). They are pure mathematical structures, in the sense of Chapter 4, as shown by their constructability in the topic-neutral material of set theory (as the set of pairs or triples, respectively, of real numbers).

Note that there is no question of these spaces being non-Euclidean. Just as we know the whole numbers do not run out, we know that ratios do not run out, and that the two-dimensional ordering of \mathbf{R}^2 extends indefinitely in both dimensions. Whether anything in physical space instantiates those structures is an empirical matter, but that just emphasizes the distinction between such structures and anything to do with space.

What is geometry? Plan B: the shapes of possible spaces

The second, very different, idea on what mathematical structures should count as geometry begins with the apparent Euclidean shape of actual space and generalizes. To count as a geometry, a mathematical structure should share sufficiently many of the important features of Euclidean geometry, whatever those may be.

One may want to generalise from Euclidean geometry for two distinct purposes, and again the results do not coincide:

Plan B1: Given that space might not be Euclidean, what are the possible shapes of space (or shapes of possible spaces)?

Plan B2: What are the distinct properties of Euclidean space that are rightly called ‘geometrical’ (and which other mathematical structures might share them in part)?

These are related projects in that they must both ‘take apart’ the conceptual structure of Euclidean geometry and extend it using some kind of intuition about possible changes. But they are about different things. The first plan concerns the philosophy of space, the real entity in the world, and asks about space in other possible worlds; it is about metaphysical possibility, perhaps informed by physics. The second is more internal to mathematics, and asks for a reasoned account of what properties mathematicians regard as geometrical and why.

As Belot puts the first question:

Which mathematical structures should we think of as representing the spatial structure of metaphysically possible worlds? For short: what are the possible structures of space? ... I take it to be obvious that Euclidean three-space corresponds to a possible structure of space. And I think it reasonable to assume the class of mathematical structures that represent possible spatial geometries correspond to some suitable natural generalization of Euclidean geometry.¹⁰

The reason we have some purchase on the answers to this question is that we seem to be well aware that space (our space or other possible spaces) could differ in at least small ways from Euclideaness. The logical consistency of, for example, hyperbolic geometry and the near-indistinguishability on the small scale of a large hyperbolic space from Euclidean space is some reason to believe that our own space could be slightly hyperbolic; and there are no countervailing reasons. Since we know very little about our space on the tiny scale, there is the epistemic possibility that it is discrete at that scale; and again there are at present no strong countervailing reasons. So the logical consistency, mathematical describability and epistemic possibility of discrete space combine to suggest its metaphysical possibility.¹¹ The success of Riemannian geometry as the foundational structure of General Relativity positively suggests that it is possible for space to have Riemannian geometry – roughly, a shape locally Euclidean but possibly differing in curvature at different points, and with distance determined by the length of paths through the space.¹² It is true that as we move further away from Euclideaness, we have less sense of what is possible as a shape of space. Belot suggests that all metric spaces (spaces with a coherent notion of distance between points) might count as possible shapes of space, but admits that our intuition cannot convincingly pronounce on the possibility of some of the stranger metric spaces, such as infinite-dimensional Hilbert spaces or a space consisting of just two points one metre apart.

Plan B2 asks what properties are counted by mathematicians as geometrical. A philosophy of geometry ought to take seriously the pronouncements of practitioners of geometry and give an account of them – especially when those pronouncements include, as they do, claims to have discovered deep and general properties not obvious from the standard study of Euclidean geometry. But there is another philosophical reason for interest in the plan: as we will see later, these deeper properties play a special role in arguments for realism about space.

It is not to be expected that there should be an exact degree of family resemblance that will definitively determine where the limit of ‘geometries’ lies. Perhaps at some point the chain of resemblances back to Euclidean space become too long to sustain a reasonable judgement that a structure is geometric. But it should be possible to say what features count as especially important.

The main reason for thinking that distance is not the whole story as to what is essential to geometry lies in the discovery of certain properties that are clearly geometrical but do not involve distance and are in an obvious sense prior to it. One kind stem from the ancient theorem of Pappus:

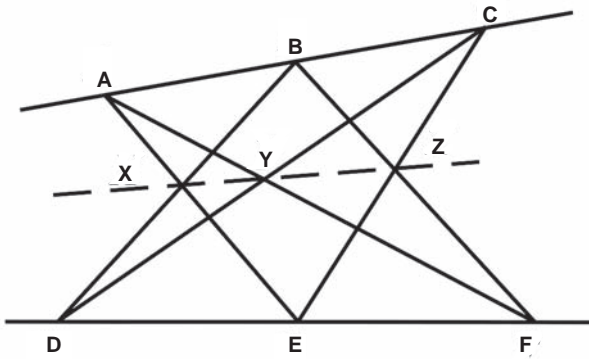

Figure 9.3 Pappus's Theorem

Source: <http://mathworld.wolfram.com/PappusHexagonTheorem.html>, reprinted in accordance with Wolfram Mathworld guidelines.

The theorem states that if we take three points on each of two lines (as shown, A, B, C on one line and D, E, F on another) then the three points of intersection $X = AE \cap BD$, $Y = AF \cap CD$ and $Z = BF \cap CE$ are collinear.¹³ The theorem does not mention distances or angles; it refers only to the ‘incidence structure’ of lines and points – to the incidence of points with lines. Since the incidence structure of points and lines is presupposed by the full panoply of Euclid’s theorems involving points, lines, angles and distances, Pappus’ Theorem and other theorems of ‘projective geometry’ such as Desargues’ Theorem describe a kind of conceptual skeleton of geometry, a structure that is part of and underlies the full structure of Euclidean geometry. Projective properties are clearly geometrical.

Having identified that, one may go in two directions. One may add to projective geometry concepts that are also clearly geometrical, but still

do not involve distance, or, of more philosophical interest, one may try to subtract still more. In the first direction, brief mentions will suffice: of Pasch's 'ordered geometry' which studies betweenness on lines, and affine geometries, studying straightness and parallelism. Both may be axiomatized and theorems developed of those geometrical properties, without any mention being made of distances.¹⁴

In the opposite direction, if projective geometry deals in clearly geometrical properties, though not involving distances, then one may well ask if one can go further in excavating even more basic geometrical properties. That is indeed possible, though at some point what is reasonably called geometrical tails off into combinatorics.

Euler, as we saw in Chapter 4, believed that he had discovered a new form of geometry in his study of the bridges of Königsberg, a pure 'geometry of position' or as we would now say, network topology. But since essentially the same theorem, and Euler's reasoning involving counting arguments on the bridges and land areas, can be found in pure graph theory, which is normally regarded as combinatorics, there is some intuitive case for regarding the material as pre-geometrical. However, topology has in general been seen as part of geometry: the way in which (the surfaces of) a cube and a sphere are topologically identical but different from a torus is a matter of shape, hence geometrical.¹⁵

The furthest reach of what is traditionally called 'geometry' is probably reached by the combinatorial entity called the seven-point plane or Fano Plane. It has seven points, and seven 'lines', each pair of lines intersecting in one point and each pair of points lying on one line:

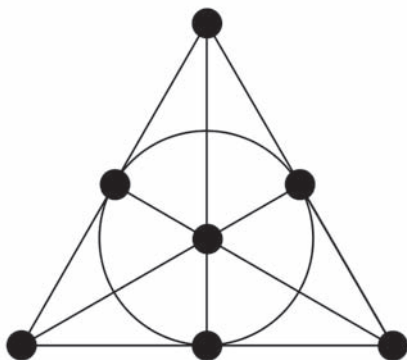

Figure 9.4 The seven-point plane

Source: http://en.wikipedia.org/wiki/File:Fano_plane.svg.

Its claim to a geometrical nature is possibly only due to a series of historical steps involving successive variations to Euclidean space.¹⁶

The difference of this plan, B2, from B1 is shown by asking whether there might be a possible space with only projective, affine or topological properties. That seems unlikely, as the properties would seem to need some medium to support them – some substrate or set of points which have the topological or other properties, but have other properties as well (such as distance). Thus questions about the possible shape of space are very different in kind to those about what properties are geometrical.

The grit-or-gunk controversy: does space consist of points?

In the previous sections, we have neither relied on nor challenged the standard identification of Euclidean geometry (considered as a possible shape of our space) with \mathbf{R}^2 and \mathbf{R}^3 . That identification means that two-dimensional Euclidean space is taken to be the set of its points, which in turn correspond one-to-one with pairs of real numbers. Real numbers themselves are specifiable in various possible ways, but in any case with continuum-many of them, one for each possible way of cutting the rational numbers into a left-hand half and a right-hand half.

It is, however, arguable that when it comes to *space*, that is an excessive amount of mathematical machinery. Perhaps the mathematical structure of space is considerably simpler. A number of reasons have been advanced for regarding space as not really consisting of the vast number of points in the continuum, and the even vaster number of subsets of points. There are also several possibilities as to what the simpler structure of space might be, including ‘grit’ (discrete space, itself with various possibilities), ‘gunk’ (regions without points) and imprecision at the small scale. In view of our lack of intimate knowledge of space at the very small scale, it is not to be expected that any of these arguments will be absolutely convincing. Nevertheless, considering them will give a sense of the possibilities in the philosophy of space.

Some of these reasons are applicable in one dimension, dealing with the question of whether \mathbf{R} is a correct model of a spatial line, while some involve higher dimensions.

First, if it is accepted that space could be as Euclid describes it – infinite in extent in all directions, infinitely divisible, and flat – it still needs a positive argument that space consists of continuum-many points. Euclid did not know about or use such a vast array of points. He merely allowed himself a point on a line wherever a construction demanded

it, for example when a circle intersected a line. That creates a presumption that he had something simpler in mind. Indeed, he would have had something simpler in mind if he followed Aristotle's view that 'it is impossible for something that is continuous to be constituted from indivisibles, e.g. a line from points'.¹⁷ Nothing in Euclid contradicts Aristotle's view, and the language of his Definitions 6 ('The edges of a surface are lines') and 13 ('A boundary is that which is the extremity of anything') suggest the Aristotelian perspective of lower-dimensional entities being created from higher-dimensional ones, rather than the modern view of the higher-dimensional ones being sets of the lower-dimensional.

However, that is no more than a presumption, since it may be argued that to be able to construct a point wherever one likes, the points must be all waiting there, in order for there to be no possibility of a gap at the point chosen. And for that to happen, it is argued, there must be points corresponding to all of \mathbf{R} , since \mathbf{R} is the unique complete (i.e. gap-free) ordered field containing the integers. If the points are not all there, there must be a gap, which will show up when one attempts to divide space exactly there. (The argument here parallels the argument of the previous chapter against Aristotle's notion of 'potential infinity': indeed, it is the same argument, applied to the infinitesimal instead of the infinitely large.)

Furthermore, if one demands to be shown an alternative to \mathbf{R}^2 and \mathbf{R}^3 as mathematical structures that 'are' two-dimensional Euclidean geometry, it is hard to exhibit one that is genuinely different. Standard stand-alone formalizations are those of Hilbert's *Grundlagen der Geometrie* (1899) and Tarski's axioms, which aimed to provide an axiomatization of Euclidean geometry that was free of the defects of Euclid's presentation (which, as is well known, sometimes involved unjustified assumptions that lines and circles intersected).¹⁸ They all contain some axiom of completeness, which in effect replicates the completeness of the real line.

A more serious argument against the use of \mathbf{R}^2 and \mathbf{R}^3 as a model for the possible Euclidean shape of space is that it is not merely unnecessary complex but productive of paradoxes, notably the Banach–Tarski Paradox.

The Banach–Tarski Theorem states that a solid ball in three-dimensional space, if regarded as a set of points in \mathbf{R}^3 , can be decomposed into several subsets which can then be reassembled (by rigid motions) into two spheres of the same size as the original. For definiteness: there are sets E_1, E_2, E_3, E_4 and E_5 , whose union is a solid ball, and such that E_1, E_2 and E_3 may be moved rigidly and reassembled into a ball the same size

as the original, and E_4 and E_5 may be moved and reassembled as a third ball, also the same size as the original.

That result has been found paradoxical. If one thinks of subsets of \mathbf{R}^3 as being regions of space, it is indeed very strange to find regions being cut up into parts and reassembled to form larger regions. As one introductory account puts it, with a philosophical spin, ‘This seems to be patently false if we submit to the foolish practice of confusing the “ideal” objects of geometry with the “real” objects of the world around us.’¹⁹

But there is another resolution of the paradox. One may deny that all subsets of \mathbf{R}^3 are rightly called ‘regions’. Forrest asserts: ‘A fundamental characteristic of a region, I say, is its quantity, which I call its volume.’²⁰ In that case, one is demanding that attention be restricted to those parts of space that can be assigned a volume (quantity, size or measure). But not all sets of \mathbf{R}^3 are measurable. Sets of points may be too finely scattered in space to be assigned volume; that is the case with the sets E_1, \dots, E_5 above. Therefore, they do not form ‘regions’, just sets of points. But if the intuition behind the idea of regions is that they should be ‘full’ parts of space, it is not surprising that a region should have parts that are sets of points so intermingled that the parts cannot individually be assigned a volume.

So one could maintain two theses. First, space, if Euclidean, could consist of its points – \mathbf{R}^3 is a perfect model of Euclidean space. Second, although every set of points is a part of space, only some sets of points form regions – intuitively, those that form regions are the ones that are full of points, without any points left out as infinitesimal ‘holes’.²¹ In summary: modelling position and distance is a different problem from modelling regions. \mathbf{R}^3 is a correct model for position in space and length; subsets of \mathbf{R}^3 in general are not right for regions, but subsets of a suitable restricted kind do form a correct model for regions.

That is still not to maintain necessarily that space does consist of points. One can hold that space admits infinite precision but its parts are all regions. Space is ‘gunky’ rather than ‘gritty’. As Arntzenius explains it:

The alternative is that space and time and matter are ‘pointless’ or ‘gunky’. The idea here is not that space and time and matter have smallest finite-sized bits, that space and time and matter are ‘chunky’. Rather, the idea is that every part of space and time and matter has a non-zero, finite, size and yet every such part can be subdivided into further, smaller, parts... a spatial or temporal decomposition of a region cannot bottom out at an ultimate level.²²

A difficulty with this proposal, from the philosophical point of view, is that points may be constructed out of regions, so that it is arguable

that one has not gained anything in simplicity. Although points may not exist in ‘gunky’ space, nests of balls getting infinitely smaller do exist: although a point x does not exist, all the balls of radius ϵ about x (strictly, about where x would be) do exist (no matter how small ϵ is), and it is hard to prevent their intersection being taken – or even if that is not allowed, the infinite precision involved, as ϵ approaches zero, appears to import all that is needed for points, which are precise.²³ There seems no complexity of a space of points that is not mirrored in the set of regions.

Whatever the correct view of that, again the distinction between philosophy of geometry and philosophy of space is useful. It is a genuine question about space as to whether it has points. If it does, \mathbf{R}^3 can be a good model of space, in that certain parts of \mathbf{R}^3 exactly correspond to regions of space (without it being maintained that other features of \mathbf{R}^3 , such as points and non-measurable sets of them, correspond to anything in space).

In the light of the difficulties of infinite precision (with points or without), one could maintain that infinite precision is not essential for modelling most of the structure of Euclidean space. If it is possible that space, though not discrete, does not admit of infinite precision in position, it would be a fuzzy metric space.²⁴ That is, distances are fuzzy quantities: they just are not precise beyond a certain degree. Such quantities are intuitively very familiar, since real measurements are of this nature. If one does surveying with measurements to 8 decimal places, one is intuitively operating with a fuzzy metric. Nevertheless the option has not been taken very seriously in the philosophical literature.

Real non-spatial ‘spaces’ with geometric structure

We now look at some real spaces and ‘spaces’ which have geometric structure. The point of this exercise is to understand in examples what geometrical structure is like, free of the tunnel vision arising from life in only one space.

The best known non-spatial ‘space’ is time. ‘Time is divided or undivided in the same manner as the line’, in Aristotle’s brief hint.²⁵ As in the graphs pictured in Chapter 4, time is regularly represented as a line, because of the commonality of one-dimensional structure (meaning of course local structure, since one does not know if time has a beginning and an end).²⁶ However, in view of the immense and well-known difficulties in the philosophy of time, I will not develop this case further. For the same reason, I will not discuss space-time, although its geometric structure is at the centre of its study.²⁷

The space of colours

The space of colours is interesting because it has a structure recognizably geometrical and multidimensional, while being very obviously non-spatial.²⁸ Thus we are very familiar with an example of geometry that is ontologically dissimilar to space. Comparing it with space will thus free our geometric intuitions and philosophical reasonings from over-dependence on the particular case of space.

What is meant here is the space of *perceived* colours, not the physical properties of surfaces that cause them. One may indeed attempt to compare and possibly identify the two, but initially, the object of interest is the variation in perceived colour. Thus human colour space may be different from that of dogs, and the space of a red–green colour-blind person may be simpler than that of someone with full colour vision.

Both introspection and controlled psychological experiments reveal that colour perception is structured in a way that is similar to space. Between red and yellow, there is perceived to be a linear range of colours from pure red through orange to pure yellow. The range appears to be continuous, in the sense of having no gaps. The same is true between any two colours. The range of all perceived colours can be arranged (in several different ways) in a ‘colour solid’, often depicted as spherical. Hues (the different pure ‘rainbow’ colours) are arranged in a circle; the radial dimension represents saturation or ‘colourfulness’, with more muted colours inside and grey in the centre, and the vertical dimension is light and dark, with white at the north pole and black at the south pole.

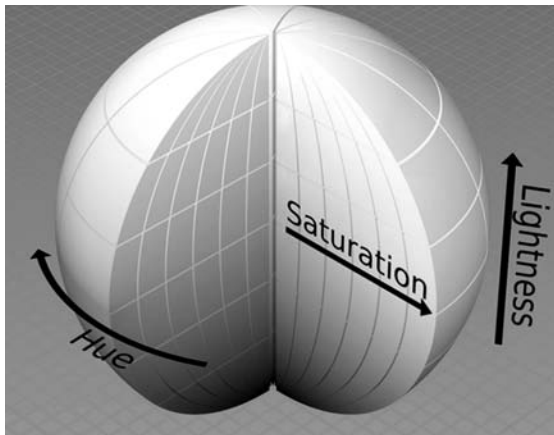

Figure 9.5 The Munsell version of the colour sphere

Source: In colour at http://en.wikipedia.org/wiki/File:HSL_color_solid_sphere_munsell.png.

To represent colour space thus does not imply that it shares every property of a sphere in Euclidean space; for example, it is not claimed that exact distances or the exact spherical shape are meaningful. But the representation is useful because colours really do literally have certain geometrical properties, in particular betweenness and dimensionality. The straight line joining two points in the sphere consists of the spectrum of colours between them; white and black are extreme and opposite points; the colours close to a particular colour really do vary in three dimensions.

The space of colours raises a number of difficult issues, including its relation to the space of reflectances of surfaces²⁹ and to variations in neurophysiological response; the explanation of the phenomenon of some colours appearing unmixed or 'primary' (red, blue, yellow and green) and the others appearing to be mixtures of them;³⁰ and the sensitivity of colour perception to the context (such as surrounding colours and shadows);³¹ and more generally, the issue of whether colours should be said to be 'in the mind' or 'in the things'.³² Those issues do not affect the significance of the colour space as an example of a geometrical structure that is not spatial.

Note that there is no grit-or-gunk controversy over the space of colours. As we are dealing with the space of *perceived* colours, and perception is not infinitely precise (indeed, the limits of perception are measurable), it does not consist of continuum-many points or indefinitely precise regions. It does not appear to consist of points at all (though experimental evidence could bear on that). *Prima facie*, it is a fuzzy space.

Spaces of vectors

Certain quantities, like forces at a point or velocities at a point in space and time, are vectors.³³ They have both magnitude and direction, and vectors of the same kind can be added. Thus a force of 5 newtons east and one of 5 newtons north, both acting at the same point, can be added to yield a force of $5\sqrt{2}$ north-east.³⁴

Magnitude varies in one dimension, in the same way as the quantities like length considered in Chapter 3. As with length, there is no prospect of strange global topology, as if some sufficiently large multiple of a force could turn out to be zero. The space of possible forces, like the space of possible lengths, is infinite, even if the actual universe is too small to fit enormous lengths or forces.

The directions of vectors, however, are more spatial, as the directions that are possible for a force or velocity at a point are constrained by the space that the point is in – the directions available in the space at that

point. (Thus vectors are not quite the same thing as the abstract variation of quantities in more than one dimension considered by Riemann and Russell, as described above; they have a genuinely *spatial* aspect.) The ‘space’ of directions at a point (or of infinitesimal paths from the point) and the tangent space at the point (the space of directions-by-magnitudes), are simpler geometrical entities than the whole space itself, since they are purely local and hence unaffected by the global topology of the space and by curvature. Thus, for two-dimensional spaces, the vast array of spaces called ‘manifolds’, including all spaces locally Euclidean (surfaces of spheres, saddles, hyperbolic geometries, and so on), have the same tangent space, namely \mathbf{R}^2 .³⁵ So the tangent space is Euclidean even for curved spaces, and hence the spaces of vectors such as forces and velocities are also necessarily Euclidean. The same applies in three dimensions: even in a curved space, the tangent space is Euclidean space \mathbf{R}^3 . Thus Euclidean geometry remains the geometry of a large class of quantities, irrespective of whether physical space turns out to be Euclidean or not.

The need to see vector spaces (of tangents, forces, etc.) as local entities is confirmed by the impossibility of identifying individual vectors (or directions) across tangent spaces at distant points in the same space. For example on the sphere, a tangent space at the equator cannot be naturally identified direction by direction with the tangent space at the north pole; if one takes a tangent vector at the equator and moves it by ‘parallel transport’ across the sphere to produce a tangent vector at the north poles, different paths of transport give different answers.³⁶

To find tangent spaces that are not strictly Euclidean, it is necessary to start with an underlying space that is locally more unlike a Euclidean space than is a manifold. For example, a discrete space has fewer directions at a point that does a continuous space. If the directions at a point are taken to be the directions to ‘nearby’ points, with the nearby points being identified as those within a certain distance, then there are only finitely many points within that distance, hence only finitely many directions at a point. Other definitions of direction could be considered (for example, the direction to all points in the space), but the result is still not exactly Euclidean.³⁷

The real space we live in

Now let us return to actual space.

First, it needs to be established if space does have real geometric properties, or a ‘shape’. Of the various geometries, does the actual space we live

in have a determinate one, which can be discovered by observation and measurement (at least for regions within the range of observation)?

We accept the arguments of Nerlich's *The Shape of Space* for realism about the geometry of space. Nerlich writes that 'space is a real live thing in our ontology. It is a concrete thing with shape and structure which plays, elegantly and powerfully, an indispensable and fruitful role in our understanding of the world.'³⁸ Or in the magisterial language of Newton, 'Absolute space, in its own nature, without regard to any thing external, remains always similar and immovable'.³⁹ Realism or 'substantialism' contrasts with both relationalism (holding that distance relations are primitive, without needing an underlying space to support them) and conventionalism (holding that distance relations could be changed by adopting different conventions of measurement).

One fundamental reason for believing in the reality of space is the 'mediation' of the distance relation: if two points are at a distance from one another, it seems that there is a path between them, that is, a part of space stretching from one to the other (which may or may not be occupied by matter).⁴⁰ This 'seeming' is grounded in the possibility of actually finding points midway between the two, or close to one end, and of constructing a material path (such as a ladder) from one point to the other, of length known beforehand. The finding and constructing involves placing matter in the intervening space, but it appears that the space is there waiting for the matter and able to accept only so much of it.

It might be asked how this argument relates to the case of close points in a discrete space, where there is no mediating space between the two points. (And our own space may be discrete, for all we know.) How is it that there is no intervening path in that case? If the original argument requires being able to find a midpoint between any two points, and this is not possible for adjacent atoms in a discrete space, is this not a counter-example?

The case clarifies the nature of the original argument. It was not claimed that there *must* be a path between any two points in any space. The question is one about the space we live in, not about other possible spaces. In *our* space, at the human scale, there is a continuous, straight path (that is, a path continuous and straight, down to the limits of measurement) joining any two points. The argument for the reality of *our* space does not depend on any claims about all possible geometries.

The second principal argument for realism about space advanced by Nerlich relies on a strategy of dealing with the more basic, deep or general properties of space (such as topology) first, and the more detailed

ones (such as exact distance) last. The deeper the property, the harder it is to argue that it is conventional. Take the example, advanced by the early Kant, of enantiomorphs in three-dimensional space such as left and right hands. If I take my right hand out of a piece of space and try to fit my left hand into the same piece of space, it is impossible. No rigid motion of hands can accomplish that. It is because space⁴¹ has the topological property of being orientable (unlike, for example, a Möbius strip in 2D). Thus orientability determines what can be done in space and is therefore a real property of space.⁴²

Nerlich argues that other geometric properties such as differentiable structure (the smoothness of curves and surfaces, for example) can be added and argued to be real. Curvature, for example, has causal effects: if space is curved in one way, free bodies without forces will move closer together; if space is curved another way, they will move apart.⁴³ If we accept the Eleatic Principle that ‘causality is the mark of being’, then the curvature of space is a reality; hence the space of which it is a property is equally real. Attempts to show that measurement of distance are conventional are also argued against,⁴⁴ but we will not survey the arguments here. (Of course, the choice of unit to measure distance is conventional; what is not conventional is the system of ratios between measured distances.)

Relationist alternatives to substantivalism are divided by Belot into two kinds, conservative and modal. Conservative relationists hold that space is constituted by the distance relations of *actual* material objects, while modal relationists hold that space is constituted by merely possible distance relations – between possible objects or between actual ones if they were moved.

Conservative relationists (who included Aristotle and Descartes) have a difficult task because there are (or may be) too few objects and actual distances to constitute all the spatial relations there would be if they were embedded in space. Belot considers the case where all that exists materially is an expanding sphere, whose radius grows without limit.⁴⁵ At a given time, there are no distances larger than the diameter of the universe at that time. Does the conservative relationist really mean that the geometry is time-dependent? That would be a possible position, but, says Belot, an unmotivated one. ‘It seems more natural to think that when matter is sparse, the structure of space may be revealed only in the course of time via the motions of matter.’

The conservative relationist can reply by taking a more radical option, as indeed Aristotle did. According to that option, spatial relations are actually caused by relations of matter, such as the touching of surfaces. On that option, a time-dependent space would be motivated, and

indeed would not be surprising, since space should expand with the material objects causing it.⁴⁶ Belot's view that space is there waiting for the motions of objects to reveal its structure involves thinking of space as a pre-existing container in which objects swim about (which already tends towards a substantialist view). That is exactly what is denied by the creation-of-space-by-matter view. Since general relativity suggests that at least the curvature of space can be affected by matter, the option that all geometric properties are brought into being by matter does not seem out of the question. *Prima facie*, whether matter creates space is a question of the powers of matter and is thus for physics to decide, rather than philosophy.

Belot's preferred option is 'modal relationalism', which holds that the geometry of space is constituted by the *possible* distance relations of material objects. The issue, as Belot recognizes, and as is especially pressing from an Aristotelian point of view, is whether these possibilities can be grounded in anything, if space itself does not exist. The substantialist has a straightforward answer: it is possible to move from A to B because *there is* a path in space connecting A to B. Without that resource, what is the modal relationist's story about why it is possible? Belot carefully considers a number of options and their difficulties. He prefers the theory that geometry is grounded in actual distances plus 'compatibility relations'. An example of these is to explain the difference between two universes each with a single point mass, the first in a Euclidean space and the second in a spherical space. The two cases differ in their 'compatibilities', meaning what could happen if, contrary to fact, the rest of space were filled with matter (the point masses would then have different distance relations with other masses: for example, without an upper bound in the first case and with an upper bound in the second).⁴⁷ The difficulty with this theory is again the grounding of the compatibilities: any counterfactual needs a truth-maker of some sort, and in this case the problem is similar to that of the enantiomorphs: what is it about space that allows distances to grow without bound in one case and not in the other?

For completeness, mention should be made of the rather few empirical scientific results on the shape of our space (apart of course from the vast number of measurements which show that space on our scale is nearly Euclidean). According to General Relativity, mass can deform space around it; the deformation is most easily measurable for the sun.⁴⁸ But on the very large intergalactic scale, results from NASA's WMAP spacecraft show that to the limits of observation, space is flat (although those limits are not very precise).⁴⁹ On the small scale, space is continuous down to the limits of observation and may be continuous all the way

down. But there have been a number of non-standard physical theories that predict it is discrete, some of which predict that the discreteness will be observable in the not too distant future.⁵⁰

Non-Euclidean geometry: the ‘loss of certainty’ in mathematics?

In the light of that survey of the philosophy of space and geometry, let us address again the Big Question in the subject.

The discovery of non-Euclidean geometry has always been the main exhibit when there are attacks on the certainty of mathematics. It was central to a book once popular in ‘mathematics for liberal arts’ courses, Morris Kline’s *Mathematics: The loss of certainty*, which represents the mathematics of the period 1830–1930 as a discipline lurching from crisis to crisis,⁵¹ and again in the most extreme major anti-objectivist philosophy of mathematics of recent decades, Paul Ernest’s *Social Constructivism as a Philosophy of Mathematics* (1998). It is not a new phenomenon. Bertrand Russell wrote of his youth: ‘I discovered that, in addition to Euclidean geometry, there were various non-Euclidean varieties and that no-one knew which was right. If mathematics was doubtful, how much more doubtful ethics must be!’⁵² In view of the high profile of the case, a philosophy of geometry should address the issue and determine which conclusions are justified and which are overblown.

Ernest calls attention to the weaknesses of some of the traditional options in the philosophy of mathematics, with some justification. But his main argument against objectivity is that intuition and proof must of their nature be unreliable. The argument is entirely contained in the following two paragraphs, which openly express doubts that are widespread, but often hidden under people’s intimidation by the prestige of mathematicians:

It is worth mentioning again the view that some mathematical assumptions are self-evident, that they are given by intuition or some form of immediate access to the (mathematical) objects known. In addition to the problems of subjectivity mentioned above ... there are also those of cultural relativism. Namely, those assumptions that the community of mathematicians regard as self-evident in one era often become the focus of intense scrutiny and doubt in another era (e.g., the axioms of geometry before and after Kant, and the axioms of arithmetic before and after Peano). Self-evidence does not seem to offer a viable basis for justifying the propositions involved, let alone the overall foundations of mathematical knowledge...

Therefore, since there is no valid argument for mathematical knowledge other than proof, mathematical knowledge must depend upon assumptions. It follows that these assumptions must have the status of beliefs, not knowledge; must remain open to challenge or doubt; and are eternally corrigible.

This is the central argument against the possibility of certain knowledge in mathematics...⁵³

There are two arguments in the passage. The second is that since the regress of reasons ends in axioms or basic propositions, the basic propositions must be dubitable. But labelling axioms as 'assumptions' does not make them dubitable. Ernst means that *no matter how strong* his intuition that $2 \times 3 = 3 \times 2$ is, he will regard it as dubitable on the sole ground that it does not follow from anything else. That is a truly heroic, ultra-Cartesian, level of doubt.

The first argument, concerning the alleged changes in axioms from one era to the next, would be a serious one if the facts were correct and axioms did change from one era to another. That is not the case. There are no eras or cultures in which $2 \times 3 = 3 \times 2$ has been denied or doubted. Mathematicians sometimes consider systems that are similar to our number system but in certain ways unlike it, but whatever happens in those systems is irrelevant to truths about 2 and 3, just because they are *other* systems and thus 2 and 3 are not in them. The suggested examples of Kant and Peano are wrong: far from denying or doubting any existing mathematical truths, Kant and Peano were keen to lay down principles that would produce all the same truths about geometry and arithmetic as previously believed, but to do so with added clarity.

It is true that there is one significant example of doubts about previous axioms, namely the discovery of non-Euclidean geometry. Euclid laid down one set of axioms, and nineteenth-century mathematicians found alternatives. But the example needs to be approached with a great deal of caution. It is a sole example of its kind, for one thing. As Gauss wrote, after understanding the possibility of non-Euclidean geometries, geometry is different: 'Perhaps in another life we may be able to obtain insight into the nature of space which is now unattainable. Until then we must not place geometry in the same class with arithmetic, which is purely a priori, but with mechanics.'⁵⁴

A significant mistake was made, but the nature of the mistake needs careful analysis.

It is true that Euclidean geometry was once thought to be necessarily true of space, and the existence of mathematically possible alternatives showed that the shape of space was an empirical question rather than a

purely mathematical one. But that means that the mistake was about the physics of space, the philosophy of space and mathematical modelling: the mathematical model of Euclidean space may not fit actual space exactly, because of the nature of space. That is a bad mistake, but not exactly a mathematical mistake. It is more like mistakenly supposing that wheels and coins are perfectly circular and that pi can be found to infinite accuracy by measuring them; that is a mistake about how accurately a certain mathematical structure is realized in a part of physical reality, rather than a mistake about the mathematics of circles. Euclid's theorems are all still true of the abstract structure, Euclidean geometry. That structure is realized in our space at our scale to a very close approximation, but possibly not exactly.

We understand now that geometry studies a number of mathematical structures, not just one. Mathematics studies all of them and physics measures which one applies; that is no different from arithmetic studying all numbers and the census department determining which one applies to the population.

A mistake was also made about epistemology, concerning self-evidence. Once the nature of space as physical is understood, it is clear that there can be no genuine self-evidence as to its shape. It cannot be necessary that space should extend infinitely or be infinitely divisible, so it is impossible that self-evidence should extend to those propositions. There were indeed long-running doubts on the self-evidence of Euclid's Fifth Postulate, from Euclid's own expression of it in a way that deliberately downplays its reference to indefinitely distant space to Zeno of Sidon's observations that certain things did not follow from Euclid's axioms without further assumptions⁵⁵ and Saccheri's eighteenth-century project to 'free Euclid from all spot'.⁵⁶ On the other hand, the possibility of discrete space was rarely considered, except by 'men of the world' like the Chevalier de Méré (whose belief in atomic space was taken by Pascal as evidence of his incompetence in mathematics⁵⁷) and a radical philosopher like Hume. That is certainly a major error, especially as Euclidean geometry was held up as the model of self-evidence. But again, the nature of the error is philosophical, not mathematical. Nor does it cast doubt on the other major epistemological fact, that it is easily perceivable and measurable that Euclidean geometry is a very accurate model of the structure of our space, in our region, at our scale. The mathematical results of Euclidean geometry are thus all directly true of our space (at that scale).

So the claims of the 'loss of certainty' in mathematics are very much exaggerated. All the number theory in Euclid is still as true as it ever was. So is the geometry, if interpreted as about multidimensional quantity rather than a body of necessarily exactly true statements about physical space.

Part II

Knowing Mathematical Reality

10

Knowing Mathematics: Pattern Recognition and Perception of Quantity and Structure

From an Aristotelian point of view, *some* of the epistemology of mathematics ought to be easy, in principle. If mathematics is about such properties of real things as symmetry and continuity, it should be possible to observe those properties in things, and so the epistemology of mathematics should be no more problematic than the epistemology of colour. An Aristotelian point of view should solve the epistemology problem at the same time as it solves the problem of the applicability of mathematics, by showing that mathematics deals directly with properties of real things.¹

Plainly there are some difficulties with that plan. It may be hard to explain knowledge of some of the larger and more esoteric mathematical structures such as infinite-dimensional Hilbert spaces, which are not instantiated in anything observable. It will even be problematic for such concepts as a 100-sided polygon, which may be instantiated but which are complex enough to confuse the sense organs. Nevertheless, it would be impressive if the plan worked for some simple mathematical structures, even if it did not work for all.

It would be desirable if an epistemology of mathematics could fulfil these requirements:

- avoid both Platonist implausibilities involving contact with a world of acausal 'abstract objects' and logicist trivializations of mathematical knowledge;
- at the lower level, be continuous with what is known in perceptual psychology on pattern recognition and estimation of quantities, and explain the substantial mathematical knowledge of animals and babies;

- make a smooth transition from a straightforward causal theory of basic mathematical knowledge such as seeing four apples to a theory of how higher mathematical truths are inferred;
- explain the mental operation of ‘abstraction’, which delivers individual mathematical concepts ‘by themselves’;
- at the higher level, explain how knowledge of unperceived, possibly uninstantiated, structures is possible;
- explain the roles of visualization and proof in delivering certainty in mathematics.

If those requirements could be met, there would be little remaining motivation either for postulating Platonist intuition of forms or inference to abstract entities, or for trying to represent mathematics as tautologous or trivial (so as not to have to postulate a Platonist intuition or inference).

Those requirements can be met – but there is still a degree of mystery involved in the transition from straightforward perceptual knowledge of quantity and structure to the more intellectual knowledge of mathematics strictly so called.

Mathematical knowledge arises in three stages, corresponding to the classical distinction between perception, imagination and intellect. Actually instantiated, sufficiently simple quantities and structures can be straightforwardly perceived, by both humans and animals. That sort of mathematical knowledge is the subject of this chapter. In the next chapter, we will see how imagination, rebranded visualization, can extend the range of knowledge beyond what is actually perceived, to properties that are not instantiated or are instantiated but not perceived. Imagination has its limits, however, and the intellect aided by proof can extend the range of mathematical knowledge far beyond what can be imagined.

Aristotelian epistemology (at least in its early stages, dealing with simple perceptual knowledge) has a very different character from Platonist or nominalist epistemology. It is much more naturalized and close to cognitive science. The Platonist has to explain knowledge of abstract entities by either intuition or inference. The nominalist has to show that mathematical knowledge may be achieved by logical or linguistic means or by manipulation of formal symbols. Constructivists or Kantians have to show how the resources of the human mind create mathematics. None of those approaches naturally gel with cognitive science or perceptual psychology. Aristotelians, on the other hand, regard basic mathematical knowledge as arising from perception of the mathematical properties of the physical world. So from an Aristotelian perspective, epistemology

(at this low level) just is the essentials of cognitive psychology. Once the findings of psychology on how knowledge of quantity, structure and space actually arises in humans are reviewed, the epistemology of perceivable properties has been done.

It would be easy to be impatient during a review of perceptual psychology, in the hope that it could be skimmed in principle before moving on to perhaps more interesting questions of knowledge of higher mathematics. That would be a mistake, similar to the mistake common in teaching mathematics, of training students on rules for manipulating symbols before they properly grasp what the symbols represent. A thorough understanding of what mathematical knowledge is available perceptually is necessary, before it can be inquired what tasks remain for higher faculties to do.

The registering of mathematical properties by measurement devices and artificial intelligence

Surely we should start with brains, infants and animals, perhaps even robots, in the hope of understanding first the simplest cases of sensitivity to the mathematical properties of things. Adult mathematical knowledge builds on and assumes the knowledge that these cognizers have managed to learn. So we should first establish what it is they know.

Quantity and structure are among the most basic and sometimes among the simplest of properties of the world. So mathematical epistemology starts very early.

Is there any mathematical knowledge in the thermometer model,² the simplest possible model of knowledge? A thermometer registers the ambient temperature, so its succession of states mirrors the succession of ambient temperatures. If it prints out the states as a graph on paper, the spatial structure of the graph is literally identical to the time structure of the ambient temperature – both might be, for example, sinusoidal.

Even this very simple model introduces a theme that will recur – that because structure is topic-neutral, it can literally be shared between the physical and mental. The thought of red cannot be red, but in principle the thought of something structured could possess literally the same structure. In this case, ambient temperature and internal graph can share the same structure, exactly or approximately.

It is true that the thermometer does not have any knowledge of that identity, in the sense of an internal representation of the fact that its succession of states resembles the variations in external temperature. That is a limitation of the thermometer model, at least if it is considered

as a model of human knowledge. But the identity of structure itself, not knowledge of it, is what is needed if the thermometer is part of a thermostat which performs the task of controlling room temperature. If a cooling mechanism is activated when the room temperature is above 25°C, that requires only causal connections between temperature, temperature registration in the thermometer and control mechanisms.

The next step towards a realistic model of simple knowledge involves the experiments of artificial intelligence. Natural intelligence is always hard to understand, whence the need for elaborate psychological experiments. With artificial intelligence, at least one knows what the system is doing, since one has programmed it (unless it has been programmed to learn, in which case one may be less informed on what it has done than one thinks). It thus provides a comprehensible model of how perception and intelligence *could* work, and thus a test-bed for epistemological claims. Artificial intelligence also enforces the useful discipline of a check on whether the system performs the intended task: if a computer system is correctly programmed with a method intended to perform a task and the task is not performed, it can be concluded that the method is inadequate to the task.

There are two basic styles of artificial intelligence, connectionist and symbolic. They model different aspects of knowledge and give different but complementary insights into human knowledge, including human mathematical knowledge.

A connectionist or 'neural net' architecture consists of a trainable 'black box' that is presented (many times) with a training set. The training set consists of many inputs and the correct label or desired output for each input. The data might be a large set of images of newborn chickens and the labels 'male' and 'female' as determined by expert chicken sexers. The neural net attempts to imitate these classifications, initially at random but gradually adjusting its insides so as to improve its performance, that is, its accuracy in classifying the images as male or female. When its accuracy on the training set is sufficiently high, it is tested on new images and asked to classify them. Typically it is found that it performs reasonably on the test set, even if not quite as well as on the training set. The nature of the insides of the box, which mediate between inputs and output, matters little, as long as it is not too simple. The black box is in effect a formula (for the output in terms of the values of the input, for example sex as a function of patterns of pixel brightnesses of chicken images) with many adjustable parameters. The aim is to find the choice of the parameters that gives the best performance on the training set (and hence, hopefully, on the test set as well). There

are many methods of learning, that is, of adjusting the parameters to achieve this end. Conceptually the simplest, though computationally impractical, is random search in the space of parameters, that is, simply trying a vast number of settings of the insides until one turns out to classify the training data well. Such systems have proved to have amazing abilities in low-level pattern recognition tasks like face recognition and fraud detection in financial data.³

Can neural nets learn to count? It is not the most natural of tasks for them, but they can perform some discrimination of numerosities. Their performance is similar to animals and infants. Like animals and infants, they exhibit a gradual degradation of performance for larger numbers.⁴

Neural nets are one step up from the thermometer model of knowledge, in that the settings of the insides in some sense – a purely causal sense – learn to form an internal representation of the world. As a result, they achieve a form of generalization, so that, for example, images of new chickens can be classified correctly. Generalization is a mysterious ability, and understanding how it is possible in such a simple model as a neural net is essential to pre-human epistemology. It can be demystified by looking at the simplest possible case, a ‘one input-one output linear neural net with no hidden units’.

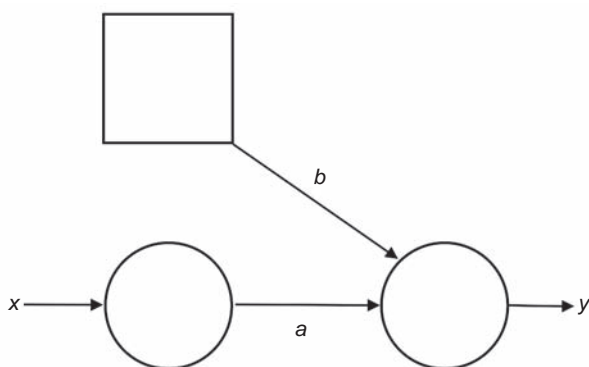

Figure 10.1 Simple neural net to predict y from x

A large number of pairs (x,y) are given, for example the ages x and heights y of many tree saplings. The aim is to predict the height of saplings from their age. The neural net accepts a value x as input, multiplies it by a constant a , adds the result to another constant b , and outputs the result $ax + b$ as its prediction of y . The constants a and b are

to be chosen so as to give the best prediction, on average, of y . So in the learning phase, the system gradually adjusts a and b until it performs well on the training set. New ages x will then be fed in and the neural net used to predict the corresponding heights y .

This problem is just standard statistical regression, or finding the line of best fit for a set of data:

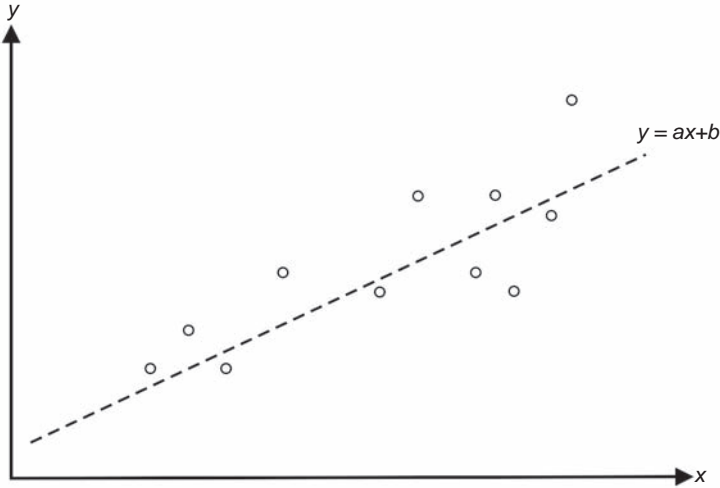

Figure 10.2 Line of best fit to a set of points

The constant a is the slope of the line of best fit and b its y -intercept, so it is possible to see what properties of data the internal settings represent: a is, in the example, how fast height of saplings increases with age. The single internal quantity a explicitly represents a mathematical entity, a rate, in the external world, a quantity evidenced in and extracted from the system's data. It is now possible to understand how generalization is possible – why using the formula $ax + b$ on new data x gives a good prediction of height. The reason is that in the external world, age really is a good predictor of height (that is, age and height are highly correlated and so lie close to a straight-line fit). That need not be so but, given that it is, the neural net is in a position to find the straight line that is the best predictor. Then the quantities a and b , which are particulars in the internal setting of the neural net, represent something that is general in the external world, the (properties of) the relation between the two universals, the age and the weight of saplings.

A standard neural net does not, however, have any way of manipulating its internal quantities like a and b as if they were symbols, for example, by saving them for later use or by combining them in rules.⁵ So if the characteristics of the data change, the neural net can learn new parameters, but cannot remember the old ones. Therefore a neural net is not a satisfactory model of human knowledge which does involve symbols.

Symbolic artificial intelligence aimed instead to create artificial intelligence by pure symbolic manipulation in a style inspired by symbolic logic, by programmed rules in human-understandable programming languages. Its successes lie in such discretely structured domains as chess playing.⁶ A large number of rules incorporating the rules of chess, strategies to apply in various board configurations, and routines for searching several moves ahead through chains of allowed moves and possible countermoves, can result in chess-playing at human level or better. The meaning of the symbols is imposed from the outside by the programmer and is not in any sense 'known' to the system (not even in the purely causal sense of a neural net); thus if some other domain had exactly the same mathematical structure as chess, a chess-playing program would apply to it without reprogramming, merely using a different dictionary of translations between its symbols and human words (or actions). The reason the program is useful for playing chess is that its rules and the computer-generated output that the rules produce (such as simulated games as it looks forward) share structural features with real chess.

That suggests that a proper analysis of how symbols work in the brain would cast light on the next stage of mathematical knowledge, especially knowledge of the discrete. Unfortunately, that process remains largely a mystery. The animal and human brain manages to combine symbolic and connectionist methods, and the human mind at least can then think self-consciously about the results. It has proved near-impossible to imitate either of these feats in artificial systems. A fundamental stumbling-block occurs at a quite early stage. How is it possible to 'cut up' the massive and continuous flow of perceptual information into discrete chunks suitable for the application of symbols? It is all very well to expect a child to associate experiences of cats with hearing 'cat', but that requires it to already have the ability to recognize a cat as a single object against a background (but continuing in time) and to correctly segment the continuous sound stream to isolate the sound-type 'cat'. Discrete symbols are easy to work with, but how can one solve the 'symbol grounding problem', which links them correctly to portions of continuous experience?⁷ Neural nets do not do anything like that, and there are few ideas on how they can 'grow' symbols in

any natural way – or at least few ideas that have proved to have any success in practice.⁸ The processes in the middle level between low-level perception and high-level object recognition remain mysterious. That is particularly problematic for understanding our knowledge of (discrete) number, which builds on our ability to pick out discrete objects from the flow of perception.

At the philosophical level, however, some haziness in the understanding of the route from perception to knowledge is not a severe loss. If we remain in ignorance of how the task is solved, at least the effort to solve it (and analysis of the failures) has made the task specification much clearer. The task is to segment experience correctly, identify discrete objects and hence count them, classify them into discrete kinds, symbolize the objects and kinds, and manipulate the symbols so as to make inferences and communicate the results. Our understanding of how to do any of those, much less all of them, is rudimentary, but neither is there any good reason to believe they cannot be done naturalistically.

Babies and animals: the simplest mathematical perception

Human knowledge differs from thermometer or connectionist ‘knowledge’ in several major respects. They include:

- Between perception and control, human knowledge inserts a layer of discrete symbol processing, expressible in language.
- Human knowledge has faculties of memory, imagination, fiction-making and inference that deal in objects not causally present to the knower.
- Human knowledge explicitly abstracts and generalizes, recognizing that different particulars have a common characteristic (represented in language by common nouns, adjectives and prepositions).
- Human knowledge is accompanied by conscious experiences: of qualia, belief, emotions, surprise and understanding.

The anthropocentric epistemology of traditional philosophy has tended to see these features as all aspects of a single human ability – explicit rational thought expressed in language. A closer attention to animal, baby and artificial intelligence shows that the truth is more complicated and that it is possible to have some of these characteristics of human knowledge without others. Discovering what mathematical knowledge animals, babies and robots have is necessary for understanding the earlier levels of human mathematical learning. Without

that understanding, accounts of human mathematical knowledge will always have a tendency to fall back into Platonism, with a pure symbol-manipulating mind in direct communion with the Forms.

We divide the field according to the two main kinds of the objects of mathematics discussed in Chapters 3 and 4, quantity and structure respectively. Some time must be devoted to surveying empirical results from animal and child developmental psychology, since the extensive research on perception of mathematical properties has hardly come to the attention of philosophers of mathematics. That is because from a Platonist or nominalist perspective, such research is unlikely to be relevant, since mathematical epistemology must be of something else (Platonic forms or logical/linguistic items, respectively). But from an Aristotelian perspective it is the main game. Let us examine just enough examples of the psychological research to establish how extensive and deep (but early in life) mathematical perception is.

Animal and infant knowledge of quantity

Animal and infant cognition is not as well understood as one would wish, since experiments are difficult and inference from the observed behaviour problematic. Animals and infants cannot reply in words to direct questions. Nevertheless it is clear in general terms that animals and babies, though they lack language, have high levels of generalization, memory, inference and inner experience. In particular, babies and animals share a numerical sense, as has become clear through careful experiments in the 1980s and 1990s.

To have any numerical ability (as opposed to just estimating sizes of heaps), a baby or animal must achieve three things:

- recognition of objects against background – that is, cutting out discrete objects from the visual background (or discrete sounds from the sound stream);⁹
- identifying objects as of the same kind (for example, food pellets, dots, beeps);
- estimating the numerosity of the objects identified (the phraseology is intended to avoid the connotations of ‘counting’ as possibly including reference to numbers or a pointing procedure, and exactitude of the answer).

Human babies can do all those things at birth. A newborn that sucks to get nonsense three-syllable ‘words’ will soon become bored, but perks

up when the sounds suddenly change to two-syllable words.¹⁰ Monkeys, rats, birds and many other higher animals can choose larger sets of food items, flee another group that substantially outnumbered their own, and with training press approximately the right (small) number of times on a bar to obtain food. Babies and animals have two distinct innate abilities in numerosity estimation: an accurate immediate perception (called ‘subitization’) of one, two and three items, and an inherently fuzzy estimate of larger sets – it is easy for them to tell the difference between ten and twenty items, but not between ten and twelve. The two abilities rely on different styles of internal representation. Subitization relies on internal symbols for the different objects, for example, allowing direct comparison of a set of three crackers with a set of two. Various experiments, especially on the time taken to reach judgements, show that the estimation of sets by the approximate ratio of their sizes relies on an internal analog representation of numerosity, a kind of ‘fuzzy number line’; the persistence of this representation in adults is shown by such facts as that subjects presented with pairs of digits are slower at judging that 7 is greater than 5 than that 7 is greater than 2. None of these judgements involve anything like explicit counting, in the sense of pairing off items with digits or numerals.¹¹

These abilities of the perceptual system show what is wrong with an objection raised in the philosophy of mathematics to Maddy’s view that one can directly perceive sets (as opposed to just heaps or aggregates). Maddy claimed that if I open an egg carton and see that there are three eggs in it, I perceive both the pale curved surface of the egg-heap and that it is structured by ‘being an egg’ into three parts, each an egg, and that that is sufficient for me to perceive a set of three eggs.¹² Balaguer argues to the contrary:

Since the set and the aggregate are made of the same matter, both lead to the same retinal stimulation; Maddy herself admits this. But if we receive only one retinal stimulation, then the perceptual data about the set is identical to the perceptual data about the aggregate. Thus, we cannot perceive the difference between the aggregate and the set. But since it is pretty obvious that we *can* perceive the aggregate, and since there *is* a difference between the aggregate and the set, it follows that we cannot perceive the set.¹³

But perception is much more active in organizing its input than that suggests. Perception does not just register the stuff in front of it – it sees it *as* this and that, and may need training to do so (for example, the

training that biology students receive so that they can see the initially tangled mass visible under a microscope as an array of different types of cells). In particular, as the case of seeing through camouflage makes clear, there is a clear difference between perceiving something as an undifferentiated mass, and perceiving it as four speckled birds hiding in a bush. The retinal input may be unchanged, but what is perceived is different, and the new perception is of something numerical. As explained in Chapter 3, it is perception of how the heap is divided by a unit-making property; and that is all there is to being a set.

In fact, since Piaget's classic experiments on how the perception of number condenses, so to speak, out of perception of the extent and density of a heap, it has been clear that elementary perception of sets and number is a difficult task. On tasks requiring discrimination between small sets, young infants are easily confused by changes in the visual extent of sets, caused for example by spreading them out. That suggests that they are using area and contour of a heap as much as perception of numerosity, and that abstracting numerosity from those accompanying features is difficult.¹⁴ It is, however, possible, and possible prior to any language-aided conceptualization. In experiments that control for other variables such as total surface area, infants (and monkeys) can distinguish sets of different small numerosities.¹⁵

If animals are inept at counting beyond the smallest numbers, they are excellent at perceiving some other mathematical properties that require keeping an approximate running average of relative frequencies. Among the most critical information for animals' survival is the (exact or approximate) covariation between natural signs and what they signify. For example, (in the human world) it is the (near-exact) covariation between the colour of traffic lights and the safe times for driving forward that enables driver survival, and (in the bird world) the covariation between daylight length and breeding time that allows birds to breed when their young will survive. Information, typically, just is covariation of this kind.¹⁶ But covariation essentially involves numerosity – though exact counts are not needed, there needs to be some running balance kept of how often sign and signified went together versus how often they did not.

The rat, for example, can behave in ways acutely sensitive to small changes in the frequencies of the results of that behaviour.¹⁷ Naturally so, since the life of animals is a constant balance between coping adequately with risk or dying. Foraging, fighting and fleeing are activities in which animal evaluations of frequencies are especially evident.¹⁸ Those abilities require some form of counting, in working out the approximate

relative frequency of a characteristic in a moderately large dataset (after identifying, of course, the population and characteristic).

There has been less research on the perception of continuous quantities. But infants of no more than six months can distinguish between the same and different heights of similar things side by side, and can be surprised if liquid poured into a container results in a grossly wrong final height of the liquid (though they are poor at judging quantities against a remembered standard).¹⁹ There is some evidence for a ‘common magnitude system’ in the brain, capable of representing any of space, time and number (that is, representing discrete number on a continuous ‘number line’).²⁰ Four-year-olds can make some sense of the scaling of ratios needed to read a map.²¹

In view of the philosophy of geometry developed in Chapter 9 above, according to which truths about space are partly mathematical but partly physical, the epistemology of geometry is of less direct interest here. But of course early spatial knowledge is well studied, with similar results to those on number and ratio.²²

The epistemological point is that perception of the simpler quantitative properties of physical things is as direct and straightforward as perception of colour and hardness.²³ While perception in general may have its philosophical mysteries, there is nothing to suggest that any of those mysteries are peculiar to mathematics.

It is true that assimilating the perception of quantity to other sorts of perception does leave a philosophical problem. The less special perception of quantity is, the more incomprehensible it becomes that knowledge of quantity should have the certainty characteristic of simple mathematics, such as the proverbial indubitability of ‘ $2 + 2 = 4$ ’. That was why Mill’s empiricism about mathematics was felt to be unable to account for the certainty of mathematical truths. I will examine the certainty of understanding in the next two chapters.

Perceptual knowledge of pattern and structure

We now turn to the perception of more purely structural, as opposed to quantitative, properties.

Smell and taste are not very structural senses, in that the ‘spaces’ of possible smells and tastes largely lack structure: there are just different smells and different tastes, each one of which seems to lack components. The opposite is true of touch, hearing and vision, which all perceive highly patterned stimuli such as, for example, Braille text, symphonies and landscapes. The perceptual faculties’ extraction of structure is what

allows a heap of notes to be perceived as a melody or a string of strokes as calligraphy.

Infants start early on pattern. Newborn babies love looking at bold stripes, which exhibit one of the simplest and most obvious of patterns, alternation.²⁴ The ability to see stripes can be used in tests of vision at forty-eight hours after birth.²⁵ Infants are equally good at recognizing alternation in time, that is, rhythm.²⁶ Their liking for rhythms of high pitch and slow tempo has been adapted to by lullabies.²⁷ Alternation is only the simplest example; many more subtle patterns in visual and aural input are perceived very early.²⁸

Symmetry, as we saw in Chapter 4, is a paradigm of the structure studied by mathematics. The ease of perceiving it is the cause of its wide use in decoration. It is important in infant perception: four-month-olds process vertically symmetric patterns faster than asymmetric or horizontally symmetric ones.²⁹ Human symmetry perception is subtle and not easy to understand or imitate.³⁰ Symmetry perception has also been demonstrated in apes, dolphins and birds; it is possible to train bees to prefer either symmetrical or asymmetrical patterns, but the preference for symmetry comes more naturally to them.³¹

The deeply automatic nature of symmetry perception is shown not only by its early development in babies but by experiments on how symmetry affects shape perception. A square is perceived as a different shape from a diamond, though the two are congruent, because of the different relations of their symmetries to the environmental horizontal and vertical axes; however, that can be overridden by adding new visual context, as in this figure:³²

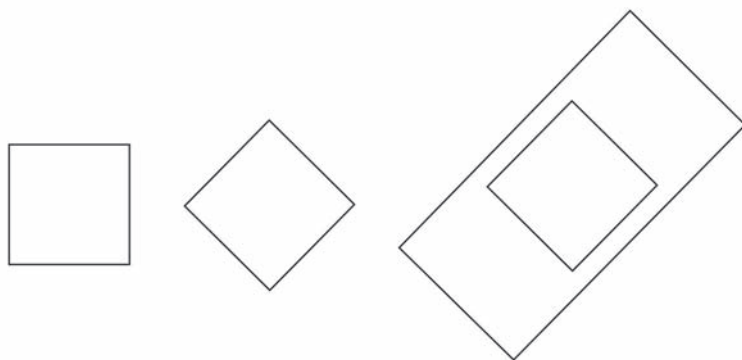

Figure 10.3 Square, diamond, and 'diamond' with context suggesting a square

Source: After Palmer, The role of symmetry (see ch. 10, note 32), figure 1.

There is also much to learn on how the lower levels of the perceptual systems of animals and humans extract information on structural features of the world afforded by perception; for example, what algorithms are implemented in the visual system to allow inference of the curvature of surfaces, depth, clustering, occlusion and object recognition. Decades of work on visual illusions, vision in cats, models of the retina and so on has shown that the visual system is very active in extracting structure from – sometimes imposing structure on – the raw material of vision, but the total picture of how it is done (and how it might be imitated) has yet to emerge.³³

A clear example of a structure that can easily be perceived visually comes from Giaquinto's *Visual Thinking in Mathematics*. The concept 'tree consisting of a start node with two children, each with two children' is purely structural, as it can be defined in pure graph theory. Instances of it can be easily picked out visually from such realizations as below (and the same would be true if parts of the diagram were drawn sideways or upside down). The visual system perceives isomorphism directly – as directly as it perceives symmetry.

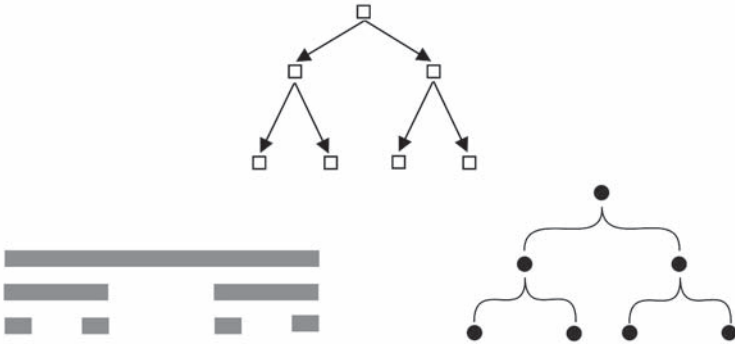

Figure 10.4 Three realizations of the same tree structure

Source: Giaquinto, *Visual Thinking in Mathematics*, figure 11.4, p. 220. By permission of Oxford University Press.

And structure is not only perceived by the senses individually. Recently, it has become clear that covariation plays a crucial role in the powerful learning algorithms that allow a baby to make sense of its world at the most basic level, for example in identifying continuing objects. Infants pay attention especially to 'intermodal' information – structural similarities between the inputs to different senses, such as the covariation

between a ball seen bouncing and a ‘boing boing boing’ sound. That covariation encourages the infant to attribute a reality to the ball and event (whereas infants tend to ignore changes of colour and shape in objects).³⁴ Intermodal information is particularly significant from a structuralist perspective, since it is the structural nature of that information that makes it accessible to more than one sense. By and large, intermodal information (such as covariation) will be structural, while unisensory information (such as colour) will not – although there are exceptions to that, since for example all senses register the same time, and time is not purely structural.

Adult humans, then, inherit a sophisticated perception of structural properties like covariation, numerosity and quantitative comparison and variation. Properties of that sort, it was argued in earlier chapters, are among the objects of mathematics. So the epistemology of mathematics should give direct perception of them a prominent place.

Again, the perception of such properties does not seem to be in principle different from the perception of colour. To the extent that we understand simple perception of what causally affects our senses, to that extent we understand the bottom level of mathematical epistemology. At that level, there is nothing special about mathematics.

11

Knowing Mathematics: Visualization and Understanding

The previous chapter reached the furthest limits of what is possible in the way of mathematical knowledge with the cognitive skills of animals and infants. Obviously those abilities are very limited when it comes to doing traditional mathematics. We may share 98% of our genes with chimpanzees, but chimpanzees are not surprised by that fact.¹ They are incapable of being surprised by that, because they cannot understand it. They lack the relevant cognitive abilities – the same intellectual cognitive abilities that are needed for reading diagrams, visualizing, using mathematical symbols, and understanding proofs.

Imagination and the uninstantiated

The human ability to cantilever knowledge out beyond the here and now involves two significantly different abilities. They are the ones attributed in traditional faculty psychology to the imagination and the intellect, respectively. They correspond to the debate in recent philosophy of mathematics on the roles of visualization versus proof.

In the words of William James, echoing medieval psychological theory: ‘Fantasy, or Imagination, are the names given to the faculty of reproducing copies of originals once felt. The imagination is called “reproductive” when the copies are literal; “productive” when elements from different originals are recombined so as to make new wholes.’² Given perception of the properties *golden* and *mountain*, the imagination can combine them into a mental image of *golden mountain*, without any need for a golden mountain being perceived. Given perception of a heap of plants in a nursery, one can imagine (visualize) what they would look like if planted out in the garden at home. That is a very useful ability, given the universal human need to plan for the future and entertain counterfactual situations.³

The imagination supplies an in-principle answer to how knowledge of uninstantiated properties is possible. The essential issue was raised by Hume in his discussion of the missing shade of blue. He writes:

Suppose... a person to have enjoyed his sight thirty years, and to have become perfectly well acquainted with colours of all kinds, excepting one particular shade of blue, for instance, which it never has been his fortune to meet with. Let all the different shades of that colour, except that single one, be plac'd before him, descending gradually from the deepest to the lightest; 'tis plain, that he will perceive a blank, where that shade is wanting, and will be sensible, that there is a greater distance in that place betwixt the contiguous colours, than in any other. Now I ask, whether 'tis possible for him, from his own imagination, to supply this deficiency, and raise up to himself the idea of that particular shade, tho' it had never been conveyed to him by his senses? I believe there are few but will be of the opinion that he can.⁴

Note that the ability attributed to the imagination in this case is not recombination, as in the example of the golden mountain, but interpolation. Perception – normal veridical perception – needs first to 'perceive a blank' in the array of blue shades. To do that, it needs to perceive the spectrum of instantiated colours, perceive their degrees of resemblance, and perceive the discontinuity between two close shades. Those are substantial tasks, but seem well within the known capacities of human perception. Then the imagination needs to perform some kind of averaging or smoothing of the two close shades. Even in the absence of a definite theory of how the imagination works, that also seems well within the known capacities of the human mind.

We may conclude that, in principle, the human mind has a well-recognized and moderately well-understood capacity to move at least some small degree beyond what is directly perceived, and to know about properties that have not been perceived, and may not have been instantiated. To see what in practice the scope and limitations of that capacity are, in the area of mathematical properties, we need to examine mathematical visualization.

Visualization for understanding structure

The word 'imagination' has in English come to be associated with poets and artists rather than scientists, and the scientific uses of the term have

largely been replaced by the word ‘visualization’. Visualization in mathematics has become a hot topic in recent years. Several philosophers of mathematics, especially those interested in mathematical practice, have argued for increased attention to visualization, conceived of as a method of knowing mathematics that contrasts with proof. Many mathematics educators have also favoured it. Their pleas have largely fallen on deaf ears in the mainstream of both philosophy of mathematics and professional mathematics itself. That is because the proponents of visualization have not given a clear explanation of what it is, in a way that would show how it fits either into the standard ontological and epistemological questions in the philosophy of mathematics, or into the standard style of formal proofs in mathematics.

An Aristotelian realist philosophy of mathematics solves this problem by explaining exactly what visualization does for mathematical knowledge. As we saw in the previous chapter, the visual system is designed to perceive quantity and structure directly (among other properties). Therefore the deliverances of visualization can feed directly into the processes of mathematical understanding and discovery by recombining and extending the concepts learned from perception. Let us look at two examples to see how it happens.

If we gain knowledge of $2 \times 3 = 3 \times 2$ not by rote but by understanding the figure

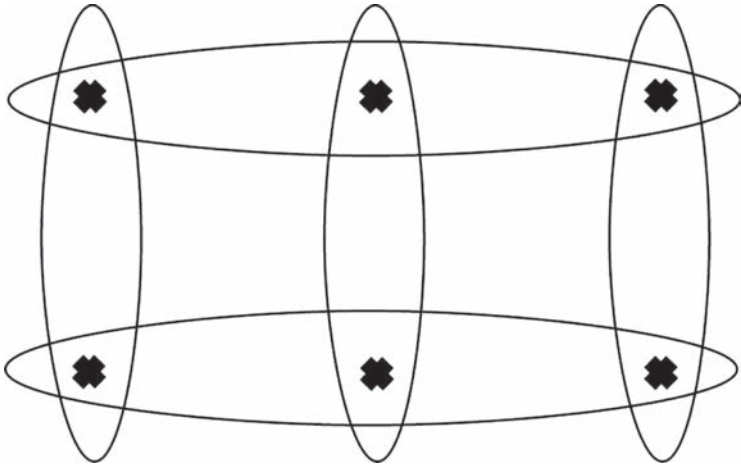

Figure 11.1 Why $2 \times 3 = 3 \times 2$

then we have fulfilled the Aristotelian ideal of complete and certain knowledge through understanding the reason why things must be so. We can also understand why the size of the numbers is irrelevant, and we can perform the same proof with more rows and columns, leading to the conclusion that $m \times n = n \times m$ for any whole numbers m and n . The insight permits knowledge of a truth beyond the range of actual or possible sensory experience, which is evidence again of the sharp difference in kind between sensory knowledge like subitization and intellectual understanding.

Plainly, the visualization gives a very different understanding of the equality than would a series of steps deducing it from Peano's axioms. It is now possible to explain exactly how it works.

The prominent Xs suggest the sameness of the six items displayed – for the purposes of the equality, any distinguishing features of them are to be disregarded. The ovals guide the visual system to divide the parts of the whole six in two different ways: the horizontal ovals suggest the partition into two sets of three, the vertical ovals the partition into three sets of two. The equality comes from recognizing that the two partitions are of the same six objects. The advantage of the diagram is that it literally instantiates the structure of the equality – the two 3s and the three 2s – and is designed so as to lead the visual system to see that structure, free of clutter. (That is why a diagram is so different from a photograph: the designer of a diagram has the opportunity to remove irrelevant structure such as textured background, thus allowing the visual system to concentrate on the relevant structure, which is normally highlighted with techniques like bold outlining.)

If we concentrate on the understanding that arises from the diagram, it is clear that the advantage of the visual system lies in its ability to gain a *global* or 'at once glance' perception of a structure. (It is the same ability that gives a graph of data an advantage over a table of figures.)

The visual system is specially set up to look for global structure,⁵ especially symmetrical structure.⁶ Moreover it appears to be a unique and important feature of the visual modality that it can present portions of space globally ('synoptically') whereas other sensory modalities – such as hearing and touch – present items in a linear sequential manner, unfolding one by one in time. This feature is the reason why vision is especially suited to giving us an idea of the spatial layout of our environments; the use of other modalities to compensate for a lack of visual perceptions does not deliver a conception of the spatial layout as effectively or as instantaneously as vision.⁷ Given the tight (but not necessary) connection between perceiving spatial arrangements of objects and forming geometrical concepts, the central role of the visual system in

learning and understanding geometry becomes all the more understandable. It also becomes clear why purely formalist and wholly non-visual axiomatic treatments of geometry have so little appeal pedagogically.

These considerations are confirmed in an example⁸ which is of special interest because the diagram is drawn in the mental visualization facility and one can immediately feel how the creation of the mental diagram rearranges one's perception of (external) structure. Consider the $n \times n$ array of numbers in which the number in the i, j place (counting from top left) is the smaller of i and j , thus:

Table 11.1 Array with i, j 'th entry equal to $\min(i, j)$

1	1	1	1	...	1
1	2	2	2	...	2
1	2	3	3	...	3
1	2	3	4	...	4
...
1	2	3	4	...	n

Why is the sum of all the numbers in the table $1^2 + 2^2 + 3^2 + \dots + n^2$? The result is far from obvious. There are algebraic ways of proceeding, but they do not give much insight into the result. The result can, however, be made obvious by drawing this mental diagram: imagine on each cell a tower of balls equal in number to the number written in the cell (coming out from the page). Now consider the horizontal layers (parallel to the page). On the bottom layer, there are $n \times n$ balls; on the second layer, $(n-1) \times (n-1)$, ... and on the top layer, only the single ball in the bottom right corner. So there are in total $n^2 + \dots + 3^2 + 2^2 + 1^2$ balls.

The essence of this procedure is the restructuring of the array of balls by implementing mentally the instruction to repartition them into horizontal layers. The ability of the imagination to focus attention on any part and set of parts allows a global understanding of structure. Moreover, in this example, the global understanding of structure obtained by visualization and imagination appears (to us) much more immediate and direct than the understanding that would be gained by following a sequence of logical steps unaided by visualization. Thus visualization and imagination seem to be a particularly attractive way of learning and understanding such mathematics.⁹

The return of visualization, and its neglect

Recently visualization has returned after more than a century in a kind of limbo, where it was frequently mentioned in teaching but considered an embarrassment in 'real' mathematics. In mathematics (at least informal mathematics education) and computer science, visualization has come to the fore. One of the early promises of artificial intelligence was the discovery and proof of interesting new theorems by computer, that is, by purely symbolic means. After decades of effort, the results have been minimal.¹⁰ Fifty years ago it was famously predicted that within a decade "a digital computer will discover and prove an important new mathematical theorem." That did not happen as scheduled.¹¹ (Nor did it happen later.) Instead, the power of computers has been used to support mathematicians' and mathematics students' visual intuitions in order to give them insight into theorems and mathematical structures. For example the graphing facilities of graphics calculators and of the popular symbolic mathematics packages Mathematica, Maple and Matlab are very heavily used by both researchers and teachers.¹² Instructional websites such as the Wolfram Demonstrations Project contain many animations to support understanding of a wide range of mathematical objects.¹³ In studies of mathematics education, research on visualization has expanded greatly since the 1980s. Educationists complain with some justice that the philosophical views of mathematicians that visualization is not 'real mathematics' inhibit understanding in the classroom.¹⁴

These developments in mathematics have been very recently reflected to some extent in the philosophy of mathematics. Several recent authors have contributed valuable case studies and urged more attention to visualization¹⁵ but have thus far made a limited impression on the direction of activities in the philosophy of mathematics.

Why visualization has been *persona non grata* in the philosophy of mathematics

An emphasis on justification and proof in the name of academic rigour, as opposed to discovery, construction, and understanding, has obscured the role of visualization in mathematical epistemology. The disconnection between visualization and both the philosophy of mathematics and formal mathematics has four related causes, which explain but do not justify the failure to integrate visualization into received accounts of mathematics. The first is the strong emphasis of published mathematics

on proof, as opposed to other mathematical activities (calculation, modeling, understanding, conjecturing, running computer searches, teaching, justifying grants, drawing and constructing diagrams and so on), an emphasis in which mathematics has been followed, often slavishly, by the philosophy of mathematics. The second cause is a focus on certainty in the epistemology of mathematics, despite fallibilism having become semi-orthodoxy in all other areas of epistemology. The third cause is a confusion between ontology and epistemology in mathematics, with proof being thought of as epistemology when it is in the first instance ontology. And the fourth is the false Platonist–nominalist dichotomy in the philosophy of mathematics, which here has yet another baneful effect. As these causes are all powerful, the neglect of visualization is overdetermined. We consider these causes briefly in turn.

It is a platitude that mathematics journals normally regard as publishable only completed (semi)formal *proofs*, and that that creates difficulties for students of mathematics wishing to understand the processes and heuristics behind the construction of proofs. There are good reasons why frontline mathematics should insist on this perfectionism, in that it has led in general to proofs that have withstood the test of time and established mathematical truths finally and in a way surveyable by later trained mathematicians. Yet in kicking away the superstructure of mental activities which have produced the final proof – from initial conjectures and calculations to informal common-room discussions and diagrams – the mathematics profession has to a degree misled outside observers, including philosophers of mathematics, as to the nature of the mathematical enterprise. Despite recurrent calls for closer attention to mathematical practice,¹⁶ mainstream philosophy of mathematics has tended to focus on the nature of numbers and other abstract entities as seen through the prism of axiomatizations and proofs of truths about them. An Aristotelian realism that suggests looking behind the formulas to the realities they describe will be more sympathetic to direct modes of knowing those realities, such as perception and visualization.

Second, the overemphasis on proof goes hand in hand with a devotion to *certainty* that is out of tune with the general fallibilism about knowledge that is, for good reasons, popular in epistemology in general. While mathematics is rightly proud that its justificatory procedures are more certain than elsewhere, that is no reason to ignore the possibility of less certain methods of confirming mathematical conjectures. Such methods might include inductive support of conjectures by the computer checking of many cases, and the confirmation of conjectures by

establishing the truth of consequences of them (described in Chapter 15 below). In particular, if it appears that visualization (graphing, drawing diagrams, etc.) is a less certain method of establishing mathematical knowledge than some other method, such as symbolic proof, that in itself is not a reason to downplay it, especially if it has some compensating advantages (for example, that visualization is more useful than proof for *discovering* mathematical truths).

Third, it is important to be clear about the perennially important philosophical distinction, that between ontology and epistemology. The close connection between proof and certainty gives the misleading impression that proof is essentially a matter of epistemology – a device for inducing certainty in the mind of the reader. But a proof (though it serves an epistemological purpose) is itself an item of mathematical ontology, namely, a sequence of propositions with logically necessary connections between them. (Compare: a photograph of a distant galaxy is an ontological item, although the purpose of printing it in the *Journal of Astrophysics* is epistemological.) Once we have classified proofs as mathematical ontology, along with numbers and axioms, we are free to look with fresh eyes at true mathematical epistemology, that is, the mental and bodily activities, of varying reliability, which lead to mathematical beliefs, knowledge and understanding – including pattern perception, counting, calculation, extrapolation of cases, checking of consequences and visualization.

Diagrams, of course, are also ontology. One should distinguish between the ontological item – the sequence of proof steps and the diagram on paper or screen, respectively – and the mental structures and activities that arise from contemplating it.

And finally, the dominance of Platonism and nominalism in the philosophy of mathematics has deflected attention from visualization. Nominalists are interested in linguistic, symbolic or logical items, which are very unlike images. And images might tend to suggest that mathematics is *about* something (since one seems to see structures in which the truths of mathematics are realized), which is a thesis the nominalist wishes to avoid. Platonists, on the other hand, are interested in a world of *abstracta* such as numbers and sets, which are not the kind of things that can be literally visualized. (An exception is James Robert Brown's non-standard Platonist view that visualization does allow one to see into the world of the Forms.¹⁷) Only the Aristotelian finds it natural to, first, perceive mathematical structure, and then to understand unperceived structures by mixing and matching ingredients in the imagination.

The mind and structural properties: the mysteriousness of understanding

'Understanding' has been used in the forgoing in an unselfconscious way, as something evident to consciousness when one looks at the examples. That is correct as far as it goes, but it is a remarkable phenomenon and must be discussed explicitly.

The lack of attention to understanding in epistemology generally has been noted and condemned.¹⁸ Understanding concerns established and accepted bodies of knowledge and theory, so the preoccupation in epistemology with threats to knowledge tends to delay development of a theory (or even a case study) of understanding. A non-sceptical epistemology aimed at giving an account of mathematical knowledge as it exists and as it is transmitted will give pride of place to understanding.

Mathematics is the home ground of understanding – one goes to mathematics for examples of pure understanding without any admixture of brute empirically derived facts. Yet philosophy of mathematics has rarely placed understanding in the foreground. It should do so.

According to traditional Aristotelianism, the human intellect possesses an ability completely different in kind from animals, an ability to abstract universals and *understand* their relations. That ability, it was thought, was most evident in mathematical insight and proof. The geometry of the earth–moon system, Aristotle says, not only describes the regularities in eclipses, but demonstrates why and how they must take place when they do.¹⁹ The demonstration consists essentially in a diagram, showing the earth–sun–moon system and the possible ways the earth can shade the moon or the moon shade the earth. With the diagram, we grasp why it must be so.

Unfortunately there is a gap in the story. What exactly is the relation between the mind and universals, the relation expressed in the crude metaphor of the mind 'grasping' universals and their connection? What exactly is understanding? 'Insight' (or 'eureka moment') expresses the psychology or intuitive internal feel of that 'grasp', but what is the philosophy behind that metaphor? Without an answer to that question, the story is far from complete. It is, of course, in principle a difficult question in epistemology in general, but since mathematics has always been regarded as the home territory of insight with certainty, it is natural to tackle the problem first in the epistemology of mathematics.

It is not easy to think of even one possible answer to that question. That should make us more willing to give a sympathetic hearing to the answer of traditional Aristotelianism, despite its strangeness. Based on

Aristotle's dictum that 'the soul is in a way all things',²⁰ the scholastics maintained that the relation between the knowing mind and the universal it knows is the simplest possible one: identity. The soul, they said, knows heat by actually *being hot* ('formally', of course, not 'materially', which would overheat the brain).

That theory, possibly the most astounding of the many remarkable theses of the scholastics, can hardly be called plausible or even comprehensible. What could 'being hot formally' mean? Nevertheless, it has much more force for the structural universals of mathematics than for physical universals like heat and mass. The reason is that structure is 'topic-neutral' or, as explained in Chapter 4, is definable using only mereology and logic. A mind, whatever it is, could have such properties, so structural properties could in principle be shared between mental entities and physical ones. While there seem insuperable obstacles to the thought-of-heat being hot, there is no such problem with the thought-of-4 being four-parted (though one must still ask what makes it the single thought-of-4 instead of four thoughts).

In fact, on simple models of (some) mathematical knowledge, the identity-of-structure theory is straightforwardly true. On the thermometer model of knowledge, there can be a literal identity between the time pattern of ambient temperature (say sinusoidal) and the pattern of readings in the thermometer or on a graph it prints out. Or if a computer runs a weather simulation, what makes it a simulation is an identity of structure between its internal model and the physical weather. The model has parts corresponding to the spatiotemporal parts of the real weather, and relations between the parts corresponding to the causal flow of the atmosphere. (The correspondence is very visible in an analog computer, but in a digital computer it is equally present, once one sees through the rather complicated correspondence between electronically implemented bit strings and spatiotemporal points.) That certainly does not imply that the structural similarity between mental/computer model and world is all there is to knowledge – that would be to accept thermometer tracking as a complete account of knowledge. In the weather model case, there must at least be code to generate and run the model and more code to interpret the model results, for example in issuing a prediction that there will be a cold front two days ahead. Nevertheless, it is clear that it is perfectly reasonable for structural type-type identities between knower and known to be an essential ingredient of knowledge, and that that thesis does not require any esoteric view of the nature of the mind.

The structure of mental entities and the role of that structure in knowledge, particularly in the knowledge of things not present, was

elaborated in the classical theory of the faculty of 'imagination', which stores and recombines images.²¹ Proclus, in the only developed ancient philosophy of mathematics, held that the imagination is where geometry is done. He holds, for the usual Platonist reasons, that imperfect physical diagrams are unsuitable, and that on the other hand the pure understanding cannot do geometry either because its concepts are 'wrapped up' and there is only one of each (so one cannot have circles of different sizes or intersecting circles, because there is only one Form of The Circle). So the understanding projects images 'distinctly and individually on the screen of the imagination', which provides a kind of 'intelligible matter' for them.²² Surely at least the core of that is correct, in that to reason about mathematical structures one needs a mental model with parts. That is confirmed by recent psychological work on the mental models underlying infants' knowledge of number and quantity,²³ as well as by anecdotes from celebrated mathematicians on their use of the imagination, such as Einstein's testimony that 'the psychical entities which seem to serve as elements in thought are certain signs and more or less clear images which can be "voluntarily" reproduced and recombined'.²⁴ You might like to introspect while re-reading the reasoning above following Table 11.1, or to answer the following question without drawing a physical diagram: how many diagonals can one draw on the surface of a cube?²⁵

The possibility of mental entities having literally the same structural properties as the physical systems they represent has implications for the certainty of mathematical knowledge. If mental representations literally have the structural properties one wishes to study, one can avoid the uncertainty that attends sense perception and its possible errors. The errors of the senses cannot intrude on the relation of the mind to its own contents, so one major source of error is removed, and it is not surprising if simple mathematical knowledge is accompanied by a feeling of certainty, predicated on the intimate relation between knower and known in this case. That is not to maintain that such knowledge is infallible just because of this close relation. In dealing with a complex mental model, especially, such as a visualized cube, the mind may easily become confused because the single act of knowledge has to deal with many parts and their complicated relations. A mental model of some complexity may even be harder to build and to compute with than one of similar complexity in wood – although experts at the mental abacus are very fast, most people find a physical abacus much easier to use.²⁶ Nevertheless, the errors of perception are a large part of the reasons for our uncertainty about matters of fact, and the removal of that source

of error for a major branch of knowledge is a matter of great epistemological significance.

That still leaves something unexplained. Instead of explaining the mystery of understanding and insight, the view that mathematical thought can operate with complex internal models has merely postponed it. What does the mind actually do with a mental model with parts, to achieve a unitary act of knowledge? For example, in visualizing a cube and asking how many diagonals can be drawn on each surface, what is it that the mind adds to the mentally drawn diagonals when it suddenly realizes 'There are two crossed diagonals on each face'?²⁷

The answer, however, remains a mystery. Nothing could be clearer than direct mathematical understanding of why $2 \times 3 = 3 \times 2$, yet an account of what that understanding is seems unreachable.

The chiliagon and the limits of visualization

Hume's example of interpolating the missing shade of blue is the standard one of the capacities of the imagination. The traditional illustration of the *limits* of the imagination is Descartes' example of the chiliagon. He writes in the *Sixth Meditation*:

I remark in the first place the difference that exists between the imagination and pure intellection [or conception]... if I desire to think of a chiliagon, I certainly conceive truly that it is a figure composed of a thousand sides, just as easily as I conceive of a triangle that it is a figure of three sides only; but I cannot in any way imagine the thousand sides of a chiliagon [as I do the three sides of a triangle], nor do I, so to speak, regard them as present [with the eyes of my mind]... it may happen that in imagining a chiliagon I confusedly represent to myself some figure, yet it is very evident that this figure is not a chiliagon, since it in no way differs from that which I represent to myself when I think of a myriagon or any other many-sided figure.²⁸

The example is repeated by Hume, who remarks, 'It is impossible for the eye to determine the angles of a chiliagon to be equal to 1996 right angles, or make any conjecture, that approaches this proportion', and by many other philosophers.²⁹ Without necessarily accepting anything of the rationalist or empiricist conception of ideas, it is surely true that our ability to visualize is confused by complexity beyond a certain level, and cannot pronounce on complex mathematical structures accurately. Some other way of navigating through complexity is needed.

12

Knowing Mathematics: Proof and Certainty

If a mathematical truth is too complex to be visualized and so understood at one glance, it may still be established conclusively by putting together two glances. Or three, or n . That is, it may be proved by a chain of inferences, each of which is clear individually, even if the whole is not clear simultaneously. That is the idea behind proof.

Proof: a chain of insights

Proof disaggregates the complexity of a theorem into a series of simple steps, each of which can be established by straightforward methods. Since a chain is as strong as its weakest link, a chain with no weak links is very strong.

That explains, in principle, how proof can extend mathematical knowledge further, beyond the limits of what is possible with visualization.

That is not to say that some kind of global view is impossible in, or even generally absent from, proof with symbolic steps. Indeed, the purpose of many mathematics research seminars is to present ‘an overview of my proof of p ’, and most mathematics research papers are preceded by a short introduction of ‘motivation’ which often includes some outline of the overall structure of the proof. Nevertheless, the main idea of formal proof is the opposite of a global view. It is to break down the proof into a series of small steps, each of which can in principle be verified without reference to anything more global. That is what gives proof its advantage for establishing certainty – once the individual steps are all checked, the whole proof is verified. But it is that very concentration on the local that impedes a global view. What is not easily gathered from a proof as such is a mental structure that directly reflects the structure of the topic of the proof.

That raises certain questions, for example about the nature of the individual steps, and whether there are axioms needed to start the process off (and if so, whether those are self-evident, or arbitrary, or something else). In Aristotelian fashion, let us consider a simple example and see the general in the particular.

We take a ‘bare hands’ proof from combinatorics, an area of mathematics particularly uncluttered with possibly doubtful assumptions (for example, about infinity). The proof was exhibited in Chapter 4, with somewhat different purposes.

Consider six points, with each pair joined by a line. The lines are all coloured, in one of two colours (represented by dotted and undotted lines in the figure). Then there must exist a triangle of one colour (that is, three points such that all three of the lines joining them have the same colour).

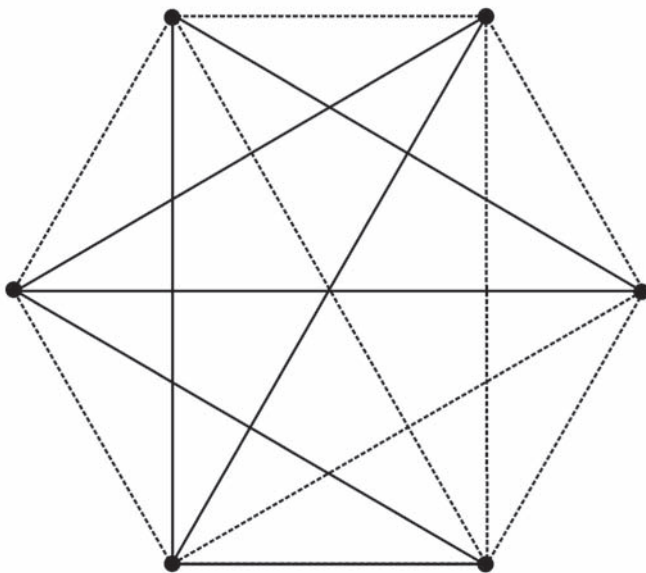

Figure 12.1 Combinatorics with six points again

Note that this result is not suitable for a one-glance visualization ‘proof’, similar to the one in the last chapter that enables understanding of why $2 \times 3 = 3 \times 2$. The reason is the complexity of the possible configurations. We might just be able to visualize a single configuration, as in

the diagram. There is no hope of visualizing all of them, and seeing that they all contain a triangle of one colour.

So we need a proof that can extend our knowledge beyond what is visualizable, by working its way step by step through the complexity.

Proof: Take one of the points, and call it O. Then of the five lines from that point to the others, at least three must have the same colour, say colour A. Consider the three points at the end of those lines. If any two of them are joined by a line of colour A, then they and O form an A-colour triangle. But if not, then the three points must all be joined by B-colour lines, so there is a B-colour triangle. So there is always a single-coloured triangle. QED.

There is nothing in this proof except what Aristotelian mathematical philosophy says there should be – no arbitrary axioms, no forms imposed by the mind, no constructions in Platonist set theory, no infinite sets, no impredicative definitions – only the necessary relations of simple structural universals and our certain insight into them, induced by following a chain of individually clear inferences. A written proof should communicate a sequence of insights to the reader, insights into necessary connections between the (quantitative or structural) universals dealt with by mathematics.¹ That is so irrespective of whether individual proofs can be fitted into an overarching deductive scheme of axioms and theorems, or whether they can be expanded into purely syntactic form.

Let us examine one of the classic proofs of mathematics from this point of view, the proof that the square root of 2 is irrational. At each step, we will take care to see what is used.

'Irrational' is a negative, suggesting the need for a proof by contradiction. A proof by contradiction is unsuitable for visualization – since a contradiction cannot be realized, the (alleged) structure is not there to be visualized. So the consequences of the contrary assumption must be deduced by more strictly logical means.

Proof:

Suppose that $\sqrt{2}$ is rational.

That is, $\sqrt{2} = p/q$, for some integers p and q [that merely explicates the meaning of 'rational']

By cancelling any common factors, we may suppose p and q have no common factors.

So $2 = (p/q)^2$ [that explicates the meaning of 'square root']

So $2 = p^2/q^2$ ['well-known' law of numbers]

So $2q^2 = p^2$ [the meaning of division]

So p^2 is even, so p is even [since it is easily proved that if p were odd then p^2 would be odd]

So $p = 2k$ for some integer k [the meaning of 'even']

So $2q^2 = (2k)^2 = 4k^2$ ['well-known' laws of numbers]

So $q^2 = 2k^2$ [dividing both sides by 2]

So q^2 is even, so q is even [as above]

Thus p and q are both even, hence have a common factor 2, contradicting the assumption that p and q have no common factor.

Therefore $\sqrt{2}$ cannot be rational. QED

The 'disaggregation' provided by the proof comes in two kinds: the first provided by the linear sequences of different steps, and the second by the 'offline' justifications provided for those steps that are not purely a matter of unpacking definitions. The justifications may be either lemmas such as 'that if p were odd then p^2 would be odd', which are of the same nature as the proof itself but smaller; or appeals to 'standard' results that are assumed established at this stage, such as $(2k)^2 = 4k^2$. These are not self-evident and must come from somewhere. In the case of such simple number-theoretic formulas, that could be proof from Peano's axioms, or one could supply understanding through a visualization, such as this one:

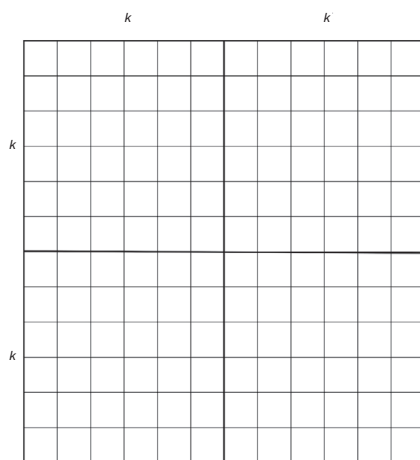

Figure 12.2 Why $(2k)^2 = 4k^2$ (A $2k \times 2k$ square consists of four $k \times k$ squares)

Which of the two approaches is preferable depends on the aim of the exercise. If the aim is to put together a series of insights, individually completely clear, so that the entire proof is both certain and as explanatory as possible, then the proof with visualizations is ideal. If the aim is to situate the proof as a theorem in a deductive system for arithmetic which is as formalized (that is, syntactic) as possible, then a proof from Peano's axioms is better. Those are different aims. The first is of obvious merit and is the one found in normal mathematical proofs, which aim to put together steps capable of being understood. Let us recall the point of the second, purely formal, exercise. It is that visualization, for all its advantages, has a less perfect track record than symbolic reasoning, when it comes to making errors. More will be said about that below.

Symbolic proof 'versus' visualization: their respective advantages

Up to about 1800, there was an easy and uncomplicated relationship between visualization and proof in mathematics. Euclid's geometry, the training ground of all mathematicians, involved essential reference to diagrams in its proofs and a focus on construction (with ruler and compass). Calculus and analysis regularly called on visual intuitions to aid proofs of the properties of continuous functions. Visualization was so intertwined in mathematics that Kant, impressed by Euclid's constructions, made intuition (*Anschauung*) the foundation of his philosophy of mathematics.² Then in the nineteenth century the relationship between visualization and the leading edge of mathematics (and the philosophy of mathematics) soured. In analysis, 'intuitive' conceptions of limits and convergence were found inadequate, in the crucial sense that they led to mistakes that could only be explained by moving to more rigorous, purely symbolic, definitions.³

The central case was Cauchy's error about uniform continuity of functions. To simplify a somewhat confusing history, Cauchy claimed to have proved that the limit of a convergent sequence of continuous functions is continuous. (For example, the sequence of partial sums of a Fourier series would converge to a continuous function.) That is true if the sequence converges uniformly, but not if it converges only pointwise. Cauchy failed to make the distinction and agreed later that he had made an error.⁴ It is one of the very few cases of errors in the full sense made by the great mathematicians (that is, results claimed proved that are false, not mere unclarities in proofs that fall short of later standards of rigour), so the case is historically significant. The distinction between uniform and pointwise convergence is very difficult to draw by visual

intuition (or by using infinitesimals). It is now normally drawn by using the epsilon–delta symbolic definition of continuity, and if that is done, the definitions of uniform and pointwise convergence differ only in the order of quantifiers. (Where pointwise continuity has ‘for all points x , there exists $N \dots$ ’, uniform convergence has ‘there exists N such that for all points $x \dots$ ’) Since order of quantifiers is purely symbolic, that is a very convincing demonstration of the superiority of symbolic methods over visualization in dealing with the conceptual slipperiness of the notion of continuity.

Mathematicians rightly took a ‘once bitten twice shy’ attitude to these errors and came to insist that any visual representations – pictures, graphs, diagrams, and so on – should be banished in final proofs (except possibly as heuristic illustrations) and only rigorous symbols and logic should be left. Cauchy, Cantor, Weierstrass and Dedekind were the architects of the arithmetization of analysis, which expunged the tacit reliance on visual intuitions in the definitions of the real numbers. At the same time, areas of mathematics lacking in visualizability, such as abstract algebra and symbolic logic, came to the fore. Frege too argued for symbols over intuitions, and was followed in that by the formalist and logicist schools in the philosophy of mathematics. Those tendencies were reinforced both by the rigid formalism of the Bourbakist school in pure mathematics and by the development of computing, which relies wholly on discrete uninterpreted symbols.

As argued above, there are good reasons why frontline mathematics should insist on a perfectionism involving proofs as formal and free of reliance on visual intuition as possible. That methodology has led in general to proofs that have withstood the test of time and established mathematical truths finally and in a way surveyable by later trained mathematicians. But that does not support formalist or logicist views that mathematics is actually *about* proofs: in the combinatorial or algebraic proofs above, for example, there is no motivation for regarding each assertion as other than about some external reality. Nor, as I shall argue next, does it suggest that proof has anything especially to do with arbitrary axioms.

Proof: logicist, ‘if-thenist’ and formalist errors

There is an alternative vision of mathematical proof to the conveying-a-chain-of-insights view, a philosophers’ picture arising from the logicist and formalist philosophies of mathematics of a century ago and encouraged by the syntactic point of view necessary for computer programming.

Or rather there are three distinct such visions, which are wrong for somewhat different reasons. The first is the logicist view according to which mathematics just is proof, being a division of logic. The second is a quite different 'if-thenist' view of mathematics, seeing it as science of what can be derived from arbitrary axioms. The third arises from Hilbert's program of formalization and the axiomatizations of set theory and number theory.

Despite logicism having failed as a program more than a century ago, it is still repeated by philosophers ill-informed of developments. Thus Peter Singer writes in a high-profile book on ethics:

The defenders of ethical intuitionism argued that there was a parallel in the way we know or could immediately grasp the basic truths of mathematics: that one plus one equals two, for instance. This argument suffered a blow when it was shown that the self-evidence of the basic truths of mathematics could be explained in a different and more parsimonious way, by seeing mathematics as a system of tautologies, the basic elements of which are true by virtue of the meanings of the terms used. On this view, now widely, if not universally, accepted, no special intuition is required to establish that one plus one equals two – this is a logical truth, true by virtue of the meanings given to the integers 'one' and 'two', as well as 'plus' and 'equals'. So the idea that intuition provides some substantive kind of knowledge of right and wrong lost its only analogue.⁵

That view is not universally accepted, nor widely accepted, nor indeed accepted at all by any living philosopher of mathematics. The reasons are well known. The original proponents of logicism around 1900 found they could not carry through their program of reducing mathematics to logical tautologies without relying on the notion of sets and set membership, which could not convincingly be represented as purely logical.⁶ As I will describe below, it was particularly implausible to claim as logical the Axiom of Infinity (stating that there exists an infinite set). But surely it is not necessary to invoke any such technical problems to explain why the logicist view of mathematics is a fantasy. Once one has appreciated how mathematics gives substantive truths about the quantitative and structural aspects of reality, as described in earlier chapters, there is unlikely to be any remaining motivation for supposing mathematical truths are trivial or tautologous. Surely there is nothing either trivial or logical about, say, the transitivity of greater-than between ratios of heights.

When the logical positivists wished to distinguish sharply between meaningful and empirical scientific statements on the one hand and necessary but trivial logical statements on the other, it was most inconvenient that logicism had turned out to be false. If mathematics dealt in substantive necessary truths, that might open the way to such horrors as substantive metaphysical truths. Since the necessary truths of mathematics could not easily be dismissed as tautologous, the logical positivists (and even to a degree Russell earlier⁷) attempted to rescue the situation with an 'if-thenist manoeuvre'.⁸ It has led to another view of mathematics popular among philosophers outside the philosophy of mathematics, a view distinct from logicism though not always distinguished from it. It holds that mathematics is about what follows from arbitrary choices of axioms. Axioms, it is said, may be freely chosen, and then the business of mathematics is to derive consequences. Putnam attributes not very accurately to Russell an expression of this view:

that mathematicians are in the business of showing that *if* there is any structure which satisfies such-and-such axioms (e.g., the axioms of group theory), *then* that structure satisfies such-and-such further statements (some theorems of group theory or other).⁹

It is true that 'if-thenism' is not refuted by some of the objections that bore against logicism. For example, the non-logical nature of set membership is not relevant, since 'if-thenism' does not claim that the basic statements of mathematics are logical, only the following of some statements from others. Some other objections to 'if-thenism' are required.

The essential problem with 'if-thenism' is that explained in Chapter 5 above. The fact that a body of knowledge, about mathematics or anything else, can be arranged as axioms and theorems is simply due to the ordinary logical fact that 'All As are Bs' is expressible as 'If anything is an A then it is a B'. That does not make categorical facts into hypothetical ones. For example, if ethics becomes axiomatized, there is no temptation to regard it as merely logic. It is just that the total body of ethical facts has a logical structure, with some following from others.

That is well illustrated by the case Putnam gives, group theory. The axioms of group theory are not arbitrary. The main purpose of group theory is to study symmetry by means of symmetry operations (such as reflections and rotations of geometrical figures). It is the nature of symmetry and symmetry operations that the composition of two symmetry operations is a symmetry operation. The first axiom of group

theory states that, and the other axioms of group theory capture the other general features of symmetry operations.¹⁰ The theorems of group theory place restrictions on, for example, the possible shapes of crystals: crystals repeat their shapes so as to fill up space, and as group theory proves, there is a restricted number of possible ways to do so.¹¹ Group theory is a body of knowledge about symmetry, not a set of deductions from arbitrary axioms.

As a philosophy of mathematics, formalism makes the same error as logicism. It mistakes the finger for what is being pointed to. Once it has been established that mathematics deal with real features of the world – its quantitative and structural features – there is little further motivation for regarding any features of the *methods* of mathematics (for example, logical and formal features) as themselves the main objects of mathematics.¹²

However, the projects of logicism and formalism were not a waste of time. They did establish some important technical truths about mathematics, especially about mathematical proof.

Axioms, formalization and understanding

The century-old story of Hilbert's Program, the axioms of set theory and arithmetic, and Gödel's Incompleteness Theorem is well known. We review it briefly here to see how it fits into the Aristotelian story about proof in epistemology that is being told in this chapter.

A true science, according to Aristotle's *Posterior Analytics*, differs from a heap of observational facts – even a heap of true empirical generalizations – by being organized into a system of deductions from self-evidently true axioms which express the nature of the universals involved. Ideally, each deduction from the premises allows the human understanding to grasp why the conclusion must be true. Euclid's geometry conforms closely to Aristotle's model,¹³ making geometry the main vehicle for conveying this aspect of Aristotle's vision into Western civilization. Perhaps those claims were overwrought, but the scholastics were right in highlighting how remarkable human understanding of universals is and how different it is from sensory knowledge. That difference is most obvious in mathematical examples, which is one reason why the philosophy of mathematics is of wide interest to philosophers generally.

To some degree, modern formal mathematics conforms to Aristotle's model. Hilbert's *Foundations of Geometry* (1899) attempted to formalize geometry completely, that is, provide axioms for Euclidean geometry that would produce all the theorems without requiring a human to

understand the meanings of the terms or to use any diagrams or geometrical intuition. As we would say now, the inferences could be checkable by computer, since they would rely on purely syntactic rules. At around the same time, Peano's axiom system for arithmetic and the Zermelo–Fraenkel axioms for set theory were developed, also designed to support purely syntactic derivations of the theorems. The ideal of syntactic derivation is different from the ideal of proof via a chain of comprehensible steps. Indeed, in practical terms, the ideals are often incompatible, in that a purely syntactic proof is too detailed to read; it becomes impossible to see the wood for the trees. In philosophical terms, however, the ideals are compatible and to a degree mutually supportive. If a proof is purely syntactic, there is no possibility of some mistake in human intuition, so it provides the highest possible level of certainty, and the highest possible level of communication of certainty. The three axiomatizations – of geometry, arithmetic and set theory – could claim to be a modern and more perfect realization of Aristotle's ideal: the organization of bodies of knowledge as necessary truths following deductively from self-evident axioms.

As an implementation of that ideal, all three axiomatizations proved to have certain flaws, but perhaps not fatal ones. Hilbert did not quite succeed in making his geometrical derivations purely syntactic¹⁴ (though subsequent axiomatizations have succeeded¹⁵); and in any case there was the problem of what if anything axioms of Euclidean geometry are self-evidently true of, given the existence of non-Euclidean geometries (as discussed in Chapter 9). Recent inquiries on whether the ordinary semi-formal reasoning in mathematics journals can be completely formalized have tended to show that, in general, it can.¹⁶ Formalization of real mathematical reasoning is not a Bourbakist pipe dream.

Peano's axioms for arithmetic did not have the same kind of problem as Hilbert's geometry. They dealt with the fixed system of natural numbers, they were self-evidently true of that system and they generated by purely syntactic means all the main theorems of number theory. Perfectionists did point to the fact that if the axioms were required to be first-order, as demanded by the very highest standards of syntacticity, then the 'axiom' of induction was really an axiom schema, that is, an infinite number of axioms conforming to a common pattern. That can hardly be called a significant flaw in formalization, since it is formally checkable that an axiom instance does conform to the pattern. A much more significant limitation for Peano's axiomatization was the corollary of Gödel's Incompleteness Theorem: that not all truths of arithmetic can be generated from the axioms (and that the defect is intrinsic and

cannot be remedied by adding any surveyable set of extra axioms). The complexity of arithmetic escapes axiomatization. That is certainly some limitation on the success of the axiomatization – and the result is also useful for refuting the philosophical position that truth in mathematics just *is* following from axioms. But that limitation should not blind us to how impressive it is that the main corpus of number theory really does follow by the most formal means from a few self-evidently true axioms.

The problems with the Zermelo–Fraenkel axiomatization of set theory were a little different. Following the discovery of Russell’s Paradox, it became clear that to avoid paradox, there could be no very simple set of axioms for set theory. The Zermelo–Fraenkel axioms proved successful in avoiding paradox (though not provably doing so), while supporting a satisfactorily wide-ranging set theory, including higher orders of infinite sets. But certain of its axioms had the same blemish as Euclid’s fifth postulate, of lacking something in self-evidence by claiming to make assertions about the infinite. The Axiom of Infinity (discussed further below) and the Axiom of Choice, though very reasonable, are not matters of straightforward logic, nor are they truths plausibly claimed to be self-evident to finite minds. The problem was compounded by the proof of the independence of the Continuum Hypothesis from the axioms. The fact that a naturally occurring statement about relatively small and easily understood infinite sets was neither provable nor disprovable from the axioms suggested the same conclusion as Gödel’s result on the complexity of arithmetic: that the subject-matter was inherently too complex to be captured by the axioms.¹⁷ Again, it is very impressive how much is captured by a set of axioms that are either self-evident or, where not self-evident, compellingly natural.

Counting

Counting is not as easy as it looks. Simple perception and subitization can manage very small numbers, visualization smallish ones, but since counting can proceed indefinitely, it belongs in the third and more intellectual stage of mathematical knowledge. That is what Kant says, in recognizing that (in modern terms) subitization might be sensory but counting is intellectual. Counting adds to an at-a-glance estimation of size the thinking of how many times a unit is contained in a quantity. ‘This how-many-times is founded on successive repetition’, Kant says.¹⁸ The immense effort needed to teach four-year-olds to count (and the waste of that effort if applied to dogs) indicates that the epistemology of medium and large numbers is different from that of very small

numbers, in the way Kant explains. Large numbers cannot be counted at a single glance; what is important is the (intellectual) 'schema' of successive addition of units that allows the aggregate to be 'synthesized', that is, counted.¹⁹ Kant attributes to the earliest Greek geometers, the founders of proof in mathematics, the discovery that the necessity in mathematical knowledge comes from assimilating an image or experience to construction or synthesis according to some rule.²⁰ From the Aristotelian point of view, that is correct except for Kant's belief that the forms in question are imposed by the mind instead of being discovered. The unit-making universal such as 'being an apple' structures the aggregate into so many apples, prior to any recognition of its doing so by any mind. Hence careful intellectual work with the universal 'successive repetition' will allow an accurate count of how many times the unit appears in the aggregate (a count expressible with further intellectual work in some structured notation for representing numbers).

There is no inherent limit to counting. That thought prepares us for tackling perhaps the toughest question in mathematical epistemology: how the infinite can be known.

Knowing the infinite

To refute arguments against the intelligibility of infinity, as was done in Chapter 8, is not to show how it could actually be known, given our limitation to the finite. It is evident that direct knowledge of an infinite structure cannot be derived purely from perceptual experience. Our perceptual experience is finite in character; no finite amount of repetition of a single perceptual act will construct an infinite object for us. We cannot literally see an infinite structure (that is, see, of an infinite structure, that it is infinite). Nor can an infinite structure fit in the visualization facility, which as we saw is easily confused by moderate finite complexity.

So the mind will have to work hard on the data of perceptual experience to extract an idea of infinity. As Descartes said in reply to Gassendi, we have a positive idea of the infinite, but this idea is not derived from sensory experience or the imagination, but from the understanding (reason).²¹

But there is a problem. Knowing the most basic fact about infinity – that an infinite set is possible – appears to be beyond the range of proof. At least, it is beyond the range of proof from anything simpler. That is the lesson of the inclusion of the Axiom of Infinity in the standard lists of axioms of set theory, such as those of Zermelo–Fraenkel. The

Axiom of Infinity states starkly, ‘There is an infinite set’, and that axiom is logically independent of the others. Bertrand Russell in *The Principles of Mathematics* asserted that the infinitude of entities was provable by logical means but, by the time of *Principia Mathematica*, he had come to agree that the matter could not be settled by logic. He writes, ‘It seems plain that there is nothing in logic to necessitate its truth or falsehood, and that it can only be legitimately believed or disbelieved on empirical grounds’.²² That remains one of the most difficult obstacles to the logicist project of reducing mathematics to logic. As Kneale and Kneale express the general verdict:

There is something profoundly unsatisfactory about the axiom of infinity. It cannot be described as a truth of logic in any reasonable use of that term and so the introduction of it as a primitive proposition amounts in effect to the abandonment of Frege’s project of exhibiting arithmetic as a development of logic.²³

Since ‘empirical grounds’ are also apparently finite, it is hard to see how they could provide evidence for the (actual or possible) existence of infinitudes. It is hard to see where the resources are to come from for knowledge about infinity. How *can* a finite mind represent or know about an infinite structure? How does the poor, finite mind cope with the vast edifice of infinitary mathematical objects?

It is always desirable to separate ontology and epistemology. But that is especially necessary on the topic of infinity, where, as we have seen, there has been a long history of doubts about the concept on the grounds of the limitations of our finite minds. So let us discuss first what it is for the infinite to exist, then whether we have adequate reason for a realist view of infinity and for a positive evaluation of our ability to know about it.

According to the (Platonist-leaning) Aristotelian philosophy of universals sketched in Chapters 1 and 2, a commitment to the reality of a universal does not imply a commitment to that universal’s being instantiated in the physical (or any other) world. Thus an uninstantiated shade of blue is a genuine universal. Contingent facts about the world determine which universals are instantiated, but it is the business of science to study all universals, instantiated or not. Contrary to Platonism, though, Aristotelianism holds that universals, infinity included, *could* be literally instantiated in the real world.

So to say that a very large finite number (say for definiteness $10^{120} + 127$) or an infinite number (say for definiteness \aleph_0) is a real

universal is not to claim that there are that number of distinct physical objects. But it is to claim that there could be that many physical objects (unless there is something in the nature of physical objects that prevents their proliferation, which is possible but unlikely given what we know of their nature – electrons do not appear to behave like lion kings or jealous gods, trying to prevent the existence of others of their kind).

There is one classic, straightforward and naïve argument which has always been at the heart of belief in large finite and infinite numbers: ‘however many you have, you could always add one more’. It is a sound argument, as it relies on an understanding of number founded on experience of small numbers but to which their being small is not relevant. We see (literally) that adding a parrot to a group of three parrots results in a whole which stands in the relation 4 to the universal, being-a-parrot. Our knowledge that we could do the same to a group of $10^{120} + 127$ parrots and create a group of $10^{120} + 128$ parrots relies on the understanding we gain from smaller cases – that replicability (adding one, or dividing into a new part) is in itself unaffected by the number of existing parts. All that is needed is the non-identity of the new part with existing parts, and ‘not’ and ‘is identical to’ are the most fundamental and topic-neutral of concepts.

If anyone were to object to that reasoning, the onus would be on them to give some account of what size the largest finite number is and why. If an actual infinity is impossible, then there are not infinitely many finite numbers. So there is a largest finite number, and every finite number is some particular finite number. So which one is it? Any reasoning as to which it is should make no reference to limitations of the human mind (or the cat or divine mind either), since the original reasoning in favour of infinity contained only concepts such as replication and non-identity, concepts which have no mentalistic element.

There is, however, no known or suspected asymmetry in numbers such as to suggest that any particular number is the last one.

This argument is stronger than the ancient argument for the infinity of space based upon the thought experiment of throwing a spear at the edge of the universe. If there were an edge to space, what would happen to a spear thrown outwards?²⁴ We understand what is wrong with this argument because, following the discovery of non-Euclidean geometries, we have come to appreciate that it is an empirical question what shape space has, that is, which of the many possible geometrical structures it instantiates. It could be Euclidean or nearly so, or it could have an edge, or it could be finite but unbounded so that throwing spears in a straight line eventually brings the thrower back to his starting point.

Which it is is an empirical question, and a difficult one to answer given the large size of space. Similarly, it is an empirical question how many things there are. We may indeed run out of electrons to count. But the argument ‘we *could* always add one more’ needs only *possible* electrons to add: it applies to an abstract mathematical structure, an Aristotelian universal in the sense described in Chapter 1. (Indeed, the argument requires either an Aristotelian or a Platonist realism even to be stated coherently.) An argument ‘we could always throw a spear further out’ would also be correct in an appropriate mathematical structure, such as three-dimensional Euclidean space. It is just that we do not know whether any part of the physical world instantiates (the whole of) that structure – just as we do not know whether any collection of physical objects instantiates $10^{120} + 127$ or \aleph_0 .

A different argument is needed on the reality of the higher infinities, those beyond \aleph_0 . That is because they cannot be reached by the process of ‘adding one’ or ‘dividing into another part’. Thus one might accept the reality of \aleph_0 but not of any higher infinities. One will accept the reality of the higher infinities if and only if one accepts the power set axiom or some mereological equivalent: that if one has a total consisting of a set or a whole divided into units, then all the subsets (or all the parts consisting of heaps of units) themselves form a totality. This has intuitive appeal, in that it agrees with what we understand in small cases, and their being small appears to have no relevance. And nothing has been found wrong with it in century’s experience with axiomatic set theory. Those are strong but defeasible reasons in favour of the reality of the higher infinities.

13

Explanation in Mathematics

There is a philosophical debate on explanation in science, and a philosophical debate on explanation in mathematics. They have proceeded largely independently of each other. For example, the *Stanford Encyclopedia of Philosophy* articles on ‘Scientific explanation’¹ and ‘Explanation in mathematics’² barely mention any common issues and have only three items in common in their extensive bibliographies. That is strange, since *prima facie* explanation works much the same way in mathematics and in science. An account of scientific explanation is incomplete if it does not cover explanation in mathematics (or at least include some reasoning on why the mathematical case is different).

From an Aristotelian realist point of view, according to which mathematics is a science of certain real-world properties on a par with other natural sciences, it is especially to be expected that explanation in mathematics and science would work similarly. Without providing a complete theory of explanation, this chapter argues that Aristotelian realism is necessary to account for the commonalities between mathematical and scientific explanations.

And surely there are some reasons for considering mathematical explanation first, since it deals with an essentially simpler and clearer subject-matter. A typical explanation in theoretical physics relies on some combination of fundamental laws and mathematical machinery, and it is often hard to judge the relative weights of the empirical and the mathematical. But in mathematics there is no such complexity, so one might hope to isolate there issues about explanation as such. Mathematics is free of possible confusions and red herrings concerning laws of nature, causes, probabilities, or inductive and abductive inferences, all of which are difficult matters tending to complicate accounts of explanation in science. Furthermore, explanation in mathematics is

more fully explanatory, as there is no residue of brute empirical facts or unexplained fundamental constants of nature. In the best cases, we can understand a mathematical explanation so thoroughly that we understand why it must be so, in all possible worlds. Explanations in natural science never quite attain that standard.

As to the notion of 'explanation' in play, it is fortunate that there is general agreement on intuitions as to what constitutes an explanation, and also, by and large, as to what constitutes better and worse explanations of a fact. Indeed, it is that general agreement that creates the 'problem of explanation' in the philosophy of science – given that there is general agreement, what is it, other than the sociological fact of that agreement, that good explanations have in common? It is agreed further that explanation has a dual ontological and epistemic aspect: explanations must point to facts 'in the world' (including general facts such as laws and axioms), but they must also have a particular epistemic effect: they must answer 'why questions', resolving some initial degree of reasonable surprise at the truth of the proposition to be explained.³

I begin with sufficiently many simple examples to illustrate the variety of mathematical explanations. Then I examine how and to what extent standard theories of scientific explanation can account for explanations in mathematics. That will establish to what extent realism in science carries over to realism in mathematics, as regards explanation.

The issues are somewhat different for explanation within pure mathematics, for geometrical explanation in science, and for non-geometrical mathematical explanation in science, so I take these in turn. We will see how explanation in applied mathematics, in particular, is best understood in the framework of Aristotelian realism philosophy of mathematics.

Explanation in pure mathematics

Explanation works in pure mathematics, apparently in much the same way as it works in science. So it is desirable to study explanation first in the comparatively simple, and absolutely necessary, subject-matter of pure mathematics.

David Hume gives a simple example:

It is observed by arithmeticians, that the products of 9, compose always either 9, or some lesser product of 9, if you add together all the characters of which any of the former products is composed. Thus, of 18, 27, 36, which are products of 9, you make 9 by adding 1 to 8,

2 to 7, 3 to 6. Thus, 369 is a product also of 9; and if you add 3, 6, and 9, you make 18, a lesser product of 9. To a superficial observer, so wonderful a regularity may be admired as the effect either of chance or design: but a skilful algebraist immediately concludes it to be the work of necessity, and demonstrates, that it must for ever result from the nature of these numbers.⁴

It does not matter for Hume's purposes whether the (standard) demonstration of this necessity is explanatory or not, but in fact it is:

If a number has digits a_n, \dots, a_1, a_0 , then the number itself is

$$a_n \times 10^n + \dots + a_2 \times 100 + a_1 \times 10 + a_0$$

while the sum of its digits is

$$a_n + \dots + a_2 + a_1 + a_0$$

Thus the *difference* between the number and the sum of its digits is

$$a_n \times 999 \dots 9 + \dots + a_2 \times 99 + a_1 \times 9,$$

which is obviously divisible by 9. So the number is divisible by 9 if and only if the sum of its digits is divisible by 9. QED.

Some essential features of this proof's explanatoriness are:

- the *prima facie* unlikeliness of the result (since only one in nine numbers is divisible by 9, it is surprising if the digit sum of an arbitrary number is divisible by 9);
- the difference being divisible by 9 provides the *link* between each number and its digit sum;
- the link has some kind of *necessity*;
- we (the normally mathematically endowed) can *understand* the link and hence how the proof works.

So an explanation has both ontological and epistemic aspects: the link and how it works in the proof is ontological, while our understanding of it is epistemic – and may be relative to who 'we' are, in that a complex proof may be explanatory 'to the wise' (in Aristotle's words), but merely convincing to those of us more mathematically challenged, who can follow each step but lack a grasp of the whole. (Compare the dual ontological/epistemic nature of proof and of logical probability/degree of belief.) What we contrast with in a why question can also be relative to our interests. Nevertheless, once we have prescind from the epistemic and psychological aspects, the truth-maker of its being

explanatory is something ontological: for example, directness of link between explanans and explanandum.)

We now list some why questions in pure mathematics, chosen for their variety, and add brief comments on the explanatoriness of the proofs that answer those questions:

1. Why is $\sqrt{10}$ a little greater than 3?

[A good proof might begin: $(\sqrt{10})^2 = 10$ (the defining or characteristic property of $\sqrt{10}$ is that its square is 10), which is a little more than $9 = 3^2$, and the square root of numbers grows gradually with the number, so $\sqrt{10}$ must be just over 3.

A less explanatory proof is: $\sqrt{10}$ is calculated to be 3.162... which is a little over 3.

A worse proof is: $\log_{10}(\sqrt{10}) = 0.5$ while $\log_{10}(3) = 0.477 \dots$ so $\sqrt{10}$ is a little over 3.]

2. Why is the square of an even number always even?

[An even number is of the form $2n$ (the defining property of an even number is that it is twice some integer), so its square is $(2n)^2 = 4n^2$, which is even. That is a fully explanatory proof and one cannot ask for reasoning more perfect as explanation.]

3. Why is the sum of the first n odd numbers always a square?

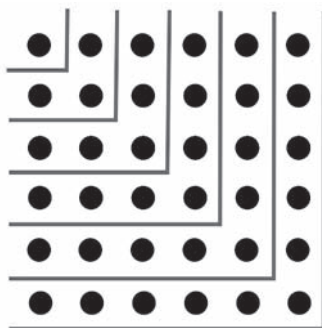

Figure 13.1 Sum of odd numbers is a square

Source: <http://www.ndl.go.jp/math/e/s1/c6.html>, reprinted with permission of the National Diet Library.

[It is possible to proceed algebraically, but it is widely agreed that the following diagram is more explanatory, even if diagrams are not allowed to count as strict proofs. As discussed in Chapter 11, the visualization allows us to see structure that links the odd numbers and being square.]

4. Why is $\sqrt{2}$ irrational?

[The usual proof, given in the previous chapter, is a *reductio ad absurdum*: Begin by assuming that $\sqrt{2}$ is rational, and derive a contradiction. It has been argued that reductio proofs are not explanatory; however, the negative nature of 'irrational' makes a reductio proof appropriate and explanatory (answering the question, 'Why can't it be rational?')⁵]

5. Why does the decimal expansion of a number repeat if and only if the number is rational?

[The proof is similar to example 2 but more complex.]

6. Why aren't all continuous functions differentiable?

[The form of the question makes a proof by counterexample suitable, but it should be a non-mysterious counterexample that shows why any initial contrary expectation was wrong, for example, $f(x) = |x|$.]

7. Why is the general polynomial equation of degree n solvable in radicals only for $n \leq 4$?

[Although the proof introduces a new kind of entity (the Galois group of permutations of the roots of the equation), the proof is felt to get to the heart of the mystery, by explaining the essential difference between the cases of degree 5 and above and the cases of degree 4 and below.]

8. Why is $\zeta(3)$ irrational? (where $\zeta(3)$ is by definition $\sum_{n=1}^{\infty} \frac{1}{n^3}$)

[The proof is one-off (not generalizable to other cases) and complicated though 'elementary',⁶ but could be the best available (there is no paradox in a proof that has few explanatory virtues being nevertheless the best explanation there is).]

9. Why is it always possible to colour a map using only four colours?

[The simplest known proof⁷ is computer-assisted and beyond human surveyability, but may be the best available (the mathematician Herb Wilf commented ‘God would not allow such a beautiful theorem to have such an ugly proof,’⁸ but surely that cannot be taken literally, as God has no choice in the matter since the space of mathematical proofs is not subject to the divine will.)]

10. Why is there the four-digit repetition very early in the decimal expansion of

$$e = 2.7182818284590452353602874713526624977572470936995 \dots?$$

[There is *no* explanation; it is a coincidence – there is no common mathematical explanation for the two blocks of digits being both 1828.⁹]

How do pure mathematical explanations fit into accounts of explanation?

Those examples provide an introduction to the variety of explanations in pure mathematics. In the light of that knowledge base, it is natural to ask which of the standard accounts of scientific explanation could apply to explanation in pure mathematics. Although an account of scientific explanation that purports to apply only to, say, causal explanation is not falsified by an inability to incorporate mathematical explanation, it does owe us some excuses as to why it sees such a wide disparity between the two, when there is *prima facie* considerable similarity in how explanations work across the board.

Some accounts of explanation in science are easily adaptable to pure mathematical explanations, some only with great difficulty. I survey briefly some accounts of explanation, both those developed for science and those with mathematics especially in mind. I begin with theories that are easily adaptable to mathematics (at some risk of being inadequate for the rest of science).

First is the original theory of scientific explanation, that of Aristotle’s *Posterior Analytics*. According to that, true scientific explanation is by syllogism; a middle term B is found which is the cause or reason of the connection between properties A and C, demonstrating why anything with property A must have property C¹⁰. Euclid’s *Elements* conforms well to that plan,¹¹ and the emphasis on the demonstration of necessities in Aristotle’s model makes it more naturally applicable to deductive mathematics than to sciences based on observational or experimental facts.

Mark Steiner advanced a theory of mathematical explanation with some similarities to Aristotle's.¹² Steiner maintains that explanatory proofs are broadly those that flow from the 'characterizing property' of a mathematical entity, a notion close to Aristotle's 'essence'. While it has proved difficult to say exactly what properties are 'characterizing'¹³ and there have been criticisms that Steiner's model does not fit certain cases,¹⁴ it remains an attractive account of why some of the central examples of explanatory proofs really are explanatory. For example, it seems that the first two examples above are straightforward as explanations largely because they start from the essential meaning of the terms (respectively square roots and even numbers) and show very quickly how the result follows from that. Issues as to whether a property used in a proof is really essential (or characterizing or central), have arisen many times, dating from Proclus' complaint that Euclid's proof of the angle sum of a triangle being 180° fails to meet Aristotle's ideal of demonstration because it has to construct exterior angles.¹⁵ The same questions arise in recent accounts of why proofs by mathematical induction seem not generally as explanatory as (equally simple) alternatives.¹⁶

Among the theories of explanation devised mainly for natural science, the unification theory of Kitcher¹⁷ is most easily extended to be applicable to mathematics as well. It sees explanation as deriving from the unifying of diverse phenomena from few principles. Successful explanation, on that view, consists in reducing the number of brute unexplained facts by deriving some from others. As far as possible, the number of different patterns of derivation should be minimized (by finding the same derivations in different areas), while the number of derived conclusions should be maximized. Axiomatization in mathematics could well fit that model, since it involves the derivation of many theorems from a small number of axioms, and it is undoubtedly true that unification by axiomatization is a mathematical virtue.¹⁸ However, Kitcher's theory has been widely criticized for its difficulties in accounting for some forms of scientific explanation, and similar criticisms would apply if it were applied to mathematical explanation. For example, it seems to be inapplicable to 'one-off' explanations such as example 8 above, and the examples in general do not suggest a leading role for axioms in explanation.¹⁹

The older deductive-nomological theory of scientific explanation, according to which a phenomenon is explained by showing that it is an instance of a covering-law,²⁰ could also well apply to mathematics. At least, it could if mathematical laws such as 'all triangles have angle sum 180° ' are allowed to count as laws, and there seems nothing to prevent that in the initial motivation for considering covering laws. However, as

with the unification theory, it is widely agreed the covering-law model is inadequate as an account of scientific explanation, and the reasons for that reoccur in the mathematical case. For example, although ‘all multiples of 9 have digit sum divisible by 9’ may be a mathematical law, in the sense of a true universal generalization, the explanation does not work simply by referring individual cases to the law and leaving it at that. Instead, the explanation involves proving the necessity of the link (in a straightforward way), the necessity being then applicable to each individual case. The law does not seem to carry the explanatory weight, while the link’s working in the individual case bypasses reference to the law.

In the literature on scientific explanation, discussion has tended to move away from covering-law and unificationist models to theories involving causality, which are much less easily applicable to explanations in pure mathematics. Accounts of scientific explanation that involve causal-mechanical models, statistical relevance, contingent laws or increased probabilification, manipulability or transmission of marks or energy,²¹ however successful with scientific explanations, have little prospect of being applicable in the acausal and deterministic realm of pure mathematics. Any attempt to apply such models to pure mathematical explanation would require considerable reinterpretation of the terms of the models, and that has not been attempted.

Again, it must be emphasized that an account of causal explanation cannot reasonably be faulted for failing to account for something that is acausal. It is just that the commonalities between scientific explanation and mathematical explanation, which are clear at the intuitive level of ‘finding connections that explain initially surprising phenomena’, remain unaccounted for on a causal theory of explanation.

Before leaving the topic of explanations in pure mathematics, it is worth noting that philosophies of mathematics themselves seem to be irrelevant to the question. One may have a Platonist, nominalist, logicist, formalist, structuralist or Aristotelian realist philosophy of mathematics, without being any the wiser as to why one proof is more explanatory than another. One reason for that is surely that those philosophies are fundamentally theories of mathematical ontology – of the nature of mathematical entities – whereas explanatoriness is partly epistemological, involving a relation of mathematical proofs to our cognitive faculties, a matter which is barely addressed by those philosophies. The issues are thus relevant to Chapter 11, where the role of understanding in mathematical epistemology was emphasized. Explanation is about answering a why question, thus about understanding why things must be so.

Geometrical explanation in science

Explanations of natural phenomena in terms of pure geometry are very common, but have not been much discussed in theories of scientific (or mathematical) explanation. That is surprising, as they are often very convincing and complete explanations, and the geometrical properties in terms of which the explanations proceed are clear and unambiguous.

As with explanation in pure mathematics, let us begin with a classic example, and reuse Euler's explanation of why it is impossible to walk over the bridges of Königsberg once and once only.²²

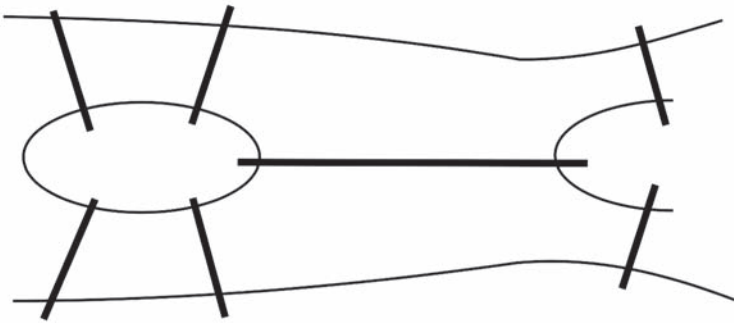

Figure 13.2 The Bridges of Königsberg again

Euler proved that, as the citizens of Königsberg suspected, it was impossible to walk over all the bridges, without walking over at least one of them twice. His proof is purely in terms of a very general aspect of geometry – the topology or interconnections of the bridges and land areas (Euler begins his paper by noting it belongs to a new, non-quantitative part of geometry, the ‘geometry of site’). There is no idealization or approximation involved in drawing the diagram; although a simplified representation of the city, it contains all the relevant geometrical features and the proof applies directly to the system of real bridges and land areas, demonstrating an impossibility about physical reality. Euler's reasoning is perfect as an explanation.

By way of examples, we list some well-known why questions in science, the answers to which are geometrical explanations:

- Why do eclipses of the moon occur at full moon?²³

- Why do circular wounds heal more slowly than long narrow ones? (Aristotle says ‘To know that circular wounds heal more slowly belongs to the doctor, but to know why belongs to the geometrician.’²⁴)
- Why do hive-bee honeycombs have a hexagonal structure?²⁵
- Why are snowflakes hexagonally symmetric?²⁶
- Why do cyclones circulate anticlockwise in the northern hemisphere but clockwise in the southern hemisphere?²⁷
- Why does the rainbow have the colours it has, and the angles it has?²⁸
- Why would the curvature of space explain how paths of moving objects diverge or converge, in the absence of forces?²⁹
- In a diagram such as Figure 13.3 of a complex water mill mechanism, why do the wheels turn whichever way they do turn?

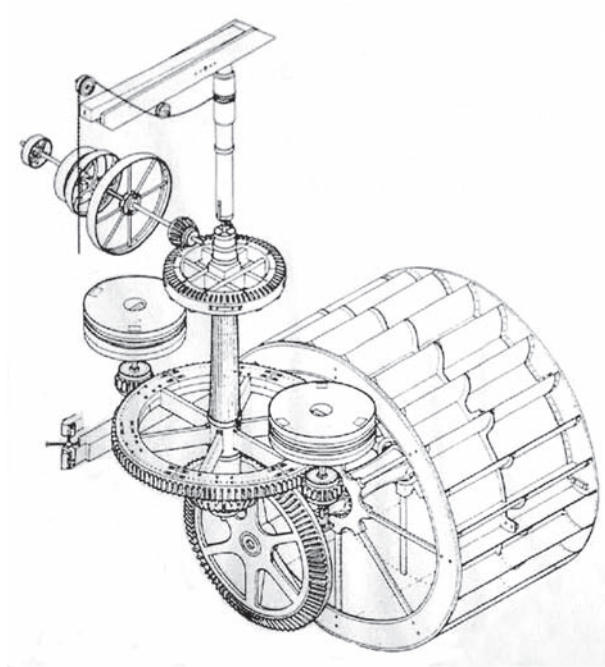

Figure 13.3 Watermill gearing, Worthing, Norfolk, 1876

Source: <http://www.norfolk Mills.co.uk/watermill-machinery.html>, copyright www.norfolk Mills.co.uk, reprinted with permission of Jonathan Neville.

This last example is particularly interesting in view of the frequent talk of ‘causal-mechanical’ explanations in theories of scientific explanation.³⁰ It is surprising how rarely those theories use examples that are literally *mechanical*, in the sense of mechanisms with levers and gearing, whose causal operations can be explained wholly in terms of geometry (supported by the rigidity of the parts, that is, their disposition to maintain their geometry).

Whatever the correct theory of scientific explanation is, it ought to be easy to apply it to explanations by geometry. On an Aristotelian realist theory – indeed, on almost any theory – shape, size and other geometrical properties have causal power and are perceivable and measurable in just the same way as other scientific properties like colour. Indeed, they are particularly easy to perceive and measure, compared to hidden causes like atomic structure.

Some account must be given, however, of why geometry is especially mathematical, in the sense of being subject to proof. To do so would require a philosophy of geometry that carefully separates empirical questions, such as what shape space has (for example, what dimension and curvature) from mathematical ones (such as the deductive structure of Euclidean geometry). That work was begun in Chapter 9 above. While the result is not essential for gaining a basic grasp of geometrical explanation in science, it would help with understanding one of the main advantages of geometrical (or other mathematical) explanation. Because mathematics is subject to insight and proof and so is open to the understanding, a mathematical explanation is superior *as explanation* to a non-mathematical causal or covering-law one. Thus it is an advance to replace a ‘black-box’ explanation of the movements of a clock’s hands with one that explains them in terms of the geometry of the internal clockwork, or to explain an experimentally established drug effect in terms of protein folding.³¹

Non-geometrical mathematical explanation in science

There are a number of explanations of scientific phenomena in which the weight of the explanatoriness falls on the mathematics. Below is a list of some why questions in natural science, the answers to which are mathematical (non-geometrical) explanations:

- Why are the life-cycles of certain cicadas a moderately large prime number of years?

[This example has been much discussed because it seems that number theory is essential to the explanation – having a large prime cycle allows the cicadas to avoid the cycles of predators, who could otherwise ‘lock’ their cycles to that of the cicadas so as to be prolific in the same years as the cicadas. The debate has largely responded to Baker’s claim that the case supports an indispensability argument for a Platonist view of numbers;³² respondents have attempted to recast the example in nominalist or at least non-Platonist terms (without distinguishing the two clearly)³³ or posed problems for Platonism such as understanding the relation between the Platonic entities and the modelled phenomena.³⁴]

- Why does a population growing at $x\%$ per year take about $70/x$ years to double? (If x is not too large.)

[This requires a simple calculation with the exponential solution of the equation expressing the $x\%$ growth rate.]

- Why do planets and some predator–prey populations cycle (repeatedly come back to their initial position)?

[Planetary motion and predator–prey interactions are governed by similar differential equations, the solutions to which are periodic.³⁵]

- Why are there animals with spotted bodies and striped tails but none with striped bodies and spotted tails?

[The explanation is in terms of the solutions of the reaction–diffusion equations governing coat pattern formation in the embryo.³⁶]

- Why is weather hard to predict?

[The Navier–Stokes equations that govern atmospheric flow are chaotic – they have a strong tendency to produce turbulence and eddies which make the prediction of the future very difficult beyond the very short term.³⁷]

- Why cannot a falling body have speed proportional to the distance fallen?

[Galileo considered two alternative theories about the speed of a falling body: that it is proportional to the time taken or to the distance traversed; then in a brilliant piece of bare-hands mathematical reasoning, he showed that the latter is absolutely impossible.³⁸]

- Why is every rigid 3D motion with a fixed point a rotation about some axis?

[The most natural explanation is in terms of the algebraic structure of the group of matrices that express rigid motions with a fixed point in 3D.^{39]}

- Why are experimental errors normally distributed?

[Poincaré said, ‘Everybody believes it, M. Lippmann said to me one day, for experimenters suppose that it is a theorem of mathematics, mathematicians that it is an experimental fact’.^{40]}

- Why is Intelligent Design theory wrong/right?

[The ID arguments against Darwinian evolutionary theory are mathematical: that ‘irreducible complexity’ cannot evolve along a near-continuous pathway by a random search process such as natural selection acting on chance mutations;⁴¹ in the absence of direct observational evidence, the replies must also be mathematical.^{42]}

For completeness, below are a few examples of mathematical explanations in the formal sciences (or ‘sciences of complexity’ or ‘sciences of the artificial’), the mathematically based sciences such as operations research, systems engineering, computer science and statistics that have developed in the last eighty years in the space between mathematics and the natural sciences (as described in Chapter 6 above). Some why questions from them, the answers to which are mathematical explanations, are:

- Why cannot a computer play chess by searching all the possible moves?
- Why are opinion surveys based on large random samples generally reliable?
- Why is it impossible to divide the octave into twelve notes so that all the important harmonies (major third, major fifth, etc.) are exact?⁴³
- Why do buses come in twos?⁴⁴

Whatever the correct theory of scientific explanation is, it would be directly applicable to such cases of mathematical explanation in science, if physical and other objects had mathematical properties in virtue of which the explanations worked. That is what an Aristotelian realist

philosophy of mathematics claims. For example, rather than taking a Platonist view of prime numbers, one should see cicada lifetimes as having the real quantitative property of discrete temporal length. Primeness is a real property of that length (in something the same way as brightness is a real property of colour, itself a real property of physical things). Such properties (like geometrical properties) have causal powers and are perceivable (in simple cases, at least).

Aristotelian realism for explanatory success

There is a great variety of mathematical explanations, both within mathematics itself and in applications of mathematics to the sciences. They provide a test-bed for theories of explanation, as they provide clear insights into why mathematical and scientific phenomena, initially surprising, must be as they are.

Standard philosophies of mathematics, and standard philosophical accounts of scientific explanation, equally fail to cast much light on mathematical explanation. That is no doubt initially because of their failure to address the problem of mathematical explanation directly, a failure understandable in terms of the purposes for which those theories were mainly developed (respectively, the nature of mathematics, in the case of philosophies of mathematics, and understanding causal and law-based explanations, in the case of theories of scientific explanation).

However, it is unclear how to extend those theories to cover mathematical explanations, and attempts to do so face some serious obstacles. Philosophies of mathematics developed to account for pure mathematics, like Platonism and logicism, have difficulty with applied mathematics in general, as argued in previous chapters, but even as regards pure mathematics, there is no obvious role in those philosophies for the notion of explanation, with its mixed ontological and epistemic aspects. For example, logicism, for all its emphasis on proof, seems to provide no resources for distinguishing between explanatory and non-explanatory proofs. Accounts of scientific explanation, meanwhile, have come to emphasize more and more the role of causality and laws of nature, thus moving away from the possibility of covering mathematical explanations.

An Aristotelian realist philosophy of mathematics provides an initial hope of recovering the unity of explanation across both mathematics and the sciences. It regards the physical world as possessing quantitative and structural properties, such as ratios and symmetries, which are perceivable and have causal powers similar to other natural properties

studied by science. The internal relations of such properties are studied by pure mathematics, while the properties as possessed by real objects are studied by applied mathematics. Thus any account of explanation in science should be able to transfer to an account of explanation in general, covering both mathematical and scientific explanations.

However, the possibility of explanation in pure mathematics suggests that the transfer of ideas should not just be one way. There is something to learn about explanation in general from the mathematical case: that an exclusive focus on causal explanation is too narrow, and that one should make sure that accounts of explanation cover those that explain in terms of the logical connections between properties, not just the causal connections.

14

Idealization: An Aristotelian View

One major objection to the Aristotelian view that mathematics studies real features of the world is that it often seems to study not reality but idealizations. Aristotle himself described the Platonists arguing that geometry studies perfect lines and circles, which cannot be realized in the physical world and hence must exist in some non-physical realm:

For neither are perceptible lines such lines as the geometer speaks of (for no perceptible thing is straight or curved in this way; for a hoop touches a straight edge not at a point, but as Protagoras said it did, in his refutation of the geometers).¹

The objection goes as follows: Geometry does not study the shapes of real things. The theory of spheres, for example, cannot apply to bronze spheres, since bronze spheres are not perfectly spherical.² Those who thought along these lines postulated a relation of ‘idealization’, variously understood, between the perfect spheres of geometry and the bronze spheres of mundane reality. Any such thinking, even if not leading to fully Platonist conclusions, will result in a contrast between the ideal (and hence necessary) realm of mathematics and the physical (and contingent) world.

The objection is still current. Thus Pincock, in setting the scene for work on how mathematics contributes to scientific understanding, dismisses the ‘exaggerated’ metaphysical conception, according to which ‘an inventory of the genuine constituents of the physical world reveals that these constituents include mathematical entities’. His argument relies on a certain view of idealization:

it is hard to deny that there are certain cases that fit the metaphysical conception of the contribution of mathematics to the success

of science. At the same time, there is good reason to think that this cannot be the whole story. In the vast majority of cases in which we find mathematics being deployed, there is little inclination for the scientist to take the mathematics to reflect the underlying reality of the phenomenon in question. We see this, for example, whenever a representation employs a mathematical idealization. An idealized representation, for my purposes, is a representation that involves assumptions that the agent deploying the representation takes to be false. When a fluid is represented as continuous, even though the agent working with the representation believes that the system is discrete, then we have some useful mathematics that resists any simple metaphysical interpretation.³

Similarly Saatsi, discussing the modelling of soap films with Plateau's (mathematical) laws, argues:

Some kind of Aristotelian realism about mathematical properties perhaps allows a little more room for linking mathematical and causal properties. Franklin [2009] presents mathematics as a 'science of quantity and structure', both construed as universals that can be instantiated in the physical world. Could we not entertain the idea that in this metaphysical framework physical soap films exhibiting Plateau's laws can be viewed as instantiating the relevant mathematical properties? But, of course, no real soap film actually instantiates the *exact* properties investigated by a mathematical theory of minimal surfaces (e.g. geometric measure theory): what we have are idealized mathematical models of real soap films that ignore forces other than those that keep the film together.⁴

Batterman argues similarly that idealizations are a problem for any 'mapping account' of how mathematics applies to the physical world, that is, an account involving some kind of 'map from a mathematical structure to some appropriate physical structure'. While that is a Platonist way of putting it, as it involves a separation between the abstract world of mathematics and the physical world, Batterman's objection from idealizations would apply equally well to an Aristotelian realist view that sees no such separation. His objection is:

The problem is simple: Nothing in the physical world actually corresponds to the idealization. So, in what sense can we have a mapping from a mathematical structure to an existing physical structure?

Mapping accounts are representative and good representations reflect the truth about the world. Idealizations, however, are false.⁵

(On the Aristotelian view, there is no mathematical structure in addition to the physical structure: the mathematics studies the structural aspects of the physical structure directly; but the objection then still applies, as the idealization would be a false statement about the physical structure.)

Plainly, there is something natural about thinking there is some gap between mathematical idealization and reality. That is understandably taken to be an argument against an Aristotelian realism about mathematics. Since idealization is a genuine phenomenon in mathematical science, an Aristotelian philosophy of mathematics will have to give an account of it.

The account has four stages:

- There are many cases where applied mathematics applies *directly* without any idealization or model–reality gap; in those cases the world does literally and exactly have the structure described by the mathematics.
- In some other cases, such as perfect circles, ideal gases and frictionless planes, the real world is indeed modelled by a simpler structure, which is an uninstantiated universal in the sense of Chapter 2. But the relation between the simpler structure and the real one is not a mysterious Platonic idealization but *approximation*, and the relations of approximation between the simple and complex structures should be subject to mathematical proof.
- Certain other cases, such as negative and complex numbers and ideal points at infinity are different; they are relatively simple mathematical structures which are realizable in principle, though their use often depends on a mathematical relation to actually realized structures which they conceptually ‘round out’.
- *Zero* and the empty set are different again. They are constructions or fictions which aid reasoning about other mathematical structures.

Applied mathematics without idealization

Let us first take up Pincock’s concession that ‘it is hard to deny that there are certain cases that fit the metaphysical conception of the contribution of mathematics to the success of science’. If *all* applications of mathematics to science involved idealization, that would be a more serious problem for Aristotelianism than if some did and some didn’t: if some

applications don't involve idealization, then there is no problem with a straightforward Aristotelian account of them, and conversely there is a problem for Platonist or nominalist philosophies that fail to acknowledge such cases.

As we saw in several previous chapters, the case of the Königsberg bridges is of that kind. The mathematically proved impossibility of walking across all the bridges without walking over one of them twice applies to the system of bridges and land areas directly, not to any idealization or model of them. That is because the bridges and land areas literally have the structure of connections to which the proof applies. The model does leave out or abstract from some aspects of the situation, such as the size of the land areas, but those are irrelevant to the proof. What the proof says about the mathematical structure relevant to the problem, namely the connections between areas, is literally and exactly true of the real system of land areas and bridges.

At an earlier stage of mathematics, the same is true of the simplest applications of the natural numbers to counting. If I put two rabbits and two rabbits in a box and later observe five rabbits in there (without any having entered), it is the fact that $2 + 2 = 4$ that allows me to infer they have bred. The possible existence of borderline cases of discrete (unit-making) universals like *rabbit* and *apple*, such as half-grown or half-decomposed or half-coalesced ones, does not affect that: clear and unambiguous instances of unit-making universals obey the laws of arithmetic exactly. '2 rabbits plus 2 rabbits are 4 rabbits' is as exact as $2 + 2 = 4$. No idealization is needed.

It is no accident that network topology and arithmetic are both discrete structures. Typically, discrete structures can be exactly instantiated in the real world. A normal family tree, for example, is really exactly a *tree* – a network that branches without cycles.

The existence of such cases of exact modelling, even if there were few of them, is a severe problem for a Platonist view of idealization. Platonism requires that there should always be a gap between mathematical idealization and reality. But the common view that 'all models are idealizations and are limited in their applicability'⁶ is false (unless of course one defines 'model' in such a way that it is necessarily a simplification of reality). There are many examples where there is no model-reality gap, hence no motive for Platonism.

Approximation with simple structures, not idealization

It has been argued that even if cases of exact modelling like Euler's bridges are possible, they are rare because typically a mathematical model or

computer simulation is a simplification or idealization of the real situation it models (and hence that any certainties proved about the model do not carry over to certainty about the situation modelled). 'But in the majority of realistic modelling situations', it is claimed, 'the models involved are simplified abstractions of the real system, and strict isomorphism between the model and the physical system is impossible to establish.'⁷

Certainly there are very many cases where applied mathematics does proceed by the use of simple models, mathematical structures that are not literally exactly true of the complicated real world situation modelled. The geometry of perfect circles is used to study wheels and coins, continuous flows are used to model the movements of discrete heaps of atoms in a real fluid, frictionless planes are used to model motion on real planes with friction. And if we model coins by perfect Euclidean circles and use that model to calculate their area, and similarly with the other examples, the answer will not be exactly true.

Any tendency towards a Platonist reaction to these cases should pause in the face of the meanings of 'simple' and 'exact', and their opposites. The opposite of 'simple' is 'complex' and the opposite of 'exact' is 'approximate' or 'imprecise'. That is, the same kinds of entities (for examples shapes) are simple and complex, and the same kinds of entities are exact (circles, say) and approximate. A simple shape is not more Platonist, unreal or abstract than a complex one. A particular shape of some inexact circle (such as the shape of a particular real wheel) is just as much, or as little, abstract or ideal as an exact circle.

The Aristotelian view of idealization in effect replaces idealization, conceived in any way Platonistically, with approximation. Typically, a complex real-world situation is modelled by a simple mathematical model, which is a possible structure that approximates (in a straightforward and measurable mathematical sense) the actual structure:⁸ it is a universal of the same kind as the actual structure, but possibly uninstantiated. (Recall that an account of uninstantiated universals was given in Chapter 2.) The one thing agreed by all writers on the topic is that an idealization deals with a simplification of the real situation – that is what makes it easier to deal with and possibly more explanatory. But a simple structure is still a structure of the same kind as the complex one: a perfect circle is as much a shape as an imperfect one.

That leaves the question of why working with the simple structure should tell us anything useful about the actual complex structure. The answer to that is mathematical, not philosophical.

Let us see what this means in the classical case of the perfect spheres of the geometer and the bronze spheres of the real world. Bronze spheres

are not perfectly spherical. So how can the study of perfect spheres help with them? Is there not a reality–idealization gap?

No. It has been found that the problem was simply a result of the primitive state of Greek mathematics. Ancient mathematics could only deal with simple shapes such as perfect spheres. Modern mathematics, by studying continuous variation, has been able to extend its activities to more complex shapes such as imperfect spheres. That is, there are results not about particular imperfect spheres, but about the ensemble of imperfect spheres of various kinds.⁹ For example, consider all imperfect spheres which differ little from a sphere of radius one metre – say which do not deviate by more than one centimetre from the perfect sphere anywhere. Then the volume of any such imperfect sphere differs from the volume of the perfect sphere by less than one sixth of a cubic metre. So imperfect-sphere shapes can be studied mathematically just as well as – though with more difficulty than – perfect spheres. But real bronze things do have (exactly) imperfect-sphere shapes, without any ‘idealization’ or ‘simplification’. So, mathematical results about imperfect spheres can apply directly to the real shapes of real things.

Note how this story replaces idealization with approximation. Instead of a supposed relation between a messy real-world bronze sphere and an idealized mathematical perfect sphere in a Platonic realm, there is a relation of approximation between two shapes, entities of the same sort (perhaps parts of space), namely the exact shape of the imperfect bronze sphere, and a definite perfect sphere close to it. Whereas a relation between a physical entity and a Platonic one is obscure, the relation of approximation between shapes is perfectly clear: it means that the boundaries of the two shapes are never far apart (say less than one centimetre).

Note also the consequence of having a fully specified mathematical relation between perfect and imperfect sphere: the relations between them, such as closeness in volume, are not a question for philosophy but are mathematically provable. If an imperfect sphere differs from a perfect one of radius 1 metre by less than one centimetre anywhere on the boundary, then it lies between spheres of radius 0.99m and 1.01m, and so has volume between the volume of those, which are respectively 4.06 and 4.32 cubic metres (compared to 4.19 for the perfect sphere of radius 1m).¹⁰ So we can calculate exactly how much margin of error the volume has. The volume lies within provable limits and there is no need for hand-waving philosophical arguments about the relation between perfect and imperfect spheres or between abstract entities and the physical world.

That is confirmed by the fact that it is quite different for surface area. An imperfect sphere that lies within 1 centimetre of a perfect sphere of radius 1 metre can have a surface arbitrarily pitted, textured and fractal, and hence can have a surface area arbitrarily much larger than the surface area of the perfect sphere. That is again a purely mathematical fact.

In general, it has come to be appreciated that to be useful, mathematical models of continuous systems must be 'structurally stable',¹¹ that is, their (qualitative or approximate quantitative) predictions are insensitive to small changes. Since all measurements are subject to small errors, and all things subject to small fluctuations, any model must be such that what it predicts is only slightly affected by such small variations. The model is then said to be structurally stable. For example, if we model a chicken in an oven by a sphere to estimate the time needed to cook it, then a small change in the radius, or a small change in shape away from a sphere, will have only a small effect on the estimated cooking time. If that were not true, the model would be useless for prediction. It is no use a theory predicting some result only for an exact sphere of radius exactly 1 metre, since no body will be exactly this shape and size, and even if it were we could not measure it exactly.

Being a circle itself is not structurally stable, in that a slightly deformed circle is not a circle. But the theory of circle area is structurally stable, in the sense just explained, that slight variations from circular shape create only slight changes in area. Similarly with the predictions of typical chaotic dynamical models: the qualitative predictions of the model do not change at all if the inputs or parameters vary slightly – the individual trajectories do change, but the observable long-term average behaviours do not. It follows that accuracy of measurement of the inputs or parameters is not needed for certainty of the long-term predictions. In a particular case, one will need to know something about how robust the model actually is to changes – but that is a purely mathematical fact about the model, itself knowable with the certainty of proof.¹²

In such cases, we can directly answer the standard problem raised for idealizations: how can assuming something false help find the truth? As Pincock puts it:

The problem with mathematical idealization should now be clear. What guarantee is there that the results of employing these false assumptions will be representations? Or, more precisely, as representations may be ranked in terms of their accuracy and adequacy, why should making false assumptions contribute to the production of *good* representations? The mystery is especially urgent in these sorts of cases as it looks like the only motivation for making false

assumptions is so that we get, in the end, a mathematical equation that we can more easily work with.¹³

The answer is supplied not by philosophy but by mathematics. If the model is structurally stable, its results must be approximately true of the real situation it models. This 'must' is subject to the guarantee of mathematical proof. But it needs to be supplemented by measurement, to discover how close the real situation really is to the simple model – for example, for a stable model with frictionless planes to apply approximately correctly to planes with friction, the friction must be sufficiently small, and that is an empirical fact that must be determined by measurement.

A favourite topic in discussions of idealization is the taking of limits so that some infinite structure is used as an idealization of something more messy and finite. In a typical example, a flow of many discrete atoms is idealized as the flow of a continuous fluid, which makes the mathematics much more tractable. We have treated such cases in Chapter 8, on infinity. Such idealizations work if and only if the behaviour in the infinite or continuous case really approximates, in a straightforward quantitative sense, the behaviour of the finite, actual case. That is a matter subject to mathematical proof if we know well the discrete and continuous structures. If we do not, as in the case of fluid flow where the discrete reality is not perfectly known, there is relevant empirical evidence: when parallels are observed between the predictions of continuous dynamical theory and the experimental behaviour of real fluids, that gives good though defeasible evidence that the true discrete flow structure is one that literally approximates a continuous flow, in the same way as a discrete Riemann integral approximates the integral of a continuous function. Once approximation is established by mathematical and experimental means, there is no need or room for further purely philosophical disquisitions of the mysteries of idealization.

Negative and complex numbers, ideal points, and other extensions of ontology

It is clear that an analysis in terms of approximation cannot apply to cases of 'ideal entities' like points at infinity or complex numbers or infinitesimals. A point at infinity is an addition to ordinary lines or planes, and the resulting enlarged structure is not an approximation to the original one. The expansion of the number system to include negative numbers as well as positive ones, or complex numbers as well as real numbers, has nothing to do with approximation: it involves some

kind of 'rounding out' of the ontology in the interests of theoretical unity and understanding, of 'conceptual simplification by existential closure'.¹⁴

There are two directions in which an Aristotelian theory of such ideal entities could go – one fictionalist and one realist. The Aristotelian is not committed to realism at this point, despite his generally realist predispositions. His realism about, for example, the most central mathematical entities like natural numbers and ratios need not imply a commitment to everything that the fevered imaginations of mathematicians might dream up.¹⁵ A fictionalist account of some mathematical entities is consistent with a realist account of others. Nevertheless, any fictionalist account would need to explain why the fictional entities are assigned some properties and not others, and how they perform whatever mathematical task they do perform. 'Mental beings with foundation in the real' (in scholastic terminology) need to have explained what their foundation in the real is. Clearly, the more foundation in the real a fiction turns out to have, the less genuinely fictional it is – the foundation is doing the heavy lifting, and the fiction and naming are a matter of convenience and accommodation to human modes of thinking and communication.

On the other hand, one might pursue the realist option more tenaciously. The Aristotelian will not easily give up the search for the realization of mathematical concepts. Given our understanding of the structure of, say, the negative and complex numbers, one can ask, are there uncontroversially real entities which instantiate those structures? If so, then those structures have the same status as natural numbers: they are realizable, and there is no further question, for the Aristotelian, as to whether those realizations are the 'true' negative or complex numbers. The situation is parallel to the case of natural numbers, where 4 is just what the relation between a parrot heap and being-a-parrot has in common with the relation of a ball heap and being-a-ball, and talk about the abstract number 4 is just a Platonistically inspired epiphenomenon possibly useful as a psychological crutch to mathematical discovery. In the same way, if there are real entities that instantiate the structures of the negative or complex numbers, those structures are just what the entities have in common.

Instantiations of the negative and complex numbers can indeed be found. Let us start with the negatives. It is true that the standard interpretations of natural numbers and real numbers as quantities, given in Chapter 3 above, do not extend to negative quantities. If 4 is the relation that may hold between a heap of parrots and being-a-parrot, then there

is no heap of ‘negative parrots’ that could stand in the relation -4 to being-a-parrot. Likewise, if 1.27 is the ratio of your height to mine, there are no entities with negative heights which could stand in the relation of -1.27 to my height.

But there are some other kinds of quantities that do stand in negative relations, in that one quantity can cancel out its opposite. That is so with displacements in a line.¹⁶ A movement of one metre west is the negative of a movement of one metre east, in that the combination of them, in either order, results in no movement. Since arbitrary positive ratios are realized in displacements east, arbitrary positive and negative ratios are realized in displacements east–west. The physical meanings (in this model) of mathematical facts about negatives are also clear; for example $2 \times -7 = -14$ means that a displacement 7 west, doubled, is a displacement 14 west (or cancels a displacement 14 east).¹⁷ Therefore, the system of positive and negative numbers is capable of realization in physical reality. Negative numbers do not need to be regarded as fictions.

Let us introduce another realization of the negative numbers, which has the advantage of highlighting multiplication. It will be useful when it comes time to ask about the realizability of the complex numbers.

Take the Euclidean line or the Euclidean plane (with an origin identified).¹⁸ Then a dilation of the line or plane, or expansion or blow-up by a factor r , is the map that expands the plane from the origin by a factor of r (for any positive real number r). The point (x, y) is taken to (rx, ry) . Blow-ups of photographs, projections onto screens and so on implement such maps (approximately).

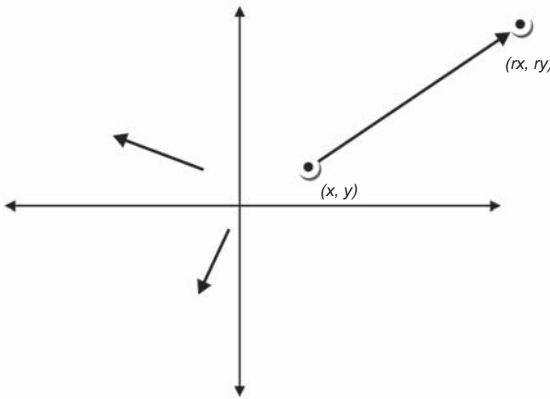

Figure 14.1 Dilation of the plane by a factor r

For each (positive) ratio r , there is a dilation of the line or plane by a factor r . Thus the full spectrum of ratios is realized in the dilations. Composition of dilations implements multiplication: if we dilate the plane by a ratio r , then dilate it by any other ratio s , the end result is a dilation by rs .

A negative dilation makes sense. For a positive ratio r , a dilation of $-r$ means a dilation by r , with a reflection through the origin: (x, y) goes to $(-rx, -ry)$. So a dilation of -1 is just reflection through the origin.

This model of multiplication resolves the puzzlement common among those who first try to learn about negative numbers, expressed in the old rhyme:

*Minus times minus equals plus
The reason for this we need not discuss.*

Minus times minus equals plus because two reflections through the origin cancel out.

Now we are in a position to ask about complex numbers. Can the square root of minus 1 mean anything? In this model, it would have to mean an operation which, composed with itself, gives reflection through the origin (that is, the -1 in the model).

That is not easily done in the line, but it is easily done in the plane¹⁹ (which was why the model of dilations in the plane was introduced). Rotation through 90 degrees around the origin (either clockwise or anti-clockwise) is an operation whose square is reflection in the origin. The composition of two 90-degree rotations is a 180-degree rotation, which has the same effect as a reflection in the origin: it takes each point to the one directly opposite, that is, (x, y) goes to $(-x, -y)$. So the square of this operation is the -1 in the model.

Has that truly found a real instance of the square root of minus 1, hence showing that the square root of minus one is not an imaginary entity? Yes and no. One could argue that a genuine *number* ought to be a generalization of a ratio or something similar (not just of an operation like expansion by a ratio). If that is demanded, that has not been done, and in that sense ‘the square root of minus 1’ remains rightly called an ‘imaginary’ number. On the other hand, there has been exhibited a real entity, consisting of simple transformations of the plane, which instantiates the whole mathematical structure of the complex numbers. The complex numbers are, from the purely structural point of view, the field (that is, set of elements with addition and multiplication defined and satisfying the usual ‘number laws’) that contains a copy of the real

numbers and contains solutions of all algebraic equations over the real numbers, in particular $x^2 = -1$. The field containing dilations of the plane by all real numbers, reflections through the origin, and rotations around the origin, satisfies that description and hence realizes the structure of the complex numbers. Yet it contains nothing rightly called imaginary, or postulated as an addition to normal ontology; all the dilations, etc. are realizable as motions of the plane, itself an entity realizable in the physical world (even if not actually so realized).

That makes it less mysterious why complex numbers should prove to be so applicable, in areas such as in the streamlines of incompressible and irrotational flow in two dimensions,²⁰ or in quantum mechanics. The use of complex numbers in quantum physics was a prime exhibit in Eugene Wigner's celebrated article 'The unreasonable effectiveness of mathematics in the natural sciences'. He writes:

Surely to the unpreoccupied mind, complex numbers are far from natural or simple and they cannot be suggested by physical observations. Furthermore, the use of complex numbers is in this case not a calculational trick of applied mathematics but comes close to being a necessity in the formulation of the laws of quantum mechanics. Finally, it now begins to appear that not only complex numbers but so-called analytic functions are destined to play a decisive role in the formulation of quantum theory... It is difficult to avoid the impression that a miracle confronts us here.²¹

The use in physics of a mathematical structure that has a simple enough geometrical model is not a miracle.

That is not to say, however, that typical pure mathematical uses of the complex numbers or ideal points at infinity require such possibilities of physical realization for those mathematical structures. The complex numbers is a structure that includes the real numbers and is in some ways simpler than the real numbers (for example in permitting the solution of all algebraic equations); the projective plane includes the Euclidean plane but is simpler (its symmetry permitting an intersection for all pairs of lines). Not surprisingly, some proofs are more straightforward in those simpler structures, and if the results are read back into the real numbers or Euclidean plane (respectively), may give a more insightful view of the result.²² The simpler overarching structures are, in Hilbert's words on ideal elements, 'introduced as a convenience to make simpler and more elegant the theory of the things you really care about'.²³ All four structures (the real numbers, the complex numbers, the Euclidean

plane and the projective plane) are realizable but probably not realized in the physical world; they are uninstantiated universals (with however close connections with structures that *are* realized, as we have seen). It is not surprising if the embeddings of some structures into simpler or more symmetrical ones contributes to understanding.

Zero

It will be noticed that in discussing negative and complex numbers, mention of zero was carefully avoided. It does not follow from the fact that we have explained the reality of negative quantities (such as displacements) that we have given an account of zero, merely because the formalism includes the statement $x + (-x) = 0$. The reason is that if two displacements cancel out, there is *nothing* remaining: hence the reality of positive and negative displacements which cancel out does not imply the existence of such an entity as a zero displacement (however convenient it may be to speak as if there is such an entity). It is the same in the case of positive ratios (of masses and so on).²⁴ The existence of arbitrarily small such ratios and the formal convenience of speaking about a 'zero ratio' does not amount to a proof of (or even good evidence for) the reality of zero.

Zero is special. It needs its own story. Writings on zero are a hotbed of constructivist opinion, not surprisingly, as it certainly looks all made up.²⁵ That is, in a way, true. We have finally reached a part of mathematics where a realist account is not applicable. (The empty set also needs special treatment, as promised in Chapter 3.)

Zero and the empty set are obviously closely related to 'nothing' – being, so to speak, mathematical versions of nothingness²⁶ – so it is likely that an account of them might be found by considering Aristotelian or other views on that subject.

There has been considerable discussion of the status of 'negative entities' in general, like absences, privations and nothingness.²⁷ Needless to say, agreement has not been reached. Nevertheless, discussion mostly proceeds within certain parameters, which can be taken as conditions of adequacy for a solution. They almost determine an account of zero and the empty set that is sufficient for the purposes of philosophy of mathematics.

These parameters are:

- Negative entities do not exist or subsist in any genuinely real or Meinongian way, as if they are parts of the furniture of the universe.²⁸

The inventory of things in the universe does not include them. That must be especially and obviously the case with *nothing*: I may be uncertain whether abstract objects or holes exist, but surely if there's anything that really does not and cannot exist, it's *nothing*. That's the point of it.

- If *nothing*, privations, fictions, abstract entities or any other such 'beings' are alleged not to exist, then some account must be given of the point of thinking or speaking about them. There are two aspects to that. First, one must explain what the reality is to which talk of the 'being' attaches: what is really there? Second, talk about, postulation of or apparent reference to such 'beings' must be doing some work. Somehow, the talk must relate to literal talk about the reality. An account of them is not complete until it is explained what that task is and how apparent reference to them accomplishes that task.
- That is so whether the talk is eliminable or not. There is no need to pretend that names must always be used to refer literally or with 'ontological commitment'. 'The same person who says that "Pegasus is a flying horse" is about Pegasus is also firm that there is no Pegasus.'²⁹ It may be that the way language works requires names for or quantification over 'beings' that the users of the language know full well are not real. Philosophers do not need to tell people that is impossible (though they do need to explain what is real and what is not, and what the point is of language and thought apparently about the non-existent).

Although negative entities are surely very simple (non)entities – after all, there is nothing to them so they cannot be complex – one should not necessarily expect a simple answer to questions about how talk of them works. That is clear, for example, in the very complicated debate about absences as causes. How is it that Smith's failure to water her office plants was a cause of their death, although the failure of distant people to water them does not count as a cause of their death (even though the plants would have survived through other people's watering them, just as well as by Smith's doing so)?³⁰ How some absences are taken to enter into causal stories and others are not is plainly a difficult question; without attempting to answer that, the lesson is that a metaphysically simple account of negative entities may need to be combined with a complex account of the role of talk about them. And those are separate tasks, in that one does not necessarily expect an account of linguistic roles to interact with metaphysical questions.

In considerable generality, there is a developed account of such entities in the scholastic theory of 'mental beings' (*entia rationis*), specifically of 'mental beings with foundation in the real' such as negations and privations. The theory bears some resemblance to modern fictionalism and also to contemporary work on absences and holes, but is not exactly the same as either.

According to scholastic theory, language and mental operations appear to refer to a wide range of 'entities' beyond those that actually exist in reality. These are quite disparate – possible horses are one thing, impossible beings like square circles another, 'second intentions' like propositions and logical implication yet another, and privations like blindness different again. A uniform treatment need not be given to all of them, except that they share lack of existence outside the mind and thus may be called in some sense 'mental beings' or 'beings of reason'.³¹ That is to be taken in a minimalist sense, to exclude any form of extra-mental existence (such as postulated in Meinong's theory of the non-existent or David Lewis's theory of possibles), while admitting there must be something mental to support linguistic reidentification, in that the utterances 'zero' and 'nothing' have stable meanings and the concepts perform some kind of role (to be specified) in thought.

This account resembles modern 'fictionalist' accounts of mathematical entities, but with certain differences. The fact that fictionalism talks more about language and the theory of mental beings more about thought is not a significant difference – since Rylean theories about the supposed lack of thought behind language have atrophied, it is generally admitted that language expresses thought, and there is no particular significance in this debate to the fact that thought is more private than language. To speak about zero, one must think about zero, and do so in a way coordinated with other people's thinking and speaking about zero. Thus a 'mental being' theory can be regarded as similar in all important (in particular metaphysical) respects to some fictionalist theory that expresses itself in linguistic terms.

But which fictionalist theory? It is not close to one standard version of fictionalism, according to which mathematical discourse purports to speak about Platonist abstract entities, but is false, since there are no such entities.³² But it is fictionalism in the broader sense in which 'The distinctive character of fictionalism about any discourse is (a) recognition of some valuable purpose to that discourse, and (b) the claim that that purpose can be served even if sentences uttered in the context of that discourse are not literally true'.³³ According to a mental being theory of zero, there is no such entity as zero but talk about it serves some useful purpose, so that theory is a version of fictionalism.

A mental being theory of zero, then, goes like this: metaphysically, zero is nothing. It has the same status as *nothing*, or absences, or privations, or lacks. It does not refer to a real quantity or ratio, as (say) ' π ' does: there is no zero quantity or ratio that could be realized in reality.

Having said that, one should explain, first, what realities are the 'foundation' of talk about zero and, second, how talk of zero helps in dealing with those realities.

The kind of literal reality to which talk of zero applies concerns the cancelling or balancing of quantities. As we saw, there can be positive and negative quantities of the same kind, such as forces and displacements. Those are realities. When a positive and a negative interact, as when two forces in opposite directions act on a body, there are two possibilities: the forces are of unequal size and the resultant is a force, or they balance exactly and there is no resultant. In the latter case, the non-existence of a resultant is the literal truth. Similarly, when two positive quantities like weights are compared as to size, their difference is usually a positive quantity, but – in the case of identical weights – there is no difference. The exceptional cases, of exact balance or the difference of identical weights, are the ones where talk of zero arises. The reality of those cases has now been fully described, without mention or 'postulation' of any alleged entity such as a zero force or weight.

It remains to explain what the role of talk of zero is, or the use of the symbol 0. What is 0 *for*, in these cases? That question can be answered by describing how sentences containing the symbol 0 are used to state true facts about (non-zero) quantities. That is well known from the way 0 is introduced into mathematical discourse. For example, to say that the difference of two quantities equals zero is to say that when one is subtracted from the other there is not anything left (as opposed to some definite quantity, as when unequal quantities are subtracted). To say that the sum of a positive and a negative displacement equals zero is to say that when they are composed, the result is a lack of any displacement. And so on. It is obvious what the mathematical convenience is of always having an answer to $x + y$, without having to continually draw attention to the exception when $x = -y$. According to a mental being theory of zero, that convenience is obtained without any metaphysical overhead.



Figure 14.2 The number line, with zero included

Convenience – or inspiration to original pure mathematics – may be served by further mental gymnastics such as ‘reifying’ zero in certain ways, for example by depicting it as a point on the number line, midway between -1 and 1 .

Stimulating as this picture may be, it does not imply the attribution of reality to zero. As in Chapter 9, we must distinguish between space and quantity. An infinitely extended line in space (supposing for the moment that space is infinitely extended and infinitely divisible) is one structure: it is without gaps and has no natural zero or any other distinguished point on it. The systems of all ratios, say of masses, has some similarity in structure to part of an infinite line. What part of a line the system of ratios corresponds to is to be determined by investigation, not by fiat. It has the same structure as one half of an infinitely extended line (endpoint not included): for each point on that half-line, the ratio of the length of the interval up to that point, to the length 1 , is one of the system of all ratios (and that is all the ratios there are). It is the same with ratios when the quantity involved admits both positives and negatives, such as displacements. There are indefinitely small and indefinitely large ratios of such quantities, both positive and negative. So the system of all ratios of them has the structure of a line infinite in both directions, with the central point missing. One may draw the number line with 0 included, but one knows that 0 is special, and that when the line is used to represent ratios, 0 does not represent a ratio although all the other points do.

The very wise advice ‘Never divide by zero’ is an indication of how special zero is. There is no ratio of a genuine quantity to zero.

There is one obvious problem for a ‘mental being’ theory of zero. It appears to require adding mental beings to real ones, which is doubtfully meaningful. If 1.73 denotes a real quantity, say a length in centimetres, how is it possible to have a real length interact with a mental being, as in the equation $1.73 + 0 = 1.73$? Is that not a category mistake?

That is not a correct description of the situation. Since a mental being is no kind of reality, there can be no interaction with it. ‘ $1.73 + 0$ ’ has a different grammar from ‘ $1.73 + 2$ ’ for the same reason as ‘I added one can of soup to the mix’ is different from ‘I added no can of soup to the mix’; the latter being, for example, paraphrasable as ‘I didn’t add any cans of soup to the mix’. No amount of mathematical convenience in using the symbol ‘ 0 ’ can alter metaphysical realities.

The empty set

The empty set also needs its own story. As remarked in Chapter 3, the empty set is not needed to ‘construct’ numbers, so there is in principle

no objection to treating it as in some degree fictional, as if the human mind decides to construct a fictional entity by putting 'brackets around nothing'. But in doing so, one should, as with zero and any other *ens rationis*, give an account both of what the foundation in reality of the concept is and what work talk of the entity performs.

Further, the most natural first occurrences of the empty set in elementary mathematics may suggest a fictional reading, as when one writes that the intersection of sets A and B is the empty set when A and B have no elements in common. Some form of fictionalism was the view of Cantor, Frege and some other founders of formal set theory, including even Zermelo, who writes, 'There exists an (improper [*uneigentliche*]) set, the *null set*, 0, that contains no element at all'.³⁴ Coming as they did from the conception of a set as a 'collection of objects', those authors naturally found difficulties with collecting nothing.³⁵

Actual arguments for the existence of the empty set tend to the circular, the magical, or reliance on 'mathematical convenience'.³⁶ Reductive theories of sets such as Armstrong's, according to which the singleton set {a} is the state of affairs of a having some unit-making property, also lead to a negative view of the existence of the empty set, since there can be no state of affairs of nothing having anything. One could also try nominating some arbitrary non-set item that could play the same formal role in set theory as the empty set, such as Lewis's bizarre suggestion of the mereological sum of all non-sets – the 'fusion of all individuals'.³⁷

The only reasonable prospect of finding a reality corresponding to the empty set comes from its relation to lack of instantiation. To say that the extension of a property is the empty set is to say that the property is uninstantiated, so there is – in an extended sense of 'state of affairs' – a state of affairs of being-a-unicorn's being uninstantiated. Thus the universals being-a-unicorn and being-a-five-term-US-president have something in common, namely being uninstantiated.³⁸ (It will be recalled that uninstantiated universals were admitted in Chapter 2, contrary to some stricter Aristotelian views.) Similarly in the case when the intersection of sets A and B is the empty set: that occurs when 'being a member of both A and B' is uninstantiated. That commonality – the being-uninstantiated that different universals share – is the foundation in reality of talk about the empty set.

It is still arguable whether being-uninstantiated is itself some kind of being or whether it should be considered a fiction. That issue will not be decided here.

Finally, if the Aristotelian is prepared to admit a fictionalist theory of zero and the empty set, was it really necessary to expend so much effort defending realism and fending off fictionalism up to that point?³⁹

Perhaps fictionalism about zero is the thin end of the wedge: if fictionalism is acceptable for zero, why not accept fictionalism about numbers more generally?

That is not right. Zero and the empty set really are special. Although there is no zero ratio – no two quantities can exist whose proportion is zero⁴⁰ – the ratio of my height to yours is realized in reality. Extremely large ratios may not be actually realized, but, unlike zero, they could be. The (discrete) double ratio is realized in the ratio of the number of shoes in a heap to the number of pairs of shoes in the heap. And so on.

Once it is accepted that Platonism is wrong, that there are no mind-independent, non-spatio-temporal and acausal ‘abstract objects’ to serve as the objects of mathematics, fictionalism puts (mind-dependent) fictions in their place across the board. Aristotelianism, by contrast, as explained in earlier chapters, puts in their place mind-independent objects which are spatio-temporal and causal, namely relations such as ratios.

15

Non-Deductive Logic in Mathematics

If mathematical realism – whether Platonist or Aristotelian – is true, then mathematics is a scientific study of a world ‘out there’. In that case, in addition to methods special to mathematics such as proof, there ought to be a role for ordinary scientific methods such as experiment, conjecture and the confirmation of theories by observations. Those methods should work in mathematics just as well as in science. Mathematics has extra and more certain methods of its own, but that should not prevent ordinary scientific methods from working.

An examination of the theory and practice of experimental mathematics will do three things. It will confirm realism in the philosophy of mathematics, since an objectivist philosophy of science is premised on realism about the entities and truths that science studies. It will suggest a logical reading of scientific methodology, since the methods of science will be seen to work in necessary as well as contingent matter (so, for example, the need to assume any contingent principles like the ‘uniformity of nature’ will be called into question). And it will support the objective Bayesian philosophy of probability, according to which (at least some) probabilities are strictly logical – they are relations of partial implication between bodies of evidence and hypothesis.

Mathematicians often speak of conjectures as being confirmed by evidence that falls short of proof. For their own conjectures, evidence justifies further work in looking for a proof. Those conjectures of mathematics that have long resisted proof, as Fermat’s Last Theorem did and the Riemann Hypothesis still does, have had to be considered in terms of the evidence for and against them. It is not adequate to describe the relation of evidence to hypothesis as ‘subjective’, ‘heuristic’ or ‘pragmatic’; there must be an element of what it is rational to believe on the evidence, that is, of non-deductive logic. Mathematics is therefore (among other things) an experimental science.

The occurrence of non-deductive logic, or logical probability, or the rational support for unproved conjectures, in mathematics is, however, an embarrassment. It is embarrassing to mathematicians, used to regarding deductive logic as the only real logic. It is embarrassing for those statisticians who wish to see probability as solely about random processes or relative frequencies: surely there is nothing probabilistic about the truths of mathematics? It is a problem for philosophers who believe that induction is justified not by logic but by natural laws or the 'uniformity of nature': mathematics is the same no matter how lawless nature may be. It does not fit well with most philosophies of mathematics. It is awkward even for proponents of non-deductive logic. If non-deductive logic deals with logical relations weaker than entailment, how can such relations hold between the necessary truths of mathematics?

Work on this topic has therefore been rare, at least until very recently. There is one notable exception, the pair of books by the mathematician George Polya, *Mathematics and Plausible Reasoning*.¹ Despite their excellence, they have been little noticed by mathematicians, and even less by philosophers. Undoubtedly that is largely because of Polya's unfortunate choice of the word 'plausible' in his title – 'plausible' has a subjective, psychological ring to it, so that the word is almost equivalent to 'convincing' or 'rhetorically persuasive'. Arguments that happen to persuade, for psychological reasons, are rightly regarded as of little interest in mathematics and philosophy. Polya made it clear, however, that he was not concerned with subjective impressions, but with what degree of belief was justified by the evidence.²

Estimating the probability of conjectures

Non-deductive logic deals with the support, short of entailment, that some propositions give to others. If a proposition has already been proved true, there is of course no longer any need to consider non-conclusive evidence for it. Consequently, non-deductive logic will be found in mathematics in those areas where mathematicians consider propositions which are not yet proved. These are of two kinds. First are those that any working mathematician deals with in his preliminary work before finding the proofs he hopes to publish, or indeed before finding the theorems he hopes to prove. The second kind are the long-standing conjectures which have been written about by many mathematicians but which have resisted proof.

It is obvious on reflection that a mathematician must use non-deductive logic in the first stages of his work on a problem. Mathematics

cannot consist just of conjectures, refutations and proofs. Anyone can generate conjectures, but which ones are worth investigating? Which ones are relevant to the problem at hand? Which can be confirmed or refuted in some easy cases, so that there will be some indication of their truth in a reasonable time? Which might be capable of proof by a method in the mathematician's repertoire? Which might follow from someone else's theorem? Which are unlikely to yield an answer until after the next review of tenure? The mathematician must answer these questions to allocate his time and effort. But not all answers to these questions are equally good. To stay employed as a mathematician, he must answer a proportion of them *well*. But to say that some answers are better than others is to admit that some are, on the evidence he has, more reasonable than others, that is, are rationally better supported by the evidence. This is to accept a role for non-deductive logic.

The area where a mathematician must make the finest discriminations of this kind – and where he might, in theory, be guilty of professional negligence if he makes poor decisions – is as a supervisor advising a prospective PhD student. It is usual for a student beginning a PhD to choose some general field of mathematics and then to approach an expert in the field as a supervisor. The supervisor then selects a problem in that field for the student to investigate. In mathematics, more than in any other discipline, the initial choice of problem is the crucial event in the PhD-gathering process. The problem must be:

1. unsolved at present;
2. not being worked on by someone who is likely to solve it soon; but most importantly
3. tractable, that is, probably solvable, or at least partially solvable, by three years' work at the PhD level.

It is recognized that of the enormous number of unsolved problems that have been or could be thought of, the tractable ones form a small proportion, and that it is difficult to discern which they are. The skill in non-deductive logic required of a supervisor is high. Hence the advice to PhD students not to worry too much about what field or problem to choose, but to concentrate on finding a good supervisor.

It is also clear why it is hard to find PhD problems that are also:

4. interesting.

It is not possible to dismiss these non-deductive techniques as simply 'heuristic' or 'pragmatic' or 'subjective'. Although these are correct

descriptions as far as they go, they give no insight into the crucial differences among techniques, namely, that some are more reasonable and consistently more successful than others. ‘Successful’ can mean ‘lucky’, but ‘consistently successful’ cannot. ‘If you have a lot of lucky breaks, it isn’t just an accident’, as Groucho Marx said.³ Many techniques can be heuristic, in the sense of leading to the discovery of a true result, but we are especially interested in those which give reason to believe the truth has been arrived at, and justify further research. Allocation of effort on attempted proofs may be guided by many factors, which can hence be called ‘pragmatic’, but those which are likely to lead to a completed proof need to be distinguished from those, such as sheer stubbornness, which are not. Opinions on which approaches are likely to be fruitful in solving some problem may differ, and hence be called ‘subjective’, but the beginning graduate student is not advised to pit his subjective opinion against the experts’ without good reason. Damon Runyon’s observation on horse-racing applies equally to courses of study: ‘The race is not always to the swift, nor the battle to the strong, but that’s the way to bet.’⁴ An example where the experts agreed on their opinion and were eventually proved right is the classification of finite simple groups, described below.

It is true that similar remarks could be made about *any* attempt to see rational principles at work in the evaluation of hypotheses, not just those in mathematical research. In scientific investigations, various inductive principles obviously produce results, and are not simply dismissed as pragmatic, heuristic or subjective. Yet it is common to suppose that they are not principles of *logic*, but work because of natural laws (or the principle of causality, or the regularity of nature). This option is not available in the mathematical case. Mathematics is true in all worlds, chaotic or regular. So any principles governing the relationship between hypothesis and evidence in mathematics can only be logical.

In modern mathematics, it is usual to cover up the processes leading to the construction of a proof, when publishing it – naturally enough, since once a result is proved, any non-conclusive evidence that existed before the proof is no longer of interest. That was not always the case. Euler, in the eighteenth century, regularly published conjectures which he could not prove, with his evidence for them. He used, for example, some daring and obviously far from rigorous methods to conclude that the infinite sum

$$1 + \frac{1}{4} + \frac{1}{9} + \frac{1}{16} + \frac{1}{25} + \dots$$

(where the numbers on the bottom of the fractions are the successive squares of whole numbers) is equal to the prima facie unlikely value $\pi^2/6$. Finding that the two expressions agreed to seven decimal places, and that a similar method of argument led to the already proved result

$$1 - \frac{1}{3} + \frac{1}{5} - \frac{1}{7} + \frac{1}{9} - \frac{1}{11} + \dots = \frac{\pi}{4}$$

Euler concluded: 'For our method, which may appear to some as not reliable enough, a great confirmation comes here to light. Therefore, we shall not doubt at all of the other things which are derived by the same method.' He later proved the result.⁵

Even today, mathematicians occasionally mention in print the evidence that led to a theorem. Since the introduction of computers, and even more since the recent use of symbolic manipulation software packages, it has become possible to collect large amounts of evidence for certain kinds of conjectures.⁶ A few mathematicians argue that in some cases, it is not worth the excessive cost of achieving certainty by proof when 'semi-rigorous' checking will do.⁷

At present, it is usual to delay publication until proofs have been found. This rule is broken only in work on those long-standing conjectures of mathematics which are believed to be true but have so far resisted proof. The most notable of these, which stands since the proof of Fermat's Last Theorem as the Everest of mathematics, is the Riemann Hypothesis.

Evidence for (and against) the Riemann Hypothesis

Riemann stated in a celebrated paper of 1859⁸ that he thought it 'very likely' that 'All the roots of the Riemann zeta function (with certain trivial exceptions) have real part equal to $\frac{1}{2}$ '. This is the still unproved Riemann Hypothesis. The Riemann zeta function is defined on positive whole numbers $s > 1$ by the formula

$$\zeta(s) = \frac{1}{1^s} + \frac{1}{2^s} + \frac{1}{3^s} + \dots$$

(Thus for example $\zeta(2) = 1 + \frac{1}{4} + \frac{1}{9} + \frac{1}{16} + \frac{1}{25} + \dots$, which is $\pi^2/6$ as in Euler's result above.) The definition can be extended to the entire complex plane: $\zeta(s)$ is the unique complex function, analytic except at $s = 1$, which agrees with the above formula on the positive integers greater than 1. It

is found that $\zeta(s)$ has obvious ('trivial') roots at the negative even integers. The Riemann Hypothesis is that all the (infinitely many) others have real part equal to $\frac{1}{2}$.⁹ For the present purpose an understanding of complex functions is not necessary: it is only important that this is a simple universal proposition like 'all ravens are black'. It is also true that the infinitely many non-trivial roots of the Riemann zeta function have a natural order, so that one can speak of 'the first million roots'.

Once it became clear that the Riemann Hypothesis would be very hard to prove, it was natural to look for evidence of its truth or falsity. The simplest kind of evidence would be ordinary induction: Calculate as many of the roots as possible and see if they all have real part $\frac{1}{2}$. This is in principle straightforward (though in practice computationally difficult, since one needs to devise subtle algorithms which save as much calculation as possible, so that the results can go as far as possible). Such numerical work was begun by Riemann and was carried on later with the results below:

Table 15.1 Early calculations of roots of the Riemann zeta function

Worker	Number of roots found to have real part $\frac{1}{2}$
Gram (1903)	15
Backlund (1914)	79
Hutchinson (1925)	138
Titchmarsh (1935/6)	1,041

'Broadly speaking, the computations of Gram, Backlund and Hutchinson contributed substantially to the plausibility of the Riemann Hypothesis, but gave no insight into the question of why it might be true.'¹⁰ The next investigations were able to use electronic computers, and the results were:¹¹

Table 15.2 Later calculations of roots of the Riemann zeta function

Lehmer (1956)	25,000
Meller (1958)	35,337
Lehman (1966)	250,000
Rosser, Yohe and Schoenfeld (1968)	3,500,000
Brent (1979)	81,000,001
Te Riele, van de Lune et al. (1986)	1,500,000,001
Gourdon (2004)	10^{13}

It is one of the largest inductions in the world.

Besides this simple inductive evidence, there are some other reasons for believing that Riemann's Hypothesis is true. And there are some reasons for doubting it. In favour:

1. Hardy proved in 1914 that infinitely many roots of the Riemann zeta function have real part $\frac{1}{2}$.¹² This is quite a strong consequence of Riemann's Hypothesis, but is not sufficient to make the Hypothesis highly probable, since if the Riemann Hypothesis is false, it would not be surprising if the exceptions to it were rare.
2. Riemann himself showed that the Hypothesis implied the 'prime number theorem', then unproved. This theorem was later proved independently. This is an example of the fundamental non-deductive principle that non-trivial consequences of a proposition support it.
3. Also in 1914, Bohr and Landau proved a theorem roughly expressible as 'Almost all the roots have real part very close to $\frac{1}{2}$ '. More exactly, 'For any $\delta > 0$, all but an infinitesimal proportion of the roots have real part within δ of $\frac{1}{2}$ '. This result 'is to this day the strongest theorem on the location of the roots which substantiates the Riemann hypothesis'.¹³
4. Studies in number theory revealed areas in which it was natural to consider zeta functions analogous to Riemann's zeta function. In some famous and difficult work,¹⁴ André Weil proved that the analog of Riemann's Hypothesis is true for these zeta functions, and his related conjectures for an even more general class of zeta functions were proved to widespread applause in the 1970s. 'It seems that they provide some of the best reasons for believing that the Riemann hypothesis is true – for believing, in other words, that there is a profound and as yet uncomprehended number-theoretic phenomenon, one facet of which is that the roots ρ all lie on $\text{Re } s = \frac{1}{2}$ '.¹⁵
5. Finally, there is the remarkable 'Denjoy's probabilistic interpretation of the Riemann hypothesis'.¹⁶ If a coin is tossed n times, then of course we expect about $\frac{1}{2}n$ heads and $\frac{1}{2}n$ tails. But we do not expect *exactly* half of each. We can ask, then, what the average deviation from equality is. The answer, as was known by the time of Bernoulli, is \sqrt{n} . One exact expression of this fact is:

For any $\varepsilon > 0$, with probability one the number of heads minus the number of tails in n tosses grows less rapidly than $n^{1/2+\varepsilon}$.

Now we form a sequence of 'heads' and 'tails' by the following rule:

Go along the sequence of numbers and look at their prime factors. If a number has two or more prime factors equal (i.e. is divisible by

a square), do nothing. If not, its prime factors must be all different; if it has an even number of prime factors, write ‘heads’. If it has an odd number of prime factors, write ‘tails’. The sequence, called the Möbius function, begins:

Table 15.3 First few values of the Möbius function

2	3	4	5	6	7	8	9	10	11	12	13	14	15	16	17	...
		2^2		2×3		2^3	3^2	2×5		$2^2 \times 3$		2×7	3×5	2^4		
T	T		T	H	T			H	T		T	H	H		T	...

The resulting sequence is of course not ‘random’ in the sense of ‘probabilistic’, since it is totally determined. But it is ‘random’ in the sense of ‘patternless’ or ‘erratic’ (such sequences are common in number theory, and are studied by the branch of the subject called misleadingly ‘probabilistic number theory’).¹⁷ From the analogy with coin tossing, it is likely that

For any $\varepsilon > 0$, the number of heads minus the number of tails in the first n ‘tosses’ in this sequence grows less rapidly than $n^{1/2+\varepsilon}$.

This statement is equivalent to Riemann’s Hypothesis. Edwards comments, in his book on the Riemann zeta function:

One of the things which makes the Riemann hypothesis so difficult is the fact that there is no plausibility argument, no hint of a reason, however unrigorous, why it should be true. This fact gives some importance to Denjoy’s probabilistic interpretation of the Riemann hypothesis which, though it is quite absurd when considered carefully, gives a fleeting glimmer of plausibility to the Riemann hypothesis.¹⁸

Not all the probabilistic arguments bearing on the Riemann Hypothesis are in its favour. In the balance against, there are the following arguments:

1. Riemann’s paper is only a summary of his researches, and he gives no reasons for his belief that the Hypothesis is ‘very likely’. No reasons have been found in his unpublished papers. Edwards does give an account, however, of facts which Riemann knew, which would naturally have seemed to him evidence of the Hypothesis. But the facts in question are true only of the early roots; there are some exceptions among the later ones. Edwards concludes:

The discoveries... completely vitiate any argument based on the Riemann–Siegel formula and suggest that, unless some basic cause is operating which has eluded mathematicians for 110 years, occasional roots ρ off the line [i.e. with real part not $\frac{1}{2}$] are altogether possible. In short, although Riemann’s insight was stupendous it was not supernatural, and what seemed ‘probable’ to him in 1859 might seem less so today.¹⁹

This is an example of the non-deductive rule given by Polya, ‘Our confidence in a conjecture can only diminish when a possible ground for the conjecture is exploded.’²⁰

2. Although the calculations by computer did not reveal any counter-examples to the Riemann Hypothesis, Lehmer’s and later work did unexpectedly find values which it is natural to see as ‘near counter-examples’. An extremely close one appeared near the 13,400,000th root.²¹ It is partly this that prompted the calculators to persevere in their labours, since it gave reason to believe that if there were a counter-example it would probably appear soon. So far it has not, despite the distance to which computation has proceeded, so the Riemann Hypothesis is not so undermined by this consideration as appeared at first.
3. Perhaps the most serious reason for doubting the Riemann Hypothesis comes from its close connections with the prime number theorem. This theorem states that the number of primes less than x is (for large x) approximately equal to the integral

$$\int_2^x \frac{dt}{\log t}$$

If tables are drawn up for the number of primes less than x and the values of this integral, for x as far as calculations can reach, then it is always found that the number of primes less than x is actually *less than* the integral. On this evidence, it was thought for many years that this was true for all x . Nevertheless, Littlewood proved that this is false. While he did not produce an actual number for which it is false, it appears that the first such number is extremely large – well beyond the range of computer calculations. Edwards comments, ‘In the light of these observations, the evidence for the Riemann hypothesis provided by the computations of Rosser *et al.* ... loses all its force’.²² That seems too strong a conclusion, since the degree of relevance of Littlewood’s discovery to the Riemann Hypothesis is far from clear. But it does give some reason to suspect that there may be

a very large counter-example to the Hypothesis even though there are no small ones.

It is plain, then, that there is much more to be said about the Riemann Hypothesis than 'It is neither proved nor disproved'. Without non-deductive logic, though, nothing more can be said.

The situation with Goldbach's Conjecture, possibly the easiest to state of the classic unsolved problems of mathematics, is similar. Based on a letter of 1742 from Goldbach, Euler conjectured that every even number (except 2) is the sum of two primes. The conjecture is still neither proved nor disproved and it is believed that a proof is not close.²³ Computer verification for individual numbers is possible and there is a distributed computing project²⁴ that has checked the Conjecture for even numbers up to and beyond 10^{18} and various weaker results are known. There do not seem to have been dramatic advances in the last fifty years.

The classification of finite simple groups

A last mathematical example of the central role of non-deductive inference is provided by the classification of finite simple groups, one of the great co-operative efforts of modern pure mathematics. As a case study, it has the merit that the non-deductive character of certain aspects was admitted rather explicitly by the principals. That was so because of the size of the project. Since so many people were involved, living in different continents and working over some years, it was necessary to present partial findings in print and at conferences, with explanations as to how these bore on the overall results hoped for.

As described briefly in Chapter 4, groups are one of the basic entities of higher mathematics, having uses in describing symmetry, in classifying the various kinds of curved surfaces and in many other areas. To read the following it is only necessary to know:

1. A group consists of finitely or infinitely many members; the number of members of a finite group is called its order.
2. Any group is composed, in a certain sense, of 'simple' groups. ('Simple', like 'group', is a technical term; 'simple' groups are not in any sense easy to understand but are so-called because they are not composed of smaller groups.)

A fundamental question is then: how many different finite simple groups are there? And what is the order of each? It is these questions that were attacked by the classification of finite groups project.

The project proper covered the twenty years from 1962 to 1981 inclusive. Groups had been studied in the nineteenth and early twentieth centuries, and various finite simple groups were found. It was discovered that most of them fell into a number of infinite families. These families were quite well described by the mid-1950s, with some mopping-up operations later. There were, however, five finite simple groups left over from this classification, called the Mathieu groups after their discoverer in the 1860s. Around 1960 it was not known whether any more should be expected, or, if not, how much work it might take to prove that these were the only possible simple groups.

The field was opened up by the celebrated theorem of Feit and Thompson in 1963²⁵ ('a moment in the evolution of finite group theory analogous to the emergence of fish onto dry land'²⁶):

The order of any finite simple group is an even number (with the obvious exception of cyclic groups).

Though the result is easy to state and understand, their proof required an entire 255-page issue of the *Pacific Journal of Mathematics*. This theorem is a consequence of the full classification result (since if one knew all the finite simple groups, one could easily check that the order of each of them was even). It thus appeared that if the full classification could be found at all it would be a vast undertaking.

The final step in the answer was announced as completed in February 1981. The full proof was spread over some 300 to 500 journal papers, taking up somewhere between 5,000 and 10,000 pages.²⁷

Of interest here is the logical situation as the proof developed, particularly the increasing confidence – justified as it happened – that the workers in the field had in the answer long before the end was reached.

It turned out that the five Mathieu groups were not the only 'sporadic' groups, as groups outside the infinite families came to be called. The first new one was discovered by Zvonimir Janko in Canberra,²⁸ and excitement ran high as researchers applied many methods and discovered more. The final tally of sporadic groups stands at twenty-six. These 'discoveries' had in many cases a strong non-deductive aspect, as explained by Daniel Gorenstein of Rutgers, who became the father figure of the project and leading expert on how it was progressing:

Another aspect of sporadic group theory makes the analogy with elementary particle theory even more apt. In a number of cases (primarily but not exclusively those in which computer calculations were ultimately required) 'discover' did not include the actual construction

of a group – all that was established was strong evidence for the existence of a simple group G satisfying some specified set of conditions X . The operative metamathematical group principle is this: if the investigation of an arbitrary group G having property X does not lead to a contradiction but rather to a ‘compatible’ internal subgroup structure, then there exists an actual group with property X . In all cases, the principle has been vindicated; however, the interval between discovery and construction has varied from a few months to several years.²⁹

Michael Aschbacher, another leader of the field in the 1970s, distinguished three stages for any new group: discovery, existence and uniqueness.

I understand a sporadic group to be discovered when a sufficient amount of self-consistent information about the group is available... Notice that under this definition the group can be discovered before it is shown to exist... Of course the group is said to exist when there is a proof that there exists some finite simple group satisfying P .³⁰

Some groups attracted more suspicion than others; for example that discovered by Richard Lyons was for some time habitually denoted Ly ? and spoken of in such terms as, ‘If this group exists, it has the following properties’.³¹ Lyons entitled his original paper ‘Evidence for the existence of a new finite simple group’.³² A similar situation arose with another of the later groups, discovered by O’Nan. His paper, ‘Some evidence for the existence of a new simple group’, was devoted to finding ‘some properties of the new simple group G , whose existence is pointed at by the above theorems’.³³

The rate of discovery of new sporadic groups slowed after 1970 and attention turned to the problem of showing that no more were possible. At a conference at the University of Chicago in 1972 Gorenstein laid out a sixteen-point program for completing the classification.³⁴ It was thought over-optimistic at the time but immense strides were soon made by Aschbacher, Glauberman and others, more or less following Gorenstein’s programme.

The turning point undoubtedly occurred at the 1976 summer conference in Duluth, Minnesota. The theorems presented there were so strong that the audience was unable to avoid the conclusion that the full classification could not be far off. From that point on, the practicing finite group theorists became increasingly convinced that

the ‘end was near’ – at first within five years, then within two years, and finally momentarily. Residual skepticism was confined largely to the general mathematical community, which quite reasonably would not accept at face value the assertion that the classification theorem was ‘almost proved.’³⁵

Notice that ‘almost proved’ indeed does not mean anything in deductive logic. With hindsight, one can say that a theorem was almost proved when most of the steps in the proof were found; but before a proof is complete, there can only be good non-deductive reason to believe that a sequence of existing steps will constitute most of a future proof.

By the time of the conference at Durham, England in 1978 (on ‘the classification of simple groups, a programme which is now almost complete’) optimism ran even higher. At that stage existence and uniqueness had been proved for twenty-four of the sporadic groups, leaving two ‘for which considerable evidence exists’.³⁶ One of these was successfully dealt with in 1980 (‘four years after Janko’s initial evidence for such a sporadic group’³⁷) and attention focussed on the last one, known as the ‘Monster’ because of its immense size (order about 10^{54}). Aschbacher, lecturing at Yale in 1978, said:

When the Monster was discovered it was observed that, if the group existed, it must contain two new sporadic groups (the groups denoted by F_3 and F_5 in Table 2) whose existence had not been suspected up to that time. That is, these groups were discovered as subgroups of the Monster. Since that time the groups F_3 and F_5 have been shown to exist. This is analogous to the situation in the physical sciences where a theory is constructed which predicts certain physical phenomena that are later verified experimentally. Such verification is usually interpreted as evidence that the theory is correct. In this case, I take the existence of F_3 and F_5 to be very good evidence that the Monster exists... My belief is that there are at most a few groups yet to be discovered. If I were to bet, I would say no more.³⁸

Gorenstein’s survey article of 1978 contains perhaps the experts’ last sop to deductivism, the thesis that all logic is deductive. He wrote:

At the present time the determination of all finite simple groups is very nearly complete. Such an assertion is obviously presumptuous, if not meaningless, since one does not speak of theorems as ‘almost proved’.³⁹

To the deductivist, the fact that most steps in a proposed proof are completed is no reason to believe that the rest will be. Undeterred, however, Gorenstein went on to say:

The complete proof, when it is obtained, will run to well over 5,000 journal pages! Moreover, it is likely that at the present time more than 80% of those pages exist...

The assertion that the classification is nearly complete is really a prediction that the presently available techniques will be sufficient to deal with the problems still outstanding. In its support, we cite the fact that, with two exceptions, all open questions are open because no one has yet examined them and not because they involve some intrinsic difficulty.

A year after the Durham conference, the experts assembled again at Santa Cruz, California, in a mood of supreme confidence. Gorenstein's survey gave 'a brief outline of the classification of the finite simple groups, now rapidly nearing completion'.⁴⁰ Another contributor to the conference began his talk, 'Now that the problem of classifying finite simple groups is probably close to completion'.⁴¹

What concern remained was less about the completion of the project than about what to do next; the editor of the conference proceedings began by commenting, 'In the last year or so there have been widespread rumors that group theory is finished, that there is nothing more to be done'.⁴² The *New York Times* Week in Review (22 June 1980) headlined an article 'A School of Theorists Works Itself Out of a Job'.

The confidence proved justified. Griess was able to show the existence of the Monster, and finally, in 1981, Simon Norton of Cambridge University completed the proof of the uniqueness of the Monster.⁴³

At least, that was claimed at the time. In the late 1980s it was discovered that a part of the proof, on 'quasithin' groups, was not quite as complete as had been thought. One gap proved hard to fill in, but was completed by Aschbacher and others in 2001.⁴⁴

Probabilistic relations between necessary truths?

The most natural conceptualization of the non-deductive relations between evidence and conclusion is that of objective Bayesianism. The (objective) Bayesian theory of evidence (also known as the logical theory of probability) aims to explain what the nature of evidence is. It holds that the relation of evidence to conclusion is a matter of strict logic, like

the relation of axioms to theorems in mathematics but less conclusive – a kind of partial implication. Given a fixed body of evidence – say in a trial, or in a dispute about a scientific theory – and given a conclusion, there is a fixed degree to which the evidence supports the conclusion. It was defended in Keynes's *Treatise on Probability* and more recently by E.T. Jaynes.⁴⁵

It says, for example, that if we could establish just what the legal standard of 'proof beyond reasonable doubt' is, then, in a given trial, it is an objective matter of logical fact whether the evidence presented does or does not meet that standard, and so a jury is either right or wrong in its verdict on the evidence.

It is not essential to the Bayesian perspective that the relation of evidence to conclusion should be given a precise number, nor that it be possible to compute the logical relation between evidence and conclusion in typical cases. It is sufficient for objective Bayesianism that it is sometimes intuitively evident that some hypotheses, on some bodies of evidence, are highly likely, or almost certain, or virtually impossible.⁴⁶ Keynes certainly believed that it was not always possible even in principle to compute an exact number expressing the relation between an arbitrary body of evidence and a conclusion. Nevertheless, it is usual as an idealization to suppose that for any body of evidence e and any conclusion h , there is a number $P(h|e)$, between 0 and 1, expressing the degree to which e supports h ; and that that number satisfies the usual axioms of conditional probability:

$$P(\text{not-}h|e) = 1 - P(h|e)$$

$$P(h_1 \text{ and } h_2|e) = P(h_1|e) \times P(h_2|h_1 \text{ and } e)$$

Polya's qualitative principles of evidence, such as the confirmation of hypotheses by their non-trivial consequences, are then easy deductions from those axioms.

The logical nature of the relation makes it particularly suitable for application to the necessary subject matter of pure mathematics. Conversely, its intuitive agreement with actual evaluation of conjectures supports it as a possible meaningful interpretation of probability (not necessarily the only valid one, as stochastic outcomes or idealized degrees of belief or idealized relative frequencies may also turn out to satisfy the same axioms).

There is one point that needs to be made precise especially in applying the theory of logical probability or non-deductive logic in *mathematics*. If e entails h , then $P(h|e)$ is 1. But in mathematics, the typical case is

that *e* does entail *h*, though that is perhaps as yet unknown. If, however, $P(h|e)$ is really 1, how is it possible in the meantime to discuss the (non-deductive) support that *e* may give to *h*, that is, to treat $P(h|e)$ as not equal to 1? In other words, if *h* and *e* are necessarily true or false, how can $P(h|e)$ be other than 0 or 1?

The answer is that, in both deductive and non-deductive logic, there can be *many* logical relations between two propositions. Some may be known and some not. To take an artificially simple example in deductive logic, consider the argument:

If all men are mortal, then this man is mortal

All men are mortal

Therefore, this man is mortal

The premises entail the conclusion, certainly, but there is more to it than that. They entail the conclusion in two ways: first, by *modus ponens* and, second, by instantiation from the second premise alone. That is, there are two logical paths from the premises to the conclusion.

More complicated and realistic cases are common in the mathematical literature. Feit and Thompson's proof that all finite simple groups (with trivial exceptions) have even order, occupying 255 pages, was simplified by Bender.⁴⁷ That means that Bender found a different and shorter logical route from the definition of 'finite simple group' to the proposition, 'All finite simple groups (with trivial exceptions) have even order' than the one known to Feit and Thompson.

Now just as there can be two deductive paths between premises and conclusion, so there can be a deductive and non-deductive path, with only the latter known. Before the Greeks' development of deductive geometry, it was possible to argue:

All equilateral (plane) triangles so far measured have been found to be equiangular

This triangle is equilateral

Therefore, this triangle is equiangular

There is a non-deductive logical relation between the premises and the conclusion: the premises inductively support the conclusion. But when deductive geometry appeared, it was found that there was also a deductive relation, since the second premise alone entails the conclusion. This discovery in no way vitiates the correctness of the previous

non-deductive reasoning or casts doubt on the existence of the non-deductive relation. That relation cannot be affected by discoveries about any other relation.

So the answer to the question 'How can there be probabilistic relations between necessary truths?' is simply that those relations are additional to any deductive relations (and may be known independently of them).

The problem of induction in mathematics

That non-deductive logic is used in mathematics is important first of all to mathematics. But it has wider significance for philosophy, in relation to the problem of induction, or inference from the observed to the unobserved.

It is common to discuss induction using only examples from the natural world, such as 'All observed flames have been hot, so the next flame observed will be hot' and 'All observed ravens have been black, so the next observed raven will be black'. That has encouraged the view that the problem of induction should be solved in terms of natural laws (or causes, or dispositions, or the regularity of nature) which provide a kind of 'cement of the universe' to bind the observed to the unobserved.

The difficulty for such a view is that it does not apply to mathematics, where induction works just as well as in natural science.

Examples were given above in connection with the calculation of roots for the Riemann Hypothesis, but let us take a particularly straightforward case:

The first million digits of π are random

Therefore, the second million digits of π are random

('Random' here means 'without pattern', 'passes statistical tests for randomness', not 'probabilistically generated', 'stochastic'.⁴⁸)

The number π has the decimal expansion

3.14159265358979323846264338327950288419716939937 ...

There is no apparent pattern in these numbers. The first million digits have long been calculated (calculations have reached beyond one trillion). Inspection of these digits reveals no pattern, and computer calculations applying tests for randomness can confirm this impression. It can then be argued inductively that the second million digits will likewise

exhibit no pattern. This induction is a good one (indeed, everyone believes that the digits of π continue to be random indefinitely, though there is no proof⁴⁹).

It is true, as argued by Baker,⁵⁰ that there is a special problem with inductive arguments in mathematics in that all the observed cases are of small numbers. Any number that can be calculated with is very small, compared to numbers in general. That bias in the evidence could raise a question as to whether any induction of the form 'All observed numbers have property X, therefore all numbers have property X' could have high probability. That does not imply, however, that inductive arguments in mathematics are generally poor. First, a bias in the evidence towards small numbers does not affect inductive arguments with more modest conclusions, such as 'All observed numbers have property X, so the next number calculated will have property X'. (The argument above about the randomness of the digits of π only extrapolated a finite distance, thus keeping to small numbers.) Second, many other inductive arguments have a bias in the evidence, without thereby becoming worthless (though they may become less secure). For example, extrapolative inductive inference like 'All observed European swans are white, therefore all swans in the world are white' is a worthwhile inductive argument, although the extrapolation beyond the observed range weakens it.

Now there seems to be no reason to distinguish the reasoning about the digits of π from that used in inductions about flames or ravens. But the digits of π are the same in all possible worlds, whatever natural laws may hold in them or fail to. Any reasoning about π is also rational or otherwise, regardless of any empirical facts about natural laws. Therefore, induction can be rational independently of whether there are natural laws (or any other such contingent principle).

This argument does not show that natural laws have no place in discussing induction. It may be that mathematical examples of induction are rational because there are *mathematical* laws or regularities, and that the aim in natural science is to find some substitute, such as natural laws, which will take the place of mathematical laws in accounting for the continuance of regularity. But if this line of reasoning is pursued, it is clear that simply making the supposition, 'There are laws', is of little help in making inductive inferences. No doubt mathematics is completely law-like, but that does not help at all in deciding whether the digits of π continue to be random. In the absence of any proofs, induction is needed to support the law (if it is a law), 'The digits of π are random', rather than the law being able to give support to the

induction. Either 'The digits of π are random' or 'The digits of π are not random' is a law, but in the absence of knowledge as to which, we are left only with the confirmation the evidence gives to the first of these hypotheses. Thus consideration of a mathematical example reveals what can be lost sight of in the search for laws: laws or no laws, non-deductive logic is needed to make inductive inferences.

It is worth noting that there are also mathematical analogs of Goodman's 'grue' paradox. Let a real number be called 'prue' if its decimal expansion is random for the first million digits and 6 thereafter. The predicate 'prue' is like 'grue' in not being projectible. ' π is random for the first million digits' is logically equivalent to ' π is prue for the first million digits', but this proposition supports ' π is random always', not ' π is prue'. Any solutions to the 'grue' paradox must allow projectible or 'natural' properties to be found not only in nature but also in mathematics.

These examples illustrate Polya's remark that non-deductive logic is better appreciated in mathematics than in the natural sciences.⁵¹ In mathematics there can be no confusion over natural laws, the regularity of nature, approximations, propensities, the theory-ladenness of observation, pragmatics, scientific revolutions, the social relations of science or any other red herrings. There are only the hypothesis, the evidence and the logical relations between them.

Epilogue: Mathematics, Last Bastion of Reason

The twentieth century – and we hardly need a longer perspective to see this – was beset by, and in cultural life almost defined by, an unteachable *enfant terrible*. From Dadaism to the 1960s to postmodernism, it was sufficient to throw tomatoes at tradition to get a full-page spread from the intellectual paparazzi.

For those who wished to retain their sanity amid the stress of twentieth-century culture, where was there to escape to? In the humanities world, there was always the past, and many a cultural refugee from various modernisms recuperated through communion with Monteverdi, or Vermeer, or Jane Austen. But for those who preferred their culture still living and breathing, the most extensive vandal-free space was science and mathematics.

Not quite all of science escaped the spirit of the age, unfortunately, and a few of the parts most visible from outside the scientific world caught some unpleasant philosophical diseases. High theory in physics was good science, but in its journey to popularization acquired some German idealism that left it coated in prose about ‘reality dependent on the observer’. The achievements of genetics suffered a similar fate, becoming known largely through the snide inverted Panglossianism of ‘selfish gene’ explanations of sociobiology. Real science, the kind that thinks hard and finds out what is the truth, became relatively hidden from view. It was still going on, though, and keeping happy several generations of dedicated researchers, almost all of them cheerfully oblivious to the cultural commentators’ manifold demonstrations to the wider community that the pursuit of truth is impossible.

Two regions of science stayed particularly free of any modern nervousness about themselves. One was engineering, for the obvious reason

that bridge construction on cultural relativist principles is forbidden by the laws of nature as strictly as by those of man. The other was mathematics.

Mathematics has several advantages as a cultural counterweight to relativisms and scepticisms. Everyone knows something about it – in fact quite a lot about it – so it is not necessary to take the word of experts about everything in it, as it is for, say, quantum physics. Second, the truths in it are subject to proof, and what is proved does not become unproved (though it can be proved better). For these reasons mathematics has always been an unfailing support for rationalist views, views which exalt the capacity of the human mind to find out the truth. Conversely, mathematics has been a perennial thorn in the side of opinions that abase human knowledge, and claim it is limited by sense experience, cultural experience or one's personal education and perspective. Any culture or person that can count to 4 has discovered that $2 + 2 = 4$, and should any fear arise of losing a grasp of that truth, resort to counting stones will quickly relieve any anxiety.

The truths of mathematics, unfortunately, cannot defend themselves, as they do not have a causal action on the physical world. Neither ethical nor mathematical truths and ideals can fight tanks, or blizzards of allegations about history or politics (though again, neither can they be liquidated by those enemies). They depend on human minds in tune with them to act on their behalf – to implement those ideals and teach them to the next generation.

It is the business of philosophy of mathematics to take the necessary defensive action, by explaining just how it is that mathematics achieves its objectivity. Regrettably, the standard alternatives in the philosophy of mathematics perform poorly on that task (quite apart from being, as argued earlier, wrong). Formalism and logicism suggest that mathematics is only objective because it is in some sense trivial. Kantian and intuitionist views see the objectivity of mathematics as a result of the contributions of the human mind. Platonism does defend a fully-fledged objectivity of mathematical truth, but at the cost of divorcing mathematics from the physical world, the world of which the rest of science delivers literal truths.

A philosophy of mathematics that is truly capable of shouldering the heavy burden of responsibility and defending the objectivity of mathematics across the vast ranges of real-world truths to which mathematics does apply will need to do better. It must defend applied mathematics as much as pure, support provably true results about the physical world

and show the continuity of mathematical knowledge across the full range of knowers, from babies to advanced research mathematicians.

The unique philosophy of mathematics meeting those requirements is Aristotelianism.

Notes

1 The Aristotelian Realist Point of View

1. The small number of works in that direction are surveyed and compared with the present work in the last section of Chapter 7 below.
2. Introductions to realist views on universals in J.P. Moreland, *Universals* (Acumen, Chesham, 2001), ch. 1; C. Swoyer, 'Properties', *Stanford Encyclopedia of Philosophy* (1999, revised 2011), <http://plato.stanford.edu/entries/properties/>.
3. D.M. Armstrong, *A World of States of Affairs* (Cambridge University Press, Cambridge, 1997).
4. Moreland, *Universals*, 28–30; D.M. Armstrong, *Universals: An Opinionated Introduction* (Westview Press, Boulder, CO, 1989), ch. 1.
5. Also called 'objects Platonism' (G. Hellman, *Mathematics Without Numbers*, Oxford University Press, Oxford, 1989), 3; 'standard Platonism' (C. Cheyne and C.R. Pigden, Pythagorean powers, *Australasian Journal of Philosophy*, 74 (1996), 639–645); 'full-blooded Platonism' (M. Balaguer, *Platonism and Anti-Platonism in Mathematics*, Oxford University Press, Oxford, 1998), 3, 5; G. Restall, Just what is full-blooded Platonism? *Philosophia Mathematica*, 11 (2003), 82–91); 'ontological Platonism' (M. Steiner, Platonism and the causal theory of knowledge, *Journal of Philosophy* 70 (1973), 57–66); 'traditional Platonism' (P. Maddy, *Realism in Mathematics*, Oxford University Press, Oxford, 1990, 21); it is probably not Plato's Platonism: discussion in M. Panza and A. Sereni, *Plato's Problem: An Introduction to Mathematical Platonism* (Palgrave Macmillan, Basingstoke, 2013), 17–26.
6. D.M. Armstrong, *Universals and Scientific Realism* (Cambridge University Press, Cambridge, 1978), 66–68; M. Balaguer, Platonism in metaphysics, *Stanford Encyclopedia of Philosophy* (2004, revised 2009), <http://plato.stanford.edu/entries/platonism/>.
7. Formulation in F. MacBride, Can *ante rem* structuralism solve the access problem? *Philosophical Quarterly* 58 (2008), 155–164; the problem introduced in philosophy of mathematics classically in P. Benacerraf, Mathematical truth, *Journal of Philosophy* 70 (1973), 661–679; discussion in Balaguer, Platonism in metaphysics, section 5.
8. J.R. Brown, *Philosophy of Mathematics: A Contemporary Introduction to the World of Proofs and Pictures* (2nd edn, Routledge, New York, 2008), ch. 3.
9. G. Rosen, Abstract objects, *Stanford Encyclopedia of Philosophy* (2001), <http://plato.stanford.edu/entries/abstract-objects/>.
10. Armstrong, *Universals and Scientific Realism*, vol. 2, ch. 19.
11. J.R. Weinberg, *Abstraction, Relation, Induction* (University of Wisconsin Press, Madison, 1965), part 2; S.E. Glenn, *Relations and Reality: The Metaphysics of*

- Parts and Wholes* (PhD, Boston College, 2000); D. Odegard, Locke and the unreality of relations, *Theoria* 35 (1969), 147–152.
12. B. Russell, *Mysticism and Logic* (Allen & Unwin, London, 1917), 75.
 13. B. Russell, *Introduction to Mathematical Philosophy* (Allen & Unwin, London, 1919), ch. 6.
 14. J. Bigelow and R. Pargetter, *Science and Necessity* (Cambridge University Press, Cambridge, 1990), 82–92; D.M. Armstrong, In defence of structural universals, *Australasian Journal of Philosophy* 64 (1986), 85–88; J. Pagés, Structural universals and formal relations, *Synthese* 131 (2002), 215–221.
 15. From Armstrong; also called ‘individuating property’ (W.v.O. Quine, *Word and Object*, MIT Press, Cambridge, Mass, 1960, 90); ‘sortal property’ (in the sense of Strawson, ‘A sortal universal supplies a principle for distinguishing and counting individual particulars which it collects’, *Individuals*, London, 1959, 168); see R.E. Grandy, Sortals, *Stanford Encyclopedia of Philosophy* (2006, revised 2007), <http://plato.stanford.edu/entries/sortals/>.
 16. Armstrong, *Truth and Truthmakers*, 113–115.
 17. Armstrong, *Truth and Truthmakers*, 118–123, building on D. Lewis, *Parts of Classes* (Blackwell, Oxford, 1991), ch. 1.
 18. Armstrong, *Truth and Truthmakers*, ch. 10; D.M. Armstrong, *What is a Law of Nature?* (Cambridge, Cambridge University Press, 1983), part II; Bigelow and Pargetter, *Science and Necessity*, chs 5–6.
 19. N. Goodman, *Fact, Fiction and Forecast* (4th edn Harvard University Press, Cambridge, Mass., 1983), 40–41; discussion in G. Molnar, *Powers: A Study in Metaphysics* (Oxford University Press, Oxford, 2003), ch. 10.
 20. Details in D.M. Armstrong, *Belief, Truth and Knowledge* (Cambridge University Press, Cambridge, 1973), ch. 12.
 21. J.Y. Lettvin, H.R. Maturana, W.S. McCulloch and W.H. Pitts, What the frog’s eye tells the frog’s brain, *Proceedings of the Institute of Radio Engineers* 47 (1959), 1950–1961; discussion on whether this is belief in F. Dretske, *Perception, Knowledge and Belief: Selected Essays* (Cambridge University Press, Cambridge, 2000), 67–73.
 22. E.g. M.A. Schmuckler, Visual-proprioceptive intermodal perception in infancy, *Infant Behavior and Development* 19 (1996), 221–232.
 23. J.J. Gibson, *The Senses Considered as Perceptual Systems* (Houghton Mifflin, Boston, 1966).
 24. E.g. R.L. Gregory, *The Intelligent Eye* (Weidenfeld & Nicolson, London, 1970).
 25. E.g. P. Geach, *Mental Acts: Their Content and Their Objects* (Routledge & Kegan Paul, London, 1957), 18–44.
 26. Introductory survey in P.C. Quinn and J. Oates, Early category representation and concepts, in J. Oates and A. Grayson, eds, *Cognitive and Language Development in Children* (Blackwell, Malden, MA, 2004), 21–60.
 27. Aristotle, *Posterior Analytics*, bk I, ch. 13.
 28. Aristotle, *De Anima*, bk III, ch. 5; R.D. McKirahan, *Principles and Proofs: Aristotle’s Theory of Demonstrative Knowledge* (Princeton University Press, Princeton, NJ, 1992), ch. 18.
 29. Works such as J. Maritain, *Distinguish to Unite: Or, The Degrees of Knowledge* (G. Bles, London, 1959) and B. Lonergan, *Insight: A Study of Human Understanding* (Philosophical Library, New York, 1957) draw various distinctions within

intellectual knowledge, but do not deal substantially with sense knowledge and how it gives rise to intellectual knowledge.

2 Uninstantiated Universals and ‘Semi-Platonist’ Aristotelianism

1. M. Balaguer, Fictionalism in the philosophy of mathematics, *Stanford Encyclopedia of Philosophy* (2008, revised 2011), <http://plato.stanford.edu/entries/fictionalism-mathematics/>
2. S. Shapiro, *Philosophy of Mathematics: Structure and Ontology* (Oxford University Press, Oxford, 1997), 86.
3. W.E. Johnson, *Logic*, Part I (Cambridge University Press, Cambridge, 1921), ch. 11; survey in D.H. Sanford, Determinates vs determinables, *Stanford Encyclopedia of Philosophy* (2002, revised 2011), <http://plato.stanford.edu/entries/determinate-determinables/>.
4. The structure of the space of colours surveyed in J. Cohen, On the structural properties of the colours, *Australasian Journal of Philosophy* 81 (2003), 78–95; further in Chapter 9 below.
5. Hume’s example of the ‘missing shade of blue’ (*Treatise of Human Nature*, ed. L.A. Selby-Bigge, 2nd rev. edn, Clarendon Press, Oxford, 1975, 6) concerns epistemology (how can our imagination fill in an unexperienced shade of blue which lies between two experienced ones?), but the example is adapted here to ontology.
6. D.M. Armstrong, *Universals: An Opinionated Introduction* (Westview Press, Boulder, CO, 1989), 75–82.
7. B. Mundy, The metaphysics of quantity, *Philosophical Studies* 51 (1987), 29–54; Mundy calls his position ‘naturalistic Platonism’, but it is identical to Aristotelian realism with uninstantiated universals. This is not the same position as ‘naturalized Platonism’, which holds there that a naturalized epistemology can allow for knowledge of abstract objects: M. Balaguer, Against (Maddian) naturalized Platonism, *Philosophia Mathematica* 2 (1994), 97–108; B. Linsky and E.N. Zalta, Naturalized Platonism versus Platonized naturalism, *Journal of Philosophy* 92 (1995), 525–555.
8. B. Ellis, The categorical dimensions of the causal powers, in A. Bird, B.D. Ellis and H. Sankey, eds, *Properties, Powers and Structures: Issues in the Metaphysics of Realism* (Routledge, New York, 2012), 11–26, section 3.
9. D.M. Armstrong, *A Combinatorial Theory of Possibility* (Cambridge University Press, Cambridge, 1989), 37.
10. Armstrong, *Combinatorial Theory*, 125.
11. Armstrong, *Combinatorial Theory*, 56.
12. Armstrong, *Combinatorial Theory*, 58–60.
13. D.M. Armstrong, *Truth and Truthmakers* (Cambridge University Press, Cambridge, 2004), 86–89.
14. It could be called ‘eliminative’ Aristotelianism, on the model of the ‘eliminative structuralism’ of S. Shapiro, *Philosophy of Mathematics: Structure and Ontology* (Oxford University Press, New York, 1997), 85–86.
15. M. Colyvan, *The Indispensability of Mathematics* (Oxford University Press, Oxford, 2001), ch. 3; Ø. Linnebo, Platonism in the philosophy of mathematics,

- Stanford Encyclopedia of Philosophy* (2009, revised 2011), <http://plato.stanford.edu/entries/platonism-mathematics/>; G. Rosen, Abstract objects, *Stanford Encyclopedia of Philosophy* (2001, revised 2012), <http://plato.stanford.edu/entries/abstract-objects/>
16. Shapiro, *Philosophy of Mathematics*, 89.
 17. The relevant *Stanford Encyclopedia of Philosophy* articles do not assume or argue for any such view: M. Gómez-Torrente, Logical truth (2010), <http://plato.stanford.edu/entries/logical-truth/>; B. Kment, Varieties of modality (2012), <http://plato.stanford.edu/entries/modality-varieties/>.
 18. But see Chapter 14 below for a fictionalist account of zero.
 19. Armstrong, *Combinatorial Theory*, 126.
 20. A. Pais, *Subtle Is the Lord: The Science and the Life of Albert Einstein* (Oxford University Press, Oxford, 1982), 210–213.

3 Elementary Mathematics: The Science of Quantity

1. References in Chapter 7 below.
2. S. Shapiro, *Thinking About Mathematics: The Philosophy of Mathematics* (Oxford University Press, New York, 2000), 257–264.
3. References in Chapter 7 below.
4. S. Shapiro, *Philosophy of Mathematics: Structure and Ontology* (Oxford University Press, New York, 1997); M.D. Resnik, *Mathematics as a Science of Patterns* (Oxford University Press, New York, 1997), 10, 82, 261, but less Platonist at 269.
5. D. Dennett, Real patterns, *Journal of Philosophy* 88 (1991), 27–51, section II; W.W. Sawyer, *Prelude to Mathematics* (Penguin, Harmondsworth, 1955); K.J. Devlin, *Mathematics: The Science of Patterns* (Freeman, New York, 1994).
6. For example, the discussions on applications in H. Field, *Science Without Numbers: A Defence of Nominalism* (Princeton University Press, Princeton, NJ, 1980); M. Steiner, *The Applicability of Mathematics as a Philosophical Problem* (Harvard University Press, Cambridge, Mass., 1998); P. Maddy, *Naturalism in Mathematics* (Oxford University Press, New York, 1997); M. Colyvan, *The Indispensability of Mathematics* (Oxford University Press, New York, 2001).
7. J. Bigelow, Sets are haecceities, in J. Bacon, K. Campbell and L. Reinhardt, eds, *Ontology, Causality and Mind: Essays in Honour of D.M. Armstrong* (Cambridge University Press, Cambridge, 1993), ch. 4, at 74–75.
8. Euclid, *Elements*, bk V, definition 3.
9. M.R. Cohen and E. Nagel, *An Introduction to Logic and Scientific Method*, abridged edn, Routledge, London, 1939, 183–187.
10. International Union of Pure and Applied Chemistry (IUPAC), *Quantities, Units and Symbols in Physical Chemistry* ('The Green Book'), Third Edition, IUPAC & RSC Publishing, Cambridge, 2007, 6.
11. Arguments for a purely relational view of quantities countered in D.M. Armstrong, Are quantities relations? A reply to Bigelow and Pargetter, *Philosophical Studies* 54 (1988), 305–316.
12. From D.M. Armstrong, *Sketch for a Systematic Metaphysics* (Oxford University Press, Oxford, 2010), ch. 13; originally in P. Forrester and D.M. Armstrong, The nature of number, *Philosophical Papers* 16 (1987), 165–186 and mostly in G. Kessler, Frege, Mill and the foundations of arithmetic, *Journal of Philosophy*

- 77 (1980), 65–79; somewhat cryptically in Aristotle: ‘The measure must always be some identical thing predicable of all the things it measures, e.g. if the things are horses, the measure is “horse”, and if they are men, “man”.’, *Metaphysics* bk 14 ch. 1, 1088a4–11.
13. G. Frege, *The Foundations of Arithmetic*, 1884, trans. J.L. Austin (2nd revised edn, Blackwell, Oxford, 1980), section 22, p. 28 and section 54, p. 66.
 14. From P.M. Simons, Against the aggregate theory of number, *Journal of Philosophy* 79 (1982), 163–167.
 15. Compare Euclid’s definition of number (*arithmos*) as ‘a multitude composed of units’, which corresponds more closely to a modern set than to a modern abstract number (as pointed out in J.P. Mayberry, *The Foundations of Mathematics in the Theory of Sets* (Cambridge University Press, Cambridge, 2000), 18).
 16. E.g. P. Maddy, *Naturalism in Mathematics* (Oxford University Press, Oxford, 1997), ch. 1; J. Bigelow and R. Pargetter, *Science and Necessity* (Cambridge University Press, Cambridge, 1990), 44–45.
 17. Pascal to Fermat, 24 August 1654, in J. Franklin, *The Science of Conjecture: Evidence and Probability before Pascal* (Johns Hopkins University Press, Baltimore, MD, 2001), 308; generally on the history of combinatorics, A.W.F. Edwards, *Pascal’s Arithmetical Triangle* (2nd edn, Johns Hopkins University Press, Baltimore, MD, 2002).
 18. E.g. in the Talmud: Franklin, *Science of Conjecture*, 172–175.
 19. An example in J.H. Lambert, *Neues Organon* (1764): see J. Franklin, Artifice and the natural world: mathematics, logic, technology, in K. Haakonssen, ed., *Cambridge History of Eighteenth Century Philosophy* (Cambridge University Press, Cambridge, 2006), ch. 28, at 842.
 20. For example, ‘the beautiful Groupee of Figures in the Corner of the Temple’ (1710); ‘Small and broken groups and sub-groups will finally tend to disappear’ (Darwin, *Origin of Species*, 1859); ‘To gader eld exposiciones upon Scripture into o collection’ (1460); ‘Number is nothyng els but a collection of vnities’ (first English Euclid, 1570, Greek *plethos*); ‘divided the Romans into six great Armies or Bands which he called Classes’ (1656); ‘hide a multitude of sinnes’ (Authorized Version, 1611, from Vulgate *multitudinem*, Greek *plethos*); ‘One in the aggregate sense as we say one army, or one body of men, constituted of many individuals’ (Dryden, 1683); ‘a pair of legges and of feet’ (Chaucer, c. 1395); ‘This triple of Principles’ (1653); ‘The musike of a set of violes’ (1561); ‘furnish the understanding with another sett of Ideas’ (Locke, 1690); ‘any values satisfying the equations, are said to constitute a set of roots of the system’ (1857); similar in D. Gillies, An empiricist philosophy of mathematics and its implications for the history of mathematics, in E. Grosholz and H. Berger, eds, *The Growth of Mathematical Knowledge* (Kluwer, Dordrecht, 2000), 41–57.
 21. E.g. ‘Any Fraternitie, Guild, Companie, or Fellowship, or other bodie corporate’, *Act 1 Edw. IV*, i. section 4 (1461).
 22. ‘Now Abel kept flocks’ (*Genesis* 4:2).
 23. Diogenes Laertius, *Lives of Eminent Philosophers*, VI.40; ‘The Extension of an universal Idea regards all the particular Kinds and single Beings that are contained under it’ (Watts, *Logic*, 1725).

24. D.M. Armstrong, Classes are states of affairs, *Mind* 100 (1991), 189–200, with some further clarifications in D.M. Armstrong, Reply to Rosen, *Australasian Journal of Philosophy* 73 (1995), 626–628; several proposals listed in A. Paseau, Motivating reductionism about sets, *Australasian Journal of Philosophy* 86 (2008), 295–307.
25. P. Forrest, Sets as mereological tropes, *Metaphysica* 3 (1) (2002), 5–9.
26. J. Bigelow, Sets are haecceities, section 3.
27. P. Simons, Negatives, numbers and necessity: some worries about Armstrong's version of truthmaking, *Australasian Journal of Philosophy* 83 (2005), 253–261.
28. B.C. Smith, *On the Origin of Objects* (MIT Press, Cambridge, Mass., 1996); compare Mayberry, *Foundations of Mathematics in the Theory of Sets*, 23: 'the vagueness that infects the notion of number at its boundary is the same vagueness that affects the notion of thing'.
29. Defended in, e.g., Maddy, *Realism in Mathematics* (Oxford University Press, Oxford, 1990), 88–96; C. Menzel, Frege numbers and the relativity argument, *Canadian Journal of Philosophy* 18 (1988), 87–98.
30. N. Goodman and W.V. Quine, Steps towards a constructive nominalism, in N. Goodman, *Problems and Projects* (Bobbs-Merrill, Indianapolis, 1972), 173–198.
31. C. Chihara, *Constructibility and Mathematical Existence* (Oxford University Press, Oxford, 1990), 201–202.
32. Paseau, Motivating reductionism about sets.
33. P. Maddy, *Realism in Mathematics*, 58–67; further discussion in Chapter 7 below.
34. C.B. Crowley, *Universal Mathematics in Aristotelian-Thomistic Philosophy* (University Press of America, Washington, DC, 1980).
35. Euclid, *Elements*, bk V, definition 5; a modern revival in B. Hale, Real numbers, quantities and measurement, *Philosophia Mathematica* 10 (2002), 304–323.
36. Further in J. Franklin, Quantity and number, in D. Novotný, ed., *Neo-Aristotelian Perspectives in Metaphysics* (Routledge, London, 2014).
37. J. Franklin, Achievements and fallacies in Hume's account of infinite divisibility, *Hume Studies* 20 (1994), 85–101.
38. In Chapter 7 I will give a more Aristotelian account of measurement which does not involve this relation between quantities and a realm of numbers.
39. B.S. Massey, *Units, Dimensional Analysis and Physical Similarity* (Van Nostrand Reinhold, London, 1971), 2.
40. B. Ellis, *Basic Concepts of Measurement* (Cambridge University Press, Cambridge, 1968), ch. 4; many references in J.A. Diez, A hundred years of numbers: An historical introduction to measurement theory 1887–1990. II, *Studies in History and Philosophy of Science* 28 (1997), 237–265; conclusions for philosophy of mathematics in C. Pincock, A new perspective on the problem of applying mathematics, *Philosophia Mathematica* 12 (2004), 135–161.
41. B.A. Davey and H.A. Priestley, *Introduction to Lattices and Order* (2nd edn, Cambridge University Press, Cambridge, 2002), ch. 2.
42. As commonly done in the social sciences; see N. Cliff and J.A. Keats, *Ordinal Measurement in the Behavioral Sciences* (Erlbaum, Mahwah, NJ, 2003). Another suggestion in B. Hale, Reals by abstraction, *Philosophia Mathematica* 8 (2000),

100–123, at 106. Russell remarks on the indeterminacy of language at this point: ‘the usual meaning [of “quantity”] appears to imply (1) a capacity for the relations of *greater* and *less*, (2) divisibility. Of these characteristics, the first is supposed to imply the second. But as I propose to deny the implication, I must either admit that some things which are indivisible are magnitudes, or that some things which are greater or less than others are not magnitudes. As one of these departures from usage is unavoidable, I shall choose the former, which I believe to be the less serious. A magnitude, then, is to be defined as anything which is greater or less than something else.’ B. Russell, *The Principles of Mathematics* (1903), section 151.

43. Discussions in Bigelow and Pargetter, *Science and Necessity*, section 2.6; Bigelow, *Reality of Numbers*, part II(c); S. Leuenberger and P. Keller, Introduction: the philosophy of vectors, *Dialectica* 63 (4) (2009), 369–380 and other papers in the same special issue.
44. On ‘value indefiniteness’ in the quantities of quantum mechanics, see J. Forge, Quantities in quantum mechanics, *International Studies in the Philosophy of Science*, 14 (2000), 43–56.

4 Higher Mathematics: Science of the Purely Structural

1. M. Ascher, *Ethnomathematics: A Multicultural View of Mathematical Ideas* (Brooks/Cole, Pacific Grove, CA, 1991), chs 2, 3, 6.
2. L. Euler, Solutio problematis ad geometriam situs pertinentis, 1735, trans. in, N. Biggs, E. Lloyd and R. Wilson ed., *Graph Theory 1736–1936* (Oxford University Press, Oxford, 1976), 3–8.
3. C. Pincock, A role for mathematics in the physical sciences, *Nous* 41 (2007), 253–275, section II, analyses this example and would be in agreement with what is said here if his statement ‘the bridge system has the structure of a graph, in the sense that the relations among its parts allow us to map those parts directly onto a particular graph’ were to take a realist interpretation of ‘structure’ as a property that the system of bridges and the graph could share.
4. H. Weyl, *Symmetry* (Princeton University Press, Princeton, NJ, 1952); G. Hon and B.R. Goldstein, *From Summetria to Symmetry: The making of a revolutionary scientific concept* (Springer, Dordrecht, 2008).
5. P. Benacerraf, What numbers could not be, *Philosophical Review* 74 (1965), 495–512; discussion reviewed in M. Panza and A. Sereni, *Plato’s Problem: An introduction to mathematical Platonism* (Palgrave Macmillan, Basingstoke, 2013), chs 3–5.
6. Classifications of various structuralist views of mathematics in E. Reck and M. Price, Structures and structuralism in contemporary philosophy of mathematics, *Synthese* 125 (2000), 341–383; C. Parsons, Structuralism and metaphysics, *Philosophical Quarterly* 54 (2004), 57–77; M. Friend, *Introducing Philosophy of Mathematics* (Acumen, Stocksfield, 2007), ch. 4; L. Lehrer Dive, An epistemic structuralist account of mathematical knowledge, PhD thesis, University of Sydney, 2003, ch. 1.
7. S. Shapiro, *Philosophy of Mathematics: Structure and Ontology* (Oxford University Press, New York, 1997); S. Shapiro, Foundations of mathematics:

- metaphysics, epistemology, structure, *Philosophical Quarterly* 54 (2004), 16–37; the Platonist nature of Shapiro's work emphasized in M. Balaguer, *Platonism and Anti-Platonism in Mathematics* (Oxford University Press, New York, 1998), 8–10; discussion of ante rem structuralism vis à vis Platonism in F. MacBride, What constitutes the numerical diversity of mathematical objects? *Analysis* 66 (2006), 63–69.
8. M.D. Resnik, *Mathematics as a Science of Patterns* (Oxford University Press, Oxford, 1997), 10, 82, 261.
 9. D. Dennett, Real patterns, *Journal of Philosophy* 88 (1991), 27–51, section II; K.J. Devlin, *Mathematics: The Science of Patterns* (Henry Holt, New York, 1994).
 10. H. Poincaré, *Science and Hypothesis* (Walter Scott, London, 1905), 20.
 11. N. Bourbaki, The architecture of mathematics, *American Mathematical Monthly* 57 (1950), 221–232; background in L. Corry, Nicolas Bourbaki and the concept of mathematical structure, *Synthese* 92 (1992), 315–348.
 12. Emphasized in S. Mac Lane, *Mathematics: Form and Function* (Springer, New York, 1986); J. Piaget, *Structuralism*, trans. C. Maschler (Harper & Row, New York, 1970); J.-P. Marquis, Category theory, *Stanford Encyclopedia of Philosophy*, article of 2007, <http://plato.stanford.edu/entries/category-theory/>; detailed history in L. Corry, *Modern Algebra and the Rise of Mathematical Structures* (Birkhäuser, Basel, 1996); discussion of later developments in D. Corfield, *Towards a Philosophy of Real Mathematics* (Cambridge University Press, 2003), ch. 10; Shapiro, *Philosophy of Mathematics*, 176–177.
 13. G.H. Hardy, *A Mathematician's Apology* (Cambridge University Press, Cambridge, 1940), 59–60; the point emphasized in Corfield, *Towards a Philosophy of Real Mathematics*, ch. 1.
 14. The philosophical interest of this example is described in Ø. Linnebo, Structuralism and the notion of dependence, *Philosophical Quarterly* 58 (2008), 59–79, section VI.
 15. Of course there are also many less physical, more abstract, realizations of the group, such as negation in classical logic.
 16. Some similar reasoning on groups in quantum mechanics in A. Peressini, Troubles with indispensability: applying pure mathematics in physical theory, *Philosophia Mathematica* 5 (1997), 210–227.
 17. Further in M. Giaquinto, *Visual Thinking in Mathematics* (Oxford University Press, Oxford, 2007), 207–208.
 18. J. Franklin, Global and local, *Mathematical Intelligencer* 36 (2014).
 19. M. Colyvan, Review of Resnik, *Mathematics as a Science of Patterns* and Shapiro, *Philosophy of Mathematics: Structure and Ontology*, *British Journal for the Philosophy of Science* 49 (1998), 652–656; Resnik's reasons for avoiding the question in *Mathematics as a Science of Patterns*, 257–261.
 20. D.M. Armstrong, *A Theory of Universals: Universals and Scientific Reasoning, vol. II* (Cambridge University Press, Cambridge, 1978), 69
 21. Armstrong, *Theory of Universals*, 70.
 22. Shapiro, *Philosophy of Mathematics*, 74, 98
 23. Shapiro, *Philosophy of Mathematics*, 74.
 24. Resnik, *Mathematics as a Science of Patterns*, 203.
 25. Shapiro, *Philosophy of Mathematics*, 73–74.

26. Note a merely grammatical matter: that a structural property is assumed to be a property of a 'system'. That is not to imply a commitment to an entity, 'the system', over and above the mereological sum of the parts. It is just a grammatical convenience: to speak of 'parts' requires a whole of which they are parts.
27. It might seem at first that a definition of symmetry in terms of there being an automorphism of a structure is more precise than this. However, the existence of an automorphism supervenes on there being parts identical in a respect: if there are such parts, then interchanging them is a structure-preserving automorphism – the structure being preserved being the one defined by the respect in which the parts are identical.
28. S. Haack, *Deviant Logic, Fuzzy Logic: Beyond the formalism* (University of Chicago Press, Chicago, 1996).
29. Ø. Linnebo, Plural quantification, *Stanford Encyclopedia of Philosophy*, <http://plato.stanford.edu/entries/plural-quant/>, 2008; application to number in B. Yi, Is two a property? *Journal of Philosophy* 96 (1999), 163–190 and D. Lewis, Mathematics is megethology, *Philosophia Mathematica* 1 (1993), 3–23; the power of mereology with plural quantification also defended in G. Hellman, Does category theory provide a framework for mathematical structuralism? *Philosophia Mathematica* 11 (2003), 129–157.
30. D. Lewis, *Parts of Classes* (Blackwell, Oxford, 1991), esp. 112.
31. G. Hellman, *Mathematics Without Numbers: Towards a Modal-Structural Interpretation* (Oxford University Press, Oxford, 1989), 48–49.
32. Standard set-theoretical expression of the definition in, e.g., S. Willard, *General Topology* (Addison-Wesley, Reading, Mass, 1970), 23.
33. The definition is mainly due to Felix Hausdorff's *Grundzüge der Mengenlehre* (1914), ch. 9; see G. Preuß, Felix Hausdorff (1868–1942), in C.E. Aull and R. Lowen, eds, *Handbook of the History of General Topology*, vol. 1 (Springer, Dordrecht, 1997), 1–20; examples from other areas of higher mathematics in J.L. Bell, Whole and part in mathematics, *Axiomathes* 14 (2004), 285–294.
34. C.S. Peirce, On the logic of number, *American Journal of Mathematics* 4 (1881), 85–95, repr. in *Collected Papers*, ed. C. Hartshorne and P. Weiss (Harvard University Press, Cambridge, MA, 1960), vol. 3, 158–170; R. Dedekind, The nature and meaning of numbers, 1887, in *Essays on the Theory of Numbers* (Open Court, Chicago, 1901, repr. Dover, New York, 1963); analysis in E.H. Reck, Dedekind's structuralism: an interpretation and partial defense, *Synthese* 137 (2003), 369–419.
35. J. Michell and C. Ernst, The axioms of quantity and the theory of measurement: translated from Part I of Otto Hölder's German text 'Die axiome der Quantität und die Lehre vom Mass', *Journal of Mathematical Psychology* 40 (1996), 235–252.
36. Further analysis in A. Newstead and J. Franklin, On the reality of the continuum, *Philosophy* 83 (2008), 117–127.
37. S. Hegarty, Aristotle's notion of quantity and modern mathematics, *Philosophical Studies* (Ireland) 18 (1969), 25–35.

5 Necessary Truths about Reality

1. An earlier but substantially different version of this chapter appeared as J. Franklin, Mathematical necessity and reality, *Australasian Journal of Philosophy* 67 (1989), 286–294.
2. A. Einstein, *Ideas and Opinions* (Random House, New York, 1954), 233.
3. P. Ernest, review of ‘Mathematical necessity and reality’, *Mathematical Reviews* 92b:00007.
4. From an anonymous referee.
5. B.A. Brody, De re and de dicto interpretations of modal logic or a return to an Aristotelian essentialism, *Philosophia* 2 (1972), 117–136, section IV.
6. Aristotle, *Metaphysics* 997b33–998a6, 1036a4–12; Proclus, *Commentary of the First Book of Euclid’s Elements*, trans. G.R. Morrow (Princeton University Press, Princeton, NJ, 1970), 10–11. Pincock takes the importance of idealizations in mathematical applications as a main reason to deny what he calls the ‘metaphysical conception’ of how mathematics contributes to science, a conception which includes Aristotelian realism (C. Pincock, *Mathematics and Scientific Representation*, Oxford University Press, Oxford, 2012, 4).
7. B. Russell, *Mysticism and Logic and Other Essays* (Allen & Unwin, London, 1917), 75.
8. A. Musgrave, Logicism revisited, *British Journal for the Philosophy of Science* 28 (1977), 99–127, section 5.
9. Einstein, *Ideas and Opinions*, 234.
10. The image is from C.G. Hempel, On the nature of mathematical truth, *American Mathematical Monthly* 52 (1945), 543–556, at 554.
11. S. Smale, ‘What is global analysis?’, *American Mathematical Monthly* 76 (1969), 4–9; L. Perko, *Differential Equations and Dynamical Systems* (3rd edn, Springer, New York, 2001), chs 2–3.

6 The Formal Sciences Discover the Philosophers’ Stone

1. An earlier but substantially different version of this chapter appeared as J. Franklin, The formal sciences discover the philosophers’ stone, *Studies in History and Philosophy of Science* 25 (1994), 513–533. H.R. Pagels, *Dreams of Reason: The Computer and the Rise of the Sciences of Complexity* (Simon & Schuster, New York, 1988); M.M. Waldrop, *Complexity: The Emerging Science at the Edge of Order and Chaos* (Simon & Schuster, New York, 1993); P. Bak, *How Nature Works: The Science of Self-Organized Criticality* (Copernicus, New York, 1996); S. Wolfram, *A New Kind of Science* (Wolfram Media, Champaign, Ill, 2002).
2. H.A. Simon, *The Sciences of the Artificial* (MIT Press, Cambridge, MA, 1969; 3rd edn., 1996).
3. F.N. Trefethen, History of Operations Research, in J.F. McCloskey and F.N. Trefethen, eds, *Operations Research for Management* (Johns Hopkins Press, Baltimore, MD, 1954), vol. 1, 3–35; S.I. Gass and A.A. Assad, eds, *An Annotated Timeline of Operations Research: An Informal History* (Springer, New York, 2004).

4. C.D. Woolsey and H.S. Swanson, *Operations Research for Immediate Application: A Quick and Dirty Manual* (Harper & Row, New York, 1975); H.A. Taha, *Operations Research: An Introduction* (7th edn, Prentice Hall, Upper Saddle River, NJ, 2003).
5. R.C. Dorf and R.H. Bishop, *Modern Control Systems* (10th edn, Prentice Hall, Upper Saddle River, NJ, 2004); R.E. Kalman, P.L. Falb and M.A. Arbib, *Topics in Mathematical System Theory* (McGraw-Hill, New York, 1969).
6. O. Mayr, *The Origins of Feedback Control* (MIT Press, Cambridge, MA, 1970).
7. N. Wiener, *Cybernetics, or Control and Communication in the Animal and the Machine* (MIT Press, Cambridge, Mass, 1948); S.J. Heims, *The Cybernetics Group* (MIT Press, Cambridge, MA, 1991).
8. B.S. Everitt, S. Landau, M. Leese and D. Stahl, *Cluster Analysis* (5th edn, Wiley, Chichester, 2011); R.R. Sokal and P. Sneath, *Principles of Numerical Taxonomy* (Freeman, San Francisco, 1963).
9. R.O. Duda, P.E. Hart and D.G. Stork, *Pattern Classification* (2nd edn, Wiley, New York, 2001); J.A. Richards, *Remote Sensing Digital Image Analysis: An Introduction* (5th edn, Springer, Berlin, 2013).
10. S.J. Orphanidis, *Introduction to Signal Processing* (Prentice Hall, Englewood Cliffs, NJ, 1996); C. Chatfield, *Analysis of Time Series: An Introduction* (6th edn, Chapman and Hall/CRC, Boca Raton, FL, 2004).
11. D. Jungnickel, *Graphs, Networks and Algorithms* (3rd edn, Springer, Berlin, 2008); M.G.H. Bell and Y. Iida, *Transportation Network Analysis* (Wiley, Chichester, 1997); J.F. Hayes and T.V.J.G. Babu, *Modeling and Analysis of Telecommunications Networks* (Wiley, Hoboken, NJ, 2004).
12. B.D. Bunday, *Basic Queueing Theory* (Edward Arnold, London, 1986).
13. C.E. Shannon, *The Mathematical Theory of Communication* (University of Illinois Press, Urbana, IL, 1949); D.R. Hankerson, G.A. Harris and P.D. Johnson, *Introduction to Information Theory and Data Compression* (2nd edn, Chapman & Hall/CRC, Boca Raton, FL, 2003).
14. M.S. Waterman, ed., *Mathematical Models for DNA Sequences* (CRC Press, Boca Raton, FL, 1989); J. Augen, *Bioinformatics in the Post-Genomic Era* (Addison-Wesley, Boston, 2005).
15. J. von Neumann and O. Morgenstern, *Theory of Games and Economic Behavior* (Princeton University Press, Princeton, NJ, 1944); L.G. Telser, *Competition, Collusion and Game Theory* (Aldine Atherton, Chicago, 1972); M. Shubik, *Game Theory in the Social Sciences* (MIT Press, Cambridge, MA, 1982); A.K. Dixit, S. Skeath and D.H. Reiley, *Games of Strategy* (3rd edn, Norton, New York, 2009).
16. M. Enquist, *Game Theory Studies on Aggressive Behaviour* (University of Stockholm, Stockholm, 1984).
17. G. Debreu, *The Theory of Value: An Axiomatic Analysis of Economic Equilibrium* (Wiley, New York, 1959); J.S. Kelly, *The Arrow Impossibility Theorems* (Academic Press, New York, 1978); E. Silberberg and W. Suen, *The Structure of Economics: A Mathematical Analysis* (3rd edn, McGraw-Hill, Boston, 2005).
18. M. Gardner, Mathematical games: The fantastic combinations of John Conway's new solitaire game 'Life', *Scientific American* 223 (1970), issue 4, 120–123; W. Poundstone, *The Recursive Universe* (Oxford University Press, Oxford, 1987), 24–47 and chs. 4, 6, 8, 10; C. Adami, *Introduction to Artificial Life* (Springer, New York, 1998).

19. G. Nicolis and I. Prigogine, *Self-Organization in Non-Equilibrium Systems* (Wiley, New York, 1977); F.E. Yates, ed., *Self-Organizing Systems: The Emergence of Order* (Plenum, New York, 1987).
20. R. May and A.R. McLean, *Theoretical Ecology: Principles and Applications* (3rd edn, Oxford University Press, Oxford, 2007); M. Kot, *Elements of Mathematical Ecology* (Cambridge University Press, Cambridge, 2001).
21. P.C.W. Davies, *The Cosmic Blueprint* (Heinemann, London, 1987); E. Jantsch, *Self-Organizing Universe* (Pergamon, Oxford, 1980); S.A. Kauffman, *At Home in the Universe: The Search for Laws of Self-Organization and Complexity* (Oxford University Press, New York, 1995); Wolfram, *A New Kind of Science*, chs 7–9.
22. H.S. Wilf, *Algorithms and Complexity* (Prentice Hall, Englewood Cliffs, NJ, 1986); L. Fortnow and S. Homer, A short history of complexity theory, in D. van Dalen, J. Dawson and A. Kanamori, eds, *Handbook of the History of Mathematical Logic*, to appear, available at <http://people.cs.uchicago.edu/~fortnow/papers/history.pdf>.
23. P. Frey, ed., *Chess Skill in Man and Machine* (2nd edn, Springer, New York, 1983); F.-H. Hsu, *Behind Deep Blue* (Princeton University Press, Princeton, NJ, 2002).
24. F. Giordano, W.P. Fox and S.B. Horton, *A First Course in Mathematical Modeling* (5th edn, Brooks/Cole, Pacific Grove, CA, 2014); B.P. Zeigler, H. Praehofer and T.G. Kim, *Theory of Modeling and Simulation* (2nd edn, Academic Press, San Diego, 2000).
25. P.M. Allen et al., *Models of Urban Settlement and Structure as Dynamic Self-Organizing Systems* (U.S. Dept of Transportation, Washington, DC, 1981); I. Benenson and P.N. Torrens, *Geosimulation: Automata-Based Modelling of Urban Phenomena* (Wiley, Hoboken, NJ, 2004).
26. J. von Plato, Probabilistic physics the classical way, in L. Krüger et al., eds, *The Probabilistic Revolution* (MIT Press, Cambridge, MA, 1987), vol. 2, 379–407; D.C. Mattis and R.H. Swendsen, *Statistical Mechanics Made Simple* (2nd edn, World Scientific, NJ, 2008).
27. M. Lesieur, *Turbulence in Fluids* (4th edn, Springer, Dordrecht, 2008); J. Gleick, *Chaos* (Cardinal, London, 1988), 119–153; J.R. Dorfman, *An Introduction to Chaos in Nonequilibrium Statistical Mechanics* (Cambridge: Cambridge University Press, 2003).
28. R.Z. Sagdeev, D.A. Usikov and G.M. Zaslavsky, *Non-Linear Physics: From the Pendulum to Turbulence and Chaos*, trans. I.R. Sagdeev (Harwood, Chur, 1988); S.H. Strogatz, *Nonlinear Dynamics and Chaos: With Applications to Physics, Biology, Chemistry, and Engineering* (Addison-Wesley, Reading, MA, 1994).
29. L. von Bertalanffy, *General System Theory* (Braziller, New York, 1969); L. Skjottner, *General Systems Theory: An Introduction* (Macmillan, Basingstoke, 1996); I.R. Hoos, *Systems Analysis in Public Policy: A Critique* (University of California Press, Berkeley, CA, 1972).
30. P.W. Colgan, ed., *Quantitative Ethology* (Wiley, New York, 1978); D. McFarland and A. Houston, *Quantitative Ethology: The State-Space Approach* (Pitman, Boston, 1981).
31. J.D. Gray, The development of mathematics: a response to Monna, *Nieuw Archief voor Wiskunde* 3 (1985), 1–6; Gleick, *Chaos*, note 29, p. 52, p. 89.
32. C.A.R. Hoare, An axiomatic basis for computer programming, *Communications of the Association for Computing Machinery* 12 (1969), 576–580.

33. R. Stallman and S. Garfinkle, Against software patents, *Communications of the Association for Computing Machinery* 35 (1992), 17–22 and 121, at 19.
34. J.H. Fetzer, Program verification: the very idea, *Communications of the Association for Computing Machinery* 31 (1988), 1048–1063.
35. J.H. Fetzer, Program verification reprise: the author's response, *Communications of the Association for Computing Machinery* 32 (1989), 377–381; further in J.H. Fetzer, Philosophy and computer science: reflections on the program verification debate, in T.W. Bynum, ed., *The Digital Phoenix* (Blackwell, Oxford, 1998), 253–273.
36. J. Barwise, Mathematical proofs of computer system correctness, *Notices of the American Mathematical Society* 36 (1989), 844–851.
37. M.M. Lehman, Uncertainty in computer application, *Communications of the Association for Computing Machinery* 33 (1990), 584–586.
38. D. Gries, *The Science of Programming* (Springer, New York, 1981), 5
39. C.A.R. Hoare, Programs are predicates, in C.A.R. Hoare and J.C. Shepherdson, eds, *Mathematical Logic and Programming Languages* (Prentice Hall, Englewood Cliffs, NJ, 1985), 141–155.
40. Unless he is Hume: *Treatise of Human Nature*, I.IV.i.
41. A similar argument is made of computer-assisted proofs of theorems in T. Burge, Computer proof, a priori knowledge, and other minds, *Philosophical Perspectives* 12 (1998), 1–37, section II.
42. H.M. Müller, letter in *Communications of the Association for Computing Machinery* 32 (1989), 506–508; cf. Hoare, Programs are predicates, note 56.
43. J. Dobson and B. Randell, Program verification: public image and private reality, *Communications of the Association for Computing Machinery* 32 (1989), 420–422; D. Mackenzie, The fangs of the VIPER, *Nature* 352 (1991), 467–468; later developments in C. Kern and M.R. Greenstreet, Formal verification in hardware design: a survey, *ACM Transactions on Design Automation of Electronic Systems* 4 (1999), 123–193.
44. D. Mackenzie, Computers, formal proofs and the law courts, *Notices of the American Mathematical Society* 39 (1992), 1066–1069.
45. M. Tiles, *Mathematics and the Image of Reason* (Routledge, London, 1991), ch. 5.
46. P.N. Johnson-Laird and R. Byrne, *Deduction* (L. Erlbaum, Hove, 1991).
47. D'Alembert, article 'Expérimentale', in *Encyclopédie*, vol. 6 (Paris, 1756), reprinted in J. Lough, *The Encyclopédie of Diderot and D'Alembert* (Cambridge University Press, Cambridge, 1954), 68–81.
48. Aristotle, *Posterior Analytics* 79a4–6; cf. *Metaphysics* 1078a14–17; H.G. Apostle, *Aristotle's Philosophy of Mathematics* (University of Chicago Press, Chicago, 1952), ch. 4.
49. K. de Laplante, Certainty and domain-independence in the sciences of complexity: a critique of James Franklin's account of formal science, *Studies in History and Philosophy of Science* 30 (1999), 513–533.
50. Further in J. Franklin, Structure and domain-independence in the formal sciences, *Studies in History and Philosophy of Science* 30 (1999), 721–723.

7 Comparisons and Objections

1. G. Frege, *The Foundations of Arithmetic*, section 22 (trans. J.L. Austin, 2nd revised edn, Blackwell, Oxford, 1980), p. 28.
2. Frege, *Foundations* section 25, p. 33.
3. The relations between these explained especially in section 72, p. 85.
4. G. Kessler, Frege, Mill and the foundations of arithmetic, *Journal of Philosophy* 77 (1980), 65–79; further in A.D. Irvine, Frege on number properties, *Studia Logica* 96 (2010), 239–260.
5. Frege, *Foundations*, section 54, p. 66.
6. E.H. Reck, Frege on numbers: beyond the Platonist picture, *Harvard Review of Philosophy* 13 (3) (2005), 25–40; W.P. Mendonça and P. Stekeler-Weithofer, Was Frege a Platonist?, *Ratio* 29 (1987), 96–110; T. Burge, Frege on knowing the third realm, *Mind* 101 (1992), 633–650; C. Wright, *Frege's Conception of Numbers as Objects* (Aberdeen University Press, Aberdeen, 1983), especially ch. 1, section v.
7. A. Kenny, *Frege* (Penguin, Harmondsworth, 1995), 161.
8. S. Körner, *The Philosophy of Mathematics: An Introduction* (Harper & Row, New York, 1962).
9. M. Tiles, *Mathematics and the Image of Reason* (Routledge, London, 1991), ch. 5.
10. P.A. Blanchette, Realism in the philosophy of mathematics, in E. Craig, ed., *Routledge Encyclopedia of Philosophy* (Routledge, London, 1998).
11. S. Shapiro, *The Oxford Handbook of Philosophy of Mathematics and Logic* (Oxford University Press, New York, 2005), 485–486.
12. A. Paseau, Naturalism in the philosophy of mathematics, *Stanford Encyclopedia of Philosophy* (2008, revised 2013), <http://plato.stanford.edu/entries/naturalism-mathematics/>.
13. M. Balaguer, *Platonism and Anti-Platonism in Mathematics* (Oxford University Press, New York, 1998), 11.
14. J. Franklin, Aristotelian realism, in A.D. Irvine, ed., *Handbook of the Philosophy of Science: Philosophy of Mathematics* (North Holland/Elsevier, Amsterdam, 2009), 103–155; further in J. Franklin, Aristotelianism in the philosophy of mathematics, *Studia Neoristotelica* 8 (2011), 3–15.
15. J.P. Burgess and G. Rosen, *A Subject with No Object: Strategies for Nominalistic Interpretation of Mathematics* (Clarendon, Oxford, 1997), abstract.
16. H. Field, *Science Without Numbers: A Defence of Nominalism* (Princeton University Press, Princeton, NJ, 1980), 56.
17. In the phrase of C. Pincock, A revealing flaw in Colyan's indispensability argument, *Philosophy of Science* 71 (2005), 61–79, section 3.
18. Some similar objections but concentrating on the reality of points in M.D. Resnik, How nominalist is Hartry Field's nominalism? *Philosophical Studies* 47 (1985), 163–181.
19. J. Franklin, Achievements and fallacies in Hume's account of infinite divisibility, *Hume Studies* 20 (1994), 85–101; P.E. Gibbs, *The Small Scale Structure of Space-Time: A Bibliographical Review* (1995), <http://arxiv.org/abs/hep-th/9506171>

20. A.G.J. Newstead, Aristotle and modern mathematical theories of the continuum, in D. Sfendoni-Mentzou, ed, *Aristotle and Contemporary Science* (Lang, New York, 2000), vol. 2, 113–129.
21. D.M. Armstrong, *Universals and Scientific Realism* (Cambridge University Press, Cambridge, 1978), vol. 1, ch. 4.
22. N. Bourbaki, 1950, The architecture of mathematics, *American Mathematical Monthly* 57, 221–232; L. Corry, Nicolas Bourbaki and the concept of mathematical structure, *Synthese* 92 (1992), 315–348.
23. P. Maddy, *Realism in Mathematics* (Clarendon, Oxford, 1992), 4.
24. D. Lewis, *Parts of Classes* (Blackwell, Oxford, 1991), 29–31; similar in M. Black, The elusiveness of sets, *Review of Metaphysics* 24 (1971), 614–636; a response attempting to make sense of ‘collecting’ using plural logic in A. Oliver and T. Smiley, What are sets and what are they for? *Philosophical Perspectives* 20 (1) (2006), 123–155.
25. T. Jech, Set Theory, *Stanford Encyclopedia of Philosophy* (2002) <http://plato.stanford.edu/entries/set-theory/> .
26. E.g. G. Boolos, The iterative conception of set, *Journal of Philosophy* 68 (1971), 215–231; G. Boolos, Must we believe in set theory? in G. Sher and R.L. Tieszen, eds, *Between Logic and Intuition: Essays in Honor of Charles Parsons* (Cambridge University Press, Cambridge, 2000), 257–268; J. Burgess, *E Pluribus Unum: Plural logic and set theory*, *Philosophia Mathematica* 12 (2004), 193–221; C. Parsons, Sets and classes, *Nous* 8 (1974), 1–12; P. Maddy, Set theoretic naturalism, *Journal of Symbolic Logic*, 61 (1996), 490–514; P. Maddy, A theory of sets and classes, in Sher and Tieszen, *Between Logic and Intuition*, 299–316; K. Fine, Properties, propositions and sets, *Journal of Philosophical Logic* 6 (1977), 135–191; K.-D. Schindler, A dilemma in the philosophy of set theory, *Notre Dame Journal of Formal Logic* 35 (1994), 458–463; M.D. Potter, *Set Theory and Its Philosophy: A Critical Introduction* (Oxford University Press, Oxford, 2004), ch. 2.
27. D.M. Armstrong, Classes are states of affairs, *Mind* 100 (1991), 189–200.
28. P. Benacerraf, What numbers could not be, *Philosophical Review* 74 (1965), 47–73, part IIIC.
29. E.g. C.W. Savage and P. Ehrlich, *Philosophical and Foundational Issues in Measurement Theory* (Lawrence Erlbaum, Hillsdale, NJ, 1992).
30. J. Azzouni, *Deflating Existential Consequence: A Case for Nominalism* (Oxford University Press, Oxford, 2004), 161.
31. D.H. Krantz, R.D. Luce, P. Suppes and A. Tversky, *Foundations of Measurement*, vol. 1 (Academic Press, New York, 1971), ch. 1.
32. Similar comments in J. Bigelow and R. Pargetter, *Science and Necessity* (Cambridge University Press, Cambridge, 1990), 60–61 and H.E. Kyburg, Quantities, magnitudes and numbers, *Philosophy of Science* 64 (1997), 377–410 (building on Helmholtz).
33. J. Michell, The logic of measurement: a realist overview, *Measurement* 38 (2005), 285–294; similar in C. Swoyer, The metaphysics of measurement, in J. Forge, ed., *Measurement, Realism and Objectivity* (Reidel, Dordrecht, 1987), 235–290.
34. W.V. Quine, Success and limits of mathematization, in W.V. Quine, *Theories and Things* (Harvard University Press, Cambridge, MA, 1981), 148–155, at 149–150.

35. Such fundamentalist attitudes criticized also in M. Leng, *Mathematics and Reality* (Oxford University Press, Oxford, 2010), 9–10, 130–132.
36. M. Colyvan, *The Indispensability of Mathematics* (Oxford University Press, Oxford, 2001), 4.
37. C. Pincock, A revealing flaw in Colyvan's indispensability argument, *Philosophy of Science* 71 (2005), 61–79, argues that Colyvan's proposal to allow 'realism' to cover views as distant from Platonism as Lewis's and Hellman's is contrary to the spirit of his conclusions, as on their views there are no genuine mathematical entities.
38. Colyvan, *The Indispensability of Mathematics*, ch. 3.
39. C. Cheyne and C.R. Pigden, Pythagorean powers, *Australasian Journal of Philosophy*, 74 (1996) 639–645.
40. Another Aristotelian reinterpretation of the indispensability argument in A. Newstead and J. Franklin, Indispensability without Platonism, in A. Bird, B. Ellis and H. Sankey, eds, *Properties, Powers and Structures* (Routledge, New York, 2012), 81–97.
41. C. Parsons, Mathematical intuition, *Proceedings of the Aristotelian Society* 80 (1979/80), 145–168, at 151.
42. J. Franklin, Artifice and the natural world: mathematics, logic, technology, in K. Haakonssen, ed., *Cambridge History of Eighteenth Century Philosophy* (Cambridge University Press, Cambridge, 2006), 817–853.
43. Plato, *Parmenides* 132a1–132b2l; G. Fine, *On Ideas: Aristotle's Criticism of Plato's Theory of Forms* (Clarendon, Oxford, 1993), ch. 15.
44. G. Hellman, *Mathematics Without Numbers: Towards a modal-structural interpretation* (Clarendon, Oxford, 1989), 53; summary in G. Hellman, Modal-structural mathematics, in A. Irvine, ed., *Physicalism in Mathematics* (Kluwer, Dordrecht, 1990), 307–330.
45. Hellman, *Mathematics Without Numbers*, 16–17.
46. Hellman, Modal-structural mathematics, at 311.
47. H.B. Enderton, Second-order and higher-order logic, *Stanford Encyclopedia of Philosophy* (revised 2009), <http://plato.stanford.edu/entries/logic-higher-order/>
48. G. Hellman, Structuralism without structures, *Philosophia Mathematica* 4 (1996), 100–123, at 103–104.
49. Hellman, Modal-structural mathematics, at 317.
50. Hellman, Structuralism without structures, at 108.
51. Leading to various characteristic difficulties concerning the 'incompleteness' of mathematical objects: F. MacBride, Structuralism reconsidered, in S. Shapiro, ed., *Oxford Handbook of Philosophy of Mathematics and Logic* (Oxford University Press, New York, 2005), 563–589.
52. S. Shapiro, *Philosophy of Mathematics: Structure and Ontology* (Oxford University Press, New York, 1997), 99–100.
53. Shapiro, *Philosophy of Mathematics*, 249.
54. Shapiro, *Philosophy of Mathematics*, 110.
55. J.R. Brown, π in the sky, in Irvine, *Physicalism in Mathematics*, 95–120.
56. J.R. Brown, *Philosophy of Mathematics: An Introduction to the World of Proofs and Pictures* (Routledge, London, 1999); 2nd edn, *Philosophy of Mathematics: A Contemporary Introduction to the World of Proofs and Pictures* (Routledge, New York, 2008), 40; more examples in R. Nelsen, *Proofs Without Words: Exercises*

- in *Visual Thinking* (Mathematical Association of America, Washington, DC, 1993).
57. Aristotle, *Physics*, bk 2, ch. 2, 193b23–194a11, discussed in J. Lear, Aristotle's philosophy of mathematics, *Philosophical Review* 91 (1982), 161–192; H. Mendell, Aristotle and mathematics, *Stanford Encyclopedia of Philosophy* (2004), <http://plato.stanford.edu/entries/aristotle-mathematics/>.
 58. Aristotle, *Metaphysics*, bk 13, ch. 3, 1077b18–1078a9.
 59. Aristotle, *Metaphysics*, bk 5, ch. 13, 1020a7–12.
 60. Aristotle, *Metaphysics*, bk 14, ch. 1, 1088a4–11, further in H.G. Apostle, *Aristotle's Philosophy of Mathematics* (University of Chicago Press, Chicago, 1952); V.E. Smith, *St Thomas on the Object of Geometry* (Marquette University Press, Milwaukee, 1954); D. Bostock, Aristotle's philosophy of mathematics, in C.J. Shields, ed, *Oxford Handbook of Aristotle* (Oxford University Press, Oxford, 2012), ch. 18.
 61. E.g. I. Barrow, *The Usefulness of Mathematical Learning Explained and Demonstrated* (London, 1734, repr. London, 1970), 10–15; *Encyclopaedia Britannica* (1st edn Edinburgh, 1771), article 'Mathematics', vol. III, 30–31; P. Mancosu, *Philosophy of Mathematics and Mathematical Practice in the Seventeenth Century* (Oxford University Press, New York, 1996), 16, 35–37, 56, 88.
 62. I. Newton, *Arithmetica Universalis* (1728), 2; similar in L. Euler, *Elements of Algebra* (3rd edn, London, 1822); both discussed in J. Bigelow and R. Pargetter, *Science and Necessity* (Cambridge University Press, Cambridge, 1990), 60–61; D.M. Jesseph, *Berkeley's Philosophy of Mathematics* (Chicago University Press, Chicago, 1993), ch. 1.
 63. J.S. Mill, *A System of Logic*, bk II, ch. Vi, section 2 (5th edn, Parker, London, 1862, I, 290).
 64. P. Kitcher, Mill, mathematics and the naturalist tradition, in J. Skorupski, ed., *The Cambridge Companion to Mill* (Cambridge University Press, Cambridge, 1998), ch. 2; D. Bostock, *Philosophy of Mathematics: An Introduction* (Wiley, Malden, MA, 2009), ch. 3.
 65. G. Frege, *The Foundations of Arithmetic*, trans. J.L. Austin (Blackwell, Oxford, 1950), 9.
 66. J.S. Mill, *System of Logic*, bk III, ch. xxiv, section 5.
 67. Argued in G. Kessler, Frege, Mill and the foundations of arithmetic, *Journal of Philosophy* 77 (1980), 65–79.
 68. S. Körner, *The Philosophy of Mathematics: An Introductory Essay* (Hutchinson, London, 1960), 179.
 69. E. Wigner, The unreasonable effectiveness of mathematics in the natural sciences, *Communications on Pure and Applied Mathematics* 13 (1960), 1–14.
 70. P. Benacerraf, What numbers could not be, *Philosophical Review* 74 (1965), 47–73.
 71. J.R. Brown, *Philosophy of Mathematics: An Introduction to the World of Proofs and Pictures* (Routledge, London, 1999).
 72. P. Kitcher, *The Nature of Mathematical Knowledge* (Oxford University Press, New York, 1983), 107–108; objections that this is too constructivist to be naturalistic in J.W. Roland, Kitcher, mathematics and naturalism, *Australasian Journal of Philosophy* 86 (2008), 481–497.

73. P. Maddy, *Realism in Mathematics* (Clarendon, Oxford, 1990), 58–63; defended from an Aristotelian perspective in D. Gillies, Review of C.S. Chihara, *Constructibility and Mathematical Existence*, *British Journal for the Philosophy of Science* 43 (1992), 263–278, section 3, and D. Gillies, An empiricist philosophy of mathematics and its implications for the history of mathematics, in E. Grosholz and H. Berger, eds, *The Growth of Mathematical Knowledge* (Kluwer, Dordrecht, 2000), 41–57; M. Kremer, Set-theoretic realism and arithmetic, *Philosophical Studies* 64 (1991), 253–271; objections surveyed and replied to in A. Levine, Conjoining mathematical empiricism with mathematical realism: Maddy's account of set perception revisited, *Synthese* 145 (2005), 425–448, section 3.
74. P. Maddy, *Naturalism in Mathematics* (Clarendon, Oxford, 1997).
75. A.D. Irvine, Nominalism, realism and physicalism in mathematics, in A.D. Irvine, ed., *Physicalism in Mathematics* (Kluwer, Dordrecht, 1990), ix–xxvi; also A.D. Irvine, Mathematical truth and scientific realism, PhD thesis, University of Sydney, 1986.
76. T. Wilholt, *Zahl und Wirklichkeit: Eine philosophische Untersuchung über die Anwendbarkeit der Mathematik [Number and Reality: A philosophical investigation of the applicability of mathematics]* (Mentis, Paderborn, 2004), reviewed by C. Pincock in *Philosophia Mathematica* 13 (2005), 329–337; G. Oliveri, *A Realist Philosophy of Mathematics* (College Publications, London, 2007) is, despite the title, constructivist in an even wider sphere than Wilholt.
77. G. Kessler, Frege, Mill and the foundations of arithmetic, *Journal of Philosophy* 77 (1980), 65–79; P. Forrest and D.M. Armstrong, The nature of number, *Philosophical Papers* 16 (1987), 165–186.
78. J. Bigelow, *The Reality of Numbers: A Physicalist's Philosophy of Mathematics* (Clarendon, Oxford, 1988); J. Bigelow and R. Pargetter, *Science and Necessity* (Cambridge University Press, Cambridge, 1990), ch. 2; J. Forge, Bigelow and Pargetter on quantities, *Australasian Journal of Philosophy* 73 (1995), 594–605.
79. D.M. Armstrong, Classes are states of affairs, *Mind* 100 (1991), 189–200; D.M. Armstrong, *Truth and Truthmakers* (Cambridge University Press, Cambridge, 2004), ch. 9.
80. B.D. Ellis, *Basic Concepts of Measurement* (Cambridge University Press, Cambridge, 1966); on which J. Forge, On Ellis's theory of quantities, in J. Forge, ed., *Measurement, Realism and Objectivity* (Reidel, Dordrecht, 1987), 291–310, with reply by D.M. Armstrong; J. Michell, Numbers as quantitative relations and the traditional theory of measurement, *British Journal for the Philosophy of Science* 45 (1994), 389–406; J. Michell, The logic of measurement: a realist overview, *Measurement* 38 (2005), 285–294; similar American work in B. Mundy, Extensive measurement and ratio functions, *Synthese* 75 (1988), 1–23; B. Mundy, The metaphysics of quantity, *Philosophical Studies* 51 (1987), 29–54.
81. C. Mortensen, On the possibility of science without numbers, *Australasian Journal of Philosophy* 76 (1998) 182–197; C. Mortensen and G. Nerlich, Physical topology, *Journal of Philosophical Logic* 7 (1978), 209–223; P. Forrest, From ontology to topology in the theory of regions, *Monist* 79 (1996), 34–50; some similar American work in B. Mundy, On quantitative relationist theories, *Philosophy of Science* 56 (1989), 582–600.

82. Bigelow, *Reality of Numbers*, ch. 6.
83. Bigelow, *Reality of Numbers*, chs 11–12; Bigelow and Pargetter, *Science and Necessity*, section 8.3.
84. Other difficulties in D.M. Armstrong, Are quantities relations? A reply to Bigelow and Pargetter, *Philosophical Studies* 54 (1988), 305–316.
85. Bigelow, *Reality of Numbers*, chs 13–14; Bigelow and Pargetter, *Science and Necessity*, section 2.6.
86. M. Giaquinto, *Visual Thinking in Mathematics: An Epistemological Study* (Oxford University Press, Oxford, 2007).
87. S. Dehaene, *The Number Sense: How the Mind Creates Mathematics* (Oxford University Press, New York, 1997).
88. E.g. Z.P. Dienes, *Building Up Mathematics* (Hutchinson, London, 1961), esp. ch. 2; A. Baroody, M.-L. Lai and K.S. Mix, The development of young children's early number and operation sense and its implications for early childhood education, in B. Spodek and O.N. Saracho, eds, *Handbook of Research on the Education of Young Children* (2nd edn, Lawrence Erlbaum, Mahwah, NJ, 2006), ch. 11.
89. An exception in M. Cappelletti and V. Giardino, The cognitive basis of mathematical knowledge, in M. Leng, A. Paseau and M.D. Potter, eds, *Mathematical Knowledge* (Oxford University Press, Oxford, 2007), 74–83.

8 Infinity

1. The need for philosophy of mathematics to consider how much of mathematics really is indispensable to science is argued in S. Feferman, Why a little goes a long way: logical foundations of scientifically applicable mathematics, in D. Hull, M. Forbes and K. Okruhlik, eds, *Philosophy of Science Association 1992* (Philosophy of Science Association, East Lansing, MI, 1992), vol. 2, 442–455.
2. D. Goldberg, What every computer scientist should know about floating-point arithmetic, *ACM Computing Surveys (CSUR)* 23 (1) (1991), 5–48; P.R. Turner, Will the 'real' real arithmetic please stand up? *American Mathematical Society Notices* 38 (1991), 298–304.
3. E.g. M.L. Abell and J.P. Braselton, *Maple by Example* (3rd edn, Elsevier, Boston, 2005).
4. D. Mackenzie, The automation of proof: a historical and sociological exploration, *IEEE Annals of the History of Computing* 17 (3) (1995), 7–29; S. Colton, Computational discovery in pure mathematics, in *Computational Discovery of Scientific Knowledge*, Springer Lecture Notes in Computer Science vol. 4660 (2007), 175–201.
5. J.G. Kemeny, J.L. Snell and G.L. Thompson, *Introduction to Finite Mathematics* (Prentice-Hall, Englewood Cliffs, NJ, 1957).
6. J. Franklin, Achievements and fallacies in Hume's account of infinite divisibility, *Hume Studies* 20 (1994), 85–101.
7. G. Nerlich, *The Shape of Space* (2nd edn, Cambridge University Press, Cambridge, 1994), ch. 3.
8. E. Schrödinger, *Science and Humanism: Physics in Our Time* (Cambridge University Press, Cambridge, 1951), 40.

9. D.J. Griffiths, *Introduction to Quantum Mechanics* (2nd edn, Pearson Prentice Hall, Upper Saddle River, NJ, 2005), ch. 1.
10. D. Meschini, M. Lehto and J. Piilonen, Geometry, pregeometry and beyond, *Studies in History and Philosophy of Modern Physics* 36 (2005), 435–464, section 4.
11. S. Wolfram, *A New Kind of Science* (Wolfram Media, Champaign, IL, 2002), ch. 9, with historical remarks on discrete space p. 1027.
12. H.H. Goldstine, *The Computer: From Pascal to von Neumann* (Princeton University Press, Princeton, NJ, 1972), part II.
13. The best-known topic of this kind is probably the theory of the Riemann integral (really Cauchy integral), replete with many theorems on the goodness of approximation of the discrete Riemann sum to the true value of the integral of a continuous function.
14. D. Zeilberger, 'Real' analysis is a degenerate case of discrete analysis, 2001, <http://www.math.rutgers.edu/~zeilberg/mamarim/mamarimhtml/real.html>; E. Bishop and D. Bridges, *Constructive Analysis* (Springer, New York, 1985).
15. A.W. Moore, *The Infinite* (Routledge, London, 1990), introduction; M. Friend, *Introducing Philosophy of Mathematics* (Acumen, Stocksfield, 2007), ch. 1.
16. J. Paris and L. Harrington, A mathematical incompleteness in Peano arithmetic, in J. Barwise, ed., *Handbook for Mathematical Logic* (North Holland, Amsterdam, 1977), 1133–1142; significance explained in G. Kolata, Does Gödel's theorem matter to mathematics?, *Science* 218 (1982), 779–780.
17. K. Gödel, What is Cantor's Continuum Problem?, *American Mathematical Monthly* 54 (1947), 515–525, at p. 520.
18. W. Charlton, Aristotle's potential infinities, in L. Judson, ed., *Aristotle's Physics: A Collection of Essays* (Oxford University Press, Oxford, 1991), 129–149; J. Lear, Aristotelian infinity, *Proceedings of the Aristotelian Society* 80 (1979), 187–210; J. Hintikka, Aristotelian infinity, *Philosophical Review* 75 (1966), 197–218.
19. G.R. Oppy, *Philosophical Perspectives on Infinity* (Cambridge University Press, Cambridge, 2006), 232; medieval versions of the distinction in Moore, *The Infinite*, 51.
20. Oppy, 245–246.
21. Moore, *The Infinite*, 149.
22. But an argument for that conclusion in the context of the continuum in Gregory of Rimini, *Commentary on the Sentences* 2.2.2.1 (R. Cross, Infinity, continuity and composition: the contribution of Gregory of Rimini, *Medieval Philosophy and Theology* 7 (1998), 89–110, at 100).

9 Geometry: Mathematics or Empirical Science?

1. J. Franklin, Achievements and fallacies in Hume's account of infinite divisibility, *Hume Studies* 20 (1994), 85–101 and citing articles; modern discussion in P. Forrest, Is space-time discrete or continuous? – an empirical question, *Synthese* 103 (1995), 327–354.
2. Discussion of attempts to prove tri-dimensionality in G.J. Whitrow, Why physical space has three dimensions, *British Journal for the Philosophy of Science* 6 (1955), 13–31; C. Callender, Answers in search of a question: 'proofs' of the tri-dimensionality of space, *Studies in History and Philosophy of Science B*, 36

- (2005), 113–136 (modern versions usually rely on an anthropic principle, so are not attempts at absolute proof of tri-dimensionality).
3. C.G. Hempel, Geometry and empirical science, *American Mathematical Monthly* 52 (1945), 7–17.
 4. B. Riemann, Über die Hypothesen welche der Geometrie zu gründe liegen (1854), *Abhandlungen der Königl. Gesellschaft der Wissenschaften zu Göttingen* 13 (1867), 133–152; trans. W.K. Clifford, On the hypotheses which lie at the bases of geometry, *Nature* 8 (1873), 14–17, 36–37.
 5. B. Russell, *The Principles of Mathematics* (Cambridge University Press, Cambridge, 1903), section 352.
 6. Francisco Suárez, *Metaphysical Disputations* 40, discussed in D.P. Lang, Aquinas and Suarez on the essence of continuous physical quantity, *Laval théologique et philosophique* 58 (3) (2002), 565–595.
 7. What about zero? This is a subtle point, to be considered in Chapter 14.
 8. E.g. A.R. Pears, *Dimension Theory of Abstract Spaces* (Cambridge University Press, Cambridge, 1975); dimension theory applies to topological spaces, and as explained in Chapter 4 above, topological spaces can be defined in purely structural terms.
 9. Russell, *The Principles of Mathematics*, section 354.
 10. G. Belot, *Geometric Possibility* (Oxford University Press, Oxford, 2011), 8–9.
 11. Philosophical survey in J.-P. Van Bendegem, Finitism in geometry, *Stanford Encyclopedia of Philosophy*, (2002, revised 2010) <http://stanford.library.usyd.edu.au/archives/fall2006/entries/geometry-finitism/>
 12. Further in Belot, *Geometric Possibility*, 20–21.
 13. It is possible for some of the cross lines to be parallel, in which case their intersections need to be interpreted as ‘points at infinity’ (or the theorem divided into cases, with parallel lines or without).
 14. V. Pambuccian, The axiomatics of ordered geometry: I. Ordered incidence spaces, *Expositiones Mathematicae* 29 (2011), 24–66; M.K. Bennett, *Affine and Projective Geometry* (Wiley, New York, 1995); W.A. Coppel, *Foundations of Convex Geometry* (Cambridge University Press, Cambridge, 1998), chs. 1, 3, 6; philosophical discussion of the nineteenth century developments in R. Torretti, *Philosophy of Geometry from Riemann to Poincaré* (Reidel, Dordrecht, 1978), section 3.2.
 15. On the neglect of topology by philosophers, see T. Mormann, Topology as an issue for history of philosophy of science, in Thomas Uebel, ed., *The Philosophy of the Sciences That Received Philosophy of Science Neglected. Historical Perspectives*, Springer, to appear, <http://philpapers.org/archive/MORTAA-7.2.pdf>; Topology for Philosophers, ed B. Smith and W. Zelanic, *The Monist* special issue, 79 (1) (1996).
 16. Namely, coordinatizing the Euclidean plane as \mathbf{R}^2 , then adding the line at infinity to obtain the projective plane, then replacing the field \mathbf{R} by the field of two elements. Another possible example is noncommutative algebraic geometry, whose connection with geometry is tenuous.
 17. Aristotle, *Physics* 231a24–26, discussed in M.J. White, On continuity: Aristotle versus topology? *History and Philosophy of Logic* 9 (1988), 1–12; details on Aristotle’s realism about the objects of geometry in R. Pettigrew Aristotle on the subject matter of geometry, *Phronesis* 54 (2009), 239–260; a modern reconstruction of Aristotle’s ontology of space in P. Roeper, The Aristotelian

- continuum: a formal characterization, *Notre Dame Journal of Formal Logic* 47 (2006), 211–232.
18. D. Hilbert, *The Foundations of Geometry* (2nd edn, Open Court, Chicago, 1980); A. Tarski and S. Givant, Tarski's system of geometry, *Bulletin of Symbolic Logic* 5 (1999), 175–214.
 19. K. Stromberg, The Banach–Tarski paradox, *American Mathematical Monthly* 86 (1979), 151–161.
 20. P. Forrest, Grit or gunk: implications of the Banach–Tarski Paradox, *Monist* 87 (2004), 351–370, at 361.
 21. Forrest, Grit or gunk, 370, n. 15, suggests the ‘maximal’ open sets: those open sets U such that for any open set V including U , $V - U$ has positive Lebesgue measure; or one could take the regular open sets: those which are the interior of their closure.
 22. F. Arntzenius, Gunk, topology and measure, in D. Zimmerman, ed., *Oxford Studies in Metaphysics*, vol. 4, (Oxford University Press, Oxford, 2008), ch. 10; earlier in D.W. Zimmerman, Could extended objects be made out of simple parts? an argument for ‘atomless gunk’, *Philosophy and Phenomenological Research* 56 (1996), 1–29; a similar plan by Whitehead and Russell discussed in D. Bostock, Whitehead and Russell on points, *Philosophia Mathematica* 18 (2010), 1–52; other arguments against points in G. Fowler, The nature and structure of space (PhD, University of Rochester, 2009); The pointfree mathematics of ‘locales’ surveyed in S. Mac Lane, Mathematical models of space, *American Scientist* 68 (1980), 184–191; advantages of regions over points in defining measure and distance discussed in C. Mortensen and G. Nerlich, Physical topology, *Journal of Philosophical Logic* 7 (1978), 209–233.
 23. Details on the construction of points out of regions in P. Roeper, Region-based topology, *Journal of Philosophical Logic*, 26 (1997), 25–309 and P. Forrest, Mereotopology without mereology, *Journal of Philosophical Logic* 39 (2010), 229–254; these authors regard the constructibility of points as an advantage, a feature rather than a bug.
 24. I. Kramosil and J. Michálek, Fuzzy metrics and statistical metric spaces, *Kybernetika* 11 (1975), 336–344; J.J. Buckley and E. Eslami, Fuzzy plane geometry I: points and lines, *Fuzzy Sets and Systems* 86 (1997), 179–187; G. Gerla, Pointless metric spaces and fuzzy spaces, in S.E. Rodabaugh et al., eds, *Applications of Category Theory to Fuzzy Subsets* (Kluwer, Dordrecht, 1992, Theory and Decision Library, series B, vol. 14, part III), 235–244.
 25. Aristotle, *De Anima* 430b.
 26. W.H. Newton-Smith, *The Structure of Time* (Routledge & Kegan Paul, 1980).
 27. Made more difficult by the impossibility of seeing the ‘pseudo-Riemannian metric’ defined by $ds^2 = dx^2 + dy^2 + dz^2 - c^2 dt^2$ as a distance (since points far apart have zero ‘distance’), and the awkwardness of finding any non-frame-relative alternative that does measure how far apart space-time points are.
 28. Riemann claims that there are only two easily perceived multidimensional continuous spaces, position and colour.
 29. The similarity between the two spaces emphasized in D.R. Hilbert, *Color and Color Perception: A Study in Anthropocentric Realism* (CSLI, Stanford, 1987), and downplayed in E. Thompson, *Colour Vision: A Study in Cognitive Science and the Philosophy of Perception* (Routledge, London, 1995), ch. 3.

30. J. Cohen, On the structural properties of the colours, *Australasian Journal of Philosophy* 81 (2003), 78–95.
31. R. Jagnow, Shadow-experiences and the phenomenal structure of colors, *Dialectica* 64 (2010), 187–212.
32. B. Maund, *Colours: Their Nature and Representation* (Cambridge University Press, Cambridge, 1995).
33. Discussions in Bigelow and Pargetter, *Science and Necessity*, section 2.6; Bigelow, *Reality of Numbers*, part II(c); S. Leuenberger and P. Keller, Introduction: the philosophy of vectors, *Dialectica* 63 (4) (2009), 369–380 and other papers in the same special issue; debates on whether some of these quantities, especially velocities are strictly ‘at’ a point or are in a region (e.g. J. Butterfield, Against *pointillisme* in mechanics, *British Journal for the Philosophy of Science* 57 (2006), 709–753) are not relevant to the present issue.
34. Defences of the reality of forces in, e.g., J. Bigelow, B. Ellis and R. Pargetter, Forces, *Philosophy of Science* 55 (1988), 614–630; O. Massin, The metaphysics of forces, *Dialectica* 63 (2009), 555–589; debate on whether component forces should be said to still exist in the composite surveyed in J. Wilson, The causal argument against component forces, *Dialectica* 63 (2009), 525–554.
35. Standard exposition in, e.g., C.J. Isham, *Modern Differential Geometry for Physicists* (2nd edn, World Scientific, Singapore, 1999), ch. 2.
36. Arguments that vectors ought to be identifiable across tangent spaces in T. Maudlin, *The Metaphysics Within Physics* (Oxford University Press, 2007), ch. 3; and against, P. Forrest, Vectors on curved space, *Dialectica* 63 (2009), 491–501.
37. There are many issues yet unsolved in explaining the geometrical properties of discrete spaces, for example, correctly defining for them dimension, curvature and direction; e.g. A.V. Evako, Dimension on discrete spaces, *International Journal of Theoretical Physics* 33 (1994), 1553–1568. For the present purpose, we may restrict attention to discrete spaces that are subsets of \mathbf{R}^n , such as \mathbf{Z}^n .
38. G. Nerlich, *The Shape of Space* (2nd edn, Cambridge University Press, Cambridge, 1994), 10.
39. I. Newton, Scholium to the Definitions in *Philosophiæ Naturalis Principia Mathematica*, bk 1 (1689), trans. A. Motte (London, 1729), 9.
40. Nerlich, *Shape of Space*, 19; further arguments on the need for something for causal influences to propagate through and bodies to accelerate with respect to in D. Meschini and M. Lehto, Is empty spacetime a physical thing? *Foundations of Physics* 36 (2006), 1193–1216.
41. ‘Space’ here should be taken locally, as the region around me within which I can move hands. One could consider the global topology of space, but that has the disadvantage that we cannot observe extremely distance space so are not sure of the universe’s global topology.
42. Nerlich, *Shape of Space*, ch. 2; G. Nerlich, Incongruent counterparts and the reality of space, *Philosophy Compass* 4 (2009), 598–613; Reichenbach’s arguments for the conventionality of topology answered in Nerlich, *Shape of Space*, ch. 8.
43. G. Nerlich, What can geometry explain? *British Journal for the Philosophy of Science* 30 (1979), 69–83, section 3.
44. Nerlich, *Shape of Space*, ch. 9.

45. G. Belot, *Geometric Possibility* (Oxford University Press, Oxford, 2010), 39–40.
46. That creates a conflict between the infinite space of Euclid and Aristotle's space which ends at the sphere of the fixed stars. 'The heaven is not anywhere as a whole, nor in any place.' (Aristotle, *Physics* 212b8–10); medieval denials of extracosmic void space in E. Grant, *Much Ado About Nothing: Theories of Space and Vacuum from the Middle Ages to the Scientific Revolution* (Cambridge University Press, Cambridge, 1981), chs 5–6.
47. Belot, *Geometric Possibility*, 119–120.
48. J.D. Anderson and E.L. Lau, Measurements of space curvature by solar mass, in I. Ciufolini and R.A. Matzner, eds, *General Relativity and John Archibald Wheeler*, Astrophysics and Space Science Library 367 (2010), 95–108.
49. http://map.gsfc.nasa.gov/universe/unI_shape.html.
50. E.g. L. Smolin, Atoms of space and time, *Scientific American* 290 (1) (January 2004), 66–75; P.E. Gibbs, The small scale structure of space-time: a bibliographical review, 1996, arXiv:hep-th/9506171v2; A. Meesen, Space-time quantization, *Revista Portuguesa de Filosofia* 61 (2005), 39–59.
51. M. Kline, *Mathematics: The Loss of Certainty* (Oxford University Press, New York, 1980), ch. 4, 'The first debacle: the withering of truth', especially 78–88.
52. B. Russell, A turning point in my life, in L. Russell, ed., *The Saturday Book* (vol. 8, Hutchinson, London, 1948), 142–146.
53. P. Ernest, *Social Constructivism as a Philosophy of Mathematics* (SUNY Press, Albany, NY, 1998), 26.
54. Gauss, letter to Olbers, 1817, in Gauss, *Werke* (Göttingen, 1880), VIII, 177, quoted in Kline, *Loss of Certainty*, 87, discussed in J. Gray, Gauss and non-Euclidean geometry, *Mathematics and Its Applications* 581 (2006), 61–80.
55. Proclus, *Commentary on the First Book of Euclid's Elements*, trans. G. Morrow (2nd edn, Princeton University Press, Princeton, NJ, 1992), 156, 169–171.
56. G. Saccheri, *Euclides ab omni naevo vindicatus* (Milan, 1733); M.J. Greenberg, *Euclidean and Non-Euclidean Geometries: Development and History* (4th edn, Freeman, New York, 2007), ch. 5.
57. Pascal to Fermat, 29 July 1654, in D.E. Smith, *A Source Book in Mathematics* (Dover, New York, 1959), II, 552.

10 Knowing Mathematics: Pattern Recognition and Perception of Quantity and Structure

1. L. Lehrer Dive, An epistemic structuralist account of mathematical knowledge, PhD thesis, University of Sydney, 2003, ch. 3.
2. D.M. Armstrong, *Belief, Truth and Knowledge* (Cambridge University Press, London, 1973), 166–171.
3. J. Garson, Connectionism, *Stanford Encyclopedia of Philosophy* (1997, revised 2010), <http://plato.stanford.edu/entries/connectionism/>.
4. T. Verguts and W. Fias, Representation of number in animals and humans: a neural model, *Journal of Cognitive Neuroscience* 16 (2004), 1493–1504; S. Dehaene, *The Number Sense: How the Mind Creates Mathematics* (Oxford

- University Press, New York, 1997), 31–35, 66–77; D. Domijan, A neural model of quantity discrimination, *NeuroReport* 15 (2004), 2077–2081.
5. The source of objections to neural nets as a general program of imitating cognition, as in J. Fodor and Z. Pylyshyn, Connectionism and cognitive architecture: a critical analysis, *Cognition* 28 (1988), 3–71.
 6. P. McCorduck, *Machines Who Think* (2nd edn, A.K. Peters, Natick, Mass, 2004), chs. 6 and 11; J. Haugeland, *Artificial Intelligence: The Very Idea* (MIT Press, Cambridge, Mass., 1985), ch. 2.
 7. S. Harnad, The symbol grounding problem, *Physica D* 42 (1990), 335–346; M. Taddeo and L. Floridi, Solving the symbol grounding problem: a critical review of fifteen years of research, *Journal of Experimental & Theoretical Artificial Intelligence* 17 (2005), 419–445.
 8. J. Franklin, How a neural nets grows symbols, Proceedings of the Seventh Australian Conference on Neural Networks, Canberra, 1996, 91–96; V. Honavar and L. Uhr, eds, *Artificial Intelligence and Neural Networks: Steps Toward Principled Integration* (Academic, Boston, 1994), chs IX–X, XIX–XXI.
 9. G. Huntley-Fenner, S. Carey and A. Solimando, Objects are individuals but stuff doesn't count: perceived rigidity and cohesiveness influence infants representations of small groups of discrete entities, *Cognition* 85 (2002), 203–221.
 10. R. Bijeljac-Babic, J. Bertoncini and J. Mehler, How do four-day-old infants categorize multisyllabic utterances? *Developmental Psychology* 29 (1993), 711–721; visual parallels in S.E. Antell and D.P. Keating, Perception of numerical invariance in neonates, *Child Development* 54 (1983), 695–701.
 11. Reviews in S. Dehaene, *The Number Sense* (Oxford University Press, New York, 1997), chs 1–2, M. Cappelletti and V. Giardino, The cognitive basis of mathematical knowledge, in M. Leng, A. Paseau and M.D. Potter, eds, *Mathematical Knowledge* (Oxford University Press, Oxford, 2007), 74–83; S. Carey, Where our number concepts come from, *Journal of Philosophy* 106 (2009), 220–254; updates on Dehaene in A. Nieder, Counting on neurons: the neurobiology of numerical competence, *Nature Reviews: Neuroscience* 6 (2005), 177–190; F. Xu, E.S. Spelke and S. Goddard, Number sense in human infants, *Developmental Science* 8 (2005), 88–101; B. Butterworth, The development of arithmetical abilities, *Journal of Child Psychology and Psychiatry* 46 (2005), 3–18; W. Mack, Numerosity discrimination: Infants discriminate small from large numerosities, *European Journal of Developmental Psychology* 3 (2006), 31–47.
 12. P. Maddy, *Realism in Mathematics* (Clarendon, Oxford, 1990), 58–67.
 13. M. Balaguer, Against (Maddian) naturalized Platonism, *Philosophia Mathematica* 2 (1994), 97–108, at 104.
 14. M.W. Clearfield and K.S. Mix, Amount versus number: Infants' use of area and contour length to discriminate small sets, *Journal of Cognition and Development* 2 (2001), 243–260.
 15. E.M. Brannon and H.S. Terrace, Ordering of the numerosities 1 to 9 by monkeys, *Science* 282 (1998), 746–749, discussed in Carey, Where our number concepts come from.
 16. R.K. Templeton and J. Franklin, Adaptive information and animal behaviour, *Evolutionary Theory* 10 (1992), 145–155; F.I. Dretske, *Knowledge and the Flow of Information* (MIT Press, Cambridge, Mass., 1981), ch. 6.

17. Review in J. Holland, K. Holyoak, R. Nisbett and P. Thagard, *Induction* (MIT Press, Cambridge, Mass, 1986), section 5.2; on an earlier stage of evolution, A. Bisazza, L. Piffer, G. Serena and C. Agrillo, Ontogeny of numerical abilities in fish, *PLoS ONE* 5 (11) (2010), e15516. doi:10.1371/journal.pone.0015516.
18. S. Lima and L. Dill, Behavioral decisions made under the risk of predation: a review and conspectus, *Canadian Journal of Zoology* 68 (1990), 619–640; M. Lawes and M. Perrin, Risk sensitive foraging behaviour of the round-eared elephant shrew, *Behavioral Ecology and Sociobiology* 37 (1995), 31–37.
19. J. Huttenlocher, S. Duffy and S. Levine, Infants and toddlers discriminate amount: are they measuring?, *Psychological Science* 13 (2002), 244–249; K. van Marle and K. Wynn, Six-month-old infants use analog magnitudes to represent duration, *Developmental Science* 9 (5) (2006), F41–F49; other references in N.S. Newcombe, The nativist–empiricist controversy in the context of recent research on spatial and quantitative development, *Psychological Science* 13 (2002), 395–401.
20. V. Walsh, A theory of magnitude: common cortical metrics of time, space and quantity, *Trends in Cognitive Sciences* 7 (2003), 483–488; L. Feigenson, The equality of quantity, *Trends in Cognitive Sciences* 11 (2007), 185–187.
21. D. Stea, D.D. Kirkman, M.F. Pinon, N.N. Middlebrook and J.L. Rice, Preschoolers use maps to find a hidden object outdoors, *Journal of Environmental Psychology* 24 (2004), 341–345; M. Vasilyeva and J. Huttenlocher, Early development of scaling ability, *Developmental Psychology* 40 (2004), 682–690; cf. C. Sophian, Perceptions of proportionality in young children: matching spatial ratios, *Cognition* 75 (2000), 145–170.
22. E.g. N.S. Newcombe and J. Huttenlocher, *Making Space: The Development of Spatial Representation and Reasoning* (MIT Press, Cambridge, Mass., 2000); L. Nadel, Varieties of spatial cognition: psychological considerations, in A. Diamond, ed., *The Development and Neural Basis of Higher Cognitive Functions* (New York Academy of Sciences, New York, 1990), 613–636; S. Dehaene, V. Izard, P. Pica and E. Spelke, Core knowledge of geometry in an Amazonian indigene group, *Science* 311 (2006), 381–384; O. Keller, *Aux origines de la géométrie: Le paléolithique, le monde des chasseurs-cueilleurs* (Vuibert, Paris, 2004).
23. Azzouni argues that in subitization and analog number representation, perception is ‘not directly sensitive to numerical properties of small sets’ (J. Azzouni, *Talking About Nothing: Numbers, Hallucinations and Fictions*, Oxford University Press, Oxford, 2010, 31–32). However, his reasons appear to be that the numerical concepts involved are not explicitly represented in perception; but that is true also of colours and all other perceived features: perception may be sensitive to them without explicit representation.
24. D.Y. Teller, First glances: the vision of infants, *Investigative Ophthalmology and Visual Science* 38 (1997), 2183–2203, based on older work such as R.L. Fantz, Pattern vision in newborn infants, *Science* 140 (1963), 296–297.
25. D. Ricci et al., Early assessment of visual function in full term newborns, *Early Human Development* 84 (2008), 107–113.
26. L. Demany, B. McKenzie and E. Vurpillot, Rhythm perception in early infancy, *Nature* 266 (1977), 718–719; S.E. Trehub, D. Bull and L.A. Thorpe, Infants’ perception of melodies: the role of melodic contour, *Child Development* 55

- (1984), 821–830; J.F. Werker and A. Vouloumanos, Who's got rhythm? *Science* 288 (14 April 2000), 280–281.
27. S.E. Trehub, Musical predispositions in infancy, *Annals of the New York Academy of Sciences* 930 (2001), 1–16.
 28. Review in D.W. Muir, D.E. Humphrey and G.K. Humphrey, Pattern and space perception in young infants, *Spatial Vision* 8 (1994), 141–165.
 29. M.H. Bornstein, K. Ferdinandsen and C.G. Gross, Perception of symmetry in infancy, *Developmental Psychology* 17 (1981), 82–86.
 30. C.W. Tyler, ed., *Human Symmetry Perception and its Computational Analysis* (VSP, Utrecht, 1996).
 31. M. Giurfa, B. Eichmann and R. Menzel, Symmetry perception in an insect, *Nature* 382 (1996), 458–461.
 32. S. Palmer, The role of symmetry in shape perception, *Acta Psychologica* 59 (1985), 67–90, discussed in M. Giaquinto, *Visual Thinking in Mathematics: An Epistemological Study* (Oxford University Press, Oxford, 2007), 15–20.
 33. A classic attempt in D. Marr, *Vision: A Computational Investigation into the Human Representation and Processing of Visual Information* (Freeman, San Francisco, 1982).
 34. L.E. Bahrick, R. Lickliter and R. Flom, Intersensory redundancy guides the development of selective attention, perception, and cognition in infancy, *Current Directions in Psychological Science* 13 (2004), 99–102; M.A. Schmuckler, Visual-proprioceptive intermodal perception in infancy, *Infant Behavior and Development* 19 (1996), 221–232.

11 Knowing Mathematics: Visualization and Understanding

1. Observed by P. van Inwagen, *The Problem of Evil* (Oxford University Press, Oxford, 2006), 126.
2. W. James, *The Principles of Psychology* (Holt, New York, 1890), ch. 18.
3. Survey of the traditional distinction in E.R. Harvey, *The Inward Wits: Psychological Theory in the Middle Ages and the Renaissance* (Warburg Institute, London, 1975); E.P. Mahoney, Sense, intellect and imagination in Albert, Thomas and Siger, in N. Kretzmann et al., eds, *The Cambridge History of Later Medieval Philosophy* (Cambridge University Press, Cambridge, 1982), ch. 30; J. Franklin, Diagrammatic reasoning and modelling in the imagination: the secret weapons of the Scientific Revolution, in *1543 and All That: Image and Word, Change and Continuity in the Proto-Scientific Revolution*, ed. G. Freeland and A. Coronas (Kluwer, Dordrecht, 2000), 53–115; modern perspectives in R.M.J. Byrne, *The Rational Imagination: How People Create Alternatives to Reality* (MIT Press, Cambridge, MA, 2005); K.D. Markman, W.M.P. Klein and J.A. Suhr, eds, *Handbook of Imagination and Mental Simulation* (Psychology Press, New York, 2009).
4. D. Hume, *Treatise of Human Nature*, I.i.1, ed. Selby-Bigge, revised by P.H. Nidditch (Clarendon, Oxford, 1978), 6, discussed in R.J. Fogelin, Hume and the missing shade of blue, *Philosophy and Phenomenological Research* 45 (1984), 263–271 and J.O. Nelson, Hume's missing shade of blue re-viewed, *Hume Studies* 15 (1989), 353–364. Hume's and the commentators' main concern is

- the difficulty of reconciling this with his doctrine of simple impressions and ideas, which need not concern us here.
5. D. Navon, Forest before trees: the precedence of global features in visual perception, *Cognitive Psychology* 9 (1977), 353–383.
 6. S.E. Palmer, Goodness, Gestalt, groups, and Garner: local symmetry subgroups as a theory of figural goodness, in *The Perception of Structure: Essays in Honor of Wendell R. Garner*, ed. G.R. Lockhead and J.R. Pomerantz (American Psychological Association, Washington, DC, 1991), 23–39.
 7. S. Ungar, Cognitive mapping without visual experience, in R. Kitchin and S. Freundschuh, eds, *Cognitive Mapping: Past Present and Future* (Routledge, London, 2000).
 8. From E. Barbeau, *Power Play* (Mathematical Association of America, Washington, DC, 1997), 18, discussed in A. Arcavi, The role of visual representations in the learning of mathematics, *Educational Studies in Mathematics* 52 (2003), 215–241, at 225.
 9. Many more simple examples of how visualization promotes mathematical understanding can be found in C. Alsina and R.B. Nelsen, *Math Made Visual: Creating Images for Understanding Mathematics* (Mathematical Association of America, Washington, DC, 2006).
 10. W.W. Bledsoe and D.W. Loveland, eds, *Automated Theorem Proving: After 25 Years* (Contemporary Mathematics, vol. 29, American Mathematical Society, Providence, RI, 1984).
 11. T.C. Hales, Formal proof, *Notices of the American Mathematical Society* 55 (2008), 1370–1380.
 12. E.g. D. Schwalbe and S. Wagon, *VisualDSolve: Visualizing Differential Equations with Mathematica* (Springer, New York, 1997).
 13. <http://demonstrations.wolfram.com/>.
 14. A. Arcavi, The role of visual representations in the learning of mathematics, *Educational Studies in Mathematics* 52 (2003), 215–241, at 235.
 15. E.g. S. Feferman, Mathematical intuition vs mathematical monsters, *Synthese* 125 (2000), 317–332; P. Mancosu, Visualization in logic and mathematics, in P. Mancosu, K.F. Jørgensen and S.A. Pedersen, eds, *Visualization, Explanation and Reasoning Styles in Mathematics* (Dordrecht, Springer, 2005), 13–30; K. Bråting and J. Pejlare, Visualizations in mathematics, *Erkenntnis* 68 (2008), 345–358; J. Carter, Diagrams and proofs in analysis, *International Studies in the Philosophy of Science* 24 (2010), 1–14; V. Giardino, Intuition and visualization in mathematical problem solving, *Topoi* 29 (2010), 29–39; A. Newstead and J. Franklin, The epistemology of geometry I: the problem of exactness, in W. Christensen, E. Schier, and J. Sutton, eds, *ASCS09: Proceedings of the 9th Conference of the Australasian Society for Cognitive Science* (Macquarie Centre for Cognitive Science, Sydney, 2010), 254–260.
 16. I. Lakatos, *Proofs and Refutations* (Cambridge, Cambridge University Press, 1976); P. Mancosu, ed., *The Philosophy of Mathematical Practice* (Oxford, Oxford University Press, 2008).
 17. J.R. Brown, *Philosophy of Mathematics: A contemporary Introduction to the World of Proofs and Pictures* (2nd edn, Routledge, New York, 2008); J.R. Brown, Peeking into Plato's heaven, *Philosophy of Science* 71 (2004), 1126–1138.
 18. L. Zagzebski, Recovering understanding, in M. Steup, ed., *Knowledge, Truth and Duty: Essays on Epistemic Justification, Responsibility and Virtue* (Oxford

- University Press, New York, 2001), 235–258; a fuller treatment in V.G. Potter, *On Understanding Understanding: A Philosophy of Knowledge* (Fordham University Press, New York, 1994).
19. Aristotle, *Posterior Analytics*, bk II, ch. 2.
 20. Aristotle, *De Anima*, bk III, ch. 8, 431b21–431b22.
 21. References in note 2 above.
 22. Proclus, *Commentary on the First Book of Euclid's Elements*, trans. G.R. Morrow (Princeton University Press, Princeton, NJ, 1970), 41–45; cf. J.F. Jones, Intelligible matter and geometry in Aristotle, *Apeiron* 17 (1983), 94–102.
 23. Deheane, *The Number Sense*, 73–76, 150–151; L. Feigenson, S. Carey and M. Hauser, The representations underlying infants' choice of more: object files versus analog magnitudes, *Psychological Science* 13 (2002), 150–156.
 24. Einstein, quoted in J. Hadamard, *The Psychology of Invention in the Mathematical Field* (Princeton University Press, Princeton, NJ, 1945), 142–143; many examples in A.I. Miller, *Imagery in Scientific Thought: Creating Twentieth-Century Physics* (Birkhäuser, Boston, 1984).
 25. Some further mathematical visualization exercises in J. Franklin, *What Science Knows: And How It Knows It* (Encounter Books, New York, 2009), 133.
 26. J.W. Stigler, Mental abacus: the effect of abacus training on Chinese children's mental calculation, *Developmental Psychology* 16 (1984), 145–176; cf. P. Saariluoma and V. Kalikoski, Apperception and memory in blindfold chess, *Memory* 6 (1998), 67–90.
 27. Some attempts to connect understanding with better-known cognitive abilities in J. Avigad, Understanding proofs, in P. Mancosu, ed., *The Philosophy of Mathematical Practice* (Oxford University Press, Oxford, 2008), 317–353.
 28. Descartes, *Meditations on First Philosophy*, Sixth Meditation, trans. E.S. Haldane (Cambridge University Press, Cambridge, 1911), <http://www.sacred-texts.com/phi/desc/med.txt>.
 29. Hume, *Treatise of Human Nature* I.iii.1; J. Hospers, *An Introduction to Philosophical Analysis* (4th edn, Routledge, Abingdon, 1997), 56.

12 Knowing Mathematics: Proof and Certainty

1. A textbook on proof from this point of view is J. Franklin and A. Daoud, *Proof in Mathematics: An Introduction* (Quakers Hill Press, Sydney, 1996; Kew Books, Sydney, 2011).
2. J. Franklin, Artifice and the natural world: mathematics, logic, technology, in K. Haakonssen, ed., *Cambridge History of Eighteenth Century Philosophy* (Cambridge University Press, Cambridge, 2006), 817–853.
3. Introduction in I. Grattan-Guinness, ed., *From the Calculus to Set Theory* (Princeton University Press, Princeton, NJ, 1980), ch. 3.
4. The interpretation of Cauchy's text is controversial, not surprisingly given that he was struggling towards a distinction which he had not yet clearly made. Reviews of attempts to show that Cauchy did not make an error in G. Schubring, *Conflicts Between Generalization, Rigor, and Intuition: Number Concepts Underlying the Development of Analysis in 17–19th century France and Germany* (Springer, New York, 2005), 432, 470 and H.N. Jahnke, ed, *A History of Analysis* (American Mathematical Society, Providence, RI, 2003), 181–184.

5. P. Singer, introduction, in P. Singer, ed., *Ethics* (Oxford University Press, Oxford, 1994), 3–13, at 8.
6. Various problems for logicism in S. Körner, *The Philosophy of Mathematics: An Introductory Essay* (Hutchinson, London, 1960), ch. 3; N. Tennant, Logicism and neologicism, *Stanford Encyclopedia of Philosophy* (2013), <http://plato.stanford.edu/entries/logicism>, section 6.
7. N. Griffin, Russell, logicism and ‘if-thenism’, in A. Schwerin, ed., *Bertrand Russell on Nuclear War, Peace and Language* (Praeger, Westport, CT, 2002), 117–138.
8. A. Musgrave, Logicism revisited, *British Journal for the Philosophy of Science* 28 (1977), 99–127; it is to be distinguished from the ‘if-thenism’ of Putnam, which is a form of fictionalism holding that mathematics deals in statements such as ‘If numbers existed, then 3 would be prime’.
9. H. Putnam, The thesis that mathematics is logic, in R. Schoenman, ed., *Bertrand Russell, Philosopher of the Century* (Allen & Unwin, London, 1967), 273–303, at 281.
10. H. Weyl, *Symmetry* (Princeton University Press, Princeton, NJ, 1952), 41–43; W. Miller, *Symmetry Groups and Their Applications* (Academic Press, New York, 1972).
11. R.C. Powell, *Symmetry, Group Theory and the Physical Properties of Crystals* (Springer, New York, 2010), ch. 1.
12. Various problems for formalism in Körner, *Philosophy of Mathematics*, ch. 5; A. Weir, Formalism in the philosophy of mathematics, *Stanford Encyclopedia of Philosophy* (2011), <http://plato.stanford.edu/entries/formalism-mathematics>.
13. R.D. McKirahan, *Principles and Proofs: Aristotle’s Theory of Demonstrative Science* (Princeton University Press, Princeton, NJ, 1992), ch. 12.
14. L.I. Meikle and J.D. Fleuriet, Formalizing Hilbert’s *Grundlagen* in Isabelle/Isar, *Theorem Proving in Higher Order Logics*, Lecture Notes in Computer Science, Vol. 2758 (2003), 319–334.
15. For example, Birkhoff’s axioms which build on the axioms for the real numbers: G.D. Birkhoff, A set of postulates for plane geometry (based on scale and protractors), *Annals of Mathematics* 33 (1932), 329–345.
16. T.C. Hales, Formal proof, *Notices of the American Mathematical Society* 55 (2008), 1370–1380.
17. Another possible interpretation is that there is no fact of the matter as to whether the Continuum Hypothesis is true or false; that still leaves the axioms and their consequences incapable of pinning down everything about the subject matter. Discussion in P. Koellner, Large cardinals and determinacy, *Stanford Encyclopedia of Philosophy* (2013), <http://plato.stanford.edu/entries/large-cardinals-determinacy>.
18. Kant, *Critique of Pure Reason*, B 300.
19. Kant, *Critique*, B 16, B179–B181; discussion in J. Franklin, Artifice and the natural world.
20. Kant, *Critique*, B xii; In the terms of contemporary cognitive science, we have a ‘category specification’ but lack a ‘visual sensation’: M. Giaquinto, *Visual Thinking in Mathematics* (Oxford University Press, Oxford, 2007), ch. 6.
21. Descartes’s Reply to Gassendi, in J. Cottingham, R. Stoothoff and D. Murdoch, trans., *The Philosophical Writings of René Descartes* (Cambridge, Cambridge University Press, 1984), II, 252.

22. A.N. Whitehead and B. Russell, *Principia Mathematica* (Cambridge University Press, Cambridge, 1910–1913), vol. II, 183; discussion in P.W. Hylton, Logic in Russell’s logicism, in A.D. Irvine, ed., *Bertrand Russell: Critical Assessments of Leading Philosophers* (Routledge, London, 1999) vol. II, 196–231, at 221.
23. W. and M. Kneale, *The Development of Logic* (Oxford University Press, Oxford, 1962), 699.
24. Lucretius, *De Rerum Natura*, book 1, lines 967–982; original in Archytas of Tarentum (C.A. Huffman, *Archytas of Tarentum: Pythagorean, Philosopher, and Mathematician King*, Cambridge University Press, Cambridge, 2005, 541).

13 Explanation in Mathematics

1. J. Woodward, Scientific explanation, *Stanford Encyclopedia of Philosophy* (2003, revised 2009), <http://plato.stanford.edu/entries/scientific-explanation/>.
2. P. Mancosu, Explanation in mathematics, *Stanford Encyclopedia of Philosophy* (2008, revised 2011), <http://plato.stanford.edu/entries/mathematics-explanation/>; a longer survey of the issues in mathematical explanation in P. Mancosu, Mathematical explanation: why it matters, in P. Mancosu, *The Philosophy of Mathematical Practice* (Oxford University Press, Oxford, 2008), 134–150.
3. B. van Fraassen, *The Scientific Image* (Clarendon Press, Oxford, 1980), ch. 5; David Sandborg’s claim that this theory would be trivialized in the mathematical case (D. Sandborg, Mathematical explanations and the theory of why-questions, *British Journal for the Philosophy of Science* 49 (1998), 603–624, section 5) relies on some theses on probability as applied to mathematical propositions that are argued against in the last chapter below.
4. D. Hume, *Dialogues Concerning Natural Religion* (1779), part IX.
5. J. Franklin and A. Daoud, *Proof in Mathematics: An Introduction* (Kew Books, Sydney, 2010), ch. 6.
6. A. Van der Poorten, A proof that Euler missed, *Mathematical Intelligencer* 1 (1979), 195–203 (corrected reprint at <http://www.maths.mq.edu.au/~alf/45.pdf>).
7. N. Robertson, D. Sanders, P. Seymour and R. Thomas, The Four-colour theorem, *Journal of Combinatorial Theory B*, 70 (1997), 2–44.
8. K.I. Appel, Review of Jensen and Toft, *Graph Coloring Problems*, *Bulletin of the American Mathematical Society* 33 (1996), 287–288.
9. M. Lange, What are mathematical coincidences, and why does it matter? *Mind* 119 (2010), 307–340.
10. Aristotle, *Posterior Analytics*, especially I.6.
11. R.D. McKirahan, *Principles and Proofs: Aristotle’s Theory of Demonstrative Science* (Princeton University Press, Princeton, NJ, 1992), ch. 12; more on the relation to mathematical traditions of explanation in C. Cellucci, The nature of mathematical explanation, *Studies in History and Philosophy of Science A* 39 (2008), 202–210, section 1.
12. M. Steiner, Mathematical explanation, *Philosophical Studies* 34 (1978), 135–151.
13. E. Weber and L. Verhoeven, Explanatory proofs in mathematics, *Logique et Analyse* 179–180 (2002), 299–307.

14. M. Resnik and D. Kushner, Explanation, independence, and realism in mathematics, *British Journal for the Philosophy of Science* 38 (1987), 141–158; J. Hafner and P. Mancosu (2005), The varieties of mathematical explanation, in P. Mancosu et al., eds, *Visualization, Explanation and Reasoning Styles in Mathematics*, Synthese Library vol. 327, part 2, 215–250.
15. Proclus, *A Commentary on the First Book of Euclid's Elements*, trans. G. Morrow (Princeton University Press, Princeton, NJ, 1970), 160–162; discussed in O. Harari, Proclus' account of explanatory demonstrations in mathematics and its context, *Archiv für Geschichte der Philosophie* 90 (2008), 137–164 and Mancosu (n. 2).
16. M. Lange, Why proofs by mathematical induction are generally not explanatory, *Analysis* 69 (2009), 203–211; A. Baker, Mathematical induction and explanation, *Analysis* 70 (2010), 681–689.
17. P. Kitcher, Explanatory unification and the causal structure of the world, in P. Kitcher and W. Salmon, *Scientific Explanation* (University of Minnesota Press, Minneapolis, 1989), 410–505; discussion in Woodward (n. 1).
18. J. Tappenden, Proof style and understanding in mathematics I: visualization, unification and axiom choice, in P. Mancosu et al., eds, *Visualization, Explanation and Reasoning Styles in Mathematics*, Synthese Library vol. 327 (2005), part 2, 147–214.
19. A detailed criticism of its application to a mathematical case in J. Hafner and P. Mancosu, Beyond unification, in P. Mancosu, *The Philosophy of Mathematical Practice* (Oxford University Press, Oxford, 2008), 151–179.
20. C. Hempel, *Aspects of Scientific Explanation and Other Essays in the Philosophy of Science* (Free Press, New York, 1965); discussion in Woodward (n. 1).
21. Surveyed in Woodward, n. 1.
22. L. Euler, Solutio problematis ad geometriam situs pertinentis (1735), trans. in *Graph Theory 1736–1936*, ed. N. Biggs, E. Lloyd and R. Wilson (Oxford University Press, Oxford, 1976), 3–8; the analysis in C. Pincock, A role for mathematics in the physical sciences, *Nous* 41 (2007), 253–275, section II, also emphasizes the high-level structural nature of the standard modern proof in graph theory.
23. Aristotle, *Posterior Analytics* 2.18; O. Goldin, *Explaining an Eclipse: Aristotle's Posterior Analytics 2.1–10* (University of Michigan Press, Ann Arbor, 1996).
24. Aristotle, *Posterior Analytics* 1.13.
25. A. Lyon and M. Colyvan, The explanatory power of phase spaces, *Philosophia Mathematica* 16 (2008), 1–17.
26. J. Kepler, *The Six-Cornered Snowflake: A New Year's Gift* (1611), trans. J. Bromberg (Paul Dry Books, Philadelphia, 2010).
27. H.M. Stommel and D.W. Moore, *An Introduction to the Coriolis Force* (Columbia University Press, New York, 1989); an intuitive introduction in D.J. Van Domelen, Getting around the Coriolis force (1996), www.algon.dk/dokumenter/coriolis.pdf.
28. Theodoric of Freiberg, *De iride* (c. 1305), excerpted in E. Grant, *A Source Book of Medieval Science* (Harvard University Press, Harvard, 1974), 435–440; C. Pincock, Mathematical explanations of the rainbow, *Studies in History and Philosophy of Science B* 42 (2011), 13–22.
29. G. Nerlich, What can geometry explain?, *British Journal for the Philosophy of Science* 30 (1979), 69–83.

30. W. Salmon, *Scientific Explanation and the Causal Structure of the World* (Princeton University Press, Princeton, NJ, 1984); survey in Woodward (n. 1).
31. A similar view of the role of mathematical derivations in M. Strevens, *Depth: An Account of Scientific Explanation* (Harvard University Press, Harvard, MA, 2008), 329–332.
32. A. Baker, Are there genuine mathematical explanations of physical phenomena? *Mind* 114 (2005), 223–238; A. Baker, Mathematical explanation in science, *British Journal for the Philosophy of Science* 60 (2009), 611–633.
33. S.I. Bangu, Inference to the best explanation and mathematical realism, *Synthese* 160 (2008), 13–20; D. Rizze, Magicada, mathematical explanation and mathematical realism, *Erkenntnis* 74 (2011) 101–114; J. Saatsi, The enhanced indispensability argument: representational versus explanatory role of mathematics in science, *British Journal for the Philosophy of Science* 62 (2011), 143–154.
34. R.W. Batterman, On the explanatory role of mathematics in empirical science, *British Journal for the Philosophy of Science* 61 (2010), 1–25.
35. L. Ginsburg and M. Colyvan, *Ecological Orbits: How Planets Move and Populations Grow* (Oxford University Press, New York, 2004).
36. J.D. Murray, How the leopard gets its spots, *Scientific American* 258 (3) (1988), 80–87.
37. T. Palmer, A weather eye on unpredictability, *New Scientist* 124 no. 1690 (11 November 1989), 56–59; R. Kautz, *Chaos: The Science of Predictable Random Motion* (Oxford University Press, Oxford, 2011), ch. 1.
38. S. Drake, Uniform acceleration, space and time, *British Journal for the History of Science* 5 (1970), 21–43.
39. M. Steiner, Mathematics, explanation and scientific knowledge, *Nous* 12 (1978), 17–28.
40. H. Poincaré, *Calcul des probabilités* (2nd edn, Gauthier-Villars, Paris, 1912), 171; debates on the reasons in W.J. Adams, *The Life and Times of the Central Limit Theorem* (2nd edn, American Mathematical Society, Providence, RI, 2009), ch. 6.
41. M.J. Behe, *Darwin's Black Box* (Free Press, New York, 1996); W.A. Dembski, *The Design Inference: Eliminating Chance through Small Probabilities* (Cambridge University Press, New York, 1998).
42. E.g. W. Elsberry, and J. Shallit, Information theory, evolutionary computation and Dembski's 'complex specified information', *Synthese* 178 (2011), 237–270.
43. N. Bibby, Tuning and temperament: closing the spiral, in J. Fauvel, R. Flood and R. Wilson, eds, *Music and Mathematics: From Pythagoras to Fractals* (Oxford University Press, New York, 2003), ch. 1.
44. R. Eastaway and J. Wyndham, *Why Do Buses Come in Threes?: The Hidden Mathematics of Everyday Life* (Wiley, New York, 2000) (As the book explains, it is a myth that buses come in threes, but they do come in twos.)

14 Idealization: An Aristotelian View

1. Aristotle, *Metaphysics* 997b35–998a4, also 1036a4–12. Aristotle's own position is that geometrical objects exist in some way in the physical world, but in what way exactly he thinks they do so is hard to determine: debate in J. Lear, Aristotle's philosophy of mathematics, *Philosophical Review* 91 (1982), 161–192, R. Pettigrew, Aristotle on the subject matter of geometry, *Phronesis* 54 (2009), 239–260 and D. Bostock, Aristotle's philosophy of mathematics, in *Oxford Handbook of Aristotle* (Oxford University Press, Oxford, 2012), ch. 18.
2. Proclus, *Commentary of the First Book of Euclid's Elements*, trans. G.R. Morrow (Princeton University Press, Princeton, NJ, 1970), 10–11.
3. C. Pincock, *Mathematics and Scientific Representation* (Oxford University Press, Oxford, 2012), 4; similarly, recent debate on understanding takes it that idealizations are literally false: M. Mizrahi, Idealizations for scientific understanding, *Philosophical Studies* 160 (2012), 237–252.
4. J. Saatsi, Mathematics and program explanations, *Australasian Journal of Philosophy* 90 (2012), 579–584.
5. R.W. Batterman, On the explanatory role of mathematics in empirical science, *British Journal for the Philosophy of Science* 61 (2010), 1–25, at 10.
6. A.C. Fowler, *Mathematical Models in the Applied Sciences* (Cambridge University Press, Cambridge, 1997), 3, quoted with approval in R.W. Batterman, Idealization and modelling, *Synthese* 169 (2009), 427–446.
7. K. de Laplante, Certainty and domain-independence in the sciences of complexity: a critique of James Franklin's account of formal science, *Studies in History and Philosophy of Science* 30 (1999), 513–533.
8. The careful treatment of J.D. Norton, Approximation and idealization: why the difference matters, *Philosophy of Science* 79 (2012), 207–232, distinguishes between approximation, 'an inexact description of a target system', and an idealization, 'a real or fictitious system, distinct from the target system, some of whose properties provide an inexact description of some aspects of the target system'; in that classification, what is being dealt with here are idealizations, with the 'inexact description' being approximation in some quantitative measure. Further afield are attempts to connect approximation with truthlikeness of theories, surveyed in C. Liu, Approximation, idealization, and laws of nature, *Synthese* 118 (1999), 229–256.
9. All perfect circles are alike; each imperfect circle is imperfect in its own way.
10. There is a technical issue over whether an imperfect sphere might be a non-measurable set of points and so not have a volume at all. In Chapter 9 we defended the view that regions of space should be measurable, but at present we can restrict the argument to measurable imperfect spheres without affecting the argument.
11. J. Franklin, Philosophy and mathematical modelling, *Teaching Mathematics and Its Applications* 2 (1983), 118–119; R.M. May, *Stability and Complexity in Model Ecosystems* (Princeton, 1973), especially ch. 2.
12. Further in J. Franklin, Structure and domain-independence in the formal sciences, *Studies in History and Philosophy of Science* 30 (1999), 721–723.
13. C. Pincock, Mathematical idealization, *Philosophy of Science* 75 (2007), 957–967.

14. K. Manders, Domain extension and the philosophy of mathematics, *Journal of Philosophy* 86 (1989), 553–562.
15. The position of J. Greth, *Elementa Philosophiae Aristotelico-Thomisticae* (5th edn, Freiburg, 1929), 1194, and some later Thomists, as explained in A. Maurer, Thomists and Thomas Aquinas on the foundation of mathematics, *Review of Metaphysics* 47 (1993), 43–61.
16. Recall that space was given a realist interpretation in Chapter 9.
17. Hence efforts to introduce negative numbers in school via walking forwards and backwards on a number line.
18. Again, Chapter 9 explained how to interpret ‘the Euclidean plane’ realistically, so there is no fictionalism involved in it.
19. Based on the well-known mathematical fact that multiplication by i is rotation through 90° in the Argand plane.
20. G.K. Batchelor, *An Introduction to Fluid Dynamics* (3rd edn, Cambridge University Press, Cambridge, 2000), 106–108.
21. E. Wigner, The unreasonable effectiveness of mathematics in the natural sciences, *Communications in Pure and Applied Mathematics* 13 (1960), 1–14.
22. A typical example is Pappus’s theorem of Euclidean geometry proved via projective geometry, which does not have to consider parallel lines as a special case: H.S.M. Coxeter and S.L. Greitzer, *Geometry Revisited* (Mathematical Association of American, Washington, DC, 1967), 67–69.
23. P. Benacerraf, Mathematical truth, *Journal of Philosophy* 70 (1973), 661–679, at 664, based on D. Hilbert, On the infinite (1925), translation in P. Benacerraf and H. Putnam, eds, *Philosophy of Mathematics: Selected Readings* (2nd edn, Cambridge University Press, Cambridge, 1983), 183–201.
24. Some similar discussion but with more technical issues in physics involved in Y. Balashov, Zero-value physical quantities, *Synthese* 119 (1999), 253–286.
25. R. Kaplan, *The Nothing That Is: A Natural History of Zero* (Oxford University Press, Oxford, 2000); C. Seife, *Zero: The Biography of a Dangerous Idea* (Viking, New York, 2000); B. Rotman, *Signifying Nothing: The Semiotics of Zero* (St. Martin’s Press, New York, 1987).
26. ‘There is no such thing as nothingness, and zero does not exist. Everything is something. Nothing is nothing’, Victor Hugo, *Les Misérables* (1862), pt 2, bk 7, ch. 6.
27. Holes are a well-studied case but are somewhat different in status, as a hole may be a part of space, itself real according to the theory of Chapter 9; even if the part of space is variable and externally specified, as in the case of a hole in a moving object, it is still part of a real entity.
28. The reasons why not are explained in M. Reicher, Nonexistent objects, *Stanford Encyclopedia of Philosophy*, (2006, revised 2012) <http://plato.stanford.edu/entries/nonexistent-objects/>.
29. J. Azzouni, *Talking About Nothing: Numbers, Hallucinations and Fictions* (Oxford University Press, Oxford, 2010), 250.
30. D. Lewis, Void and object, in J. Collins, N. Hall and L.A. Paul, eds, *Causation and Counterfactuals* (MIT Press, Cambridge, Mass., 2004), 277–290, at 282; H. Beebe, Causing and nothingness, in *ibid.*, 291–308. <http://strangebeautiful.com/uwo/metaphys/collins-hall-paul-caus-counterfactuals.pdf>.
31. Introduction and classification in D.D. Novotný, Scholastic debates about beings of reason and contemporary analytic metaphysics, in L. Novák,

- D.D. Novotný, P. Sousedík and D. Svoboda, eds, *Metaphysics: Aristotelian, Scholastic, Analytic* (Ontos Verlag, Heusenstamm, 2012), 25–40; also G. Klima, The changing role of *entia rationis* in mediaeval semantics and ontology: a comparative study with a reconstruction, *Synthese* 96 (1993), 25–58.
32. M. Balaguer, Fictionalism in the philosophy of mathematics, *Stanford Encyclopedia of Philosophy*, <http://plato.stanford.edu/entries/fictionalism-mathematics/>.
 33. M. Leng, Fictionalism in the philosophy of mathematics, *Internet Encyclopedia of Philosophy*, <http://www.iep.utm.edu/mathfict/>; in detail in M. Leng, *Mathematics and Reality* (Oxford University Press, Oxford, 2010).
 34. E. Zermelo, Untersuchungen über die Grundlagen der Mengenlehre I, *Mathematische Annalen* 65 (1908), 261–281, trans. in J. van Heijenoort, *From Frege to Gödel: A Source Book in Mathematical Logic, 1879–1931*, (Harvard University Press, Harvard, MA, 1967), 199–215, at 202 (with ‘fictitious’ for *uneigentlich*).
 35. A. Oliver and T. Smiley, What are sets and what are they for? *Philosophical Perspectives* 20 *Metaphysics* (2006), 123–155, section 1.1; A. Kanamori, The empty set, the singleton and the ordered pair, *Bulletin of Symbolic Logic* 9 (2003), 273–298.
 36. Oliver and Smiley, section 1.2.
 37. D. Lewis, Mathematics is megethology, *Philosophia Mathematica* 1 (1993), 3–23, at 9; something similar in E. Zermelo, On boundary numbers and domains of sets: new investigations in the foundations of set theory, in W. Ewald, ed., *From Kant to Hilbert: A Source Book in the Foundations of Mathematics*, vol. II (Oxford University Press, Oxford, 1996), 1219–1233; some later protestations on the meaninglessness of the empty set in P.A. Carmichael, The null class nullified, *Philosophical Review* 52 (1943), 61–68 and P.A. Carmichael, Animadversion on the null class, *Philosophy of Science* 10 (1943), 90–94.
 38. There are obvious resemblances with Frege’s idea that the empty set is the extension of a Concept such as ‘not self-identical’, but the Aristotelian interpretation is without any of Frege’s Platonist overhead.
 39. Compare Lytton Strachey’s query as to why Lord Acton was straining at the gnat of papal infallibility when he had swallowed the camel of Roman Catholicism (L. Strachey, *Eminent Victorians*, Oxford University Press, Oxford, 2003, 75).
 40. Though an infinitesimal ratio is not out of the question, for example if one quantity is finite and one infinite.

15 Non-Deductive Logic in Mathematics

1. A first version of this chapter appeared as J. Franklin, Non-deductive logic in mathematics, *British Journal for the Philosophy of Science* 38 (1987), 1–18; a version almost identical to the present one appeared as Non-deductive logic in mathematics: the probability of conjectures, in A. Aberdein and I. Dove, eds, *The Argument of Mathematics* (Springer, Dordrecht, 2013), 11–29. It is reprinted with permission from Springer. G. Polya, *Mathematics and Plausible Reasoning* (vol. I, *Induction and Analogy in Mathematics*, and vol. II, *Patterns of Plausible Inference*, Princeton University Press, Princeton, NJ, 1954); recent

- revivals in D. Fallis, The epistemic status of probabilistic proof, *Journal of Philosophy* 94 (1997), 165–186; J.R. Brown, *Philosophy of Mathematics: An introduction to the world of proofs and pictures* (Routledge, London, 1999), ch. 10; D. Fallis, The reliability of randomized algorithms, *British Journal for the Philosophy of Science* 51 (2000), 255–271; D. Corfield, *Towards a Philosophy of Real Mathematics* (Cambridge University Press, Cambridge, 2003), ch. 5; A. Baker, Is there a problem of induction for mathematics?, in M. Leng, A. Paseau and M.D. Potter, eds, *Mathematical Knowledge* (Oxford University Press, Oxford, 2007), 59–73; A. Baker, Non-deductive methods in mathematics, *Stanford Encyclopedia of Philosophy* (2009) <http://plato.stanford.edu/entries/mathematics-nondeductive/>; I.J. Dove, Towards a theory of mathematical argument, *Foundations of Science* 14 (2009), 137–152, section 3; B. van Kerkhove, and J. P. van Bendegem, Pi on earth, or mathematics in the real world, *Erkenntnis* 68 (2008), 421–435; L. Lehrer Dive, An epistemic structuralist account of mathematical knowledge, PhD thesis, University of Sydney, 2003, ch. 6; some brief remarks in G.B. Kolata, Mathematical proofs: the genesis of reasonable doubt, *Science* 192 (1976), 989–990.
2. Polya, *Mathematics and Plausible Reasoning*, vol. I, 68.
 3. C. Chandler, *Hello, I Must Be Going: Groucho Marx and His Friends* (Doubleday, Garden City, New York, 1978), 560.
 4. C. Fadiman, *The American Treasury* (Harper, New York, 1955), 794.
 5. Polya, *Mathematics and Plausible Reasoning*, vol. I, 18–21. A translation of another of Euler's publications devoted to presenting 'such evidence...as might be regarded as almost equivalent to a rigorous demonstration' of a proposition is given in vol. I, 91–98.
 6. Many examples in J.M. Borwein and D. Bailey, *Mathematics by Experiment: Plausible Reasoning in the 21st Century* (A.K. Peters, Natick, MA, 2004); J.M. Borwein, D.H. Bailey and R. Girgensohn, *Experimentation in Mathematics: Computational Paths to Discovery* (A.K. Peters, Natick, MA, 2004); J. Müller and M. Neunhöffer, Some computations regarding Foulkes' conjecture, *Experimental Mathematics* 14 (2005), 277–283; some comments on experimental mathematics of this kind in D. Epstein, S. Levy and R. de la Llave, About this journal, *Experimental Mathematics* 1 (1992), 1–13; philosophical examination in A. Baker, Experimental mathematics, *Erkenntnis* 68 (2008), 331–344.
 7. D. Zeilberger, Theorems for a price: tomorrow's semi-rigorous mathematical culture, *Notices of the American Mathematical Society* 46 (1993), 978–981.
 8. B. Riemann, On the number of primes less than a given magnitude, translated in H.M. Edwards, *Riemann's Zeta Function* (Academic, New York, 1974), 299–305.
 9. Accounts in Edwards, *Riemann's Zeta Function*; J. Derbyshire, *Prime obsession: Bernhard Riemann and the Greatest Unsolved Problem in Mathematics* (Joseph Henry Press, Washington, DC, 2003), ch. 5; K. Sabbagh, *Dr Riemann's Zeros* (Atlantic, London, 2002); M. du Sautoy, *The Music of the Primes: Searching to Solve the Greatest Mystery in Mathematics* (HarperCollins, New York, 2003).
 10. Edwards, *Riemann's Zeta Function*, 97.
 11. R.P. Brent, J. van de Lune, H.J.J. Te Riele, and D.T. Winter, On the zeros of the Riemann Zeta Function in the critical strip (II), *Mathematics of Computation*, 39 (1982), 681–688; X. Gourdon, The 10^{13} first zeros of the Riemann Zeta

- Function, and zeros computation at very large height, 2004, <http://numbers.computation.free.fr/Constants/Miscellaneous/zetazeros1e13-1e24.pdf>.
12. Edwards, *Riemann's Zeta Function*, 226–229.
 13. Edwards, *Riemann's Zeta Function*, 193.
 14. A. Weil, *Variétés abéliennes et courbes algébriques* (Hermann, Paris, 1948).
 15. Edwards, *Riemann's Zeta Function*, 298.
 16. Edwards, *Riemann's Zeta Function*, 268–269.
 17. G. Tenenbaum, *Introduction to Analytic and Probabilistic Number Theory* (Cambridge University Press, Cambridge, 1995), Part III.
 18. Edwards, *Riemann's Zeta Function*, 268.
 19. Edwards, *Riemann's Zeta Function*, 166.
 20. Polya, *Mathematics and Plausible Reasoning*, vol. II, 20.
 21. Edwards, *Riemann's Zeta Function*, 175–179; further in A. Ivić, On some reasons for doubting the Riemann Hypothesis, in P. Borwein et al., eds, *The Riemann Hypothesis: A resource for the aficionado and virtuoso alike* (Springer, New York, 2008), 131–160.
 22. Edwards, *Riemann's Zeta Function*, 269; further reasons for regarding the computed values as too small to be representative in P. Sarnak, Problems of the millennium: the Riemann Hypothesis, in Borwein, *The Riemann Hypothesis*, 107–115.
 23. Y. Wang, ed., *Goldbach Conjecture* (World Scientific, River Edge, NJ, 2002); discussed from the point of view of experimental methods in J. Echeverría, Empirical methods in mathematics, *Spanish Studies in the Philosophy of Science. Boston Studies in the Philosophy of Science*, vol. 86, ed. G. Munévar (Kluwer, Dordrecht, 1996), 19–55 and in Baker, Is there a problem of induction for mathematics?
 24. <http://www.ieeta.pt/~tos/goldbach.html>.
 25. W. Feit, and J. Thompson, Solvability of groups of odd order, *Pacific Journal of Mathematics*, 13 (1963), 775–1029.
 26. R. Solomon, A brief history of the classification of the finite simple groups, *Bulletin of the American Mathematical Society* 38 (2001), 315–352.
 27. D. Gorenstein, *Finite Simple Groups* (Plenum, New York, 1982), 1; a 'cleaned-up' final version in D. Gorenstein, R. Lyons and R. Solomon, *The Classification of the Finite Simple Groups* (American Mathematical Society, Providence, RI, 6 vols, 1994–2005).
 28. Z. Janko, A new finite simple group with abelian 2-Sylow subgroups and its characterization, *Journal of Algebra* 3 (1966), 147–186.
 29. Gorenstein, *Finite Simple Groups*, 3–4.
 30. M. Aschbacher, *The Finite Simple Groups and Their Classification* (Yale University Press, New Haven, CT, 1980), 6–7.
 31. J. Tits, Groupes finis simples sporadiques, *Séminaire Bourbaki*, in *Springer Lecture Notes* no. 180 (1969/1970), 204.
 32. R. Lyons, Evidence for a new finite simple group, *Journal of Algebra*, 20 (1972), 540–569.
 33. M. O'Nan, Some evidence for the existence of a new finite simple group, *Proceedings of the London Mathematical Society* 32 (1976), 421–479, at p. 422.
 34. D. Gorenstein, The classification of finite simple groups (I), *Bulletin of the American Mathematical Society New Series*, 1 (1979), 43–199.
 35. Gorenstein, *Finite Simple Groups*, 5–6.

36. M.J. Collins, ed., *Finite Simple Groups II* (London Mathematical Society, London, 1980), 21.
37. Gorenstein, *Finite Simple Groups*, 110.
38. Aschbacher, *The Finite Simple Groups*, 13–15.
39. Gorenstein, The classification of finite simple groups, 50–51.
40. D. Gorenstein, An outline of the classification of finite simple groups, in B. Cooperstein and G. Mason, eds, *The Santa Cruz Conference on Finite Groups, Proceedings of Symposia in Pure Mathematics*, vol. 37, 1980, 3–28, at 3.
41. D.C. Hunt, A computer-based atlas of finite simple groups, in Cooperstein and Mason, *ibid.*, 507–510.
42. G. Mason, Preface to Cooperstein and Mason, *ibid.*, xiii.
43. Gorenstein, *Finite Simple Groups*, 1.
44. M. Aschbacher, The status of the classification of the finite simple groups, *Notices of the American Mathematical Society* 51 (2001), 736–740.
45. J.M. Keynes, *A Treatise on Probability* (Macmillan, London, 1921); E.T. Jaynes, *Probability Theory: The logic of science* (Cambridge University Press, Cambridge, 2003); a somewhat less objectivist version in J. Williamson, *In Defence of Objective Bayesianism* (Oxford University Press, Oxford, 2010); introductions in J. Franklin, Resurrecting logical probability, *Erkenntnis* 55 (2001), 277–305; J. Franklin, *What Science Knows: And How It Knows It* (Encounter Books, New York, 2009), ch. 10.
46. J. Franklin, The objective Bayesian conceptualisation of proof and reference class problems, *Sydney Law Review* 33 (2011), 545–561.
47. H. Bender, On the uniqueness theorem, *Illinois Journal of Mathematics* 14 (1970), 376–384.
48. E.g. A.L. Ruhkin, Testing randomness: a suite of statistical procedures, *Theory of Probability and Its Applications* 45 (2001), 111–132; Franklin, *What Science Knows*, 162–163.
49. G. Marsaglia, On the randomness of pi and other decimal expansions, 2005, <http://www.yaroslavvb.com/papers/marsaglia-on.pdf>.
50. Baker, Is there a problem of induction for mathematics?
51. Polyá, *Mathematics and Plausible Reasoning*, vol. II, 24.

Select Bibliography

Note: This is not in any sense a complete bibliography of recent philosophy of mathematics or of works referred to. It lists just those books and articles that have proved especially valuable for forming the point of view of this book.

- Armstrong, D.M. (1991), Classes are states of affairs, *Mind* 100, 189–200.
- Baker, A. (2009), Mathematical explanation in science, *British Journal for the Philosophy of Science* 60, 611–633.
- Belot, G. (2011), *Geometric Possibility* (Oxford University Press, Oxford).
- Benacerraf, P. (1965), What numbers could not be, *Philosophical Review* 74, 495–512.
- Benacerraf, P. (1973), Mathematical truth, *Journal of Philosophy* 70, 661–679.
- Bigelow, J. (1988), *The Reality of Numbers: A Physicist's Philosophy of Mathematics* (Clarendon, Oxford).
- Bigelow, J. (1993), Sets are haecceities, in J. Bacon, K. Campbell and L. Reinhardt, eds, *Ontology, Causality and Mind: Essays in Honour of D.M. Armstrong* (Cambridge University Press, Cambridge), ch. 4.
- Bigelow, J. and R. Pargetter (1990), *Science and Necessity* (Cambridge University Press, Cambridge).
- Brown, J.R. (2008), *Philosophy of Mathematics: A Contemporary Introduction to the World of Proofs and Pictures* (Routledge, New York).
- Carey, S. (2009), Where our number concepts come from, *Journal of Philosophy* 106, 220–254.
- Cheyne, C. and C.R. Pigden (1996), Pythagorean powers, *Australasian Journal of Philosophy* 74, 639–645.
- Colyvan, M. (2001), *The Indispensability of Mathematics* (Oxford University Press, Oxford).
- Corfield, D. (2003), *Towards a Philosophy of Real Mathematics* (Cambridge University Press, Cambridge).
- Corry, L. (1992), Nicolas Bourbaki and the concept of mathematical structure, *Synthese* 92, 315–348.
- Crowley, C.B. (1980), *Universal Mathematics in Aristotelian-Thomistic Philosophy* (University Press of America, Washington, DC).
- De Laplante, K. (1999), Certainty and domain-independence in the sciences of complexity: A critique of James Franklin's account of formal science, *Studies in History and Philosophy of Science* 30, 513–533.
- Dehaene, S. (1997), *The Number Sense: How the Mind Creates Mathematics* (Oxford University Press, New York).
- Dennett, D. (1991), Real patterns, *Journal of Philosophy* 88, 27–51.
- Ellis, B. (1968), *Basic Concepts of Measurement* (Cambridge University Press, Cambridge).
- Field, H. (1980), *Science Without Numbers: A Defence of Nominalism* (Princeton University Press, Princeton, NJ).

- Forrest, P. (2002), Sets as mereological tropes, *Metaphysica* 3 (1), 5–9.
- Forrest, P. *The Necessary Structure of the All-Pervading Aether: Discrete or Continuous? Simple or Symmetric?* (De Gruyter, Berlin, 2013).
- Forrest, P. and D.M. Armstrong (1987), The nature of number, *Philosophical Papers* 16, 165–186.
- Franklin, J. (1987), Non-deductive logic in mathematics, *British Journal for the Philosophy of Science* 38, 1–18.
- Franklin, J. (1989), Mathematical necessity and reality, *Australasian Journal of Philosophy* 67, 286–294.
- Franklin, J. (1994), The formal sciences discover the philosophers' stone, *Studies in History and Philosophy of Science* 25, 513–533.
- Franklin, J. (2009), Aristotelian realism, in A.D. Irvine, ed., *Handbook of the Philosophy of Science: Philosophy of Mathematics* (North Holland/Elsevier, Amsterdam), 103–155.
- Franklin, J. (2011), Aristotelianism in the philosophy of mathematics, *Studia Neoaristotelica* 8, 3–15.
- Franklin, J. (2014), Quantity and number, in D. Novotný and L. Novák, eds, *Neo-Aristotelian Perspectives in Metaphysics* (Routledge, London), 221–244.
- Giaquinto, M. (2007), *Visual Thinking in Mathematics* (Oxford University Press, Oxford).
- Gillies, D. (2000), An empiricist philosophy of mathematics and its implications for the history of mathematics, in E. Grosholz and H. Berger, eds, *The Growth of Mathematical Knowledge* (Kluwer, Dordrecht), 41–57.
- Hellman, G. (1989), *Mathematics Without Numbers: Towards a Modal-Structural Interpretation* (Oxford University Press, Oxford).
- Irvine, A. ed. (1990), *Physicalism in Mathematics* (Kluwer, Dordrecht).
- Irvine, A.D. (2010), Frege on number properties, *Studia Logica* 96, 239–260.
- Kessler, G. (1980), Frege, Mill and the foundations of arithmetic, *Journal of Philosophy* 77, 65–79.
- Körner, S. (1960), *The Philosophy of Mathematics: An Introduction* (Hutchinson, London).
- Lehrer Dive, L. (2003), An epistemic structuralist account of mathematical knowledge, PhD thesis, University of Sydney.
- Leuenberger S. and P. Keller (2009), Introduction: The philosophy of vectors, *Dialectica* 63, 369–380.
- Lewis, D. (1991), *Parts of Classes* (Blackwell, Oxford).
- Lewis, D. (1993), Mathematics is megethology, *Philosophia Mathematica* 1, 3–23.
- Linnebo, Ø. (2008), Structuralism and the notion of dependence, *Philosophical Quarterly* 58, 59–79.
- Maddy, P. (1990), *Realism in Mathematics* (Oxford University Press, Oxford).
- Maurer, A. (1993), Thomists and Thomas Aquinas on the foundation of mathematics, *Review of Metaphysics* 47, 43–61.
- Michell, J. (1994), Numbers as quantitative relations and the traditional theory of measurement, *British Journal for the Philosophy of Science* 45, 389–406.
- Michell, J. (2005), The logic of measurement: a realist overview, *Measurement* 38, 285–294.
- Mortensen, C. and G. Nerlich (1978), Physical topology, *Journal of Philosophical Logic* 7, 209–223.
- Mundy, B. (1987), The metaphysics of quantity, *Philosophical Studies* 51, 29–54.

- Musgrave, A. (1977), Logicism revisited, *British Journal for the Philosophy of Science* 28, 99–127.
- Nerlich, G. (1994), *The Shape of Space* (2nd edn, Cambridge University Press, Cambridge).
- Newstead, A.G.J. (2000), Aristotle and modern mathematical theories of the continuum, in D. Sfendoni-Mentzou, ed., *Aristotle and Contemporary Science* (Lang, New York), vol. 2, 113–129.
- Newstead, A. and J. Franklin (2008), On the reality of the continuum, *Philosophy* 83, 117–127.
- Newstead, A. and J. Franklin (2012), Indispensability without Platonism, in A. Bird, B. Ellis and H. Sankey, eds, *Properties, Powers and Structures* (Routledge, New York), 81–97.
- Paseau, A. (2008), Motivating reductionism about sets, *Australasian Journal of Philosophy* 86, 295–307.
- Pincock, C. (2007), A role for mathematics in the physical sciences, *Nous* 41, 253–275.
- Pincock, C. (2012), *Mathematics and Scientific Representation* (Oxford University Press, Oxford).
- Polya, G. (1954), *Mathematics and Plausible Reasoning* (2 vols, Princeton University Press, Princeton, NJ).
- Reck, E. and M. Price (2000), Structures and structuralism in contemporary philosophy of mathematics, *Synthese* 125, 341–383
- Resnik, M.D. (1997), *Mathematics as a Science of Patterns* (Oxford University Press, New York).
- Shapiro, S. (1997), *Philosophy of Mathematics: Structure and Ontology* (Oxford University Press, Oxford).
- Steiner, M. (1998), *The Applicability of Mathematics as a Philosophical Problem* (Harvard University Press, Cambridge, MA).

Index

- abstract objects, 13–15, 26, 104–5,
110, 121, 230
- abstraction, 19–20, 56, 172
- algebra, abstract, 51–4
- animal mathematical knowledge,
174–7
- applied mathematics, 5, 54–5, 77–9,
90–2, 113, 120, 125, 224
see also modelling, mathematical,
and simulation
- approximation, 132–3, 225–9
- Archimedes, 133
- Aristotelian realism, 11–12, 105, 113,
115, 220, 261–2
semi-Platonist, 23–4, 26–9
- Aristotle, 65, 98, 109, 116, 122–3, 136,
151, 158, 188–9, 200, 212, 216, 222
- Armstrong, D.M., 25–7, 29, 40, 127
- Arntzenius, F., 152
- artificial intelligence, 19, 87–8,
167–72, 185
- Australian realism, 33, 126–7
- axiomatization, 54, 63, 76, 129, 135,
199–202, 213
- Azzouni, J., 288n.23
- Baker, A., 218, 258, 299nn.1/6
- Balaguer, M., 105, 174
- Banach-Tarski Paradox, 151–2
- Batterman, R., 223
- Bayesianism, 255
- Belot, G., 147, 158–9
- Benacerraf, P., 45, 49–50, 125
- Berkeley, G., 102
- Bigelow, J., 34–5, 40, 127–8
- Bourbaki, 51, 110, 197, 201, 270
- Brown, J.R., 121–2, 125, 128, 187
- Burgess, J.P., 105–6
- calculus, 7
see also Cauchy–Riemann–
Weierstrass approach to calculus
- Cantor, G., 109–10, 134–5, 239
- Cauchy–Riemann–Weierstrass
approach to calculus, 45, 137,
196–7
- causal power of mathematical
properties, 17–18, 115–16, 158,
217
- certainty of mathematics, 92–7,
160–2, 183, 186, 190, 192, 194
- chaos theory, 86, 132, 228
- Cheyne, C., 115
- Chihara, C., 42
- chiliagon, 191
- cicada life cycle length, 217–18
- civilization, significance of
mathematics for, 260–2
- coincidences in mathematics, 212
- colours, space of, 11, 15, 22, 154–5
- Colyvan, M., 115
- combinatorics, 38–9, 60–1, 149, 193
- complex numbers, 46, 128, 229–34
- complexity, 3, 82, 87, 190–3, 219
- comprehension axiom, 16, 136
- computer science, 87, 92–5, 130
- conjectures, evidence for, 241–5
- constructivism, 138, 160, 234
- continuity, 61–2, 197
- continuous quantity, 34, 44, 63,
107–8, 123, 176
- continuum, 46, 64, 108, 131, 134,
144, 150
- Continuum Hypothesis, 135, 202
- counting, 117–18, 202–3, 225
- d’Alembert, J., 98
- Dedekind, R., 63, 197
- Dehaene, S., 128, 286n.4, 287n.11
- Descartes, R., 39, 83, 158, 191, 203
- determinables and determinates, 22–3
- diagrams, knowledge from, 182–4,
187, 190, 210
- differential equations, 79, 218
- discrete quantity, 36–8, 44, 123,
131, 175

- Edwards, H., 248–9
 Einstein, A., 29, 67, 76, 190
 Ellis, B., 24, 127
 empty set, 43, 238–40
 epistemology, Aristotelian, 18–20,
 122, 165–7, 182, 188
 Ernest, P., 160–1
 Escher, M., 69, 70
 ethnomathematics, 48
 Euclid 45, 150–1, 200, 212
 Euler, L., 48–9, 244–5, 250
 experiment in mathematics, 98–100,
 125, 241, 246, 253, 299
 explanation
 geometrical, in science, 215–17
 in pure mathematics, 208–14
 mathematical, in science, 217–20
 theories of, 212–14
 exponential growth, 7, 55, 79, 218
- Fermat, P., 38
 Fetzer, J., 93
 fictionalism, 230, 236, 239–40
 Field, H., 107–8
 finitism, 112, 134–6
 formal sciences, 82–92, 219
 formalism, 105, 124, 200
 Forrest, P., 40, 152
 foundations of mathematics, 51, 124
 four-colour map theorem, 211–2
 Franklin, J., 105, 223, 275n.50,
 301nn.45/46/48
 Frege, G., 15, 37, 101–4, 124, 197, 239
 fuzzy quantities, 46, 153, 174
- Galileo, 98, 218
 Gauss, C.F., 161
 geometry, 141–62
 discrete, 156–7, 160, 162
 Euclidean, 69, 141, 146, 150, 162
 finite, 149
 non-Euclidean, 141, 160–2
 of non-spatial ‘spaces’, 153–6
 projective, 148
 geometrical explanation in science,
 see explanation
 Giaquinto, M., 128, 178
 Gödel’s Incompleteness Theorem,
 135, 200–1
- Goldbach’s Conjecture, 250
 Goodman, N., 41
 Gorenstein program in group theory,
 251–4
 graphs of functions, 38, 54
 group theory, 52–4, 109, 199, 211,
 219, 250–4
- Hardy, G.H., 51, 247
 Hellman, G., 27, 59–60, 117–19
 Hempel, C., 141
 Hilbert, D., 124, 151, 200–1, 233
 Hoare, C.A.R., 93–4
 Hölder, O., 63
 homoiomerous properties, 16, 104
 Hume, D., 45, 80, 141, 181,
 191, 208
- ideal entities, 43, 229–30, 233
 idealization, 74–5, 222–9
 if-thenism, 75–7, 141–2, 199–200
 imagination, 180–1, 184, 190
 indispensability argument, 114–17
 inductive arguments in mathematics,
 257–9
 infant mathematical knowledge,
 173–8
 infinity, 21, 111–2, 129–40
 axiom of, 119, 129, 203–4
 knowledge of, 140, 203–6
 potential, 136–40
 information theory, 85, 175
 intelligent design theory, 219
 intermodal properties, 19, 178
 intuitionism, 138
 Irvine, A., 126, 276nn.4/14
- James, W., 180
- Kant, I., 116, 158, 161, 196, 203
 Kemeny, J.G., 130
 Kessler, G., 103, 127, 266
 Keynes, J.M., 255
 Kitcher, P., 125–6, 213
 Kline, M., 160
 Kneale, M., 204
 Königsberg bridges, 48–9, 96, 149,
 215, 225
 Körner, S., 125

- Lehrer Dive, L., 269, 286
 Lewis, D., 40, 60, 110, 236, 239
 local and global structure, 55, 78–9,
 88, 183
 logic, non-deductive, 241–3, 254–7
 logic, role in mathematics, 57–8, 97–8
 logical positivism, 199
 logicism, 105, 124, 198–9, 220

 Maddy, P., 42–3, 125, 174
 mathematics
 as science of quantity, 1–2, 6, 31–2
 as science of structure, 31–2,
 48–50, 56
 discrete, 130–1
 elementary, 32, 34
 higher, 32, 34, 48–54
 measurement theory, 45–6, 113–14
 mental beings, 236
 mereology, 38, 40–1, 57–60
 Michell, J., 113–14, 127
 Mill, J.S., 123–5
 modal structuralism, 117
 modelling, mathematical, and
 simulation, 88–9, 98–100, 120,
 132, 189, 225–9
 Moore, A.W., 138
 Mortensen, C., 127
 Mundy, B., 24

 necessity of mathematical truths
 applied to reality, 28, 67–73, 92,
 95–6
 negative numbers, 230–2
 Nerlich, G., 157–8
 Newstead, A., 271n.36, 277n.20,
 278n.40, 290n.15
 Newton, I., 45, 123, 157
 Noether, E., 51
 nominalism, 12–13, 106–8
 number, 36–8
 see also complex numbers, negative
 numbers, zero
 number theory, 135, 202, 208, 218

 operations research, 83–4
 order structures, 45–6, 50, 63

 Pappus's Theorem, 148

 Pargetter, R., 127
 Parsons, C., 116
 Pascal, B., 38, 162
 Pasch, M., 149
 pattern recognition, 84, 167–9, 176–7
 Peano's axioms, 59, 112, 195–6, 201
 Peirce, C.S., 63
 perception of mathematical
 properties, 18–19, 124–5, 173–9
 Piaget, J., 175, 270n.12
 Pigden, C., 115
 Pincock, C., 222–3, 228, 269, 272
 Plato, 39, 116, 263, 278
 Platonism, 13–14, 26–8, 33, 50, 101–2,
 110, 116, 166, 222, 263
 Platonist-nominalist false dichotomy,
 14–15, 101, 104–6, 128, 187
 plural quantification, 58
 Poincaré, H., 51, 219
 Polya, G., 242, 249, 255, 259
 probability of conjectures, *see logic*,
 non-deductive
 Proclus, 190, 213
 proof, 94, 160, 185–6, 192–6
 proportion, *see ratio*
 Putnam, H., 114, 199
 Pythagoras, 44

 quantities, intensive and extensive,
 35–6
 quantity
 definition of, 45–6
 multidimensional, 143–4
 relation to structure, 63–6
 see also mathematics as science
 of quantity; discrete quantity,
 continuous quantity
 quantum mechanics, 131, 233
 Quine, W., 114, 125, 137

 ratio, 6, 24, 34–5, 64, 114, 232, 238
 relations, reality of, 2, 15–16,
 77, 79
 relativity theory, 147, 159
 Resnik, M., 33, 50, 119
 Riemann, B., 143–4, 245, 248
 Riemann Hypothesis, evidence for,
 245–50
 Rosen, G., 105–6

- Russell, B., 16, 58, 75, 124, 144–5, 160, 199, 204
 Russell's Paradox, 135–6
- Saatsi, J., 223
- scholasticism, 139, 144, 189, 230, 236, 297n.31
- Schrödinger, E., 131
- semi-Platonism, *see* Aristotelian realism
- sets, 16–17, 38–43, 110–1, 129, 138
- set-theoretical constructions, 59, 62, 109–10
- Shapiro, S., 21, 27, 33, 38, 50, 56–7, 119–21
- Simons, P., 40
- Singer, P., 198
- sortal property, *see* unit-making property
- space, 131, 146–7, 150–4, 155–60
- statistics, 84
- Steiner, M., 213
- structural stability of models, 100, 228
- structure, 16, 48–51, 54
 definition of, 57–9
 perception of, 176, 179
 relation to quantity, 63–6
see also mathematics as science of structure
- Suárez, F., 144
- subitization, 174
- symmetry, 6, 49, 70–1, 177, 199–200
- theoretical juice extractor, 77
- tiling, 68, 72
- time, 153
- topology, 49, 61, 283nn.15/17
- ultrafinitism, 112
- understanding, 20, 188–91, 200, 209, 214, 217
- uninstantiated universals, *see* universals
- unit-making properties, 16, 36–7, 41–2, 58, 64, 103, 127
- universals
 instantiated, *see* Aristotelian realism
 uninstantiated, 21–9, 181, 204, 226, 239
- vectors, 46, 128, 142, 155–6
- visualization, 181–7, 196
- von Neumann, J., 90
- Wiener, N., 90
- Wigner, E., 125, 233
- Wilf, H., 212
- Wilholt, T., 126
- Zeno of Sidon, 162
- Zeno's paradoxes, 134
- Zermelo, E., 129, 201–3, 239
- zero, 234–8